

JULY 1924

RADIO AGE

The Magazine of the Hour

WITH WHICH IS COMBINED

Radio Topics

In This Issue

A Portable Tuned Impedance Reflex.

Latest Developments of the Wizard Circuit.

By John B. Rathbun.

Short Wave Transmission and Reception.

Vacuum Tube Efficiency.

Announcing a Radio Favorite Popularity Contest.

Hints for Summer Radio.

Radio Age and Radio Topics Features, Pictures and Latest Diagrams.

Radio in Other Lands.

Corrected List of Broadcasting Stations.



Let Our Hook-ups Be Your Guide

Price
25
Cents

MANHATTAN

ELECTRICAL SUPPLY CO., INC.

MAKERS OF THE FAMOUS



MANHATTAN
The Loud Speaker with
Concert Modulator

*The Manhattan Loud Speaker
with its "concert modulator"
gives real tone quality.*

MANHATTAN

LOUD SPEAKER
AND



RED SEAL
PHONOGRAPH
ATTACHMENT

Oldest and Largest Distributors of



114 SO. WELLS ST., CHICAGO

NEW YORK

ST. LOUIS

SAN FRANCISCO

ZENITH

TRADE MARK

Radio Companion

A six-tube set completely self-contained! No need to open case to operate
No exterior loop or antenna required

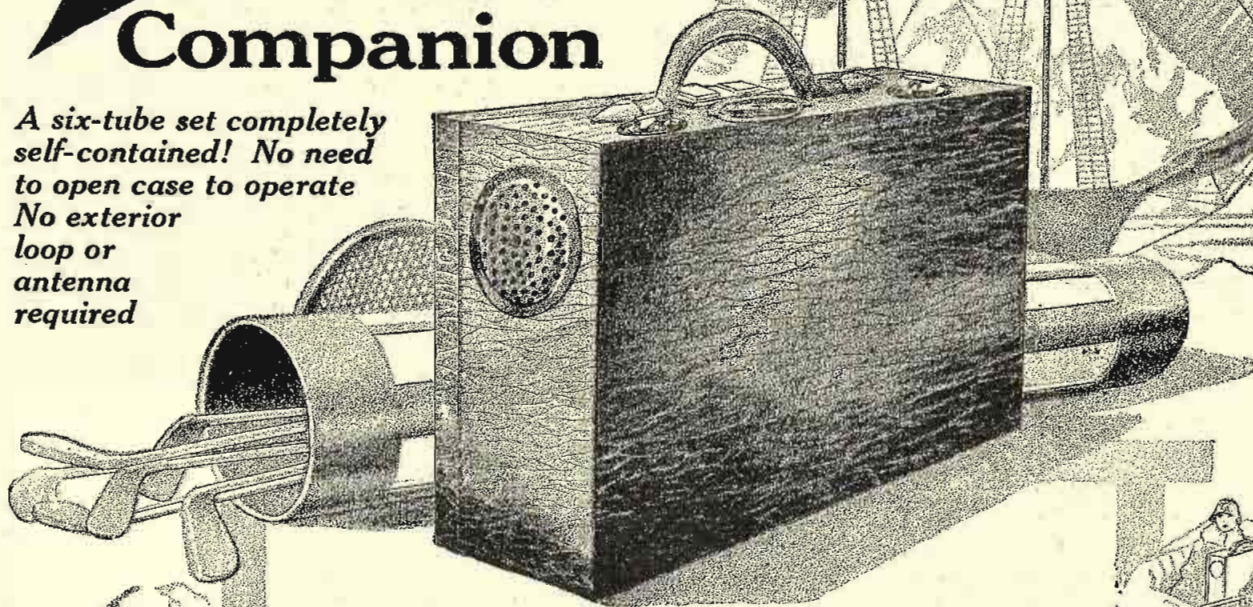

Zenith — MacMillan's Choice Encased in a Light Traveling Bag!

Here's a six-tube radio set that's entirely self-contained—tubes, "A" batteries, "B" batteries, loud speaker and loop antenna complete, and it's a *Zenith!*

Packed into a small, beautifully finished traveling case—much smaller than the average suitcase—this new Zenith is the most compact set ever made giving clarity, quality, volume and distance.

Do you see those two little buttons close to the handle? Those are the controls. In order to operate the new Zenith Radio Companion you simply turn the controls to bring in the station you want—then for maximum volume you swing the case so that the loop is facing that particular station. You will be astonished at the clearness with which the music and the voices come through—and in what volume!

Think what it would mean to you to be able to take one of these new Zeniths with you on your travels and outings. A real radio set—the exclusive choice of Donald B. MacMillan for his Arctic expedition—yet so compact that it takes up no more space than a light traveling bag!

Think of the fun you could have with this set—the dance music you could listen to on moonlit nights—the orchestras that would play for you as you and your pals gathered round the camp fire—the com-

panionship it could give you on your motor parties—at the bathing beach. Picture the enjoyment it could bring your guests at the house-party or the week-end gathering.

Again, think how such a set would while away a lonesome evening in that dreary out-of-town hotel—what a god-send it would be to that invalid mother—to that dear relative or friend who must spend weeks and months in the hospital!

But if you have already been initiated into the wonders of the Zenith, you don't need to be told the extraordinary use you could get from this new model or the fun it could give you.

Just the knowledge that you could pick up this beautifully finished case—even as you would pick up your hand bag—and take it with you across city, country, lakes, mountains, and *still* turn those two controls and be able to listen at a moment's notice to the world you have left behind—that thought alone should be enough to suggest the infinite delights provided by this new Zenith Radio Companion.

You will want to know more of this remarkable set—so light and compact, so easy to operate, so wonderfully convenient. You will want to see it for yourself, at the very earliest moment. No ear-phones, you understand. No outside antenna. Yet clarity, volume, quality, distance! A real Zenith, packed into a traveling case!

Your name and address on the coupon, and the coupon placed in the mail, will bring you full particulars.

Listening, with the keenest pleasure, to music and voices in the cities they have left behind!

Lively orchestras entertain these boys, miles and miles from civilization.

Receiving the latest market reports, the latest news developments, with the aid of the Zenith Radio Companion.

The height of luxury—motoring to music!

When three is company at the bathing beach.

A constant source of entertainment and delight to the invalid.

Zenith Radio Corporation
 McCormick Building
 Chicago, Illinois

ZENITH RADIO CORPORATION,
 Dept. 3-F, 328 S. Michigan Ave., Chicago, Ill.

Gentlemen:

Please send me illustrated literature on Zenith Radio, including full particulars of the new Zenith Radio Companion.

Name.....

Address.....

RADIO AGE

The Magazine of the Hour
Established March, 1922

WITH WHICH IS COMBINED

Radio Topics

Volume 3

JULY, 1924

Number 7

CONTENTS

	Page
A Portable Tuned Impedance Reflex.....	5
By John B. Rathbun	
"Radio Age" Buys "Radio Topics".....	9
Short Wave Transmission and Reception.....	11
By Frank D. Pearne	
Operating the Detector Tube by Grid Bias.....	13
By Brainard Foote	
No "Summer Slump" Found in Radio.....	15
Getting the Most Out of Your Vacuum Tubes.....	17
By Felix Anderson	
Radio World's Fair Approaches.....	19
The Station That Happiness Built and Other Broadcasting Features.....	20, 21
A Radio Favorite Popularity Contest.....	22
A Three Tube Wizard Circuit.....	23
By John B. Rathbun	
Recharging Storage Batteries from a 32-Volt Lighting System.....	25
Radio in Other Lands—a New Department.....	28, 29
Radiotorials.....	31
Pickups and Hookups by Our Readers.....	32
Radio Age Data Sheets.....	31, 39
The Troubleshooter Section for Fans.....	46
Corrected List of Broadcasting Stations.....	50
With the Manufacturers.....	55, 56

Radio Age is published monthly by
RADIO AGE, Inc.

Advertising, Editorial and Publication Offices,
520 N. Dearborn St., Chicago

FREDERICK A. SMITH, *Editor*
RUSSELL H. HOPKINS, *Associate Editor*
FRANK D. PEARNE, *Technical Editor*
FELIX ANDERSON, *Technical Assistant*
LOUIS L. LEVY, *Circulation Manager*
M. B. SMITH, *Business Manager*

Advertising Manager
HARRY A. ACKERBURG

Eastern Representatives
DAVIDSON & HEVEY
17 West 42nd Street, New York City
Telephone, Longacre 1698

Advertising forms close on the 10th of the month
preceding date of issue

Applicants for membership in A. B. C.

Issued monthly. Vol. 3, No. 7. Subscription price, \$2.50 a year.

Entered as second-class matter April 4, 1924, at the post office at Chicago,
Illinois, under the act of March 3, 1879.

Copyright, 1924, by RADIO AGE, Inc.

A Chat With the Editor

THE EDITOR takes this opportunity to welcome into the big RADIO AGE family the many other thousands of readers who are with us this month because of our purchase of the magazine, RADIO TOPICS.

We wish to assure our new readers that the same editorial policies which have made RADIO AGE one of the most popular of practical radio periodicals will be followed carefully. We believe that our method of printing only the best of constructional data and plenty of it will result in continued prosperity and growth.

Our magazine has again occupied larger quarters and has increased its organization in both the business and editorial departments. Russell H. Hopkins, an efficient and experienced magazine man, becomes Associate Editor, and Harry A. Ackereburg is advertising manager.

For both of them we bespeak your good will with the assurance that they will extend to you the most willing co-operation.

Radio as an industry is to step forth into a new era during the coming ninety days. Improvements in apparatus and more stable conditions of manufacture and sale will place the business on a higher plane.

Immense numbers of new enthusiasts are getting into radio daily. To all these recruits and to our loyal followers of the last two years we suggest that you do not fail to read each issue. New features for RADIO AGE are in process of development, to the end that the magazine shall live up to its sub-title, "The Magazine of the Hour."

The next few issues especially should be watched closely, for when plans now under way are fully developed, RADIO AGE will be bigger, better and more of a necessity to the conscientious radio fan than ever before.

Frederick Smith

—Editor, RADIO AGE

The GREBE TAPERED GRIP DIAL

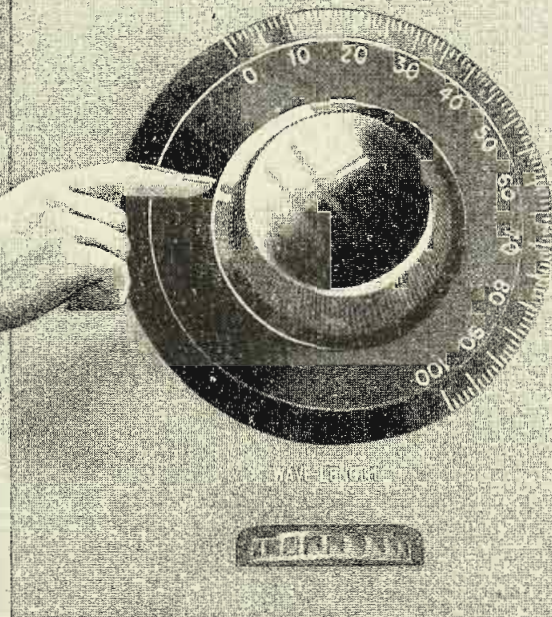

TRADE MARK
REG. U.S. PAT. OFF.

"A slight deviation leads to a great error."

— Confucius

In tuning in the distant stations there must be unflinching precision. The Grebe Tapered Grip Dial gives that precision.

Doctor Mu

THE first tuning dials were ungainly in appearance and crude in performance. Some years ago this company perfected the Tapered Grip Dial, moulded from lustrous black bakelite, that has since become standard equipment on all Grebe Receivers.

This and other details of Grebe craftsmanship are fully protected by patents granted and pending.

Ask your Dealer or write us

A. H. GREBE & CO., INC.

Van Wyck Blvd. - Richmond Hill, N. Y.

Western Branch: 451 E. 3rd St., Los Angeles, Calif.

Grebe Regenerative Receivers are licensed under Armstrong U. S. Pat. No. 1,113,149, Oct. 6, 1914

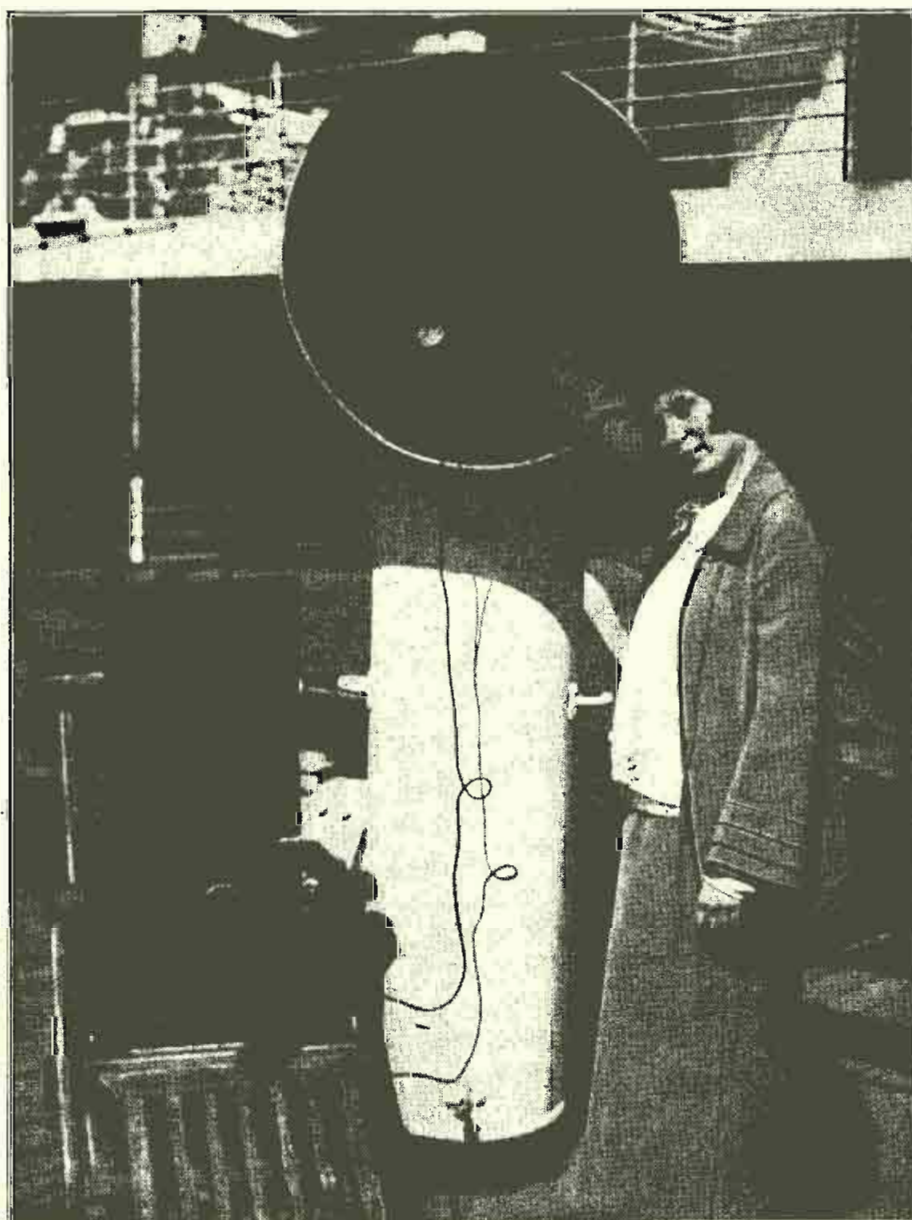

From Foto Topics.

THE LOUDEST OF ALL LOUD SPEAKERS

And a permanent one, too! Ethel Hirsch, a traveler on board the S. S. California, enjoyed a concert on her portable so well that she wanted her fellow voyagers to share it. So she dropped the ear phones into a giant ventilator on the ship. Immediately passengers on the entire deck could hear the concert in clear, forceful tones. Try it the next time you travel o'er the brine.

RADIO AGE

The Magazine of the Hour

M. B. Smith
Business Manager

A Monthly Publication
Devoted to Practical
Radio

Frederick A. Smith
Editor

A Portable Tuned Impedance Reflex

By JOHN B. BATHBUN

LAST Summer, when the portability craze was at its height, the writer did a considerable amount of experimenting with circuits which were primarily designed for compactness, and among these circuits were several reflex types. At first the reflex principle made an appeal to me because of the dual role played by the tube, but after playing with these circuits for some time I learned that the conventional form of reflex seldom lived up to expectations because of certain losses which took place in the radio frequency phase. Beautiful in theory but particularly "punk" in practice, was the conclusion arrived at after Experiment No. 5 had been filed away in the archives.

In the first place, I never succeeded in attaining any great degree of radio frequency amplification when the conventional untuned short wave transformers were used, and as regeneration in the true sense was impossible with these circuits, there was much left to be desired in the way of distance reception. Again, the tubes which gave excellent results in amplifying radio frequency currents gave but poor amplification in the audio phase, and so on through all of the usual troubles met with when radio frequency is used.

Only One Peak

Theoretically, a single tube reflex with a crystal detector gives one stage of radio amplification, one stage of audio amplification, and rectification or detection. Practically, the full benefit of this dual action is never realized when an untuned radio transformer is used as a coupling for the reason that there is only one single wave length on which the transformer gives peak amplification, and this peak is not so very high at that. The circuit is never perfectly tuned in and this results in much less volume and range than we would expect at first glance. It is imperative that we have perfect tuning both in the tube and detector circuits if we are to obtain maximum results in regard to distance, volume and selectivity.

With an untuned detector circuit we must depend entirely upon the condenser and tuning inductance in the first stage for selectivity, and when we are in the vicinity of a powerful broadcasting station this single control alone is not sufficient.

With this idea in view, I next tried a reflex circuit in which tuned air core transformers of the neutrodyne type were used, the secondary of the transformer being tuned in the usual way with a 23 plate condenser. This was a very decided improvement and the volume and selectivity became at least 50 per cent better than before as the entire circuit was now tuned to the incoming frequency with a sharp amplification peak at the transformer output. However, there was still one fault remaining and this was the regeneration and partial rectification that still took

on there was no further difficulty with free oscillations and the audio amplification was tremendously increased. In fact, the latter was great enough to operate a loud speaker with enough volume to hear it in every room of a large five-room apartment. A 1000-watt station, two blocks away, could be tuned out "cold" with very little loss in volume. The transformer used was a typical neutrodyne transformer with 15 turns on the primary and 65 turns on the secondary.

Transformer Takes Space

Still there was much to be desired in the set even though the tuned transformer gave far better results than the usual untuned type. The neutrodyne transformer took up a great deal of valuable space and at times there was a considerable display of body capacity which most certainly was not desirable. At one time it seemed that I had reached the end of the line and that my carefully developed reflex circuits were only partial successes at the best. At no time was the volume of the tube doubled as it should have been, according to the principles of the circuit, and the distance received was only comparable to a rather indifferent regenerative circuit.

About this time I had an opportunity to use a well-known factory-made radio frequency set that employed tuned impedance coupling instead of transformers, and the excellent performance of this little set at once opened the question as to whether tuned impedance could not also be employed with profit on a reflex set. This was tried some days after with most gratifying results and the circuit is shown in diagrammatic form by *Fig. 1*. The radio frequency transformer is eliminated but the audio transformer (AT) is still used as before.

Starting at the left of *Fig. 1* we have the familiar fixed coupler (FC) which was used in both the "Baby Heterodyne" and the "Wizard" circuit described in past issue of RADIO AGE. The primary coil (L1) has 28 turns of No. 24 wire while the secondary coil contains 60 turns of the same size wire. Both coils are wound on a three inch tube according to the details given in the March issue of this magazine. For very long aerials it is likely that better results will be had on low wave lengths if a few turns are removed from the secondary coil (L2), while with short aerials

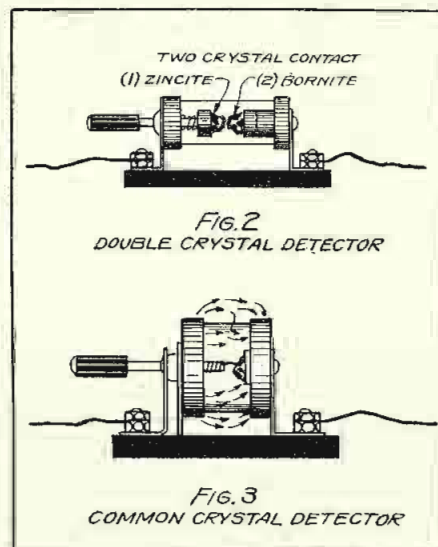

place through the grid-plate capacity of the tube. The inductance of the transformer primary in the plate circuit was sufficient to cause oscillations in the circuit even when the primary coil was reduced to as low as 12 turns. That the tube acted to a limited degree as a detector could be easily proved by lifting the cat's whisker off the crystal and at which time signals could still be heard with fair volume.

It now occurred to me that these oscillations could be suppressed and at the same time that the audio amplification could be increased by giving a negative bias to the grid of the tube by means of a small flashlight battery placed in the grid circuit. Trial immediately proved the worth of this theory and from this time

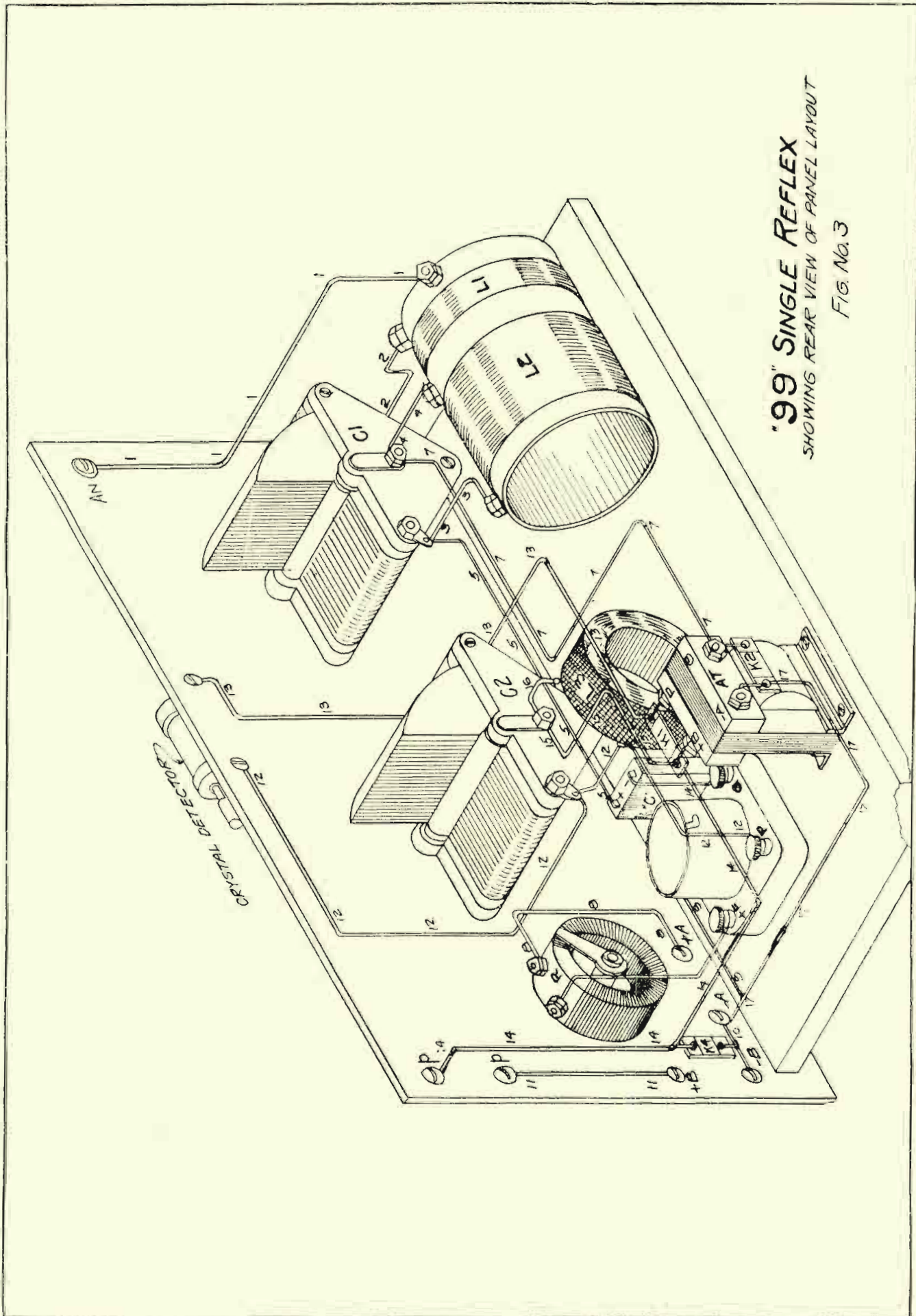

'99" SINGLE REFLEX
 SHOWING REAR VIEW OF PANEL LAYOUT
 FIG. No. 3

It may be necessary to add a few turns to (L2) in order to get the higher wave lengths. This sort of coupler, when once properly adjusted, eliminates the taps and many controls necessary with the ordinary variocoupler and as a rule gives sharper tuning with less loss. The secondary coil is tuned to wave length by the (0.0005mf) variable condenser (C1).

35-Turn Honeycomb Good

A 50 turn honeycomb coil (L3) forms the plate impedance coupling and is tuned to wave length by the second 0.0005mf variable condenser (C2). The use of the two condensers (C1) and (C2) in combination with their inductances makes tuning very sharp and selective. Don't be attached to the idea that only a 50 turn honeycomb will suffice at this point, for with many aerials a 35 turn honeycomb will give just as good results. In case that a honeycomb is not available, then about 40 turns of No. 26 D.C.C. wire on a three inch pasteboard tube, or 35 turns on a four inch tube will do just as well. The use of a four inch tube permits of the condenser (C2) being placed inside of the tube.

This circuit requires a hard amplifying tube such as the UV-201A, C-301A, UV-199 or the C-299. Soft detector tubes like the UV-200 or C-300 cannot be used owing to the high plate voltages that must be carried. Very good results can be obtained with the UV-199 or C-299, and as this is to be used principally as a portable set it is very desirable that these tubes be used. The WD-11 or WD-12 are not good as radio frequency amplifiers and should not be used, although the low voltage demanded by these tubes makes them very tempting for use on a portable receiver. It has been found by experiment that a "B" battery voltage of 67.5 volts gives the maximum results and that 90 volts gives but little improvement. A considerable degree of audio amplification is had with 45 volts but a higher voltage is desirable.

At "C" in the grid circuit of the tube we have a three cell, 4.5 volt flashlight battery with its negative pole to the grid of the tube. This gives the grid a negative bias, and as before explained, reduces the tendency toward free oscillations and greatly increases the volume of the audio stage. No grid leak nor detector is used as the tube acts only as an amplifier.

The Crystal Detector

Now we arrive at one of the most important parts of the circuit—the crystal detector at (CD). This is in series with the plate, primary coil of the audio transformer (AT) and the "B" battery. Impulses from the plate pass through the crystal, are rectified, and then pass to the audio transformer where they are increased in voltage at the grid of the tube by the step-up ratio of the transformer (AT). The tuned impedance (L3) is connected to the input side of the crystal and to the plate in such a way that the radio frequency pulsations are forced to the crystal and yet cannot short circuit to the "B" battery because of the inductive reactance of the coil. This coil, however, allows the direct current from the "B" battery to flow freely to the plate, but will

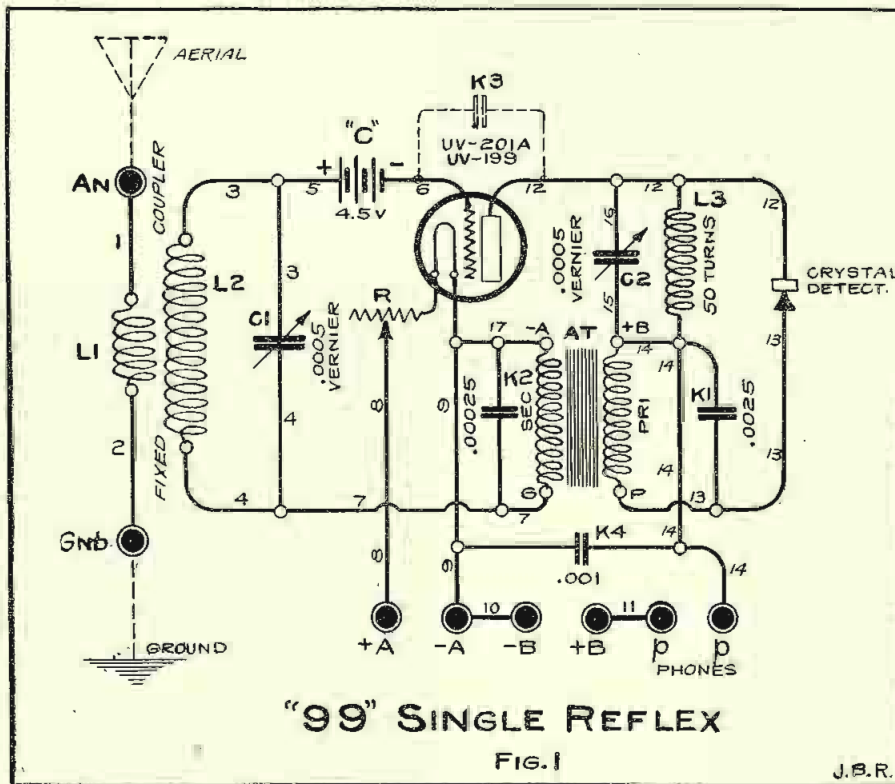

not permit of oscillating current flow in the opposite direction.

There are many crystals or minerals which will operate satisfactorily at this point and there are others which will hardly give audible signals. Galena is a poor mineral to use as it does not stand up under the heavy plate current, and the same is true of pyrites. Of all the simple crystals used, the best all around results were had with a silicon crystal combined with a silver or gold catwhisker. The silicon crystal can be used in the ordinary detector stands and seems to improve with use. The silver or gold catwhisker does not corrode nor oxidize and seems more stable in operation than the copper or bronze wire.

Best of all the crystals tried is the two crystal type in which one crystal acts in the usual capacity while the second crystal is used as a catwhisker in contact with the first. The particular make of two crystal stand which gave very satisfactory service was the "Harco," the general design of which is shown in Fig. 2. The signal strength was comparatively high and the adjustment was very stable so that there was little tendency toward getting out of adjustment through vibration, and the crystals were not microphonic.

It was discovered in these experiments that the design of the crystal detector stand has much to do with the efficiency of the circuit, and that certain stands gave much better results than others even when the same crystal was used in either of the holders. Crystal detector stands having large diameter end, placed close together, gave very poor results regardless of the crystal used. An example of the type of stand to avoid is shown in Fig. 3 where the end caps (m) are large in diameter and close together, thus giving a very pronounced condenser effect which practically short circuits 50 per cent of the radio cur-

rent which should pass through the crystal. Fully half the current jumps across from one end plate to the other without going through the crystal at all. The detector of Fig. 2 suffers very little loss from this effect as the plates are well apart and of small presented area.

For Inherent Capacities

There is another stunt that may or may not improve the volume of the reception according to the design of the crystal detector stand. This is the deliberate addition of capacity across the crystal as shown by the dotted lines at (K3), to be used only with detector stands which have a very small inherent capacity. Properly proportioned, this condenser will act as a small reservoir for the waves and will prevent the flow of the reverse waves that ordinarily takes place to a small extent through all simple crystals. It is a commonly accepted idea that the crystals allow the waves to flow through the contact only in a single direction, but this is not exactly true, as there is always a small amount of leakage of the reverse waves. The small condenser, if of exactly the proper capacity, will effectively stop this leakage and will correspondingly improve the rectification. With the detectors experimented with, the capacity of this fixed condenser varied between the limits of 0.00015 and 0.00035 mf.

While almost any good audio transformer (AT) can be used in this circuit with success, I had the best results with the small "Hedgehog" transformer which at one time proved both effective and economical. As regards tone, the five to one ratio is slightly the best but the ten to one ratio gave greater amplification without introducing much distortion. For a portable set, such as we are describing, the "Hedgehogs" are ideal as they occupy only one-quarter the space volume demanded

by the more conventional types. It would seem that the very small volume of iron contained in the core of these transformers reduces the core losses to a minimum and hence the transformer is much more sensitive than those large types which contain about a quarter pound of sheet laminations.

Next we come to the subject of the fixed bypass condensers which in many circuits are considered as being so essential to the proper functioning of the circuit. Usually these fixed condensers (K1) and (K2) are shown connected across both the primary and secondary coils of the audio transformers for bypassing the radio frequency current around the high inductance of the transformer windings. While theoretically such condensers are necessary to prevent choking back the flow of the radio frequency current, yet in practice this is not always necessary or desirable, since the distributed capacity of the secondary windings of the secondary coil is usually sufficient to bypass the R.F. without the further addition of a fixed condenser. The use of (K1) and (K2) can be determined by experiment, and if the circuit works without them they should be omitted. At any rate, the circuit is not critical to the capacity of the condensers and almost anything between 0.0005 and 0.0025 will operate. Condenser K4 is always advisable.

Size of the Panel

The minimum size of panel which it is desirable to use is 6x10" x 3-16 inches, but if ease in wiring up is to be considered, a 7x14x3-16 inch panel is advised. It is quite difficult to get at some of the connections for soldering on the smaller panel, but of course it can be done if one has the patience.

The isometric view of the completed set is shown by Fig. 3 where the relative location of the parts can be clearly seen. The wires in this view are numbered to correspond with the numbers on the wiring diagram of Fig. 1, but as some of the wires are necessarily hidden behind the parts in the isometric, it is best to follow the wiring connections of Fig. 1 or at least check up the connections by this diagram. While isometric views are very useful in showing the general arrangement of the apparatus and the location of the longer runs of wire, yet they often lead to discussions when they are used for making connections.

Preliminary tuning to wave length is performed by the secondary condenser (C1) while condenser (C2) adjusts the tube output frequency so that the radio frequency current will not short circuit through the "B" battery. These two controls combined give a high degree of selectivity, and powerful local stations which would ordinarily leak past the fixed coupler and condenser (C1) are met with a second check by the coil (L3) and condenser (C2). Still further, the crystal detector itself has a decided effect on selectivity, so that we have at least three adjustments which tend to filter out undesired stations.

Operation No. 4 consists of adjusting the crystal to its most sensitive point by

moving the handle of the detector around until the movable contact comes into contact with a good "hot spot." This is more easily done on this set than with the ordinary plain crystal set for the reason that the radio waves acting upon the crystal are given a preliminary amplification by the tube, and secondly for the reason that the receiver will shriek or howl if the crystal is off the hot spot.

Just at this point I would like to mention that the crystal detector is an indicator of free oscillations in the tube or can be made to show whether the tube is acting properly as an amplifier or improperly as a detector. If the circuit is not bal-



Photo from Intl.

CARDINAL BROADCASTS

Patrick Cardinal Hayes of New York City is shown above at the microphone of Station WEAJ broadcasting his first public message on his return from Rome. The broadcast was arranged through the Catholic Charities.

anced properly or if the "C" battery is not giving the proper negative bias to the grid of the tube, then the tube will act as a detector in a plain regenerative circuit and there will be no audio amplification. If the tube is oscillating, the crystal will not be effective and the set will operate equally well with the cat's whisker on or off of the crystal. Under these conditions, the set will operate at a fair volume without the crystal in circuit at all. When the tube is acting properly as an amplifier, there will be a terrific howl in the phones the instant that the catwhisker is lifted off the crystal. This is a sure test for free oscillations, and if good volume

is expected, try the "howl test" by lifting the catwhisker.

Save Filament Current

With the crystal properly adjusted as above, next turn the dial of (C1) to about the middle of the scale, and then rock (C2) back and forth very slowly until a signal or voice is heard. Now readjust (C1) until the signal is at a maximum, and adjust the rheostat until the filament temperature is proper for the greatest signal strength. If the first trial does not result in getting a station, move (C1) slightly and repeat the (C2) adjustments and rheostat until a station is heard. After the station is brought in at its best value by the above means, readjust the crystal detector. Some little experience will be required before you can cause the set to deliver its full volume. Never turn the tube rheostat too far as this tends to cause howling and uses an unnecessary amount of filament current.

A fixed type of crystal detector is convenient because no adjustment is necessary, but on the other hand the maximum volume can never be obtained from such a crystal on all wave lengths. A crystal detector is sensitive to variations in wave lengths, so sensitive, in fact, that a station can often be tuned in and out with a crystal adjustment alone. Hence, if we are to have maximum volume and selectivity, we must have adjustment in the crystal. This adjustment is not so difficult as with the simple crystal set, and is very easily handled when one is accustomed to a crystal and knows where to find the hot spots.

In operating this circuit it should be remembered that it is exceedingly selective and that the condenser tuning adjustments must be very carefully made to bring in a station. For this reason vernier condensers are an absolute necessity since an eighth turn of the vernier is often sufficient to bring in a station and then to knock it out completely. Fortunately the dials can be logged for different wave lengths just as with a neutrodyne, and when a station is brought in, the condenser settings should be recorded in a memorandum book so that the station can again be brought in by returning the dials to the proper positions.

Best Aerial 60-75 Feet

Now we come to the question of the aerial. For the best results this should be from 60 feet to 75 feet long. If the aerial is much shorter than this, it will be difficult to bring in distant stations and the signals will be weak on local. If much longer than 75 feet we will lose selectivity and the set will be noisy due to the greater embrace of atmospherics.

This is mentioned here for the reason that we have had reports from our readers on aerial lengths ranging from 10 feet to 400 feet, and of course no circuit will work properly at either of these extremes. Fair results, about 60 per cent of the results obtained with an outdoor aerial, can be had with an indoor aerial of about 40 in length. On local stations, not more distant than 50 miles, such aeriels deliver a fair volume but are deficient in regard to distance.

"Radio Age" Buys "Radio Topics"

WITH this issue RADIO AGE, "The Magazine of the Hour," takes over "RADIO TOPICS," formerly published by the Topics Publishing Company in Oak Park, Ill.

Henceforth the combined publications will be known as RADIO AGE, with which is combined RADIO TOPICS. Editorial, publication and advertising offices will be located at 500 N. Dearborn St., Chicago, the main offices of RADIO AGE.

The staff of RADIO AGE will hereafter be in charge of all editorial and advertising matter formerly used by RADIO TOPICS. Efforts are being made beginning with this issue to combine the best features of both magazines into one bigger and better RADIO AGE.

Readers of RADIO AGE will notice many new features on scanning the July issue, while TOPICS readers will find several departments of RADIO TOPICS incorporated in this issue, in addition to the regular RADIO AGE features.

Subscribers to RADIO TOPICS will receive the new RADIO AGE as usual, with no extra charge for the combined

features. Advertisers will be given the same considerate service in the hope that readers of both publications will be united into one big happy family. No effort will be spared to turn out the most authoritative and valuable technical articles in future issues of RADIO AGE, and interesting features, liberally illustrated with up-to-the minute pictures and drawings, will attract the lay reader.

Technical inquiries sent to RADIO TOPICS during the past few weeks have been turned over to RADIO AGE and answered with the technical efficiency that has made RADIO AGE a by-word for dependability during the past few years. All other correspondence will be taken care of faithfully and carefully, with the full co-operation of the former editors and publishers of RADIO TOPICS.

RADIO TOPICS readers are urgently asked to correspond with the combined magazines and to take advantage of the many opportunities and services rendered readers without any charge. Criticism and comment are more than welcome at any time.

RADIO AGE, with which is combined

RADIO TOPICS, has entered a new era in the radio field. Each issue will surpass the preceding one in every classification, and it is our earnest prediction that before the end of this year RADIO AGE will be the leader in its field and the recognized authority on radio throughout the world.

Attention of both RADIO AGE and RADIO TOPICS readers is called to the RADIO AGE INSTITUTE announcement on page 51 of this issue. The INSTITUTE is a TOPICS feature which we hope will be of particular benefit to amateur experimenters and manufacturers who want RADIO AGE'S technical O. K. on their radio sets and parts.

The results of important INSTITUTE tests will be published from time to time in RADIO AGE.

The "Radio Favorite Popularity Contest" announced on page 22 should be welcomed by the hundreds of "fans" who want to give their favorite radio announcer or entertainer a boost.

Here's hoping!



MAKING IT A RADIO SUMMER

Kadel & Herbert.

Hardly a camping trip this Summer will be complete without its radio equipment. No matter how far you go, you can't be so far that your radio won't reach a broadcasting station. Here "father and son" are shown whiling away a dull afternoon by tuning in the distant city on their reliable portable set.

Short Wave Transmission and Reception

By FRANK D. PEARNE

A FEW years ago, if anyone had ventured the prediction that the year 1924 would find the air so full of broadcast waves that there would be so much interference as to make good clear reception of any particular station hard to obtain, he would have been the laughing stock of the community.

But the then inconceivable troubles of the broadcast listener of today have come to pass, and unless something is done to improve these conditions, it is not very hard to see what the result will be. The United States Government, in an effort to prevent just such a chaotic condition, has allotted certain wave lengths to certain districts in order that one district will be able to tune in on stations located in other districts, while local broadcasting is carried on.

But the ever increasing number of stations has reached the point where all the allotted waves have been used up, and it is necessary in large cities such as Chicago and New York to double up; that is, several stations must use the same wave length with a consequent division of time. If such is the case at the present time, what are we to expect in the coming years? Recent experiments conducted by the Westinghouse engineers and the General Electric Company have proven conclusively that the heretofore supposed useless waveband below 150 meters may be the solution of the problem. Low wave broadcasting is no longer an experiment, but is an accomplished fact, and has proved to be one of the greatest improvements in the science of radio transmission and reception.

In 1920, KDKA, the first broadcasting station in the world, was opened at Pittsburgh. From that time on, broadcast stations sprung up all over the country. In the month of November, 1923, station KFKX was installed at Hastings, Nebraska, by the Westinghouse Manufacturing Company and operated as a relay station, by means of which programs broadcast at Pittsburgh on waves of approximately 100 meters were picked up and rebroadcast at 341 meters, thus making it possible for broadcast listeners in the far West to receive these programs just as well as those located in the East. This broadcasting at Pittsburgh takes place at the same time they broadcast their regular program on 326 meters.

Another relay station, KBPM, was opened at Cleveland, Ohio, and the most surprising thing is the fact that station KDKA is now furnishing programs to the British company in England on these low waves which are picked up by special receivers and repeated on longer wave lengths for the benefit of listeners in Great Britain and Continental Europe. Thus the people of Great Britain, France, Germany, Belgium and the Scandinavian countries are now enjoying the benefits of programs given in this country.

The progress of the experiments which

made this type of broadcasting possible is rather interesting. First, a short wave station was built on the roof of station KDKA, from which waves of approximately 100 meters were transmitted to a few receiving stations located in and around Pittsburgh. Then came the receiver at Cleveland where the short waves were repeated by station KDPM. Next, between Pittsburgh and Springfield, Mass. These experiments being satisfactory, short wave receivers were installed in twenty cities in the homes of amateurs. All reported that reception on short waves was excellent and that there were none of the drawbacks to broadcast reception found in the longer waves we are using today.

These tests proved that high frequencies (low wave lengths) go much farther with the same power input than ordinary broadcast waves. Daylight has little or no effect upon their carrying power.

These two facts alone are enough to predict a change in broadcasting in the near future. Station WGY of the General Electric Company at Schenectady, N. Y., also has been doing some good work in the development of short wave broadcasting. They, too, have reached distances never before reached with the longer waves. From this station signals are transmitted on 107 meters so clearly and with such volume that it has been found quite possible to rebroadcast them 3000 miles away. Several times all eight of the British Broadcasting Company sta-

tions received and relayed WGY'S programs.

On one occasion an entire program from the Wanamaker Auditorium in New York was carried by wire to WGY, where it was put on the air at 107 meters and also on 380 meters. The short waves were picked up and relayed by the British stations, where they were reproduced as clearly as though they were played in London. These short wave signals are constantly heard in Los Angeles on a loud speaker and a two tube set, even when it was still daylight over half of the distance.

Amateurs located in Chicago, who are equipped with short and long wave receivers, say that when KDKA is broadcasting on both 104 and 345 meters, the reception on the short wave set is more than twice the volume of that on the longer wave.

Now, summing up the advantages of the short wave over the longer, we find that such reception is almost entirely free from static, even in the hottest weather, and will travel in daylight practically as well as by night. Greater distances can be covered with the same power, and, last but not least, the wave length is so far below the ordinary broadcast range that they may vary from 75 to 150 meters without any interference from any of the standard allotted waves. Very short aeriels are required for both transmitting and receiving, the maximum length being a little over thirty-five feet. The greatest difficulty in this type of broadcasting seems to be in keeping the frequency constant. The frequency of a 100 meter wave is 3,000,000 cycles, and in order to keep it constant, the aerial must be so constructed that it will not swing in the wind, for this will change the frequency,

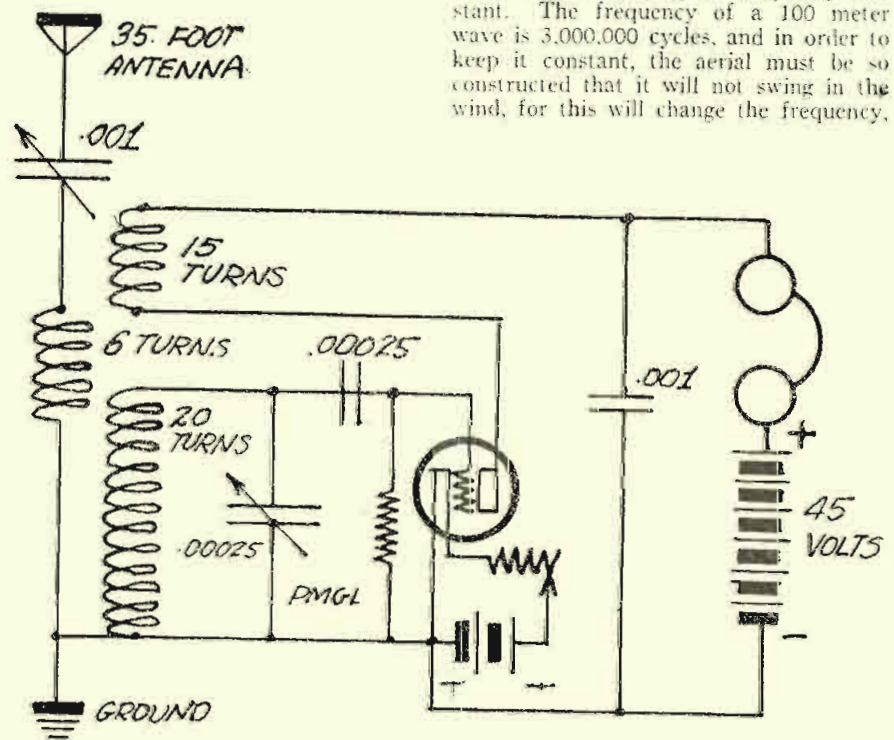

Figure 1. A diagram of a short wave receiver adapted to the signals of the broadcast relay stations. Often signals can be easily heard and distinguished on the shorter waves when not even the main wave can be heard.

and of course this changes the wave length.

The entire transmitting unit is suspended on springs in order to prevent any change in wave length from vibration. Now about the short wave tuner. No doubt there are many of our readers who would like to listen in and make tests on these waves. The construction of such a set is practically the same as the longer wave tuner, with the exception of the winding of the coils. Cutting down the number of turns in all the inductances will do the trick. For those who wish to construct a new set for the purpose, the circuit shown in Figure 1 is suggested.

The vario-coupler used here should be rewound to suit the case. After stripping off the winding, the tube should be wound with twenty turns of No. 20 double silk, or cotton insulated wire. These turns should be wound with a piece of twine between them, and after the winding is finished the twine is removed. No taps are taken off. The ends of the coil are anchored by drilling small holes in the tube and taking the ends down through one and up through the other.

It is best not to use any cement to hold the turns in place, but if one cannot wind the coil tight enough to hold its position, then a very thin application of celluloid dissolved in acetone may be used, but it should be very thin. The primary, or aerial inductance, is wound on top of this coil. First wrap the winding with two or three layers of empire cloth. This may be a strip of cloth about one inch wide and should be placed nearer to the bottom than to the top. Over this wind six turns of No. 20 double cotton covered wire, separating the turns in the same way as those of the first coil. Before these turns are put on, however, lay a strip of cotton tape lengthwise of the coil, leaving the ends long enough to fasten the ends of the wire by means of a needle and thread. The coil, wound on the tape, will hold it in place.

The rotor is wound with fifteen turns of No. 20 wire. The condenser, which is shown as shunted across the terminals of the secondary winding, should be of small capacity. From 5 to 11 plates will do and it should be equipped with a vernier adjustment if possible. A 43 plate condenser in the aerial circuit will help in getting close tuning, and this also should be a vernier. These are about all the points which differ from the ordinary tuner. In the circuit described in Figure 1 the circuit is as follows: from the aerial to the rotating plates of the 43 plate condenser, from the stationary plates to the top end of the 6 turn coil and through this coil to the ground. The top terminal of the secondary winding (20 turns) to the stationary plates of the 11 plate condenser and through the grid condenser to the grid binding post on the tube socket. The lower end of this 20 turn coil is connected to the ground, the revolving plates of the 11 plate condenser, the negative terminals of both the filament and plate batteries, and to one side of the .001 M.F. fixed condenser. One terminal of the tickler coil (rotor) is connected to the phones and to the remaining side of the .001 fixed condenser. The other side of the rotor is

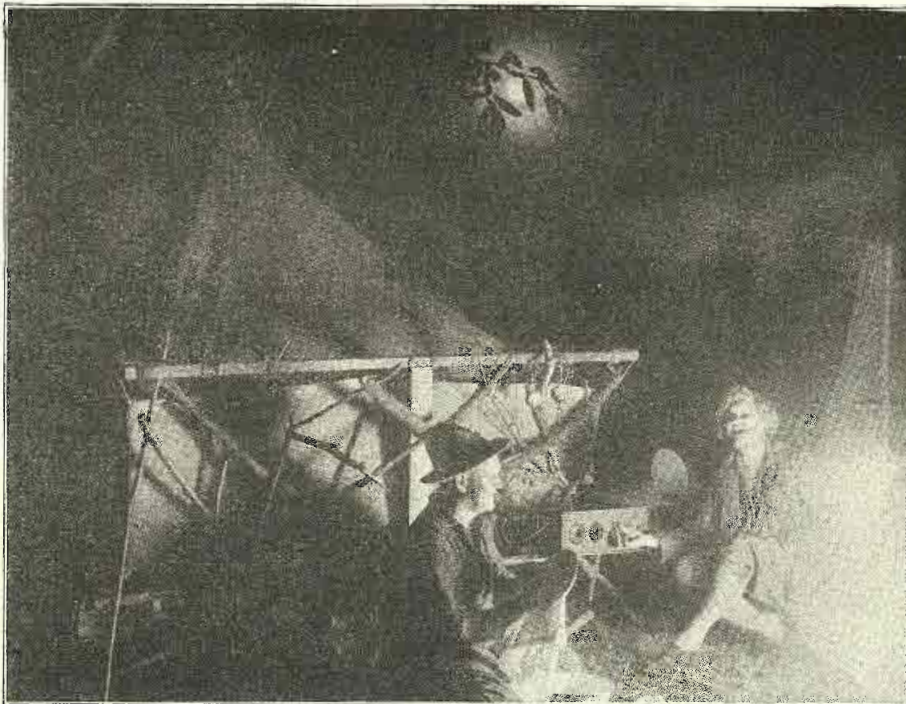

"THERE'S MUSIC IN THE AIR"

From Foto Topics.

And what could be a better place for dreamy music than a moonlight night, with a blazing campfire and a jovial companion? Here two hike-weary campers are tuning in on the cheering melodies from some distant station. The stillness of the night adds volume to the improvised loud speaker shown in the picture.

connected to the plate binding post on the tube socket. The filament and rheostat are connected in the ordinary way as shown. The 2 megohm grid leak is connected across the grid binding post on the socket and the filament binding post on the socket.

The standard UV-201-A tube will work very well. This should be supplied with a plate voltage of approximately forty-five volts, and the filament should be controlled by a 25 ohm rheostat. If the 201-A tube is used, the filament may be operated with four large dry cells. The wiring should be done with good heavy wire such as No. 14 tinned copper, and all connections should be carefully soldered. There are many things to be taken into consideration in the construction of a good tuner. Larger coils and condensers than necessary are not practical. It will be noticed that short wave stations will come in at the bottom of the condenser scale and, if too many plates are used, the zero capacity of the condenser will be too high, and likewise too much wire on the coils will increase the resistance.

If the circuit has a high resistance, it will be found that it will not tune sharply, so for good construction do not neglect to keep this fact in mind. There is no immediate prospect of much improvement in clearing up the ether; consequently the interference problem will probably become worse before it gets better, and for this reason it is a good plan to take advantage of every little detail which will help in making for good reception. Most of us know from experience that many of the little things so often suggested as improvements and savers of energy do not always seem to improve the set as we

(Continued on page 40)

Short Wave Experiments Succeed

Radio engineers of the U. S. Naval Research Laboratory were so impressed with their results of recent experiments with short-wave transmission and reception in daylight, that they have designed a new short-wave transmitter for the Naval Airship Shenandoah, according to Dr. A. H. Taylor, chief of the laboratory.

Through the co-operation of amateurs in over forty states, some stations a thousand or more miles distant, have secured excellent results in two-way communications on 3,000 kilocycles or 100 meters, in radio telegraphy and also in radiophone transmission tests. The reliability of short waves and their ability to carry for long distances, especially in the daytime, Dr. Taylor points out, have resulted in the construction of a transmitter which will go as low as 80 meters with a steady wave. He believes that short waves do not follow ordinary transmission laws.

The short-wave Shenandoah set just completed and tested during the past week is for use on 3,000 kilocycles. This set was designed for use when the Shenandoah goes to the North Pole, where it will be daylight most of the time. It is operated by a 24-volt storage battery, kept charged during operation, but good for a number of hours transmission in an emergency. Telephone transmission for a short distance, as in making landings and mooring the ship, can be handled by this set, and also CW transmission. A motor generator will supply a plate voltage of 750 volts. In keeping with needs for economy in weight and space aboard the airship, this one-wave set is both small and light.

Discovers Radio Wave Is Slower Than Light Wave

SAN FRANCISCO, CAL.—The discovery that the radio wave travels slower than light has been announced by Capt. J. J. See, professor of mathematics in the United States Navy, government astronomer at Mare Island Navy Yard, and well known authority on the theory of ether.

According to Capt. See the radio wave travels around the globe with a velocity of 165,000 miles a second, while light travels 186,000. Capt. See considers that his discovery in the velocity of the propagation of the radio wave about the earth may prove the most notable step in the development of the wave theory since Roemer's original discovery of the velocity of light in 1675.

Outline of Theory

An outline of the chief conclusions is condensed below:

"The mean velocity of the wireless wave was found to be about 173,000 miles per second. This figure is about 13,000 miles per second less than that of light, but ten years ago we did not suspect the cause.

"2. In March last a wireless signal was sent from the sending station near New York to Warsaw, Poland, and reflected back in 0.54 of a second of time. The double distance is 8,500 miles, and the transmission comes out about 158,000 miles per second.

"3. The mean of the two independent determinations of the wireless wave is 165,500 miles per second.

Phenomenon Explained

"4. What is the cause of this? This—The aether or particle of ether is only one-four thousandth part as large in diameter as the hydrogen molecule, so that compared to ordinary molecules of the size of oranges the aetherons would be like smoke from a cigar, and moving with a velocity of 294,000 miles per second. The wave travels through the solid earth as well as through the air and free space above the air, but is much resisted in the solid globe. As the ether is 689,321,600,000 times more elastic than air in proportion to its density—thus almost infinitely elastic—the medium cannot suffer a break in its continuity, yet the movement above the earth is held back by the slower movement of the wave in the earth. The resistance in the globe thus acts as a drag on the wave at its base. The result is that the wave bends around the earth, as long known yet heretofore not generally understood.

"5. This bending is quite analogous to the change of form of water waves as they run ashore—the top of the wave gains on the base.

"The results are of interest in connection with the wave theory of magnetism and the cause of universal gravitation, because they bear on the cause of the fluctuation of the moon's mean motion."



Photo from photographs.

COLLEGE GIRL BUILDS OWN SETS

Gloria E. Hollister, daughter of Dr. Frank C. Hollister, of New York City, would rather tinker with tubes and potentiometers than attend an afternoon tea-dance with her flapper friends. She is president of the Radio Club of Connecticut College and is an expert in radio matters. Here she is shown in her laboratory, working on a set of her own design.

Congress Shelves Radio Legislation

Washington. — Adjournment of Congress left radio legislation still unenacted. The next regular session will convene in December.

Should a special session be called after the national nominating conventions, it would not take up radio.

The White bill has been meeting with some opposition, through the efforts of a lobby working against any plan that would strengthen government control of the air. It is contended the radio industry is still in its infancy and therefore should not be subjected to too much control by any government department.

In this connection, it is argued that the present plan, which was decided on through a series of voluntary conferences, is all right now and that there will be plenty of time to consider changes at the session.

That is also about the standing of the Dill bill, which is designed to amend the copyright law in order that copyright pro-

ductions can be broadcast without payment of royalties.

Although the arguments of the various authors before the committee made a distinct impression at the time, yet if the bill were to come to a vote, it would stand a very good chance of passing.

But members of the committee say that there is little hope of getting it on the calendar, and they feel convinced that the bill, with all other radio legislation, will go over until next winter.

Of course, the advocates of all this planned legislation will keep at work trying to influence Congress. But they face the jam that always occurs at the close of a session, as well as the difference of opinion concerning the merits of any of the plans that have been suggested.

Music Clubs Broadcast

The musical clubs of Union College, Schenectady, N. Y., made their final public appearance for the season of 1923-24 last month when they presented a program of college music from WGY.

Operating the Detector Tube by Grid Bias

By BRAINARD FOOTE

ALTHOUGH it has long been known that it is possible to operate the gassy or "soft" type of detector tube without a grid condenser or grid leak, the latter method of detection is far more commonly employed, possibly because the listener gets his receiver working well without any knowledge of "grid bias" or of "characteristic curves."

Perhaps another drawback to former methods of showing the grid bias scheme of detection is that the required "C" battery was shunted across a potentiometer. This practice soon runs down the "C" battery and adds unnecessary expense to the set's upkeep. However, by a slightly different connection of the "C" battery, this objection is removed and the battery wears out only through the same depreciation that it would undergo were it standing idle on the dealer's shelves.

To understand just how we may detect without a grid condenser, we must study for a moment what is termed the "characteristic curve" of the tube. This is a graphical representation of the relationship between the voltages impressed upon the grid of the tube and the current in the plate circuit which is drawn from the "B" battery. Tubes differ in their characteristic curves, but a representative graph for a soft tube like the UV200 or the C300 is shown in Fig. 1. The horizontal axis is divided into units for the grid voltage, with zero or no voltage shown at the center and negative and positive voltages on either side.

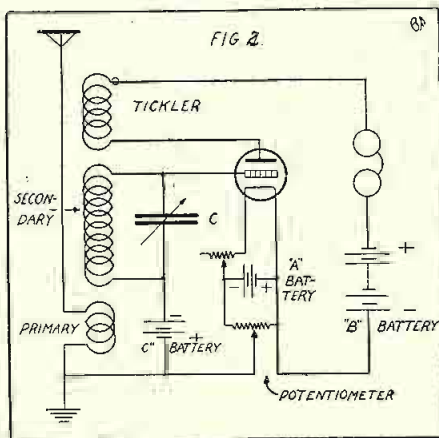

Figure 2. Grid bias control can be used to advantage with any circuit. Here's one which will work well for broadcasting or amateur waves, constants for each being given in the article.

The "Bends"

With a negative 5 volts there is scarcely any current flowing in the plate circuit. But as the voltage is increased toward the positive, the current increases sharply, being somewhat more than one milliamperere (one thousandth of an ampere) at

zero volts on the grid. Thence the relationship is quite uniform for a while and the "curve" is a straight line. With a positive charge or "bias" on the grid, of 2 volts or thereabouts, the curve bends over to the right and from that point on, further increases of positive voltage have less and less effect. There are two distinct "bends" in the curve, and when the grid voltage is adjusted in some way so that the tube is operated at either of these points, detection occurs.

Why is it that the tube detects only at these two bends? Assume that we set the grid voltage to negative one volt. At that point, the current through the telephone receivers in the plate circuit is about 0.7 milliamperere. The incoming signal energy sets up an alternating voltage in the secondary circuit which is impressed upon the grid. As the signal energy alternates from positive to negative, it adds to or subtracts from the normal grid voltage of minus one an equal amount, perhaps changing the grid voltage from minus 2 to zero.

When the alternation on the grid is positive, the grid becomes zero, and the plate current increases to about 1.2 mils. When the alternation is negative, the plate current drops to about 0.4 mils. These variations in the plate current are not equal, even though the fluctuations of grid voltage which produces them are equal.

If the plate current changes were equal, the effects in the phones would be equal and opposite and no sound would be heard at all. The effective current which causes sound in the receivers is equal to the difference between these fluctuations of plate current and is equal to the increase, minus the decrease. The increase is about 0.5 mils and the decrease 0.3 mils. Hence the effective plate current is 0.2 milliampereres. Of course the actual voltage of the incoming signal is less than is indicated, but the result is the same.

Most soft detectors operate best with a negative bias on the grid and use therefore the lower operating point. This is more economical, anyway, since the plate current drain on the "B" battery is only about half of that required for detection on the upper point. However, both points should be tried, and it is necessary to reverse the "C" battery in the circuit to do this.

A Sample Circuit

This grid bias plan can easily be used in connection with any soft detector tube and any circuit. It will not work with a hard or amplifier type of tube because its characteristic curve is practically a straight line and the variations of plate current would then be equal and opposite.

Fig. 2 gives the well-known three coil regenerative receiving circuit which is so popular today because of its easy operation, selectivity and sensitivity. The primary has but a few turns and is the

customary "untuned" coupling winding. The secondary is tuned by a variable condenser, while the tickler controls the feedback. The grid return lead is made through a regulation type of "C" battery of 3 to 4½ volts and thence to the movable arm of a 300 or 400 ohm potentiometer. This is shunted across the "A"

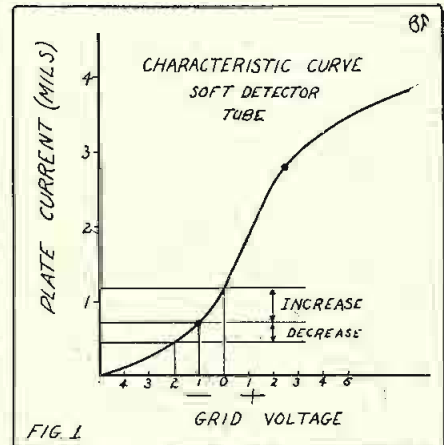

Figure 1. The characteristic curve of the soft detector tube shows the relationship between voltages impressed upon the grid and the current in the plate circuit.

battery and by the correct combination of the "C" battery voltage and the voltage picked off the "A" battery by the potentiometer contact, the grid may be varied from a normal voltage of negative five up to positive five.

A good rheostat is of value in such a circuit, for the detector voltage should be adjusted to a point just below the familiar "hissing" sound. It is not necessary to adjust it afterwards, but each time the set is turned on, the detector rheostat should be set just below the hissing point for best sensitivity. The "B" battery is 22½ volts. Sometimes variations of a few volts in the "B" battery will help a little, but generally speaking, this is not the case. When the "B" battery voltage is altered, a readjustment of the potentiometer makes the tube sensitive again. Different "B" battery voltages alter the characteristic curve and call for a different grid bias to adjust it to the above-mentioned "bend."

Fig. 3 is a photo of a model receiver constructed according to the circuit of Fig. 2. The regular 180 degree variocoupler is used in connection with a variable condenser of .00025 mfd. capacity. For broadcast work, the coils should be wound with No. 20 wire, although a smaller size will do equally well for the tickler coil. The primary should have 15 turns, the secondary, starting one turn's space from the primary, is wound with 60 turns, while the tickler has 50.

This construction was followed in the set illustrated and then the coils were re-

wound for amateur C. W. reception. The primary and secondary were wound with No. 16 wire for sharp tuning. Five turns formed the primary and 25 the secondary. The tickler was wound with 20 turns of No. 20 wire.

Easy Regeneration

One highly desirable feature of the grid bias detection method is the great increase of sensitivity when the tube is away from the point of regeneration. When very close to regeneration, the difference in sensitivity between the two methods is not so pronounced, but without regeneration the tube is far more sensitive than with a grid condenser. At first glance this might not seem a very great advantage, but it really is, for it is possible to attain the same signal strength from a distant broadcasting station with considerably less feedback than is necessary with the grid condenser. This means that the operation of the set will be much more quiet and free from regeneration noises. And the very fact that regeneration need not be pushed quite so hard means a big improvement in quality of reception.

For reception of local concerts with a detector and two stages of audio, the quality is considerably bettered by using very little feedback and the grid bias scheme. This is only natural, for less regeneration means better clarity. And the same sensitivity can be obtained with less feedback. The grid becomes less affected by hand capacity disturbances when it is directly connected to the secondary winding and the tuning of the set is in that way improved.

All in all, the condenser-less detection idea bids fair to increase in popularity once it is tried out by a few listeners and found to be a more scientific and satisfactory fashion of detection.

War Vets Hear Convention

Salt Lake City, Utah.—Thousands of wounded and disabled American veterans of the great war, patients in hospitals and institutions "listened in" on the deliberations of their comrades of the Disabled American Veterans of the World War, at the organization's fourth annual national convention, in Salt Lake City, June 25 to 28. The elaborate musical program and addresses of the initial convention session on June 25, in the world-famous Mormon Tabernacle, were broadcast to all parts of North America over KDYL radio station in this city. Madame Schumann-Heink, famous prima donna, sang "The Star Spangled Banner" and also gave a repertoire of arias as part of the opening day's program. All of the musical and vocal selections, addresses by distinguished guests and speeches by national military and disabled veterans' leaders, were broadcast by KDYL, which is in charge of H. C. Mailander, a wounded veteran of the great war.

One of the subjects to be taken up by this Summer's radio conference will be emergency work. Secretary Hoover's radio executives are working out other details and planning for the organization of several research and development committees.

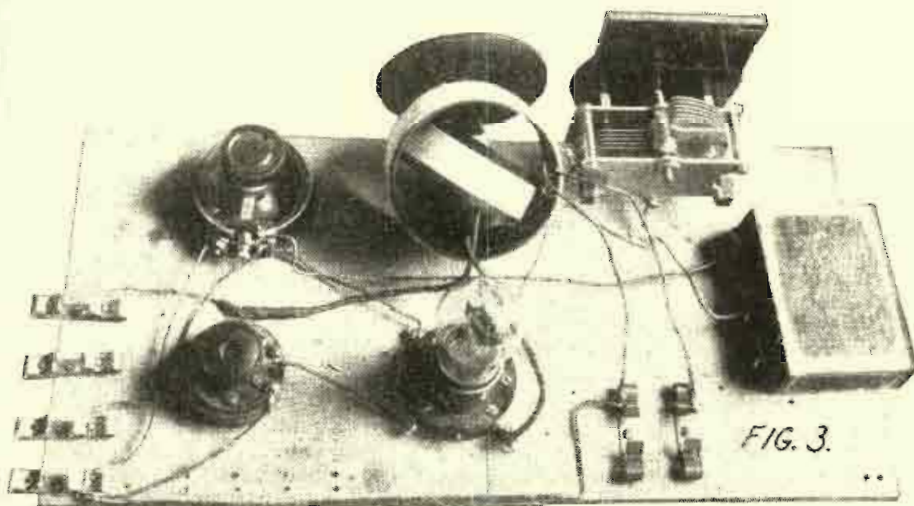

Figure 3. A board layout of the three coil tickler set which uses no grid condenser. The potentiometer and the C battery adjust the grid to the proper working potential.

The Heart of the Radio

By ERNEST WALKER SAWYER

Chief Engineer, Electrad

The grid leak is far more important an item in a radio set than the safety valve of a steam engine. It should really be called "The Heart of the Radio," as it controls the flow of electrons in the circuit.

Electrons are the little fellows who carry the music from the antenna to your ears. Your antenna may be perfect and your tubes may be operating at remarkable efficiency; but if the electrons do not move along the path to your ear in a smooth and orderly manner, the music is distorted.

Your volume depends very much on the grid current and directly on the plate current. An important factor which determines the grid current is the number of negative electrons which are attracted to the grid from the filament. The negative charges on the grid sometimes reach a point where they practically stop the flow of plate current. The grid current piles them up. Unless a grid leak is in use, the tube will become choked up and will not operate. If the grid leak is the incorrect size, the tube will only partially operate.

The grid leak condenser permits incoming signals to enter your tube without loss of energy in the grid leak; but the grid leak is the true controller of the system. If the negative charges on the grid are permitted to accumulate, they simply clog the circuit. The grid potential is lowered and the plate current is lowered. The grid leak permits the excess to leak off, thus restoring the plate current to its normal value.

Each type tube, each individual tube of same type, each variation in voltage, current or in strength of signal, requires a variation in grid resistance for maximum efficiency and that variation is covered by engineers of the Radio Corporation as follows:

WD11 and WD12	2 to 3 megohms
UV200	1 to 2 megohms
UV201A	2 to 9 megohms
UV199	2 to 9 megohms

"A grid leak resistance between 2 and 5 megohms is satisfactory for average work. A resistance between five and nine megohms is somewhat better for weak signals," according to a popular definition.

At first thought, you would naturally advise use of a variable grid leak for every set, but the public as a whole do not want so many variables; so the next best thing is to adopt for each type set, that fixed leak which gives best average results on local stations.

From the foregoing, it is easy to see that when you have once found the correct grid leak for the particular set, tubes, antenna, ground and station, you should be assured that the resistance should remain exact. You see, therefore, that you must use utmost caution in purchasing only those leaks that are properly made by responsible people. Insist that your grid leaks be certified, correct and guaranteed.

In a further article I will describe the proper method of manufacture of certified grid leaks.

MORE ABOUT TUBES

Tubes are all important in the operation of a Radio set. Another article on Tubes, by Felix Anderson, will be found on page 17, this issue.

No "Summer Slump" Found in Radio Interest

Here Are Some Suggestions to Maintain the Efficiency of Your Set

The extent to which this is turning out to be a real "radio Summer" is becoming more apparent with the ever-increasing efforts made by broadcasters, manufacturers and other interests in the industry to set a high-water mark of perfection for radio reception during the coming weeks.

Because of the flood of inquiries received during the past month, RADIO AGE has decided to publish in this issue what it considers the most vital factors for the successful operation of a radio set during the hot season.

Stations Stronger

Little difficulty should be experienced in securing good reception in the Summer, because of the fact that during the past year the power of sending stations has been materially increased.

This status is expected to eliminate

many of the previous difficulties noted during the Summer season, not to mention numerous improvements and refinements in receiving apparatus now on the market.

All these situations will undoubtedly result in greater satisfaction to the radio enthusiast and the upkeep of the high pitch of interest which characterized the entire month of June.

The radio fan who heeds the following suggestions will be sure of a successful radio Summer. Here they are. Study them closely:

That Portable Set

Put your set in the pink of condition. Whether your radio receiver is to be used at home, at the seashore or in the mountains, see that the connections are gone over and tightened up, that old batteries are replaced and that a good set of tubes is installed.

Camp Aerials

In camping with a radio, if your receiver is one of the antenna type, erect your aerial wire from the camp to a branch of one of the tallest trees in the immediate vicinity. If thunderstorms are prevalent, it will be found advisable to erect an additional antenna not over ten to twenty feet off the ground. That type of aerial is not so readily influenced by atmospheric disturbances. An aerial of this character can be of any length from 100 to 200 feet.

Loose Coupling

Whether you use a receiver which operates from a loop, or a receiver which operates from an antenna, the sensitivity of the receiver should be reduced in times of atmospheric disturbances either by reducing the filament temperature or

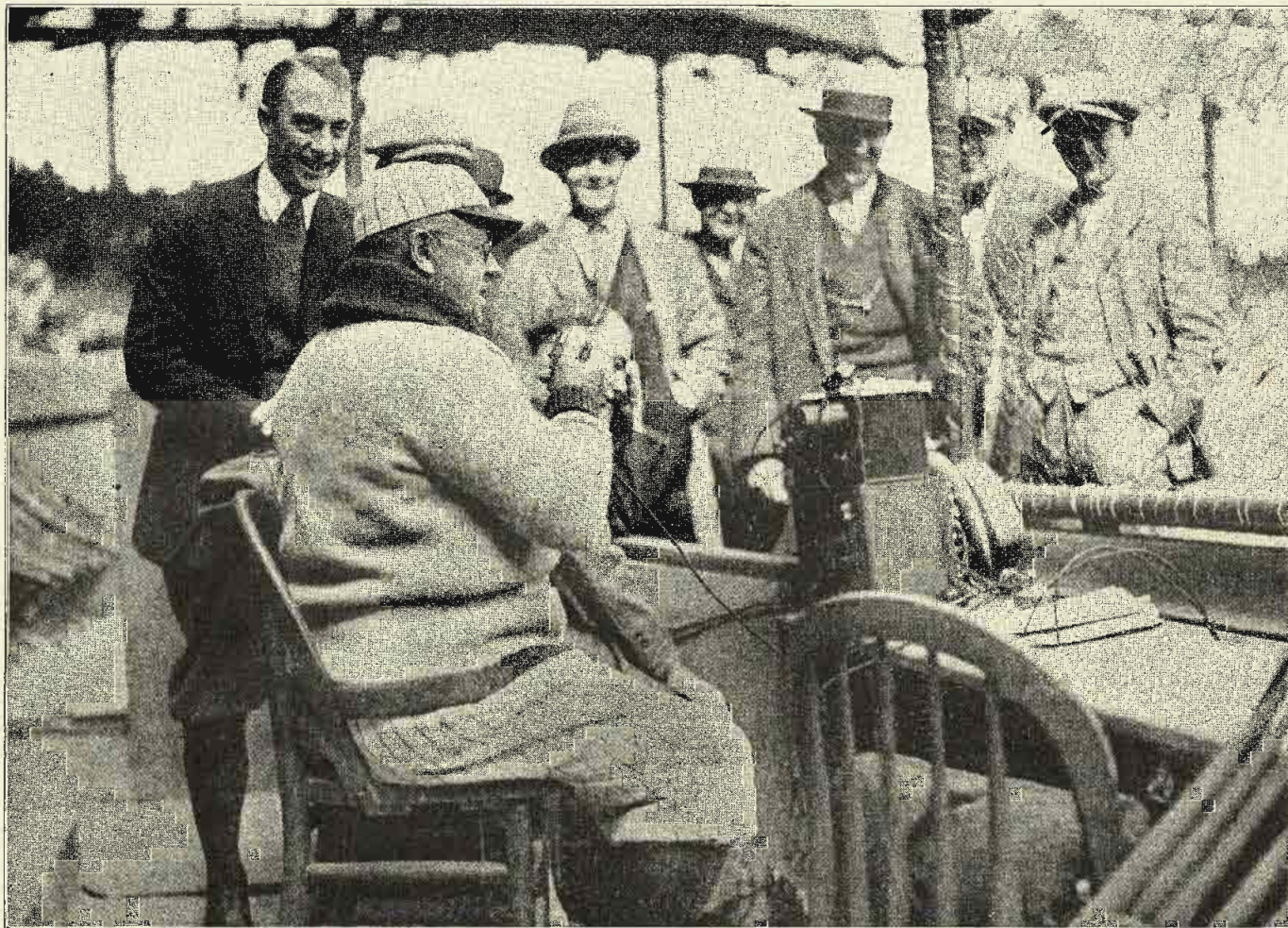

"UNCLE ROBBIE" TELLS 'EM HOW IT'S DONE

Kadel & Herbert.

The guiding genius of the Brooklyn Nationals is telling the radio world, through WEAJ, that his team is about to go into the fray and lick the New York Giants beyond recognition. By the expression on Robbie's face, he seems fairly confident that his team will turn the trick. Whether his prediction was true is another story. The New York and Brooklyn baseball clubs are using radio to good advantage this season, doing their broadcasting direct from the ball grounds.

by "loosening the coupling," so that the best results might be obtained from your local stations. On the other hand, if atmospheric conditions are good, the filament temperature should be readjusted to normal so that the sensitiveness of the receiver might be increased and reception obtained from broadcasting stations located at greater distances. The long low aerial or the loop type of receiver will give marked relief this summer from atmospheric disturbances.

Portable Grounds

See that you have a good ground connection when the aerial is used. If such cannot be obtained at the camp or at the sea-shore, the equivalent of a good ground connection can be had in the use of a piece of wire 100 to 200 feet in length laid over the surface of the ground and directly underneath the aerial.

Guard Against Moisture

Receiving apparatus in the camp should be duly protected from moisture and dampness. A moderate amount of moisture and dampness may not interfere with the operation of the average type of receiving set, but at least the set should not be allowed to get wet by exposure to rain or inclement weather.

Tuning Portable Sets

Broadcast listeners should bear in mind that the electrical constant of aerials erected at the sea-shore or in a camp, may be quite different from the electrical constant of the aerial used with the same set at home. This means that stations formerly heard at home will not come in at the same point on the dials in the camp. It should not be difficult to locate new positions for such tests after the first evening's operation.

Phone Cords

With regard to head telephones, be sure that the headset cord is not worn; that the connections are tight at the back of the headphone and that the caps are also screwed down tight.

Install fresh batteries, and new tubes; tighten up all connections; protect the receiver from dampness; use a lower aerial when atmospheric disturbances are present and a longer aerial when reception conditions are favorable, and see that your headset is in good condition.

SUMMER FANS

What results did you obtain with your radio during hot weather? RADIO AGE will be glad to print the best letters on this subject from fans.

"Radio Dead Spot" Revived

DX reception has been logged from a number of distant stations by an antennaless receiving set at Montauk Point, L. I., which until now has been believed by many radio experts to be a dead spot for other than nearby local stations.

This performance resulted from a hasty experiment conducted under the supervision of Dr. Francis LeRoy Satterlee, of Flushing, L. I., inventor of the Satterlee Coils. It adds another to the list of achievements already credited to the inventions of this well-known scientist.

Known as Dead Region

Government maps have proclaimed the narrow strip of land between Block Island Sound and the Atlantic ocean as being quite dead for western sending stations.

So far as known, previous scientific investigations for radio reception have been futile and it is generally reported that sets conveyed to Montauk Point by vacationists, even when operated under the best working conditions, with long aerials on high hills and connected to good grounds, have failed to pick up any other stations than Boston and Springfield, Mass.

Previous to Dr. Satterlee's experiment the longest distance ever known to have been brought in at Montauk Point was a Chicago station, received on a five-tube set with headphones.

Dr. Satterlee motored to his summer

bungalow on Montauk and set up a four-tube antennaless receiver. Experiments ensued for several days and a number of distant stations were logged daily, including Chicago, Miami, Ottawa, Pittsburgh, Canton and Washington, D. C.

No scientific explanation has yet been made by Dr. Satterlee as to the reasons for the existing "dead spot" formerly condemned by all who had attempted reception at Montauk.

Dr. Satterlee used a Moon C2A set hooked up with his antennaless circuit with the Satterlee coils.

Radio Helps Isolated

Up in Sable Island, Canada, WGY is church, school, newspaper, and theatre for the inhabitants. Writing to WGY recently, Harold F. Henry, superintendent of Humane Establishment, stated, "We on Sable Island, being a life saving station, have no schools or church and the steamer only visits us three or four times a year. We depend on radio broadcasting for church services, concerts and news. The WGY Players have my best wishes and I hope they never fade."

ZR-3 to Use Radio

Plans for radio communication with the German-built ZR-3, the new giant airship of the Navy, when she crosses the north Atlantic early in July, are going forward through the cooperation of the U. S. Weather Bureau and the Naval Communication Service.

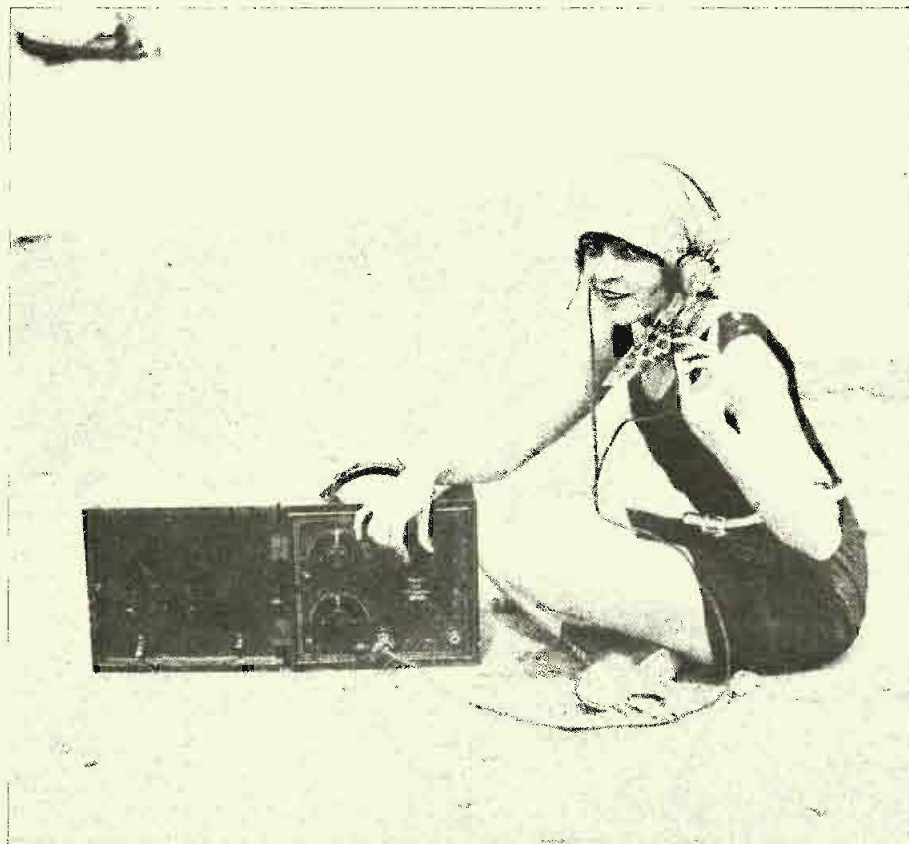

WHAT ARE THE WILD WAVES SAYING?

This fair beach flower is demonstrating that the outdoor girl is taking to radio this Summer. Between dips in the ocean at Atlantic City and lazy canoe trips, she can tune in on a nearby hotel's syncopated music. Don't you wish you were in Atlantic City?

Kodak & Hester

How to Get the Most Out of Your Vacuum Tubes

By FELIX ANDERSON, Technical Assistant

SOMEONE at some time made the remark that a chain was no stronger than its weakest link. A mighty practical and sound statement which can be applied to practically any material thing in a figurative way. Interpreting it into radio, we might say that a radio receiver is no better than its weakest part.

Much has been said about the tuning components, their construction and uses, much has been written and said about arrangements thereof, and still more has been said about circuits and methods of connecting various tuning arrangements. But in the idea of the writer, little has been said in the methods to use to coax the utmost out of the veritable heart of the circuit—the vacuum tube.

It is not the intention to furnish the reader with a lot of details of the history of the discovery and development of the receiving valves—information of that nature can be obtained from practically any collections of facts on radio and its past. On the other hand, the writer knows from bitter, expensive and heartrending experience that a few details on the most effective manner to use in approaching a vacuum tube with the intention of extorting maximum efficiency therefrom will be without question appreciated.

It brings back the fond memories of the sad end of our first tube, which passed away peacefully after long years of faithful service, because some thoughtless experimenter presented us with a drawing that applied the plate battery potential across the filament terminals. In those days we didn't know how to protect the filament with fuses, and only had a vague idea that if the B battery (which in those days consisted of flashlight batteries) were applied to the A battery posts, something would happen inside of the tube—maybe the plate would melt—it was too expensive to try it out.

In general, nowadays, about the same conditions exist among the bugs who experience the thrill of buying their first triode. They purchase one, plug it into the tube socket, and if it doesn't work, they blame it on to something. If they happen to have an incorrect connection and it burns it out, they say—well, never mind what they say, but if they miss anything it usually is not their fault.

What Kind of Tube?

One of the commonest questions that is asked a radio man is the old one with moss on it, "What Kind of a Tube Shall I Buy?"

The choice of tube depends upon several things. They are enumerated as follows:

1. Battery Supply.
2. Circuit Used.
3. Kind of Reception Desired.

So, first of all, no matter what kind of set you want to build, you have to consider the source of power for lighting the fila-

ment and whether dry cell or wet cell batteries are to be used. This goes further into the detail of how much money one desires to expend upon the original outlay and maintenance of the receiver to be operated. If you have a lot of money to spend it is a wise thing to employ the tube that uses wet cell storage

Classifying the Tubes

First of all, the UV201A tube can be operated on either dry or wet cells, but it is decidedly a wiser move to operate this type of tube with a good six volt storage battery. With this tube, we have its big brother, a comparatively monster current eater, the Western Electric tube. Both of these tubes are good tubes, and both of them represent the means of obtaining the greatest volume regardless of current consumed.

The UV201A tube makes a good radio frequency amplifier, a much better audio frequency amplifier, and a fair detector. The WE tube is a wonderful radio frequency amplifier, only fair as a detector, but gives beautiful audio frequency amplification.

We therefore find that if we want a tube for detection purposes the wisest thing to do is to invest in a UV200, when the filament source is a storage battery. We do not insist that the UV201A will not detect—what we are trying to put across is that the 200 tube is designed for detection purposes, and should therefore be used.

Now if I were building a radio frequency circuit I would very seriously consider the UV199 tube as the radio frequency amplifiers. These little tubes are wonders when it comes to that, because they are built for that purpose. They make good detectors, and good audio frequency amplifiers, when one considers their input. The only thing one can possibly hold against this little triode is that its volume does not come up to the six volt tube. And that's saying a lot for a little tube like that.

We have had good success with WD11 tubes in regenerative detector circuits, but not with radio frequency circuits. At audio frequencies the tube shows up somewhat better, but all in all, we find it best this WD11 and its sister, the WD12, to straight detector circuits. In fact, we doubt if there are many sets now in use that really use more than three WD11 tubes; a detector and two stages of audio frequency, unless a push-pull power amplifier is used. Now, then, we hope that we have a sort of a basis to work from.

Handling Tubes

From the time that the tubes leave their manufacturers they are handled by this fellow and that, by this freight hand and that, and if you are a wise radio man, make the salesman whom you are bargaining with test the tube you are going to buy. We remember when they used to have sets in the stores and we used to put the tube in the socket to make sure that it was really good in an operating test.

Never handle or permit your tubes to be handled roughly. That is, if you want the filament to be in one piece, and keep the grid from touching the plate. A tube



Kadel & Herbert,

AN EFFECTIVE RADIO PLEA

Little Jimmy Davis, son of James J. Davis, secretary of labor, recently made a plea over the microphone at Station WRC in behalf of the starving children of Central Europe. Jimmy is a forceful orator and made a favorable impression on all his listeners. After all, "like father, like son."

batteries as a source of current supply. On the opposite side we have the man who wants to make his set economical as possible, and for him the dry cell tube is to be specified.

But we have two or more different kinds of dry cell and wet cell tubes to choose from.

represents a very delicate precision instrument, and to bang it around and hit it on a table is about the same as throwing a monkey wrench into a printing press. The manufacturer takes pains in packing it carefully to prevent it from becoming broken internally and externally, and you should take the same precautions.

Tube Accessories

No matter how good a tube may be, it can always be ruined insofar as its action as either radio frequency amplifier, detector audio frequency amplifier or oscillator is concerned by the use of poor accessories. One can hardly consider the tuning or transformer components of a circuit as accessories; but they can be likened to links in a chain, and as we said before, a chain is no stronger than its weakest link.

In the olden days, we used to have tubes that had the wires coming right out of the glass stems—no bases on them. The wires, of course, were delicate, and required careful handling to keep them from breaking off; but in spite of that fact, they were superior in a way to the present day tubes, because the capacity effects presented by the virtue of the long leads and the metal shell of the present day tube construction were not encountered. But we often sacrifice electrical principles for mechanical strength, and hence we have to contend with a necessary evil—the socket. Tubes often have to be changed quickly and the bayonet type of socket seems the most effective way of doing this. However, that does not mean that we cannot use a good tube socket. They should be chosen with care and consideration.

Porcelain sockets, because of their high insulating qualities, are probably the most efficient electrically that an experimenter can use. There are several good types on the market, and their use is highly advisable. Many embryo experimenters feel that because of their low price they are to be shunned, but this is not the case. Hard rubber sockets are next in line, considering efficiency from an electrical standpoint. Bakelite sockets are not bad, but beware of imitations. Fiber, moulded and composition sockets should be avoided if the utmost in radio perfection is to be sought.

Some Sockets Go Low

Incidentally, we have seen tube sockets that have as low a resistance as two megohms; their users wonder why they don't get long distance, and many others wonder why their neutrodyne's won't balance. This item may seem trifling—but remember that you can't over-look trifles when you start to experiment with high frequency electricity. Radio signals are weak and elusive. The signals leak through the tube elements (especially in radio frequency amplifiers) enough without having more of it sneak to the plate post via the moulded mud route.

You can get around the whole business of using a tube socket by correctly locating the respective prongs on the tube with regard to their values as plate grid and filament contacts, and solder your wires directly thereto. This assures positive contact, and does away with any stray



Knecht & Heiler

GIRL BUILDS SMALLEST LOOP AERIAL

This miniature loop aerial, said to be the tiniest ever constructed, was made by Helen M. Obermiller, daughter of a noted radio engineer. It is called a variometer loop because the inside winding of the loop revolves. Although small in size, it contains quite a lot of wire. Helen has demonstrated its efficiency before several radio fans by using it on her receiver, a three stage radio frequency set. Remarkable results have been obtained.

capacity offered by the extra metal shell that some tube sockets incorporate.

The use of adapters should be particularly avoided in circuits where it is absolutely not necessary. Use a good tube socket of the correct design for the tube used, and eliminate losses which might occur through the use of one of the substitute sockets.

The contacts on the tube socket should be very clean; if not, noises will without question be heard and blamed upon some other part of the set. The springs should be tight and firm, and care should be taken in ascertaining that the contact still touch when the tube is turned in the socket so that it will engage the bayonet slot.

The longer you make your leads to the grid and plate contacts, the greater your losses will be (especially in radio frequency circuits) because the incoming signal travels quite readily across the capacity effect presented by the wires, connections and any other surface that presents any amount of capacity. The secret of the UV199 tube as a radio frequency amplifier lies in the fact that the leads are short and direct, and the capacity effect is eliminated as much as is commercially possible.

Where binding posts are provided on the tube sockets, soldering lugs should be used; otherwise the connections should be made tightly with a pliers. Before screwing a socket to a mounting board, make sure that all the machine bolts holding the springs to the socket are tight,

as a loose spring is a source of never ending noise.

Controlling Accessories

The controlling accessories listed according to their respective importance in a circuit are as follows: The grid leak and condenser, the rheostat, the potentiometer, the plate battery, and the filament battery. In some circuits, the bypass condenser across the phones is also a necessity.

The subject of the grid leak was considered of such importance that the writer felt that a special explanation of its construction and adjustment was necessary, and readers will find a detailed review of this important control in the June, 1924, RADIO AGE, under the title of PMGL. Its adjustment in the course of getting the most out of a tube will be explained a little later.

Together with the grid leak, the grid condenser should be chosen with much care and thought. Paper makeshifts are worthless in an ideal radio receiver.

In buying a grid condenser, two or three sizes should be tried. Capacities of .00325 MFD, .0005 MFD and .0003 MFD are very useful capacities to have handy when determining the best operating features of a triode. Usually the UV201A tube works best with a .00025 MFD, as does the WD11 and 12. The UV199, however, sometimes works better with the .0003 MFD or the .0005 MFD condenser.

These condensers should be of the fixed
(Continued on page 36)

Radio "World's Fair" To Attract Thousands

New York Show Surpasses All Expectations

THE first Radio World's Fair, which is to be held in the Madison Square Garden, New York City, from September 22 to 28, under the auspices of the Radio Manufacturers' Show Association, is attracting more universal attention than any other commercial exposition ever held in this country.

Leading newspapers here and abroad are devoting columns to the coming show which promises to be the largest and most complete exhibition of scientific achievement ever staged.

As nine-tenths of the exhibiting space in Madison Square Garden has already been contracted for and as the remaining ten per cent is oversubscribed, it is practically a certainty that the exposition will be forced to spread out and take in the 69th Regiment Armory, located just across the street. Notwithstanding the fact that the coming show will be for radio manufacturers of national reputation only and the opening date is still several weeks off, Manager Kerr now has almost enough applications in hand to fill both buildings and new requests for space are coming in by every mail.

Foreign Division Planned

Among the new features to be introduced this season will be a "Foreign Division" in which many of the important radio interests abroad will be represented by carefully selected official exhibits. The European manufacturers and inventors are said to be making elaborate preparations for their initial invasion of America and they promise to furnish the radio fans of this country with a few real surprises.

Another important innovation will be a special "Board of Radio Authorities," now being chosen with great care, which will award suitable prizes to the most meritorious wireless inventions perfected during 1924. The competition will be open to all and no entry fee will be charged. In addition to presenting each successful inventor with a medal, a diploma or cash, the jury of experts will also endeavor to assist each inexperienced successful inventor to market his or her invention to the best possible advantage at no cost. Public demonstrations and tests of the new inventions will be held daily and many startling devices will probably be brought to light.

Extraordinary feature programs will be put on every afternoon and evening in which the most prominent radio geniuses of the age will appear personally. There will also be a series of broadcasting experiments made during the show which will enlist the services of the ablest radio engineers and the most powerful broadcasting stations of the entire world.

Dealers to Be Helped

Special arrangements have been made for the accommodation of dealers from all parts of the country who are expected

to attend in large numbers. Two hours per day, from 11 A. M. to 1 P. M., will be set aside for the exclusive transaction of business between exhibitors and wholesale buyers. The general public will not be admitted until one o'clock every afternoon and the show will remain open until eleven o'clock every night. Through another special arrangement the exposition will be open on the afternoon and night of Sunday, September 28, which is the closing day.

At the close of the New York show the exhibits, booths and decorations will be taken to Chicago and from there the big spectacle will be moved on to Los Angeles. The local, Chicago and California expositions will be identical in almost every detail.

Manager Kerr plans to establish one of the finest experimental radio stations obtainable in the tower of Madison Square Garden at an early date for the purpose of enabling an official committee to conduct preliminary tests with the hope of solving many of the most perplexing radio problems of the present day. A detailed report by this official committee will be announced on September 22. The preliminary tests are also expected to pave the way for the success of the ultra-important trans-oceanic and trans-continental broadcasting experiments which are

to be made between September 18 and 28.

Amateurs to Compete

The Amateur Builders' Contest, which will be of an international character this year, will be a good sized exhibition in itself. Entries are already coming in from Europe, South America and distant points in this country. Space enough to display several hundred sets has been reserved and twenty-five valuable prizes will be awarded to the winners.

"Radio Age" to Be There

RADIO AGE, the Magazine of the Hour, will have a booth and exhibit at both the New York and Chicago radio shows. Manufacturers, dealers and "fans" attending these shows are cordially invited to "drop in" and get acquainted with the magazine and those who are helping to make it the leader in its field.

At the New York show, RADIO AGE'S booth will be Number 15 in Section L. Look for it, you eastern fans!

At the Chicago exhibition, to be held at the Coliseum, the RADIO AGE booth will be Number 4 in Section S.

A detailed program of the events and daily schedule of the New York Radio Show will be published in the next issue for the guidance of fans who expect to attend.



"THIS IS STATION 2LO SPEAKING"

Kadel & Herbert.

Raymond G. Chassevant, shown in the picture, spoke those thrilling words into his receivers and the household heard them fly from the loud speaker with all the force of a local station. Many fans are having a lot of fun talking through their own loud speakers. Connect your head set across the primary of the transformer of the first stage of your amplifier, the "B" battery being connected and the tubes turned on as usual. Then talk into your head set as shown in the photo and your loud speaker will repeat what you are saying.

The Station That Happiness Built

How a Mixture of Technique and Human Nature Made WIP a Winner

By R. H. HOPKINS

WHAT is it that makes a radio broadcasting station popular in the eyes of the thousands of fans who "listen in?"

Can it be the programs alone? Or the strength of the station; the contests it holds—or merely the personality of the announcer?

If such a question could be answered, the country would know less broadcasting failures. Men venturing into the broadcasting field would be able to know beforehand just how to get that "indescribable" something that makes—or breaks—radio stations.

Station WIP, located on the Gimbel Brothers Building in Philadelphia, perhaps has come closer to solving the question of "What Makes a Successful Broadcaster?" than any other in the field.

No given recipe was followed; no stern rules mapped out and followed to the letter. Success came naturally because only a few fundamental principles were outlined at the beginning.

Happiness Succeeds

After all is said and done, the only vital reason for WIP'S success seems to be "Happiness; or a Sound Mixture of Radio Knowledge with a Liberal Dose of Human Nature." That's the prescription.

The managers of WIP looked over the long list of failures and near-failures and came to the conclusion that you can't please all the people all the time; but you can give each class of people their turn at being pleased.

This decided, WIP proceeded to pick the men to guide its ethereal destiny. They looked for radio experts where expert knowledge of broadcasting apparatus was needed. They got these men and put them where they belonged: in the technical departments of the station.

Then they looked around for some young men who didn't know so much about radio as a science, but who did know something of human nature. Men who know just when to turn off the flow of jazz music and insert a dash of Beethoven instead. They wanted men whose voices sounded as if they hadn't a care in the world, and who could be happy all evening with nothing more than a homely microphone staring them in the face.

These men were found—technical experts and human beings as well. The former were given full charge of making WIP heard for thousands of miles; the latter were told to make the station a symbol of happiness and care-free good cheer that would turn homes into rendezvous of laughter.

The technical men succeeded; but their work would have been in vain had it not been for the irresistible personalities of the men in the studio, coupled with their

almost uncanny ability to tell what sixty per cent of radio listeners want to hear.

WIP Heard in Europe

"This is Station WIP, Gimbel Brothers, in Philadelphia." You have no doubt heard this announcement; it's been heard all over the United States, in England, France, Germany, South America, Hawaii and other places in the far corners of the earth. And perhaps you've wondered just what was going on behind the scenes at WIP and how it was operated.

A New Feature for Radio Age Fans

A new class of public entertainers is growing up in American public life.

A decade ago the most popular group of men and women before the public eye consisted of the motion picture and stage stars; but in the years to come it will be the radio entertainers and announcers who will hold the spotlight of favor.

Just as the "movie" stars won their army of admirers, so are the unseen radio singers, actors, announcers and other entertainers forcing their way to the coveted spot in the Great American Heart.

In the belief that radio entertainers will eventually be known in more millions of homes than the motion picture could ever hope to penetrate, RADIO AGE is beginning a new feature; the creation of a department which will deal wholly in acquainting the radio public with the men and women who broadcast their talents over the radio to an unseen but appreciative audience.

Their pictures, their life stories and the facts and thrills of their existence will be recorded for the enlightenment and amusement of the "fans" who listen to them nightly. Readers are asked to help improve this department, which begins in this issue.

WIP has two large antenna towers 200 feet above the street. The station consists of the operating room, the main studio, which is used for solos, speeches, quartets; and the studio-auditorium for large choruses, orchestras and bands. There are nine remote control rooms located in various parts of the city to facilitate broadcasting from other buildings.

In both the main studio and the studio auditorium the walls are padded and draped in such a way that there is little reverberation of sound—just a full round tone without echo. The main studio is comfortably furnished with wicker chairs, tables, settees—all the comforts of home,

in fact. Fine tapestries hang from the walls. A grand piano occupies one corner and two microphones on mahogany stands are ready to catch the slightest sound.

A small black box on the studio wall controls the microphones. A large red light in the center of the box warns the artists, when the microphones are connected with the transmitter, to keep absolute silence. The transmitting apparatus feeds 500 watts of radio-frequency energy to the antenna system.

The microphones, of the duralium type, are extremely sensitive and pick up the slightest sound. The two in the main studio are connected to a "mixing panel" which blends the sounds. In this way the bass notes of an orchestra are picked up by one microphone, the high notes by another and the two blended in the "mixing panel" into perfect orchestration. It is in the "speech input amplifier" that the operator controls the sound intensity and regulates the amount of energy fed into the "main transmitter." Now the greatly amplified sound, now electrical energy, that originated in the studio, is carried through wires to the "main transmitter" where it is received by a 50-watt vacuum tube that again amplifies it. Next, it is passed to the "modulator," the two 250-watt vacuum tubes that balance and modulate the energy. The next and last step, after the energy has been amplified and modulated, is feeding it into the "oscillator," which consists of two 250-watt vacuum tubes incorporated in a circuit tuned to 500 meters or 590 kilocycles. The oscillator sends the sound that originated in the studio, out through the antenna system in the form of radio-frequency energy to be received everywhere.

The operating staff of WIP need no introduction. They are known wherever the station is heard, and they are known for their bubbling enthusiasm and perpetual desire to please their listeners and spread good cheer as far as WIP'S power can be picked up.

But the staff are known only by their operating initials, so here they are properly: "H. G." is Charles Goudy, better known as Hank, the chief engineer of WIP. "C. W." is Charles Weir, operator. "S. K." is Samuel Kale, operator. "E. D." is none other than Edward Davies, director. "H. P. I." is Helen Pulaski Innes, manager of the programs who sorts out the orchestra selections, vocal numbers and other features with surprising tactfulness. "U. W." is Uncle Wip, the kiddies' idol and the cause of frequent epidemics of heart trouble in Eastern flapper colonies. In private life "Uncle Wip" is Chris. W. Graham.

WIP'S main studio and operating room are enclosed in glass, thus giving a picturesque effect.

"Radio Age" Broadcasts from Station WTAY

RADIO AGE has taken to radio! Negotiations have been completed whereby RADIO AGE, the Magazine of the Hour, is to broadcast regularly from Station WTAY, located on the Oak Park Arms Hotel, Oak Park, Ill.

The entire technical resources of RADIO AGE will be used to present a series of programs dealing with the operation and building of radio sets. No other radio station in the Middle West, nor any other radio magazine in the country offers such a radio service to radio listeners.



HUGH B. MARSHALL

This is the popular studio director and announcer at WTAY, Oak Park, Ill., from which RADIO AGE broadcasts technical radio talks every Wednesday evening at 7 o'clock. Drake Studio.

WTAY is one of the most efficient stations in the Chicago territory and is exceedingly popular with the fans because of the fact that its wave length does not approach that of any of the other stations who are bunched together in the neighborhood of 360 meters.

220 Wave Length

WTAY operates on a wave length of 220 meters and it is possible to "tune in" at any time.

Every Wednesday evening, about 7 o'clock, RADIO AGE will come on the air for its weekly talk on technical and general radio. This service began Wednesday, June 11, and is now in effect.

J. A. Callanan, well known technical radio expert and a special writer for RADIO AGE, delivered the first two talks, which were enthusiastically received and caused considerable comment.

In the future, besides Mr. Callanan, the RADIO AGE broadcasts will be delivered by Frank D. Pearne, John B. Rathbun, Roscoe Bundy, Felix Anderson and other authorities whose contributions are a regular feature of the monthly RADIO AGE.

The subject of these radio talks are

published weekly in a booklet issued by The Pioneer Publishing Company, Oak Park, Ill., for Station WTAY. Fans may obtain these programs weekly by requesting their names be put on the mailing list. A letter to the Station Editor, Care RADIO AGE, will do it.

Five Programs in July

During July the RADIO AGE programs will be broadcast from WTAY on the evenings of July 2, 9, 16, 23 and 30. Tune in and be convinced of their value! Correspondence with the experts who deliver the radio talks is urgently invited. If you wish to question the speaker on some topic he mentioned, or if you wish further information on the subject he presented, address him care WTAY, Oak Park Arms Hotel, Oak Park, Ill., or care RADIO AGE, 500 N. Dearborn St., Chicago.

There is absolutely no charge for question-and-answer service requested by fans. Drawings and diagrams will be furnished if desired.

Hugh B. Marshall is studio manager and announcer of WTAY. Assisting him are a coterie of able artists who produce jazz and classical programs throughout the week from 6:45 p. m. until after 10:30. An elaborate studio is maintained in the Oak Park Arms Hotel.

This is WTAY broadcasting! All together for RADIO AGE programs!

What Makes an Announcer?

"In the wording of a sentence or a phrase, in the choosing of a word, hinges the success or failure of the radio speaker," said Wheeler McMillen, associate editor of Farm and Fireside, who broadcast talks over the Sears-Roebuck Agricultural Foundation station—WLS, recently.

"The resonant quality of the voice plays a big part through the microphone, just as it does in ordinary conversation," continued Mr. McMillen, "but resonance is only half of the secret of effective broadcasting. Some voices, gifted with a clear, sharp, vibrating quality, capable of carrying to every corner of a lecture hall, are changed by the microphone to a series of incoherent blurs. The radio fan puts all the blame on the peculiar carrying power of the voice, but it also is due to a poor choice of words in the making of a sentence.

"Radio phonetics is a new subject. As yet no one knows very much about it. But after a few observations, I am convinced that the man whose voice is lacking in radio quality can substitute a carefully constructed speech, and the result will be at least 50 per cent improvement over ordinary efforts. Short sentences made up of simple words are the most effective. If long sentences are used, make them compound. A compound sentence is more simple than a complex. A few longer sentences always are necessary for the sake of variety. The beginning and ending of a paragraph should be made of short, pithy sentences packed with thought.

"A monosyllable with a long vowel is harder to pronounce sharply than a syllable with a short vowel. Listeners-in cannot see the periods by radio; the speaker must make them evident. This can be done if words are chosen for the endings and beginnings of sentences that are sharply defined. The sentence ending, especially, must never be ragged. Words are clearest and most easily pronounced that end in sharp consonants, such as 'p' in handicap, 'k' in overlooked, and 't' in pursuit.

"Radio talking is a good deal like magazine writing," Mr. McMillen said. "The same tactics must be employed in both. There is more in the building of a good radio talk than the planning of words and sentences. That is the beginning. The word structure must be built around a general plan aimed to attract and hold the interest. The opening sentence should strike the keynote of the speech and at the same time give a hint of suspended interest that will keep the listeners at the phones."

KGO Has New Studio

The broadcasting resources of KGO, at Oakland, California, have been greatly increased by the introduction of a San Francisco studio at the Hotel St. Francis. The new studio was opened May 28 with an address by Ralph McLaren, acting mayor of San Francisco.

Ground wires under San Francisco Bay connect the San Francisco studio with the control room and power house of KGO ten miles away. It will no longer be necessary for San Francisco artists to travel to Oakland to fill a radio engagement with KGO, the facilities of a high class, powerful station being brought to them by means of wire lines.



Vanity Fair Photo.

"UNCLE WIP SPEAKING"

"Uncle Wip," or Chris. W. Graham, is the kiddies' friend at Station WIP, Philadelphia. His jovial voice almost makes up for the absence of his equally jovial countenance over the ether waves. Here he is shown in the act of greeting his radio admirers at the opening of an evening's program.

Who Is Your Candidate for the RADIO HALL of FAME ?

Which radio announcer or entertainer holds first place in your heart? RADIO AGE intends to find out, through the medium of a **RADIO FAVORITE POPULARITY CONTEST!**

Each month RADIO AGE will publish an intimate interview and photographs of the radio entertainers and announcers winning the greatest number of fans' votes in RADIO AGE.

This new idea is for the benefit of the great army of fans who would like to know more of the men and women who supply their entertainment over the ether waves. If you like this new feature, help us make it a permanent success. It is entirely up to you, Mr. Radio Reader.

So get busy! Read the rules printed below, get your friends together and decide on your favorite Radio Man (or Woman.) Then clip the coupon and send in your vote. Watch early issues of RADIO AGE for results of the first Radio Popularity Contest ever conducted.

Rules of the Contest

1. Readers of RADIO AGE are entitled to as many votes as they wish. Each coupon counts for one vote, and only those written on blanks clipped from RADIO AGE will be honored.

2. The candidate must be a person identified with the Radio World and may be an announcer, entertainer, inventor, manufacturer or, in fact, any person in any manner connected with the great radio industry.

3. State clearly the name of your favorite, his classification (announcer, enter-

tainer, etc.), the station from which last heard and approximate date when you were entertained.

4. Send in the coupons at once. First tabulations of results will appear in the September RADIO AGE and monthly thereafter until a grand winner is decided upon.

5. Radio entertainers are usually announced through the microphone, but it is suggested that in the event voters do not know the name of the announcer, they should give only the station from which he announces.

POPULARITY CONTEST COUPON

Harry Aldyne,
Contest Editor,
RADIO AGE,
500 N. Dearborn St., Chicago.

I wish to cast my vote for:

Name of favorite

Classification

Station..... Approx. date heard

My name

My address

Three Tube Wizard Circuit

By JOHN B. RATHBUN

IN RESPONSE to the many inquiries for a diagram of the Wizard circuit with two stages of audio amplification, I have prepared the following hook-up. Approximately fifty sets have been built as shown and have given very good results on both local and distance reception, loud speaker operation frequently being attained on stations located 500 to 800 miles from Chicago under favorable conditions. With the local stations such as WGN, WDAP and KYW it was necessary to turn down the audio tubes very low because of the tremendous volume obtained with the speaker.

At the left is the detector portion of the circuit which is already familiar to many of our readers. This consists of the standard fixed coupler (FC) with the tuned secondary controlled by the single variable condenser (C1). At this point it might be well to mention that the number of turns in the secondary coil of (FC) are somewhat dependent upon the length of the aerial used, but for the average aerial of

about 60 feet, it will be found that 60 turns on the secondary will give very good results. The turns on the primary are not critical, but with UV201A tubes or the UV199 tube I have found that 28 turns are all that is necessary to cause proper regeneration without working the filament at too high a temperature. The greater the number of turns on the primary, the lower we can turn down the filament, that is, up to a certain point. Details of this coil were published in the April issue of RADIO AGE.

For the proper control of the regeneration a vernier rheostat (R1) and a 200-ohm potentiometer (PO) must be used. A variable pencil mark type grid leak (GL) and a 0.00025 mf grid condenser (GC) are clearly shown. Either the UV201A, C301A, UV199 or the C299 tubes give very good results both in the detector circuit and in the audio stages, but I do not recommend either the WD11 or WD12. The latter tubes tend to broaden the tuning and thus reduce the selectivity.

After much tinkering around with the audio stages, I have found that only two phone jacks are desirable, one two circuit jack after the detector tube at (J1) and one single circuit jack (J2) placed after the second audio stage. Thus, by turning out the audio stages by the rheostat (R2), we can plug into jack (J1) on the detector alone, or else can plug into (J2) and use both amplifier stages. The degree of volume can then be controlled by the single rheostat (R2). An intermediate stage jack after the first audio stage introduces unnecessary complication.

A five to one ratio was used for both stages without appreciable distortion and with very good volume. Slightly greater volume can be attained by using a ten to one ratio for the first stage (1) and a five to one ratio for the second stage (2), but with increased chances of distortion. In the diagram I have marked the transformer terminals at the ends of the coils and also the primary coils (PRI) and the secondary coils (SEC). On some trans-



WHEN RADIO BUGS GET TOGETHER

You have a congregation of experts such as shown in the above picture. They are the operators and announcers of Station WIP, located on Gimbel Brothers' Building, Philadelphia, Pa. From left to right: "Uncle Wip," announcer; Edward Davies, station director; J. G. Pollock; Charles Weir (rear), Samuel Kale; Charles Goudy, chief operator; W. P. Saunders, announcer. Between themselves they manage to make WIP one of the most popular stations in the East.

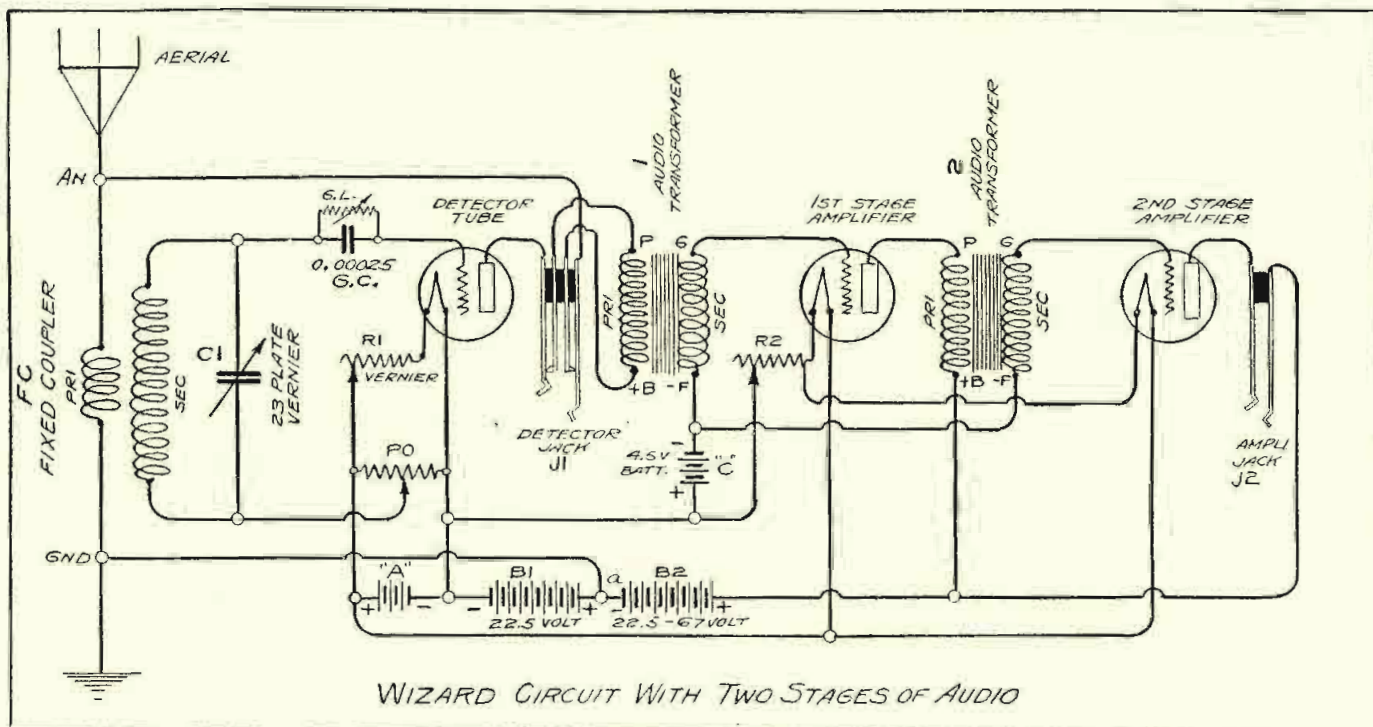

formers only the primary and secondary are marked, as often transformers are not critical to the location of the grid connection (G). With other transformers particular care should be taken to connect the post (G) of the transformer to the grid post of the socket.

According to conventional layout, the "B" battery (B1) is a 22.5 volt battery with the positive tap at (a) connected to the plate of the detector tube. However, we will obtain better signal strength of (B1) is a 45-volt battery but with a considerable increase in the cost. The connections are the same in both cases, and this should not cause any confusion in the hookup should a 45-volt battery be adopted.

Plate battery (B2) for the audio tubes is connected in series with battery (B1), the negative (-) of battery (B2) being connected to the positive (+) of (B1). The voltage of (B2) should be so chosen that the total voltage on the plates of the two audio tubes is from 67.5 to 90 volts for maximum amplification. The total audio plate voltage is the sum of the voltages of batteries (B1) and (B2), hence if (B1) is a 45-volt battery then (B2) should also be a 45-volt battery if we wish to obtain a total of 90 volts on the amplifiers. If 22.5 volts is used at (B1), then a voltage of 45 volts at (B2) will give us 67.5 volts on the audio tubes, and to obtain 90 volts total we must make (B2) a 67.5-volt battery.

When a total plate voltage of 67.5 volts or 90 volts is used on the plates of the amplifier tubes, a "C" battery must be used to "bias" the grids of these tubes with a negative charge. The negative terminal of the "C" battery is connected to both (-F) terminals (secondaries) of both transformers, and in this way a continuous negative charge is established on the grids which gives maximum amplification, and a minimum of distortion and plate current consumption. The "C" battery is simply

a very small flashlight battery and can be connected permanently in the circuit without a cutout switch, since there is little flow of current under any conditions. A two-cell, three-volt battery can be used for a plate voltage of 67 volts, while a three-cell, 4.5-volt battery is best used with 90 volts on the plate. The higher the plate voltage on the amplifier tubes, the higher must be the "C" battery voltage.

Radio Compasses for Leviathan

Radio compasses, or direction finders, have been installed on the Leviathan and SS. President McKinley, of the Shipping Board, eight ships of the Admiral Line, nine of the Matson Navigation Company, and four of the Standard Oil Company, it was recently announced by the Department of Commerce.

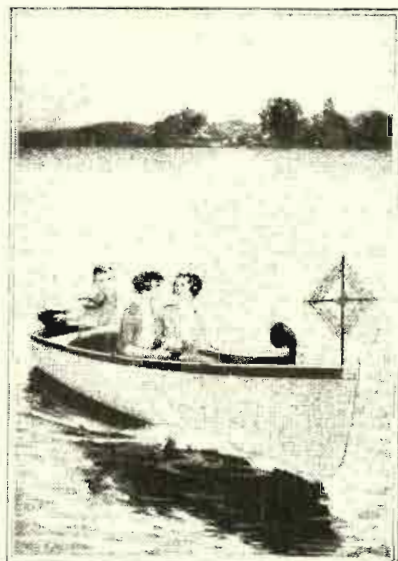

Ground May Supplant Ether

The recent experiment at the University of Illinois which utilized the ground as a better means of radio communication than through the so-called ether, shows that obstacles are of temporary duration in the progress of radio.

Transmission tests during the war were successful when utilizing the ground instead of the air. Because of the stress of the war, the experiments could not be carried out at that time and it is just possible that the work now being carried on at the Illinois school is along these lines.

Experiments in ground transmission have received the serious attention of American, British and French scientists and while they were conducted privately, the results showed a big advance since the discovery of the coherer as a detector of electro-magnetic waves and the discovery of the rectification of a particular family of crystals. This is a big step toward greater efficiency, but what does this mean in comparison to the even greater discovery of the modern vacuum tube?

Science, in all its branches, is but an orderly progress toward the more efficient new discoveries which present themselves in rapid succession, until a particular branch of the art suddenly evolves into something extraordinary—a new conception—and then the smaller refinements take place as before.

It is not at all surprising to a radio engineer to hear of someone discovering something new, for this is the age of discovery and great things will be accomplished in the years to come.

**ARE YOU SAVING
THE RADIO AGE
DATA SHEETS?**

Recharging Storage Batteries From 32 Volt Lighting System

ALL types of storage "A" and "B" batteries may be readily and successfully recharged from a 32 volt farm lighting system. We are printing herewith a diagram showing how the "A" and "B" radio battery may be recharged by merely using the house lighting receptacles connecting with a cord and 32 volt lamp in series with the battery.

Therefore it is advisable to purchase the 24 volt "B" batteries where the charging device is that of a 32 volt house lighting system. The accompanying diagram shows the manner in which a 48 volt "B" battery may be recharged; that is by charging only half or 12 cells at one time, then shifting the leads to the additional 12 cells or 24 volts.

A fully charged radio "A" or "B" battery will have a specific gravity reading of 1.275 to 1.300 and may be considered discharged when it has a specific gravity reading of 1.175. For best radio results the battery should be recharged when it has a reading of 1.200.

It is possible to recharge higher voltages from a 32 volt lighting system; that is, batteries using up to 500 volts on power amplifiers and transmitters, by following the instructions on the attached diagram. Any multiple of this system may be used, such as 48, 72, 96 and 120 volts.

High Charge Current Needed

Owing to the very low charging current needed for a "B" battery the efficiency of a charging plant is not lowered to any great extent by charging it from the plant storage batteries, rather than from the generator. However, a high charging current is needed for an "A" battery and it should only be charged while the generator is being operated to charge the plant battery. After obtaining the polarity make sure that the positive of the charging line is attached to the positive of the 6 volt storage battery as indicated on the attached diagram for recharging "A" batteries.

"C" Battery Voltage

A NUMBER of radio set owners today require the use of a "C" battery. Those who possess storage "B" batteries need not purchase a separate cell or battery for this purpose.

We are printing two diagrams showing the manner in which negative "B" taps can be taken off a storage "B" battery and used for "C" battery purposes.

(Continued on next page)

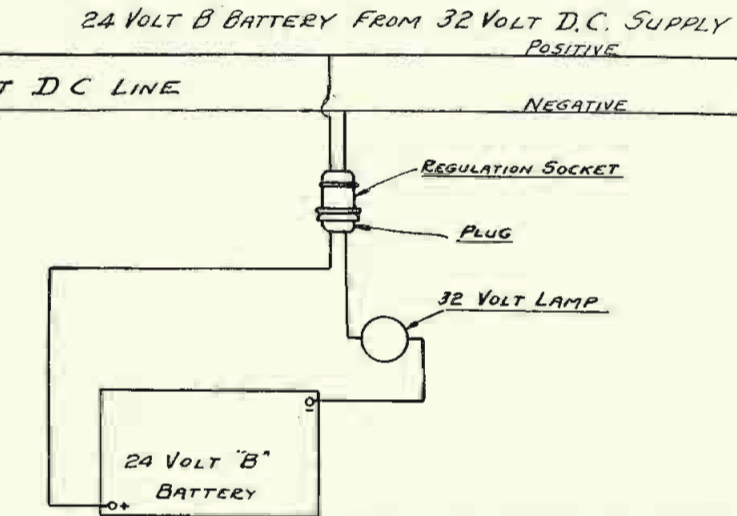

DETERMINE POLARITY OF LINE BY PLACING CHARGING LEADS IN A GLASS OF WATER & BUBBLES WILL ARISE FROM NEG LEAD IT IS VERY IMPORTANT THAT THE NEG. OF THE BATTERY CONNECTS TO THE NEG. OF THE CHARGING LINE & THE POSITIVE OF THE BATTERY TO THE POS. OF THE CHARGING LINE

Figure 1. The above diagram shows the connections and necessary parts for charging a 24 volt storage B battery, if you happen to live in a place where 32 volt DIRECT current is available. A 20 or 25 watt lamp should be used as indicated to regulate the charging rate.

Select the socket which is most convenient for charging the battery. Screw in an attachment plug, being careful that the two wires do not touch each other. Determine the polarity of the charging wires by placing the ends of the attachment leads in a glass of water. Bubbles will form around the negative wire. If both leads show bubbles, the negative lead will give off a far greater number. After determining which is the positive and which is the negative lead, put some-kind of a distinguishing mark on the negative and always use this particular socket when charging.

To properly recharge the batteries the positive of the charging line must go to the positive of the battery. This should be easy as you have marked your charging line, and the positive poles of the storage "A" and "B" batteries are usually plainly marked.

For Recharging

When recharging "B" batteries, use a 32 volt 25 watt or a 32 volt 15 or 20 watt lamp. It is possible to recharge only 24 volts of "B" battery at one time.

CHARGING RADIO "A" BATTERY FROM 32 VOLT SYSTEM

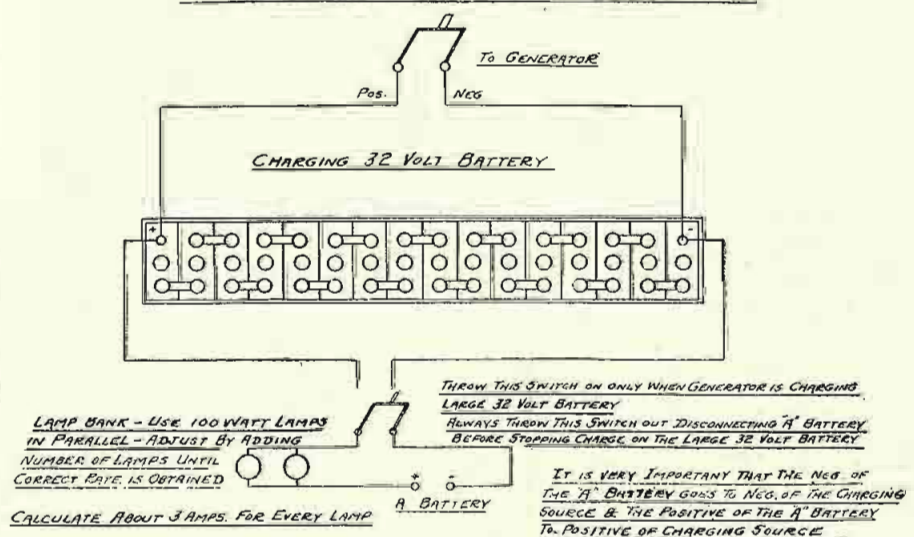

IT IS VERY IMPORTANT THAT THE NEG. OF THE "A" BATTERY GOES TO NEG. OF THE CHARGING SOURCE & THE POSITIVE OF THE "A" BATTERY TO POSITIVE OF CHARGING SOURCE

Figure 3. You can charge your A battery just like a regular charging station in the manner shown herewith. The charging is done at the same time as the household batteries are recharged. The A battery should not be charged separately.

The voltage for "C" batteries varies from 2 to 6 volts on the ordinary receiving set. If 6 volts are required, it is necessary to use three storage cells of the "B" battery, if 4 volts then two cells, 2 volts one cell.

Diagram 4 will answer the purpose for most cases. Note that the three end cells of the battery have been divided from the balance of the 24 cells. This hookup gives an individual six volt, four volt or two volt battery as a "C" battery. In rare cases it may be that more than 6 volts will be required for "C" battery. If so then the required amount of voltage may be tapped off in accordance with diagram 4 for "C" battery.

When the battery requires recharging, the "C" battery cells should be thrown in series and the entire battery recharged just the same as though it were a standard 48 volt "B" battery.

Diagram 5 shows the "C" battery as a part of the regular "B" battery and is recommended where a radio set is so wired that the negative "A" and negative "B" battery are connected together.

For proper operation as a "C" battery the negative "B" lead is extended to any number of cells which are to be used as a "C" battery. In this particular diagram, 6 volts or 3 cells are utilized. However, this hookup should not be used where the negative "B" battery lead goes to the positive "A." Diagram 4 should be used for this purpose.

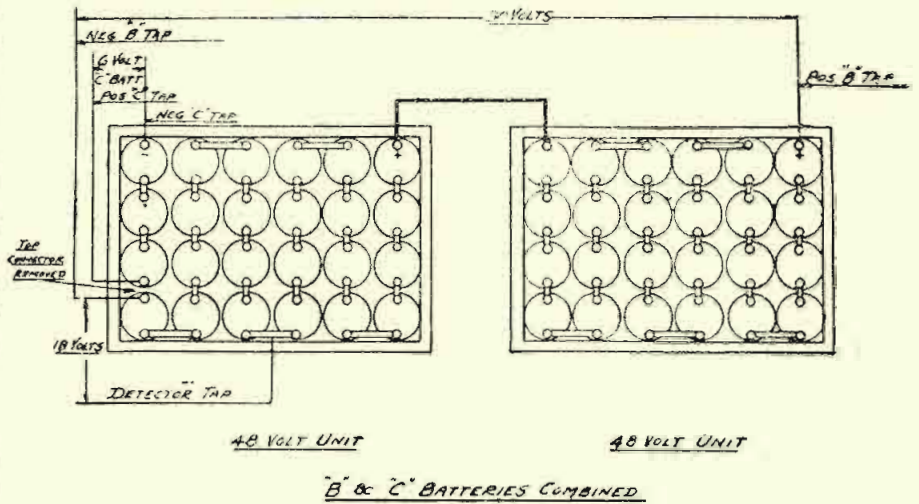
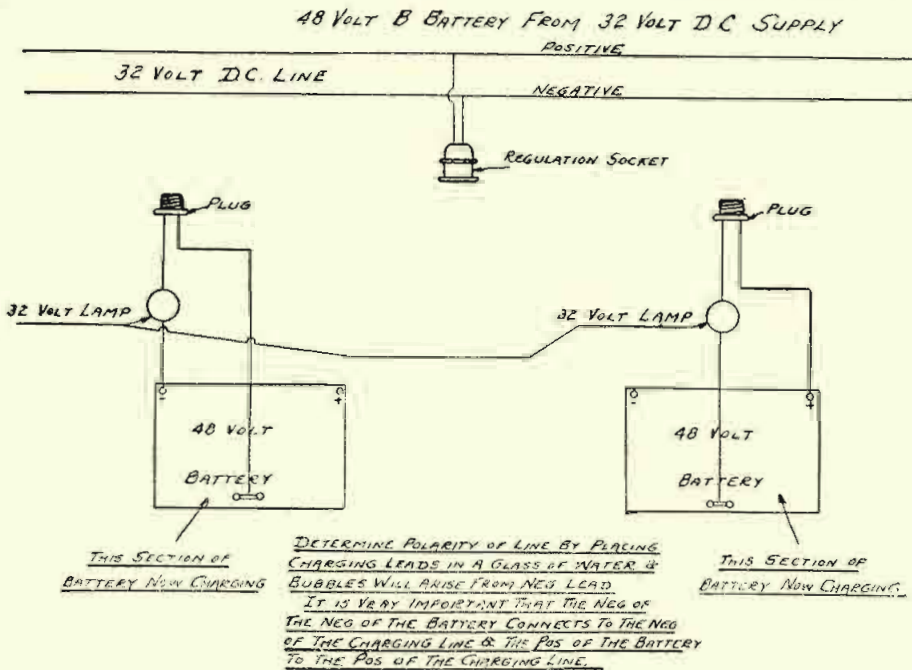

DIAGRAM SHOWING HOW "C" BATTERY VOLTAGE IS TAPPED FROM REGULAR "B" BATTERY

THIS IS THE RECOMMENDED DIAGRAM

Figure 4. The circuit diagram shown above provides for a method of obtaining C battery for the amplifiers. This set of connections should be used when the negative B is connected to the positive A terminal.

Figure 2. The larger types of storage B batteries are charged in the manner shown below. Note especially the method of determining the polarity of the line as lettered on the diagram.



DETERMINING POLARITY OF LINE BY PLACING CHARGING LEADS IN A GLASS OF WATER & BUBBLES WILL ARISE FROM NEG LEAD. IT IS VERY IMPORTANT THAT THE NEG OF THE NEG OF THE BATTERY CONNECTS TO THE NEG OF THE CHARGING LINE & THE POS OF THE BATTERY TO THE POS OF THE CHARGING LINE.

Radio Enlists Nature's Aid

Recent reports from England describe an experiment which may cause some American broadcasters to stop and consider whether they have developed the art of radio entertainment to its highest degree of perfection.

The dispatches stated that British listeners were treated to a concert by nightingales and other native songbirds. The manager of the broadcasting station, who conducted the test, had the microphone cleverly concealed in the native haunts of the birds so their singing might be enhanced by the natural setting. The plan is not very different from that already accomplished and popularized by means of the motion picture camera.

Explorers have gone out into the forests and fields for the purpose of photographing wild animals in their natural surroundings. Why should not radio be utilized to accomplish for the ear what the camera has done for the eye? It would appear far better to allow the birds to roam about with absolute freedom and enjoy their singing than to keep them caged.

Moreover, it would be a rare treat for the city dweller who does not have either the leisure or the facilities to enjoy the country.

What About Europe?

What progress is Europe making in the radio field? RADIO AGE will give you the latest steps in European broadcast and reception advances. The first of an interesting series begins in this issue, page 28.

Heart Throbs Via Radio

A letter received by Station WBZ leads us to believe there are more ways than one to get heart throbs by radio. It is true they have been transmitted, but this particular letter states that the program transmitted from WBZ by one of its talented musicians caused an increase of heart throbs to a farmerette in Canada, who promptly sent in a proposal. The musician answered, "Thanks, but I'm

already attached."

In another instance an announcer got all mixed up trying to put an artist's name across. In desperation he approached the artist—a pretty girl—and said, "Of all the names—why should you have such a tongue twister? Why don't you change it to something easy—my name for instance?" The girl called his bluff and made the announcer break down and confess he was already married.

Gigantic Radio Net Ready for Emergency

[COPYRIGHT: 1924]

WASHINGTON, D. C.—A gigantic radio net of transmitting stations is being developed throughout the United States, to connect eventually every city and town, and practically every household, as far as reception alone is concerned.

Under the supervision of the Department of Commerce, this means of disseminating important information, especially in times of emergency, would reach more individuals than there are telephone subscribers and a larger number than the combined newspaper readers of the nation. For transmission alone it would link up more radio stations than there are telegraph stations, and, considering that they would broadcast, the distribution would be available to all owners of radio sets; almost to every citizen.

The operation of this "net" would be instantaneous and direct to all parts of the country. Secretary Hoover's administration of matters radio would be broadened to the Republic at large in any hour of need.

Partially in Effect Now

This proposed radio net is partially in operation today, with the number of broadcasting stations now increasing each week, and fans estimated anywhere between five and twenty millions. But despite its growth the present system transmits only news and entertainment at scheduled intervals. What the Government wants ultimately is a system of stations that, in emergencies such as a declaration of war, the call to arms of the nation's man power or the disruption of continental communications and traffic lines, could be called on to take the air either locally by district groups or throughout the country simultaneously, and handle urgent traffic.

Details of such a gigantic scheme, the like of which has never been attempted anywhere, are already being worked out by the Department of Commerce with the close co-operation of all radio interests. The germ of the idea was started at the Amateurs' Convention in Chicago last fall, when representatives of their organizations offered to co-operate with railroads after regular communication systems failed. This work has already gone in to the test stage.

In several instances operating amateurs have aided in the transmission of railway messages successfully. The American Radio Relay League has appointed a committee to work out details. The league co-operated with the Pennsylvania System between the Atlantic Seaboard and the Mississippi River recently in an emergency test, to the gratification of the General Superintendent of Telegraph. Other railway systems have declared their desire to establish such an amateur radio auxiliary system in anticipation of a failure of their wire communications or the need for additional terminal and receiving stations along their rights of way.

18,000 Amateurs Help

The activities of between seventeen and eighteen thousand licensed amateurs, all owning listed transmission stations and all code operators, are only one phase of the general scheme of linking radio nationally. Most of the telegraph and telephone systems of the country are willing to co-operate, if the need arises, but some of them declare that interruptions in their established lines of communications are so infrequent that the necessity of using radio as an auxiliary is not needed.

Co-operation of all interests is reported

from Seattle, New York, Atlanta, and Baltimore supervisors, where district emergency organizations are being formed. The Associated Press and the United Press have expressed considerable interest through their desires to supply newspaper clients with current news when regular lines of distribution fail. Details of a general national plan, with special local provisions, are being developed by the radio section of the Commerce Department at Washington.

The Radio Section of the Department of Commerce and its nine district supervisors, stationed in Boston, New York, Baltimore, Atlanta, New Orleans, San Francisco, Seattle, Detroit and Chicago, are attempting to co-ordinate the various elements of the proposed national radio net. The Post Office, Agricultural Department, and the Army and Navy are also interested. Not long ago, the chief supervisor of radio sent communications to all field supervisors directing them to make a survey of radio facilities in their districts, ascertaining the possibilities of hooking up all stations in an emergency, and the attitude of the business, railway, communication and other interests.

Replies received from practically every district show that the amateurs, manufacturers, broadcasters, railways, newspapers, civic interests, and even the telegraph and telephone companies are ready to co-operate. Many of them are anxious to test the proposed plan in an effort to establish a reliable secondary or emergency communication system.

Given Wave Lengths

The Commerce Department has authorized both amateurs and broadcasters to transmit on assigned wave lengths in emergencies, under the direction of their district supervisors. It is even suggested that licenses of stations where operators are on duty specify that the transmitter must be held in readiness to serve the community or other interests in the event of public need.

Supervisor Beane of the Ninth District, with offices in Chicago, has probably progressed further in his district than any other supervisor. He has not only secured the co-operation of practically all radio stations throughout the middle west, but has had several practical demonstrations, indicating the aid of such a voluntary radio service. Recently he called a conference on the subject, at which representatives of all branches of the art and industry were present. He reports that amateurs stand ready to handle two-way communication for railways; broadcasters volunteered to serve as point-to-point stations using CW, co-operating with amateurs for delivery of messages. It was suggested that press dispatches be handled by voice for localities not lined up for code point-to-point transmission.

Secretary Hoover is said to have obtained the hearty co-operation of President Coolidge in lining up the radio fans for the common good.

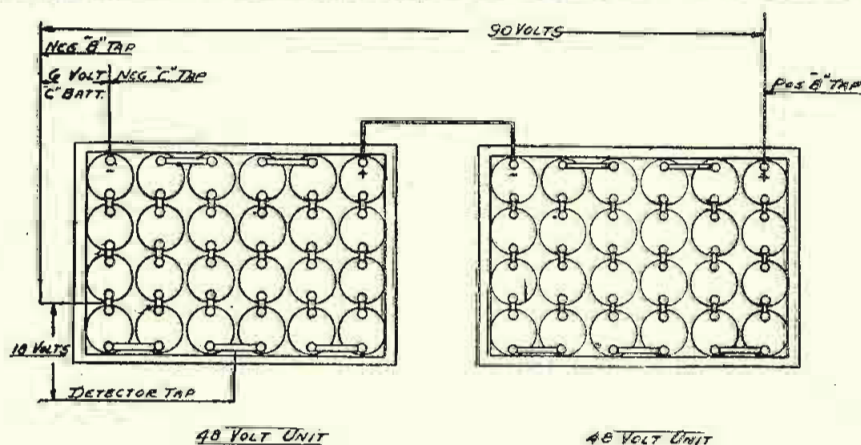

*"B" & "C" BATTERIES COMBINED
ON RECEIVING SETS WHICH CONNECT NEG. B TO NEG. A IT IS NOT
NECESSARY TO OPEN TOP CONNECTOR BUT USE AS SHOWN ON DIAGRAM*

*DIAGRAM SHOWING HOW "C" BATTERY VOLTAGE IS
TAPPED FROM REGULAR "B" BATTERY*

Figure 5. Another method of obtaining C battery voltage without opening any connections on the battery unit. This set of connections is used, only when the negative B is connected to the negative A battery.

Radio In Other Lands



Nations of World Gradually Adopting Radio

Washington, D. C.—General interest in radio, especially in broadcasting, has not only developed in this country, but its popularity has circumnavigated the globe from west to east, and is now going over the top and bottom. Recent reports indicate that this means of universal and rapid communication has reached the northern and southern extremities of the world.

Literally radio now reaches from "Greenland's icy mountains to India's coral strands," and even to the southern tips of Africa and South America.

Denmark is installing four transmitting stations in Greenland to communicate with Iceland and the main land of Europe; the Radio Club of Bengal, at Calcutta, India, is licensed to broadcast, and has installed a powerful receiving station which brings in London broadcasts.

Publicity and advertising in Chile have increased radio interest and nightly programs are sent out for urban and rural residents; while in South Africa arrangements for the broadcasting of music, instructions, etc., are planned for the natives by stations in Durban, Johannesburg, and Cape Town.

Unknown in Sicily

Radio, however, is still unknown in some countries, such as Sicily, barely introduced in Portugal, and slow to develop in Japan, despite the fact that this novelty-loving race seized upon the phonograph and camera with great interest. In other lands it is prohibited, in Jamaica, for instance. Operations are controlled by the governments in England, Germany, Denmark, Spain and Lithuania. In some countries foreign interests are striving to secure a monopoly, according to consular reports received by the Department of Commerce.

Although practically every American from the age of seven to ninety-seven knows considerable about radio, there are still countries whose citizens do not know what the word "listening-in" means, and few of them have ever tuned in a set. In Sicily, for example, the term "radio" usually means a new kind of talking machine, although perhaps there are a few who know it refers to wireless telephone, the use of which is forbidden by the government.

Out of a population approaching 2,000,000 citizens, the consul found only three of those interviewed who knew

Editor Leaves for Europe to Make Radio Survey

Frederick A. Smith, editor of RADIO AGE, left for an extended trip to Europe early last month to make a survey of radio conditions and prospects abroad.

During a two months' stay in all the important countries of Europe, Mr. Smith will send exclusive dispatches which will be published in RADIO AGE. These will give intimate insights into conditions as they actually exist "over there," as well as the real nature of the future of radio broadcasting and reception in principal European countries.

Mr. Smith is a former war correspondent and is therefore familiar with the countries through which he is traveling and observing for RADIO AGE. His stories will be illustrated by pictures taken by himself.

The principal countries to be visited by Mr. Smith will be the British Isles, France, Belgium, Holland, Germany, Switzerland, Czecho Slovakia, Italy and a few others.

"Many American radio fans are now receiving European broadcasts regularly," Mr. Smith said before his departure. "Communication between the two continents is becoming easier every day.

"Because of perfected radio sets and the consequent development of international radio communication, Europe will be made more of a neighbor to America. Therefore interest in what Europe is doing in the line of radio activities will be stimulated and the fans of both continents united in a closer bond of common interest. What one group is doing will soon be of utmost importance to the other group across the sea."

With the idea of creating a department of international interest, RADIO AGE in this issue begins a department known as "Radio in Other Lands." Items concerning radio development abroad, including Mr. Smith's dispatches, will be printed in this section. Correspondence is invited from home fans as well as those in other countries,

what he wanted when he asked for tubes for a radio set. In the north of Italy, there are said to be a few hundred receiving sets which receive Eiffel Tower broadcasts, and probably Berlin, Brussels and London. The Italian government is known to have issued only four permits for broadcast receivers in Palermo, and it is doubted if more are authorized.

Radio Rare in Portugal

A few months ago, radio was scarcely heard of in Portugal. There was a complete lack of interest even when the papers reported that London was broadcasting and that America had been heard. There seemed to be a disposition to frown on such things as copper wires stretched from house tops through the medium of which far distant voices and sounds of gay music were mysteriously conjured into reality. One day a local shop imported a three-tube set from France and exhibited it in a window.

The public inferred that the "thing to do" was to install a radio outfit. The machine was promptly marked "Sold," and ever since a dozen or more people have been before the window. Lisbon woke up to the possibilities of listening-in. Shortly after an evening paper devoted a column to the possibilities of catching foreign programs, the heading stating in large type:

"Here in Lisbon, we can dance to the sound of jazz music being played in London."

Popularity grew by such leaps and bounds, that the "Radio Academia de Portugal" was founded in Lisbon. This is an amateur organization composed of some forty members. The instrument now operated by this club has two head-pieces and one loud speaker which so far *whispers* rather than *speaks*.

Opening Up in Spain

In Barcelona, Spain, a movement to develop the radio telephone has started, which may mean the opening of the market for apparatus to all countries. An association of radio dealers seeks to obtain a government concession to broadcast, which may be granted, as restrictions are decreasing and the Marconi Company is becoming interested. During the great war wireless operation was prohibited in Spain, and even after peace was established offenders were sometimes arrested.

Recently, however, a proposal to establish wireless stations without government permission or regulations was suggested; or the alternative, that government concessions be made to operators. There are today about 1,000 receiving sets in Spain. This shows a fair interest.

Regular broadcasting is expected to commence in Austria on July 1, 1924, a concession for the purpose having been granted to a group composed of banks and electrical firms. The Post and Telegraph Administration will soon issue radio regulations on the basis of the new contract.

Marking the inauguration of radio activities in the Canton of Zurich, the first broadcasting station was put into operation on June 1. This station is being erected by the Swiss Radio Association, the transmitting apparatus being mainly of American manufacture.

Radio for Military Use

Two state-controlled radio stations are in operation in Lithuania, one located at Kovno, and used exclusively for military purposes, and the other at Memel, operated for both military and private communication. Preparations for broadcasting of concerts are being made under the supervision of the Ministry of Communications, equipment having been purchased in France. A bill to regulate the use of radio apparatus in Lithuania has been placed before the Parliament.

The Netherlands Indies government intends to erect two new wireless stations in Sumatra, one of which will be located at Bougkalis, a free port and transfer point for that section of Sumatra. The erection will probably begin in July, and upon its completion the installation of a station at Belawan will be undertaken and should be in operation some time during the fall of this year.

A recent German decree, regulating wireless communication, stipulates among other things that the erection and maintenance of wireless sending and receiving apparatus for communication in any form may only be carried on with the permission of the National Telegraph Administration.

Austria Wakes Up

The demonstrations of broadcasting by the Technological Trade Museum have made radio very popular in Austria, Assistant Trade Commissioner F.M. Zwickel reports to the Department of Commerce. In view of the great economic and social importance of broadcasting, which has created a new industry in Austria, a permanent service has been undertaken by the Oesterreichische Radio-Verkehrs-Aktiengesellschaft. At present this company cooperates with the Austrian Postal authorities in the matter of transmission.

It is proposed to use the radio installation on the building of the War Ministry for the first broadcasting station. Experiments have already been made with a normal sending power of one kilowatt. Different wave lengths will be used; on March 25 broadcasting took place for the first time and on a 1200 meter wave length. On Easter another trial took place, and regular broadcasting is to be started on July 1.

It is planned to broadcast general programs comprising musical performances, lectures, fairy tales for children, weather, market and exchange reports. Economic data, intended for a small clientele, will consist of foreign prices of commodities and stocks, tariff rates, freight rates, and other important economic reports. These reports will be given in code, which will be changed every week so as to avoid listening in by those not entitled to the service.

The tax for a radio set will be 10 gold crowns collected by the federal post-offices. To cover the expenses of the broadcasting station, every owner of a radio set will have to pay a yearly fee of possibly 50 gold crowns. This fee will be reduced considerably in cases of hospitals, associations and schools. Motion picture houses and other public places, where radio is used for advertising purposes, will pay a higher rate.



REACHING THE VOTERS THROUGH RADIO

Kadel & Herbert.

French candidates for public offices are now using radio extensively in their campaigns for election. A candidate has entrenched himself in the automobile shown above, and his speech is being broadcast for miles by means of the radio microphone attached to the top of the car. Quite a crowd has gathered to witness this novel electioneering method.

Here's the Best Hookup Book Ever Printed!

RADIO AGE ANNUAL ILLUSTRATED for 1924

SPECIAL FEATURES

- | | |
|----------------------------------|------------------------|
| Simple Crystal Set | Reinartz |
| Long Distance Crystal Set | Hagnes |
| Your First Tube Set | Hopwood |
| Kopprasch Circuit | Cockaday |
| Erla Reflex | Neutrodyne |
| Kaufman Tuner | Three-Circuit Tuner |
| Grimes Inverse Duplex | Super-Heterodyne |
| Two Stage Amplifier | Simple Radio Frequency |
| Junior Heterodyne | Ultra Audion |
| One Tube Loop Aerial | Rosenbloom |
| Wave Trap, Filter and Eliminator | Push-Pull Amplifier |
| Loading Coils | Portable Reinartz |
| Transformers | Wave Meters |
| Battery Charger | Two-Circuit Crystal |

Forty-five Complete Articles Dealing with Every Phase of Radio. One Hundred and Fifty Isometric Picture Drawings and Diagrams. Dozens of Helpful Hints.—The Best Hookup Book Ever Printed

Published by Radio Age Inc.
500 N. Dearborn Street
Chicago, Ill.
PRICE ONE DOLLAR

Detach this Coupon, fill in, pin a Dollar Bill to it and mail TODAY!

If Paying by Check Add 5 Cents for Exchange.

RADIO AGE, Inc., 500 N. Dearborn St., Chicago, Ill.

Gentlemen: Attached find One Dollar (\$1) for which kindly forward me by return mail one copy of RADIO AGE ANNUAL FOR 1924. If not satisfied with it I will return it to you within three days and you will refund my money.

Name

Address

City State

RADIOTORIALS

CONGRESS has adjourned without acting either way on pending radio legislation, according to the news dispatches from Washington.

Unless a special session is called, which does not seem likely at this time, radio will be untouched by legal attachments until next year, at least.

The two most important measures which were shelved by the adjournment of the well-meaning but unusually deliberative governmental bodies are the White Bill and the Dill Bill. The first proposes to establish governmental control over radio broadcasting, reception and perhaps the industry eventually. This bill, while not viciously attacked, did not go through because some representatives of the people wanted to know just why such a young and untried industry as radio should suffer the bonds of law so soon. Accordingly, it is unlikely that the White Bill will ever become a law—so the fans may rest assured they will not be hindered for some time to come in that respect.

The Dill Bill is more far reaching in its scope. It is liberal and fair-minded. It asks that the copyright laws be amended so that copyrighted music can be broadcast without the payment of levies to the music publishers. Although this bill has been opposed at every step by huge organizations and moneyed interests, as well as several prominent music publishers, it was about to be passed with a fair majority when Congress adjourned.

There is still hope for the Dill Bill, then, and we hope that when it finally reaches the President's desk it will represent the result of a fair compromise between the broadcasters and the music publishers, in the interests of the fan who listens to broadcast music and helps the sale of the published article by buying the pieces he likes best.

Government legislation, we believe, appears to be the only means yet suggested which offers any kind of a solution to the bitter enmity between the broadcasters and the so-called music "trust."

Radio's recent jump to prominence in official circles such as Congress is only one indication of its growing importance. Big capital interests, legislators and public spirited citizens are realizing more and more that radio will some day control the destinies of our nation; and accordingly they are setting out to prevent its too sudden growth to an unwieldy influence. Quick government control, the legislators aver, will prevent radio from becoming a menace instead of the help and pleasure it should be.

In a measure these radio-legislators are right. Something must be done to prevent the air from becoming a bedlam of tangled wave lengths. Something must be done to prevent the ether from being clogged with propaganda and useless stuff that will discourage interest in the world's latest miracle.

If legislation works along those lines, it will be beneficial. But if it takes a political trend, this country will see a united uprising of righteously aroused fans—lovers and promoters of the good in radio.

RADIO followers who are interested in the probable outcome of the maze of overlapping wave lengths which are now exasperating the fan with the small set will do well to read Mr. Pearne's article on short wave transmission and reception in this issue of RADIO AGE. Experts in the radio broadcast field are racking their brains daily in an effort to solve the problem of too many broadcasting stations and their effect on the amateur, who is growing tired of trying to tune out the stations he does not want to hear. If short wave transmission—or the broadcasting of programs in a wave band below 150 meters, will solve the problem, no effort should be spared by the big experimental stations to reach this desired state of ethereal bliss. Heretofore a wave band below 150 meters was considered practically useless; but, now experiments actually show that it may be the ultimate salvation of an overworked broadcast system. All of which goes to show that radio is only beginning to uncover its surprises.



IS THE SUMMER radio bugaboo finally being overcome? It looks like it. Radio manufacturers, broadcasters and even the fans themselves held their breaths during the first warm days of June, in fearful anticipation of what was going to happen to radio reception when the weather started to perform its seasonal antics. The radio legion remembered with a sigh that the few summers radio has seen have been more or less unsuccessful and the object of much harsh criticism. But they are beginning to realize that the radio bugaboo of former years was principally a state of mind and the result of overheated talk by those who didn't know how radio could be adjusted to suit the seasons. Stronger broadcasting stations, better sets and more technical information in the minds of the set users are making this a real Radio Summer and a pleasant one at that, with a surprising lack of such bugbears as static, weak broadcasting and the childish fear of lightning. Let's get together and end the summer in a blaze of radio success!

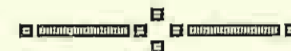

WHAT wonders radio has wrought! The thrill that accompanied the first transmission of a telegraph message shrinks into historic background when we think of how the deliberations of a huge presidential nominating convention were sent to a waiting world over the ether. The broadcasting of the Republican and Democratic national conventions last month marks a decided step forward in the radio world. These events show that there will be no excuse in the future for ignorance on the part of the masses, and that no great happening need be missed just because a person can't attend in person. The United States is being bound into one united and patriotic mind by the magic voice of Radio.

Pick-ups and Hook-ups by our Readers

The material appearing under the title "Pickups and Hookups by Our Readers" in RADIO AGE, is contributed by our readers. It is a department wherein our readers exchange views on various circuits and the construction thereof. Many times our readers disagree on technical points, and it should be understood that RADIO AGE is not responsible for the views presented herein by contributors, but publishes the letters and drawings merely as a means of permitting the fans to know what the other fellow is doing and thinking.

BACK in the May Pickups Pages, we printed a good-natured letter containing what Earl Fetty of Tekmah, Nebr., thought was a correction and contested one of the stations listed by Curtis Springer and Kenneth Fischer of Indianapolis, Ind. Now we appreciate this spirit of watchfulness of our readers and it is our sincere desire to have fellows keep their eyes open for errors in our pages and report them.

However, Mr. Fetty was in error, and we have no less than fifteen letters of various nature from scathing to gentle corrections telling us that our Pickups Pages are the "stuff" and not to let anyone tell us different. By that, we don't mean to criticize Mr. Fetty's correction—by all means *NO*. We thank him for his watchfulness, and hope the other DT's will keep alert likewise so that no one puts anything over on our section.

Some time ago the editor of RADIO AGE asked us how we could print all these lists without some kind of proof as to their authenticity and correctness. Our reply was that all of the radio fans are strictly honest when it comes to asserting

CONTRIBUTORS		
Kenneth Glass	Clarence B. Gannon A. J. Baumgardner	D. F. Howe
DIAL TWISTERS		
Name	Address	Circuit
Hilmar T. Boehm	636 Fifty-first Street, Milwaukee Wis.	Grebe
W. J. Waterson	Lorrain Avenue, Montreal, N., Quebec, Canada	Reinartz
Joseph A. Ratte	175 Lagauchetieres Street, Montreal, P. Q., Canada	Blooper
W. S. Stringall	Albion, Calif.	Crosley XJ
Irving Q. Miller	Tarrytown, N. Y.	Blooper

themselves on paper, and while they may exaggerate when they are verbally giving some story of a long distance reception, they always are very careful about convicting themselves as prevaricators when it comes to putting any such stories down on paper. The editor was a little skeptical as to our theory—but this proves quite conclusively that no fan attempting to enter the Dial Twisters columns will intentionally submit things that are not true, and clinch the whole business by putting his name to it.

We print Mr. Fetty's endeavor to get

himself out of the "mess," as he terms it, just to show you what good sports we have among our reading clientele:

RADIO AGE,
Gentlemen:

I am in receipt of a letter from A. E. Fischer in reply to my letter to you, published in your May issue, in which I stated that station KFSG was not authentic.

He informs me that it is operated by Aimee Semple McPherson, of Echo Park, Los Angeles, California, on 278 meters with 750 watts.

Now I got myself in wrong depending on you, and I'm passing the buck. How come it isn't listed in your broadcast list? For the Luvvamiike, square you and me both at the earliest possible date.

Yours respectfully,
EARLE FETTY,

Tekamah, Nebr.

So now we have a bakelite crepe on our hands, and about the only excuse we can give is that in spite of the fact that we maintain a special Washington News Service for the purpose of letting us know of changes in station calls and new licenses, the Department of Commerce puts one over on us once in a while by sneaking out a call or two that never comes to our notice. Now this happens to be one of them, and in such instances, we have to rely upon the interest of our reader friends to point out errors in the broadcasting lists. Our Editor even offers a free copy of RADIO AGE for every error reported. If you can find enough errors, you can get a year of RADIO AGE free.

The Pickups Editor wants to thank all those concerned, and all those who were kind enough to drop a card with the nota-

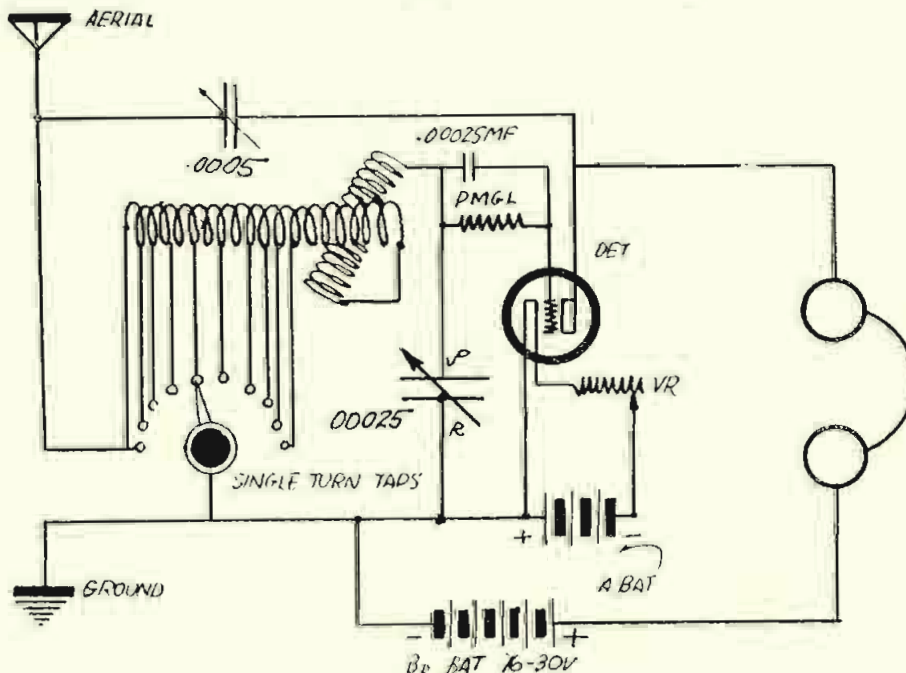

Figure 1. A diagram of the detector circuit devised by Kenneth Glass, using the Reinartz Audio Regenerator principle.

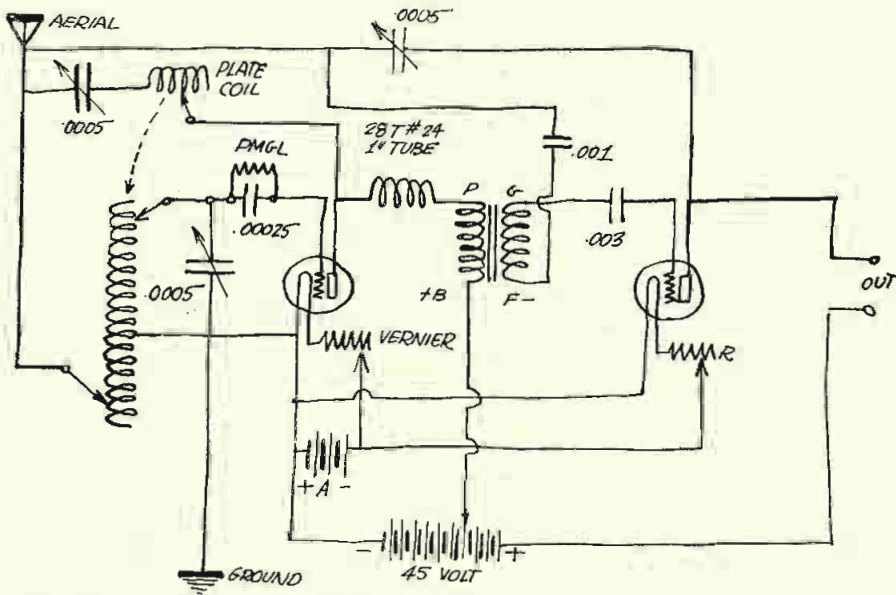

Figure 2. An exact reproduction of the sketch submitted by Clarence Gannon of Baltimore, Md., who gets results with the Reinartz Audio Regenerator hooked up as shown. This circuit uses the standard Reinartz coil.

tion, and hopes that this same warm interest in the Pickups Pages will continue.
—The Pickups Editor.

Last month we promised to print the letters which contained the suggestions and reports submitted by two of our reader friends who have built the Reinartz Audio Regenerator. Kenneth Glass has devised a way of making a one tube regenerator and describes his results in the following:

RADIO AGE,
Gentlemen:

I have read with interest your one night reception records published in the several numbers of RADIO AGE. I tried several times to see how many stations I could get one night, and found that Monday night seems to be when most of the stations in the East are on the air. I am enclosing my two best records of fifty stations each received on the nights of Monday, March 17th, and Monday, March 31st. I hope you will see fit to publish these, as I have noticed that most of your Dial Twisters are located in the Central States which I believe gives them a better chance for a record.

I have a one tube Reinartz Audio Regenerator. To this I have added a regular two stage audio frequency amplifier. Both of these records were made on two tubes. I am enclosing the diagram of my detector circuit, and I hope that these records are good enough to get me in the D. T. column.

Yours sincerely,
KENNETH GLASS.

144 S. Mt. Vernon Ave.,
Uniontown, Pa.

The following list is the record of stations heard by Mr. Glass on the Regenerator in 5 hours and 20 minutes of listening, Mr. Glass explaining that he stopped at 11:15 P. M. on account of static.

Kenneth Glass
144 South Mt. Vernon Avenue
Uniontown, Pa.

Stations heard Monday, March 17
WCAU, WBZ, KGO, KDKA, WRC,
WCAE, WMAQ, WGY, WNAC, 8DBH,
8BRM, WBT, WOR, WABL, WJAK,
WDAR, WCAP, CFCF, WDAF, WWJ,
WHAN, WPAB, WJAS, WAAM, WEAN,
WEAF, CFCF, CFCF, WOO, KSD, WSB,
WOS, WBAV, KOV, WFI, WFAA,
WSAI, WHAZ, WCX, WBBG, WMC,
WRAX, WBBN, WLW, WTAS, WBBF,
WCB, KFKX, KFOP, WTAX.

Stations heard Monday, March 31
KDKA, WBZ, WDAR, KGO, WNAC,
WABL, WEAN, WOC, WWJ, KOV, WOO,
WEAF, WCAP, WJZ, WOR, CFCF,
CFCF, WGY, WBAK, WBBM, WPAB,
WTAS, WKAR, WBBR, WGR, WLW,
WOS, WRC, WSB, WHN, WCB, D,
WPAH, KSD, WCX, WFAA, WCAE,
WBAV, WDAF, WBBG, WBBF, WJAS,
WMC, WOAW, WBAP, WBAH, KFOP,
KFKX, WRAX, KFI, KHJ.

Semi-daylight reception of KGO both times VERIFIED. Also KFI and three stations from Texas. I have also verified reception of KHJ.

Does that make him a Dial Twister? It sure does. We thank him for the report, and print his diagram showing the connections of the detector circuit (regenerator bugs, please notice) in Figure 1.

Now herewith we present the suggestions and results of another fan's experimenting with the same circuit. He uses a circuit more like the original, and gets good results as well.

RADIO AGE,
Gentlemen:

Referring back to the Reinartz Audio Regenerator, described by Felix Anderson in the February, 1924, issue, I would like to make a few suggestions:

- (1) For higher waves 400 to 600 meters, shunt coil of coupler with a 23 plate condenser.
- (2) A standard spider web coil can be used as is indicated on the accompanying diagram (Figure 2). Shunt the coil with a .0005 condenser. A grid leak and condenser of .00025

A WORD TO OUR NEW READERS Regarding Technical Information Service

TO THOSE readers who formerly were accustomed to refer to the staff of RADIO TOPICS for answers to radio problems, the technical staff of RADIO AGE extends its welcome and assurance that questions submitted by them will be accorded the same accurate and generous attention that has been given to our regular clientele in the past.

Technical information service is rendered by Felix Anderson, Associate Technical Editor, under the supervision of Frank D. Pearne, Technical Editor, in the most accurate and speedy way possible. Our new readers may feel sure that their problems will be accorded personal attention such as is not found elsewhere.

In order to assure a smoothly running system, it has been found necessary to require the co-operation of the individuals using this service; and to instruct our new readers in the correct manner to avail themselves of this service, we reprint the following notice from our May, 1924, issue:

- (1) Before writing, it is a good policy to look through the compiled articles which have appeared in RADIO AGE for the past year, which have been reprinted in a large heavily bound edition called the RADIO AGE ANNUAL. It can be obtained from the circulation department postpaid for \$1.00.
- (2) Do not ask us to compare advertised products. Information of this nature should be obtained from the manufacturer and not from RADIO AGE.
- (3) Don't expect the Technical Office to devote its entire efforts to your questions by asking a great number of them. Write on the subject you are puzzled about.
- (4) Information requiring a lot of work should be obtained from such sources as can be hired to carry out special and individual experiments. Give the other fellow a chance by making your requests contain just what you need.
- (5) Put questions in the following form:

- A—A standard business size envelope, carefully stamped and addressed **must be enclosed**. A stamp alone will not get you an answer.
- B—Write with typewriter or ink, and on one side of the paper only. If possible, use a typewriter.
- C—Draw your diagrams in pencil on sheets separate from your questions, label them carefully, and fasten all correspondence together. Failure to do so might result in the loss of one of the pages of your letter or a diagram when the mail is sorted. Put your name and address on each sheet.

D—Write orders for back numbers, subscriptions and the ANNUAL on separate sheets. Do not mix these notations with your questions. These orders must be kept on file by the business department, and cannot be referred to the Technical Office.

E—Keep a copy of your letter and diagram on hand so that we can refer you to them.

F—Address all requests for information on technical questions to RADIO AGE, Inc., Technical Office, 500 N. Dearborn Street, Chicago, Illinois.

IMPORTANT—Letters not complying with the foregoing requests will not be answered.

MF with a PMGL should be used.

(3) UV201A and UV199 tubes are good in this circuit. Do not use soft tubes. The nearer the plate voltage is to normal the better. If UV201A's are used, set the detector at 36, and the amplifier 45.

I have been running tests with this hookup, and I find it satisfactory. Very good for distance, sharp tuning (if good condensers are used) and volume enough on 1,000 mile receptions to remove headphones from head and still hear concert plainly.

The minor details of this circuit are few and one owning a Reinartz can easily make the changes. For beginners, I strongly recommend the coupler as specified in RADIO AGE of February as the tuning unit.

This is a summary of a few months of work with the old circuit, and with the necessary amplification, it should equal a super-het.

Very truly yours,

CLARENCE B. GANNON.

1731 Ensor Street, Baltimore, Md.

The Wizard Fans will probably welcome this letter containing suggestions with reference to the Wizard circuit described in the April, 1924, issue by J. B. Rathbun. One of our readers contributes the following:

RADIO AGE,
Gentlemen:

I have been experimenting with the Rathbun "Wizard \$10 Receiver," the hookup of which was published in RADIO AGE for April. I have devised a hookup for adding a two-stage amplifier.

I find this receiver very selective and if a variometer of a good make is inserted at the point marked X on diagram almost unbelievable amplification may be obtained.

The tuning is accomplished with the variable condenser, variometer and the detector rheostat, and, by the way, this is an extremely critical

unit of this set. It should have a good variable grid leak of from 1 to 10 megohms.

A word about the coil for those who do not have this magazine. It was wound on a bakelite form, $3\frac{1}{2}$ inches in diameter and 3 inches long, using No. 18 S. C. wire, with 22 turns on the primary, leave a space of one-half inch and wind the secondary with the same size wire and IN THE SAME DIRECTION AS THE PRIMARY. (This is very important.) Put 60 turns on the secondary.

After being wound the coil is mounted directly on the terminals of the variable condenser as shown in Figure 1.

This improves tuning, looks and also conserves space.

The whole set may be mounted on a panel 6x21 inches. A switch may be provided at X for the purpose of cutting the variometer out of the circuit when not wanted.

I have found the amplification tremendous with this set, often working loud speaker on two tubes.

The audio frequency transformers may be of any good make and preferably of low ratio, such as 3 or $3\frac{1}{2}$ to 1, as this cuts down distortion.

I am over 1,800 miles from station WBZ at Springfield, Mass., and they have come in on loud speaker, using only two tubes, with plenty of volume to enable them to be heard anywhere in a seven-room house.

This is a neat, well operating set, as well as an economical one for the average amateur to build and operate, and if one uses GOOD materials and uses care in building he will be greatly repaid for the trouble.

Very truly yours,

D. F. HOWE,

302 Chestnut Street, Quincy, Ill.

Readers who are using this circuit might try out the suggestions outlined by Mr. Howe, and write him of their results.

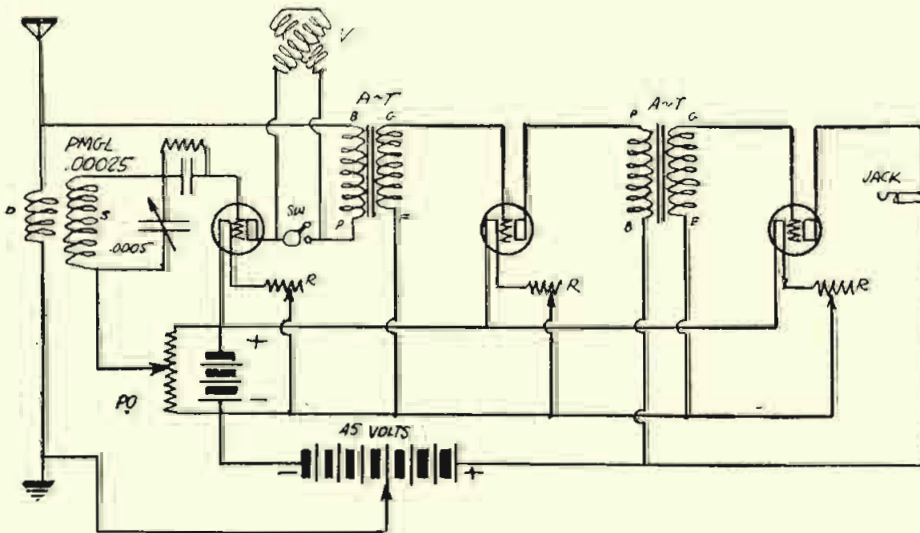

Figure 3. D. F. Howe suggests using a variometer in the plate circuit of the Wizard circuit as shown when audio amplification is used. A switch enables the user to throw it or out of the circuit at will.

We feel that the idea is logical. Good work, Mr. Howe.

Back in our October, 1923, issue we published a description of what is known as "Your First Tube Set." Here it is July, 1924, and we are still getting letters of interest, records and suggestions with reference with this little receiver. Fans who write in have learned to call it the FT set, and we feel that it probably did more good with fans who fondly handled their first vacuum tube than any other. The supply of October back numbers has long since been exhausted, but nevertheless we still get requests for its description. Incidentally, the description has been reprinted in the RADIO AGE ANNUAL, and fellows who are not acquainted with it can get the details of this little "kindergarten" receiver, together with forty-five other good hookups, for \$1 from the circulation department.

Now we hear from another fan who has long been an admirer of the set with the following communication addressed to the writer of the article describing the set:

RADIO AGE,
Chicago, Ill.
Gentlemen:

I was very glad some time ago to be of assistance to a gentleman in Nashville, Tenn., whom you referred to me for advice upon circuits for improvised aeriols, etc., and have thought some time since of letting you know about a stunt I have developed in my experimenting along Ultra Audion lines. The instrument is so wonderful that I wish you could listen over it.

In your regular "First Tube Set" I wound a plain 56 turn spiderweb coil on the common black fibre form so commonly used, and tapped the coil every 7 turns. These taps lead to common unions with two separate sets of switch points joined together. Aerial lead from primary condenser goes to first switch centre, and grid lead runs from second switch centre. Both condensers are low loss, and act like the finest vernier condensers I ever used. The plate lead is continuous from first switch point of first switch to outer tap of the coil then on to the plate terminal of socket. A .001 fixed condenser for by-pass from plate lead to Plus "A" terminal I find best by all means for getting distance and giving latitude to the dials.

I have heard all over the United States with this thing, loud and clear, using 130 foot aerial, W. D. 12 tube. Until Edgewater Beach station was changed in wave length I could absolutely tune in and out all Chicago stations perfectly without overlap. I use a wave trap and listen to them only when I desire to. The new Rainbow station is so near me that I can see their towers and aerial a half mile from my window, but I can tune them in and out perfectly without the trap, and the reception from them is something beautiful. There are scores of combinations to be had with use of the two sets of switches

and one can play upon them like a piano.

Find circuit drawing herewith, also accept my sincere thanks for your most valuable contributions to the world of radio.

Yours truly,
A. J. BAUMGARDNER.
4840 N. Lincoln Street, Chicago, Ill.

Now we want to explain the first part of Mr. Baumgardner's letter by saying that we referred a fellow Dial Twister to him for some information on antennæ which we happen to know he used while engaged as a traveling salesman. He took one of these little FT sets with him, and used it on various kinds of aerials at the places he stopped when on the road. And Mr. Baumgardner, being a true radio bug, gladly furnished the information. His experiments with the FT set as described in the letter are shown on the diagram in Figure 4. Before we go on with the rest of the contributions, we want to extend to him our cordial thanks, and express our wish that if he has any more finds that he thinks may be interesting, we would be glad to hear from him.

636 Fifty-first Street,
Milwaukee, Wis.

RADIO AGE,
Gentlemen:

I purchased your magazine for the first time last night and I assure you that from now on I'll buy a copy every month it is issued. I was particularly interested in your club of SQUEAL HOUNDS or DIAL TWISTERS, so I am submitting my list of stations for a membership in the club. The following stations I received in two weeks on my GREBE:

KDKA, KFGD, KFHD, KFI, KFIX, KFKB, KFKX, KFLZ, KFNF, KPOP, KGO, KGW, KSD, KYW, WAAW, WABA, WBAH, WBAP, WBBB, WBL, WBT, WBZ, WCAE, WCAL, WCAP, WCAS, WCAU, WCBF, WCK, WCX, WDAP, WDAP, WEAF, WEAH, WEAN, WFAA, WFAA, WGN, WGR, WGY, WHA, WHAA, WHAD, WHAS, WHAZ, WHB, WIAO, WIAX, WJAX, WJAZ, WKY, WLAG, WLS, WLW, WMAJ, WMAQ, WMAJ, WMC, WNAC, WOAV, WQAW, WOC, WOO, WOO, WOR, WOS, WPAH, WPAH, WRC, WSAI, WSB, WTAM, WTAQ, WTAS, WTAY, WVAE, WWJ, 2XD, 2XB, WFAH, WBAK, KFIM, CFCA, CKAC, CJCE.

Yours truly,
HILMAR T. BOEHM.

P. S.—Please inform me who has the slogan, "In the Heart of La."

Can anyone tell Mr. Boehm who makes use of the slogan he mentions? We don't happen to be acquainted with it—but we do know a good list when we see it.

Some time ago we printed a letter from a Montreal fan. He said he wanted competition from Montreal—here he is. We have several letters from fans up there—but space is limited and we can't print all of them, unfortunately.

RADIO AGE,
Gentlemen:

With reference to the Pickup Pages of your fine magazine, I see that Mr. Winkle is probably the first

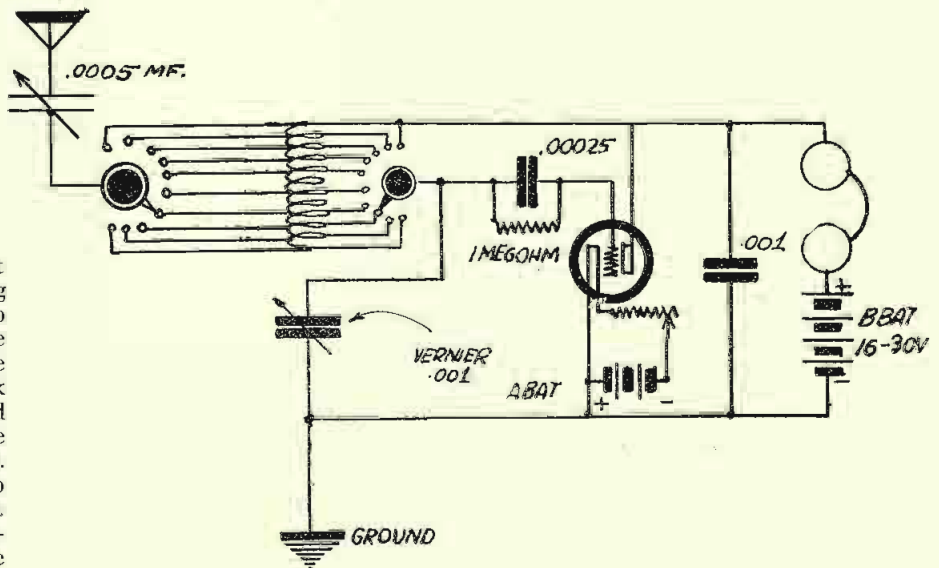

Figure 4. The FT circuit as revised by Mr. Baumgardner of Chicago. He finds this circuit very selective, and extremely sensitive to long distance stations.

Reinartz booster to have his name inscribed on the Dial Twisters list for Montreal. I think that Reinartz wants some beating. I submit herewith a list of stations received on a single peanut tube, over a period of five months, most of them at any time they are broadcasting, given fair conditions.

In Mr. Winkle's list of stations, I notice he has not received direct those elusive stations at Ottawa. However, I must congratulate him on receiving KYW at Chicago, on 536 meters, which I cannot seem to receive in spite of an excellent location.

I would like to say in passing that H. Hardman's article on the Reinartz modification was very interesting and would be glad if that gentleman would, through you, Mr. Editor, give us some more facts on rewinding the coil, number of turns, etc.

In closing I would like to express my appreciation on the works of the various contributors to the "AGE" and the clean-cut illustrations that accompany them.

Having been confined to bed all the winter through ill health, I must say that my Reinartz has been a splendid companion to me during the long, dreary evenings.

Thanking you for taking up so much space, I shall be curious to see next month's magazine, and how many stations constitutes the record for Montreal.

Yours faithfully,
W. J. WATERSON.

Lorain Avenue, Montreal, North,
Quebec, Canada.

**Calls heard by
W. J. Waterson
Montreal, Canada**

KDKA, WBZ, WCAE, WCAP, WCBF, WDAP, WDAR, WEAF, WFI, WGA, WGY, WHAZ, WIP, WJAR, WJAX, WJAZ, WHY, WJZ, WLW, WOC, WOO, WOR, WHB.

It is a pleasure to learn that RADIO

AGE may have helped you to spend some of those lonely hours pleasantly, and feel that some of our readers might like to drop you a few lines to compare notes and results. We shall be glad to have you "visit" the department again.

RADIO AGE,
Gentlemen:

After reading the list sent in by Mr. Winkle of Bordeau Street, Montreal, I am sending mine hoping it will interest you and other readers of your magazine which I cannot praise too much, even though I only know it for three months. As others say, "it certainly is the goods."

I hook as many as nine stations the same evening, and as I only have had the set for a short while, I think twenty-five stations is not so bad. Here's hoping to hear from other Montrealers.

Truly yours,
JOSEPH A. RATTE.

175 Lagauchetieres Street,
Montreal, P. Q., Canada.

**Calls heard by
Joseph A. Ratte
175 Lagauchetieres Street
Montreal, P. Q., Canada**

KFKX, WLS, WGN, WJAZ, WDAP, WLW, WEAR, WWAD, WDAR, WFI, WOR, WJZ, WJAR, WBZ, WHAZ, WGY, WGR, CKCZ, CFCX, WJAX, WTAM, KDKA, CFCF, CKAC, CHYC.

RADIO AGE,
Gentlemen:

Having read the May RADIO AGE and stubbed my toe into the Dial Twisters Club, I concluded to write. Perhaps it will get the gate or the waste basket, but we should try anything once. How many of the fans will agree with me if I say that it is very much harder to get the Eastern stations than it is for the East to get the West?

I've got six tubes in my set. Don't think I use 'em all on the head phones. I don't. Six UV199, I use
(Continued on page 44)

Getting the Most Out of Your Vacuum Tubes

(Continued from page 18)

mica type, and should be purchased only when they are marked "tested capacity" and not "tested mica" or other misleading terms. They should be firmly soldered in the circuit, the condenser being as close to the grid post of the tube socket as it possibly can be. Sometimes sockets are so constructed that they can be mounted directly thereon.

If a circuit is noisy when all other precautions have been taken, it can invariably be traced to a poor grid condenser. The thing to do is to substitute it with one that is as near perfect as possible.

Rheostats

Faulty rheostats or rheostats with adjustments that are too coarse are often the contributors of noises in sets, especially in detector circuits. The proper rheostat to use in a detector circuit is the carbon type, which permits an even straight flow of increasing or decreasing current as the controlling knob is turned. Wire rheostats are satisfactory in amplifying circuits, and at present there has appeared on the market a small cartridge resistance of the proper resistance for the popular tubes now on the market to be used in conjunction with various battery supplies.

These cartridge rheostats have no controls, and are inserted into clips connected in the filament circuit, and provide automatically the proper resistance. These are not recommended for detector circuits, however.

Potentiometers

Wire potentiometers, like rheostats, unless of good design are apt to inflict noises upon the ears of the listener. There are several types on the market, but the writer much prefers the carbon disk or graphite sector type to the wire ones. They are usually furnished in 200 ohm (maximum) and 400 ohm (maximum) sizes. The 400 ohm size is the most satisfactory for all around purposes.

"A" and "B" Batteries

The subject of A batteries will be discussed in a later article; especially the connections for dry cells to give longer life and more efficient service.

B batteries, whether dry battery type or storage type, should have provision made for taps so that the plate potential of the tube may be varied at will. A difference of one or two volts often makes all the difference in the world.

It is quite advisable to have a voltmeter with a scale reading of from 0 to 10 volts DC handy, and it is very desirable where eight or ten tubes are used as on a Super-Heterodyne. This meter will enable the operator to tell just what each and every tube is consuming, and more intelligent operation together with economical upkeep in battery consumption is possible.

BAKELITE

TRADE MARK REG. U. S. PAT. OFF.

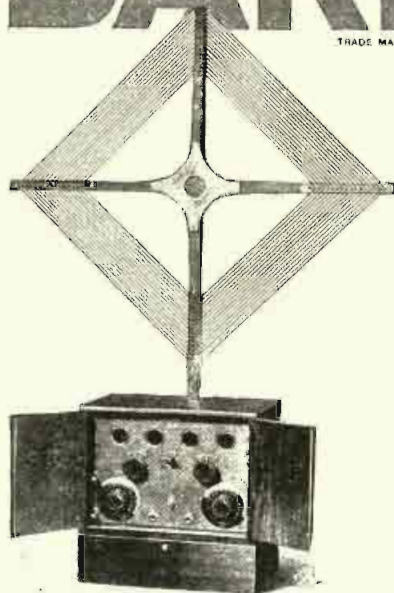

DeForest and Bakelite

Bakelite is standard insulation on all DeForest Radiophones—from panels to transformer covers. The effective protection afforded by Bakelite is a strong factor in the success of these well known radio sets.

Good insulation must have mechanical strength and rigidity, chemical inertness, heat and water as well as electrical resistance and, last but not least, durability. Bakelite possesses all these characteristics in a very high degree.

The fact that practically every radio manufacturer uses Bakelite is an excellent endorsement of its value for radio insulation.

Write for a copy of
our Radio Booklet H

BAKELITE CORPORATION

247 Park Avenue, New York, N. Y.
Chicago Office: 636 West 22d Street

Send for our Radio Map

Enclose 10c and let us send you the Bakelite Radio Map. It lists the call letters, wave length and location of every broadcasting station in the world. Address Map Department.



THE MATERIAL OF A THOUSAND USES

Dividend for RCA

The board of directors of the Radio Corporation of America, at their meeting, May 23rd, declared a dividend payable on all preferred stock of the Radio Corporation to stockholders of record on June 6th. The dividend will be 3½ per cent, being 1½ per cent, respectively, for the first and second quarters of 1924.

EDITOR'S NOTE—In our next issue, Mr. Anderson will take up in detail the use of these various controlling accessories, their relative positions in circuits, and the subject of grid return lines together with some other valuable data on the most effective methods to employ in getting the very most out of your vacuum tubes.

Always Mention RADIO AGE When Writing to Advertisers



Super

CRYSTAL

New Non-Metallic Housing Eliminates Scratches & Squealing.

Wonderful new crystal—has millions of sensitive spots—long life—cannot short circuit.

FITS ANY STANDARD DETECTOR

At your dealer—otherwise send purchase price and you will be supplied postpaid.

50

Chas. Freshman Co. Inc.

Radio Condenser Products

106 Seventh Avenue, New York City

TROUBLE CHARTS (Q-20-22)
VACUUM TUBE TROUBLES

TUBES—Continued.

(8) **TUBE SOCKETS.** The tube socket is very frequently the cause of weak signals or open circuits. The fact that the filament lights up does not mean necessarily that the socket is perfect. It may be that the grid and plate prongs are not making the proper contact with the contact springs in the socket, and this will stop the action of the tube just as surely as an open filament line. Clean off the tube prongs and springs, scraping them to a bright surface, and then bend up the springs to insure proper contact with the prongs.

Only the highest grade sockets should be used, in which the insulation is of hard rubber, bakelite, porcelain or similar approved type. Cheap sockets are often made of soft compositions which are partial conductors, and which may short circuit the feeble radio frequency currents. This of course reduces the range and signal strength of the set.

Wherever possible, connections should be soldered to the socket binding posts. Contact must be perfect at this point. Clean the socket perfectly from dirt, grease, pencil marks, etc., as these are partial conductors which will short circuit the radio frequency current.

(9) **ADAPTERS.** The adapters used for carrying dry cell tubes in standard sockets often fail to make the proper contact with the socket. See that they are clean and that all connections are tight. Adapters reduce the output even when in good condition.

(10) **DIRTY TUBE BASES.** The insulating plate at the bottom of the tube, which supports the four tube prongs, must be perfectly clean and free from pencil marks. If this is not the case, then you may be reasonably sure that the radio frequency current is short circuited to some extent in the base. The practice of dealers in marking their name on the base of the tube with a rubber stamp cannot be too thoroughly condemned.

(11) **DETECTOR WILL NOT OSCILLATE.** When the detector tube in a regenerative circuit will not oscillate properly or give the proper range and signal strength, the trouble may be due to the tube itself, but it is much more likely that it is due to trouble in the circuit. When in proper condition, the tube should squeal or howl when the tube is turned up so that it burns above normal brightness or when the tickler or plate variometer is turned way over into the position of maximum regeneration. Turning the rheostat of the detector above normal should first cause distortion, and then should follow by giving a sharp "Click" and then howling.

In the tuned plate type, the trouble may be that there is not sufficient inductance in the plate circuit due to a defective plate variometer. In the feed-back type it may be that the tickler has not a sufficient number of turns or that a short circuit exists in the plate or tickler line. A weak battery or high resistance rheostat will cause the trouble.

(12) **TUBE HOWLS AT ALL TIMES.** This is due to the tube breaking down into free oscillations because of excessive regeneration or too much filament current. It may be that the "A" battery voltage is too high for the tube or that the resistance of the rheostat is not sufficient to control the current properly.

COPYRIGHT 1924
 RADIO AGE

COMPILED BY
 J. E. RATHBUN

Q-20-22

BATTERIES (DD-50-1)
STORAGE BATTERIES

GENERAL PRINCIPLES. As in the case of the primary battery (dry cell), the elements of the storage cell consist of two chemically dissimilar plates or electrodes immersed in a fluid electrolyte. During the discharge of the cell the electrolyte attacks the plates and chemically reduces them to the same chemical compound. When completely reduced, there is of course no electrical difference of potential between the plates and the cell is said to be completely discharged and has no longer the ability to cause the flow of current.

By passing current from an outside source through the cell in the reverse direction to the flow of current during discharge, the chemical composition of the plates is restored to its original condition and again is capable of supplying current. The process of restoring the plates to a condition where a difference of potential again exists between them is known as "charging" and is a distinctive property of the storage or "secondary" cell. This charging process can be repeated a great number of times until the plates are finally wasted away by the losses that take place within the cell.

From the above it will be seen that the storage battery does not actually store electricity as electricity, but simply stores the energy expended by the charging current in the form of latent chemical energy. As soon as the electrodes are connected by an electrical conductor, the chemical reaction of the electrolyte with the plates begins, and this reaction (discharge) results in the liberation of energy in the form of electricity. The difference of electrical potential between the plates is due to a difference of chemical potential, and no flow of current takes place without an equivalent change in the chemical nature of the plates.

While there are a great number of combinations possible, the commercial storage cell consists of two or more coated lead plates immersed in a dilute solution of sulphuric acid in water. This is known as the "lead-sulphuric cell" and is in great favor because of its high voltage and low internal resistance. Another commercial type, not so commonly used, is the Edison cell in which an alkaline electrolyte is used in combination with iron and nickel electrodes. The voltage of the Edison cell is considerably lower than the lead-sulphuric type.

THE LEAD-SULPHURIC CELL. In its simplest form the lead-sulphuric cell consists of two latticed lead plates or "electrodes" which are coated with lead sulfate. When fully charged, the positive electrode coating or "active material" is lead peroxide while the coating on the negative plate is spongy metallic lead. The positive plates when fully charged are chocolate brown in color, while the negative plates have the characteristic dull gray or slate color of metallic lead.

When the cell is being discharged, the sulphuric acid of the electrolyte gradually combines with the active material to form lead sulphate, and as the discharge continues the sulphuric acid gradually disappears from the solution to enter into combination with the lead. When fully discharged, most of the acid has disappeared leaving almost pure water behind, and as the acid is heavier than the water the specific gravity gradually falls off as the cell approaches the discharged condition. So closely is the specific gravity related to the amount of charge in the cell that we can use a hydrometer to determine the current still remaining.

COPYRIGHT 1924
 RADIO AGE

COMPILED BY
 J. E. RATHBUN

DD-50-1

Get a Job Like These Earn \$3500 to \$10,000 a Year



20 Years Old— Makes Almost \$500 a Month

Harold Hastings of Souther, Mass., says: "The profit on my electrical business amounts to \$475.00 a month. My success is due entirely to your instruction. You make your men just what you say—Electrical Experts. No man will ever make a mistake enrolling for your course."



Dickerson Gets \$7500 a Year

"I earned \$30 a week when I started with you—\$50 a week when half through your course. Now I clean up at the rate of \$7500 a year. Thank you a thousand times for what you did for me. Electricity pays big on the farm." Herbert M. Dickerson, Warrentown, Va.



\$20.00 a Day for Schreck

"Use my name as a reference and depend on me as a booster. The biggest thing I ever did was answer your advertisement. I am averaging better than \$500 a month from my own business now. I used to make \$18.00 a week." A. Schreck, Phoenix, Ariz.



Pence Earns \$9000 a Year

W. E. Pence, Chehalis, Wash., says: "Your course put me where I am today, Mr. Cooke—making \$750 a month doing automobile electrical work—think of it—\$9000 a year. Besides that I am my own boss. My wife joins me in thanking you for what you did for us."

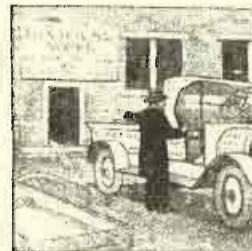

\$30 to \$50 a Day for J. R. Morgan

"When I started on your course I was a carpenter's helper, earning around \$5.00 a day. Now I make from \$30 to \$50 a day and am busy all the time. Use this letter if you want to—I stand behind it." J. R. Morgan, Delaware, Ohio.



Spare Time Work Pays Stewart \$100 a Month

"Your course has already obtained a substantial increase in pay for me and made it possible for me to make at least \$100 a month in spare time work. You can shout this at the weak fellows who haven't made up their minds to do something yet." Earl Stewart, Corona, Calif.

in the Big Pay Field of **ELECTRICITY**

It's your own fault if you don't earn more. Blame yourself if you stick to your small pay job when I have made it so easy for you to earn \$3500 to \$10,000 a year as an electrical expert. Electrical Experts are badly needed. Thousands of men must be trained at once. One billion dollars a year is being spent for electrical expansion and everything is ready but the men. Will you answer the call of this big pay field? Will you get ready now for the big job I will help you get? The biggest money of your life is waiting for you.

I Will Train You at Home

I will train you just like I trained the six men whose pictures you see here. Just like I have trained thousands of other men—ordinary, everyday sort of fellows—pulling them out of the depths of starvation wages into jobs that pay \$12.00 to \$30.00 a day. Electricity offers you more opportunities—bigger opportunities—than any other line and with my easily learned, spare time course, I can fit you for one of the biggest jobs in a few short months' time.

Quick and Easy to Learn

Don't let any doubt about your being able to do what these other men have done rob you of your just success. Pence and Mergan and these other fellows didn't have a thing on you when they started. You can easily duplicate their success. Age, lack of experience or lack of education makes no difference. Start just as you are and I will guarantee the result with a signed money back guarantee bond. If you are not 100% satisfied with my course it won't cost you a cent.

Free—Electrical Working Outfit and Tools

In addition to giving my students free employment service and free consultation service, I give them also a complete working outfit. This includes tools, measuring instruments, material and a real electric motor—the finest beginners' outfit ever gotten together. You do practical work right from the start. After the first few lessons it enables you to make extra money every week doing odd electrical jobs in your spare time. Some students make as high as \$25 to \$35 a week in spare time work while learning. This outfit is all FREE.

Mail Coupon for FREE BOOK— The Vital Facts of the Electrical Industry

The coupon below will bring you my big free electrical book—over 100 interesting pictures. The real dope about your opportunities in electricity—positive proof that you, too, can earn \$3500 to \$10,000 a year. Send for it now. Along with the book I will send you a sample lesson, a credit check allowing you a \$45.50 reduction, my guarantee bond and particulars of the most wonderful pay-raising course in the world. Send the coupon now—this very second may be the turning point in your life. Send it while the desire for a better job and more money is upon you, to

L. L. COOKE, Chief Engineer

Chicago Engineering Works

DEPT. 82-B 2150 Lawrence Ave., Chicago

**The Cooke
Trained Man
is the Big
Pay Man**



L. L. COOKE, Chief Engineer
Chicago Engineering Works, Dept. 82-B
2150 Lawrence Ave., Chicago, Ill.
Without obligating me in any way send me the "Vital Facts" your Free Book. Sample lessons and particulars of your Free Book. (Sample lessons and particulars of your Free Book. Sample lessons and particulars of your Free Book.)
I want Service and proof that you can fit me for a big-pay electrical job.
Name.....
Address.....

**BATTERIES (DD-50-2)
STORAGE BATTERIES**

CHARGING. When fully discharged, practically all of the active material or coating has been reduced to lead sulphate, and as both plates are now in equilibrium from a chemical standpoint there is no longer an electrical difference of potential between them. The voltage of the cell gradually falls off until it becomes zero at full discharge.

By passing a charging current in the reverse direction to the discharge, the lead sulphate is broken up chemically into the original lead peroxide and spongy lead, and the resulting sulphuric acid turned loose returns to the electrolyte. The return of the acid to the water during charge of course increases the specific gravity until at full charge the gravity is again the same as in the beginning. The discharge of the acid causes the active material to contract during charge and thus there is a strong tendency for the active material to work loose from the plates and to become detached. To prevent the coating from falling off the lead electrodes, the latter are latticed and grooved in such a way that the pellets are held firmly in position under ordinary charging conditions.

During the charging process the water of the electrolyte is partly decomposed into hydrogen and oxygen gases. The hydrogen gas can be seen bubbling up rapidly around the negative plate while smaller quantities of oxygen appear around the positive plate. The gases are produced in the proportion of two parts of hydrogen to one part of oxygen, or in the same proportion that these gases exist in water. As the charge proceeds, the gas is produced in increasing quantity until at full charge the electrolyte bubbles or "boils" with considerable vigor. This is known as "gassing" and is an indication that full charge is being approached.

At the start of the charge, the hydrogen gas at the negative electrode enters into chemical combination with the lead sulphate coating to form reduced metallic lead, hence there are not so many bubbles at the beginning of the charge as part of the gas is being absorbed by the plates. At the positive plate, the oxygen is attacking the lead sulphate to form the oxide of lead known as the "peroxide" and little oxygen is therefore in evidence in the form of bubbles until the lead sulphate is well reduced.

UNIT CAPACITY OF CELLS. The unit of capacity of a storage cell is the "amperehour," or the product of the amperes and time in hours for the complete safe discharge. Thus, if a cell can maintain a flow of two amperes for 20 hours between full charge and full safe discharge, then the capacity of the cell is equal to: 2x20=40 ampere hours. Practically, however, the capacity varies somewhat with the rate at which it is discharged so that under standard conditions the cell is assumed to completely discharge within eight hours time. The greater the flow in amperes, the less will be the capacity in amperehours.

Under a standard rating, a 40 amperehour cell will be discharged at the rate of: 40/8=5 amperes. This is the rate at which the cell is assumed to develop its full capacity.

When we refer to the complete "safe discharge" we mean the lowest point to which the cell can be discharged without danger of sulphating or other trouble. It is never safe to fully discharge a lead-sulphuric cell to the point where the voltage drops to zero for the reason that a hard impenetrable insulating coat of lead sulphate is likely to be formed which will make re-charging difficult or even impossible. As a general rule it is not safe to discharge a lead-sulphuric cell below 1.8 volts or below 1150 as determined by the hydrometer.

COPYRIGHT 1924
RADIO AGE

COMPILED BY
J. B. RATHBUN

DD-50-2

**BATTERIES (DD-50-3)
STORAGE BATTERIES**

CAPACITY OF BATTERIES. The capacity of a battery in amperehours is proportional to the exposed area of the plates, that is, the area to which the fluid electrolyte has free access. The greater the area of the plates, the greater will be the capacity in amperehours and the rate of discharge in amperes. The voltage of the cell, however, is independent of the area and depends mostly upon the amount of charge remaining and upon the nature of the plates and density of the electrolyte.

It is for this reason that we make every attempt possible to increase the effective area of the plates by latticing them and by the use of spongy materials which will allow the electrolyte to penetrate to greater depths into the active material.

In order to make the storage cell more compact it is the usual practice to use a number of small plates connected in parallel rather than one pair of large plates. Thus a small battery of the radio type may have five positive plates and six negatives, the positives and negatives forming in effect two large single positive and negatives. One more negative than positive is used.

Commercial batteries used for radio and automobiles are arranged with the following number of plates in parallel: 3, 5, 7, 9, 11, 13, 15 and 17. However, the very small storage cells used for "B" batteries usually have only two plates, one negative and one positive. In terms of amperehours the more common "A" storage cells are rated at 20, 40, 60, 80, 100 and 150 ampere hours, although certain makers sometimes depart from this practice in special cells.

The variation of capacity with the rate of discharge is shown by the following average figures. Here the discharge rate is given in hours while the second column shows the capacity as a percentage of the rated capacity at an eight-hour standard rate. The discharge completed in eight hours is taken as 100 per cent of the rated capacity.

DISCHARGE RATE (IN HOURS)	PERCENT OF 8-HOUR CAPACITY
8 hours.....	100%
6 hours.....	96%
4 hours.....	88%
2 hours.....	70%
1 hour.....	48%

In other words, if we completely discharge a battery in one hour, we will only obtain 48 per cent of the number of amperehours that we could get if we discharged it at a slower rate in eight hours. For this reason a battery should not be overloaded, and if the rate of discharge in amperes is greater than one-eighth the capacity in amperehours, we had better use a larger battery or else use two batteries in parallel.

Owing to losses which take place within the cell, such as resistance losses for example, the number of amperehours supplied to the cell in the form of charging current is greater than the amount recovered on discharge. The ratio of the amperehours discharged to the amperehours of charging current is called the "efficiency" of the battery and seldom exceeds 60 per cent in the smaller radio batteries when charged at home. Thus, if we supply 100 amperehours by means of the charger we can hardly expect much more than 60 amperehours during full discharge. This also varies with the discharge rate.

COPYRIGHT 1924
RADIO AGE

COMPILED BY
J. B. RATHBUN

DD-50-3

TOWER'S

TOWER'S
Scientific
 WEIGHS ONLY 8 OZ
 Perfect Tone Mates
 \$2.95
 Plus a few cents postage



OUR \$200,000.00 COMPANY
STANDS SQUARELY BACK OF EVERY HEADSET

WORLD'S
GREATEST
HEADSET
VALUE

Longer Cord (full 5 feet). Stronger Magnets, Higher Resistance, Increase of Sensitivity, Perfect Tone Mates
 EVERY SET TESTED BY LICENSED RADIO OPERATORS

Send no money - Order on a Post-Card

THE TOWER MFG. CO. : 98T BROOKLINE AVENUE, BOSTON, MASS.

Scientific

Short Wave Transmission

(Continued from page 11)

expect. But this is due to the fact that the human ear is not so sensitive as it might be, and one little improvement may not appear to make much difference in the reception.

If we take the trouble to watch all of the places where losses may occur and correct several, or all of them, we shall at once notice the difference in reception. One of the most important items is the resistance of the circuit.

Just where resistance in a set may occur is a question not very well understood by the layman. First, we often have too much resistance in the different coils used as inductances. Then there is the resistance offered by poorly constructed condensers. Usually we think that resistance means too great a length of wire which has too small a cross section, but, as a rule, while this may be true to some extent, it is more often caused by the material on which the coil is wound, or in the varnish which is used to hold the turns in place.

Some sort of a support is necessary for the coils, so we cannot escape this loss, but we can reduce it considerably by using the right kind of material. The best tube known on which a coil may be wound is not high priced insulating material, but is a good oven dried paper or cardboard tube without the use of any kind of insulating varnish. The wire used should have the largest possible cross section,

which, while it may be very stiff and hard to wind, will give better results than the smaller wire having a higher resistance.

For the frequencies used in ordinary radio reception, the use of stranded conductors is of no avail, and a good heavy solid wire is to be preferred. In selecting the proper variable condenser, the builder is confronted with another problem. It is much better to purchase a high priced condenser having a very low high frequency resistance than to play around with one of inferior quality. There are several scientifically constructed condensers on the market at the present time and one should not be satisfied with merely obtaining one which is supposed to have the right capacity, and it is earnestly suggested that the user make a careful study of variable condensers before making a selection.

In constructing the aerial for a short wave tuner, use a good heavy single strand of copper wire and keep the length at approximately thirty-five feet or less.

COMING IN SEPTEMBER

A new technical feature, never before undertaken by a radio magazine. Watch RADIO AGE for this unusual innovation.

Club Meetings by Radio!

Dallas, Texas.—An experiment to determine whether it is possible to hold a club meeting by radio with all the members seated comfortably in their homes, has been tried out successfully by radio

fans in this vicinity. The meeting was called to order by the president, motions carried and all business transacted with as much ease as though the members were gathered in one room.

The idea was conceived by members of the West Gulf Amateur Phone Club, which was started by local representatives of the American Radio Relay League. Practically all members have installed radiophone transmitters in their homes.

Due to bad weather the suggestion was made that members hold their meetings "on the air."

Notices were sent to all club members, suggesting a wave length of 190 meters. At the appointed time the president called the meeting "to order" through his radiophone. The roll was called by the secretary and as their names were spoken the members picked up their microphones and answered, "present."

As each set had been carefully tuned in advance all members of the club could hear everything that took place. The session lasted two hours and met with such general approval that it was voted to hold subsequent "ether meetings" every Sunday afternoon thereafter.

Fans See Auto Race by Radio

Radio fans who found themselves unable to attend the International Motor Sweepstakes, the 500-mile race at Indianapolis on May 30, had it brought right to their homes by radio.

A soundproof booth was constructed under the judges' stand and in addition

there were microphones in the pits. The broadcaster in the booth had the race information "fed" to him by racing experts furnished by the Prest-o-Lite Company, battery manufacturers.

The broadcaster in turn sent out the descriptive news directly through Station WGN on the Edgewater Beach Hotel, Chicago. With a corps of ten men, the broadcasting was kept "up-to-the-minute" throughout the entire racing period. The first story was on the air at 9:30 a. m. and was kept up until late in the afternoon. "Sen" Kaney, WGN announcer, was in personal charge.

Through the word pictures from the trackside the listener-in was transported there in spirit and actually was able to visualize the hurry of the crowd as it made its way to the seats in the mile and a half of grandstands; the vivid colors of the women in gala attire were pictured graphically and the strident call of the refreshment vendors and program boys preceded the hustle of the track itself as the race neared.

The fans heard the roar of the racing motors and the howls of the thrill-mad spectators as a favorite driver came hurtling down the stretch. At last they were able to get the terrific uproar which greeted "Jo" Boyer as he crossed the finish line first.

In between the reports of the races Mr. Kaney gave intimate human interest sketches of the crowd, the drivers and the officials.

Radio Aids World Flight

Despite the fact that the Army-world-flight planes are not equipped with radio receiving or transmitting apparatus, radio aided these airmen in their trip westward from the Aleutian Islands to Japan.

The Coast Guard Cutter "Haida" and the Fisheries Steamer "Eider" stood by along the westward route of the Army aviators, virtually establishing a radio chain between the American radio stations and those of Japan. They furnished advance data as to weather conditions along the route, relaying their dispatches to the planes before they "took" off on their 860-mile jump.

The first aid of radio and the government vessels on the long flight was planned before the planes left Chicagoff, on the Island of Attu, en route to Kaschewabara Bay on Japan's Island of Paramushiru in the Kuriles group.

Major Blair of the Signal Corps, who has charge of the radio communication for the Army and is aboard the "Haida," returned to the United States when the flyers reached Japan, where both Japanese and U. S. naval vessels took up the radio service. It is expected that later on he will be sent to Labrador to establish a system of radio communication for these airmen on their trans-Atlantic flight back home. Weather forecasts are already arranged for on the Atlantic route, and it is planned that at least one of the Army planes will be equipped with radio before the last leg of the flight starts from England.

FREE



To Each Purchaser of a World Battery

A 24-Volt "B" Storage Battery positively given FREE with each purchase of a WORLD "A" Storage Battery. The WORLD Battery is famous for its guaranteed quality and service. Backed by years of Successful Manufacture and Thousands of Satisfied Users. You save 60%.

Prices That Save and Satisfy

Auto Batteries		Radio Batteries	
6-Volt, 11 Plate \$12.25	6-Volt, 80 Amps. \$10.00	6-Volt, 100 Amps. 12.50	6-Volt, 120 Amps. 14.50
6-Volt, 13 Plate 14.25	6-Volt, 140 Amps. 16.00		
12-Volt, 7 Plate 17.00			

Shipment Express C. O. D. subject to examination. 5 per cent discount for cash in full with order.

2-Yr. Guarantee Bond in Writing With Each World Storage Battery

Proves satisfactory World performance. Mail this ad with your name and address—we will ship battery day order is received; and give you your choice of "B" Storage Battery or a handsome nickel finish Auto Spottite, FREE. Write TODAY.

WORLD BATTERY COMPANY
1219 So. Wabash Ave. Dept. 36, CHICAGO, ILL.

This FREE "B" Storage Battery takes the place of dry cell "B" batteries. Can be recharged and will last indefinitely. To be sold retail for \$8.00. It is the only battery of its kind equipped with solid rubber case and insurance against acid and leakage. Take advantage of this remarkable introductory offer NOW. (To those who prefer it, we will send FREE a handsome nickel finish Auto Spottite, instead of the "B" Battery. Be sure to specify which is wanted.)

GIVEN FREE

To introduce this new and superior World "B" Storage Battery to the Public.



TRY THE NEW

Pfanstiehl

PURE INDUCTANCES

FOR RADIO EFFICIENCY

"Pfans:" You have been trying out all kinds of circuits. You know those you like best. Let us suggest that you now endeavor to improve these favorite circuits to their highest efficiency.

Much has been said recently about the necessity of good parts. Inductances are of extreme importance for efficiency. Pfanstiehl Pure Inductances are good because:

1. Air-cored means no absorption of signal strength;
2. Stagger-wound means no appreciable distributed capacity;
3. Vermer control of adjustment means distance-getting.

Manufactured by
Pfanstiehl Radio Service Co.
Highland Park, Ill.
Chicago Office: 1001 W. Washington Blvd. (Haymarket 8010)

\$4.75 Post Paid or at your dealer's.



P-301 Variometer.
With two 50-turn untapped coils as a variometer with PERFECT RATIO OF INDUCTANCE.

Other Pfanstiehl Pure Inductances

	Turns	Price	Wave Length
P-201.....	25	\$.35	100-340
P-202.....	35	\$.59	125-470
P-203.....	50	\$.65	170-650
P-204.....	75	\$.74	220-960
P-205.....	100	\$.90	300-1300
P-206.....	150	1.10	470-1980
Pfanstiehl Ultra Audion.....		\$0.95	
Pfanstiehl Reinartz.....		1.75	

\$6.00 Post Paid or at your dealer's.



P-600. Oscillator for Superheterodyne. Oscillates sharply and steadily and improves the hook-up.

P-300 Variocoupler.
Using this Unit in our Efficiency hook-up (furnished with Unit) a Wisconsin fan picked up Hawaii.

A Physicist's View of Sound Waves and Radio Rays

By Frank D. Pearne

Carl Pfanstiehl, noted radio engineer and scientist, addressed the radio division of the Electric Club of Chicago last month on the subject, "Sound Waves and Radio Rays."

Mr. Pfanstiehl, who is president of the Pfanstiehl Radio Service Company, Highland Park, Ill., presented his up to date views and theories from the standpoint of the physicist rather than that of the conventional radio engineer, however. It was this method of delivery that proved novel and interesting to his expert listeners.

Mr. Pfanstiehl stated that the science of radio had grown so fast and contained so much of the spectacular that in his opinion, too little attention has been given by radio fans to the underlying principles of the science. Therefore, he was going to confine his address to a few of the fundamental principles involved, and tried to make his audience visualize what actually takes place with the aid of various electrical demonstrations.

He discussed air vibrations, or waves, which strike our ears and give us the sensation of sound. While air can sustain waves from less than eight to probably more than one hundred thousand cycles per second, the average human ear is capable of responding only to frequencies of about sixteen to approximately twenty thousand cycles per second. He explained that air waves consist of alternate areas of compression and rarification above and below normal atmospheric pressure, which expand in ever widening circles from the source of the vibration. A so-called noise is merely a jumble of air vibrations without any rhyme or reason and usually unpleasant to the ear, while a tone is caused by periodic vibration.

Explains Musical Tones

The most interesting part of the discussion was an explanation of what gives various musical tones their particular and distinctive quality. For instance the pitch of middle C is usually taken as 256 complete vibrations, or cycles, per second. (One compression and one rarification constitute one complete vibration, or one cycle). But what is it that enables the ear to distinguish between middle C when played on the violin, harp, piano, or when intoned by the human voice? Why is it that some tones sound thin and lifeless, while another tone of the same pitch and loudness sounds rich and full and much more pleasant to listen to?

Tone quality is entirely dependent on the number and character of smaller and more rapid waves that exist simultaneously with the fundamental or principal wave. The fundamental wave is always the one of the lowest frequency and determines the pitch of the tone, while the little waves, or ripples on top of the fundamental, give the tone its characteristic quality. A number of lantern slides were shown, made from photographs of sound waves coming from various musical instruments, and also the human voice.

In some cases, such as tone coming from a single organ pipe, the smaller or harmonic waves almost completely overwhelm the fundamental, or principal wave. The smaller waves are called overtones. The overtones whose frequencies are an even multiple of the fundamental are called harmonic overtones. The individual frequency of certain of the higher overtones may be more than twenty times the frequency of the fundamental.

Therefore, it is wonderful that radio transmitting and receiving instruments can transmit and record the extremely complicated and rapid vibrations constituting music with any degree of fidelity. The speaker then urged the radio engineers to combine their best efforts toward developing radio apparatus that would transmit and receive music of better quality than that usually accomplished. The low base voice vibrates at about 60 cycles per second and a high soprano at about 1,300 per second. The range generally employed in music is from 27 to 4138 cycles.

Mr. Pfanstiehl then explained the newest theory of the constitution of matter that is generally accepted today by the physicist. He stated that all the atoms of the different elements are made of much smaller pieces of matter called protons and electrons. In other words, the two elements from which everything in the universe is made are the proton and the electron. The only thing that differentiates an atom of one element, say

silver, from an atom of another element, say oxygen, is in the number and arrangement of the tiny electrons that rotate in regular orbits around a central nucleus which consists of various numbers of electrons and protons packed very tightly together. The simplest element is that of hydrogen, which consists of one electron rapidly rotating in an orbit around a nucleus which consists of one proton. The proton is 1,845 times as heavy as an electron, but is believed to be about the same size as an electron. The size of a hydrogen atom therefore is really the size of the orbit of its revolving electron. The actual size of the proton and electron taken together is only about 100,000th of the size of the orbit of the electron of the size of the atom as a whole.

The most complicated element known is uranium, which is believed to consist of ninety-two planetary electrons revolving in various orbits around a very complicated central nucleus consisting of 238 protons and 146 electrons, very tightly packed together. The uranium nucleus is so complicated and compact that some of these constantly explode. When this occurs, the atom is broken up and simpler atoms are formed. This process is called "radio activity" and the element radium is one of the principal radio-active elements which lends itself most readily to experimental work, and is therefore usually thought of in connection with radio activity. In fact, all of the elements constituting our world have sprung from a disintegration of uranium atoms.

The Source of Energy

This disintegration process is the final source of all forms of energy. It follows that matter is continually disinte-

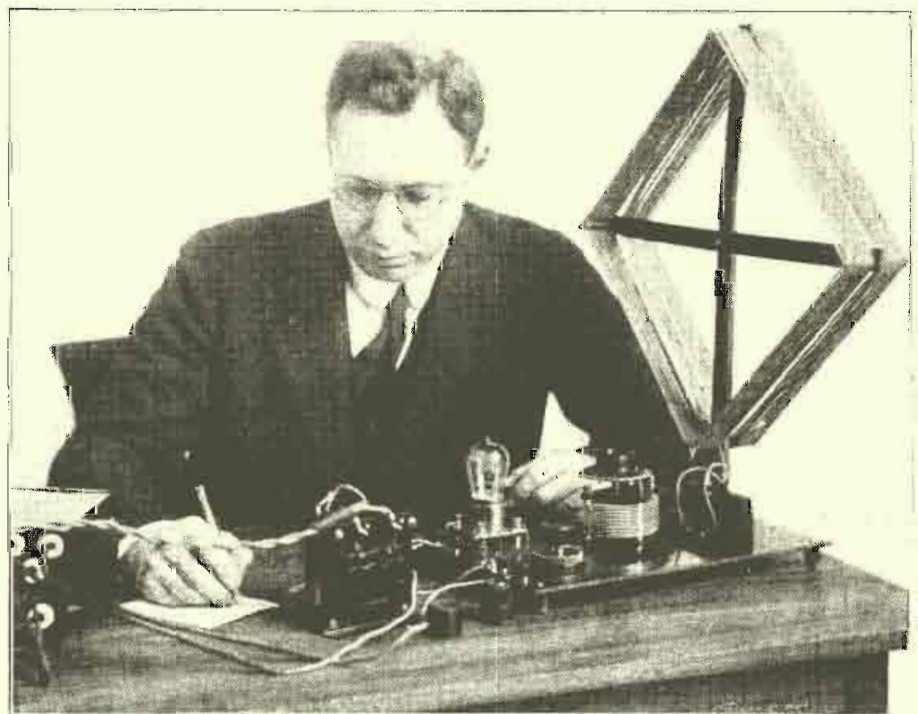

ASTOUNDS RADIO EXPERTS

Carl Pfanstiehl, noted radio expert, thrilled an audience of technical men at the Electric Club, Chicago, last month, when he delivered an authoritative discourse on radio progress and technicalities. It is recorded in this issue of RADIO AGE by Frank D. Pearne.



The amazing Harkness Knock-out Circuit, operating a loud speaker on 2 tubes, can now accompany you wherever you go on your vacation.

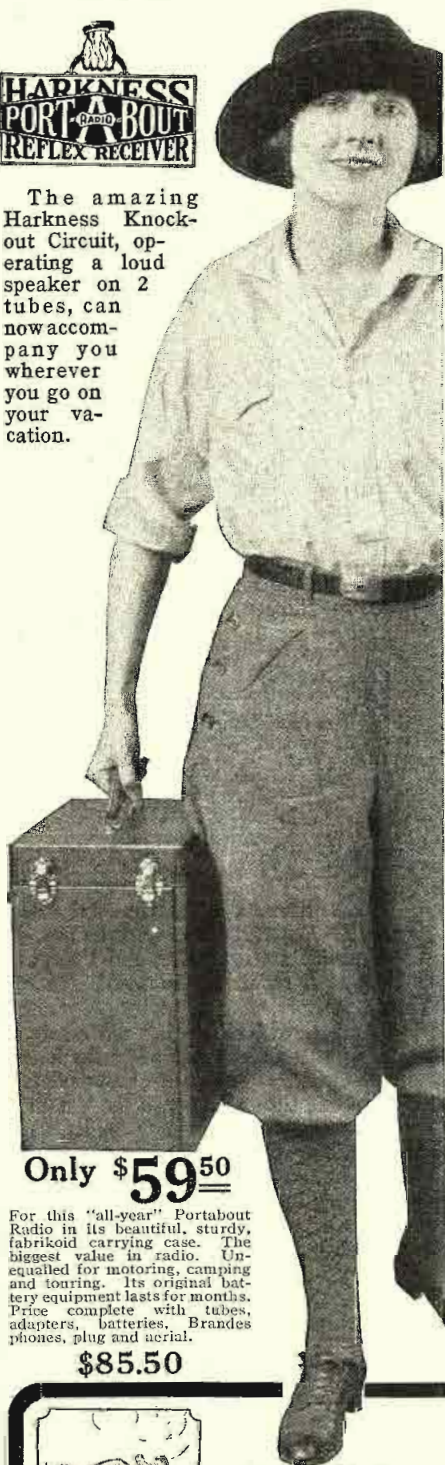

Only \$59⁵⁰

For this "all-year" Portabout Radio in its beautiful, sturdy, fabrikoid carrying case. The biggest value in radio. Unequaled for motoring, camping and touring. Its original battery equipment lasts for months. Price complete with tubes, adapters, batteries. Brandes phones, plug and aerial.

\$85.50



Take your PORT-A-BOUT with you to the beach.



In camp "the voice of the world" is yours through the PORT-A-BOUT.

Don't Delay

Demand for Portabout prevents supplying all dealers immediately. If your dealer is not supplied with Portabout, we will supply you direct and credit your purchase to him. Mail us his name and address with your money order and receive a Portabout without delay!

RADIO STORES CORPORATION

National Factory Representatives.
218 West 34th Street,
Dept. RA-624
NEW YORK

grating into energy, or it can be said that all matter is a form of more or less stable energy. Whenever an electron which is rotating around nucleus of an atom is jarred, or knocked out of its regular orbit, it throws off into space, in a straight line, a tiny particle of free energy, or a tiny chunk of matter much smaller than an electron, whichever way you want to think of it. The little particles of electron dust are so tiny that they travel through space with the speed of light; namely, 186,000 miles per second. These little particles of radiant energy are called "quanta" according to the so-called quantum theory. The energy shot off from the electrons which are rotating nearest to the nucleus of an atom are of higher frequency than when they are shot off from electrons rotating in outer or larger orbits inside of an atom. Therefore the larger the orbit of the exciting electron, the lower will be the frequency of the emitted radiation.

In order to produce radiations of a low enough frequency suitable for use in radio communication, an artificial orbit must be established for the electrons in order to get one large enough. This is accomplished by causing a disrupted electric current, which is merely a stream of free electrons traveling along a wire, to circulate around a coil of wire and very rapidly alternate its direction. By frequency is meant the number of volleys of particles shot off in a second. The highest frequencies known are produced by spontaneous distortion of a radio-active atom that originates in the nucleus. These rays are called "gamma rays" and have frequencies of several hundred million, million, million cycles per second. The next lower group of frequencies is called "X rays" and are of the order of one million, million, million cycles per second. The next lower group are called "ultra violet" or actinic rays, having frequencies of around fifteen thousand million million cycles.

Just below this comes the very narrow range of frequencies to which our eyes respond as visible light. The range covered by our eyes is very small and varies from 750 million, million cycles, which gives us the color of violet, down through the other colors to red which has a frequency of 375 million cycles. The next lower range is the infra red, which includes the heat rays which our skins detect as heat. Below this there is a range of frequencies that have not yet been produced or detected. Below this unknown range begins the "Hertzian," or radio waves. The range used at present for radio communication is from three million cycles to about fifteen thousand cycles.

The question of resonance, or tuning, was demonstrated with various mechanical and electrical apparatus. Small electric light bulbs were lighted by radiant energy sent from one table to another.

Amateurs Break Records

The breaking of a world's record coupled with other long distance work, during the Pan American amateur radio tests just concluded by the American Radio Relay League in co-operation with the Revista Telegrafica, demonstrates that the South American amateurs are becoming as efficient in short wave transmission as those in this country.

ARROW BATTERY SLASHES Prices TO CONSUMERS

Prices Smashed! Quality Not Sacrificed

ONLY

Here is real battery quality, guaranteed to you, at prices that will astound the entire battery-buying public. Order direct from factory. Put the Dealer's Profit in your own pocket. You actually save much more than half, and so that you can be convinced of true quality and performance, we give a **Written Two-Year Guarantee**

Here is your protection! Noneed to take a chance. Our battery is right—and the price is the lowest ever made. Convince yourself. Read the prices!
Special 2-Volt Radio Storage Battery, \$3.75
Special 4-Volt Radio Storage Battery, 6.00
6-Volt, 60 Amp. Radio Storage Battery, 7.00
6-Volt, 80 Amp. Radio Storage Battery, 8.00
6-Volt, 100 Amp. Radio Storage Battery, 9.50
6-Volt, 120 Amp. Radio Storage Battery, 11.50
6-Volt, 140 Amp. Radio Storage Battery, 13.00

We ask for no deposit. Simply send name and address and style wanted. Battery will be shipped the day we receive your order Express C. O. D., subject to your examination on arrival. Our guarantee accompanies each battery. We allow 5% discount for cash in full with order. You cannot lose! Act quick. Send your order today—NOW.

Arrow Battery Co.
1421 South Wabash Ave.
Dept. 11 Chicago, Ill.



The Traffic Cop of the Air

He arranges in orderly fashion the mass and jumble of Broadcasting Stations that are seeking entrance to your set and brings 'em in, one at a time, so you can enjoy them! Never reduces, but nearly always increases volume. Add a Ferbend Wave Trap to your set and "Police" your reception. Regulate the Traffic!

Guaranteed to tune out any interfering station. The price is \$3.00. Shipment is made express post C. O. D. plus a few cents postage. If you prefer, send cash in full with order and we will ship postage prepaid. Send us your order today.

FERBEND Wave Trap

FERBEND ELECTRIC COMPANY
16 E. South Water St.
Chicago, Ill.



DOLLAR RADIO SPECIALS

- 3 Standard Base Bakelite Sockets.....\$1.00
- 6 Porcelain Sockets 1.00
- 125 Ft. Tinned Copper Wire No. 16..... 1.00
- 1 Pr. Rubber Ear Cushions and New Radio Map 1.00
- 150 Ft. Stranded Tinned Copper Aerial Wire. 1.00
- 35 Ft. Spaghetti 1.00
- 3 Honeycomb Coils—35, 50, 75 turns..... 1.00
- 1 HOOK-UP PKG. 12 Ft. Spaghetti, 24 Terminals, 1 Tube Solderal, 3 Ft. Rosin Core Solder, 15 Ft. Tinned Wire..... 1.00
- 3 Bakelite Dials—3" or 2 1/2"..... 1.00
- 50 Ft. Genuine Copper Ribbon Aerial..... 1.00
- 3 Genuine Foote Triple or Double Crystals, value, \$1.80 1.00
- 1 Reinartz Coil, value, \$2.00..... 1.00
- 1 Monodyne Set, regular \$10.00 EXTRA SPECIAL 5.95

Send for large illustrated catalog No. 5A

WESTERN RADIO CORPORATION
Cedar Rapids, Iowa

I MAKE THE BEST CHOCOLATE BARS

Mints and Chewing Gum. Be my agent. Everybody will buy from you. Write today. Free Samples. MILTON GORDON, 106 Jackson St., Cincinnati, Ohio

"Let Our Hookups Be Your Guide"—RADIO AGE.



Bristol Single Control Radio Receiver

Complicated combinations are eliminated when tuning in with Bristol Single Control Radio Receiver—every station is on the one dial. It gives the joys of radio with technicalities left out.

The well-known Grimes Inverse Duplex System (non reradiating) is utilized in this Receiving Set. Because of the reflex, only four tubes are required to give power equivalent to six. The price, without accessories, \$190.00.

Audiophone Loud Speaker

You forget the radio equipment when listening thru the Audiophone Loud Speaker. The tone is full, clear and pleasing. It gives a true reproduction of the original. Made in three models—Senior \$30.00, Junior \$22.50, and Baby \$12.50.

Ask for Bulletins Nos. 3014 and 3015-P.

Made and Sold by

The Bristol Company
Waterbury, Connecticut

Pickups By Our Readers

(Continued from page 35)

a Crosley Model XJ receiver with a 2 stage push and pull power amplifier. Anyone will recognize the fact that 3 tubes are used to tune in. On the 3 tubes I have had the following stations loud and clear:

KGG, KGW, KGO, KPO, KOP, KZN, KDYL, KFL, KHJ, KFAU, KDKA, WDAP, WBAP, CFCN, CHBC, KDPT, KDYW, KFAV, KFCF, KFIN, KFKX, KIX, KJO, KJS, WDAF, WFAV, WOS, WOAW, WLW, WIAZ, WOAG, CKCK, CKCH, CKCD, WSAI, and once WDAM.

I have had many others but they

were not logged because they would not come in regularly.

Perhaps this won't interest you, but I think it was pretty good, as most of these were logged during August and September, 1923. Here's hoping that you don't think I'm too big a prevaricator. I have had loud speaker reception on all. KDKA came in wonderfully on loud speaker, using six tubes.

Very sincerely yours,

W. S. STRINGALL.

Albion, California.

P. S.—I don't suppose you know it, but RADIO AGE is the best magazine that I've seen yet.

Just because some of the fellows have been doing good work on one tube sets

doesn't mean that the fellows with the super-heterodynes, plexes, reflexes and radio frequency receivers should hold back. Probably they do get distance—so does the fellow with the bigger sets. The difference lies in the fact that when the big boys get them they get them good. The secret of the smaller sets lies in the fact that one can tune faster, and you are more apt to do freak receiving. By that we mean that you can follow practically any noise that peeps by with more ease than you can with a larger set, due to the fewer controls. Mr. Stringall has a good set, and from experience, we know that it takes a good set to reach out over the mountains like his does.

RADIO AGE,
Gentlemen:

I'll bet yours must be a pleasant job, reading over all those records! Well, I'll slip you mine. Glance over it, and let me know if it makes me a Dial Twister?

KDKA, KFGZ, KFKX, KOV, KYW, WAAM, WABL, WBBG, WBBR, WBZ, WCAD, WCAE, WCAP, WCBG, WCX, WDAF, WDAP, WDAF, WFAF, WEAM, WEAN, WEAQ, WFAB, WFI, WGI, WGN, WIAZ, WGR, WGY, WHAA, WHAM, WHAS, WHAZ, WHB, WHN, WIAD, WIP, WIAR, WIAS, WIAZ, WIJ, WJZ, WKAQ, WKAR, WLS, WLW, WMAK, WMAQ, WNAQ, WOAN, WOC, WOO, WOR, WOS, WPAB, WPAJ, WOAM, WRC, WRW, WSAI, WSAI, WSB, WTAB, WTAM, WTAS, WTAY, WTAT, WWAD, WWJ, NAA, CFCF, CHYC, CKAC, CKCH, PWX.

Add to these the experimental stations 1XAL, 2XB, 2XI and the amateur phone station 1KR, and I think there is a record quite worth reading. Hi!

Does that let me in? Anyway, here is the main dope. My set is a single circuit (Squak box or Blooper). It is a one tube affair with the WD11 tube being used. It was built last September but failed to function until January. The reason for this continued silence is quite a joke (but not to me). The set is homemade, and constructed of parts purchased in the local 5 and 10 cent store. The coupler which I built myself had pigtail connections. The pigtails were green, and flexible. One day, disgusted with the set, I cut open all the connections. Imagine my joy (?) when I found that the pigtails were constructed entirely out of cloth with no wire inside.

I'm going to let the single circuit slide for a while, and try the condenser variocoupler and variometer set. I would appreciate any help from some of the fellows who may have had experience with this hook-up. I don't believe there is any circuit as good as the little old single circuit if it is properly operated. Let's hear from you on that.

Sincerely,

IRVING Q. MILLER.

Tarrytown, N. Y.

Quite an experience—trying to tune with cloth pigtails on a coupler rotor. It reminds us of the joke about the fellow who had heard of using a bedspring of a bed for an antenna, and after trying it

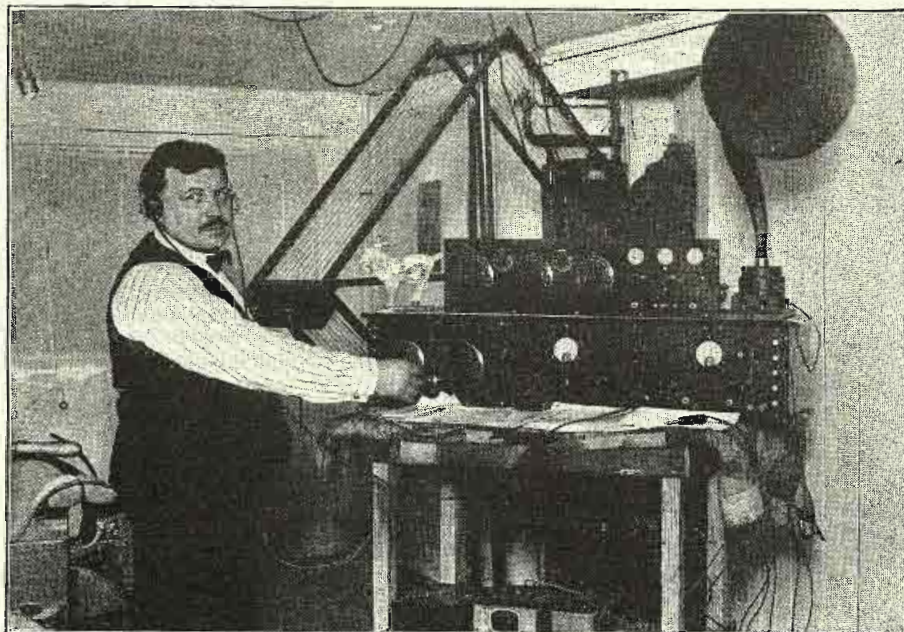

NEUTRODYNE VS. SUPER-HETERODYNE

Charles Zeman of 2400 South Fifty-eighth Court, Cicero, Illinois, is the engineer of the building in which RADIO AGE is located. He is an ardent booster of The Magazine of the Hour, and is very proficient in the art of making good sets. The illustration shows Mr. Zeman at work comparing the results and actions of an eight-tube super-heterodyne of his own make, and a neutrodyne. Note especially the well made loop antenna and the businesslike appearance of the super-het. Evidently radio "has got his goat" for if you will look real closely you will notice it standing on top of the super-het just above his hand.

out unsuccessfully for some time investigated and found the bed didn't have a spring at all. The bottom was made up of wooden bed slats!

RADIO AGE,

I recently purchased a copy of the RADIO AGE, and one copy was enough for me to want it for a year. *May the distance between your covers ever increase.*

F. W. CUMMINGS.

So if we don't stop writing and printing letters and contributions now, Mr. Cummings' wish may come true to the extent of our having to print the last couple of lines on the front cover. In closing, we wish to remind you of that Portable Set Static Puncturing contest. Don't forget to have a happy vacation.

"ROLLS ROYCE" RADIO TUBES



Like their name, significant of quality. Durable and powerful. Bring in distance with a maximum of volume and clearness.
 Type 200... 5 Volts, 1 Ampere Detector Tube.
 Type 201A... 5 Volts, .25 Ampere Amplifier and Detector.
 Type 199... 3-4 Volts, .06 Ampere Amplifier and Detector.
 Type 199... 3-4 Volts, .06 Ampere
 With Standard Base. Amplifier and Detector.
 Type 12... 1 1/2 Volts, .25 Ampere Platinum Filament. Amplifier and Detector.

"THE ROLLS ROYCE OF RADIO TUBES"

ALL TYPES.....\$2.50
 Type 202 (5) Watt Transmitters.....3.00

ALL TUBES GUARANTEED

to work in Radio Frequency Especially adapted for Neutrodyne, Reflex and Super-Heterodyne Sets.
 SHIPPED PARCEL POST C. O. D.
 WHEN ORDERING MENTION TYPE.

ROLLS ROYCE TUBE CO.
 21 Norwood St. (Dept. A) Newark, N. J.

British Favor Amateur Union

Hartford, Conn.—Further impetus to the movement for uniting transmitting radio amateurs into a world association was given when Gerald Marcuse, secretary of the Transmitters' Section of the Radio Society of Great Britain, visited America recently.

Mr. Marcuse is making a tour of the country to study American and Canadian amateur methods. While in Hartford he told Hiram Percy Maxim, president of the American Radio Relay League, that he would lend his personal support to the International Amateur Radio Union. The first plans for this world association of amateurs were drawn up during Mr. Maxim's recent European trip, and the final organization will take place at a special radio congress in Paris during the Easter holidays of 1925.

Maj. William C. Borrett of Dartmouth, Nova Scotia, manager of the League's Maritime Division, visited Hartford at the same time and asserted that Canadian amateurs were ready to become connected with such a union, and predicted it would be invaluable as a means of establishing friendly relations among the peoples of the countries represented.

B-METAL
 B-METAL for volume and for distance. Ask your dealer.
 B-METAL REFINING CO.
 5th Floor, 525 Woodward Ave.
 DETROIT, MICH.

3 REMARKABLE RADIO SETS

Each one of these radio sets has established unusual records for sets of its capacity. Thousands have been sold, both in New York City and throughout the U. S. by mail. Large volume sales and small profits. Elaborate descriptions gladly sent FREE.

"LITTLE GIANT" ONE TUBE RADIO SET \$9.97

Amazing NEW DESIGN for marvelous BIG POWER at low price. Made and sold only by us, America's BIGGEST Radio Dealers, where you buy in SAFETY. Shipped C. O. D. \$9.97, with written money-back guarantee. Complete Kit ready to assemble, with blueprint and 8-page booklet of diagrams and instructions. Capacity up to 1,000 miles.

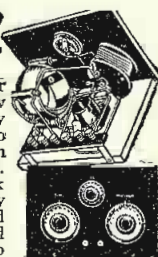

"The De Luxe Ambassador" \$27.95

A New Three-Tube Kit—using Genuine Ambassador Coil. Sold mounted just like picture, ready to wire for 7x10 cabinet. Remarkable volume and clarity assured. Capacity, 2,000 to 3,000 miles. Shipped C. O. D. \$27.95 with written money-back guarantee and complete wiring diagrams, blueprint, etc. An ideal portable set, to also use at home.

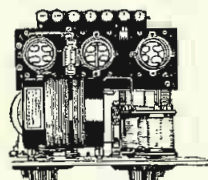

"The De Luxe Neutrodyne" \$34.49



Our famous 5-Tube Neutrodyne that reaches Coast to Coast. All standard, synchronized, genuine licensed Hazeltine Neutrodyne parts. Not only of extraordinary beauty but capable of amazing results. Shipped C. O. D. \$34.49, with written money-back guarantee with blue print showing assembly and wiring.

DEMONSTRATORS WANTED.

Live young man in every town and neighborhood, to own, operate and take orders for one or more of these sets. Hundreds are now in this fascinating paying work for us. Furnished you at discount. Liberal financial arrangements. Describe yourself. Ask for plan.

3 CIRCULARS FREE

Write for circular on set interesting you. See the illustrations, lists of parts, reports of distance and selectivity tests and letters from users. There is radio education waiting for you. Send today.

The RADIO-SHACK LARGEST Radio Dealers in America.

Dept. RA7, 55 Vesey Street, New York, N. Y.

378 DX STATIONS

DX Fans. If you have not logged 300 stations in past six months you need a Kennedy Three Circuit Tuner. The Kennedy Tuner logged 378 stations from September 15th to March 15th, including 2LO, London; SWA, Cardiff, Wales; CFCN, Calgary, Alberta, Canada; KGW, Portland, Oregon; KFI and KHJ, Los Angeles, California; KPO, San Francisco, California; KGO and KLX, Oakland, California.

Kennedy Tuner Takes the Place of

3 Honeycomb Coils at \$1.40.....\$ 4.20
 1 Honeycomb Coil Mounting..... 5.00
 1 23-Plate Vernier Condenser..... 5.00

INCLUDING GLOBE TROTTER DIAGRAM \$5.00 \$14.20

T. J. KENNEDY
 Radio Globe Trotter

1360 University Avenue, New York, N. Y.
GUARANTEE: If not satisfied after 30 days will cheerfully return your money.
 Send for Free Diagram.

"RADIO ON THE FARM" IN AUGUST RADIO AGE.

Trouble The Shooter



C. K., Chicago, Ill.

Question: Kindly inform me if an aerial attached to a pole which swings and sways would have any effects directly or indirectly on the signals received. Is a steady, rigid pole more satisfactory?

Answer: It is advisable to have the antenna system stretched taut and tight so that no part of the system will sway. Swaying antennas cause fading signals and uncertain tuning. In an ordinary receiver it becomes impossible to log with any degree of accuracy. Furthermore, the Fire Underwriters specify that all antenna installations must be rigidly secured, the antenna must not be allowed to sway, and must be constructed in such a manner that it shall not in any way endanger the lives or property of people by coming into contact with live wires or to cause damage by falling. By all means, make a creditable looking job with the aerial system. Solder all the joints and make approved splices. The added gain in the form of strong signals on the DX stations will amply repay your trouble.

F. J. J., Vera Cruz, Ind.

Question: On pages 50 and 51 of your RADIO AGE ANNUAL you show an Erla single tube reflex circuit, but I can't quite understand all of the details. Page 50 shows fixed condensers of .002 and .002 MFDS capacity. It also calls for one switch blade. The list of materials calls

for condensers of .001 and .002 MFDS capacity and the same list specifies two switch blades. Which is right, and how is this explained? Will this circuit tune easily? Will it operate a table talker and to what extent? Is the circuit fundamentally noisy? How is it for getting DX? Is it good for Summer reception? How does it compare with the Cockaday circuit described on page 37? About how much should the materials cost without phones, batteries, tube and other accessories? Will it easily and with volume tune in stations broadcasting on the higher wave lengths? Thanking you for your trouble, and knowing you will give me a reliable and accurate reply, I shall watch your columns for my answer.

Answer: Relative to the condenser connected across the B battery, this is not important, and may be a large capacity without detracting from the effectiveness of the circuit. On the other hand, it is important that the condenser across the transformer have the correct capacity. If the coupler has two sets of taps provided for in its primary winding, it becomes necessary to use two switch blades. It depends entirely upon the type of coupler you use. I would advise that you get one that has windings tapped in a series of about 8 coarse taps consisting of about 10 turns to each tap with about 8 more consisting of one turn each. This will permit you to make very close adjustment of the aerial circuit. However, a fixed

coupler or a Selectoformer can be used to advantage as in the Sure Fire Reflex circuit of the May issue of RADIO AGE. The losses of the taps can in this way be eliminated. If a variocoupler with a tapped primary is used, it is not possible to accurately log a DX station, unless the dial position, the switch blade and filaments settings are noticed. If a fixed coupler or Selectoformer is used, the logging can be done accurately. The set will operate a table talker to good advantage on local stations. The volume will of course not be terrific but will be of sufficient quantity to entertain in a small room. This depends entirely upon where and how the set is operated and constructed. The set is very quiet and the crystal detection provides a beautiful tonal quality. The DX range is average. I believe the Cockaday beats it for DX, but bows to it for beauty in tone and volume. It makes a good portable set. Cost of the set should be around \$20 with average parts. Tuning depends upon the type of tuning system you use. If you provide yourself with a coupler of the correct range, it will cover the entire allotment of broadcast waves.

W. B. R., Roanoke, Va.

Question: I am a regular reader of your valued publication. From the February issue of this year I built the Reinartz Audio Regenerator. WGY at

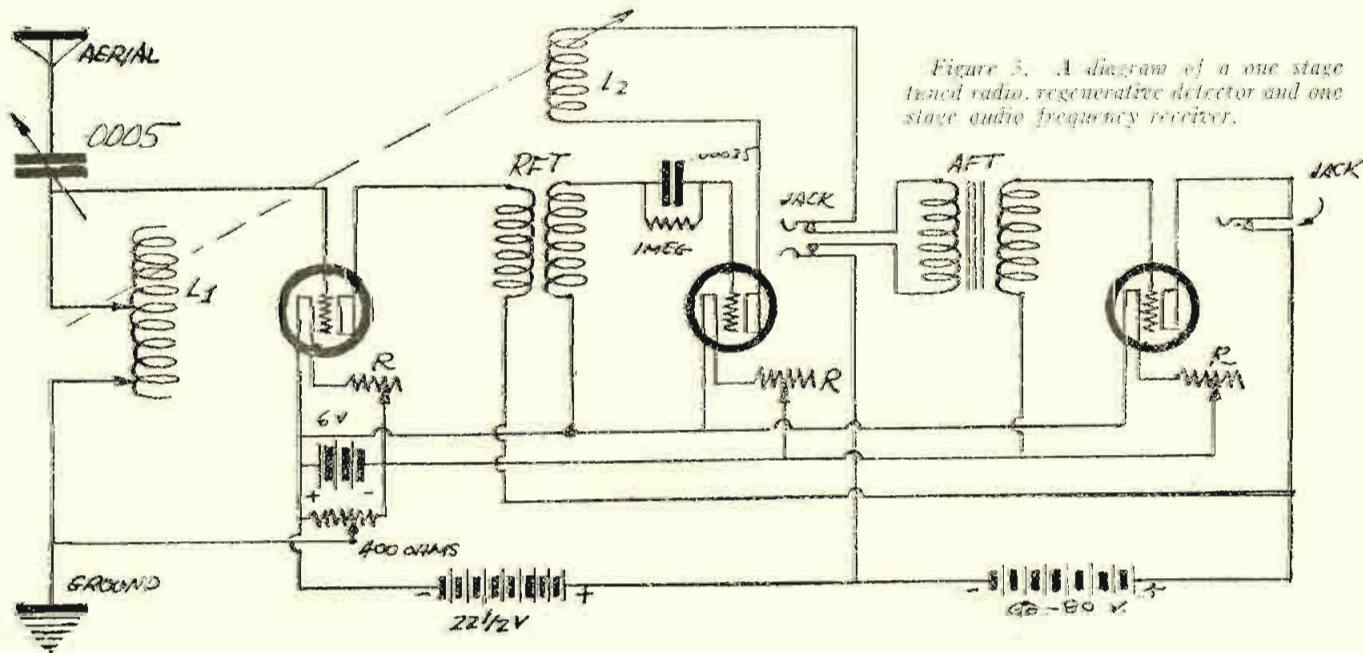

Figure 3. A diagram of a one stage tuned radio, regenerative detector and one stage audio frequency receiver.



More Money For You in RADIO

THE amazing expansion of Radio has opened up hundreds of wonderful new positions on land and sea. Big salaries, fascinating, easy work, short hours, and a wonderful future are offered to ambitious men who get into Radio now.

Take advantage of these wonderful opportunities to step into a big paying position in this great new field. Radio offers you an opportunity to travel and see the world, with all expenses paid, and a fine salary besides. Or you can stay at home and work up to a position paying up to \$10,000 a year. One of our recent graduates secured a position one week after graduating, paying a salary of \$300 per month. Hundreds of others report equal success.

Easy to Learn Radio at Home

Hundreds of men are already earning handsome incomes in this wonder science. If you want to get into a profession where opportunities are unlimited make Radio your career—become a Certified Radio-trician.

Thousands of Certified Radio-tricians are wanted to design Radio sets; to make new Radio improvements; to manufacture Radio equipment and to install it; to maintain and operate great broadcasting stations and home Radio sets; to repair and sell Radio apparatus; to go into business for themselves; to operate aboard ship and at land stations.

You can easily and quickly qualify in your spare time at home through the help of the National Radio Institute, first school to teach radio successfully by mail, established 1914. No previous experience or training needed. Prominent Radio experts will help you. Free, with course—circuits and parts for building latest receiving set, also three instruments loaned to students, making the work thoroughly practical. The same plan that has already helped hundreds of our graduates to real success and real money in Radio is open to you.

Send for BIG BOOK

No other field today offers such great opportunities as Radio. Take your choice of the many wonderful openings everywhere. Prepare now to step into the most interesting and best paid profession today. Read about the opportunities open now—the different kinds of work—the salaries paid. Write today for the 32-page book that tells how America's first and biggest Radio school can teach you to become a Certified Radio-trician in your spare time. Mail the coupon or write a letter NOW.

National Radio Institute

Dept. 53GA

Washington, D. C.

National Radio Institute, Dept. 53GA
Washington, D. C.

Without obligation send me your book, "Rich Rewards in Radio," which tells all about the opportunities in Radio, how spare time study at home will qualify me quickly as a Certified Radio-trician so I can get one of these splendid positions, and how your Employment Service helps me to secure a big pay job. (Please write plainly.)

Name.....Age.....

Street.....Occupation.....

City.....State.....

Schenectady, New York, comes in with terrific volume but I have trouble in getting other stations. When I hold my hand on the grid wire it seems to improve reception on these stations. I used only high class parts. Could you offer some suggestions as to how I could improve the all-round effectiveness of the set?

Answer: The action of the grid circuit you speak of suggests that you might get better results by using a regular .00025 MFD, grid condenser with a pencil mark grid leak. I find that it is almost a necessity with the dry cell tubes if DX stations are desired. The audio component remains the same. If you find that this change does not bring the desired results, connect the parts in the circuit shown in Figure 1. I find that this arrangement is very effective in every case.

E. H. D., Papillion, Nebr.

Question: We would appreciate a little explanation of a few problems with reference to a Reinartz circuit with which we have been experimenting. While working with the circuit, we chanced to place a makeshift coupler in the antenna circuit in place of the usual variable condenser used to tune the antenna, which consisted of 18 turns of wire on a rotor with a stator of 22 turns. This we found increased both our range and distance, and makes the set very much easier to tune. The only drawback is that we find it difficult to tune in the wave lengths over 500 meters. We get them, but only faintly. Could you suggest any arrangement to use with this discovery, which would help us to get the higher wave stations more clearly? Is there any way to wind a coil that would help? What do you think of a set using one stage of radio frequency, detector and one stage of audio frequency amplification, using the Reinartz system of tuning? Kindly let us have a diagram of the connections.

Answer: The action you describe is a well known argument in tuning. In some cases it will be found that inductance variation is superior to capacity tuning. It seems that you find the former more efficient in your case. It is a fact that inductance variation, accomplished as a rule with variometers or coupler of the type you speak, give a higher voltage variation than condenser tuning will. The drawback is as you describe; the tuning range is limited and you cannot cover the same scale as you can with a condenser. The inductance variation method also has higher losses than a good condenser tuned circuit unless it is very carefully constructed. At the risk of losing the reception of the very low wave stations, you can add a few more turns to either of the coils (stator preferred) and increase the efficiency of the set on the higher waves. It would be a good plan to use a basket-weave variometer in the circuit. It has low losses, and low distributed capacity, and at the same time because of its sharp tuning qualities, it will cover a greater wave length range than the ordinary composition, high leakage variometers. Your experiment sounds interesting, and logical. It might be a good plan for some of our
(Continued on next page)

Jiffy RIBBON ANTENNA

Will Not Kink or Curl!

Improve your set's efficiency with a "Jiffy" antenna. Non-Corrosive, can't rust! Do away with the unsightly wires—"Jiffy" is neatest of all.

"Jiffy" antenna comes complete to install with two insulators. In a few minutes you have an aerial that cannot be excelled.



At your dealers,
or direct

\$1.50

Apex Stamping Company
Dept. R.A. Riverdale, Ill.

Welty's

SUPERADIO 3-1 Audio Amplifying Unit.....\$7.00
SUPERADIO 2-1 Detector Unit... 2.50

These units are very efficient in every circuit, especially for 5-tube Neutrodyne. WELTY'S LOUD SPEAKER...\$25.00
WELTY'S Loud Speaker Unit... 6.00
WELTY'S Combination Victrola Loud Speaker Unit..... 9.00

If your dealer cannot supply you write direct.

William A. Welty Company,

36 S. State St. Chicago, Ill.

HOWARD PARTS

No. 1001 Rheostat, \$1.10
No. 1003 Potentiometer, \$1.50
No. 1002 Micrometer, \$1.50
At All Dealers.



Dept. A

4248 N. Western Ave.

RADIO CABINETS RADIO SETS EQUIPPED PANELS

Ask Us About PHUSIFORMERS

LAKESIDE SUPPLY CO., Dept. R
73 West Van Buren Street
Telephone, Harrison 3840 CHICAGO, ILL.

Don't fail to renew your subscription to RADIO AGE when it expires.

The Greatest Book on RADIO ever written

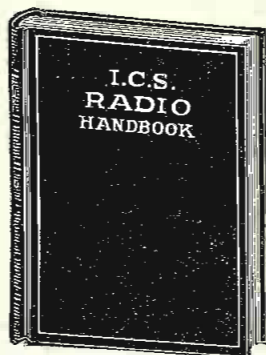

only **\$1**
514 pages
Pocket
Size

50,000 SOLD

Compiled by HARRY F. DART, E.E.
Formerly with the Western Electric Co.,
and U. S. Army Instructor of Radio.
Technically edited by F. H. DOANE

NEW edition just off the press! The greatest book on radio ever written. Price only \$1. Filled with sound, practical, tested information for every radio fan, from beginner to hard-boiled owl. Written, compiled and edited by radio experts of national reputation.

Every page tells you something useful. And there are 514 pages! More than 150 illustrations and diagrams!

You may dip into this I. C. S. Radio Handbook at random, or hunt up special information you want, or read it right through. Different types of receiving and sending hook-ups are explained; electrical terms and circuits; antennas; batteries; generators and motors; electron (vacuum) tubes; interesting experiments; definitions, and thousands of suggestions for getting more pleasure out of radio. Will save you from wasting money on things that won't work.

Send \$1 to-day and get this 514-page I. C. S. Radio Handbook before you spend another cent on parts. Money back if not satisfied.

TEAR OUT HERE

INTERNATIONAL CORRESPONDENCE SCHOOLS
Box 3731-B, Scranton, Penna.

I enclose One Dollar. Please send me—post-paid—the 514-page I. C. S. Radio Handbook. It is understood that if I am not entirely satisfied I may return this book within five days and you will refund my money.

Name.....
Address.....

RADIO AGE and RADIO AGE ANNUAL

A year's subscription to this magazine and a copy of the famous handbook of drawings and instructions on how to make standard receiving sets. 112 pages.

All for \$3.00

Send today by check, registered mail or money order to

RADIO AGE, Inc.
500 N. Dearborn St. Chicago, Ill.

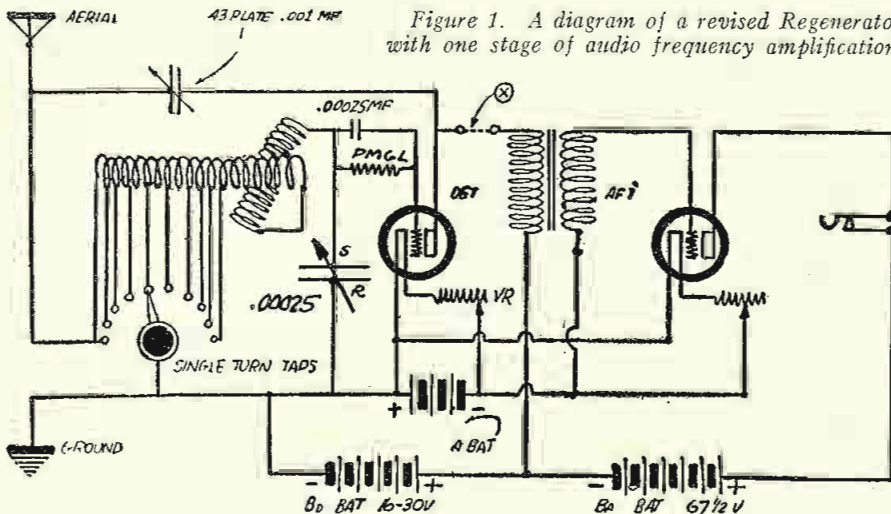

Figure 1. A diagram of a revised Regenerator with one stage of audio frequency amplification.

and the variocoupler coil should have as few losses as possible to make up a good receiver. I would also advise the use of a pencil mark grid leak.

V. A. B., Kokomo, Ind.

Question: From your February, 1924, issue, I built the Baby Heterodyne receiver, and I have with it enjoyed many receptions from long distance stations. I am now seeking to improve it. I already have two stages of audio which operates a loud speaker with wonderful volume on both long distance and local stations. I am now looking for a diagram showing how to add one stage of radio frequency to the hookup. Kindly print a diagram of the circuit with additions I desire. I would also like a list of parts necessary.

Answer: I am printing in Figure 5 a

diagram of the Baby Heterodyne showing the addition of a stage of radio frequency. The only other parts you will need are as follows:

- 1 50 turn honeycomb coil.
- 1 23 plate .0005 MFD variable condenser.
- 1 200 to 400 ohm potentiometer.
- 1 tube UV199 or UV201A.
- 1 rheostat to suit tube.
- 1 tube socket.
- Binding posts and other makeup.

In making up the radio frequency unit you must use an amplifier tube for the first stage of radio. You can use anything you like for the detector tube as long as it is not a WD11. For the radio frequency tube on the diagram, use a
(Continued on page 53)

INTERNATIONAL BABYDYNE RECEIVER

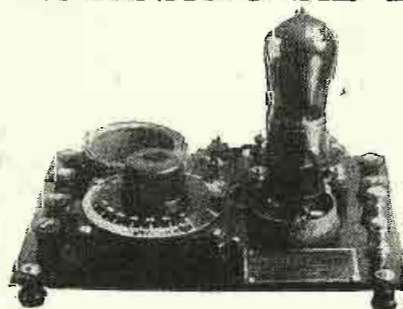

The last word in simplified radio! This set will tune in over 1,000 miles.

LIST PRICE: \$10 (Without the tube).

Dealers and jobbers: This set will be the rage this summer; especially among vacationists and campers. Write for our discounts.

The above set can be coupled to a two-stage amplifier with advantage.

SET COMPLETE \$15

With tube, phones, batteries, etc.

This offer bears a real money-giving value, for we include in it only guaranteed articles!

\$50.00 IN CASH

will be given for the best acceptable plan of a case to enclose the Babydyne with tube, batteries and headphones.

THE "MUST" IN THE CASE:

- It must be light.
- It must be compact.
- It must be portable style.
- It must be of fair strength.
- It must be cheap to construct.
- It must be ingenious in build.

SOMEONE of the Babydyne users will win this prize; it may be you if you send us your diagram and photograph.

\$3.00 RADIO TUBES \$3.00

We handle a famous line of radio tubes that are fully guaranteed and replaced if unsatisfactory.

(Discount to dealers)

INTERNATIONAL BABYDYNE RADIO RECEIVER

TRADE MARK

Manufactured by

A. & T. RADIO COMPANY

Dept. B, DANVERS, MASS.

Corrected List of U. S., Cuban and Canadian Broadcasting Stations

Complete Each Issue

THE list of broadcasting stations on these pages is brought up to date each month by additions of new stations and deletion of those which have suspended operation. The list is the product of a vast volume of correspondence and its completeness is due in large measure to the assistance of our special news service in Washington, D. C. Suggestions, corrections and additional data will be welcomed from readers and broadcasters.

KDKA	Westinghouse Electric & Mfg. Co.	East Pittsburgh	326	KFLH	Erickson Radio Co.	Salt Lake City, Utah	261
KDPM	Westinghouse Electric & Mfg. Co.	Cleveland, Ohio	270	KFLP	Everette M. Foster	Cedar Rapids, Iowa	240
KDPT	Southern Electric Co.	San Diego, Calif.	244	KFLR	Brazell Radio Shop	Little Rock, Ark.	261
KDYL	Telegram Publishing Co.	Salt Lake City, Utah	260	KFLS	University of New Mexico	Albuquerque, N. Mex.	254
KDYM	Savoy Theatre	San Diego, Calif.	244	KFLU	Rio Grande Radio Supply House	San Benito, Texas	236
KDYQ	Oregon Institute of Technology	Portland, Oreg.	360	KFLV	Rev. A. T. Frykman	Rockford, Ill.	229
KDYX	Star Bulletin	Honolulu, Hawaii	360	KFLW	Missouri Electric Supply Co.	Missoula, Mont.	234
KDZB	Frank E. Siefert	Bakersfield, Calif.	240	KFLX	George Roy Clough	Galveston, Tex.	240
KDZE	Rhodes Department Store	Seattle, Wash.	270	KFLY	Paro Radio Supply Co.	Fargo, N. Dak.	231
KDZI	Electric Supply Co.	Wenatchee, Wash.	360	KFLZ	Atlantic Automobile Co.	Atlantic, Pa.	273
KDZO	Nichols Academy of Dancing	Denver, Colo.	360	KFMQ	University of Arkansas	Fayetteville, Ark.	263
KDZR	Bellingham Publishing Co.	Bellingham, Wash.	261	KFMR	Morningside College	Sioux City, Iowa	261
KFAD	McArthur Bros. Mercantile Co.	Phoenix, Ariz.	360	KFMS	Freimuth Dept. Store	Duluth, Minn.	275
KFAE	State College of Washington	Pullman, Wash.	330	KFMT	Dr. George W. Young	Minneapolis, Minn.	231
KFAF	Western Radio Corp.	Denver, Colo.	360	KFMU	Stevens Bros.	San Marco, Tex.	240
KFAJ	University of Colorado	Boulder, Colo.	360	KFMV	M. G. Sator	Long Beach, Calif.	266
KFAN	The Electric Shop	Moscow, Idaho	360	KFMW	Carleton College	Northfield, Minn.	283
KFAR	Studio Lighting Service Co. (O. K. Olsen)	Hollywood, Calif.	280	KFMY	Boy Scouts of America	Long Beach, Calif.	229
KFAU	Independent School Dist. of Boise City, Boise High School	Boise, Idaho	270	KFMZ	Roswell Broadcasting Club	Roswell, N. M.	252
KFAW	The Radio Dea (W. B. Ashford)	Santa Ana, Wash.	280	KFNC	Alonzo Monk, Jr.	Corsicana, Texas	234
KFAY	W. J. Virgin	Medford, Oreg.	283	KFNE	Henry Field Seed Co.	Shenandoah, Iowa	266
KFBC	W. K. Ashill	San Diego, Calif.	278	KFNF	Leslie M. Schaubert	Colliway, Miss.	254
KFBE	Reuben H. Horn	San Luis Obispo, Calif.	242	KFNH	State Teachers College	Springfield, Mo.	236
KFBG	First Presbyterian Church	Tacoma, Wash.	360	KFNI	Warrensburg Electric Shop	Warrensburg, Mo.	234
KFBK	Kimball-Uppson Co.	Sacramento, Calif.	283	KFNL	Radio Broadcast Ass'n	Paso Robles, Calif.	240
KFBL	Leese Bros.	Everett, Wash.	224	KFNV	L. A. Drake Battery and Radio Supply Shop	Santa Rosa, Calif.	234
KFB5	Trinidad Gas & Electric Supply Co. and the Chronicle News	Trinidad, Colo.	360	KFNX	Peabody Radio Service	Peabody, Kansas	240
KFBU	The Cathedral (Bishop N. S. Thomas)	Laramie, Wyo.	283	KFNY	Montana Phonograph Co.	Helena, Montana	261
KFCB	Nielson Radio Supply Co.	Phoenix, Ariz.	238	KFNZ	Royal Radio Company	Burlington, Calif.	231
KFCF	Frank A. Moore	Walla Walla, Wash.	360	KFOC	First Christian Church	Whittier, Calif.	236
KFCG	Electric Service Station (Inc.)	Billings, Mont.	360	KFOE	Vern Peters	Wallace, Idaho	224
KFCP	Ralph W. Flygare	Ogden, Utah	360	KFOF	Rehrer Electric Co.	Marshfield, Oregon	240
KFDJ	Fred Mahaffey, Jr.	Houston, Texas	360	KFOH	The Radio Bungalow	Portland, Oregon	283
KFCY	Western Union College	Le Mars, Iowa	252	KFOI	Moberly High School Radio Club	Moberly, Missouri	246
KFCZ	Omaha Central High School	Omaha, Neb.	258	KFOJ	Leslie M. Schaubert	Marengo, Iowa	224
KFDA	Adler's Music Store	Baker, Oreg.	360	KFOK	Echophon Radio Shop	Long Beach, Calif.	234
KFDD	St. Michaels Cathedral	Boise, Idaho	252	KFOO	Lith Day Saints University	Salt Lake City, Utah	261
KFDD	University of Arizona	Tucson, Ariz.	268	KFOQ	Willson Construction Co.	Dallas, Texas	268
KFDF	Oregon Agricultural College	Corvallis, Oreg.	360	KFOR	Ora William Chancellor	Galveston, Texas	240
KFDO	H. Everett Cutting	Bozeman, Mont.	248	KFOS	David City Tire & Electric Co.	David City, Nebraska	226
KFDR	Bullock's Hardware & Sporting Goods (Rob. G. Bullock)	York, Neb.	360	KFOU	College Hill Radio Club	Wichita, Kansas	231
KFDV	Gilbrech & Stinson	Fayetteville, Ark.	360	KFOV	Hazelwood, Mo.	Richmond, Calif.	254
KFDX	First Baptist Church	Shreveport, La.	360	KFOX	Davis Electrical Corporation	Sioux City, Iowa	234
KFDY	South Dakota State College of Agriculture and Mechanics Arts	Brookings, S. Dak.	360	KFOY	Board of Education, Technical High School	Omaha, Nebraska	248
KFEZ	Harry O. Iverson	Brookings, S. Dak.	360	KFOZ	Beacon Radio Service	St. Paul, Minn.	226
KFEC	Meier & Frank Co.	Minneapolis, Minn.	231	KFPQ	Leon Hudson Real Estate Co.	Fort Smith, Ark.	233
KFEL	Winner Radio Corp.	Portland, Oreg.	360	KFPK	Edwin J. Brown	Seattle, Wash.	224
KFEO	J. L. Scroggin	Denver, Colo.	254	KFPH	Garretson and Dennis	Los Angeles, Calif.	238
KFER	Auto Electric Service Co.	Fort Dodge, Iowa	231	KFPI	Harold Chas. Mailander	Salt Lake City, Utah	242
KFEV	Radio Electric Shop	Douglas, Wyo.	261	KFPL	C. C. Baxter	Dublin, Texas	242
KFEW	Angus & Scudder	Minneapolis, Minn.	261	KFPM	The New Furniture Co.	Greenville, Texas	242
KFEY	Bunker Hill & Sullivan Mining and Concentrating Co.	Kellogg, Idaho	360	KFPN	Missouri National Guard	Jefferson City, Mo.	242
KFEZ	Asso. Engr. Societies of St. Louis	St. Louis, Mo.	248	KFPQ	G. & C. Radio & Electric Shop	Olympia, Washington	236
KFFB	Jenkins Furniture Co.	Boise, Idaho	240	KFPR	Los Angeles C. Foresty Dent	Denison, Texas	231
KFFE	Eastern Oregon Radio Co.	Pendleton, Oreg.	360	KFPS	Carter A. Ross Motor Service Co.	Casper, Wyo.	242
KFFO	Dr. E. H. Smith	Hillsboro, Oreg.	226	KFPV	Heintz & Kohlmoos, Inc.	San Francisco, Calif.	236
KFFP	First Baptist Church	Hillsboro, Oreg.	226	KFPW	St. Johns M. E. Church, S.	Cartersville, Mo.	268
KFFQ	MacDonald Motor Co.	Colorado Springs, Colo.	286	KFPX	Symons Investment Co.	Spokane, Wash.	283
KFFR	Nevada State Journal (Jim Kirk)	Sparks, Nev.	226	KFQA	First Presbyterian Church	Pine Bluff, Ark.	242
KFFV	GraceLand College	Lamoni, Iowa	360	KFQB	The Searchlight Publishing Co.	Fort Worth, Texas	254
KFFX	McGraw Co.	Omaha, Neb.	278	KFQC	Kidd Brothers Radio Shop	Tulsa, Okla.	227
KFFY	Pinous & Murphy	Alexandria, La.	278	KFQD	Clifton Supply Co.	Anchorage, Alaska	280
KFFZ	Al. G. Barnes Amusement Co.	Dallas, Tex. (Portland)	226	KFQE	Dickenson-Henry Radio Laboratories	Colorado Springs, Colo.	224
KFGA	Lepina State University	Baton Rouge, La.	254	KFQF	Donald A. Beall	Minneapolis, Minn.	224
KFGD	Clackson Radio & Electric Co.	Chickasha, Okla.	248	KFQG	Southern Calif. Radio Ass'n	Los Angeles, Calif.	226
KFGH	Leland Stanford University	Stanford University, Calif.	273	KFQH	Albert Sherman	Hill Country, Calif.	231
KFGL	Arlington Garage	Arlington, Oreg.	234	KFOI	The Thos. H. Ince Corp.	Culver City, Calif.	234
KFGQ	Carry Hardware Co.	Boone, Iowa	226	KFQJ	Angelus Temple	Los Angeles, Calif.	278
KFGV	Heldreder Radio Supply Co.	Utica, Neb.	224	KGB	Tacoma Daily Ledger	Tacoma, Wash.	252
KFGX	First Presbyterian Church	Texarkana, Tex.	254	KGG	Hallock & Watson Radio Service	Portland, Oreg.	360
KFGZ	Emmanuel Missionary College	Berrien Springs, Mich.	268	KGN	Northwestern Radio Mfg. Co.	Portland, Oreg.	312
KFHA	Western State College of Colorado	Gunnison, Colo.	252	KGO	General Electric Co.	Oakland, Calif.	360
KFHB	Rialto Theater (P. L. Beardwell)	Hood River, Oreg.	280	KGU	Marion A. Mulron	Honolulu, Hawaii	360
KFHD	Utz Electric Shop Co.	St. Joseph, Mo.	226	KGW	Portland Morning Oregonian	Portland, Oreg.	492
KFHP	Central Christian Church	Shreveport, La.	266	KGY	St. Martins College (Rev. Sebastian Ruth)	Lacy, Wash.	258
KFHH	Amorose A. McGuire	North Bay, Wash.	260	KHJ	Times-Mirror Co.	Los Angeles, Calif.	395
KFHI	Fallon & Greenleaf	Santa Barbara, Calif.	260	KHQ	Louis Cassmer	Seattle, Wash.	360
KFHR	Star Electric & Radio Co.	Seattle, Wash.	270	KHJ	Electric Shop	Oakland, Calif.	360
KFHX	Robert W. Nelson	Hutchinson, Kan.	229	KJQ	Northwest Radio Service Co.	Seattle, Wash.	270
KFI	Earle C. Anthony (Inc.)	Los Angeles, Calif.	469	KJR	Bible Institute of Los Angeles	Los Angeles, Calif.	360
KFID	Ross Arbuckle's Garage	Jola, Kans.	246	KJS	Warner Brothers Radio Supplies Co.	Oakland, Calif.	360
KFII	Romson Polytechnic Institute	Portsmouth, Oreg.	230	KKL	Tribune Publishing Co.	Oakland, Calif.	509
KFIL	Windsch Electric Farm Equipment Co.	Louisburg, Kan.	234	KLZ	Reynolds Radio Co.	Denver, Colo.	283
KFIO	North Central High School	Spokane, Wash.	252	KLM	San Joaquin Light & Power Corp.	Spokane, Calif.	273
KFIP	Yakima Valley Radio Broadcasting Association	Yakima, Wash.	224	KMO	Love Electric Co.	Tacoma, Wash.	360
KFIU	Alaska Electric Light & Power Co.	Juneau, Alaska	226	KNT	Grays Harbor Radio Co. (Walter Henrich)	Aberdeen, Wash.	263
KFIV	V. H. Brovles	Pittsburg, Kans.	240	KNX	Electric Lighting Supply Co.	Los Angeles, Calif.	360
KFIZ	Reorganized Church of Jesus Christ of Latter Day Saints	Independence, Mo.	240	KOB	New Mexico College of Agriculture & Mechanic Arts	State College, N. Mex.	360
KFJZ	Daily Commonwealth and Oscar A. Huelsman	Fon Du Lac, Wis.	273	KOP	Detroit Poles Department	Detroit, Mich.	286
KFJB	Marshall Electrical Co.	Marshalltown, Iowa	248	KPO	Hale Bros.	San Francisco, Calif.	423
KFJC	Seattle Post Intelligencer	Seattle, Wash.	233	KPP	Apple City Radio Club	Hood River, Oreg.	360
KFJF	National Radio Manufacturing Co.	Oklahoma City, Okla.	252	KOV	Doubleday-Hill Electric Co.	Pittsburgh, Pa.	360
KFJJ	Liberty Theatre (E. F. Marsh)	Astoria, Oreg.	252	KQW	Charles D. Herrold	San Jose, Calif.	360
KFJK	DeFries Radio and Electric Co.	Bristow, Okla.	233	KSD	V. C. Battery & Electric Co.	Berkeley, Calif.	278
KFJL	Hardacre Manufacturing Co.	Ottumwa, Iowa	242	KST	Post Dispatch (Palitzer Pub. Co.)	St. Louis, Mo.	546
KFJM	University of North Dakota	Grand Forks, N. Dak.	229	KTW	First Presbyterian Church	Seattle, Wash.	360
KFJO	Valley Radio, Div. of Elec. Constr. Co.	Grand Forks, N. D.	280	KUO	Examiner Printing Co.	San Francisco, Calif.	360
KFJR	Ashley C. Dixon & Son	Stevensville, Mont. (near)	228	KUY	Coast Radio Co.	El Monte, Calif.	256
KFJV	Thomas H. Warren	Dexter, Iowa	228	KYG	Portable Wireless Telephone Co.	Stockton, Calif.	360
KFJW	Iowa State Teachers' College	Cedar Falls, Iowa	259	KWH	Los Angeles Examiner	Los Angeles, Calif.	360
KFJY	Tunwall Radio Co.	Fort Dodge, Iowa	248	KWJ	Westinghouse Electric & Mfg. Co.	Honolulu, Hawaii	270
KFJZ	Texas National Guard, One hundred and twelfth Cavalry	Fort Worth, Texas	254	KYW	Preston D. Allen	Oakland, Calif.	360
KFKA	Colorado State Teachers College	Greeley, Colo.	248	KZN	Cope and Johnson Co.	Salt Lake City, Utah	268
KFKB	Brinkley-Jones Hospital Association	Millard, Kans.	256	KZV	Wenatchee Battery & Motor Co.	Wenatchee, Wash.	360
KFKC	Conway Radio Laboratories (Ben H. Woodruff)	Clinton, Ark.	260	WAAB	Vahlemann Jensen	New Orleans, La.	268
KFKV	F. F. Gray	Butte, Mont.	283	WAAC	Thompson-Jones	New Orleans, La.	360
KFKX	Westinghouse Electric & Manufacturing Co.	Hastings, Neb.	286	WAAD	O. O. Mechanics Institute	Cincinnati, Ohio	360
KFKZ	Nassour Bros. Radio Co.	Colorado Springs, Colo.	234	WAAF	Chicago Daily Drivers Journal	Chicago, Ill.	286
KFLA	Abner R. Willson	Butte, Mont.	283	WAAG	Gimbel Brothers	Milwaukee, Wis.	286
KFLB	Signal Electric Manufacturing Co.	Menominee, Mich.	248	WAAM	I. R. Nelson Co.	Newark, N. J.	263
KFLD	Paul E. Greenleaf	Franklinton, La.	234	WAAN	University of Missouri	Columbia, Mo.	254
KFLF	National Educational Service	Denver, Colo.	268	WABW	Omaha Grain Exchange	Omaha, Neb.	360
KFLG				WABA	Lake Forest College	Lake Forest, Ill.	268

CLASSIFIED ADVERTISEMENTS

Ten cents per word per insertion, in advance. Name and address must be counted. Each initial counts as one word. Copy must be received by the 15th of month for succeeding month's issue.

RADIO CIRCUITS

If your Nentrodyne won't "Neut" o. k., send 10c for Details of Kladag Coast to Coast circuit, bill of materials, etc., to change over your Neut into a set that will bring them all in from Mexico City to Tunucu, Cuba, on a loud speaker. Or send \$5.00 for all extra parts, blue print, etc., you need to do this. Stamps accepted. Radio list for stamp. Super Heterodyne specifications, 10c. Kladag Radio Laboratories, Kent, Ohio.

RADIO EQUIPMENT.

WHOLESALE PRICES ON STANDARD RECEIVERS, 25% discount; list for stamp. LIVE PROPOSITION to DEALERS. Thomas Radio Co., 111a Dix St., Muncie, Ind.

RADIO BATTERIES

Super Radio A and B Circuit Batteries, which bring in long distance reception. Sold for cash or on payment plan. Write for prices and details. Radio Battery Corporation, 501-B Industrial Bank Bldg., Flint, Mich.

MISCELLANEOUS

158 GENUINE Foreign Stamps. Mexico War Issues, Venezuela, Salvador and India Service. Guatemala, China, etc., only 5c. Finest approval sheets 50 to 60%. Agents Wanted. Big 72-p. Lists Free. We Buy Stamps. Established 20 Years. Hussman Stamp Co., Dept. 152. St. Louis, Mo.

PATENTS

To the Man with an Idea

I offer a comprehensive, experienced, efficient service for his prompt, legal protection and the development of his proposition.

Send sketch of model and description, for advice as to cost, search through prior United States patents, etc. Preliminary advice gladly furnished without charge.

My experience and familiarity with various arts frequently enable me to accurately advise clients as to probable patentability before they go to any expense.

Booklet of valuable information and form for properly disclosing your idea free on request. Write today.

RICHARD B. OWEN, Patent Lawyer
81 Owen Bldg., Washington, D. C.
2278-M Woolworth Bldg., N. Y. City

From London to Honolulu

HAVE YOU BUILT YOUR

"Nameless"?

Ask Your Dealer or Write

BREMER-TULLY MFG. CO.

532 S. Canal St., Chicago

Radio Car Spans East Canada

Montreal, Can.—In order to stimulate interest in radio throughout the rural districts of the Province of Quebec, a car of the "flivver" type and equipped with the latest receiving devices, has left Montreal to cover every district populated by French-Canadians. It is expected the itinerary will amount to more than 9,000 miles.

Department of RADIO ENGINEERING

Radio Age Institute



Look for the Approval Seal

The above approval seal will be furnished free of charge by RADIO AGE, and any article bearing this seal has been approved by the Institute Laboratory.

We will be pleased to receive and test any materials that are offered on the market and give them our endorsement where they meet all Institute tests. Send materials to RADIO AGE INSTITUTE, 500 N. Dearborn St., Chicago.

A RADIO GOLD MINE!

Radio Age Annual, the best hookup book, and one year's subscription—\$3. If you want this double bargain sign the coupon and mail at once. Send price by check, currency or money order. If by check add five cents for exchange. Clip the coupon at the right.

Radio Age, Inc.,
500 North Dearborn Street
Chicago

Gentlemen: Please send me by return mail your illustrated Radio Age Annual, containing more than 100 big pages of hookups and instructions and also send me Radio Age, The Magazine of the Hour, for one year. I enclose \$3. This will give me a one dollar book and a \$2.50 subscription at

a saving of fifty cents. Please start my subscription with the.....number.

Name

Street Address

City

State.....

If book alone is desired, mark cross here and enclose \$1.00. If subscription only, mark cross here and enclose \$2.50.

Corrected List of U. S., Cuban and Canadian Broadcasting Stations

Table listing broadcasting stations across the United States, Cuba, and Canada. Columns include call letters, station name, location, and frequency. Stations listed include WABB (Harrisburg Sporting Goods Co.), WABD (Parker High School), WABE (Young Men's Christian Association), WABG (Arnold Edwards Piano Co.), WABH (Lake Stanley Co.), WAHI (Bangor Railway & Electric Co.), WAHL (Connecticut Agricultural College), WABM (F. F. Doherty Automobile and Radio Equipment Co.), WABN (Waldo C. Grover), WABO (Lako Avenue Baptist Church), WABP (Robert F. Winge Co.), WABQ (Haverford College Radio Club), WABR (Scott High School, N. W. R. Foley), WABS (Essex Manufacturing Co.), WABT (Holiday Hall Radio Engineers), WAHV (Victor Talking Machine Co.), WAHW (John H. De Wit, Jr.), WAIB (Henry B. Joy), WABY (John Marshall, Jr.), WABZ (Coliseum Place Baptist Church), WBAI (Purdue University), WBAJ (The Dayton Co.), WBAK (Wireless Electric Corp.), WBAO (James McMillin University), WBAW (Worthington-Carter Publishing Co.), WBAV (Erner & Hopkins Co.), WBAZ (John B. Stonger, Jr.), WBB (Western Electric Co.), WBBB (Newark Radio Laboratories), WBBE (Barber-Batter Service), WBBF (Georgia School of Technology), WBBG (Irving Vermilye), WBBH (I. Irving Bell), WBBJ (Neal Electric Co.), WBBK (Grace Covenant Presbyterian Church), WBBM (Frank Adams Produce Co.), WBBN (Blake, A. B.), WBBP (Mich. Limestone & Chemical Co.), WBBQ (Frank Cook), WBBR (Peoples Pulpit Assoc.), WBBT (First Baptist Church), WBBU (Jenks Motor Sales Co.), WBBV (Johnstown Radio Co.), WBBW (Raffner Junior High School), WBBY (Washington Light Industry, Co.), WBBZ (Noble B. Watson), WBC (T. & H. Radio Co.), WBCB (Pennsylvania State Police), WBCS (D. W. May, Inc.), WBCU (Southern Radio Corp.), WBCV (Westinghouse Elec. & Mfg. Co.), WBCW (St. Lawrence University), WBCX (Kantmann & Buer Co.), WBCY (Clyde R. Bradford), WBCZ (Entekim Electric Co.), WCA (Nebraska Wesleyan University), WCAJ (Alfred P. Daniel), WCAL (St. Olaf College), WCAM (Villanova College), WCAN (Santors & Co.), WCAP (Chesapeake & Potomac Telephone Co.), WCAR (Alamo Radio Electric Co.), WCAS (William Hood Dunwoody Industrial Institute), WCAT (South Dakota State School of Mines), WCAU (Durham & Co.), WCAV (J. C. Dice Electric Co.), WCAW (University of Vermont), WCAZ (Carthage College), WCBA (Charles W. Heimlich), WCB (University of Michigan), WCBG (William G. Vidva), WCBH (Hunt Radio Co.), WCBJ (Paul H. Stuber), WCBK (Howard S. Williams), WCBL (Nicoll, Duncan & Rush), WCBM (I. C. Mann), WCBN (F. Richard Hall), WCBP (Northern Radio Mfg. Co.), WCBQ (Charles Sawyer), WCBR (James P. Boland), WCBT (The Radio Shop, Inc.), WCBU (First Baptist Church), WCBV (University of Mississippi), WCBW (Charles H. Mester), WCBX (Clark University), WCBY (Arnold Wireless Supply Co.), WCBZ (Tullahoma Radio Club), WCC (George P. Rankin, Jr. and Mattand Solomon), WCCB (Radio Shop of Newark), WCCD (The Forks Electrical Shop), WCCF (Coppitell Bros. Music House), WCCG (Six, Back & Butler Dry Goods Co.), WCCH (University of Texas), WCCJ (Detroit Free Press), WCCK (Tampa Daily Times), WCCL (Kansas City Star), WCCM (F. Laurence Martin), WCCN (Trinity Methodist Church), WCCO (The Courier), WCCP (Automotive Electric Co.), WCCQ (Board of Trade), WCCR (Lit. Brothers), WCCS (Samuel A. White), WCCU (Sigmund Kilburn), WCCV (Radio Equipment Co.), WCCW (Fred Ray), WCCX (A. H. White & Co.), WCCY (Kirk, Johnson & Co.), WCCZ (Herman Edwin Burns), WCD (Gibham-Schnee Electric Co.), WCD (Robert Phillips), WCD (C. T. Scherer Co.), WCD (Radio Specialty Co.), WCD (Richardson Wayland Electric Co.), WCD (M. F. Broz Radio Co.), WCD (Wisc. Dept. of Markets), WCD (Electric Range & Power Co.), WCD (Rollins College), WCD (Superior State Normal School), WCD (Morton Radio Supply Co.), WCD (Trenton Temple Baptist Church), WCD (S. M. K. Radio Corp.), WCD (Taylor's Book Store), WCD (Somerset Radio Co.), WCD (The Quimby Enterprises), WCD (The Strand Theatre), WCD (Church of the Covenant), WCD (James L. Bush), WCD (E. D. Fallon), WCD (American Telephone & Telegraph Co.), WCD (Wheat & Board of Trade), WCD (Cornell University), WCD (University of South Dakota), WCD (Borough of North Plainfield), WCD (Shepard Co.), WCD (Ohio State University).

Figure 4. Radio frequency amplification is added to the Baby Heterodyne receiver in the manner shown in the illustration below.

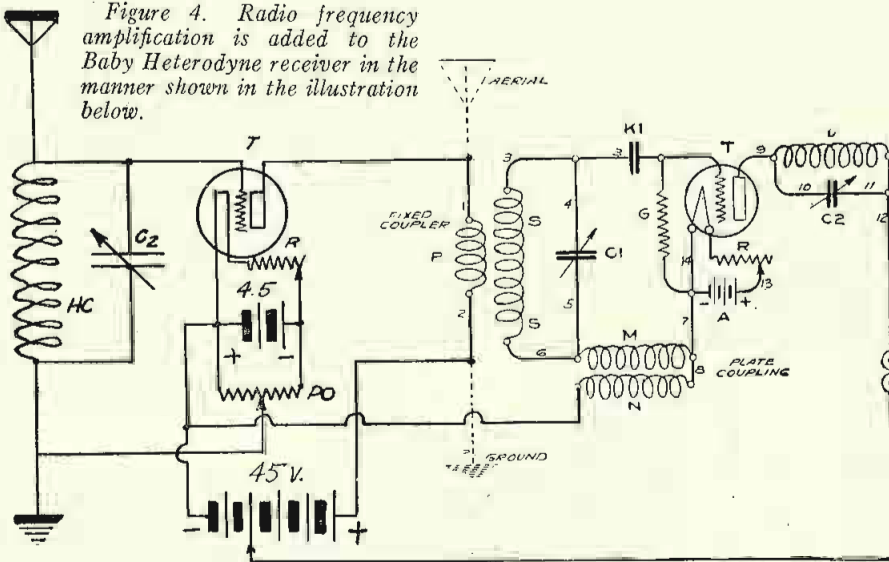

The Trouble Shooter

(Continued from page 49)

UV201A or UV199. The UV199 works exceptionally well as a radio frequency amplifier. A potentiometer must be used as shown, in order to keep the radio tube from oscillating. It maintains a positive bias on the grid of sufficient strength to keep the free oscillation (howling) of the tube from distorting the signal. Use 45 volts B battery on the tube as shown. Higher voltages do not greatly increase the efficiency of the circuit, but do add greatly to the life of the B battery, upon which there is a considerable drain.

These questions are picked from the steady quota of mail which arrives daily. Technical service is free to all those who carefully observe the rules and requirements set down in the announcement printed in this issue. Use the department for your problems, but don't forget to comply with the rules. Letters that do not follow the required lines cannot be answered.—Technical Editor.

Three Chicago Stations Change

Three Chicago broadcasting stations have been affected by shifting and shake-ups during the past month.

The stations are WGN, WDAP and the old WJAZ. When the shifters got through with their work, WDAP had passed out of existence, WJAZ was tabled for a time, and a new station, WEBH, had entered the ethereal activities.

The change follows the sale of the equipment at the Edgewater Beach station by Eugene F. McDonald Jr., president of the Zenith Radio corporation, to W. H. Dewey, manager of that hotel. The rearrangement, it is hoped, will go a long way toward clarifying the ether of interference and will be a move welcomed by the fans.

The Chicago Tribune succeeds the Board of Trade in control of the station at the Drake Hotel, hitherto known as WDAP. Those call letters passed into radio history and the call letters at the Drake will be WGN.

The Board of Trade has relinquished control of the station but the service furnished by it—crop and market reports, weather forecasts and standard time signals—will be continued in addition to the Drake features—Jack Chapman's orchestra, Drake concert ensemble, Blackstone quintet and the Barton organ programs.

WGN will be under the microphone guidance of two of the country's best known announcers, "Sen" Kaney and Jack Nelson.

Mr. McDonald's decision to sell the station at the Edgewater Beach was made early this month. He offered Mr. Dewey the opportunity to purchase it and was accepted. Mr. Dewey plans to continue its operation as the Edgewater Beach Station under the call letters WEBH.

Mr. McDonald reassumes control of the old call letters of the Edgewater Beach—WJAZ—by which that station was known from the time it was established, May 12, 1923, until it was taken over by the Tribune last March. These letters will be used temporarily at the Zenith experimental station on the McCormick building, but later Mr. McDonald plans to establish a broadcasting station in some outlying section with a studio in the downtown district.

SPECIAL FOR JULY
 The Reinartz Radio Booklet, by Frank D. Pearne, fully illustrated, and RADIO AGE, for \$2.50. Price of booklet alone is 50c. Send check, currency or money order to RADIO AGE, 500 N. Dearborn Street, Chicago.

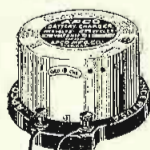

You Can Also Charge "B" Batteries at Home!

The APCO "B" Battery Charger is a worthy ally to the successful APCO Charger for "A" batteries. Renews any 24 or 48 volt wet "B" battery in ten hours—without disconnecting set. It's noiseless, clean and as easy to hook up as an electric iron. Complete with wires ready to use—\$10. Write for interesting circular and nearest dealer's name.
 APCO MFG. CO., Fisk St. Providence R. I.



from the RB Laboratory
 This 52 page Book describes how to make
9 KNOCKOUT Radio Receivers
 50¢

B. R. Linton, Hapeville, Ga., using the 1-tube Knockout set described in this book, hears KFI, Los Angeles and many other distant stations regularly on his loud speaker.

YOU, too, can build a Knock-out distance-getter. This book tells you how! No "trick" circuits; each of the sets has been built and tested in the Radio Broadcast laboratory—where all new circuits are tried out—under the personal direction of Arthur H. Lynch. The 9 Knock-out sets described in this book were chosen because of the exceptional results obtained with them by hundreds of Radio Broadcast readers. You can buy all of the parts from your nearest dealer.

The first edition of Radio Broadcast's Knock-out series was sold in less than 10 days. The second edition—more data, more photographs—is going fast. If your dealer cannot supply you, use the coupon today. If dissatisfied we will refund your money.

RADIO BROADCAST, Doubleday, Page & Co., Garden City, N.Y.

I enclose 50 cents in payment for a copy of Radio Broadcast's Knock-Out Series to be sent to

R. T.

PREMIER
 Audio HEHEHOG Transformer
 Frequency Transformer
 One-half actual size \$3.50
 Best for Portable Sets
 About the size of an English Walnut. Saves space light weight; mounts anywhere; unsurpassed in performance. Ratio 1 to 3, 1 to 4, 1 to 5, \$3.50. 1 to 10, \$4.50.
 Ask your dealer for this "Little Wonder"
 Premier Electric Company
 3803 Ravenswood Avenue CHICAGO

RADIO BIG MONEY IN A BIG FIELD
 Be a RADIO EXPERT. Make big money. Win success in this new uncrowded field. Trained men needed. Learn quickly, at home in spare time, to construct, install, operate, repair, maintain and sell radio equipment.
RADIO EXPERTS EARN \$3,000 TO \$10,000 a year
 Short course, low cost, easy terms, money back guarantee.
FREE Wonderful tube receiving set of latest design. Range of 1000 miles. Write today for "RADIO FACTS."
 E. G. Moberg, Radio Eng. Radio Association of America
 4513 Ravenswood Ave., Dept. 27 Chicago

MYERS "HI-MU TUBES"

Famous Myers Amplifiers Again on the Market

First Orders Will be Given Preference on Delivery
 Price, \$5.00

BARSOOK COMPANY

Sales Representative
 53 W Jackson Blvd CHICAGO

Corrected List of U. S., Cuban and Canadian Broadcasting Stations

WOAA	Dr. Walter Hardy	Arduere, Okla.	360	WRAY	Radio Sales Corp.	Scranton, Pa.	280
WOAC	Maas Radio Co.	Lima, Ohio	266	WRBC	Immanuel Lutheran Church	Valparaiso, Ind.	278
WOAD	Friday Battery & Electric Corp.	Siagoorney, Iowa	360	WRC	Radio Corporation of America	Washington, D. C.	439
WOAE	Miffland College	Freeman, Neb.	360	WRH	Chicago Herald & Examiner	Chicago, Ill.	566
WOAF	Tyler Commercial College	Tyler, Texas	360	WRK	Dixon Bros. Electric Co.	Hamilton, Ohio	360
WOAG	Apollo Theater (Belvedere Amusement Co.)	Belvedere, Ill.	224	WRL	Union College	Schenectady, N. Y.	360
WOAH	Palmetto Radio Corp.	Charleston, S. C.	360	WRM	University of Illinois	Urbana, Ill.	360
WOAI	Southern Equipment Co.	San Antonio, Texas	385	WRR	City of Dallas (police and fire signal department)	Dallas, Texas	360
WOAN	Vaughn Conservatory of Music (James D. Vaughn)	Lawrenceburg, Tenn.	360	WRS	Tarrant County Radio Research Laboratory (Koenig Bros.)	Furrtown, N. Y.	273
WOAO	Lyradion Mfg. Co.	Michawaka, Ind.	360	WSB	Clemson Agricultural College	Clemson College, S. C.	360
WOAP	Kalamazoo College	Kalamazoo, Mich.	240	WSAC	J. A. Foster Co.	Providence, R. I.	241
WOAQ	Portsmouth Kiwanis Club	Portsmouth, Va.	360	WSAG	City of St. Petersburg (Loren V. Davis)	St. Petersburg, Fla.	264
WOAR	Henry P. Lundskow	Kenosha, Wis.	229	WSAI	United States Playing Cards Co.	Cincinnati, Ohio	309
WOAT	Boyd M. Hamp	Wilmington, Del.	360	WSAJ	Grove City College	Grove City, Pa.	360
WOAV	Pennsylvania National Guard, 2d Battalion, 112th Infantry	Erie, Pa.	242	WSAN	Albion Radio Club	Albion, Pa.	229
WOAW	Women of the World	Omaha, Neb.	526	WSAP	Seventh Day Adventist Church	New York, N. Y.	263
WOAX	Franklyn J. Wolff	Trenton, N. J.	240	WSAR	Doughly & Welch Electrical Co.	Fall River, Mass.	254
WOC	Palmer School of Chiropractic	Davenport, Iowa	484	WSAT	Douglas-Walsh Hardware Co.	Plainview, Texas	268
WOI	Iowa State College	Ames, Iowa	360	WSAU	Camp Marfield	Chesham, N. H.	229
WOK	Pine Bluff Co.	Pine Bluff, Ark.	360	WSAW	John J. Long, Jr.	Canandaigua, N. Y.	275
WOO	John Wainmaker	Philadelphia, Pa.	509	WSAX	Chicago Radio Laboratory	Chicago, Ill.	268
WOQ	Western Radio Co.	Kansas City, Mo.	360	WSAY	Frank Austin (Port Chester Chamber of Commerce)	Port Chester, N. Y.	233
WOR	L. Bamberger & Co.	Newark, N. J.	405	WSAZ	Chas. Electric Shop	Pomeroy, Ohio	258
WOS	Missouri State Marketing Bureau	Jefferson City, Mo.	441	WSB	Atlanta Journal	Atlanta, Ga.	129
WPAB	Pennsylvania State College	State College, Pa.	283	WSL	J. & M. Electric Co.	Utica, N. Y.	273
WPAC	Donaldson Radio Co.	Okmulgee, Okla.	360	WSY	Alabama Power Co.	Birmingham, Ala.	360
WPAD	Doolittle Radio Corp.	New Haven, Conn.	268	WTAB	Fall River Daily Herald Publishing Co.	Fall River, Mass.	248
WPAP	North Dakota Agricultural College	Agricultural College, N. Dak.	360	WTAC	Penn Traffic Co.	Johnstown, Pa.	360
WPAL	Superior Radio & Telephone Equipment Co.	Columbus, Ohio	286	WTAF	Louis Gallo	New Orleans, La.	242
WPAM	Auerbach & Guehl	Topeka, Kans.	360	WTAG	Kein Music Co.	Providence, R. I.	258
WPAP	Theodore D. Phillips	Winchester, Ky.	360	WTAH	Carmen Ferro	Belvedere, Ill.	236
WPAR	Ward Battery and Radio Co.	Beloit, Kans.	236	WTAJ	The Radio Shop	Portland, Me.	230
WPAT	St. Patrick's Cathedral	El Paso, Texas	360	WTAL	Toledo Radio & Electric Co.	Toledo, Ohio	252
WPAU	Concordia College	Moorhead, Minn.	360	WTAM	Walsh Storage & Electric Co.	Cleveland, Ohio	390
WPAZ	John E. Koch (Dr.)	Charleston, W. Va.	373	WTAP	Cambridge Radio & Electric Co.	Cambridge, Wis.	242
WQAA	Horace A. Beals, Jr.	Parkersburg, Pa.	360	WTAQ	S. H. Van Gordon & Son	Osseo, Wis.	220
WQAC	E. B. Gish	Amarillo, Texas	234	WTAR	Reliance Electric Co.	Norfolk, Va.	280
WQAD	Whitall Electric Co.	Waterbury, Conn.	242	WTAS	Charles E. Kristain	Elgin, Ill.	275
WQAE	Moore Radio News Station (Edmund B. Moore)	Springfield, Vt.	275	WTAT	Edison Electric Illuminating Co.	Boston, Mass. (portable)	244
WQAF	Sandusky Register	Sandusky, Ohio	240	WTAU	Ruggs Battery & Electric Co.	Teaneck, N. J.	242
WQAL	College County Telephone & Telegraph Co.	Collegeville, Pa.	360	WTAZ	Cambridge Radio & Electric Co.	Trenton, N. J.	220
WQAN	Scranton Times	Scranton, Ill.	280	WTAX	Agricultural & Mechanical College of Texas	College Station, Tex.	280
WQAO	Calvary Baptist Church	New York, N. Y.	360	WTAY	Williams Hardware Co.	Streator, Ill.	231
WQAP	Ahlene Daily Reporter (West Texas Radio Co.)	Ahlene, Texas	360	WTAZ	Todar-Oak Leaves Broadcasting Station	Oak Park, Ill.	220
WQAS	Prince-Walter Co.	Lowell, Mass.	266	WTB	Thomas J. McGuire	Lambertville, N. J.	283
WQAX	Radio Equipment Co.	Peoria, Ill.	360	WTC	Kansas State Agricultural College	Manhattan, Kans.	273
WQJ	Calumet Baking Powder—Rainbow Gardens Station	Chicago, Ill.	448	WTAB	Heinig, Swern & Co. (John Rasmussen)	Waco, Texas	360
WRAA	Ries Institute	Houston, Texas	259	WWAC	Sanger Bros.	Philadelphia, Pa.	360
WRAF	The Radio Club (Inc.)	Lafayette, Ind.	224	WWAD	Wright & Wright (Inc.)	Philadelphia, Pa.	360
WRAH	Stanley N. Read	Providence, R. I.	231	WWAE	Alamo Dance Hall L. J. Crowley	Joliet, Ill.	227
WRAL	Northern States Power Co.	St. Croix Falls, Wis.	248	WWAF	Galvin Radio Supply Co.	Camden, N. J.	230
WRAM	Lombard College	Galesburg, Ill.	244	WWAO	Michigan College of Mines	Houghton, Mich.	244
WRAN	Black Hawk Electrical Co.	Waterloo, Iowa	236	WWI	Ford Motor Co.	Dearborn, Mich.	273
WRAO	Radio Service Co.	St. Louis, Mo.	360	WWJ	Detroit News (Evening News Assn.)	Detroit, Mich.	517
WRAY	Antioch College	Yellow Springs, Ohio	242	WWL	Loyola University	New Orleans, La.	260
WRWA	Avenue Radio Shop (Horace D. Good)	Reading, Pa.	238	WYAM	Electrical Equipment Co.	Miami, Fla.	283
WRAX	Flaxon's Garage	Gloucester City, N. J.	268	WYAW	Catholic University	Washington, D. C.	236

Canadian Stations

CFAC	Calgary Herald	Calgary, Alberta	430	CHCM	Riley & McCormack	Calgary, Alberta	415
CFCA	Star Pub. & Ptg. Co.	Toronto, Ontario	400	CHCS	The Hamilton Spectator	Hamilton, Ont.	420
CFCE	Marconi Wireless Teleg. Co. of Canada	Montreal, Quebec	440	CHYC	Southern Electric Co.	Montreal, Quebec	410
CFCH	Abney Power & Paper Co.	Ironbridge, Ont.	400	CJCA	Edmonton Journal	Edmonton, Alberta	450
CFCL	La Cie de L'Evenement	Quebec, Quebec	400	CJCG	London Free Press Ptg. Co.	London, Ont.	430
CFCN	Radio Supply Co.	Edmonton, Alberta	410	CJCD	T. Eaton Co.	Toronto, Ont.	410
CFCL	Centennial Methodist Church	Victoria, British Col.	400	CJCE	Sprott-Shaw Radio Co.	Vancouver, B. C.	420
CFCN	W. W. Grant Radio (Ltd.)	Calgary, Alberta	440	CJCI	Maritime Radio Corp.	St. John, New Brunswick	400
CFCO	Sennembinia-K. Dickson (Ltd.)	Bellevue, Quebec	450	CJCM	J. L. Phillips	Mont Joli, Quebec	430
CFCC	Radio Specialties (Ltd.)	Vancouver, B. C.	400	CJCN	Simon Gagne & Co.	Toronto, Ont.	410
CFCR	Laurentide Air Service	Sudbury, Ont.	420	CJCS	Evening Telegram	Toronto, Ont.	430
CFCW	The Radio Shop	London, Ont.	410	CKAC	La Presse Pub. Co.	Montreal, Quebec	430
CFCD	Sparks Co.	Nanaimo, B. C.	430	CKCD	Vancouver Daily Province	Vancouver, B. C.	410
CFQC	The Electric Shop (Ltd.)	Saskatoon, Saskatchewan	400	CKCE	Canadian Indeneud. Telephone Co.	Toronto, Ont.	450
CFRC	Queens University	Kingston, Ontario	450	CKCH	Canadian National Railways	Ottawa	435
CFUC	University of Montreal	Montreal, Quebec	400	CKCK	Leahy Pub. Co.	Regina, Saskatchewan	420
CHAC	Radio Engineers	Halifax, Nova Scotia	400	CKCO	Ottawa Radio Association	Ottawa, Ont.	440
CHBC	Albertan Publishing Co.	Calgary, Alberta	410	CKCX	P. Burns & Co.	Calgary, Alberta	445
CHCB	Marconi Company	Toronto, Ont.	410	CKLC	Wilkinson Electric Company	Calgary, Alberta	400
CHCD	Canadian Wireless & Elec. Co.	Quebec, Quebec	410	CKOC	Wentworth Radio Supply Co.	Hamilton, Ont.	410
CHCE	Western Canada Radio Sun (Ltd.)	Victoria, B. C.	400	CKY	Manitoba Telephone System	Winnipeg, Manitoba	450
CHCL	Vancouver Merchants Exchange	Vancouver, B. C.	440				

Cuban Stations

PWX	Cuban Telephone Co.	Habana	400	2HS	Julio Power	Habana	180
2DWO	Pedro Zayas	Habana	300	2OL	Oscar Collado	Habana	290
2AB	Alberto S. de Bustamante	Habana	240	2WW	Amadeo Saenz	Habana	210
2BK	Mario Garcia Velez	Habana	360	5EV	Leopoldo V. Figueroa	Colon	360
2BY	Frederick W. Borton	Habana	260	6KW	Frank H. Jones	Trinacu	340
2CX	Frederick W. Borton	Habana	320	6KJ	Frank H. Jones	Trinacu	275
2EV	Westinghouse Elec. Co.	Habana	220	6BX	Antonio T. Figueroa	Cienfuegos	170
2TW	Roberto E. Ramirez	Habana	230	6DW	Jose Ganhue	Cienfuegos	225
2HC	Heraldo de Cuba	Habana	275	6BY	Jose Ganhue	Cienfuegos	300
2LC	Luis Casas	Habana	250	6AZ	Valentin Ullivari	Cienfuegos	200
2KD	E. Sanchez de Puent	Habana	350	6EV	Josefa Alvarez	Cubaeren	225
2MN	Rafael Simon	Habana	270	8AZ	Alfredo Brocka	Stgo. de Cuba	240
2MG	Manuel G. Salas	Habana	280	8BY	Alberto Cayula	Stgo. de Cuba	250
2JD	Raul Perez Falcon	Habana	250	8FU	Ames Vntne	Stgo. de Cuba	225
2Kp	Alvira Daza	Habana	150	8DW	Pedro C. Anlez	Stgo. de Cuba	275
				8EV	Eduardo Mateos	Stgo. de Cuba	180

Eisemann Has New "Receiver"

Alexander Eisemann, treasurer of the Freed-Eisemann Radio Corporation, has a new receiver permanently installed in his home at 815 Park Avenue, New York City. It has self-moving installation. In fact, it is an eight-pound portable boy and has already shown marvelous selectivity in selecting its parents from millions who would have been honored had they been chosen. Since its initial HOWL at four o'clock Saturday morning, May 3, it has eliminated squeals with remarkable efficiency. It is equipped with an extraordinary loudspeaker that is difficult to overload, and is easier for recharging. It is portable, and can follow the laws and boys

age of the universe, including DAD, and it is guaranteed to entertain all comers for many years to come. The new receiver is to be known as the Alexander Eisemann Junior. It is a model, and there isn't money enough in the whole world to buy it. Everybody's doing fine, thanks!

"Indorarial" Cuts Interference

Electrad, Inc., has placed a new and novel indoor aerial, called "Indorarial," on the market, and judging from initial comments from the large body of radio fans, the innovation is going to be exceedingly successful. The "Indorarial" is a

The Indorarial contains 600 feet of wire equally spaced between two pieces of specially prepared paper. It is instantly collapsible and portable without the danger of tangling wires. For best results, according to tests made in the RADIO AGE INSTITUTE laboratory, two Indorarials are used; one for aerial and one for ground.

The RADIO AGE tests revealed that this aerial affords sharp tuning and reduces static to almost a negligible quantity. Local stations especially can be brought in with amazing clearness and volume. The capacity is approximately

With the Manufacturers

Additional News on Page 56.

Crosley Portable a "Winner"

In order to meet the demand for portable radio apparatus, the Crosley Radio Corporation has made the new 51-P, which enables radio fans to "take their entertainment" with them during the months of out-of-door activities.



The portable is a regenerative detector and one-stage audio amplification outfit in a strong leatherette covered and nickel trimmed portable cabinet.

Loud speaker volume is obtained on nearby stations. The list price is \$25. The Crosley 51-P is 12½ inches wide, 11¾ inches high and 7½ inches deep. It weighs

twenty-one pounds with batteries, phones and aerial equipment, space being provided in the cabinet for these accessories.

Gibson Joins Freed-Eisemann

J. D. Gibson has always been a wireless enthusiast. Long before he left school, he was building sets, and back in 1910 he was operator of the "ancient" station NY on Forty-second Street. Later he was with the American Mercantile Company's traffic department and during the war he was chief electrician in charge of the Central Control Station on Whitehall Street. In 1918 he went in the Ship Owners' Radio Service as European representative, and three years ago he joined the A. H. Grebe Company in Richmond Hill, L. I. The first of June he signed up with the sales force of Freed-Eisemann Radio Corporation. In his varied experience he hasn't lost a bit of his belief in radio and is thoroughly convinced that it is the greatest discovery of any age.



WQJ Latest Chicago Station

Chicago has another broadcasting station. This time it's WQJ, the Calumet Baking Powder Company—Rainbo Garden Station, being owned jointly by both.

WQJ operates on a 448 meter wave length, and its studio is located on the second floor of the Rainbo Gardens Building, Clark St. and Lawrence Ave., Chicago. The studio is elaborate and efficient, being constructed at a cost of several thousands of dollars.

Jerry Sullivan, widely known radio musician, singer and song writer, is the director in charge, and Phil Schwartz is his assistant. R. J. Engler, recently of WOS, Jefferson City, Mo., is in charge of the mechanical equipment.

One of the features of WQJ's programs, which is expected to make it especially popular this Summer, is the dance music of Ralph Williams' famous Rainbo Orchestra and selections by his entertainers.

**NEXT TIME INSIST
ON**

**"GOMET"
"B" BATTERIES**

At all good radio
stores or write

ELECTRICAL MFG. AGENCY
25 N. Dearborn St., Chicago, Ill.

ERLA BLUE PRINTS

Erla Receivers out-distance other sets with an almost unbelievable volume and a naturalness that cannot be distinguished from the source of reception.

This is the famous Erla Reflex Hook-up. Less than one year old—but has taken the entire nation by storm. Every listener-in raves about it and wants a set of his own immediately.

So easy to construct that anyone who can handle a screw driver can build the set complete in a surprisingly short time—about 1½ hours. Everything is so simple and easy.

NO SOLDERING WHATEVER—ONLY A SCREW DRIVER NEEDED

The results from the Erla 3 tube is naturalness itself and cannot be improved upon. Actual size working diagrams make everything simple and easy. Every piece of apparatus and every wire is pictured in its exact place—every article needed is listed on the diagrams.

Diagrams sent same day your order is received. Send P. O. or Express Money Order or Bank draft or Bank Cashier's check. Do not send stamps or personal checks.

Erla Hook-up Diagram Prices

- 3 sheets for making 1 tube set 25c
- 3 sheets for making 2 tube set 35c
- 3 sheets for making 3 tube set 50c

Frank D. Pearne

Sole Distributor of Erla Diagrams for U. S. and Canada
829 Waveland Avenue, Chicago, Ill.

Dealers Write for Quantity Prices

With the Radio Manufacturers

The Thermoformer

Engineers and inventors have long realized the importance of operating tubes directly off lighting circuits. Numerous attempts have been made to accomplish this for radio receiving sets, but the results have been keenly disappointing, except in the case of tubes used for transmitting purposes. Even so, the apparatus involved in converting the usual lighting current into usable vacuum tube current has been entirely too elaborate and out of all proportion to the cost of the batteries this replaced.

Mr. R. E. Sabin, a noted chemical engineer of Somerville, N. J., with the cooperation of L. G. Pacent, a radio manufacturer and engineer of New York City, worked out the solution of harnessing commercial lighting current to the usual receiving set. These practical men worked out an indirect method of harnessing commercial lighting current, in which such current is merely used as a source of heat.

They have adapted the thermoelectric method of energy transfer of the solution of the greatest radio problem of today—the operation of vacuum tubes on a lighting current. The thermoelectric power transformer consists of a number of pairs of dissimilar metals in contact, one junction being in close thermal relationship with, but neutrally coupled electrically from a resistor element in the power or lighting circuit. The difference in temperature between the metal members causes the flow of current, and while the potential of a single thermo-couple is quite low, any desired potential may be obtained by using a battery of bimetallic units connected in series.

Novel adjustments of the electrical re-

sistances, thermal conductivities, emissivities, radiation, etc., of the various parts have been made, all contributory to the final perfected result.

The perfected thermoelectric transformer device, which has been given the significant name of "Thermoformer," consists of a neat pressed metal container in which are placed the several rows of bimetallic units, as well as the electrical



resistor element. The lighting current is led directly to the resistor element, which operates in much the same manner as the heating element of an electric iron. This heat is brought to bear, without any substantial electrical coupling, on special electrode castings, while the other end of each of these special castings is in contact with a strip of metal which comprises the other member of the thermo-couple. The thermo-couple units are all joined together so that their individual electrical outputs are combined for the desired output. The container is provided with screened top and bottom to permit the passage of air to carry away the undesired heat.

The "Thermoformer" can be arranged to operate the filaments of a number of vacuum tubes, which is the more difficult

task, as well as the high-voltage "plate" circuits which usually call for the so-called "B" batteries. There is no hum or buzz or other indication of the lighting current used to operate the tubes.

Ogden Forms New Corporation

Clarence E. Ogden, founder and president of the Automatic Electrical Devices Company, manufacturer of the Hom-charger and manufacturer of vibrating rectifiers, has recently organized and incorporated under the laws of Ohio, a new concern—The Kodol Manufacturing Company—for the manufacture of a portable radio set, of which he is the inventor, together with other electrical and radio specialties.

This company's first offering to the trade will be a small, compact and really portable long distance radio set—The KODEL—the Camera of Radio. This set weighs less than 5 pounds complete with all accessories. Contained within a neat leather covered case 5 3/4 x 4 1/2 x 8 inches in size is a standard UV-100 tube, "A" and "B" dry batteries, pair of standard headphones, ground and aerial wires. This set operates quite successfully without either ground or aerial, the two wires merely being thrown on the floor. With ground connections only, surprising distances have been received, and using aerial the Kodel has a range of from 2,000 to 3,000 miles.

"Snow White Fluid" for Radio

J. W. Johnston, manufacturer of Snow White Products, in Rochester, N. Y., was surprised to learn that his "Snow White Fluid" was being used extensively for radio instrument marking purposes.

"Snow White Fluid" heretofore has been used for such applications as white shoes, dresses, golf balls and window ads, and it was quite by accident that a radio fan discovered its successful adaptability to radio sets.

According to Mr. Johnston, the Special Grade Snow White Fluid is an extraordinarily satisfactory preparation for marking curved arrow points and titles of various kinds of radio connections. It is also good for marking tie-in connections and for making figures and indentations on dials. RADIO AGE INSTITUTE has tested Snow White Fluid and found it to be all Mr. Johnston claimed in the radio building line.

New Models of Magnavox

The new model Magnavox Reproducers R3 and R2 contain refinements making for greatly increased efficiency as well as economy of operation.

Current consumption, as the result of improvements in the magnetic circuit, has been so reduced that it is now an unimportant factor. The new R3 and R2 models can be operated at any point between .1 ampere and .6 ampere when supplied with six volts. An average current consumption of one-fourth ampere results from the use of a three-volt battery of either dry cell or storage type.

The Best in Radio

Telmaco Radio Guide Book describes all, 10c.

Our new 64-page Catalog No. TGR contains twenty of the most popular radio circuits printed in blue. These include the Super-Heterodyne, Neutrodyne, Grimes Inverted, Colpitts, Flewelling, Reinartz, Diode Electrad, Super-Regenerative and many others. Each article used in circuits is attractively pictured instead of appearing in straight schematic form. Besides containing blue prints, the best in radio is also illustrated and described. Catalog sent postpaid for Ten Cents. Each circuit worth double.

Send for your copy today.



20 Circuits
in Blue in
Catalog

DEALERS! Our New Dealers' Catalog and Price List describes nearly all the better Standard Radio Lines. You should have it. Mailed FREE to all bonafide dealers making request on their business stationery.

TELMACO
Quality Radio Exclusively
Established 1918

Radio Division
TELEPHONE MAINTENANCE CO.
20 So. Wells St. Dept. C Chicago, Ill.

Your Radio Problems Solved for 30 Cents in Stamps

IF YOU are constructing a receiving set, and you need help in the way of clear diagrams and full detailed descriptions you may have it by return mail.

We have laid aside a limited number of back numbers of Radio Age for you. Below we are listing the hook-ups and circuit diagrams to be found in these magazines. Select the ones you want, enclose 30 cents in stamps for each one desired.

We advise immediate attention to this as the stock of back numbers of several issues already has been exhausted.

May, 1922

—How to make a simple Crystal Set for \$6.

October, 1922

—How to make a Tube Unit for \$23 to \$37.
—How to make an Audio Frequency Amplifying Transformer.

November, 1922

—Photo-electric Detector Tubes.
—Design of a portable short-wave radio wavemeter.

May, 1923

—How to make the Erla single-tube reflex receiver.
—How to make a portable Reinartz set for summer use.

June, 1923

—How to build the new Kaufman receiver.
—What about your antenna?

July, 1923

—The Grimes inverse duplex system.
—How to read and follow symbols.
—Proper antenna for tuning.

September, 1923

—Simple Radio Frequency Receiver.

December, 1923

—Building the Haynes Receiver.
—Combined Amplifier and Loud Speaker.
—A selective Crystal Receiver.

January, 1924

—Tuning Out Interference—Wave Traps—Eliminators—Filters.
The article which was announced from stations WJAZ, WOC and WOAW.
—A Junior Super-Heterodyne.
—Push-Pull Amplifier.
—Rosenbloom Circuit.

February, 1924

—How to make a battery charger.
—Improved Reinartz Circuit.
—Interference rejectors.
—Single Tube Heterodyne.
—How antenna functions.
—Adding two audio stages to selective receiver which began as a crystal set.
—Superdyne receiver.

March, 1924

—An Eight-Tube Super-Heterodyne.
—A simple, low loss tuner.
—Junior Heterodyne Transformers.
—A Tuned Radio Frequency Amplifier.
—How to make the Kopprasch Receiver.
—Adding Radio Frequency to the Variometer Set.
—Simple Reflex Set.

April, 1924

—An Efficient Super-Heterodyne (fully illustrated).
—Selecting the Right Receiver.
—A Ten-Dollar Receiver.
—Anti-Body Capacity Hook-ups.
—Radio Frequency Amplification.
—Reflexing the Three-Circuit Tuner.
—Index and first two instalments of Radio Age Data Sheets.

May, 1924

—Construction of a Simple Portable Set.
—An Ideal Set for the Summer Camper.
—A Traveling Man's Receiver.
—Radio Panels.
—Making a Baset-Weave Tuner.
—Third Instalment of Radio Age Data Sheets.

June, 1924

—Important Factors in the Construction of a Super-Heterodyne.
—A Universal Amplifier.
—A Sure Fire Reflex Set.
—Adding Radio and Audio to Baby Heterodyne.

RADIO AGE, Inc.

500-510 North Dearborn Street

CHICAGO, ILL.

CROSLLEY

Announcing — **The New Models** — each a leader in its line



Crosley Trirdyn 3R3, \$65.00



Crosley Trirdyn 3R3 Special, \$75.00



Crosley 51, \$18.50



Crosley 51-P Portable, \$25.00



Crosley 52, \$30.00



Crosley 51-A, \$14.00



Crosley 50, \$14.50



Crosley 50-A, \$18.00

Guaranteed Satisfaction at a Reasonable Price

CROSLLEY 50—A new one tube Armstrong Regenerative Receiver. We believe this to be the most efficient one tube receiver ever put on the market. Like our present Model V, which it supersedes, it will bring in, under average conditions, on headphones, broadcasting stations at a distance of one thousand miles or more. Uses any standard storage battery or dry cell vacuum tube. *Price, \$14.50.*

CROSLLEY 50-A—A new two stage Audio Frequency Amplifier to match the new Model 50 receiver. This unit is equipped with a filament switch for shutting off the current from the "A" and "B" Batteries. When used in connection with the Crosley Model 50 Receiver, it gives the equivalent of a three-tube regenerative receiver. *Price, \$18.00.*

CROSLLEY 51—In twenty-four days this receiver became the biggest selling radio receiving set in the world, and it holds that position today. It uses two standard storage battery or dry cell tubes, regenerative detector and one stage of audio frequency amplification. Will bring in local stations on the loud speaker at all times, and under average conditions will also bring in distant stations on the loud speaker. *Price, \$18.50.*

CROSLLEY 51-A—A new one stage Audio Frequency Amplifier to match the Model 51 receiver. When used in connection with the Crosley Model 51 Receiver it gives the equivalent of a three tube regenerative receiver. *Price, \$14.00.*

CROSLLEY 52—A new three tube Armstrong Regenerative Receiver, has phone jack to plug in on two tubes and filament

switch to turn off the "A" and "B" Batteries. It is unusually efficient, will provide loud speaker volume on distant stations under practically all conditions, and is in every way an ideal receiver for the home. *Price, \$30.00.*

CROSLLEY 51-P—This is our new portable set. It is the Crosley Model 51 two tube receiver mounted in a leatherette covered carrying case, has a compartment for a pair of headphones and one to hold an ample power plant for the popular dry cell vacuum tubes. This receiver can be used as a stationary set in the home or as a portable. *Price, \$25.00.*

CROSLLEY TRIRDYN 3R3—This three tube receiver gives the efficiency and volume of a five tube receiver. Incorporating Radio Frequency Amplification, Regenerative Detector with one stage of Bellied, and one stage of straight Audio Frequency Amplification. Can be calibrated accurately—stations logged and returned to at will. Used on outdoor or short indoor antenna and is, we believe, the most efficient and sharpest tuning receiver on the market at any price for listening in long distance stations. *Price, \$65.00.*

CROSLLEY TRIRDYN 3R3 SPECIAL—This Receiver is exactly the same as the Trirdyn 3R3 except the solid mahogany cabinet is larger, and more handsomely designed to harmonize with the most beautiful furniture settings. There is sufficient space inside for all the "A" and "B" Batteries required when standard dry cell tubes are used. *Price, \$75.00.*

Write for Descriptive Circular.

For Sale by Good Dealers Everywhere.

THE CROSLLEY RADIO CORPORATION

Powel Crosley, Jr., President

723 ALFRED STREET

CINCINNATI, OHIO

Licensed under Armstrong
U. S. Patent No. 1,113,149

Crosley Owns and Operates
Broadcasting Station W L W

CROSLLEY
Better—Cost Less
Radio Products