

JUPITER:
Fractal Planetscapes
for the QL

**SuperBasic
in ACTION!**

**Simon Goodwin's
New Network
Driver**

FlexNet

**Taking it
easy with
EASEL!**

**Review:
CASH TRADER**

ISSN 0951-9335



9 770951 933023

D I G I T A L P R E C I S I O N
 A **I** G I T D L **P** R E C I S I O N
 A P **G** I T D L I **R** E C I S I O N
 A P R I **T** D L I G E C I S I O N
 A P R I D **T** L I G E C I S I O N
 A P R I D E **L** I G T C I S I O N
 A P R I D E I **L** G T C I S I O N
 A P R I D E I N **G** T C I S I O L
 A P R I D E I N I T **C** G S I O L
 A P R I D E I N I T S **G** C I O L
 A P R I D E I N I T S L **C** I O G
 A P R I D E I N I T S L O **I** C G
 A P R I D E I N I T S L O G **C** I
 A **P R I D E** I N I T S **L O G I C**

Digital Precision Ltd wishes its customers a very merry Christmas and a prosperous New Year.

We are happy to offer you a seasonal extra: until 28th January 1993, you may deduct an extra 10% off all our prices. This is in addition to the existing Special Deals where you can get upto 25% off already! SUPER!!

Don't hesitate: this offer won't be repeated or extended.

From 1st January 1993 we are compelled by law to charge all our non-VAT registered, non-UK EEC customers Value Added Tax @17.5% (we don't charge the VAT if you supply us your valid VAT number when ordering). Our Terms and Conditions are hereby amended: Such non-VAT registered EEC customers must add 15% (formerly 5%) to the quoted price. This change has NO EFFECT on our customers in the UK and in other non-EEC countries.

Contents

Editor

Helen Armstrong

Publisher

Mark Kasprovicz

Advertising Manager

Jim Peskett

Creative Director

John Stanley

Graphic Artist

Stevie Billington

Magazine Services

Linda Miller, Frances
Maxwell,
Pauline Wakeling

**Sinclair QL World,
Published by Arcwind
Ltd.**

**The Blue Barn,
Tew Lane, Wootton,
Woodstock,
Oxon. OX7 1HA
Tel: 0993 811181
Fax: 0993 811481
ISSN 026806X**

If you have any comments or difficulties please write to the editor and we will do our best to deal with your problem in the magazine, though we cannot guarantee individual replies.

Back issues are available from the publisher price £2.50 UK, £2.99 Europe. Overseas rates on request.

Subscriptions from: Arcwind
The Blue Barn, Tew Lane,
Wootton, Woodstock, Oxon.
OX7 1HA
UK: £23.40
Europe: £32.90
Rest of World: £40.90

Reprographic Services: The
Wace Group, London.
Distributed by: Seymour
Press Ltd.,
Windsor House, 1270
London Road, Norbury,
London, SW16 4DH

1993 ARCWIND LTD.
Sinclair QL World is
published 12 times a year. All
rights reserved.
Reproduction in whole or in
part without written
permission is strictly
prohibited. We welcome
contributions, all material
must be supplied with a
S.A.E.

8

TROUBLESHOOTER

Bryan Davies gets reacquainted with Quill

10

OPEN CHANNEL

Fishhh ... MusiQL? ... QL World backnumbers ... QL rom types ... virtues of DataDesign ... hardware interfacing ... re-springing microcassettes ... Sam Coupe

13

THE BRISTOL FAIR

Henry Orlowski has been deep in fair affairs in Clevedon.

14

QL SCENE

DJC very well thank you!

16

SUPERBASIC IN ACTION

Simon Goodwin starts a new series on applied SuperBasic.

20

QL SERIAL PORTS

For constructors - Dennis Briggs' guide to checking ports, especially SER2.

23

THE NEW USER GUIDE - part 22

The Keyword Index from PARUSE(varname) to POSITION(#chan) via PI.

27

JUPITER

A SuperBasic program - John de Rivas goes into orbit

28

CASH TRADER

Review - Charles Tassell puts the DP upgrade to work.

30

DIY TOOLKIT

Simon Goodwin's magnum opus to date - Flexynet driver for the QL network ports. Part 1.

35

POINTER TOOLS

Bryan Davies practices on Digital Precision's helpful package for Pointer Environment users.

37

EASY WITH EASEL

Henry Orlowski shows how Easel can make light, entertaining work of your home and business presentations - starting with basics.

39

ONE MAN'S SYSTEM

Alex Munden tells an everyday story of lost files.

41

PERFECTED QLQ

A F Wilson uses Merz QLQ font editor and Perfection to make scientific fonts.

44

BOOK PAGE

Four aged but useful QL titles reviewed by users.

46

INSTANT ACCESS

At-a-glance guide to your software and hardware suppliers.

47

MICRO ADS

PERFECTION SPECIAL EDITION

POWER

PERFECTION SPECIAL EDITION has 253 (two hundred and fifty three) direct/menu commands (not counting options in sub-menus), plus 32 special characters (like Bold on) that can be inserted 'directly' plus intelligent (and now excellently documented) macros. Comparisons with other word processors on the subject of power are hence quite unnecessary.

EASE OF USE

Independent reports, customer feedback and published reviews (of its less able but still excellent predecessor, PERFECTION) leave one in no doubt as to which word processor is friendliest – PERFECTION SPECIAL EDITION, with its intuitive, silky handling. Uniquely, it has two operating modes, with both menus (visible or invisible – they even look like Quill's) and direct commands (for when you familiarise yourself with the system). Uniquely, both modes are 're-entrant' (so you can use any menu option or direct command while you are in the middle of performing another option or command – block handling, etc, becomes a dream). Uniquely, PERFECTION SE has fully automatic memory management, grabbing and releasing RAM instantly as your document grows or shrinks – programs without this don't take full advantage of the multi-tasking abilities of the QL! Uniquely, PERFECTION SE leaves you in the driving seat, not juggling things around 'underfoot' while you are typing. Uniquely, PERFECTION SE allows up to nine different documents to be handled simultaneously from one copy of the program – each with totally independent margin, tab, justification, control panel, etc, settings. Uniquely, each document can itself have up to six environment settings, each settable or recallable instantly with a single keypress combination. Each document can have any number (up to 500,000 on GOLD CARD) of candidate blocks! Each document can have two independent windows (of any depth, of any (but same) width across) 'on to' it, even with overlapping text – that allows you to edit in one place while viewing another, to compare 'before editing' with 'after editing' (you can arrange to have one window remain 'frozen' in time), etc. Uniquely, we realise how much faster it is to type in something like CTRL/SHIFT/F5 than (say) F3 D U – both involve three keys, but as the former doesn't require the keys to be pressed in just one specific order, or to be released in any order at all (together will do), it is in practice twice as fast as the latter, where no key may be pressed until its predecessor is released. Also, sequences like CTRL/T (top) and then CTRL/G (go to next occurrence of string in set direction) can be accomplished by holding down CTRL and then tapping T and G. Uniquely, by providing eight user-definable strips, PERFECTION SE allows you to cope with printers of the future, not just the printers that now exist – you can attach the strips to any printer features. Uniquely, PERFECTION SE's status lines give full information on all relevant global settings. And the manual has an index. Also, it has all the important bits at the front.

PC CONQUEROR GOLD SPECIAL EDITION – This terrific new product for QLs with 1.5 Mb or more makes your QL system into a PC. A well-equipped PC too, with about a megabyte of expanded RAM installed, and the ability to read, write and format SD/DD/HD/ED disks (the last by making them into pseudo hard disks). Disk performance is up to 5 times faster. Other performance is up to 55% faster than standard CONQUEROR on GOLD CARD. There are many extra features too – see our ads in June - September 1992 QLW for full details.

DR-DOS V 6.0 – The latest and most capable DOS of all!

QMATHS MATHEMATICAL SYSTEM PART TWO – An excellent complement to QMATHS, with loads of 'functionality' – fractals, function evaluation, terrain plotting, masses of maths & stats, etc.

QUICKLASER – The definitive output tool from PRO PUBLISHER to HP LaserJet II (or compatible) printers. Printed output quality subjectively exceeds that from any other QL product.

TRANSFER UTILITY SPECIAL EDITION – Does everything – 16 case change options, 14 types of sorting (multiple sorts possible), auto string translations, etc.

LIGHTNING SPECIAL EDITION GOLD CARD VERSION – See June-Aug 1992 QLW for details: optimal speed from GOLD CARD, ST/QL, THOR XVI. Free upgrade from the ROM SE version (return ROM + disk) if you are ordering something else at same time: if not, £10 charge.

SUPERB PRINT QUALITY & FLEXIBILITY

Uniquely, using the aforementioned automatic link, you can output PERFECTION SE documents using over a thousand fonts (a huge variety of styles and sizes, supplied on the PUBLISHER and TOOLBOX disks) on virtually any printer – from the humblest Epson RX80, Brother M1009 or Star LC10 (which are all single font machines when used with most word processors) to top-end lasers. *You are not limited to the fonts built into the printer!!* All PERFECTION SE **bold/underlined/italics/sup_{er}/sub**, etc, settings are preserved. Proportional spacing and micro-justification are automatic, even when you mix fonts of differing widths and heights (even on the same line), vary line spacings, etc. Uniquely, you are not trapped with one type of micro-justification (ie adding all the space between words, and using the predefined widths of characters as their separation) – with our

system, you can vary (in 5% steps) the ratio of micro-spaces added between words to that added between characters (the latter in proportion to their *individual* widths). Ratios around 65%-35% – not the 100%-0% forced upon you by some other word processors – seem to give the most pleasing results. Uniquely, you are not limited to mere rectangular columns plus headers/footers – that's all the rest can do – you can output in any sequence to any number of frames (text flowing from one to the next), each of any shape – irregular polygons of up to 66 sides, circles, multi-column or part-column boxes (hundreds of types of borders, thousands of textures), doughnuts, wrap-around shapes, even re-entrant ones ('join-the-dots' type borders, even with intersecting edges) – all with micro-justification and proportional spacing! Look at the example on this page. Of course, if super-fancy effects (like wraparound windows and mixing different font widths on the same line while maintaining right justification) are not of the essence, PERFECTION SE's direct printer output is excellent with all your printer's capabilities supported.

THE FASTEST

For benchmarking, we've used a public domain version of the first book of The King James Bible, all fifty chapters of the book of Genesis. This came to **one hundred and forty pages**, well over **forty two thousand words** excluding headers and footers, well over **two hundred and twelve thousand characters** excluding justification ones, **fifty full chapters** and **one thousand five hundred and thirty three indexed verses!!** We didn't use a smaller file (as used to benchmark other programs) as PERFECTION SE's timings for most operations then become impossible to stopwatch (too fast!). The hardware used for all timings was GOLD CARD: speeds would be **further improved by over three times** using the ST/QL 030. Of course, LIGHTNING SE was used. File operations were to ramdisk: normal slave blocks would give identical times. All settings on **everything** were for maximum speed, except where indicated to the contrary – we do not force full speed upon you in operations like scrolling and global Search & Replace. PERFECTION SE's speed for these is switchable (at run-time and when configuring), as too great a speed may cause overshoot (with scrolling) or fatal alteration (if there is human error inputting the target or replace strings). Here are the benchmarks for this huge document:

Load 140 pages: 0.6 seconds (yes 0.6, not 6!) ☆ Import 140 pages: 0.6 seconds (yes 0.6, not 6!) ☆ Save 140 pages: 0.5 seconds (yes 0.5, not 5!) ☆ Export 140 pages: 0.5 seconds (yes 0.5, not 5!) ☆ Case-sensitive search from top for word at bottom: 0.4 seconds (yes 0.4, not 4!) ☆ The same, but case-insensitive: 0.5 seconds (yes 0.5, not 5!) ☆ Case-sensitive search backwards from bottom for word at top: 0.4 seconds (yes 0.4, not 4!) ☆ The same, but case-insensitive: 0.5 seconds (yes 0.5, not 5!) ☆ Automatic Search & Replace, in Fast (No Query) mode, of last 600 occurrences: 7.4 seconds (same length replace string); 7.7 seconds (shorter replace string); 10.5 seconds (longer replace string – longer time as we deliberately chose a high *density* of replaces to handicap PERFECTION SE into auto-managing memory – without causing any heap fragmentation, but still with only a 0.005 second overhead per replace!) ☆ Automatic Search & Replace in Slow ('Querying') mode: arbitrarily slow, typically 30 times slower – because we deliberately allow for human response time (in case you want to abort) before proceeding from one replace to the next. ☆ Scrolling 100 lines of text, up or down, by full-width screen page: 1.5 seconds ☆ Scrolling 100 lines of text on full-width screen, line by line, in slow (full) mode: 5.7 seconds (down)/5.8 seconds (up) ☆ As above, but in medium speed mode: 4 seconds ☆ The same, but in fast mode and default settings: 13.5 seconds to scroll through the whole massive document, averaging 0.23 seconds per 100 pages (!) – and this could be made up to ten times faster by reconfiguring PERFECTION SE ☆ Reformatting paragraphs, changing margins, justification, etc, of existing text: c5 times faster than predecessor ☆ Inserting (or undoing) emphasised, underlined, italics, superscript, subscript, 8 strips, 6 environment settings: Instant (i.e. immeasurable) ☆ Navigation to line or page or to top or bottom or to 8 markers or to highlights/blocks: Instant ☆ Setting new margins, justification, etc: Instant ☆ Deleting block of 100 pages: 0.3 (yes, 0.3 not 3!) seconds ☆ Copying/moving block of 100 pages (not just 10!), downwards or upwards: 3.4 seconds (yes, including all the time for automatic memory management and anti-fragmentation – other programs are light-years behind) ☆ Spellcheck as you type: Ten times faster than anyone can possibly type ☆ Spellcheck all 140 pages in the document using the 350,000 word Mega Dictionary: 3.9 seconds (20 'errors' – like 'pluck!') ☆ And using our tiny dictionary (well, tiny by our standards – large by comparison with most others): 5.1 seconds (566 'errors') ☆ Time taken to create user dictionary from the results of the second spellcheck (566 errors): 0.8 seconds to extract all 'errors' from document and clean document; 1.9 seconds to create a full user dictionary therefrom and also a sorted, duplicate-free wordlist file (for browsing) ☆ Spellcheck file (ASCII or native): Even faster. ☆ Print first 10 pages to file: 3.5 seconds. ☆ Change every occurrence in 140 pages of God to @ed in bold underlined italics, strip 8 – 9.5 seconds! ☆ Virtually everything else: instant.

For prices, see the coupon page of our ad. For more info, read our detailed QLW ads in early 1991 for PERFECTION, plus the extra features of the SE (well, about half of them) listed in the June-August 1992 issues. You can upgrade from the standard PERFECTION (or PLUS) to the SPECIAL EDITIONS for the difference in current price, plus £10: no manuals or dictionary disks to be returned – we'll send a supplement to the manual.



PERFECTION PERFECTION PLUS

Perfection is the finest word processor available for any computer. We have received dozens of letters from happy users saying just this... and all of these letters were unsolicited. "Superb" was used most often.

Perfection manages to achieve all the sophistication of the most complex PC word processors while still using a user interface as friendly as Quill's. Perfection has a dual system of user control: menus while you are familiarising yourself with the program, and direct commands for the time when you feel ready for more adventurous things. The two systems can be used interchangeably and even simultaneously. Even more exciting - both systems are iterative. In case you don't understand what this means, let us give you an example: suppose you wished to move a block of text using the menus. You would choose Block Move (yes, it is right in the first menu) and the screen would then tell you to move your cursor to the start of the block. On most word processors you would have to navigate manually to this position: indeed, on many of them (Quill included) only a subset of the normal navigation commands would be available. On Perfection, not only can you use all the manual navigation commands (viz all 28 permutations of CTRL, ALT, SHIFT and the arrow keys) but in addition you can use direct commands like Go To Line or Page or any of eight markers. Even more amazingly, you can use Search (either as a direct command or from the menus) even though you are already 'within' a menu option.

Perfection has about 200 commands, but the layout of menus and the choice of keys for the direct commands makes it very easy to master. Though a 100+ page manual is provided (with all the important bits right at the front), you should only need to consult it for specialised operations like macros.

Even if speed is not particularly important to you, we assure you that Perfection's lightning performance will enable you to use the word processor in sensible ways that you would not have dreamed possible before. For example, scrolling 100 pages or so is accomplished so quickly using the normal navigation commands that you do not need to bother using a menu option to do the move. Spellchecking, assuming you have Perfection Plus, is accomplished virtually instantly: to spellcheck this whole ad (all the pages) would take under 1.5 seconds... Searching (you can switch case sensitivity, as well as equivalences between tabs, soft spaces and hard spaces) is at the rate of about 100 A4 pages per second.

Moving from one word processor to another is usually very traumatic. With Perfection, this will not be the case. Not only can Perfection read in Quill _doc and _exp files directly (you do not even need to tell it they are Quill files) but it can make direct and immediate use of your existing Quill printer driver. File re-export is also possible.

Perfection is truly WYSIWYG: this means that bold appears bold on screen, Italics appear as Italics, underlined as underlined, and so on. Of course, your printer may have functions we do not know about (upside down?). To deal with these, Perfection provides a number of on-screen shaded strips: these can be attached to any printer function you wish, and will not upset justification as a translate would. Of course, translates are provided as well!

A variety of statistics on the document being processed are available: some of them are on view all the time, the rest can be toggled to instantly. Not only is there a word count, but also page, line, character and special character (like Superscript Off) counts. There are also a dozen status indicators, letting you know whether you are in Insert or Overwrite mode, whether a block is defined, whether interactive spellchecking is enabled etc. Current line (from top as well as within page) and column positions and character codes are also available.

A terrific feature of Perfection is the dual screen mode. You can view one part of the document while editing another. The sizes of the two windows are themselves adjustable, both in real-time or via the configurator. We should devote more space to the configurator: however, it must suffice to say that everything that could be dynamically set within Perfection may also be preset with the configurator. The configurator can, for example, allow you to select any of 256 colours for any of a dozen parameters (like paper colour, border colour, status window ink and paper colour etc).

Perfection is fully multitasking without need for any external accessory: however, if you already use QPAC or Taskmaster or similar and are happy, you may go on doing so.

There is absolutely no way that we can prepare you for the quality 'feel' of Perfection. We have a great deal of experience using PC word processors costing many hundreds of pounds: with absolutely no exception, Perfection is far easier to use and master.

So if you thought Perfection was unattainable, you have a very pleasant surprise coming to you!

LIGHTNING SPECIAL EDITION LIGHTNING

These programs accelerate QL operation by up to 10x (2x -4x is typical) without having any adverse effect whatsoever on compatibility or anything else. Lightning SE is typically 40% faster than the standard version. This acceleration is totally independent of, and in addition to, any speed-up obtained by hardware means. So if you have Gold Card, your need for Lightning SE is just the same as if you had only an unexpanded QL - Lightning SE will accelerate both by the same ratio.

The Lightning programs achieve their acceleration by automatically paging out sections of the QL's operating system and replacing these with optimal, concise code written by us.

Lightning installation is a completely automatic and one-off: no knowledge of computing or programming is required. Once installed, Lightning can be completely forgotten about - you will soon get used to the superb speed! Knob twiddlers are catered for too.

Lightning technology is not built in to any of our other programs. Perfection users (as well as users of all other QL software) should therefore use Lightning all the time.

In summary: if you do not have Lightning, you are wrong. Buy this one FIRST OF ALL!

PROFESSIONAL PUBLISHER

The Professional in Professional Publisher refers to the quality of output from that program, and is not meant to suggest any complexity of operation. Few programs are as easy to use as this one: > 99% of users will be able to do with-

out using a manual! Professional Publisher is by far the best DTP program for the QL. It is fully compatible with Perfection, Editor, Quill, Eye-Q & the ASCII editors. It allows you to both create and import both text and graphics. Text can be 'poured' into boxes of any shape, size and number, automatically maintaining justification and hyphenation settings. So flowing text around graphics is a doddle.

Professional Publisher is supplied with a generous selection of fonts of various sizes, as well as clip art.

Justification is by pixel, not by character. This gives a much smoother effect.

It is pointless for us to try to list all of Professional Publisher's features - we would end up filling half the magazine! We will concentrate on just a few 'points': Professional Publisher is extremely precise, performing all its computations accurate to a small fraction of a millimetre. All its features can be preset by you using its configurator, ridding out the need for repetitive key strokes.

The program is extraordinarily versatile while remaining intuitive in its user interface. Buy it!

PROFESSIONAL PUBLISHER TOOLBOXES

Toolbox I is an excellent collection of high definition fonts, clip art and utility programs for Professional Publisher. While the fonts supplied with Professional Publisher are excellent, many users will feel the need for a wider range of typefaces and styles.

Toolbox II starts where Toolbox I leaves off, providing an even better - and different - font collection.

The two Toolboxes complement each other and are available together at a special price.

FONT ENLARGER GRAFIX

Font Enlarger does exactly what you would expect it to from its name. While Professional Publisher is also capable of enlarging fonts, it does them 'on the fly' and consequently is not able to remove the jaggedness caused by magnification. Font Enlarger is much cleverer, and enhances detail without any step effect.

While the built-in printer driver for Professional Publisher is excellent with 9-pin printers, it is not optimal with 24-pin or laser printers. Grafix is.



EYE-Q ULTRAPRINT

Eye-Q is the finest graphics program for the QL. While there may be other graphics programs with a few more features, no other program comes anywhere close to Eye-Q in sheer enjoyability. Eye-Q develops a pleasurable tactile relationship with you, and makes you feel like an artist (even if you aren't). Eye-Q graphics can be read in by Professional Publisher, and the latter's pages can be exported to Eye-Q (using Toolbox I). Everything in Eye-Q is menu-driven and there is context-sensitive help.

While Eye-Q has its own printer driver, Ultraprint allows you 22 distinct styles/sizes of printer output. The reasoning is that the scale of gradation suitable for pictures is probably unsuitable for text or line drawings.

PC CONQUEROR SOLUTION

PC Conqueror makes your QL into a PC-compatible machine, automatically. It does this by software means only, so there are no screws to undo or wires to fiddle with. Your QL stays a QL too.

Why, might you ask, should you wish to make your QL into a PC-compatible? The reason is simple: you may wish to run the same programs at home as you do at work. Alternatively, you may wish to tap into the vast storehouse of PC software of every type and description you could imagine.

Using PC Conqueror could not be easier. Just boot up your machine with the PC Conqueror disk in floppy 1 and within 10 seconds your QL will be transformed into a PC that is just waiting to be switched on. From this point on you will do exactly the same as you would if you were running a 'real' PC - this means putting a DOS disk (any version) into one of your drives and pressing a key. If you do not already have legal access to a copy of DOS, we can provide you with one at reasonable cost (see our price list).

PC Conqueror runs as fast as it is possible for a PC emulator to run: we have used all our skills to make it work quickly. Of course, you can make the emulation must faster by using Gold Card and Lightning SE. With this combination, you should get speed noticeably better than that of a PC XT...

PC Conqueror allows you to fine-tune the operating environment of the PC in order to improve performance. If you get a hard disk or other high capacity floppy system, you can utilise part or all of it as a PC hard disk.

PC Conqueror occupies under 80K and leaves 667K free for DOS when run on a Trump Card. This is more than you will get on a 'real' PC.

Solution does what Conqueror does but is about half as fast and is not quite as compatible.

SPELLCHECKER MEGA DICTIONARY

Spellchecker is what makes Perfection into Perfection Plus. We have made it available as a separate item for two reasons: (a) to allow Perfection owners to add it later (b) to allow users of other word processors to benefit from the very best in spellchecking technology.

Spellchecker is supplied complete with three dictionaries of differing sizes as well as a system for building, reviewing and maintaining user dictionaries.

Spellchecker's ultimate accessory is the Mega Dictionary, which gives the user a vocabulary of over 350,000 words!

3D PRECISION CAD SYSTEM

This program allows you to manipulate shapes and figures in 2D and 3D at a speed that will leave you breathless. Irrespective of whether your interest is in CAD, in animation or in just having fun, this program should not be missed. You can output to plotters directly from it, or alternatively create graphics screens to be manipulated and output by Eye-Q, Ultraprint or Professional Publisher.

SUPER SPRITE GENERATOR

SSG moves things about the screen very fast and very smoothly, without flicker. Sprites can have up to 16 frames.

MEDIA MANAGER SPECIAL EDITION MEDIA MANAGER

Media Manager Special Edition (MMSE) is a program to be used both when things have gone wrong as well as when things are perfectly OK. It allows for automatic, semi-automatic and manual correction of a huge variety of disk and tape problems. It allows you to explore disks and tapes to your heart's content, producing all sorts of different diagnostic reports. MMSE is very simple to operate, being menu-driven and assuming no degree of computer knowledge whatsoever.

MMSE also allows you to tidy, catalogue, sort and order your disks and cartridges.

The standard Media Manager is both less powerful and less user-friendly, but manages to work on an unexpanded QL.

Both programs allow for data transfer between PC and QL. With MMSE, this transfer is at file and directory level, is bi-directional and is completely automatic.

SPECIAL DESKTOP PUBLISHER DESKTOP PUBLISHER

These programs are quite primitive compared to Professional Publisher. However, if you have not experienced that program as yet, you will find both of these very competent. Both are capable of producing excellent results. The cheaper one has fewer features but is able to run on smaller systems.

EDITOR SPECIAL EDITION THE EDITOR

With the sole exception of Perfection, this is the best word handling system on the QL. Editor's features include an unrivalled degree of programmability and the ability to cope with the entire 256 character ASCII set. The Special Edition has enhanced document-type facilities, including column blocks and on-screen page break displays. Neither program is suitable for computing novices. Until Perfection, Editor Special Edition would have been our 'Desert Island Program'.

Editor SE can do a few things that Perfection can't, so the ideal combination is to have both (they are compatible at file level and can multitask). If you order Editor SE at the same time as Perfection, you can have Editor SE at half price.

PROFESSIONAL ASTROLOGER PROFESSIONAL ASTRONOMER

The Astrologer program teaches you Astrology from scratch and enables you to automatically produce text narrative on personality delineation, year-to-year and minute-to-minute life predictions, compatibility interpretations and so on. Whether or not you believe in astrology – indeed, especially if you do not – this program is one that you cannot afford to have. You can tailor the readouts (both in terms of quantity and what is said) to your own particular requirements. The amount of fun you can have with this program is endless. Do not blame us if you start believing in astrology, though!

Astronomer is an extremely fast and accurate solar system calculator, with planetary views, planet faces, eclipses, dimerama display etc..

TURBO BASIC COMPILER

Turbo is the finest BASIC compiler for the QL and arguably the finest BASIC compiler for any computer!

Turbo automatically converts working BASIC programs into optimised machine code, usually with no need for human intervention. The benefits of this conversion are vastly enhanced running speed (as well as much faster loading, encryption and automatic bug fixing for a variety of QL interpreter oddities). Typical speed-up is 40x – 100x.

Turbo is provided with a 200 command toolkit, adding many useful commands to BASIC. Most of these commands will be of immediate use to the programmer, whether he is a novice or an expert. There are commands to load strings and floats into RAM, and to extract them automatically; to search memory and to move its contents; to control jobs and change their priorities, manage pipes, allocate and deallocate memory, to control both rubber and virtual arrays, to present INPUT with an editable default, to have random access to files and much more.

TOOLKIT III

Toolkit III starts where Toolkit II stopped, adding about 60 new commands and enhancing many existing dual functions. Toolkit III is available either on disk or on ROM, and works whether or not you have Toolkit II.

Toolkit III commands can, with only a couple of exceptions, be compiled using Turbo.

QFLICK CARD INDEX

All QL owners have a copy of Archive, supplied free with the QL. While Archive is competent, it is very hard to get to grips with and is not particularly fast. QFlick presents a very convenient alternative – a snappy, simple-to-use, pointer-controlled card file database. You can move data between QFlick and Archive in either direction.

QFlick is not itself programmable but we document its data structure and give guidance on how to program it using Turbo.

ARCHDEV + RTM DATABASE ANALYSER ARCHIVE TUTORIAL NAMES + ADDRESSES MAILMERGE DAT-APPOINT SEdit SCREENPRINT RECOVER

This suite of utilities will greatly enhance your use of the Archive database system.

Archdev + RTM is a straight replacement for Archive: It gives enhanced speed, greater workspace and a much cleaner boot-up. All your existing applications will work.

Database Analyser provides very fast and comprehensive statistics about your Archive databases.

Archive Tutorial proceeds systematically through the whole philosophy and grammar of Archive, providing you with expert and patient guidance.

Names + addresses, Mailmerge and Dat-Appointment are ready-to-run, off-the-shelf Archive applications, providing an address database, mailmerging and appointment diary respectively. You now have no excuse not to use Archive.

SEdit allows you to create and edit screen format files in Archive. Screenprint allows you to print them out.

Recover allows you to get back lost Archive databases, created when you switched off the computer without properly exiting from Archive.

XREF SUPERBASIC MONITOR BETTERBASIC EXPERT SYSTEM

XRef analyses the structure of a BASIC program, providing detailed reports on things like variable usage, what calls what, dynamic call hierarchy of procedures and functions, and so on.

SuperBasic monitor actually monitors and reports on the performance of BASIC programs as they run under the interpreter.

BetterBasic analyses and automatically corrects structural flaws in your programs and allows you to customise things like indentation, number of statements per line, filtering out of noise words, etc.

The three programs together provide a matchless diagnostic and auto-correcting facility for BASIC programs.

TRANSFER UTILITY

This program copies files at high speed between devices, performing translates as it goes along. Ideal for all sorts of applications, including transfers from microdrive to disk.

QMATHS SYSTEM

This is an incredible mathematical compendium for the QL. Pride of place goes to the symbolic problem solver: this can solve equations, simplify expressions, factorise, expand, etc, all symbolically. If you could sneak this one into a maths examination, you would have a formidable ally. QMaths knows about all the algebraic operators, powers, roots, brackets, trigonometry, matrices, determinants, vectors, factorials, permutations, combinations, binomials, exponentials, logarithms, hyperbolics, inverse functions, infinite series including Taylor & Maclaurin expansions, complex numbers, conversions, Fourier series, and lots of calculus: both differential and integral, including integration by parts and definite integrals. QMaths optionally displays its workings and comes with a superb interactive tutorial.

The package also contains an Interpretive, fractal, image-generating language with loads of beautiful fractal programs supplied for you to use and edit – no programming skill is required.

There is also a multiple precision floating point maths package, giving calculations at precisions up to over 600 decimal digits of accuracy.

There is even more to this system, but we think we have told you enough.

QMON MACHINE CODE MONITOR

The latest version of Tony Tebby's superb monitor: an absolute must for those who really want to know what is going on in the QL. No other machine code monitor even comes close.

Do not confuse this program with SuperBasic monitor, which monitors SuperBasic, not machine code.

COMPARE

This program compares files – data or program – at colossal speed. Where a mismatch is detected, the relevant areas are highlighted and you can shuffle, displace and align very easily.

CASH TRADER WITH ANALYSER PAYROLL

Cash trader with Analyser is an accounts system designed by businessmen and not by wretched accountants! Consequently, it has excellent reporting and management facilities, and is very flexible. It is aimed primarily at the layman, probably a sole trader running a small or medium sized business. All the features you would expect – including audit trail – are present.

Payroll is a reasonably flexible system designed to automate the payroll function in small businesses.

Both programs are configurable, with editable defaults letting you adapt the programs from year to year.

HARDBACK WITH FINDER

This is the ultimate hard disk backup and management utility, with all the sophisticated features you could want. User dialogue is via overlapping pop-up windows – the whole program just feels right. It is possible to scan the disk at great speed, too.

DISKTOOL WITH QUICKDISK

This permits you to add password protection to disks, to optionally increase disk storage capacity on DSSD drives by 36K and to increase speed of access by as much as 30%. All this is done while maintaining full compatibility. Automatic file management is also provided.

DIGITAL C SPECIAL EDITION DIGITAL C

These are extremely fast and efficient C compilers, complying with and surpassing the Small C definition. The Special Edition goes much further, including support for structures, pointers, long pointers, >64K code size, direct access to QDOS traps, etc. The Special Edition C generates code that runs about twice as fast as the other.

SPECIAL DEALS

5% off total if you buy 2 programs/upgrades;
10% off 3; 15% off 4; 20% off 5; 25% off 6+
Upgrades cost difference in price + £10
Non-UK Europe add 5%, rest of world 10%

For full terms and conditions, please refer to any of our QL World ads from Jan-Nov 1990, or write in including a SAE

CPORT IMPROVED VERSION

A brand new CPORT system, enabling you to rapidly convert your SuperBASIC programs into C (ANSI or Lattice). The new (October 1992) version is now as close to being fully automatic as makes no difference - you must get it!

Owners of our earlier CPORT versions should return disk + SAE for a free upgrade.

SUPERFORTH COMPILER WITH REVERSI

Forth is the most logical computer language. This compiler produces multitasking code. The manual teaches you Forth-83 from scratch.

IDIS SPECIAL EDITION IDIS

These Intelligent disassemblers make the otherwise terrifyingly complex task of understanding other people's machine code programs absurdly easy. The SE version, which has a higher hardware requirement, sorts out some routines, replaces addresses with names, untangles data from code and much more.

QKICK FRONT END SYSTEM

This is a simple, easy-to-master, pull-down menu controlled multitasking front end. QKICK runs in the background and can be called up at any time. It provides you with notepads, sophisticated file/sector/RAM handling, backing up facilities, a dock, diary, calculator, mini-database and so on.

ADVENTURE CREATION TOOL SPECIAL EDITION

ACT is a must for every programmer. The name of the program is misleading, insofar as it has capabilities far beyond the 'mere' creation of adventures. ACT has utilities providing animated graphics, data compression, language design, parsing, maps, object-oriented control etc. If all you want to do is generate adventures, though, you do not need to be a programmer to use it. This is a purchase you will never regret.

PEDIT

A fast, modern and capable printer driver for the programs bundled with the QL.

MICROBRIDGE

Superb contract bridge bidder (ACOL etc) and player, using millions of random but reconstructable hands. Microbridge also includes a state of the art Interactive bidding tutor and a clear instruction manual. There is nothing like this anywhere else!

SUPER ASTROLOGER

A very cut-down version of Professional Astrologer - still great fun, though!

SUCCESS CP/M EMULATOR

Allows your QL to run CP/M programs at great speed.

3-D PRECISION CAD SYSTEM	£ 49.95	d
ADVENTURE CREATION TOOL SPECIAL EDITION	49.95	e
ARCADIA GAME	9.95	f
ARCHIVE DEVELOPMENT SYS + RUN-TIME MODULE	29.95	a
ARCHIVE TUTORIAL	19.95	a
BETTER BASIC EXPERT SYSTEM	24.95	a
BLOCKLANDS GAME	9.95	f
CASH TRADER v3.3 + ANALYSER	99.95	c
COMPARE FILE UTILITY	19.95	a
COPY UTILITY FOR BACKING UP	9.95	a
CPORT BASIC TO C TRANSLATOR WITH C68K COMPILER	99.95	c
CPORT BASIC TO C TRANSLATOR	89.95	c
DATABASE ANALYSER FOR ARCHIVE	19.95	a
DAT-APPOINTMENT APPOINTMENT DATABASE SYSTEM	19.95	d
DESKJET/LASERJET DRIVER FOR PRO PUBLISHER	19.95	s
DESKTOP PUBLISHER SPECIAL EDITION	39.95	c
DESKTOP PUBLISHER	24.95	d
DIGITAL C COMPILER	29.95	a
DIGITAL C SPECIAL EDITION	49.95	a
DISKTOOL WITH QUICKDISK	19.95	b
DROIDZONE GAME	9.95	f
DR-DOS v6.0 STATE OF THE ART PC OPERATING SYSTEM	79.95	e
EDITOR SPECIAL EDITION	49.95	d
EDITOR	29.95	a
EYE-Q GRAPHICS SYSTEM	39.95	a
FONT ENLARGER	19.95	e
GAMES COMPENDIUM (ALL FIVE GAMES)	29.95	a
GRAFIX 24-PIN UNIVERSAL PRINTER DRIVER	14.95	e
HARDBACK + FINDER HARD DISK MANAGER	49.95	c
IDIS INTELLIGENT DISASSEMBLER	24.95	a
IDIS SPECIAL EDITION	39.95	d
LIGHTNING ACCELERATOR	24.95	a
LIGHTNING SPECIAL EDITION ACCELERATOR	49.95	h
LIGHTNING SPECIAL EDITION FOR GOLD CARD	39.95	a
MAILMERGE DATABASE SYSTEM	19.95	a
MEDIA MANAGER SPECIAL EDITION	49.95	d
MEDIA MANAGER	24.95	a
MEGA DICTIONARY	29.95	s
MICROBRIDGE	39.95	d
NAMES AND ADDRESSES DATABASE SYSTEM	19.95	d
PAYROLL SYSTEM	49.95	c
PC CONQUEROR GOLD SPECIAL EDITION WITH DR-DOS v6.0	179.95	g
PC CONQUEROR GOLD SPECIAL EDITION	99.95	g
PC CONQUEROR WITH DR-DOS v6.0	139.95	e
PC CONQUEROR	59.95	e
PEDIT PRINTER DRIVER FOR XCHANGE	19.95	a
PERFECTION PLUS SPECIAL EDITION WITH SPELLCHECKER	139.95	c
PERFECTION PLUS WITH SPELLCHECKER	99.95	e
PERFECTION SPECIAL EDITION WORD PROCESSOR	99.95	c
PERFECTION WORD PROCESSOR	59.95	d
PERFECT POINTER TOOLS	29.95	a
PROFESSIONAL ASTROLOGER WITH ASTRONOMER	69.95	a
PROFESSIONAL ASTROLOGER	59.95	a
PROFESSIONAL ASTRONOMER	29.95	f
PROFESSIONAL PUBLISHER TOOLBOXES (PARTS ONE & TWO)	49.95	e
PROFESSIONAL PUBLISHER TOOLBOX PART ONE	29.95	e
PROFESSIONAL PUBLISHER TOOLBOX PART TWO	29.95	e
PROFESSIONAL PUBLISHER	89.95	c
QFLICK CARD INDEX SYSTEM	29.95	a
QKICK FRONT END SYSTEM	24.95	a
QMATHS MATHEMATICAL SYSTEM PART ONE	69.95	c
QMATHS MATHEMATICAL SYSTEM PART TWO	59.95	c
QMATHS MATHEMATICAL SYSTEM (PARTS ONE & TWO)	99.95	c
QMON MACHINE CODE MONITOR v2.05	39.95	a
RECOVER ARCHIVE UTILITY	19.95	a
REVERSI GAME	9.95	f
SEDIT + SCREENPRINT ARCHIVE UTILITIES	39.95	a
SOLUTION PC EMULATOR WITH DR-DOS v6.0	109.95	e
SOLUTION PC EMULATOR	29.95	e
SPELLCHECKER WITH DICTIONARIES	49.95	d
SUCCESS CP/M EMULATOR	49.95	b
SUPERBASIC MONITOR	24.95	a
SUPERFORTH COMPILER WITH REVERSI	39.95	a
SUPER ASTROLOGER	24.95	f
SUPER BACKGAMMON GAME	9.95	f
SUPER SPRITE GENERATOR	29.95	a
TOOLKIT III WITH ROM	49.95	h
TOOLKIT III	29.95	a
TRANSFER UTILITY SPECIAL EDITION	29.95	b
TRANSFER UTILITY	9.95	b
TURBO BASIC COMPILER + TOOLKIT	79.95	a
ULTRAPRINT SCREEN DUMP UTILITY	19.95	a
XREF SUPERBASIC PROGRAM ANALYSER	29.95	a
KEY>>>>>> Available either on cartridge or disk		a
Available only on disk		b
Minimum 512K exp:only available on disk		c
Minimum 256K exp:either cartridge or disk		d
Minimum 256K exp:only available on disk		e
Available only on cartridge		f
Minimum 1.5Mb RAM:only available on disk		g
As well as cartridge or disk, you get a ROM		h

NEW!



Send to: DIGITAL PRECISION LTD, 222 THE AVENUE, CHINGFORD, LONDON E4 9SE or phone 081-527 5493

Please rush me:

Name: Address:

Postcode:

Encl: CHEQUE/VISA/ACCESS/MASTERCARD/PO/MO/CASH for £

Card No: Expiry: Signed:

Delete as appropriate: (QL/THOR/STQL)(MDV/3.5"/5.25")(Disk=360/720/1440/2880/6400 sectors; nb 1 sector=0.5K)(if 720 sectors: SSSD/DSSD)

DIGITAL PRECISION LTD

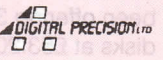

Bryan Davies
gets
reacquainted
with Quill.

shooter

Trouble

Greenweld Electronics (see INFORMATION) have again been offering ICL One Per Desk circuit boards at a low price. These boards were offered at £2.50 (plus VAT and £2.75 post & packing) in the October bargain catalogue, and may still be available. They contained one 68008 chip (the QL cpu), and various other chips which are unlikely to be of interest to most readers. As a source of a replacement 68008s, these pcbs could hardly be beaten. When the boards were out of stock recently, Greenweld supplied me with a new 68008 for £3 (that may not be a standard price, though).

The same company has been offering 3.5-inch HD disks at £53.20 for 100 (plus

VAT and £2.75 post & packing), which is a good price. The 100-plus disks I bought all formatted without trouble. D-type connectors also are priced reasonably, for those who make-up their own cables. The post and packing charge is per-package for most items; spread over several items, it doesn't increase the price of individual items greatly.

Disks

G M Young has thrown away several unbranded disks which could not be formatted in his 3.5-inch Epson drives. He feels the failures, plus the age of the disks, and the fact that they are unbranded, may indicate deterioration of the magnetic coating. He may be right, but my own inclination would be to blame the drives instead. The disks had been largely unused, and stored in an environment where physical (including magnetic) deterioration seems unlikely. On the other hand, the drives will have had a fair amount of use over several years and could be suffering from dirt on the read/write heads, misalignment of the heads, or other ailments. That would not necessarily stop them from working with some disks; disks are not all identical.

No further investigation is possible with the disks concerned, because they have been thrown away. As noted before, feel free to send me discarded disks, for further checking. The drives on my QLs are DD and ED 3.5-inch and it isn't convenient to check 5.25-inch disks on these systems, but they can be checked on my PC. Lack of 5.25 drives is the reason for delay in commenting on four disks sent in by R Snow. He feels that the disks themselves may well be alright, and

suspects a low recording level on his single-sided drive. Maybe the Christmas period will provide me with time to set up a 5.25-inch drive with a QL and test these disks.

Hopefully, there will also be time to reformat the ED disk used for the Conqueror MS-DOS "environment", that having disappeared for no obvious reason.

The number of points raised in P H Tanner's letters is usually large enough to make me overlook several of them. Obviously retirement hasn't turned this QL user into a cabbage; he is full of questions. One of them was whether or not the presence of a Gold Card in the QL speeds-up program loading from microdrive. He quotes 14 seconds to load Quill on his system, the basic system having no disk interface but using Minerva.

Text87 demo

Having recently received a copy of the demonstration version of Text87 Plus-4, I can vouch for it being well worth having. It is in fact the complete program, with functions such as saving and printing disabled. You can check out all the features of the program, to ensure that it is what you want before putting down your money. The disks being supplied have the latest, 3.1 version of the program on them. Several pages of instructions are provided - enough to get the feel of the program, but you need the full manual to really understand some of the functions.

There are some bubblejet users around in the QL world now, presumably using the standard Canon printers of this type. They might be finding it difficult to "drive" them properly. Have a look at

the Software87 advert, and you will see that the 2488 drivers disk is noted as being for "24-pin and bubblejet printers".

Anyone who has been reading PC magazines and is half-tempted by the advertised wonders of the Windows software is advised to call a certain well-known QL figure and discuss the matter with him. He expresses himself to be highly frustrated by the antics of that particular piece of software. His one major problem is in thinking that intelligence should be sufficient to deal with it; a knowledge of witchcraft might be more useful. As with me, his investment in PC equipment to tie in with industry is enough to buy a large pile of QLs, yet this software gem still won't run properly for him. Stick with the QL for a less-stressful life!

Someone presently less happy with the wonders of the QL is my better half, who has had trouble doing her accounts since the hard disk drive was reconnected to the QL. For some reason not yet investigated, nearly all her ALTKEY settings have disappeared; some of them now bring the system to a standstill, and there was much resetting (accompanied by a highly-charged atmosphere) during the last data-entry session. It was trying to install and configure the latest version of Conqueror on the hard disk that resulted in corruption of the existing ED set up. There is more than a suspicion that the large number of files on the hard drive will have to come off, for the whole thing to be reformatted yet again. That will give me the incentive to complete the delayed review of DP's HardBack hard disk back-up program, however. (That sounds more like a

classic hard disk problem than a pure QL one! - Ed.)

Quill Oddity

Going to meetings of the local Quanta group has forced me to become re-acquainted with Quill; not too difficult, as that program has to be the easiest of all to learn. There are more than a few oddities about Quill, though. Perhaps the most frustrating one is its grasping ways with memory. It takes just about every byte there is available when it is loaded. If you want to run anything else concurrently with it, load the something else first. Alternatively, reserve some memory before Quill is loaded, then recover the reserved memory after loading Quill. Unfortunately, my recollection of how to do this effectively was not up to the task at the last meeting. In the old days, you could format fixed ram disks, which could then be re-formatted to zero size, freeing-up space for use after Quill was loaded, but

current ram disks are of the dynamic type which do not allow of this treatment.

What happens if you reformat RAM1_ to zero size is that you get a RAM2_ of the same size as RAM1_ originally was, and the same happens as you work your way through to RAM8_.

Reformat the latter and you are back to a full-size RAM1_. There is more than one other way of reserving space, and details have been given in previous

issues of QL World, but I cannot remember which issues.

To give proper control of Quill (and other programs), you need to use a switching program such as Q_Switch, Taskmaster or QRam/QPac. These three all allow you to specify how much memory each program can have.

To give proper control of Quill (and other programs), you need to use a switching program such as Q Switch, Taskmaster or QRam/QPac.

Taskmaster and QPac do require rather a lot of memory themselves, though, and they are best used on a larger Trump Card or Gold Card system if you want to run several major application programs.

Coupled with the refresher course in Quill, we were looking at the demo version of Text87, and it was interesting to note that putting that program before Quill in a boot routine did not enable it to run. (The Quill version being used had been "treated" to

make it EXEC-able, incidentally.) While Text87 started alright, it did not have enough memory available to load documents. Apparently, it does not commandeer the memory it requires, when it first starts, and the arrival of Quill immediately after it ensured that all the remaining memory got snapped up all

but 3584 bytes, that is, and you can't load much of a document with that.

Text87 is very good at loading different formats of file, taking almost anything without complaint or delay. Quill is not so obliging. Asked to Import a boot file, it refused, on the basis the file did not exist, despite it being clearly displayed when a directory was asked for. On the other hand, it did import a list of Text87 fonts. The only obvious difference between the files was that the second one had an extension (_A87) in the file name; sure enough, renaming the boot file to BOOT_LIS satisfied Quill that it was ok to import.

INFORMATION

ICL OPD pcb and floppy disks:
Greenweld Electronics Ltd.
27 Park Road
Southampton SO1 3TB.
Tel: 0703 236363
Fax: 0703 236307

plus4

A Quantum leap in QL Wordprocessing

Users have expressed their verdict in letters published in Quanta!

+1 USER FRIENDLY TO THE EXTREME

Context-sensitive help * File selector boxes * Highly compatible with Quill.

+2 THE MOST POWERFUL QL WP

Reformats as you edit * Remembers paragraph formats between sessions * Integrated spell checker with dictionary browse and replace * Multiple Windows over multiple documents allow you to edit one text while looking at a different one for reference * On-screen page-preview and pagination accounting for columns and variable line-spacing.

+3 UNRIVALLED PRINT QUALITY

Nothing else can compete in text and character formatting * Fully supports proportional spacing, mixed character widths and justifies correctly * Multiple paragraph formats with different margins and line-spacing for each * Right, centre and decimal tabs * Multiple columns plus headers and footers * Desktop publishing with several different page layouts in the same document. All the above features available at the highest text-mode letter quality resolutions of 360 x 360 dots per inch (24-pin printers) or 300 x 300 dpi (deskjet and laser) at fast print speed and with very large texts.

+4 FASTEST QL WORDPROCESSOR

Amazing timings on QL and 8 MHz Atari ST with QL emulator. Gold card would be much faster than both * A 70 page text (24,000 words, 141,000 characters) was used * Load (first time from floppy disk--not ram disk or slave blocks): 25s (STQL 17s) * Save (to floppy disk): 37s (STQL 32s) * Search / Replace 580 instances (auto reformats the affected paragraphs to account for different lengths of search and replace strings--not leaving

you with hundreds of lines with ruined format to sort out manually): 43s (STQL 14s) * Change right margin of whole text (with complete reformat): 65s (STQL 17s) * Move 10 pages from top to bottom (times include manual marking and positioning of the text and reformat after the move): 35s (STQL 15s) * Scroll full screen over text 100 lines (full screen line by line--not just the last line, not just the last line over every 10th or 100th line of text): 19s (STQL 5s) * Change justification of whole text (change is instant, times represent full screen refresh after the change): less than 2s (STQL 1s) * Many other operations (e.g. goto page, line, top, etc., case sensitive search, insert typefaces, auto reformat of edited paragraph, change individual paragraph margins) are instant, with only a quick screen refresh to complete the task.

Fully compatible with all QL ROMS, Gold Card, STQL, QVME STE in high resolution, Thor. Requires disk drive and 256 K memory.

Prices (payable by cheque -- air mail overseas)

text87plus4	£79
2488 drivers for 24-pin and bubblejet printers	£19
typeset90-deskjet drivers for all HP Deskjets	£19
typeset90-Epson drivers for Epson Lasers	£39
fountext88 + founded89 graphic driver	£39

Also: QDesign II: £54 * QSpread: £54 * QPac II: £39 * QTop: £34 * QD4: £44 * ArcEd: £24 * FiFi: £19 * Mouse £49

Software87, 33 Savernake Road, London NW3 2JU

DEMO!

We have produced a working demo version of plus4 to try for yourself. The demo has all the commands apart from save, export, spell check and print (sample print output for different printers is included). Send £2 in postage stamps (no cheques please) to get your disk and leaflets.

Open Channel

Open Channel is where you have the opportunity to voice your opinions in Sinclair QL World. Whether you want to ask for help with a technical problem, provide somebody with an answer, or just sound off about something which bothers you, write to: Open Channel, The Blue Barn, Tew Lane, Wotton, Woodstock, OX7 1HA.

Fissssh

A tip to QL users who get no results from connecting a QL to a Sony tv scart connector. Link pins 16 and 19 on the scart plug, and it should work.

Request to QL software houses - please can you write programs for us so we can convert our monitors into tropical fish tanks and firework displays like they do on PCs? Thank you.

**Paul Merdinin
Dover
Kent**

If you must convert your monitor into a fish tank, remember to unplug it first.

Restocking?

Like your other correspondents, I am delighted that QL World still exists. As a long-time but still very inexperienced user, I find that your pages solve many problems, and I use my back issues considerably. However, some are getting tatty. Are binders available?

You have done various features on printers, but never one on the "QL printer", the Seikosha 1000A. Although now obsolescent it has given me excellent service, and still does. However, it needs a new ribbon now. Does anyone make them?

I have been trying to get hold of the program MusiQL, reviewed in QL World February 1990. Does anyone know if it is still available, and where from?

Finally, if I build myself a Midi interface, is there any software available for it?

Please keep publishing!

**Martin Baxter
Ulverston
Cumbria**

It does look now as if there is no reliable stock of backnumbers beyond what we have published. The Maxwell-vintage ones seem to have been eliminated when that business left its old premises, and although there are rumours of caches of older ones, we don't know where they are. However, the office has now ordered a new batch of binders.

MusiQL bobbed up and then bobbed down again, and I'm sure I have seen it around since, but a check has failed to turn it up. It was quite a good program. MusiQL alert!

The question of Midi is vexed. There used to be hardware and software for the QL, but it was never perfect, and none of the commercial publishers seem to be dealing in it now. Quanta is selling the former Miracle midi interface to members, but it does not work with the Gold Card as yet.

As for the Seikosha - it's a very old printer. Have you spoken to a Seikosha dealer? Otherwise, EEC Ltd. are good on QL supplies, but this may be beyond them.

Sources for any of these items would be welcome.

Mothball

In early 1986 I purchased a QL, believing it to be the best computer on the market, both for its potential and for beginners. But being a merchant seaman, I had to put my QL into storage shortly after its purchase, and it is only this autumn that I have de-mothballed it and, to my delight, find that it works perfectly.

I am worse than an amateur, though, as on digging out the steadily growing mountain of QL Worlds since that April of 1986, and starting to grope my

way through them, I find that I know nothing about computers, relatively speaking, and worse still, all the literature that was evidently available in those days is no longer available.

However, as I now have plenty of time to devote to the QL, after reading some of the QL Worlds, I would not even consider changing my QL for something else.

So I am wondering if there is anybody that is in a position to let me have copies of QL World or QL User prior to April 1986, so that I can start at the beginning, solving all those problems that you solved so long ago. Of course, any other literature on the QL would be of assistance also.

Many thanks in anticipation.

**I A Ivey
Okehampton
Devon**

Rom types

In Open Channel August 1992, M L Huppe asked about the various QL roms. I have dug out some information, and here is a short answer.

The AH rom was first produced in June 1984 and contained the first usable version of the operating system, Qdos 1.02. The JM came next, and was very similar, but the mass-production version, and the first to fit on two chips on the circuit board. The JS version was the most up to date version used in machines sold in the UK, and spawned the JSU rom, which was the adaptation for the US television standard (NTSC), which uses fewer lines than the European standards.

The last version was the MG rom, which was designed for use in continental Europe, and comes in several forms - MGE

for Spain, MGS for Sweden, and so on.

All the roms from the JM onwards should be plug-compatible. Like all computer operating systems, they all contain bugs, so I feel that the best version is the one that runs the software you habitually use. Changing to a later version will not bring large improvements, but may introduce problems. (There is a marginal preference for buying your raw QL in the JS form if you can, as more of the later software was written with that version in mind.)

Simon Goodwin wrote a series of articles on the QL rom and its bugs, the first in QL World August 1987, which detailed the evolution of the rom and the bugs in current versions. Subsequent articles in September 1987, June 1988 and February 1989 described bugs that are common to all versions. Most of the information in this letter was taken from Simon's article in 1987.

**John Langford
Farnham
Surrey**

Comment: Now that back issues are so hard to get hold of, we should be looking at the possibility of reprinting some older articles that are still felt to be useful or informative. Please write and tell me which articles you found particularly helpful back in the olden days - before my time! We don't, of course, want to stuff QL World with reprints - many of our readers have been with us since 1984 - but some writers who are no longer in touch (not just with us, but with anyone we know, indeed), like Ron Massey and Colin Opie, for instance, were immensely popular and helpful in their day, and newer users could reap the benefit.

ZX Queries

Congratulations on the smooth transition from MCM to Arcwind. I hope you can keep up the current standard of writing. Hopefully, with Miracle's babies on the way, there will soon be an expansion in the QL market.

When someone at the London Quanta sub-group confirmed that you were continuing, I tracked down your address to order a copy of the April issue. A voice said 'No problem' to ordering a backissue. The June issue however said 'See HHL' for the April issue, and I thought, what do I do now? But being a busy chap, I had to leave the problem for a month or so - and then the April issue arrived! Thank you very much for excellent service.

I have an idea for an article: We read much about the internal workings and the history of Qdos. However, the same is not true of SuperBasic. In particular, I would be interested in the relation of SuperBasic to the ZX Basics. I know that the ZX81 Basic was developed from the ZX80, but I don't know where the Spectrum Basic originated from.

I read somewhere that SuperBasic was "tagged onto Qdos", which suggests that it was originally written using a different cpu. Did the short-lived interface 1, with its 'hook' code to extend the Basic, provide the prototype for the QL's procedures? Is there any code on the QL which is directly descended from the ZX80/81?

Could we also have an article on the TRA command. I have a program which changes the error messages, but I do not know how it works.

Please could you ask the excellent Simon Goodwin to review all the bugs, rom calls and system tables he has found and used. Every so often we have had articles on each of these, but not on the whole lot. If he does write such an article, please could you try to put it astride the Keyword Index so that we can pull it out as well?

I have a Minerva'd QL with a Gold Card. The only

disadvantage of it is that the excellent QKick and Disktool no longer work with it. I only mention this because you recently reviewed Disktool, but did not mention whether you had tried it with that combination. Both of my programs are probably early versions (2.00).

Another command which appears to have gained funny habits with the Gold Card is OPEN_IN. I was unable to use DEVs with it, though both OPEN and OPEN_OUT worked ok.

Phew! I think that's it. Sorry it's so long, but I do not often write. Best of luck to Miracle, TF Services, Jochen Merz, yourselves and everyone else in the QL world.

PS A final brainstorm: How about a (new) article on the previous incarnations of the QL? Thor was before my time, and I understand Laurence Reeves tried something similar before Minerva.

**A Patt
Pyrford
Surrey**

New Archive

Bryan Davies regrets that there is not a complete replacement for Archive. I have been using DataDesgin by Progs (Haachstraat 92, B-3020 Veltem, Belgium) and find it a very satisfactory replacement for Archive. It is easy to use, flexible, rapid, works with a mouse, and can be programmed from Basic if you so choose. One can pass Archive files into DataDesign. I have not encountered any bugs yet. Archive is perfectly workable even if it has some annoying hics, and its procedures allow much flexibility, but DataDesign is a better alternative.

About mice: it has been mentioned that SER_Mouse could be used in SER1 in conjunction with a printer. I wired up a double-ended cable so that SER1 could output to the printer and the mouse could send signals. Well, there were problems. To print, I had to disable the mouse software (sermoff) and unplug the mouse. I found that it was the mouse connection

to TxD (pin 2 of SER1) which prevented the printer from receiving data. There were other problems, too. So I went back to using the mouse on SER2. This has the disadvantage that, if I want to use a modem, I must swap the connection to SER2. I hope those little SER connections can support many unpluggings. Maybe Mike Lloyd will have something to say about this problem.

**Ian Pizer
Geneva
Switzerland**

Interfacing

I am interested in interfacing to the QL. I have looked through the manual but have found no help. I would like to interface several input devices, such as temperature, light and moisture sensors. These sensors I would buy or make, but I do not know how to interface them to the computer. I also want to print out any collected data at certain points in the day. I would be most grateful if you

could send me any relevant material or give me any advice to help me solve my problem.

**Stuart Risby
Balcombe
West Sussex**

If anyone has been working in this field with their QL, we would like an article on it. Write to me for more details.

Micro-jiggling

I have noticed that microcassettes become unusable and give rise to "Format failed" or "Bad or changed medium" error messages for a reason that is readily corrected.

If the small bronze spring, to which the pressure-pad behind the tape is attached, becomes flattened by long use, the tape is not held against the tape head with sufficient pressure to receive signals from, or pass them to, the tape head.

I have constructed a device to help me reshape the little spring, and often correct this fault. It should obviously be

Editor's notebook

A nervous whisper has been going round that something nasty has happened to DJC. In fact, the reverse is true: the only things that have upset Dilwyn's routine are extra work (lucky chap) and a new young Jones (all according to plan). It's curious that something massing ten times less than its nearest relations can make more noise and lose them more sleep than the average Quanta AGM in full swing, but it's true. Dilwyn's new catalogue is out now, by the way.

QL World has a new printer ... so (we sincerely hope) this issue will arrive earlier in the month than the previous one. By March we should be back on track. Fingers crossed.

Peter Hale in the USA tells me that the retraction of the rumour that 12 QLs had been used to power a Cray in the 'States (designated the Cray Z-2B) had produced another American who insisted that it was not only possible, but true ...

Oyez oyez. We want a user report on the current Quanta Midi interface (and any supporting software), a Quill expert, and a reviewer for DJC's Text'n'Graphics and Screen Dazzler. Contact the Editor with reasons why it should be you.

**HAVE YOU FILLED IN YOUR READERS'
SURVEY YET?? IF NOT, DO IT NOW!!**

made of plastic, aluminium or other non-ferrous material.

(The device, which we can't easily reproduce here, is a little jig or container in which the microcassette fits snugly upright, and flush with the top. One side is slightly taller than the other three, and has two small holes drilled, at exactly the spacing of the undulations in the bronze spring (5 mm apart), sufficient to take a wire of the same calibre as paperclip wire - or, in fact, a paperclip - bent to an extended u-shape.

The holes in the raised side hold the refashioned paperclip firmly. The jig holds the microcassette firmly. The u-shaped wire can be withdrawn from, or extended through, the two small holes. Read on ...)

In use, the device must be mounted on a firm enough base-board, the paper-clip retracted, and the cartridge dropped into the cartridge-shaped container, label side towards the clip. The clip is then pushed forwards to hold down the edges of the bronze spring.

By inserting a small, firm wire (again, preferably non-ferrous) under the spring, and pushing carefully upwards, the spring may be bent until its pressure on the tape again proves effective.

I have often found that this enables me to continue using a cartridge that I have otherwise been unable even to format.

LGL Unstead-Joss Edinburgh

Comment: If you are going to try this, our recommendation is: To make sure that your bent paperclip is holding the edges of the bronze spring firmly down before you attempt to exert any upwards pressure on the middle of the spring. Only attempt the operation using the close-fitting jig on a firm base-board as instructed. One false move without the restraining device described will cause a tiny, subsonic boiinnng, and the little bronze spring will vanish into a corner of your room, never to be seen again.

No banana!

It's nice to see that QL World has survived intact. I like the more prominent free-ad, but I am always reluctant to cut up my copy. I can see the reason for disallowing photocopies, but would like to suggest an alternative. I am skint at the moment and my sub is coming up for renewal - perhaps you can arrange for a free subscription to reward my ingenuity! It would help maintain records of advertisers, give a standard-size sheet for storage, and avoid the need for readers to cut up the magazine if you had the advert coupon printed on the back of the sheet of paper used for the address label. This would also give you proof of subscription (the address label). Brilliant! Don't forget the subscription!

**Ron Allpress
Thwait
Suffolk**

Nice try, Ron! But no banana. I'm tempted to offer a free sub to the first reader to spot the deliberate mistake, but we've got an offer on the Readers' Survey at the moment, so I'll let the cat out of the bag myself. We don't print our address labels on a separate sheet any more ...

Up the wall

Until recently I was smug and contented knowing that I had long ago surmounted my printer driver problems. Then my printer's cut-sheet feeder began to play up, so I bought a Panasonic KXP-4430 laser printer, having first established that a friend's Canon LBP-4 appeared to respond immaculately to the Quill (adapted for Perfection) Brother HR15 printer-driver which I used. The 4430 however did not respond, so I adapted the Quill Epson driver and used the Epson emulation on the printer. This allows me to print Courier or Century PS fonts, but my preference is for Times, which is resident in the 4430. However, Times is only available if you use the Hewlett Packard/Panasonic LP emulation.

The instruction book with the

4430 gave me enough information to adapt it to do some tricks like double-width characters, but the instructions on the HP commands are beyond me. I am faced with building up the printer-driver from scratch and I simply retire at that point.

I rang Freddy Vachha of Digital Precision who has always been helpful in the past. He suggested two alternatives: if I had Professional Publisher (which I have) and I obtained the Gold Card version of Perfection (which I have ordered) I could pour my Perfection text into Pro-Pub and use the HP Laserjet driver (which DP sell at under £20). Or I could just build up the printer driver using the printer's manual.

Well, ProPub is not a program I use enough to push myself through the learning curve of getting to understand it properly. Anyway, this seems to be an overcomplicated route to producing a Times font. The thought of building up the printer driver (accompanied by a sort of hearty throwaway line - I quote from memory only - "It's a bit bloody, but it always is ...") leaves me cold.

Has anyone out there got a driver up and running which fits my needs? If they have, please let me know.

**Paul Stewart
Stockwell
London**

Freddy is right about printer drivers, though it's usually the operator's fingernails which end up bloody. Going from a WP through a DTP is a bit long-winded for everyday documents (although we have known people to get hooked). Can anyone help?

Scuse me

I read with interest the item in the October issue about Noud Snelder's work on the development of the SCSI interface enabling the PC to think it is a QL. If this is possible, I shall be able to work from home and in the office. The problem with my previous set-up is that I have limited memory and do not have a hard disk.

I am currently running an

Olivetti M250E at work and would like to know if the package will be compatible with this machine. If so, I shall be pleased to receive any further information you may have, and the cost if known.

**Andre Saubolle
Ardee
Eire**

Whoa! First, the Miracle SCSI card is not the same as the Miracle PC card, although both are currently under development. In due course, Miracle will advertise these new cards, cost and all, and that's the best time to approach them with questions about compatibility. The SCSI card is aimed primarily at hard disk users, although (we are told) it will be suitable for floppy drives as well.

Dear Simon

Thanks a very lot for your educational articles in DIY Toolkit. I'm an unemployed PC technician from Sweden and a keen QL World reader since the beginning of 1988. I'm mainly interested in programming, hardware, operating systems, processors, etc., so the QL is the ideal computer for me.

I'm collecting old QL software and QL articles. A rumour said that the GST Macroassembler and the GSTC should go into the public domain, but that was at least a year ago. The GST C to Atari ST was good and had a well written manual, so it's a pity it disappeared as a commercial QL program. I'm interested in the early QL days like the exciting one about Supercharge and Turbo. And how about the full story on the GST CP/M68 that first was intended for the QL. Did CP/M68 ever appear as an operating system for the QL, and was anyone using it?

**Alf Akerlund
Sollentuna
Sweden**

Perhaps someone can help with a second-hand copy? If so write for Simon's attention (I'm forwarding Ake's letter to him). Articles about the history of the QL always remind me of the ancient Chinese curse "May you live in interesting times."

BRISTOL SHOW

Henry Orłowski reports back on the Bristol Quanta Group's Autumn Fayre.

What can you do on a Sunday during a month of wet and windy weather? Go to the Bristol Quanta Workshop, of course. Hundreds did, and enjoyed the event on 29 November tremendously. What's more, the weather stayed mild and dry.

The Bristol QL user group held their autumn workshop at the Walton Park Hotel in Clevedon, Avon, as usual, following on from the previous successful events staged by this group. The event had been well previewed in both QL publications and the local press, so interest and attendance was high. A

number of claims have been made by us in Bristol for the superiority of the Bristol workshops, and I believe that a general consensus of traders and visitors alike would put this workshop into a top category.

Several hundred turned up from all parts of the UK and even from Europe. They came to marvel at the esoteric setups, or preview hardware and software, or to have their QLs mended, or just to absorb the atmosphere.

Most of the well-known QL suppliers were there and did brisk business: Dilwyn Jones Computing, CGH, TF Services, Jochen Merz, EEC, Jurgen Falkenburg, Miracle Systems, Adman Services, Qubbesoft, Qbits, Di-ren, Pointer Products and QLEA (East Anglian user group). Quanta signed up several new members at their stall.

Among the wares on show were the Serial Mouse from EEC; Hermes the 8049 chip replacement from TF Services; QSpread from Pointer Products; the Rom Switch,

housed in a separate box (no soldering required) by QLEA; and their Midi Interface from Quanta.

Of course, no QL meeting would be complete without the screwdriver and soldering iron activities - machines being mended or rejuvenated or refitted were everywhere to be seen.

I mustn't forget to mention to famous Bristol Bring'n'Buy stall, ably manned by Mike and Jack. Here you could get or dispose of your second-hand drives, interfaces, monitors, software, etc. However, what made this a well-rounded and professional event that it was the staging by the Bristol group of a series of lectures on subjects of general interest in a separate presentation room with large screen monitors.

The presentations included an introduction to SuperBasic by John Miller from the Bristol group; beginners' machine code programming by Alan

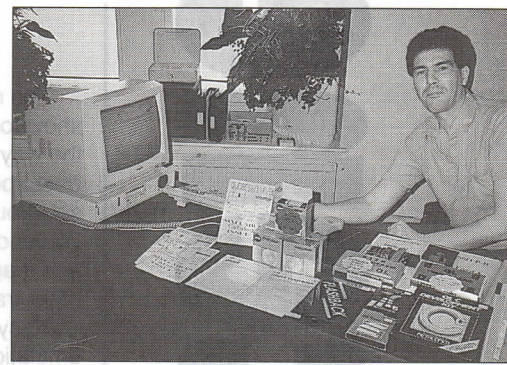

Bridewell (appearing soon in a QL World near you); and Dbas, the new database program by Quanta's Phil Borman.

A number of traders took advantage of this facility of demonstrate their products to large attentive groups of interested enthusiasts, away from the bustle of the main floor. In general, this was a very well-attended event with a variety of features and something of interest for everyone. Most traders expressed satisfaction with the level of business, while most users enjoyed a fruitful and interesting day out. I can't wait for the next one.

Telephone: 0753-888866 (EEC) **W.N. Richardson & Co.**
 Fax: 0753-887149

18-21, Misbourne House,
 Chiltern Hill,
 Chalfont St Peter, SL9 9LE.

SINCLAIR QL PRICE LIST DECEMBER '92

All Prices Include 17.5% VAT

QL Computers MOST PRICES LOWER

JS COMPLETE 6 Months Warranty, QL Computer, PSU, Psion Software (Quill, Archive, Abacus & Basel) £120.00
 Free one year membership to QUANTA, the independent QL User Group with over 400 library programs, advice etc. WITH JM ROM £ 95.00

PART EXCHANGE A part exchange allowance of £30 is available against the above.
JM BACKUP Includes QL Computer and PSU only £ 75.00 WITH JS ROM £ 85.00
TINKERERS SPECIAL £49 (Please enquire for further details)

Accessories * NOTE: EXTERNAL (SER2) 3 BUTTON MOUSE AND SOFTWARE WITH EXTRA FUNCTIONS. NOW HERMES COMPATIBLE. *

PC KEYBOARD INTERFACE, INTERNAL FITTING, FOR FITTING 102 KEY KEYBOARD £ 75.00
PC KEYBOARD, UK version, 102 key (AT) £ 25.00
PC KEYBOARD INTERFACE and KEYBOARD (INCLUDES FREE JOYSTICK OR PSU) £ 90.00
CASE and LEAD for EXTERNAL FITTING of Keyboard Interface £ 17.00
JOYSTICK with QL lead (no interface required) £ 10.00
*** QL MOUSE, 3 Button, Software controlled, externally mounted, simply fits in SER2** £45 **REMOTE MOUSE** £ 55.00
MOUSE for QIMI interface, also OK for Atari ST and Amiga £ 10.00

Disk Drives THE UNIVERSAL DRIVES ARE ALSO SUITABLE FOR ACORN BBC, ATARI ST, AMIGA, SPECTRUMS, IBM, AMSTRAD AND OTHER PC COMPATIBLES

Universal 3.5" 1Mb disk drive, cased with PSU and free QL lead	£ 70.00	2 Units for dual drive	£130.00
Universal 3.5" 2Mb disk drive, as above but 2Mb capacity	£ 90.00	2 Units for dual drive	£170.00
3.5" 1Mb Uncased disk drive (CITIZEN)			£ 25.00
3.5" 2Mb Uncased disk drive (CITIZEN)			£ 49.00
Lead for uncased disk drives, or other universal micros	£10.00	POWER SUPPLY FOR UNCASED DRIVES	£ 6.00

Parallel Printers **NEW RANGE**

SAMSUNG SP093 80 Col, 300 cps, 50 NLQ, 3K Print Buffer, Centronics, Tractor Feed/Sheet Feed, Paper Park £149.00
OLIVETTI COLOUR PRINTER, 24 pin, 200 cps, 50 NLQ, 40K Buffer, Epson LQ2550/IBM Compatible £239.00
CENTRONICS PARALLEL Printer Interface for above printers £ 27.00
QL LEAD FOR SERIAL PRINTERS £ 10.00

Monitors **GOLDSTAR 14" HIGH RES EGA Colour, 0.31 Dot Pitch, 85 COLUMN IN STYLISH GREY WITH NON GLARE SCREEN** £199
BUY NOW WHILE STOCKS LAST TILT & SWIVEL BASE £5

Microdrive Cartridges and Spares

4 New Cartridges in a wallet	£ 10.00	8 prog carts for reformatting in 2 wallets	£ 15.00
Plastic Storage filing box including 20 new cartridges			£ 45.00
QL Psion Software V2.35 Includes Quill, Abacus, Archive, and Easel IN WALLET			£ 20.00
QL Psion Software Separate programs			£ 12.00
QL power Supply Unit	£ 10.00	Membrane (and instructions)	£ 9.00
TV or Network leads	£ 3.00	QL Top & Bottom Case	£ 5.00
IC's ZX 8301	£ 6.00	ZX 8302	£ 3.00
MC 68006	£ 12.00	8049 (IPC)	£ 3.00
		MC 1377	£ 3.00

(S.A.E. for other spares and repairs)

VISA Payment terms: CWO, Access, VISA et cetera
 Cheques - allow 10 days
 Product subject to availability, E&OE
TEL: 0753 888866

Delivery: Carriage - £9
 Postage - £3
 Overseas - Add £10 for delivery
FAX: 0753 887149

TF Services

MINERVA

The ULTIMATE operating system upgrade

MKII MINERVA now with battery for 256 bytes rom, CRASHPROOF clock & interface (I/O) for robots etc. Can autoboot from battery rom.

Other features (Common to MKI/MKII):
 Autoboot on reset/ Multiple Basic/ Faster scheduler-graphics (100% of Lightning)-string handling etc/ WHEN ERROR/ Second screen/TRACE Foreign keybd drivers/ 'Warm' fast reset etc

MKI to MKII UPGRADES: up to 1.79 - £5. Rest FREE (send rom (PROTECT LEGS!) and disk or 2 mdvs)

Original MKI..... £40 MKII..... £65

ALL VERSIONS FULLY GOLD CARD COMPATIBLE

HERMES

A replacement QL co-processor (IC 8049 IPC)

Do you get keyboard bounce?
 Do you find Fast serial input unreliable?
 Do you want to run an HSI 14400 bps node?
 If you can say YES to any one of these, then this is a product you have been waiting for

- Gives up to 19200 bps RELIABLE serial input
- Independent baud rates
- Stops keyboard 'bounce' (unwanted repeat chrs)
- Improves 'fuzzy' and 'random' sound
- Provides extra input and output lines
- Key click
- Reset/INT invoked more safely

FITTING is a simple job. Simply remove the QL top (8 screws) and replace the chip marked '8049' next to microdrive 1.

PRICE (including manual & software) **£25**

BULLETIN BOARD

QBBS - The first UK QL scrolling bulletin board. Now even larger with international ECHOmail and 10MB of files (including the WHOLE King James' bible!)

071-706 2379 1/21/23/22/22b1s 24hrs

QL SPARES

Faulty QL boards (excl plug in ICs)..... £9
 Keyboard membrane..... £8
 Circuit diags... £2
 68008 cpu..... £8
 1377 PAL..... £3
 J11 rom set..... £10
 Power supply..... £12
 6302 ULA..... £10
 6301 ULA..... £10
 8049..... £8
 HDU ULA..... £12

Other components (sockets etc)... please PHONE

Qualsoft

Viewdata-VT52-VT100 QL TERMINAL EMULATOR

Multitasking for electronic mail, PRESTEL etc, CET download. Compatible with Tandata Qconnect QL modem/adaptor. Use Qconnect RS232C to drive unbuffered modems. Comprehensive RS manual.

Software (3.5" or mdv) & manual **£30**

FILE TRANSFER - to transfer text AND programs error free (XMODEM) BETWEEN computers

Available for IBM compats, ATARI ST & Sinclair QL
 Connects to Psion range with RS232C comms link
 Software £7.50 per m/c. Cable £10 (name 2 m/cs)

All prices include VAT and postage in the UK

QL REPAIRS

QLs tested with Thorn EMI test rig and ROM software (HDU hardware extra if required)

£27 - 6 month guarantee

VISA 12 Bouverie Place, London W2 1RB (tel: 071-724 9053)
 SCROLLING BBS FOR ORDERING/QL HELP and FAX - 071-706 2379

QL Scene

EEC Impressed by Bristol

"The most successful QL show for some years", was the way Bill Richardson described the Quanta Bristol subgroup meeting at Wavendon on 29 November, and it appears that all the other traders felt the same.

QL system expansion and emulation seemed to be the main topics, and all the individual and company presentations were very well attended.

Attending the Bristol show for the first time, Jurgen Falkenburg spoke at length not only about the PC "Keyboard 90" interface which has been selling successfully through EEC for two years, but also about QL hard disk system up to 416 megabytes and peripherals such as hard disk interfaces, controller cards and bus expanders to carry them and also your Gold Cards. EEC are also selling

these in the UK, keeping costs down by endeavouring to standardise on a 40MB MFM 5.25 NEC drive and an 80 MB MFM Microscience unit, but other combinations using MFM and RLL hard disks can be obtained and supplied as separate items or as complete kits.

For a leaflet on the JFC (Falkenburg) hard disk systems, contact EEC at the address below. Users seriously contemplating a purchase should ask Bill if he can get them a copy of the technical literature.

Bill has also asked QL World to pass on his apologies for the fact that they advertised Goldstar monitors in last month's QL World which they have been unable to supply. EEC is working on the acquisition of an equivalent, QL-compatible colour monitor to offer as an alternative.

The story goes that the new batch of monitors that EEC thought they had their mitts on turned out to have been sold to Russia, now desperate for computer equipment. This is not the first time, says Bill, that their buying plans have been thwarted by the volatile overseas market - they were also pipped at the post for a batch of printers bearing the precious cyrillic font not long ago.

It would be nice to think that the monitors were going to Russian QL users who had heard about the Goldstar's QL adaptability.

Contact **EEC (W N Richardson & Co) at 18-21 Misbourne House, Chiltern Hill, Chalfont St Peter, Bucks SL9 9UE. Tel. 0753 888866.**

EXTRA EXTRA Reconditioned Philips CM073 14" monitors in now!

QSpread upgrade, QVME Card from Merz

Jochen Merz's *QSpread*, now in version 1.08 as announced in last month's *QL Scene*, is available as an update to current users who return their master disk and two International Reply Coupons. *QSpread* now has relative and absolute cell references, echo function, GOTO a cell, improved filename selection, multi-letter columns, Pi as a constant with rounding to a given number of decimal places, and other improvements.

Merz's QL Emulator/QVME card for the Mega STE is being shipped to customers. Tests have given a resolution of 1280 x 720 pixels on a 17-inch monitor. The resolution varies with the quality of the monitor - a multisync monitor is recommended, but not obligatory. Programs which run under the Pointer Environment and programs

running under the Extended Mode emulator have been shown to run on the QVME, including Perfection and text87. (Text87 also uses the larger screen size), plus the Pision Four software.

The QVME card plugs into any Mega STE without soldering. It also provides a monochrome screen driver which can be used under TOS, allowing screen sizes up to 1024 x 880 pixels (Calamus displays a full A4 page) where a suitably large monitor is in use. However, 14-inch multisyncs give about 800 x 500 pixels in both Qdos and Tos modes.

Merz are no longer advertising in pounds sterling - to avoid having to overcompensate for possible currency fluctuations, prices will be quoted in DM and customers in other currency areas can pay at the current conversion rate (allowing for postage, of course). Some Merz merchandise can be bought directly in the UK through other dealers.

**Jochen Merz
Software, Im Stillen
Winkel 12, D-4100
Duisburg 11, Germany.
Tel. (international) 010
49 2035 01 274.**

All Formats Diary

Coming dates for the All Formats Computer Fair are:

Feb 6 London Novotel, Hammersmith (by Hammersmith underground station, various lines); Feb 7 Wales University Union, Park Place, Cardiff; Feb 13 London Sandown Park, Esher, Surrey, M25 junctions 9 and 10; Feb 14 West Midlands National Motorcycle Museum, M42 junction 6; Feb 20: Haydock Park Racecourse, M6 junction 23; Feb 21 Scotland City Hall, Candleriggs, Glasgow; 27 Hemel Hempstead Dacorum Pavilion, The Marlowes Centre; 28 Feb western Brunel Centre, Templemeads Station, Bristol. Mar 7 North University Sports Centre, Calverley Rd., Leeds Mar 20 London Sandown Park Mar 21 West Midlands National Motorcycle Museum 25 Mar West Brunel Centre, Templemeads, Bristol.

Check with any particular supplier that you are hoping to see whether they will be at a particular Fair. Many QL suppliers only attend the Scotland and London fairs with any regularity. In London the Hammersmith venue is preferred. EXTRA EXTRA! Entrance only £2 between 2 and 4 pm in future!

Quasar from Germany

Sinclair QL User Club eV in Germany have sent QL World some copies of their quarterly journal *Quasar*. *Quasar* is a substantial A4, card-covered journal, with clean print, and running ambitiously to maps, and portraits photocopied from original photographs - inexpensive but in many cases surprisingly recognisable! The September issue at 38 pages is a little thinner than the earlier issues in 1992, as befits the usual summer slump in spare-time computer activity!

SQLUC eV can be contacted at **Grüner Weg 25, 5202 Hennef 1, Germany. Tel. (local) 02242 81666.** Individual issues of *Quasar* are priced DM 5, £2 sterling, US\$3.50, BeF 105, or 20 French francs.

DJC - NO PROBLEM!

Dilwyn Jones of DJC has been in touch to tell us that rumours of their demise (not, of course, promulgated by *QL World*) have been not so much exaggerated as confabulated:

"Stories have been circulating that DJC has closed down or been sold or (even worse) gone bust. This is not the case, as time will prove. DJC has not closed or been sold or gone bust and is alive and kicking and looking forward to an excellent year for QL users in 1993. Best wishes to all our customers and readers."

Says Dilwyn. Further, DJC's new 24-page catalogue (one of the things that has been occupying Dilwyn's attention recently) is available free on request in the UK (free with orders to overseas customers, or send one International Reply Coupon if you want just the catalogue). As well as their software list, it contains a list of other QL suppliers, services and publications, and answers to several commonly-asked questions like: What is a Pointer Environment? And explains why you may have to trust DJC's answering machine if you can't get through to him immediately. (In a nutshell, because he is juggling work and a new baby.)

Contact **Dilwyn Jones Computing at 41 Bro Emrys, Tal-y-bont, Bangor, Gwynedd, LL57 3YT, UK. Tel. 0248 354023.** Please avoid calling very early or late, as the phone still rings even when the answering machine is on!

Erratum

Rich Mellor has sent a correction to the PD Font Editor (October 1992): line 30 should read:

30 POKE a+1.0 (number of characters being defined less one!!)

Miracle's Wanderings

Miracle Systems will be attending the QL fair in Bologna on 24 January, and the one in Eindhoven, run by Marco Holmer, on 27 February. We don't have much more in the way of details at present.

Ergon Emulator Advances

Ergon Developments' ZM-X Sinclair Spectrum emulator system for the QL (ZM-2 emulator and ZM-3 pseudo-compiler) is now into version 3.30-0.78/3.30-0.42. What this means (apart from a trend towards ever more memory-intensive version numbers) is that the system now has improved compatibility and other updates. These include more supervision options such as a Z80 monitor facilities (dis/dump, trace, alter regs, breakpoint, watchpoint, poke); border and true sound emulation; new multi-key keyboard mode; and direct exchange of data with ZX Interface 1. Disciple, Plus-D and Opus Discovery disk conversion utilities are now available. Upgrades are free to users sending back their

original disk. To receive the new 40-page manual, send 8000 Italian lire or 10 International Reply Coupons in addition. The ZM-X system costs £35.

Open World now costs £19, along with two free utilities (by the same author) on a PC-formatted disk. One of these imports QL screens into a PC (they can be saved as GIF files) and the other to read QL disks on MS-DOS 5.0, a Unix workstation, Sun Sparcstation, etc. Write to Ergon for more details.

Ergon's QL Library Manager is now £19.

Ergon Developments (Davide Santachiara), Via Emilio de Marchi 2, 42100 Reggion Emilia, Italy. Phone (international) +39 342 492323,

Maastricht joins SJPD

SJPD Software have added the following popular programs to their public domain lists:

C68 3.05 on five disks; *Micro Emacs 3.11* on two disks; an Amateur Radio Disk, including a suite of packet radio programs; and Education Disk; Lyapunov Space, a mandelbrot program; the Maastricht Treat Text Files; and last but not least, the QL World art competition winner of 1988, the *Turning Head Demo* by Mark J Swift (now putting his talents to use writing emulator software for the QL).

For lists and prices, contact **Steve Johnson, SJPD, 36 Eldwick St., Burnley, Lancs BB10 3DZ.** Help him by writing rather than phoning to order lists.

File-linking Fleet Tactics

Di-Ren's large QL sea-battle game, *Fleet Tactical Command*, has now been released in a PC version after it's successful move to a version 2 last year. Di-Ren's recent new release *Fileserver* - a program designed to allow QL the QL's processor to link directly to a PC and its peripherals - mean that the game can now be played between linked QLs and PCs. Di-Ren are offering specific QL, PC or combined QL/PC packages of *Fleet Tactical Command*.

QL World understands that QL/PC *Fileserver* is on the market, but, upholding the tradition of first releases, a minor problem is being sorted out as we write. Di-ren have already issued QL World with an update.

Information about *Fleet Tactical Command* can be obtained from Di-Ren, and information on *Fileserver* can be had from Di-Ren or from Dilwyn Jones. Linking cables for QLs and PCs can be obtained from Tony Firshman at TF Services.

Di-Ren, 43 David's Road, Forest Hill, London SE23 3EP. Tel. 081 291 3751.

QL Scene

Machine Code Scrambled

In part 10 of Systematic Machine Code, parts of listings 5 and 6 were scrambled during repro. If anyone needs copies of these, please write to the Editor.

Athens Club

Dear Sir,
We are not many but we are fanatic QL users from Athens, Greece, and we have the same problem as other lonely QL users in the world, without any support except Sinclair QL World. So we decided to create a Sinclair QL Club, and we appeal to Greek QL users and members to contact the following address: Stathis Grigoriadis, QL Athens Club, Tarsu 6-8, 10440 Athens, Greece. Tel. (local) 01/8814652. Bitnet address: SINCLAIR@GRATHUN1.

Time for Action!
Simon Goodwin's
new series presents
useful QL
SuperBasic
programs.

SuperBasic

in Action

NEW SERIES

Reliable, adaptable programs can be written in the SuperBASIC language built in to the QL. It makes appropriate use of well-known Toolkit commands, noting alternatives and compiler options along the way.

File recovery

First up is Revive, a SuperBasic program to recover files from damaged disks. Revive has several excellent features. It is very simple to use, with just two options - one to map out the bad disk, and another to recover data. In future issues I shall premiere Psion accessories, format converters, and other goodies suggested by readers.

Revive takes non-standard disk formats in its stride. As well as the normal 1:3 double-sided interleave, it recognises the single sided variation used by Amiga Qdos, and the 1:1 interleaved 'Fast Format' from *DIY Toolkit* volume D, (*QL World* November 1990). To teach Revive, just present it with a good disk in the new format.

Revive needs a system that allows direct sector access with names like "FLP1_*D2D"; a printer is useful but not essential. Most QL disk systems fit the bill, including CST, Cumana, Medic, Miracle and PCML interfaces. MCS and Microperipherals disk users may need to upgrade to a later rom to allow direct sector access.

For best results you need a second drive - MDV can be used, but FLP2 or RAM is preferable - and a simple text editor. *Micro Emacs*, or the demo version of *spy* in the Quanta library are fine; alternatively you can use *QED*, from TF Services bulletin board or other PD sources, or commercial editors like

```

100 REMark REVIVE - SuperBASIC in Action disk data recovery program - ©SNG
110 IMPLICIT% black,white,red,green,index,temp,first,last,top_limit,reason
120 IMPLICIT% stepping_offset,block_size,tracks,cylinder_size,track_size
130 IMPLICIT% total_blocks,block_bytes,block_no,xlator,name_length
140 IMPLICIT% sector_no,track,offset,sector_side,c
150 DATA AREA 8
410 :
420 DIM sector$(512),k$(10),dname$(10),file$(44)
430 dname$="FLP1_*D2D" : top_limit=191
440 black=0 : red=2 : green=4 : white=7
450 INK #0,white : PAPER #0,black : CSIZE #0,1,0
460 PAPER black : INK white
470 MODE 4 : CLS #0
480 REPEAT startup_loop
490   RETRY_HERE
500   HEADING
510   INK green
520   PRINT "\          This program will not attempt to write to ";dname$;
530   PRINT " but it is "\          good practice to write-protect all ";
540   PRINT "disks used in that drive." : INK white
550   PRINT
560   PRINT "Please put a good disk of the same format as the faulty one"
570   INPUT "in ";(dname$);" then press ENTER, or Q to Quit ";k$
580   IF k$=="Q" : EXIT startup_loop
590   IF LEN(k$)=9 : dname$=k$
600   OPEN_IN #3,dname$
610   PRINT
620   :
630   REMark Read format-dependent information
640   GET #3\1 : sector$=INPUT$(#3,512)
650   IF sector$(1 TO 4)<>"QL5A"
660     COMPLAIN "Disk is not in QL format." : NEXT startup_loop
670   END IF
680   stepping_offset=STRING$(sector$(39 TO 40))
690   block_size   =STRING$(sector$(33 TO 34))
700   tracks       =STRING$(sector$(31 TO 32))
710   cylinder_size=STRING$(sector$(29 TO 30))
720   track_size   =STRING$(sector$(27 TO 28))
730   total_blocks =STRING$(sector$(25 TO 26)) DIV block_size
740   block_bytes  =block_size * 512
750   DIM xlator(cylinder_size-1),block$(block_bytes)
760   :
770   INK green : PRINT "          ";
780   IF track_size=block_size : PRINT "Singl"; : ELSE PRINT "Doubl";
790   PRINT "e sided disk, ";tracks;" tracks with ";
800   PRINT cylinder_size;" sectors of 512 bytes each."
810   PRINT "          Disk space is divided into ";total_blocks;
820   PRINT " blocks of ";block_bytes;" bytes each."
830   PRINT
840   INK white
850   :
860   REMark Read logical to physical translation data
870   FOR index=0 TO cylinder_size-1
880     temp=CODE(sector$(41+index))
890     IF temp>127 : temp=temp+128 : REMark Weight for SIDE 1 = 256
900     xlator(index)=temp
910   END FOR index
920   :
930   PRINT "Please replace the faulty disk for file recovery."
940   INPUT "Enter S to Scan disk, R to Recover data or Q to Quit ";k$
950   IF k$=="S" : SCAN_DISK
960   IF k$=="R" : RECOVER_FILE
970   IF k$=="Q" : EXIT startup_loop
980 END REPEAT startup_loop
990 INK green
1000 PRINT "\Data recovery program finished."
1010 STOP
1020 :
1030 :
1040 :
1050 :
1060 :
1070 :
1080 :
1090 :
1100 :
1110 :
1120 :
1130 :
1140 :
1150 :
1160 :
1170 :
1180 :
1190 :
1200 :
1210 :
1220 :
1230 :
1240 :
1250 :
1260 :
1270 :
1280 :
1290 :
1300 :
1310 :
1320 :
1330 :
1340 :
1350 :
1360 :
1370 :
1380 :
1390 :
1400 :
1410 :
1420 :
1430 :
1440 :
1450 :
1460 :
1470 :
1480 :
1490 :
1500 :
1510 :
1520 :
1530 :
1540 :
1550 :
1560 :
1570 :
1580 DEFINE PROCEDURE TRUE_SECTOR(sector_no)
1590 track = sector_no DIV cylinder_size
1600 offset = track * stepping_offset
1610 sector = sector_no MOD cylinder_size
1620 side = xlator(sector) && 256
1630 sector = ((xlator(sector) && 127) + offset) MOD track_size
1640 REMark PRINT "Logical sector: ";sector_no;
1650 REMark PRINT " is physical track ";track;

```



```

1660 REMark PRINT " side ";side<>0;" sector ";sector
1670 GET #3\track*65536+side+sector+1 : sector$=INPUT$(#3,512)
1680 REMark PRINT #0,sector$
1690 END DEFine
1700 :
1710 DEFine PROCEDURE GET_BLOCK(block_no)
1720 LOCAL index,read_ok
1730 block$="" : read_ok=1
1740 FOR index=block_no * block_size TO (block_no + 1) * block_size - 1
1750   RETRY_HERE
1760   IF read_ok
1770     TRUE_SECTOR index
1780     block$ = block$ & sector$
1790   ELSE block$=FILL$("X",block_size) : EXIT index
1800   END IF
1810 END FOR index
1820 REMark PRINT "Block ";block_no\block$
1830 END DEFine
1840 :
1850 DEFine PROCEDURE COMPLAIN(moan$)
1860 IF LEN(moan$)<>0 : PAPER #0,red :CLS #0 : PRINT #0;" ";moan$
1870 INPUT #0,\,,"Press ENTER to continue ";k$
1880 PAPER #0,black : CLS #0
1890 END DEFine
1900 :
2390 DEFine PROCEDURE HEADING
2400 CLS : CSIZE 2,0 : INK green,white
2410 PRINT "QL disk data recovery program v 1.04,"
2420 PRINT " Copyright 1992 Simon N Goodwin."
2430 CSIZE 0,0
2440 END DEFine
2450 :
2460 DEFine FuNction STRING%(a$)
2470 LOCAL c
2480 c=CODE(a$)
2490 SElect ON c
2500   =128 : RETurn CODE(a$(2))-32768
2510   =129 TO 255: RETurn CODE(a$(2))-256*(256-CODE(a$))
2520   =REMAINDER : RETurn CODE(a$)*256+CODE(a$(2))
2530 END SElect
2540 END DEFine STRING%

```

Devpac, The Editor, QD, S_EDIT or ED.

Disk faults

Versions of QFLP up to 1.14 have a nasty bug which renders the first track of the disk unreadable after a zero-length file was generated. The bug was fixed in version 1.15, but not before it inspired the development of Revive a simple but powerful utility that can recover files from damaged disks, even when the directory is unreadable.

QL file recovery is easy enough if you can still see the file name in the directory - just copy the file to a new disk, and re-format the original once you have recovered as much as possible. If the disk directory is intact, you should find that most of the files can still be read, although a few bad sectors may stop you part-way through a file with a 'read/write' error.

Revive can be used to recover the later part of such a

file, by skipping over the bad blocks. But Revive is most useful when a disk fails to respond to DIR. Revive has only two options, which do all I have ever found necessary.

One option maps out the disk, showing file locations and bad tracks and sectors, while the other scoops up the data you need. IF QFLP can find the program or data - or even part of it - Revive will bring it back.

Revive

The program is presented in two parts. The first chunk, listed this month, reads the header from a disk that still works, in the same format as the faulty disk. It examines the format details in the first sector - side 0, track 0, sector 1 - and deduces the number of tracks, sides, and disk interleave.

Most QL disks have eighty concentric tracks, split into sectors on each side. When a double-density disk drive is running, sectors are passing

under the disk head at 22.5K per second, rising to 45K or 100K each second if you're lucky enough to have HD or ED drives. To give the program some time to process the data, the QL applies a configurable 'interleave'.

It is difficult to trek your way through a QL disk with a sector editor, because QL sectors are allocated in staggered order. The most common 720K format starts with sectors 1, 4 and 7 on side 0, then the same three sectors on side 1, followed by 2, 5, and 8 on each side in turn, with 3, 6, and 9 used last.

If that's not complicated enough, the sequence changes on the next track, where sectors 2, 5 and 8 are used first, and 1, 4, and 7 last. On track 2, the story is different again...

All this scrambling is too much trouble for a human, and it changes for single-sided, Amiga and various 'fast format' disks! Revive makes life simple by automatically working out the sector

numbers for each of 480 blocks on the disk, so you can work with 1.5K blocks in order of allocation, rather than scrambled sectors of 512 bytes. Block 0 holds the format information and 'disk map', usually followed by the directory later in track 0, though it can grow elsewhere too.

Decodes

The TRUE_SECTOR procedure listed here decodes the interleave. It converts a logical sector number from 0 to 1439 (or more) into physical side, track and sector numbers. The map and format details are explained in much more detail in DISKMAP_DOC, part of DIY Toolkit's Volume D for Disks.

Revive reports the start and end of each block so you can spot breaks and match up the end of one block with the start of another. This is easy enough for text, but may be difficult or impossible for code files.

Luckily most disks fill fairly steadily so breaks in files are rare. In any case you only need to match the sections of the files you need to recover, and small files (under 1473 bytes) are never fragmented, so recovery is automatic most of the time. You just scan the disk, look through the report for the files you want, and read off the relevant blocks to a RAM disk. Revive is much faster and more reliable than re-typing your data from scratch!

Next month *SuperBasic in Action* will conclude the listing for Revive, with the complete listings for the TRUE_SECTOR, SCAN_DISK and RECOVER_FILE procedures, conversion notes, and a demonstration of Turbo task error-trapping. I shall also explain the new formats of HD and ED disks.

Are you a SuperBasic user? Do you want to be? Do you think you will find Superbasic In Action (intermediate SuperBasic) helpful? Do you have any alternative requests? Write to **The Editor, QL World, Arcwind Publications, The Blue Barn, Tew Lane, Wootton, Oxon OX7 1HA.**

MIRACLE

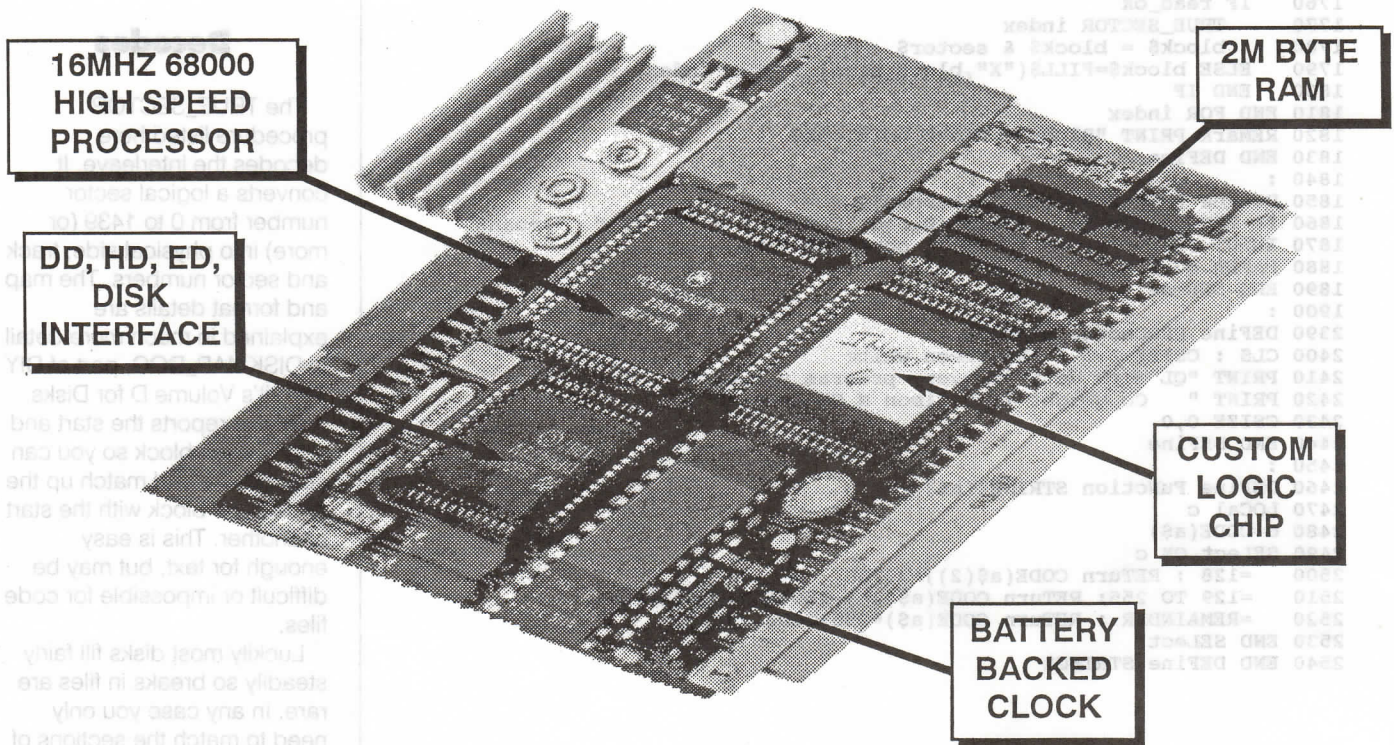

QL GOLD CARD

£225 inc. (£200 export)

This is the expansion that has been revolutionising the QL. It is very easy to fit - it simply plugs into the expansion port at the left hand of the QL - and once fitted it will instantly increase the execution speed of the QL by about 4 times due to the presence of a 16MHz 68000 on board. There is 2M of fast 16 bit RAM of which QDOS sees a contiguous 1920K. The remainder is used for shadowing the QL's ROM and display memory and for the GOLD CARD's own code.

There is a disk interface which can access 3 mechanisms (4 with the DISK ADAPTER) of 3 different densities, DD (double density, 720K), HD (high density, 1.44M) and ED (extra high density, 3.2M) in any mix. The disk interface connector is the same type that was fitted to the TRUMP CARD so most QL compatible disk drives can be used. Please note that DD drives still give a capacity of 720K per diskette. Our DUAL ED DISK DRIVE allows the GOLD CARD to access DD, HD and ED diskettes.

Another feature is the battery backed clock. When the QL is switched on the contents of the clock are copied into the QL's clock so that the time and date are correct. The firmware in the ROM gives the GOLD CARD all the functionality of the TRUMP CARD like TOOLKIT II and there is a sub-directory system for floppy and RAM disks.

Physically the GOLD CARD is about half the size of the TRUMP CARD and so fits almost all within the QL. Its current consumption is well under the allowable maximum so no special power supply is required. The GOLD CARD comes with a 14 day money back guarantee and a 2 year warranty.

SYSTEMS

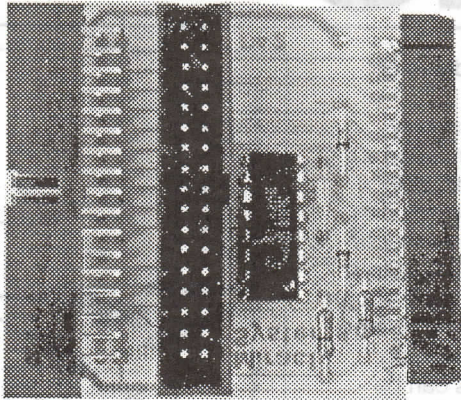

DISK ADAPTER £15 inc. (£15 export)

Plugs into TRUMP CARD or GOLD CARD to allow access to 2 dual disk drives (i.e. 4 mechanisms) as FLP1_, FLP2_, FLP3_, FLP4_.

BOX OF 10 ED DISKETTES £30 inc. (£30 export)

Ten 3.5" ED diskettes. Gives capacity of 3.2 MBytes when used with GOLD CARD and DUAL ED DISK DRIVE.

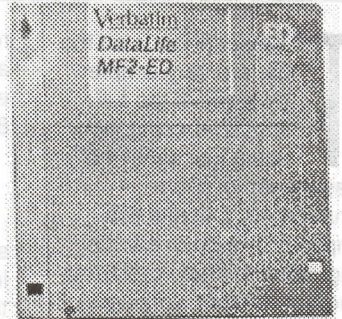

QL CENTRONICS £25 inc. (£25 export)

Connects SER1/SER2 to Centronics parallel printer. 3 metre cable included. (D9 serial plug option for German and American QL available.)

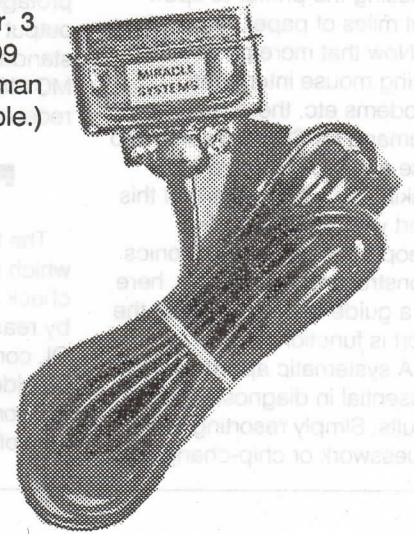

DUAL ED DISK DRIVE £175 inc. (£155 export)

Two 3.5" ED mechanisms, power supply and cables. Connects with GOLD CARD to read/write/format DD/HD/ED diskettes. Includes 10 ED diskettes.



Tel: (0904) 423986

To place an order by phone please have your credit card ready. For overseas customers we charge the prices shown in brackets.

To order by post, please fill in the form opposite or write to us quoting your credit card number and expiry date, or enclosing a cheque payable to MIRACLE SYSTEMS Ltd.

To: MIRACLE SYSTEMS Ltd, 25 Broughton Way, Osbaldwick, York, YO1 3BG, U.K. Tel: (0904) 423986

Please send me _____

I enclose a cheque to the value of: £ _____

Or debit credit card

Expires /

Name _____ Signature _____

Address _____

**For constructors -
Dennis Briggs'
guide to
checking-out QL
serial ports.**

QL SERIAL PORTS

The serial ports on the QL are very simple versions of the full RS232 specification, using just six of the possible ten-or-more connections. Despite this simplicity, the ports can be plagued with many problems ranging from not working at all, to producing bits of garbage among the output data. This becomes very evident when the data is directed to a printer, as totally unpredictable results ensue. One example just left out the odd character, while another sent out form feeds willy-nilly, causing the printer to spew out miles of paper.

Now that more people are using mouse interfaces, modems etc. there is more demand for SER2 to come into use and more people are asking how to ensure that this port works properly. For people with some electronics constructing experience, here is a guide to checking that the port is functional.

A systematic approach is essential in diagnosing the faults. Simply resorting to guesswork or chip-changing is

receiver ships are soldered in, and also that soldering is essential in replacement of the 8302 ULA.

Oscilloscope

It may be possible to work solely with a logic probe and intuition, but the easiest, albeit the most expensive, way to pinpoint problems is by using an oscilloscope.

A total of six integrated circuits are involved in this part of the QL, if you include the two small voltage regulators. The 8302 ULA, along with the 8049 co-processor, are the main protagonists with the input and output suitable handled by the standard MC1488 and MC1489 line driver and receiver.

Power supply

The first vital step, and one which is often overlooked, is to check to the QL power supply by reading the voltage at the QL connection. This has to provide 15 volts ac as well as the nominal 9 volts, a point very often overlooked when a

soldering and bridging of connections.

With the power supply connected to mains, pop a small 12-volt, 3-watt bulb across the two relevant pins (the centre pin and either of the outer ones) of the output connector of the power supply to make sure that the voltage does not drop on loading. Misleading results can be obtained if a one-off reading is made with a digital voltmeter. This is due to the presence of a thermal fuse in each of the two supply lines, to protect against a possible fire hazard. On occasions I have had an open circuit voltage reading appearing to be about right with the fuse blown. I can only

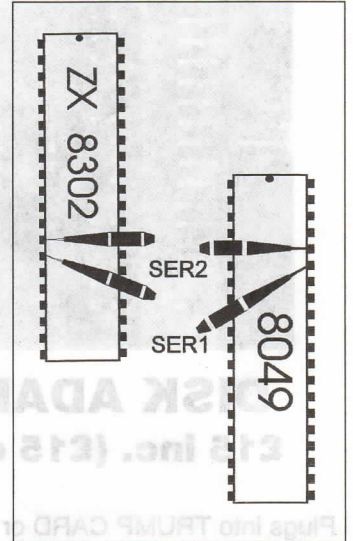

On the ZX8302, SER1 is on pin 13 and SER2 is on pin 14. On the 8049, they are on pins 35 and 36 respectively.

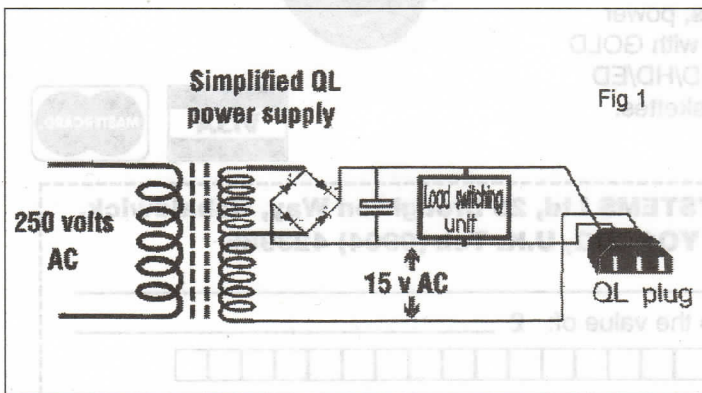
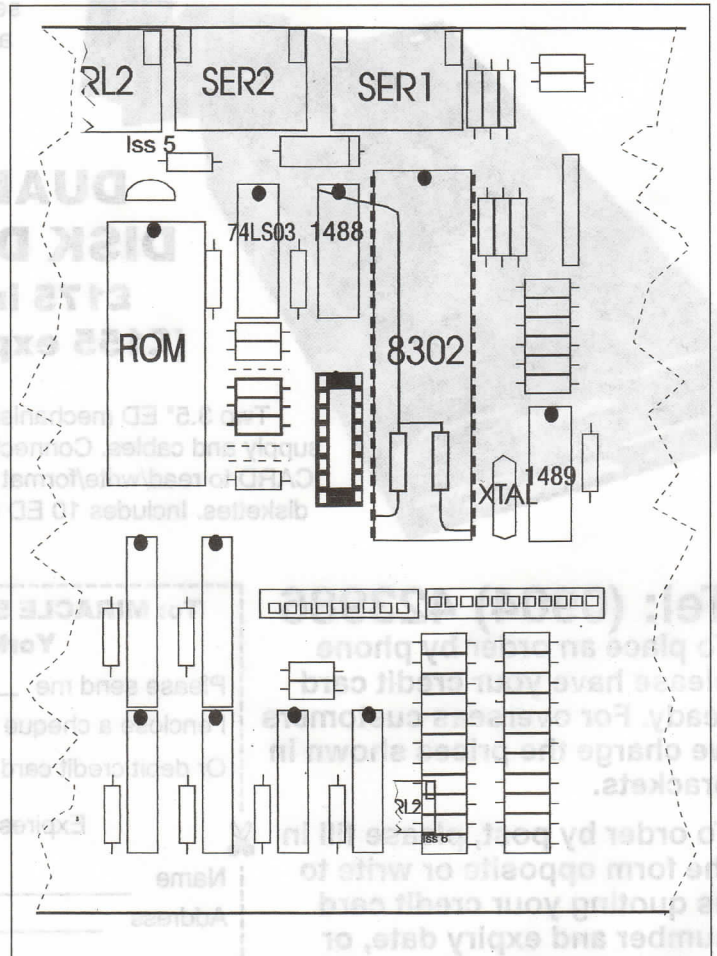

Diagram of the QL power supply. Measure across the centre and one outer pin of the output connector.

guaranteed to be a long and painful process probably ending in failure. Bear in mind that the RS232 driver and

replacement unit is being proposed. CST overcame the problem on the QL-based Thor with some devious



The layout of part of the QL's interior, showing some of the main chips, with the optional pulldown resistors in place.

assume that the fuse debris is sufficiently conductive to produce an indication.

Inside the QL

Carry on checking the voltages at the input of the QL to the two tiny regulators. One is situated behind the reset switch while the other is under the main heat sink. While the multimeter is in your hand, have a look at the inductor in the supply line. It is situated next to the 7912L. It has an appearance similar to a resistor but has a green body. If the line is overloaded then the 7912L should shut down but occasionally goes short circuit with the inductor following suit. The resultant blow-hole is usually underneath. Check for a voltage drop across it, or almost zero resistance.

With the input voltage confirmed, check the output voltage from each regulator. The 7812L regulator does on occasions run hot, causing it to shut down, cool off and start up again. Issue 6 boards were fitted with a slightly larger NEC version to overcome this problem. Unfortunately I cannot locate this particular device in any of the major electronics catalogues.

Have a look at the markings on the co-processor. It should be marked V 0.7 of Philips or NCR manufacture. It is possibly one of several other types, but at this point in the diagnostic stage it is much easier to pinpoint problems with the original-specification ICs in place. When you have located the fault, then by all means experiment with other improved versions. If, however, the machine then fails with the super chips installed, they are not all that much of an improvement. (Master of the understatement, our Dennis.)

Two ports

With the voltages correct, connect the two ports together with a suitable cable. For goodness' sake do not hack about with Telecom plugs, as the correct PCC ones are just as cheap.

A stage comes when the

voltages are correct but the problem is still present. Disconnect the computer and remove the 8302 chip. Inspect the pins on the 8302. The tarnish on the legs is a result of trying to cure a hardware problem with a squirt of juice. But never mind the history lesson. Just clean the legs very gently with a pcb cleaner block, abrasive pencil, or other fine abrasive. Blow or brush any swarf off the pins before you replace the chip.

```

10 CLS
20 OPEN#3,SER1
30 OPEN#4,SER2
40 REP LOOP
50 FOR A=0 TO 255
60 PRINT#3,CHR$(A);
70 PRINT INKEY$(#4.);
80 END FOR A
90 END REP LOOP
    
```

The Basic program for sending data.

Here I will get cries from the armchair experts about static, wrist straps, leg irons, etc. Quite right, but the fact is that if you have something which is not functioning you may as well attempt a cure as it cannot make it any worse. (Erm. May we expand on that, Dennis? What Dennis means is, cleaning the legs of the IC is a standard cure for non-

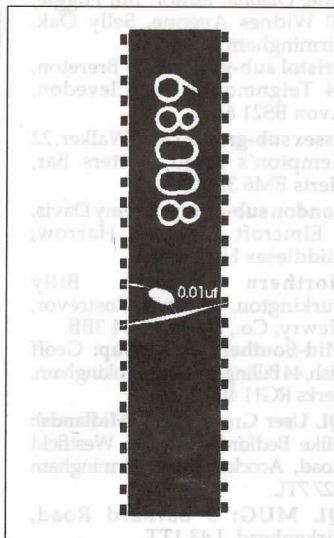

The .01µF capacitor shown is included in some models, or can be added

conduction problems, and worrying about static won't get the problem solved. In general, however, messing with something you don't understand because it isn't running right will often make the problem worse. If in doubt, ask Dennis if he can fix it for a competitive quote. For some DIY static precautions, see the box below.)

Data flow

Once this is done, power up again and use a small Basic program to send data in both directions from one port to the other. Look at the results on the screen very carefully making absolutely sure that the characters displayed are correct. The carriage returns must be directly under each other; also, there must not be any apparent stuttering in the display. Break out of the Basic program for it to display the line number it has stopped at. This will indicate whether the data output or input has failed. Pop a PAUSE between each line and run it again.

Monitor pin 35 of the 8049 with a scope for activity when a channel is opened to SER1; similarly pin 36 for SER2. Follow the signal in at pin 9 and 10 of the MC1488, coming out on pin 8. Data is sent out by the 8302 on pin 13 for SER1, and pin 14 for SER2 via the MC1488. The Basic program will hang at line 60 if there are problems in this area. If it hangs at line 70, then check the appropriate input and output pins on IC26 MC1489.

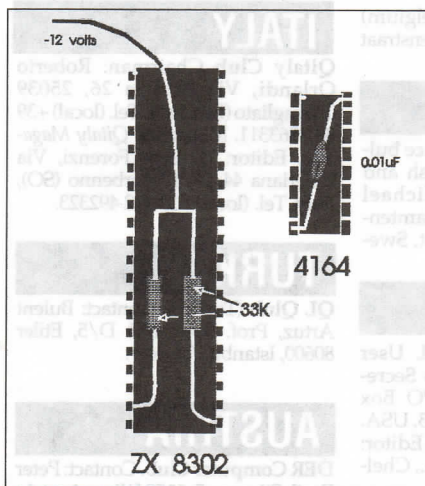

The 33K resistors and .05µF capacitor are in place on later boards. If not they can be added if wished.

When changing or replacing the 8302 solder pulldown resistors are best soldered in the position shown. Some 8302s may appear to work without them, but the smooth flow of data when they are fitted can be clearly seen on the screen.

Scraping by

Some items of RS232 equipment are powered from the port. The maximum current that can be drawn is only 30 milliamps. This is barely sufficient for some of the serial to parallel printer interfaces which have appeared for the QL in the past, but provided the unit is OK they do work. If you are using one of these units then plug it into both the QL and your printer to make sure finally that every part is functional.

Replacement of the soldered-in RS232 line driver chips is a fiddly process. During manufacture, all the legs are cropped and bent over. Removing these risks damage to the board, and replacing the board is much more expensive than replacing the chip! The method I use is to cut all the legs close to the chip, turn the board over, suck out the solder from underneath, and remove each discarded leg individually.

IC sockets can be fitted when you put in the new chip - much more convenient, unless you have a mouse board interface in use. The lack of clearance with this device means that the line driver ships

must be soldered in place. For those who want to overcome this and are prepared to give it a bit of thought, then the mouse interface board can be cut in two carefully (preferably after its out of warranty) and the connections to the rom socket hard-wired. This approach to what is a major problem to plug-and-go people can be overcome with a few dabs of solder, but definitely don't try it unless you are clear about what you are doing.

Static!

Everyone knows that static electricity can damage certain electrical components if they are handled without static-draining precautions. Dennis assures us that QL chips can take rough handling, but if you are the cautious type and don't have an antistat strap, here are some rough-and-ready precautions which will reduce the chances of static damage:

Don't walk or shuffle while working on a component - sit still. Movement generates a static electrical field. Don't work in a nylon shirt or other synthetic clothing, which generate static freely. Nylon carpets are another culprit. Dry air encourages static, so on a dry day (especially a cold, dry one) when your door-knobs, hifi casing or cat are giving off sparks - leave electronic investigations for another, damper, day.

It is possible for static to damage a semiconductor component that then fails gradually, partially, or long after the event. Static damage, however, does not occur while components are soldered to a circuit board.

Never attempt to handle electrical equipment which is powered up or connected to the mains or a power supply. The QL is a low-power device, but there is always a risk of mains shock if something malfunctions. If using scope or meter probes on a powered-up device, be careful not to short anything. Don't open, handle or use probes on a mains-potential device like a power supply while it is connected. Be aware that some transformers and large capacitors can give a painful shock well after the power supply is disconnected, because of stored charge.

While QL World makes every effort to achieve accurate information, the staff and publishers accept no responsibility for loss, damage or injury resulting from published material. There is always an element of risk when working with electrical equipment - if in doubt, seek the assistance of a competent person.

QUANTA



Independent QL/Thor Users Group

Worldwide Membership is by subscription only, and offers the following benefits:

Monthly Newsletter - up to 40 pages

Massive Software Library - mostly FREE!

Free Helpline and Workshops

Regional Sub-Groups. One near you?

Advice on Software & Hardware problems

Discounts from most major suppliers

Subscription just £14 for UK members

Overseas subscription £17

Barclaycard: Visa: Access: Mastercard

* Now in our NINTH successful year *

Further details from the Membership Secretary

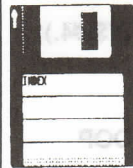

Bill Newell
213 Manor Road
Benfleet
Essex. SS7 4JD
Tel (0268) 754 407



CLUB

FRANCE

QL Contact France. Contact: Jean-Louis Dianoux, 38-40 Rue Stephenson, 75018 Paris, France.

BELGIUM

Club Sinclair BruQsL (Belgium) Contact: Jaques Tasset, Aarlenstraat 104, 1040 Brussels, Belgium

SWEDEN

International QL Conference bulletin board system (Swedish and English). Contact: Michael Cronsten, System Operator, Jamten-TCL, S Soere 1073, 83030 Lit, Sweden.

USA

New England Sinclair QL User Group (USA) Membership Secretary: Sherm Waterman, PO Box 8763, Boston, MA 02114 8763, USA. Magazine: *NESQLUG News*. Editor: Peter Hale, 195 Central Ave., Chelsea, MA 02150, USA.

NORWAY

Norwegian All Sinclair Association (NASA) Contact: P Monstad, NASA, N-5580 Oelen, Norway. Magazine: *Sinclair Magazine*.

ITALY

Qitaly Club Chairman: Roberto Orlandi, Via Brescia 26, 25039 Travagliato (BS), Italy. Tel. (local) +39 30 6863311. Magazine: *Qitaly Magazine*. Editor: Dr Eros Forenzi, Via Valeriana 44, 23010 Berbenno (SO), Italy. Tel. (local) +39 342 492323.

TURKEY

QL Qlub (Turkey). Contact: Bulent Artuz, Prof. Sitesi B/1 D/5, Etiler 80600, Istanbul, Turkey.

AUSTRIA

DER Computer Club. Contact: Peter Postl, Stieberg 5, 1150 Wien, Austria

ENGLAND

Quanta (UK) Membership Secretary, Bill Newell, 213 Manor Road, Benfleet, Essex SS7 4JD. Magazine: *Quanta*. Editor: Bill Fuggle, 20 Widnes Avenue, Selly Oak, Birmingham B29 6QE.

Bristol sub-group: Roy Brereton, 94 Teignmouth Rd, Clevedon, Avon BS21 6DR.

Essex sub-group: Dave Walker, 22 Kempton's Mead, Potters Bar, Herts EM6 3HZ.

London sub-group: Jeremy Davis, 6 Elmcroft Crescent, Harrow, Middlesex HA2 6HN.

Northern Ireland: Billy Turkington, Fairyhill, Rostrevor, Newry, Co., Down BT34 3BB.

Mid-Southern sub-group: Geoff Fish, 44 Billing Avenue, Wokingham, Berks RG11 4JE.

QL User Group (West Midlands): Mike Bedford-White, 16 Westfield Road, Acocks Green, Birmingham B27 7TL.

QL MUG: 3 Barnard Road, Birkenhead, L43 1TT.

SCOTLAND

Scottish QL Users Group Contact: Alan Pemberton, 65 Lingerwood Rd., Newtongrange, Midlothian EH22 4QQ. Newsletter.

HOLLAND

Sin_QL_Air (Netherlands) Membership Secretary: Bob Visser, Snelrewaard 6, 2904 SN Capelle, a/d IJssel, Netherlands. Magazine: *Quasar*. Editor: C H M Biemans, Elzenstraat 5, 5461 CL Veghel, Netherlands.

GERMANY

Sinclair QL User Club eV (Germany) Foreign Contact: Franz Herrmann, Talstrasse 21, d-W5460 Ochenfels, West Germany. Magazine: *Quasar*.

SPAIN

Qliper Editor: Marcos Cruz, Acacias 44, (Monteclaro), E-28023 Pozuelo de Alarcon, Spain. Magazine: *Qliper*.

THE NEW USER GUIDE

KEYWORD INDEX

I This month in the Keyword Index, Mike Lloyd starts with *PARUSE(varname)* of Super Toolkit 2, and ends with *POSITION(#chan)* - via PI.

PARUSE(varname)

[Super Toolkit 2]

PARAMETER HANDLING FUNCTION

varname the "local" name given to a procedure's parameter

SuperBasic's flexibility with parameters and coercion is extremely welcome, but can occasionally cause a few identification difficulties that can be resolved by *PARTYP* and *PARUSE*. The latter function reveals what category of variable is represented by a given user-defined procedure or function parameter. One of three values is returned:

- 0 = null
- 1 = variable
- 2 = array

If the user-defined procedure "CENTRE" is called with a single parameter locally referred to as *TEXT* the following code within the procedure definition will reveal whether *CENTRE* has been called with an array or a normal variable or no parameter at all:

```
225 param_usage = PARUSE(text)
```

PAUSE value

PAUSE #chan

[Minerva only]

KEYBOARD CONTROL COMMAND

value (Optional) A floating point value
 #chan A valid input channel number

The *PAUSE* command simply postpones the execution of the next statement by a given amount of time expressed in fiftieths of a second. This assumes the UK's 50 Hz power supply. With a 60 Hz power supply a *PAUSE* value of 1 will delay the interpreter for one-sixtieth of a second. If a keypress is detected during a *PAUSE* the delay is abandoned immediately. If no parameter is given to the command then *PAUSE* will wait forever for a keypress to occur.

PAUSE is perhaps of most value within a loop containing *KEYROW* functions (the alternative *INKEY\$* has its own pausing mechanism and *INPUT* waits for an *ENTER* regardless). It is important to flush the keyboard buffer before a *PAUSE* because otherwise any keypresses stacked up in the buffer will terminate the *PAUSE* unintentionally. Use a dummy *KEYROW()* function call before the *PAUSE* command to achieve this.

Be warned that PAUSE will not work in compiled SuperBasic programs because they do not have the special #0 channel through which direct keyboard input is obtained. Minerva owners can provide PAUSE with a channel number that is listening out for a keypress. Turbo users can try using the COMMAND_LINE directive to overcome this problem, or more simply circumvent it by rewriting compiled programs to avoid PAUSE altogether.

PEEK(address)

PEEK_W(even_address)

PEEK_L(even_address)

[Minerva]

PEEK(location)

PEEK_W(location)

PEEK_L(location)

PEEK_F(even_address)

PEEK\$(address, bytes)

[Turbo Toolkit]

MEMORY HANDLING FUNCTIONS

address	A valid integer within the range of the memory capacity of your QL.
even_address	A valid even integer within the range of the memory capacity of your QL.
location	EITHER a valid integer
OR	an offset with the format "\\value"
OR	a vector and offset with the format "\\vector \format"
bytes	An integer representing the number of bytes to return.

SuperBasic programmers occasionally need directly to examine the contents of memory addresses, a task achieved by the PEEK family. The QL's memory comprises a huge number of addresses each containing an eight-bit (or one byte) value. If you know the address of a byte of memory, PEEK will return its contents. Because the QL's cpu can handle 16-bit and 32-bit values internally SuperBasic contains PEEK_W to return a 16-bit value and PEEK_L to return a 32-bit value. It is an unviolable convention that the first byte of a larger value begins at an even address, but it is up to the programmer to ensure that the argument passed to the function meets this requirement.

When memory contents are discussed a number of terms are used to describe the same type of value. The following table translates between alternatives:

4-bits	half-byte	1 nibble
8-bits	1 byte	1 byte
16-bits	2 bytes	1 word
32-bits	4 bytes	1 long word

Minerva owners are over-blessed with extensions to the functionality of the PEEK functions. Firstly, the restriction on using even addresses for words and long words is removed, which allows PEEK_W and PEEK_L to be used as fast methods of grabbing multi-byte values stored by a program anywhere in reserved memory. For programmers aware of the layout of the QL's system variables the other Minerva enhancements are extremely valuable because they provide a quick, foolproof method of reaching the appropriate offset from the base of the system variables area. The $x = \text{PEEK_W}(x \ y)$ expression accesses the offset from the offset! For instance, the location of the Qdos channel table is stored as a long word beginning at the 48th byte from the start of the system table. Each entry in the channel table is 40 bytes long, so $\text{PEEK_L}(\backslash 48 \ \backslash 40 * \text{chan})$ will return the required value. (Please note that Turbo Toolkit provides equivalent functionality with the BASIC() series of functions.)

The Turbo Toolkit team felt that SuperBasic's PEEK family were a little restrictive and added PEEK_F, which assumes that the address is the first byte of the location of a floating point number. All floating point numbers, no matter their decimal size, are held internally as 6-byte sequences: PEEK_F decodes the six bytes into their decimal equivalent (this happens whether or not a genuine floating point number has been stored at that location). Like other multi-byte PEEK functions, PEEK_F must be passed an even address value.

The PEEK\$ function, also available in the Turbo Toolkit, can be extremely valuable when moving chunks of memory around. PEEK\$ assigns the Ascii values of a declared portion of memory to a string variable. Thus a memory location holding the value 65 will be translated to an "A" in the string it is copied to. PEEK\$ can be used to sort, search for and retrieve fixed-length entries in a database managed in reserved memory rather than held in conventional variables. PEEK\$ can also be used to manipulate the screen map which begins at memory address 131072 and takes up the first 32K of RAM. Try the following:

```
100 FOR x = 131072 TO 137472 STEP 128
```



```

110 Line_of_Pixel$ = PEEK$(x, 128)
120 POKE$(x + 6400, Line_of_Pixel$)
130 END FOR x

```

PENDOWN #chan
PENUP #chan

TURTLE GRAPHICS DIRECTIVES

#chan (Optional) A valid screen channel

The QL's graphics cursor simultaneously responds to conventional graphics commands and to turtle graphics commands, which gives the QL programmer the luxury of being able to use whichever is most convenient for the task in hand. Turtle graphics make much of turning and moving specific distances, whereas conventional graphics rely on co-ordinates in the style of map references. PENDOWN ensures that the "turtle" will leave an ink-coloured traces during subsequent manoeuvres. PENDOWN followed by a MOVE command is the equivalent of a LINE x1, y1 TO x2, y2 command. PENUP is used to ensure that the "turtle" leaves no trace during subsequent MOVE commands, which can be replicated in conventional graphics commands by the LINE x1, x2 command (which simply relocates the graphics cursor at the given co-ordinates).

PI

TRIGONOMETRICAL FUNCTION/CONSTANT

PI is a system constant implemented as a function (hence the format PI() will not produce an error). Pi is the ratio between the diameter of a circle and its circumference, roughly 23/7. Pi is an irrational number which can never be precisely expressed in decimal terms, which is why it is convenient to have a function which returns a relatively accurate value for PI rather than have programmers try to remember one.

SuperBasic makes much of the concept of radians, each radian being the length of a circle's radius bent around its circumference. Slightly more than 6 radians are required to make up a full circle; more precisely, 2*PI radians are needed. This should waken distant memories of the 2*pi*r formula of school maths. [A more comprehensive review of Superbasic trigonometry belongs in the Concepts section of the New User Guide.]

PJOB(job)

[Super Toolkit 2]

TASK MANAGEMENT FUNCTION

job The job identification number or name

PJOB is a function that returns the priority of an independent task or job running in Qdos. Qdos splits processor time proportionately between all the genuinely multi-tasking programs (when tasks are run concurrently they may all be loaded into memory simultaneously but only one of them will be active). The priority which can be assigned to a task is represented by a value between 0 and 128, with 32 being the default and 0 representing no time whatsoever. If three tasks are loaded all with a priority of 32 they will receive exactly one third of the processor's attention over a given period of time.

POINT #chan, xpos, ypos, xpos1, ypos1, xpos2, ypos2, ...
POINT_R #chan, xpos, ypos, xpos1, ypos1, xpos2, ypos2, ...

GRAPHICS PROCEDURE

#chan (Optional) A valid screen channel. Defaults to WINDOW #1.
xpos, ypos A pair of graphics co-ordinates

At its simplest, with one set of co-ordinates, the POINT command lights up a single pixel in the current INK colour. Multiple sets of co-ordinates are allowed but rarely used; it is usually better to put the POINT command in a loop. POINT always plots pixels relative to the origin of the graphics grid that by default coincides with the bottom left corner of the window. Its location can be changed using the SCALE procedure. POINT_R takes its bearings from the current location of the graphics cursor. A surprisingly effective starry sky can quickly be obtained by repeated, random POINT statements:

POKE address, byte
POKE_W even_address, word
POKE_L even_address, longword

POKE location, byte, byte1, byte2, ...
POKE_W location, word, word1, word2, ...
POKE_L location, longword, longword1, longword2...

[Minerva]

POKE\$ address, string

[Turbo Toolkit]

MEMORY HANDLING PROCEDURES

address	Any memory location address, odd or even
even_address	An even-numbered memory location address
byte	An integer between 0 and 255 (unsigned) or between -126 and 127
word	An integer between 0 and 65,535 (unsigned) or between -32,766 and 32,767
long-word	An integer between 0 and 16,777,215 or between -8,388,608 and 8,388,609
string	A string representing a sequence of Ascii values

POKE is the opposite of PEEK in that it sends values to memory addresses rather than extracts them. PEEK is wholly benign and can be used across the entire range of memory addresses without fear. POKE, on the other hand, is restricted to ram addresses only (you cannot POKE a new value into a read-only memory address) and has the potential to bring down your QL. You might, for instance, declare an area of reserved memory with the RESPR command and quite harmlessly start to POKE values into the reserved memory addresses. Qdos will not warn you, however, should you accidentally send a value into a byte outside the reserved area.

The Minerva rom has tinkered with POKE to a much lesser degree than with PEEK, with the effect that you can now update a series of values into successive addresses with a single call of the POKE command. Turbo Toolkit takes this principle one step further and allows you to declare a string of Ascii values which can then be placed into sequential memory addresses. In both cases you merely declare the starting address. One of Minerva's interesting but completely useless side effects is that you can now use the POKE command with an address but no value to put in it.

Should you be tempted to POKE values into the QL's system tables area you should always use one of Turbo's BASIC() or Minerva's PEEK(offset) functions to determine where the values are going to be placed. Qdos has an alarming habit of relocating bits of the system tables without warning.

POSITION(#chan)

[Turbo Toolkit]

FILE INPUT/OUTPUT FUNCTION

#chan (Optional) A channel opened to a file or pipe

When you are writing at a low level to a re-opened file it can be convenient to be aware of exactly where in the file the output is being placed. Qdos sees files as streams of one-byte-wide Ascii values and it has no understanding of lines and paragraphs in wordprocessed text or records and fields of database files. Rather like its graphics cursors, Qdos keeps track of a pointer which can move through the file. When a file is opened the pointer points to the first byte in the file. As data is read from the file or written to it the pointer automatically increments itself. Programmers who wanted to overwrite a specific portion of a file could do so by moving the file pointer forward with the INPUT(#chan) function and then writing to the file with PRINT #chan. The POSITION and SET_POSITION keywords in the Turbo Toolkit now make this process easier to manage.

Turbo also implements pipes, or communication channels between tasks. A pipe can be likened to a file that only exists in memory and that has both a read pointer and a write pointer open simultaneously. As things are read from the pipe the remaining contents shuffle up towards the front of the file. In all other respects, pipes can be treated like temporary files. In normal use everything written to a pipe should be appended to the end of the file and everything read from the pipe should be taken in sequence from the beginning. In such cases there is little need to know anything about the actual location of the two pointers. However, if you are unsure about whether a pipe is getting full the POSITION() function could provide a warning that nothing further should be written to the pipe until something has been extracted from the other end. Advanced users can use POSITION() and SET_POINTER to shift the pointers up and down the pipe, perhaps to overwrite some previously-sent but unread information or to read data out of sequence.

Finally, although Qdos tries to treat all devices as though they were files there are some attributes of files which cannot apply to every sort of device. Network channels, printers and screens are potentially of infinite capacity and do not have a pointer. If you use POSITION() with any of the non-file devices other than pipes you will generate an error.

Jupiter

John de Rivaz has

adapted a Fractal program for the QL.

editor of Fractal

AS Report I once challenged readers to produce a simple iteration that would

produce planets on computer screens.

Reader Mark Dakto came up with a three page Pascal program for the Macintosh, and I have adapted some parts of it in the more concise SuperBasic to work with the QL.

The constants a and k set the type of world drawn, and it is left up to readers to find values that produce other results - here we plot a Jupiter type planet, with a banded atmosphere and even a red spot, which is somewhat elongated.

The variable numits can be changed for a more detailed plot. The value of 30 gets a quick result, whereas 300 gives a more elaborate picture. Mylat and Mylong set the latitude and longitude of the viewer.

A number of variables such as "piby28" and "COSlongCOSlat" are introduced during the program to prevent CPU time being wasted by repeatedly working out the same product. These could have been given single letters, but this would have made the program less comprehensible. Lines 500 to 550 could be used in other programs to map a rectangle onto a sphere.

QL owners with extended ram and ramdisk facilities may like to modify the program to save a number of screens with different Mylong, and then to replay them in succession to produce a rotating planet.

```
190 MODE 4:WINDOW 512,255,0,0:PAPER
0:CLS
200 :
210 REMark Jupiter Program
220 REMark _____
230 REMark by John de Rivaz July 1989
240 REMark Based on an article in
Fractal Report 3
250 REMark 28p stamp appreciated for
sample copy and subscription details
260 REMark West Towan House, Porthtowan,
Truro, Cornwall TR4 8AX
270 :
280 LET k=-.23:a=3.6E-2 : REMark change
for different planets
290 LET numits=300 : REMark change
for density of plot
300 LET mylat=30 : REMark change
for viewpoint (degrees)
310 LET mylong=180
320 radius=127 : REMark adjust
to fill screen
330 LET aspect_ratio=3/2 : REMark QL
specific for "BLOCK"
340 LET piby28=PI/28:pipt8=PI+.8:twopi=P
I*2:twopiby10=twopi/10:conrad=1.74533E-2
350 LET mylat=mylat*conrad
:SINmylat=SIN(mylat):COSmylat=COS(mylat)
360 LET mylong=mylong*conrad
370 :
380 FOR x_start=3 TO 24 STEP 3
390 LET colour= 2*(1+(x_start/3) MOD
3)
400 FOR y_start=twopiby10 TO
twopiby10*8 STEP twopiby10
410 LET x=x_start:y=y_start
420 FOR iteration=1 TO numits
430 LET x=x-k*SIN(y)
440 LET y=y+x*(1-a*x)
450 IF y>twopi THEN LET y=y-
twopi:GO TO 450
460 IF y<0 THEN LET
y=y+twopi:GO TO 460
470 LET lat=(x-14)*piby28:long=y+
pipt8
480 LET COSlat=COS(lat):SINlat=SIN
(lat):long=long-mylong:SINlong=SIN(long)
490 LET COSlongCOSlat=COS(long)*
COSlat
500 IF COSlongCOSlat*COSmylat+
SINlat*SINmylat<0
510 BLOCK 1,1,radius*(SINlong*
COSlat+1)*aspect_ratio,radius*(1+
COSlongCOSlat*SINmylat-
SINlat*COSmylat),colour
520 END IF
530 END FOR iteration
540 END FOR y_start
550 END FOR x_start
```

Long-time Cash Trader user Charles Tassell is impressed by the updates.

Cash Trader

INFORMATION

Program: Cash Trader V3.3 + Analyser

Price: £99.95

Supplier: Digital Precision Ltd., 222 The Avenue, Chingford, London E4 9SE Tel. 081 527 5493

Cash Trader has been around almost as long as the QL itself. The original program was marketed by Quest in 1985. Since then Cash Trader has been gradually improved and updated. Digital Precision have recently released a new version which has made Cash Trader a most powerful accounts program.

Banks too

The name Cash Trader implies that this program is designed only for cash transactions. This could not be further from the truth. It can in fact handle a large number of bank accounts as well as debit, credit and cash accounts. Payments and receipts can be accounted for as cheques, direct debits, transfers, standing orders, interest, cash and even unpaid cheques. Cash Trader is in essence a single-entry accounts package.

One area in which computerised accounts score over the straight paper systems is in the number of separate headings you can have. Cash Trader is especially good in this respect as this latest version can have up to 999 headings. This means you no longer have to have the dreaded "other payments" column.

When Cash Trader is loaded you are presented with a main menu which has a number of options on it. Each option is a separate program which is loaded when you select it. After you have finished with

the option you have chosen, you are returned to the main menu again and the chosen option is removed from memory. This means memory requirements of Cash Trader are kept to a minimum.

Entries

The three principle options from the main menu are Entries, Reports and Analyser.

The Entries option is used for entering all movement of monies within the accounts. In order to enter data you are prompted for all the details such as date, required account and transaction type. One of the useful features of Cash Trader is the way in which you select which heading you wish to allocate a transaction to.

There are no account codes which need to be remembered. Each time you have to select a heading, a window is opened which contains a list of all the relevant heading. At the same time the first heading in the list is placed in the box which requires the entry. If this is not the correct heading you can either move down the list with the cursor keys or press the first letter of the heading you want.

When you have finished your Entry the information is then updated to all the relevant accounts. On the

screen there is an upper window which contains a profit and loss report and also a Balance sheet report. This window can also be used to display a VAT report or document lines during data entry. If when you first set up Cash Trader you put into the system detailed items from your accounts, such as balances of overheads and profits carried forward, then after each Entry the above reports can give you an indication of the general health of your business/accounts. It is not necessary however to include this detailed information if you do not wish to.

VAT, if the above sub-total is zero. This can be useful if you have to pay a bill in which the VATable element of the bill has been contra-accounted against a zero rated output. When you set up the headings in Cash Trader you have to give each one its own VAT category. This category can be amended during the entry of invoices. If you are not VAT registered then by allocating NONE to the headings you will skip the VAT summary at the end of Entries. Once you have completed all your Entries you then return to the main menu. At this stage all the information is written to your disk.

QL CT ANALYSER

EXTRACTION CRITERIA		TOTAL DOCUMENTS	
Name of Extract file	System File	439	
Doc. Type.....	EXTRACTED DISC	0	
Analysis Group.....	Date Sorted	NO	
Analysis Head.....			
Reference.....			
Payment Type.....	DOCUMENT NUMBERS		
VAT RATE.....	Starting Doc	1	
Comment.....	Finishing Doc	439	

Type in Name of Extraction File.
Use CTRL/+ or F2 Key to correct.
Press 'ESC' to go back to Menu.

Cash Trader - Analyser Search criteria data, input screen

VAT

Monies can be entered with or without VAT included. At the end of an entry you are asked if the figures entered are inclusive or exclusive of VAT. If your sub-total is exclusive of VAT, a useful feature of Cash Trader enables you to have a total which consists entirely of

Reports

The Reports option is principally used to produce printed output of the accounts. The one exception to this is the document review option. With this option you are prompted for the first and last document number you wish to review. After this you have the

choice to output to the screen or the printer. With each document reviewed, you see all the details you have entered complete with the headings it is allocated to. The other options under Reports are VAT, Balance sheet and Profit and Loss reports. A further option is a Trial Balance printout. With this you get a list the balances of all the headings rather than just Balance sheet or Profit and Loss account items.

Analyser

The Analyser is the third principle option from the main menu and is the most powerful and important module in the Cash Trader suite. One of the biggest problems with any computer accounts program can be that you enter a lot of information but then have trouble getting out the details you want. You either find that you can not get out the information you want, or you have the opposite, with so much paper that you still can not find the information easily. Cash Trader analyser enables you to extract all documents that meet a search criteria.

When you want to decide what to search for, you are presented with a table with various options on it. These range from choosing which account headings to include in the search, to choosing either a payment or receipt documents, or both. You can select a range of document numbers, or a range of dates to limit the search. If you have, for example, entered car registration numbers against various bills, you can then extract all the bills for an individual car.

Once you have made your extraction you can then either subject it to another search in order to reduce the number of documents it contains, or you can select the print option. This contains a few differences from the print option which is available from the main menu. Firstly, when you decide to output to the printer you can change the destination of the print. This means you can print to a file instead of your printer. With the output now in a plain text file you can load it into a word

Group Report For POWER..... (22/58)		VARIABLE COSTS.	
ELECTRIC STORE.....	1353.12	SPRAYS CER. 92.	
ELECTRIC OTHER.....	573.47	SPRAYS CER. 93.	
REPAIRS TRACTOR.....	991.88	SPRAYS AP. 92.	
REPAIRS IMPLI.....	2885.39	SPRAYS AP. 93.	
REPAIRS SPRAYER.....	555.57	FERT. CER. 92.	
REPAIRS CARS.....	268.83	FERT. CER. 93.	
PETROL.....	1851.95	FERT. AP. 92.	
GENERAL OILS.....	189.05	FERT. AP. 93.	
FUEL OIL.....	1684.63	SEEDS 92.....	
TAX ROAD & MOT.....	170.00	TRANSPORT AP. 91	
INSURANCE ROAD.....	1588.00	CONTRACTORS CER	
		CONTRACTORS AP.	

Tue 24 Nov 12:32

Doc. No. 440 Date 30 Sep 92	Group VARIABLE COSTS.		
Type RECEIVED	Analysis SPRAYS CER. 92.	552.21	
4: CASH FLOAT... 133.88	Value	100.00	
Ref. CHEQUE..... JKL 89N	VAT Rate	STND	
	Comment		Line 1

Cash Trader - Entries option. Bottom split window is where data is input

processor such as Quill or The Editor, to manipulate and print as you require.

The second difference to the print option is the ability to suppress zero items. This means that if a heading has a zero balance, it is not printed in the group listing it belongs to. When you have a lot of zero balances this can quite usefully reduce the size of a report.

Reconciliation

The final difference to the print option is the Bank Reconciliation report. This is the most important improvement that Digital Precision have made to the Cash Trader Analyser module. With the reconciliation option you have a report that lists every single entry to each of the account headings. Each heading is listed one at a time in date order so that you can easily trace any payments or receipts made to or from that heading. Usually every cheque you write is paid from a bank account heading to a trading account heading, which means you will get a print out of all cheques in date order. This enables a complete audit trail to be done.

Cash Trader has a separate configuration program. This enables you change the

program to run on a QL with either one or two disk drives. You can also change the maximum number of headings you want to use and how many lines you may have in each document. This will affect the amount of memory Cash Trader will require for program space and/or data space. When you make any changes from within the configuration program it informs you of its new memory requirements.

If after you have been using Cash Trader for a while you decide that you have not allocated enough headings for your accounting needs you can use the configuration program to increase the number of headings. The program will look at your existing data files structure and then decides if it can reorganise the files without disturbing the entered information. If it can not add the extras headings without changing the files it will give you the option to stop the reorganisation, otherwise it will produce carried forward totals to keep your accounts true.

Retrieval

I have been using Cash Trader on my own accounts for almost as long as it has been available on the QL. In

the past the biggest problem with Cash Trader has been difficulty getting the information which has been typed in, out again. Although the Analysers has been available for a number of years, it has always had the drawback that the only way to see details entered in the comment boxes is through the document review option. This has the problem that it also prints out all the information entered against other headings when an invoice has more than one item on it. With the Reconciliation report all the headings, complete with their comments, are printed together in date order. This means, for example, that if you look at the listing for car repairs you get all the bills grouped together, rather than having to look down a long printout interspersed with other headings.

I find Cash Trader simple to set up and use. While at first glance it might seem that Cash Trader is only a business program there is no reason why you could not use it for keeping track of your own personal accounts. In fact, with the account headings having names rather than codes, Cash Trader is ideally suited for infrequent users as it guides you through all entries.

DIY TOOLkit

Simon Goodwin begins the most ambitious DIY Toolkit project yet - Flexynet, a new software driver for the QL network ports.

This project introduces several new programming techniques to DIY Toolkit. It shows the use of assembler macros to generate fast code with minimum programming effort. It demonstrates direct access to the QL's custom hardware, programming the ZX-8302 chip directly, and illustrating the precautions necessary when sharing the QL hardware with other multi-tasking routines.

Thing List

This is also the first DIY Toolkit project to make use of the 'Thing list' - a way to share data between tasks, commands and programs without risky PEEKs and POKEs. The Flexynet Thing records the current network transmission and reception rates.

Flexynet is a good example of real-time programming. The design reveals the Byzantine internal timing of 128K and expanded QL systems, and compensates for the variations automatically. At best Flexynet can transfer more than 10K per second between two Gold Cards. Even humble 68008 systems manage over 4K per second, with code in fast ram, rom or static ram such as the MCS MultiRom.

The protocol (rules governing the transfer of data) is flexible enough to run as fast as the hardware will allow. This is important as faster processors become available, and programs and data files expand to match.

As QL users also run Qdos on Thor, ST and Amiga emulators, we need a quick way to let them talk to one another. If it can support PCs,

Spectrums, SAMs and other micros, so much the better. We need a new, flexible protocol which uses common hardware and will work as fast as the machines at either end.

Old NETs

Serial ports are already available but hard to wire up, and unreliable too, in Sinclair implementations, unless your QL boasts a Hermes upgrade. Top speed for standard serial ports is 19200 baud; Flexynet can go twice as fast as that, even on a standard QL, and over 100,000 baud if processor speed will allow it. Still higher rates are limited by the cable rather than processor speed.

Sinclair's original QL NET device was rudimentary, but it is replaced with much-extended software when Toolkit 2 is fitted. The NET protocol is powerful and quite reliable, especially when Minerva is installed at both ends of the link, but it has several weaknesses.

Sinclair's protocol is slow and compatible with few other computers. Data is transferred in fixed 'packets' of 128 bytes, so short messages have to be padded with junk, and long ones are slowed because they are split into sections.

Contrary to many reports, the QL NET device can talk to the ZX Spectrum, if the Interface 1 add-on is fitted, but timing errors mean that data is corrupted if the Spectrum sends more than one character in reply. Such errors are easily made if a fixed-speed protocol is chosen, so the DIY Toolkit scheme is configurable to match the speed of the hardware at both ends of the link.

```
100 REMark Sinclair QL World HEX LOADER v 3
110 REMark by Marcus Jeffery & Simon N Goodwin
120 :
150 CLS: RESTORE : READ space: start=RESPR(space)
160 PRINT "Loading Hex...": HEX_LOAD start
170 INPUT "Save to file...";f$
180 SBYTES f$,start,byte : STOP
190 :
200 DEFine FuNction DECIMAL(x)
210 RETURN CODE(h$(x))-48-7*(h$(x)>"9")
220 END DEFine DECIMAL
230 :
240 DEFine PROCedure HEX_LOAD(start)
290 byte = 0 : checksum = 0
300 REPEAT load_hex_digits
310   READ h$
320   IF h$="*" : EXIT load_hex_digits
330   IF LEN(h$) MOD 2
340     PRINT"Odd number of hex digits in: ";h$
350     STOP
360   END IF
370   FOR b = 1 TO LEN(h$) STEP 2
380     hb = DECIMAL(b) : lb = DECIMAL(b+1)
390     IF hb<0 OR hb>15 OR lb<0 OR lb>15
400       PRINT"Illegal hex digit in: ";h$ : STOP
420     END IF
430     POKE start+byte,16*hb+lb
440     checksum = checksum + 16*hb + lb
450     byte = byte + 1
460   END FOR b
470 END REPEAT load_hex_digits
480 READ check
490 IF check <> checksum
500   PRINT"Checksum incorrect. Recheck data.":STOP
520 END IF
530 PRINT"Checksum correct, data entered at: ";start
560 END DEFine HEX_LOAD
570 :
580 REMark Space requirements for the machine code
590 DATA 1044
600 :
610 REMark Machine code data
620 DATA "43FA03CE34780110","4ED249FA00E46010"
630 DATA "49FA009E600A49FA","0056600449FA01DE"
640 DATA "347801184E926636","554366302471E800"
650 DATA "2A31E8046B266726","4E414E40007C0700"
660 DATA "1E2800A010070200","00186714B03C0018"
670 DATA "671A080000046708","70F7604E70F14E75"
680 DATA "10070000001813C0","000180024ED41200"
690 DATA "08C100072C0A2406","48424A4266064846"
700 DATA "48423C0213C10001","8002260651CBFFFE"
710 DATA "48434E7113C00001","800251CBFFFE5385"
720 DATA "66E2700013C70001","8002027CD8FF4E75"
730 DATA "0805000067025285","41F900018020263C"
740 DATA "000009C4243C00FF","00FF300208100000"
750 DATA "56C8FFFA671414C0","30020810000057C8"
760 DATA "FFFA14C0558562E2","60B8538366DC602E"
770 DATA "6100025866AE41F9","00018020342C0004"
780 DATA "3602966C00026316","4847050047FA02BA"
790 DATA "70114E414CDF00A0","02010048670470FF"
800 DATA "60820810000067E0","0810000066FA3002"
```

Toolkit 2

Toolkit 2's file server is neat because it allows programs to use remote devices, with few limitations. But it is sluggish, particularly now that floppy disks and expanded memory are the norm. Even with Gold Cards at both ends, FSERVER reduces the speed of LBYTES from FLP1_ to about 1.5K per second. That's a long time if you're waiting for a 32K screen or task file, and both machines are tied up while the transfer takes place.

The current version of Flexynet consumes all the processor power while it runs, but it's much faster. The 'packet' size is limited only by available memory. You can send several short packets in a second, or one monster block, flat out across the net. Short packets are ideal for multi-player network games.

Test Results

I have tested Flexynet successfully on four 68008 QL systems and two Gold Cards kindly loaned by Miracle Systems. Further tests are underway and I welcome reports from readers.

The Flexynet prototype uses three configurable delays, adjustable with the NETRATE command. The units are entirely arbitrary, and reflect initial loop counts for the simplest possible input and output timers, made from DBRA loop instructions. Memory permitting, these run steadily on a 68008 and 68000 processor.

The cache memory of later processors like the 68020, 030 and 040 invalidates such timing loops, so those systems will need new Flexynet primitives. If you have a really fast processor such as a risc chip you should be able to implement this protocol using hardware interrupts. That'll keep it busy...

NETVAR%

The function NETVAR% can read any of the delay settings. Supply a parameter to indicate which delay you want to read. NETVAR%(1) returns the transmission delay used when

sending bits with the value zero. 'One' bits count down from twice the value, so zeros - which are more common - are sent faster than ones.

NETVAR%(2) gives the reception delay. If NETREAD waits more than the specified number of loops, it assumes a one bit; otherwise it assumes zero.

NETVAR%(3) returns the timeout. Flexynet reports 'not complete' if NETREAD counts beyond this while waiting for the next pulse from the net. Has the lead come unplugged? The timeout must exceed the second parameter by a comfortable margin or NETREAD may give up too soon.

NETRATE parameters are integers in the same order. If you pass zero for any parameter its setting is unchanged. This avoids the need for lines like NETRATE NETVAR%(1), NEW_RX, NETVAR%(3) which would need three extension calls and three searches through the Thing list; NETVAR 0,NEW_RX,0 needs only one of each.

SETRATE

For a standard QL with code in rom or fast ram, I recommend SETRATE 5,3,127. Try 6,3,127 if you get extra 1s at the receiver.

Using a Gold Card with a fast ZX-8301, I recommend SETRATE 8,4,0 at both ends. This managed over 10K per second from my Thorn EMI to Samsung QLs. SETRATE 10,5,0 is slightly slower, but just as reliable on my set-up. In the other direction, with the British machine listening, I had to step down to SETRATE 33,12,0.

There is a wide margin for error at slow speeds. Using standard 68008 QLs and a transmission delay of 60 I can send 32K screens reliably at reception rates from 28 to 46. If you're setting up a link from a new machine it's wise to use longish delays till you've got something working. It can help to use NETPOLL to see how the receiver is getting on.

NETREAD 131072,32768 reads a screen from another machine via Flexynet. Once you've entered this, and set

DIY Toolkit FLEXYNET, Listing 2, page 2 of 2

```
810 DATA "0810000057C8FFFA", "66E4D804B0036402"
820 DATA "5204300208100000", "56C8FFFA67D0D804"
830 DATA "B003640252043002", "0810000057C8FFFA"
840 DATA "66BCD804B0036402", "5204300208100000"
850 DATA "56C8FFFA67A8D804", "B003640252043002"
860 DATA "0810000057C8FFFA", "666ED804B0036402"
870 DATA "5204300208100000", "661ED804B0036402"
880 DATA "B003640252043002", "0810000057C8FFFA"
890 DATA "6646D804B0036402", "5204300208100000"
900 DATA "56C8FFFA6732D804", "B003640252043002"
910 DATA "0810000057C8FFFA", "661ED804B0036402"
920 DATA "520414C430020810", "000056C8FFFA5385"
930 DATA "6600FF3C6000FEAC", "6000FF241C006100"
940 DATA "014A6600FEA01006", "3C1448463C141200"
950 DATA "08C1000713C10001", "8002343C17751CA"
960 DATA "FFFE181A13C10001", "8002260651CBFFFE"
970 DATA "484313C000018002", "D8046402D64351CB"
980 DATA "FFFE260613C10001", "8002D8046402D643"
990 DATA "51CBFFFE484313C0", "00018002D8046402"
1000 DATA "D64351CBFFFE2606", "13C100018002D804"
1010 DATA "6402D64351CBFFFE", "484313C000018002"
1020 DATA "D8046402D64351CB", "FFFE260613C10001"
1030 DATA "8002D8046402D643", "51CBFFFE484313C0"
1040 DATA "00018002D8046402", "D64351CBFFFE2606"
1050 DATA "13C100018002D804", "6402D64351CBFFFE"
1060 DATA "484313C000018002", "51CBFFFE53856600"
1070 DATA "FF5213C100018002", "51CEFFFE13C00001"
1080 DATA "80026000FDBE3478", "01124E92662E5743"
1090 DATA "66284E402449614E", "661C232E8006702"
1100 DATA "38813232E80026704", "394100023232E804"
1110 DATA "6704394100046000", "FD9270F14E753478"
1120 DATA "01124E9266F65343", "66F03E31E8006FEA"
1130 DATA "DE474E40611066DE", "226E005833B470FE"
1140 DATA "E80078036D07000", "4E4128484BEC00B8"
1150 DATA "41FA005E91CE3678", "00E6201567162A40"
1160 DATA "43ED002A93CE7001", "4E934A8066EC49ED"
1170 DATA "003C4E7570187242", "74002A4A4E41244D"
1180 DATA "4A8066264BE80034", "214D00104BFA001E"
1190 DATA "47E80026720D36DD", "51C9FFFC4BEC00B8"
1200 DATA "20952A8849E8003C", "70004E75312E3038"
1210 DATA "0008466C6578794E", "6574544847250000"
1220 DATA "000200050003007F", "0901000000000102"
1230 DATA "0005FC4A074E4554", "53454E44FC3A074E"
1240 DATA "455442454550FC2A", "074E4554504F4C4C"
1250 DATA "FC1A074E45545245", "4144FECC074E4554"
1260 DATA "5241544500000001", "FF16074E45545641"
1270 DATA "52250000", "*", 88615
```

* QL WORLD DIY TOOLKIT - FLEXYNET - PROTOTYPE BYTE I/O ROUTINES.
* Version 1.08, Copyright 1993 Simon N Goodwin, Rights Reserved.
* 6800X QL/ZX-8302 version; generic I/O port versions to follow.

```
tx_control equ 98306 ZX-8302 TXCTRL register
sv_txmode equ 160 Offset to TXCTRL shadow sysvar
sv_thing equ 184 Offset to THING LIST pointer
mode_mask equ 24 NET sets both mode bits
drive_mode equ 16 MDV mode bit 3=0, bit 4=1
mdv_bit equ 4 MDV mode control bit number
ser_bit equ 3 RS-232 SER1/SER2 flag bit
net_outbit equ 7 Network port output bit
net_input equ 98336 QL IPC read register
net_inbit equ 0 Network port input bit
```

* Bit input macros; code templates used to read each bit

```
read_high macro
move.w d2,d0
poll\@ btst #net_inbit,(a0)
dbne d0,poll\@
endm
```

```
read_low macro
move.w d2,d0
poll\@ btst #net_inbit,(a0)
dbeq d0,poll\@
endm
```

the NETRATES, type NETSEND 131072,32768 on the other machine. You should see the screen copied to the receiver, line by line. Several machines can NETREAD as any one NETSENDS.

PATTERNS

Fascinating patterns appear if you send or receive a screen at slightly the wrong speed. There is no checking or 'handshaking' yet, as it's interesting to see which bits go wrong when tuning the net.

Bright dots, diagonal stripes or an all-white screen signify spurious one bits; increase the reception delay, or cut the transmission delay. Pixels appear darker than expected if a one bit is mis-read as a zero. To fix this, boost the transmission delay, or slow the receiver with NETRATE 0,RX,0.

Make notes of the values you've tried at each end, or you could go round and round for ever. Very small values are fast but unreliable. Exact performance depends on the exact hardware - suck it and see! The protocol is designed to iron out speed variations, but the greater the fluctuation the slower you must go to get reliable data transfer.

In every case I have tried, Flexynet is substantially faster than the Sinclair NET driver. I intend to refine the protocol on the basis of comments from users, so I'm eager to hear of the best parameters for your system.

Once you can send screens reliably in both directions you can leave the settings alone and use Flexynet to transfer any file via memory and the net. Use LBYTES and NETSEND at one end, with NETREAD and SBYTES at the other. Use POKE_L to prefix a task file with its dataspace, then set the result with SEXEC.

It helps to use ramdisk, so the more ram you have the better. You may wish to split very large files into sections. You can interrupt the receiver with ESC or SPACE while it is waiting for the start of the message.

While the receiver is busy reading the net there is no time to poll the keyboard; IPC KEYROW calls take over 5

milliseconds each on a standard QL. You can regain control of a busy receiver by unplugging the NET cable at either end, forcing a timeout. NETSEND ignores the keys while it is transmitting a block. Wait, or press reset!

Speed limits

You MUST run the Flexynet code in fast memory; QL internal memory is not fast enough. Different QLs have different speeds. My original 1984 AH QL is slightly slower than my second machine, made by Samsung; the user mode bus bandwidths are 867 and 896 K/sec respectively. These differences depend on the video circuit in the 8301 chip, so Gold Cards are also affected, shifting 9198 or 9532K per second.

Even if the code is in rom, or fast ram such as Gold Card, Trump Card 2, CST RAM+ or the original 256K Simplex Data board, it will run slower whenever the processor accesses the internal 128K or the custom chip ports. I test the routine by transferring the 32K screen image from one QL to another; this is a particularly difficult test as display memory is slowed by the ZX-8301 chip which takes priority over the processor!

Flexynet seems to co-exist happily with Sinclair's NET, as long as you don't try to use both at once. They share the same hardware, but FSERVICE is not disturbed by NETSEND messages at speeds I've tried.

Timeout

If a Sinclair NET driver pipes up while a Flexynet driver is waiting to read, Flexynet reports a 'not complete' error. You can configure the 'timeout' interval between signals to suit yourself. The default is 127 sampling loops, but values may be up to 32767, allowing very slow reception without timeout errors.

Listing 2 is the complete code file, encoded as hex data with a SuperBasic loader. If you enter and RUN this program it will read and check the data, then save it as a concise code file which you

```

*
* Compare D0 countdown with timeout in D3; result is D4 bit 0
*
decide macro
  add.b d4,d4
  cmp.b d3,d0
  bcc.s fast\@
  addq.b #1,d4
fast\@
  endm
*
* Wait for a state change & time next bit; abort if necessary
*
up_bit macro
  read_high
  beq.s \1
  decide
  endm
*
down_bit macro
  read_low
  bne.s \1
  decide
  endm
*
* Bit output routines; send the most significant bit of D4.B
*
send_high macro
  move.l d6,d3
  move.b d1,tx_control
  add.b d4,d4
  bcc.s leave_hi\@
  add.w d3,d3
leave_hi\@ dbra d3,leave_hi\@
  endm
*
send_low macro
  swap d3
  move.b d0,tx_control
  add.b d4,d4
  bcc.s leave_lo\@
  add.w d3,d3
leave_lo\@ dbra d3,leave_lo\@
  endm
*
* This is the start of the executable code
*
initialise lea.l define,a1
           movea.w $110.w,a2 BP.INIT vector
           jmp (a2)
*
* NETREAD address,length
*
read_bits lea.l net_read,a4 Point A4 at reading routine
          bra.s get_longs Get parameters from BASIC
*
* NETPOLL address,length
*
netpoll lea.l poller,a4
        bra.s get_longs
*
* NETBEEP rate,pulse_count
*
netbeep lea.l squeaker,a4
        bra.s get_longs
*
* NETSEND address,length
*
send_bits lea.l net_send,a4
get_longs movea.w $118.w,a2 Pick up CA.GTLIN vector
          jsr (a2)
          bne.s exit
          subq.w #2,d3 Two parameters are needed
          bne.s bad_param
          movea.l 0(a1,a6.1),a2 Destination or beep rate
          move.l 4(a1,a6.1),d5 Length of message
          bmi.s bad_param D5 must be positive
          beq.s exit Zero bytes, that's easy!
          moveq #0,d0 Redundant; D0=0 if OK so far
          trap #1 MT.INF - point A0 at SYSBASE
*
* Set supervisor mode and disable interrupts for real-time I/O

```

can re-load later like this:

```
X=RESPR(1044)
LBYTES
FLP1_FLEXYNET_CODE,X
CALL X
```

This adds NETBEEP, NETPOLL, NETRATE, NETREAD, NETSEND and NETVAR% to your SuperBasic vocabulary. Remember that X should be an address in fast ram.

DIY Toolkit disk Volume Y includes the Flexynet object code, in ram and rom formats, documentation and full source for Flexynet, plus example SuperBasic routines to work the network hardware directly and explore the Thing list.

As usual I've been able to include more on the disk than can be printed here; Send £7 for the whole volume on disk (specify your format) and just £3 more for any further volume. Write to DIY Toolkit, Cwm Gwen Hall, Pencader, Dyfed, Cymru SA39 9HA or cheer Richard up with a call on (0559) 384574.

Primary Source

Listing 1 starts with the macros. These are blocks of assembly code which start with their name and a keyword, MACRO, and continue to the next ENDM. Once defined a macro can be copied out at any place in the program by giving its name.

Local labels and parameters are marked with a backslash character. \1 returns the text of the first parameter on the line, \2 gives the second, and so on. \@ is replaced by a number corresponding to the number of times the macro has been assembled, so POLL@\ becomes POLL1, POLL2 and so on each time the macro is invoked.

Macros use more memory than subroutine calls or loops, because the whole routine is copied out every time, but this also makes them faster. In this application the top speed is determined by the number of bytes or words of memory which are accessed in the course of sending or receiving one bit.

Macros make it easy to 'unroll' the loop that sends and receives eight-bit bytes, without the need to copy

blocks of code in the source file, wasting space and risking incongruity.

Equates

The macros are followed by some equates, giving names to useful numbers like the address of the ZX-8302 transmit control register, address 98306 or TX_CONTROL. SV_TXMODE is the offset of the system variable that shadows TX_CONTROL. Co-operative programs write bytes here as well as to the write-only register TX_CONTROL, so you can check the transmission mode from Basic with PEEK(164000), on standard systems with system variables at 163840.

MDV_BIT is set when the microdrives are busy, and SER_BIT selects between SER1 or SER2. Both bits are set when the net hardware is in use. The ZX-8302 shares hardware between the net and these devices. If you try to use two at once, Flexynet reports 'in use'. Try again when the microdrives have stopped.

Bit 7, the most significant bit of the byte, is used to set the level at the net port. On other computers with standard PIO (Programmable Input Output) chips you need to set the data direction with an initial MOVE to the I/O control port, before reading or writing the corresponding data bit, usually mapped nearby. I shall discuss this further in a future article. On the QL incoming data appears in the least significant bit of the ZX-8302 port at 98336, named NET_INPUT here.

Signal processing

The listing continues with GET_LONGS, a shared routine to fetch two long integer parameters and pass them on to the routine at the address in A4. Last, for this month, come the experimental routines NETPOLL and NETBEEP.

NETPOLL and NETBEEP are more useful for signal processing than direct data transfer. For instance, NETPOLL allows digital sampling via the network port. This can be used to decode

```

trap or.w #0 Supervisor mode
select_net move.b #700,sr Concentrate; interrupts off!
move.b sv_txmode(a0),d7
andi.b d7,d0 Working copy of TXMODE
beq.s #mode_mask,d0 Check bits 3 & 4
cmp.b not_busy
beq.s #mode_mask,d0 In network mode?
btst ready
beq.s #mdv_bit,d0 Microdrives active
* Ignore SER bit for now...
*
* Eek! Microdrives are using the ZX-8302
*
in_use moveq #-9,d0 Report IN USE
bad_param bra.s cheer_up Return in user mode
exit moveq #-15,d0 Set Qdos ERR.BP report code
rts

*
not_busy move.b d7,d0 Retrieve old mode
ori.b #mode_mask,d0
move.b d0,tx_control Set ZX-8302 NET mode
jmp (a4)
*
* NETBEEP - the test tone output routine
*
squeaker move.b d0,d1
bset #net_outbit,d1
move.l a2,d6 Pick up time constant
move.l d6,d2 Keep a copy
swap d2 Check high word
tst.w d2 If non-zero, use both
bne.s squeak
swap d6 Move zero to low word
swap d2
move.w d2,d6 Match high & low words
*
squeak move.b d1,tx_control Transmit a HIGH level
move.l d6,d3
loop_on dbra d3,loop_on Wait at that level
swap d3
nop Improve wave symmetry
loop_off move.b d0,tx_control Transmit a LOW level
dbra d3,loop_off Wait some more
subq.l #1,d5 Have we finished?
bne.s squeak No, do it again
*
it_worked moveq #0,d0 Signal ERR.OK, it worked
release move.b d7,tx_control Restore old ZX-8302 mode
cheer_up andi.w #d8ff,sr User mode, interrupts on
rts
*
* The POLLER stores D5 bytes of bit times from (A2) onwards
*
poller btst #0,d5 Is D5 even?
beq.s even
addq.l #1,d5 Make it even
lea.l net_input,a0
move.l #2500,d3 Wait a few seconds
move.l #FFF0FF,d2 Byte timeouts
reader read_high
beq.s check_time No pulse yet...
move.b d0,(a2)+ Store exit count
read_low
move.b d0,(a2)+ Store exit count
subq.l #2,d5 Count down in bytes
bhi.s reader
bra.s it_worked
*
check_time subq.l #1,d3 Count down timer
bne.s reader Try again!
bra.s timeout

```

any digital data stream, from morse code to MIDI and the cassette data formats used by many home computers.

NETBEEP lets you send signals the other way, generating test tones, control pulses and even rudimentary polyphonic sound, with one note from the NET port and harmony accompaniment from the 8049 co-processor!

NETBEEP takes two parameters, in arbitrary units. The first is the delay between pulses sent to the net port. Higher values give longer delays and lower pitches. The second parameter is the number of pulses (from level 0 to 1 and back to 0) to be sent.

If the first parameter is greater than 65535 it is interpreted as two 16 bit words, and you can set the width of pulses at high and low levels independently. This is called varying the mark/space ratio, and can produce interesting effects.

The default is fairly even; the NOP pads out the code while level 1 is generated, so that each half of the loop reads

three words of code from memory, in addition to the delay and level-changing instructions. The 68000 and 68008 read one word ahead, so the word after BNE.S SQUEAK is fetched each lap, and discarded if the branch is taken.

Exact timings depend on the instruction, but memory speed is usually the most significant factor. This is why the 68020 and above feature internal memory, or 'cache'. Motorola's new 68060 processor boasts a branch cache and pre-reads both paths that follow a branch instruction. If execution takes a new path the overhead is just one clock; if the branch goes the same way as before the 68060 just skips along its internal pipeline, taking no extra time at all.

NETPOLL

NETPOLL is a simple sampling routine which stores timings as bytes in memory. The parameters are the address of the memory for storage, and the number of

bytes available. Odd values are rounded up, so an even number of transitions from 0 to 1 and back are recorded. The overhead of counting the loops means that rising transitions are spotted slightly late.

Our first two macro calls appear in the READER loop. READ_HIGH copies in the code to wait for a high level at the net port, counting down in D0. Similarly, READ_LOW waits for a low level. These macros will be re-used several times in next month's NETREAD routine.

NETPOLL stores timing bytes in rather an odd form, as DBRA counts down from 255 (by default) to -1, which has the same representation as a byte. Descending values from 254 to 0 indicate increasing delays. 255 means that the timer ran out before a pulse arrived.

NETPOLL can be adapted to store pairs of words, if you can afford the memory and want to sample slower data. Increase both words of D2, use MOVE.W D0,(A2)+

instead of the two MOVE.B's, and subtract #4 from D5 each time round the loop.

NETPOLL waits a few seconds for the first pulse, and reports not complete thereafter. The value in D3 determines the number of maximum bit times (256 loop units) that NETPOLL will wait.

Next month I shall reveal the source for NETREAD, NETSEND and the Thing routines, which will be useful to many programmers. Meanwhile I'm keen to hear how you get on with Flexynet, and other suggestions for this column.

DIY Toolkit

QUBBESoft P/D

38, Brunwin Road, Rayne, Braintree, Essex. CM7 5BU. Tel. 0376 347852

Public Domain & Shareware Software

C68 Compiler Runtimes (3Disks) £3.00p
C68 Compiler Src Cde (2 Disks)... £2.00p
MicroEMACS V3.11 (2 Disks)..... £2.00p
GNU Text Utilities (2 Disks)..... £2.00p
QL Emu for AMIGA (2 Disks)..... £2.00p
SPEC 1 Q.A.T.S..... £1.00p
SPEC 2 Molecular Graphics..... £1.00p
SPEC 3 XLisp V1.4a..... £1.00p
SPEC 4 QPacer..... £1.00p
SPEC 5 C Tutorial..... £1.00p
SPEC 6 Lib QPTR..... £1.00p
SPEC 7 Lib CPORT..... £1.00p
SPEC 8 QRactal Screens Demo..... £1.00p
SPEC 9 QL Home Finance..... £1.00p
SPEC10 ZM1+ SPECTRUM Emu..... £1.00p
SPEC11 Lib CURSES..... £1.00p
SPEC12 ELVIS Editor..... £1.00p

PD Disks 1 to fl.....£1.00p ea.
(Each Disk contains 10 programs and a Menu Handler. Each program can be RUN from the MENU unless other-wise stated).

P&P PD & Shareware

Qty.	U.K.	Euro	Z1	Z2
1-3	£0.50	£1.00	£1.50	£1.75
4-6	£0.75	£1.50	£2.00	£2.25
7-9	£1.00	£2.00	£2.50	£2.75
10-12	£1.25	£2.50	£3.00	£3.25
13-15	£1.50	£3.00	£3.50	£3.75
16-18	£1.75	£3.50	£4.00	£4.25

Euro-All EEC & Scandinavian Countries
Z1-Middle Eastern, Nth & 9th America & Canada
Z2-Australia, New Zealand, Japan etc.

Catalogue

S.A.E. (A5 Size) or International Reply Coupon.

New QL Hardware

QEP 3 EPROM Programmer:- Will program 2716 to 27512 5V MOS & CMOS Eproms. A4 Manual inc. £120.00p

Trump Card :- 768K RAM, Toolkit 2, Disk Interface, Dynamic RAM Disk, A4 Manual. £95.00p

ExpandeRAM :- 512K of RAM with thru port to connect other peripherals (i.e. Disk I/Face, Eprom Board). £45.00p

ExpandeRAM :- 0K of RAM, as above except User supplies RAM chips (8=256K, 16=512K). £20.00p

Twin 3.5in Disk Drives :- Fully cased with internal P.S.U., 720K formatted capacity per Drive. £100.00p

2nd User Hardware & Software

QL's (JS/JM).....From £45.00p
Disk Interfaces.....From £30.00p
Disk Drives (Twin).....From £75.00p
Printers.....From £55.00p
Monitors (Grn).....From £35.00p
Monitors (Colour).....From £75.00p
Used MDV's.....80p each
QL Related Books.....Half Price
QL World Back Iss.....75p each
QUANTA Back Iss.....40p each
All types of Commercial S/Ware including Games, Utilities, Front Ends etc. etc., too many to list.

Payment Methods

Cheques (in UK Pounds Drawn on UK Bank), Postal Orders, International Postal Orders payable to:- QUBBESoft P/D
Eurocheques payable to:- R.Dunnett
Cash in UK Pounds is also accepted.

All Prices Exclude P & P. Please Ring for details

IF AN ADVERT IS WRONG, WHO PUTS IT RIGHT?

We do.

The Advertising Standards Authority ensures advertisements meet with the strict Code of Advertising Practice. So if you question an advertiser, they have to answer to us.

To find out more about the ASA, please write to Advertising Standards Authority, Dept. X, Brook House, Torrington Place, London WC1E 7HN.



This space is donated in the interests of high standards in advertisements.

Bryan Davies
ventures gingerly
into GUI territory
for the QL.

INFORMATION

Program: Perfect Pointer Tools

Price: £29.95

Supplier: Digital Precision Ltd., 222 The Avenue, Chingford, London E4 9SE. Tel. (081)-527-5493

It may seem inappropriate that someone who doesn't express great enthusiasm for the QJump Pointer Environment should be reviewing Perfect Pointer Tools, a set of utilities based upon that user interface. The least that can be said is that my viewpoint isn't heavily biased in favour of the advertised product. In fact, the GUI (Graphical User Interface) approach to linking the computer user to the operating system and applications programs is definitely something that I am in favour of; it is just that I have considerable reservations about the way it has been implemented (on other computers as well as on the QL), so far.

Digital Precision also had reservations about the Pointer Environment, not least about the instructions (or lack of them) provided for the user. The PE seemed to be designed for, and sold to, people who know a fair amount about the inner workings of the QL, and its software; little consideration is given to the ordinary user. DP is much closer to ordinary users, and understands their wishes, and difficulties better. The Perfect Pointer Tools were written by Martin Berndt, in Germany, and subsequently taken up by DP and "productionised" to make them more suitable for DP customers. This becomes apparent, before the Tools are actually used, in the 19-page instruction booklet. The PE is sufficiently unusual in construction for it to be desirable to load the PPT, or

(at least) have the files accessible from a utility with a "view" facility, before starting to read the instructions in any depth.

The Things

The entry of Things, Guardian Mode, Zzzz buttons, Hot_Wake, and the like into an uninitiated user's life is not an event that can be taken lightly. The meaning in the mumbo-jumbo is hard to fathom, and DP had little choice but to take the language as it stood (TH_LOAD, ERT, HOT_STUFF, stuffer buffer etc.) and try to make it intelligible to the ordinary user. In this they have succeeded fairly well, although it is made clear that the supplied instructions do not set out to be a tutorial in the Pointer Environment.

As the name implies, these are "tools". They are not application routines in themselves, but are intended to make use of the QL more convenient. There is also a strong element of making computing more visually attractive and interesting. Windows are an integral part of any graphic interface, and they certainly enhance the screen display. Major application programs for the QL tend to work only "full-screen"; that is, they occupy the whole screen area, all of the time.

If you use only the one program nearly all the time, this is the way you will want things but, if you want to run several programs, you may want to know the status of more than one of them at any given time, and windows are required to achieve this

condition. The simplest, and commonest, example is a clock. You may run Quill all the time, but it would often be useful to have the date and time displayed at the same time as Quill. Although the basic QL is a multi-tasking computer, it is not set up to do such a simple thing as display (conveniently) a clock "on top of" an application program, and you have to either write your own routine to do this (most users won't be able, or willing, to do this) or buy a utility program such as PPT which has the function built-in.

Windows are of limited use if they cannot be altered in size and moved around the screen, to avoid one window obscuring important information that is in another one. Equally, it is little use have a windowing system if you find on returning to a previous window that parts of it have disappeared. A few years ago, it would have been sufficient for windows to be provided for passive functions, such as the clock, a Free Memory indicator, and a CAPS LOCK key status indicator, but it is now expected that GUIs provide active windows from which applications can be started, suspended, stopped, etc.

Restrictions

The program is available on cartridge or disk, and there is no restriction on its use in terms of the memory required. That is, a basic out-of-the-box QL should be suitable. You are advised that the program may not run too well on older versions of Qdos, such as the AH; even the JM version is

said to be marginal for PPT, which seems an undesirable restriction, in view of the large number of JM QLs that must still be in use. There are conflicts with some other software, and you may have to experiment with the order in which resident routines are loaded; for example, you are advised to load DP's Lightning before PPT. Those who wish to get more involved in the system of which the Pointer Environment is just part are advised to buy QPac 2 from Jochen Merz (or Software87, or DJC).

Two linked boot files are used to start PPT; the split boot is needed only by some versions of Qdos. The initial screen display includes the three standard SuperBASIC areas, with the cursor flashing in window 0 as usual. The larger windows display information, one giving the jobs currently loaded, their version numbers, and the job type; the other window displays jobs and the keys that activate them. This latter information was not self-explanatory to a user unfamiliar with QRam/QPac nomenclature and operation. You need to read the instructions to find out that the listed keys for jobs have to be hit with the Alt key held down.

ENTER, ESC and the Space Bar have special significance; ENTER will start a highlighted job running in its own window, ESC will kill-off the job you are currently "in" (but you can resurrect it subsequently), and the Space Bar will enable a "Thing box" (button) to be moved. At the top of the screen are a row of Thing boxes/buttons, to give access

POINTER TOOLS

to the PPT functions. You get to a button by repeatedly keying Ctrl+C, until the required button is highlighted. Pressing Enter causes the highlighted job button to be removed and a window opened with that job running in it.

The positions and colours associated with job buttons and windows are configurable, using the standard QJump Config routine (which is supplied). Windows can be moved and sized subsequently, from the keyboard or with a mouse. As is normal with GUIs, a mouse is a desirable device to have, but the same things can be done from the keyboard. It is simply a matter of ease of use, and the QJump environment in general feels better when a mouse is available. The mouse pointer sensibly changes to reflect the area it is in and there are a variety of well-constructed pointers, such as a pencil for the Font Editor window. The small clock pointer for the Digital Clock window tends to be rather irritating, in so far as it always shows the time as 12:48!

Clock puzzle

For some reason which didn't become clear during the review period, trying to activate the System Panel job resulted in the system (with JS rom and 2.31 Gold Card) locking up. This Panel is where you would enter details of system configuration, such as the printer port name, default program and data drives, and network devices.

The Digital Clock display is clear, and includes the date. It brought up a point which was unexpected - the displayed time didn't always change when the clock window was not the topmost (that is, current) one. As the QL's multi-tasking capability is perhaps its most-touted feature, by technically-minded enthusiasts, how come the clock isn't fully multi-tasking? In fact, the clock did keep running in some situations, and there was no obvious explanation for the inconsistent behaviour. Another shortcoming is that no facility is provided to change

the date or time from the Digital Clock window; you have to use SDATE from the Basic command line to do that.

The System Information window gives details of how memory is being used, and states how many Jobs are running and Channels are open. It also gives version numbers for Qdos, the Pointer Interface and the Window Manager. If the user obtains later versions of the PTR_GEN and WMAN files, these can be used instead of the supplied versions, but it might be necessary to make alterations to the boot file to allow for size changes in these files.

Font Editor

The Font Editor provides an 8x9-pixel grid for editing characters. You can construct new fonts, or re-design existing ones, so long as they are in the standard Sinclair format. The _QLS fonts from Professional Publisher are standard, as are the five _FNT files supplied with Perfect Pointer Tools, but the _FNT files from Professional Publisher use a larger grid and cannot be edited with Font Editor.

The Printer window has an extensive collection of settings, for three printer groups - (Epson) FX-800, Epson LQ and NEC LQ. Beware of making changes when a printer is not connected, as the program is likely to lock the QL up then. The bottom line of the window is a type-in area - you can enter lines of up to 80 characters here (including printer codes prefaced by \$) and send them directly to the printer. The setting areas are for justification, typeface, size, attributes, margins, line spacing, port, and such functions as perforation skip, line feed, form feed etc. You can choose to send CR alone, or CR plus LF, at line ends.

Unless the user digs more deeply, the foregoing is all there will be to be seen. Interesting, but limited in usefulness. What has to be done is study the instructions on the Hotkey functions. For general operations, Hotkeys are set up in the boot file, but

they can be set up during operations if desired. A Hotkey will enable a program to be run, according to specified parameters. The obvious example is Quill, which can be set to run without grabbing all the available memory. All programs attached to Hotkeys can be started by an Alt key combination (eg Alt+Q for Quill). Presumably partly because of this system, the standard ALTKEY function contained in disk interfaces appears to be killed off.

Programs which are Executable are handled differently from Basic programs, and there are three methods for making executable programs available one for permanently-resident programs, another for programs which you may want to remove during a session, and the third for programs to be loaded from disk. Provision is made for dealing with programs that do things which would upset the PPT system. For example, Turbo-compiled programs are classified as "Impure" (DP must love that!) because of the presence of self-modifying program code. To cope with this, a "spare" set of the code for such programs is loaded; that is, there is always one more set of code than there are copies of a Turbo-compiled program running, which makes for wasteful use of ram. Programs which are "Pure" have just the one set of code loaded, however many copies of the program are running.

Psion challenge

Most QL users are still Psion fans, and the famous quartet of programs present special problems for any management program. They tend to be memory hogs, trying to prevent any other programs (including their associates) from running simultaneously with them. The Hotkey system circumvents this nasty habit by doing much the same thing itself, grabbing all the memory from the start. When a Hotkey is specified for starting, say, Quill, the amount of memory to be made available to it can be specified. The Hotkey system is "mother" and applications programs have to do what

they are told. Those familiar with QRam/QPac will be aware that there is a Grabber routine to convert the Psion programs into well-behaved ones (as far as memory usage is concerned, anyway) and that can be used as an alternative to the Hotkey method, if QRam/QPac is installed.

The screen handling is done very nicely. Mouse pointer design and movement is good and the windows for the supplied jobs are sensibly constructed and consistently laid out. Windows re-appear promptly, and intact. The overall environment has considerable attractions for the technically-curious user, but may not appeal so much to users who want only to use applications and be able to switch between them. The new user needs to plough through much strange language to learn how to construct an appropriate boot file; Digital Precision has done a lot to make the subject comprehensible, but there was only so much they could do.

If you have a horror of writing even a few lines of Basic code, Perfect Pointer Tools may not be for you, if only because the essence of making a usable PPT set-up is creating a boot file which incorporates all the things you wish to be able to do when the system is running. Users with the necessary knowledge should be able to build themselves a capable set-up, allowing the running of all their favourite programs. The emphasis is to a large extent on presentation, and it must be said that the standard Qdos screen presentation is rather basic, and can do with some improvement.

POINTER TOOL

Henry Orlowski presents a step-by-step tutorial on using Easel, the graphic member of the Psion Quartet.

Easy with Easel

This is the first part of a series of articles, in which we look at possible applications for Psion *Easel* and try to increase its usefulness to the average QL user.

Easel is part of the original 'Psion Four' suite of programs that came bundled with the QL. It is a utility for drawing graphs, bar charts, or pie charts to provide a graphical means of presenting sets of figures.

Easel is one of those programs that we've all had a quick look at and agreed that it does some impressive things. The trouble is that it's not seen to be as useful as, say, a wordprocessor. We all need to write letters. Note the prevalence of wordprocessors for the QL in addition to *Quill*. There are *text87*, *Perfection*, a choice of editors, and all are popular judging by the number of letters and articles that appear about.

Even database programs like *Archive* have an immediate impact and use for details like addresses, telephone numbers and birthdays, and there are numerous other programs like *Datadesign*, *Archivist* and *Oflick* available to satisfy our needs.

Not just business

Easel however is perceived as only useful in a business presentation environment for sales or profits figures represented in a pictorial form. But we don't feel the need to send someone a bar chart of the daily temperatures on our holiday abroad. We'd rather write them a letter. Unsurprisingly, therefore there are not many alternatives to *Easel*, unless you count PC programs that you can run under *Conqueror*.

Even *Abacus*, the other 'business' program is now starting to get competition

from others, like *Qspread* from Jochen Merz.

But if *Easel* is not considered to be useful in a personal or home environment, it certainly is in the type of business presentation previously mentioned. You can use it to show your profits over the months, your sales, your market share trends, your reducing costs, your reducing workforce costs, your inventory levels, or your production figures.

Of course business people are busy, and it helps enormously to see figures in graph form. A picture is worth a thousand words, they say, and sometimes you need an appreciation of the trends or the relative comparisons between pieces of information rather than a set of figures, so that you can simply judge whether you're doing well or badly. A graph gives you an infinitely better feel for this than a table of figures.

If the above is true for a business or a research project, then it could make a useful contribution to a non-business application. Let's examine what sort of non-business applications *Easel* might be able to help in.

Home finance

The first that springs to mind is in the home or personal finance domain. As in

business, one is interested in income compared with outgoings or costs. As it's entirely possible that you get the same wage each week or

which may have put you over the limit? *Easel* can't of course rectify your finances but it might help you make sense of them. It might even let you see

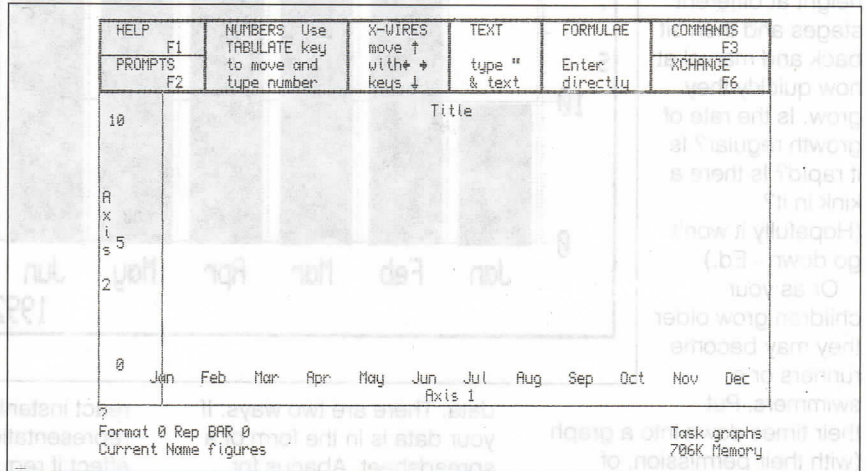

month there's no real point in seeing this as a graph, unless you like straight lines. But your outgoings can go up and down to an extent you don't always appreciate. With a graph you will be able to see this clearly.

Take food bills. Why are

the effect of budgeting for extraordinary items over a longer timescale, and demonstrate the improved cash flow situation that might result.

Many people follow major sports such as soccer or rugby or cricket. At the end of

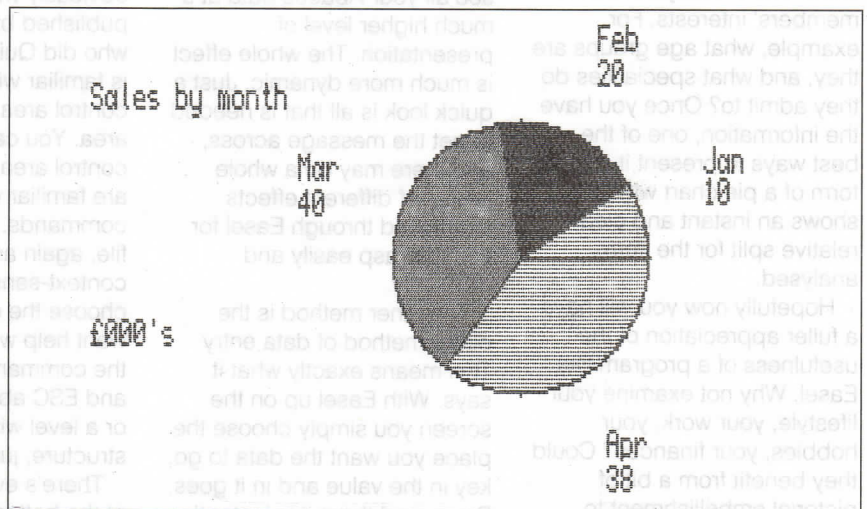

they more some months than others? If you can see the high spots then you may be able to relate them to the source of the problem. Are there any other items that put you in the red, unexpected costs such as an unforeseen car repair, or a large insurance payment

the season the supporter might like to view how the points were gained over the course of the season, with instant visibility of long runs of draws, losses or wins, and compare it with the team's last year's performance, side by side.

Personal statistics

Many of us also have children and we delight or otherwise at the progress they make. One of the most obvious signs of progress is in height gain. With Easel you could enter the child's height at different stages and then sit back and marvel at how quickly they grow. Is the rate of growth regular? Is it rapid? Is there a kink in it? (Hopefully it won't go down - Ed.)

Or as your children grow older they may become runners or swimmers. Put their times down into a graph (with their permission, of course) and view the progress. Is the rate maintained? Could it be faster? Only a pictorial display will make this clear and highlight any possible areas of potential improvement.

You might also run a local group, club or association. Most such groups perform some sort of analysis of their members' interests. For example, what age groups are they, and what specialities do they admit to? Once you have the information, one of the best ways to present it is in the form of a pie chart which shows an instant and clear relative split for the items analysed.

Hopefully now you will have a fuller appreciation of the usefulness of a program like Easel. Why not examine your lifestyle, your work, your hobbies, your finances? Could they benefit from a bit of pictorial embellishment to make you understand them more clearly? Let's have a quick look at what the program can do and how it works.

Data entry

The first thing you need to know is how to enter all your

data. There are two ways. If your data is in the form of a spreadsheet, Abacus for example if it was an accounts application, then you can export it from Abacus and subsequently import it into Easel. If you have *Xchange* then it is even simpler to move data from Abacus to Easel in one operation with the program doing most of the work for you. Suddenly you see all your Abacus data at a much higher level of presentation. The whole effect is much more dynamic. Just a quick look is all that is needed to get the message across, and there may be a whole gamut of different effects expressed through Easel for you to grasp easily and efficiently.

The other method is the direct method of data entry. This means exactly what it says. With Easel up on the screen you simply choose the place you want the data to go, key in the value and in it goes. Bang, and there it is instantly displayed on screen, as a bar against a scale for example. Do you want to put some text in the graph for a heading or some notes? Just choose the place and type it in. Some people call this 'interactive', because the result is exactly as your mind intended it. It also gives you the scope to

A Basic Bar Graph

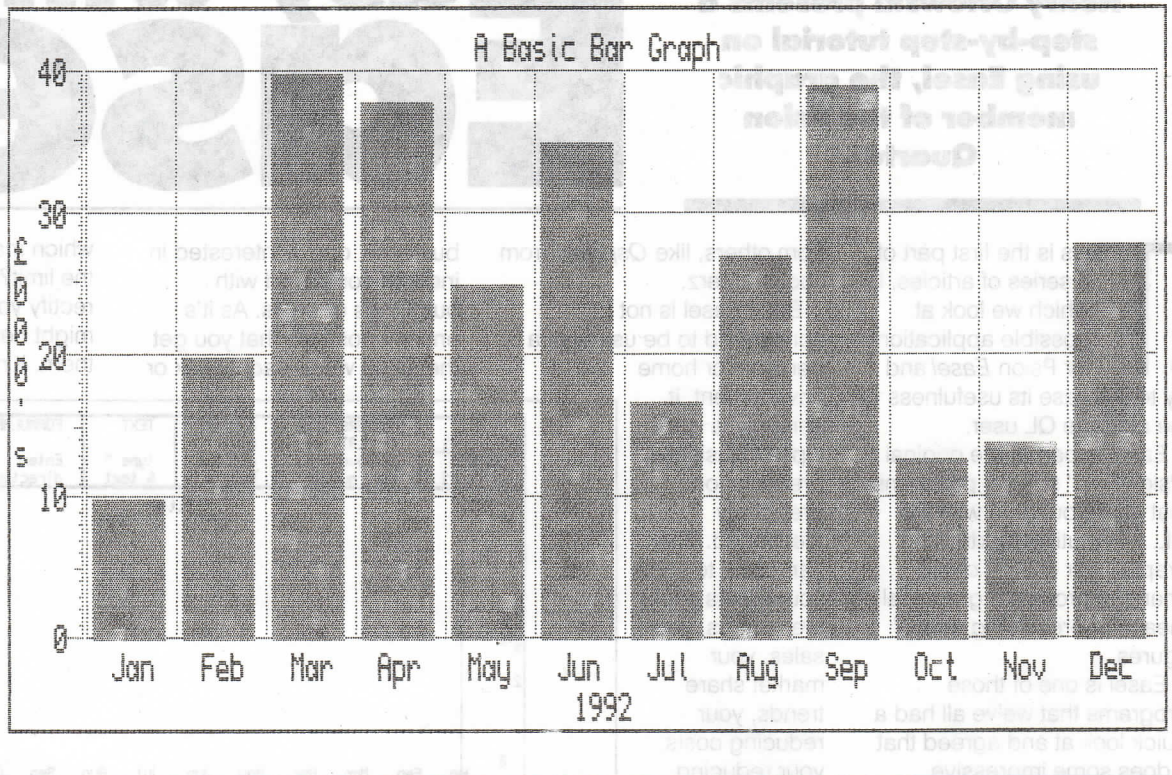

react instantly to a real representation and amend the effect if required. To you and me it just seems like the most sensible way of doing it anyway. This is the method we shall concentrate on in these articles.

Like Quill

At first glance, Easel is obviously written and published by the same people who did Quill, which everyone is familiar with. There is a control area and a display area. You can get rid of the control area with F2 once you are familiar with the commands. F1 calls up a help file, again as in Quill. It's not context-sensitive, but you can choose the exact item you want help with. F3 gives you the command menu, as Quill, and ESC aborts a command or a level within the command structure, just like Quill.

There's even a status area at the bottom of the screen which lists the basic settings you are currently within, again just like Quill. What is different is the look of the display area. Unlike a relatively blank screen as in Quill, you get the outline of a graph. This is what you enter your figures and text into for instant entry on screen.

Load up Easel and examine

the display. You will notice the crosswires on Jan. Press the right arrow key to see the vertical crosswire move. Now press the up cursor key to see the horizontal crosswire move. Press the cursor keys until the crosswires are in Feb. Then press TAB. See the crosswires move instantly to Mar. Keep pressing TAB and over they go a month at a time. Let's now get back to Jan. We do this by pressing Shift TAB until we get there.

You will see that some items are already included in the display for you. There is a title called Title, a horizontal axis called Axis 1, a vertical axis called Axis 2, a scale of 0 to 10 on the left hand side of the display, and a series of cells named Jan to Dec subdividing the horizontal axis. These are of course not fixed, and you will invariably have to change them to suit what you are doing. The cell names could possibly be of most use, since they represent the months of the year, and the horizontal axis is normally used to represent a time-scale. However it might just as easily be Mon, Tues, Weds, etc., or Week 1, 2 or 3.

Next month we will put items into the graph and build it up until we are happy that it looks like the graph we intended it to be.

One Man's System

Monday morning, and time to open the office for another week. When I say "office", I mean the spare bedroom at the top of the house. One of the advantages of working from home is that you don't have to commute very far. The week is already off to a good start. A little man in my head is working away with a hammer, punishing me for drinking with a few friends last night. I shall have to go and see my old friend the Marquis of Lansdowne. At least the barman will tell me whether I enjoyed myself enough to justify the suffering.

Sure signs

I know when it's Monday without consulting a calendar. All the envelopes in the post are those brown ones with windows, bearing more unreasonable demands for money. The rest are colourful efforts to tempt me to spend or invest the money that the brown envelopes keep insisting that I give to them. It really is remarkable how the bills seem to increase in direct proportion to my as-yet-unpaid invoices. How do they know?

Having consigned the bills to the pending tray and the circulars to the round grey one, it's time to boot the QL. Everything seems to be OK, so I use a slightly modified form of Phil Spink's excellent Taskforce multitasking routine (from DIY Toolkit) to load Quill and Archive, to start on the day's tasks.

It's unlikely that I'll be called upon to raise a camera in anger today, unless something miraculous happens (like a last minute plea from a desperate client), but I can always find plenty to do on the list of things I keep putting off "till tomorrow". According to the diary there are two outstanding invoices which require gentle reminders and one which is ripe for a Mark I stropmy letter. The first two are simple enough: all I have to do is run the start-up program in Archive and a menu appears offering me all the necessary options. Once the reminders are consigned to the printer

Alex Munden faces up to an interface disaster.

the next step is to select the mailmerge option, which loads a pre-formatted reminder letter and inserts the relevant details.

Custom Archive

Over the past six or seven years I have custom written all the programs I use in Archive, either from examples in the User Guide or modified from articles in QL World. This includes a mailmerge program, which I find extremely useful for "personalised" mailings. Everything is menu-driven, and each utility invokes facilities to modify or examine records, create job files and print out invoices and statements. There are also facilities to print out my income and expenditure ledgers and to prepare a passable income and expenditure summary for my accountant to massage before submitting the figures to the tax man.

However, one of my proudest achievements is a utility to convert the standard Archive date(1) format into a more acceptable form. Basically, it gives each day the correct suffix so that mailmerged letters look less obviously computer-produced. The program is long-winded, and I have no doubt whatsoever that it could be tidied up, but it works and it hasn't let me down yet.

The next task on the list is to finish a press release I've been working on for a client. As a freelance photographer I'm occasionally commissioned by clients to record some, to them,

newsworthy event. As a result, I'm often asked for my advice about what to say in the accompanying press release and where to send it. It seemed only sensible to sell this advice rather than give it away, so I now offer a limited PR facility on my list of services.

Press releases

I've always been a firm believer that an effective press release should be double spaced and cover no more than one side of an A4 sheet of paper. After all, most journalists have enough to do between lunches, so the more bumf they have to read, the less likely it is that they will show any spark of real interest. Quill, modified with TurboQuill Plus, suits this purpose well and I've also built up a useful selection of press contact lists in Archive which I use to mailmerge personalised copy. As a direct result, some of my clients have had some excellent press coverage.

Quill has also done sterling service in my efforts at short story writing, but the great novel has yet to come to fruition, even though I've been working on the outline for the past fifteen years. (Only fifteen? Ed.)

Once the press release is finished I shall be moving on to a slightly more ambitious project. Another client wants a publicity leaflet to advertise his services. The photographs have already been prepared and the copy has been written up, now all I have to do is design the layout for his approval before

passing everything over to the printers.

Envelope back

I have no doubt that it's possible to produce perfectly acceptable camera-ready artwork on a QL, provided one can afford the combination of one of the latest all-singing wordprocessors and a laser printer, but my budget is dictated by the rigours of the recession. For the time being, Page Designer 2 offers me the facility to do passable roughs for the printers to refer to, while they do the typesetting on their dedicated machines. It has worked before, although I won't pretend that it's easy to get the exact result I'm looking for and I'll probably end up doing a rough of the rough on the back of an envelope.

Life is certainly much easier since I got a Trump Card. When I first started using a QL I relied on microdrives as the storage medium, but I was soon restricted for space and supplies of cartridges were not getting any easier. As soon as I could afford it, I invested in Miracle's 512K Expanderam and a Cumana disk interface running twin 720K, 3.5-in Cumana disk drives. Although this resulted in the inevitable three-foot-long black box taking up most of my desk space, they served their purpose well enough.

I get through a fair number of disks during the course of a year, particularly as I keep two copies of everything as backup. The brand I normally use, which I buy from a well known high street catalogue store, has been very reliable, in fact the only two failures so far were disks from a large

Japanese corporation which also makes pretty good televisions and personal stereos!

Heavy use

The QL itself is a fairly late JS rom model, issue D17, and is the third unit I've had. The first two were returned under guarantee and I was almost beginning to believe that I was unlikely to get a fully working machine. I have followed Sir Clive Sinclair's somewhat chequered career since his first calculator and I invested in many of his earlier projects, such as the infamous Black Watch and various "hi-fi" amplifier and tuner kits, some of which actually worked. As it turned out, I've not had any major trouble with the unit since, despite having it in almost daily use. The keyboard has stood up well to the heavy pounding it gets, although the "E" is just beginning to show signs of bounce, which means the membrane is probably starting to wear out.

I also have to admit that there have been power supply problems, which really began after I fitted the expansion boards. I already had one of Tony Firshman's mains filter units, which cured a lot of problems, but the 7805 regulator IC had a tendency to overheat, which led to unpredictable crashes when the chip's shut-down temperature was reached. The first cure was to piggy-back a second regulator chip, but these were later replaced by higher rated versions.

Even so, there were still occasional problems and I eventually settled for a Q-Power switched-mode regulator. To judge from the discolouration of the chip when it was removed, it was still having to cope with a considerable load, but now the system runs much cooler and I don't think I've had a single crash since which couldn't be attributed to mains supply problems.

Psion uses

I continually upgraded the Psion programs while they

were available and I'm now on version 2.35, with version 2.38 of Archive. So far I have yet to find a use for Easel, but Abacus has been called into service for calculating prices on items like picture reprints, frames and albums. I can count on the fingers of one hand the number of commercial programs I have bought over the years, and most of those are file recovery or handling utilities. Having had my share of problems in the past with software and hardware suppliers, many of whom were well-known names on the QL scene that have since fallen by the wayside, I seldom resort to new software. Even then I prefer to buy from the long-established names.

The cut-down version of the toolkit in the disk interface seemed more than adequate for my needs at the time, despite any number of articles in QL World singing the praises of Toolkit II, but the main bugbear was the QFlash ramdisk. It's an excellent utility, which I used to load modified printer drivers, dedicated to each Psion program, so that I had instant access for printing. The problem was that I only had the microdrive version, which meant that I always had to make sure the master cartridge was in drive two when I started up, as part of their software protection routine.

Then, one fateful Monday morning (it always seems to be Mondays), everything seemed to boot up as usual so I loaded an important document into Quill for a rewrite and saved it back to disk. Then disaster struck - a request for another document produced the dreaded "no files found" message. This has happened to me before, once as a result of a power cut during the "hurricane", and again, almost a year later, as a result of a power surge during a thunderstorm, so I knew exactly what to do: insert the backup disk and start again. Then things began to get interesting.

Black hole

To this day I don't know exactly what happened, but

the backup disk became corrupted as well. I was probably too panicky to think clearly at the time, but a year's worth of Archive data files to vanish into a great black hole. Fortunately Chas Dillon's Recover program came to the rescue. I had written a utility which provided me with hard copy of the field names in all my Archive files, a key requirement if Recover is to be of any use, and after a couple of days of toil and sweat I managed to recreate a full set of records.

This time I was able to load another document but an attempt to replace it resulted in the same error message. Hoping that this was merely a software failure I returned to SuperBasic and attempted a directory. The error message this time was "not found" so I tried to format a blank disk, only to get "format failed". The answer was simple. Panic.

After a cup of strong black coffee, I reset the machine and booted up Media Manager Special Edition. This is a very powerful set of utilities but it needs to be handled with caution and patience. Having used the facility provided to make a byte for byte copy of the suspect disk onto a "clean" disk, it didn't take long to establish that both the map and directory were totally corrupted. At this stage I didn't dare take things any further. It was obvious that the interface was prepared to read disks but it clearly didn't want to write to them. There was probably something seriously wrong with the firmware and I couldn't risk further a corruption.

Cumana inspection

As the drives had been overhauled by Cumana only a few months previously it seemed sensible to give them a call to discuss the problem. If things had been interesting, they were now starting to get serious. My first contact at Cumana had heard of the QL roughly on the same terms as Mr Babbage's Analytical Engine. He passed me to a post-Victorian colleague. Sadly, the initial diagnosis was

none too promising, although he did offer to give the interface a thorough examination if I sent it to him.

Later the same day the service manager phoned me, but all he could offer was his sympathy. It seems Cumana no longer even possess a QL on which to test their products, and their stock of spare parts is so limited as to make any serious repair highly unlikely.

The day passed in a mood of severe depression. My budget is, as always, limited, so the prospect of a new system was out of the question. Adman Services were helpful but obviously couldn't do anything without seeing the offending part and meanwhile I had a box full of disks containing all my business data, correspondence and documents.

Inspiration

Then, in a moment of inspiration, I phoned Ron Dunnett at QubbeSoft. Not only did he have a replacement interface for sale, but as an alternative he was also in a position to make me an offer on a second-user (such a wonderful expression) late-model Trump Card. Within less than a week things had returned to something like normal. Not only does the new setup take slightly less room, but it's almost worth it for the "instant" dynamic ramdisk and the on-board printer buffer alone. My trusty Panasonic only has a 1K buffer, so the whole system was effectively suspended every time I wanted to print anything. Once I've had time to work my way through the manual I'm certain that the extra facilities made available by having the full version of Toolkit II will have other benefits too.

However, there will be plenty of time to get to grips with the rest of the Toolkit later. For the time being I'll press on with the jobs in hand. Apart from anything else, I recently received a letter from QL World asking for a few lines about my experiences. Heaven knows what I'll find to write about, but I'll think of something.

Perfected QLQ

A F Wilson needed a scientific font. He found Merz's QLQ printer font editor was the answer.

INFORMATION

Program: QLQ
Supplier: Jochen Merz Software, Im Stillen Winkel 12, W-4100 Duisberg 11, Germany.
Price: £21.00 plus postage and packing

Earlier this year I had a need for a WYSIWYG scientific wordprocessor. This required a science-friendly character set (Greek alphabet and some chemistry/maths symbols). Unfortunately, none of the current QL wordprocessors appeared suitable. However, with the aid of a new program QLQ (printer font editor and download utilities), a screen font editor, and *Perfection* wordprocessor (V3.00), I was able to solve my dilemma.

In the first instance, the scientific character set (or symbol set, or font) must be designed for QL screen output and saved to disk (in this case as SCIENCE_FONT). This was straightforward enough, as there are plenty of commercial and PD font editors available. To interface the scientific character set with *Perfection* required overwriting one of the four WYSIWYG screen fonts - standard, italics, subscript and superscript. In this case, *Perfection's* ITALIC_FONT was chosen for overwriting (may I include here the necessary warning to anyone carried away with enthusiasm - you must, of course, NEVER use the original program disk for this kind of editing) with the scientific character set (SCIENCE_FONT). The new character set was mapped as Ascii codes 32 to 127, resulting in full WYSIWYG screen output.

Printing

However, printing these special characters or symbols to my 24 pin STAR LC24-200 printer was more of a challenge. A quick scan of *QL World* adverts, in particular the software from Jochen Merz in Germany, resulted in the purchase of QLQ, a 24-pin letter-quality printer font-editor. QLQ includes 14 additional downloadable LQ printer fonts. When you consider that a single rom font card for the Star LC24-200 costs £25 plus VAT, then QLQ has to be considered the bargain of the year at only £21. The second scientific character set was duly designed for printer output in elite mode and saved to disk as SCIENCE_QLQ.

The printer 'DIP or EDS' switch for ram usage was changed from Input buffer mode to Download buffer mode (refer to your printer manual). Next, the printer driver for the wordprocessor has to be modified. The italics ON control code (27,4) in *Perfection's* Epson printer driver was replaced with the control code for selecting LQ elite download character set (27,73,14). The Italics OFF control code (27,5) was replaced with select rom character set (27,37,0). The rom character set setting reverts the printer back to using the built in rom fonts. LQ elite was used in the example above, however, LQ pica (27,73,6) or LQ proportional (27,73,7) are also permissible.

Strips

Perfection not only allows WYSIWYG screen output, it also allows special markers called STRIPs to be embedded into the document. The STRIP markers alter the ink/paper of the text marked to signify non-WYSIWYG screen output. These STRIP markers are translated into printer control codes at print time. The main advantage of STRIP markers are that they can take advantage of special printer functions which are not available as screen output like shadow, outline, italics, double height, double strike, etc. Although italics screen output was sacrificed in favour of the science font, italics can still be accessed via the STRIP and printer functions. STRIP strings 1 and 2 of the printer driver were redefined as italics on (27,4) and italics off (27,5) respectively. The modified printer driver was saved to disk as SCIENCE_DATA.

Lastly, as I have the full QPTR environment, *Qpac2*, I was able to define a number of applications (*Perfection*, *Download*, *Font_Editor*, etc.) as Buttons (text icons). I was now ready to use the combination of *Perfection* and QLQ as a 'pseudo' scientific wordprocessor. The SCIENCE_QLQ font was loaded into the QL's ram with LQ_load, and then downloaded to the printer using the DOWNLOAD button. *Perfection* was loaded using the PFN button. The test document was loaded into *Perfection*, and then the

Figure 1: Download to Printer

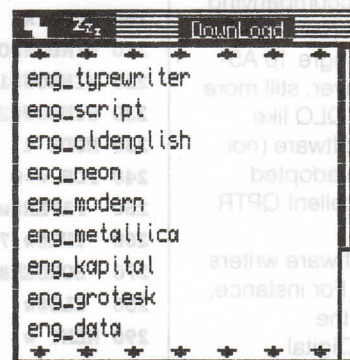

SCIENCE_DATA printer driver was installed. The resulting printed document was quite spectacular.

Interfacing

The process outlined above and summarised below should help point the way for those wishing to interface specialised fonts/symbols with their wordprocessor without sacrificing screen and printer WYSIWYG output. If WYSIWYG screen output is not required, then redefine Perfection's STRIP strings in the printer driver as LQ elite or LQ pica or LQ proportional, download character set for ON and rom character set for OFF. There is no need this time to overwrite or redefine Perfection's italics.

1. Design and save screen font (_font)
2. Design and save printer font (_qlq)
3. Modify and save printer driver (_data)
4. Printer switched to download buffer mode
5. LQ_load_qlq into the QL's ram
6. DOWNLOAD_qlq to printer
7. Load Perfection
8. Load printer driver
9. Send document to printer

Download utilities

QLQ is an acronym for Q-Letter Quality. It's a 24-pin printer font driver (see **Figure one**) and editor (see **Figure two**). QLQ contains 14 new LQ fonts and NOT 12 as stated in the manual, QPTR extensions, LQ SuperBasic extensions, demo program and boot file. The documentation accompanying the QLQ software (on 3.5in disk) is only a meagre 10 A5-size pages, however, still more than sufficient as QLQ like most European software (not including the UK) adopted Tony Tebby's excellent QPTR interface.

Why are UK software writers not using QPTR? For instance, can you imagine the transformation if Digital Precision's flagship desktop publisher, Propublisher, had a

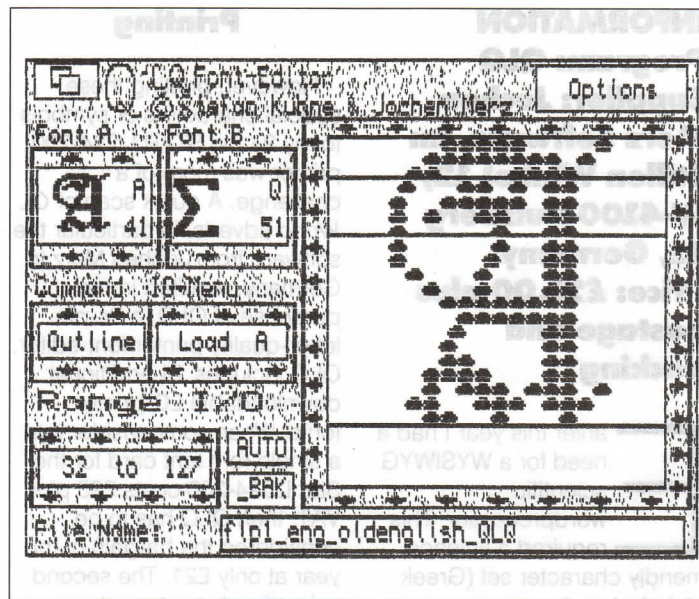

good interface! For example, the Qdesign graphics program has set a new standard for all QL software. Not only is Qdesign a superb piece of software, it is also the best implementation of a WIMP interface on the QL that I have seen. The phenomenal success of WIMP-based software for the Apple Macintosh and Microsoft's Windows for the IBM PC compatible market supports the view of many QL users that Tony Tebby's QPTR interface or something even better is crucial to the continuing prosperity of the QL.

Politics aside, QLQ adds

eight new commands to SuperBasic: LQ_init, LQ_dev, LQ_load, LQ_list, LQ_remv, LQ_remvall, LQ_download and TH_FIX. These commands are discussed briefly in the manual with some examples, however, it is best to look at the listing of the program DEMO_bas for more detail. Most 24-pin printers are fitted with either 7K or 8K of ram. This ram can either function as a input buffer (accepting Ascii codes) or as a downloadable font buffer (accepting character definitions). The 24-pin printer must be set to font or download mode (refer to your Printer manual).

Listing 1: English QLQ Boot Program

```

100 REMark ** boot_QLQ_english **
110 dev$='flp1_'
120 :
130 REMark
140 a=RESPR(14638):LBYTES dev$&'ptr_gen',a :CALL a
150 a=RESPR(10100):LBYTES dev$&'wman',a :CALL a
155 a=RESPR(12000):LBYTES dev$&'HOT_rext_english',a:CALL a
160 a=RESPR(2250) :LBYTES dev$&'LQ_rext',a :CALL a
165 a=RESPR(17754):LBYTES dev$&'MENU_rext_english',a:CALL a
170 :
180 REMark
210 WINDOW#0,256,42,0,214
220 WINDOW#1,258,224,254,32
230 WINDOW#2,256,183,0,32
235 MODE 4
240 FOR w=0 TO 2
250 PAPER#w,0
260 INK#w,7
270 BORDER#w,1,4
280 CLS#w
290 NEXT w
300 :
310 EXEC dev$&'DOWNLOAD_english'

```

The fonts

The QLQ disk contained two versions of QLQ, in English and German. The English fonts were all prefixed: for example, 'eng_oldenglish_qlq'. However, the extensions HOT_rext, MENU_rext and the utilities DOWNLOAD, FONT_EDITOR were all suffixed with _english, for example 'DOWNLOAD_english'. A common suffix would have made copying files easier with the TK2 command WCOPY. The lack of an English boot program was an important omission, particularly for novice users. The novice, not knowing of the existence of two versions, would probably end up running the default German version. Listing one rectifies this omission. Note that the RESPR size of Menu_rext is 17754 for the English version and 17500 for the German version. An English version of DEMO_bas was also omitted.

As already stated, QLQ has adopted the QPTR interface, so it came as no surprise that DOWNLOAD was available as a button (text icon). The inclusion of the SuperBasic extension TH_FIX ensured that

every Thing had been installed. The QPTR version of the SuperBasic extension LQ_Download was DOWNLOAD. DOWNLOAD was initialised using EXEC flp?_download_english. DOWNLOAD, as its name suggests, downloads fonts to the printer. However, before a font can be downloaded, it first has to be loaded (LQ_Load) into the QL's ram. The button version of DOWNLOAD lists all LQ_Loaded fonts on execution, see Figure one.

Figure three illustrates the results achieved with downloadable fonts. You will have probably noticed from the printouts that the QLQ extra fonts are all proportionally spaced,

Book Page

Filling in the details on Qdos

Title: *The Sinclair Qdos Companion*

Author: Andrew Pennell

Publisher: Sunshine Books, 1985

Price: £6.95

Available: Second Hand and Fairs

QL-specific: Yes

This book is a guide to the Qdos operating system for readers familiar with 68000 or 68008 machine code. Unlike other titles on this subject, it does not rehash Tony Tebby's 1984 Qdos manual; I have it at hand whenever I program the QL.

Andy Pennell is a star QL programmer, the author of Hisoft's MonQL and Devpac Assembler. In order to write this book he worked his way through the QL rom and early documentation, testing system routines and recording his findings. It is full of practical information and advice absent from other books.

The Qdos Companion is a guided tour of the QL rom, arranged in logical order by subject, rather than the arbitrary sequence of system traps and vectors. I much prefer this organisation, which allows for full explanation and fills in the gaps, covering data-structures and concepts as well as Traps and Vectors.

Diagrams, tables and assembly-code examples are sprinkled through the text, which is well-written with useful discussion and historical notes, and little duplication of material.

The Qdos Companion has nine chapters. After an introduction to Qdos come guides to Multi-tasking, the second processor, generic Input/Output and built-in device drivers. The exact

action of each 'open' and 'close' routine is explained, with protocols and offsets for those who like to tweak channel definitions.

Later chapters discuss supervisory functions like Exceptions, Interrupts and the Task Scheduler. Pennell explains the system lists and tables, how to add external roms and devices, and how to turn off Qdos to use the second screen, listing facilities that still work with Qdos disabled.

A chapter on Qdos utilities explains general routines like the clock, message, memory and base conversion functions. Another covers the tables and routines of the SuperBasic interpreter, with a correction for the 'CALL' bug on early roms and CAT and QDOS\$ extensions as examples, but nothing about tokenisation.

Appendices list Ascii and error codes, plus SuperBasic and Qdos system variables in order. The Qdos list has hex and decimal addresses, assuming the usual base of 163840. Trap calls and vectors are tabulated alongside the page number of the relevant explanation, aiding disassembly as well as original programming.

The Qdos Companion was based on a disassembly of the JM rom, pre-dating disks and extra features added for JS and MG, but it gives a broad overview and many details lacking from other Qdos books. If you program the QL in machine code the Qdos Companion is worth having, whatever books you already own.

Simon N Goodwin

QL-specific assembler reference

Title: *Assembly Language*

Programming on the Sinclair QL

Author: Andrew Pennell

Publisher: Sunshine Books, 1984

Price: £7.95

QL-specific: Yes

This was Andrew Pennell's first QL book, and works well as a prelude to the Qdos Companion for those new to QL machine code but familiar with assembly language, perhaps on earlier micros. It must compete with bulkier guides to 68000 code, but has the advantage that it is specific to the QL, while contrasting the 68008 with other 68000-family chips.

Sunshine Books are cheaply bound and the 'perfect binding' at the spine soon breaks, shedding pages, but the paper is strong with ample margins. I have opted to have the spine replaced with a comb binder - most print shops can do this for about 50p.

The book starts by explaining the QL hardware and memory organisation, followed by notes on number bases and processor 'addressing modes', with SuperBasic equivalents. I still refer regularly to the chapter on 'Condition Codes, Branching and Arithmetic', which clearly explains the many ways to shift and compare values.

QL-specific code examples include routines to print text and numbers, scroll the screen, poll keys and plot pixels in each display mode, plus a multi-tasking TRACE for Basic. These simple examples range in size from 4 to 136 bytes and make little use of Qdos, but they are a good start and allow useful programs to be written, with or without an assembler.

Assembly Language Programming introduces the

entire 68008 instruction set. It goes into detail, showing the function of each bit in every instruction, and doubtless helped Andy to write his Assembler and Monitor.

An alphabetic guide to 68008 instructions forms a third of the book, including notes on usage, possible pitfalls and fast alternatives. All the instructions are covered, but the dividend in DIVS and DIVU is wrongly stated to be 16 bit (actually 32 bits) and there are no timings for individual instructions.

The last section lists and documents a well-structured Basic disassembler which converts memory contents into 68008 code mnemonics. A tiny machine-code routine boosts the speed by a factor of about four times, and another allows Basic SElect statements to be re-coded in fast assembler.

Simon N Goodwin

Making Archive more user-friendly

Title: *The Archive Users' Reference Manual*

Author: Stephen Morris

Publisher: Glentop

Price: £14.95

Available: Currently

QL-specific: No

The Archive Users' Reference Manual by Stephen Morris is part of a series of reference manuals. The others include Quill and Abacus. The series is not QL specific, but actually deals with Psion's Xchange, and the various computers which can use it. The difference between individual elements of Xchange and the Psion suite is not great, and the book is relevant to stand-alone Archive users.

The book runs to 22 pages and is nicely put together, effectively bound with a spiral

ring binder which is covered in a semi-hard plastic cover. This means that it can be laid flat, fitting in with the reference nature of the series.

Part 1 covers 'Your computer and Archive', and deals with the basic of using a computer and such issues as computers that can use Archive and the relevant ways each computer (eg the OPD, Tonto and the QL) use Archive.

Part 2, 'Using Archive', covers the opening and closing of files, designing a screen layout, entering and editing data, selecting, searching and sorting data, and management and housekeeping commands. Commands are dealt with in the same format throughout the book by listing the command, then its effect, options and how to use it, followed by comments. These headings are listed clearly on the left half of each page with the text taking up the right half. The writing style is clear and easy to follow, with all the terms fully explained.

Part 3, 'Printing with Archive', deals with installing the printer. Printer codes, Ascii tables and install_bas or printer driver files, are all dealt with in reasonable step by step detail. Commands for printing (eg Dump, Spoolon and Lprint) are then described along with the use of varying typefaces. Printer faults are listed in the same format as commands, with the fault, the reason for it, and possible remedies well laid out.

Part 4, 'Programming with Archive', discusses the use of variables, which are described with the book's usual clarity, followed by chapters on writing a program and program flow which show the reader how to integrate the various commands into usable code. While this section is good, I thought that it did not fully cover the subject.

The section on Functions is straightforward in naming the function, listing its arguments, its effects and an example. The other section, which I thought a little weak, is 'Dealing with Errors'. Discussion on the nature and cause of errors takes place with examples of the trace and

error commands. One procedure, dealing with validation of a field's contents, is included but more on this area would have been welcome.

Chapter 20 deals with importing and exporting to the other Psion programs, and although it talks to Xchange users, it is useful to the Psion suite user.

The section on the Task Specification Language (TSL) is specific to Xchange users. TSL is a macro program feature of Xchange, which can be written in any text editor that produces Ascii code. Programs basically consist of the codes for a series of keystrokes and when the program is executed, the keystrokes are 'invisibly' performed so that, for example, Archive is loaded and an application is run. Brief examples of TSL programs are given.

The book finishes by re-enforcing its reference style with a five-page Glossary and a six-page Index. Overall the book is novice to intermediate level. There are many QL users who shy away from Archive and yearn for an easy database, but is there such a thing? All software takes time and effort to get the most from. Archive is a powerful database and this book goes a long way towards making it more user-friendly.

David McCullagh

Think big with Psion software

Title: *Developing Applications on the Sinclair QL - Practical Ideas for Home and Business Use.*

Author: Mike Grace

Publisher: Mike Grace

Publisher: Sunshine Books (Scot Press) 1984

Price: £6.95 in 1985

Available: Fairs and second-hand

QL Specific: Yes

If you've never believe that using a computer was meant to be fun as well as productive, then Mike Grace's infectious enthusiasm for the QL and the bundled software might just change your mind.

Grace stresses that it's no

good having powerful software unless you understand how that software works and, more importantly, how to apply it. Otherwise, it's rather like using a Ferrari to drive around to the corner-shop for a pint of milk.

Having said that, I must take the author to task for his misleading title. The book is concerned only with the Psion software, and makes no reference to SuperBasic. Also, to judge by the examples he provides for each of the Psion packages, there is a very wide spectrum of meaning to his use of the word 'application'.

Grace rightly points out that the strength of the Psion software is that you can use it straight away without the tedium of learning to program. He lists a while range of possible uses for student, home-users, club secretaries, part-time businesses and self-employed people - in short, anyone with a QL, although he does caution that some things are better done on paper than on computer. The emphatic message is: QL computing is for you!

The book is divided into five sections covering a general introduction to the QL and Psion software, and each of the bundled software packages Quill, Abacus, Archive and Easel. Grace relies on the reader to cross-reference with the User Guide - the main weakness of his book - and he does not attempt a comprehensive description of all the commands.

The longest section deals with Quill, where the author encourages flair and creativity rather than viewing it merely as a kind of electronic typewriter. His account is comprehensive enough to enable the reader to use it effectively. However, the text needs to be read with the improvements of Version 2.35 in mind.

The section of Abacus is thorough and stimulating with interesting comments on the User Guide examples, together with several of his own applications. There is a useful table of the most commonly-encountered Abacus commands and functions, and an illustration of the use of several of the more

esoteric ones, like ave() and if(). However, Grace's diary/schedule-planner application is a good example of his own injunction that some things are better done on paper!

The section of Archive covers most of the commands and functions, illustrated by some simple database applications. His advice on the opening and closing of Archive files is misleading as database files are always at risk while they are open (as opposed to being looked at) even if they have been closed at some previous time. Grace does a particularly effective bit of soap-box shouting at the end of this section on how really good a computer the QL is. Unfortunately, the book starts to thin out a good deal from this point on.

Grace, like most other people, raves over Easel and what he calls its incredible flexibility, but you'll need to study the User Guide in much more detail than for the other Psion packages to get the full benefit of this.

At the end of the book, there is a glossary of both general and QL-specific jargon terms followed by a summary of chapter contents. Overall, there are few niggles with a book which is clearly laid out and written in a fresh and unpatronising style.

For anyone who has not dared to think big with their Psion software or finds the User Guide too daunting, then I would recommend getting your hands on it.

David McCullagh



FREE! ZOO!

**SOFTWARE PACK
WHEN YOU BUY AN AMIGA
FROM SILICA**

PLUS!

GFA BASIC +
PHOTON PAINT 2

£265

TOTAL VALUE OVER



Silica are pleased to offer THE Software Pack of the Year FREE with every Amiga purchased at normal Silica prices. It includes the sensational new title ZOO! which has received rave reviews as the most original game ever seen on the Amiga.
ZOO! - "Knocks the socks off Sonic." - 97% - Amiga Computing - Nov '92
STRIKER - "Footballer of the Year - and no mistake..." - 94% - CU Amiga - June '92
PINBALL DREAMS - "It's quite simply superb" - 94% - AUI - Sept '92
TRANSWRITE - Premier word processor (UK version) with a 90K spell checker. Plus, with every Amiga from Silica, we will give you Photon Paint 2 paint package and GFA Basic programming language. A total of over £265 worth of free gifts.

ZOO! PACK:
 ZOO! - platform title of the year..... £25.99
 STRIKER - soccer simulation..... £25.99
 PINBALL DREAMS - pinball simulation..... £25.99
 TRANSWRITE - word processor..... £49.95

PLUS!
 GFA BASIC v3.5 - programming language £50.00
 PHOTON PAINT 2 - paint package..... £89.95
£267.87

AMIGA 600

with **FREE!**



AND



PLUS!



The new Amiga 600 uses state-of-the-art surface mount technology, for maximum reliability and features a 3 1/2" floppy drive, mouse, TV modulator and smart card slot all as standard. The innovative smart card slot accepts games, ROM or RAM cards (from 1Mb up to 4Mb) and will take advantage of many future new developments. The very latest version of the operating system, Kickstart/Workbench v2.05 is used in the Amiga 600 and its enhanced chip set facilities include improved graphics resolution, increased genlock support and the facility for up to 2Mb of chip memory. The Amiga 600 is fully compatible with the A670 CD-ROM Drive and Interface which will give it access to a full range of CDTV titles and audio CDs. The Amiga 600 is available from Silica in several configurations including a special 2Mb RAM upgrade optional extra - see the chart below.

A600 + LEMMINGS + DPAINT III

£299

INC VAT - Ref: AMC 0666

NEW! AMIGA 1200



£399

INC VAT - Ref: AMC 1200

- Motorola 68020EC Processor
- 14.19MHz Clock Speed
- 32-bit Architecture
- 2Mb Chip RAM Standard
- Amiga DOS v3.0
- AA Chip Set for Enhanced Graphics
- 16 Million Colour palette
- 2-256 Colours on Screen
- 1 x 32-Bit CPU/RAM Expansion Slot
- PCMCIA Smart Card Slot takes 512K - 4Mb PC Cards
- Built-in TV Modulator
- 96 Key keyboard with Numeric Keypad
- 2 1/2" Internal Hard Drive Optional Extra
- 1 Year On-site Maintenance

NEW! AMIGA 600 PACKS

WILD, WEIRD & WICKED EPIC 'HARD DRIVE' PACK



The Wild, The Weird and The Wicked (WWW) is the title of Commodore's new Amiga 600 games pack. Priced at £349, it comes complete with Amiga 600 computer and mouse, plus a range of high quality entertainment software. For pack contents, plus a list of the FREE gifts from Silica with every Amiga 600, see the chart on the right.

£349

INC VAT AMC 0649



For the more serious user, the £499 Epic Language Pack is based around the A600HD, the A600 with 20Mb hard drive. It includes challenging adventure games and software for the linguistically minded! Details are shown on the chart on the right along with a list of the FREE gifts from Silica with every Amiga 600 purchased.

£499

INC VAT AMC 0799

NEW LOW PRICE!

AMIGA 500 Plus CARTOON CLASSICS



- PACK INCLUDES:**
- THE AMIGA 500 PLUS..... £399.99
 - BUILT-IN 1Mb DRIVE..... FREE
 - A620 TV MODULATOR..... FREE
 - THE SIMPSONS..... £24.99
 - CAPTAIN PLANET & THE PLANETEERS..... £25.99
 - LEMMINGS..... £25.99
 - DELUXE PAINT III..... £79.99
- PLUS! FREE FROM SILICA**
- ZOO! PACK..... £127.92
 - PHOTON PAINT v2.0..... £89.95
 - GFA BASIC v3.5..... £50.00
- PACK VALUE: £824.82**
PACK SAVING: £545.82
SILICA PRICE: £279.00

We are pleased to offer the original 1Mb Amiga 500 Plus (Kickstart/Workbench v2.04), including a built-in 18-key numeric keypad and Cartoon Classics software at a new low price of £279 (previous Silica Price £299). The Amiga 500 Plus can be upgraded, using any of the hundreds of peripherals that are now available, which include the award winning range of GVP hard drives. GVP peripherals can also provide PC emulation, additional RAM expansion, processor acceleration and extra hard drive storage space. There is also a wide range of expansions which give the A500 Plus higher resolutions and more colour and genlocking capabilities.

1Mb A500 PLUS CARTOON CLASSICS

£279

INC VAT - Ref: AMC 0592

AMIGA 600 COMPUTER OPTIONS

- 1Mb AMIGA 600 + MOUSE, 3 1/2" Disk Drive, TV Modulator, Smart Card Slot
 - 20Mb HARD DISK - Very fast, mass storage for programs and data
 - DELUXE PAINT III - Award winning graphics and animation package
 - LEMMINGS - Save the Lemmings as they drop into 100 screens of danger
 - MICROPROSE GRAND PRIX - Racing Sim with all the thrills & spills of the track
 - SILLY PUTTY - The pliable arcade game of immense playability
 - PUSH OVER - A game of puzzles. Get Col Ant save Colin Curry's Quavers?
 - EPIC - A Sci-Fi adventure. Can you guide a space fleet across the solar system?
 - ROME - Your goal is to become Emperor in this role playing adventure
 - MYTH - Can you stop the spread of evil and question the judgements of the gods?
 - TRIVIAL PURSUIT (in 3 languages) - The great trivia quiz game for the Amiga
 - WORD PROCESSOR + DICTIONARY (in 5 languages) - For creating documents
 - 1 YEAR ON-SITE WARRANTY
- PLUS! - FREE FROM SILICA**
- ZOO! PACK - Four top Amiga titles - see panel above
 - PHOTON PAINT v2.0 - An art package with numerous features & special effects
 - GFA BASIC INTERPRETER v3.5 - A language for programmers of all levels

	NO HARD DRIVE	20Mb HARD DRIVE	
	'LEMMINGS'	WWW PACK	EPIC PACK
• 1Mb AMIGA 600 + MOUSE, 3 1/2" Disk Drive, TV Modulator, Smart Card Slot	£299.99	£299.99	£299.99
• 20Mb HARD DISK - Very fast, mass storage for programs and data	-	-	£299.00
• DELUXE PAINT III - Award winning graphics and animation package	£79.99	£79.99	-
• LEMMINGS - Save the Lemmings as they drop into 100 screens of danger	£25.99	-	-
• MICROPROSE GRAND PRIX - Racing Sim with all the thrills & spills of the track	-	£34.99	-
• SILLY PUTTY - The pliable arcade game of immense playability	-	£25.99	-
• PUSH OVER - A game of puzzles. Get Col Ant save Colin Curry's Quavers?	-	£25.99	-
• EPIC - A Sci-Fi adventure. Can you guide a space fleet across the solar system?	-	-	£29.99
• ROME - Your goal is to become Emperor in this role playing adventure	-	-	£25.99
• MYTH - Can you stop the spread of evil and question the judgements of the gods?	-	-	£19.99
• TRIVIAL PURSUIT (in 3 languages) - The great trivia quiz game for the Amiga	-	-	£29.99
• WORD PROCESSOR + DICTIONARY (in 5 languages) - For creating documents	-	-	✓
• 1 YEAR ON-SITE WARRANTY	-	-	✓
PLUS! - FREE FROM SILICA			
• ZOO! PACK - Four top Amiga titles - see panel above	£127.92	£127.92	£127.92
• PHOTON PAINT v2.0 - An art package with numerous features & special effects	£89.95	£89.95	£89.95
• GFA BASIC INTERPRETER v3.5 - A language for programmers of all levels	£50.00	£50.00	£50.00
TOTAL PACK VALUE:	£673.84	£734.82	£972.82
LESS PACK SAVING:	£374.84	£385.82	£473.82
SILICA PRICE:	£299	£349	£499
2Mb RAM	PRICE OF UPGRADE TO 2Mb RAM WITH BATTERY BACKED CLOCK	+	+
		£45	£45
		RAM 0610	RAM 0610

ALL PRICES INCLUDE VAT - DELIVERY IS FREE OF CHARGE IN THE UK MAINLAND

SILICA SYSTEMS OFFER YOU

- **FREE OVERNIGHT DELIVERY:** On all hardware orders shipped in the UK mainland.
- **TECHNICAL SUPPORT HELPLINE:** Team of technical experts at your service.
- **PRICE MATCH:** We normally match competitors on a "Same product - Same price" basis.
- **ESTABLISHED 14 YEARS:** Proven track record in professional computer sales.
- **£12 MILLION TURNOVER (with 60 staff):** Solid, reliable and profitable.
- **BUSINESS + EDUCATION + GOVERNMENT:** Volume discounts available 081-308 0888.
- **SHOWROOMS:** Demonstration and training facilities at our London & Sidcup branches.
- **THE FULL STOCK RANGE:** All of your requirements from one supplier.
- **FREE CATALOGUES:** Will be mailed to you with offers + software and peripheral details.
- **PAYMENT:** Major credit cards, cash, cheque or monthly terms.

Before you decide when to buy your new Amiga computer, we suggest you think very carefully about WHERE you buy it. Consider what it will be like a few months after buying your Amiga, when you may require additional peripherals or software, or help and advice with your new purchase. And, will the company you buy from contact you with details of new products? At Silica Systems, we ensure that you will have nothing to worry about. We have been established for almost 14 years and, with our unrivalled experience and expertise, we can now claim to meet our customers' requirements with an understanding which is second to none. But don't just take our word for it. Complete and return the coupon now for our latest FREE literature and begin to experience the "Silica Systems Service".

MAIL ORDER HOTLINE 081-309 1111

SILICA SYSTEMS

MAIL ORDER: 1-4 The Mews, Hatherley Rd, Sidcup, Kent, DA14 4DX Tel: 081-309 1111
 Order Lines Open: Mon-Sat 9.00am-6.00pm No Late Night Opening Fax No: 081-308 0608

LONDON SHOP: 52 Tottenham Court Road, London, W1P 0BA Tel: 071-580 4000
 Opening Hours: Mon-Sat 9.30am-6.00pm No Late Night Opening Fax No: 071-323 4737

LONDON SHOP: Selfridges (1st floor), Oxford Street, London, W1A 1AB Tel: 071-629 1234
 Opening Hours: Mon-Fri 9.30am-7.00pm (Sat close 6.30pm) Late Night: Thursday - 8pm Extension: 3914

SIDCUP SHOP: 1-4 The Mews, Hatherley Rd, Sidcup, Kent, DA14 4DX Tel: 081-302 8811
 Opening Hours: Mon-Sat 9.00am-5.30pm Late Night: Friday - 7pm Fax No: 081-309 0017

ESSEX SHOP: Keddies (2nd floor), High Street, Southend-on-Sea, Essex, SS1 1LA Tel: 0702 462463
 Opening Hours: Mon-Fri 9.30am-5.30pm (Sat 9.00am-6.00pm) No Late Night Opening Fax No: 0702 462365

To: Silica Systems, QLW-0293-80, 1-4 The Mews, Hatherley Rd, Sidcup, Kent, DA14 4DX

PLEASE SEND A 64 PAGE AMIGA COLOUR CATALOGUE

Mr/Mrs/Miss/Ms: Initials: Surname:

Company Name (if applicable):

Address:

Postcode:

Tel (Home): Tel (Work):

Which computer(s), if any, do you own? 80J

... E&OE - Advertised prices and specifications may change - Please return the coupon for the latest information.



SUBSCRIBE TO SINCLAIR QL WORLD AT LAST YEARS PRICES AND SAVE ££££££'S

UK
£23.40
(12 MONTHS)

EUROPE
£32.90
(12 MONTHS)

**REST OF
WORLD**
£40.90
(12 MONTHS)

PLEASE SEND YOUR
SUBSCRIPTION FORM TO
SINCLAIR QL WORLD,
THE BLUE BARN, TEW LANE,
WOOTTON, WOODSTOCK,
OXON. OX71HA.
TEL:0993 811181
FAX:0993 811481

I WISH TO SUBSCRIBE TO
SINCLAIR QL WORLD
WE HAVE HAD TO RAISE THE
COVER PRICE OF QL WORLD
BUT WILL BE HOLDING LAST
YEARS SUBSCRIPTION PRICE
FOR THE IMMEDIATE FUTURE
ONLY.

Existing subscribers will not be affected.

PLEASE DEBIT MY CREDIT CARD ACCESS/VISA

CARD NUMBER.....

EXPIRY DATE

PLEASE SEND ME A 12/24 MONTH SUBSCRIPTION TO SINCLAIR
QL WORLD.

NAME

ADDRESS

TELEPHONE NUMBER.....

SIGNED

DATE

STARTING WITH ISSUE.....

Eidersoft Ice rom

(windows, icons, pointers) front end, choice multitasking & mailmerge m'drive cartridge, plus 128k RAM extension in TECHNOLOGY RESEARCH Delta discdrive/printer interface. All manuals and documentation included. Complete package £60. Telephone 0732 355341

PC Conqueror original

£65 QL computer vers JM £60 super toolkit 2 EPROM cartridge £18 Centronics printer interface £18 Phillips green Hi-res monitor BM7502 £70. Telephone 0233 626713 (Kent)

QL £50 green monitor

£30, real time digitizer £50, Twin disk drive £50, software: digital S.E. £25, editor S.E. £25, touch typist £6, assembler £12. Telephone 021449 8041

Unused Penman plotter

suitable for use with QL, PC, BBC and RM computers. Up to A2 size. Bargain at only £120. Tel: 0449 767130

QL 640k twin 3-1/2"

drives, mouse, minerva, cased separate keyboard £150. Tonto with monitor £100. Qram, painter, eye Q, CPM emulator, sprite generator, MDVS, games, books, mags. Tel: Jeff 0908 233008

SINCLAIR QL + twin floppy

drives, 256k memory, separate keyboard, many games £125 0491 681821

640k JS QL twin 3-1/2"

drives housed printer, monitor, schon keyboard, Tandata modem, eidersoft mouse. V2.35 Psion suite turbo Quill taskmaster spellbound speedscreen £220 ono. buyer collects. Tel: 0765 640331

QL unexpanded AH

version PSU Psion software manual etc. Any offers Miracle Systems QL modem £20. Phone: John 0689 855444

JS QL, Metal case, PC

keyboard and I/face, twin 3-1/2" d/drives and OPD m/drives, some software, new colour monitor £250 ono. Also Tandata modem 3, CQVI Digitiser and more. Tel: (Derby) 0332 677746

QL unexpanded JM

version, shinwa CPA 80Q printer, joystick, Software including Psion suite, Eye-Q and Games, 40 MDV's, Manuals etc, £150 Tel: 0256 764006 evenings only

QL Minerva Rom, Trump

Card 3-1/2" D/D, Miracle centronics (x2) Tandata modem, serial printer, 6 years QLWorld, Quanta mags, books, software, b/w television extra MDV. Sensible offers please. Tel: 0977 515428

**Professional poolster
REVOLUTIONARY
NEW SYSTEM**

COMBINES

*Sound logic with A.I. to win £ hundreds £
Analysis of Bookies Factors for matches
Common sense improves chances of Mega-Win*

UNIQUE ENTRY SYSTEM

*Takes only a few minutes each week
Over 300 teams in data-bank.*

Minor league teams automatically added.

Prior to PC release @ £99.00

To QL users offered at SPECIAL PRICE £49

THIS MONTH

MONEY BACK GUARANTEE - Make a profit in your first full season or your money back.

256K ROM minimum. Discs Only. State 3.5 or 5.25

CHEQUE OR P.O. TO S.CANTON, OCEAN COMPUTER SERVICES, PO

BOX 68, NORTH DO. Manchester M8 6NJ

Tel. 061 740 9002

Please send coupon to: Advertising Department Sinclair/QL World, The Blue Barn, Wootton, Woodstock, Oxon. OX7 1HA. Please place this Classified Advertisement in the next issue of Sinclair/QL world.

NAME

ADDRESS

DAYTIME TELEPHONE NO

I enclose a cheque/P.O. to the value of £17.65 (inc. VAT) for a lineage advertisement of no more than 30 words. Please make cheques payable to: Arcwind Ltd.

CLASSIFIED

DJC

Dilwyn Jones Computing

41 Bro Emrys, Tal-y-Bont,
Bangor, Gwynedd LL57 3YT U.K.
Tel: Bangor (0248) 354023

QL SOFTWARE

NB PLEASE NOTE THE MEANING OF CODES IN SQUARE BRACKETS BELOW:

- [R] RAMDISK REQUIRED
- [F] AVAILABLE ON FLOPPY DISK
- [M] AVAILABLE ON MICRODRIVE
- [128K/512K] MINIMUM MEMORY REQUIRED.
- [PC] FOR IBM PC AND COMPATIBLES.
- [TK2] TOOLKIT 2 REQUIRED.

CATALOGUE

THE CATALOGUE CONTAINS MORE DETAILS OF THE PROGRAMS. CALL FOR A COPY, OR ASK FOR A COPY WITH YOUR ORDER.

DEMONSTRATION VERSIONS

Demo versions are available for some of our programs. They cost £2.00 each and this cost is refundable against the full price of the full version, see lists below.

FLOPPY DISKS & LABELS

35" DSDD UNBRANDED DISKS	£0.40
35" DSDD FLOPPY DISKS	£0.70
MICRODRIVE CARTRIDGES	£2.50
100 DISK LABELS	£2.00
100 DISK LABELS ON PRINTER ROLL	£2.50
100 ADDRESS LABELS ON ROLL	£2.00
100 MICRODRIVE LABELS ON ROLL	£2.00

Please add £0.50 postage per roll of labels (max postage £2.50 if only ordering labels. Add £2.50 per order for floppy disks. No extra postage on microdrive cartridges.

FILE TRANSFER

DISCOVER	£20.00
[F 256K] Copy files QDOS to PC disks and vice versa.	
MULTI DISCOVER	£30.00
[F 256K] Enhanced versions, extra formats.	
TEXTIDY	
[F M 256K] Strip Quill files etc down to plain text.	
OPD INTERCHANGE	£15.00
ICL/OPD file transfer utility. Unsuitable Gold Card.	
QL-PC FILESERVER	£24.50
[F 128K] QL/PC software for serial cable link, access PCs drives, printer, transfer files, etc	

LEISURE

SOLITAIRE	£15.00
[F M 128K] A very addictive patience card game.	
CRICKET SECRETARY	£12.00
[F M 128K] For cricket buffs everywhere!	
QUESTION MASTER	£10.00
[F M 128K] For revision or entertainment.	
QUIZ SETS each	£5.00
FLEET TACTICAL COMMAND II QL	£49.95
[F 512K] Naval strategy game, play on 2 networked QLs.	
FLEET TACTICAL COMMAND II PC	£69.95
[PC] Licenced PC version of this superb game.	
COMBINED QL & PC VERSIONS	£85.00
Package deal for both QL and PC versions together.	
FTC2 DATA PRINT UTILITY	£9.95
[F 128K] Print out data from FTCII described above.	
THE FUGITIVE	£9.95
[F 512K] Text adventure game.	
COCKTAILS WAITER	£10.00
[F 256K] Database of 100's alcoholic drinks recipes.	
RECIPE SETS each	£5.00

PROGRAMMING

S EDIT	£20.00
[F 384K] DEMO VERSION	£2.00
EASYPTR II	£49.00
[F 256K] Pointer environment programming aid.	
EASYPTR II BUDGET VERSION	£35.00

DISA DISASSEMBLER

[F 256K] Interactive pointer driven disassembler.	£29.00
BASIC REPORTER	£10.00
[F M 128K] BASIC programming aid, list variables, etc.	
BUDGET QLIBERATOR COMPILER	£25.00
[F M 128K] BASIC compiler for unexpanded QL	
QLIVERATOR BASIC COMPILER	£50.00
[F 256K] Excellent BASIC compiler for the QL	
QLOAD & QREF UTILITY	£15.00
[F M 128K] Fast loader and cross reference utility	
MEGA TOOLKIT on disk	£25.00
on EPROM cartridge and disk	£40.00
Comprehensive toolkit of over 200 BASIC extensions	

FILE HANDLING

LOCKSMITHE	£14.95
[M 128K] Microdrive backup program, byte for byte!	
4MATTER	£23.50
[F M 384K] Complete software backup system.	
TOOLCHEST	£14.95
[M F 256K] Create customised microdrive doctor	
FILES 2	£12.00
[F M 128K] Simple to use popup file handling utility.	
FILEMASTER	£12.00
[F M 512K R] For bulk copying of files, & disk labelling.	
THE GOPHER	£12.00
[F M 128K] File finder, for disk, mdv, or hard disk	
[F M 128K] DEMO VERSION	£2.00
WINBACK	£25.00
[F 256K] Hard disk and ED disk backup utility	
[F256K] DEMO VERSION	£2.00

DISPLAY SOFTWARE

BANNER	£25.00
[F 512K] Banner printing program for Epson etc printers.	
VISION MIXER 1	£10.00
[F 512K] Screen display system.	
VISION MIXER PLUS	£22.50
[F 384K] Enhanced, menu driven version	
PICTUREMASTER	£15.00
[F 256K] Screen drawing utility for use with VMixer, etc	
PICTUREMASTER PLUS	£20.00
[F 384K] Enhanced version, extra features.	
UPGRADE TO "PM PLUS"	£5.00

PRINTER DUMPS

SIDEWINDER PLUS	£24.95
[F M 512K] Screen and DTP page printer dump utility.	
Suitable for 9 and 24 pin printers	

GRAPHICS

THE PAINTER V4.04	£25.00
[F 512K] 100% m/code pointer driven graphics program.	
THE CLIPART	£12.00
[F 128K] 3 disks packed full of screen pictures	
PICTORIAL INDEX FOR THE CLIPART	£4.00
New printed index for the Clipart, with screen dumps	
QRACTAL	£20.00
[F 512K] Machine code fractals program.	
QRACTAL SCREENS	£2.00
[F 128K] Sample screen pictures made with QRactal.	
IMAGE PROCESSOR 2	£15.00
[F 512K] Graphics and picture editing, etc utility.	
[F 512K] DEMO VERSION	£2.00
PD2 CLIPART	£10.00
[F 128K] 2 disks of clipart screens.	
SCREEN SNATCHER	£10.00
[F M 128K] Grab screen displays from other programs.	
TEXT 'N' GRAPHIX	£20.00
[F 256K] Print text files containing screen dumps.	
[F 256K] DEMO VERSION	£2.00
TRANS24	£10.00
[F M 128K] Translate 9 pin graphics for 24 pin printer.	
SCREEN COMPRESSION	£10.00
[F M 128K] NEW! Save space by compressing pictures	

TEXT

QTPY 2	£29.95
[F 512K] Spelling checker, uses pointer environment.	
BIBLE TEXT DISKS, PLAIN TEXT FORMAT	£20.00
BIBLE TEXT DISKS, QUILL FILE FORMAT	£20.00
[F 512K] Text of the King James Bible on disks	
SPELLBOUND	£30.00
[F M 384K] Spelling checker, non-pointer environment.	
SPELLBOUND SPECIAL EDITION	£50.00
[F 512K] Improved version with larger dictionary, etc	
UPGRADE TO SPECIAL EDITION	£30.00
Please return master disk/cartridge when upgrading.	
QUICK POSTERS	£10.00
[F M 128K] Text poster maker for use with Star printers.	

DATABASES

ADDRESS BOOK & LABEL PRINTER	£15.00
[F M R 384K] As used by DJC, database + label printer.	
[F M R 384K] DEMO VERSION	£2.00
DATA DESIGN	£50.00
[F 512K] Programmable pointer environment database	
FLASHBACK	£25.00
[F M 256K] Fast database written in machine code.	
FLASHBACK SPECIAL EDITION	£40.00
[F 256K] Enhanced version of Flashback	
QL GENEALOGIST SECOND EDITION	£30.00
[F 384K] Family trees and family history program.	
UPGRADE TO SECOND EDITION	£12.00
Please return master disk with upgrade order.	
BUDGET 128K GENEALOGIST	£12.00
[F M 128K] Cut down version for unexpanded machines.	
DISK INDEXER	£12.00
[F M 256K] Make a database of contents of your disks.	
DBEASY	£15.00
[F 512K] Database front end for Archive etc.	
DBPROGS	£15.00
[F 512K] A collection of Archive utilities and text files	

QL HARDWARE

MINI PROCESS CONTROLLER	£59.95
Relay switched outputs, controlled via QL serial ports.	
SOFTWARE TOOLKIT FOR MPC	£9.95
[F 128K] Extensions to simplify control the MPC.	
NETWORK PROVER	£3.50
A small box which plugs between networked QLs.	
QPOWER REGULATOR	£24.95

OTHER QL SOFTWARE

QPAC1	£19.95
[F 512K] Pointer environment utilities.	
QPAC2	£39.95
[F 512K] Files maintenance menu, hotkeys, etc.	
QTOP	£29.50
[F 256K] Desktop system, files, job control, etc.	
PRINTERMASTER	£20.00
[F M 128K] Printer control utility.	
HOME BUDGET	£20.00
[F M 128K] Domestic bills and accounts program.	
REMIND-ME	£12.00
[F M 128K] Dates reminder program. Very easy to use.	
REMIND-ME PLUS	£20.00
[F M 128K] Enhanced version.	
SCREEN ECONOMISER	£10.00
[F M 128K] Screen saver blander.	
SCREEN DAZZLER	£15.00
[F M 384K] Like screen economiser, but instead of blanking out the screen advances moving objects or screen effects to save screen burn-ins, like some PC programs!	
SLOWGOLD	£5.00
[F 128K] Slowdown routine for Gold Card or any QL.	
TASKMASTER	£25.00
[F M 384K] Task switching utility.	
DISK LABELLER	£10.00
[F 256K] Prints neat labels for your floppy disks	
THE CAT	£5.00
[F M 128K] List filenames in columns.	
ROB ROY BARGAIN PACK	£10.00
[F M 128K] Reviewed in Q L World August 1991	

THE SMALL PRINT! POSTAGE AND PACKING CHARGES: Software is sent post-free to UK addresses. To other countries, please add £1.00 per program for postage and packing (sent by airmail where possible). PRICES: All prices are shown in UK Pounds Sterling. PAYMENT: We can accept payment by cheque (in UK Pounds Sterling currency only, please) drawn on UK branch of a bank or building society, by Eurocheque with card number written on the back, Postal Order, or by these credit cards: VISA, ACCESS, MASTERCARD, EUROCARD or by CONNECT card. Please state the card type, number, expiry date, your address, and sign orders sent by post. We can also accept orders paid by credit card over the telephone. There is an answering machine for when I am unable to answer in person so that I can call you back later. Goods remain the property of DJC until paid for in full. PLEASE STATE IF YOU REQUIRE SOFTWARE ON 3.5 OR 5.25 INCH DISKS OR MICRODRIVE CARTRIDGE