

SINCLAIR

QL

WORLD
INCORPORATING QL USER

Every Month £1.25 January 1987

DENMARK DKR 40.00

GERMANY DM 9.00

NETHERLANDS DFL 9.25

**CUT PRICE
SOFTWARE**

Details · Inside

MULTI-TASKING
Simultaneous
software survey

Desktop publishing

Text processing
with The Editor

Speech synthesisers
compared

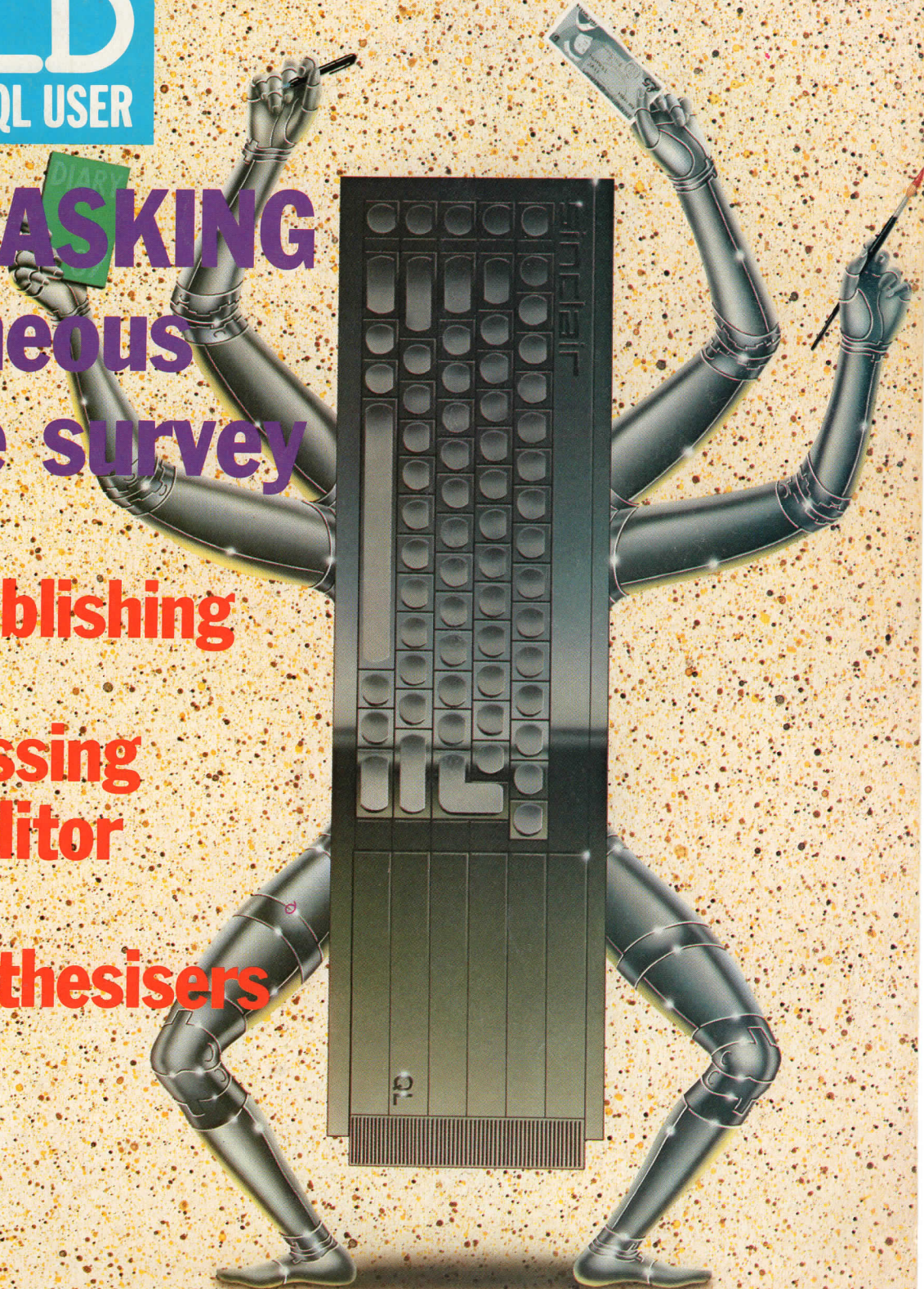

EYE-Q V2.0

COMPLETE WITH LARGE A4 MANUAL **£29.95**
 The Definitive QL Graphics/Cad Package
 This one has ALL the features
 You've seen the rest – now try the best

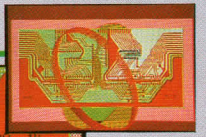
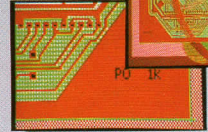
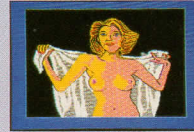

SUPER SPRITE GENERATOR V4.0

The Definitive QL all-purpose animator/designer
£29.95 Complete with instructions.

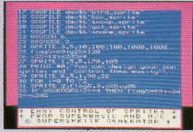

SUPER MEDIA MANAGER V1.12

The Definitive QL Manager & Data Recoverer for all native and alien media
 MICRODRIVES ● DISKS ● RAMDISKS ● ALIEN DISKS
£39.95 COMPLETE WITH LARGE A4 MANUAL
 £24.95 for a "microdrive only" version

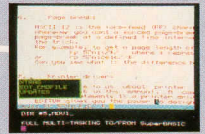
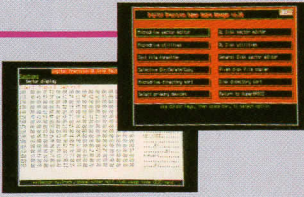
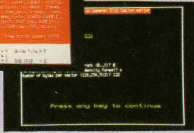

THE EDITOR

THE DEFINITIVE WORD & TEXT PROCESSING SYSTEM
 Typically 10-20 times faster than Quill, with far more commands & flexibility – even object machine code can be edited directly! Command files supported, easy navigation to/from Quill.

£24.95 COMPLETE WITH LARGE A4 MANUAL



SUPERCHARGE VI.19

The highly acclaimed SuperBASIC compiler – now the established classic
£59.95 COMPLETE WITH LARGE A4 MANUAL

CLARIFICATION

Digital Precision would like to make it quite clear that the technical term 'pseudo compiler' used to describe QLiberator refers to the 'pseudo code' which that product interprets, in a manner analogous to SuperBASIC, but less slowly, when a pseudo-compiled task is run. SuperCHARGE and TURBO are true (not-pseudo) compilers that produce real 68008 machine code which the QL's processor can directly execute at absolute top speed.

BETTER BASIC EXPERT SYSTEM

Make your programming & your programs more readable & correct – this configurable utility cleans up code, correcting & annotating as it goes along.

COMPLETE WITH MANUAL **£19.95**

SUPERFORTH V2.0

Complete FORTH-83 system – the fastest & easiest FORTH on the QL. Supplied with the strongest OTHELLO on the market

£29.95 COMPLETE WITH LARGE A4 MANUAL
 Reversi is available on its own for **£9.95**

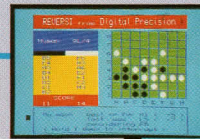

BLOCKLANDS

65536 different levels (each the size of 64 screens) – Thousands of different enemies

£9.95

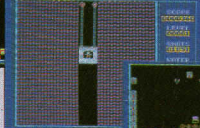
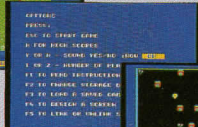

DROIDZONE

The fastest of all QL games – the speed is incredible!

£9.95

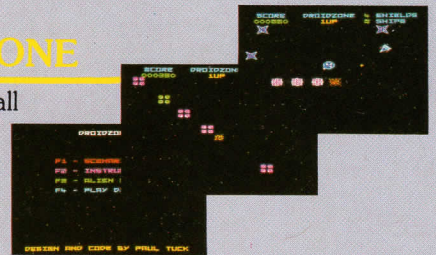

BACKGAMMON V3.0

Complete with rules – a strong opponent

£12.95

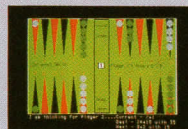

MONITOR/DISASSEMBLER V3.0

Complete with instructions

£18.95



SUPER ARCADIA

£9.95 for 2 games

SPECIAL PRICE £22 for Blocklands Droidzone & Arcadia bought together

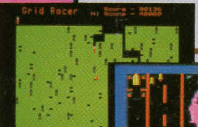

GIGA MOUSE + GigaBASIC + E.A.S.E. £89.95
QSOUND + QPRINT board £89.95
GIGA KEYBOARD (full action, IBM-AT style, user installable – no soldering) – highest quality **£99.95**
BEWARE OF CHEAP & NASTY IMITATIONS



TURBO

A TOTALLY NEW COMPILER BY SIMON GOODWIN

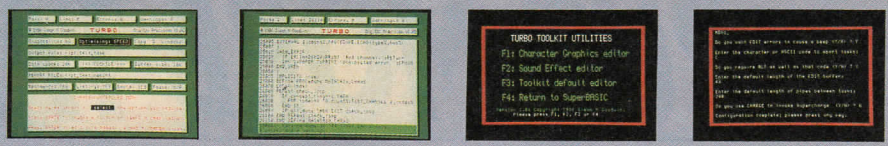

What Do You Get?

SPEED – TURBO is an optimising SuperBASIC compiler, even faster than SUPERCHARGE! Remember, SUPERCHARGE itself was three times faster than the pseudo compiler QLiberator (review, QL WORLD, October 1986) even without using SUPERCHARGE's speed optimising facility! TURBO has a completely new, fast, compact library.

COMPATIBILITY – With the entire syntax of SuperBASIC.

MULTITASKING – You can run any number of tasks simultaneously – all utilities for task management supplied.

EASE OF USE – Compiler directives, utilities, fully configurable user interface, defaults, one key compilation, on-screen help, abort at any time, listing window adjustable before or during compilation, run other tasks as you compile, full support for extra RAM – resident compilation, copy up to 16 SuperBASIC windows, preset/in-program/post-compile DATASPACE setting.

TASK COMMUNICATIONS – Pipes allow BASIC or any task to print & input ANYTHING through RAM to themselves or one another (temporary files – who needs them!). Plus these features unique to TURBO:

Any number of tasks can share procedures & functions.
 Tasks can read & write variables (even arrays) in other TURBO tasks.
 Channels can be shared between separately compiled tasks.
 Fast library manager included.
 Option strings can be passed as parameters of EXECUTE.

LINKING in microseconds of any number of modularly compiled tasks – hence allowing compilation of any size of program on an unexpanded QL. If there is a change to be made to one program module, it is the only one you need to recompile!

VIRTUAL ARRAYS – arrays on disk or cartridge. Dimension arrays larger than available RAM – lightning quick 'cache' buffered access.

ACCURACY is superb – two more digits of displayed accuracy than either interpreter.

REPORTING of warnings & errors with explanation & location (line, statement, even position within statement).

FAST LOADING – a 100K compiled task will load from cartridge in 8 seconds!

FRIENDLINESS – TURBO takes interpreter bugs in its stride, with relaxed error checking. It compiles most wrongly structured programs (provided they do not crash under the interpreter). Unlike SUPERCHARGE, TURBO is not strict – it automatically mimics the behaviour of the interpreter when it finds a structural fault, and annotates the listing to describe what TURBO has done to correct the mistake.

UNLIMITED output code size – no 64K code limit!

COMPACT output code, with zero library overhead – no need for separate (8K!) interpreter runtimes.

FAST COMPILATION – much faster than SUPERCHARGE, which was twice as fast as the pseudo compiler (QL WORLD, October 1986) – 108K of typical SuperBASIC compiled to 72K, parsing at the rate of 480 lines/min & code generating at the rate of 940 lines/minute.

IMPLICIT DATATYPES supported – accelerated, fully re-entrant integer FOR loops (at last!) & integer/string SELECT, on all QL versions.

WHEN ERROR trapping of ANY error to a single point, or any number of local error handlers – fully hierarchical. Works on all QL versions! Error handlers have access to line & error numbers – you can then RETRY/CONTINUE to an external error-handler, or restart processing as you choose.

ONE HUNDRED example programs provided (on cartridge/disk) – a full tutorial & reference guide.

OPTIMISATION of either space or speed, selectable by the user on a line by line or block basis. TURBO's string/integer in-line 68008 code is twice as fast as that generated by SUPERCHARGE, which was no slouch.

RUBBER ARRAYS – ever needed to preserve array contents on redimensioning?

ARRAY AND REFERENCE PARAMETERS – pass both variables & arrays of any number of dimensions by 'Reference', so parameters can be used to pass values back from a procedure or function, or even to another task. 'Local' & 'value' parameters will still work fine – string value passing is much quicker than with SUPERCHARGE.

LUCID documentation in the form of an indexed manual with well over 200 A4 pages.

AND NO LENSLOK – TURBO is protected only by copyright law ...

TURBO is supplied with a user-configurable TOOLKIT with over 150 useful commands, utilities & functions (not just calls to ROM routines), at no extra cost. Fast, flexible, friendly utilities let you monitor dataspace used, or time spent on particular lines, for any TURBO task. Alter task details. Set your own default filenames, devices, windows, dataspace, report-types, code optimisation, sound control, CSIZES, colours control keys, etc.!

Now programs can perform binary random access, even with microdrive; move or search areas of memory (great for graphics programs, editors, utilities etc.); edit variables on screen; control flashing cursors; TYPE-IN things to the keyboard (for function keys, network/terminal systems etc.); control and interrogate tasks and devices; define graphics; maintain overlapping windows; play continuous 'background' music – plus lots more commands and utilities. Supplied with 60 page manual, plus configurator, sound and font designers, library manager, and ROYALTY FREE RUNTIME PACK for professional software developers.

After a year selling SUPERCHARGE hand over fist, DP knows exactly what makes a good SuperBASIC compiler. One year and 3000 man-hours on, after careful market research we bring you **TURBO** – a completely new compiler from the Supercharge team.

GET THE BEST – GET TURBO

TURBO costs **£84.95** including TURBO TOOLKIT
 TURBO TOOLKIT is available on its own for **£24.95**

There is a £35 discount for SUPERCHARGE owners who send in pg. 100 of the SC manual with their order. This offer terminates on 31st December 1986.

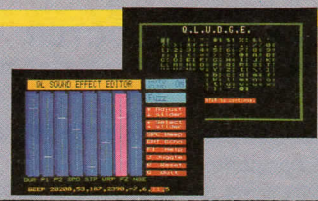

PROFESSIONAL ASTROLOGER V1.4

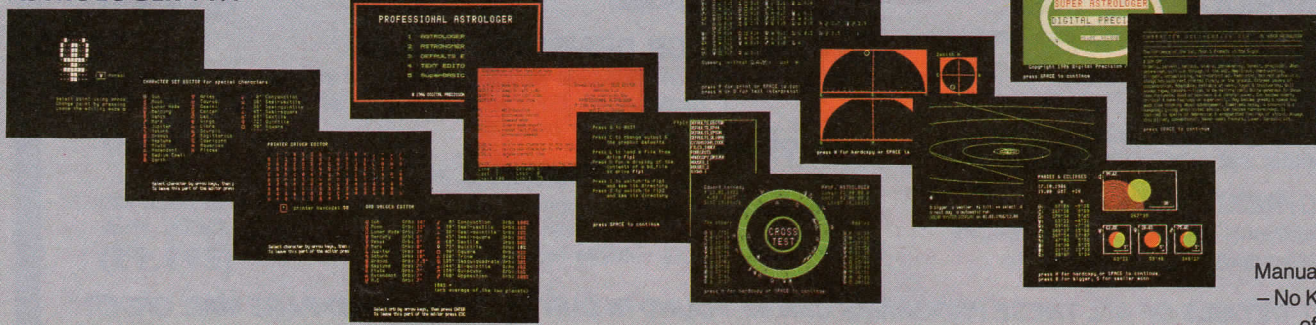

Huge A4 Manual Supplied – No Knowledge of Astrology required

- NEW BONUS – You may deduct £1 from the total price if you buy any 2 programs, £2 if you buy any 3 programs, £3 if you buy any 4 programs and so on. (These offers do not apply to upgrades).
- Orders from abroad are welcome. Please add £1 (£2.50 for programs over £25) per program for orders from Europe and £1.50 (£4 for programs over £25) per program for orders from other countries, to cover airmail postage and packaging costs. Cheques from abroad should either be drawn on a UK bank or be Eurocheques – if you are unable to obtain either of these add £5 to your order price to cover cheque clearing charges.
- If you have an early version of one of our programs, send the microcartridge(s) (not the packaging) to us accompanied by £5 (£10 if SUPER ASTROLOGER or over £25).
- All our software is 100% compatible with all memory expansion & disk systems.
- Programmer & dealer enquiries are welcome. Demonstrations of all our programs are available at Micro Anvika, 220A Tottenham Court Road, London.
- SUPERCHARGE + ICE is available for £79.95 – or £89.95 with CHIOce too! The corresponding prices with TURBO instead of SUPERCHARGE are £104.95 & £114.95
- All our Software is compatible with the THOR & QLT machines – we guarantee to support the QL & QL compatible market through 1986 & 1987 at the very least.

- PROFESSIONAL ASTROLOGER **£59.95**
- PROF. ASTRO with ASTRONOMER **£69.95**
- SUPER ASTROLOGER (elementary) **£24.95**

To: DP, 222 THE AVENUE, LONDON E4 9SE
 (Or use the Credit Card Hotline ☎ 01-527 5493)

Please rush me Name: _____ Address: _____ Postcode: _____

Enclosed Cheque Cash P.O. Access/Mastercard Visa/Barclaycard

for the amount of £ _____ Number: _____ Expiry date: _____

Please indicate if you have: 3 1/2" disks 5 1/4" disks Microdrives only

Signature: _____

"THE ONLY SOFTWARE HOUSE DEDICATING ALL ITS RESOURCES TO THE QL"

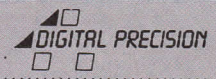

PUT MORE TALENT ON YOUR QL

We've a great new range of high-quality products for your QL — ranging from practical tools and utilities to a colourful arcade game and a riveting text adventure.

Find out about them all in our new Software Catalogue. It's out now. It's **FREE**. If you haven't got your copy yet, phone us or write in — we'll send one out to you straightaway.

CURRENT PRODUCTS

THE LOST KINGDOM OF ZKUL

Explore the ancient dwelling place of the Dwarves and locate the treasure. A classic text adventure.

(£14.95)

WEST

An exciting text adventure set in the Wild West.

(£14.95)

THE LOST PHARAOH (Stefan Kuhne)

A fast and addictive maze game.

(£14.95)

COSMOS (G. F. Cornwell)

Displays star maps for any date, place and time.

(£14.95)

CARTRIDGE DOCTOR

Rescues data from corrupted microdrive cartridges.

(£14.95)

ASSEMBLER WORKBENCH (Eddy Yeung)

A complete set of tools for the machine code programmer, combining an Assembler, Monitor and Screen Editor.

(£24.95)

GRAPHIQL +

A comprehensive graphics package (re-issue of Sinclair's QLPaint).

(£24.95)

TECHNIQL

A 2-D CAD package, suitable for general, scientific and engineering applications.

(£49.95)

TECHNIKIT

An additional module for TECHNIQL for plotter output, font generation etc.

(£24.95)

NEW PRODUCTS

QIMP (L. Hirschbiegel)

A flexible Icon Manager program.

(£39.95)

BASIC-ALLY (Eddy Yeung)

An indispensable aid for debugging SuperBASIC programs.

(£29.95)

JUNGLE EDDI (Stefan Kuhne)

Tarzan had better watch out!

A fun arcade game.

(£14.95)

RAM DISK & PRINT SPOOLER (Eddy Yeung)

Useful QL utilities.

(£9.95)

NEMESIS (Paul Brittain)

Track down the most wanted man in the Universe. A riveting text adventure.

(£14.95)

SIDEWAYS (N. Clift)

Prints everything sideways. Invaluable for spreadsheets, diagrams, text etc.

(£19.95)

QL TOOLSET (B. Silver)

Over 100 extensions to SuperBASIC. Easy file handling, bit manipulation, memory management, job control and screen graphics.

(£19.95)

PCB DESIGNER 1 (F. Sasche)

A professional design package for printed circuit boards. Single-sided Eurocards. Includes autorouting option and camera-ready print-out.

(£99.95)

PCB DESIGNER 2 (R. Delemos)

Double-sided boards up to 270mm x 150mm of any size can be designed with this easy-to-use package. Zoom facility. Print-outs suitable for direct tracing.

(£99.95)

FULL DETAILS OF ALL THESE PROGRAMS CAN BE FOUND IN OUR ILLUSTRATED 20-PAGE MAIL ORDER CATALOGUE. MAKE SURE OF YOUR FREE COPY. GET IN TOUCH WITH US TODAY!!

TALENT
COMPUTER SYSTEMS

CURRAN BUILDING, 101 ST JAMES ROAD, GLASGOW G4 0NS.

Telephone: 041-552 2128

SOFTWARE FROM SCOTLAND

Editor
 Ken McMahon BA
Sub Editor
 Harold Mayes MBE
Production Editor
 Jim McClure
Production Assistant
 Isabelle Risner
Art Editor
 Chris Winch
Design Assistant
 Neil Tookey
Technical Associate
 Marcus Jeffery BSc
Editorial Assistant
 John Barnes

Advertising Manager
 Kathy McLennan
Advertising Executive
 Jane Brooks Wadham

Magazine Services
 Sheila Baker
 Anna Morrison

Publisher
 Paul Coster BSc

Managing Director
 Richard Hease

CONTRIBUTORS

Colin Opie
 Mike James
 Marcus Jeffery
 Ron Massey
 Mike Lloyd
 James Lucy
 Robert Penfold
 K. B. J. Judson
 D. Marsh
 Edward Leigh

Microdrive Exchange 01-731 7948
 System Design

Sinclair QL World,
 79-80 Petty France,
 London SW1H 9ED.
 Telephone 01-222 9090
 Fax 01-222 0461
 Telex 9419564 FOCUS G
 ISSN 0268067X

Back issues are available from the publisher price
 £1.50 U.K. £3 Overseas. Please telephone
 01 222 9090 to check availability.

Published by Focus Magazines Ltd, London
 Distributed by Quadrant Publishing Services,
 Sutton.

Subscription information from: Quadrant
 Subscription Services, Oakfield House, Perrymount
 Road, Haywards Heath, West Sussex 0444 459188
 (£15 U.K. £30. Europe. £45 rest of the world)

Please allow 5 weeks from date of order to receipt
 of first subscription copy

Typesetting and make-up by
 Cradley Print PLC, England.

Printing by Cradley Print plc, England.

© COPYRIGHT SINCLAIR QL WORLD — 1987

CONTENTS

■ ■ JANUARY 1987

5	QL SCENE • News round-up.
8	SOUND SYSTEMS • Hardware additions for budding musicians.
12	OPEN CHANNEL • Your points of view.
15	EVEN BETTER BASIC • A utility for perfectionists?
16	SOFTWARE APPLICATIONS • The business users' column
19	BEYOND WORDS • A new text editor.
20	TAKEN TO TASK • We take on the multi-taskers.
25	HOLD THE FRONT PAGE • Desk-top publishing hits the QL
27	UTILITY FILE • Applications software reviews.
32	TECHNICAL HELPLINE • Do you have a problem? Write to us.
34	READER OFFER • Bargain software.
36	BETTER BASIC • Mike Lloyd points the way.
39	TURBOCHARGED • Turbo Toolkit shows its face.
40	SOFTWARE FILE • Create your own adventures.
44	QL CONNEXIONS • Continuing our interfacing series.
48	PUZZLE PAGE • All those solutions and a new mind-boggler.
50	THE PROGS • Short and simple type-in utilities.
54	INSTANT ACCESS • QL product directory.
57	MICRODRIVE EXCHANGE • Ready-to-run software service.

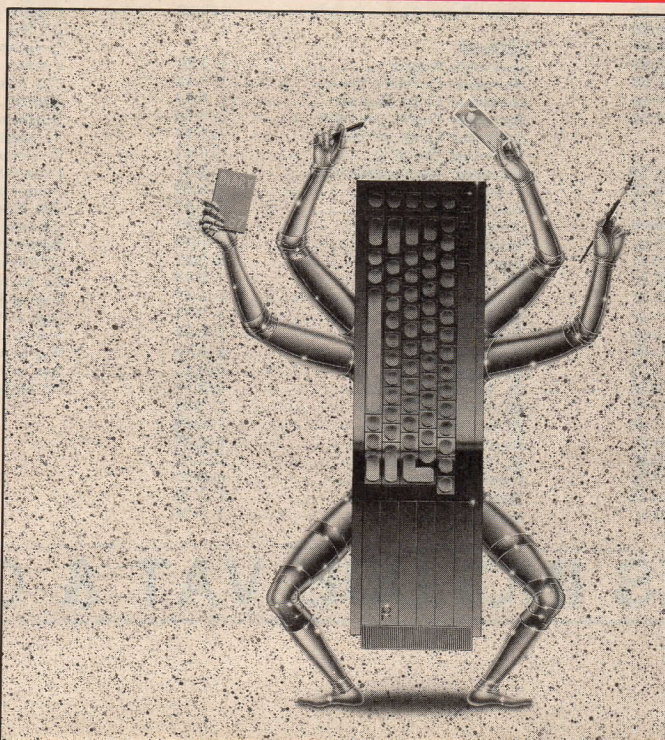

NEXT MONTH

Computer tutor

There is a woeful lack of educational software for the QL but the machine is an ideal tool for teaching school-age children the rudiments of maths and spelling. Starting in February, our educational series will show you how to write programs that children will enjoy as well as learn from.

QL vs Amstrad PC

We thought it might be interesting to put the new Amstrad PC1512 up against the QL and see which emerged on top. The results might surprise you.

Plus

Our usual mix of news, features, reviews and listings.

STRONG COMPUTER SYSTEMS

BRYN COTTAGE, PENIEL, CARMARTHEN, DYFED SA32 7DJ. TEL: 0267-231246

THE ASTRACOM 1000 MULTISTANDARD INTELLIGENT MODEM £198.00
Complete with Communications Software for Prestel etc.

128K QL Computer.... £149.00

640K QL Computer... £259.00

SPECIAL OFFER PSION 2.3 SOFTWARE ONLY £9.95

QL TECHNICAL GUIDE..... £14.95

QL SERVICE MANUAL..... £19.95

(A) Assembly Language Programming On The Sinclair QL by Andrew Pennell } £3.50 each
(B) The Sinclair QDOS Companion by Andrew Pennell }

TALENT WORKBENCH (ASSEMBLER MONITOR) + TITLES (A) and (B)... £29.00

PRINTER PRICES INCLUDE MIRACLE SYSTEMS INTERFACE

CITIZEN 1200	£209.00
CANON PW1080A	£279.00
TAXAN KP910	£419.00
MP 165 165cps TRF	£239.00
Miracle Systems Parallel Interface	£ 20.00
2000 Sheets Fanfold Paper	£ 16.00
Serial Cable	£ 8.00
Pershell Printer Cable for SANDY etc.	£ 10.00

ACCESSORIES

4 Microdrive cartridges	£ 8.00	Transform Box	£ 5.00
10 Cartridges with Transform Box	£23.00	10 DS/OD 5.25" Disks..	£19.00

RIBBONS

Brother M1009	£5.50	MT80 or Shinwa.....	£8.00
Quen Data	£6.00	SP1000A (Sinclair).....	£7.50
Texan	£7.00		

MONITORS (Cables Included)

Microvitic Cub 1451/DQ3 Colour.....	£249.00
Microvitic Cub 1451/DQ3 With Stand	£269.00
Swivel Stand for Microvitic	£ 25.00
Philips BM7502 Green Monochrome	£ 99.00
3250 WATT MAINS FILTER	£ 36.00
MIRACLE SYSTEMS MODAPTOR	£ 39.00
MICROSTICK JOYSTICK WITH ADAPTOR	£ 16.00
QL JOYSTICK ADAPTOR	£ 5.00
EIDERSOFT MOUSE	£89.00

DISC & RAM UPGRADES



MEMODISK 512K RAM +PARAPORT +DISK INTERFACE	£199.00
ABOVE WITH DUAL 3.5" DRIVES.	£399.00
TOOLKIT EPROM FOR MEMO-DISK. INCLUDES MULTITASK WINDOWS - ICONS - RAM DISK-WILD CARD ETC.	£20.00
MIRACLE SYSTEMS 512K EXPANDERAM	£119.00
INTERNAL D.I.Y. 512K RAM BOARD	£109.00
INTERNAL 512K RAM FITTED BY US	£136.00
DUAL 3.5" DISK DRIVE	£209.00
NEC 3.5" DUAL DRIVES + INTERFACE	£299.00
DUAL DRIVES + INTERFACE + EXPANDERAM OR INTERNAL.....	£399.00
10 QUALITY DS/DD 3.5" DISK IN LIBRARY CASE	£29.00
LOCKUP DISK STORAGE BOX FOR 40 3.5" DISKS	£ 14.00

(Please state whether Cumana or PCML drive required)

SOFTWARE

BUSINESS

Cash Trader (Disc & Cartridge)	£59.95
TR Systems Payroll	£63.00
Project Planner.....	£35.00
Entrepreneur	£35.00
QL Home Finance (Buzz)	£21.95
Touch Typist	£12.00
Eidersoft Qspell (Carts)	£20.00
Eidersoft Qspell (Disk)	£23.00
Talent Techniq	£44.00
Digital Eye-Q	£24.00
Concept 3D CAD	£34.00
Pro. Astrologer (Cart/Disk).....	£49.00
Pro Astrologer + Astronomer	£59.00

LANGUAGES

GST Macro Assembler	£44.95
Metacomco Assembler	£29.00
Metacomco BCPL	£49.00
Metacomco LISP	£49.00
Metacomco Pascal.....	£69.00
Metacomco 'C'	£79.00
Metacomco APL	£89.00
Digital Basic Compiler.....	£49.00
Digital Forth + Reversi	£24.00
Qmon Monitor/Debugger.....	£18.00
Talent Cartridge Doctor.....	£13.00
Qflash Ramdisk + Toolkit	£19.00
Talent Workbench	£24.00
Digital Media Manager	£35.00
Sign Designer	£19.00
Supertoolkit II on Eprom	£34.00
Eidersoft Ice Toolkit	£10.00
Eidersoft Ice Artice	£13.00
Eidersoft Ice Choice	£15.00
Eidersoft Ice Eprom	£24.00

Eidersoft Ice Compendium	£59.00
Ice Rom and Choice	£39.00
Pro Fortran 77	£89.00
Pro Pascal	£89.00
Turbo	£79.00
Turbo Toolkit	£24.00
The Editor	£24.00
Better Basic Expert System	£29.00

LEISURE

Microdeal Hopper	£ 7.95
Microdeal Cuthbert/Space	£ 7.95
Microdeal Crazy Painter	£ 7.95
Microdeal Flight Simulator	£15.95
Microdeal Lands of Havoc.....	£13.95
Microdeal The King	£14.95
Microdeal Aquanaught 471.....	£18.95
Classic Adventure	£ 9.95
Match Point	£12.95
Qdraw	£14.95
Spook	£ 9.95
Digital Astrologer	£22.95
BJ 3D	£ 9.95
Scrabble	£12.95
QL Jabber	£ 9.95
Talent Zkul.....	£12.95
Talent West	£12.95
QL Paint	£23.95
QL Sprite Generator	£19.95
QL Superbackgammon	£11.95
Psion Chess	£16.95
Hyperdrive	£12.95
QL Super Arcadia	£12.95
Steve Davis Snooker	£12.95
Talent Comos	£12.95
QL Fictionary	£ 9.95

Citadell	£ 8.95
Knight Flight	£12.95
Zapper with Eagle	£ 8.95
Nemesis	£11.95
Baron Rouge	£17.95
Gwendoline	£17.95
Bridge Player II	£17.95
Classic Adventure.....	£ 9.95
BJ The Return	£ 9.95
Dragonhold	£18.95
Karate	£13.95
The Lost Pharaoh	£14.95
Qboids	£ 9.95
Squadrons	£13.95
Pyramide Vroom	£14.95
Pyramide Wanderer 3D	£19.95
Pyramide Mortville Manor	£18.95
Pyramide Nucleon	£18.95
The Pawn	£19.95
Caverns	£ 9.95
Bounders	£ 9.95
QL Reversi	£ 9.95
QL Meteor Storm	£ 9.95
Digital Blocklands	£ 9.95
Digital Droidzone	£ 9.95
War in the East (Complete)	£39.00
War in the East (Scen. 1)	£20.00
War in the East (Scen. 2 or 3).....	£13.00
3D Slime	£11.95

ALL PRICES INCLUDE VAT & CARRIAGE

Sportsware from Transform

Transform Ltd has produced a specialist program to help golf clubs work out the handicaps of their members. Extensive use is made of screen displays, which enables the operator to make technical checks as entries are input. A record of each member can be displayed subsequently. Hard copy is available for many of the options, among which is one to print the entire list of handicaps.

The program was written originally for the QL with dual disc drives and expanded memory but is also available for the IBM PC using the Psion *Xchange* suite. The QL version will permit a club with 500 members to produce 3,500 qualifying competition entries. Transform claims that one year's golfing activities can be contained in the database but, if necessary, the facility to set up a new database exists.

The criteria throughout are based on the

recommendations of The Council of National Golf Unions for all qualifying competitions, although the program also contains provision for open or domestic competitions. Should the handicap rules change, Transform will update the software for a small charge. The QL version costs £175 and a subscription program is also available priced at £44.

Transform is at 24 West Oak, Beckenham, Kent GR3 2EZ. Tel: 01-658 6350.

Easy Archive from Ark

Ark Distribution has announced an addition to its range of data processing software for the QL. *Archivist* is described as a fast, flexible, general-purpose Archive database manager.

The system is designed to appeal to users who want the facilities of Archive without having to write lengthy procedures. It also overcomes one of the major

disadvantages of Archive, the susceptibility to corruption of unclosed data files.

The software is supplied inclusive of the Psion Run Time Module which enables it to run independently of Archive. It has comprehensive file management, arrange, change, print and view menus. Another option will read any field to the screen 20 records at a time, forwards or backwards through the file, a feature commonly known as browsing.

Archivist costs £29.95 and is available from Ark Distribution, Corve Farm House, Chale Green, Isle of Wight PO38 2LA. Tel: 098 379 496.

Sexist software?

Housewife is the dubious title of a new software release from DJW. The program facilitates the compiling of shopping lists and there is also a recipe database. A pleasant program — pity about the name.

DJW has also produced the first new QL joystick to appear for some time. The joystick is constructed of rigid black plastic and has four suckers on the base so you can stick it to the table.

Watch for a full review of both in February.



DJW joystick. Designed with the housewife in mind.

Super directories

Catloader is a new program from SD Microsystems designed to simplify selection loading and running of programs from Microdrives.

The package consists of two sections — Main System which contains cartridge maintenance or housekeeping routines; and Microdrive Controller which is described as a Microdrive management system with disc-like commands.

Features include automatic master menu creation, automatic cloning, multiple formatting and a facility called super directories which lists all files in large letters without screen overflow.

Catloader costs £9.95 from SD Microsystems, PO Box 24, Hitchin, Herts.

Compware goes for languages

Compware doubled its range of QL software overnight by acquiring exclusive manufacturing and distribution rights to the Computer One range of QL programs. Computer One specialised primarily in languages. The complete range is Pascal, Forth, Assembler, Monitor and Typing Tutor.

Compware has also produced a new product of its own. The addition of *Swopper*, a task-switching program — see page 20 — takes the total number of programs in the Compware range to 11.

Compware is at 57 Repton Drive, Haslington, Crewe CW1 1SA. Tel: 0270 582301.

Sandy micro to be QLiberated

Liberation Software is releasing a much-enhanced version 2.0 of its SuperBasic compiler *QLiberator*. In what is apparently an effort to counteract an aggressive advertising campaign by Supercharge publisher Digital Precision, Liberation emphasises the ability of *QLiberator* to compile any SuperBasic code without the need for re-working.

The approach is obviously

the correct one so far as Sandy is concerned. The company has adopted *QLiberator* as the native compiler in its new 68000 QL-compatible machine, the Futura, designed by Tony Tebby.

Digital Precision, however, will be hoping to consolidate its hold on the market with the launch of the *Better Basic Expert System*, a kind of pre-compiler program cleaner,

and the new Turbo compiler. Although the toolkit which accompanies turbo or can be bought separately is reviewed in this issue, there is still no sign of Turbo.

At the time of writing the Digital Precision answerphone was unable to comment on the delay.

Liberation Software, 43 Clifton Road, Kingston-upon-Thames KT2 6PJ. Tel: 01-546 7795.

S Y S T E M S

SOUND

In common with other Sinclair machines, the musical abilities of the QL could best be described as dismal. Now all has changed. Mary Soens auditions three QL sound systems.

One of the few attributes for which the QL is not noted is its ability to generate genuinely useful noises.

That games writers have been unable to implement reasonable sound effects to accompany gameplay is more a credit to programmers than to the ubiquitous BEEP command.

That is no longer the case. By one of those strange coincidental conditions where an idea is developed independently in widely-separated localities, we now have two voice synthesisers available for the QL. In addition, the German firm ABC has produced a

the QV200 announces itself with "QL Computer Speech" and an SPS copyright notice is printed above the F1/F2 information windows.

Allophones

Introduction to the SPS system in the manual includes basic information regarding allophones — component sounds from which more complex sounds are made — and includes a table of the 64 allophones along with the decimal number and duration times of each.

Although requiring a little practice

illustrate the methods for using each type of speech transmission. The allophones required to produce the word "January" would look like:

JH1 AE1 AE1 NN1 YY2 XR1 IY1

Five pauses, with a range of 10mS to 200mS, are available to provide audio separation for syllables and sentences

Decimal value	Allophone	Duration
10	JH1	140mS
26	AE1	120mS
11	NN1	140mS
25	YY2	180mS
47	XR1	360mS
19	IY1	250mS

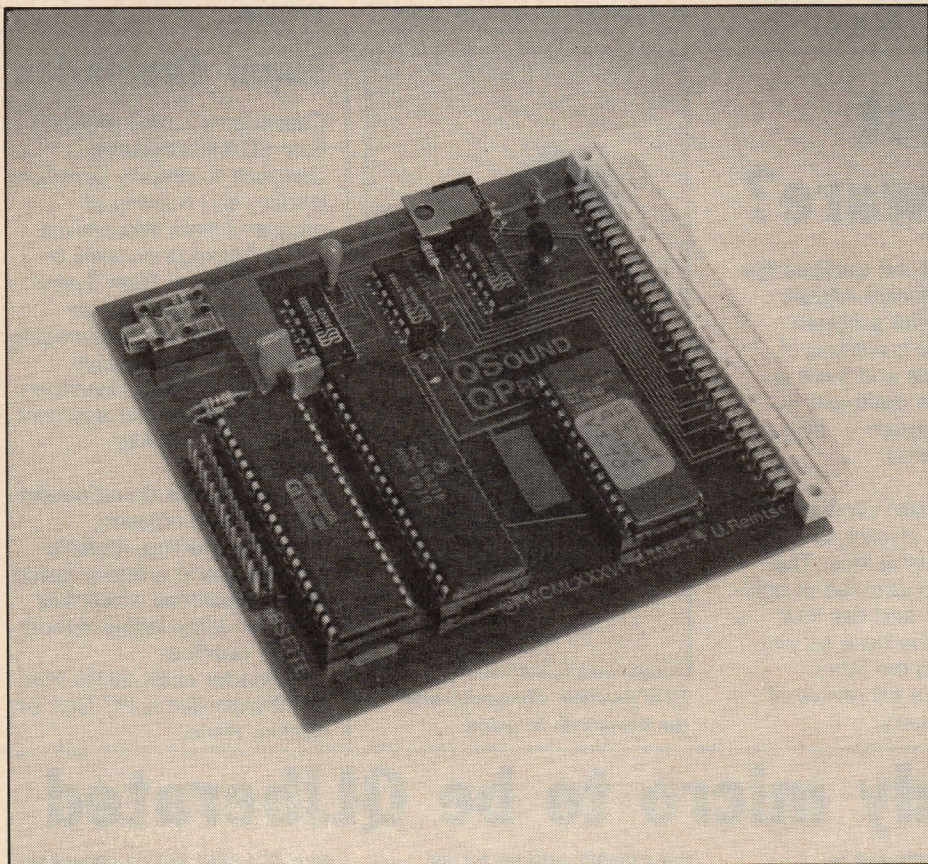

dedicated board for producing acceptable music with its QSound/QPrint.

Designed and built in the U.K., the QV200 Speech Synthesiser module consists of a PCB card interfacing through the QL expansion port, an automobile-type speaker and a cartridge which includes a number of typical application examples.

Once installed, the first indication that something new has been added to the QL is that, on power-up or re-set,

with the unfamiliar method of inputting speech symbols, using the QV200 is reasonably simple. Words and sentences are constructed from mnemonic symbols and may be PRINTed from a SuperBasic program or COPYed directly from a cartridge or disc. A third method of transmitting mnemonic codes is by POKEing the decimal values of the allophones directly to the QV200 board.

Examples supplied on the cartridge

and may, like the voiced allophones, be compounded to produce extended timings. Line spaces can, to some extent, be used to extend some of the allophone sounds.

The sound of some of the allophones is improved by putting a short pause at the end of a word, effectively switching off the allophone rather than allowing the sound to continue to its programmed conclusion. A typical example is with the sound of the "k" as used in "mark". Without the PA1 immediately after the KK1 allophone, the sound is more of a ks.

Novel approach

A novel and useful approach to the production of speech, the QV200 is a versatile system which can cope with virtually any problem connected with speech in almost any language.

An American import — inputting "z" causes the unit to say "zee" — the *Talker* is somewhat simpler to use since it contains its own power supply, connects to the ser2 port and characters are printed to it by the OPEN#[ch],ser2 : PRINT#[ch],a\$ commands. In this respect, it operates as an extension of the QL operating system, rather than requiring dedication of the expansion port as is the case with the QV200 Speech Synthesiser.

Supplied as a self-contained, independent black box with built-in speaker, only two connections are required, one to the ser2 port — if it is connected to the ser1 port the Talker will hiss — and the other to the mains. A red button on the top of the case is used for testing and will cause the unit to say "OK" when pressed.

Since no other software for using Talker is required, the cartridge supplied contains several rather good application demonstration programs. Practical use of Talker aptly demonstrates the diversion taken by pronunciation and spelling. I found that a number of words had either to be misspelled or they had to be broken into syllables to obtain the correct pronunciation:

Pronunciation

The simplest way to circumvent any pronunciation problems is to type-in the appropriate text, correctly spelt, save it as a file and fine-tune it later with a text editor. Be that as it may, Talker, within a few limitations imposed by any form of electronically-generated speech, does a grand job. A number of points regarding its use worth remembering are:

Using otherwise incorrect spacing will sometimes improve the clarity of the spoken word.

Pronunciation is sometimes improved

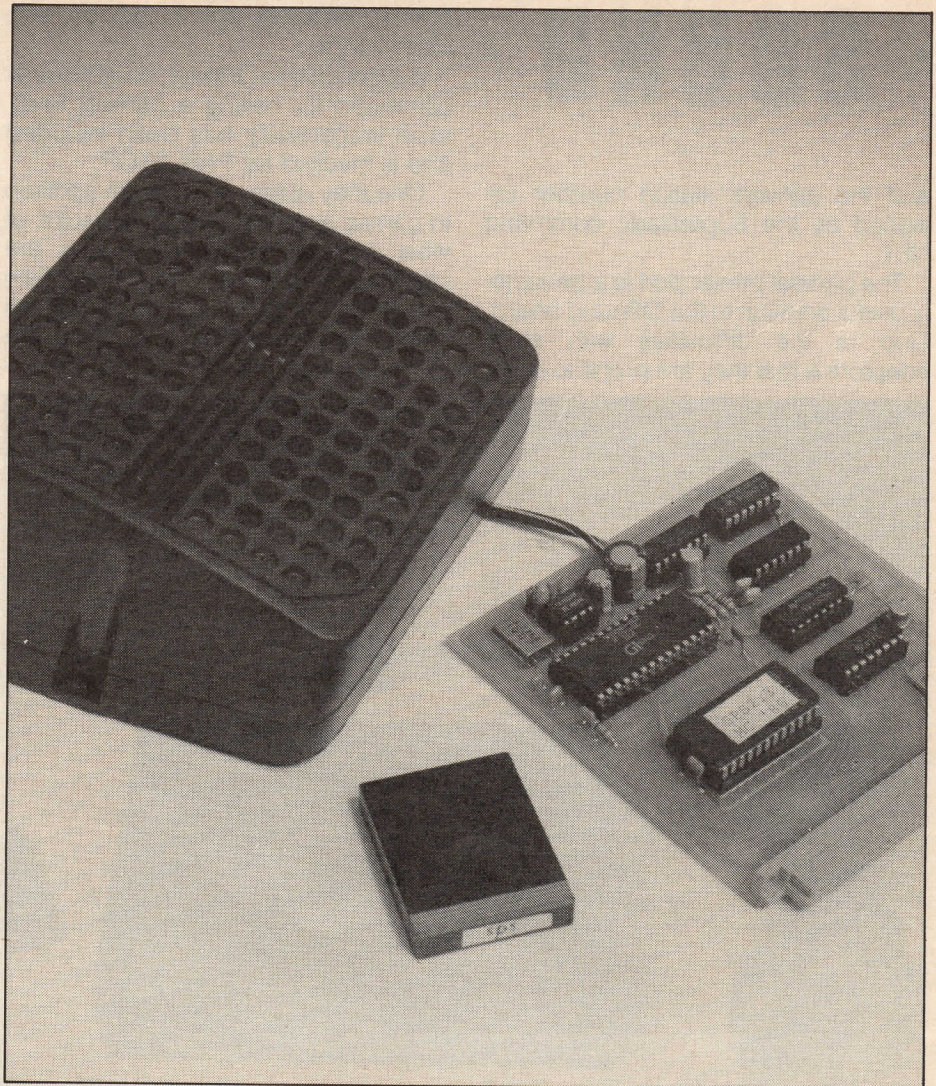

Word Input	Pronunciation	Altered spelling/spacing
Read (present tense)	read (past tense)	Reed
Ware (as in software)	war	Where
Programmed	programmed	Pro grammed
David	dahvid	Dayvid
Tiny	tineye	ti ne
July	julie	Julii or Juleye
Banger	similar to "danger"	bang er

by incorrect spelling.

Talker normally will ignore anything but alphanumeric characters but spaces, commas and full-stops have a definite effect on the pauses between syllables and words.

Where a space is inserted into a word deliberately, the pronunciation of a letter or combination of letters may be altered drastically.

The deliberate input of double letters will sometimes extend the sound of a syllable.

Testing Talker on some real tongue-twisters, such as supercalifragilisticexpialidocious or whatever, produces a surprisingly close approximation of correct (?) pronunciation. Even medical names, or just random rubbish, are dealt with reasonably, although non-

English words often have to be spelt more or less phonetically.

From ABC Electronics, *QSound*, is a dedicated sound system which, almost incidentally, includes a parallel printer port and a number of useful Basic extensions.

Three sound effects

Intended to be operated from the QL through an audio power amplifier, the heart of QSound is the AY-3-9810 three-channel sound chip. It does not assume the users have three ears; the purpose of the three channels is to provide a method for playing counterpoint melody from three separate program scores simultaneously. Three sound effects have been included —

EXPLODE, BELL and SHOOT. Included with the kit is a demonstration program of a number of rather well-produced music scores. The demonstration program also includes application examples of the new sound commands available to the system.

Parameters for producing music include notes — including flats and sharps; rests, a range of seven octaves, 16 relative volume levels, duration of notes ranging from one-fifth of a second to 25.1 seconds, 32 changes of noise frequency, a range of 16 wrap curves, 32,768 wrap lengths, sound sync stops and individual activation of any one of the three waiting channels.

Of less readily-apparent use, a number of additional commands more commonly seen in various toolkits are not included. Among them are functions controlling the cursor — enable/disable, cursor flash rate, moving the cursor up or down by one row and moving the cursor left or right by one column.

Miscellaneous commands include font control, a keyword for obtaining the Qdcs release number of your QL



and the network station number assigned by the SuperBasic command NET.

The parallel printer port is a genuinely useful addition to the QSound board. One of the difficulties with serial adaptors is that they are prone to drop-

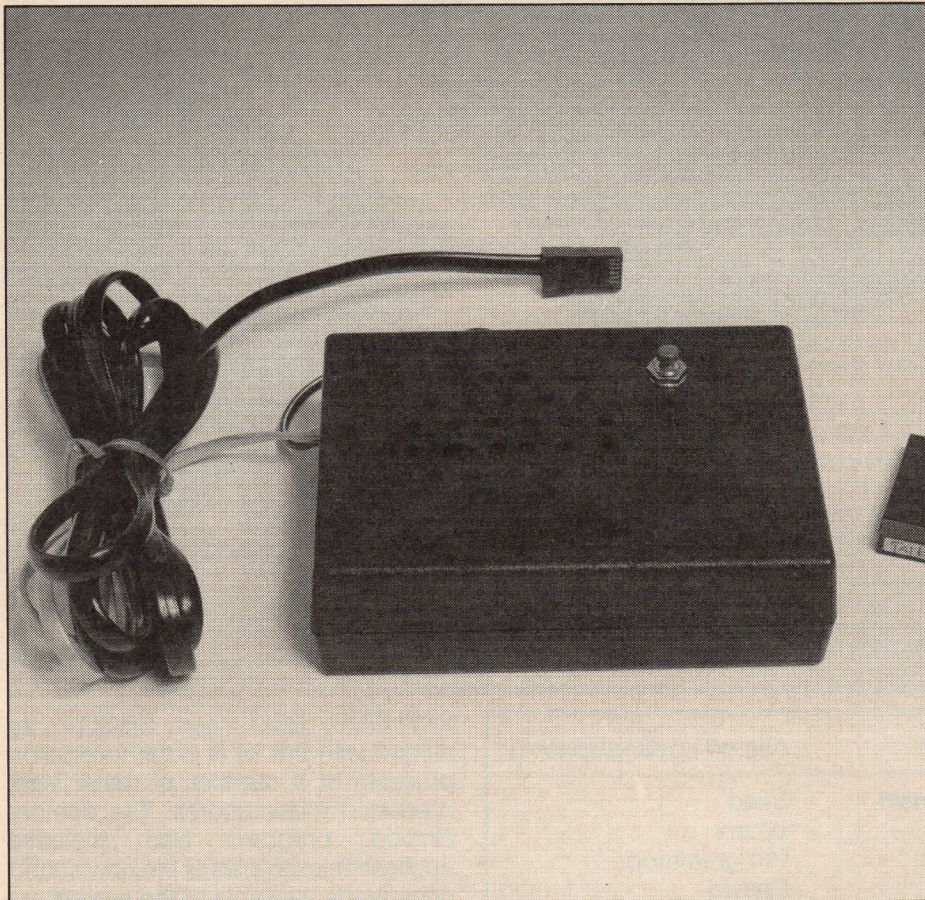

ping characters when serial data is fed to a printer. My usual printer interface is through the Sandy Super Q board and I recommend that type of approach to coupling a printer to the QL.

QPrint provides a number of additional facilities including serial emulation. If PAR_USE SER is added to the beginning of a boot program, all output sent normally to a serial port will be sent to the new PAR device instead.

Aids for handicapped

Another advantage of the QPrint parallel port is that, provided there is sufficient memory, buffers — in multiples of 512 bytes, from 512 bytes to 63K — can be specified for efficient background spooling. By specifying OPEN#[ch],PAR_64, a 32K buffer is reserved for printing a complete

screen, allowing you to get on with other things.

Exceptional to QPrint, an additional command for halting a printing operation immediately has been included and is invoked by PAR_STOP.

One may reasonably ask, in addition to games and other similar pursuits, of what possible or practical use are voice synthesisers? An immediate answer is that they are very useful aids for the visually handicapped. There are other applications in areas for literary

or other forms of education and speech therapy.

One of the problems encountered with any form of voice synthesiser is that the user will usually have to tune in to the form of speech produced by electronic means. Without considerably more sophisticated circuitry than is possible at the price being charged for either the QL Speech Synthesiser or the Talker, both units sound a little like something from *Dr. Who*.

Missing from the structure of the synthesised word are inflection and accenting, although a reasonable approximation may be made with the use of the implementation of pauses of either system.

Another difficulty associated with electronic speech synthesising is that both systems are limited to what I always think of as mid-mouth speech. Labial or guttural sounds tend either to be softened or eliminated.

QSound is a system which will probably be the beginnings of a whole genre of music generation devices for the QL and its derivatives. One of the finest products yet released from ABC, a number of very useful utilities have been included on the QSound board.

My only criticism of QSound/QPrint is that I felt that the documentation left something to be desired. The first eight pages, in addition to a number of minor printing errors, outline the new keywords. Pages nine to 22 deal with machine code applications of QSound.

Besides the demonstration supplied with the system, there is little other information regarding practical applications. Users would seem to be left mostly to their own devices — literally and figuratively — and ingenuity.

Easiest method

If you want to transpose music from score to program, probably the easiest method is to work out, longhand, the values of the individual notes in terms of pitch and length. Conversion of note length is not made any easier by the fact that conversion is done in units of 1/50th of a second.

There is little doubt that someone eventually will produce a program to make writing music for QSound for musical illiterates somewhat easier. The demonstration program illustrates clearly an important aspect of this type of add-on. Unless you are able to read a musical score and/or understand the relevance of musical notation, programming QSound to make anything other than a random collection of cacophonous noises will require a careful session with pencil and paper prior to an energetic application to the keyboard.

Information

Product: QV2000 Speech Synthesiser **Price:** £59.95

Source: Maurice Computers, Brookside, S. Kilvington, Thirsk, North Yorks YO7 2NL

Product: The Talker **Price:** £80.00

Source: Sector Software, 39 Wray Crescent, Ulnes Walton, Leyland, Lancashire. Tel: 0772 454328

Product: QSound/QPrint **Price:** £89.95

Source: Digital Precision, 222 The Avenue, London E4 9SE. Tel: 01-527 5493.



QL Expansion

from the creators of . . .



QDISC

The best-selling floppy disc interface (now issue 4) is fitted with a 16K EPROM containing many 'Toolkit' extensions, and CST's own Ram Drive. It may be used with most 3.5" or 5.25" floppy disc drives, CST's own twin slimline double sided 80 track 3.5" units being exceptional value for money, with 720K of formatted storage per drive. The Toolkit provides a wide range of SuperBASIC commands and functions designed to improve access to the powerful facilities of the QL without the need for machine-code programming. Job control is made easier, files can be used for random access, alternative character sets can be produced, 'wild cards' can be used in file operations, etc.

Ram Drive

The Ram Drive device driver allows free memory to be used as though it were a very high speed disc, in fact the fastest such device when used with the RAM-plus. Ideally used for the storage of temporary results, or multiple screen images for animated displays, it also eases the copying of files in single disc systems. The Ram Drive can only use memory which is free, so the full advantage is only felt if the QL is equipped with additional memory. Built into QDisc 4 and Thor, the Ram Drive is also available on 3.5" and 5.25" floppy disc.



The CST RAM-plus unit expands the available memory of the QL to the limit of 640K. Using high grade 256K memory devices, this unit is the only one which offers the high performance of no wait-state operation. Housed in a rugged metal case, the RAM-plus unit has an expansion slot which duplicates the QL's, allowing any other CST peripheral to be used. Among the advantages derived from using the RAM-plus are the performance improvements of software and storage devices, and the ability to multitask several programs at once.

SCSI

CST's Interface for Rodime compatible Winchester handles up to 8 SCSI devices and is complete with floppy disc interface. Using enhanced QDISC software, it supports heirarchical directories, easing file management; with well over 1000 files being possible, this is absolutely essential. A Data Management Utility is provided which speeds up backups by only copying recently modified files.



The Q-488 provides comprehensive yet simple access to the IEEE 488 Instrument Bus for the Thor and QL. Developed with IEEE specialists Procyon Research Ltd, the Q-488 interfaces to equipment directly from SuperBASIC and other languages and provides commands for low level bus control and even built-in bus analysis.



The CST Thor is the ultimate development of the QL. Available in single and dual floppy and 20M SCSI Winchester models each with 640K RAM, parallel printer and mouse ports, battery-backed clock and separate 84 key PC-AT style keyboard, it is built into an attractive metal case with internal power supply and expansion slot for peripherals. Supplied with many unique extensions to QDOS including multitasking at a single key-stroke, enhanced screen windowing and making full use of all the keys on the full-travel keyboard, the Thor is supplied with a specially commissioned version of the Psion Xchange software suite, and a comprehensive manual. Contact your distributor for details.



Cambridge Systems Technology
24 Green Street, Stevenage, Herts SG1 3DS
Telephone: Stevenage (0438) 352150



Please supply:-	UK inc VAT	Overseas
Qdisc Interface 4 (3.5" util. disc)	£79.95	£72.70
Qdisc Interface 4 (5.25" util. disc)	£79.95	£72.80
QEP-III Eprom programmer (QL/THOR)	£115.00	£103.20
RAM-plus 512K QL memory	£139.95	£125.20
CST Dual 3.5" cased floppy discs	£219.95	£200.40
CST Q-488 GPIB instrument interface	£224.25	£198.40
CST QDISC SCSI interface	£230.00	£203.40
Qdisc 4 + dual 3.5" drives	£275.00	£249.40
Qdisc 4, RAM-plus + dual 3.5" discs	£405.00	£363.60
3.5" Utility disc inc. Ram Drive	£10.00	£10.00
5.25" Utility disc inc. Ram Drive	£10.00	£10.00
Eprom V1.16 for issue 2/3 Qdisc	£15.00	£15.00
Qdisc issue 2/3 (3.5" utility disc)	£49.95	£45.50
Qdisc issue 2/3 (5.25" utility disc)	£49.95	£45.50
Export administration		£5.00
Airmail outside Europe		£5.00

Prices are inclusive of carriage
CST reserve the right to alter prices and specifications without prior notice

Name _____

Address _____

Post Code _____ Telephone _____

I enclose a cheque/PO for £ _____

Please deduct my Access/Mastercard/Eurocard/Diners Club a/c

Card No.

Expiry Date _____

Signature _____

Open Channel is where you have the opportunity to voice your opinions in *Sinclair QL World*. Whether you want to ask for help with a technical problem, provide somebody with the answer, or just sound off about something which bothers you, write to: Open Channel, Sinclair QL, Petty France, London SW1H 9ED.

O P E N

Folly

I am a design engineer with several years' experience in the design of microcomputer systems. I have undertaken a folly which involves designing a system for my use, the hardware of which will be of known quality. I intend to port Qdos on to this system. Having examined elements of the code and read several volumes on the O/S, I believe this is achievable.

I find myself lacking a precise understanding of

how to install new devices to the O/S. In the January, 1986, issue of *QL User* you mentioned a book, *QL Interfacing and Hardware*, which McGraw-Hill does not publish, contrary to the information in the article.

I would be grateful if you could inform me as to where or how, and at what cost, I may obtain the information.

S. Jaglowski,
Warrington.

Editor's reply:
QL Connexions will cover installation of new devices to Qdos.

As a consultant astrologer of more than 25 years' standing, I can assure Dr Maltby that the value of the astrological approach lies in the speed with which we can identify problems and suggest solutions.

In many cases a psychologist or business adviser would reach the same conclusions and offer the same advice but it takes them much longer to get there.

Janet Augustin,
Brighton.

Editor's reply:
You draw an analogy between the laws of physics and human behaviour, but you then go on to say that the analytical techniques of the physical sciences are inappropriate criteria on which to assess the validity of astrology.

You further assert that there is more to astrology than mathematical computation, having just criticised Maltby's conclusions for relying on insufficient statistical data.

Flaws in your argument aside, the Professional Astrologer review was just that — a software review.

One-liner

An additional line, number, 32085, crept into my "dumpy" screen dump routine which you published in the October issue. It is clearly a mistake and should be omitted. It was not on the paper listing but sneaked into the Microdrive file as these things do.

The programming may look a bit odd, having been optimised for speed of interpretation rather than elegance. I would be prepared to put an expanded and commented listing into an s.a.e. from anyone who wished to see how it works. But don't all write at once.

P. H. Tanner,
145, Broomhill Drive,
Glasgow G11 7ND.

The price is right

I am puzzled by the reference in the penultimate paragraph on page 15 of the November 1986 issue to Sinclair QLs "selling for £150 complete with a printer". If there is no misprint I am very interested.

Can you cast any light on the matter? I have been considering QLs at £128 to £149 as good value.

W. J. Henry,
Belfast.

Editor's reply:
At the time of writing, Dixons is selling the QL for £119.99. It is also selling the Serial 8056 thermal printer for £49.99. If, however, you buy the printer with the QL it is £20 cheaper. The complete package would, therefore, cost £149.98.

Sport for all

I am writing in the hope that an improvement can be made to *Sinclair QL World*. Looking through other computer magazines I always see a Top Ten Software Guide but never in *QL World*. If it were to have a Top Ten poll it would help youngsters like myself to choose QL games.

I would also like to see more sport games being made for the QL. So far there are only games like *Matchpoint*, *Chess*, *Super Backgammon* and *Snooker*. Why not games like football, basketball, baseball and cricket which other computers produce?

Richard Evans,
Carmarthen.

Editor's reply:
Sinclair QL World is not essentially a games magazine so we have avoided the top ten and points approach to games reviews. We had an adventure round-up in October.

The last word

I would like to reply to Dr John Maltby's letter in the November issue regarding the nature of astrology. I appreciate his difficulty. The quoted article contained a number of unsound generalisations but it is a fallacy to equate astrological predictions with weather forecasts; a truer analogy exists between astrology and psychology.

Let us equate the aspect Mars Square Uranus with boiling water and then let us pour an equal amount of boiling water into a tin vessel, an earthenware vessel and a vacuum flask. The tin will transmit the heat immediately; the earthenware will absorb the heat and transmit it more slowly; and the vacuum flask will not transmit it at all. The effect of the hot water is conditioned by its container.

The effect of an astrological aspect is conditioned by the psychology and social conditioning of the individual. One person may erupt immediately, another may consider the effects and gradually let go his anger/frustration in a controlled way; the third would internalise the distress and — apart from the doctor who has to treat the resulting

ulcer — no-one would know anything had happened.

Once it is recognised that astrology falls within the realms of animal or psychological studies rather than physics, appropriate tests will doubtless be devised.

I do not think that Gauquelin should be dismissed so lightly and if Dr Maltby had studied birth data in sufficient quantity he would quickly recognise the psychological factors which relate to Mars in the twelfth, Saturn in the ninth and so on, which Gauquelin demonstrates adequately in his tables of planet-related occupations.

It must be recognised that astrology is a complex subject and there is much more to it than mathematical computation. Even the best computer programs should be regarded as a tool for the astrologer rather than as guidance for the astrological client.

No matter how good the computerised synthetic reading — and Digital Precision is one of the best — it is crude when compared to an individual consultation, where the birth chart, the progressed chart, the current aspects, the social and educational attainments of the client and the human relationships are considered.

CHANNEL

Bird brain

It was gratifying to hear that Alexander Tagaris — Open Channel, October — found my article about user-defined graphics helpful. He raises a very interesting point about using UDGs in Quill and other commercial programs. I have corresponded with a number of people — one of whom was compiling a Latvian bird directory — on this subject and some of the information has appeared in *Quanta*, the organ of the independent user group.

As far as I can see, there are two possible approaches — modify the code of the commercial program so that it uses a user-defined font in RAM; or run a multi-tasking program which monitors all open channels and allows selection of the font to be used.

I have had some success with both methods and could provide further details if required. Quill is a special case, in that there is a different font already built into the code of the program, that for the super- and subscripted letters. If you can do without them, they may be replaced by your own font by patching the program. The different font is then accessed by entering subscript mode. Howard Clase from Canada has submitted a program to the *Quanta* library which does that.

James Lucy,
Colchester.

Time to spare

As a reader of *QL World* from the first issue who is always impatient for the next issue to arrive, may I congratulate you and your staff for an excellent publication which improves each and every month?

Re-reading back issues I noticed a letter in the old *QL User* dated Jan/Feb 1986 from Neville Cresdee of

Gosport. He mentioned the annoyance of having to re-set the SDATE every time the QL is switched on.

As the original publicity for the machine claimed that battery back-up would be standard, I wondered if any of your expert readers had carried-out a conversion or modification.

F. Merrison,
Pinner, Middlesex.

Editor's reply:

A number of programs, such as Choice by Eidersoft and Taskmaster by Sector Software incorporate clock update routines; but you have to enter the date at the beginning of every session. Rainbow Digital Repairs is working on just such a battery-backed clock.

ROMs in a queue

I have owned a QL for one year. Among my library of software. I have a few ROMs. Could you tell me if there is anything on the market to allow me to plug in more than one at a time?

If so, how can I get one and what would it cost? If not, what is the problem in manufacturing this very important piece of hardware?

D. Walster,
Dartford, Kent.

Editor's reply:

Rumour has it that Digital Repairs is developing a board which will allow you to plug in several ROMs. Ultrasoft is working on the same line, so we should hear something soon.

Pompous

I refer to Mr Senior's letter headed slap-happy in the November issue criticising the standard of published programs. Senior is obviously a programmer of some experience and ability but I find his comments more than a little disheartening and little short

of pompous. I am sure that many readers such as myself are new to computers and programming and, having found the QL manual totally confusing, turn to outside publications for guidance and encouragement. The guidance is received from clear, well-written articles or features, and the encouragement from using that information and seeing a program work, whatever its size.

Obviously those first programs are unnecessarily long or cumbersome and the fine tuning can come only from a greater understanding of the machine and technique, which in turn results from experience.

Features such as The Progs can serve only to encourage both the novice and the experienced alike and, as I understand it, act as a window to promulgate new ideas and so can only be for the better.

I believe that Sir Clive's idea behind the Sinclair range of computers was to "sell machines to people to learn programming" and not deride their attempts to do that. Surely a better approach would be to offer advice as to where or how procedures may be made more efficient.

B. Gibson,
London SE17.

Fair Xchange

Having owned a QL for 18 months I have become one of the many dedicated users, albeit mainly for small business use. The Psion suite of software has proved to be of exceptional value.

With *QL World* providing much very interesting and relevant information, I have been able to understand the capabilities of the QL and progress beyond Quill, which was the original reason for my purchase.

Because we now have the use of an Apricot F2 for word processing and spreadsheet work, I am able

Pen is out

I received my QL in June and became very interested in the graphics side of it. The idea of a lightpen then occurred to me, so I started looking for one.

Could you tell me if they exist for the QL? If so, where I could obtain one and also some information on them — how much they cost, do you need an interface, and can you save pictures formed by them on Microdrives?

Sean Borodale,
Bath, Avon.

Editor's reply:

Theoretically, virtually any lightpen could be hooked up to the QL; the major problem is software. Despite the proliferation of graphics packages, one does not exist.

to make personal use of the QL. There will be times, however, when it will be used for business purposes. On this basis we are considering purchasing the Psion *Xchange* for the Apricot. It is in this area that advice would be appreciated. Using *Super Media Manager*, V1.12, is it possible to transfer files between the two computers? There seem to be varying opinions as to whether or not this is possible.

Ian Treherne-Donnelly,
Wellingborough.

Editor's reply:

Super Media Manager has a facility called alien disc file copier. Using this facility it is possible to copy non-QL format discs. Three operating systems are catered for — CP/M, Acorn DFS and MS DOS. Xchange on the Apricot F2 — and the IBM PC and compatibles operates under MS-DOS, so you should be able to transfer files with no problems. You can obtain Psion Xchange from Transform Ltd. Tel. 089 283 4783.

ULTRASOFT UTILITIES FOR THE SERIOUS USER

TOOLBOX II (v1.18)

A serious self-stipulating backup utility using only superbasic extensions. Make exact microdrive format copies. Clone to any device and between any devices, even single floppy drives. SAFE, SURE, CERTAIN, PRECISE AND FAST FILE HANDLING in a user friendly packet. Comes with Ultrasoft standard and dynamic ramdisks (Ultradisk), real multitasking call-up clocks (depress ALT/SHIFT) with system information. Toolbox II is now delivered with a memory cut-off program and a diskmonitor. If you work with ramdisks or need any backup copies, you cannot afford to be without this programme. Comes with a fully documented manual. DM49.00 £14.95

QKICK (v2.5)

Qkick is the programme for the user who needs to work. A fully multitasking programme running completely in interrupt 7 as a call-up background routine. Complete desk top facilities including a notepad and appointment diary. Save screens while playing — ideal for high score proof etc. Save memory, load memory alter job priorities and much more for the programmer while working within the current programme. For the businessman there is not only the note pad and appointment diary and calendar but an easy-to-use database for addresses etc., WITH a software interface to the PSION Organiser II AND WITH an easy transfer routine to put those addresses or the data you need into the current programme, i.e. while working in Quill, find the address you need and transfer it straight into Quill from Qkick or quickly look up an address or telephone number while working with any other programme. Also comes with an automatic screen switch off/on routine to prolong the life of your monitor and a real multitasking spooler — spool from within Quill. IT IS AN AMAZING PROGRAMME AND MANY VERY GOOD PROGRAMMERS SAID IT WAS IMPOSSIBLE TO WRITE. Comes with a fully documented manual. DM84.95 £24.95

FULL HOUSE

Reviewed in *QL World* 11/86 — 'it is good fun to play, worryingly' addictive. Superb colour graphics. You need nerves of steel to play. A fruit machine poker game completely identical to many machines found in German pubs. DM39.90 £12.95

NEW RELEASES

QMASTER

THE DATABASE FOR THE QL. Driven by pull-down and pop-up menus. User defined variables and routines. VERY EASY AND SAFE TO USE. SEND OR RING FOR A DEMO CARTRIDGE. If you need to use a user friendly database then this will suit you and leave database-headache free at the end of a database day. User manual. DM159.95 £49.95

GRAPHIC CONSTRUCTION SET

Now you can write your own customised graphics programme which can do as much and more than other graphics programmes, in as little as 6-8K of basic. A set of superbasic extensions that really allow to design a programme that suits your needs and not to suit your needs to the programme. Comes with a compiled demonstration example and fully documented user handbook. DM49.90 £14.95

Main distributor: **Hardware & Software Systems**
Maximilianstrasse 42A,
D-4400 Münster Tel: 0251 271653

UK Distributor: **EIDERSOFT**
Hall Farm,
North Ockenden,
Upminster, Essex Tel: 0708 851099

Belgian, Netherlands,
Luxembourg **Guy Delforge**
Jan Hamminecke Str. 39,
Mariekerke, Bornem, Belgium
Tel: 052 335910

A SPECIAL MESSAGE TO ALL THOSE PEOPLE WHO HAD A SINCLAIR COMPUTER FOR CHRISTMAS

(and those who have had
one for years)

THE NEW YEAR
MICROFAIR IS ON
JANUARY 31st 1987
AT THE
HORTICULTURAL HALLS
LONDON SW1.

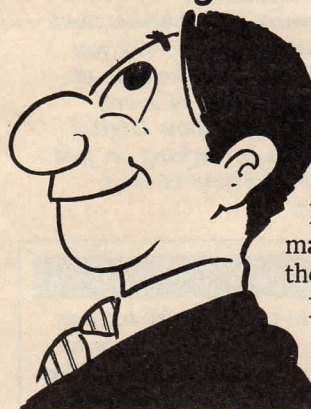

Looking for great gizmos for
your new Spectrum or QL?

There's one place you will
find everything:
THE MICROFAIR.

If it's new it will be on
show. If it's original
you'll find it on sale. If
you need advice you only
have to ask the exhibitors. If
you want to meet thousands of
enthusiasts, just come along
and enjoy yourself.

There's everything for
Sinclair Computers. Hardware,
Software, Books, User Clubs,
Programming Aids, Games,
many at special 'show' prices —
there's even a bring and buy sale.

For a fun day out and a chance to
see and buy everything new and
exciting . . . you won't beat the
MICROFAIR.

THE NEW YEAR MICROFAIR

JANUARY 31st 1987

AT THE HORTICULTURAL HALL
GREYCOAT STREET/ELVERTON STREET
LONDON SW1. 10am-6pm

ADMISSION: £2.00 (ADULTS)
£1.50 (KIDS UNDER 14 YRS)

SEND NOW FOR REDUCED PRICE ADVANCE TICKETS

Send to Mike Johnston (Organiser), Dept Q.L.
ZX MICROFAIRS, 71 Park Lane, London N17 0HG.

Please send me _____ advance tickets
(Adult @ £1.50)

Please send me _____ advance tickets
(Child under 14 @ £1.00)

Name: _____

Address: _____

22nd
ZX MICROFAIR

Please include a stamped, self-addressed envelope and make
cheques/POs payable to ZX Microfair

> Even Better Basic.

SOFTWARE RELEASE

Digital Precision Describes its Better Basic program as an expert system. James Lucy makes some less sensational observations.

SuperBasic is one of the greatest assets of the QL, being very flexible and allowing structured programming. Some people would take the view that the interpreter is a little over-generous in its work and that it fails to reject code which might be ambiguous. Making use of the generosity of the interpreter, either knowingly or unwittingly, can result in programs which behave in an unexpected and unintended manner.

They may also be difficult to follow, both for an outsider and the programmer after the passage of a few months. If the SuperBasic is to be compiled, deviations from proper programming practice can produce real problems, although some compilers are more tolerant than others. BetterBasic, from Digital Precision, provides a means of analysing a SuperBasic program, highlighting errors of structure and making amendments automatically. In addition, it can tidy the layout of program lines, making the code more readable.

Executable

BetterBasic is supplied on Microdrive or floppy disc as required. It is accompanied by a 20-page A4 manual. The program was written originally in SuperBasic and has been compiled using Supercharge, so the result is an executable, 28K, multi-tasking job. That means the QL can be used for something else while the program is doing its work, although the analysing process is fast in practice.

The program requires a number of SuperBasic extensions to be resident when it runs, something taken care of by the boot program. Those extensions occupy 4K of RAM and are the run-time routines from the Turbo Toolkit. It is not, however, a cheap way of obtaining the Toolkit because the use of the extensions from interpreted Basic is restricted.

The program is very simple to use.

Once it has been started with EXEC, prompts appear for source and destination devices and filenames, together with self-explanatory questions to select the various options available.

Range of devices

Provision is made for a range of devices, including two kinds of floppy, Microdrive and RAMdisc. The source file, or the processed output, or both, may be listed on the screen as BetterBasic progresses. The output may be re-numbered — confusingly called re-sequenced by BetterBasic — it may be re-formatted to a tidier layout and diagnostic comments may be included.

If you are concerned about the size of BetterBasic and whether it would allow a large program to be checked, there is no difficulty because it works to and from files of arbitrary size. It will also work on files prepared in a text editor, inserting line numbers if required, although it is amusing to watch it try to make sense of a binary file.

The author of BetterBasic, Charles Dillon, has a good reputation as a programmer, so it is not surprising to find the operation of the program straightforward and smooth, with intelligent defaults and no rough edges.

Having established that the program does what it sets out to do, the key question is whether the achievement of BetterBasic is worthwhile — and worth money. Re-numbering can, of course, be done from SuperBasic, and the re-formatting can be carried-out, albeit not so efficiently, in Quill or some other editor.

Compensation

Because the optional re-formatting involves adding many spaces, the program can grow substantially in the process; as partial compensation, all 'THEN' words are removed, replaced where necessary with colons. The analysis and checking of structures in a program is useful and can indicate

some unnoticed errors of style or syntax, but the 'intelligence' of the program is necessarily limited and it cannot correct really gross errors which would require blocks of code to be moved around.

All that said, BetterBasic provides in one place a useful means of checking and tidying a program and the final output is well-formatted and easy to read.

The BetterBasic documentation is very good. The manual is well-laid-out, clearly written, concise and allows ready access to any item of information. Digital Precision seems to have found a daisywheel to replace its NLQ dot-matrix, so the print is very clear, which it needs to be because the paper is a brilliant orange/red — to discourage photocopying — and is very hard on the eyes.

DP has an entirely understandable wish to discourage piracy but the genuine buyer suffers, to no avail in this case because the program can easily be used without instructions.

Could be improved

I must confess slight disappointment with BetterBasic, while accepting that it does well what it sets out to do. Describing it as an expert system in the advertising material rather raises expectations which are not fulfilled. The main point is that it could have been much more comprehensive, providing more information on the way the source program could be improved, such as a report on the structure of the program, on the use of variables, on the program flow at run-time highlighting bottlenecks and other information which Basic analysers on other machines can provide.

The idea of an expert system is that the knowledge of an expert is condensed into the machine so that it can be accessed by non-experts; had more of Dillon's expertise been included, BetterBasic would have been a more attractive proposition.

The Sinclair QL was regarded at its launch as a low-cost micro for small business. At its original price of £399 you could buy a powerful micro with its own cheap data storage medium in the two Microdrives and four powerful programs for general business use in the Psion package. With the reduced price bargains which can now be obtained, one high street supplier recently selling the QL for less than £120 or less than £180 with printer, the QL presents a marvellous opportunity for the small business to enter the world of computing.

A computer can aid a business not only by simplifying existing tasks but by making available, in a usable format, information about that business. With access to that information the businessman can plan more effectively, identify his market more easily and control day-to-day processes efficiently.

The business under discussion is a video film hire club. Its product is the library of video films for hire, its market its existing and potential club membership. A large number of businesses exist all offering the same service.

Apart from the location and organisation of the business, which helps to ensure that the video library is convenient to use, a large range of video titles on offer separates the good clubs from the bad. Some of the more successful clubs supply multiple copies of the popular titles to ensure that club members have a better chance of hiring the film they want to see. That helps to prevent the membership defecting to other clubs in the area because their desired viewing is always out on hire.

Database files

Archive is the main Psion program used to automate a video club, with two database files being created. The first holds the details of the product — the library of films — while the other maintains details of the membership. The product database contains title, male star, female star, male support, female support, director, format — i.e., Beta, VHS — hire charge, on hire, borrower, membership number, date of hire, number of occasions hired.

With that information stored for each video film a vast amount of detail can be obtained about the state of the business using the enquiry and report features of Archive. The procedures designed for the club in this example supply the detail described. This, however, is by no means a complete list of the variations of enquiries which can be made and the procedures can be

Running a video hire club can be difficult unless you have a QL to keep track of things. Graham and Hilary Gibson describe how.

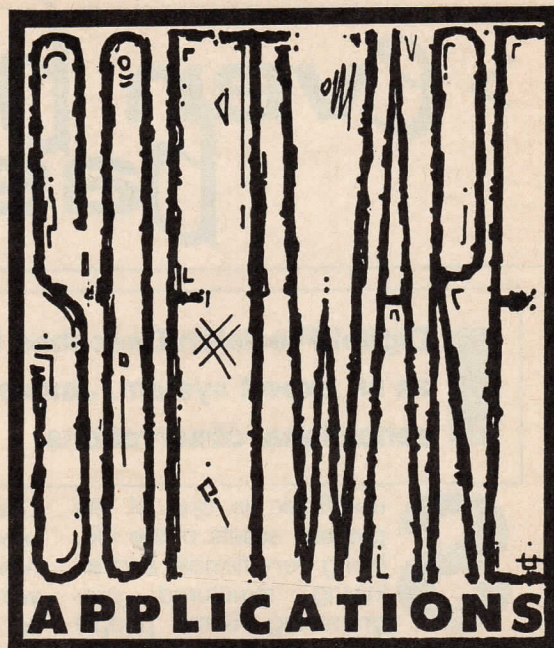

TITLE\$:	STARWARS
MALESTAR\$:	HARRISON FORD
FEMSTAR\$:	CARRIE FISHER
MALESUPPORT\$:	R2D2
FEMSUPPORT\$:	MARK HAMIL
DIRECTOR\$:	GEORGE LUCAS
VHS\$:	YES
HIRECHGE :	2.50
ONHIRE\$:	YES
BORROWER\$:	MR H SOLO
MEMNO\$:	12345678
DOH\$:	12.12.2015
NOHIRES :	255

amended or added to to supply the information in the desired format.

A member visiting the video club has the option of browsing through the collection to see if there is a film which appeals or alternatively can approach the receptionist and enquire about any films available which meet the given criteria.

They can be advised of all the films with a particular actor or actress in the starring or supporting role, or a film directed by a favourite director. Films can be listed by title to see quickly if it is in the library and, if it is, whether it is available for hire. All the comedy, thrillers or westerns can be listed to show the availability of a particular type of film.

Perhaps the club member wishes to see a black comedy starring Eddie Murphy, or perhaps wishes to see a selection of films starring Meryl Streep.

All those options assist members' quickly to find a film of their choice and helps the club to offer a better service

to its membership. Once a film has been selected, the receptionist enters that fact in the database record. The members' name and membership number are entered and automatically the 'On Hire' and 'Date of Hire' fields are updated.

When a film is returned, its record in the database is found and the 'On Hire' field is returned to 'No'. That action clears the 'Borrower' and 'Membership Number' fields automatically, calculates the hire fee and then clears the 'Date of Hire' field ready for selection by another member.

At the end of each day a report is generated showing the number of videos returned, calculating expected income and the number of videos which have been on hire longer than four days with the names and membership numbers of the borrower. It is then possible, if required, to show details of other videos those members have on hire from the club.

To help keep down the costs of the

business it is important that information about the popularity of particular types of film can be obtained. One of the video club's major expenditures is in the stock of videos available, so it is important that only videos which are popular with the membership are stocked. It is uneconomical to purchase videos destined only to stay on the library shelves.

To supply that information the club prints-out, once a month, a report listing all the films in the club sorted by popularity and type. That shows which videos are being hired and which are a possible waste of space. It also shows how many times a particular video is being lent, so that a decision can be made on when it should be withdrawn or, if still popular, replaced by a new copy. At the same time a TOP 10 chart of each type of film is printed and displayed in the showroom.

On an occasional basis the club reports on all the videos by title to maintain a printed record of all the films held in stock and has the additional facility to report separately on all the films on hire to enable a stock check to be performed.

Monitors growth

The other database is the details of the members. It is of a simpler format and is used primarily as a means of locating members and seeing how frequently they use the club. The format is name, membership number, address, telephone number, enrolment date, number of videos hired by type.

The database is also used to monitor the growth of membership and to identify the areas where members live. That information helps with the decisions on advertising and mailshots used to notify existing and potential members of forthcoming events and to widen the awareness of club facilities.

Initially the video club used the QL with a TV originally used for previewing video films. Since installation it has bought a monochrome monitor for £80, taking the total investment to slightly more than £220 plus VAT. In addition to the Archive database facilities it uses Quill for general correspondence and is beginning to investigate the use of Abacus and Easel to manage its cashflow and general business finances.

The QL is not the best computer the small business can buy but its cost certainly makes the decision to buy a computer easy. It has brought computer facilities to a company which would never have been able to justify the expenditure if it had had to pay more than the cost, in this case, of three good films.

T. K. COMPUTERWARE

★ Your QL Stockist ★
Telephone: 0303-81-2801

SOFTWARE:

Archiver	18.00	Concept 3D	40.00
Archiver (disk)	24.00	TechniQL	50.00
Cash Trader	60.00	GraphiQL	21.00
Cash Trader (disk)	64.00	QDraw	15.00
Decision Maker	35.00	Eye Q	29.00
Entrepreneur	35.00	QL Paint	24.00
Home Finance (Buzzz)	22.00	Viewpoint	20.00
Impact Sales Ledger	46.00	Peintre	15.00
Purchase Ledger	46.00	Graphic Toolkit	15.00
Nominal Ledger	46.00	Sign Designer	18.00
Impact set above	135.00	Better Basic	20.00
Impact set + Stock Cont	175.00	GST Macro Assembler	45.00
Sales Order	46.00	Prospero Pro Pascal	92.00
Purchase Order	46.00	Pro Fortran-77	92.00
Integrated Accounts	85.00	Supercharge	50.00
Life & Business Organiser	20.00	SuperForth	25.00
Ospell	25.00	Super Media Manager	40.00
Ospell (disk)	29.00	Super Media Manager (disk)	40.00
Touch Typist	12.00	Turbo	85.00
Copymate	13.00	Turbo (disk)	85.00
Equate	40.00	Turbo Toolkit	25.00
ICE Eprom	29.00	The Editor	25.00
Choice	16.00	Metacomco C	85.00
Toolkit	10.00	Pascal	75.00
Artice	14.00	API	95.00
Icicle	20.00	BCPL	51.00
ICE set above	84.00	LISP	51.00
Key Define	10.00	Talent Assembler Workbench	25.00
QL Switch	15.00	Cartridge Doctor	13.00
Ram Disk (QILash)	11.00	Computer One Monitor	24.00
Ram Toolkit (QILash)	10.00	Forth	34.00
Ram Disk set above (cart)	19.00	Pascal	50.00
Ram set above (Eprom)	25.00	ROMon	30.00
Ram set above (disk)	21.00	QMON	20.00
Mouse set (std)	70.00	Mouse set (de-luxe)	90.00
Task Master	25.00	QL Multitask	15.00
Nucleon	20.00	Abacus, Quill, Archive, Easel set	10.00
Super Sprite Generator	29.00	Chess	17.00
Super Toolkit 2	34.00	Bridge Player	20.00
Front Page	23.00	Cosmos	14.00
Flight Simulator	17.00	Matchpoint	14.00
Professional Astrologer	60.00	Scrabble	15.00
PIAstrologer + Astronomer	70.00	Snooker	13.00
Squadrons	16.00	Super Astrologer	24.00
Backgammon	13.00	Classic Adventures	10.00
Karate	15.00	Pawn	20.00
Aquanaught	20.00	Baron Rouge	17.00
Blocklands	10.00	BJ in 3D	12.00
BJ The Return	10.00	Boulder	8.50
Caverns	11.50	Dragonhold	20.00
Droidzone	10.00	Executive Adventure	13.00
Fictionary	11.50	Gwendoline	18.00
Hyperdrive	13.00	Jabber	8.75
Knight Flight	15.00	Land of Havoc	19.00
Lost Pharaoh	15.00	Metor Store	11.50
Mortville Manor	20.00	Quboids	9.00
Slime 3D	13.00	Wanderer 3D	20.00
Jungle Eddy	15.00	Reversi	10.00

PRINTERS:

Micro Pheripherals MP165	215.00	Centronics Printer Interface	19.50
Cannon PW 1080A & lead	279.00	Serial printer lead	10.00
Taxan KP 910 & lead	419.00	Parallel printer lead	12.50
Epsom LX 86 & Interface	278.00	Tractor Feed for LX 86	22.00
Queen Data d/wheel + I/F	199.00	Sheet Feeder LX 80	55.00

MEMORY EXPANSIONS:

512k Expanderam (Miracle)	119.00	MODEMS	
512k Internal upgrade	112.00	Modem (Miracle)	49.50
512k Expanderam + Ram Disc	127.00	Modaptor	39.00
512k MCS board + disk I/f	199.00	Tandata QCOM	84.00
		Astracom 1000	199.00

DISK DRIVES:

Disk I/Face (Cummana)	86.25	DISK SYSTEMS:	
Single 3.5" Drive	115.00	Single D/D & Interface	201.00
Dual 3.5" Drives	199.00	Dual D/D & Interface	285.00
Dual 5.25" Drives	199.00	Single D/D & 512k MCS QBoard	310.00
		Dual D/D & 512k MCS Board	395.00

MONITORS:

Phillips 7502 + lead	98.00	SOUND:	
Phillips 7522 + lead	104.00	QL Talker	75.00
Microvetic D03 Colour	260.00	QL Speech Synthesiser	60.00
		QL Sound	70.00

COMPUTERS:

QL JS, Ver. 2.3 S/ware	149.00	QL 640k, JS, 2.3 S/ware	260.00
Psion Organiser 2 CM	94.00	Psion Organiser 2 XP	138.00

SUNDRY:

10 DS/DD disks (unbranded)	22.50	QL Service Manual	19.00
10 DS/DD disks (branded)	31.00	10 Microdrive cartridges	17.50
Power Clean Filter	36.00	Quickshot 2 Joystick + adaptor	16.00
Cartridge Storage Box	5.50	QL Dustcover	5.00

QL Books at £4.50 please call for titles available.

Please phone for details of other QL products in stock

★ All prices are in £ and include VAT and UK mainland delivery by Post or Securicor ★

Telephone order payment by:



or send Cheque, Postal Orders or Eurocheque to:

**T.K. COMPUTERWARE, STONE STREET,
NORTH STAMFORD, ASHFORD, KENT CT25 6DF**
Telex: 966676 PMFAB G

WDSOFTWARE

FOR THE SINCLAIR QL:-

JOSS £15 on mdv or 5 1/4" flp, £17 on 3 1/2" flp

Forget syntax errors and mistyped names in file commands! Just move a cursor and press SPACE. Cursor keys or joystick allow access to up to 8 microdrives and all the discs your interface will handle, with up to 150 files on each. Scroll & print directories, COPY, DELETE or PRINT any file, select TV or Monitor mode before LOADING/RUNNING a program. Use keyboard only to set date or label a medium. Easy to use with Psion or other software. No silly icons to learn - JOSS will tell you what it's doing! Mass copying/printing utilities and programmer's toolkit. Specify disc size, tracks and interface (CST, Cumana, PCML, MicroPeripherals) or microdrive only.

RefQL7 £11 on 2 mdvs or 1 3/2" flp, £9 on 5 1/4" flp

For use with ARCHIVE 2, contains 1300 useful references and a search/print program. Find programs, articles and reviews buried in the magazines on your shelf! Cheap updates of earlier editions.

Mdv Extension Cable (8" £5.50

Add ZX Microdrives to your QL.

Joystick Adaptor £4.99

FOR THE QL, SPECTRUM, (ALL), BBC & ELECTRON:-

WD Morse Tutor £4 cassette, £6 mdv or 5 1/4", £8 3 1/2"

Teach yourself to read Morse Code. From absolute beginning to 18 wpm! Feedback on screen or printer. Random letters, numbers or mixed, 100 random sentences, many helpful features include phonetic speech via Currah Micro-Speech (Spectrum). Discs unsuitable for BBC B+.

We export hardware and third-party software. Ask for lists

PAYMENT:-

In advance, in **STERLING** on British bank branches, international Giro, Postal Order or **ACCESS/MasterCard**. Add £1 outside Europe for AIRMAIL.

FROM:-

WDSOFTWARE (QLW),
Hilltop, St Mary, Jersey, C.I. Tel: (0534) 81392

BYTEBACK

GAMES

Boulder	8.50
Quboids	8.50
Karate	12.50
Vroom	13.00
Blocklands	8.50
Droidzone	8.50
Lost Pharaoh	12.50
Wanderer	17.00
Othello 3D	13.00
3D Slime	11.00
BJ The Return	9.00
BJ in 3D Land	8.00
Spook	9.00
Mr Smith	11.00
King	12.50
Citadel	6.00
Zapper and Eagle	6.00
Knight Flight	12.50
Chess	16.00
Match Point	12.50
Snooker	12.50
Scrabble	12.50
Flight Simulator	16.00
Lands of Havoc	16.00

ADVENTURE

Pawn	15.00
Classic Adventures	8.50
Mortville Manor	17.00
Aquanaut 471	17.00
Dragonhold	17.00
West	12.50
Zkul	12.50

LANGUAGES

Supercharge	48.00
Turbo Compiler	75.00
Turbo Toolkit	21.00
Assembler Workbench	21.00
Metacomco Assembler	35.00
Metacomco C	85.00
Metacomco Lisp	53.00
Metacomco BCPL	53.00
Metacomco Pascal	75.00
Superforth	24.00

UTILITIES

QL Paint (GraphiQL Plus)	20.00
Home Finance (BUZZ)	19.00
Graphic Toolkit	13.00
ICE (EPROM)	25.00
CHOice	14.50
ICE Toolkit	11.00
ARTice	12.50
Icicle	17.00
Ospell	17.00
The Editor	21.00
Super Astrologer	19.00
Professional Astrologer	45.00
Super Media Manager	34.00
Better Basic	17.00
Nucleon	17.00
Eye-Q	21.00
Super Sprite Generator	25.00
QL Peintre	13.00
Touch Typist	10.50
Sign Designer	15.00
Cosmos	12.50
TechniQL	45.00
Cartridge Doctor	12.50
Ram Disk	13.00

HARDWARE

Quickshot II Joystick	8.00	Miracle Autodial Modem	45.00
Quickshot TURBO (Microswitched)	12.00	Miracle Expanderam 512	115.00
Joystick Adaptor	4.50	Centronics Interface	19.00
Transform Microdrive Box	4.50	Eidersoft Mouse (+ ICE AND ARTice)	72.00
4 Microdrive Cartridges	7.50	20 Microdrives in Transform Box	39.00

CATALOGUE AVAILABLE SEND S.A.E.

ALL PRICES INCLUDE VAT AND FIRST CLASS POST
TELEPHONE (0636) 79097 FOR PERSONAL ASSISTANCE

Send Cheque/PO to:

BYTEBACK 20a SPRING GARDENS,
NEWARK, NOTTS NG24 4UW

beyond Words

SOFTWARE RELEASE

Why pay for word processing software when Quill is free? Ron Massey looks for the answer in Digital Precision's Editor.

The Editor, another superb program from Digital Precision, started life as a personal answer for its author, Chas Dillon, for deficiencies found in other text editors. The release version of *The Editor*, which costs £24.95, has increased in scope to such an extent that it now exceeds feature specifications found in even the best of many of the word processors available.

Written in Supercharged SuperBasic, Editor is extremely fast. If that alone is not sufficient to tempt you to look seriously at this superb program, of even more importance its compound command capabilities makes — naming just one almost trivial example — building an index from a finished document of almost any size the work of a few moments.

Noticeably, certain system commands have been omitted. Of these is the facility for obtaining a directory of other file-handling commands. Natively multi-tasking, Editor is started with Exec. That means that if you wish to obtain a directory, pressing <CTRL><C> will return you to SuperBasic, where you can load another program, perform file-handling functions or whatever, as usual. Pressing <CTRL>&<C> will return you to Editor.

Help pages

Since the screen is likely to be in something of a mess, pressing the screen refresh key will return Editor and the current document display to all its former glory.

Three full-screen help pages are available for pressing <F1>. Once you have read the manual, those command reminders — at least until you are familiar with the system — are very useful.

The information line, at the bottom of the main window, provides details of the cursor position in terms of line and character numbers, total line count of the document currently loaded and the mode — either Insert or Overstrike.

Files loaded with the RU. command will indicate non-printable characters with the Editor special font set, which consists of over-scored printable char-

acters. Command entries, after pressing <F3>, appear in this window and, during command execution, a copyright symbol appears on the extreme left side of the window.

Reading and writing to or from devices occurs, as with Quill, to the default devices established either with the configuration program or with the typed-in device identification.

Much more powerful than a simple word counter, Editor has implemented an iteration counter instead. If, for example, you enter RP F. — Repeat Find — Fred, the search will whizz through a document and, at the end, display the "Search Failed" message along with the number of occurrences of "Fred".

Document word counts are acquired in a similar manner by inputting RP CW — Repeat Cursor to Word right. When the "Search Failed" message appears, also in the same window will be the number of the words counted.

Where your time is at a premium a valid question any sensible person will ask is "How much of an improvement will Editor give me over, say, Quill or some other text editor?"

The bench testing figures, based on the test format similar to the one performed by the author during development testing, give a reasonable indication of tremendously-improved performance. The notation convention used in each test is the input command followed by the time, in seconds, taken to complete a full operation, including screen drawing time.

Many users will consider using The

Editor as a viable alternative to Quill. One of its attractions is its speed. Not so readily apparent, other features provide a powerful tool for producing all kinds of formatted text, with as much assurance as is possible with any kind of computer that the program will not impose its limitations on the user.

Complete cursor control allows you to increment the cursor by word or line, to top or bottom of screen or file; start or end of a defined block; page a screen forward or backwards or by character, in any direction.

Deletions

Deletions may be made by character, word, line either to the left or right of the current cursor position, or by block. Document justification may be left, right or centre. Documents may be ordered by any common parameter — alphabetical or numerical — or lines renumbered in any progression. Command entries may be input individually, recalled, or edited.

Once having a completed document in Editor, a command file may be invoked for deleting Quill or other control codes, putting a document into a particular format, sending control codes to a printer; the possibilities for the subject of command files are virtually endless. Of equal importance, the response to the keyboard is instantaneous.

Seldom have I encountered a program which positively scintillates with such due care and attention to the program flow and function as I have with Editor.

Test	v1.2 Editor	v2.3 Quill	v1.7 Ed
Load 10626 word text file	r.filename 22.4	F3/O/F/I filename 11:15.9	r.filename 47.1
Load file — quill	ru.filename 19.7	F3/L filename 26.8	r.filename 65.1
Load file — object	ru.filename w	—	—
Save file — text	51.5	F3/S filename 89.2	sa 150.7
Merge file — text	af.filename 51.2	F3/O/M filename 215.7	if.filename 351.9
Move block fwd by 200	200n;bm 4.7	F3/C etc 219.2	200n;ib;db;200n 309.4
Delete 100 lines	100d 3.1	CTRL/DOWN x100 119.1	100d 199.6
Find string — case dependent	fc.\$\$\$*** 14.1	—	fc.\$\$\$*** 16.7
Find string — case independent	f.unmatched 39.2	F3/S unmatched 49.7	f.unmatched 42.8
Find 10th occurrence	10f.matched 24.2	F3/S matched + <C> 9x 34.6	10f.matched 35.3
Find backwards	fb.matched 41.1	—	fb.matched 41.1
Split 50 lines at column 30	50(29cr;s;n) 44.4	By hand, quite a long time.	50(29cr;s;n) 281.1
Page from top to bottom (10K words)	SHIFT/ALT/DOWN 11.1	SHIFT/DOWN 194.5	SHIFT/ALT/DOWN 98.7
Generate 100 lines of 64 cols	bs;be;100bi 11.1	F3/C + 100x <C> 273.7	bs;be;100ib 258.8

If you are the kind that likes to write a letter, calculate your finances and play chess all at the same time, multi-tasking is for you. Marcus Jeffery investigates the options.

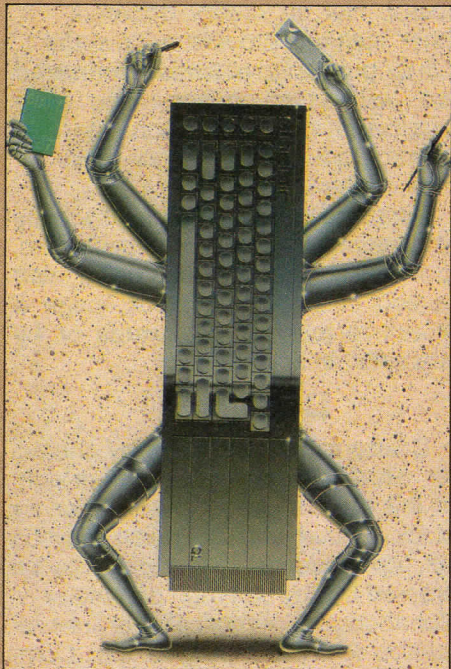

Multi-tasking allows the user to run more than one program simultaneously. Your QL has only one processor, so it is impossible to run two or more programs concurrently. Nevertheless, by careful sharing of the processor time between a number of jobs, the effect of simultaneous execution can be achieved.

You may not previously have considered the possibilities of multi-tasking software but running multiple programs can be very useful. It is not unreasonable to assume that many people have found a time when running, say, Quill and Archive together would have been helpful. I have sometimes been in a position where I have wanted to run two copies of Quill with different documents — one for reference and one for writing. At present, the easiest method of achieving it is to Merge the two files and then delete the unwanted text when finished. That, however, can soon become tedious, or impossible if the reference information is not in the form of a Quill document.

If you are still not enamoured of the joys of multi-tasking software, imagine yourself as a games player. *Chess* is a good example, where moves can take

some time on the higher levels. While your chess program is running, it is impossible to run any other programs, so you cannot proceed with that letter you wanted to write. You either give up the Chess, or regress to the pen and paper era.

Consider also the problem if, in the middle of the game somebody telephones, needing vital accounts information from an Abacus file. Well, so much for the game but with multi-tasking software you could easily switch from Chess to Abacus and back. Further, the computer will have been musing over its next move while you were away.

Not so simple

Though you may not have realised it, the standard QL is a multi-tasking computer. If you look in the Keywords section of your QL User Guide you will see that EXEC and EXEC_W are specifically for this purpose. They are defined as commands which will load a sequence of programs and execute them in parallel.

Each separate program is known as a job, each with its own stack and data areas. The QL can handle up to 255 concurrent jobs, each of which will be allocated a variable slice of processor

time. That allocation is not so simple as it may appear. Obviously, if the computer spends too much time swapping between jobs, to give the effect of simultaneous execution, nothing will ever be done. The processor allocation is controlled by the scheduler which will continually start and stop jobs, allocating resources as specified. The amount of time allocated to each job depends on the priority of the job. That can be set by the programmer to any value between 0 and 127. The higher the number, the more time slices the job will be allocated.

Though multi-tasking has many advantages, running programs simultaneously must slow the execution speed of each. Two programs running concurrently with the same priority will run at slightly less than half of their normal speed. Thus it would be of little use using multi-tasking in time-critical programs.

Re-drawing

Unfortunately, matters are not so simple or we could all multi-task any programs we wanted without the need for special software.

There is the obvious problem of retaining screen information between one job and another. I expect most

Taken To Task

people have encountered the classic clock programs. They multi-task with any other jobs which may be running. The advantage is that they usually use a small window in the corner of the screen, thus leaving most of the screen free for other uses. Even if the window is over-written, the clock will be almost immediately re-displayed as it is updated during its next time slice.

Imagine, however, the problems when trying to multi-task programs requiring the whole screen. That is primarily a problem of the application software. The Computer One Assembler package includes instructions showing the user how to multi-task the editor and the assembler so that they run concurrently.

CTRL—C is used to switch input between the two jobs and the screen is taken care of automatically. The Psion programs have a facility for re-drawing the screen — try pressing SHIFT—F5 — but that is of little use, since they will not multi-task without additional software.

Many other factors must also be taken into account. Imagine that one of your multi-tasking jobs was sending data to a printer. It is well-known that printers execute far slower than computers so, having started to send information, the printer job will have to halt until a signal from the printer tells it that more information can be sent. In this instance, the job is said to be suspended. The other two states for a job are active and inactive, depending on whether the job is running — i.e., will receive time slices — or not.

For true and useful multi-tasking, all of these and many more factors must be handled by the software. We decided to look at five multi-taskers available for the QL.

The first of the products we considered and the most recent arrival on the QL scene, is *Taskmaster* from Sector Software. Designed specifically for

multi-tasking, it arrives as a single master cartridge and 16-page booklet housed in a small wallet.

According to the introduction, Taskmaster was designed initially to allow the user to have all four Psion programs in the machine simultaneously and to be able to switch between them at will. The final version should allow you to multi-task any executable program, up to the limit of nine programs

bers—the later versions being slightly more efficient—but the various manuals estimate the required memory for, say, Quill, to be anywhere between 60K and 100K.

Loading and running Taskmaster could not be easier. The first run will involve making a copy to Microdrive or disc and that is explained in detail in the manual. Everything is menu-driven, with clear prompts and messages, and seems to be idiot-proof.

It is expected that most users will have discs, though Taskmaster will run just as easily from Microdrive. The easiest method of starting the system is to save the four Psion programs on the same disc as Taskmaster. On running the boot file, Taskmaster will ask for time and date — entered by changing on-

screen values using the cursor keys — if it has not already been entered, and will then display its load screen. That will give the option of loading automatically as many of the Psion programs for which you have available memory.

The main Taskmaster window is known as 'INFO DESK'. It displays the keys ALT-F1 to ALT-F5 and ALT-1 to ALT-9 and their associated programs. ALT-F1 is the INFO DESK and ALT-9 is

always SuperBasic command level. ALT-Fs to ALT-F5 are usually reserved for the Psion programs but could be replaced with any other programs you may require.

ALT-1 gives access to the Files utility. It is completely menu-driven, allowing you to copy and delete files, back-up groups of files, choose and re-

name files, and format or obtain directories from devices. In all cases, file operations will not involve typing-in file names but merely selecting them from a scrollable menu. Most of them re-

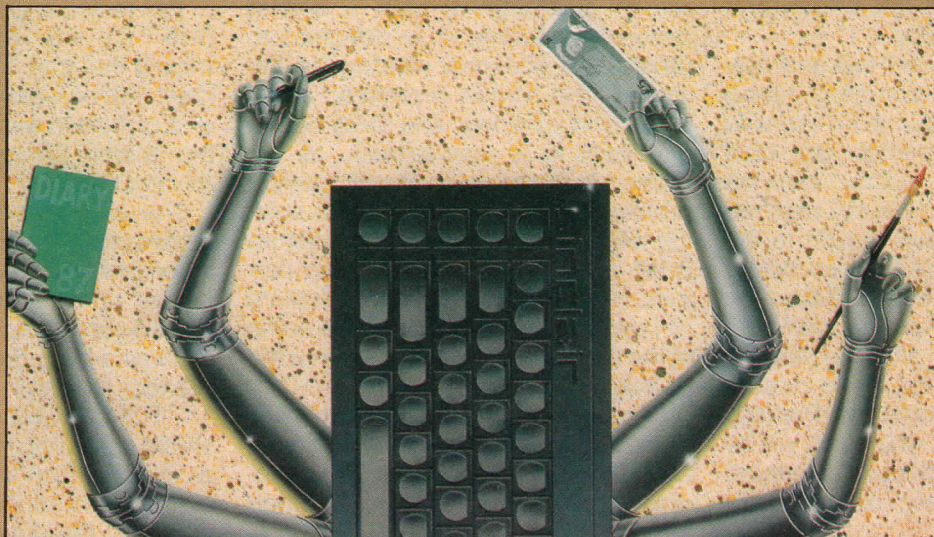

running simultaneously. As you may expect, that requires plenty of memory. Taskmaster and its associated software require a staggering 80K of memory, so unless you have at least 256K extra RAM, the package is not advisable. The memory use can be reduced somewhat by neglecting to load the 'Files' and 'Calculator' utilities, though the former is particularly useful. Having given that warning, it should be

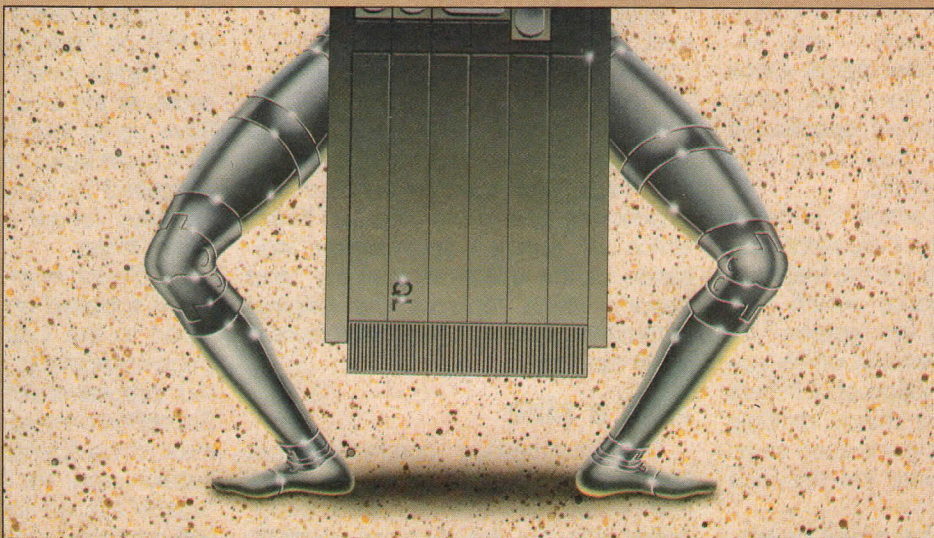

stressed that anybody wanting to make serious use of any of the multi-tasking programs is likely to need at least some memory expansion. In all cases, one of the major intended uses for the software is to multi-task the Psion packages.

Memory requirements for them tend to vary with the different version num-



Taken To Task

quire no explanation but Choosing a file is an unusual facility.

The Files utility is very fast and useful, negating those annoying typing errors. It would, of course, be useful to be able to use it to load, say, Quill documents. That is exactly what the Choose option is for. Having reached the Load stage in Quill, switch to the Files utility. Select the Choose option and the appropriate device. Select the Quill document you want to load from the directory given and, on leaving Files, this name will be typed directly on to the Quill command line. Perhaps not something about which you will be excited but a neat and useful feature, which is characteristic of the entire package.

Second level

Hidden from normal use is a second level to the Files utility. Having selected it, more sweeping activities can be performed. This level will give the options Directory, Before, After, Containing and Type. The default values for all those options is 'All files' but they may be changed to include only files before or after a certain date, containing a certain alphanumeric string or extension, or of a certain type — e.g., executable or Sinclair Relocatable. Once those options have been set, other commands have a more specialised effect. Back-up may now work only with a selected type of file.

The other software which is bundled with Taskmaster is the *Calculator* program. It looks nothing like the traditional calculator keyboards which you often find adorning the screen. Instead, a window appears in which you may type any combination of numbers and the operators plus, minus, multiply and divide. The enter key is used as an equals sign to calculate the previous line of calculation.

Although that can be useful for simple calculations, another feature exists. If you leave the Calculator utility using SHIFT+ESC, the final number will be typed on to the command line of whichever program you left to enter the Calculator utility. That will often be from one of the Psion programs, such as Quill, but could be from any job, including SuperBasic.

There are many more points which serve to make this a professional-looking product. It seems that, for some reason, the date data in the device directory is not normally updated. That is rectified by Taskmaster whenever you save a file, making full directories very fast even from Microdrive.

Another thing which may worry you the first time it happens is a screen protection device. It will blank the screen automatically after a certain period of inactivity. It is designed to protect the phosphor coating on the screen. The screen is restored easily by pressing any key. The delay before the blanking is user-settable, as explained in the manual. That is rarely a problem for normal use, as your coating will be affected only if a still picture is left burning away for extended periods. Nevertheless, it is another feature of Taskmaster and demonstrates some of the thought which has gone into the package.

Compware claims, on the front of its manual, that *Swopper* is the "ultimate QL task-swopping program". The program is supplied on a single cartridge with a 12-page pamphlet. The machine code multi-tasking program, which uses less than 9K of RAM, uses the following set-up procedure:

```
swopper = respr (9000)
1bytes mdv1_swopper,swopper
call swopper
```

Do not forget the load address, as happened in the manual. Having typed it or run an appropriate boot file, two new commands become available specifically for multi-tasking. They are:

```
exec_s filename [,size] [,flag]
```

and:

```
exec_sr filename,size,flag,delay,
command_string
```

They may be abbreviated to 'es' and 'esr' respectively. In addition, the function 'heap' will return the size of the largest free area in the common heap, which will give an approximate indication of the available memory, and 'respr', which replaces the original command, does not work once there is a job running.

Add a size

The multi-tasking commands are similar to the SuperBasic 'exec' commands, except that they start a 'swappable' job. So, for instance, a multi-tasking Quill could be executed by the command:

```
exec_s mdv1_quill
```

The problem here is that Quill will grab all the available RAM space, ensuring that there is no room for more jobs to be started. Therefore a size needs to be added. So:

```
exec_s mdv1_quill,80
```

would set up Quill with 80K of memory. The 'flag' parameter allows the user to specify whether or not memory should be allocated to save the screen from either Quill — in the foregoing case — or SuperBasic. If '-3' is used, specifying that no extra memory should be set aside for the screen, the screen will be re-drawn each time you switch between jobs, rather than being displayed instantly.

The re-drawing is a simulation of the SHIFT-F5 key combination. It also means that part of, say, a Quill document will be visible between the margins of the two windows in the centre of the screen on return to SuperBasic monitor mode.

The slightly longer version of the command, `exec_sr`, is used to include a command line in the loading. That is of use primarily when the loading is carried-out from inside a program, such as a boot file. For instance:

```
exec_sr mdv1_quill,80,0,900,
F3&'1mdv2_letter'&ENT$
```

would load Quill from Microdrive one, as before. The zero value tells the computer to allocate 32K of RAM for each of the Quill and SuperBasic screens. Additionally, it will load the Quill document "letter" from Microdrive two. That assumes that the variables F3\$ and ENT\$ have been set up with the codes for the F3 control key and the ENTER key. The delay of 900 is necessary to give Quill time to initialise itself before the commands are executed.

When using Swopper, SuperBasic is always accessed by SHIFT-ALT-F1. The other tasks are accessed by SHIFT-ALT and the function keys F2 to F5. Those keys will be assigned in order as the jobs are set up. You can have up to four tasks on those keys. Five more tasks can be added and are accessed by holding-down the F1 to F5 keys longer when switching between tasks.

QL Switch from Psientific Software is again supplied on a single Microdrive, taped to the inside of a small eight-page manual. QL Switch can run up to four programs simultaneously with the SuperBasic interpreter. The programs must all be specified at the start of the session and are then loaded from a 'switch' file. An 'install' program is provided to allow you to define and save your switch start-up programs.

Nevertheless, that reduces the usefulness of the multi-tasking software. One of the great advantages of multi-tasking is the ability to load a multi-tasking program while still holding and working with other programs in memory. Having said that, some of the Psion programs do not release mem-

ory the way they should, so loading new multi-tasking routines could soon have you running out of space.

This multi-tasking software gives more flexibility in its switching methods. During the install procedure you can define your own switching keys. The four tasks, their names, and the access keys can be displayed at any time by typing 'switch' when in SuperBasic command mode. SuperBasic is accessed by CTRL-C.

QL Switch does not give the option of saving the screens for faster switching. Instead, the SHIFT-F5 command is given automatically when accessing Psion programs. The refresh-screen command is again specified in the install sequence, so it would be very easy to specify different refresh keys for your programs. The manual is brief but that is more than compensated for by a number of possible demonstrations which are included as one of the options on the boot-file menu.

When buying a 256K or 512K Memodisk expansion and disc interface from Micro Control Systems, you will also receive a free utilities ROM. It is a fairly primitive ROM on a board but is designed to be used only once — to load the utilities into memory and thence to disc. Subsequently the utilities can be loaded from disc without the presence of the ROM. Should you wish, you could load them from ROM every time but that is not recommended.

In addition to file-handling, a clock, command files, Microdrive extensions, job control, a function key definer, memory management functions, and windows, icons and fonts, the MSC Utilities ROM Provides a Task Controller.

It is not really designed to compete with the software sold specifically for the purpose of allowing multi-tasking but will, nevertheless, allow you to carry-out the majority of multi-tasking operations. To begin, you must use a text editor to set up a multi-test file. It will typically be of the form:

```
FLP1__QUILL
100000
FLP1__ARCHIVE
100000
```

which would specify that Quill and Archive, both of which will be found on disc one, should be set up as multi-tasking jobs with SuperBasic. It also sets aside 100,000 bytes for each job.

Once that file has been set up, the command TASK can be used in the form:

TASK filename [as above]
to initialise the multi-tasking jobs. A Task Controller Menu will be displayed in the middle of the screen and press-

ing one of the function keys will take you to the relevant job. The screen is not held but restored each time using the SHIFT-F5 approach.

Unfortunately, there appears to be no method of changing the screen restoration sequence, so if you are not using Psion programs you will have difficulties. I tried multi-tasking two Metacomco Editor programs. The Task Controller Menu covered the area where the file information is typed, so I had to type by guesswork. Further, since the screens were not refreshed, it was possible to have switched from one to the other with no apparent change in text and be told that you are at the bottom of the file, even when you can see more text on the screen.

Another problem is that you can multi-task only the executable programs you have loaded. From each of those programs, CTRL-S — re-definable in the initial file — will return you to the Task Controller Menu. From there the other programs can be accessed or CTRL-F1 will return you to SuperBasic. Unfortunately that will also close all files and jobs. The only way to reactivate the multi-tasking programs is to start them again from scratch using the TASK command.

Major advantage

Choice, from Eidersoft, allows you to set up four multi-tasking programs in addition to the ICE environment. The program tasks are specified from the program *Choice*, prior to loading, just as with the previous two multi-taskers. From *Choice*, you save a '_TSK' file containing details of which tasks are to be loaded, and from where. During the initialisation of the tasks, using *Choice*, you will be asked whether or not you want the screens to be instantaneous. If so, you will have a choice between either setting aside 32K of memory for each screen or specifying a refresh key combination if there is one.

One major advantage of the system is that you will have access to the file manipulation commands available from ICE but, for some strange reason, accessing the program disc director in ICE will freeze the system on return to the Task menu.

Taskmaster is definitely the Rolls-Royce of the multi-testing packages. It seemed completely idiot-proof, even for me, and extremely user-friendly. To use Taskmaster successfully, you will need plenty of memory. In addition to the 90K required by Taskmaster, Files and Calculator, there seems to be no facility to turn off the 32K screen memory allocation in favour of the more economical SHIFT-F5.

Swopper is a very viable alternative,

being capable of most of what is possible from the multi-tasking element of Taskmaster. It is designed for the more down-to-earth programmer rather than, say, the business user. It is not particularly user-friendly compared to Taskmaster and requires more work on the part of the users.

It is possibly unfair to compare the MCS Task command with those dedicated multi-tasking packages. It performs as it purports to do and no more. For those who have a Memodisk interface, it may be a very useful command but it is certainly not worth buying the interface for.

Finally to QL Switch. The package, even without a save screen facility, demonstrates very flexible handling of the different tasks, doing its best to ensure that no problems of key duplication and so on occur. It is a pity, therefore, that it limits itself to only four multi-testing programs, all of which must be specified during the start-up procedure. The latter tends to put it in the same league as the MCS Task and Eidersoft Choice, which is not where an independent, dedicated multi-tasking package should be.

The major disadvantage with Swopper and Choice is that they do not truly multi-task. Background tasks are suspended until you return to them. Taskmaster, QL Switch and Task Controller will actually run several programs at once, but only Taskmaster has the ability to make sensible use of the screen, thus preventing chaotic displays when two programs simultaneously try to use the screen. It is that factor which puts Taskmaster in a league of its own.

INFORMATION

Taskmaster £25
Sector Software, 39 Wray
Crescent, Ulnes Walton, Leyland,
Lancs PR5 3NA. Tel: 0772 454328
Swopper £19.95
Compware, 57 Repton Drive,
Haslington, Crewe CW1 1SA. Tel:
0270 582301
QL Switch £14.95
Psientific Software, 37 Cottesmore
Road, Hessle, North Humberside
HU13 9JQ. Tel: 0482 649187
Task Controller £14.95 or free with
Memodisk interface.
Micro Control Systems, Electron
House, Bridge Street, Sandiacre,
Nottingham NG10 5BA. Tel: 0602
391204
Choice £16.95
Eidersoft, The Office, Hall Farm,
Church Lane, North Ockenden,
Upminster, Essex RM14 3QH. Tel:
0708 851099

MAIL LIST

£24.95

Allows you to retrieve names & addresses from within ARCHIVE. Other features include single key functions, prints address labels, exports files to Quill also compatible with our stock control.

STOCK CONTROL

£24.95

Keeps records of all stock items including retail price, trade price, minimum order level, items on order & many other features.

QL APPOINTMENT DIARY

Records appointments dates & times, can be used as diary, dentist, doctors, hairdressers, service engineers. Program allows 26 users, up to 40 appointments per day plus many other features.

QSPELL

£24.95

Spelling checker for Quill supplied with 25000 words, checks an A4 page in 24 secs.

PAYROLL

£63.25

Calculates weekly, monthly or 4 weekly payroll full tax calculations, coin analysis & payment rounding.

ARCHIVE

Our team of programmers are able to write programs to your requirements, phone for further details.

QL KEY DEFINE

£9.95

For those who use Quill or SUPERbasic this program is a must allowing you to define up to 2k on each key.

QL CALC

£9.95

Enables you to press CTRL & any other key to give you a full calculator. Compatible with Quill, Archive, Abacus & Easel. Many other features.

QL SWITCH

£14.95

Allows users with extra memory to run Quill, Archive, Abacus & Easel at the same time or two Archive programs & Quill.

RAM DISC

£14.95

Enables users with extra memory to set up a ram disc; programs can then be instantly saved & reloaded. A printer spooler is also included to allow you to print whilst using other programs.

TOOL KIT

£9.95

This program will copy all or selected files, delete one or selected files, display file to screen, change file name, format & print multiple copies of Quill files.

PRINTERS

DOT MATRIX

Citizen 120D	£209.00
Seikosha SP1000	£208.85
Epson LX 86	£247.25
Taxan Kaga	£287.50

DAISYWHEEL

Brother HR20 daisy wheel £495.00

ACCESSORIES

LX tractor feed £20.70

We also stock ribbons for the above printers.

Please add £5.75 for delivery of printers & monitors.

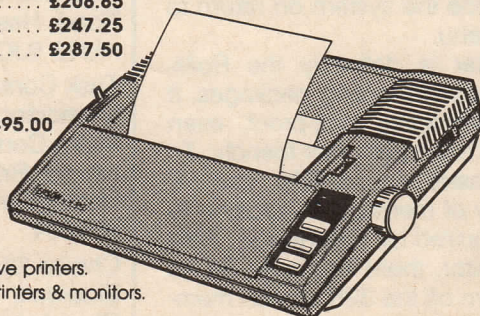

INVOICING

£49.95

Sales day book, sales ledger & audit trail, for disk only, holds up to 4500 invoices with names & addresses, invoice address, plus multiple delivery addresses, links with stock control, retains invoices, also available Three part paper printed for invoicing.

MONITORS

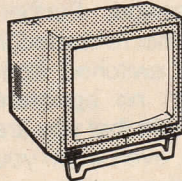

Philips 7502 £86.25
Please add £5.75 for delivery.

MICRODRIVE STORAGE BOX

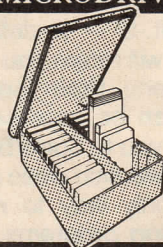

£4.95

MICRODRIVE CARTRIDGES

Single £1.75
Box + 10 cartridges £22.45
Box + 20 cartridges £39.95
Please add £1.00 p&p on boxes.

PRINTER PAPER

2000 sheets continuous paper £13.00
700 sheets 3 part paper £24.40
1000 continuous labels £6.65
Please add £3.75 p&p on paper £1.30 on labels.

DISKS

DOUBLE
SIDED
DOUBLE
DENSITY
DISKS

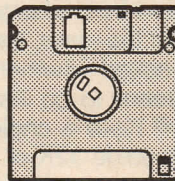

£3.00

DISK BOXES

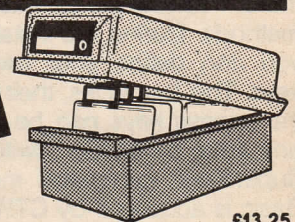

£13.25

3 1/2" box holds 40 £13.25
3 1/2" jumbo box holds 80 £17.00
Please add £1.30 p&p for disks & boxes.

ACCESSORIES

Monochrome monitor lead £5.75
RS 232 lead £11.50
Centronics interface £19.50

DISK DRIVES & INTERFACES

Cumana disk interface £79.90
Sandy disk interface £215.00
Single 720k disk drive £139.90
Dual 1440k disk drive £241.50
Please add £5.75 p&p.

MEMORY EXTENSIONS

512K £125.00

ORGANISER

Psion organiser XP £139.50
RS 232 link £47.95
64k data pack £79.95

← QL to ORGANISER £39.95 →

← QL to PC £29.95 →

XCHANGE

£295.00

Xchange is available from Transform Ltd. to run on the following: IBM PC/XT/AT & IBM compatibles, APRICOT PC, F series, XEN, ICL DRS20, DRS300, OPD, LOGICA KENNET, MERLIN 4000, VICTOR SEREUIS, TORCH GRADUATE & BT TONTO. We offer on site training & database applications to suit your requirements. Network upgrades enables XCHANGE to run up to 10 workstations. Evaluation packs available for £10.00.

PC FOUR

£79.95

A cut-down version of Xchange as supplied on the QL but with the added facility of 65,535 entries in Archive, 999 lines in Abacus & mail merge plus key define built into Quill.

PSION XCHANGE

ARCHIVE DATABASE

Multifile relational database. Only memory restricts the number of files in use at one time. Variable length records with a maximum of 255 characters per field, 255 fields per record, 65535 records per file. Command language allows the user to define procedures using a powerful editor. Flexible multifile indices provide fast access and a form designer for screen and printer input and output.

QUILL WORDPROCESSOR

Text and page formatting, underlining, bold, italic, superscript, subscript, justification, tabs, line spacing, page size, page headers, footers and numbering. On screen editing, fast page access, cut and paste, block copy, block move, insert/overwrite modes, search and find, search and replace, key define and mail merge. Document size only restricted by disk capacity, background printing, allows the user to print documents while working on others.

EASEL BUSINESS GRAPHICS

3D Business graphics including bar, line and pie charts, no limit to the number of values or numbers or sets of figures. Automatic rescaling, user define colours, text annotation of graphs at any pixel point. Intelligent evaluation of data formulae or manipulation of existing data. Images stored in internal format; monitor resolution is the only limit on final image quality. Accepts data from spreadsheet, database, etc.

ABACUS SPREADSHEET

Expansive spreadsheet with 999 rows, 255 columns, virtual memory system buffers to disk only when full, facilitating very large spreadsheets. Efficiency memory used only for full cells, each cell only uses 14 bytes. Variable width cells, block copy, block move, insert/delete columns and rows, merge and consolidation of data from different spreadsheets. Accurate to 15 significant figures, full range of mathematical, scientific, date, average, ASCII and DIF conversion.

£295
INC. VAT

PC FOUR £79.95



Exceptional in two respects, *Front Page* is the first commercial software release compiled using the production version of *Q-Liberator* and it is the first QL text-orientated graphics program designed specifically to produce professional-quality columnised copy in which an unlimited variety of simple graphic illustrations and bordered text blocks may be incorporated.

Desk-top publishing for production of leaflets, club newsletters, magazines or press releases is accomplished with equal ease and much of the drudgery usually associated with page layouts has been eliminated.

Hybrid

Front Page works like a hybrid spreadsheet, word processor and specialised graphics program in that the visible screen area — or viewing port — is a representation of only a small part of the page available for the final A4 hard copy.

A specialised printer driver has been included for reproduction of the graphic screen, rather than direct character translation. By scrolling and/or panning around the screen page, 100 columns by 100 rows are available for text or graphics. The over-sized screen page is translated automatically into a double-density screen dump for compressing the screen layout to A4 layout.

The screen arrangement consists of a large window for the viewing port, beneath which is a command window, at about the location of window #0. Once into the write option, text is pasted directly into its appropriate location on the viewing port.

HOLD THE FRONT PAGE

Desktop publishing software has taken the PC world by storm. David Hawthorne looks at the first packages for the QL.

Entirely menu-driven, the command range provides a very flexible printed copy layout system. The majority of the system commands are entered by toggling between alternative choices from the menus. GOTO column and row selection is available, as well as continuous cursor movement.

Standard spacing

A window block is marked on the area which is to receive the copy. After selecting the CSIZE, text is added within the column block. By pressing <Enter>, text is "fixed" within the block.

Screen cursor movement increments in the standard QL character spacing. Graphic content may be laid out on the 800×800 pixel page, where user-defined graphics are designed on an 8×8 grid, instead of the conventional 9×5 or 10×6, minimising the staircase effects evident in diagonal lines. An extensive range of user-defined graphics is possible to produce special layout configurations.

Character sets

Front Page includes three user-defined graphics sets and four UDG subsets. The normal QL CSIZE character set is supported. In addition, there is a facility to incorporate other character sets. As supplied, the system includes the standard QL character set and a custom set, for producing bold typefaces.

Mode 4's normal CSIZE 0,0 will produce a final hard copy print size a little smaller than the condensed character typeface available to most dot matrix printers.

Consistent with other advanced features available to the Front Page system, blocks of text or graphics may be moved or duplicated; boxed advertisements or notices may be columnised within distinctive borders. A complete range of text-editing facilities is included, such as cut-and-paste, and the system is capable of simple two-dimensional CAD. When the layout copy is completed, the Front Page special graphic printer driver will make a full-

page A4 copy of the screen layout page, complete with graphics and columns.

Developments

Designed to be compatible with standard QLs, users will have half of their copy page in RAM with the other half on Microdrive. Other configurations can utilise RAM discs, floppies or other peripherals.

Described as an entry into the field of publishing by author Peter Chambers, Front Page is being developed into a full-fledged desk-top publishing system for the QL.

Being considered for add-on developments to Front Page are graphics and text libraries enabling typing in, for example, inch-high characters directly from the keyboard. Also being planned are program additions allowing input of Spectrum UDGs and screens.

Exciting

Other plans include Quill file input, sectioning-off extra RAM for individual pages, cut-and-paste throughout RAM, up-and-down loading via the ser2 port and improved graphics-type editing facilities.

A number of users whose interests are in the production of text in its many formatted forms have longed wistfully to have a utility like Front Page since the QL was launched. A genuinely exciting product and incredibly good value, the possibilities for future additions to the Front Page system are almost endless.

Information

FRONT PAGE £22.50
Gap Software, 17 St.
John's Terrace, London
E7 8BX
Tel: 01-552 5452



The Definitive SuperBASIC Compiler

Q_LIBERATOR will compile your programs without changes and give you the benefits of speed, fast loading, error trapping and multitasking. See what our users say:

"Very useful and easy to use . . . It does as it claims . . . Supercharge for me is now totally redundant. I personally have managed to compile a major graphics program, some 56k of code alone, on an unexpanded machine, reducing it to 27k of code with an increase in speed of about 7 times."

- W.G. Jones, Portsmouth

"Absolutely excellent . . . A real compiler for SuperBASIC should compile ANY program that can be interpreted, and in that respect Q_Liberator is perfect."

- A. Hegedus, Harrow

Q_LIBERATOR also contains tools to support PIPES, job communication, and programmed error trapping. Q_LIBERATOR runs on any QL, Thor or QXT and is an integral part of the Sandy Futura system software.

Supplied with an 80 page printed manual on 3.5 inch disk or microdrive (with disk copy facility).

Price includes VAT and postage. Please send Sterling cheque or PO with order. Overseas orders, price includes carriage. Send SAE for more information.

**PRICE
£69-95**
Liberation Software

43 CLIFTON ROAD
KINGSTON-UPON-THAMES
KT2 6PJ
01-546 7795

SCHÖN QL KEYBOARD



IF YOUR QL KEYBOARD CAUSES THIS, THEN YOU NEED ONE OF THESE.

NEW

THE SCHÖN NUMERIC PAD
The new Schön numeric keypad will again consist of full travel keys and will connect via curly cable to the rear of any QL. The keypad has all numerics, also decimal point and Enter key. Available soon. Details from our address below.

Before you send off your keyboard for expensive repairs why not consider the best QL peripheral available: the Schön QL Keyboard. It is the FIRST and only DIRECT replacement keyboard for the QL microcomputer. Not only will it cure problems such as above but a true full travel keyboard will finally release the best from your QL. (WARNING!! Best is toxic). As you can see from the above photograph, the compactness of the QL is retained, the only radical change being the keys. It is equipped with 64 full travel keys all of which are two shot moulded and there is of course a full size space bar. 5 red keys distinguish the function keys on the left.

The Schön QL Keyboard is only £54.95 inc. VAT and is now available either through this advertisement or through various retail outlets. The Schön QL Keyboard is fully guaranteed for 12 months. Installation time: 5 minutes. No cutting or soldering required.



Send your order and remittance to: Dept 01, Schön Keyboards, 15 Northcote Crescent, WEST HORSLEY, Surrey, KT24 6LX. Tel: (04865) 3836.

Mr/Mrs/Miss
Address

Amount enclosed Signature

PLEASE ADD £1.70 FOR POSTAGE AND PACKING. OVERSEAS: Please deduct VAT and add £3.00 extra for postal costs.

PLEASE ALLOW 28 DAYS FOR DELIVERY.

TRADE ENQUIRIES WELCOME.

QL SUPERTOOLKIT II

Written by Tony Tebby.

OVER 118 COMMANDS INCLUDING FULL SCREEN EDITOR, PRINT USING, LAST LINE RECALL, ALTKEY, JOB CONTROL, FILE HANDLING, DEFAULT DIRECTORIES, EXTENDED NETWORK (ALLOWS DISCS, PRINTERS ETC TO BE SHARED BETWEEN QL's.) NEW BROADCAST PROTOCOL.

16K Eprom Cartridge Version @£ 34.50d
Configurable Version on Microdrive @£ 34.50d
Configurable Version on 3.5" Disc @£ 34.50d

Q LIBERATOR

Superbasic and Toolkit II Compiler
Microdrive Version @£ 69.92d
5.25" Disc Version @£ 69.92d
3.5" Disc Version @£ 69.92d

Q Liberator will be incorporated into the operating system of the Sandy 68000 (QLT)

MAGNETIC MEDIA

Microdrives (Pkt 4) @£ 7.91c
3.5" DS/DD (each) @£ 2.76c
3.5" DS/DD (per 10) @£ 25.30c
5.25" DIS, D/D (per 10) @£ 13.80c

QL HARDWARE

NEC 3.5" Disc Drive @£ 94.30b
Eprom Cartridge (each) @£ 8.05c
Eprom Cartridges (per 10) @£ 52.90c
QEP III Advanced Eprom Programmer @£115.00d
Sinclair QL 128K Computer @£138.00a
Sandy Super 512K QBoard Inc Toolkit II @£215.00d
Eprom 2764 250n/s 8K @£ 2.99c
Eprom 27128 250n/s 16K @£ 3.45c
Wide range of Connectors & Semiconductors.

68000 SERIES COMPUTER

SANDY 68000 512K Computer @£575.00a
Amega type specification at 25% of the cost
★ Full Multi-tasking ★ Dual 3.5" Disk Drives
★ IBM-AT Style Keyboard ★ Internal Power Supply
★ 16 Colour Hi-Res Graphics ★ RAM expandable to 8 Mega Bytes

QL SOFTWARE

AMBITION By Way Ahead @£ 28.95c
An advanced Business Orientated Strategy game for up to 4 players. Ambition simulates a comprehensive environment in which you can pursue a complex business career over a twenty eight year period.



TONY TEBBY Software

RAM Disc, Driver @£ 9.20c
QLFP (Specify Vers No Microperiph disc Upgrade @£ 14.95c
QMON II Microdrive @£ 19.95c
QMON II 3.5" Disc @£ 21.95c

COLIN OPIE Software

Character Font & Editor @£ 10.81c
Cross Assembler 6502/65C02 @£ 29.90c
Cross Assembler 8084 Series @£ 29.90c

MONITORS 85 Characters (Price incl lead)

Philips Monitors
BM7502 Green Hi-Res @£ 89.70a
BM7522 Amber Hi-Res @£ 92.00a
CM8533 Colour Med-Res @£289.80a
Hantarex Monitors
HX-12 Green Hi-Res @£ 79.50a

TV/MONITORS 85 Characters (Price incl lead)

Philips CT2016 16" @£294.40a
Philips CT2216 16" Remote @£322.00a

RGB CONVERSION (Philips/Pye TV's Only)

Conversion Kit (D.I.Y.) @£ 57.50d
Factory Conversion @£ 80.50a

READYMADE LEADS

Phono to UHF @£ 2.60c
RGB QL DIN to Phono @£ 4.60c
RGB 8-6 pin DIN @£ 4.60c
RGB 8-7 pin DIN (Hitachi) @£ 5.75c
RGB 8-7 pin DIN (Ferguson) @£ 5.75c
RGB 8 pin to SCART (Euro) @£ 8.05c

SWITCHING UNITS

RS232C 2 to 1 'T' (All Lines) @£ 57.50d
RS232C 4 to 1 (All Lines) @£ 80.50d
RS232C 2 to 2 'X' (8 Lines) @£ 69.00d

HOW TO ORDER: ALL PRICES INCLUSIVE OF VAT

By Post. Enclose your Cheque/P.O. made payable to CARE Electronics. Or use ACCESS/VISA. Allow 7 days for delivery. Please add carriage.

a=9.99 b=5.00 c=1.00 d=2.00



OPEN
9am-5pm Mon-Thu
9am-4pm Fri-Sat
800 ST ALBANS ROAD,
GARSTON, WATFORD,
HERTS. WD2-6NL.
Tel: 0923-672102

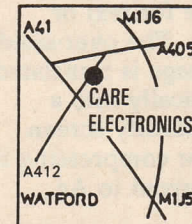

NEW PRODUCT AVAILABLE
SANDY
68000 SERIES
COMPUTER



UTILITY FILE

If the early releases are any criterion 1987 looks set to be a bumper year for programming utilities. Ron Massey checks the early crop.

QKick Ultrasoft £34.95

A second entry into the U.K. market from the German software house Ultrasoft, *QKick* is a kind of background front-end and differs from similar utilities in that invoking *QKick* will suspend all other currently-running programs, both Basic and jobs, temporarily.

Exceptional in that it is written in Interrupt Seven, *QKick* is entirely menu-driven; invoking *QKick*, by pressing `<CTRL>&<SHIFT>`, initialises a menu bar at the top of the screen along with a window containing copyright and owner's registration information.

Command entries are generally made with `<SPACE>` and the cursor keys; the "opps" option is usually invoked with `<ESC>` or entering a null string pressing `<ENTER>`, with no other input.

Pressing `<SPACE>` initially highlights the left menu header, *DESK*, and gives access to the sub-menus for information concerning the immediate operating environment such as System, Memory, Channels and Clock. Other *DESK* options include:

A choice of *QKick* entry keys. Defaulting to `<ALT><SHIFT>`, other combinations include `<ALT><CTRL>` or

`<CTRL><SHIFT>`, if the default combination is being used with a program such as *Keydefine*.

Screen off time. Defaulting to a delay of 120 seconds, if no input is made at the keyboard for the set period of time the monitor display is disabled. Pressing any key will re-activate the screen. Options range in increments of 30 seconds from 30 seconds to 15 minutes.

CQueue char. The usual convention followed for switching between *QL*

altering these values determines the delay before a character will repeat and the latter value determines the repeat frequency rate. Setting both values to zero makes for very fast typing.

Selecting *FILES* invokes its sub-menu containing a list of options for a complete range of file controls:

Directory provides successive pages of files on either floppy or RAM disc.

View — an option for copying a file to the screen.

File Info provides a directory from which a particular file is selected. Another window provides the statistics regarding type, length, dataspace and last update.

Copy, a selected file to a named drive.

Backup, a whole media from one drive to another.

Change will convert every occurrence of one string with another and provide a report of the number of

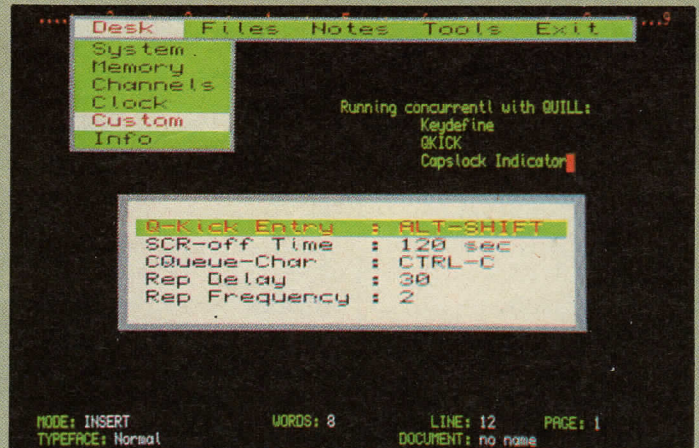

jobs and SuperBasic is by pressing

`<CTRL>&<C>`. If for any reason other key combinations are required, characters from `chr$(1) - <FDTRL>` & `<A>` - to `chr$(255) - <ALT>` and any key other than `<CAPSLOCK>` or the cursor keys — may be selected as replacement keys.

Rep Delay and *Rep Freq*. Defaulting to a value of 30 and 2 respectively,

conversions at the completion of the option. *Delete* will delete selected files.

Format will format a selected floppy or RAM disc.

The *NOTES* menu header — a useful 800-character, two-page Notepad.

QKick Diary — entries are made against a time-scale starting at 0700 and



ending at 2200. Diary files may be saved as separate page files from within QKick and loaded subsequently into the page, as required. Calendar — in conventional calendar format, preceding and successive months may be paged. Hex and decimal converter.

The TOOLS main menu header provides a further indication of the real power of the QKick system. The options from the sub-menu enable you to Edit Memory, a File, or a Sector directly; the Job control option produces a further menu giving access to Job information, Job pointers and setting Job priorities.

More options from the TOOLS menu allow you to Load or Save Memory and to Save a screen directly. The latter facility is useful for producing screenshots of games or saving particular screen layouts for introduction into one of the graphic programs for modification.

Because of the exceptional nature of QKick coding, it is not possible to access Microdrives from within QKick. Another minor limitation is that <CTRL><F5> — the QL listing pause — will produce a system re-set rather than cause the QL to hang.

One point which must be observed is that programs such as Quill, which have a tendency to grab every available bit of memory, will not leave sufficient working space for QKick. Whenever QKick is to be loaded prior to the main program, a RAM disc should be formatted. In the case of Quill, once running, users should enter <F3><0><F><F> — for format — and RAM1_ — with or without sector.

Failing to observe this point can make the screen switch-off facility unreliable and could cause a keyboard lock-out. If that occurs, the last image you will have of your just-complete 20,000-word document will be just prior to its dissolving into a multi-coloured display.

Planned additions to the production version of QKick include an address and telephone number database with a software interface to the Psion Organiser; a background printer spooler and data string transfer to the current foreground program.

Although possibly a little on the expensive side, QKick is an extremely useful addition to any routine library and will not very easily be equalled.

Reconfigurable Toolkit Care Electronics £28.75

A derivative of Tony Tebby's *Toolkit II*, you now have the opportunity of obtaining a re-configurable toolkit, with the same high specification, from Care Electronics. Users of the EPROM version of *Toolkit II* will already be familiar with the range of important additions to SuperBasic commands available to the system, as reported in the August issue of *QL World*. *Reconfigurable Toolkit II* command groups, however, may be separated into considerably smaller toolkits for particular applications where memory is held at a premium.

Command groups are menu-selectable from 32 main categories. Also included in the screen information is a brief description of the

procedures and functions available in each group. Detailed information is available from the particularly good documentation.

When you are satisfied the toolkit contains all the commands required for your specification, pressing <F3> will

Reconfigurable Toolkit allows you to customise a toolkit so that it contains only the commands you need for particular applications.

With the ever-increasing popularity of toolkits, I hope this selective approach will become a standard



produce another menu for consolidating the commands as a single toolkit file. You then have the option of quitting the program or continuing to make additional toolkit files.

A very useful concept, the Qjump innovative approach with

feature of new toolkit releases from other publishing houses.

Where that is particularly important are for those mega-programs, where memory is short or when other machine code extensions are required which could otherwise conflict with each other.

Super B Toolkit Hisoft £29.95

It often seems as if the facilities provided by the native language of any computer always leaves something to be desired. Either the commands you need are not available or many of them fail narrowly to provide a particular facility you need. In this respect, the QL is certainly no exception.

Because of the tremendous diversity of interests of QL owners, toolkits, in all their many varieties, have proved a popular method of providing off-the-peg additions to SuperBasic keywords. The Hisoft *Super B Toolkit*, in common with other

EPROM-based systems, adds its command structure to the SuperBasic vocabulary immediately at switch-on or re-set.

In many ways, having extensions added with the use of an EPROM is far better than the more conventional loading of the software through one of the QL drives. Once installed in the ROM socket at the back of the QL, the new extensions become an integral part of the QL operating system.

After grouping the commands according to type or similarity, a pattern becomes apparent that particular emphasis has been placed on screen control and, for a not readily understandable reason, bit manipulation.

Screen control options include enabling or disabling the screen

UTILITY FILE

cursor, loading or saving a screen area and a number of other commands relating to horizontal and/or vertical positioning of the contents of a window — returning the number of pixels; returning pixel position; the position of a character; and the number of horizontal or vertical characters in a window.

A comprehensive command list is provided for adequate control of jobs and provides facilities for activating, suspending or removing a job. Other job-related commands make provision for printing a job list, setting priority, and creating a job.

Curiously, novel but dubiously useful games

routines have been included and provide facilities for producing



and displaying high-score tables. While that may be useful to programmers of limited experience, I felt that the coding space on the EPROM could have been better-used for other, more general games routines, as most games writers implement their own systems for manipulating scoring tables.

Although the concept of Super B Toolkit is a viable one and the Hisoft system

provides a number of powerful commands to SuperBasic, I cannot help feeling that a more general-purpose toolkit would have been better.

One of the problems with language utilities is that programs relying on the presence of additional software, whether running as a job or on EPROM, for their operation will not work without its presence in the operating system. This will mean that, for the most part, users of the Super B system will have to restrict the use of the new commands for their programs, unless it proves to be a universally popular system.

The Super B documentation is well-presented and highly-detailed. While I felt that both a command summary and grouping the commands according to type, rather than putting them in strict

alphabetical order, would have made finding particular keywords or categories easier, it is nonetheless one of the better instruction manuals.

If you take your programming seriously and would like to provide an advanced operating environment for your development work, you should find Super B Toolkit a worthwhile addition to your software library.

QL MDV TOOLKIT

£9.99

QL MDV ASSEMBLY LANGUAGE TOOLKIT

£29.99

Two sets of programs from Compware have



Cont. p34

Sinclair QL World reader offer

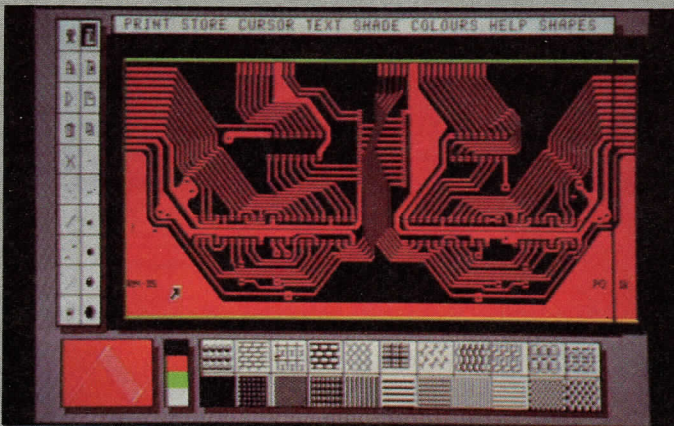

single lines in any of six widths. multiple lines in any of four patterns, spray facility, as well as the more usual features such as eraser, screen wipe and text option selection.

"If you are looking for a good general illustration package, Cad Pak has a great deal to recommend it".

To obtain your copy of

Cad Pak at this unbeatable offer price send your cheque or postal order for £11.95, payable to Sinclair QL World, together with the coupon on this page to:

Sinclair QL World (Cad Pak offer)

79-80 Petty France
London SW1H 9ED

Cad Pak is available to readers at the reduced price for a limited period only. The offer closes on Monday, January 19, 1987. So make sure of your copy of Cad Pak and send your order today.

Join the leading edge of computer-aided design by taking advantage of our special Cad Pak Offer. Cad Pak by Datalink Systems is one of the foremost design packages available for the QL. In the shops it would cost you £14.95 but we are able to offer it exclusively

to readers of *Sinclair QL World* for only £11.95 — a saving of £3.

This is what Utility file reviewer Ron Massey had to say about it in the August 1986 issue:

"Two columns of icons offer virtually every drawing tool imaginable and include cut and paste,

Please send me _____ copies of Cad Pak at the Sinclair QL World offer price of £11.95. I enclose a Cheque/Postal Order for £ made payable to Sinclair QL World Ltd.

Name

Address

Please allow 28 days for delivery

EIDERSOFT SYSTEMS & SOFTWARE



Sales hotline 0708 851099

THE EIDERSOFT QL SUPPORT SERVICE NOW OVER 1000 MEMBERS!

9 PIECE QL BOOK SET!
(Worth over £50)



GAMES PACK (£16.95)



KARATE (£14.95)

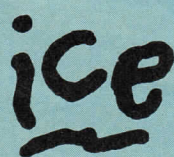
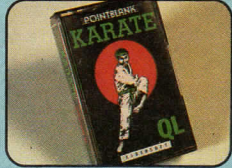

SINCLAIR USER CLASSIC AWARD

PCW/QL WORLD ★★★★★

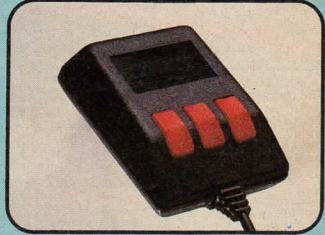

NOW WITH OPTIONAL MOUSE CONTROL AND A RANGE OF SUPPORT SOFTWARE

ICE the award winning icon driven front end for the QL is now supplied in a mouse upgradable form. The system can be supplied complete with the mouse, or the mouse can be purchased later and fitted at home. You can choose between a standard mouse or a fully ball-raced supreme mouse, both in matching QL black.

ICE £29.95 MOUSE £39.95 SUPREME MOUSE £59.95

Existing ICE owners will receive a £15 trade in when purchasing ICE and mouse together.

Joining Bonus. Pay only **£19.95** inc. support fee and choose any of the above titles to go with your regular support.

WHAT DOES ESS OFFER?

Regular support **£10.95** per annum. In return for joining the ESS you will receive an incredible 20% discount off the RRP of all current Eidersoft software except integrated accounts, special prices on QL repairs and a 10% discount on microdrives or diskettes, a regular monthly newsletter, special offers on software, books and hardware and support in writing for your QL problems. **BUSINESS SUPPORT £39.95** as above but with many extra benefits including telephone support, QL loan and much more.



£14.95 ARTICE
The ultimate mouse controlled graphics program with many excellent features



£16.95 CHOICE
Allows you to multi-task 4 programs (inc. Psion programs) and ICE on an expanded QL

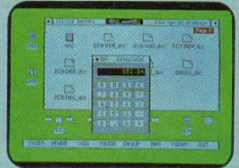

£12.95 TOOLKIT
Use ICE features and mouse in your own programs

PSION ORGANISER XP £139.50 CM £99.50

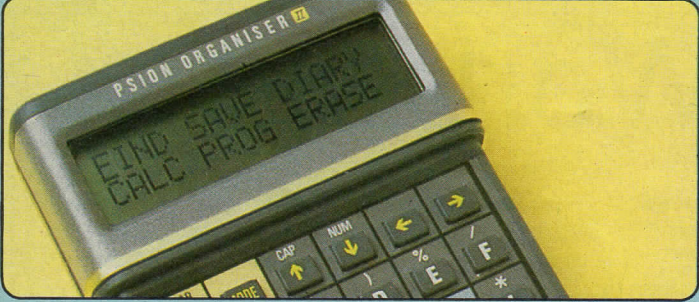

This amazing pocket PC can store your entire Archive database, as well as providing you with a diary, calculator and full programming language. Optional RS232 and free Eidersoft Software allows easy two way communication with QL or Thor. **PLEASE WRITE OR TELEPHONE FOR FULL DETAILS.**

ICICLE



NEW £14.95

Allows for user defined icon control of Quill, Abacus, Superbasic and many other programs. Comes complete with a superb multi-job print spooler.

Note: All ICE systems software is fully compatible with the mouse and requires the ICE ROM to run.



£16.95 SUPER VALUE GAME PACK
4 games for the price of one! B.J. in 3D land, Citadel Eagle and Zapper in this super value pack.



★★★★★
KARATE £14.95

The top selling Karate Game for the QL with Superb Graphics

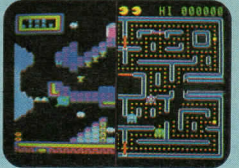

BJ The Return/Spook £10.95 each

SPOOK — The ultimate munchman game — PCW recommended ★★★★★
BJ — A cavern style platform game that is fun for all.



DISK SYSTEMS AT AMAZING PRICES PLEASE TELEPHONE!! 0708 851099

- ★ MICRODRIVES **£16.95** for 10 remember 10% discount for ESS members.
- ★ FLOPPY DISKS DDDS 3.5" **£29.95** for 10. QUALITY BRANDED DISKETTES.

BUSINESS SOFTWARE

Including integrated accounting. Please phone for a full catalogue

QL REPAIRS

Standard	£35	Please phone
Keyboard	£17	0708-851099
Microdrive	£37	for service

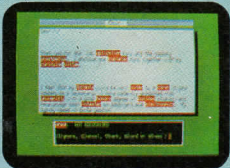

£24.95 QSPELL £29.95 DISK
The only spelling checker available for Psion Quill, 1000's sold. 25,000 word dictionary with the facility to add 1000 user words on a standard QL.



£18.95 QFLASH RAM DISK & TOOLKIT
This amazing utility gives you Ram disks that will work on any QL up to 10 times faster than those currently available on memory cards and alike. The toolkit utility include a facility to copy the entire contents of a microdrive to ram in 7 seconds! Who needs disk drives!



AVAILABLE NOW
with PSION  XCHANGE
the ultimate QL compatible
computer

PC
THOR

**£80
QL TRADE
IN**



- ★ Totally QL compatible
- ★ 640K ram *Superbasic
- ★ 128K user EPROM space
- ★ Extended operating system
- ★ Battery backed clock
- ★ IBM style keyboard with numeric key pad
- ★ Centronics & serial ports
- ★ Mouse port
- ★ ICE + front end
- ★ Full user port at rear
- ★ 3.5" floppy disk storage
- ★ Full user support and maintenance agreement
- ★ Networking capability
- ★ Optional 20MB hard disk
- ★ Improved speed of operation over expanded QL

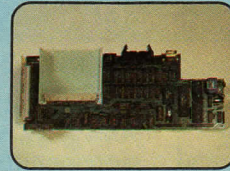

Brand new PCB design provides built-in interfaces, battery clock and centronics printer port.

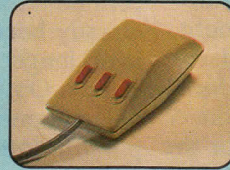

Optional THOR mouse plugs directly into the mouse port, which will also accept the Eidersoft mouse.

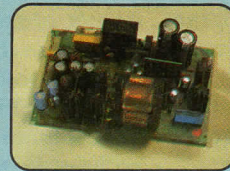

Efficient switch mode PSU ensures reliability and adequate power for peripherals.

Illustrated THOR 1FW with Phillips CM8533 monitor.

NEARLY £500 WORTH OF SOFTWARE FREE WITH EACH THOR COMPUTER

PSION  XCHANGE
Version 3

Free with the Thor comes the award winning Psion Xchange suite as supplied on ICL OPD and other micros. This is a much enhanced version of the Psion QL packages, that allows you to run up to six Xchange tasks simultaneously, automatically switching data between programs. The powerful TSL, task sequencing language allows you to automatically control each task via a simple program. This makes an ideal environment for training and "non-computerate" staff. All the programs include extra features not found in the QL versions. Quill has an extract function for cutting and pasting paragraphs, mail merge with Archive, a super glossary function that allows you to assign text and commands to single keys and many other improvements to existing commands. Abacus offers several new

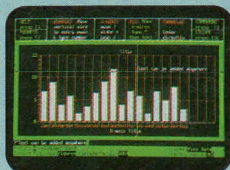
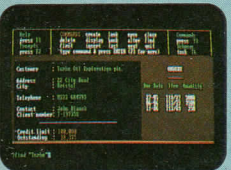

commands including cell protection and titles command. In Archive the USR function allows you to link in machine code routines, and the \$EDIT command offers improved screen designing. Easel includes the famous 3D bar graphs to give your presentations that professional polish.

THOR PC SYSTEM SOFTWARE

With the Thor is an improved version of the ICE computer front end, that allows simple housekeeping to be achieved by the use of mouse or cursor. Built in screen dumps by QDUMP DANSOFT allow you to snapshot the screen at any time to the printer or a file. A much enhanced operating system gives you menu control, single key task switching between Xchange and other tasks (including Superbasic) and extended windowing capabilities.

CST THOR more than just a peripheral....

OPD is the trade mark of ICL.
Xchange is the trademark of Psion Ltd.

* QL, Superbasic are the trade marks of SRL.

EIDERSOFT, THE OFFICE, HALL FARM, NORTH OCKENDON, UPMINSTER, ESSEX RM14 3QH.

All machines include, QL, Xchange, System Software, Keyboard and 6 months warantee and support.



- | | |
|--|---------------|
| <input type="checkbox"/> THOR PC 1F 640K, single 720K 3.5 disk drive | £599 ex VAT |
| <input type="checkbox"/> THOR PC 2F 640K, double 720K 3.5 disk drives | £699 ex VAT |
| <input type="checkbox"/> THOR PC 2FW 640K, 20MB Winchester, single 3.5 720K disk drive | £1399 ex VAT |
| <input type="checkbox"/> THOR Mouse matching cream high quality mouse | £49.95 ex VAT |
| <input type="checkbox"/> THOR Monitor Phillips monochrome monitor (green screen) | £90.00 ex VAT |
| (NOTE: THOR compatible with ALL QL monitors monochrome and colour) | |
| <input type="checkbox"/> 12 months additional warantee and support (at purchase) | |
| <input type="checkbox"/> I wish to trade in my QL JM <input type="checkbox"/> £70 JS <input type="checkbox"/> £80 FOR CREDIT | |
| <input type="checkbox"/> QJUMP EPROM Programmer | |
| <input type="checkbox"/> I am interested in full details on the CST THOR | |

} Winchester Model £75.00 ex VAT
£100 ex VAT
£100 ex VAT

All Eidersoft prices include VAT and Postage

- | | | |
|---|---|--|
| <input type="checkbox"/> I am interested in Eidersoft support service | } <input type="checkbox"/> £10.95 regular | <input type="checkbox"/> £39.95 business |
| <input type="checkbox"/> Please supply further details on _____ | | |
| <input type="checkbox"/> Please supply _____ | I enclose a cheque for £ _____ | |

Please deduct my Amer X/Access/Visa Card Exp. Date

OVERSEAS ORDERING Deduct VAT and add £1 per item P&P Europe, £2 World. Only Credit Cards, Eurocheques and Cheques drawn on UK Clearing Bank accepted.

EIDERSOFT GERMANY: CONTACT EIDERSOFT, POSTFACH 605 212 2 HAMBURG. TELEPHONE 60 4048 3660
EIDERSOFT FRANCE: CONTACT PYRAMIDE, 8 RUE DU RUISSEAU, 75018 PARIS. TELEPHONE 142 54 3967
EIDERSOFT USA: PO BOX 288, BURGETTSTOWN PA IS021

TECHNICAL HELPLINE

Our resident QL technobuff Colin Opie sorts out your programming problems.

Line problem

I am searching for the means to emulate the "POINT (x,y)" command on the Spectrum for the QL. As you are no doubt aware, this command returns either 0 or 1 for the pixel (x,y): 0 for the paper colour and 1 for the ink colour.

I had written a program for the Spectrum, using this command, which would ascertain on-screen the intersection of two lines. The first line is drawn normally, then before a point is plotted for the second line. A

check is carried-out on pixel (x,y), using the aforementioned command, to see if it has already been set — i.e., it is no longer the paper colour. Obviously if the value is one, that is a point of intersection.

Unfortunately the lines do not possess equations, otherwise it would be possible to calculate any point/s of intersection via simultaneous equations, so I am in something of a quandary.

**Andrew Storey,
Carlisle.**

As anyone who has used the QL graphics seriously will know, different concepts and rules have to be merged. For example, the textual and block-fill statements use pixel positioning relative to the top left-hand corner of a window. A window is defined in terms of pixels and relative to the top left-hand side of the screen. Graphics commands such as point, line, arc, circle and so on use a different system.

Initially a graphics window will have its origin (0,0) at the bottom left-hand corner of a window. Further, the window will be 100 graphics units high. The position of the origin and the graphic-unit size of a window can be changed later by using the SuperBasic 'SCALE' command.

If you are confused at this point, perhaps look at Jan Jones' book *QL SuperBasic, The Definitive Handbook*. That still leaves us with Storey's problem. SuperBasic does

not support a 'PIXEL (x,y)' function — until now.

Before going on to see how we might achieve it, we need to know how the QL screen is organised. This screen is 32 kilobytes long and starts at machine address \$20000 (131072). Figure one shows how individual pixels are created — reproduced with permission from *QL Assembly Language Programming*, p.205, courtesy of McGraw-Hill. Note that in four-colour — high-resolution — mode, each 16-bit word is used to create eight pixels. In eight colour — low-resolution — mode, each 16-bit word is used to create four pixels. For each row of pixels 64 words are used, giving 512 — i.e., 64 × 8 — pixels/line in high-resolution mode and 256 — 64 × 4 — pixels/line in low-resolution mode. The screen is always 256 pixels high.

Figure 1. Screen memory layout. Reprinted by of McGraw-Hill (U.K.).

The only common denominator in all screen-handling commands is the pixel. It is true that graphics commands do not use pixel co-ordinates but a little mathematics would enable us to turn graphics positions into pixel positions easily. Armed with that information we can now write a SuperBasic function to return a pixel colour in a given screen mode — see figure two.

The function is called

screen address which holds the required pixel. Variables 'a%' and 'b%' are then set to the even and odd byte values respectively. To extract the bit information we need a 'mask' and 'xp%' is used for that purpose. Armed with the appropriate mask, variable 'pc%' can be set to the pixel colour value. Note that in eight-colour mode we need to mask in two further bit weightings.

Colour	High-resolution: (Normal) —	Low resolution: Normal —	Flashing —
Black	0	0	8
Blue		1	9
Red	2	2	10
Magenta		3	11
Green	4	4	12
Cyan		5	13
Yellow		6	14
White	6	7	15

in the form 'colour = pixel (m,x,y)', where 'm' is the mode of the screen — 4 = high, 8 = low-resolution. Colour values returned for the two screen modes are given in the table.

The local variable 'mem' is first set to the

A certain amount of care and experimentation will be needed when mapping pixel co-ordinates to graphics co-ordinates. Even with the vertical graphics scale set to be the same as the number of pixel lines for any particular window,

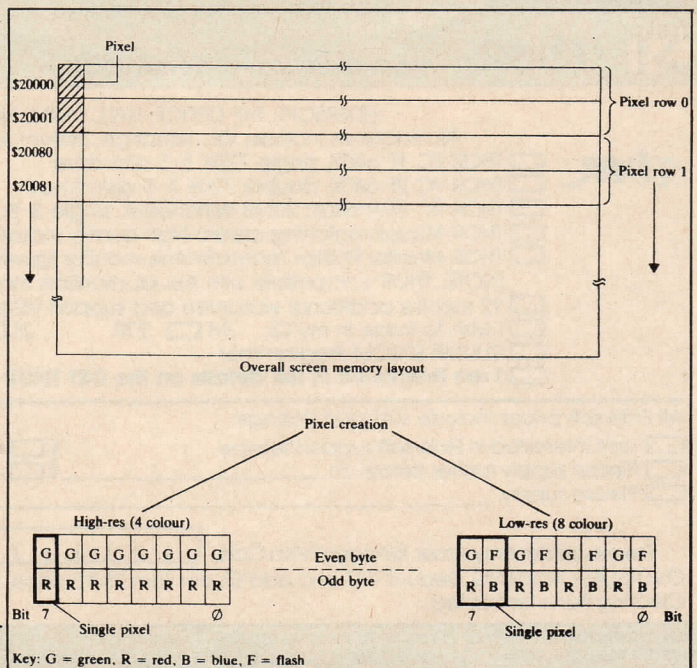

Loan program

the horizontal positions will be slightly different.

```

900 DEFine FuNction
pixel (m%,x%,y%)
905 LOCal mem, xp%,
pc%, a%, b%, c%
910 c% = (12 - m%):
xp% = (x% DIV c%)*2
915 mem =
131072 + xp% + y% * 128
920 a% = PEEK (mem):
b% = PEEK (mem + 1)
925 xp% = 2↑(7 - (8 DIV
c%)*(x% MOD c%))
930 pc% = (xp% &&
a%)*4 + (xp% && b%)*2
935 pc% = pc% DIV xp%
940 IF m% = 8
945 xp% = xp% DIV 2
950 c% = (xp% &&
a%)*8 + (xp% && b%)
955 c% = c% DIV xp%:
pc% = pc% + c%
960 END IF
965 RETurn pc%
970 END DEFine

```

Figure 2. Pixel function listing

To see the function in action you could try the following three very simple programs. The first and third must be run in monitor mode with four colours and the middle one in TV mode with eight colours. Add each program to the PIXEL code, perform a LISTing of the final program and then RUN, without clearing away the listing.

```

a) 100 FOR y= 100 TO
200
110 FOR x= 100 TO
200
120 BLOCK
1,1,x,y,pixel(4,x,y)
130 NEXT x
140 NEXT y
150 STOP

```

In this first program we are using the BLOCK command, which uses pixel co-ordinates relative to the top left-hand corner of the window. As the two main monitor windows are the same size we get a copy of part of channel 2 in channel 1.

```

b) 100 for y= 100 TO 200
110 FOR x= 64 TO 120
120 BLOCK

```

I am writing a business loan program which works perfectly so far, except that I cannot figure a way to save VARIABLES (a\$, a, b, name\$) on Microdrive. Details of any client will be able to be called up from Microdrive and

loaded into the main program structure. I have tried using various methods such as SBYTES and LBYTES but I cannot get the variables, which are floating about in my QL memory, to save.

S. Davison,
Lanchester,

```

2,1,2*(x+80),6,7-pixel
(8,x,y)
130 NEXT x
140 NEXT y
150 STOP

```

This second program requires an offset in the 'x' direction because we are dealing only with one window in TV mode. Notice how the colour is inverted in the screen copy.

```

c) 100 CLS: SCALE 60,0,0
110 FOR y= 10 TO 40
120 FOR x= 0 to 50
130 INK 7-pixel (4,x,y)
140 POINT x,50 - y
150 NEXT x
160 NEXT y
170 STOP

```

In this final example we can see the effect of mixing pixel co-ordinate values, as used in the PIXEL function, with graphic co-ordinates, as used by POINT. Remember that the graphic origin is in the bottom left-hand corner and therefore in line 140 we need to invert our copy. Our graphics scale is set to a maximum of 60 in the vertical direction by the SCALE statement — see line 100. In terms of pixels the monitor window is 200 pixels high and therefore we get more than three times magnification during the copy. Change the scaling factor to between 60 and 200 and see what happens.

As a final note, always remember that PIXEL uses absolute pixel locations. If you define windows and/or set SCALE factors within windows, it is for you to make the match as appropriate.

Anyone with a reasonable degree of programming expertise will appreciate the, shall we say, humorous side of this letter.

First and foremost we do not use LBYTES and SBYTES to load and save variables floating around in memory respectively. Let us take Davison's problem as an example. We are dealing with data representation and file-handling. A file can be regarded as a collection of data, just as a card index box contains written data. The file holds the data in a series of records, each record having a number of fields.

The overall file would contain as many records as customers. To use the large QL memory to the full and to increase processing speed, it would be common to set up arrays to hold the field data. For example, 'name\$(200,50)' could be used to store up to 200 customer names, each of up to 50 characters long. An array 'period(200)' could be used to hold the corresponding repayment period values for the same 200 customers and so on. That would mean that 'name\$(30)' and 'period(30)' would hold the appropriate data for the 30th customer record in the file. To save the data to Microdrive we need to set up a loop to print-out all the data in the arrays. For example:

```

OPEN #3,
'mdv2_cust_data'
FOR cust = 1 TO 200
PRINT #3,
name$(cust)\

```

```

period(cust) \. . . . .
ENDFOR cust
CLOSE #3

```

The backlash '\' is required between items because the INPUT statement needs an 'ENTER' — i.e., LF — character to exist between items when reading them back in. Later, to get the data back into the arrays, the following could be used:

```

OPEN_IN #3,
'mdv2_cust_data'
FOR cust = 1 to 200
INPUT #3, name$(cust),
period(cust), . . . . .
ENDFOR cust
CLOSE #3

```

What has been achieved is very simple data file-handling. There are, of course, much more advanced and clever ways of doing things. If we have a disc interface with the FPOS SuperBasic extension, together with other toolkit file extensions, we could perform indexed file-handling and save a considerable amount of memory.

We could use hashing techniques to improve speed, and so on. To discover the world of file-handling techniques and simple database management, buy a good textbook on programming. It does not have to relate directly to the QL, as the methods discussed will be adaptable to various machines.

Alternatively we could try some lateral thinking and use the Psion *Archive* or *Abacus* programs to perform the task. Did you know that the Eidersoft *Impacct* accounts system was written in the Archive programming language? The versatility and power of *Impacct* make it a fine example of the use of a database language to solve a file-handling problem.

VIEWPOINT

TRUE THREE DIMENSIONAL CAD FOR THE SINCLAIR QL

VIEWPOINT is a sophisticated design and educational package which enables you to:

- ★ Construct a 3D wire-frame image from two dimensional drawings, using lines, rectangles, boxes, circles, spheres and polygons.
- ★ Rotate and translate the completed image within a spherical polar coordinate system.
- ★ Zoom in/out and change perspective.
- ★ Use hidden line removal on single convex polygons to enhance the final view.
- ★ Save the finished object to cartridge or disc, either as a 3D set of coordinates or as a machine code subroutine.
- ★ Dump the finished drawing to any printer.

"An exceptionally well planned 3d modelling program. Incorporating powerful professional illustrator's features and a number of superb demonstration files."
— *Sinclair QL World*, Dec.

AVAILABLE ON CARTRIDGE FOR £19.95

Also available at £19.95 DRAGONHOLD

"... of its type, its certainly better than anything else around on the QL."
— *Your Sinclair*, June.

★ SPECIAL OFFER ★ SPECIAL OFFER ★ SPECIAL OFFER ★
Buy BOTH programs together and save £5. VIEWPOINT + DRAGONHOLD £34.90.

Send cheque or P.O. to:



11 Bannerdale Road
Sheffield S7 2DJ
Tel: 0742 583665

All goods are despatched by first class return.

TASK MASTER

TASKMASTER

True multi tasking on the Q.L. 4P5ion programs + SuperBasic + utilities in 512k ram. E.G. print a spreadsheet, sort a file, run a basic program, write a letter . . . ALL AT THE SAME TIME
2P5ion programs + super basic + utilities in 256k ram.
And Or up to nine other executive programs.

FILES

Powerful file manipulation . . . backup by date/type/extension.
E.G. all _doc files changed since 4 P.M.

CALCULATOR

Standard calculator functions output may be fed into any program. E.G. VAT directly into document.

£25.00

SECTOR SOFTWARE

39 Wray Crescent, Ulnes Walton,
Leyland, Lancashire
Tel: 0772 454328
Access & Visa welcome

Cont from p29

been made available to users wanting access to the more esoteric functions of Microdrive systems. *QL MDV Extensions Toolkit* provides a ready-made system for Microdrive cartridge applications. Keywords, along with example SuperBasic program applications, enable you to read directly from or write to the format information of a cartridge, or to read and write directly to Microdrive sectors with full verification. Also included is a facility for setting the number of format repeats, invaluable and time-saving for formatting new cartridges.

In common with other toolkits, routines may be called from SuperBasic and provide a stream for error-trapping non-existent files, thus

preventing program crashes.

The more comprehensive of the two programs, *QL MDV Assembly Language Toolkit* includes more than 1,000 lines of fully-commented source code. An expanded version of the simpler toolkit, additional facilities are available for implementing sophisticated protection routines. Other options include write to a Microdrive sector, with or without verification.

Subordinate routines are available for performing Microdrive selection, searching for defined sectors, de-selecting all Microdrives, quick read, write or verify and a pause until the drive motor reaches full speed.

Compatible with any assembler conforming to the Motorola 68000 standard, such as Assembler Workbench, Metacomco or Adder

assemblers, the Toolkit source code does not require macros.

Compware MDV and ASM MDV Toolkits are an invaluable aid for the serious programmer and represent very good value. Of equal importance, Compware documentation covers aspects of the structure of

Microdrive files, not readily available elsewhere, in a clear and concise manner.

Supplied separately or combined on a single cartridge, Compware Toolkits will enable you to utilise either the user's toolkit or the more comprehensive version for additional features.

Information

QL MDV Toolkit

QL MDV Assembly Language Toolkit

Compware
57 Repton Drive
Haslington
Crewe CW1 1SA
Tel. 0270 582307

Reconfigurable Toolkit

Care Electronics
800 St Albans Road
Garston
Watford
Herts. WD2 6NL
Tel. 0923 672102

Super B

Hisoft
The Old School
Greenfield
Bedford MK45 5DE
Tel. 0525 718181

QATS-QL Applications Traffic Supervisor (VERSION 2)

QATS is a utilities package and universal boot program designed to minimise your use of the keyboard by cutting down on all those unnecessary, boring keystrokes needed to execute jobs, copy and delete files and display directories. And it's quick to use because it's menu driven. For example, to start a PSION program you press two keys—one to give PSION menu and one to choose a program from that menu. When you quit the program you will return to QATS ready to run another PSION program or any of the easy-to-use QATS utilities. QATS stays in your QL all the time, always available. The comprehensive manual includes 20 step by step examples to get you started.

QATS allows you to:

- ★ set up menus to run your own jobs (EXEC'able programs only)
- ★ rearrange the supplied menus and add your own to suit your own style of working
- ★ copy files quickly, selectively or not
- ★ delete files, selectively or not
- ★ control jobs running in the machine
- ★ multi-task your own programs (if EXEC'able) in any combinations subject to the size of your QL
- ★ start PSION jobs (expanded QL's only)
- ★ display paged directories showing filenames in alphabetical order with file sizes
- ★ use the sophisticated wild card file facility—essential for managing floppy and hard disks

OUTPUT CONTROL, the first of a series of extensions planned for running under QATS, is a printing package (with extended printer driver) which will:

- ★ print in the background while you do other work
- ★ divide unformatted files into pages with headings
- ★ print on continuous stationery or single sheets
- ★ print labels
- ★ print mailing lists

QATS EPROM is also available. If the QATS EPROM is in the ROM slot at the back of your QL then you will save 16K of memory. However, if you want to use the ROM slot for something else QATS will automatically allow for its missing EPROM and load from backing storage.

QL is a trademark of Sinclair Research Ltd. PSION is a trade mark of PSION Ltd.

To: COPE, 3 Langham Mansions, Earls Court Square, London SW5 9UH

Please send me:

....copies of QATS @ £20 each = £.....
copies of Output Control @ £15 each = £.....
copies of QATS EPROM @ £10 each = £.....

All prices include VAT p&p U.K. only.

Overseas orders please add £4 to cover airmail p&p.

Indicate: 5.25 1440 sectors disk/microdrive cartridges.

I enclose cheque (payable to COPE)/cash: £.....

Title:.....Name:.....

Address:.....

Postcode:.....Tel:

Allow at least 14 days for delivery. Items may be posted separately. SQLW 11

PDQL

Software for the QL

49 Frederick Street,
 Birmingham B1 3HN
 Tel: 021-233 3042

MAKE THE MOST OF YOUR QL for home or business use — Order from list or write for our current catalogue.

ARCHIVE INTERACTIVE TUTORIAL	£21
SCREEN DESIGNER	£15
DATABASE RECOVERY	£20
DATABASE ANALYSER	£7
SCREEN FORMAT PRINTER	£7
FILE DUMP	£7
COMPARATOR	£8
COPIER	£8
LAZARUS Disc File Recovery	£20
CASH TRADER UPGRADE (existing users)	£39
SUPERFAST (new users)	£80
PDQ PAYROLL	£70
VAT ACCOUNTS	£25
NAME & ADDRESS Standard Archive	£18
Extra Run Time Module	£18
MAILMERGE De luxe	£14
INVOICE GENERATOR	£30

Many other General Utility, Archive Utility and Archive Application systems. New systems or adjustments to existing systems built to order.

Prices include VAT and postage within the UK. Cheques with orders to, and full descriptive list available from PDQL.

When writing please indicate if you have disc-drive and/or extended memory.

PRICES DOWN — READ NOW

★ Reduced prices valid on orders with coupon received by 15 Jan. ★

SWOPPER ~~£19.95~~ £14.95

Enables you to swap between different Psion packages and Basic. Runs multiple copies of Quill Abacus Archive and Easel and still have access to Basic. If you have enough RAM, Swopper will save screen contents so Swopping is instantaneous.

MICRODRIVE COPYCAT £10.99

Copies many protected programs. Sold subject to legal use. Very good value.

BOOT 128k £5.99

Enables an expanded QL to run programs that won't normally run with extra RAM. Just insert in MDV1_, reset your QL, wait . . . and run your "fussy" software. Easily configured.

1 TO 1 DUMP £5.99

Enables you to obtain true hard copy with 1:1 aspect ratio using Epson FX80 printer.

MICRODRIVE TOOLKITS

Read and write microdrive sectors and read headers from your own Basic or assembly language programs. Full details of microdrive format in comprehensive manual.

BASIC EXTENSIONS..... £9.99
 ASSEMBLY LANGUAGE...~~£19.95~~ £14.95
 BOTH~~£24.95~~ £19.95

MEDIC RAM UPGRADE — EXTRA 256k ~~£79~~ £65

DEALERS: Wanted for our range of QL software including the Computer One products included in this advert.



57 REPTON DRIVE,
 HASLINGTON, CREWE CW1 1SA
 Tel: (0270) 582301

PRICES INCLUDE VAT AND DELIVERY
 EXPORT ORDERS WELCOME: WRITE FOR TERMS

computer ONE

Software for the QL

A selection of quality software packages available directly from **COMPWARE**

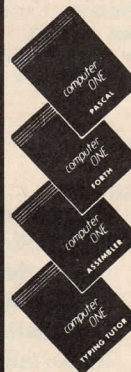

PASCAL	£29.95
FORTH	£29.95
ASSEMBLER	£19.95
MONITOR	£14.95
TYPING TUTOR	£9.95

Inclusive of VAT & P&P.

Name:

Address:

Please send me:

.....I enclose £

BETTER BASIC

Sorting routines are the cornerstone of most data processing software. Mike Lloyd provides an insight into the way they work.

Sorting routines are the computing equivalent of the proverbial mousetrap — build a better one and the world will beat a path to your door. Data sorting is one of the commonest tasks which computers perform and it is also one of the most time-consuming, which is why there is so much interest in finding more efficient ways of

Sorting routines have a well-defined task. They must place arrays of data into a regular order. The simplest of sort routines, such as those listed here, have only a single sort criterion. Taking as an example the task of sorting a library of books into order, that criterion might be the authors' names in alphabetical order. Alternatively, multiple criteria might be specified, such as fiction/

The ability of the QL to coerce data types ensures that the routines listed here will sort integer, numerical and string arrays with no

random list of numbers into order, shifting around the numbers on the screen as it does so. Watching this process should give an excellent

Listing 1.

```
100 DEFine PROCedure bubble (array)
105 LOCAL a, b, temp$, flag
110 FOR a = 1 TO DIMN(array)-1
115   flag = 1
120   FOR b = 1 TO DIMN (array)-a
125     IF array(b) > array(b+1)
130       flag = 0
135       temp$ = array(b)
140       array(b) = array(b+1)
145       array(b+1) = temp$
150 REMark >> SHOWsort lines
155 IF showing:swap b,b+1
160 IF KEYROW(1) = 8:RETURN
165 REMark >> END SHOWsort lines
170   END IF
175   NEXT b
180   IF flag THEN RETURN
185 NEXT a
190 END DEFine bubble
```

putting information into order.

The ideas behind the three sorting procedures introduced in this article are not new but the routines have been specially written to make the most of the strengths of the QL. This article also includes a listing for a test harness which can be used to prove that sorting has been properly carried-out and to compare the speed with which the routines work.

non-fiction, main and sub-categories, name of author and year of publication. The two most important considerations when developing a sorting routine are speed of operation and flexibility. The advantages of speed are obvious. Flexibility means the ability to sort any type of data into order; it would be inconvenient to have separate routines for strings, integers and real numbers.

Listing 2.

```
200 DEFine PROCedure insert (array)
205 LOCAL a, b, loop, temp$
210 FOR a = 1 TO DIMN (array)-1
215   b = a:temp$ = array(b+1)
220   REPEAT loop
225     IF temp$ < array(b) AND b > 0
230       array(b+1) = array(b)
235 REMark >> SHOWsort lines
240 IF showing:swap b, b+1
245 IF KEYROW(1) = 8:RETURN
250 REMark >> END SHOWsort lines
255     b = b-1
260   ELSE
265     EXIT loop
270   END IF
275   END REPEAT loop
280   array(b+1) = temp$
285 END FOR a
290 END DEFine insert
```

modification. The only limitation placed on the data by the procedures is that numerical arrays must be of a single dimension — e.g., DIM numbers (20) — and string arrays of two dimensions — e.g., DIM array\$(9,12).

Although sorting algorithms are not particularly complicated it

insight into how these routines work.

In preparation for next month's program, each of this month's sorting procedures has two lines, plus some warning REMarks, which are solely for the benefit of the demonstrator. They should be deleted before the routines are incorporated in other programs.

At the heart of most sorting algorithms is a very simple set of commands which swaps around array elements:
TEMP\$ = ARRAY(X)
ARRAY(X) = ARRAY(Y)
ARRAY(Y) = TEMP\$

The rest of a sorting routine is concerned merely with selecting values for X and Y. All sorting procedures which

Listing 3.

```
300 DEFine PROCedure
sort (array)
310 qsort array, 1,
DIMN(array)
320 END DEFine sort
```

can be difficult to see how they work just by examining a program listing. Next month's article will be devoted to a sorting demonstration program which will put a

KEYWORDS OF THE MONTH

A

UTO and EDIT and therefore they are presented together as this month's Keyword of the Month. AUTO and EDIT are two of the QL suite of editing keywords which are used normally in direct commands — i.e., not as part of a listing — when writing programs. The others are RENUM, NEW, CONTINUE, RETRY, DLINE and LIST.

Spectrum owners who graduated to the QL might be impressed by the editing commands the QL offers but they make a miserable show compared to those available on

many other computers. The QL, however, offers the distinct advantage of allowing the user to define a suite of editing commands based on those provided in SuperBasic.

To return to AUTO and EDIT, both allow program lines to be written or amended by bringing the line into the command window — Window #0. Pressing ENTER returns the line to its place in the listing. Incidentally, closing the command window and re-opening it either as a console or as a screen prevents its use for all direct commands, including those for program editing. That offers a small measure of

protection for programs but any error met by the interpreter would cause the computer to hang up in these circumstances.

Both AUTO and EDIT can take up to two parameters. The first is the start line number and the second is the increment between line numbers. For example: *AUTO 500, 5* places line 500 in the command window, complete with any statements already associated with it. After ENTER is pressed line 505 is presented, and so on until the programmer presses BREAK — CTRL and Space. The command:

EDIT 500, 5 has exactly the same effect as *AUTO 500, 5*. With a single parameter, such as: *AUTO 300* line 300 will be sent to the command window and a default increment of 10 is assumed, so the next line will be line 310. On the other hand: *EDIT 300* also sends line 300 to Window #0 but there is no increment; no other program lines are presented when ENTER is pressed. When used with no parameters, both AUTO and EDIT assume a default line number value of 100; AUTO assumes an increment of 10.

contain an element-swapping routine like this can be demonstrated by next month's sort demonstrator.

The most simple sorting algorithm is the bubble sort, which is featured in almost every computer manual and introductory textbook — see listing one. It takes each array element in turn and compares it to its neighbour, swapping if

they are out of order. Passes are repeated until no more swaps are made, indicating that the array is in order.

The bubble sort is about the simplest algorithm to understand and turn into a program, hence its popularity, but it is extremely slow. The time taken to complete a sort is exponentially proportional to the number of elements in

the array. In other words, each extra array element to be sorted greatly extends the sorting time.

A refinement on the

algorithm invented in Britain in the 1960s. The routine begins by dividing the array into two parts and selecting an arbitrary middle value. At the end of the first pass, all the items less than this value are placed above it in the array and all the items of greater value are below it. The routine is called recursively to deal with each of those parts in turn until the entire array is in order.

The final routine — listing five — is a test harness for all three procedures. It produces a random array of numbers which is sorted in turn by each of the procedures.

The output comprises the sorted array, to make sure that the job has been done, and the time taken.

Enter "TEST" to get things working. To incorporate any of the sorting procedures into another program, remove the REMARKS and the two lines listed between them, re-number if appropriate and merge the routine into the program. Each procedure is called by its name followed by the name of the array.

```
Listing 4. 400 DEFine PROCedure qsort (array,bot
tom,top)
403 LOCAL loop, lo, hi, pointer
406 lo = bottom:hi = top
409 pointer = bottom
412 REPEAT loop
415 IF lo >= hi:EXIT loop
418 IF array(lo) > array(hi)
421 temp# = array(lo)
424 array(lo) = array(hi)
427 array(hi) = temp#
430 REMark >> SHOWsort lines
433 IF showing:swap lo,hi
436 IF KEYROW(1) = 8:RETurn
439 REMark >> end SHOWsort lines
442 IF pointer = lo
445 lo = lo+1: pointer = hi
448 ELSE
451 hi = hi-1: pointer = lo
454 END IF
457 ELSE
460 IF pointer = lo
463 hi = hi-1
466 ELSE
469 lo = lo+1
472 END IF
475 END IF
478 END REPEAT loop
481 IF ABS(top-bottom)<2 THEN RETurn
484 qsort array, bottom, pointer-1
487 qsort array, pointer+1, top
490 END DEFine qsort
```

Listing 5.

```
500 DEFine PROCedure test
505 LOCAL a(20),b(20)
,x,y,time
510 INK 7: CLS:
showing = 0
515 FOR y = 1 TO DIMN(a):
a(y) = RND(199)
520 STRIP 2:PRINT
"RANDOM"!a(1 TO)!
525 FOR x = 1,2,3
530 FOR y = 1 TO DIMN(a):
b(y) = a(y)
535 STRIP 0: PRINT: time
= DATE
540 SELECT ON x
545 = 1: bubble b: PRINT
"BUBBLE"
550 = 2: insert b: PRINT
"INSERT"
555 = 3: sort b: PRINT
"QUICKSORT"
560 END SELECT
565 PRINT !b(1 TO)!
570 PRINT \DATE - time!
"seconds"
575 END FOR x
580 END DEFine test
```

bubble sort is the insert sort — listing two. A single pass is made through the array and each item is moved in turn up the list until it is in its appropriate place.

The most complex and most efficient sorting routine — listings three and four — is the Quicksort, a recursive

MPC SOFTWARE

SOFTWARE

Leisure Software

BJ The Return	£9.00
Bounder	£9.00
Bridge Player	£12.00
Bridge Player II	£17.00
Cavern	£10.00
Chess	£17.00
Dragonhold	£17.00
Eidersoft 3 pack	£15.00
Fictionary	£10.00
Flight	£17.00
Jabber	£9.00
Karate	£13.50
King	£13.00
Lost Pharaoh	£13.00
Matchpoint	£13.00
Meteor Storm	£10.00
Mr. Smith	£11.50
Othello 3D	£13.00
Poker	£13.50
Quboids	£9.00
Scrabble	£13.50
Squadrons	£14.50
Startrek	£4.00
Steve Davis Snooker	£13.00
Vroom	£13.50
Wanderer	£17.00

Adventures

Mortville Manor	£17.00
Zkul	£13.00
West	£13.00
The Quill (Adventure Writer)	£22.00

Utilities

Artice	£13.00
Cartridge Doctor	£13.50
Choice	£15.00
Copier	£12.00
Font Designer	£7.00
Graphic Toolkit	£13.50
Gardener	£20.00
ICE	£26.00
ICicle	£18.00
Nucleon	£17.00
Q-Flash	£19.00
Q-Flash ROM	£23.00
QL Mon	£14.00
QL Paint	£25.00
QL Peintre	£13.50
RAM Disc	£14.00
Shrink Program	£5.00
Sprite Designer	£12.00
Techniq!	£45.00
Touch Typist	£11.00

Business

CAD QL	£15.00
Cash Trader	£55.00
Concept 3D	£32.00
Concept 3D Demo	£2.00
Cryptor	£13.50
Decision Maker	£32.00
Home Finance	£20.00
Project Planner	£32.00
QSpell	£18.00
Techniq!	£45.00
Transact	£25.00
Viewpoint	£17.00

Languages

APL	£99.00
Assembler (Metacomco)	£35.00
Assembler Workbench	£21.00
C	£90.00
Forth (Computer 1)	£34.00
Fortran 77 (Prospero)	PHONE
Macro Assembler (GST)	£37.00
Pascal (Metacomco)	£82.00
Pascal (Computer 1)	£40.00
Pascal (Prospero)	PHONE

BOOKS

Sinclair QL Adventures	£3.00
Artificial Intelligence on the QL	£3.00
Maths on the QL	£3.50
Developing Applications on the Sinclair QL	£3.00
Simulation Techniques on the Sinclair QL	£3.00
Quill, Easel, Archive & Abacus on the QL	£3.00
Inside the Sinclair QL	£6.00
Desk-top Computing with the Sinclair QL	£3.00
Word Processing with the Sinclair QL	£3.00
Database Management on the Sinclair QL	£4.00
Advanced Programming with the Sinclair QL	£4.00
Making the Most of the Sinclair QL	£3.00
Machine Code Programming on the Sinclair QL	£4.50
Using Graphics on the Sinclair QL	£4.50
Introduction to Superbasic on the Sinclair QL	£3.50
Profiting from the QL (Abacus)	£4.00
QL Games Master	£3.00
QL Superbasic	£3.00
QL Computing	£3.00
QL Advanced User Guide (QDOS)	£14.50
Quantum Theory	£4.00
QL Quill	£4.50
Sinclair QDOS Companion	£6.95
QL Service Manual (circuit diagram etc.)	£19.95
Hackers Handbook (Hardback)	£4.50
Creating Adventure Programmes on your Computer	£2.50
How to Computerise Your Business Successfully	£2.50
QL Handbook	£5.95
QL Compendium	£5.95
Exploring Artificial Intelligence on the QL	£3.50
Archive Users Reference Manual	£7.00
Abacus Users Reference Manual	£7.00
Quill Users Reference Manual	£7.00
QL Technical Guide	£19.95
Computer Art & Graphics	£9.00
IBM PC Users Guide	£4.50
Xenix Users Handbook	£5.00
MS-DOS, an Introduction	£5.00
68000 Microprocessor Handbook	£14.95
68000 Assembly Language Programming	£19.95
Understanding the 68000	£7.95

Sinclair QDOS Companion

The QDOS Companion, by Andrew Pennell, one of the most prolific authors on the QL, is essential reading if you are interested in programming the QL in machine code. It describes all the features of QDOS, and gives details of all the TRAPS, and Vector calls. It includes details on how to access the keyboard, screen, serial ports etc. from machine code, how to communicate with the 8049 co-processor, and how to write multi-tasking programmes and lots more.£6.95

QL Service Manual

The QL Service Manual is the book issued by Sinclair Research to QL Repair companies, and contains all you need to know about the QL Hardware. It has full circuit diagrams, including the Micro-drives, details on the various chips and their function, block diagrams, details on how to repair the QL, and the components used and lots more.£19.95

Machine Code Programming on the Sinclair QL

This book is a guide to writing machine code using the 68008 processor in the QL. It starts with the very basics with a description of binary numbers, and finishes with details on how to link in machine code routines as new SuperBASIC keywords, and the creation of Jobs. Ideal for the beginner to QL Machine Code. £4.50

QL Games Compendium

This book by Tim Hartnell contains listings for over 20 QL games/leisure programmes including: Eliza (In which you QL can carry on a conversation with you), Qthello, Magicians Maze, Detective Q, Stockbroker, Tryst with Mephistopheles, QL Racer. It also contains details on how the games work, and on how to write you own programmes for the QL£5.95

HARDWARE

Disc products

Cumana Disc Interface	£78.00
Interface & Single drive	£195.00
Interface & Dual drive	£290.00
10 x 3.5" discettes (Guaranteed)	£30.00
3.5" discette	£3.20
40 x 3.5" lockable disc storage box	£13.00
3.5" disc head cleaner	£8.00

Prices quoted for 3.5" systems, phone for 5.25" disc systems.

Special Offer: Buy a disc system and get as many discettes as you want at only £2 each!!!

Memory Products

Miracle Expanderam 512	£115.00
Internal 512K upgrade	£118.00
RAM disc software	£14.00
Memory 'Shrink' program	£5.00

Miracle Expanderams are compatible with most disc systems, and cause some QL software to run up to 30% faster.

Other Products

Microvitec 1451DQ3 QL Colour Monitor	£280.00
Fidelity QL Monitor	£180.00
Phillips 14CF1114 Colour TV/Monitor	£210.00
Miracle Modaptor	£30.00
Centronics Printer Interface	£20.00
Serial Cable	£7.00
QL Computer & Software	£130.00
Repaired QL	PHONE
Eidersoft Mouse (New Version)	PHONE
Microdrive Cartridges	£1.80
Joystick Adaptor	£4.50
Arcade Professional Joystick	£38.00
Arcade Joystick	£17.00
Elite Joystick	£15.00
Cheetah 125 Joystick	£9.00
Pro Ace Joystick	£10.00
Wiz Card Joystick	£8.00

Postage:

UK: FREE.
Europe: £1.00 for each book ordered.
Outside Europe: £3 on all orders + £1.50 for each book.

Also available a large range of software and hardware for the Atari ST and Commodore Amiga.

Printers

Citizen 120D	£280
120CPS draft, 25 CPS NLQ	£280
Citizen MSP10	£400
160 CPS draft, 40 CPS NLQ	£400
Citizen MSP20	£550
200 CPS draft, 50 CPS NLQ	£550
Ribbons £5 each.	

All printers come fitted with both friction & tractor feed.

All printers have all the relevant interfaces and leads included, and carry a 2 year guarantee. Sample printouts available.

Modems

Astracom 1000 multistandard intelligent modem has 300/300, 1200/75, 75/1200, 1200/1200 baud communications with autodial/answer, and Prestel software	£195.00
Miracle Systems Modem with 1200/75 and 1200/1200, autodial and Prestel Compatible Software	£49.00
Free copy of 'Hackers Handbook' with all Modems.	

All prices correct at the time of going to press. E&OE.

turbo toolkit «

SOFTWARE RELEASE

As we all hold our breath waiting for the new compiler from Digital Precision, James Lucy looks at the toolkit which accompanies it.

A toolkit is a collection of utility routines and programs, usually intended for the more advanced user, which compensates for deficiencies in the original machine and caters for special needs. There is almost an embarrassment of toolkits available for the QL, which might lead one to suppose that the standard machine is unusually inadequate, but it is probably a reflection of the ease with which SuperBasic may be extended with special machine code additions.

It follows that any new product in the field needs to offer something special, particularly because there is a clear market leader in Tony Tebby's toolkit. *Turbo Toolkit* by Simon Goodwin via Digital Precision has much to offer and is intended to complement Tebby's version while still providing a number of the core features expected of any toolkit, such as job control and font setting. The Toolkit is included if you buy the Turbo compiler, or may be purchased separately and, in addition to its general functions, has a number of special features for users of all DP compilers.

On any medium

Turbo Toolkit is available on any medium and is accompanied by a comprehensive and well-written manual, printed regrettably on eye-boggling, photocopier-confounding red paper.

Since there are about 60 extra SuperBasic command/keywords provided it is not possible to discuss them all. Selecting some highlights, owners of DP compilers will be very pleased with the IMPLICIT commands, as they allow integer FOR...END FOR loops, and SELECT ON string variables. For everyone, the problem of trapping file system errors — e.g., 'File not found' — is largely overcome with DEVICE_STATUS and DEVICE_SPACE.

ALLOCATE and DEALLOCATE solve the inability of SuperBasic either to reserve resident procedure space when a job is running or to release any memory which may have been obtained — they reserve memory from the common heap. New versions of EXEC allow chains of jobs to be run;

communicating via pipes, jobs may be started with a specified priority, and the EXECUTE_A command runs a job but checks repeatedly any specified key.

Sound effects

As Toolkit is supplied, pressing ALT-SPACE will stop the executing job but the keypresses may be changed as desired. Random access file handling is included, meaning that you can extract or write data anywhere in a file, in conjunction with the binary input and output functions. Those functions read and write strings, word integers and floating point values in their internal, fixed- or known-length format.

A new capability, to me at least, is the commands which give direct access to the SuperBasic data structure. As is well-known, SuperBasic is a moving target for peeks and pokes, so the BASIC_B% commands and the like are potentially very useful. You will need a good book on how SuperBasic is laid out but those commands greatly simplify programs which monitor or fiddle with running SuperBasic programs—some good ones are included in the example programs file.

Commands are provided for job control, font changes and cursor control. The last-named facility turns on the cursor for input in a channel other than zero and must be used only with console channels. Using it is a good way of crashing the machine if a console channel has been closed and reopened as a screen channel without your knowledge — the Quill boot program does this to Channel 1. A final embellishment is TYPE_IN, which allows a program to enter a line into the current input window as if it had been typed by the user; those with compilers can produce trivial one-liners to define keys as command strings for instance.

Embellishment

From the foregoing, it should be apparent that you are getting good value — but there is more. A utilities program allows configuration of the toolkit to a limited degree and editor programs are included for fonts and sound effects.

The sound effects program allows you to play with the parameters of the

enigmatic BEEP command until you find a sound you like. A useful extra facility is 'Juggle', which produces sounds at random, hoping to find a close approximation to what you are seeking. The various BEEP parameters are displayed continuously on-screen and are represented graphically by audio-mixer type sliders. The sliders seem a waste of time and appear to slow the program; if the original SuperBasic program was supplied that could be dealt with by interested parties.

QLudge stands for the QL user-defined character editor, familiar to users of the Quanta library, and in this compiled and revised version it is neat and effective. A character is displayed on a grid in its pixel-by-pixel constituent parts and may be modified as desired using the space bar and cursor keys. A whole font can be designed and saved in a form suitable for re-loading and putting into use with Turbo Toolkit commands. Two pre-defined fonts are provided, which is fortunate, since re-defining whole fonts is a chore.

Comprehensive

The distribution cartridge/disc holds yet more useful features, since Goodwin has produced a file showing how Turbo Toolkit commands can be used. The examples, some of which must be compiled, include SuperBasic trace and profile programs and a very useful FIND command which locates procedures in SuperBasic programs. In addition, some little tricks which people may have missed are included, even though they do not use Toolkit commands — blanking the video output, for instance.

Turbo Toolkit is a comprehensive product which will not, I think, leave you wondering where your money went. It offers a wide range of features to all, whether or not they own a compiler or another toolkit.

A new version of the Toolkit with some extra features has now been released. The main additions are support for virtual arrays, which allow arrays of any size using Microdrive or disc as overflow storage, commands which simplify creation of programs to play background music, and a Library Manager program.

SOFTWARE FILE

The games potential of the QL is at last being exploited to the full. The Quill Adventure Writer brings game creation within the grasp of everyone. For those who prefer to play, QL adventures and arcade games are re-defining the standards.

Tank Busters

Sellasoft
£14.95

First let me say that this game is absolutely brilliant. Arcade dwellers and those who spent a good deal of time propping-up bars circa 1980 will recognise it as the coin-op classic *Battle Zone*. The idea is that you are in the driving seat of a tank. Your viewing screen shows the surrounding landscape, a futuristic panorama with craggy-looking mountains on the horizon and pyramidal structures dotted around.

Using the joystick you can drive the tank wherever you want to go. Speed over the vast empty expanse, go in for a closer look at some of those structures, wander

a total illusion of movement is created; there is no flicker at all. That provides amazing realism. You can drive up to objects, drive round them, turn round and they are in front of you. When you become bored with that you can fire your cannon and blow them to pieces, hopefully before they do the same to you.

The game is full of neat tricks. You can often spot tanks through the wire-framed pyramids but if you fire the shells just bounce off them. When you are attacked from the side, shells whistle across the viewscreen and disappear into the distance.

The biggest surprise occurs when you have accumulated some points and risen through several levels. Your tank is

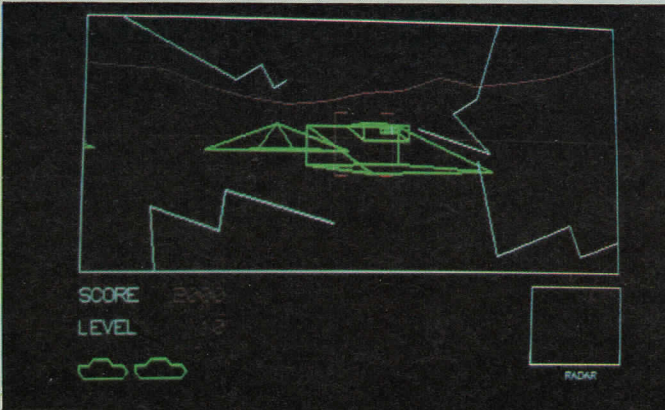

about aimlessly. The problem is that your fun is soon interrupted by the enemy. The enemy also drive tanks with the aim of blowing you off the face of the map.

Everything in *Tank Busters* is drawn in 3D wireframe graphics. Tanks, pyramids, enemy radar installations are all moving 3D objects. The scrolling is so smooth that

strafed by fighter aircraft. They can be shot down and if you are successful they disintegrate in mid-air.

Tank Busters is superb in every respect. The feeling of realism is unequalled by any other game of which I can think. If you never buy another game for the QL, make sure you have this one.

The Quill Adventure Writing System

Gilsoft
£22.95
£10.95

The Quill Adventure Writing System allows QL owners with little technical programming knowledge to create adventure games of respectable quality. It promises to provide many would-be adventure writers the freedom to create their own worlds of swords and sorcery, intrigue and suspense, murder, mystery and science fiction.

It costs £10.95 if you supply the media — two Microdrive cartridges or one floppy disc — and the manual is in two ASCII files or, if you pay £22.95, you receive the complete package with printed and bound manual and the media supplied in a presentation case.

The two ASCII files can either be copied to the screen or printer or IMPORTed line by line to the Quill word processor. The manual is extensive and the first part takes the user step by step through the processes of creating a small demonstration adventure, from simple location texts to complex event-handling.

The second part is rather like an appendix and provides detail on every part of the program and keywords which can be used in it. Although it

is detailed and helpful, it contains numerous inaccuracies and small, hidden mistakes, which do not become apparent until the user tries to type-in that particular command. Apart from the mistakes, the manual is fairly well-written and even contains tips on how to sell your adventure.

The software is well-written, with syntax error-checking on every input. The program adopts a database approach to protect the user from direct machine code programming. On loading you are presented with the main menu, from which all the major functions can be called by pressing the appropriate key. Various parts, such as the vocabulary and event-handling routines, are referred to as tables — event tables and status tables.

The vocabulary table holds up to 255 words, which includes all the objects to be used. Only the first four letters of a word are used. The parser is not up to the standard to be found in *The Pawn*, since this one picks out only the first two words it recognises but it is adequate for most uses.

The program can store 255 messages, which can be printed to the screen during the course of the adventure. The message "I'm hungry" might be printed after a set number of moves has been taken. Messages can be printed according to various conditions or actions, enabling the program to give intelligent responses to most commands.

The location text table can hold the written text

for 252 locations, each as long or as short as you wish — memory permitting, of course. A useful feature is the ability to change ink colour in the text, so important directions or instructions can be highlighted.

The movement table holds all the data concerning locations which are connected and how the player can move in the adventure. Words used for movement must be present in the vocabulary.

The Object Start Location table holds all the location numbers for the objects at the start of the adventure. Entries can be Amended or Printed. A blank entry in this table is created when an object description is entered in the Object Text table.

The next two options on the menu form the heart of The Adventure Writer, for it is from here that every major decision in the adventure is made. The Event Table takes actions depending on certain words and conditions being satisfied. If a word present in the Event Table is entered, and the conditions are true, the action is performed. There are 16 conditions which can be used and 39 actions which can be performed, so reasonably complex logical decisions and actions can be created and entered.

Entries can be Inserted, Amended, Deleted or Printed and blocks of information can be placed beneath each other, so that, after completing the

action, it "falls through" — if so desired — to the next.

The Status Table works in the same way as Event Table but, whereas the Event Table operates only on typed-in commands, the Status Table is checked between turns, after a command has been entered.

One of the most useful features is the ability to play and test the adventure currently held in memory while still in The Adventure Writing System. That makes testing and debugging the adventure much simpler, as sections of particular interest can be assessed quickly, modified, then tested, without tedious re-loading.

When the adventure is ready, it may be saved as a complete machine code file, completely self-contained, and requiring no further use of The Adventure Writer.

The screen display is very clear and informative, with all the information presented in an easily-understandable way. Obviously a great deal of work has gone into the program but the manual seems to have been written in a hurry.

Overall I would recommend The Quill Adventure Writing System to anyone who would like to create their own adventures but lacks the technical programming skills. The program has been well-written and error-trapped but the manual is not to the standard it should be. This is not the case with the more expensive version.

Information

Tank Busters, Sellasoft, Tel. 0283 45301
The Quill Adventure Writing System, Gilsoft,
30 Hawthorne Road, Barry, S. Glamorgan. Tel. 0222
41361 ext 430
War In The East, T.K. Computerware, Stone Street,
Stanford, Nr. Ashford, Kent TN25 6DF. Tel. 0303
812052.
The Dark Side Of The Moon, Javid Systems,
5 Cheltenham Road, Gloucester GL2 0JE. Tel. 0452
23594.

War In The East

Sharp Inc
£39.95

This is not a game for the faint-hearted. *War In The East* is the kind of game played by real war-game enthusiasts, presumably with plastic soldiers when there was no alternative.

attack/defence strength and the number of moves it can make. The latter factor is affected by the nature of the terrain; moving across mountains and swamps is more costly than traversing clear countryside or cities.

Phase two is the attacking phase. Any decisions you made to



The game is a simulation of the Russo-German conflict of the Second World War. Three scenarios are available — Barbarossa 1941 covers the initial German invasion of The Soviet Union; Stalingrad 1942 covers the second summer of the war; Destruction of army group center focuses on 1944 with the Russians on the road to Berlin.

In all, there are four cartridges — Scenario 1 together with the master program is £19.50 and the other two can be added at a cost of £13.50 each.

You take the role of the German armies and Allies and the computer controls the Russians. There are five phases to the game. A detailed map display occupies the top half of the screen, complete with German and Russian army units in place.

Phase one is the movement phase. The cursor flashes over each unit to be re-positioned and the lower screen provides relevant information such as the type of unit — infantry, SS infantry, Panzer division and so on, its

attack enemy units during phase one are carried-out and the map is updated accordingly. Phases one and two are repeated by the computer on behalf of the Russians. During phase five reinforcements for both sides are added to the map.

The whole move process takes about 15 minutes, depending on how much thought you put into it. The victory conditions vary in each scenario; for Barbarossa total victory is achieved if you are in control of all eight Russian cities at the end of the game, after 20 turns.

The game, if that is not too frivolous a word for it, is very much more complicated than can be described here. The American magazine *Times Designs* suggested that it could be used to teach tactics to officers in military colleges. Whether or not that is the case, *War in the East* is undoubtedly one of the most comprehensive and accurate games of its kind — definitely one for enthusiasts and those with plenty of time to spare.

The Dark Side Of The Moon

Javid Systems
£16

I have never been a fan of Pink Floyd so I cannot say I was immediately taken by the title of this science fiction text adventure. The inlay information which set the scene was even less impressive but it is unwise to make judgments on such superficial evidence and closer examination proved worthwhile.

You take the role of Captain Franklin, commander of the Starflash, a cargo freighter shipping valuable lunar selenium ore to Earth. On one of those purely routine trips you are surprised to be accompanied by the

awesome Admiral Cola — ridiculous name. All becomes clear, however, when you receive a transmission from the stricken Moonbase which has been attacked by alien Chins from the planet Chinoss.

The game, which consists of four phases, is supplied on two Microdrives. Phase one begins with you sitting in the cockpit of the Starflash, having just landed on the surface of the Moon. You have a number of companions in addition to the awesome Admiral Cola. The remainder of the cast, in order of appearance, is Dusty Miller, Robbie Robot and Nobbie Clark. Nobbie appears alongside a smelly sock, in the sleeping quarters.

Each phase must be complete to obtain a password which can be used to gain entry to the next. The problems follow

the usual adventure format. Before you can leave the ship and explore the lunar terrain you must collect all the necessary equipment. You do not need the mind of a genius to determine that a spacesuit and helmet might be useful but not everything is so obvious.

In terms of plot and gameplay, *Dark Side Of The Moon* succeeds inasmuch as it meets all the criteria for a good adventure. It is certainly one of the most expansive games of the type available for the QL and the average adventure player should find it an enduring challenge.

There are a few criticisms I would make. The player's input disappears after one second, so that the response can be scrolled up from the screen base. That can be annoying; as it is often essential to

know what you have just entered to elicit a particular response, it is easy to forget. The parser did not seem to be particularly sophisticated. According to the instructions the first two letters of a direction, i.e., NO for North, were adequate but that was not always the case. There was no command to ascertain what exits were available from a particular location and entering one which was not prompted the response 'Please rephrase your command' as did a number of other things.

That the *Dark Side Of The Moon* is the first Javid Systems attempt at an adventure is obvious but the game does not suffer unduly for it. It is enjoyable, has a few moments of humour and, judging by the size of it, will keep me occupied at least until the cricket season starts.

AT LAST!

**A REAL KEYBOARD
FOR THE QL**

THE RAINBOW KEYBOARD

A PROFESSIONAL 'FEEL' KEYBOARD
WITH 81 FULL TRAVEL KEYS
INCORPORATING CURSOR
AND NUMBER PADS, SIMPLY
TO INSTALL.

£69.95 + VAT

**QL REPAIRS
FROM £17.95**

**72 hour express
service available.**

PHONE FOR DETAILS

REAL TIME CLOCK BATTERY BACK-UP

**THE REAL TIME CLOCK
MAINTAINS THE DATE
AND TIME WHILE
SWITCHED OFF.**

FITTED FOR £19.95

**640K INTERNAL
MEMORY £115**

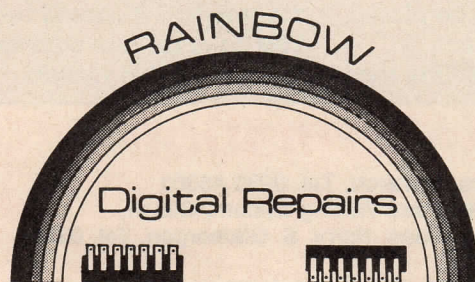

Clark House, Haxby, York YO3 8HU
Tel: (0904) 768853

MIRACLE SYSTEMS LIMITED

14 day full money back guarantee on all products
12 month warranty on all products
All prices include VAT and P&P

QL MODAPTOR + £39

- ★ Interfaces QL to any std. modem
- ★ 300/300, 1200/75, 1200/1200 baud
- ★ Auto-dials with DTR
- ★ Plugs into SER2
- ★ Complete with software

QL MODEM £49.00



- ★ 1200/75—e.g. PRESTEL
- ★ 1200/1200 half duplex
- ★ Autodial
- ★ 3 metre cable
- ★ Plugs into SER2
- ★ Complete with software
- ★ Not BT approved

QL EXPANDERAM 512K £125.00

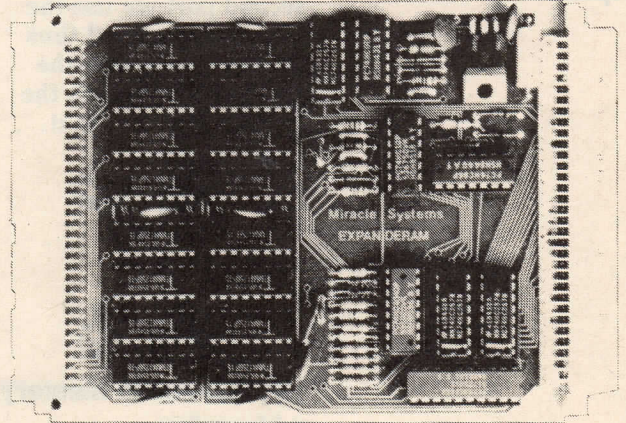

- ★ Increases QL memory to 640K
- ★ Through connector for Disc Interface
- ★ Low power consumption
- ★ Can speed up some programs
- ★ Able to use larger QUILL documents, etc
- ★ Black cover included.

QL CENTRONICS £19.50 PRINTER INTERFACE

QL SERIAL CABLE £7.50

QL JOYSTICK ADAPTOR £4.99

QL RAM DISC £14.95

- ★ Configures RAM as Disc
- ★ Speeds up some programs
- ★ Supplied on microdrive
- ★ Includes Spooler
- ★ Includes Screen Dump



Tel: (0454) 317772
Orders welcome by telephone or post



MIRACLE SYSTEMS LTD, 20 Mow Barton, Yate, Bristol BS17 5NF, UK.

Please send me

Please find a cheque enclosed to the value of £.....

or debit my credit card no

Expiry date / / Signed

Send to: Name

Address

MIRACLE SYSTEMS LTD, 20 Mow Barton, Yate,
Bristol BS17 5NF, UK.

QL CONNECTIONS

Colin Opie takes our complete guide to QL interfacing a stage further by explaining how the 68008 QL processor addresses peripheral devices.

Having looked last month at what micro-computer-based control systems were, in this second part we use the knowledge gained thus far to explain how the processor addresses the devices attached to it.

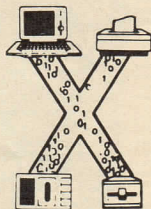

Asynchronous memory addressing

The 68008 processor is an asynchronous device. That means it will perform its memory accesses in an asynchronous manner. A dialogue, therefore, has to exist between the processor and the devices it is addressing. An advantage of this addressing mode is that memory accesses always operate in the fastest time possible. A disadvantage is that the addressed devices require a certain degree of intelligence to be built around them to create the dialogue.

Note that the 68008

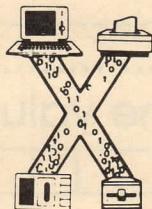

does not have separate memory and I/O address maps and, therefore, peripheral devices are accessed in the same way as memory devices. It is important to remember this and to be aware that when we refer to memory accesses we are implying an access to any device — generically known as

slave devices — outside the processor.

Let us look briefly at the operations involved. For specific timing diagrams, reference should be made to the Motorola 68000 manual, now in its fifth edition.

Memory read operations

A memory read cycle is started by the 68008 processor. The processor sets the R/WL line high to signify a read, places the address on the address lines A0 to A19, sets the status lines FC0 to FC2 appropriately, and sets the address and data strobes — ASL and DSL — low. The slave devices

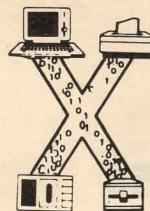

will respond to those processor actions by decoding the address, placing data on to the data bus lines D0 to D7, and setting the data transfer acknowledge — DTACKL — low.

The 68008 will respond to the slave device signals by latching in the data and then pulling the address and data strobes — ASL and DSL — high. The slave devices finish the dialogue by removing the data from the data lines D0 to D7 and setting the data transfer acknowledge lines — DTACKL — high.

A memory write cycle is started by the 68008 processor. The processor sets the R/WL line low to signify a write, places the address on the address lines A0 to A19, sets the status lines FC0 to FC2

appropriately, sets the address and data strobes — ASL AND DSL — low, and places the data on to the data lines D0 to D7.

The slave devices will respond to those processor actions by decoding the address, storing the data currently on the data bus lines D0 to D7, and setting the data transfer acknowledge (DTACKL) low.

The 68008 will respond to the slave device signals by removing the data and then pulling the address and data strobes — ASL and DSL — and the R/WL line high. The slave devices finish the dialogue by setting the data transfer acknowledge line — DTACKL — high.

Synchronous 6800/6502 device addressing

The 68000 family of processors was designed to provide easy interfacing to 6800/6502 peripheral chips — e.g., the 6845 CRT controller or the 65422 Versatile Interface Adaptor. Two problems have to be overcome to do this. First, the 6800/6502 processors and their peripheral chips are synchronous devices and cannot provide the dialogues described for asynchronous read and write operations. Second, they cannot operate at the high system clock rate of

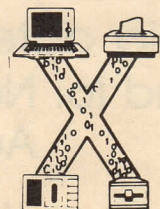

8MHz. A more typical clock rate for the devices would be 1MHz.

Of course, there are many other devices, not

just 6800 series chips, which are purely synchronous and have relatively slow access times — e.g., common RAM/ROM chips. The 68008 solves those

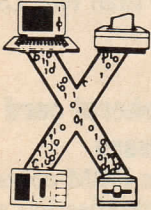

problems by using two special signal lines. First, there is the 'E' line which is a 1MHz clock signal suitable for use as the synchronous device clock input. Second, there is the 'VPAL' line. That input line is driven low by

does not provide the 68000 'VMAL' output signal used by the synchronous slave devices to condition chip select signals. An external circuit is required.

VMAL generation and chip select

So long as the external memory address decode circuitry can supply the VPAL signal, a very simple circuit can be used to create suitable VMAL and VPAL signals for the slave device chip select circuitry and the 68008 processor respectively. The circuit is shown in figure one. The memory address decode circuitry generates an active high VPA signal when it sees a

circuitry. That effectively signifies that it is this particular chip which is being addressed. The VMAL signal is fed to the

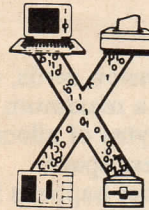

second chip select — CSI — as a chip select timing conditioner.

As can be seen, the task of interfacing slow synchronous slave devices to the 68008 processor is far from onerous. We shall be using the simplicity of this approach in the design of Control II boards.

then entering the linked list of external interrupt physical access layer routines.

One, and only one, of those linked routines should recognise the interrupt source and deal with it appropriately. The routine which services the interrupt must perform the necessary actions pursuant to the recognised interrupt source and then clear the interrupt.

Exactly how the interrupt is cleared will depend solely on the type of device which issued the interrupt. All such interrupt service routines should terminate with an RTS instruction, not RTE, regardless of whether or

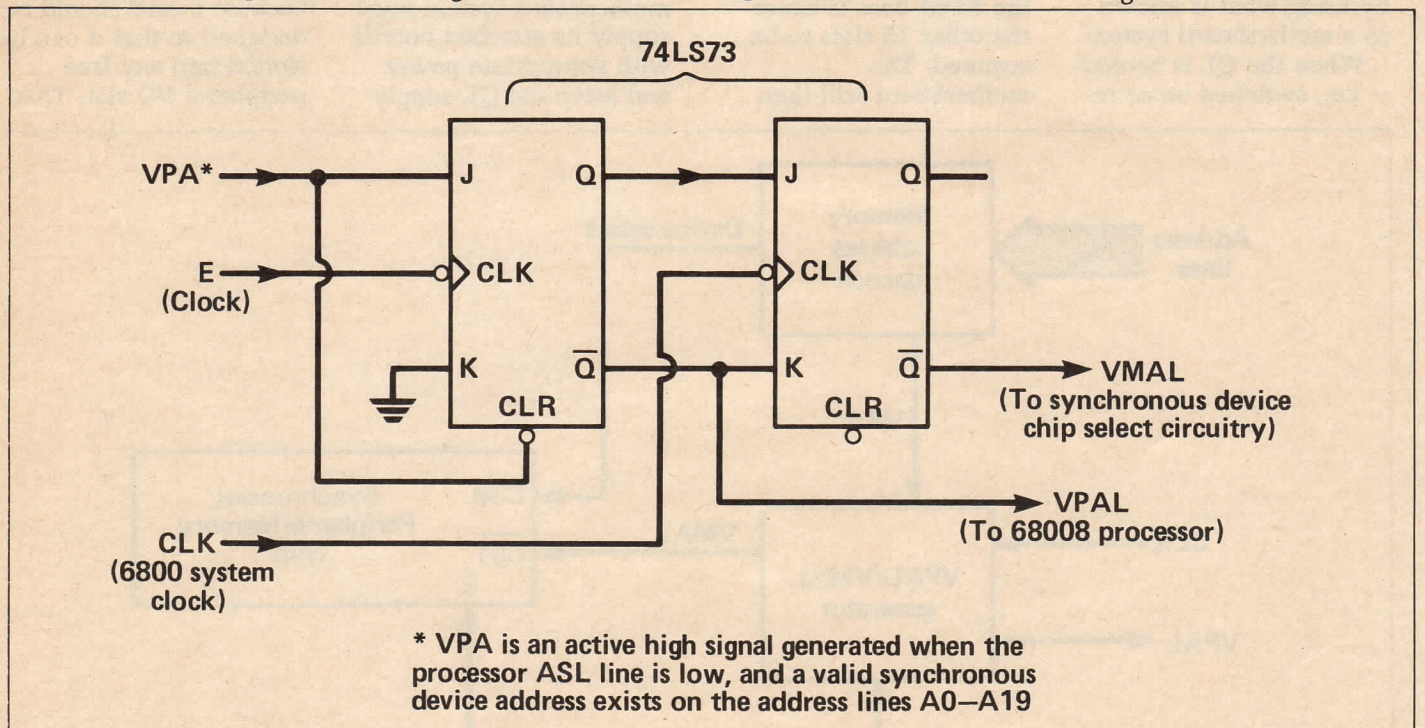

external memory decoding circuitry whenever a valid peripheral chip address is recognised on the address lines A0 to A19.

The 68008 uses this input to adopt a state of

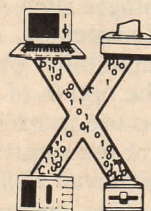

synchronous protocol addressing. Unfortunately, the 68008

valid synchronous slave device address on the address lines. That is fed into the circuit which produces the two required output signals with appropriate timing.

The VMAL line created from the circuit in figure one is fed into the synchronous device chip select circuitry. Figure two shows how it is performed for a synchronous slave device with two chip select lines. Note that one chip select — CS0 — is fed by the memory address decode

External interrupts on the QL

Interrupts supplied by external devices to the 68008 in the QL are not normally supplied on the priority interrupt lines IPL0/2L and IPL1L. Instead, the QL expansion connector furnishes the interrupt line EXTINTL. An external device may pull this line low to signal an interrupt request IRQ. The QL operating system will respond to the request by saving the processor registers and

not it serviced the interrupt. At the end of the linked list of service routines the operating system will restore the

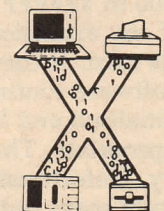

processor registers and execution of the interrupted code will continue.

QL CONNECTIONS

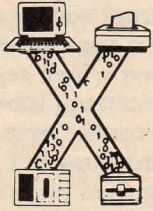

QL expansion interface

The expansion port, positioned inside the left-hand side of the QL, is the main peripheral I/O expansion slot. Single expansion cards may be plugged-in directly, or a series of cards may be attached simultaneously by using what is known as a motherboard system.

When the QL is booted — i.e., switched on or re-

expansion cards, each with a maximum 16 kilobytes of allocated address space.

What happens to the other 15? If a motherboard system is being used, the ROM in slot zero must be special and contain a short piece of code which scans the remaining 15 slots for the QL. This one detail is so important it is accepted practice to configure slot zero on a motherboard, such that the only thing the ROM does is cause the other 15 slots to be scanned. The motherboard will then

memory card should contain the entire 512K of memory. As slot zero, in the peripheral I/O motherboard system, is almost always special, up to 15 I/O cards may also be attached.

The attached cards may draw a total of 500mA from the VIN supply rail — 7-9V DC — available on the expansion connector. That is suitable for most low-power single card extensions. A motherboard system must supply its attached boards with appropriate power and leave the QL supply

more than two LS-TTL gates.

Peripheral card ROM software

The ROM containing the initialisation and SuperBasic extensions for any one peripheral I/O card must lie at the bottom of the 16K address space. The format of the header for this ROM will be discussed in detail later. The code must be position-independent because a card should be designed so that it can be slotted into any free peripheral I/O slot. That

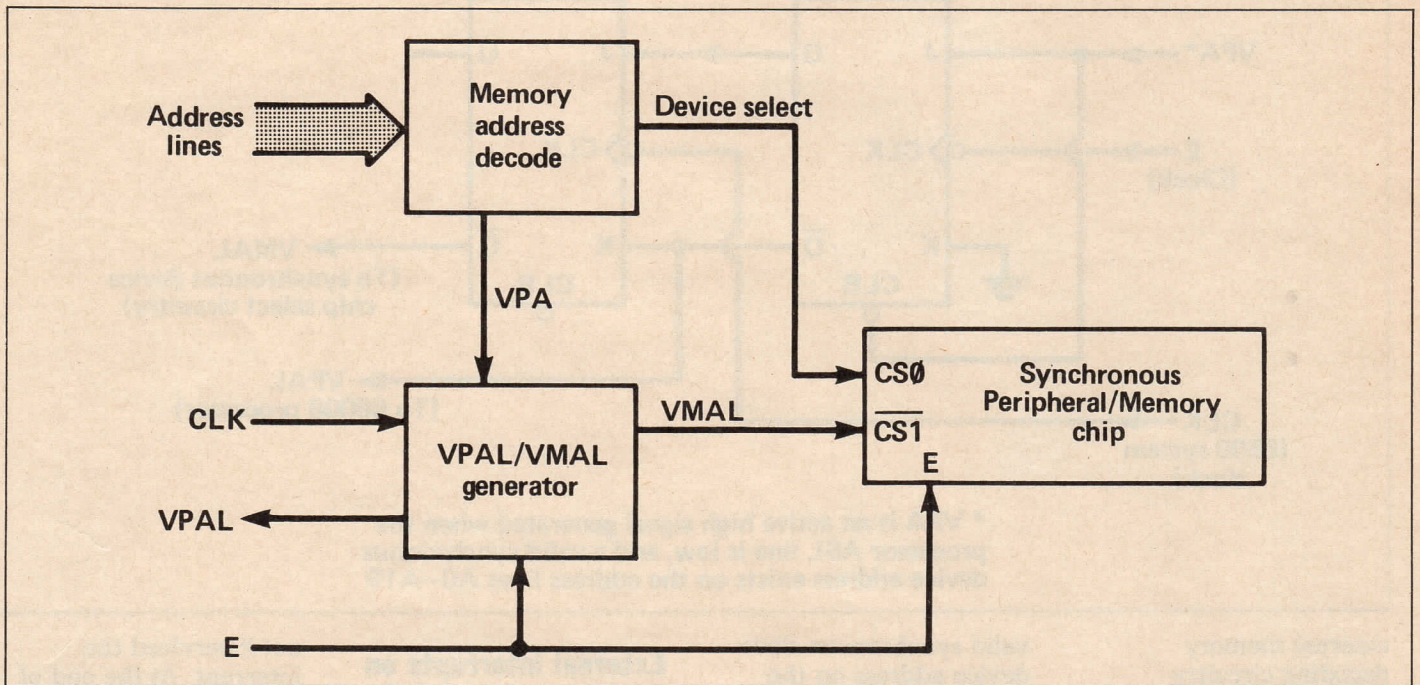

set — one of the actions it will take is to scan the peripheral I/O area — \$C0000 to \$FFFFFF — to see if any extension card ROMs exist. If they do, the software routines will be initialised and linked as appropriate. That is the theory. Unfortunately, the QL truly scans only the first possible card slot — i.e., slot 0, the one at location \$C0000. In part one we saw that there are 16 possible logical

contain only connectors for slot positions one to 15 maximum.

Expansion cards

When expanding the configuration of the QL, both the RAM and the peripheral I/O areas are utilised through the expansion port. Only one memory card should be attached. If it is intended to fill the half-megabyte area with RAM, a single

free. Suitable earth plane screening should also be used by a motherboard system. No card, memory

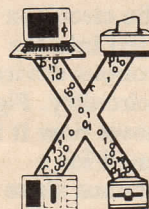

or peripheral should load any output logic pin on the expansion port by

includes slot zero if no motherboard system is being used — i.e., a single card extension exists.

Clearly that has advantages such as less board switching, no incompatibility problems, and the option of being able to use more than one copy of the same board.

● Next month Colin Opie looks at the expansion port connector and describes expansion board addressing.

Subscribe to *QL World*

Copies of the latest issue of *QL World* disappear fast from the shelves. If you cannot go to the shops on our publication date, you can miss the mixture of news, reviews and features which make *QL World* the only magazine for serious QL users.

The only way to avoid possible disappointment is to subscribe to the magazine. In that way, a copy will drop on to your doormat each and every month. Copies are sent direct by our printer, so by subscribing you should receive the magazine even

before it reaches newsagents.

A subscription also makes an ideal present for someone who takes the QL seriously. Why not make a present of a subscription?

To subscribe to *QL World*, complete the order form and send it, together with a cheque or postal order for £15 for the U.K. and £30 for Europe, to the address shown. Do not delay. Send your order now and relax in the knowledge that you will never again miss a copy of *QL World*.

Sinclair/QL World
(Subscriptions)
Oakfield House,
Perrymount Road,
Haywards Heath,
RH16 3DH.

Name _____

Address _____

Postcode _____

TANDATA COMMUNICATIONS FOR THE SINCLAIR QL **UNBEATABLE PRICES!**



APPROVED
for use with
telecommunication systems
run by British
Telecommunications
in accordance with the
conditions in the
instructions for use

The only communications package for the QL. The modules are available separately but, by using all three as a complete matched system, full advantage can be taken of the integrated features.

Q-CONNECT

Complete RS 232 output for general communications from 75-9600 baud with full two way buffering and flow control. Software on a micro drive to support all 3 modules includes Prestel Viewdata/Videotex and VT100 emulation, and many other features.

Q-MOD

Manual dial V23 modem operating at 1200/75 bps and 1200/1200 half duplex.

Q-CALL

Provides traditional pulse/loop disconnect auto-dial and auto answer.

**Q-CONNECT Q-MOD
AND Q-CALL NOW ONLY**

£79.99

**Q-CONNECT AND
Q-MOD ONLY**

£59.99

PRICES INCLUDE VAT & P&P

I'd like to know more about Tandata communications for the QL.

Name _____

Address _____

Tel No _____

Send to:
Tandata Marketing Ltd.,
Albert Road North, Malvern,
Worcs. WR14 2TL.

Tandata

Tandata Marketing Limited

Albert Road North, Malvern, Worcs. WR14 2TL.
Telephone: 06845 68421. Telex: 337617 Tandat G.
Prestel *799# Telecom Gold 81: TAN001
A subsidiary of Tandata Holdings plc.
Prestel is a registered trade mark of British Telecommunications plc.

PUZZLE PAGE

Marcus Jeffery returns with a new teaser and the last of last year's solutions.

If you are too busy to spend too much time trying to solve a complex puzzle, this month all I shall do is ask you to find a simple answer. This month's problem originated in a science fiction book by

Figure 1.

To Godelize the message: "TEA"

1. Take the series of primes, starting at 2. In this case, only the first three are necessary. They are 2, 3, 5.
2. Convert the letters in the message into numerical values. To do so, replace each letter by its position in the alphabet. Thus, TEA becomes 20, 5, 1.
3. Raise each prime to the power of the Relevant letter:
 $2^T = 2^{20} = 1048576$
 $3^E = 3^5 = 243$
 $5^A = 5^1 = 5$
4. Finally, multiply the values for the final answer.
 The Godelized form of TEA is:
 $1048576 \times 243 \times 5 = 1274019840.$

more than 1,000 significant digits. I have reduced that slightly in figure two to make things easier to type-in. I would be interested if anybody could find a more condensed form of storing this number and other numbers of this form, because I found that part particularly difficult. As usual, I will be interested to see any programs you may devise to find the answer.

RULES

All entries must be written on the panel provided on this page. Any other form of entry will be disqualified. Entries must be sent by post to: Puzzle Page, Sinclair QL World, 79-80 Petty France, London SW1H 9ED, to arrive no later than 12th January 1987. The winner will be the first correct entry drawn out of the editor's hat. If nobody submits the correct answer, the winner will be the person with the nearest answer. All entries will be judged by the editor, whose decision is final and no correspondence will be entered into regarding the result.

ENTRY FORM

The message reads:.....

 Name
 Address

Frederik Pohl, *Starburst*. At one point he described a message-encoding algorithm, known as Godelized Language. Using the algorithm, it is possible to condense a message of any length into a single, very large, unique number.

The message is encoded as the natural order of primes, raised to various powers. The series of primes — 2, 3, 5, 7, 11 and so on — represent the position of a character, with the first character being 2, the second 3, the third 5, and so on. The content of the message is shown by the power to which the prime number is raised. Here 'A' to 'Z' are given the values '1' to '26'.

Once all the primes and powers have been calculated, the product of all the factors gives the final message. If that does not seem too clear, the example in figure one should help.

The answer I want is very simple. Calculate the number shown in figure two, then de-Godelize it to give the original message, which you should then fill in on the entry form.

I must warn you that the final number contains

Figure 2.

(980869 × 534131 × 167727 × 714502 × 878758)¹
 (919181 × 594255)³
 (886937 × 439310 × 689710 × 515531)⁵
 (212055)¹⁰
 (496009 × 728575 × 467539 × 470761)¹⁵
 (989571 × 366689 × 697709 × 923099)¹⁵
 (871844 × 874394 × 6844361 × 527711)²⁰
 ÷
 (552653 × 727955 × 683467 × 630170)¹
 (593750 × 859429 × 966649 × 758843)¹
 (652740)³
 (983471 × 678215 × 172800)⁵
 (54375)²

SOLUTIONS

October

The Mass Clubbing, as the ring of cavemen tried to choose the next tribal leader, certainly prompted plenty of replies. They employed a variety of methods, including the primitive exhaustive search.

One of the most popular methods was to solve the reverse of the problem. That involves adding to the circle of cavemen until a solution is found. I leave it to D. J. Buller to explain the theory behind this method:

This stone age tribe used to brew a very potent liqueur out of mango leaves. They called it Cheng because that was the noise made when they crashed together the stone vessels in which the drink was stored.

One day, after the tribe had played its notorious head-bashing game, the leader felt some pity for all the others lying on the ground. He ran back to his cave and fetched several bottles of Cheng, with Mis en Bouteilles dans nos Caves written on each. Having taken a swig himself, the leader looked for the man he would like to make his deputy. He gave him a

Figure 3.

```

10 Extra = 9: Old_Winner = 8: Leader = 1
20 Find_Next_Winner
30 PRINT Extra + Leader
40 :
100 DEFine PROCedure Find_Next_Winner
110 Extra = Extra + 1
120 New_Winner = Old_Winner + 10
130 IF New_Winner > Extra THEN
140   New_Winner = New_Winner - Extra - Leader
150   IF New_Winner > 9 THEN
160     New_Winner = New_Winner + 1
170   END IF
180 END IF
190 IF New_Winner <> 0 THEN
200   Old_Winner = New_Winner
210   Find_Next_Winner
220 END DEFine

```

Explanation:

1. Start with 10 cavemen, including leader. Label leader 0. Winner is No. 8 — calculated manually.
2. Add extra cavemen; first loser must be No. 10 hence, new winner can be found from previous recursion, using No. 9 as effective leader.
3. continue step 2, until winner is No. 0 — i.e., leader

draught of the potent liqueur, then gave him these instructions.

"Starting with yourself, continue counting in the way we all know. When you have run out of numbers, give the person the bottle, revive him, and stand him as your right-hand man. Then give him these instructions, exactly as I have given them to you."

The leader — No. 1 — stepped back into his place in the circle and waited to see what would happen. Of course, he was often involved in the game, and there were cries of one, two, three, four, five, six, seven, eight, nine, CHENG." He was very anxious about the quality of the man who would stand on his left. At first it was his deputy — No. 2 — he had selected, but it then became number four, then number five. He liked number five and was pleased to see that no new person was elected for a very long time.

It was not until many bottles of Cheng had been drunk and a great deal of counting had been done that a new person — No. 476 — was appointed to stand there. Not at all pleased with that

development, the leader promptly hit number 476 on the head again and ever after always selected a total of 475 men to play the game.

The correct answer to the puzzle was 475. In other words, the leader should choose 474 cavemen in addition to himself.

I would like to thank all readers who sent programs and letters for this problem. I am sorry I could not include all the programs but I have included one listing, chosen at random from the shorter solutions, from R. Oxborough — figure three.

As a final note, we can accept photocopies of the entry form if you do not want to damage your magazine. The winner, M. J. Kirkup of Hither Green, London, was horrified by the possibility.

November

I would like to thank J. R. Klunder for his very comprehensive answer to the problem. His program is listed in figure four. Unfortunately, he estimates that this will take roughly $1.1 * 10^{120}$ years — i.e., $7 * 10^{106}$ times the current age of the universe. If you do not think the number of big enough, look at this month's puzzle.

It seems that Mr Klunder has been developing an inferiority complex because his QL keeps telling him how much quicker it is at sums. Therefore he decided to have a little bet to see who could find the correct answer quickest. Looking at the foregoing number, I feel that the odds were heavily stacked in Klunder's favour.

The first thing to calculate is the number of possible three-colour sequences. There are 12 initially and from each there are five possible adjacent colours. From the second colour there are again five possible adjacent colours, because there is no reason why the bug should not return to the original colour side. That gives a total of:

$12 * 5 * 5 = 300$
three-colour sequences.

Next we have to calculate the maximum possible route. To do so we will assume that the bug always hops to the correct side to give the maximum total number of hops — i.e., assume that we find the solution.

After each hop, we will cross off one of the 300 possible sequences if it has been completed.

It is not until the bug has reached the third side that our first sequence of three colours has been completed. Therefore we have visited three sides and have only 299 possible three-colour sequences remaining. On the next hop, we must cross off another three-colour sequence, corresponding to the last three of our four sides visited. That leaves 298 possible three-colour sequences. At the next hop, we must cross off another, and so on.

Thus we can conclude that if the bug can find a route which will cover all of the 300 three-colour sequences, it will visit:

$300 + 2 = 302$
sides.

That still leaves us with the problem of deciding whether or not such a route exists. If it did not exist, you would certainly have had a problem because Klunder calculates there are:

$60 * (5!)^{60}$
possible routes. Even reducing those through symmetry would leave you with an overwhelming problem.

Fortunately I am not so cruel and a 302-side solution exists. Even the program in figure four will find it in a reasonably short time. Once you have found one solution of this length, you can be sure that a longer solution does not exist, as was the winner, Michael Hussman, of Hamburg, W. Germany.

```

100 DIM p(400,2):DIM m(12,5):p(1,1)=1:p(1,2)=5:p(2,1)=2:p(2,2)=1:1=2:b=2:n=1:c=9
110 RESTORE 230:FOR i=1 TO 12:FOR j=1 TO 5: READ m(i,j):NEXT j: NEXT i
120 REPEAT lp: IF ok: doit: ELSE IF p(1,2)<5: nxt: ELSE bk
130 IF 1=1 THEN EXIT lp: END REPEAT lp
140 DEFine FuNction ok: f=0: i=3: REPEAT d
150 IF f=1 OR i>1 THEN EXIT d
160 IF p(i,1)=c :IF p(i-1,1)=p(1,1): IF p(i-2,1)=p(1-1,1)THEN f=1
170 i=i+1: END REPEAT d:IF f=1:RETurn 0:ELSE REturn 1:END DEFine
180 DEFine PROCedure doit: 1=1+1: p(1,1)=c: p(1,2)=1: c= m(c,1)
190 IF 1>b:b=1:n=1:ELSE IF 1=b:n=n+1:END IF :PRINT 'L'!'1'!'B'!'b'!'N'!'n:END DEFine
200 DEFine PROCedure bk:REPEAT blp:1=1-1: IF p(1,2)< 5 THEN EXIT blp:END REPEAT blp
210 nxt: END DEFine
220 DEFine PROCedure nxt : p(1,2)=p(1,2)+1: c=m(p(1,1),p(1,2)) :END DEFine
230 DATA 9,12,5,4,2,9,1,4,3,8,8,2,4,6,10,2,1,5,6,3,4,1,12,7,6,3,4,5,7,10
240 DATA 10,6,5,12,11,9,2,3,10,11,11,12,1,2,8,11,8,3,6,7,9,8,10,7,12,1,9,11,7,5

```

THE

P+R:O=G<S

If you have a program that is worthy of consideration, send it to 'The Progs', Sinclair QL World, 79-80 Petty France, London SW1H 9ED. We pay for everything published at the usual page rates — £80 per thousand words.

Rename: Ian Robinson

In recognition of the fact that in recent months The Progs has been biased heavily in favour of the games players, the January Progs are all utilities. That this one can be found on all the toolkits is indicative of its usefulness.

Rename does just that. It will change the name of any of your Microdrive or disc files. To use the procedure type `RENAME "MDVL_", "OLDNAME" TO "NEWNAME"` (ENTER).

```

100 REMark *****
*****
110 REMark *** 'Rename' (c) I.
Robinson ***
120 REMark *** Three string pa
rameters ***
130 REMark ** device$,oldname$
,newname$ **
140 REMark *****
*****
150 REMark e.g. RENAME "mdvl_"
,"Boot" to "Program"
160 REMark or RENAME "mdvl_"
"Boot", "Program"
170 Sum=0:Address=RESPR(298)
180 FOR a=1 TO 298
190   READ byte
200   Sum=Sum+byte
210   POKE Address+a-1,byte
220 END FOR a
230 READ Checksum
240 IF Checksum<>Sum
250   PRINT 'Error in Data':ST
OP
260 END IF
270 SBYTES mdvl_program,Addres
s,298
280 CALL Address
290 RENAME "mdvl_" ,"program" T
O "Rename_Bin"
300 PRINT 'No errors'
310 STOP
1000 DATA 67,250,0,12,52,120
1010 DATA 1,16,78,146,112,0
1020 DATA 78,117,0,1,0,16
1030 DATA 6,82,69,78,65,77
1040 DATA 69,0,0,0,0,0
1050 DATA 0,0,52,120,1,22
1060 DATA 78,146,102,0,0,200
1070 DATA 12,67,0,3,102,0
1080 DATA 0,198,65,246,152,0
1090 DATA 45,73,0,88,112,1
1100 DATA 114,255,118,4,78,66
1110 DATA 74,128,102,0,0,170
1120 DATA 112,66,114,14,118,25
5
1130 DATA 78,67,74,128,102,0
1140 DATA 0,148,67,250,0,166
1150 DATA 34,188,0,0,0,14
1160 DATA 34,110,0,88,69,246
1170 DATA 152,8,112,3,52,18
1180 DATA 84,66,118,255,67,250
1190 DATA 0,144,78,67,74,128
1200 DATA 102,0,0,110,47,8
1210 DATA 67,250,0,130,147,206
1220 DATA 32,74,145,206,54,120
1230 DATA 0,230,112,1,78,147
1240 DATA 32,95,74,128,103,28
1250 DATA 67,250,0,102,34,17
1260 DATA 6,129,0,0,0,64
1270 DATA 34,129,112,66,118,25
5
1280 DATA 78,67,74,128,103,178
1290 DATA 112,249,96,54,67,250
1300 DATA 0,74,34,17,118,255
1310 DATA 112,66,78,67,74,128
1320 DATA 102,38,34,74,116,0
1330 DATA 52,18,84,66,211,194
1340 DATA 82,137,46,9,2,7
1350 DATA 0,254,34,71,52,17
1360 DATA 84,66,12,66,0,36
1370 DATA 106,0,0,26,118,255
1380 DATA 112,7,78,67,47,0
1390 DATA 112,2,78,66,32,31
1400 DATA 78,117,112,249,96,25
0
1410 DATA 112,241,96,246,112,2
44
1420 DATA 96,234,0,0,0,0
1430 DATA 0,0,0,0,0,0
1440 DATA 0,0,0,0,0,0
1450 DATA 0,0,0,0,0,0
1460 DATA 0,0,0,0,0,0
1470 DATA 0,0,0,0,0,0
1480 DATA 0,0,0,0,0,0
1490 DATA 0,0,0,0
1500 DATA 20696 :REMark Checks
um

```

Caps lock John Bradshaw

Another obviously titled and Psion programs to indicate amazingly useful utility, Caps whether you are in upper- or lock can be used alongside lower-case mode. Quill, Abacus, or any of the

```

100 WINDOW 512,206,0,0:PAPER 0:INK 7
110 MODE 4
120 PRINT TO 30;'CAPS LOCK INDICATOR'
130 PRINT '\\'Type the number in the brackets if you wish to use the routine with
QUILL.\\'

```



```

140 INPUT 'Border width (0)      : '!border_width
150 INPUT 'Border colour (0)    : '!border_colour
160 INPUT 'Paper colour (0)     : '!paper_colour
170 INPUT 'ink colour (2)       : '!ink_colour
180 INPUT 'Window width (50)    : '!window_width
190 INPUT 'Window height (10)   : '!window_height
200 INPUT 'X coord (200)        : '!xcoord
210 INPUT 'Y coord (245)        : '!ycoord
220 RESTORE
230 address=ALCHP(110)
240 :
250 REMark Use RESPR(110) in line 230 if you do not have this extra command
260 :
270 FOR num_bytes=0 TO 93
280 READ byte
290 POKE address+num_bytes,byte
300 END FOR num_bytes
310 POKE_W address+94,window_width
320 POKE_W address+96,window_height
330 POKE_W address+98,xcoord
340 POKE_W address+100,ycoord
350 :
360 REMark Use MDV in the next line if you do not have disc drives
370 :
380 SEXEC flp1_caps_bin,address,110,0
390 :
400 REMark If you used the RESPR command in line 230 then do not type in line 42
0
410 :
420 RECHP address
430 DATA 96,12,0,0,0,0,74,251,0,4
440 DATA 67,65,80,83,112,11,114,255,116,1
450 DATA 78,65,52,120,0,200,67,250,0,62
460 DATA 78,146,40,124,0,2,128,136,118,255
470 DATA 116,8,12,20,0,0,103,10,67,250
480 DATA 0,24,112,7,78,67,96,8,67,250
490 DATA 0,22,112,7,78,67,112,17,114,0
500 DATA 78,67,96,224,67,65,80,83,32,79
510 DATA 78,32,67,65,80,83,32,79,70,70
520 DATA border_width,border_colour,paper_colour,ink_colour

```

Sound Sampler

John Davies

If you have ever tried to emulate the sound of a Martian laser blaster, a dog barking, a police siren, or you simply want middle C, you will find this a handy program.

Sound Sampler enables you to alter the beep parameters and listen to the sound at the same time. A kind of simple synthesiser.

```

100 DEFine PROCEDURE Sound
110 LOCAL duration,pitch1,pitch2,gradx,grady,wrap,
fuzz,random,fast,time
120 LOCAL userin, i, line$
130 CLOSE #1: OPEN#1,con 450x200a36x12_128
140 PAPER 207: INK 2: MODE 8
150 duration=20000: pitch1=60: pitch2=40: gradx=18
00: grady=5: wrap=5: fuzz=0: random=13: time = DATE
E: RANDOMISE
160 CSIZE 2,0: CLS: STRIP 7: AT 0,10
170 PRINT 'SOUND EXPERIMENTS'\\: STRIP 207
180 PRINT 'Use top row numbers to alter each\'par
ameter. Press the number to move upwards, and \';
185 UNDER 1:PRINT 'SHIFT':;UNDER 0:
190 PRINT ' the number to movedownwards. Press R f
or random, any other key to PAUSE.'
200 PRINT'Write down the command when it is wha
t you want.'
210 STRIP 5: AT 16,0: PRINT'1 = time, 2 = pitch 1,
3 = pitch 2 '\4 = grad x, 5 = grad y, 6 = wrap
'\7 = fuzzy, 8 = random
220 REPEAT sounding
230 line$='BEEP '&duration&','&pitch1&','&pitch2
&','&gradx&','&grady&','&wrap&','&fuzz&','&random

```

```

240 AT 12,0: CSIZE 2,1: STRIP 6
250 INK 0: PRINT line$;FILL$( ' ',37-LEN(line$)):
STRIP 207
260 CSIZE 2,0: AT 14,0: parm=1: INK 1
270 FOR i=5 TO LEN(line$)
280 IF line$(i) = ',' THEN PRINT TO i-2;parm::
parm = parm + 1
290 END FOR i
300 PRINT TO LEN(line$)-2;'8 ': INK 2
310 BEEP duration,pitch1,pitch2,gradx,grady,wrap
,fuzz,random
320 REPEAT testing
330 userin = CODE(INKEY$(20))
340 IF userin <> 0 OR NOT BEEPING THEN EXIT te
sting
350 END REPEAT testing
360 IF userin <> 0 THEN
370 fast = DATE - time
380 time = DATE
390 SELECT ON userin
400 ON userin = 49, 33
410 SELECT ON fast

```



```

420      ON fast = 1: duration = duration + (- 610      IF fast = 0 THEN gradx = gradx + (-80
200 * (userin=33)) + 100: duration = INT(duration/ 0*(userin=36)) + 400
100)*100      620      ELSE
430      ON fast = 0: duration = duration + (- 630      gradx = gradx + (-4*(userin=36)) + 2
4000 * (userin=33)) + 2000: duration = INT(duratio 640      END IF
n/1000)*1000      650      IF gradx > 32767 THEN gradx = 32767
440      ON fast = REMAINDER : duration = dura 660      IF gradx < -32768 THEN gradx = -32768
tion + (-20 * (userin=33)) + 10      670      ON userin = 53, 37
450      END SElect      680      grady = grady + (-2*(userin=37)) + 1
460      IF duration > 32767 THEN duration = 327 690      IF grady > 7 THEN grady = 7
67      700      IF grady < -8 THEN grady = -8
470      IF duration < -32768 THEN duration = -3 710      ON userin = 54, 94
2768      720      wrap = wrap + (-2*(userin=94)) + 1
      730      IF wrap > 15 THEN wrap = 15
      740      IF wrap < 0 THEN wrap = 0
      750      ON userin = 55, 38
      760      fuzz = fuzz + (-2*(userin=38)) + 1
      770      IF fuzz > 15 THEN fuzz = 15
      780      IF fuzz < 0 THEN fuzz = 0
      790      ON userin = 56, 42
480      ON userin = 50, 64      800      random = random + (-2*(userin=42)) + 1
490      IF fast < 2 THEN pitch1 = pitch1 + (-20 810      IF random > 15 THEN random=15
*(userin=64)) + 10      820      IF random < 0 THEN random = 0
500      IF fast >= 2 THEN pitch1 = pitch1 + (-2 830      ON userin = 82, 114: REMark 'R'
*(userin=64)) + 1      840      pitch1=RND(255): pitch2=RND(255)
510      IF pitch1 > 255 THEN pitch1 = 255      850      gradx=RND(32767): grady=RND(15)-8
520      IF pitch1 < 0 THEN pitch1 = 0      860      wrap=RND(15): fuzz=RND(15): random=RND(
530      ON userin = 51, 35      15)
540      IF fast < 2 THEN pitch2 = pitch2 + (-20 870      ON userin = REMAINDER
*(userin=35)) + 10      880      AT 19,0: FLASH 1: INK 1
550      IF fast >= 2 THEN pitch2 = pitch2 + (-2 890      PRINT'PROGRAM IS PAUSED': FLASH 0: INK
*(userin=35)) + 1      2
560      IF pitch2 > 255 THEN pitch2 = 255      900      PAUSE: AT 19,0: PRINT FILL$( ' ',17)
570      IF pitch2 < 0 THEN pitch2 = 0      910      END SElect
580      ON userin = 52, 36      920      END IF
590      IF fast < 2 THEN      930      END REpeat sounding
600      gradx = gradx + (-80*(userin=36)) + 4 940      END DEfine Sound
0

```

Label Printer R Williams

This program really needs no explanation. It performs a simple yet invaluable task, that of printing-out labels for your Microdrive cartridges.

```

100 REMark R. WILLIAMS - 28/8/86
110 MODE 4:WINDOW 448,100,32,16:BORDER 2,2:WINDOW#2,448,100,32,116
120 BORDER#2,2,4:PAPER 2:INK#2, 0:PAPER#2,4:INK 7:CLS#2:st=1
130 CLS:OPEN#3,SER1Z:UN=0:PRINT#2,' MICRODRIVE LABEL PRINTER:'
140 PRINT#2\' Put paper in Printer; Enter Name of Cartridge and Details.'
150 PRINT#2\' Works with Epson compatible printers:'
160 PRINT#2\' EL = Maximum length for Elite typeface:'
170 PRINT#2\' or else it will print in Condensed typeface.'
180 REpeat L
190 PRINT#3,CHR$(27);CHR$(64);CHR$(27);CHR$(71);CHR$(27);CHR$(48)
200 RR=0:CLS:INK 5:AT 1,33:PRINT '<EL <MAX'
210 AT 1,0:PRINT 'NAME OF CARTRIDGE: ':INK 7:INPUT:name$
220 IF LEN(name$)>14
230 MAX=20:IF LEN(name$)>19:CLS:PRINT ' TOO LONG! ':PAUSE 50:GO TO 200
240 ELSE :MAX=14 :END IF
250 IF MAX>14:PRINT#3,CHR$(15):ELSE :PRINT#3,CHR$(27);CHR$(77);
260 IF st:CLS#2:st=0
270 PRINT#2,!name$ :SW=1:PRINTIT:LINES 1:SW=0
280 IF LEN(name$)>12:PRINT#3,CHR$(27);CHR$(80);CHR$(15):MAX=18:ELSE :MAX=12
290 AT 2,0:INK 5: PRINT ' INSIDE LABEL: ':INK 7:PRINT name$
300 AT 2,36:INK 5:PRINT'(ENTER New Name if necessary)'
310 INK 7:AT 2,19:INPUT;INFO$:IF INFO$<>'':name$=INFO$
320 IF LEN(name$)>16:AT 2,0:CLS 3:PRINT 'NAME TOO LONG!':PAUSE 50:GO TO 290
330 PRINT#3,CHR$(27);CHR$(50);:LINES 1:UN=1:PRINTIT:UN=0
340 FOR RR=1 TO 3
350 INK 5:AT 2+RR,36:PRINT"<MAX (ENTER to End)"
360 AT 2+RR,7:PRINT 'INFORMATION: ':INK 7:INPUT;INFO$
370 IF RR=1
380 PRINT#3,CHR$(27);CHR$(64);CHR$(15);CHR$(27);CHR$(48);CHR$(27);CHR$(71);
390 name$=INFO$:MAX=18:PRINTIT
400 IF INFO$='

```



```

410   FOR RRR=RR TO 2:PRINTIT:END FOR RRR:LINES 2:EXIT RR
420   END IF
430   ELSE
440   name$=INFO$:PRINTIT
450   IF INFO$=""
460   FOR RRR=RR TO 2:PRINTIT:END FOR RRR:LINES 2:EXIT RR
470   END IF
480   END IF :IF RR=3:LINES 2
490   END FOR RR:END REPEAT L
500   DEFINE PROCEDURE PRINTIT
510   NL=MAX-LEN(name$):FILX=NL/2:FIL2=NL-FILX:IF FIL2<0:FIL2=0
520   IF FILX<0:FILX=0:END IF :IF SW: LINES 1
530   PRINT#3,'!':FILL$(' ',FIL2):IF UN:PRINT#3,CHR$(27);CHR$(45);CHR$(49);
540   PRINT#3,name$;:PRINT#3,CHR$(27);CHR$(45);CHR$(48);
550   PRINT#3,FILL$(' ',FILX);'!':
560   END DEFINE PRINTIT
570   DEFINE PROCEDURE LINES (TY)
580   IF TY=1:PRINT#3,'!':FILL$('=',MAX);'!'
590   IF TY=2:PRINT#3,'!':FILL$('-',MAX);'!'
600   END DEFINE LINES

```

Whoops

In the November issue we published some of the winning entries for the Design a Screen competition. One of the programs, *The Worm*, was chopped in half. Here is the tail end.

```

36 DEFINE PROCEDURE ground
37 FOR n=0 TO 300 STEP 10:LINE n,100 TO n*10-1200,
0:NEXT n
38 FOR n=100 TO 80 STEP -2:LINE 0,n-((100-n)*(100-
n)) TO 350,n-((100-n)*(100-n)):NEXT n
39 END DEFINE
40 DEFINE PROCEDURE sky
41 c=7:FOR n=1 TO 400:INK c:POINT RND((n/2) TO 350
),RND(100 TO 200):c=((c=7)*2)+((c=2)*7)
42 NEXT n:END DEFINE
43 DEFINE PROCEDURE write:CSIZE #0,2,0
44 FOR n=1 TO 8:CURSOR #0,60-n,20-n:INK #0,(n):OUE
R #0,1:PRINT #0,"Dedicated to 'NEW AGE' music":OUE
R #0,0:NEXT n
45 INK #0,4:END DEFINE

```

Whoops

Also in the November issue, program 1 of Starport 2001 became somewhat garbled. Here it is as it should be.

```

10 REMARK
20 REMARK STARPORT 2001
30 REMARK
40 REMARK Written APR 86 By Karl Jeffery
50 REMARK
100 WINDOW#1,512,256,0,0
110 MODE 8
120 prog=RESPR(3000):a5=RESPR(3000)
130 LBYTES mdvl_code,prog:LBYTES mdvl_grap,a5+200
140 POKE a5+55,0:POKE_W a5+14,0
150 PAPER 0:CLS:CSIZE 3,1:OVER 1
160 FOR I=1 TO 7
170 CURSOR I*8+5,I*8+40:INK I
180 PRINT "S T A R   P O R T   2 0 0 1"
190 NEXT I
200 CSIZE 0,0:AT 20,3:INK 5:PAPER 1:OVER 0
205 PRINT "      PRESS ENTER TO START THE GAME      "
210 IF INKEY$<>CHR$(10)THEN GO TO 210
220 CALL prog,a5
230 FOR I=1 TO 100:NEXT I:BEEP
240 GO TO 150

```

INSTANT ACCESS

QL-related hardware, software and service index

HARDWARE

ABC Electronic

010 49 521 8980881

Mouse/Software

Astracom

0792 473697

Modem

Cambridge MicroElectronics Ltd

0223 314814

Q-From Eprom Programmer/Software

Care Electronics

0923 672102

Phillips and other monochrome monitors

Chromagraphics

04012 4699

High-resolution monitors

Commpak Data

0792 473697

Astracom 1000

Computer Supplies

146 Church Road, Boston, Lincs.

Joysticks

Compware

0270 582301

Disc Drives, Memory, Monitors/Software

CST

0438 352150

Thor, Qdisk/IEEE Interfaces, Drives, RAM,

Winchester, Eprom Programmer, Q + 4

Cumana Ltd

0483 503121

Disc Drives/Interface

Data Distributors Ltd

0990 28921

Kaga, Sinclair Vision

Datalink

031 554 6040

Printer Interfaces

D. J. W. Software

11 Pound Close, Bramley, Hampshire,

RG26 5BL

Eidersoft

0708 851099

QL Mouse, Disc Drives/Software

Eprom Services

0532 667183

Tony Firshman Services

01-267 3887

Mains Spike Filter

4 Systems

01-844 1399

Hardware and Software

Kempston Ltd

0234 856633

Disc/Centronics Interface

Management Science Ltd

17 West Hill, London, SW18

QL Case/Software

Micro Peripherals Ltd

0256 473232

Disc Drives/Interfaces

Microworld

0293 545630/0273 6711863

Printers and Monitors

Mirage Systems

0272 603871

Expanderam 512K/Software

Modem House

0392 69295

Opus Supplies Ltd

Redhill 65080

PCML Ltd

0372 67282/68631

QL & RAM cards/Software

QUANTA

The Independent QL users group

* monthly newsletter (36/40 pages)

* free advice

* tutors (Archive etc.)

* massive software library (mostly free)

* supports for local groups

* workshops

* printer hotline

Further details from Brian Pain, 24 Oxford St, Stony Stratford, Milton Keynes, MK11 1JU Tel: (0908) 584271

Penman Products Ltd

0903 209081

Penman plotters

Printerland

0484 514105

Printers/Software

Sandy (U.K.) P.C.P.

0234 219814

QLT, Disc systems, SuperQboard, RAM

boards

Silicon Express

0533 374917

Disc interface/drives, Centronics interface,

RAM boards, Monitors, Printers

Slave Software

050 846 8866

Q Disc/Software

SMC Supplies

01-441 1282

Joystick Adaptor, Centronics and Epson Serial

Strong Computer Systems

0267 231246

Printers and Monitors/Software

T.K. Computerware

0303 812052

Stockist

Tandata

06845 68421

Q-Connect, Q-Mod, Q-Call

Technology Research Ltd

0784 63547

Disc interface with RAM and Centronics port

Transform Ltd

089 283 4783

QL dust cover, Microdrive storage box, RS232

lead, disc drives, monitors and printers

Viglen Computer Supplies

01-8112 9902

SOFTWARE

Adder Publishing Ltd

0223 277050

Utilities

Anglo Services Ltd

0705 671421

Utilities

Ark Distribution

098 379 496

Utilities

Breakthrough Software

0763 45482

Utilities

Bridgebrook Intek

45 Burleigh Avenue, Wallington, Surrey

Utilities

Business Software

01-863 1861

Utilities

Collins Soft

Freeport, 30, London W1E 7JZ

Utilities

Compugem Ltd

01-731 7948

Games

Computer One

0223 862616

Utilities

Consumers Association

Subscription Dept, PO Box 44, Hertford,

SG14 1SH

Utilities

C.P. Software

10 Alexandra Road, Harrogate

Games

D. A. Bando

81 Mount Pleasant, Wembley

Utilities

D. J. Walker

22 Kimptons Mead, Potters Bar, Herts EN6

Utilities

"NEW RIBBONS FOR OLD"

from
ALADDINK

ALADDINK WILL RE-INK YOUR OLD FABRIC RIBBONS
AT GREAT SAVINGS AGAINST NEW PRICES!!

INTRODUCTORY OFFER

Send a dry fabric ribbon cassette (stating printer
make and model) with £2 and we'll re-ink it and
quote you for future re-inkings.

ALADDINK (Dept QL), 4 Hurker Crescent, Eyemouth,
Berwickshire TD14 5AP. Or 'phone for a quotation:
08907 50965

D. S. Enterprises

01-671 0209

Utilities

Data Management

0904 760351

Utilities

DataGen

0989 67469

Utilities

Datalink Systems

097081 360

Utilities & Games

Digital Precision

01-527 5493

Utilities & Games

D.R.K. Products Ltd

Bar 1, Pipers Lane, Markyate, St Albans,

Herts AL3 8QF

Micro Cartridge Rack

D. S. Enterprises

01-671 0209

Utilities

Eigen Software

45 Bancroft Road, Widnes, Cheshire WA8

OLR

Games

Equate

2 Ffordd Derwyn, Penyffordd, Chester CH4

0JT

Utilities and Games

Gemini Marketing

0395 265165

Utilities and Games

G. S. T. Computer Systems

0954 81991

Utilities

Hisoft

0582 696421

Utilities

Intek Software

01-500 8534

Utilities

J. & D. Software

3 Alfred Road, Lowtown, Warrington

Key Software

0703 695182

Games and Utilities

Labochrome

173 Rue De Fragnee B-4000 Liege, Belgium

Games

Maurice Computers

Brookside, South Kilvington, Thrisk, North

Yorks, YO7 2NL

Utilities

McGraw-Hill

0628 23431

Utilities

MetaComCo

0272 428781

Utilities

Microprocessor Engineering Ltd

Hanley Road, Southwater, Horsham, Sussex

Games and Utilities

MicroApl

01-622 0395

Games and Utilities

Microdeal

0726 68020

Games and Utilities

Micr-A-Soft

0204 29643

Games and Utilities

N. Alexander

53 Allen Road, Wolverhampton, West

Midlands

Utilities

OPD/QL FILE INTERCHANGE

Give your QL the capability of reading and
writing files on microdrive cartridges that
are in the format used by the ICL OPD (and
the Merlin TONTO. Transfer XCHANGE and
SuperBasic files between the OPD and QL.

Available for £16 inc. P&P from:

D. J. WALKER, 22 Kimptons Mead,
Potters Bar, Herts EN6 3HZ
or send SAE for full details.

New Horizons Software

Fourwinds, 30 Cwm Lane, Rogerstone,

Gwent

Games

Owl Computer Training

044 282 7302

Utilities

Paddy Software

0726 832718

Utilities

Palantir Products

60 St Lukes Road, Bedminster, Bristol

Utilities

PCS

8 Oakgrove Way, Bridgwater, Somerset

PCS Utilities

Peakcrown Ltd

4 Beeby Road, Scraftoft, Leicestershire LE7

9SG

Games

Peak Electronics

32 Clifton Avenue, Hartlepool, Cleveland

Utilities

Plantir Products

60 St Luke St, Bedminster, Bristol

Utilities

INSTANT ACCESS

Solent Systems

0983 865694

Utilities

Stevenson & Partners

0428 51500

Utilities

Super Plant Software

097 423 223

Utilities

Talent Computer Systems

041 552 2128

Games and Utilities

TDI Software Ltd

0272 742 796

Utilities

TR Computer Systems

093 924 621

Utilities

WD Software

0534 81392

Utilities

ZitaSoft

Steve Jones, 93 Foxbourne Road, London

SW17 8EN

Utilities

QL SMALL TRADERS PACK

Sales/Purchase ledgers, Stock Control, Mailing List, Label Printer, Billboard, Unit Converter, Fone File, Mdv Utility, auto-CLONE—all on ONE BIG-VALUE cartridge plus FREE mini-calc programs.

* Fully menu-driven & Epson compatible.
ONLY £19.95 (inclusive). Add £1 p/p (abroad).
NEW! MICRODRIVE CONTROLLER: 1-key commands, scroll/print DIRs plus much more for £9.95.
Send cheques/PO's or SAE for full details:

SD MICROSYSTEMS (DEPT QL)
P.O. BOX 24, HITCHIN, HERTS, UK

SERVICES

Computer Repair Centre

0379 52588

Data Printing Services

25 Seymour Road, Bath, BA1 6DY

Owl Computer Training

044 282 7302

Quanta

0908 564271

Rainbow Repairs

0904 768853

Zedem Computers Ltd

0234 213032

4RS CORRESPONDENT Club. Catering for new QL users. Confused? Need Help? Send s.a.e. to 4RS Correspondent Club, 45 Elizabeth Road, Basingstoke, Hants RG22 6BA. For non-committal intro letter.

"CUMANA DUAL 3.5" disc drive including interface + 10 double sided 3.5" discs all hardly used. £200 including carriage paid to UK address. Telephone: 0977-42829 evenings.

STOP PLAYING GAMES

Use your computer to make money. Turn your hobby into a home-based income. Full and part time opportunities to cash in on this tremendous market. High earnings easily possible. Open to any amateur micro user and gamer. Write for free details.

Westlink Promotions (CV1)

108 George Street
Edinburgh EH2 4LH (37)

QL POOLSWINNER VERSION 2.0

THE ULTIMATE POOLS PREDICTION PROGRAM
*IMPROVED MASSIVE DATABASE Poolswinner is a sophisticated pools prediction aid and took over 4000 hours to compile. It comes complete with large database with over 35,000 matches since 1985. All English and Scottish team names are included.

*FORECASTS score draws and no score draws with built in perm generator and faster than wester 1.0—mark your coupon direct from screen.
*SUCCESSFUL We guarantee that POOLSWINNER performs considerably better than chance. If you can prove otherwise we shall refund.
*UNIQUE The prediction Formulae calculates the efficiency of every team with present and past results—but no tedious typing. We have yet to see a predictor that uses this method.

ONLY £14.99 on microdrive cartridge
SAME DAY DESPATCH FROM:
XENON, 24 WHARNCLIFFE STREET,
BARNLEY, SOUTH YORKSHIRE S70 8BP

COMPUTER CLEANERS

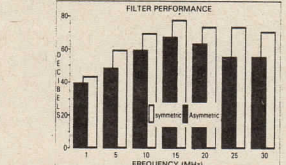
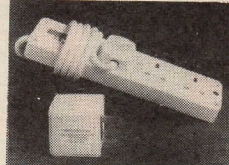

STOP LOCK-UPS AND DATA CORRUPTION

If this is due to mains interference then our plugs may be the answer. As well as cutting high voltage spikes they smooth the cut spikes and filter RF interference from 1 to 30 MHz (better than 40db) and up to 130 MHz.

Some customer comments:

"With the cleaner... (locking up)... is no problem now"—*Electrical engineer.*

"... these computer cleaners work"—*Commodore user group.*

"Many thanks for your help, efficiency and, above all, for producing such an effective device"—*N Daghli, New Zealand*

ADAPTOR—1 three pin socket £14 inclusive

ADAPTOR—2 three pin sockets £18 inclusive

TRAILING 4-WAY SOCKET £24 inclusive

Simply plug in—no wiring required.

TONY FIRSHMAN SERVICES

12 Bouverie Place, London W2 1RB. 01-724 9053

QL VOICE AND SOUND

★ QV200 Speech Synthesiser £59.95 ★

A complete speech synthesis system—plugs into expansion slot. Single board design with amplifier and 5 Watt loudspeaker. Resident software links the unit into QDOS, supports mnemonics. Provides an unlimited vocabulary of highly realistic speech. Applications include Communication, Education, Games, etc.

★ QV400 (as above, but requiring external amplifier) £52.95 ★

★ QS400 Stereo Sound Synthesiser £69.95 ★

A single board design which plugs into the QL expansion slot. Full stereo sound synthesis, under QL control. Features six tone generators, mixers, envelope shapers, noise generators, amplitude control and resident software. Use for music synthesis, complex sound/special effects.

★ QMS400 (Mono version of above) £59.95 ★

★ QSV400 Stereo Sound and Speech Synthesiser £84.95 ★

Both stereo sound and voice synthesis, a single board design.

★ QL Stockmarket Investor Program £19.95 ★

A utility for personal investment analysis and data storage. EPROM Programming available. TRADE/EXPORT enquiries invited. All prices are inclusive in U.K. Overseas please add 5%.

MAURICE COMPUTERS

Brookside, S. Kilvington, Thirsk, N. Yorkshire YO7 2NL.

Tel: (0845) 22918

QL REVISOR

Create your own set of revision files fine-tuned to your own requirements. Group together all the relevant facts and review them regularly without having to plough through the pages of a text book or hastily scribbled notes. Alternatively exams or multiple choice questions can be written and output to screen or printer.

A series of pages is created. Each page can be in any of three formats:

(i) **A block of text**—with the unique 'memorise' capability. The text written can be cleared and restored repeatedly (in single lines, in sections or completely) by a single keypress. Thus helping in the necessary 'parrot-fashion' learning of essential facts.

(ii) **Question and single answer**—useful for foreign language vocabulary testing.

(iii) **Multiple choice questions** (with 1-5 answers)—these can be marked automatically and the results output to a printer if required. The order of answers to each question can be jumbled for every viewing.

Pages can be viewed sequentially or at random. Revisor is a learning/teaching program not just a quiz—each question can have its own explanation which is revealed when requested. Screen layout is completely under your control and all QL text sizes are supported. Quick and easy editing with on-screen instructions at every stage. Files can be saved/loaded to any device, merged with existing files, exported to Quill, and can be linked so that auto-run one after the other.

Menu-driven. 100% multitasking machine code.

Please send payment of **£14.50** (by cheque drawn on a UK bank, by eurocheque or postal order) for immediate despatch.

No additional charge for worldwide overseas air mail.

Send SAE or phone for more details.



DIGITRIX, Wishingtons,

Porkellis, Helston,

Cornwall TR13 0LB.

Tel: (0326) 40529

QL REPAIRS

ANY FAULT £27.95 INCLUSIVE OF P&P, INSURANCE AND 3 MONTHS GUARANTEE. FOR REPAIRS ON OTHER MICROS PHONE FOR DETAILS.

SUREDATA

45 WYCHWOOD AVENUE
CANONS PARK, EDGWARE
MIDD. H&B 6TG

Telephone: 01-951 0124

FRONT PAGE

FOR THE QL
BY
GAP SOFTWARE

DESK-TOP PUBLISHING
FOR THE SINCLAIR QL

HERE IS A SUMMARY OF THE FACILITIES:

- 800 x 800 pixel drawing area.
- Supports all QL text sizes.
- Alternative font.
- Very simple text entry.
- User-defined graphics on 8 x 8 square.
- Freehand graphics.
- Cut and paste.
- Load and save full and part screens.
- Up to 80 lines and 133 columns.
- Load your own screens.
- Supports floppies, ramdisks, etc.

WHEN REPLYING, PLEASE
MENTION QL WORLD

GAP SOFTWARE, 17 ST. JOHN'S TCE, LONDON E7 8BX. 01-552 5452
P&P INCLUDED FOR UK AND EUROPE. ADD £1.00 FOR OUTSIDE EUROPE.

This advertisement
was prepared with
FRONT PAGE

FRONT PAGE

...is supplied as two cartridges and a user manual. It is complete, ready to use. Now it is possible to try desktop publishing for yourself for only

£22.50!

Of course, once you have created your masterpiece, you will want to print it. FRONT PAGE has a built-in routine to print. It allows Epson and Epson-compatible to do a full A4 page. And you can customise it for your own system, as well!

Yes, the QL can now do desktop publishing, and can do it economically!

FRONT PAGE allows you to do something USEFUL with your QL. Design your own artwork, produce your Company newsletter, make up leaflets quickly.

AND DO IT ECONOMICALLY!

FRONT PAGE is:

★★★ FULLY MENU-DRIVEN ★★★

★★★ SIMPLE TO USE ★★★

AND...

"An innovative design package with pagemaker potential. Shows small companies can still make magic." *John Gilbert, 'Sinclair User', Nov. '86 (5 star review).*

REMEMBER WHERE YOU READ IT FIRST—ON FRONT PAGE!

Ideal Presents for all QL Users, and/or Gardeners

Find out what flowers to grow and where to plant them in your garden with our **Archive compatible plant data banks and planners.**

See Review in *Sinclair QL World* October, 1986 p.33 "...It is not surprising that Superplant has had sales from all over the world..."

Choice of 5 gardening modules, each including separate data bank and 7 planning programs at £11.95 each (inc. p. and p.).

'Shrubs, trees and climbers' Planner

'Fruit trees and bushes' Planner

'Plants for the House and Office' Planner

'Wild flowers for the garden' Planner

★ ★ ★ 'Garden Flowers' Planner (new package, just out, with all the facts about your favourite bedding, herbaceous and rockery plants) ★ ★ ★

All 5 gardening modules available together on microdrive, 3.5" or 5.25" disk for £39.

Phone: 097-423 223 or 01-533 0222 (answerphone) for more details/orders or send cheques, P.O.

Access Card Nos. to: Superplant Software, Llangeitho, Tregaron, Dyfed, Wales SY25 6QG.

SHADOW GAMES

Our comprehensive range of top-selling games are available through the post or from selected stockists. At £12.95 each: AREA RADAR CONTROLLER, SPACE PARANOIDS, NIGHT NURSE, BLAST BUGGY, QUAZIMODO. At £14.95, the two-game, action-packed, STAR GUARD and GALACTIC INVADERS. At £14.95, for a limited time only, the incomparable: PAINT MASTER.

New titles will soon be announced. WATCH THIS SPACE! Good programmers are always in demand. Let us publish your game or utility. Write for details.

SHADOW GAMES, 1/2 The Cottages,
Malden Hatch, Tidmarsh, nr Reading,
Berks RG8 8HP

QL KEYDEFINE

Uses ALT as extra shift to re-define all the keys. Up to 2K of text or commands on each key, includes Quill spooler. A must for Quill or Archive or basic users. £9.95

Pscientific Software, 37 Cottesmore Road, Hessele, N. Humberside.
Tel: 0482-649187.

READY
TO RUN
SOFTWARE

MICRODRIVE EXCHANGE

FEATURED PROGRAMS

In return for a small administration charge (per program — including a royalty for the author), we will copy on to blank Microdrives any or all of the featured programs.

Each program will be a direct copy of the published listing, or an extended version of that listing where the program in question was too long to print in full (programs for which an abridged version has been published are marked with an asterisk).

It must be stressed that we are not selling the software, nor providing any guarantee

that it performs any particular function (though we check every program to appear in *Sinclair QL World*). We are offering a service to readers who wish to obtain *Sinclair QL World/QL User* programs on drive rather than by typing them in straight from the page.

HOW TO ORDER

Listed are programs which have appeared as listings in *QL World/QL User* and *Sinclair QL World*.

To the right of each program entry is a small box, which you should mark with a bold cross if you want to order that program.

Once you have put a cross next to all the programs you wish to have copied on to Microdrive, complete the rest of the order form and send it with your PO/cheque AND BLANK FORMATTED DRIVE to:

MICRODRIVE EXCHANGE,
Sinclair QL World,
79-80 Petty France,
London SW1H 9ED.

If you wish us to supply the drive, please add an extra £2.50 for every drive required and mark the order form appropriately.

Please allow 28 days for delivery.

UPDATE

There is now a total of 22 programs on Microdrive Exchange, including arcade games, programming utilities and educational software. The total number of programs has been increasing steadily month by month and will continue to do so.

This month, however, we have decided not to make an addition to the list as all The Progs listings have been kept deliberately short and easy to enter. Watch for the February issue which will contain details of an exciting new software service to run alongside Microdrive Exchange.

ORDER FORM

Author	Language	Program Name	Price	Issue	Size
Giles Todd	(B)	DIY Assembler	£5	Mar/Jun	120 <input type="checkbox"/>
<i>Converts Assembler source into m/c object code</i>					
Richard Cross	(AO)	Mini Monitor	£3	Oct	60 <input type="checkbox"/>
<i>Pocket-sized monitor with comprehensive facilities</i>					
A Didcock	(B)	Connect4	£1	Sept	15 <input type="checkbox"/>
<i>Pit your wits against the QL</i>					
Shergold & Tose	(B)	*Golf	£2	May	35 <input type="checkbox"/>
<i>From fairway to green on 50 courses of varying difficulty</i>					
Williams & Holliday	(AO)	Paladin	£5	Apr	70 <input type="checkbox"/>
<i>The basis of our games programming series — a Space Invaders type-game written entirely in machine code</i>					
Richard Cross	(MB)	Sprite Animation	£2	Apr	50 <input type="checkbox"/>
<i>A subtle blend of machine code and SuperBasic which produces a versatile sprite designer and high-speed animator</i>					
Steve Deary	(B)	Pacman	£1	Mar	20 <input type="checkbox"/>
<i>A reasonably fast rendition of the famous arcade favourite</i>					
Andy Carmichael	(B)	Family Tree	£3	Aug	100 <input type="checkbox"/>
<i>Archive program and database for setting-up and displaying large family trees</i>					
James Lucy	(B)	Composer	£3	Oct	50 <input type="checkbox"/>
<i>Composer and play sheet music on the QL</i>					
Mathew Capp	(B)	Miners	£2	Aug	30 <input type="checkbox"/>
<i>A nail-biting management simulation which puts you in charge of the NCB</i>					
P J Smith	(B)	*DIY Adventure	£1	Feb	60 <input type="checkbox"/>
<i>A skeleton framework where you have to slot in the details to create your bespoke adventure</i>					
R Green	(B)	Othello	£1	Aug	25 <input type="checkbox"/>
<i>A 3D version of the well-known board game Othello for one or two players</i>					
S J Ackers	(S)	*Touch Type	£4	Aug	80 <input type="checkbox"/>
<i>Touch-typing course — 14 lessons, on-screen keyboard, 800+ word vocabulary and WPM readout</i>					
Rob Sherratt	(AO)	FCOPY	£4	Mar'86	80 <input type="checkbox"/>
<i>A machine code Microdrive utility for turbocharged file copying</i>					
Alan Prior	(B)	World Map	£2	Mar'86	80 <input type="checkbox"/>
<i>A high-resolution multi-coloured map of the world for geography buffs</i>					
J M Dower	(B)	Mushyman	£2	Jun/Jul'86	15 <input type="checkbox"/>
<i>Mushroom munching arcade action</i>					

Tony Quinn (S) *CAD QL £4 Sept'86 180
Professional features include rubber banding and user-definable symbol library

Stuart Campbell (MB) Attack of the Things £3 Oct'86 45
Can you repulse the attacking Things?

Karl Jeffery (MB) Starport 2001 £3 Nov'86 40
An authentic version of the arcade game Galaxians

Marcus Jeffery (S) QL Go £4 Apr/May'86 40
A must for strategy games enthusiasts

J P Hartrey (B) Britain £2 Nov'86 20
Improve your geography knowledge with this round Britain quiz

KBG Judson (S) Darts £2 Dec'86 30
The popular pub pastime in pixels

B=SuperBasic, AO=Assembler+Object Code (ready to run), MB=Machine Code+Basic Loader, S=Supercharged

Name

Address

No. of programs ordered Total cost £.....

Total sectors

(max. 200 per drive)

No. of drives sent

No. of drives required @ £2.50 each £.....

Plus postage—packing £.....0.75

Sub total £.....

Add VAT @ 15% £.....

TOTAL TO BE SENT £.....

Please copy on to Microdrive the programs above which I have indicated with a cross. I enclose a cheque/PO to the value of £..... made payable to *Sinclair QL World*. I understand that *Sinclair QL World* undertakes to supply only these programs (copied on to Microdrive) and accepts no liability for their operation as defined by the author. Neither can *Sinclair QL World* supply additional information about any of the listings other than that originally printed. Any article reprints required must be ordered and paid for separately at £1 each inclusive of post and packing (£2 overseas).

QL SPECIALS

microdeal
ELECTRONIC PUBLISHING



THE KING MULTI-SCREEN DONKEY KONG ARCADE GAME

Normal Price £14.95
Mail Order Special Price **Just £7.50**



FLIGHT SIMULATOR THE ONLY SIMULATOR FOR THE QL — 9 DIFFERENT SCENARIOS

Normal Price £19.95
Mail Order Special Price **JUST £14**



CUTHBERT IN SPACE A TRUE ARCADE ZAP-EM-UP FOR ALL THE FAMILY. HELP CUTHBERT LOOT THE MORONIANS PLANET.

Normal Price £14.95
Mail Order Special Price **JUST £7.50**



HOPPER ORIGINAL FROGGER STYLE ARCADE GAME WITH POOR OLD HOPPY TRYING TO CROSS THE MOTORWAY

Normal Price £12.95
Mail Order Special Price **JUST £5**

AQUANAUT 471 GRAPHIC ADVENTURE WITH OVER 100 SCREENS

Normal Price £19.95
Mail Order Special Price **JUST £14**

LANDS OF HAVOC

GRAPHIC ADVENTURE WITH 2000 SCREEN PLAYING AREA. COMES COMPLETE WITH 9 FULL COLOUR MAPS

Normal Price £19.95
Mail Order Special Price **JUST £10**

CRAZY PAINTER

WHISTLE WHILE YOU WORK IN THIS ZANY-CRAZY PAINT THE FLOOR GAME, LOOK OUT FOR DOGS, CRAZY PAINT EATERS, SNAKES, & BUCKETS OF TURPS.

Normal Price £12.95
Mail Order Special Price **JUST £5**

JOYSTICK INTERFACES

Normal Price £4.75

Special Price

JUST £3

(Allows any Atari Commodore Joystick to plug into the QL)



Orders by Post to

microdeal

Box 68, St Austell,
Cornwall PL25 4YB

Orders by Phone
with Credit Card



VISA

AMERICAN EXPRESS



0726 68020

Name _____ Address _____

Post Code _____

Please Supply

Qty	Item	Price

Add 75p P & P per order

P & P 75p

I enclose a cheque for £ _____ Total _____

Please charge my Credit Card type _____ Number _____

The Dark Side of the Moon

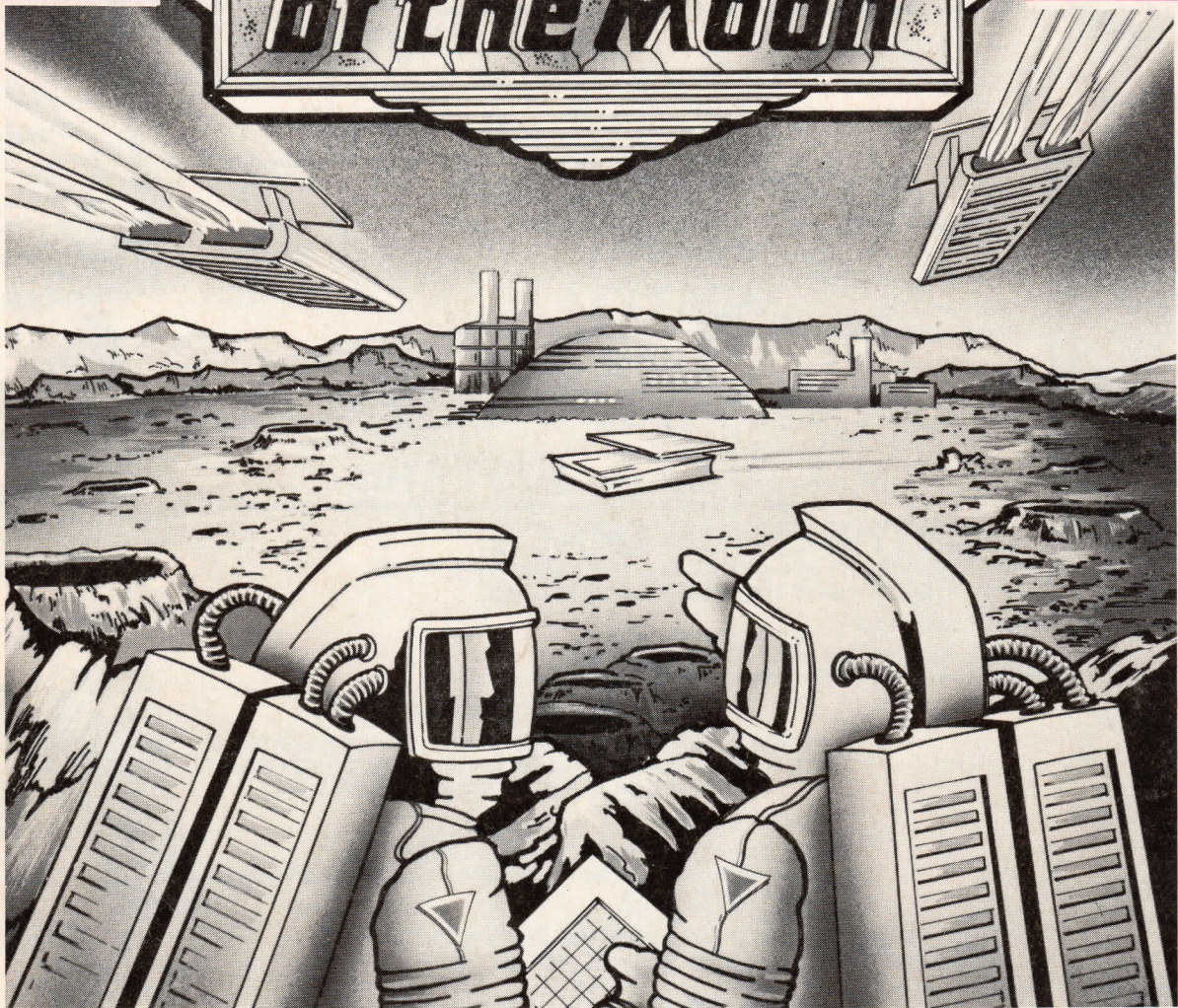

A NEW QL MEGA-TEXT ADVENTURE

During a routine flight to the moon Admiral Cola and Captain Franklin learn that the moonbase and mineral mine have been taken over by hostile aliens. To avoid enemy radar they land their spacecraft some distance from the base and then set off on a dangerous mission to recapture it.

Packed onto two cartridges this big-value mega-text adventure contains over 150 descriptive and imaginative locations and a wide variety of problems, traps, mazes and puzzles with logical solutions.

It includes an extensive vocabulary, over 50 objects and a number of intelligent characters capable of carrying out tasks.

Amazingly all this can be yours for only £16 (including postage and packing). Send your cheque or postal order to the address shown below. Or telephone 041 552 0759 and quote your Access or Barclaycard number.

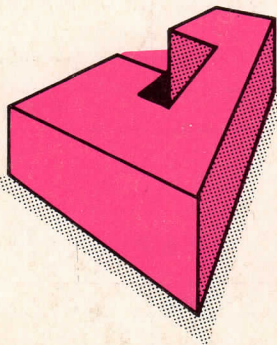

Javid Systems

5 Cheltenham Road
Gloucester GL2 0JE