

SEPTEMBER  
1963

# *Practical* 2/- **WIRELESS**

**VERSATILE  
DOUBLE-TRACE  
OSCILLOSCOPE**

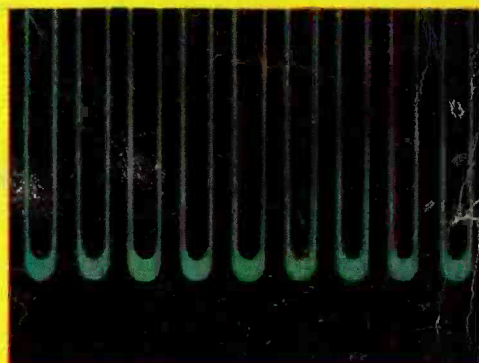
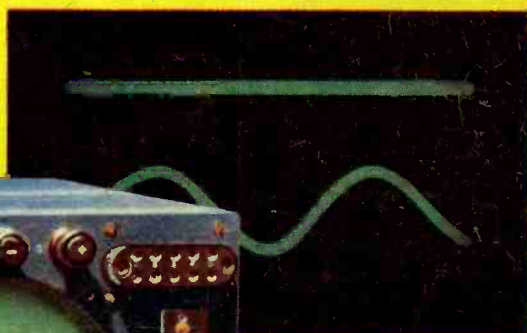
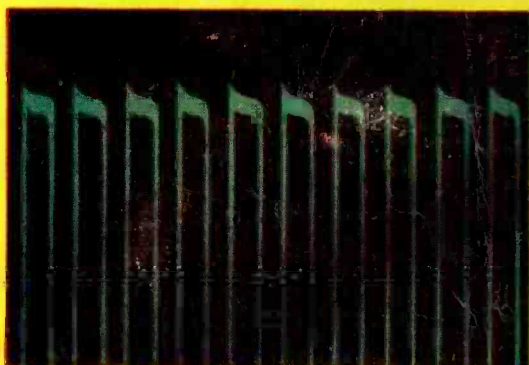

**FOUR-STAGE PROGRESSIVE CONSTRUCTION**



**SOLDERING INSTRUMENTS**

**EQUIPMENT FOR THE RADIO AMATEUR**

**ILLUSTRATED**

- List 64.
- $\frac{3}{16}$ " DETACHABLE BIT
- IN
- PROTECTIVE SHIELD
- List 700

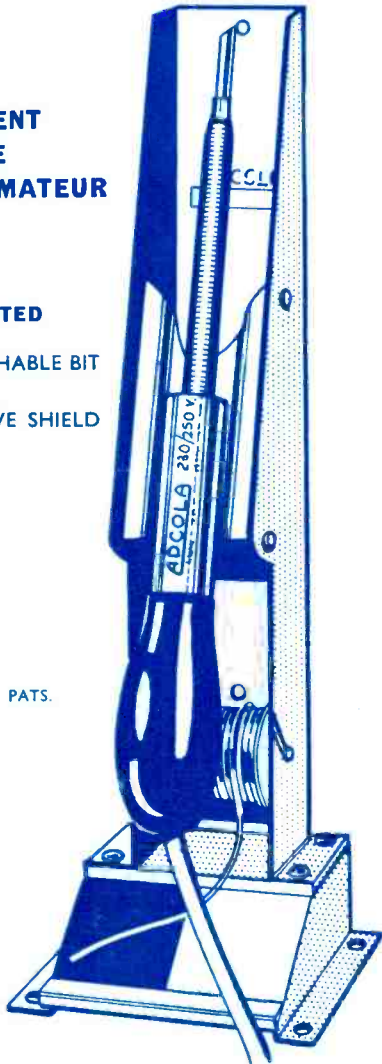

BRIT. & FOR. PATS.

**Sales & Service**

APPLY DIRECT FOR CATALOGUE TO

**ADCOLA PRODUCTS LTD**  
**ADCOLA HOUSE**  
**GAUDEN ROAD, LONDON, S.W.4**

Telephones MACaulay 4272 & 3101      Telegrams SOLJOINT LONDON SW4

**BRAND NEW AM/FM (V.H.F.) RADIOGRAM CHASSIS AT £13.13.0 (Carriage Paid)**

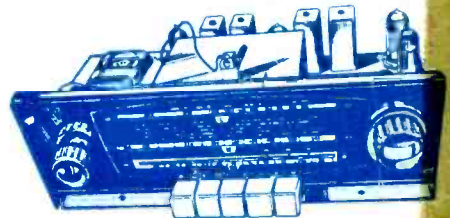

A.C. ONLY. Chassis size 15 x 6½ x 5½in. high. New manufacture. Dial 14½ x 4in. In 2 colours, predominantly gold. Pick-up Ext. Speaker, Ae. E. and Dipole sockets. Five push buttons—OFF, L.W., M.W., F.M. and Gram. Aligned and tested. O.P. Transformer. Tone Control. 1000-1900 M.: 200-500 M.: 88-98 Mc/s. Valves EZ80 rect.; HC181, EP89, EAB30. EL84, ECC85. Negative feed-back circuit. Speaker and Cabinet to fit chassis (table model), 47/6 (post 5/-). 9 x 6in. ELLIPTICAL SPEAKER, 30/-, to purchasers of this chassis. **TERMS:** (Chassis) £3.10.0 down and 5 monthly payments of £2. Cheap Room Dipole for V.H.F., 12/6. Feeder 6d. yd. Circuit diagram 2/6.

**THE "VERONA" SPEAKER CABINET ONLY £5.9.6. (carr. 7/6).**



Beautifully finished in semi-matt medium walnut. 23½in. high x 11½in. x 13½in. Takes 8in. speaker with room below (11½ x 10in.) for amplifier, if desired. (Our 5 W. amplifier price 80/-, post paid, suits). Speakers from 18/6 to £4. **SPECIAL OFFER** of 18/6 Speaker, Cabinet and Amplifier for only 29 carriage paid.

**PUSH-PULL AMPLIFIER £5.5.0 (5/- Carr.)**

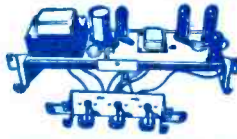

Brand new 200/240 A.C. mains. Base, treble and vol. controls. With valves EZ80, ECC83 and 2-EL84 giving full 8 w. Chassis 12 x 3½ x 3½in. With o.p. transformer for 2-3 ohm speaker. Front panel (normally screwed to chassis) may be removed and used as "flying panel". Stereo version 2 x 4 w., same price. Fixed panel. Tone & Vol. Controls.

**TAPE RECORDER AMPLIFIER**



Type TR3. Fully built, high gain, low noise, printed circuit. Attractive grey and gold front panel 13 x 11½in. Height 5½in. overall. Front to back 5½in. Vol. and on-off tone. Mix. radio and ext. speaker jacks. Valves magic eye, ECC83, ECL82, EZ80. Mains trans. Ready to bolt to B.S.B. Deck. Complete with switch wafers wired. Our Price **ONLY £6.13.0** (5/- Packing and Carr.) Also available for Colliaro Deck at 5/- extra.

**6-TRANSISTOR KITS AND SETS**

All brand new parts. Revine and Vynair Cabinets. Different colours. All holes drilled in printed circuit boards. Full M.W. and L.W. coverage. Car aerial socket. Alignment service, 17/6, inc. return post. A.J. parts supplied separately. Built in 2/3 hours. 500 mW. output. Booklets 2/6, refunded on purchase of kit.

**SUPERHET CIRCUITS THE "SCALA" THE "MILAN"**



"Scala" Kit £4.10.0. (Post 3/-). Size 8½ x 2 x 5½in. high and 3½in. speaker; or fully built £7.10.0.



"Milan" Kit £5.17.6. (Post 2/6). Size 9 x 3½ x 7in., 8 x 2½in. sp. 4000.

100 mF. + 200 mF. ELECTROLYTIC. New 275 v. (350 v. surge). 4in. x 1½in. dia., 5/- each. (Post 1/-). **ALL ITEMS ARE NEW AND FULLY BUILT UNLESS OTHERWISE STATED. TESTED BEFORE DESPATCH.** Terms Available on items over £5. Send 6d. (stamps will do) for 20 page illustrated catalogue. Delivery by return C.O.D. 2/- extra. **ALL ITEMS GUARANTEED 12 MONTHS VALVES 3 MONTHS**

**GLADSTONE RADIO**  
**"SCALA" CAMPRD., FARNBOROUGH, Hants.**  
 Farnborough 3371      FARNBOROUGH CLOSED SATS.

Tubes

Carr. & Ins. 12/6.

Table listing tube types (e.g., MOST MULLARD, MAZDA, COSSOR) with their respective prices in various currencies (£, \$).

HIGHEST QUALITY—COMPARE OUR PRICES

GUARANTEED NEW TYPES

GUARANTEED VALVES

by return of post THE MOST ATTRACTIVE COMPETITIVE VALVE LIST IN THE COUNTRY

All valves are new and unused unless otherwise advised.

Table with 4 columns: POST, 3 MONTHS GUARANTEE, FREE SURVANCE, TRANSIT INSURANCE. Details guarantee terms for valves.

Large table listing various vacuum tube models (e.g., OZ4, 1A7GT, 6X4) and their corresponding prices in various currencies.

SPECIAL TEMPORARY OFFER Due to large Bulk Special Purchase we are offering MW 31-74 Tubes at the unrepriceable price of 29/-...

TRANSISTOR RADIO Zephyr 6 transistor midgeed de luxe superhet (180-560 metres with leather case for only £4.10.0)

100 RESISTORS 6/6 Excellent. Sizes 1-1 watt.

100 CONDENSERS 10/- Miniature Ceramic and Silver Mica Condensers, 3 pF to 5,000 pF. List VALUE OVER £5.

SILICON RECTS. 250V 500mA standard TV replacement. Top quality 8/6 (3 for 24/-)

3 VALVE AMPLIFIERS Kit of new parts, consisting chassis, valves and output transformers, valves (P61, 61G6, 6X51) and all components. With full instructions for making high gain amplifier with separate base and treble controls, negative feedback, etc. Truly unusual value at 29/-

P.M. SPEAKERS. 3Ω Top Makes. 4in. 7/6 6in. 8/6 7 x 4in. 7/6

VALUE! 4 watt AMPLIFIERS excellent amplifier with high gain preamp stage, 10F3 driving 10P14 output stage, complete with 5in. speaker. In attractive 2-tone case. Tone control, negative feedback, ready for immediate use, individually tested. Amazing volume and clarity, ideal for guitars, record player, etc. p.a. in small halls, baby alarms etc. Easily worth £5. Our price whilst stocks last. Carr. Packing, etc. 7/6. 45/-

CO-AX, low loss, 8d. yds., 25 yds., 11/6, 30 yds., 22/-, 100 yds., 42/6. CO-2, Plugs, 1/3. Wall outlet boxes 3/6.

ALL WAVE RADIOS

VERDI 55, MAINS 5 VALVE SUPER-SENSITIVE SUPERHET. Really attractive light quality, modernistic, pastel and gold cabinets. Very compact. Wavebands 18-50m 180-550m, 700-2000m, ferrite aerial and throatout aerial. Smooth slow motion tuning. High flux 4in. speaker. AMAZING S.W. PERFORMANCE. CLARITY. VOLUME. Standard miniature valves, 42 pin sockets, standard layout. Truly unusual value and UNREPEATABLY absolutely complete with guarantee and circuit. Tax paid. 7 Gns.



VERDI 54. As above but medium and long wave only. 6 Gns. each.

BBC/ITA 14in. TVs. With CRM 141 Tubes. Absolutely complete, tested for raster. Famous make, large purchase enables us to offer them at Carr. 12/6. £4.19.0

P.V.C. CONNECTING WIRE 100 yd. 30 null: Special Price 7/6. 200 yd. 30 null: Special Price 12/6. 471. Cont. 1/- 4 Cols different colours. 4/- Connecting flex. Prices as above.

AM/FM RADIOS Fantastic offer. 7 valves plus 2 diodes. Contemporary Cabinet. Top quality and finish. A.F.C. A.Z.C. Absolutely complete. Guaranteed 5 months £11

TRANSISTORS Guaranteed Top Quality Huge reductions. Red Spot standard L.F. type now only 7/6. White Spot R.F. 2/- Mullard Matched Output Kits (OC811 and 2-OC81) 12/6. Receiver Kits. (OC44, OC45, OC) 24/- (OC81(2), six transistors. 24/-

PORTABLE RECORD PLAYERS. Take all sizes Records, all speed, amplifier, auto-changer, Garrard new "Shindig" Gram. In two-tone Case. 13 gns. All absolutely new. PORTABLE RADIOGRAMS. As above with 5 valve superhet radio, 3led, and Long wave. Fantastic value. 17 kns.

AF114 8/- OC26 12/6 OC31 5/- AF115 7/6 OC36 14/- OC31D 5/6 AF113 7/6 OC44 5/6 OC170 8/6 AF117 7/- OC4 5/6 OC171 8/6 AF127 9/6 OC72 5/6 XB104 5/6

TELEPHONE C.O.D. ORDERS DISPATCHED THE SAME DAY.

ENQUIRIES WELCOMED Quantity Prices or Quotes for items not listed, particularly rare values.

Post: 2 lbs. 2/-, 4 lbs. 2/6, 7 lbs. 3/6, 15 lbs. 4/-, etc. (C.O.D. 2/- extra). ALL ITEMS LESS 5% AND POST FREE IN DOZENS. Send 6p. for list of 1,000 snips

RETAIL SHOP 350-352 FRATTON ROAD, PORTSMOUTH DEVONIAN COURT, PARK CRESCENT PLACE, BRIGHTON 7, SUSSEX

TECHNICAL TRADING CO.

**No. 19. 2-8 Mc/s TRANSMITTER RECEIVER**

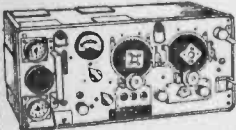

This most famous Army Transmitter Receiver covers 2-8 Mc/s (150-37 metres in two bands). Has an intercom, amplifier. Designed for 12 and 24 volt operation but supplied with "P.W.". Mains conversion details. Uses a 6 valve superhet receiver, I.F. being 465 Kc/s, and a 6 valve transmitter designed for voice and C.W. operation. Incorporates test and tuning meter for voltages, aerial loading and current tests. Panel Controls: Frequency tuning, P.A. tuning, Gain control, MCW CW, R/T switch. Het-tone netting. On-off Quench aerial. AVC LT-HT—Drives tests. Supplied complete with instructions book. **ONLY 75/-.**

**12ft. WHIP AERIAL (U.S.), 10/-.**

**RELDA EXCLUSIVE!!!**

**100,000 O.P.V. MULTI-TESTER**

**MODEL EP.100K.** A handy size high sensitive multi-tester with a shock-proof meter of 9.5µA. Incorporates three germanium diodes and simplified meter scale for easy reading. **RANGES:** D.C. Volts: 0.5V, 2.5V, 10V, 50V, 250V (100,000 ohm/V), 500V, 1,000V (35,000 ohm/V). A.C. Volts: 2.5V, 10V, 50V, 250V, 1,000V (12,500 ohm/V). D.C. Amps: 10µA, 250µA, 2.5mA, 25mA, 250mA. Ohms: 0-20K ohm, 0-200 ohm, 0-2M ohm, 0-20M ohm. Centre—160 ohm, 1.6K ohm, 16K ohm, 160K ohm. L.I.: 18µA, 180µA, 1.8mA, 18mA. L.V. 3V.

Decibels: minimum 20dB—plus 62dB. Size: 5 1/2 in. x 3 1/2 in. x 2 1/2 in.

ORIGINALLY £14.14.0.

**OUR PRICE £6.19.6 COMPLETE**

**50,000 O.P.V. MULTI-TESTER MODEL EP.50K.** Shipped complete. **ONLY £9.19.6.** Leadset available.

**30,000 O.P.V. MULTI-TESTER MODEL EP.30K.** Shipped complete. **ONLY £8.19.6.** Leadset available.

**MODEL TK20A 1,000 O.P.V. ON AC AND DC**



Extremely compact wide range multi-tester. A most useful instrument for hobbyists, experimenters and technicians who require a reliable tester at a budget price. Operation is extremely easy; simply plug leads into desired scale and you are ready to go. **RANGES:** D.C. voltage: 0-15-150-1,000 v. (1,000 o.p.v.). A.C. voltage: 0-15-150-1,000 v. (1,000 o.p.v.). D.C. current: 0-100 mA. Resistance: 0-100K. Size: 3 1/2 x 2 1/2 in. Complete with battery, test leads and instructions, fully guaranteed. 49/6.

**L.20 HIGH QUALITY LEATHER CASE.** For EP.10K, EP.30K and other meters of similar size. Takes care of your meters when they are most likely to get knocked around. Size 6 x 5 1/2 x 1 1/2 in. **ONLY 19/-.**

MAIL ORDERS TO  
(DEPT. P), 32a COPTIC STREET,  
LONDON W.C.1.

**NEW!**

★ BATTERY OPERATED  
★ TRANSISTORISED



**ONLY £5.19.6**

Not a toy—a new electronic invention offered for the first time. No musical knowledge required—can be played immediately. Full range of notes. Ideal for the youngster or for any group looking for a new "electronic" sound. As used by many famous groups all over the world. Show your friends how talented you are without any real effort. Supplied complete with instructions, simple tunes and ready to play. Size approx. 14 1/2 x 4 1/2 in. dia.

**MT.1000 TAPE RECORDER**



The smoothest performing battery model available. Uses 4 transistor plus diode push-pull amplifier with built in speaker stop/record/play back/rewind switch volume control speed control pause switch. Size only 7 1/2 x 6 1/2 x 2 1/2 in. Attractive two-tone case. Complete with mike, earphone, batteries, tape and instruction manual. **ONLY £9.19.6.**

plete with mike, earphone, batteries, tape and instruction manual. **ONLY £9.19.6.**

**INEXPENSIVE HI-FI RADIO JACK**

**GT.50.** Full medium wave coverage. Ideal for all tape recorders, amplifiers etc. No batteries required—just plug in. You will be amazed at the reception this pushes into your equipment. **ONLY 29/-.**

**NEW H402 ULTRA SUB-MINIATURE TRANSISTOR COIL SET.**

Smallest 2 gang variable condenser 1 1/2 in. square x 1 in. deep. 3 L.F.s and Osc. Coil 1/2 in. square x 1 in. high. Ferrite rod with medium wave coil ready wound. All supplied with suggested 4 transistor set circuit and parts list. Matched coils shielded and impregnated. High Q 465 Kc/s. all slug tuned. Tuning dial and knob fits securely on shaft. **ONLY 24/6 complete.**

**AUTOMATIC SOLDERING IRON S.F.I.**

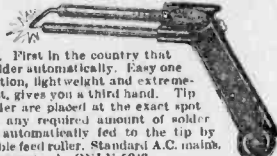

80 watt. First in the country that feeds solder automatically. Easy one hand action, light weight and extremely robust, gives you a third hand. Tip and solder are placed at the exact spot needed, any required amount of solder can be automatically fed to the tip by adjustable feed roller. Standard A.C. mains. Fully guaranteed. **ONLY 52/6.**

**EAGLE DE-LUXE 4 BAND SHORT WAVE COMMUNICATION RECEIVER RX.60.**



4 band power-packed Superheterodyne circuit. Covers Broadcast Band (550-1600 Kc/s) and Short Wave from 1.6-30 Mc/s in 3 bands. Electrical Bandspread. Built-in "R" meter, A.V.C., noise limiter, B.F.O., Phone Jack. Built-in 5 in speaker. Never before such fantastic value in Short Wave receivers, beautifully styled, features a precision electrical Bandspread dial, 0-100 logging scale for easy self calibration. Separate bandspread tuning condenser and calibrated "g" meter for accurate tuning. Sensitive circuit features A.V.C. to minimise blasting and/or fade out. A.N.L. to reduce annoying interference. Send for further details or send £34 for the Buy of your label

**R.F. FIELD INDICATOR RF.40.**



Designed for checking the radiation from a transmitting antenna. The sensitivity can be controlled by adjustment of panel control the antennalength or by increasing distance from the radiator. Freq. range 1-250 Mc/s 200µA D.C. Meter. Complete as illus. with instructions. Price 69/6

**TAPE SPlicer AND CUTTER. Model T.635.**

Cuts 2 rounded indentations in the tape splice leaving the edges of the tape which contact parts of the recorder entirely free of adhesive. As little as 1/2 in. tape need be removed. Complete with instructions. 15/-.



**TELEPHONE PICK-UP COIL**

**PT.100.** Induction Pick-up coil enabling conversations to be picked up without tapping of wires or special telephone circuits. Simply attach to telephone by rubber suction pad and connect lead to the input of any medium gain amplifier or direct to any tape, disc, or wire recorder. Brand new complete with 50ft. shielded cable. *Requires no electrical connections—offers virtually unlimited use.* **ONLY 12/6.**

**A MINIATURE TAPE RECORDER IN KIT FORM ONLY**

**£4.19.6**



Exclusively offered complete with all accessories. No extras to buy. Consisting of three transistor amplifier, record-play volume control, miniature speaker

forward-rewind switch, reel of tape and spare reel, motor, attractive coloured case, 11c, and earphone sockets, pick-up coil mike, earphone and carrying handle supplied. Standard battery operated. Simple to put together in less than one hour. Brand new and guaranteed.

**MULTI-PURPOSE TOOL SET**



Model 7900. Consisting of insulated plastic handle, 5 interchangeable screwdriver bits including Phillips type, one hammer, 5 hexagon sockets (1/2" - 7/16") and extension bar. Complete in Vinyl roll case, 8/6.

**SCREWDRIVER SET**

3264. Consisting of 1 1/2 in., 9/16 in., 7/16 in., 6/16 in. and 3/16 in. drivers and 4 1/2 in. Phillips type and complete with wall bracket. Flame-proof and shock-proof handles. Display bagged. **ONLY 12/6.**

**PORTABLE MAINS SOLDERING IRON S.P.I.**



80 watts. Features removable handle that covers tip and barrel. Complete with lead and plug. **ONLY 14/6.**

CALLERS WELCOME AT  
87 TOTTENHAM COURT ROAD,  
LONDON, W.1. MUS 9606



# THE R.S.C. BASS-MAJOR 30 WATT GUITAR AMPLIFIER

A MULTI-PURPOSE HIGH FIDELITY, HIGH OUTPUT UNIT FOR VOCAL AND INSTRUMENTALIST GROUPS

Eminently suitable for bass guitar and all other musical instruments

- ★ Incorporating two 12in. heavy duty 25-watt high flux (17,000 lines) loudspeakers with 2in. diameter speech coils. Designed for efficiently handling full output of amplifier at frequencies down to 25 c.p.s.
- ★ Dual Cone in second speaker reproduces frequencies up to 17,000 c.p.s.
- ★ Heavily made cabinet of convenient size 24 x 21 x 14in. has an exceptionally attractive covering in two contrasting tones of Vynair.
- ★ For 200-250 v. to 50 c.p.s. A.C. mains operation.
- ★ Four jack socket inputs and two independent vol. controls for simultaneous connection of up to four instrument pick-ups or microphones.
- ★ Separate bass and treble controls providing more than adequate "Boost" or "Cut".
- ★ LEVEL frequency response throughout the audible range.
- ★ SUPERIOR TO UNITS AT TWICE THE COST.

**39<sup>1</sup>/<sub>2</sub> Gns.**

Send S.A.E. for leaflet.  
OR DEPOSIT OF £4.30 and 12 monthly payments of £3.9.11. Carr. 17/6.

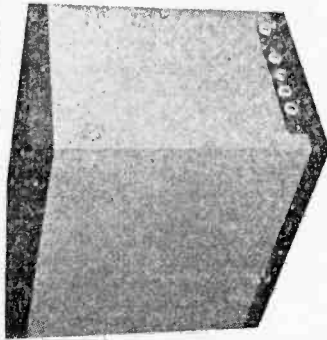

**R.S.C. JUNIOR GUITAR AMPLIFIER**  
5-watt high quality output. Separate bass and treble "cut" and "boost" controls. Sensitivity 15 m.v. Two high impedance inputs. 10in. loudspeaker. Handsome, strongly made cabinet (size 14 x 14 x 7in. approx.) finished in attractive and durable polychrome. 200-250 A.C. mains operation. **£8.19.6** Or DEPOSIT £1 and 9 monthly payments of 1s. Carr. 7/6.

**LINEAR TREMOLO/REAMP. UNIT**  
Designed for introducing the Tremolo effect to any amplifier which is fitted with a reserve power supply point for smoothed H.T. and 6.3 v. A.C. L.T. This applies to practically all amplifiers of our manufacture, and to those of several other manufacturers. The unit plugs into power supply point and any input socket of amplifier. Controls are Speed (frequency of interruptions). Depth (for heavy or light effect). Volume and Switch. Three sockets are for two inputs and Foot Switch. **4 Gns.** ONLY

**DERBY NOW OPEN AT 26 Osmaston Road THE SPOT**

**TRANSISTOR SALE.** Mullard OC71 3/9, OC45 4/11, OC44 4/11, OC72 4/9, OC81 4/11, OC171 3/6, Ediswan XA101 3/9, XB102 3/9, XA112 3/9, XB113 3/9, XB104 3/9, XC101 A 3/9. Postage 6d. for up to 3 Transistors.

**D.C. SUPPLY KIT.** 12 v. 1a. consisting of a partially drilled metal case, mains trans. F.W. Bridge Rectifier, 2 fuseholders and fuses. Change Direction switch, variable Speed regulator and circuit. For 200-250 v. A.C. mains. Suitable for Electric Trains. Limited number available at 29/11.

**SELENIUM RECTIFIERS**  
F.W. BRIDGE 24 v. 2 amp. .. 14/9  
6/12 v. 1 a. .. 3/11 24 v. 20 amp. .. 89/9  
6/12 v. 2 a. .. 6/11 H.T. TYPES H.W.  
6/12 v. 3 a. .. 9/9 150 v. 40 mA. .. 3/9  
6/12 v. 4 a. .. 12/3 250 v. 50 mA. .. 3/11  
6/12 v. 6 a. .. 15/3 250 v. 60 mA. .. 4/11  
6/12 v. 10 a. .. 26/9 250 v. 80 mA. .. 5/11  
6/12 v. 15 a. .. 35/9 250 v. 250 mA. .. 11/9  
**CONTACT COILED.** 250 v. 75 mA. F.W. (Bridge). 10/11. 250 v. 50 mA. F.W. (Bridge). 8/11. H.W. 250 v. 60 mA. 5/11.

**LINEAR TAPE PRE-AMPLIFIER**  
Type LPL. Switched Negative feedback equalisation Positions for Record (1in. 3in., 7in. and Playback. EM84 Recording Level Indicator. Designed primarily as the link between a Collaro Tape Transcriber and a high fidelity amplifier, but suitable for almost any Tape Deck. Only 9 gns. S.A.E. for leaflet.

**HUGE PURCHASE OF IRANIAN NEW 34v. 20 AMP. F.W. (BRIDGE) SELENIUM RECTIFIERS.** each

**49/9**

**R.S.C.** (Manchester) Ltd.  
LEICESTER: 32 High St.  
Half-day Thursday  
BIRMINGHAM: 6 Gt. Western Arcade (Opp Snow Hill Sta) No half-day

MAIL ORDERS to 5 County Arcade, Leeds 1. Terms: C.W.O. or C.O.D. No C.O.D. under £1. Postage 2/9 extra under £2. 4/6 extra under £5. Trade Supplied. S.A.E. with all enquiries please.

SHEFFIELD: 13 Exchange St. Castle Market Bldgs. Sheffield Half-day Thursday  
HULL: 51 Savile St., Hull  
LIVERPOOL: 73 Dale St. Liverpool 2  
BRADFORD: 56 Morley St. (above Alhambra Theatre) Bradford Half-day Wednesday

**R.S.C. SENIOR Guitar Amplifier**  
14 watt high-fidelity push-pull output. Separate bass and treble "cut" and "boost" controls. Twin separately controlled inputs so that two instruments or "mike" and pick-up can be used at the same time. Two loudspeakers are incorporated, a 12in. high flux 14 watt bass unit, and a 6 x 4in. elliptical for treble. Cabinet is well made and finished as Junior Model. Size approx. 18 x 18 x 8in. Only **16 Gns.** Carr. 10/-  
Send S.A.E. for leaflet. Or DEPOSIT 37/- and nine monthly payments of 37/-.

**HEAVY DUTY LOUDSPEAKERS IN SUBSTANTIAL REXINE COVERED CABINETS.** Type BG1. Suitable for Bass Guitar. Speak Unit 15in., High Flux. 15 ohms, 25 watts. Cabinet size approx. 24 x 21 x 13in. Only 19/9 gns. Or Deposit 42/- and 12 monthly payments of 34/9.

Type BG2. Suitable for Bass Guitar. Super Sensitive. 15in. 15 ohms high flux speaker. Cabinet size approx. 30 x 21 x 14in. Attractive covering of two contrasting tones of Rexine and Vynair. Rating 50 watts. Only 29 gns. Or Deposit £3.7.6 and 12 monthly payments of 50/-.

Type BG3/2. Suitable Bass and Lead Guitar. Two 12in. high flux 15 ohm 25 watt speakers, one with aluminium speech coil and dual code to provide smooth frequency response from 25 to 17,000 c.p.s. Cabinet size approx. 30 x 21 x 14in. Covered in two contrasting tones of grey Vynair and Rexine. Rating 50 watts. Only 29 gns. Or Deposit £3.7.6 and 12 monthly payments of 50/-.

**LARGE REXINE COVERED SPEAKER CABINETS.** Heat shock-board construction. Very attractive two tone covering of Rexine and Vynair. Size 30 x 21 x 16in. cut for 15in. or 18in. speaker or for two 12in. 11 gns. or Deposit 25/9 and nine monthly payments 25/9. Size 30 x 30 16in. cut for 15in. or 18in. speaker 15 gns. or Deposit 30/4 and nine monthly payments 30/4. Suitable speakers available.

**FANE EXTRA HEAVY DUTY LOUDSPEAKER 15in. TYPE 153.** 40 watts. Total flux 375,000 lines. Extremely high sensitivity. 15 ohm voice coil. Only 13 gns. or Deposit 35/- and 12 monthly payments 35/-.

**FANE EXTRA HEAVY L/SPEAKER 18in.** 15 ohms, 60 watts. 3in. diam. Speech Coil. Total Flux 375,000 lines. High sensitivity. ONLY 25 gns. or Deposit 52/9 and 12 monthly payments of 43/-. Send S.A.E. for leaflet on 13 and 18s.

## R.S.C. B20 BASS GUITAR AMPLIFIER

A highly efficient unit incorporating a massive 15in. high flux loudspeaker specially constructed to withstand heaviest load conditions. Rating 25 watts. Individual bass and treble controls give ample "boost" and "cut". Two high impedance jack socket inputs are separately controlled. All controls are conveniently positioned in a recess on top of the cabinet. Cabinet is of substantial construction and attractively finished in two contrasting tones of Rexine and Vynair. Size approx. 24 x 21 x 13in. Operation from 200-250 v. 50 c.p.s. A.C. mains.

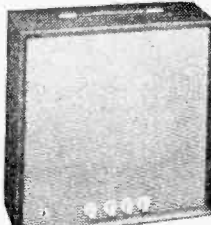

Send S.A.E. for leaflet. Or Deposit £3.2.0 and 12 monthly payments of 56/10. Carr. 17/6.

**29<sup>1</sup>/<sub>2</sub> Gns** Or Deposit £3.2.0 and 12 monthly payments of 56/10. Carr. 17/6.

**EX. GOVERNMENT ACCUMULATORS.** Size 7 1/4 x 4 x 2in. 2 v. 18 A.H. brand new. 6/9 each. 3 for 15/6.

**EX. GOVT. SMOOTHING CHOKES.** 200 mA. 3-5 H. 50 ohms, Parmeko 8/9; 150 mA. 10 H. 50 ohms 9/9; 80 mA. 20 H. 500 ohms 5/9; 120 mA. 12 H. 100 ohms 8/9; 50 mA. 50 H. 1,000 ohms 6/9; 100 mA. 10 H. 100 ohms 6/9; 80 mA. 5-10 H. 250 ohms 2/11.

**COMPLETE POWER PACK KIT, 19/11** Consisting of Mains Trans., Metal Rectifier. Double electrolytic, smoothing choke chassis and circuit. For 200-250 v. A.C. mains. Outputs 250 v., 60 mA. 6.3 v. 2 a.

**R.S.C. POWER PACK, 39/9.** Louvered metal case only 8 x 5 1/2 x 2 1/2ins. Stove enamelled. For 200-250 v. A.C. mains. Output at 4 pin plug and socket 250 v. 60 mA. fully smoothed and 6.3 v. 2 a. Suitable for power requirements of almost any Pre-amp or Radio Tuner.

**R.S.C. BABY ALARM or INTER-COMM. KIT.** Complete set of parts with diagrams, etc. Housed in two polished walnut finished cabinets of pleasing design. High sensitivity. For 200-250 v. A.C. mains. Fully isolated. Controllable at both units. An Intercomm. of this class would normally cost £20-£30. Only 89/6. carr. 5/- or assembled ready for use 6 Gns.

**EX. GOVT. SELENIUM RECTIFIERS 12v 15 AMP (BRIDGE) F.W. ONLY 19/9**

MANCHESTER: 8-10 Brown St. (Market St.) Manchester 2. No half-day  
LEEDS: 5-7 County (Mecca) Arcade Brigatts, Leeds. No Half-day

**R.S.C.** (Manchester) Ltd. MAIL ORDERS to 5 County Arcade, Leeds 1. Terms: C.W.O. or C.O.D. No C.O.D. under £1. Postage 2/9 extra under £2. 4/6 extra under £5. Trade Supplied. S.A.E. with all enquiries please.

<b>LEICESTER:</b> 32 High St. Half-day Thursday	<b>BIRMINGHAM:</b> 6 Gt. Western Arcade (Opp Snow Hill Sta) No half-day	<b>SHEFFIELD:</b> 13 Exchange St. Castle Market Bldgs. Sheffield Half-day Thursday	<b>HULL:</b> 51 Savile St., Hull Half-day Thursday	<b>LIVERPOOL:</b> 73 Dale St. Liverpool 2 Half-day Wednesday	<b>BRADFOUR:</b> 56 Morley St. (above Alhambra Theatre) Bradford Half-day Wednesday	<b>MANCHESTER:</b> 8-13 Brown St. (Market St.) Manchester 2 No half-day	<b>LEEDS:</b> 5-7 County (Mecca) Arcade Briggate, Leeds No Half-day
--	---	---	--	--	--	---	---

### FANE HEAVY DUTY HI-FI SPEAKERS

12in. 15 ohms. Cast chassis. Exceptionally robust 2in. diam. Voice Coil Assemblies. 122/10 20w., 5 gns. 122/10A 20w., 6 gns. 122/12 20w., 6 gns. 122/12A 20w., £7.19.6. 122/14 22w., 9 gns. 122/14A 22w., 10 gns. 122/17 25w., 11 gns. 122/17A 25w., 12 gns. 15in. 15 ohms. Cast chassis. Exceptionally robust 2in. diam. Voice Coil Assemblies. 152/12 20w., 12 gns. 152/12A 20w., 13 gns. 152/14 27w., 14 gns. 152/14A 27w., 15 gns. 152/17 35w., 16 gns. 152/17A 35w., 17 gns. "A" indicates dual cone type, 30-17,000 c.p.s. Send S.A.E. for leaflets. Terms available.

### R.S.C. 30-WATT ULTRA LINEAR

#### HIGH FIDELITY AMPLIFIER A10

A highly sensitive Push-Pull high output unit with self-contained Pre-amp, Tone Control Stages. Certified performance figures compare equally with most expensive amplifiers available. Hum level 70 db down. Frequency response 2-3 db. 30-30,000 c/s. A specially designed sectionally wound ultra linear output transformer is used with 807 output valves. All components are chosen for reliability. Six valves are used, EF85, EF86, ECC83, 807, 6X4, GZ34. Separate Bass and Treble Controls are provided. Minimum input required for full output is only 12 millivolts so that ANY KIND OF MICROPHONE IS PICK-UP IS SUITABLE. The unit is designed for CLUBS, SCHOOLS, THEATRES, DANCE HALLS or OUTDOOR FUNCTIONS, etc. For use with Electronic ORGAN, GUITAR, STRING BASS, etc. For standard or long-playing records. OUTPUT SOCKET PROVIDES L.T. and H.T. for a RADIO FEEDER UNIT. An extra input with associated vol. control is provided so that two separate inputs such as Gram and "Mike" can be mixed. Amplifier operates on 200-250 v. 50 c/s. A.C. Mains and has output for 3 or 16 ohm speakers. Complete Kit of parts with fully punched chassis and point-to-point wiring diagrams and instructions. If required perforated cover with carrying handles can be supplied. The amplifier can be supplied, factory built with EL34 output valves and 12 months guarantee, for 14 gns. Send S.A.E. for leaflet.

### 11 Gns.

Carr. 10/-  
rying handles can be supplied. The amplifier can be supplied, factory built with EL34 output valves and 12 months guarantee, for 14 gns. Send S.A.E. for leaflet.

TERMS: DEPOSIT 33/9 and 9 monthly payments of 33/9.  
Suitable microphones and speakers available at competitive prices.

**WE STOCK ARMSTRONG, DULCI, LINEAR, ROGERS, LEAK and JASON EQUIPMENT GOODMANS W.B. AND FANE SPEAKERS**

GARRARD and GOLDING 7/TABLES

**SUPERHET FEEDER UNIT.** Design of a high quality Radio Tuner (specially suitable for use with our Amplifiers). Delayed A.V./C. Controls are Tuning, W.Ch. and Vol. Only 250 v. 15 mA. H.T. and L.T. of 6.3 v. 1 amp. required from amplifier. Size approx. 9 x 8 x 7in. High Simple alignment procedure. Point-to-point wiring diagrams. Instructions and priced parts list with illustrations, 2/6. Total building cost £4.15.0. S.A.E. for leaflet.

### R.S.C. BATTERY TO MAINS CONVERSION UNITS

Type BM1. An all-dry battery eliminator. Size 5 1/2 x 4 1/2 in. approx. Completely replaces battery supplying 1.4 v. and 90 v. where A.C. mains 200-250 v. 50 c/s is available. Suitable for all battery portable receivers requiring 1.4 and 90 v. This includes low consumption types. Complete kit with diagrams, 39/9, or ready to use, 46/6.

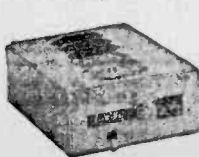

Type BM2. Size 8 x 5 1/2 x 2 1/2 in. Supplies 120 v. 90 v. and 60 v. 40 mA and 2 v. 0.4 a. to 1 amp. fully smoothed. Thereby completely replacing both H.T. batteries and L.T. 2 v. accumulators when connected to A.C. mains supply 200-250 v. 50 c/s. L.T. A14-E

FOR ALL BATTERY RECEIVERS normally using 2 v. accumulators. Complete kit of parts with diagrams and instructions, 49/9, or ready to use, 59/6.



250-250 v. 50 c/s. Output for 2-3 ohm speaker.

In every detail and includes full punched chassis and instructions. Exceptional value at only £4.15.0. or assembled ready for use 25/- extra. Plus 3/6 carr., or deposit 22/6 and 5 monthly payments of 22/6 for assembled unit.

### DERBY

Now open at 28 Osmaston Road THE SPOT

**R.S.C. GRAM AMPLIFIER KIT.** 3 watts output. Negative feedback controls. Vol. Tone and Switch. Mains operation 200-250 v. A.C. Fully isolated chassis. Circuit, etc., supplied. Only 39/9. Carr. 3/9.

**THE SKYFOUR T.R.F. RECEIVER**  
A design of a 3 valve long and medium wave 200-250 v. A.C. Mains receiver with selenium rectifier. High gain H.F. section and low distortion detector. Valve line-up 6X7, 6P6L, 6V6G. Selectivity and quality excellent. Simple to construct. Point-to-point wiring diagrams. Instructions and parts list 1/8. maximum building costs £4.8. 6. and a attractive walnut veneered wood cabinet 12 x 6 1/2 x 5 1/2 in.

**MULTI-METERS.** CABY MI. Sensitivity 2,000 ohms per volt. A.C. and D.C. 54/- .A10. Basic Meter sensitivity 155 micro-amps A.C. and D.C. ranges £4.17.6. H.20. Sensitivity up to 10,000 ohms per volt A.C. and D.C. £6.10.0. 30,000 ohms per volt £8.19.6.

**R.S.C. JUNIOR HI-FI REPRODUCER.** The very latest Goodmans Axlette 8 High Fidelity loudspeaker (retailing at approx. 5 gns.) fitted in a specially designed Bass Reflex cabinet size 12 x 18 x 10 1/2 in. Acoustically lined and ported and finished in polished walnut veneer. Matching impedance 15 ohms. Frequency range 40-15,000 c.p.s. Power handling 8 watts nominal. Ideal for Stereo. Limited number. Carr. 4/6

8 Gns.

### 12in. 10 WATT HIGH QUALITY LOUDSPEAKER

In walnut veneered cabinet. Gauss 12,000 lines. Speech coil 3 ohms of 15 ohms. Only £4.19.6. Carr. 5/-. Terms: Deposit 11/3 and 9 monthly payments of 11/3. 12in. 20 WATT HI-FI LOUDSPEAKERS IN CABINETS. Size 18 x 18 x 10 1/2 in. Finish as above. Terms: Deposit 17/9 and 9 monthly payments of 17/9. Only £7.19.6. Carr. 4/6. For larger types see page 378.

18 x 18 x 10 1/2 in. Finish as above. Terms: Deposit 17/9 and 9 monthly payments of 17/9. Only £7.19.6. Carr. 4/6. For larger types see page 378.

**LINEAR LG34 GRAM AMPLIFIER**  
High quality. Separate Bass and Treble controls. Handsome appearance. 5 gns.

### R.S.C. 4.5 WATT A5 HIGH-GAIN AMPLIFIER

A highly-sensitive 4-valve quality amplifier for the home, small club, etc. Only 50 millivolts input is required for full output so that it is suitable for use with the latest high fidelity pick-up heads, in addition to all other types of pick-ups and practically all "mikes". Separate Bass and Treble Controls are provided. These give full long-playing record reproduction. Hum level is negligible being 71 db. down 15 db. of Negative feedback. H.T. of 300 v. 25 mA and L.T. of 6.3 v. 1.5 a. is available for the supply of a Radio Feeder Unit, or Tape-Deck pre-amplifier. For A.C. mains input of 200-250 v. A.C. Fully isolated chassis with baseplate and Blue Hammer in every detail and includes full punched chassis and instructions. Exceptional value at only £4.15.0. or assembled ready for use 25/- extra. Plus 3/6 carr., or deposit 22/6 and 5 monthly payments of 22/6 for assembled unit.

**R.S.C. BASS REFLEX CABINETS.** JUNIOR MODEL. Specially designed for W.B. H.F.102 speaker, but suitable for any good quality 10in. speaker. Acoustically lined and ported. Polished walnut veneer finish. Size 18 x 12 x 10 1/2 in. Handsome appearance. Ensure superb reproduction for only £3.19.6.

**STANDARD MODEL.** As above but for 12in. speakers. Size 20 x 15 x 13 1/2 in. For ideal or horizontal use. £5.19.6. Suitable legs with brass ferrules. 19/8 per set of 4.

### R.S.C. CORNER CONSOLE CABINETS

Polished walnut veneer finish. Pleasing design. JUNIOR MODEL. Size 20 x 15 x 13 1/2 in. or 8 x 5 1/2 in. or 10 x 6 in. speakers. £2.9.9. STANDARD MODEL. Size 27 x 18 x 12 1/2 in. for 8 or 10in. speakers. £4.11.9. SENIOR MODEL. Size 30 x 20 x 15in. for 12in. Speaker. Suitable Speaker systems below. Only 7 gns.



**AUDIOTRINE HI-FI SPEAKER SYSTEMS.** Consisting of matched 12in. 12,000 line, 15 ohm high quality speaker, cross-over unit (consisting of choke, condenser, etc.) and Tweeter. The smooth response and extended frequency range ensure surprisingly realistic reproduction. Standard 10 watt rating £4.19.9. Carr. 5/-. Or Senior 15 watt, 7 gns. Carr. 7/6.

**AUDIOTRINE EQUIPMENT CABINETS**  
Size 36 x 15 x 18in. Beautiful walnut veneered finish. Elegant contemporary design. Robust construction. Suitable for 10 or 12in. Uncut, removable baseboard. Depth above Only 12in. baseboard 5 1/2 in. Carr. 15/-. Terms: Dep. 20/9, and 9 monthly pymts. 29/9



# AUDIOTRON HI-FI TAPE RECORDER KIT

**REALISM AT INCREDIBLY LOW COST. CAN BE ASSEMBLED IN AN HOUR**  
 Incorporating the latest Collaro Studio Tape Transcriber. The audiotone High Quality Tape Amplifier with negative feedback equalisation for each of 3 speeds. High Flux P.M. Speaker, empty Tape Spool, a Reel of Best Quality Tape and a Handsome Portable carrying Cabinet with latest attractive two-tone polychrome finish, size 14 1/2 x 15 x 8 1/2 in. high and circuit. Total cost if purchased individually approximately £40. Performance equal to units in the £60-£80 class. S.A.E. for leaflets. **TERMS.** Deposit £2.13.9 and 12 monthly payments of 44/-. Cash price if settled in 3 months.

25<sup>1</sup>/<sub>2</sub> Gns. Carr. 17/6.



# HIGH FIDELITY 12-14 WATT AMPLIFIER TYPE A11

**PUSH-PULL ULTRA LINEAR OUTPUT "BUILT-IN" TONE CONTROL PRE-AMP STAGES**

Two input sockets with associated controls allow mixing of "mike" and gram., as in A.10. High sensitivity. Includes 5 valves, ECC83, ECC85, EL84, EL84, E281. High Quality sectionally wound output transformer specially designed for Ultra Linear operation and reliable small condensers of current manufacture. **INDIVIDUAL CONTROLS FOR BASS AND TREBLE** "Lift" and "Cut". Frequency response + 3 db. 30-30,000 c/s. Six negative feedback loops. Hum level 60 db. down. **ONLY 23 millivolts INPUT required for FULL OUTPUT.** Suitable for use with all makes and types of pi-k-ups and microphones. Comparable with the very best designs. For **STANDARD OF LONG PLAYING RECORDS.** For **MUSICAL INSTRUMENTS** such as **VIOLIN, BASS, LEAD OR RHYTHM GUITARS, etc.**

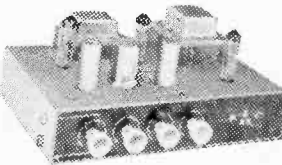

**RADIO FEEDER UNIT.** Size approx 12 x 9 x 7 in. For A.C. mains 200-250v. 50 c.p.s. Output for 3 and 15 ohms speakers. Kit is complete to last nut. Chassis is fully punched. Full instructions and point-to-point wiring diagrams supplied. **Only 8 Gns. Carr.** (Or factory built 51/- extra.)

Will required lower metal cover with 2 carrying handles can be supplied for 18/9. **TERMS ON ASSEMBLED UNITS. DEPOSIT 24/9 and 9 monthly payments of 24/9.** Send S.A.E. for illustrated leaflet detailing Ready-to-assemble Cabinets. Speaker. Microphones, etc., with cash and credit terms.

**B.S.R. MONARDECK TAPE DECKS.** Speed 3 1/2 in. per sec. With high quality recording heads. £6.19.6. Carr. 5/-. Cabinets to take Deck and amplifier 39/6. **BASS AND TREBLE CONTROL 4 IN 1. AMPLIFIER.** Output 1 watt. for 3 ohm speaker. Transistors Mullard OC71, OC81D, OC81, OC81. Fitted Vol. Controls with switch. Assembled and tested. Suitable for any normal crystal pick-up. **Only 59/9.**

# R.S.C. STEREO/TEN HIGH QUALITY AMPLIFIER

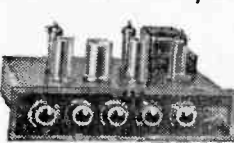

A complete set of parts for the construction of a stereo-phononic amplifier giving 5 watts high quality output on each channel (total 10 watts). Sensitivity is 50 millivolts suitable for all crystal stereo heads. Ganged Bass and Treble Control give equal variation of "lift" and "cut". Provision is made for use as straight (monaural) 10-watt amplifier. Valve line-up ECC83, ECC83, EL84, EL84, E281. Outputs for 2-3 ohm speakers. Point-to-Point wiring diagrams and instructions supplied. Send S.A.E. for leaflet. Full constructional details and price list 2/6. Carr. 10/-. **Kit can be supplied assembled ready to use for 59/6 extra**

Kit can be supplied assembled ready to use for 59/6 extra

# SENSATIONAL STEREO OFFER

A complete set of parts (4 Gns.) to construct a good quality Stereo amplifier with an undistorted output total of 10 watts. For A.C. mains input of 200-250 v. Sensitivity 130 m.v. Ganged Vol. and Tone Controls. Preset balance control. Full instructions and wiring diagrams supplied. Stereo Pick-up Head 18/9 extra with above only.

**SOLDERING IRONS.** 230-250 v. 30 watts. First quality. For Radio work. 18/9. Spare elements and bits available.

**HEAVY DUTY CHARGER KIT** 6/12 v 6 amps, variable output. Consisting of Mains Transformer 0-200-250 v. F.W. (Bridge) Selenium Rectifier; Ammeter. Variable Charge Rate Selector Panels, Plugs, Fuses, Fuseholder and circuit. 59/9. Carr. 4/6.

# R.S.C. BATTERY CHARGING EQUIPMENT

All for A.C. Mains 200-250v., 50 c/s. Guaranteed 12 months.



**Assembled 4-5 amps 6/12 v.**  
 Fitted Ammeter and variable charge rate selector. Also selector plug for 6 v. or 12 v. charging. Louvred steel case with stoved blue hammer finished. Fused and ready for use with mains and output leads. Carr. 5/-. Terms: Deposit 13/3 and 5 monthly payments 13/3 6/12 v. 3a. all facilities as above. **Only 59/9. Carr. 3/9.**

**ASSEMBLED 6/12 v. 2 amps.**  
 Fitted Ammeter and selector plug for 6 v. or 12 v. Louvred metal case finished attractive hammer blue. Fused, ready for use with mains and output leads. Carr. 4/9. 6/12 v. 2 amp. 27/9 Less meter.

**BATTERY CHARGER KITS**  
 Consisting of Mains Transformer, F.W. Bridge, Metal Rectifier, well ventilated steel case, Fuses, Fuse-holders, Grommets, leads, Heavy Duty Clips, circuit. Carr. 3/6 extra  
 6 v. or 12 v. 1 amp. .... 22/9  
 As above, with Ammeter 28/9  
 6 v. or 12 v. 2 amps. .... 19/9  
 6 v. or 12 v. 2 amps. .... 25/9  
 6 v. or 12 v. 2 amps. Inclusive of Ammeter. .... 35/9  
 6 v. or 12 v. 4 amps. .... 45/9  
 6 v. or 12 v. 4 amps. with Ammeter and variable charge rate selector. .... 52/9

# R.S.C. MAINS TRANSFORMERS (FULLY GUARANTEED)

Interleaved and Impregnated. Primaries 300-230-250 v. 50 c/s. Screened TOP SHROUDED DROP THROUGH  
 250-0-250v. 70mA, 6.3v. 2a. 0-5-6.3v. 2a 17/9  
 350-0-350v. 80mA, 6.3v. 2a. 5v. 2a. 19/9  
 250-0-250v. 100mA, 6.3v. 2a. C.T. 1a. ... 21/9  
 250-0-250v. 100mA, 6.3v. 3.5a. C.T. ... 19/9  
 250-0-250v. 100mA, 6.3v. 4a. 0-5-6.3v. 3a 25/9  
 300-0-300v. 130mA, 6.3v. 4a. 6.3v. 1a. 15/9  
 Mullard 510 Amplifier. 29/9  
 300-0-300v. 100mA, 6.3v. 4a. 0-5-6.3v. 3a 26/9  
 300-0-350v. 100mA, 6.3v. 4a. 0-5-6.3v. 3a 26/9  
 350-0-350v. 150mA, 6.3v. 4a. 0-5-6.3v. 3a 29/9  
 425-0-425v. 200mA, 6.3v. 4a. 5v. 3a. 34/9  
**FULLY SHROUDED UPRIGHT**  
 250-0-250v. 60mA, 6.3v. 2a. 0-5-6.3v. 2a. ... 17/11  
 Midget type 2 1/2 x 3 1/2 in. 17/11  
 250-0-250v. 100mA, 6.3v. 4a. 0-5-6.3v. 3a 27/9  
 300-0-300v. 100mA, 6.3v. 4 a. 5v. 3a. 27/11  
 300-0-300v. 130mA, 6.3v. 4a. C.T. 6.3v. ... 27/11  
 1a. for Mullard Amplifier ... 33/9  
 350-0-350v. 100mA, 6.3v. 4a. 5v. 3a. 27/11  
 350-0-350v. 150mA, 6.3v. 4a. 5v. 3a. ... 35/9

**FULLY SHROUDED (continued)**  
 425-0-425v. 200mA, 6.3v. 4a. C.T. 5v. 3a 55/-  
 425-0-425v. 200mA, 6.3v. 4a. C.T. 6.3v. 4a. C.T. 5v. 3a. ... 59/9  
 400-450v. 250mA, 6.3v. 4a. C.T. 5v. 3a 69/9  
**OUTPUT TRANSFORMERS**  
 Midget Battery Pentode 66 : 1 for 354, etc. .... 4/6  
 Small Pentode, 5000Ω to 3Ω ... 4/6  
 Small Pentode 7/8, 0/0/0 to 3Ω ... 4/6  
 Standard Pentode 5,000Ω to 3Ω ... 5/9  
 Standard Pentode 7,000Ω to 3Ω ... 5/9  
 10,000Ω to 3Ω ... 5/9  
 Push-Pull 8 watts, EL84, or 6V6 to 3Ω or matched to 15Ω ... 9/9  
 Push-Pull 10-12 watts to match 6V6 or EL84 to 15Ω ... 19/9  
 Following types for 3 and 15Ω speakers:  
 Push-Pull 10-12 watts 6V6 or EL84 ... 18/9  
 Push-Pull 15-18 watts 6L6, KT66 ... 22/9  
 Push-Pull Mullard 610 Ultra Linear ... 29/9  
 Push-Pull 20 watts, sectionally wound, 6L6, KT66, EL34, etc. ... 49/9

**MIDGET MAINS PRIMARIES** 200-250 v 50 c/s. 250 v. 60 mA, 6.3 v. 2a. ... 11/9  
 250-0-250 v. 60 mA, 6.3 v. 2a. ... 12/11  
 Both above size 2 1/2 x 2 1/2 in.  
**FILAMENT TRANSFORMERS**  
 All with 200-250 v. 50 c/s. primaries 6.3 v. 1.5a. 5/9; 6.3 v. 2a. 7/8; 0-4-6.3 v. 2a. 7/9; 12 v. 1 a. 7/11; 6.3 v. 3 a. 8/11; 6.3 v. 6 a. 12 v. 1.5 a. twice, 17/6.  
**SMOOTHING CHOKES**  
 150 mA, 7-10 H 250 ohms ... 11/9  
 100 mA, 10 H 200 ohms ... 8/9  
 80 mA, 10 H 350 ohms ... 5/9  
 60 mA, 10 H 400 ohms ... 4/11  
**CHARGER TRANSFORMERS**  
 All with 200-250 v. 50 c/s. primaries  
 0-15 v. 11 a. 12/9; 0-15 v. 2a. 14/9; 0-15 v. 3 a. 16/9; 0-15 v. 5 a. 19/9; 0-15 v. 8 a. 24/9; 0-15 v. 8 a. 26/9.  
**AUTO (Step up/Step down) TRANS.**  
 0-110/120-230/250 v. 50-80 watts, 13/9;  
 250 watts, 16/9; 150 watts, 27/9.  
**MICROPHONE TRANSFORMERS**  
 120 : 1 high grade, clamped, 8/9.







POSTAL ENQUIRIES and MAIL ORDERS to Dept. P.W.  
**STERN RADIO LTD.**  
 6-12 TUDOR PLACE, TOTTENHAM COURT ROAD, LONDON, W.1.  
 Tel.: Museum 6125/9

**DEMONSTRATIONS and SHOW ROOMS at STERN RADIO Ltd**  
 109 FLEET STREET LONDON, E.C.4  
 Tel. Fleet St. 5812/3  
 OPEN: 9 a.m. to 6 p.m. SAT. Close 1 p.m.

**PREMIER RADIO**  
 23 Tottenham Court Rd. LONDON, W.1.  
 Tel. Museum 3451/2  
 OPEN: 9 a.m. to 6 p.m. THURS. Close 1 p.m.

**MULLARD DESIGNS**

**MULLARD 2-VALVE PRE-AMPLIFIER TONE CONTROL UNIT**

Employing two EF86 valves and designed to operate with the Mullard AMPLIFIERS but also perfectly suitable for other makes.

- ★ Equalisation for the latest R.I.A.A. characteristics.
  - ★ Input for Crystal Pickups and variable reluctance magnetic types.
  - ★ Input (a) Direct from High Imp. Tape Head. (b) From a Tape Amplifier or Pre-Amplifier.
  - ★ Sensitive Microphone Channel. ★ Wide range BASS and TREBLE Controls.
- KIT OF PARTS £6.60**      **ASSEMBLED AND TESTED £9.10.0** (Carr. & Ins. 5/-).

**MULLARD 3-VALVE PRE-AMPLIFIER TONE CONTROL UNIT**

Designed mainly for Mullard Range of Amplifiers, also suitable for any Amplifiers requiring input up to 250 mV. Incorporates

5 Input Channels, including for Tape and Magnetic Pickups. Separate Bass and Treble controls. High pass filter 20 to 160 c/s. low pass filter 5-9 Kc/s. Totally enclosed in case size 11 1/2" x 4 1/2" x 4".

**KIT OF PARTS £10.00**      **ASSEMBLED AND TESTED £13.13.0** (Carr. & Ins. 5/-).

**MULLARD "5-10" MAIN AMPLIFIER**

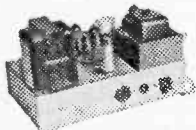

For use with MULLARD 2 or 3 valve pre-amplifier with which an undistorted power output of up to 10 watts is obtained. SPECIFIED COMPONENTS AND MULLARD VALVES including PARMEKO MAIN TRANSFORMER and our choice of PARMEKO or PARTRIDGE Output Transformer. COMPLETE KIT (Parmeko Output trans.)

**KIT OF PARTS £10.00**      **ASSEMBLED & TESTED £13.10.0**

ABOVE INCORPORATING PARTRIDGE OUTPUT TRANS. £1.6.0 extra.

**COMBINED PRICE REDUCTIONS**

- (a) The KIT OF PARTS to build both the "5-10" Main Amplifier and the 2-Valve Pre-amplifier. .... **£15.15.0**
  - (a) The "5-10" and the 2-Valve Pre-amplifier both Assembled and Tested. (Carr. & Ins. 8/6). .... **£21.10.0**
  - (b) KIT OF PARTS to build the "5-10" Main Amplifier and 3-Valve Pre-Amplifier. .... **£19.10.0**
  - (b) The "5-10" and the 3-Valve Pre-amplifier both Assembled and Tested. (Carr. & Ins. 10/-). .... **£25.10.0**
- With PARTRIDGE OUTPUT TRANSFORMER £1.6.0 extra.

**THE MULLARD "33/RC"**  
 A HIGH QUALITY AMPLIFIER DEVELOPED FROM THE VERY POPULAR 3-WATT MULLARD "33" DESIGN.

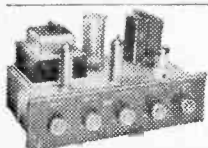

**KIT OF PARTS £8.8.0**  
**ASSEMBLED AND TESTED £11.10.0**  
 Complete to the MULLARD specification including PARMEKO OUTPUT TRANSFORMER. Switched inputs for 78 and L.P. records plus a Radio position. Power to drive a Radio Tuner is also available.

**THE "MONO-GRAM"**

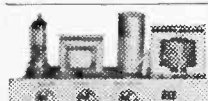

A small Amplifier of genuine high quality performance. Incorporates new MULLARD EC186 Valve, separate BASS and TREBLE controls and produces up to 3 watts undistorted output. (Carr. & Ins. 3/6).  
**Kit of Parts £4.10.0**      **Assembled and Tested £6.0.0**

Perfectly suited for Portable Installations for which purpose we offer PORTABLE CASE £3.10.0, the AMPLIFIER (KIT) and 8 x 5in. SPEAKER (£1.0.0). All for Alternative with ASSEMBLED AMPLIFIER (Carr. & Ins. 10/-).  
 The case quoted above will accommodate some 4-speed Single Record Units. A larger model for autochanger is available for extra 10/-. With this Equipment a COMPLETE PORTABLE RECORD PLAYER CAN BE BUILT for. .... **£14.0.0**



**THE "TUDOR" STEREO AMPLIFIER**

PRICE **£15.0.0** (Pkg. & Carr. 7/6)

A self-contained Shelf-mounting Amplifier designed to provide high quality stereophonic and monophonic reproduction. Each channel provides a rated output of 6 watts and for monophonic operation approx. 12 watts is produced. Separate BASS and TREBLE CONTROLS. The Cabinet is finished in Black Crackle. Size 14 x 8 x 4in. Send for full specification.



WE ARE PLEASED TO ANNOUNCE THAT ALL STERN'S PRODUCTS are NOW AVAILABLE from **CLYNE RADIO LTD.**  
 12 SUPFOLD HOUSE GEORGE STREET, CROYDON Telephone: MUN 3250

**MODEL CR3/S TAPE RECORDER**

MODEL CR3/S incorporates the HF/TR3 Mk. II Tape Amplifier (described below) and the Collaro "Studio" Twin Track 3-speed Deck operating at 1 1/2in., 3 1/2in., and 7 1/2in. speeds. Complete with microphone and 1,200ft. tape.

PRICE **£43.0.0**

COMPLETE KIT **£33.8.0**

(Carr. & Ins. 15/-).



**STEREO TAPE PRE-AMPLIFIER**

Model STP-1. For use with current TRUVOX, BRENNELL or COLLARO "STUDIO" 1/2 and 1/4 track Stereo Decks. Incorporates Ferroxcube Oscillator, 4-speed Equalisation Signal Level Meter and separate Gain Controls. Includes separate Power Unit.

**KIT OF PARTS £22.0.0** (Carr. & Ins. 8/6).

**ASSEMBLED AND TESTED £28.0.0**



**MULLARD TYPE "C" TAPE PREAMPLIFIER**

Suitable for most 1/4-track Mono Tape Decks. Incorporates Ferroxcube Push-Pull Oscillator, Treble Indicator, and 3-speed equalisation. Includes separate Power Unit.

**KIT OF PARTS £14.0.0**

**ASSEMBLED £19.10.0** (Carr. & Ins. 7/6).



**MULLARD TAPE AMPLIFIER (MODEL HF/TR3)**

Based on Mullard's Type "A" design and suitable for most 1/4 track Mono Tape Decks. Incorporates Ferroxcube Treble Indicator, Gison Output Transformer, and 3-speed equalisation. Includes separate Power Unit.

**KIT OF PARTS £13.13.0**

**ASSEMBLED £19.0.0** (Carr. & Ins. 7/6).



**STERN'S "ADD-A-DECK"**

A self contained Unit consisting of Garrard Deck and matched Pre-Amplifier on one chassis Provides full tape recording facilities and replays through Pick-up Sockets of standard Radio Receiver or Amplifier.

PRICE, includes complete **£18.18.0**

(Carr. & Ins. 10/-).



**!! COMBINED PRICE OFFERS !!**

Includes small charge for special testing and PRECISE MATCHING of the ASSEMBLED PRE-AMPLIFIER (or Amplifier) to TAPE DECK.

- STP-1 (KIT) and "STUDIO" Deck ..... £48.0.0
  - STP-1 (KIT) and Brenell Deck ..... 291. 0/0 Assembled .... £275.0.0
  - STP-1 (KIT) and Truvox Deck ..... 251. 0/0 Assembled .... £259.0.0
  - TYPE "C" (KIT) and "STUDIO" Deck. .... £28.10.0 Assembled .... £33.0.0
  - TYPE "C" (KIT) and BRENNELL Deck ..... 243. 0/0 Assembled .... £290.0.0
  - TYPE "C" (Assembled) and WEARITE Deck 270. 0/0 (Inc. Head Lift Transf.)
  - HF/TR3 (KIT) and "STUDIO" Deck ..... £28. 0/0 ..... £38.0.0
  - HF/TR3 (KIT) and BRENNELL Deck ..... 243. 0/0 Assembled .... £50.0.0
  - HF/TR3 Assembled and WEARITE Deck ..... £70. 0/0 (Inc. Head Lift Transf.)
- (Carr. & Ins. on above, 15/-).

**THE MULLARD "510/RC" AMPLIFIER**

The popular complete "5-10" incorporating Control Unit providing up to 10 watts high quality reproduction with an input of 600mV. Specified components and new MULLARD VALVES, includes PARMEKO MAINS TRANSFORMERS and choice of the latest PARMEKO or PARTRIDGE Output Transformers.

COMPLETE KIT **£12.0.0**

ASSEMBLED **£16.0.0**

With PARTRIDGE OUTPUT TRANS. £1.6.0 extra. (Carr. & Ins. 7/6).



# SURBITON PARK RADIO LTD.

FOR POST HASTE—POST FREE SERVICE

## MARTIN RECORDAKITS

### HALF TRACK

B.S.R. TD2 Monardeck. Latest model, 5 1/2 in. spool.....	£9.9.0
Deposit £1.0.0 and 9 monthly.....	£11.1.0
Tape Amplifier for B.S.R. Deck, printed circuit ready wired with EC038, ECL82, EM85 and EZ80. Complete with all plugs, sockets, panels, knobs etc. The whole amplifier mounts on to the deck making a self-contained unit.....	£8.8.0
Deposit £1.0.0 and 8 monthly.....	£11.1.0
Case with 7 x 4 in. speaker, two-tone grey.....	£4.4.0
Complete Kit as above, with Tape and Microphone.....	£22.0.0
Deposit £2.4.0 and 12 monthly.....	£11.16.6
Collaro Studio Deck. Very latest model, 3 speeds, 7 in spools.....	£10.19.6
Deposit £1.2.0 and 8 monthly.....	£11.7.3
Tape Amplifier for Studio Deck, with ready wired printed circuit, control and input panels, mains and output transformers, knobs, plugs, screws etc. EP96, EC038, EM84, EZ81 and 2-EL34, 3 watts output. Magic eye, Radio and Mic. Inputs Ex L/S socket, Tone and Monitor controls. Can be used as amplifier.....	£11.11.0
Deposit £1.4.0 and 12 monthly.....	19/-
Case for above, with 9 x 3 in. speaker, two-tone grey.....	£5.5.0
Complete Kit, with Tape and Microphone.....	£29.0.0
Deposit £2.18.0 and 12 monthly.....	£2.8.2
Building instructions available at 2/6 each kit (refunded if kit bought)	

### JASON F.M. TUNERS

FMT1, complete with 4 EF91 valves.....	£6.18.0
Deposit £1.0.0 and 6 monthly.....	£11.2.6
FMT2, less power, complete with 4 EF90 valves.....	£8.7.6
Deposit £1.0.0 and 8 monthly.....	£11.1.0
FMT3, with power, complete with 4 EF90 and 1 EZ80.....	£10.5.0
Deposit £1.5.0 and 10 monthly.....	£11.0.0
FMT3, Fringe, complete with valves, less power.....	£10.5.0
Deposit £1.6.0 and 10 monthly.....	£11.0.0
FMT3, with power, complete with all valves.....	£12.0.0
Deposit £1.4.0 and 12 monthly.....	19/10
JTV/2, switched F.M. and TV sound, self powered, all valves.....	£14.17.6
Deposit £1.12.0 and 12 monthly.....	£11.4.5
Mercury 2, as JTV/2 but less power, all valves.....	£10.12.6
Deposit £1.3.6 and 12 monthly.....	17/5
Instruction book is included in all kits, but otherwise 2/6 and 3/6.	

### AMPLIFIERS (MONO)

Linear L45 3 watt, 3 valve.....	£5.19.6
Linear Dionico, 12 watt, suitable Mic. or Guitar.....	£12.12.0
Deposit £1.7.0 and 12 monthly.....	£11.0.9
Linear Concord, 30 watt, ideal Guitar amp., with case.....	£18.0.0
Deposit £1.16.0 and 12 monthly.....	£19.1.0
Dulci GA5, integrated amp. and P.A., 5 watt, ECL86 valve.....	£13.8.2
Deposit £1.8.8 and 12 monthly.....	£11.1.6
Dulci DPA15, 16 watt with 2 valve pre-amp.....	£25.4.0
Deposit £2.10.8 and 12 monthly.....	£21.1.11
Tripletone Hi-Fi Major with pre-amp. Guitar or Mic.....	£15.18.9
Deposit £1.15.3 and 12 monthly.....	£11.6.1
Leak TL12, 10 watt Main amp. only.....	£18.18.0
Deposit £2.0.8 and 12 monthly.....	£11.1.11
Leak Variatone III pre-amplifier.....	£15.15.0
Deposit £1.11.8 and 12 monthly.....	£11.6.1
Quad, 15 watt Main amplifier only.....	£22.10.0
Deposit £2.5.0 and 12 monthly.....	£11.17.4
Quad pre-amplifier Mono.....	£19.10.0
Deposit £1.19.0 and 12 monthly.....	£11.12.4

### AMPLIFIERS (STEREO)

Dulci AC202, integrated.....	£12.12.0
Deposit £1.7.0 and 12 monthly.....	£11.0.8
Dulci GA205, integrated.....	£18.18.0
Deposit £2.0.8 and 12 monthly.....	£11.1.11
Bogers Cadeo Mk. 2 with 4 amplifier, 4 ECL86 valves.....	£28.15.0
Deposit £2.13.6 and 12 monthly.....	£2.4.5
Leak Stereo 20, Main amplifier.....	£30.9.0
Deposit £3.4.6 and 12 monthly.....	£2.10.3
Leak Variatone III, stereo pre-amplifier.....	£25.0.0
Deposit £2.10.0 and 12 monthly.....	£2.1.6
Quad 22 Stereo Control Unit.....	£25.0.0
Deposit £2.10.0 and 12 monthly.....	£2.1.6
For Quad Main Amplifiers see Mono section above.	

### LOUDSPEAKERS

Goodmans Axiote 8.....	£5.5.7
Goodmans Axiom 10.....	£6.5.11
Goodmans 5K/20/XL.....	£7.0.0
Wharfedale Super 8/RS/DD.....	£6.14.2
W.B. HF1012 10in.....	£4.7.6
R.T.C. 12in. Unit, 15 watt.....	£5.5.0
R.T.C. Hi-Fi Master.....	£8.8.0
Goodmans XO 5000 cross-over.....	£1.19.0

### QUARTER TRACK

B.S.R. TD2, Marriot heads, L series.....	£11.11.0
Deposit £1.4.0 and 12 monthly.....	19/-
Tape Amplifier, as opposite, but quarter track.....	£9.9.0
Deposit £1.0.0 and 9 monthly.....	£11.1.0
Case, two-tone grey, with speaker.....	£4.4.0
Complete Kit, with tape and microphone.....	£28.0.0
Deposit £2.10.0 and 12 monthly.....	£2.1.6
Collaro Studio Deck, Marriot X series heads.....	£17.17.0
Deposit £1.7.0 and 12 monthly.....	£11.9.4
Tape Amplifier as over but quarter track.....	£12.12.0
Deposit £1.7.0 and 12 monthly.....	£11.0.8
Case, with speaker, two-tone grey.....	£5.5.0
Complete Kit, with tape and microphone.....	£35.0.0
Deposit £3.10.0 and 12 monthly.....	£2.19.2
Tape Pre-amplifier for Collaro Studio Deck, with power supplies, EC038, ECL82, EZ80 and EM85. Radio and Mic sockets, gives an equalized output of 400mV.....	£8.8.0
Half Track.....	£11.0
Deposit £1.0.0 and 8 monthly.....	£9.9.0
Quarter Track.....	£11.0
Deposit £1.0.0 and 9 monthly.....	£11.1.0
TAPE HEADS	
M.S.S. Quarter track, Record/Playback and Erase Set.....	£33.0.0
Bradmatic High track 3 speed Playback head only.....	£1.12.6
Bradmatic Half track Record/Playback and Erase Studio Set.....	£119.6.0
Collaro pressure pad for third head position.....	4/-
Brenell Mk. 5 Series 2 4-speed deck half track.....	£32.11.0
Deposit £3.5.0 and 12 monthly.....	£2.14.0
Brenell Mk. 6 Tape Amplifier with power pack.....	£26.0.0
Deposit £2.12.0 and 12 monthly.....	£2.3.2

### RADIO TUNERS

Armstrong T4C V.H.F. Tuner, self powered.....	£17.19.0
Deposit £1.19.6 and 12 monthly.....	£11.9.5
Armstrong S78 Mk. 2 A.M./F.M. Tuner, self powered.....	£25.12.0
Deposit £2.13.0 and 12 monthly.....	£2.2.4
Armstrong AF208 A.M./F.M. Radio chassis, base and treble control, P.U. inputs etc.....	£21.4.0
Deposit £2.6.0 and 12 monthly.....	£11.14.0
Armstrong Jubilee Mk. 2 A.M./F.M. push-pull output stage.....	£28.5.0
Deposit £2.16.8 and 12 monthly.....	£2.6.11
Armstrong Stereo 55 A.M./F.M. Radio chassis, with stereo gram.....	£29.18.0
Deposit £3.2.6 and 12 monthly.....	£2.9.5
Armstrong Stereo 12 Mk. 2 A.M./F.M. Radio chassis, stereo gram and push-pull output stages.....	£40.5.0
Deposit £4.0.8 and 12 monthly.....	£3.6.11
Brass enclosure available for AF208 and Jubilee Mk. 2.....	7/6

### GRAMOPHONE UNITS

Garrard SRP10 with GC8 cartridge, Mono, single player.....	£59.11
B.S.R. UA14 with TC8 cartridge, Mono, 4-speed changer.....	£6.19.8
Deposit £1.0.0 and 6 monthly.....	£1.3.3
Garrard Autoslim, Mono GC8 cartridge, 4-speed changer.....	£6.19.8
Deposit £1.0.0 and 6 monthly.....	£1.3.3
Garrard AT6 Autoslim de Luxe, GC8 Mono cartridge.....	£11.9.0
Deposit £1.8.6 and 6 monthly.....	£1.4.9
Philips AG1018, Stereo, will change 7 in. records.....	£12.12.0
Deposit £1.7.0 and 12 monthly.....	£1.0.8
Decca Deram Arm and Plug-in Shell.....	£5.5.0
Decca Deram Transcription Cartridge.....	£4.14.8
Decca Deram Auto Cartridge.....	£5.13.8
Goldring GL58 with arm, less cartridge.....	£15.19.8
Deposit £1.12.0 and 12 monthly.....	£1.6.6
Goldring "88" Transcription, no arm.....	£17.14.0
Deposit £1.19.0 and 12 monthly.....	£1.9.0
Goldring GL55K, as GL58 but less pick-up arm.....	£13.1.7
Deposit £1.8.6 and 12 monthly.....	£1.1.6
Garrard 4E1/2 with Mono GC8 cartridge.....	£17.0.0
Deposit £1.14.0 and 12 monthly.....	£1.3.2
Garrard Lab Type "A" Transcription auto-changer, Mono GC8.....	£19.14.9
Deposit £1.19.6 and 12 monthly.....	£1.12.9
Garrard 301.....	£20.12.2
Deposit £2.3.2 and 12 monthly.....	£1.14.0
Garrard 301 Strobe.....	£22.0.0
Deposit £2.4.0 and 12 monthly.....	£1.16.6

48 SURBITON ROAD, KINGSTON UPON THAMES, SURREY

Established over 30 years

Telephone KIN 5549

We pay all postage and insurance. All orders despatched same day. Money refund guarantee.  
Hours: 9 a.m.—6 p.m. (1 p.m. Wednesday). We do not close for lunch. Open all day Saturday.

# New 10th Edition Newnes Great Profit Maker!

# Radio & TV Servicing

DATA FOR MODELS RIGHT BACK TO 1956

This latest 10th Edition provides all the technical information you need for quicker repair work now and for years ahead! It gives you full servicing data and specialist repair methods for the popular models marketed by 70 principal makers and companies—current models back to 1956. It is essential to the shrewd repair man because people are keeping their sets longer. If you have never before examined this famous reference work now is your opportunity. See the latest edition for a week on free examination without obligation to buy.

COMPLETE IN  
6 VOLUMES

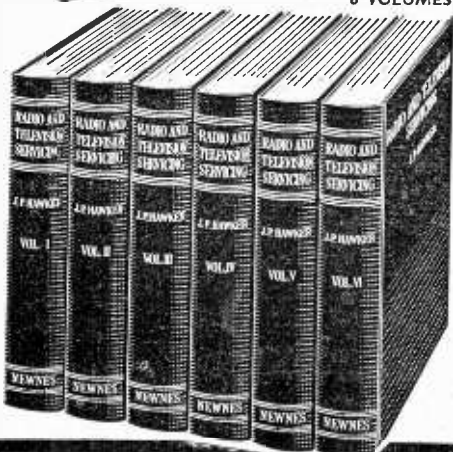

**TELEVISION · RADIO · RADIOGRAMS · CAR RADIOS  
TAPE RECORDERS · RECORD REPRODUCERS**

DATA FOR ALL THESE MAKES—Alba, Ambassador, Argosy, Armstrong, Baird, Beethoven, Berec, Brayhead, B.R.C., B.S.R., Bush, Capitol, Champion, Channel, Collaro, Cossor, Cyldon, Dansette, Decca, Defiant, Dynatron, E.A.R., Eddystone, Ekco, Elizabethan, Emerson, E.M.I., Emisonic, English Electric, Ever Ready, Ferguson, Ferranti, Fidelity, Ford Motor Co., Garrard, G.E.C., Gramdeck, Grundig, H.M.V., Invicta, K-B, McCarthy, McMichael, Marconiphone, Masteradio, Motorola, Murphy, Pageant, Pam, Perdio, Peto Scott, Philco, Philips, Pilot, Portadyne, Portogram, Pye, Radiomobile, Raymond, Regentone, R.G.D., Roberts' Radio, Sobell, Sony, Sound, Spencer-West, Stella, Stereosound, Strad, Ultra, Vidor, Walter, Webcor. Includes 50 page supplementary section of older models

**PLUS 2 YEARS' FREE POSTAL ADVISORY SERVICE**

## More than 4,000 Circuits and Component Layout Diagrams · 2,250 Popular Models

Use it **FREE** for 7 days  
to prove its value



Every purchaser receives a Free copy of  
**TV ENGINEERS POCKET BOOK**  
(Value 12/6d)

272 PAGES : OVER 200  
PRACTICAL ILLUSTRATIONS

Concise information on installing,  
fault-tracing and repairing, servicing  
equipment, alignment, etc.

An invaluable companion to  
your set for on-the-spot repairs

Hurry - Post Coupon To-day

George Newnes Ltd., 15-17 Long Acre, London, W.C.2.  
Send me Newnes RADIO AND TELEVISION SERVICING (in 6 volumes) and TV ENGINEERS POCKET BOOK without obligation to purchase. I will return them in 8 days or send 15/- deposit 8 days after delivery, then twenty monthly subscriptions of 15/-, paying £15/15/- in all. Cash price in 8 days is £15.

If you are under 21 your father must complete this form. If married woman your husband must complete.

Full name \_\_\_\_\_ { Mr.  
(BLOCK LETTERS) \_\_\_\_\_ Mrs.  
Address \_\_\_\_\_ Miss

\_\_\_\_\_  
Occupation \_\_\_\_\_  
Signature \_\_\_\_\_

Tick ✓ where applicable  
The address on left is—

My Property	<input type="checkbox"/>
Rented unfurnished	<input type="checkbox"/>
Parents' Home	<input type="checkbox"/>
Furnished Accom.	<input type="checkbox"/>
Temporary Address	<input type="checkbox"/>

(RV)533/68

# CLYNE RADIO LTD.



18 TOTTENHAM COURT ROAD, W.1  
162 HOLLOWAY ROAD, LONDON N.7  
9 CAMBERWELL CHURCH STREET, S.E.5  
12 SUFFOLK HOUSE, GEORGE ST., CROYDON MUN 2875  
10 WITHY GROVE, MANCHESTER, 4

All post orders, etc., to 162 HOLLOWAY ROAD, LONDON, N.7

## THE COMPONENT SPECIALISTS

MUSEUM 5929/0095  
NORTH 6295/617  
RODNEY 2875  
MUN 2875  
Blackfriars 5379

### The "AIR KING"

Our new highly successful Six transistor luxury portable with the "SLIM LINE" look. To build yourself, with printed circuit chassis for reliability and simplicity in construction. May be used as Car Radio, with full MEDIUM wave and LONG wave coverage.

Look at these features!

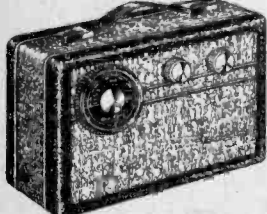

- ★ 500 milliwatt output to high flux 7 x 3 1/2 in. high fidelity loudspeaker.
- ★ Six selected Mullard Transistors in latest super sensitive circuit, plus germanium diode. ★ Compact size—only 9 1/2 x 3 1/2 x 1 1/2 in.
- ★ Attractive three-tone cabinet. Black, Dark Grey, and Silver Grey, with gilt control knobs and all gilt fittings.
- ★ Coax socket for car aerial. ★ Brand new guaranteed components. ★ Push pull output. ★ Automatic volume control. ★ Long life battery. ★ Super sensitive internal ferrite rod aerial. ★ Nothing more to buy. Cabinet included.

Special inclusive price for **£7.19.6**  
Plus P. & P. 4/-

Alignment service available. Full assembly details and individually priced parts list, all of which are available separately, price 1/8 post free.

### The "HIGHWAYMAN"

At last a quality Car Radio to build yourself, at an economical price. Look at these features:—

- ★ Attractive styling. ★ Push-pull output. ★ 3 latest Mullard transistors plus valves type 6BF8 and 6CH8.
- ★ No Buzz. High Output and sensitivity. ★ Printed circuit (newest type). 7" x 4" High flux p.m. speaker.
- ★ Medium and Long Waves. ★ Push buttons for fine tuning control. ★ Extremely low Battery consumption (less than 1 amp.) ★ Easy to fit any make car (Positive earth only). ★ 12 volt operation. ★ Compact size measures only 7" x 4" x 2" deep. ★ Easy Assembly. Supplied with dial and drive already mounted.



All parts available separately but if purchased at one time, the whole will be supplied at a special inclusive price of only **£10.19.6**  
Plus 4/- P. & P.  
Parts list and comprehensive instruction booklet 2/6, post free. (Deduct from cost if complete parcel purchased later.)

## NEW BRANCH CROYDON

NOW OPEN AT  
12 SUFFOLK HOUSE, GEORGE ST.

Municipal 3250  
(One minute from East Croydon Station)  
OPEN ALL DAY SATURDAY



### MODEL TK.20A

Size 3 1/2" x 2 1/2" x 1 1/2". Meter size 2 1/2" x 1 1/2". Sensitivity 1000 o.p.v. on both A.C. and D.C. volts. 0/15, 0/150, 0/1000 volts. D.C. Current. 0/150 mA. Resistance. 0/100K. Complete with test prods, battery and full instructions. OUTSTANDING VALUE at

**42/-** Plus 1/6 P. & P.

### MODEL TK.50

Size 5" x 3 1/2" x 1 1/2" 1000 ohms per volt AC/DC. DC Current 1-250 mA. DC and AC volts. 10, 250-500 and 1000 V. Resistance 0-10K. 0-100K. Complete with test prods, battery and full instructions. Outstanding buy at

**57/6** Plus 2/6 P. & P.



### The SINCLAIR SLIMLINE

A new miniature 2 TRANSISTOR printed circuit pocket radio. Completely portable and the smallest of them all—only 2 1/2" x 1 1/2" x 1". Uses latest Micro Alloy Transistors and built in ferrite aerial will receive all stations on Medium Wave—B.B.C., 208, etc. Easy to assemble—no alignment problems. All required components, including earpiece

ONLY **49/6** P. & P. 1/6.

All parts sold separately.

### AN ALL BRITISH PRECISION TEST METER

(To build yourself)



Designed for Test bench and produced for us by one of Britain's leading technical training organisations this instrument covers the following nineteen basic ranges: D.C. Voltage 0-2.5, 0-10, 0-50, 0-100, 0-500, 0-1000. (All ranges 5000 ohms per volt). A.C. Voltage 0-10, 0-50, 0-100, 0-500, 0-1000. (All ranges 5000 ohms per volt). D.C. current 0-200 microamps. 0-10 mA., 0-100 mA., 0-250 mA.,

0-500 mA. A.C. current, 0-200 microamps. Resistance, 0-200,000 ohms. (Easily extendible to 2 megohms.) Accuracy, 3% of F.S.D. on D.C. ranges, 4 1/2% on A.C. ranges, any frequency between 15-20,000 C.P.S. (50 Hz wave) 2% on resistance range. Positive Range selection by means of plug and socket. Easily constructed, full instructions being given with each assembly. All necessary components offered at the **ABSURDLY LOW PRICE** of 59/6 P. & P. 2/6. Strictly limited quantity!!

### TAPE RECORDER CONSTRUCTORS

**LATEST COLLARO STUDIO TAPE TRACK REPIPER.** Latest type incorporating Record, Interlock, Level, Button, 3 motors 3 speeds, 1, 3, 7 1/2 l.p.s., Takes 7 in. spools. Push-button controls. **NEW LOW PRICE. OF £10.10 ONLY!** plus 7/6 P. & P. Usual H.P. facilities.

**NEW TAPE RECORDER AMPLIFIER TYPE 831-V.** Sub-assembled—anyone can build! Printed Circuit, all components mounted and dip soldered. Already tested. Each

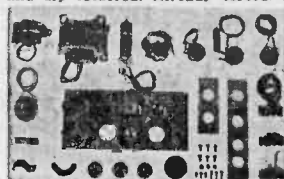

lead out to length. All that is required to complete the tape recorder is for a few components to be mounted in the cabinet and the free ends of the leads soldered to terminals which are clearly marked, everything supplied, all you need is solder iron, pliers and screwdriver. Valve line-up: EF88, ECC83, 2 x EL34, EZ81 and EM84 magic eye. Monitoring facilities, output socket for feeding to high quality amplifier can be used as "straight" amplifier for record reproduction. **EQUALISING ON TWO SPEEDS. OUTSTANDING VALUE AT £11.11.0 plus 2/6 P. & P.** including all necessary instructions.

**ATTRACTIVE TWO-TONE PORTABLE CARRYING CASE** for record reproduction. **EQUALISING ON TWO SPEEDS. OUTSTANDING VALUE AT £11.11.0 plus 2/6 P. & P.** including all necessary instructions. **ATTRACTIVE TWO-TONE PORTABLE CARRYING CASE** for record reproduction. Fitted with 9 in. x 6 in. High Flux P.M. speaker for high quality reproduction. Inclusive price **£5.5.0 plus 5/- P. & P.** Full list of competitive prices (and stands on request). The above 3 items purchased at one time, **SUPPLIED CARR. PAID.**

**NOW AVAILABLE! FOUR TRACK STUDIO DECK AS ABOVE. FITTED WITH HIGH-FI FOUR-TRACK HEADS. PRICE £13.19.6 plus 7/6 P. & P.** Four track heads supplied separately, complete with mounting bracket for Studio Deck at 92/6 pair, plus 2/6 P. & P.

**TAPE RECORDER AMPLIFIER 831-4V.** Exactly as 831-V but four track. Suitable for the above 4-track heads. **PRICE £12.12.0 plus 2/6 P. & P.**

**PRE-AMPLIFIER KIT TYPE 831Z-CI.** Complete high quality pre-amplifier kit for use with Collaro Studio Deck. **Price £8.8.0 plus 2/6 P. & P.**

**N.B.** Four-track deck and amplifier fit the above case without any modification whatsoever.

**TELEPHONE PICK-UP COIL.** Designed to feed into the microphone input of either a tape recorder or any high gain amplifier. Easily attached to telephone by rubber suction attachment. The coil is electrostatically shielded to minimise hum pick-up. When connected to telephone this model is more than adequate for a fully modulated tape recording. Brand new complete with 5 ft. shielded cable. **ONLY 14/-.** Post free.

### TAPE ! TAPE !

For the first time in this country Canada's Hi Fi Magnetic Recording Tape. Made by "Bel-Clear" of Canada.

Following sizes available, others to follow. **Braud New, NOT Sub-standard.** High grade Acetate base, attractively boxed, fitted leaders, 1000 ft.

5 1/2 in. 12/6; 5 1/2 in. 900 ft., 15/-; 5 1/2 in. 1200 ft., 18/6; 7 in. 1200 ft., 18/6; 7 in. 1800 ft., 25/-; P. & P. 6d. per spool. 3 or more post free. (Nota fide trade inquiries invited.)

**PLASTIC SPOOL CONTAINERS** for spool sizes 3 in. 1/6; 5 in. 2/-; 7 in. 2/3. **PLASTIC TAPES** 1/2 in. Best quality. 3 in., 1/3, 4 in., 2/-; 5 in., 2/-; 5 1/2 in., 2/3; 7 in., 2/6. P. & P. 8d. per item. Orders over £1 post free.

**THE NEW R.C. TRANSISTOR TAPE TUNER.** May be used with most Tape Recorders. Full Medium wave coverage, ferrite rod aerial, sensitivity control. Attractive case size only 9 1/2 x 4 1/2 x 1 1/2 in. deep. Carded code numbers for easy identification. Solder, wiring wire, PP3 battery and step-by-step instructions supplied. **SPECIAL INCLUSIVE PRICE FOR ALL COMPONENTS inc. battery 27/6 P. & P. 2/6.** Itemised price list and instruction sheet 3d. post free. All parts available separately.



# INCREASE YOUR KNOWLEDGE

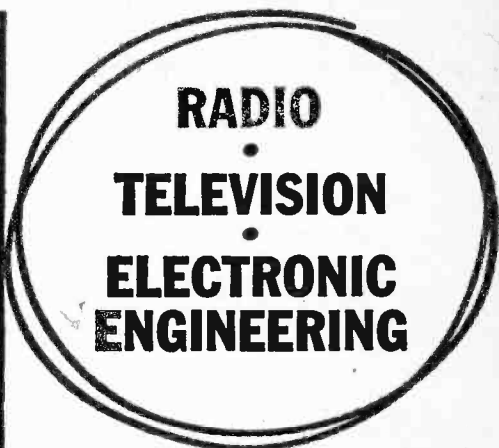

MEMBER OF THE ASSOCIATION  
OF BRITISH CORRESPONDENCE COLLEGES

**CHOOSE THE RIGHT COURSE FROM:**

RADIO AND TELEVISION ENGINEERING, INDUSTRIAL TELEVISION, RADIO AND TELEVISION SERVICING, RADIO SERVICE AND SALES, VHF/FM ENGINEERING, ELECTRONICS, COMPUTERS AND PROGRAMMING, ELECTRONIC TECHNICIANS, SERVOMECHANISMS, TELEMTRY, COLOUR TV, INSTRUMENTATION, AND PRINCIPLES OF AUTOMATION.

**ALSO EXAMINATION COURSES FOR:**

A.M. Brit. I.R.E.; City and Guilds Telecom. Technicians, C. & G. Radio and T.V. Servicing (R.T.E.B.), and P.M.G.'s Certificates. C. & G. Radio Amateurs' Certificates.

**LEARN AS YOU BUILD**

Practical Radio Courses: Gain a sound knowledge of Radio as you build YOUR OWN 5-valve superhet radio receiver, Signal Generator and High-quality Multimeter. At the end of the course you have three pieces of permanent and practical equipment and a fund of personal knowledge and skill. ICS Practical Radio Course opens a new world to the keen Radio amateur.

**THERE IS AN ICS COURSE FOR YOU**

Whether you need a basic grounding, tuition to complete your technical qualifications, or further specialised knowledge, ICS help you with a course individually adapted to your requirements.

There is a place for you among the fully-trained men. They are the highly paid men—the men of the future. If you want to get to the top, or to succeed in your own business, put your technical training in our experienced hands.

ICS Courses are written in clear, simple and direct language, fully illustrated and specially edited to facilitate individual home study. You will learn in the comfort of your own home—at your own speed. The unique ICS teaching method embodies the teacher in the text; it combines expert practical experience with clearly explained theoretical training. Let ICS help you to develop your ambitions and ensure a successful future. Invest in your own capabilities.

**FILL IN AND POST THIS COUPON TODAY**

You will receive the FREE ICS Prospectus listing the examinations and ICS technical course in radio, television and electronics. PLUS details of over 150 specialised subjects.

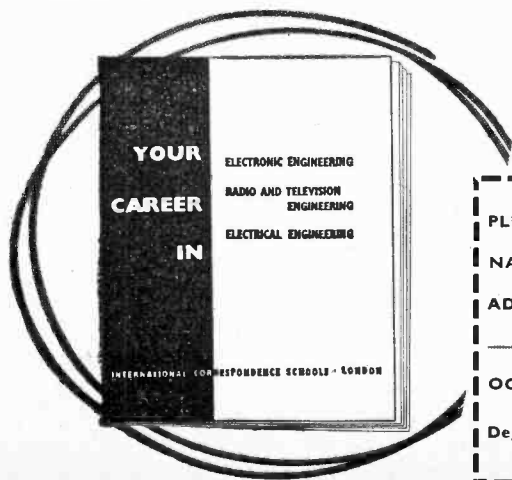

PLEASE SEND FREE BOOK ON \_\_\_\_\_

NAME \_\_\_\_\_

ADDRESS \_\_\_\_\_

OCCUPATION \_\_\_\_\_ AGE \_\_\_\_\_

INTERNATIONAL CORRESPONDENCE SCHOOLS  
Dept. 170, INTERTEXT HOUSE, PARKGATE RD, London SW11

Brand new individually checked and guaranteed VALVES

Table listing various vacuum tube types and their specifications, organized in columns. Includes types like AC/HL, AR8, ARP3, etc., and their corresponding manufacturers and prices.

MANY OTHERS IN STOCK include Cathode Ray Tubes and Special Valves. U.K. orders below £1. P. & P. 1/-; over £1, 2/-; over £3, P. & P. free C.O.D. 2/6 extra. Overseas Postage extra at cost.

MARCONI COMMUNICATION RECEIVERS. CR.150. Frequency coverage 2-60 Mc/s in 5 bands. 20 I.F.s. 1.600 kc/s, 2nd 463 kc/s. Image signal protecting over 40 dB up to 30 Mc/s and 20-40dB from 30-60 Mc/s. Self checking calibration (built in calibrator). Stabilisation of supply and temperature compensation. Electrical and mechanical bandspread. Metering and visual tuning indicator. Bandpass from 100c/s to 10kc in 5 stages. Acoustic filter associated with 100c/s. Bandpass position for CW reception. Facilities for diversity reception. In as new guaranteed condition with original mains power supply unit £70 or without power supply unit £60. Carriage 30/-.

£15.10. As above but rack mounted model, £14.10. Individual frequency coils for above £1 each or set of 9 £8. Either mode, carriage £1.00. Original mains power pack for H.R.O. 110/220 v. A.C. Brand new in original packing, 45/-, P. & P. 4/-.

R.209 RECEPTION SET. A 10-valve high-grade Superhet Receiver with facilities for receiving R.T (A.M. or F.M.) and C.W. frequency Mc/s-20 Mc/s. Hermetically sealed. Built on miniature valves and incorporating its own vibrator power supply unit driven by a 6 v. battery (2 point connector included). The set provides for reception from rod, open-wire or dipole aerial with built-in loudspeaker or phone output. Dimensions: Length 12in., width 8in., depth 9in. Weight 23 lb. In as new, tested and guaranteed condition. £23.10.0, including special headphone and supply leads. Carr. £1.

P. C. RADIO LTD 170 GOLDHAWK ROAD, W.12 Shepherd's Bush 4946

PANEL METERS table listing various meter types and their prices. Includes types like 0-500µA 2 1/2in. round D.C., 0-25mA 2 1/2in. round D.C., etc.

# ACCLAIMED THE MOST AMAZING RECEIVER EVER

You've never seen or heard transistor set design like this before. Small enough to conceal in one hand, the Sinclair "Slimline" gives choice of British and European programmes with staggeringly good quality from its own internal ferrite rod aerial. With its entirely new R.F. Reflex Circuit, superhet selectivity is achieved without any of the latter's problems of alignment. And it's so easy to build with its neat printed circuit board and well illustrated and presented instructions. Success is assured before you begin to build even if you are new to receiver construction.

Such dramatic new standards within even smaller dimensions are made possible through the wonderful new MAT Transistors in circuitry developed exclusively to exploit their amazing characteristics—yet it costs so little to build this minute receiver with its giant performance—so send for yours NOW!

THE PERFECT SET FOR YOUR HOLIDAY!

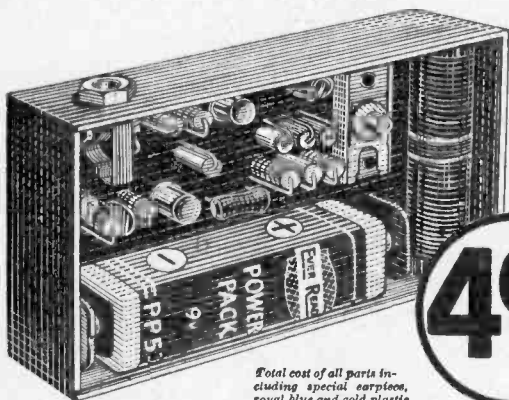

Total cost of all parts including special earpiece, royal blue and gold plastic case and instructions.

A SINCLAIR GUARANTEED DESIGN

## MAT TRANSISTORS

MAKE THIS WONDERFUL PERFORMANCE POSSIBLE



Gold-plated leads assure perfect contact

These amazing new Micro Alloy Transistors take transistor performance into entirely new fields by their coverage of A.F., I.F., R.F. and V.H.F. frequency bands. They provide far greater gain for less power consumption so that two MAT Transistors can do the work of three ordinary types with considerable saving in space, components and cost. Each one is carefully tested before leaving the factory. For full description, send for our book "22 TESTED CIRCUITS USING MICRO-ALLOY TRANSISTORS", price 5s. 9d. inc. postage.

MAT 100 7/9 each      MAT 101 8/6 each  
MAT 120                      MAT 121

See our other advertisement on page 451

**SINCLAIR radionics LTD.**  
69 HISTON ROAD, CAMBRIDGE



THE  
SINCLAIR  
"SLIMLINE"  
MICRO-RADIO  
RECEIVER

BUILT IN A  
COUPLE OF  
HOURS

2 3/4" x 1 5/8" x 5/8"  
COMPLETELY  
SELF-CONTAINED

49 1/6

RECEIVES HOME, LIGHT, THIRD AND  
COUNTLESS EUROPEAN STATIONS WITH  
FANTASTIC EASE AND QUALITY

Comprises brand new sub-miniature components, genuine MAT TRANSISTORS, elegantly designed plastic case and calibrated tuning control with high quality featherweight earpiece; also thoughtfully presented step-by-step instructions.

Enthusiastic testimonials continue to pour in. Here are more typical examples.

"Building was quite easy. I have used my 'Slimline' in cars and on trains and it has been remarkably efficient." C.V.L., Gillingham.

"The quality from the earpiece provided is excellent. Have brought in dozens of stations on this set... a most companionable little receiver." T.L.B., London, N.8.

"Quite fantastic. I would never have thought quality, selectivity and volume could be so good from so small a set. It looks smart, too." E.K.H., Basingstoke.

To SINCLAIR RADIONICS LTD., 69 Histon Rd, Cambridge

Please send Parts for building SINCLAIR "SLIMLINE" RECEIVER...

"22 Tested Circuits Using Micro Alloy Transistors"

...MAT 100: ...MAT 120: ...MAT 101: ...MAT 121 Transistors  
for which I enclose Cash/ Cheque/ Money Order  
for £..... Mark off items required

NAME \_\_\_\_\_  
ADDRESS \_\_\_\_\_

BLOCK LETTERS PLEASE PW9

# LASKY'S RADIO

The finest range of Transistor Receivers available for home construction

## "COROVER" 'SIX'

★ A 6-transistor plus 2-diode superhet receiver using the latest circuitry. ★ Three Mullard AF117 alloy diffused transistors are used with OA79 and OA91 diodes followed by OC81D and two OC81's in push-pull. ★ I.F. frequency 470 Kc/s. ★ Covers the full medium and long wavebands. ★ Sockets provided for personal earpiece or tape recorder, and car radio aerial. ★ Large internal ferrite rod aerial give high sensitivity. ★ Uses four 1.5 v. pen torch batteries. ★ All components mounted on a single printed circuit. Simple stage by stage instructions. ★ Cabinet size 6 1/2 x 4 x 1 1/2 in. With carrying handle. ★ All coils and I.F.'s ready wound.

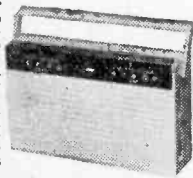

ALL COMPONENTS AVAILABLE SEPARATELY. Data and instructions separately 2/6. Refunded if you purchase the parcel.

CAN BE BUILT FOR

**£5.7.6**

P. & P. 4/- ex. Batteries 1/4.

## "SPRITE"

Inclusive price of

**79/6**

P. & P. 3/6 extra.



★ Six-Transistor Superhet Miniature Personal Pocket Radio. ★ Tunable over Long and Medium wavebands. ★ Uses FP3 battery, Ferrite Rod aerial. ★ I.F. Frequency 470 Kc/s. Transistors: 3 Philco 2067's, 2 Mullard OC81 M OC81 DM and OA90 diode. ★ 3 inch speaker. ★ Printed circuit 2 1/2 x 2 1/2 in. ★ Slow Motion Drive. ★ In Plastic Case. Size 4 x 2 1/2 x 1 1/2 in.

In order to ensure perfect results, the SPRITE is supplied to you with R.F. and I.F. stages. Driver and Output stages ready built with all components ready mounted on the printed circuit. To complete assembly you only have to fit the wavechange switch, tuning condenser and drive, volume control, earphone socket and aerial rod, the remaining components all having been pretested at the factory for you. The SPRITE is offered as above, pre-assembled, plus cabinet, speaker and all components for final construction, at the inclusive price of 79/6. Postage and packing 3/6 extra. Data and instructions separately, 2/6. Refunded if parcel is purchased. Real calf leather case, wriststrap, personal earphone and case for earphone and battery 12/6 the lot extra. Make no mistake this is a SUPERHET receiver of genuine commercial quality. It is not a regenerative circuit.

## "REALISTIC" 'SEVEN'

STAR FEATURES ★ ★ ★ ★

★ 7 Transistor Superhet. 350 Milliwatt output into 4-inch high flux speaker.  
★ All components mounted on a single printed circuit board, size 5 1/2 x 5 1/2 in. one complete assembly.  
★ Plastic cabinet, with carrying handle, size 7 x 10 x 3 1/2 in. in choice of colours: Red/Grey, Blue/Grey, all Grey.  
★ Easy to read Dial.  
★ External Socket for car aerial.  
★ I.F. frequency 470 Kc/s.  
★ Ferrite rod (int'l) aerial.  
★ Operates from PP9 or similar batt.  
★ Full comprehensive data supplied with each Receiver.

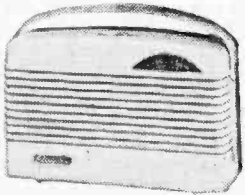

An Outstanding Receiver. Lasky's Price for the complete parcel including Transistors, Cabinet, Speaker, etc., and Full Construction Data: **£5.19.6**

P.P. Battery 3/6. Data and instructions separately 2/6. Refunded if you purchase the parcel.

207 EDGWARE ROAD, LONDON, W.2. Near Praed St. PADDINGTON 3271/2 BOTH OPEN ALL DAY SAT. Early Closing Thurs. Mail Orders to Dept. P.W., Edgware Rd.

33 TOTTENHAM COURT ROAD, W.1. Nearest Stn., Gooch St. MUSEUM 2605

152 3 FLEET STREET, LONDON, E.C.4. Telephone: Fleet Street 2833. Open all day Thursday. Early closing Sat.

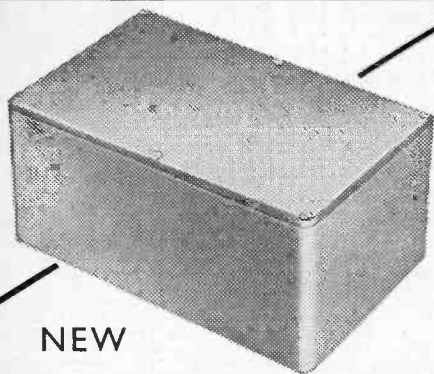

## NEW EDDYSTONE DIECAST INSTRUMENT BOX

An addition to the three existing Diecast Boxes is the Cat. No. 903, illustrated above. This has dimensions of approximately 7 1/2 in. x 4 1/2 in. x 3 in. deep—the increased depth is a notable feature. The box is cast in aluminium, thus saving considerable weight and, as with the others, is complete with a close-fitting flanged lid. Natural finish. Data sheet on request.

No. 898. 4 1/2 in. x 2 1/2 in. x 1 in.  
No. 899. 4 1/2 in. x 3 1/2 in. x 2 in.  
No. 845. 7 1/2 in. x 4 1/2 in. x 2 in.

Write the Manufacturers:

**STRATTON & CO. LTD. BIRMINGHAM 31**



## EXPRESS ELECTRONICS 32 SOUTH END CROYDON SURREY TEL. CRO 9186

VALVES		NEW TESTED AND GUARANTEED FOR THREE MONTHS				
1C1	4/8 6BE6	7/- 12AU7	6/9 DH77	5/- EF86	9/- PL83	7/-
1C2	7/6 6BH6	5/9 12AX7	6/8 DH142	8/6 EF91	4/- PY33	10/-
1C3	6/6 6BR6	5/9 12BE6	8/8 DH150	10/- EF92	5/8 PY61	6/9
1P1	6/6 6BT7	8/9 12BH7	10/8 DK91	4/9 EL41	9/8 PY92	7/6
1P3	2/9 6BW6	6/6 12K8GT11	12/6 DK96	6/6 EL84	7/- PY83	7/6
1FD1	6/6 6BW7	7/- 12Q7GT	7/8 DL92	5/8 EM85	10/- R19	8/6
1FD9	4/- 6D2	4/- 12N8T	6/- DL94	6/- EY51	7/8 85A1	8/6
1P1	6/6 6P12	4/- 16A3	8/- DL96	6/8 EX81	10/- U52	2/6
1P10	6/6 6H6GT	2/- 19A45	8/6 EB91	4/- EZ40	5/8 U78	7/6
1P11	6/- 6J7GT	7/8 25A8T	7/6 EB41	7/8 EZ80	6/- U78	5/6
1R5	4/8 6K7G	5/8 25L8GT	7/6 EB40	8/6 EZ21	6/9 U142	7/6
1R5	4/- 6K9G	6/- 30C1	7/8 EC081	4/- HV22	9/8 UBC41	8/6
1T4	2/9 6Q7G	5/8 30L7	7/8 EC082	8/9 KT33C	6/8 UCH42	8/6
1U5	5/8 6SL7GT	6/- 35L8GT	7/8 EC33	6/9 N17	8/8 UF41	8/6
3Q4	5/8 6N7GT	7/6 35W4	8/6 EC84	6/6 N18	5/8 UL41	8/6
3R4	5/8 6V9G	7/6 35Z4GT	8/- ECC85	7/6 N19	6/- UY41	7/6
3V4	6/- 6X4	5/- 3763	7/6 ECF90	6/8 N09	7/- W17	3/6
6Y3GT	5/- 6X5G	6/9 80	6/- EC182	7/8 PC08	7/6 W76	4/6
8Z4	6/6 8T7	7/8 DAF91	4/- EC142	6/- PCP80	7/8 W142	8/6
6AK6	5/8 8D3	4/- DAF96	6/8 ECH81	10/- PCP82	6/8 X17	4/0
6AL5	4/- 9D7	9/8 DUC90	12/6 ECL80	8/8 PC82	6/9 X142	9/6
6AM6	4/- 12AD6	11/8 DP91	3/- ECL82	7/6 PCL34	9/- X150	9/6
6AT6	5/- 12A18	10/- DP96	8/8 EP41	9/- PL81	9/8 Z77	4/-
6BA6	5/- 12AT7	4/- DL176	7/6 EP80	8/- PL82	7/- ZD17	4/-

ASK FOR RESISTOR AND CAPACITOR COLOUR CODE. FREE WITH EVERY PURCHASE

High Stability Resistors 1W 5% 500 to 1M, 9d. Midret Ceramics 500 v., 9d. Conn. Super Quality 1in. 6d. Plus 9d. Sockets 9d. Silicon B.T. Rects. 250 v. 300 mA 1in. x 1in. 8/6. Contact Coiled 250 v. 50 mA 6/8. 85 mA 8/8. NEW TRANSISTORS by MULLARD. OC19. OC26. OC66. 25/- OC44. OC45. 5/- OC70. 7/- OC71. 5/- OC72. 6/- OC72 Matched pair. 12/- OC74. OC75. OC78. 7/6; OC81. 6/-; OC81 Matched pair. 12/-; OC170. OC171. 7/6.

VALVES MATCHED IN PAIRS  
EL34 27/6. EL84 15/-. N709 15/-. 6V6G 15/-. 6BW6 14/- per pair. Push-Pull O.P. Transformer for above 3 15Ω 14/8. P. & P. 1/6. 12in. P.M. Speakers 3Ω 24/6. Baker's "Belhurst" 12in. 16Ω 15W Stalwart 80/- 12in. Stereo Model £8.15.0.

SETS OF VALVES  
DK91, DP91, DAF91, DL92 or DL94... 16/6  
DK96, DP96, DAF96, DL96... 26/-  
1C3, 1P1, 1FD1, 1P1... 26/-  
1R5, 1T4, 1R5, 3R4 or 3V4... 16/6  
ECH42, EP41, EB41, EL41, EZ40... 37/6  
UCH42, EP41, EB41, EL41, UY41... 35/-  
Postage and packing 6d. Over £1 post free. C.O.D. 4/-.



**UNIVERSAL AVOMETERS**



Guaranteed perfect working order. Supplied complete with leads, batteries and instructions.  
**Model "D"** 34 range **£8.19.6**  
**Model "T"** 50 range **£11.0.0**  
 Registered Post 5/- extra.

**MICROAMMETERS**

0-500 microamps. 2 1/2 in. circular flush panel mounting. Dials engraved. 0-15, 0-500 volts. **BRAND NEW. BOXED. 15/- P.P. 1/6.**

**7.5 K.V.A. AUTO TRANSFORMERS**

0-115-230 volts. Brand new boxed. **£15. Carriage 10/-.**

**230/250 VOLT A.C. MOTORS**  
 4 1/4 in. dia., 90 watts, 5,000 r.p.m. in. spindle. **22/6. P.P. 1/6.**

**1 K.V.A. ISOLATION TRANSFORMERS**

230 v. Pri., 230 v. Sec. Boxed. **£5 each. Carriage 10/-.**

**VARIAC TRANSFORMERS**  
 24 amp., 230 volt primary, 185 to 250 volt output. **£12.10.0. Carriage 10/-.**

**TELEPHONES TYPE "H"**

Sound powered, generator bell ringing, 2 line connection. Fully tested. **£4.19.6 pair. Carr. 5/-.**

**MINIFLUX HI-FI TAPE HEADS**

Set of three, record, playback, erase. Only 29/6 set. **P.P. 9d.**

**3000 WATT AUTO TRANSFORMERS**

0-115-230 volts, step-up or step-down. Brand new, boxed ex-U.S.A. **£7.10.0 each. Carr. 10/-.**

**PANEL METERS**

100µA	2 1/2"	F.M.	D.C.	42/6
3100µA	3 1/2"	F.M.	D.C.	62/6
1 mA	2 1/2"	F.M.	D.C.	25/-
30/0/30 mA	2 1/2"	F.M.	D.C.	9/6
350 mA	2 1/2"	F.M.	D.C.	10/8
300 v.	2 1/2"	Proj.	A.C.	19/8
300 v.	2 1/2"	F.M.	A.C.	25/-
500 v.	2 1/2"	F.M.	A.C.	25/-
120 v.	3 1/2"	F.M.	D.C.	32/6

Postage Extra.

**FIELD TELEPHONES TYPE "F"**

Suitable for many applications. Generator bell ringing, 2 line connection. With batteries and wooden carrying case, fully tested. **£4.19.6 per pair. Carr. 5/-.**

**SUB-STANDARD D.C. AMMETERS**

9 ranges, 150mA, 1.5A, 3A, 7.5A, 15A, 30A, 60A, 300A, and 450A. Housed in leak portable case. 8 in. mirror scale. Supplied brand new with all shunts and leather carrying case. **£15 each. P.P. 10/-.**

**P.C.R.2 RECEIVERS**

800-2,000 metres, 190-550 metres 6-22 Mc/s. output for phones or 3 Ω speaker. As new **£5.19.6**. Carr. 10/6. PCR2 as PCR2 but covers 190/550 metres, 2-7 Mc/s, 7-22 Mc/s. including top band. As new **£8.8.0**. Carr. 10/6. All above models can be supplied with internal power unit to operate on 200/250 v. A.C. at 39/6 extra or alternatively plug-in external power units are 35/-.

**AVO WIDE RANGE SIGNAL GENERATORS**

Frequency coverage 50 Kc/s to 80 Mc/s in six turret operated ranges. For use on standard A.C. mains. Packed in original transit cases with accessories. Supplied in as new condition, fully checked before despatch. **£15. Carriage 10/-.**

**NATIONAL H.R.O. RECEIVERS**



**SENIOR MODEL** Supplied complete with full set of 9 coils covering 50 kc/s to 30 Mc/s. Each receiver thoroughly checked and available as follows:  
**TABLE MODEL.** As new condition **£25.**  
**TABLE MODEL.** Extremely good used condition **£19.19.0.**  
**RACK MODEL.** Extremely good used condition **£18.18.0.**  
 Carriage 1/- extra.

200/250 volt A.C. power packs for above receiver, also sold separately. **58/6. Carr. 5/-.**

**PRECISION COMBINATION VOLTMETER/AMMETER FOR A.C. AND D.C.**

Two separate instruments housed in polished wood case, 6 in. scales with knife edge pointers.

Volts A.C. and D.C. 160-300-600 v. Amps. A.C. and D.C. 25-50-150-200 A. Supplied complete with all current shunts, leads and leather carrying case. Manufactured by Elliott Bros. Supplied brand new. **£9.19.6 each. Carriage 7/6.**

**HALLICRAFTER S-36 V.H.F. RECEIVERS**

F.M./A.M. 27-143 Mc/s. 110 volt A.C. (transformer supplied for 230 v. A.C.) Improved version of S-27. Tested before despatch. Brand new boxed with instruction manual. **£40 each. Carr. £2**

**MINE DETECTOR No. 4A**

Will detect all types of metal. Fully portable. Complete equipment supplied tested with instructions. **39/6. Carriage. 10/6. Battery 8/6 extra.**

**COLLARO STUDIO TAPE TRANSCRIBOR**

Brand new 1982 model, 3 speeds, 3 motors, digital counter, etc. With latest Bradmatic heads and interlock button. Supplied with spare spool, instructions, fixings, 10 ens. each. Carr. paid.

**FABULOUS TAPE OFFER**

Famous American Brand Tapes. Brand new, fully guaranteed. 5 in. - 900ft., 10/6. 5 in. - 900ft., 13/6. 5 in. - 1200ft., 13/6. 7 in. - 1800ft., 18/6. 7 in. - 2400ft., 27/6. P. & P. extra. S.A.E. for full tape list.

**MULTIMETERS BRAND NEW - FULLY GUARANTEED LOWEST EVER PRICES**

Supplied with Leads, Batteries and Instructions.

1,000 Ω/VOLT	20,000 Ω/VOLT
0/15/150/1,000 v. A.C. and D.C.	0/10/50/250/500/1,000 v. A.C. and D.C.
0/150 mA D.C.	0/50µA/0/125/500 mA D.C.
0/100 K Ω D.C.	0/50K/500K/5 meg., etc. 97/6. P. & P. 2/6.
38/6. P. & P. 1/6.	
30,000 Ω/VOLT	30,000 Ω/VOLT
0/1/10/50/250/500/1,000 v. D.C.	0/10/50/250/500 v. A.C.
0/10/50/250/500 v. A.C.	0/50µA/0/10/250 mA D.C.
0/50µA/0/10/250 mA D.C.	0/10K/1 meg./10 meg., etc. £5.10.0. P.P. 2/6.
0/10K/1 meg./10 meg., etc. £5.10.0. P.P. 2/6.	0/1/1/2/10/25/100/250/500/1,000 v. D.C. and A.C.
0/50µA/5/50/500 mA/0/12 amp. D.C.	0/50µA/5/50/500 mA/0/12 amp. D.C.
0/60K/6 meg./60 meg., etc. £8.17.6. Post paid.	0/60K/6 meg./60 meg., etc. £8.17.6. Post paid.
50,000 Ω/VOLT	50,000 Ω/VOLT
0/10/50/250/500/1,000 v. D.C. and A.C.	0/10/50/250/500/1,000 v. D.C. and A.C.
0/25µA/2.5/25/250 mA D.C.	0/10K/100K/1 meg./10 meg., etc. £7.10.0. P.P. 2/6.
0/10K/100K/1 meg./10 meg., etc. £7.10.0. P.P. 2/6.	100,000 Ω/VOLT
100,000 Ω/VOLT	5/2.5/10/50/250/500/1,000 v. D.C.
5/2.5/10/50/250/500/1,000 v. D.C.	2.5/10/50/250/1,000 v. A.C.
10/250µA/2.5/25/250 mA/10 amp. D.C.	10/250µA/2.5/25/250 mA/10 amp. D.C.
20K/200K/2 meg./20 meg. ohm. etc.	20K/200K/2 meg./20 meg. ohm. etc.
£8.19.6 post paid.	£8.19.6 post paid.



Hours of Business: 3 Lisle Street, 9 a.m. - 6 p.m. Half Day Saturday  
 34 Lisle Street, 9 a.m. - 6 p.m. Half Day Thursday

**MARCONI CR100/8 RECEIVERS BRAND NEW**

Packed in original transit cases and complete with handbook/manual. 60 Kc/s to 30 Mc/s. 200/250 volt A.C. operation. Tested before despatch.

**£35** Carriage £2.

**COSSOR 1035 DOUBLE BEAM OSCILLOSCOPES**

Available in perfect condition. Fully tested and checked. £45 each. 11 carr. Many other types of 'Scopes in stock. E.M.I., Solartron, Mullard, etc. Enquiries invited.

**L.T. METAL RECTIFIERS**

All full wave, bridge connected. Brand new.  
 12/18v. 1.5A. 3/6 24/36v. 4A. 22/6  
 12/18v. 2.5A. 6/3 24/36v. 6A. 27/6  
 12/18v. 4A. 8/3 24/36v. 15A. 45/-  
 12/18v. 6A. 12/3 36/48v. 2A. 18/6  
 12/18v. 10A. 22/6 36/48v. 4A. 39/6  
 12/18v. 15A. 37/6 36/48v. 6A. 32/6  
 24/36v. 1A. 7/3 48/60v. 2A. 21/-  
 24/36v. 2A. 13/6 48/60v. 10A. 82/6  
 Please add postage.

**L.T. TRANSFORMERS**

All primaries tapped 200/250 volts 1 Battery Charging, 3.5, 9 or 17 volt, 1 amp., 9/8. Ditto 2 amp., 14/8. Ditto 4 amp., 16/6. 9 or 17 volt, 6 amp., 26/6.  
 2 Model Type 3, 4, 5, 6, 8, 10, 12, 15, 18, 20, 24 or 30 volt, 2 amp., 18/6. Ditto 4 amp., 30/-. Ditto 5 amp., 37/6. Add postage.

**MINIATURE MODEL ACCUMULATORS**

Lead Acid. BRAND NEW. 2v. 1.5 A.H., 4 x 1 1/2 in. 11b., 5/8. P.P. 1/3. 12v. 0.75 A.H., 4 x 3 x 1 1/2 in. 21b., 15/6. P.P. 1/6.

**R.C.A. PLATE TRANSFORMERS**

Pri. 200/250 v. sec. 2,000-0-2,000 v. 500 mA, tapped 1,500 v. New. Boxed. **£8.10.0. Carriage 15/-.**

**DUMONT K1051I DOUBLE BEAM C.R.T.**

Twin Gun. Brand new, boxed. **59/6. P.P. 3/6.**

**1.2 Ohm 12 Amp RHEOSTAT**  
 Geared slider type, new boxed. **16/6 each. P.P. 3/6.**

**SILICON RECTIFIERS**

70v. P.I.V. 1 amp. 3/8  
 400v. P.I.V. 500mA. 3/6  
 200v. P.I.V. 6amp. 5/6  
 post extra.

**MINIATURE PANEL METERS**

For 1 1/2 in. dia. panel hole.  
 0-50 µA 39/6 0-300 v. D.C. 27/6  
 0-500µA 32/6 "S" meter 35/-  
 0-1 mA 27/6 "VU" meter 42/6  
 0-5 mA 27/6

**CONSTANT VOLTAGE TRANSFORMERS**

95-180v. Input. 115v. Output. 500 Watts. Can be used in series for 230v. **£4 each. Carr. 10/-.**

**WESTON MICROAMMETER MOVING COIL RELAYS.** Brand new boxed, fully guaranteed. **42/6 each. P.P. 2/-.**

**G.W. SMITH & CO (RADIO) LIMITED**  
 Phone: GERRARD 8204/9155  
 Cables: SMITHEX LEISQUARE  
 334 LISLE STREET, LONDON, W.C.2

# CRYSTALS & COMPONENTS LTD

TEL: TEM 1189 Dept. P.W.11 2, 4 EARLHAM STREET, W.C.2.

Near Cambridge Circus. A few minutes' walk from Leicester Square or Tottenham Court Road Underground Stations  
HOURS OF BUSINESS: 9 to 6. Saturdays 9 to 1. OPEN ALL DAY THURSDAY

## WIRELESS SET NO. 19

Complete with original power supply unit for 12 volts input. Transmitter/Receiver covering 2-8 Mc/s and V.H.F. 240 Mc/s. 6 valve superhet receiver and 6 valves in Transmitter. Using I.F. of 465 Kc/s. For voice and C.W. In good condition not tested. £4.17.6. Plus £1 packing and carriage. **Microphone and headset for this set 17/6 plus 2/6 post and packing. 19 Set Variometers, 17/6 plus 2/6 post and packing. Control box for 19 set, 10/- plus 2/- post and packing.**

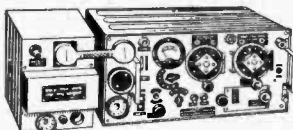

## TYPE 68 TRANS/RECEIVER

3 to 5.2 Mc/s. Portable station with range up to 10 miles under good conditions. In very good condition, complete with valves hand mike and aerial rods. 70/- plus 9/6 carriage and packing. Require 150 V. H.T. 3 V. L.T. and 9 V. G.B.

## B.C. 221 FREQUENCY METERS

Every one tested and working in perfect order. Exterior slightly soiled. £10m £12.10.0. Packing and carriage 17/6.

## CRYSTALS!!!

**LARGE RANGE OF 10X, 10X1, FT243, FT243B CRYSTALS ALWAYS IN STOCK.**

Send stamped and addressed envelope for our free, comprehensive list.

## SPECIAL OFFER OF 6in. METRO-VIC TEST METERS

ALL AT ONE PRICE 25/- FOR CALLERS ONLY

including

0/20/50 mA, 0/100 mA, 0/15 mA, 0/500 mA, 0/50 mA, 0/300 volts D.C., 0/30 volts D.C., 0/60 volts, 0/100 volts, 0/5 Kv, 0/500 volts, and many others. All in perfect condition (surface mounting).

## E.H.T. TRANSFORMERS

**E.H.T.1.** Input 200/250 volts 50 C/s. Output 2kV, 10 Ma/4 v. 1A. 0-2-4V. 1.5A. 22/6, P. & P. 5/-.  
**E.H.T.2.** Input 200/250 volts 50 C/s. Output 2.5 kV, 10 Ma/6.3 v. 3A. 2 v. 1.5A. 3.5 kV. D.C. Wkg. 22/6, P. & P. 5/-.  
**E.H.T.4.** Input 200/250 volts 50 C/s. Output 2,000 v. 15 Ma/4 v. 1.5A. 0-2-4 v. 2A. 29/6, P. & P. 5/-.

## FIELD STRENGTH METERS

100-150 Mc/s. Contains 0-1 mA meter. 185 valve, chrome telescopic aerial, etc. New condition in black crackle case. Operates on 1.5 V. and 90 V. batteries. Dimensions: 7 x 7 x 7in. 45/-, P. & P. 2/6.

## 20-0-20 AMMETER

2in flush mounting. D.C. Brand new. 11/6 each, post 1/6.

## A GEARED ELECTRIC MOTOR

**FOR ONLY 9/6. Post and Packing 2/6.** Due to bulk purchase we are able to offer these 24 V. Rotary Convertors at this fantastic price. Easily modified for mains operation (full simple conversion details supplied). Complete with 400 to 1 reduction gearbox.

## AR 88 LF RECEIVERS

75-550 Kc/s and 1.5 to 30 Mc/s. 110/240 v. A.C. input. In as new condition and fully tested £30. Carriage and packing 25/-.

## TYPE 38 TRANS/RECEIVERS

Brand new. Operating on 7.4 to 9 Mc/s. Trans/Receivers. Complete with headphones, throatmicrophone, junction box and aerial rods. Operate on 150 volts HT & 3 volts LT dry batteries. Complete less batteries and not tested. 42/6 per set plus 6/6 post. Or £4 per pair plus 10/- post and packing.

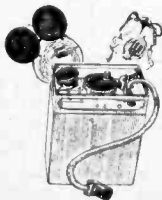

## R109 RECEIVER

1.8-3.9 Mc/s and 3.9-8.5 Mc/s. For audio or phone operation, loudspeaker, complete with Vibrator pack for 8V D.C. input. Fully valued, untested but in good clean condition. 65/- plus P. & P. 10/-.

## VIBRATOR POWER SUPPLY UNIT

6 volts D.C. input, 230 volts 100 mA A.C. output and 6 V. L.T. out. Fully smoothed, with OZ4 rectifier valve. Brand new in steel case with pilot light, on/off switch and Silydlok fuse on front panel. Measures 8 1/2 x 6 x 5 1/2in. 39/6 plus 6/6 post and packing.

## TEST SET 193A

For testing quartz crystals of 1in. and 1/2in. pin spacing and B7G based crystals. 240V and 80V A.C. input including 0-100 micro-amps, 3in. scale meter, indicator light and variable control. 19in. rack mounting but completely enclosed. AS NEW. £4.15.0 carr. paid.

## MICA CAPACITOR

In cast metal and ceramic .0002 Mfd 6000V working. 2/6 plus 1/6 P. & P. each.

## SILICON RECTIFIERS

Westinghouse 1,000 P.I.V. 503 mA, 9/- each 800 P.I.V. 500 mA, 7/8 each. 400 P.I.V. 300 mA, 3/6 each.

## WOBBULATOR FREQUENCY MULTIPLIER

Band 1. Channels 1-13 with 50 micro/ammeter and 0-80 dB attenuator. £9. P. & P. 10/-.

## TF.144G STANDARD SIGNAL GENERATOR

85 Kc/s to 25 Mc/s. Fully serviced and in perfect condition. £36 post paid.

## DOUGLAS AUTO TRANSFORMERS

Auto 115-200-230-250v. 300w. 45/-, P.P. 5/-.  
Auto 110-120-200-240v. 75w. 16/-, P.P. 3/6.  
Auto 115-200-230-250v. 500w. 78/6, P.P. 5/-.  
Auto 115-200-220-240v. 1kW. 119/-, P.P. 6/6.

## TERMS OF BUSINESS

CASH WITH ORDER. Handling charge of 1/6 on all orders under 20/- where P.P. is not otherwise stated. Postage charges indicated apply to U.K. only. C.O.D. orders min. £1.

## L.T. TRANSFORMERS

Pri.: 240 volts. Output 6.3 volts 5 amps. 8/6, post 2/6. Pri.: 240 volts. Output 17 volts 1 amp. 9/6, post 2/-.

## H.T. TRANSFORMERS

Type (350/120) Tapped 200/250 V. input 350-0-350 v. 120 mA. 6.3 V. 3 1/2 amp. 5 V. at 2 amps. 16/6, P. & P. 3/6. Type 5K Pri. 200/250 V. Output 350/0/350 V. 350 mA. 5 V. 3 amps. Tapped 4 V. 2 V. 2 amps. 10 kV. ins. 20 V. 1 amp. 7.5 V. 1 amp. 5 kV. 5 mA. Price 25/-, Post & Packing 6/-.

## SPECIAL H.D.

50 volts 10 amps. transformers, 250 volts input. Brand new and boxed. Conservatively rated. 55/- each. Carriage 7/6.

## ASSORTED PACKETS OF 100 BRAND NEW RESISTORS

Including miniature and high stab., 12/6 post paid all useful values.

**CONDENSERS 100 ASSORTED** including mica, ceramic, metal tubular etc. 15/- post free.

## VARIABLE AIR-SPACED CONDENSERS

150 pFd with 1in. spindle. 4/6 each.  
75+75 pFd with 1in. spindle. 4/6 each.  
100 pFd pre-set. 2/- each.  
50 pFd pre-set. 1/6 each.  
4 Gang H.R.O. Variable 390 pFd. 12/6 each.

**NEW, REVISED EDITION  
OF A STANDARD TEXT BOOK**

# Wireless Servicing Manual

W. T. COCKING, M.I.E.E.

WIRELESS SERVICING MANUAL has become the standard guide to repair, maintenance and adjustment of radio receivers. Brought fully up to date for this tenth edition, it includes a chapter on transistors and transistor sets. In practice transistor sets present similar problems to valve sets, and the policy has been to emphasise differences. Other chapters cover every aspect of radio receiver servicing, and an appendix provides much useful data. The author is well known as former editor of *Electronic Technology* and present editor of *Industrial Electronics*.

288 pp., 8½" x 5½". 25s. net, by post 26s.

Published for "Wireless World" by

**ILIFFE BOOKS LTD**

DORSET HOUSE, STAMFORD STREET, LONDON, S.E.1

**BEST HOLIDAY SET**



Size 5½ x 3½ x 2in.

**AFTER SALES FAULT-FINDING  
GUARANTEE**

**Coloured illustration Component List  
on Request.**

**CONSTRUCTIONAL BOOKLETS 2/6**

Trade and Retail

**OSMOR** 418 BRIGHTON ROAD  
S. CROYDON CRO 5148

**AN AEI PRODUCT**



6 ft. flexible lead  
with cordgrip

Will give a lifetime  
of service

Heats up from cold  
in 2½ mins

25 watt model  
for radio work

Heat concentrated  
in bit

## Anatomy of a Superior Soldering Iron

The Solon range of electric soldering irons includes 15 and 25 watt models for radio, TV and electronic equipment; 65 watt models for household and workshop use. Larger models up to 240 watt also available.

Select a

**SOLON**

TRADE MARK

Used in industry for over 30 years

Obtainable from your usual radio or electrical supplier

ARMSTRONG AF208AM/FM RADIOGRAM CHASSIS

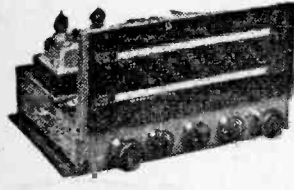

STEREO 12 Mk. 2 \$40/5/- 8 watts push-pull output from each channel, 16 watts total; VHF, with automatic frequency control medium and long bands; A hi-fi system on one compact chassis.

STEREO 55 £29/18/- Junior version of Stereo 12: 5 watts per channel, 10 watts total; VHF and medium bands; inputs for tape, pick-ups and future stereo radio.

JUBILEE Mk. 2 £25/5/- Mono: 8 watts push-pull output; VHF, automatic frequency control, medium and long bands; Separate tone controls; Pick-up and tape inputs.

AF208 (ILLUSTRATED) An AM/FM mono chassis of 5 watts output covering VHF and medium bands. An inexpensive version of the Jubilee Mk. 2.

All carriage free. Write for free literature.

New Boxed VALVES 90-day Guarantee

Table listing various vacuum tubes (0Z4, 1R5, 1R5, etc.) with their specifications and prices.

NEW ELECTROLYTICS FAMOUS MAKES

Table listing electrolytic capacitors (TUBULAR, TUBULAR, CAN TYPES) with their specifications and prices.

TELESCOPE CHROME AERIALS. 13in. extending to 43in., 8/6 ca. Coax Adaptor Plug, 1/6 extra. TRIPLEXERS Bands I, II, III ... 12/6 COAX PLUG 1/- LEAD SOCKET 2/- PANEL SOCKETS 1/- CARBON BOXES 4/- BALANCED TWIN FEEDER yd. 60, or 300 ohms only. DITTO SCREENED per yd. 1/6. 80 ohms only. Wirewound Ext. Speaker Control, 10 x 3/4", 25 1/2 8/6. WIRE-WOUND POTS, 3 WATT. Pre-set Min. TV Types. All values to 10 ohms to 25 K, 3/4" ca. 20 K, 50 K, 4/6. (Carbon 30 K to 2 meg., 3/7). WIRE-WOUND 4 WATTS Pans. Long spindle. Value, 50 ohms to 50 K, 6/6; 100 K, 7/6. PHILIPS TRIMMERS. 0-10 pF, 3-30 pF, 1/- TRIMMERS. Ceramic, 30, 50, 70 pF, 9d.; 100 pF, 1/5 pF, 1/3; 250 pF, 1/6; 500 pF, 7/6 pF, 1/9. TV etc. TRIMMER, 1000 pF, with knobs, 2/-. RESISTORS. Preferred values, 10 ohms to 10 meg., 1 w., 4d.; 1 w., 4d.; 1 w., 8d.; 1 1/2 w., 8d.; 2 w., 1/-. High Stability, 1%, 2%. Preferred values 10 1/2 to 10 meg. Ditto 5% 10 1/2 to 22 meg., 8d. 5 watt } WIRE-WOUND RESISTORS { 1/3 10 watt } 10 ohms-10,000 ohms { 2/- 15 watt } 10 ohms-10,000 ohms { 2/- 12.5K to 47K 10 w. ... 3/-

Volume Controls 80 ohm CABLE COAX Linear of Log Tracks Semi-air spaced 3in. Round spindles. Midget Stranded core 6d. yd. 5 K ohms to 2 Meg. 80 yds. 25/- L.S. 3/-; D.P., 4/6; Stereo I/£10/6; D.P. 14/6

BAKER SELHURST LOUDSPEAKERS

12in. Baker 15w. Stalwart 3 or 15 ohms, 45-13,000 c.p.s. ... 90/- 12in. Stereo, Foam Suspension, 12w., 35-16,000 c.p.s. ... £21.75 12in. Standard H.D., 25-16, 40-14,500 c.p.s. ... £25.00 12in. De Luxe 15w. 25-17,000 c.p.s. ... £29.10 12in. Bass 25w. 20-18,000 c.p.s. ... £12.12 15in. Auditorium, 35w., 18-20 c.p.s. to 12 kc/a. Ideal Bass Guitar. £18.



Details and Enclosures, plans, S.A.E.

LOUDSPEAKERS P.M. 3 OHM 2 1/2, 3, 4in. 5in. Rola, 7in. x 4in. Rola, 15/6; 6in. Rola, 18/6; 8in. Plesey 17/6; 10 x 6in., 22/6; 10in. Rola, 30/6; 12in. B.A. 30/-; 13 1/2 x 8in. Double Cone E.M.I., 33/6. STENTORIAN HF1012. 10in. 3 to 15 ohms, 10w. 87/6; 8in. HF812 72/-; Tweeter T350 30/-.

MAINS TRANSFORMERS 200/250 v. A.C.

Standard, 250-0-250, 80 mA, 6.3 v. 3.5 a. tapped 4 v. 4 a. Rectifier, 6.3 v. 1 a. 5 v. 2 a. or 4 v. 2 a. 22/8, ditto, 350-0-350 ... 29/6 MINIA TUBE 200 v. 20 mA, 6.3 v. 1 a. 10/6 MIDGET 250 v. 45 mA, 6.3 v. 2 a. ... 15/6 SMALL, 250-0-250, 50 mA, 6.3 v. 2 a. ... 17/6 STD. 250-0-250, 85 mA, 6.3 v. 3.5 a. ... 17/6 HEATER TRANS. 6.3 v. 1j amp. ... 7/6 Ditto, tapped 1.4, 2, 4, 5, 6.3 v. ... 8/6 1 1/2 a. sec. 6.3 v. amp. ... 10/6 GENERAL PURPOSE LOW VOLTAGE, 2 amp. 3, 4, 5, 6, 8, 9, 10, 12, 15, 18, 24, 30 v. ... 22/6 AUTO TRANSFORMER, 150 w. ... 22/6 0, 115, 200, 250, 350 v., 500 w. ... 82/6 MULLARD '8107' Mains Transformer ... 8/6 PARMEKO MAINS TRANSFORMER. Made for special contract, the ratings can safely be doubled. Guaranteed 2 years. Primary 0-110-210-300-250 v. H.T. 300-0-300 v. 50 mA. L.T. 6.3 v. 1.8 amp. Size 4 x 3 x 3in. ... 17/6

INTERVALS TRANSFORMERS. 3:1 or 5:1 9/-

O.P. TRANSFORMERS. Heavy Duty 50 mA 4/6. Multitap, 7/6. Multitap to heavy duty push pull, 10 w., 15/6. Miniature, 384, etc. 5/9. 10 w. O.P. matching trans. 3, 7, 15, 12H. 85 mA. L.F. CHOKES 15/10H, 40/95 mA, 5/-; 10H, 85 mA. 10H; 10 H, 150 mA, 14/-.

L.F. TRANSFORMERS 7/6 pair

465 KHz. Tuning Miniature Can, 2 x 1 1/2 x 1 1/2 in. High Q and good bandwidth. Data sheets. Standard size Weyrad, 10/6 pair.

FULL WAVE BRIDGE SELENIUM RECTIFIER:

2, 6 or 12 v. 100, 200, 500, 11/3; 4 a., 17/6 CHARGER TRANSFORMERS. Tapped input 200/250 v. (or charging at 2, 6 or 12 v., 1j amp., 15/6; 2 amps., 17/6; 4 amps., 22/6. Circuit included. 4 AMP. CAR BATTERY CHARGER with amp-meter Leads Fuse Case, etc., for 6 v. or 12 v., 68/9. AMMETER 0 to 6 amp., 9/8.

BOOKS list S.A.E.

Boys' Book of Crystal Sets ... 2/6 'W-W' Radio Valve Data ... 6/6 High Quality Speaker Enclosures ... 6/6 Valve and TV Tube Equivalents ... 9/6 TV Fault Finding ... 5/- Mullard Amplifier Manual ... 8/6 Radio Valve Guide, Books 1, 2, 3. 4 or 5. 5/- Transistor Superhet Receivers ... 7/6 Practical Radio Inside Out ... 3/6 Master Colour Code Chart ... 1/6 Transistor Controlled Models ... 7/6 Principles of Colour TV ... 15/- International Radio Stations List ... 1/6

4 TRANSISTOR PUSH-PULL AUDIO AMPLIFIER

Size 3 x 1 1/2 x 4. A ready built miniature push-pull amplifier with Driver and output transformers, 4 transistors. Ideal for use with record players, intercoms, BABY ALARMS, etc. Complete with full instructions and circuit. Price 47/6 9 v. Batt. 23in. Speaker 15/-

1963 RADIOGRAM CHASSIS

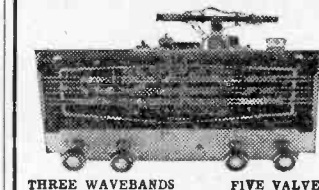

THREE WAVEBANDS FIVE VALVES S.W. 16 m.-50 m. LATEST MULLARD M.W. 200 m.-550 m. ECH81, EF98, EB8C1, L.W. 800 m.-2,000 m. EL84, E220

12-month guarantee. A.C. 200/250 v. 4-way Switch; Short-Medium, Long/Gran. Ferrite Aerial A.V.C. and Negative feedback, 3 ohm output, 5 watt. Glass dial, horizontal wording, size 13in. x 4in. Aligned and calibrated. Isolated Chassis, size 13 1/2 in. x 9in. high x 5 1/2 in. deep. £8.196 Carr. & Ins. 4/6.

C.R.T. BOOSTER TRANSFORMERS

for heater cathode short circuit, or tubes with falling emission. Full instructions supplied, mains input. Type A optional 2.5% and 50% boost 2v. or 4v. or 6.3v. or 10.8v. or 12.6v. State voltage required. PRICE 10/6.

TWIN GANG TUNING CONDENSERS. 365 pF

miniature 1in. x 1 1/2 in. 10/- 500pF Standard with trimmers 9/-; midget, 76/-; with trimmers 9/-; 500pF slow motion tuning, standard or midget, 9/-; SMALL 3 gang 500 pF, 17/- SINGLE 365 pF, 7/6. SINGLE 10 pF, 25 pF, 50 pF, 75 pF, 100 pF, 160 pF, 5/6. Solid dielectric 100, 300, 600 pF, 3/6. 7 kV. CONDENSERS. New stock, 0.001 mid. 7 kV. T.C.C. 8/6; Ditto, 20 kV, 9/6; 0.1 mid. 7 kV, 9/8. Tubular 500 v. 0.001 to 0.05 mid. 9d.; 0.1 1/-; 0.25, 1/8; 0.5/350 v., 1/8; 0.1/350 v. 9d.; 0.1/2,000 v., 0.1/1,000 v., 1/8; 0.1 mid. 2,000 v., 3/6. CERAMIC CONDS. 500 v. 0.3 pF to 0.01 mid., 9d. SILVER MICA CONDENSERS, 10% 3 pF to 300 pF, 9d.; 500 pF to 3,000 pF, 1/-; Close tolerance (± 1 pF) 2.2 pF to 47 pF, 1/-; Ditto 1% to 50 pF to 815 pF, 1/-; 1,000 pF to 5,000 pF, 1/9.

65 kc/c SIGNAL GENERATOR

Price 15/- Uses B.F.O. Unit, Z4 3003B ready made with valve 1R5, 140K KIT SIZE 2 x 4 1/2 in. One resistor to change. Full instructions supplied. Battery 3/6 extra. 69/11V. Details S.A.E.

WAVECHANGE SWITCHES

8 p. 4-way 3 wafer long spindle ... 6/6 2 p. 2-way, or 2 p. 8-way long spindle ... 3/6 4 p. 2-way or 4 p. 3-way long spindle ... 3/6 3 p. 4-way or 1 p. 12-way long spindle ... 3/6 Wavechange "MAKITS". Wafers available: 1 p. 12 way, 2 p. 6 way, 3 p. 4 way, 4 p. 3 way, 6 p. 2 way, 1 wafer switch, 8/6; 2 wafer switch, 12/8; 3 wafer switch, 16/-; additional wafers up to 12, 3/6 each extra; Targite Switches, s.p., 2/-; d.p., 3/6; d.p.d.t., 4/-; Min. Slide d.p.d.t., 3/6.

CRYSTAL MIKE INSERTS, 6/6

High output. Size 1 1/2 in. dia. x 1 in. ACOS MIC. 14, insert 1 1/2 in. dia. x 1 in. 8/6 ACOS 39-1 DE LUXE STICK MIKE 35/- TSL QUALITY STICK MIKE ... 25/-

Valveholders. EA50. 6d. B12A, CRT, 1/3. 4 or 5. 5/- and 7 pin. 1/6. MOULDED Mazine 8 pin. int. oct. 6d. BTG B8A, B8B, B9A, 9d. BTG with can, 1/6. B9A with can, 1/9. Ceramic EF50, BTG, B9A, int. oct. 1/-, B7G, B9A cans 1/- each. Valve plugs BTG, B9A, 2/3.

HIGH GAIN TV PRE-AMPLIFIERS

HAND I R.M.C. Tunable channels 1 to 5. Gain 18dB. EC88A valve Kit price, 29/6 or 49/6 with power pack. Details 6d. (PCC84 valves if preferred.) Coils only 9/6. BAND III I.T.A. - Same prices. Tunable channels 8 to 13. Gain 17dB. Circuit and coils only 9/6.

RADIO COMPONENT THE ORIGINAL Our written guarantee with every purchase NEW COMPONENT LIST 1/-.

**THE "INSTANT" BULK TAPE ERASER AND RECORDING HEAD DEMAGNETIZER**

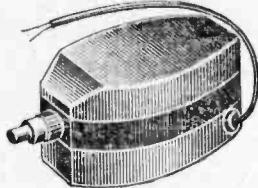

200/250 v. A.C. **35/-** Leaflet S.A.E.

**AMERICAN "BRAND FIVE" PLASTIC RECORDING TAPE**

Double Play 7 in. reel, 2,400ft. 49/- 5in. reel, 1,300ft. 25/-	Spare Plastic Reels
Long Play 7 in. reel, 1,800ft. 35/- 5in. reel, 1,200ft. 23/6	3 1/2 in. 1/6
Standard 7 in. reel, 900ft. 18/6	4 1/2 in. 2/-
5in. reel, 1,200ft. 25/-	5 1/2 in. 2/-
5in. reel, 900ft. 18/6	7 1/2 in. 2/6
7 in. Metal Reels 1/8	

"EASYSPLICE" Tape Splicer 5/-.

**CRYSTAL SET BOOKLET, 1/-.**  
**CRYSTAL DIODE G.E.C., 2/-.** GEX34, 4/-, OA31, 3/-.  
**HIGH RESISTANCE PHONES, 4,000 ohms, 15/-.** pr.  
**MOVING COIL PHONES, 10 ohms, 10/-.**  
**SWITCH CLEANER, Fluid squirt sprout, 4/6 1/2.**

**"6-1" TRANSISTOR RADIO MEDIUM AND LONG WAVE KIT**

First class components to make a 6 transistor 2 waveband superreg circuit chassis. Ideal for portable or table radio. All parts including BVA transistors, ferrite aerial, with car aerial coil, printed circuit, 8 1/2 in. x 2 1/2 in., but EXCLUDING Speaker and cabinet.  
Speakers, 35 ohms, 7 x 4 in. 21/-  
5 in., 17/6. 3 1/2 in., 15/6. **£4.5.0**

**BULGIN PLUGS AND SOCKETS, Non-reversible**

P71, 2-pin, 4/3; P73, 3-pin, 4/6; P194, 6-pin, 6/8.  
"DOMINA" plugs, 2/6; sockets, 2/6.  
**JACKS, English open circuit, 2/6.** Closed circuit, 4/3.  
Grundig type, 3-pin 1/3; Grundig lead jack, 3/6.  
**JACK PLUGS, English, 3/-.** Screened, 4/-; Grundig, 3-pin, 3/6; Phono Plugs, 1/-; Sockets, 6d.  
**ALADIN FORMERS and cores, 1 in., 8d.; 1 1/2 in., 10d.**  
**O.S. FORMERS** 4087 or cores, 10c. TV1 or 2, 1/2 in. sq. x 2 1/2 in., or 1 in. sq. x 1 1/2 in., 2/- with cores.  
**SLOW MOTION DRIVES, 6/1, 4/3.**  
**SOLOIN IRON, 20V, 200V or 220V, 24/-.**  
**ANTEX SUB-MIN. IRON, 10w., 200 or 240v., 29/6.**  
**BENCH STAND** for above, 12/6. Snarers in Stock, 1/16 in. Paxolin Panels, 10 x 8 in., 2/-.  
Miniature Contact Cooled Rectifiers, 250V 50mA, 7/6; 250V 60mA, 8/6; 250V 85mA, 9/6; Selenium Rect., 300V, 85mA, 5/-.  
TV etc., Silicon Sub. Min. Rectifier, 250V 450mA, 10/-; K3/25, 600V 5mA, 5/-.  
RM4, RM5, 14A100, 14A116 10/- each. FC31, 20/- coils. Venrite "P" Type, 3/- each.  
Osmor Midge "Q" Type, add dust core from 4/- each. All ranges, List S.A.E.  
**Teleton D.W.R., L. and Med. T.R.F. with reaction, 4/-.** Med. wave D.R., 3/6.  
Ferrite Aerials, M., 8/9; M. and L., 12/6.  
Osmor Ferrite Rod Aerials, L. and M. for transistor circuits, 10/- each.  
Ferrite Rods, 8 x 1 in., 3/-; 8 x 1 1/2 in., 3/-.  
H.F. Chokes, 2/6. Osmor Q.P. 6/9.  
T.H.F. Coils, A/H/F, 7/- pair; HAX, 3/-.  
Osmor DRR2, 4/6; DRR1, 2/6.  
Radio Screwdriver, 5 in., 6d. Test Prods., 2/9. Neosid Trimming Tool, 1/9. Neon Mains Tester Screwdriver, 5/-.  
Solder Radiograde, 40. yd., 1/6 1/2.

Aluminium Chassis, 18 s.w.g. Plain undrilled, 4 sides, riveted corners, lattice fixing holes, 2 1/2 in. sides, 7 x 4 in., 4/6; 8 x 7 in., 5/6; 11 x 7 in., 6/6; 13 x 8 in., 8/6; 14 x 11 in., 10/6; 15 x 14 in., 12/6.  
Aluminium Panels, 18 s.w.g., 12 x 12 in., 4/6; 14 x 9 in., 4/-; 12 x 8 in., 3/-; 10 x 7 in., 2/3; 8 x 6 in., 2/-.

**ADAstra 3-3 AMPLIFIER 3 WATTS HIGH FIDELITY AT LOW COST**

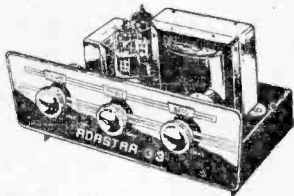

**READY BUILT, WIRED & TESTED** A.C. only, 200-250 V. Valves ECL86 and EZ80. 3 ohms quality output. Mullard tone circuits. Controls: bass boost, treble and volume. Separate engraved front panel with die luxe finish. Quality mains transformer. Stove enamelled cabinet size 6 in. x 5 in. x 3 in. Bargain Price £4.19.6. Details S.A.E.  
"Performs agreeably well" (The Gramophone)

**JASON FM TUNER COIL SET 29/-.** 1/2" coil aerial coil, oscillator coil, two I.F. transformers 10.7 Mc/s. detector transformer, heater choke. Circuit book using four 6A3/6, 2/6.  
**Complete Jason FM TUNER Kit, Jason chassis, with calibrated dial, components and 4 valves, £6.5.0.**  
**Model FMT2** with new shelf cabinet, 5 valves components and power pack, £10.

**MAINS DROPPERS, Midget adjustable sliders** 0.3A, 1,000 ohms, 5/-; 0.2A, 1,200 ohms, 5/-; 0.15A, 1,500 ohms, 5/-; 0.1A, 2,000 ohms, 5/-.

**WIRE TRANSFORMERS, 50/-, 3/9.**  
P.V.C. Covered Wire, single or stranded, Ed. yd. Slewing, 1 or 2 mm., 2d.; 4 mm., 3d.; 6 mm., 5d. yd.  
**SPEAKER-PRET, Gold, Maroon or Green Cloth, 17 x 2 1/2 in., 5/-; 25 x 3 1/2 in., 10/-.** Tycan, various colours 2 1/2 in. wide from 10/-; 4 in., 20 in. wide from 5/-.  
Samples S.A.E. Expanded Metal, Gold, 12 x 1 1/2 in., 6/-.  
Panel mounting fuse holders 2/-. Fuses 60mA, 5/5.

**RADIO AND TELEVISION SPARES**

All leading makes, volume controls, etc., line output transformers, etc., B. V. A. valves (current and obsolete types). Send S.A.E. for quotation.

**WEYRAD**

**COILS AND TRANSFORMERS FOR 2-WAVE TRANSISTOR SUPERHETERS WITH PRINTED CIRCUIT BOARD TECHNIQUE (O.P. Aerial, L., Long and Medium Wave Aerial—R2W**  
On 6 in. rod, 208pF tuning, with car aerial coupling coil, 12/6  
Osc. Coil P501AC, 176pF tuning, 5/4  
1st and 2nd I.F. Trans.—P502CC, 470K $\Omega$  11/16 in. dia. by In. 5/7 each  
3rd I.F. Trans.—P503CC, 6/-  
Spare Cores 8/6 each  
Driver Transformer—LFD74, 9/6  
Wavechange Slide Switch d.n.d., 3/6  
Printed Circuit—PCA1, Size 21 x 8 1/2 in. Ready drilled, and printed 9/6  
Volume Control, 5K-DP, 4/6  
35 ohm Speakers, 3 1/2 in., 15/6; 5 in., 17/6; 7 x 4 in., 21/-.  
Tuning Gang with trimmers 10/6  
6 Mullard Transistors and diode, 42/6  
Constructor's Booklet, 2/-  
3 ohm O.P. Trans. O.P.T.1 10/6

**NEW MULLARD TRANSISTORS**  
OC71 8/-, OC72 7/6, OC81D 7/6, OC81 7/6, OC44 3/7, OC45 3/8, OC171 10/6, AF17 9/6.  
Sub Miniature Condensers, 0.1 mFd, 30V., 1/3; 1, 2, 4, 5, 10, 25, 30, 50, 100 mFd, 15 volt 2/6 ea. Transistor Holders 1/3

**R.B.C. Pocket 2-Transistor, Plus Diode** M.W. and L.W. Radio Kit, 22/6.  
Miniature earpiece, 7/6. Batt, 2/3.  
Circuit details, etc., S.A.E.

**BUILD YOUR OWN RECORD PLAYER**

**AND SAVE POUNDS!!**



Famous Autochange or Single Player units supplied with Brand New 2-tone deluxe Portable Cabinets 17x15x8 1/2 in. Strong carrying handle, gilt finish clips and hinges. As used by Famous Make for 200ns, hotels. Ready cut-out motor board 14 x 1 in. Front baffle with 7 x 4 in. high flux loudspeaker stage amplifier ready built on metal chassis 12 x 3 x 2 1/2 in. Quality 3 ohm output transformer, tow hum level circuit, Volume and Tone controls, 3-core safety mains lead. All items fit together perfectly. Special instructions enable assembly in 30 minutes, only 5 wires to join! 12 month written guarantee. Available separately or package deals as below.

**AUTOCHANGER KITS COMPLETE (as above).**  
B.S.R. Monarch ... £11.10.0 P.P. 5/6  
Collaro ... £11.15.0 P.P. 5/6  
Garrard ... £2.5.0 P.P. 5/6

**SINGLE PLAYER KITS COMPLETE (as above).**  
Garrard auto stop/start ... £11.8.0 P.P. 5/6  
E.M.I. auto stop/start ... £11.8.0 P.P. 5/6

**OR SEPARATELY**  
Cabinet with cut out board £3.2.6 P.P. 3/6  
Amplifier with 7 x 4 in. speaker £3.17.6 P.P. 2/6

**AUTOCHANGERS**  
B.S.R. UA14 ... £6.5.0 P.P. 4/6  
Garrard Automis ... £6.17.8 P.P. 4/6

**SINGLE PLAYERS**  
E.M.I. auto stop/start ... £5.10.0 P.P. 4/6  
Garrard SRP10 ... £5.10.0 P.P. 4/6  
E.M.I. (separate pick-up) £2.7.8 P.P. 3/6

**TRANSCRIPTION UNITS Stereo/Mono**  
Garrard 4HF ... £18.10.0 P.P. 5/-  
Philips AG10B ... £12.5.0 P.P. 5/-  
Garrard AT6 ... £10.10.0 P.P. 5/-

**BAKRAIN**  
B.S.R. Autochange UA12 Stereo/Mono ... £7.10.0 P.P. 4/6  
Replacement sapphire stylus available from 5/3.  
Replacement Xials from 15/-; Stereo from 31/6.

**GABY MULTIMETER**

Moving-coil Model M.L. **54/-**

Measures D.C. or A.C. 6 v., 30 v., 120 v., 600 v., 1200 v. D.C. 30 mA, 300 mA. Ohms 0-100K. Leaflet S.A.E.

**ARDENTE Transistor Transformers**

Type D3035, 7.3 CT; Push-Pull to 3 ohms for OC72, etc., 1 x 1 x 1 in. 9/8  
Type D3034, 1.75 : 1 CT. Push-Pull Driver for OC72, etc., 1 x 1 x 1 in. 9/8  
Type D3038, 11.5 : 1 Output to 3 ohms for OC72, etc., 1 x 1 x 1 in. 9/8  
Type D187, 18.2 : 1 Output to 3 ohms for OC72, etc., 1 x 1 x 1 in. 12/-  
Type D239, 4.5 : 1 Driver Transformer, 10/-  
Type D240, 8.5 : 1 Driver Transformer, 10/-

**ARDENTE TRANSISTOR CONTROLS**

5K or 1M $\Omega$  5K switch, dia. 0.9 in., 5/3  
Type VC1760, 5K with switch, dia. 0.7 in., 10/8  
Dead air earpiece xtal or magnetic, 7/6  
Sub-min Jacks, 1/9. Plugs, 1/9.

**COMPONENT SHOP SPECIALISTS**

**337 WHITEHORSE ROAD WEST CROYDON**

Telephone: **THO 1665**  
(Export welcome, Send resistance and extra postage, no C.O.D.)

P.P charge 1/-. C.O.D. 2/- extra.

**RADIO-AMATEUR GEAR  
EDUCATIONAL KITS**



**TEST INSTRUMENTS  
HI-FI EQUIPMENT**

**With the clearly-written instruction manuals,  
anyone can build any of these models—  
Have the world's best equipment—and save money**



**AMATEUR BANDS RECEIVER. Model RA-1.** Covers all Amateur Bands from 160 to 10m. Special features incl. half lattice crystal filter, 8 valves, signal strength "5" meter, tuned R.F. amplifier stage ... .. £39.66

**NEW!**  
**"OXFORD" LUXURY  
TRANSISTOR PORTABLE.  
Model UXR-2.** The ideal domestic, car, or personal portable receiver. 10 Semi-conductors. Send for full details. £14.18.0 (Inc. P.T.).



**NEW! 5W HI-FI MONO AMPLIFIER. Model MA-5.** A low-priced amplifier based on the S-33. Printed circuit construction makes it easy to build ... .. £10.19.6

**TAPE RECORDING/PLAYBACK AMPLIFIER.** Stereo (TA-IS) £24.10.0 Monaural (TA-IM) ... .. £19.2.6  
**STEREO CONTROL UNIT. USC-1.** Luxury model with inputs to suit any pick-up or tuner ... .. £19.10.0

**HI-FI EQUIPMENT CABINETS.** Large range, in kit form or assembled and finished, available to meet various needs. Details on request ... .. from £6.19.6 to £29.8.0

**6W DE LUXE AMPLIFIER. Model S-33H.** An inexpensive Stereo-Mono amplifier, with high sensitivity. Suitable for Decca Deram cartridge ... .. £15.17.6

**6 TRANSISTOR PORTABLE. Model UXR-1.** Prealigned I.F. transformers. Printed circuit, 7 x 4in. high flux speaker. Real hide case. Very easy to build ... .. £12.11.0

**SHORTWAVE TRANSISTOR PORTABLE. Model RSW-1.** Two short bands, trawler and medium wave £19.17.6 (Inc. P.T.).  
**HI-FI A.M./F.M. TUNER.** Covers F.M. 88-108 Mc/s. A.M. 1.6-5.2, 200-550, 900-2,000 m. Tuning heart (£4.13.6 inc. P.T.) and I.F. Amp. (£20.13.0). Printed circuit board. Total ... .. £25.6.6



**"MOHICAN" GENERAL  
COVERAGE  
RECEIVER.  
Model GC-1U.** Fully Transistorised. Excellent portable or general purpose receiver for amateur or short wave listening. See full spec. leaflet. £39.17.6

**HI-FI F.M. TUNER.** Tuning range 88-108 Mc/s. Tuning unit (FMT-4U) with 10.7 Mc/s. I.F. output (£2.15.0 inc. P.T.). I.F. Amp. (FMA-4U) complete with cabinet and valves, (£12.6.0). Total ... £15.1.0



Assembled models also available; prices on request — Deferred terms available over £10. Free Delivery U.K.

**SEND FOR FREE BRITISH HEATHKIT CATALOGUE—OVER 50 MODELS TO CHOOSE FROM**

**NOW AVAILABLE!**

**MONO CONTROL UNIT. Model UMC-1.** Suitable for cabinet mounting or free-standing. Ideal for use with MA-12 or similar amplifier requiring 0.25 v. or less for full output ... .. £8.12.6



**PORTABLE SERVICE OSCILLOSCOPE. Model OS-1.** Compact portable scope, ideal for servicing and general work. Printed crct. Case 7 1/4 x 4 1/2 x 12 1/2 in. long. Wt. only 10 1/2 lb. £19.19.0

**5in. OSCILLOSCOPE. Model O-12U.** Wide band amplifiers essential for TV servicing, F.M. alignment, etc. T/B covers 10 c/s-500 kc/s in 5 ranges ... .. £35.10.9

**VALVE VOLTMETER. Model V7A.** Measures up to 1,500 volts (D.C. and R.M.S.) and 4,000 pk. to pk. Res. 0.1% (1,000MΩ) £13.18.6

S-33

**6 W STEREO AMPLIFIER. Model S-33.** 3 w/chl. Inputs for radio-tape-gram. Stereo/Mono ganged controls. Sensitivity 200 mV. £13.7.6

**HI-FI 18 W STEREO AMPLIFIER. Model S-99.** Ganged controls. Stereo/Mono gram, radio and tape recorder inputs. P/B selection. £27.19.6

**HI-FI SPEAKER SYSTEM. Model SSU-1.** Two speakers in ducted port bass reflex cabinet. Bookcase model £10.17.6 Legs 14/6 extra.

**MULTIMETER. Model MM-1U.** Ranges: 0-1.5 v. to 1,500 v. A.C. and D.C. 150μG—15A D.C. 0.2% to 20MΩ 4 1/2 in. 50μA meter ... .. £12.10.0

**R.F. SIGNAL GENERATOR. Model RF-1U.** Up to 100 Mc/s fundamental, 200 Mc/s on harmonics. Up to 100 mV output all bands ... .. £12.15.6



DX-40U

**250**

**AMERICAN HEATHKIT MODELS**

Full details of direct Mail Order Scheme and catalogue can be obtained from us for 1/- post paid. (FREE to Service Departments).

**AMATEUR TRANSMITTER. Model DX-40U.** Self-contained. 80-10 m. Power input 75 w. CW, 60 w. peak C.C. phone. Output 40 w. to aerial. Provision for V.F.O. ... .. £33.19.0

**AMATEUR TRANSMITTER. Model DX-100U.** Covers all amateur bands, 160-10 m. 150 w. D.C. input, self contained with power supply. Modulator, V.F.O. £74.19.0



DX-100U

**DAYSTROM LTD.**

Dept P.W.9, GLOUCESTER, ENGLAND.

A member of the Daystrom Group, manufacturers of the  
WORLD'S LARGEST-SELLING ELECTRONIC KITS

Send me **FREE BRITISH CATALOGUE** (Yes/No)

Full details of model(s) \_\_\_\_\_

NAME \_\_\_\_\_

ADDRESS \_\_\_\_\_

PW9

# Practical Wireless

Vol. XXXIX No. 679 SEPTEMBER, 1963

## 50 Years On

### Editorial and Advertisement

Offices:

#### PRACTICAL WIRELESS

George Newnes Ltd., Tower House,  
Southampton Street, W.C.2.

© George Newnes Ltd., 1963

Phone: Temple Bar 3363

Telegrams: Newnes, Rand, London,  
Registered at the G.P.O. for trans-  
mission by Canadian Magazine Post.

### SUBSCRIPTION RATES

including postage for one year

To any part of the world £1.9.0

## Contents

Editorial .....	397
Round the World of Wireless .....	398
A Versatile Double-trace Oscilloscope .....	400
Amateur Band Frequency Checking .....	405
A Top Band T.R. Transmitter .....	408
The Novice 3 .....	413
The Photophone .....	420
A Simple Stroboscope .....	424
Test Gear Techniques .....	427
Hearing Aid Amplifier .....	433
On Your Wavelength .....	437
The Malvern Tape Recorder .....	438
Home Inter-com Unit .....	442
Books Reviewed .....	445
Semiconductors .....	446
Trade News .....	457
Club News .....	451
Letters to the Editor .....	462

The Editor will be pleased to consider articles of a practical nature. Such articles should be written on one side of the paper only, and should contain the name and address of the sender. Whilst the Editor does not hold himself responsible for manuscripts, every effort will be made to return them if stamped and addressed envelope is enclosed. All correspondence intended for the Editor should be addressed: The Editor, PRACTICAL WIRELESS, George Newnes, Ltd., Tower House, Southampton Street, London, W.C.2. Owing to the rapid progress in the designs of wireless apparatus and to our efforts to keep readers in touch with the latest developments, we give no warranty that apparatus described in our columns is not the subject of letters patent.

Copyright in all drawings, photographs and articles published in PRACTICAL WIRELESS is specifically reserved throughout the countries signatory to the Berne Convention and the U.S.A. Reproductions or imitations of any of these are therefore expressly forbidden. PRACTICAL WIRELESS incorporates "Amateur Wireless".

THIS year, the Radio Society of Great Britain celebrates its Golden Jubilee. We are sure that readers will want to join us in congratulating the R.S.G.B. in reaching this landmark and in offering our good wishes for the future.

In those 50 years, the R.S.G.B. has gained not only materially by continuously increased membership, facilities and activities. It has gained in prestige as our National amateur radio society and as our representative at home and at international conferences where the interests of amateur radio are at stake. It has been the guardian of those privileges and facilities necessary for the continuance of amateur radio and we must all be grateful for their stalwart efforts through the years.

The achievements and successes of the R.S.G.B. have been made possible by both members and officials of the society, acting both individually and collectively. And almost everyone has benefited—from the transmitting amateur to the short wave listening enthusiast—whether they are members of the society or not.

1913-1963! Very few enthusiasts can claim to have been active in the hobby during the entire period. Those that have, can look back on remarkable changes: from a handful of dedicated experimenters groping into the virtually unknown, to the hundreds of thousands (probably millions) of enthusiasts today with the knowledge of 50 years of pioneering to draw on. They can compare today's sophisticated equipment with the crudity of the early days. They can recall having seen radio transform the world's social habits, particularly in that branch we call television, and the world's communications systems.

It seems improbable that the next 50 years could see such revolutionary and stirring changes and developments. Yet, 50 years ago people were probably thinking much the same! Or at least, some were not—those inspired to tackle the seemingly impossible—hence the major breakthroughs, including that of radio communications.

Although in these commercial and highly organised days we do not expect the isolated amateur to influence major research fields, the collective results of amateur activity can be important.

Even for the humblest enthusiast new spheres of exploration constantly develop. For those with more experience the field is considerably larger and we need go no further than to consider the video scene. Here we have the prospect of transistor TV receivers, closed circuit TV set-ups, amateur TV transmitting, video tape recording, etc. None of these things are "new" in the strict sense but they are all lines of interesting experiment. In some of these fields at least, our sister journal PRACTICAL TELEVISION is actively interested and constructional articles are planned for the near future.

Those early experimenters of 50 years ago were fired by the stimulus of comparatively untried and unfamiliar spheres. We like to think that at least some of the spirit survives today.

Our next issue dated October will be published on September 6th



# of WIRELESS

**NEWS AT HOME  
AND ABROAD**

## New Scientific Attache in Washington

**DR. JOHN A. SAXTON** has been appointed Director of the United Kingdom Scientific Mission in Washington D.C., and Scientific Attache at the British Embassy there. He will take up his duties early in 1964, replacing Dr. Harry Hookway who will be returning to the United Kingdom on completion of a three-year tour of duty.

Dr. Saxton, who is 49, has been Deputy Director of the radio research station of the Department of Scientific and Industrial

Research, since 1960. He joined DSIR in 1938, working in the Radio Division of the National Physical Laboratory. His work on the dielectric properties of the atmosphere and on studies of radio wave propagation at very high frequencies has made him well known in Europe and North America.

He has also been actively concerned in the affairs of the International Scientific Radio Union and the International Radio Consultative Committee (CCIR). In 1945 and again in 1950 he undertook a tour of duty in the U.K. Scientific Mission as radio physics liaison officer, and in 1961, at the invitation of the University of Texas, he spent a year there as visiting Professor of Electrical Engineering.

## Transmitters for Radio Free Europe

**THE** transmitting power of Radio Free Europe will be increased considerably when four new short-wave transmitters, recently ordered from the U.S. firm of General Electric, begin operation. These new transmitters—each with a rated output of 250kW—will double the transmitting power of Radio Free Europe in Portugal, where they are to be installed.

The high-power transmitting valves employed in the new equipment are modern vapour-cooled components which are superior to the bulky conventional water-cooled variety.

## BRITISH EQUIPMENT FOR NORWAY

**SPITZBERGEN** is a flourishing Norwegian coal mining centre situated on a group of islands 600 miles due north of Harstad, on the northern mainland of Norway. These two towns are linked by a short-wave radio communications system, but as a result of noise, fading and interference (especially that caused by the Aurora Borealis occurring in these latitudes) telegraph messages relayed by the system are susceptible to errors. To help prevent these errors and correct those that remain, the Norwegian Telegraph Administration recently ordered a new type of automatic error-correcting equipment from the Marconi Company.

The Autospec equipment, as it is called, automatically changes ordinary telegraphic signals into a special code before they are transmitted by radio. At the receiving end, the Autospec terminal can determine whether an error has occurred, and in the majority of cases, decide what the error is and automatically correct it. In cases where automatic correction is not possible, the presence of an error is indicated by a special character which is printed in the received message.

## TRANSCIVERS FOR THE CITY'S POLICE

**THE** City of London police recently carried out a series of evaluation tests on miniature transceivers designed for the use of police officers on patrol. The sets are small enough to be accommodated in a constable's pocket and each has a range adequate for the City area.

If adopted for regular use, the transceivers will enable the officer on duty to maintain continuous contact with his headquarters.

*Right: A City of London police officer holding one of the portable transceivers which may soon be in general use.*





## New Relay Station for Scotland

**B**UILDING work commenced recently on the BBC's new v.h.f. sound and television relay station to serve Shetland. The station is situated three miles south-east of Lerwick, at Ward of Bressay. The associated receiver station is sited at Fitful Head, where programmes will be received from Orkney prior to re-transmission.

## "JAMBOREE-ON-THE-AIR"

**T**HE dates of this year's "Jamboree-on-the-Air" have been announced recently by the organisers of this important event. October 19th and 20th are the chosen dates when amateur operators with any past or present connection with the Boy Scout movement, will be attempting to contact other "scouting-hams" throughout the world.

Participation Certificates will be awarded to all those qualified amateurs who forward reports of contacts to their National Organiser as will all short-wave listeners who submit reports. Once again this year, the Boy Scout World Bureau Station in Ottawa (VE3WSB) will be active during the event.

## R.S.G.B. GOLDEN JUBILEE CELEBRATIONS

**O**NE of the events marking the occasion of the R.S.G.B.'s Golden Jubilee was a reception held at Mullard House in London, when members of the R.S.G.B. council were the guests of Mullard Ltd. The reception, which was held on July 1st, was preceded by a special programme of demonstrations and films arranged by Mullard for the council members and other well known figures in the field of amateur radio.

Among the distinguished company at the reception were the Mayor of Holborn (in whose borough the Society's H.O. is based) and Mr. J. Clarricoats, O.B.E., who is the R.S.G.B.'s general secretary. A special cake, which had been prepared for the occasion, was cut by Mr. Norman Caws, the president of the R.S.G.B.

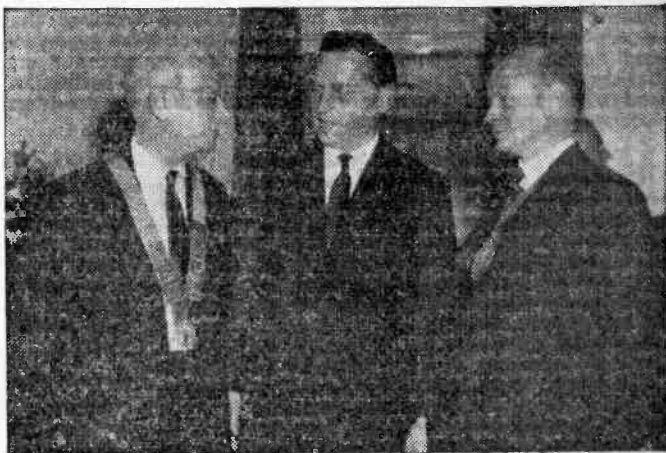

This photograph taken at a reception held at Mullard House, shows (left to right) Mr. N. Caws, president of the R.S.G.B., Dr. F. E. Jones, a director of Mullard, and the Mayor of Holborn.

## Telemetering Conference in London

**E**XPERTS in the field of telemetering will gather in London later this year, to attend the first International Telemetering Conference. The Conference has been fostered by three American societies who have previously sponsored a national conference in the U.S. As Britain is to be host country, the British Institution of Radio Engineers and the Institution of Electrical Engineers will both play important parts in the organisation of the event.

The Conference sessions will be held entirely at the I.E.E. headquarters in London.

## International Radio Show

**T**HE 1963 Paris Radio and Television Show will be, for the first time this year, an international event. Since it is usual for such exhibitions to be exclusively national events, the French organisers have taken an unprecedented step forward, in what may well prove to be the path to be taken by the authorities of other countries.

This move towards an international rather than national event has been welcomed by both the French radio industry and the many foreign firms who have applied for space at the exhibition.

All fields of the industry will be represented at the show, which will last for 11 days, from September 5th to the 15th.

## TRANSLATION BY RADIO

**I**N future, foreign visitors to the Westminster theatre, London, will be able to listen to the dialogue of the play in their own language. Translations of the play will be relayed from the theatre's projection room and picked up by a transistor receiver which will be supplied to each visitor. The receivers are equipped with earphones and a switch, which will enable the visitor to select any one of four languages.

The equipment has been installed by Philips.

The theatre management decided to use the equipment permanently after hired equipment had been employed successfully to provide a party of visitors with a German translation of the play.

# A Versatile DOUBLE-TRACE OSCILLOSCOPE

By J. H. B. Gould

This series deals with the construction of instruments based on the 5in. and 6in. cathode-ray tubes currently available on the surplus market. This and succeeding articles cover the basic instrument and progressively more advanced versions that incorporate a timebase, a.c. amplifiers, a square-wave generator and double-trace facilities. The individual constructor can decide for himself how far to go—according to his inclination and requirements. A further article will deal with the use of the instrument as an oscillograph.

**M**OST general-purpose oscilloscopes have screen diameters in the range 1in. to 6in. Where the physical size of the instrument is of secondary importance, the larger size screens provide a much better service than their more diminutive cousins. A wide range of 5in. and 6in. c.r. tubes are available at the present time, and the types quoted here have been selected on the basis of low anode voltage:

5in. screen tubes: 5AP1; 5BP1 (CV 601); 5HP1.  
6in. screen tubes: VCR97; ECR 60; E4504-B-16.

These all have medium-persistence phosphors, suitable for oscilloscope duty, and give a green trace although most types are also available in blue or white (a blue trace has advantages for oscillography).

Should a long-persistence trace be required for any reason, a type VCR517 or VCR517B would be suitable. Both have 6in. screens.

The tubes mentioned all operate satisfactorily at e.h.t. voltages between 1,500 and 2,000. The "Y" deflector plates need between 50 and 130V for maximum deflection, depending upon the e.h.t. voltage and the colour of the screen phosphor. Deflection sensitivities can be improved by lowering the anode voltages, but this tends to decrease the definition of the spot obtained and it also limits the brightness of the trace. If the e.h.t. voltage is reduced too far, the instrument would have to be viewed in a dark room!

As the two sets of deflectors within the tube are located at different distances from the screen, one

set (D3, D4) is considerably more sensitive than the other. There is usually plenty of voltage available from the sweep generator for the "X" plates whereas the "Y" plates, being supplied from the circuit undergoing examination may find themselves short of deflection voltage. For this reason, it is customary to operate the tube with the more-sensitive plates deflecting vertically. This is the case when the locating pip on the tube base points upward.

## Body of Instrument

Whether the case, chassis and front panel are acquired ready-made (the author adapted a Loran indicator for this purpose—see photographs) or whether they are built up from scratch, there are a few points which must be borne in mind.

In view of the high voltage involved, all main structural parts *must* be of metal (preferably thin sheet steel, as this assists in magnetic screening).

The main factors fixing the size of the instrument are the length of the tube, the size of the transformers that have to be accommodated and the areas of front panel necessary for the controls. The smallest overall dimensions at which constructional difficulties can be avoided will be about 12in. by 9in. by 18in. deep.

## Tube Mounting Arrangements

Cathode-ray tubes are by their nature very susceptible to the presence of magnetic fields; for this reason, the transformers are best housed behind the

TABLE I PIN CONNECTIONS & RATED HEATER VOLTS

Screen Diameter	Heater Voltage	Pin No.*									
		H	H	K	G	A2	A1	D1	D2	D3	D4
6in.	4.0	4	3	2	1	6	5, 7 10	11	9	12	8
5in.	6.3	1	11		10	7	4	3	8	9	6

\* Counting clockwise from locating pip.

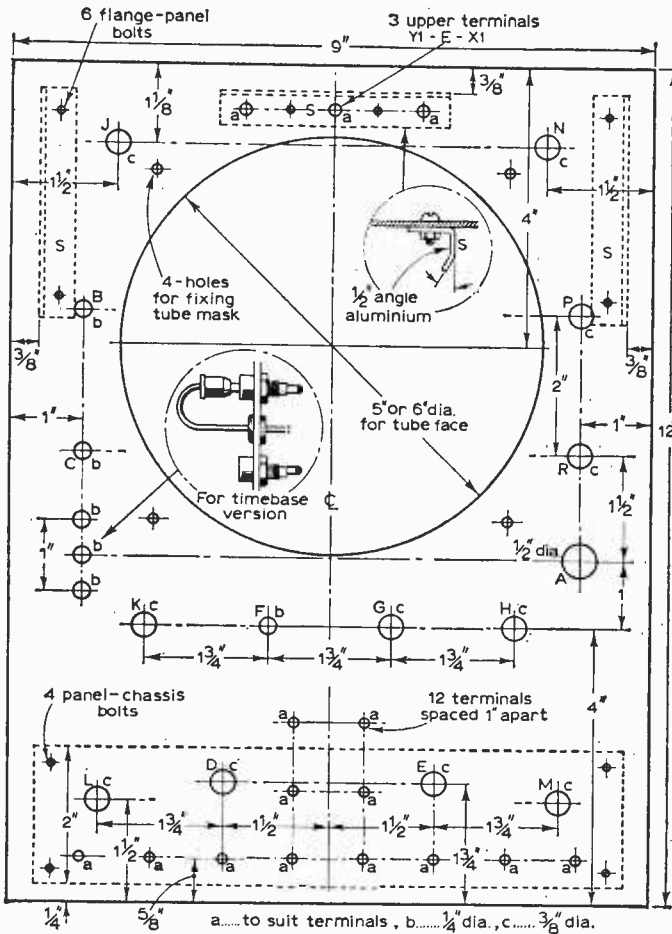

Fig. 1: Drilling details of the front panel.

tube where leakage flux can do the least harm. Nevertheless, tubes like the VCR97 can tolerate a transformer mounted immediately beneath the electron gun, provided a magnetic shield (obtainable with the tube) is used.

In this model, the method of mounting the tube is as follows: its main weight is carried on a rubber or padded-metal collar fixed to the front panel, the rear being supported by the base socket which is itself clamped by a single centre screw to a bridge erected on the chassis. This arrangement allows the whole tube to be rotated for alignment of the deflection axes. The tube shown is of the 6in. variety. Five-inch tubes rely for support at the rear on a saddle clamped over the base socket, allowing much the same freedom of movement for adjustments.

If a transformer has to be mounted below the tube, it should lie exactly on the centre line of the chassis, as far as the rear as possible, flat and with its winding limb aligned along the long axis of the tube. If a sharply-defined spot cannot be found with this arrangement, the situation can usually be improved by rotating the tube shield through a few degrees one way or the other (but not with the instrument switched on).

**Types of Instrument**

The four types of instrument to be described are:

- (1) A simple, basic oscilloscope.

TABLE 2 KEY TO FRONT PANEL DRILLING

TYPE OF INSTRUMENT	'LIVE' TERMINALS	CONTROLS
1 Basic Oscilloscope	X a.c. X d.c. Y a.c. Y d.c. Mod. (Intensity)	Mains Switch (S2) A Intensity (VR4) B Focus (VR3) C Y-Shift (VR1) D X-Shift (VR2) E
2 Timebase Version	External Sync. Dummy for above Calibration Sweep-generator output	X-Selector (S3) F Sweep Amplitude (VR6) G Sweep Frequency (VR7) H Sweep Sync. (VR5) J
3 Amplifier Version	Trace-Splitter Sync. Dummy for above	Y-Selector (S4) K A1 Gain (VR8) L A2 Gain (VR9) M
4 Trace-Splitter Version		Trace-Splitter Sync. (VR12) N Trace-Splitter Frequency (S5) P Trace Separation (VR10) R

Plus earth terminals as required. Alternatively, the mains switch may be incorporated with the intensity control.

- (2) As (1), but with time-base.
- (3) As (2), but with a.c. amplifiers.
- (4) As (3) but with square-wave generator and beam splitter circuit.

One type can become the next, merely by acquiring the necessary components. However, it is not an easy matter to cut holes in the chassis or panel for additional components when the 'scope is partly constructed; therefore it is a good idea to decide what will eventually be required right at the beginning, and carry out the necessary panel and chassis drilling before attempting anything further. Figs 1 and 2 and Table 2 give this information for each type of instrument.

**Front Panel**

With the exception of the intensity and focus controls (see below), the layout of controls and terminals on the front panel is a matter of convenience and personal preference. The arrangement indicated in Fig. 1 is recommended as having proved very satisfactory in practice. It should be noted that all the drilling required for stages 1 to 4 inclusive is given on this diagram. As previously mentioned, it is prudent to consider carefully one's likely future requirements, and so to provide for the fitting of additional components — although maybe it is intended only to proceed as far as stage 1 or 2 for the present.

The purpose of the various holes can be established by referring to Table 2.

**Rotary Switches**

Table 3 gives details of the selector switches required for the different type of instrument. Using this information in preference to that appearing on the circuit diagrams will prevent fitting a switch that is inadequate for its final task.

**The Chassis**

The most convenient place for the octal valveholders is near the sides of the chassis where they are easy to get at. The e.h.t. rectifier is conveniently mounted on an insulation-strip "sub-chassis" fixed to the tube base support bridge.

This valve requires a "B4" type of valveholder. In addition to the e.h.t. transformer, instruments

**Key to valve sockets in Fig. 2:** instrument type (2)—A h.t. rectifier; B sync amplifier; C sweep generator; D sweep amplifier; type (3)—E and F amplifiers; type (4)—G trace-splitter; H and J spares.

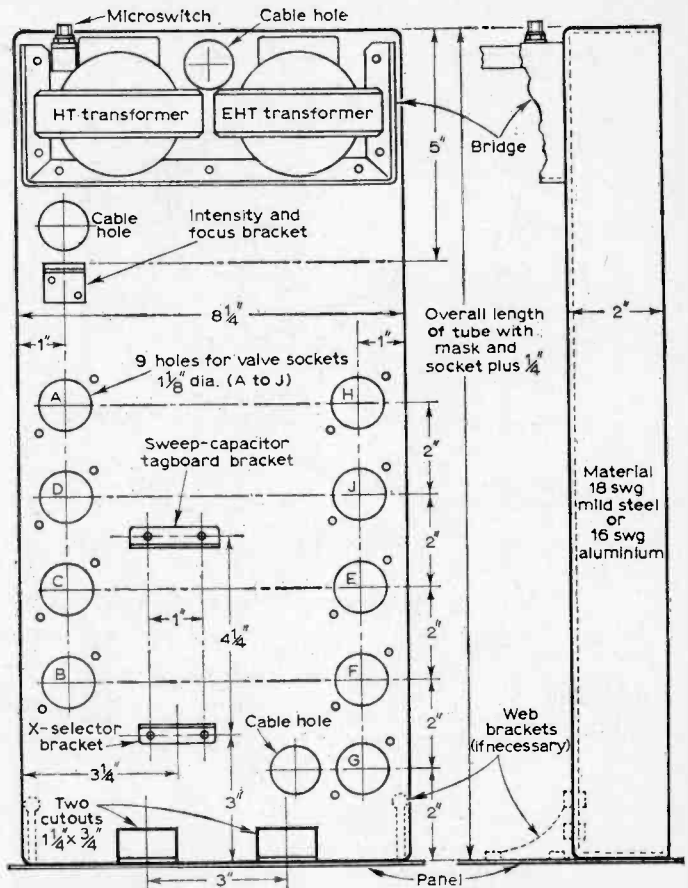

Fig. 2: Chassis dimensions. The two brackets in the lower centre of the chassis are required for instruments type 2, 3 and 4.

**TABLE 3 ROTARY SWITCHES**

Type of Instrument	S3	S4	S5
1	—	—	—
2	2-pole 7-way	—	—
3	3-pole 7-way	3-pole 4-way	—
4	3-pole 7-way	4-pole 4-way	2-pole 4-way

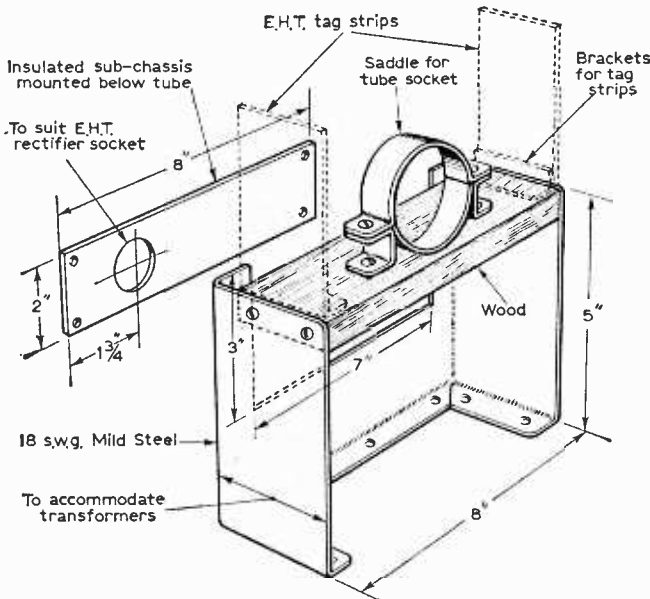

Fig. 3: Bridge assembly for American type tubes.

of type 2 and above will require an *h.t.* transformer, for which space must be found.

In Fig. 2 are full details for making and drilling the chassis.

The construction of two different types of bridge assembly for supporting c.r.t.s of either British or

American manufacture is covered in Figs. 3 and 4.

**Tube Supply Network**

The best place for the high-voltage members of the tube resistor chain is at the rear of the instrument, near to the tube base, and rigidly supported (on a tag-strip, for example). This chain includes the focus and intensity controls (VR3 and VR4) which stand at over 1,000V above earth. These controls can take the form of ordinary potentiometers as long as they are mounted, *not* on the front panel, but on an insulating strip fixed near the back of the instrument with the rest of the e.h.t. chain. Drive from the control knobs is carried along two, 1/4 in. diameter paxolin rods which pass through bushes on the panel, along the length of the tube and are then coupled to shafts of the potentiometers.

**E.H.T. Supply**

The e.h.t. supply is derived from a transformer having a 1,250 to 1,650V secondary, with 2V and 6.3V (tapped at 4V) windings for the e.h.t. rectifier and the c.r.t. heaters respectively. A half-wave valve rectifier is specified. If an e.h.t. metal

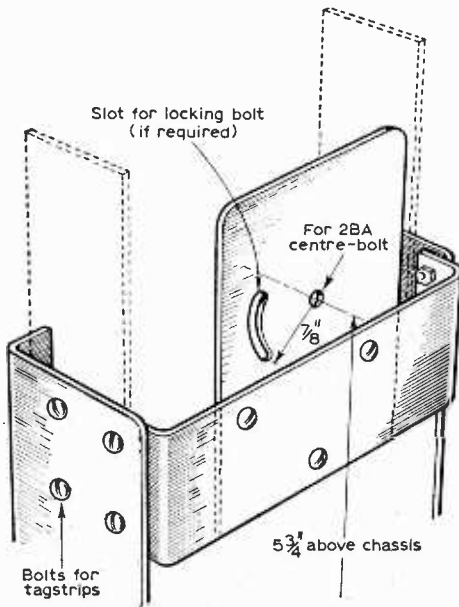

Fig. 4: Construction of the bridge mount for British tubes.

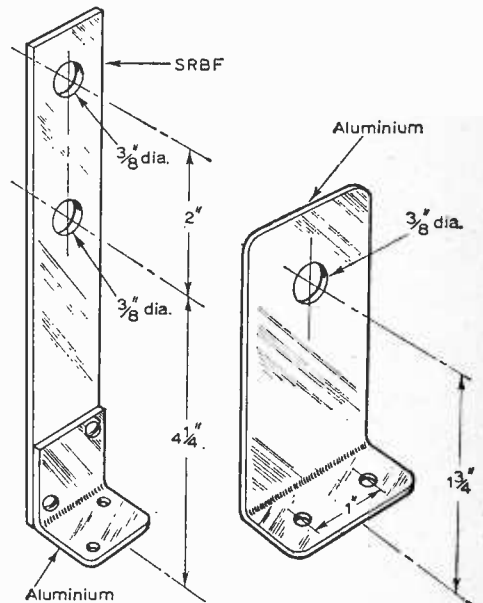

Fig. 5 (left): The bracket for the intensity and focus controls.

Fig. 6 (right): Bracket for the X-selector switch.

rectifier is preferred, the "+" or red side should be connected to the transformer; no 2V winding is then necessary. The circuit diagram of the e.h.t. section appears in Fig. 8.

**Precautions—**

The voltage on the tube is between 1,500 and 2,000V and would certainly be lethal if mishandled. The mains plug **MUST** be removed from its socket before any adjustments are carried out. It is also a good idea to include the interlock switch of Fig. 8. This takes the form of a normally-open microswitch, mounted at the extreme rear of the chassis in such a way that its plunger bears against the back wall of the case. It does not isolate the instrument from the mains, but at least it removes the most dangerous voltages should the case be opened with the mains plug inadvertently left in.

If the oscilloscope develops a fault of the "no trace" variety, short-circuit the live side of the e.h.t. smoothing capacitors to the chassis with a well-insulated tool before investigating the trouble. The fault could be due to a break in the voltage-divider network, which would leave a dangerous charge on these capacitors for some time after the instrument has been switched off.

**Shift Controls (Simple Oscilloscope)**

The circuit given in Fig. 7 is for instrument types 2 and above. If an instrument of type 1 only is required, there is one difference in this circuit and it concerns the shift controls.

Oddly enough, adjusting the position of the spot in the simple form of oscilloscope presents more difficulties than it would if the instrument were

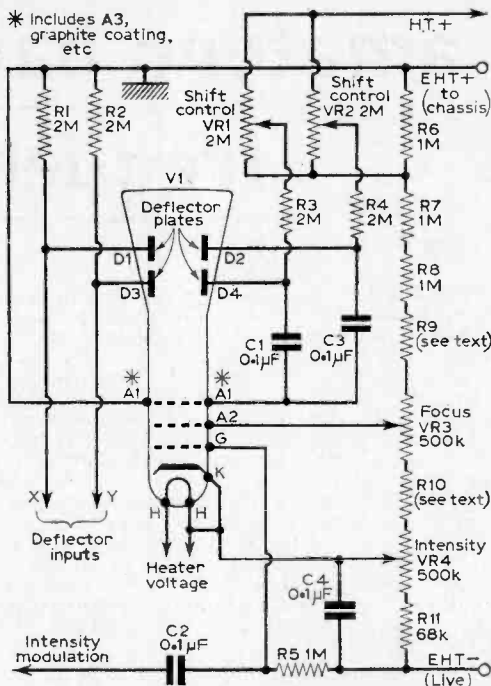

Fig. 7: Supply network for the cathode-ray tube.

equipped with a timebase. This is because there is no h.t. to balance the shift voltage.

There are two possible alternatives: If the oscilloscope is to be used for comparing a.c. values only, the positive end of the shift potentiometer should be connected to earth; R6 of Fig. 7

—continued on page 461

**COMPONENTS LIST FOR INSTRUMENT TYPE 1**

(basic oscilloscope Figs. 7 and 8)

**Resistors:**

- R1 2MΩ
- R2 2MΩ
- R3 2MΩ
- R4 2MΩ
- R5 1MΩ
- R6 1MΩ
- R7 1MΩ
- R8 1MΩ
- R9 } see text
- R10 }
- R11 68kΩ
- R12 470kΩ

All 10%, 1/4W carbon

- VR1 2MΩ carbon potentiometer
- VR2 2MΩ carbon potentiometer
- VR3 500kΩ carbon potentiometer
- VR4 500kΩ carbon potentiometer with d.p. switch (S2)

**Capacitors:**

- C1 0.1μF paper 350V
- C2 0.1μF paper 350V
- C3 0.1μF paper 350V
- C4 0.1μF paper 350V
- C5 0.1μF paper 3,000V
- C6 0.1μF paper 3,000V

**Valves:**

- V1 5AP1; 5BP1 (CV601); 5HP1 (5in. screens) VCR97; ECR60; E4504-B-16 (6in. screens)
- V2 SU2150A; VU120; HVR2A

**Transformer:**

- T1 Mains (e.h.t.) transformer. Tapped primary. Secondaries: 0 to 1,250—1,650V 5mA; 2V 1.5A; 6.3V (tapped at 4V) 1A.

**Switches:**

- S1 Microswitch
- S2 d.p. on/off switch (may be incorporated in VR4)

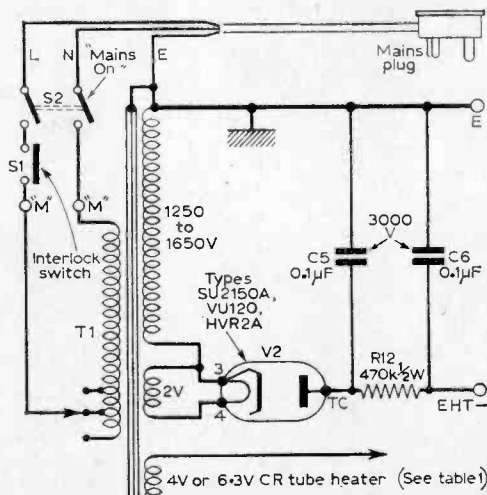

Fig. 8: The e.h.t. power supply.

# amateur band frequency checking

By F. G. Rayer

SHORT-WAVE listeners often use some means of locating the exact limits of an amateur band as the tuning scale calibration of many receivers is not sufficiently accurate for this purpose. When transmitting, an accurate means of frequency checking is essential to avoid operating outside the permitted bands. Various methods of frequency checking are thus very useful, for both receiving and transmitting, and especially with home-built equipment.

For locating amateur bands and harmonics a wavemeter or absorption frequency meter is often employed. When accurate checking over a very narrow band of frequencies (such as a single amateur band) is needed, some form of heterodyne frequency meter is generally used in conjunction with a receiver. This also allows calibration for receiving purposes.

## Absorption Meter

This is extremely useful for checking oscillator, multiplier and output stages of a transmitter to see that circuits are tuned to the correct harmonics. For example, a 1.85Mc/s oscillator might be followed by a doubler for 3.7Mc/s working. With home-built equipment and home-wound coils the 3.7Mc/s circuit might easily be tunable to the third harmonic of 5.55Mc/s as well as the required second harmonic (3.7Mc/s). To avoid this the absorption meter may be used to give a quick check.

The usual absorption meter circuit is shown in Fig. 1 and it may be built with a fixed coil or plug-in coils. With 1½ in. diameter formers, eight turns occupying about 1 in. will cover approximately 40Mc/s—10Mc/s, while 26 turns will cover about 10Mc/s—3.3Mc/s. Other coil sizes and capacitor values are equally suitable.

To check oscillator, multiplier or p.a. stages the absorption coil is held in line with the equipment coil. When the absorption meter is tuned to the correct frequency it draws power, thus causing a small movement on the grid or anode current meter of that stage. The meter is best calibrated for 3.5, 7, 14, 21 and 28Mc/s bands. It will then show at once that multiplier or other stages are working on the harmonics required to avoid out-of-band operation.

If a t.r.f. receiver is adjusted until its detector is just oscillating the absorption meter will stop

this oscillation when it is tuned to the same frequency as the receiver. This offers a simple method of finding amateur or other bands on a home-built t.r.f. receiver.

## Indicating Device

An indicator may be added to the absorption meter, using either of the circuits in Fig. 2. The instrument is then suitable for checking circuits not equipped with a grid or anode current meter.

Care is needed if a 1mA or similar meter is used, as sufficient r.f. can easily be picked up to damage the meter. Sensitivity may be reduced by adding a resistor in one meter lead. The instrument is particularly useful for low power oscillators.

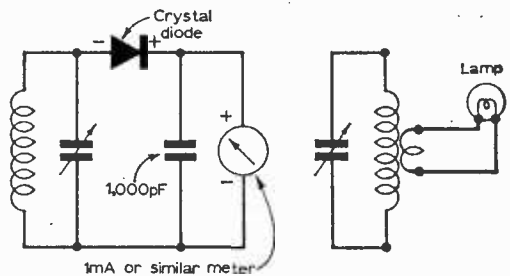

Fig. 2: Two absorption meter circuits including some form of indicator.

If a lamp is used this can be 6V 0.06A for low-power circuits or 6.3V 0.3A for average purposes. The instrument can be built in very portable, compact form and is useful for quick checking of oscillator, buffer, multiplier and output stages.

Absorption meters give reasonably accurate indications if loosely coupled to the circuit being checked. They are, however, really intended for location of the tuning position of any band or for ascertaining harmonics, not for exact calibration within a single band. Loose coupling increases accuracy of readings.

## Crystal Standard

For exact measurement within a single band a crystal marker is most often employed in conjunction with the station receiver. This allows calibration of the receiver or of a transmitter variable oscillator.

A typical marker circuit, incorporating a 100kc/s crystal, is shown in Fig. 3. The harmonic amplifier stage V2 is optional. If it is omitted

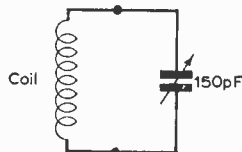

Fig. 1: The absorption frequency meter.

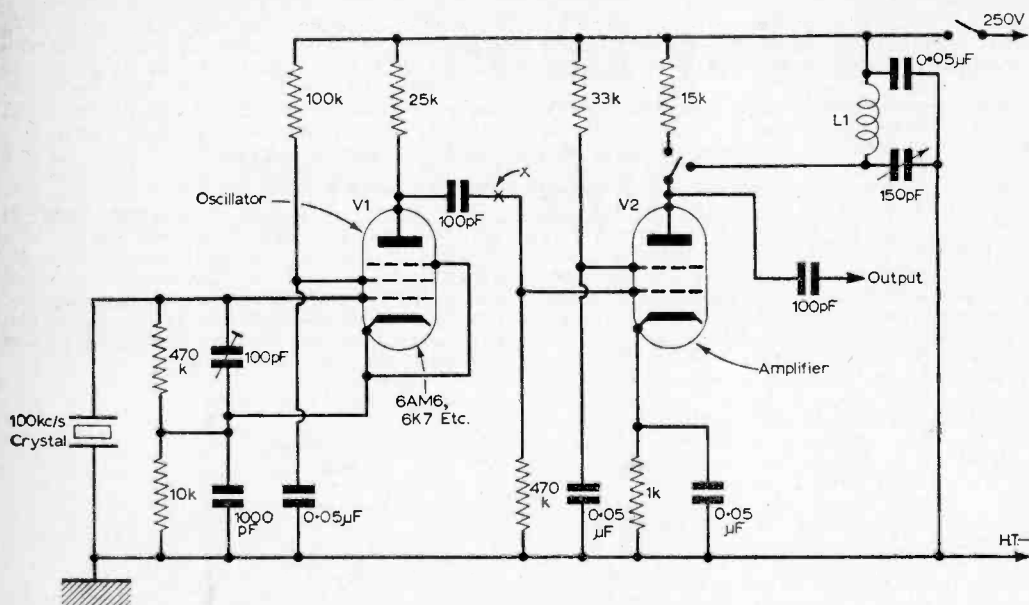

Fig. 3: A crystal marker circuit with optional harmonic amplifier.

the output is taken from the 100pF capacitor at X. In these circumstances harmonics of a 100kc/s crystal may be heard up to perhaps 10Mc/s to 15Mc/s or so with a sensitive receiver. With a less sensitive receiver harmonics may be lost much earlier, so that they cannot be found beyond 2Mc/s to 4Mc/s or so.

#### Optional Amplifier Stage

If the harmonic amplifier is added it may be left unused by employing the 15kΩ resistor as anode load. To increase harmonic output L1 is switched in and roughly tuned to the harmonics needed. If increased coverage is required, further coils can be used at L1. The amplifier can be any high-gain tetrode or pentode.

Power for a crystal marker can usually be drawn from the receiver; alternatively a small power pack may be used if available. If required a power unit may be constructed especially for the marker. A suggested simple circuit is shown in Fig. 4.

If the marker employs a 100kc/s crystal (which is generally convenient) its output will be on 100kc/s and multiples of 100kc/s. Early harmonics, such as 600, 700, 800, 900 and 1,000kc/s (1Mc/s), will be heard throughout the medium waveband. For amateur band calibration the harmonics of interest will be those on 1.8, 1.9 and 2Mc/s (160m band); 3.5, 3.6, 3.7 and 3.8Mc/s (80m band); 7 and 7.1Mc/s (40m band); 14, 14.1, 14.2, 14.3 and 14.4Mc/s (20m Band); 21, 21.1, 21.2, 21.3 and 21.4Mc/s (15m band) and from 28Mc/s upwards (10m band).

The oscillator may be tuned to zero beat with the 200kc/s Light Programme or to the 2.5Mc/s National Physical Laboratory station by adjusting the 100pF trimmer. A short aerial is used and coupling from the marker is adjusted, if necessary, so that the marker signal is of similar strength to

the station tuned in. Any difference in frequency between the station and marker harmonic will be heard as a rapid fluttering sound or will produce a rise and fall on the receiver tuning indicator if fitted. The difference is reduced to the minimum by adjusting the trimmer. The degree of accuracy achieved can easily be much higher than demanded by the GPO for amateur transmitters.

To calibrate a receiver the required harmonics are tuned in and the receiver dial is marked. To

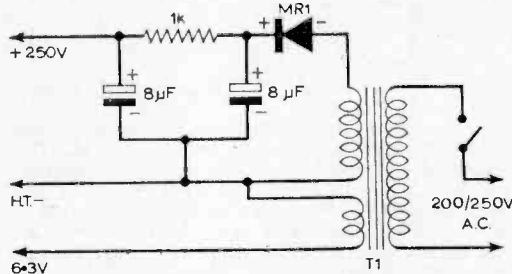

Fig. 4: A power pack for the crystal marker.

calibrate a transmitter v.f.o., tune in the required marker harmonics on the receiver and adjust the v.f.o. to zero beat with the marker signal. The v.f.o. dial can then be drawn up to suit. Where the edge of a band falls between two marker harmonics the dial can be equally divided, to arrive at this point, provided the capacitor is not near either extreme setting.

#### Crystal Calibrator No. 10

The surplus crystal calibrator No. 10 is equipped with a 500kc/s crystal, mixer and tunable oscillator and harmonics may be heard up to 10Mc/s to



30Mc/s according to receiver sensitivity. The h.t. supply required is up to about 300V at 10mA to 15mA and this can generally be taken from the receiver.

In its original form the calibrator required 12V at 0.3A for the valve filaments. This supply may be obtained from dry batteries but is a little inconvenient.

The valve filament requirements may be reduced to 3V at 0.3A by disconnecting R19, VR1 and R20, as shown in Fig. 5. A two-cell dry battery may then be used. The valves actually have 1.4V 0.1A filaments, but the filament chokes are 30 ohms, so operation from a two-cell battery is in order. Power connections are as in Fig. 5. V1 (not shown in the diagram) is a neon modulator and therefore requires no filament supply.

value at first. A preset further smoothing capacitor R2 because it would charged if the calibrator switch were always to switch off by disconnecting from the 6.3V supply, thus excessive filament voltage.

**Using the Calibrator**

The calibrator is used in the described for the 100kc/s mark crystal harmonics are heard at 500. These may be used as calibration already explained. With the tunable switched in, the dial indicates megacycles decimal places and this will allow through a particular amateur band.

407  
is convenient. No higher voltage with the rectifier momentary

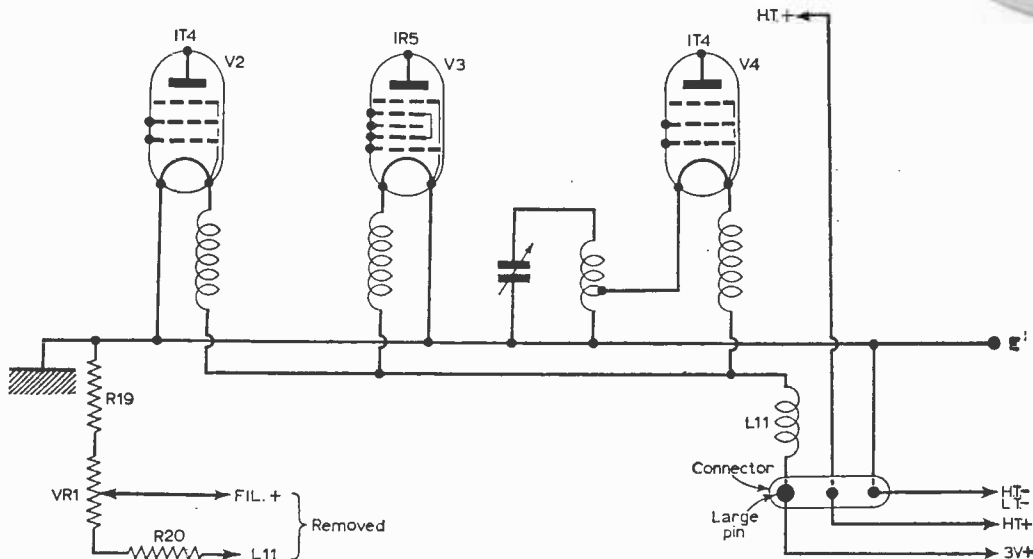

Fig. 5: The crystal calibrator No. 10 power supply circuit.

To avoid the use of any battery filament current can be taken from the circuit given in Fig. 6. This is connected to the 6.3V heater line of the receiver, which will also be used to provide h.t. In a unit of this kind, built for the No. 10 calibrator, MR1 was a 12V 0.5A rectifier. R2 is 470 ohms and R1 is adjusted until the filaments receive approximately 1.3V. In the unit built R1 was 17 ohms, but it would be wise to check the voltage with a higher

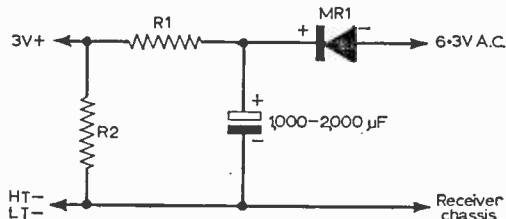
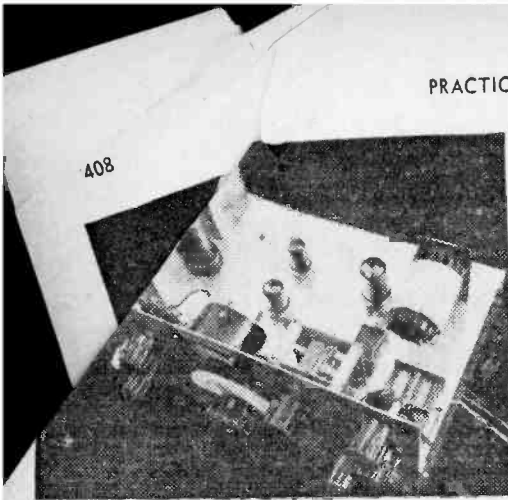

Fig. 6: The calibrator filament supply.

The amateur bands are 1.8—2, 3.5—3.8, 7—7.1, 14—14.35, 21—21.45 and 28—30Mc/s.

A receiver should be switched on at least 15-20 minutes before calibrating it, and this also applies to a v.f.o. if not temperature compensated. When calibrating a v.f.o. with a crystal marker the receiver calibration is of no importance as the receiver is merely used to find zero beat between the v.f.o. and marker harmonic. The marker in Fig. 3 produces c.w., so the usual b.f.o. is required to obtain an audible tone. With a t.r.f. receiver an audible tone will be heard if the detector regeneration is sufficiently advanced to cause oscillation.

Occasionally an amateur band crystal is used to identify one edge of the usual amateur bands. For example, if a 3.5Mc/s crystal oscillator is employed its fundamental will be heard on 3.5Mc/s and harmonics on multiples of this frequency, which include 7, 14, 21 and 28Mc/s. Failing this, a listening check will soon show if the correct 100kc/s (0.1Mc/s) harmonics to calibrate a band have been used.



# A Top Band R.T. Transmitter

By G3OGR

Continued from page 324 of the August issue

FIG 4 shows the underside of the chassis, components in each stage being kept clear of those in other stages, to avoid instability. In these circumstances, no neutralising is required. All leads carrying r.f. should be short and direct. Bypass capacitors and associated resistors should be near the valveholder tags, and all construction should be rigid.

### Constructing the V.F.O.

The v.f.o. coil L1 is a single winding medium wave oscillator coil, with adjustable core permitting variation on inductance from about 70 to 130 $\mu$ H. Adjustment of the frequency coverage obtained by VC1 is possible by means of TC1, and modification of the core position. The aim is to get a coverage of approximately 1.8-2Mc/s with the full 180 degrees rotation of VC1. As the exact values of C4 and C5 have some influence on frequency coverage, it might in some cases be necessary to replace C1 by a fixed capacitor of other value than that shown.

When wired, the v.f.o. can be tested by listening for the carrier with a receiver, and this allows frequency coverage to be adjusted. Space is available to fit a ball drive to VC1, but this was found rather unnecessary, if a large control knob is used. The knob has a cursor, reading against a scale cemented to the panel. Final calibration of this scale should be left until construction is finished.

In Fig. 4, lead Y from R3 passes along against the chassis and front runner, to tag Y of the "Tune" switch, so that h.t. is applied to v.f.o. and buffer, when this switch is closed.

### Buffer Stage

Tag 6 of V2 is connected by the lead A to the slider of the drive potentiometer VR1. Tag B on VR1 goes to R6, as in Fig. 4.

L3 is a medium wave single winding aerial coil, with core, and inductance adjustable from about 130-215 $\mu$ H. Stray circuit capacity allows the coil to be resonated at about 1.9Mc/s. This is done, when the r.f. section is complete, by switching the

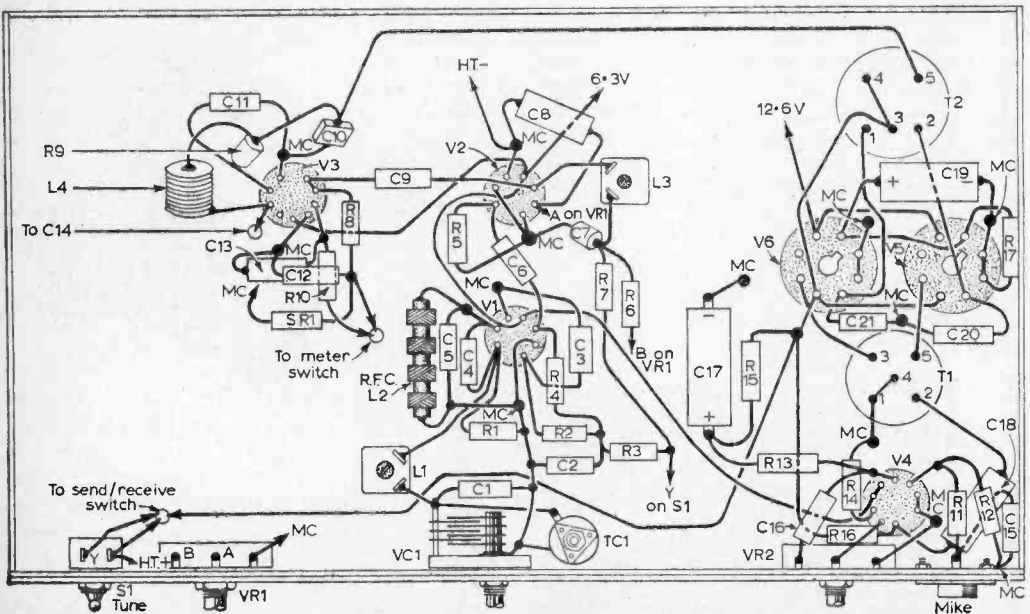

Fig. 4: The complete underchassis wiring diagram.

# THE WHARFEDALE Super Range

Each loudspeaker in this range is fitted with roll surround for low resonance and double diaphragm assembly for extended HF response.

## SUPER 10/RS/DD

Impedance 10/15 ohms.  
Flux density 16,000 oersteds.  
Max. input 10 watts rms  
or 20 watts peak.  
Frequency range 30-20,000 c/s.  
Aluminium Voice Coil.  
Roll surround and double  
diaphragm.  
Bass resonance 38/43 c/s.  
Price: 218/8 inc. P.T.

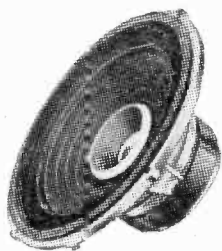

## SUPER 8/RS/DD

Impedance 10/15 ohms.  
Ceramic Magnet.  
Flux density 14,500 oersteds.  
Total flux 60,000 maxwells.  
Aluminium Voice Coil.  
Max. input 6 watts rms  
or 12 watts peak.  
Frequency range 40-20,000 c/s.  
Bass resonance 50/60 c/s.  
Price: 134/2 inc. P.T.



Write for information and fully illustrated 12 page booklet

## SUPER 12/RS/DD

Impedance 12/15 ohms.  
Flux density 17,000 oersteds.  
Total flux 190,000 maxwells.  
Aluminium Voice Coil.  
Max. input 20 watts rms  
or 40 watts peak.  
Frequency range 25-20,000 c/s.  
Bass resonance 26/32 c/s.  
Price: 350/- (no tax).

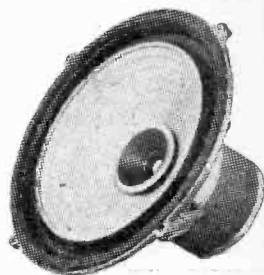

# Wharfedale

WHARFEDALE WIRELESS WORKS LTD  
IDLE, BRADFORD, YORKSHIRE

Telephone: Idle 1235/6.

Telegrams: 'Wharfedel' Idle, Bradford.

# IMPROVED

Modern styling in light grey with legible black engraving.

Constructed to withstand adverse climatic conditions.

Ever ready case, including leads, prods and clips.

Improved internal assemblies.

Re-styled scale plate for easy rapid reading. 2 basic scales, each 2.5 inches in length.

New standards of accuracy, using an individually calibrated scale plate.  
d.c. ranges 2.25% f.s.d.  
a.c. ranges 2.75% f.s.d.

Available accessories include a 2500V d.c. multiplier and 5, 10 and 25A shunts for d.c. current measurement.

STANDARDS OF



# ACCURACY AND RELIABILITY

The Mk. 4 MULTIMINOR is an entirely new version of this famous Avo instrument and supersedes all previous models. It is styled on modern lines, with new high standards of accuracy, improved internal assemblies, and incorporating panclimatic properties.

The instrument is supplied in an attractive black carrying case, which also houses a pair of leads with interchangeable prods and clips, and an instruction booklet. It is packed in an attractive display carton. Robust real leather cases are available, if required, in two sizes, one to take the instrument with leads, clips and prods, and the other to house these and also a high voltage multiplier and a d.c. shunt.



Mk 4

# MULTIMINOR

D.C. Current: 100µA f.s.d. — 1A f.s.d. in 5 ranges      RESISTANCE: 0-2MΩ in ranges using 1.5V cell.  
A.C. Voltage: 10V f.s.d. — 1,000 V f.s.d. in 5 ranges      SENSITIVITY: 10,000Ω/V on d.c. Voltage ranges.  
D.C. Voltage: 2.5V f.s.d. — 1,000 V f.s.d. in 6 ranges.      1,000Ω/V on a.c. Voltage ranges.  
D.C. Millivolt range: 0 — 100mV f.s.d.

● For full details of this great new pocket-size instrument, write for descriptive leaflet.

**AVO LTD**

AVOCET HOUSE - 92-96 VAUXHALL BRIDGE ROAD - LONDON, S.W.1 - Tel: VIctoria 3404



MM17

**THE  
PEMBRIDGE  
COLLEGE  
OF ELECTRONICS  
PROVIDES TRAINING  
IN RADIO  
AND TELEVISION**

## ATTENDING COURSE

Full-time One-Year Course in Radio and Television. College course in basic principles for prospective servicing engineers.

Next course commences 3rd September, 1963. This course is recognised by the Radio Trades Examination Board (R.T.E.B.) for the Radio and Television Servicing Certificate examinations. Provides excellent practical experience on valve and transistor radio receivers and all well-known makes of television receivers.

To:

**The Pembridge College of Electronics (Dept. P11)  
34a, Hereford Road, London, W.2**

Please send, without obligation, details of the One-Year Course.

Name \_\_\_\_\_

Address \_\_\_\_\_

meter to read grid current. The v.f.o. is adjusted to 1.9Mc/s, and the core of L3 is rotated until maximum grid current is obtained. Tuning should be quite flat, and if the v.f.o. is adjusted to 1.8Mc/s or 2Mc/s there should only be a small drop in grid current.

V2 is also operating when the "Tune" switch is closed. VR1 is adjusted so that the meter shows the correct grid current for V3.

**Power Amplifier**

The power amplifier is V3. The r.f. choke L4 is fitted vertically. A hole is drilled as near to tag 7 of the valveholder as possible, and the anode lead goes directly through this hole to C14. The tank coil L5 consists of 55 turns of 24s.w.g. or 26s.w.g. wire, on a 1½in. diameter or similar former. The former is bolted to a strip of paxolin, mounted vertically above the chassis by a bracket (Fig. 3).

VC2 needs to be 250pF or larger, and a receiver type tuning capacitor was found satisfactory. A midget component, with very small spacing between plates, is unsuitable. A capacitor of average size, if clean and correctly spaced, should not spark over. If it does so, it may need cleaning, or adjusting.

VC3 is a 2-gang or 3-gang broadcast receiver type capacitor, and as this will generally be adjusted for a fairly low impedance output, no possibility of sparking over should be expected. A total capacity of at least 1.000pF (2x500pF) is required for many aerials. If a 3-gang capacitor is to hand, the extra capacity may be useful, with some aerials. But if any particular aerial requires an increase in capacity here, this can be made up by shunting a fixed mica capacitor across VC3. VC2 and VC3 are both bolted to the panel.

**The A.F. Modulator**

This section is very straightforward. A screening can is used over the double-triode V4. With the driver transformer T1, tags 1 and 2 are the primary; tags 3, 4 and 5 are the secondary, tag 4 being the centre tap. Other push-pull input transformers can be wired in the same way once the terminations have been identified.

The primary of the modulation transformer T2 is tags 1, 2 and 3, tag 3 forming the centre tap; tags 4 and 5 are the secondary winding. If other modulation transformers or modulator valves are employed, the ratio may readily be found. To do this, divide the p.a. stage h.t. voltage by the current drawn by the p.a. valve. Divide the resultant figure by the optimum load specified by the valve data for the valves V5 and V6, and extract the square root. This is the required ratio.

A coaxial socket is fitted to the panel, for the microphone lead, which is screened in the usual manner. The gain control VR2 is adjusted so that adequate modulation is achieved, at normal voice level, with the microphone at a convenient distance.

**Meter Switch and Shunts**

The meter switch S2 has two positions, so that grid current or cathode current may be read. When reading grid current, the positive meter terminal

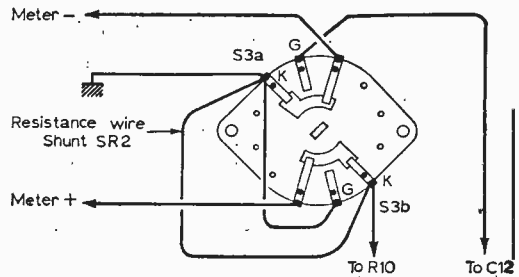

Fig. 5: The wiring of S3.

goes to chassis. Shunt SR1 is in parallel with the meter, and also serves to complete the grid circuit, when the meter is reading cathode current. When cathode current is observed, the negative meter terminal is connected to the chassis, and shunt SR2 provides a suitable full-scale deflection.

Fig. 5 shows the meter switch wiring. The meter may be a 1mA, 2mA, 5mA, or even 10mA instrument. If the meter is suitable for grid current readings without a shunt, then resistor SR1 can be 1kΩ, which will have little effect on meter readings. But if a 1mA or other fairly sensitive instrument is fitted, SR1 must be selected to give a suitable range. The value of SR1 may be found by trial, or can be calculated as follows: subtract 1 from the number of times the full-scale deflection is to be increased, and divide the meter resistance by the resultant number. This gives the shunt value in ohms.

Shunt SR2 has to be of very low value, and is soldered directly to the switch, as in Fig. 5. A short piece of 24 s.w.g. or similar resistance wire can be used, the length being adjusted until the meter range is suitable for the cathode current.

Ranges of 0-5mA for grid current, and 0-100mA for cathode current, would do well. The meter actually fitted was a converted thermocouple instrument, with the thermocouple removed. As shunts were being made, it was decided to provide ranges of 0-4mA and 0-80A, so that normal operating points of 2mA and 40mA would give a half-scale reading.

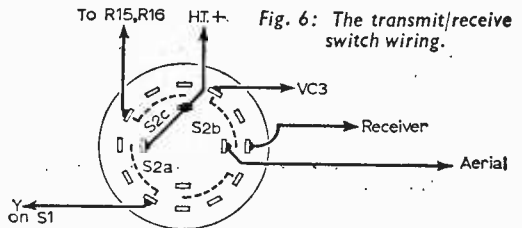

Fig. 6: The transmit/receive switch wiring.

**Transmit-Receive Switch**

Wiring to the transmit-receive switch S2 is shown in Fig. 6: One pole switches the aerial to L5 for transmitting purposes, and to the receiver aerial terminal for receiving.

Two poles switch the h.t. positive circuit, so that h.t. is applied to the h.t. modulator line, and to V1 and V2, when the switch is in the transmit position.

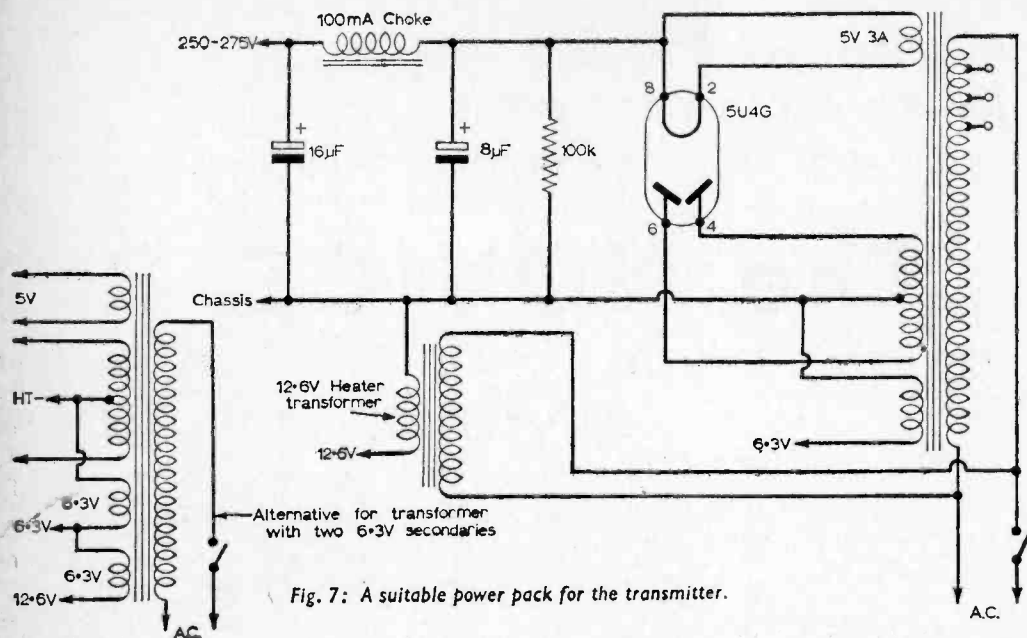

Fig. 7: A suitable power pack for the transmitter.

#### "Tune" Switch

The "Tune" switch S1 is in parallel with one section of the transmit-receive switch, so that h.t. may be applied to V1 and V2 only, for tuning-up purposes.

If desired, any spare contacts on the switch can be wired to the receiver loudspeaker, to silence this when the transmitter is working. Whether this is required depends to some extent on the layout of equipment, type of receiver, etc. Feedback from loudspeaker to microphone will cause howling, unless volume is kept low.

#### Power Pack

This can be of usual type, and a suitable circuit is shown in Fig. 7. The h.t. requirements are about 80-100mA at 250V to 275V. The l.t. requirements are 6.3V and 12.6V for heaters.

The power pack can be situated anywhere convenient, and coloured flexible leads or a 4-pin plug and socket, appropriately wired, may be used for connecting purposes.

Power pack and all heaters are left running continuously, in the normal way, when the equipment is in use.

#### Operating

As a fairly large number of amateurs begin working on top band, some details on operating may be useful.

The transmitter may be tested with a dummy load, such as a 15W or 25W household lamp. The lampholder is wired from aerial lead to transmitter chassis. VC3 is closed.

The v.f.o. is adjusted to the frequency required, and the "Tune" switch is closed. The meter is switched to read grid current, and VR1 rotated

to obtain approximately 2mA. The "Tune" switch is then opened.

The meter is next switched to read cathode current, and the transmit-receive switch is turned to the transmit position. A rather high current reading will probably be obtained, and VC2 should be rotated to find the dip in cathode current, which will be very much lower. The lamp load should glow, showing that r.f. current is being produced. To increase loading, VC3 is slowly opened, VC2 being re-adjusted as necessary to keep the p.a. tuned for minimum current. As loading is increased in this way, the minimum current will increase, and the lamp will light more strongly. Loading is adjusted until the p.a. draws 40mA, if a 250V supply is used. This represents a little under 10W input. Sufficient r.f. should be produced to light a 15W lamp quite well.

In normal operation, a reply can be made to a station calling CQ. To do this, tune the v.f.o. to the calling station's frequency, and adjust the loading. When the station stands by, the transmitter is switched on, and a reply made.

Alternatively, a clear space in the band may be sought on the receiver, and the v.f.o. then be tuned to this frequency, by listening for the carrier on the receiver. The transmitter is then switched on and loaded up, and a CQ call can be made. The switch is then turned to receive, for replies.

Any usual transmitting aerial can be employed. End-fed wires are quite often used. Loading, with the aerial, is adjusted in the same way as described for the lamp. It must be appreciated that the impedance of the aerial, which depends on the aerial length and other factors, will influence the setting of VC3. ■

*No soldering is necessary to construct this portable receiver and it will thus prove to be an ideal set for the beginner to build*

# The NOVICE 3

By D. B. Pitt

**T**HIS receiver is a pocket-size, three-transistor, reflex, medium-wave receiver whose sensitivity should be good enough for local station reception in most areas. A long waveband may be added later. A simplified version for *good reception areas* is described at the end of this article.

There is nothing particularly novel about the circuitry, but some of the practical methods used in construction may be of interest and offer some new ideas to the reader.

The circuit is laid out on a wooden baseboard and pressure contacts may be used for all but five of the twenty or so junction points.

Alternatively, solder tags may be used instead of brass washers for the various points on the board and all components soldered into position to make a more permanent job of the receiver.

Some readers who are still not too sure of their skill with the soldering iron may care to make it in the first way to gain confidence, then substitute soldered junctions at a later stage.

A detailed list of all components needed is provided.

## The Chassis

The chassis consists of a piece of good quality softwood such as deal, and the measurements must be very carefully adhered to and the wood cut with fair accuracy as it is to fit into a small plastic box of a definite size.

First, the main shape, 4in. x 2½in. x ½in. (planed) is cut out as in Fig. 1. Then three pieces are removed at X, Y and Z, using a fine saw so as to make as neat a cut as

possible. Piece Y will have to be removed, of course, with two sawcuts followed by a chisel-cut along the third side.

The baseboard can now be smoothed where necessary with fine sandpaper and tried out for a neat fit in the bottom of the plastic case.

This case is one of the small boxes often used for pieces of amateur equipment as described in this and other radio publications. It is of coloured opaque polystyrene, is manufactured by the Plastic Box Co., Market Rasen, Lincs., and is available for very little cost from many advertisers in this magazine. Its size is roughly 4½in. x 3in. x 1½in.

The fifteen small brass washers (or solder tags if needed) can now be fitted on to the board with small round-headed brass wood screws. A suitable

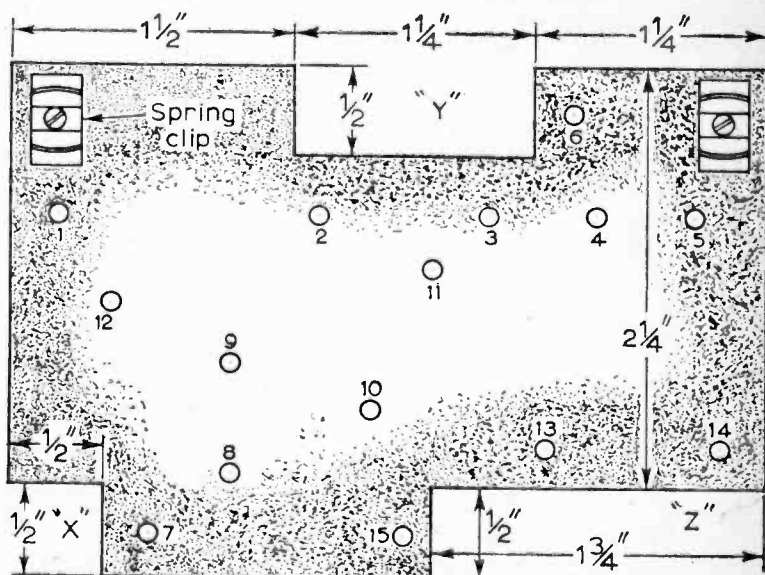

Fig. 1: A full-size chassis drawing which may be used as a template.

size will probably be  $\frac{1}{8}$  in. No. 2 gauge (a broader gauge may introduce the risk of splitting the wood at the edges), but if solder tags are to be fitted,  $\frac{1}{16}$  in. screws of the same gauge will be quite adequate for the purpose.

The layout of the contact points is important, as might be guessed when using so small a baseboard. For this reason Fig. 1 has been reproduced *exactly full size* so that the page may be carefully laid on the baseboard and the points pricked through the paper with a sharp point.

The washer at point 15 can be seen to overlap the edge of the wood a little. This is deliberate and its purpose will be explained later. The two Terry clips are of the smallest size (gauge 000) and are supplied with their own special wood screws. They may be a rather tight fit on some of the broader types of ferrite rod, but a certain amount of straining seems to have no harmful effect on these very useful little clips.

**Fitting the Main Components**

All the components used should be the smallest obtainable as this makes for easy construction.

If the reader is offered the choice of two components with different gauge wire leads he should choose the one with the *thinner or more flexible wires* as these give much less trouble when fitting.

The largest currents flowing in this circuitry are so small that thin wires are no disadvantage electrically.

There are a few points which are perhaps not immediately apparent from Fig. 2 which should be used as the main guide for mounting the smaller components.

(1) All resistors and capacitors (condensers) should be mounted flat on the board, the wires

off a piece of standard connecting wire) should be slipped over the left-hand wire lead of the 100pF capacitor C2 where this passes over the 0.005µF capacitor C1 and the 100kΩ resistor R1 (or their leads).

A similar piece of sleeving should be slipped over the right-hand wire lead connecting the 4.7kΩ resistor R4 to point where it passes over the 8µF electrolytic capacitor C4 (or its lead).

**The Three Connecting Wires**

There are only three formal connecting wires on the board. These should be of p.v.c. insulated wire (preferably miniature gauge as this is more flexible and less bulky).

The three wires are connected as follows, passing in as short a path as possible *under* the other

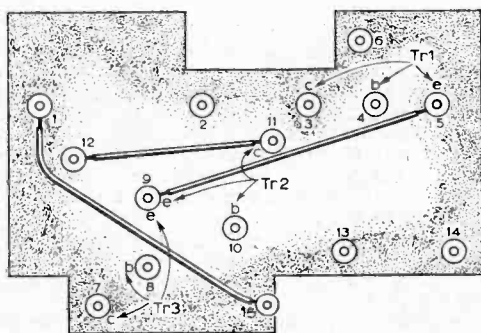

Fig. 3: The positions of the connecting wires and transistor base details.

components or their leads directly from:

- Point 1 to point 15
- Point 5 to point 9
- Point 11 to point 12

It is important that these connecting wires should be in close contact with the board by passing *under* the other components as, in this position, accidental breakage whilst handling is much less likely to occur (see Fig. 3).

**The Transistors**

The transistors are connected to the points as numbered in Fig. 3. Note that the emitters of both a.f. transistors share a common junction (point 9) and that the two paint spots which mark the collectors face away from each other. Note also the special arrangement of the r.f. transistor leads.

The transistor wire leads should not be shortened but all the wires curved gently over so that the body of each transistor rests its *side* against the lid of the case when it is closed. This curling of the leads gives a useful "shock-absorber" effect.

If at any time the transistors are soldered into position a "heat-shunt" should be used and the connection made as quickly as possible. A pair of pliers gripping the lead between the transistor body and the point of soldering is effective for this.

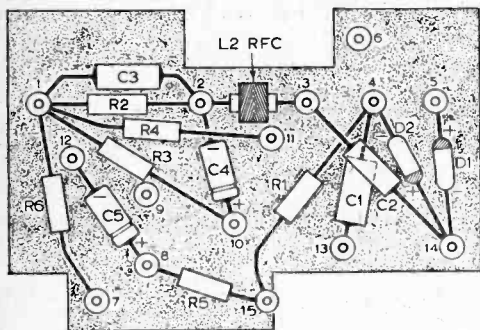

Fig. 2: Showing the arrangement of the majority of the components.

being shortened only as much as is necessary to give a firm but tidy contact.

(2) The wires of the small r.f. choke (L2) should *not* be shortened but bent to form a double crank so that the coil stands *clear of the board* roughly level with the ferrite rod.

(3) The electrolytic capacitors and the diodes *must* be connected the proper way round, the correct polarity (+ or -) being shown in Fig. 2.

For guidance the can of the electrolytic capacitor is always negative (-) and the wire emerging through an insulating bush is always positive (+). The red end of the diode indicates positive, the black or colourless end denotes negative.

(4) A short length of p.v.c. sleeving (stripped



When soldering the transistors the soldering iron must be *properly earthed* or switched off just before the joint is made if earthing happens to be difficult.

### The Earpiece Socket

The crystal earpiece recommended for this receiver is an inexpensive one generally available through numerous advertisers in this magazine.

It is supplied complete with a miniature jack-plug and socket and this latter part must be modified slightly before use. The constructor should move the jack-plug in and out of the socket a few times and note how it works.

The plug terminals make contact with the tube part of the socket and with a small springy arm which clicks into a groove towards the end of the jack stem.

Besides these two essential parts there is an extra arm that extends rigidly outside and beyond and finally hooks round the end of the springy arm.

When the jack is inserted the springy arm moves slightly away from the larger, fixed one, the resulting gap breaking the electrical contact between the two arms.

This crystal earpiece is intended for use with a small loudspeaker radio and the extra contact is provided so as automatically to switch off the loudspeaker when the earpiece is being used for private listening.

The required modification is quite simply performed. The "hook" part of the outer fixed arm is slightly straightened so as no longer to embrace the end of the smaller springy arm. It is then strained upwards away from the springy arm and the hook part then rebent to its former shape.

This outer arm is the *only* part which needs to be moved and when correctly adjusted should *just fail* to touch the springy arm when the jack is inserted. The action of the switch has, in short, been directly *reversed*. Fig. 4 should make the whole operation clear. Although it may sound complicated it is, in fact, a matter of a minute's work with tweezers or sharp-nosed pliers.

The socket is provided with three perforated tags and a 4in. length of insulated (preferably miniature) connecting wire should be soldered to each, using the minimum of solder (Fig. 5c).

### The Tuning Capacitor

The tuning capacitor is a small, compression-type, solid dielectric trimmer of around 500pF capacity.

These variable capacitors have the advantage of cheapness, small size, mechanical stability and, when used with a knob of fairly large diameter, a built-in slow-motion drive effect—a useful property which is often forgotten.

Unfortunately they are difficult to calibrate with numbers or station names, but in a set of this sort the disadvantage is a minor one.

The screw must first be removed along with its two washers, one brass, one mica or transparent plastic. The screw and the mica washer are discarded and a longer screw of the same gauge (6B.A.) is substituted, the original brass washer being replaced before screwing in. The new screw

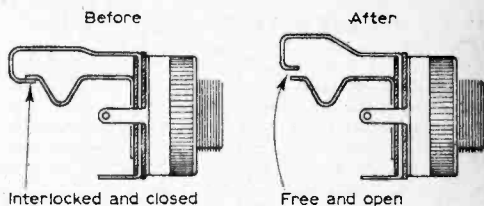

Fig. 4: The earpiece socket before and after modification.

should be about 1in. in length.

It is important that the transparent washer should *not* be replaced as its presence would make the receiver next to impossible to tune correctly.

Notice that the capacitor is *not* exactly symmetrical. One of the brass strips is flat whilst its neighbour has a small "hump" to provide a point of easy flexion (Fig. 5b).

It is important to distinguish between these terminals when the tuner is connected up and the term "humped" will be used to make the difference quite clear.

The two brass tags should now be bent double to touch the porcelain base (this saves space) and

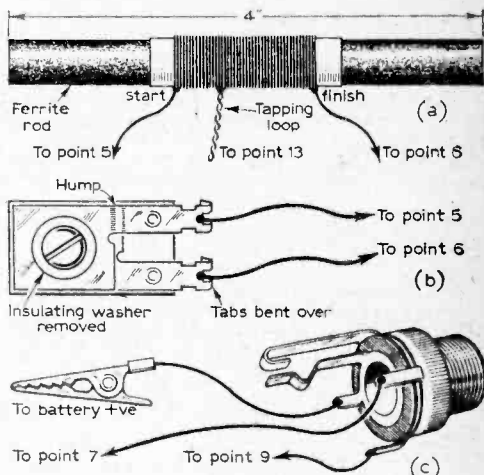

Fig. 5: Showing connections from (a) the aerial, (b) the tuning capacitor and (c) the earpiece socket.

a 4in. length of insulated connecting wire soldered to each.

This completes *all* the *essential* soldering, i.e. five fly-leads in all, three on the earpiece socket and two on the tuning capacitor.

### The Aerial Coil

The signal pick-up device is a 4in. length of ferrite rod, wound with a suitable coil.

If the ferrite rod needs to be shortened to give exactly 4in. it is best done by filing a fairly deep groove all the way round to form a ring. The rod can now be clamped in a vice between two pieces of softwood to act as jaws and, provided the groove lies exactly at the edge of the wood, a steady pressure on the protruding end will snap

it off precisely where desired without risk of failure.

Adepts at the art of breaking a ferrite rod can snap it confidently at the groove, using their fingers, but beginners are warned that, like an expensive vase, it is *easier to break than to unbreak!*

To wind the coil (medium waveband) make a small paper sleeve on the middle of the rod and, leaving 6in. to start, wind on ten turns of approximately 30s.w.g. enamelled wire. Form a loop about 4in. long (twist this to make it secure) and carry on winding a further 35 turns in the same direction, leaving a final 6in. free at the end.

The first and last turns will have to be anchored in some way, preferably with a band of Sellotape. "Pile-winding" should not be used; it is recommended that a single layer should be wound with each wire touching its neighbour. This is a little

#### LIST OF COMPONENTS

##### Resistors:

R1	100k $\Omega$	} Sub-miniature, lowest wattage ( $1/10$ or $1/4$ W), 10% tolerance
R2	2.2k $\Omega$	
R3	330k $\Omega$	
R4	4.7k $\Omega$	
R5	220k $\Omega$	
R6	4.7k $\Omega$	

##### Capacitors:

C1	0.005 $\mu$ F	} Any type, smallest possible	
C2	100pF		
C3	0.01 $\mu$ F		
C4	8 $\mu$ F		} Electrolytic, at least 3 volts wkg
C5	8 $\mu$ F		

##### Semi conductors:

D1, D2	Crystal diodes (OAB1)
Tr1	R.F. transistor (SBO78)
Tr2, 3	Audio transistors (OC71)

##### Miscellaneous:

- Crystal earpiece with plug and socket (C.R.-5)
- L2 Miniature r.f. choke, wire-ended, 1 to 2mH (2 to 3mH if both wave bands required)
- VC1 500pF compression-type trimmer (Radio-spares)
- Plastic case (see text)
- Softwood board 4in. x 2 $\frac{1}{2}$ in. x  $\frac{1}{2}$ in.
- No. 1450 battery (3 volts)
- Screws, washers, miniature croc-clip, wire, etc.

slower work but the resulting coil is neater and more reliable. It is termed "close-winding" (Fig. 5a).

#### Final Steps

The two holes required can now be drilled in the plastic case. By placing the tuning capacitor on its *side* and sliding it along the floor of the case so that the screw point touches the back wall the correct level for drilling can be found. It is roughly  $\frac{3}{8}$ in. from the floor and midway along the back. A  $\frac{1}{8}$ in. drill is needed.

The other hole (for the earpiece socket) is in the left wall of the case towards the front, so that the "works" of the socket occupy a position just above the  $\frac{1}{2}$ in. x  $\frac{1}{2}$ in. missing corner of the base.

This piece of wood has, of course, been removed so that the baseboard can be taken out of the case, if necessary, without the need to remove the socket.

A  $\frac{1}{4}$ in. hole is required to accommodate the socket screw.

The chassis can now be lowered into the case and the fly-leads from socket and tuner connected to the correct points (see Fig. 5). Note that the "humped" tuner terminal *must* be connected to point 5. The socket and tuner are coupled tightly to the case, using the nuts and washers provided, and all that remains to connect are the three coil terminations, which can now be fixed. These wires may be shortened a little where necessary and beginners should remember that the ends of enamelled wire need to be scraped or burnished clean before a connection is made. The ferrite rod may now be fitted gently into its two clips.

The tuning capacitor will need a knob of some sort, of course, and although these can be bought it is more interesting to seek out an attractively coloured plastic button, bottle cap or toothpaste cap which can be drilled with a small hole to fit over the screw. The knob is quite simply retained in position by clamping it tightly between two 6B.A. nuts towards the end of the screw. Note that the tuner tags point *away* from the earpiece socket, i.e. to the right.

#### Testing the Receiver

Take a 1450-type three-volt battery and after making sure that the longer brass strip lies parallel to its top surface and the shorter one perpendicular to it, push the battery into the large space in the corner of the baseboard so that the short strip is uppermost and the longer strip makes contact with the edge of washer No. 15. If this washer has been left overlapping the wood by  $\frac{1}{8}$ in. or so, as previously mentioned, it will make a good contact with the longer (negative) strip (Space Z, Fig. 1).

The reader will have noticed in Fig. 5c that one of the fly-leads from the earpiece socket does not go to one of the board junctions but terminates freely in a miniature crocodile clip or similar contact device.

This clip must now be connected to the shorter (positive) strip of the battery and the earpiece jack-plug inserted. Not until this has been pushed fully home will any sound be heard in the earpiece because of the battery switching device which has been constructed from it by the modification previously described.

A slight hiss in the earpiece indicates that current is flowing through the transistors. The r.f. choke must now be pushed as close as possible to the aerial coil wound on the ferrite rod. When the reader turns the tuning knob through its full range of movement a number of heterodyne squeals should be heard as various stations are tuned through.

If no such sounds are heard there is no need to worry. The ferrite rod should be simply eased from its clips, turned through half a circle, then clipped back into position facing the opposite way.

If all components and all contacts are correct the heterodyne notes will now be heard on turning the knob.

The only thing which remains to do is to move the r.f. choke further away from the tuning coil, little by little, until the local stations are heard clearly and without distortion. The pocket receiver is now complete.



**A NEW-PRACTICAL WAY  
of UNDERSTANDING**

# Radio - Television - Electronics

Including: Transistors; VHF/FM, Hi-Fi equipment; Computers; Servo-mechs; Test Instruments; Photo-electrics; Nucleonics, etc.

**FOR ...Your Career...Your Own Business...An absorbing Hobby**

Radiostructor—an organisation specialising in electronic training systems offers a new self-instructional method using specially designed equipment on a "do-it-yourself" basis.

You learn by building actual equipment with the big kits of components which we send you. You advance by simplesteps, performing a wholeseries of interesting and instructive experiments—with no complicated mathematics! Instructional manuals employ the latest techniques for showing the full story of electronics in a practical and interesting way—in fact—you really have fun whilst learning! Post the coupon below, now, for full details.—

**RADIOSTRUCTOR**  
**LEADS THE WORLD**  
**IN ELECTRONICS TRAINING**

**POST NOW**

To RADIOSTRUCTOR (Dept. G82)  
READING, BERKS.

Please send brochure, without obligation, to:—

★ Name \_\_\_\_\_

Address \_\_\_\_\_

9/63

★ **BLOCK CAPITALS PLEASE**  
(We do not employ representatives)

**LATEST HIGH QUALITY COMPONENTS FROM THE MAXI-Q RANGE . . . . .**

TESTED AND TRIED OVER 5 FREQUENCY RANGES

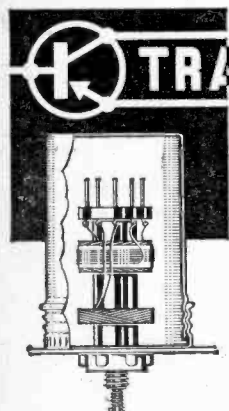

**TRANSISTOR DUAL PURPOSE COILS**

- ★ Coils for transistor superhets or converters, with or without an R.F. stage and using 465 Kc/s or 1.6 Mc/s. I.F.
- ★ Novel B9A Based for Plug-in application—Screw threaded for Chassis application.
- ★ Formers moulded in low-loss polystyrene for best results.
- ★ Each coil is packed in an aluminium container which may be used as a screening can.
- ★ Brass threaded adjustable iron-dust cores.  
The following colour code identifies the coils:  
 BLUE — Aerial coil with base input winding.  
 YELLOW — Interstage R.F. coil with couplings.  
 RED — Oscillator coil for 465 Kc/s I.F.  
 WHITE — Oscillator coil for 1.6 Mc/s I.F.

PRICE 4/9d. each

Coverages: Range 1T—15.4 Mc/s; 2T—515/1.545 Mc/s; 3T—1.67/5.3 Mc/s; 4T—5/15 Mc/s; 5T—10.5/31.5 Mc/s.

Full technical details now included in Technical Bulletin DTB.4—1/6d.

- IFT.13 Miniature 465 Kc/s I.F. Transformer . . . . . 7/6d. each
- IFT.14 Miniature 465 Kc/s Last I.F. Transformer .. 7/6d. each
- IFT.16 Miniature 1.6 Mc/s I.F. Transformer . . . . . 6/6d. each
- IFT.17 Miniature 1.6 Mc/s Last I.F. Transformer .. 6/6d. each

GENERAL CATALOGUE covering full range of components, send 1/6d. in stamps. PLEASE SEND S.A.E. WITH ALL OTHER ENQUIRIES.

**DENCO (CLACTON) LTD., (DEPT. P.W.), 357/9 Old Road, Clacton-on-Sea, Essex**

**RADIO UPKEEP AND REPAIRS**

A. T. Witts, A.M.I.E.E.  
Ninth Edition

In the latest edition of this established work new information has been added on Transistor and F.M. receivers and there is now a separate chapter devoted to the alignment of receivers. The chapters on meters, aerials, and feeders have also been re-written. 18/- net.

FROM ALL BOOKSELLERS

**PITMAN**

Parker St., Kingsway,  
London, W.C.2

**SPEAKERS**

by GOODMAN, ELAC, PLESSEY, etc.

	P. & P.
4in. square . . . . .	12/- 1/6
5in. round . . . . .	12/- 1/6
7 x 4in. elliptical . . . . .	13/6 1/6
8 x 5in. . . . .	16/6 2/-
10 x 6in. . . . .	23/6 2/-

**VISCONOL CONDENSERS T.C.C. At half List Price**

	Each
.001 mfd 6kV CP56 QO	3/-
.001 " 10kV CP56 VO	4/-
.0025 " 2.5kV CP55 HO	3/-
.0025 " 5kV CP56 QO	5/-
.005 " 3kV CP56 HO	3/-
.005 " 5kV CP56 HO	5/-
.025 " 2.5kV CP56 HO	5/-
.05 " 5kV CP57 QO	9/-
.05 " 10kV CP59 TO	10/-
.1 " 5kV CP58 QO	10/-
.25 " 2.5kV CP57 HO	9/-
.5 " 25kV CP57 X	20/-

P. & P. 1/- each

**OUR FAMOUS READIPACKS**

- No. 1 100 resistors 1w to 5w 10ohm to 50 meg.
  - No. 2 25 condensers 1pf to 1000pf 5% to 20%
  - No. 3 20 condensers 1000pf to .01mfd
  - No. 4 12 condensers .01mfd to .1mfd
  - No. 5 25 Hi-stab resistors 1, 2 and 5% 10ohm-25mek.
  - No. 6 10 w/w Resistors 6ohm-82K ohm
  - No. 7 4 Carbon controls volume, tone, etc.
- All at 8/6 each. POST FREE

**SWITCHES FOR MULLARD CIRCUITS**

	to specification and "Mullard approved"
TR2 2V Pre-Amp. . . . .	12/9
TR3 3V Pre-Amp. . . . .	12/9
TR4 3V Pre-Amp. Lo/Pass	10/9
TR5 3V Pre-Amp. Hi/Pass	10/9
Fitr . . . . .	8/4
TR6 3V Tape Amp Rec/Play	16/6
TR7 3V Tape Amp. Eqz . . . .	7/4
TR8 Tape Pre-Amp. Rec/Play	16/6
TR9 Tap Pre-Amp Eqz . . . .	7/4
TR10 Stereo Pre-Amp. Selector	18/6
TR11 Stereo Pre-Amp Ch/E . . .	9/6
TR12 Stereo Pre-Amp Stereo-Mono . . . . .	9/6

P. & P. 1/- per switch.

**TELE-RADIO (1943) LTD**  
189 EDGWARE ROAD, LONDON W.2  
PADDDington 4455

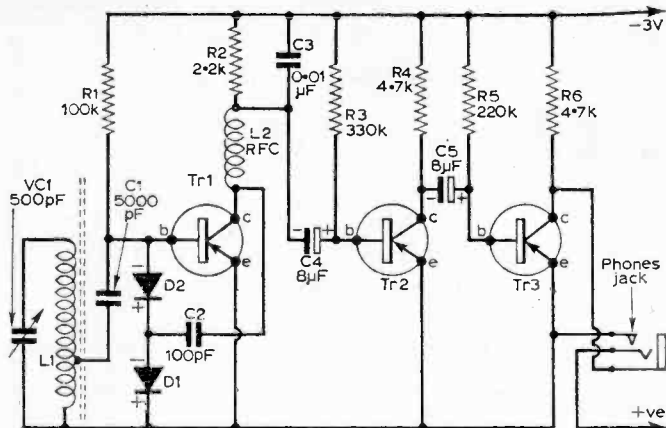

Fig. 6: The complete circuit.

To switch off simply extract the jack-plug from the socket.

Although a very simple receiver to build, well within the scope of a beginner, it should give plenty of entertainment and can be put together in quite a short time.

The prototype was designed using the cheapest possible materials. Apart from the screws, washers and wood all were obtained from various component stockists advertising in this magazine.

### Adding a Long Waveband

Many readers, having constructed this receiver, will be interested in adding a long waveband, principally to receive the Light Programme on 1,500m.

For this all that is required is a small on/off switch of some sort and some extra coil wire.

The existing coil should be unwound and started again according to the following instructions:

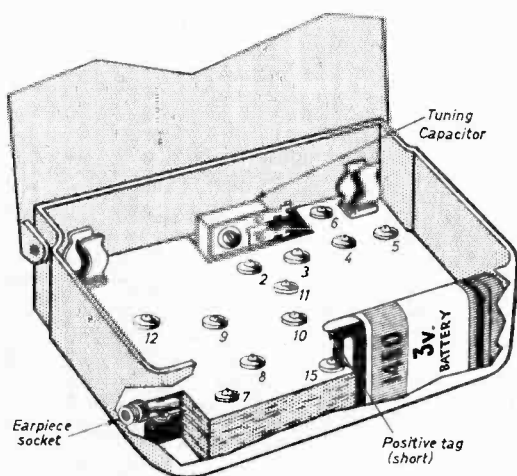

Fig. 7: A view of the chassis mounted in its case, showing the positions of the battery, tuning capacitor and earpiece socket.

(1) Proceed exactly as before but when the 45th turn is reached do *not* cut the wire, but, instead, form a *second* loop 4in. long and twisted as before.

(2) Place a *second* paper sleeve on the rod as close to one of the clips as possible. lead the wire to this sleeve and on it wind 100 turns in a deep bundle or pile, leaving 6in. free at the end and anchoring the last turn firmly. Both coils are wound in the *same* direction.

The first loop (tapping at the 10th turn) goes to point 13 as before. The second tapping (45th turn) goes to one terminal of the on/off switch. The end of the coil (145th turn) goes to point 6. A piece of connecting wire must now be fixed between point 6 and the other terminal of the switch.

As there is plenty of room on the case for fitting a small switch of one of the various types sold the reader can make his own arrangements for fixing it.

The position of the r.f. choke may now have to be adjusted slightly, but apart from this the set should function immediately as a two-waveband receiver.

### Two-Transistor Version

In areas of *good* reception, the third transistor (Tr3) and its associated components may be conveniently omitted. This saves considerably in costs and avoids the possible danger of instability through attempting high a.f. gain where it is not really needed.

The simplified version is obtained by simply omitting Tr3, R5, R6 and C5, and connecting the fly-lead which is shown in Fig. 5 as leading to point 7, to point 11 instead.

Washers 7, 8 and 12 will now be unnecessary, as will also the wire in Fig. 3 shown as connecting points 11 and 12.

### The Theoretical Circuit

The theoretical circuit appears in Fig. 6 and functions as follows:

The signal is selected by the tuned circuit and capacitor-coupled to the first r.f. transistor. The amplified signal is deflected by the high r.f. impedance of the choke and applied to the junction of the two diodes via the 100pF capacitor. The a.f. resulting from rectification appears *directly* at the base of Tr1 and, after being amplified, meets the high a.f. load of the 0.01μF capacitor and 2.2kΩ resistor in parallel and passes to the base of Tr2 (a.f. transistor) via the electrolytic capacitor. This second transistor is in its turn R-C coupled to Tr3, whose output drives the crystal earpiece.

Although extremely economical of components, the circuit functions very efficiently at the given supply voltage.

# The PHOTOPHONE

By M. L. Michaelis

**Experiments with  
light waves - a new  
interest for the amateur  
electronics interest.**

*Continued from page 311 of the August issue*

**O**N first appearances, one might imagine that the counting function could be achieved easily. With S1 still in the position labelled "audio", i.e.: making contacts "a", C3 couples any audio or other modulation component of the incident light out to P2, the a.c. output socket. The relay is disconnected, thus cannot energise, and contact RC is thus open in this state, so that nothing else is connected to P2.

If a beam of light is switched on or off, this will give a sudden change of voltage at P2, which one would at first think already constitutes a suitable pulse for operating a digital counter. The author made the mistake of this assumption initially, and was surprised that, in most cases, it did not work! It was observed that pointing a pocket torch at the photocell and switching it on and off never produced any response whatsoever in the digital counter connected to P2 in this "audio" setting. Leaving the torch switched on, and waving the beam as fast as possible across the photocell window still failed to produce any response whatsoever in the digital counter.

It was then tried holding the photophone close to the workshop fluorescent lighting tubes, and switching these on and off, with the digital counter connected to the "audio" output. This produced the first results, in that the counter sometimes, and rather erratically, counted the starter flickerings of the lamps. The final experiment in this series was to fire an electronic photographic flash unit in the workshop. This *always* worked, cleanly, exactly, and reproducibly. The digital counter registered one count for every flash, even if it was pointing in a different direction than at the photophone.

These experiments already make their own explanation pretty clear. It is not a question of intensity, but one of *pure speed* for getting this type of operation. The digital counter, on account of its differentiating circuits, can respond only to true fast pulses, and not to any form of sluggish rise and fall of voltage. The rising flank of an input signal to the counter must take no longer than at the most some 50 $\mu$ sec, corresponding to an effective flank frequency of at least 5kc/s, if the digital counter is to accept it with certainty as a "proper" pulse. All slower signals are rejected by the counter circuitry, a most necessary function to prevent all sorts of erratic countings from capacitor fluctuations, mains kicks, etc.

If, therefore, the a.c. output from the photocell is to be capable of operating the counter direct, the light input must rise very suddenly indeed to full brilliance. Only the electronic flash-unit meets this requirement with certainty. The flashes when fluorescent tubes are switched on clearly meet the requirement approximately, and are thus sometimes counted in this arrangement. But no incandescent filament lamp satisfies the demand. The filament takes at least a hundredth of a second to light up, which is far too slow. Furthermore, even the fastest human movements are also still too slow, so that waving the lit torch about also failed to produce a counter-response.

### **Flank-accelerating Amplifiers**

At this point another experiment was tried, namely feeding the slow a.c. outputs from P2, obtained by waving the torch about, into a high-gain audio amplifier of conventional type, then in turn connecting the digital counter to the output of this amplifier.

This produced good responses of counting, even when the torch was waved about relatively slowly. The explanation is here that over-driving an amplifier with any waveform whatsoever always produces fast flanks in the output, as the amplifier is rapidly swung from cut-off to saturation on a tiny portion of the excessive input amplitude. This treatment is, if prolonged, certainly not good for an ordinary amplifier, and produces various side-effects of an erratic nature due to grid current blocking. However, it is common practice in electronic-circuit techniques to use specially designed amplifiers for this signal flash speeding-up function, and such a circuit could be used here—although extremely clumsy in comparison to the simple solution finally adopted.

It is merely necessary to use the *d.c. changes*, which are not limited to any great extent by the exact speed of light beam switching, to operate a small relay, whose contacts switch a d.c. voltage into the counter every time the relay energises. Although the complete energising action of a relay is again a relatively slow process, taking some hundredth of a second or thereabouts, the actual moment of electrical connection on the contacts is always a very fast action, fully accepted by the digital counter as "a pulse".

The only new danger here is that, after first making contact, the relay suffers a momentary mechanical rebound, so that the contact is broken again for a brief interval, to be immediately made anew. Such effects, of course, may cause the counter to register two or more counts each time. A digital

counter of the type already published in this journal should not show this effect with any relay in good condition, as its own dead-time subsequent to an initial pulse is at least as long as any relay-contact vibrations take to die out. Experiments with a fast pulse-scaler input, as in the advanced digital register already published in this journal, also in fact showed virtually no double-counts with a good relay, but some trouble with older, dilapidated specimens. Thus, although the reader is warned of the possibility of such effects, the dangers of multiple counting are really negligible, if the ordinary digital counter circuit published in this journal is employed, and if care is taken to procure a really sound relay.

### Circuit Arrangements for the Pulse Relay

When S1 (Fig. 1) is switched over to "Pulse", contact "a" is broken, so that the direct a.c. output from V<sub>2</sub> cathode is disconnected from P2. Contact "b" is now made, so that the midjet relay forms the principal cathode load of V<sub>2</sub>.

When intending to use this function, S1 should, initially, be still at the "audio" setting, and the intended lamp should be set up and directed at the photocell, all being finalised and fixed in the arrangement where a passing person or object can interrupt the beam, for counting. With a meter connected to P1, VR1 should be set for balance (zero reading) with the lamp operating. S1 should then be switched over to "pulse", and *only then*. A final adjustment is then made to VR1, to restore zero reading on the meter, with the lamp still operating into the photocell. This assures that V<sub>2</sub> is resting virtually cut-off in the steady state where the beam is waiting to be interrupted, and thus a minimum of strain on the components.

Now consider what happens when the beam is interrupted. As soon as it is cut off, V<sub>2</sub> is biased heavily negative, by an amount equal to the d.c. photoelectric signal due to the lamp reaching its grid in the steady state. This d.c. steady-state signal is always half of the actual signal from V<sub>1</sub>, on account of the 1:2 voltage-divider action of R5/R6. When the beam is interrupted, therefore, V<sub>2</sub> is heavily cut off, and the relay does not yet respond. However, as soon as the interrupting object has passed and the beam is restored to the photocell, the *whole* of the signal is passed on to V<sub>2</sub> from V<sub>1</sub> at first, by virtue of C1 shorting-out R5 for transients. V<sub>2</sub> grid is thus suddenly driven very positive, leading to a surge of current through the relay, causing it to energise at once. The contact RC closes, switching the +90V supply to the digital counter, which registers a count.

As soon as C1 has charged on the time constant given by C1, R5, R6, which is about half a second, the circuit returns to the balanced d.c. resting condition, with the relay de-energised again, and V<sub>2</sub> resting around cut-off. The fact that the count is registered at the re-make instead of the break of the beam is quite unimportant, as the one must logically follow the other in one-to-one correspondence!

It is very important to operate this circuit only after proper adjustment of balance, or slight resting cut-off, under conditions of a steady beam. Too positive settings of VR1 can cause excessive

standing anode current in V<sub>2</sub>, leading to rapid destruction. This danger does not exist in the "audio" setting, because of the much greater cathode load, R4, then operative. In this setting no adjustment of VR1 whatsoever can lead to a dangerous condition.

Those constructors fearing accidental misadjustment of VR1 on "pulse" operation, or due to tampering from uninitiated persons, should make S1 a double-pole type, using the second pole to switch another VR1 into circuit on "pulse" setting, which can be in the form of a screwdriver preset inaccessible to unauthorised persons.

This additional control is first set with the slide at the chassis-end before switching over to "pulse" and then, using as powerful and concentrated light beam as possible, gradually advanced until counting of every interruption is just certain. If the light beam really is good and strong, in the form of a small, properly focused spotlight, it will be found that the resting-point is then not a balance, but in fact with V<sub>2</sub> quite considerably cut-off, as should be checked with a meter at P1. This condition is very safe.

### Speed Limitations

There are two requirements for this beam-interruption counting, if reliable performance is to be certain. Firstly, the re-make of the beam must be fast enough compared with the time constant on C1, R5; secondly, the time of interruption must be long enough to allow C1 to discharge. The exact value for C1 can be adapted to the shape and speed of passing of the objects to be counted, and if necessary, the resting point must be shifted up to a maximum of about 5mA standing current in V<sub>2</sub>.

If a relay of about 1 to 3 mA operating-sensitivity can be obtained, then V<sub>2</sub> can be given an *anode* load in the form of a resistor of about 47kΩ 5W, which would limit the maximum anode current to a safe value under all circumstances, and the circuit can be adjusted for balance on VR1 under conditions of darkness. The resting-state with a beam of light is then with the relay energised, each interruption de-energising it and giving a count upon return of the beam.

This mode of operation works solely on the d.c. signals, and is thus equally effective at any speed of beam interruption; it was originally intended, and is still envisaged, for the prototype as soon as a suitable relay can be obtained. In the former days, when model aeroplane radio control sets worked entirely with valves, relays of this high sensitivity were very easy to obtain from model stores. But today such model control sets have gone over to the higher-current lower-voltage transistors, so that at the time of production of this article and the prototype the writer was unable to obtain a midjet relay more sensitive than 10mA. Those relays of considerably greater sensitivity which were available were rather large units.

### Audio-Frequency uses of the Photophone

We now come to the third group of uses of the photophone, which really gave rise to the choice of name. Whilst these "audio" uses are less common in the conventional run of amateur experiments, they probably provide some of the most interesting new fields for the keen reader out for

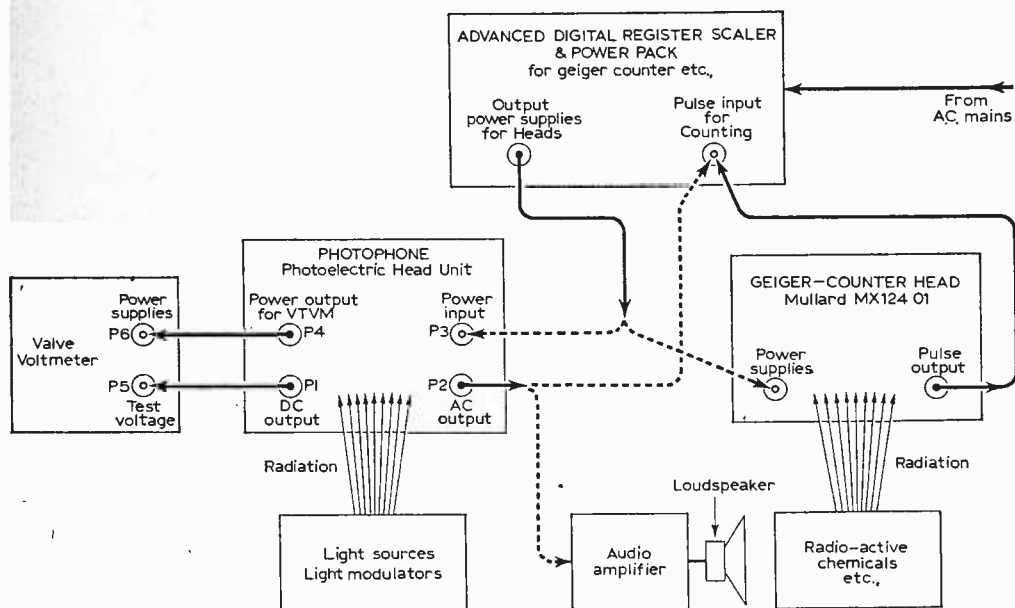

Fig. 3: A block diagram showing how certain apparatus is used in conjunction with the photophone.

new ideas to experiment with. They involve production of amplitude-modulated beams of light, possibly transmission of these over very considerable distances by means of lenses or parabolic-dish mirrors, on the familiar "searchlight" principle, and subsequent reception in the photophone set to "audio" operation. The audio output from P2 can then be fed to any available amplifier, the gramophone terminals of the domestic radio being admirable for the purpose.

#### Sensitivity

The author initially expected considerable demands to be placed on a light-beam modulator capable of producing a modulated light source giving usable audio output from the photophone, expecting large vibrations of light-slit shutters, driven by some form of powerful loudspeaker-movement system, to be necessary.

Initial experiments showed these fears to be fully unjustified; the actual sensitivity is quite astonishingly high. Thus, if an ordinary open torch bulb, without mirrors, lens, or any sort of concentrating device, is held about 3in. in front of the photophone window, an ordinary rubber band stretched between the fingers held such that the shadow falls on the window, then the rubber band is lightly strummed with the fingers the audio output is about equal to that of a gramophone pick-up.

If a good point-focus pocket torch is beamed into the photophone, and the gain turned up reasonably on the amplifier, it is virtually as difficult as with any ordinary microphone to prevent the familiar acoustic feedback howls and whistles. The sound vibrations from the loudspeaker rattle the batteries and metal of the torch, giving sufficient modulation to the light emitted to produce new sound in the loudspeaker to complete the feedback

circle. If the same torch is beamed at a range of some dozen yards or more into the photophone, and tapped with the fingertips, the tapping sounds and rattlings appear strongly amplified in the speaker. It is easy to see that a rubber band stretched across the path of a beam of light entering the photophone, having a suitable paper cone attached, would function as a simple photo-microphone for modulating speech and music on to light beams, and mechanically minded readers can easily think up improved arrangements for getting greater sensitivity out of this kind of gadget.

#### The Optical Siren

Another type of modulator easily constructed by the amateur is afforded by the *optical siren*. A very simple example of such a device was built by the writer during initial tests and for demonstration purposes. A small cardboard disc is fixed to the spindle of a high-speed toy motor, with a circular ring of 24 equally-spaced holes near its periphery, arranged such that a small torch bulb shines through each hole in turn as it passes when the disc is revolved by the motor.

If this device is properly adjusted and directed near to the photophone an audio output more than enough to fully load any ordinary amplifier is easily obtained. Still clearly audible output in the speaker was obtained at a range of 10yd with this device, without any form of focusing at all, just the bare torch bulb behind the rotating disc.

The photograph also shows a simple mount of rubber bands for demonstrating the "string modulator" principle.

Experimenters could investigate the possibilities of using a lamp shining across the strings of musical instruments into the photophone for purposes of pick-up. It would be amusing to try



this inside the casing of a piano! Certain notes of the piano could be selected in preference to others by suitable positioning of light beams, so that numerous interesting possibilities are open to musically minded tape recorder enthusiasts. These possibilities are not easily available in the same *selective* manner with ordinary microphones.

For those experimenters mainly interested in electronic circuits the optical siren provides interesting potentialities. If the siren disc, instead of being fitted with a ring of holes, has any desired waveform cut round its periphery, then that waveform will be faithfully produced as output from the photophone and can be amplified in the usual manner. This is one of the simplest methods of constructing a signal generator for complicated waveforms. Thus, taking a typical example, a signal where one "cycle" is to consist of two sine-waves followed by a squarewave, then a sawtooth wave, then a brief space followed by a pulse, then repeat, would be rather awkward, though possible, to produce in oscillator circuits.

The optical siren, however, can manage this task easily. Just draw the desired waveform round the periphery of a piece of cardboard, cut out and rotate in front of the lamp. The frequency is determined by the speed of the motor (variable resistance) and the number of times a complete cycle is contained round the disc. An amusing party game in experimenter circles would be to observe the appearance of certain vowels or simple sounds on an oscilloscope and then try to draw and cut out a siren disc *from memory* which will speak this sound. This will probably not be possible for complete words unless discs of very large diameter are used, but various continuous sounds could be attempted.

#### Optical Transmitting and Receiving Apparatus

Where the aim is to transmit modulated light messages over distances large compared to the dimensions of the actual apparatus at each end, i.e. at least the length of the garden, familiar optical principles may be used. The cheapest system capable of sufficient effective aperture, and thus probably more effective for amateur purposes than the use of lenses, is afforded by a pair of parabolic mirrors. These should be at least 1yd in diameter and are best made of paper-mache subsequently painted inside, smoothed and given a coating of aluminium paint.

A suitable parabola is drawn initially on a piece of stout cardboard, cut out and pressed into the raw dish in all orientations to give the final parabolic shape before drying. The transmitting light source and its modulating device should be as small as possible compared to the transmitting dish and situated at its focal point. The photophone is situated at the focal point of the receiving dish, with the window facing the dish. The axes of both dishes must be aligned such that they are in line and accurately facing each other. The author has heard of equipment of this kind, of amateur construction, attaining workable ranges between 10 and 30 miles, though that is extremely difficult.

#### Microwave Transmissions

The observant reader will have noticed the extreme similarity of this form of wireless equipment for visible light frequencies to the arrange-

ments in familiar use at microwave radar and telecommunications frequencies, so that the link to conventional radio is particularly clear. It would thus be useful to conclude this article with a brief discussion of the relationships between these various fields, particularly as a recent letter in this journal from a reader mentioned the question of using photon-transmission to overcome the limitations of microwave transmissions to optical line-of-sight paths.

Looking at the last question more closely it is seen to be a mere play of words, because the transmission of "photons" (particles having energy quantum and definite mass attributable to them) and the transmission of electromagnetic waves (linked electric and magnetic fields moving through space) amount to one and the same thing and thus go hand in hand, whatever the frequency of operation, right from the longest of long waves, through microwaves, light, X-rays and down to the excessively short-wavelength atomic gamma rays.

The two transmissions, treated as separate phenomena in a conventional way of thinking, are indisputably shown to be merely two different ways of looking at the same actual single effect on the basis of modern scientific research. This may seem rather hard to believe or to visualise but that is the fault of the very limited capacity of the human brain in visualising things, because it can only work with analogies and is never able to perceive things absolutely directly—and no analogy can be a perfect representation of the thing itself. This may all sound somewhat theoretical, yet it is nevertheless most important for the ambitious practical radio experimenter in these modern times who "really wants to know". One is faced with so many new devices and words nowadays in this field that it is most useful to grasp some of the more basic ideas firmly.

If we want to treat a certain radiation as electromagnetic waves then we have the familiar quantities of frequency and wavelength to use whose product gives the velocity of light, which is common to all electromagnetic radiations. If, on the other hand, we wish to treat the radiation as a machine-gunning of particles, called "photons", out of the transmitting aerials into space there is absolutely no *fundamental* reason against doing this, even at medium and long wave broadcast frequencies except one of convenience and custom. However, the operative relations then to be used will appear unfamiliar. The effective mass of each photon is, for example, given by the frequency of the corresponding wave radiation divided by the *square* of the velocity of light, apart from a certain constant factor of multiplication. It is thus easy to see that this mass will be exceptionally tiny unless the frequency is very huge indeed, so that at all reasonable frequencies represented by normal radio waves right down to microwaves it is far more convenient to think of a continuous stream, more easily represented on the basis of the wave radiation picture, and to forget that this could also be considered as broken up into a vast mass of exceedingly tiny individual particles known as photons.

---

THE CONCLUDING INSTALMENT OF THIS  
ARTICLE WILL APPEAR NEXT MONTH

# A SIMPLE

# STROBOSCOPE

by L.E. Profaze

THE stroboscope is a useful tool in the laboratory and workshop and it forms an interesting exercise for the home-constructor who wishes to build something rather different from radio receivers. Few components are required apart from the special discharge tube which is obtainable, inexpensively, from the surplus market.

### Function of the Stroboscope

In operation the stroboscope produces a continuous series of short-duration, intense flashes of light, the repetition frequency of which can be varied from about 6 to 250c/s for the tubes specified. If a vibrating or rotating mechanism is viewed with the aid of this pulsating light its apparent rate of motion can be reduced until at the point of synchronism the object will appear stationary.

When attempting to detect mechanical faults in machines whose parts move too fast for detailed observation by the unaided human eye, or in research work where it is desired to examine the behaviour of an object under oscillatory conditions, the stroboscope can be of great assistance. The stroboscopic disc, found on many gramophone turntables is an example where the principle is used to check the speed and constancy of rotation of a mechanism by reference to a known and fixed frequency light source, in this case the flashes from a lamp energised by the 50 cycles per second mains supply.

### The Discharge Tube

The heart of the instrument is a special gas-filled tube which contains four electrodes to form two discharge-gap systems. The main gap is between two of these, the anode and cathode, while the remaining pair, known as the trigger electrodes, initiate the breakdown of the main gap when, with a suitable positive potential applied to the anode, relative to the cathode, an appropriate potential difference is created between the triggers.

The tube functions in a manner closely similar to the three electrode cold cathode tubes which are commonly found in computers and electronic photo-flash guns. In its quiescent state the anode to cathode resistance is of a high order and pro-

viding the critical anode voltage is not exceeded this condition will be maintained.

If, however, an increase in the anode voltage occurs, to a point above this critical level, a discharge will take place and the resistance will fall to a very low value.

With the anode held just below the critical voltage value a suitable positive voltage pulse applied to the trigger electrode will also initiate the main discharge. Thus the small amount of energy in the trigger pulse is able to release the principal discharge which though it may last perhaps only  $10\mu$  seconds its peak current may reach a value of 200-400A.

Activation of the trigger gap causes electron emission from the specially prepared cold cathode. These electrons create a condition of ionisation within the gas and positive ions thus produced strike the cathode surface and set free further electrons; an effect which is cumulative. If the anode is held at a positive potential with respect to the cathode a discharge will take place between

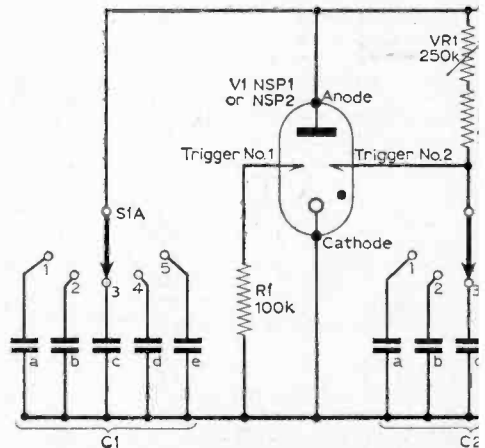
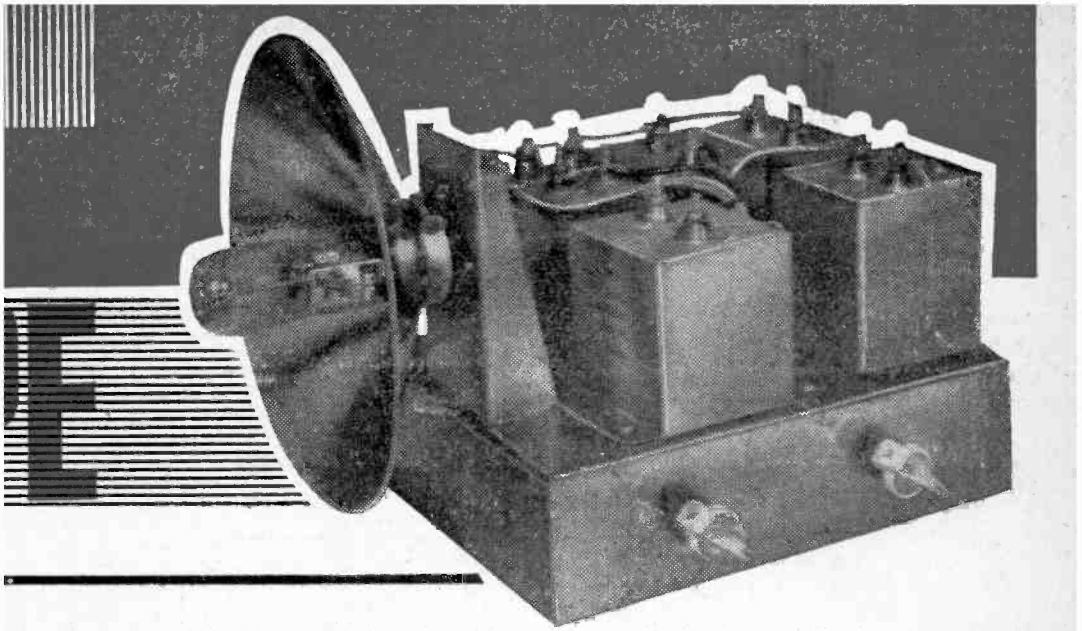

Fig. 1: The complete circuit



these two electrodes which is accompanied by the generation of light having the characteristic colour due to the neon gas used.

In the stroboscope tube the initiating discharge is created between two trigger electrodes, instead of between a trigger and the cathode for the sake of stability at high sensitivity.

#### Self-triggering

A suitably shaped voltage pulse can be applied to the trigger electrodes from an external generator, such as a multi-vibrator, but it is also possible for simplicity to use a continuously self-triggering arrangement. The instrument described in this article employs the latter system and from the photographs the general construction is visible.

A rudimentary but adequate tin-plate reflector soldered to the lugs of a capacitor clip is attached to the base of the lamp and the general constructional plan follows that outlined in an article in PRACTICAL WIRELESS (May 1963 issue) which advocated the use of tin-plate for this type of

work. The final form and the materials used, however, are in no way critical and are largely a matter of what is available or to suit individual preference.

The banks of capacitors, above and below the chassis, are selected in pairs by a switch adjacent to the fine frequency potentiometer and provide five frequency ranges. The high wattage series charging resistor is clearly visible to the left of the potentiometer. As they are plentiful and cheap, block-type capacitors have been used for the higher capacity values and it is suspected that many amateurs possess this pattern but seldom find a use for them.

The essential factors governing their selection are correct capacity value, adequate working voltage (not less than 400V) and good insulation resistance. Electrolytics are not recommended.

The capacitor connected between the anode and cathode stores and furnishes energy for the main discharge and its capacity value must be chosen with care for maximum light output and freedom from instability. Between flashes this capacitor must recharge almost completely and at the higher frequencies there is a risk of producing spurious discharges. The values suggested by the tube manufacturer have been used in the instrument shown which appears to function satisfactorily.

#### Frequency Range

The frequency of operation is governed by the value of the supply voltage, the value of the capacitor C2, its associated charging resistor and the characteristics of the discharge gap. Table 1 gives approximate values of C2 with the measured frequency ranges achieved with the prototype.

It is important to remember that with the many variables present it cannot be guaranteed that exactly the same frequencies will be reproduced in other models. The figures given are to be regarded only as a guide and while they can be calculated mathematically the majority of experimenters will doubtless prefer to follow the writer's example and determine them empirically.

It must be recognized that the inherent stability of such a simple circuit will be inferior to that

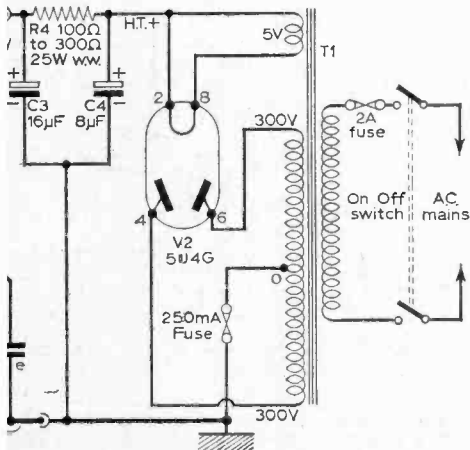

(uding a suitable power supply..

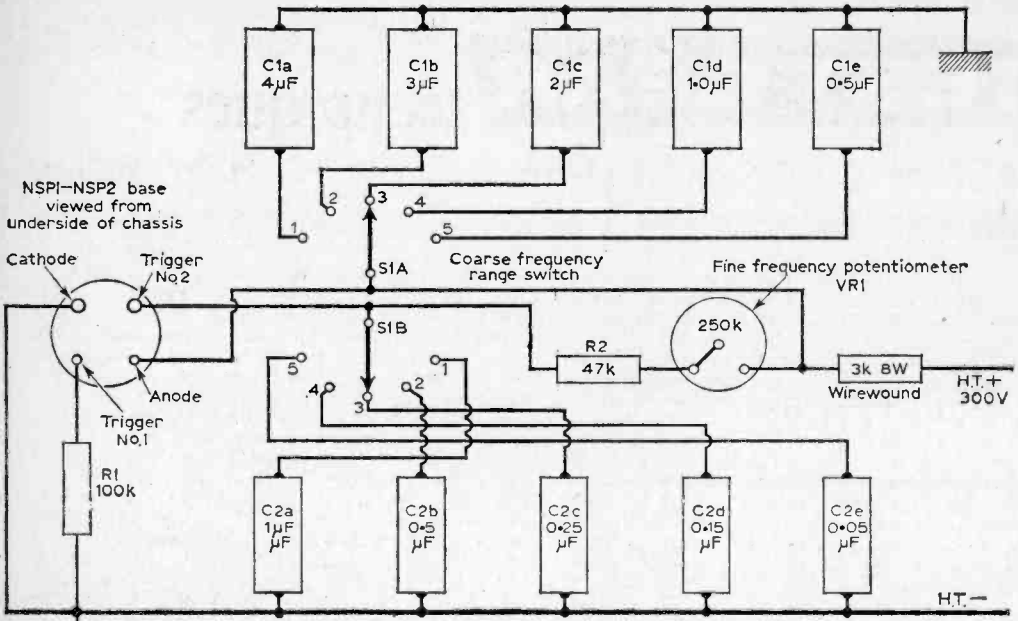

Fig. 2: The practical wiring diagram.

resulting from the adoption of a more elegant circuit but it is sufficient for normal practical purposes. The actual values of components often show considerable discrepancy when compared with their nominal values especially if wide tolerances are involved.

It will be seen that the power supply components have not been included on the same chassis as the generator. It was felt desirable to keep the functional part as light as possible to facilitate directing the beam of light at different angles and therefore the heavy power unit components were best kept separate.

As the tube does not have a heater only two supply leads are needed and no doubt the majority of experimenters will have at their disposal a power unit capable of providing about 300V at 50 to 100mA for the occasional use of this apparatus.

**Practical Applications**

It should not be difficult for the experimenter to find suitable mechanisms upon which to test the completed instrument; anything which rotates is suitable especially if it can be marked with equally spaced black and white lines. Subdued ambient lighting is advised.

An electric fan is an ideal example. Another device which is especially applicable to the radio enthusiast is the loudspeaker cone when energised by a regular waveform. Speech or music is unsuitable due to the lack of uniformity of its wave shape. The loudspeaker should preferably be a large one with a freely suspended cone in which a good degree of movement can be induced with the aid of a signal generator and amplifier.

Some idea of the frequency ranges can be obtained by varying the frequency of the applied signal and adjusting the stroboscope to synch-

TABLE I		
Value of C1	Value of C2	Measured Frequency Range
4µF	1µF	6-25 c/s
3µF	0.5µF	12-40 c/s
2µF	0.25µF	25-86 c/s
1µF	0.15µF	66-166 c/s
0.5µF	0.05µF	125-250 c/s

ronism to provide calibration points, but care is necessary to avoid confusion with multiples of the signal generator frequency; start at the lowest frequency and keep both the oscillator and the stroboscope in step and it should be possible to carry out the task satisfactorily.

**A Word of Caution**

Gears and other powerful rotating mechanisms should be treated with respect when they are in motion. Since when viewed with light from this instrument they may have no *apparent* motion, it is easy to forget that they may still be capable of causing physical injury if touched with the fingers.

Other uses for these tubes include the photographic recording of the flash as a time marker; cine camera enthusiasts may find them useful for creating special effects when tilting.

The well defined high current pulses are excellent for actuating electromagnetic counters and relays. The lowest frequency of the instrument described in this article was, in fact counted with the aid of one of the government surplus counters introduced in series with the h.t. supply.

The very high voltage pulse necessary to trigger the electronic photo-flash tubes can be derived by using one of these stroboscope tubes in series with the primary of a high step-up ratio transformer. ■

# TEST GEAR techniques

## PART 7 THE OSCILLOSCOPE CONTINUED

H. W. Hellyer

IN the Miller Transitron timebase of Fig. 5 the problem is largely solved by taking the blanking pulse from the screen grid and the further re-energement of a diode and potential divider, plus the use of a cathode follower which helps avoid the use of a blocking capacitor. (The last item has the disadvantage of affecting brightness during sweep period.) By using one half of a double triode for his function and the other half as a cathode follower between the oscillator and the deflection circuit an economical circuit is obtained.

The second cathode follower (V2 in Fig. 5) has the function of improving the flyback time at low sweep speeds and reducing the value of components for the suppressor back coupling. Briefly the Miller circuit works as a feedback amplifier with a capacitor augmenting the Miller-effect capacitance between anode and grid.

More properly the circuit shown should be called a Miller integrator screen-coupled phantotron. The important CR combination here consists of the  $C_g$  capacitance with a series of switched capacitors coupled to the cathode follower, whose impedance acts as the charging resistor. The anode voltage falls linearly as the capacitor discharges until the screen grid voltage takes effect. The screen change is fed to the suppressor grid via the differentiating circuit; the suppressor is driven negative. Anode current is then decreased, more cathode current goes via the screen grid, which accelerates the negative-going swing of the suppressor, and a rapid switching sequence takes place. This gives linear forward sweep and an abrupt flyback—the sawtooth waveform we require. As both the charge capacitor C and the suppressor feedback component must consist of a bank of switched components the balance of the circuit is maintained for various timebase speeds.

We must note a few of the factors affecting the Y amplifier before we discuss the applications of the oscilloscope. The frequency response has already been mentioned. Equally important is the deflection sensitivity and the rise time.

### Deflection Sensitivity

The deflection sensitivity is the voltage of input to the Y amplifier for unit distance of vertical displacement of the tracing spot. A typical figure for a direct input might be 5V per millimetre,

which is obviously inadequate for the work we need to do where signals are in microvolts. The addition of an amplifier brings the sensitivity to 100mV per centimetre. But these small pulses must be amplified without distortion and, as the waveforms to be investigated can be extremely complicated, a wide bandwidth is required. From this is derived the specification of the frequency response, for the oscilloscope amplifier must be capable of a level output, within small limits, over the whole of the band to be investigated.

Sudden changes in response can result in the phenomenon of "overshoot" that has a drastically distorting effect on the trace, particularly of signals approaching the form of a square wave (perhaps the most difficult waveform to reproduce faithfully). The frequency response of a Y amplifier may be 3dB down at 3Mc/s and 6dB down at

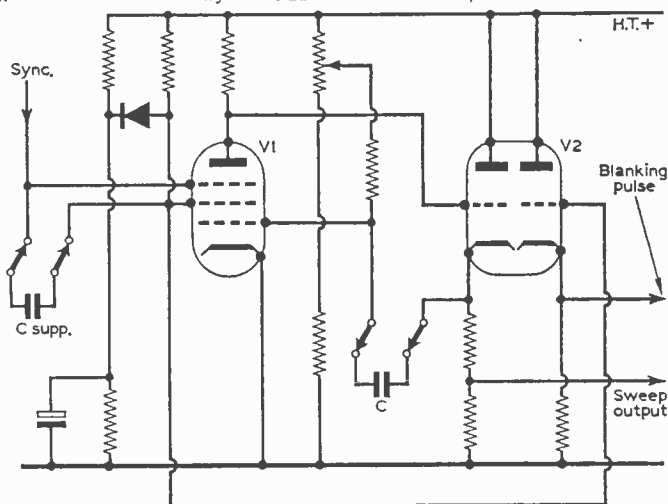

Fig. 5: Miller-transitron timebase with cathode follower output for blanking pulse and sweep output.

7Mc/s, which is better than an abrupt dip at the upper end of the frequency spectrum for another reason—the rise time.

### Rise Time

This is the measurement of the time it takes an amplifier to respond to a sudden change in the amplitude of the applied signal. A little thought will show us that this is related to the bandwidth. In fact the bandwidth in megacycles is equal to 0.4 divided by the rise time in microseconds. In practical terms to display a square wave with a rise time of  $0.25\mu\text{sec}$  accurately the amplifier needs a  $0.4/0.25$  bandwidth or 1.6Mc/s.

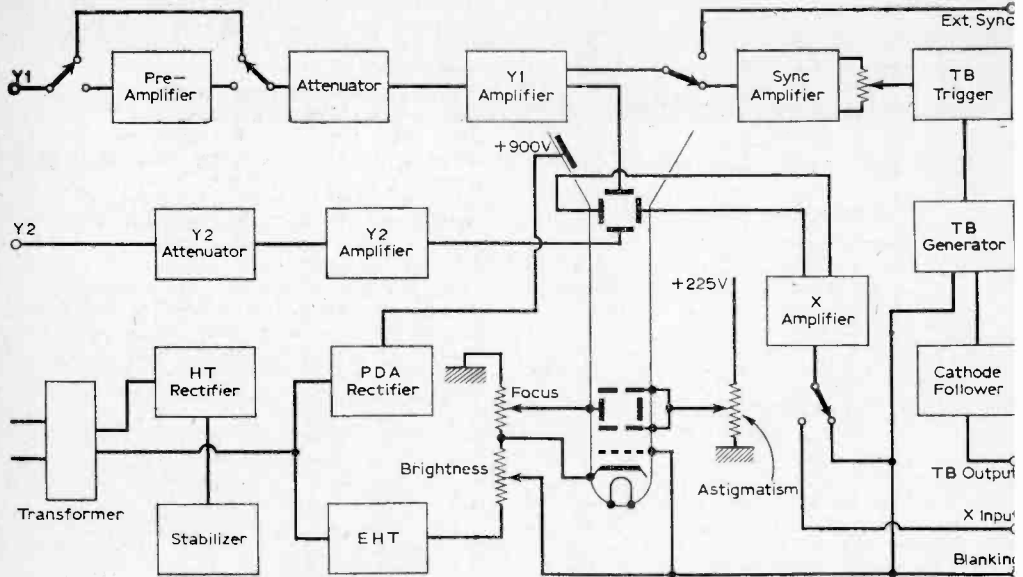

Fig. 6: Block diagram of the Cossor 1091, double-beam oscilloscope.

### Commercial Specifications

As an example of the type of specifications that may be met in practice consider the quoted figures for one or two differing instruments:

The Philips circuit, Student's Oscilloscope with DG7-6 c.r.t., has a vertical deflection sensitivity of 10mV/cm and a frequency characteristic linear up to 10kc/s and within 6dB at 35kc/s. The timebase frequency range is from 25c/s to 20kc/s.

The "Versatile" model, with the DG7-32 tube and blocking oscillator timebase (convertible to X amplifier for trace expansion), has a similar vertical deflection but the frequency response is linear within -1dB from 0.5c/s to 200kc/s and within -3dB up to 250kc/s.

The Taylor 33A is widely used in general service work; it has a vertical deflection of 80mV/in., a response of 10c/s to 6Mc/s within 0.5-3dB and a timebase covering 10c/s to 500kc/s.

Another favourite is the Beulah 0-12U-F with 10mV/cm, a rise time of better than 0.08μsec, a response of 3c/s to 5Mc/s (2.2dB down at 3.58Mc/s) and a sweep of 10c/s to better than 500kc/s.

One really small instrument with a versatile range of facilities is the Cossor 1039. The Mk II model of the M range has a single-stage Y amplifier with two gain positions: 75, giving a 25c/s to 120kc/s bandwidth, and 20, giving 25c/s to 1.5Mc/s, with a sensitivity on the high-gain position better than 0.15V/mm and on the low-gain position 0.056V/mm and a timebase from 10c/s to 50kc/s.

In the larger range a very widely used oscilloscope is the 1091 double-beam instrument by Cossor. A block diagram of this quite elaborate instrument is shown in Fig. 6. Using a 93D tube or an alternative 93L long-persistence tube, it has a wide range of facilities, including 21 calibrated

sweep speeds and a five times trace expansion with a timebase covering 1/4c/s to 200kc/s. Two identical Y amplifiers operate from d.c. to 3Mc/s (30% down). A minimum deflection of 4cm is obtainable on the 3Mc/s point and the switchable attenuator affords a sensitivity of as small as 0.5V/cm with a pre-amplifier in the Y1 channel which increases the sensitivity to 5mV/cm.

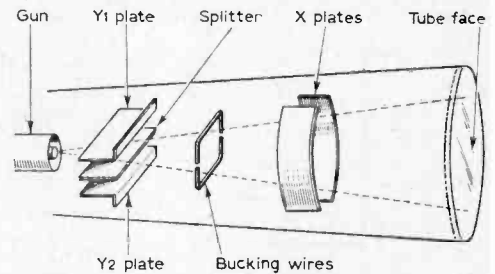

Fig. 7: A "split-beam" c.r.t.

This by no means covers the field but it does illustrate the wide range of differences in instruments and accents the need for a careful choice of the instrument most suitable for the job in hand.

### The Double-beam 'Scope

The most obvious facility of a double-beam oscilloscope is the comparison of traces. This may be for the purpose of frequency comparison, or to check the input against the output trace when testing an amplifier's response, for distortion checking, stage gain measurements, etc.

By applying the two signals to the vertical plate in such a way that the horizontal timebase is

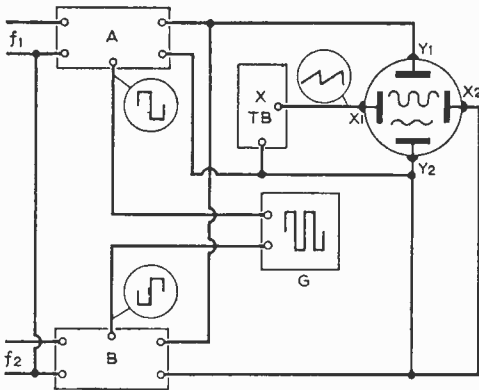

Fig. 8: Beam-switching principle to obtain more than one trace on a single-beam tube.

common to both inputs, but two traces are produced, and then varying the amplifier controls until the two traces are superimposed and identical, direct measurement of gain is possible by comparing the Y amplifier control settings.

One method of producing these two beams is to employ a cathode ray tube with a splitter plate between the Y plates, as illustrated in Fig. 7. The electron beam, travelling from the gun towards the screen, is split by this auxiliary plate with

each divided portion controlled in the vertical sense by one of the Y plates. Both beams, however, pass within the field of the X plates and thus horizontal deflection is common.

There are refinements to this basic structure, such as the bucking wires shown in Fig. 7, which have the function of cancelling interference between the two beams by adjustment of their potentials. Anti-trapezium devices are fitted (Y-plate deflection will be asymmetric) and shift controls enable the deflecting fields of the two Y plates to be independent. But there is a practical limit to the variation.

An alternative method is the construction of a cathode ray tube with two separate electron guns and deflector systems. This is the double-beam method. It has its logical extension in some very expensive multiple-beam tubes used for special purposes, but which need not interest us here.

The method that does have a direct interest for us is the addition of an electronic switch to a single-beam instrument. By applying to the Y plates two vertical deflecting voltages alternately, at intervals that are short compared with the persistence of the screen phosphors, and using the persistence of vision to aid the illusion, two traces are apparently obtained, displaced by an amount determined by the shift voltages, but still controlled in the horizontal sense by the X time-base. These two traces are actually "dotted in" by the brief switching of the electron beam, but,

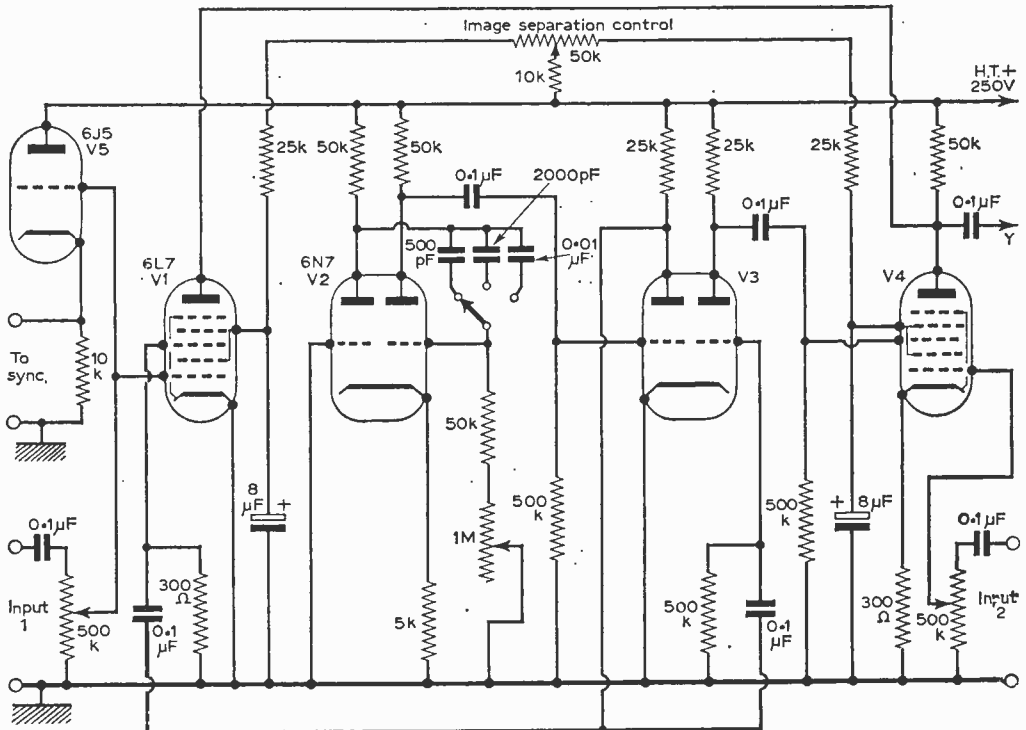

Fig. 9: Circuit of a beam-switching unit (Haas and Hallows).

because of the persistence of the phosphors and of vision, they appear as continuous lines.

Two Y amplifiers are required, with a multivibrator generating a square-wave voltage which is applied to the control electrodes of the two amplifiers in antiphase.

Fig. 8 shows the rudiments of this system. The square-wave generator G applies a pulse to each of the two amplifiers, A and B, while the two amplifiers receive separate signals, f1 and f2. The outputs of both amplifiers are connected to the Y plates, and because of the controlling action of the generator, trace their result in succession. To be more explicit, the Y1 signal goes through the A amplifier while the B amplifier is virtually "switched-off" and the Y2 signal grounded. Then the switch reverses, the Y2 signal is allowed to pass through the B amplifier and the Y1 signal is suppressed.

The switching frequency is important, and some method of varying it has to be made, without this variation causing the square-wave to be distorted. However, there are methods of switching which also allow the antiphase pulses to be unequal in length. This has the effect of feeding one amplifier to the plates for shorter working periods and thus the trace becomes dimmer. This can be an aid to direct comparison of individual traces.

At low switching frequencies, say below 100c/s, the trace tends to sparkle as persistence limits are approached—this varying, of course, with the tube being employed. At high frequencies, above 15,000c/s, for example, there is a tendency for the rapidly moving spot to make space between the two traces luminous. Again, the annoyance factor of this effect depends on the type of tube in use.

A little thought will show us that the best frequency must be half the applied sweep, so that the images are traced in turn, with no apparent interruption. In practice, this means that the operator has to make delicate adjustments of the sweep frequency. One pitfall to avoid is that of hitting on a multiple of the sweep frequency, which will give most peculiar broken traces that can be extremely misleading until one knows how to interpret them. This is done deliberately for some frequency comparison tests.

In a well-known commercial version, the Heathkit Model S-3U, the switching rates are in steps of 150, 500, 5,000 and 15,000c/s. A very useful though inexpensive instrument, this Electronic Switch has an amplifier response from d.c. to 100kc/s  $\pm 1$ dB, separate gain and sync controls and an input range from 0.1 to 1.8V, r.m.s.

Image separation can be obtained by varying

the above currents of the two amplifiers. In the circuit of Fig. 9 (from *The Oscilloscope at work*, by Haas and Hallows, published by Iliffe and Sons), this is achieved by alteration of the screen grid voltages of the amplifier valves.

In this circuit, the multivibrator is V2, with V3 assisting in the shaping by "slicing" the crests. V1 and V4 are the amplifiers, with the switching pulses applied to their third grids from the two anodes of V3, and thus working in antiphase. Input signals are fed to the first grids. The switching frequency is variable in steps by switch S, which selects the coupling capacitor between the anode of V2A and grid of V2B. Continuous variation is made possible by the 1M $\Omega$  potentiometer.

With this type of circuit, it is recommended that signals be amplified to a suitable level before application to the switch unit inputs, because of the difficulty of amplifying a steep-fronted waveform correctly.

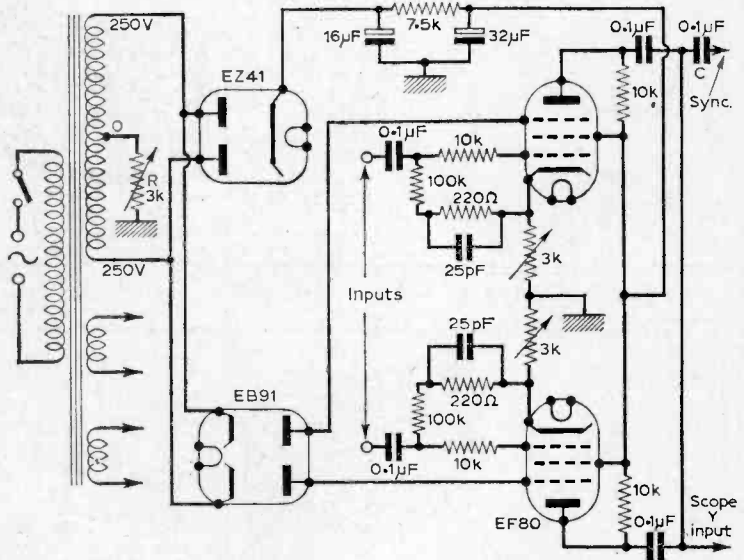

Fig. 10: Beam-switching unit, employing mains pulses.

A simplified version of this switching method is depicted in Fig. 10 (*Practical Radio Engineer*, March, 1955). Here, the two amplifier valves have inputs applied to their control grids, and a rectified mains signal provides a heavy negative pulse to each suppressor grid in turn, at 1/50th second intervals.

The X timebase of the single-beam scope (which in the experimental rig was a Cossor) is set to 100c/s. Amplifier gain is adjusted by controlling the negative feedback and the outputs are fed to a common point for take-off to the Y plate, or the Y input of the main instrument. Control of synchronisation is by the coupling C to the oscilloscope sync terminal and pulse rate control within the limits set by the design is effected by variation of the centre-tap potentiometer R.

PART 8 APPEARS NEXT MONTH



# PORTABLE TRANSISTOR RADIOS

BACKED BY SUPER AFTER SALES SERVICE

## ROAMER SEVEN Mk. III

● 9 stages—7 transistors and 2 diodes.

Covers Medium and Long Waves, Trawler Band and two Short Waves to approx. 17 metres. Push-pull output for room filling volume from rich toned heavy duty 5in. speaker. Ferrite rod aerial for M & L waves and telescopic aerial for S Waves. Air spaced ganged tuning condenser ensures wonderful station selection. Simulated hide case with gilt trim and shoulder and hand straps. Size 9 x 7 x 4in. approx. **The perfect portable and the ideal car radio.** (Uses PP9 battery available anywhere.)

## 5 WAVEBAND PORTABLE OR CAR RADIO

Amazing performance and specification

Total cost of all parts now only

**£5.19.6** P. & P. 5/6.

Parts Price List and easy build plans 3/-.

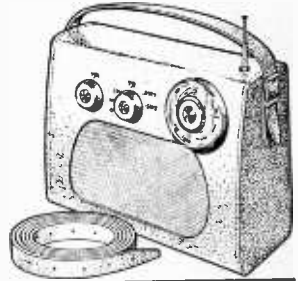

## MELODY SIX

NEW!

● 8 stages—6 transistors and 2 diodes.

Our latest completely portable transistor radio covering medium and long waves. Incorporates pre-tagged circuit board, 3in. heavy duty speaker, top grade transistors, volume control, tuning condenser, wave change slide switch, sensitive 6in. ferrite rod aerial. Push-pull output. Wonderful reception of B.R.C Home and Light, 20R, and many Continental stations. Handsome leather look pocket size case, only 6 1/2 x 3 1/2 x 1 1/2 in. approx., with gilt speaker grille and supplied with hand and shoulder straps.

Total cost of all parts **£4.9.6**

P. & P. 3/-, Parts Price List and easy build plans 2/-.

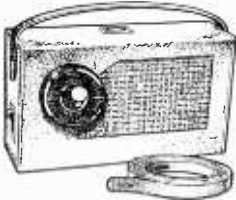

## TRANSONA FIVE

"Home, Light AFN, Luz, all at good volume." G.P., Durham.

● 7 stages—5 transistors and 2 diodes.

Fully tunable over medium and Long Waves and Trawler Band. Incorporates Ferrite rod aerial, tuning condenser, volume control, 3in. super tone speaker, etc. Attractive case. Size 6 1/2 x 4 x 1 1/2 in. with red speaker grille. (Uses 1289 battery available anywhere).

Total cost of all parts now only **42/6**

P. & P. 3/6.

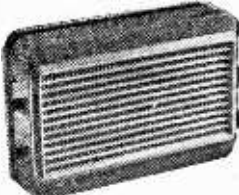

Parts Price List and easy build plans 2/-

## TRANSONA SIX

NEW!

● 8 stages—6 transistors and 2 diodes.

This is a top performance receiver covering full Medium and Long Waves and Trawler Band. High-grade powerful magnet 3in. speaker makes listening a pleasure. Push pull transformers for ample power. Ferrite rod aerial. Many stations listed in one evening including Luxembourg loud and clear. Attractive case in grey with red grille. Size 6 1/2 x 4 x 1 1/2 in. (Uses PP4 battery available anywhere).

Total cost of all parts now only **59/6** P. & P. 3/6.

Parts Price List and easy build plans 1/6



## POCKET FIVE

● 7 stages—5 transistors and 2 diodes.

Covers Medium and Long Waves and Trawler Band, a feature usually found in only the most expensive radios. On test Home, Light, Luxembourg and many Continental stations were received loud and clear. Designed round supersensitive Ferrite Rod Aerial and fine tone 3in. moving coil speaker, built into attractive black case with red speaker grille. Size 5 1/2 x 1 1/2 x 3 1/2 in. (Uses PP4 battery available anywhere).

Total cost of all parts now only **42/6** P. & P. 3/-.

Parts Price List and easy build plans 1/6

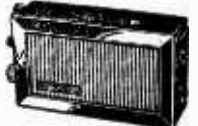

## SUPER SEVEN

● 9 stages—7 transistors and 2 diodes.

Covers Medium and Long Waves and Trawler band. The ideal radio for home, car or can be fitted with carrying strap for outdoor use. Completely portable—has built in aerial for wonderful reception. Special circuit incorporating 2 R.F. stages, push pull output, 3in. speaker (will drive larger speaker). Size 7 1/2 x 5 1/2 x 1 1/2 in. (Uses PP6 battery available anywhere.)

Total cost of all parts now only **£3.19.6** P. & P. 3/6. Parts Price List and easy build plans 2/-.

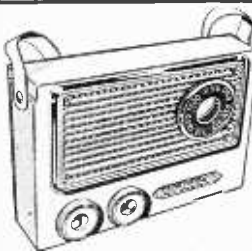

## ROAMER SIX

● 8 stages 6 transistors and 2 diodes.

Listen to stations half a world away with this 5 waveband portable. Tunable on Medium and Long waves, Trawler Band and two Short waves. Sensitive ferrite rod aerial and telescopic aerial for short waves. Top grade transistors. 3-inch speaker, handsome case with gilt fittings. Size 6 1/2 x 4 1/2 x 1 1/2 in.

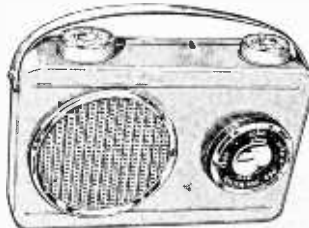

Total cost of all parts now only **£4.19.6** P. & P. 3/6. Parts Price List and easy build plans 3/-.

## Radio Exchange Co.

27 HARPUR STREET, BEDFORD

Phone 2367 ● Opposite Co-op. ● 10-1 p.m. Sats.

All components used in our receivers may be purchased separately if desired. Parts price lists and easy build plans supplied free with sets of parts or available separately at prices stated.

**"THE CONSTRUCTOR'S PARADISE"**  
**BEAR HUDSON LTD.**

63, GOLDHAWK ROAD, SHEPHERD'S BUSH, LONDON, W.12  
 (Next to Goldhawk Road, Metropolitan Stn.) Phone SHE 2581/4794  
 Open all day Saturday

**TRUE HI-FI FROM CRYSTAL P.Us.**

**TSL  
 CONSTANT VELOCITY  
 EQUALISER**

This remarkable new T.S.L. development makes quality almost as good as the finest professional magnetic pick-ups to be obtained from crystal or ceramic

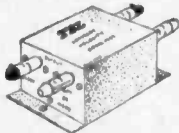

types. With it, even cheap record players become first-class instruments. With good equipment results are astonishing. Ideal for B.S.R., Collaro, Garrard and Acos. With plugs for mono or stereo. 3 years' guaranteed. Ready for use.

**30/-  
 POST FREE**

**M.A.T. MICRO-ALLOY GOLD-PLATED TRANSISTORS**

**Phenomenal Performance**

A revolutionary advance in transistor technique and performance. Will operate up to 150 Mc. with current gains of better than 250. With a single "MAT" stage gains as high as 1,000 times are possible. Absolute minimal voltage and current collector requirements: ultra low-noise gold-plated leads. FULLY DATA SHEETS FREE. Also "92 Tested Circuits using M.A.T." covering S.W., Hi-F. Personal and TV applications (also 104 x 7 1/2 in.) 5/- post free.

**ADT140** New wonder transistor with cut off at 500 Mc. **15/-**

**ALWAYS IN STOCK**—Bernards Radio Books. Over 70 titles for constructors. Send 6d. for full catalogue.

**1,000 BRAND NEW  
 LOUSPEAKERS FROM  
 2in. to 12in. TO CLEAR**

Brand new, guaranteed. Special bulk purchase. Great chance for Hi-Fi enthusiasts. **10/-**

**TEST METERS** in a wide range of types. S.A.E. brings list.

**THE FANTASTIC  
 SINCLAIR 'SLIMLINE'  
 VEST-POCKET RECEIVER**



All parts (except bat.) come to

**49/6**

With full instructions.

- ★ MAT TRANSISTORS
- ★ AMAZING RANGE AND QUALITY
- ★ 2 1/2 x 1 1/2 x 1/2 in.
- ★ SUPER SENSITIVE

This fantastic receiver, using latest Micro-Alloy Transistors brings in countless stations (med. wave) with truly superb quality and sensitivity. Absolutely self-contained with printed circuit board and all parts for easy building. With special ear-piece.

Hi-Fi by JASON, LEAK, LORENZ, QUAD, RADFORD, TSL, WHARFEDALE, W.B., etc.

**COMPONENTS - HI-FI - BOOKS - SERVICE**

- 24-HOUR MAIL ORDER SERVICE with all goods guaranteed.
- ★ FREE POSTAGE on orders over 20/-; add 1/- postage if under.
- ★ HI-FI INSTANT COMPARISON ARRANGEMENTS.
- ★ COMPREHENSIVE TECHNICAL SERVICE for Customers.
- ★ BULK PURCHASING DEPT. and own manufacturing facilities mean **LOWEST PRICES.**

**10% HI-STAB RESISTORS**

1 and 1/2 W. 10Ω to 10 meg. 6d. each. 5/- per doz. State values required. Specially recommended for transistors.

**PREFABRICATED TRANSISTOR  
 UNITS BY GORLER etc.**

We stock all famous Gorler prefabricated de-luxe transistorised units for constructors seeking the very finest standards. 24 page book of circuits, 2/- post free.

**HI-FI AUDIO AMPLIFIERS**

125 mW 29/6	1 1/2 Watt 87/6
1/2 Watt 52/6	2 Watt 102/6
1 Watt 92/6	2 1/2 Watt 107/6

**TRANSISTORS BY MULLARD**

Guaranteed Brand New

OC44, usual price 9/3 8/- OC72, usual price 8/- 8/-  
 OC45, usual price 9/- 5/- OC81D, usual price 8/- 8/6  
 OC71, usual price 6/6 5/- OC81, usual price 5/- 6/-  
 Matched pairs can be supplied for no extra cost. Set of 6—OC44, 2 x OC45, OC81D, matched pair OC81, 32/6. Post free.

**'GOLDHAWK' RADIO TUNER**

Ultra-sensitive diode receiver with uniquely selective tuning system. Ideal feeder for 2 1/2 W. hi-fi, or use as pocket receiver. Post free. Part with instructions.

**FREE TO AMBITIOUS ENGINEERS**  
 — THE LATEST EDITION OF ENGINEERING OPPORTUNITIES

**Have you sent for your copy?**  
**ENGINEERING OPPORTUNITIES** is a highly informative 156-page guide to the best paid engineering posts. It tells you how you can quickly prepare at home for a recognised engineering qualification and outlines a wonderful range of modern Home Study Courses in all branches of Engineering. This unique book also gives full details of the Practical Radio & Electronics Courses, administered by our Specialist Electronics Training Division—the B.I.E.T. School of Electronics, explains the benefits of our Employment Dept. and shows you how to qualify for five years promotion in one year.

**We definitely Guarantee  
 "NO PASS — NO FEE"**

Whatever your age or experience, you cannot afford to miss reading this famous book. If you are earning less than £25 a week, send for your copy of "ENGINEERING OPPORTUNITIES" today—FREE.

**BRITISH INSTITUTE OF ENGINEERING  
 TECHNOLOGY (Incorporating E.M.I. Institutes)**  
 (Dept. SE/21), 29 Wright's Lane, London, W.8

**WHICH IS YOUR  
 PET SUBJECT?**

- Mechanical Eng.,
- Electrical Eng.,
- Civil Engineering,
- Radio Engineering,
- Automobile Eng.,
- Aeronautical Eng.,
- Production Eng.,
- Building, Plastics,
- Draughtsmanship,
- Television, etc.

**GET SOME  
 LETTERS AFTER  
 YOUR NAME!**

- A.M.I. Mech. E.
- A.M.I.C.E.
- A.M.I. Prod. E.
- A.M.I.M.I.
- A.I.O.B.
- A.F.R. Ag.S.
- B.Sc.
- A.M. Brit. I.R.E.
- City & Guilds
- Gen. Cert. of Education
- etc., etc.

**PRACTICAL  
 EQUIPMENT**

Basic Courses and Theoretical Courses for beginners in Radio, T.V., Electronics, Etc., A.M. Brit. I.R.E. City & Guilds Radio Amateurs' Exam. R.T.E.B. Certificate P.M.G. Certificate Practical Radio Radio & Television Servicing Practical Electronics Electronics Engineering Automation

**INCLUDING  
 TOOLS!**

The specialist Electronics Division of B.I.E.T. (Incorporating E.M.I. Institutes) NOW offers you a real laboratory training at home with practical equipment. Ask for details.

**B.I.E.T.  
 SCHOOL OF  
 ELECTRONICS**

**POST COUPON NOW!**

Please send me your FREE 156-page "ENGINEERING OPPORTUNITIES" (Write if you prefer not to cut page)

NAME .....

ADDRESS .....

SUBJECT OR EXAM THAT INTERESTS ME .....



SE 21

**THE B.I.E.T. IS THE LEADING ORGANISATION OF ITS KIND IN THE WORLD**

# A transistorised HEARING AID amplifier

By V. H. PIDDINGTON

A HEARING aid can be an expensive item, but a resourceful constructor is in a position to effect a considerable saving should a requirement for one arise either personally, or among relations and friends. The unit to be described is suitable for those who, while not appearing really deaf, find it difficult to make out speech or conversation. This kind of difficulty is usually caused by a lack of sensitivity to high tones above 1,000c/s, and this unit has been designed to have a falling response below this frequency. For more severe cases of general deafness, the frequency response could, of course, easily be extended downwards by using larger values of coupling capacitor. If there

however, the supply is only 1½V, and it hardly seems necessary to include stabilising precautions at a cost of three extra components per stage, bearing in mind that in this application small size is of primary importance. Some degree of stabilisation could be obtained by connecting the base resistors in Fig. 1 directly to collector, instead of h.t. negative, at the expense of some loss in gain. The method used was chosen to give the highest gain, and in practice appears to work reasonably well under conditions encountered in normal use. If the unit becomes very warm (such as when left in the sun), there is some loss of gain, but it is not serious.

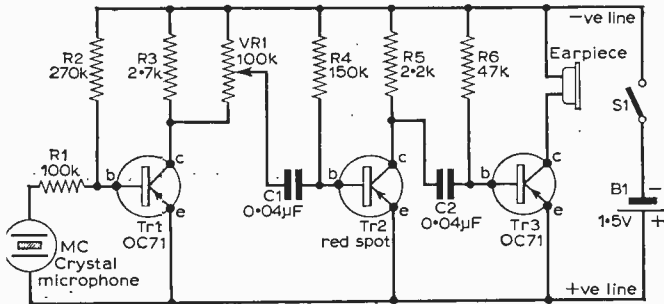

Fig. 1: The circuit of the amplifier.

is any doubt, medical advice should be sought first. (This particular unit has also found use in listening for breakdown in high-voltage power supplies!)

**Circuit**

As will be seen from Fig. 1, the amplifier is of the simplest possible design so that the number of components may be kept to a minimum. Three transistor stages are used, and it will be noted that each stage is biased by base current flowing in the resistor connected between base and negative supply.

One of the commonest ways of providing protection against change of transistor characteristics with temperature is to derive the base bias voltage from a potentiometer across the h.t. supply, and to include a bypassed resistor between emitter and positive line as shown in Fig. 2. In this circuit

**Collector Current**

It will be noticed that a red-spot surplus transistor is used for the second stage, while OC71's are used for the other two. This was due solely to availability at the time of building and surplus types could be used throughout. An OC70 would be the best choice of readily available transistors for the input stage on the score of noise, but an OC71 is correct for the output stage.

It is important in transistor amplifiers with low supply voltages to keep the collector current down to somewhere

near the minimum necessary for reliable small-signal amplification, which is about 0.25mA for most low power audio transistors normally available. The collector current of the first stage is set to this value, while the second stage is biased a little higher at about 0.3mA to ensure that sufficient output current is available to drive the output stage. If the collector currents on these two stages were not kept low, the voltage dropped across the collector resistor would be so large as to have in-

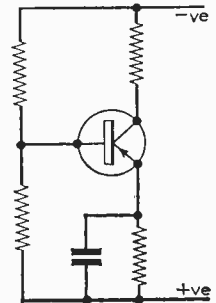

Fig. 2: Base bias voltage derived from potentiometer.

sufficient collector-emitter voltage for proper operation of the transistor. It will probably be necessary to select the base bias resistors because leakage current will have a considerable effect on these low levels of collector currents, and readily available transistors are likely to have considerable variations in leakage current.

### Output Stage

The earpiece used is of  $1,000\Omega$  impedance and  $250\Omega$  d.c. resistance; it is popularly used for transistor pocket radios. With this earpiece, and a supply voltage of  $1\frac{1}{2}$ , the collector current should be  $1.5\text{mA}$  for maximum power output. With the figures quoted, the maximum power output that can be obtained with about 5% distortion is  $0.5\text{mW}$ , which is quite sufficient for this application. If it should be desired to power the amplifier from a 3V battery, the output stage should be biased to  $3.0\text{mA}$ . For most hearing aid applications, however, the 1.5V cell provides sufficient power, and lasts longer. Incidentally, when using a 3V supply, the collector current of the voltage amplifier stages should be set at the same values as with a 1.5V supply.

### Microphone

The microphone in this unit is a small, square crystal insert which can be obtained from retail suppliers of transistor components, and can be seen in the centre of Fig. 3.

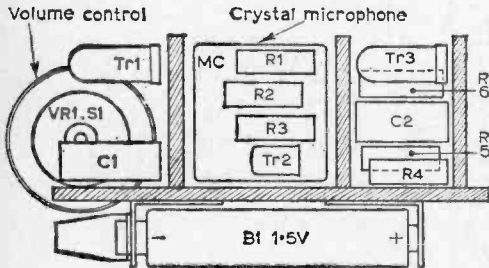

Fig. 3: Showing the compact layout of components achieved with this design.

### Construction

The layout is perhaps a little unusual, but can be very useful to amateur constructors when it is desired to pack a number of components into a small volume. Fig. 3 is an underside view of the unit out of its case, and as will be seen the components are supported between small phenolic boards, the lead wires being threaded into small holes drilled in these boards.

The battery bracket is made from a length of tag strip, with all the tags removed. The two end feet have had the tag part cropped off, and are mounted lengthwise along the strip, forming the battery clips. One pole of the on/off switch (on the volume control) is soldered to a bent tag which is in turn screwed to the negative battery clip.

Transistor Tr1 and C1 are in the first compartment; Tr2, R1, R2 and R3 are in the middle under the microphone unit, and Tr3, C2, R4, R5 and R6 are in the last compartment.

Component wires are used for whatever linking is necessary on the support boards. Where it is

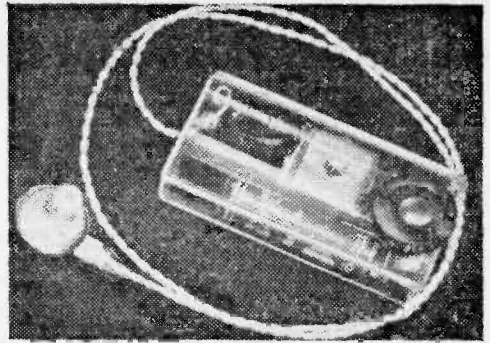

The finished amplifier.

unavoidable that transistors come close to the boards, the lead wires are taken through the board and looped back through another hole so as to leave some wire available for the application of a thermal shunt (such as pliers) when soldering. The photograph shows the complete unit in its case, which being clear plastic, gives a good view of the "works". The inside should be painted and would give a very pleasant effect. This case has a sliding lid, which has a hole in the end to allow the volume control knob to project outside the case.

### Performance

The unit described has a gain of 66dB at a temperature of  $25^{\circ}\text{C}$ , and a maximum power output of  $0.5\text{mW}$ . The frequency response of the amplifier is flat above  $1,000\text{c/s}$  and falls 12dB per octave below  $1,000\text{c/s}$ , but this could, of course, be modified by the use of larger value coupling capacitors. Lower working voltage units are available, physically smaller than the 250V capacitors used in this amplifier.

It should be borne in mind that the overall frequency response is affected by the microphone and earpiece. Earpieces in particular, tend to have a peak between  $1,000\text{c/s}$  and  $2,000\text{c/s}$ .

## CELESTE 7-Transistor Portable Radio

Referring to the blueprint enclosed in the June issue of PRACTICAL WIRELESS, the rod aerial shown in Fig. 1, Fig. 2 and Fig. 5 is Osamor type PW/FRI, plus QXL (external aerial coil)—whereas the Components List specifies Weyrad type RA2W. These two types of rod aerial are not directly interchangeable, and the connections for the RA2W are given below.

**M.W. Section:** BLUE—VC1, GREEN—C1, YELLOW—S1 ("M"), WHITE—Red on L.W. coil.

**L.W. Section:** YELLOW—Yellow on M.W. coil, RED—white on M.W. coil, BLACK—+ve line, WHITE—+ve line.

A  $150\text{pF}$  mica or ceramic capacitor must be added between the two Yellow tags and +ve line when using the RA2W.

**Oscillator Coil:** If the specified oscillator coil is used (Weyrad P50/1AC) the following capacitor values should be used: C2,  $150\text{pF}$ ; C4,  $220\text{pF}$ .

**TOP QUALITY—LOW COST**  **AMATEUR RADIO EQUIPMENT**

**CR 66 COMMUNICATIONS RECEIVER**

**THE FINEST KIT EVER OFFERED**



Frequency Range 540 Kc s to 30 Mc s in four Band-switched ranges.

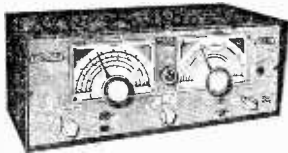

Electrical Bandsread. Coil Unit wired ready and I.F. Transformers factory aligned, no test equipment required. Temperature compensated trimmers. Regenerative I.F. stage for maximum gain and B.F.O. Panel aerial trimmer, separate speaker switch, 3 watts output for external 2-3 ohm speaker. Separate cathode follower for tape recording etc. Valve line-up—ECH81, EBF89, ECC81, EL84, EZ80, EM84. (Optional extra). For 200-250 volt A.C. Cabinet size 16 x 6½ x 8½ in.

Complete Kit with 17-page Instruction Manual **£18.5.0**

Carriage 6/-.

Tuning indicator parts with EM84 17/6.  
H.P. Terms available on request.

★ **P.R. 30 R.F. PRESELECTOR** ★



Frequency range 1.5-30 Mc/s.

Substantially improves the performance of any superhet receiver.



G4HZ writes . . . I am delighted with it, it improves my Eddystone 640 in all respects. The difference with the Preselector is fantastic, a weak signal on 15 metres about S2 changed to S8. On the L.F. Bands, unwanted noise and mush is cut out.

G3RIA writes . . . The results in conjunction with my Eddystone 888 are amazing. Signals are twice as strong with much higher signal/noise ratio. A first class product well worth the money.

The P.R.30 uses EF 183 Frame Grid R.F. Amplifier and provides up to 20 dB gain. Features include vernier tuning, gain control, selector switch for either dipole or end fed antenna. External power supplies (obtainable from Rx). Smart styling in grey and black. Complete, ready for use, with all plugs, cables,

**£4.17.6** Carr. 3/-.

**THE NEW CR 45** ★ **NEW STYLING TOP PERFORMANCE**

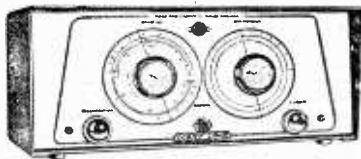

- ★ Tunes 10-2000 metres (5 Coils).
- ★ Separate electrical bandsread.
- ★ Three slow motion vernier drives.
- ★ Low loss polystyrene plug-in coils, factory aligned.
- ★ Dials calibrated in frequencies and degrees.
- ★ Power output 3 watts for 2/3 ohm speaker.
- ★ Valve line-up: ECC81/EL84/EZ80.
- ★ Front Panel Silver and Black, control knobs Grey.
- ★ Provision for panel phone jack.

Superb styling. World-wide reception. Total building cost, with 2 Coils, 25-75 and 60-175 metres. Instruction Manual 11 pages, less Cabinet

**£6.19.6** carr. 3/6.

CR 45 Cabinet Silver Grey, 12 x 5½ x 7 in. sliding door for easy coil changing **27/6** Extra coils, all ranges **4/9** each.

**ALL PARTS AVAILABLE SEPARATELY**

★ **THE MINI-CLIPPER** ★

- ★ Tunes 10-2000 metres (5 coils).
- ★ Miniature 1 valve, all band receiver.
- ★ Low loss polystyrene plug-in coils, factory aligned.
- ★ Air spaced ball bearing condensers.
- ★ Provision to add two-transistor amplifier.
- ★ Battery lasts months.

**36/6**

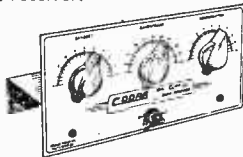

Can be built in an evening, will receive Amateur and Broadcast stations from all parts of the world. Total building cost with one coil 25-75 metres, Instruction Manual 4 pages, 36/6, carr. 2/6. Extra coils, all ranges, 4/9 each. Electrical bandsread available. All parts available separately.

★ **THE SUPER CLIPPER** ★

- ★ Tunes 10-2000 metres (5 coils).
- ★ Large precision dial, dual slow motion drives.
- ★ Bandsread on all Bands.
- ★ High gain valve/transistor hybrid circuit.
- ★ 2 Mullard transistor amplifiers, pre-assembled and tested.
- ★ Low loss polystyrene plug-in coils, factory aligned.
- ★ Batteries last months.

**88/6**



Easy to assemble, this top performing All Band Receiver brings a new world of listening pleasure to your finger-tips at low cost. Total building cost with 2 Coils, 20-60 and 55-190 metres, Instruction Manual 7 pages, 88/6, carr. 2/6. Extra Coils, all ranges, 4/9 each. Front Panel, Silver Grey, 10 x 7½ in., 6/9.

Please note NEW address. We have now acquired new modern premises, combining all depts., offices and laboratories. New equipment under development will be announced in due course. CODAR Equipment is famous for Top Quality, Peak Performance and Easy-to-Follow Instructions—no guesswork. 6d. in stamps brings illustrated leaflets. Coming shortly, 70 watt 5 Band Transmitter Model No. CT80.

**CODAR RADIO COMPANY**

**BANK HOUSE, SOUTHWICK SQUARE, SOUTHWICK, SUSSEX**

G3IRE

Canadian Distributors: JAYCO ELECTRONICS, TWEED, ONT.

G3IPA

# WEYRAD

## 6-TRANSISTOR 2-WAVE SUPERHET RECEIVER MODIFICATIONS NOW AVAILABLE FOR 500 mW OUTPUT

ROD AERIAL—RA2W 6 in. long, 3/8 in. diameter, connections to tags on Coils. For 208pF tuning capacity. Complete with Car Aerial Coil ... ..	12/6
OSCILLATOR COIL—P50/1AC M.W. covered with 176pf tuning capacity, L.W. by extra padder ... ..	5/4
I.F. TRANSFORMERS 1st and 2nd Stage—P50/2CC ... ..	5/7 (2 required)
3rd Stage—P50/3CC ... ..	6/-
DRIVER TRANSFORMER—LFDT4 ... ..	9/6
OUTPUT TRANSFORMER—OPT1 ... ..	10/6
PRINTED CIRCUIT—PCA1 ... ..	9/6

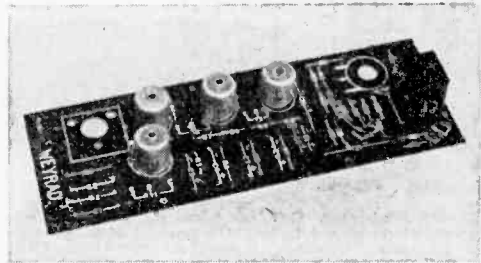

In response to many requests we have redesigned the output stages to give 500mW and to enable a standard 3 ohm Speaker to be used. Full details of the simple changes are given on a separate leaflet available on receipt of stamp.

CONSTRUCTOR'S BOOKLET WITH FULL DETAILS ... ..	2/-
TRANSISTOR A.F. AMPLIFIER TYPE A.F.1—LOW IMPEDANCE INPUT, 3-TRANSISTOR, 500mW OUTPUT, FULLY ASSEMBLED WITH VOLUME CONTROL ... ..	63/6

**WEYMOUTH RADIO MANUFACTURING CO., LTD.**  
REGENT FACTORY, SCHOOL STREET,  
WEYMOUTH, DORSET

TRANSISTORS AND DIODES			
Transistors	2-OC72 16/-	Matched Pns.	
AC107 14/6	OC74 8/-	2xOC72 16/-	
AD140 25/-	OC78 8/-	2xOC78 16/-	
AF102 27/6	OC81 6/-		
AF114 11/-	OC81M 8/-	Germanium Diodes	
AF115 10/6	OC82 10/-	BY100 13/-	
AF116 10/-	OC83 6/-	OA70 3/-	
AF117 9/6	OC170 9/6	OA79 3/-	
AF118 20/-	OC171 10/6	2-OA79 6/-	
AF124 10/-	OC71 25/-	OA81 2/6	
AF125 10/6	TK1000C	OA90 3/-	
AF126 10/6	Mixer 9/3	OA91 3/-	
AF127 9/6	TK1000C	OA95 3/6	
OC16W 35/-	IF & IF2	OA210 9/6	
OC19 25/-	18/-perpair	GEX34 4/-	
OC26 25/-	TK1001C	GEX35 4/-	
OC44 6/-	DR 8/-	GEX36 10/-	
OC44M 9/3	TK1001C		
OC45 6/-	OP	Sundry Types	
OC45M 9/-	16/-perpair	PXA102 4/6	
OC70 6/6	TK1002C	Red Spot 3/6	
OC71 5/-	DR 9/3	White	
OC72 8/-	TK1002COP	Spot 5/-	

A set of Transistors comprising 1 OC44, 2 OC45, 1 OC81D, 2 OC81, 32/6 set.  
Set of Audio Transistors, 1 x OC81, 2 x OC81, Driver Matched Pair, 15/6 set.

MICROPHONES	
Acos Mic 39/1 ... ..	32/6
Table Stand ... ..	7/6
Floor Stand Adaptor ... ..	12/6
Acos Mic 40 ... ..	19/6
Acos Mic 45 ... ..	19/6
BM3 Microphone ... ..	45/-
Table Stand ... ..	12/6
Floor Stands MS4—3 sections ... ..	59/6
MSB—2 section floor stand chrome	105/-

GRAMOPHONE UNITS	
BSR TU12 unit, with Mono TC8H cartridge. £3.19.6. BSR GU7 unit, with TC8M or TC8H cartridge, Mono, £4.15.0. BSR GU7 unit, with TC8S cartridge, stereo, £5.5.0. Garrard Autoslim, automatic, with GC8 Mono cartridge, £7.15.0. Garrard Autoslim, automatic, with EV26 Stereo cartridge, £8.10.0. Garrard Autoslim, De Luxe, with GC8 Mono cartridge, £11.5.0. Garrard Autoslim, De Luxe, with EV26 Stereo cartridge, £12.0.0. BSR Monarch UA14 with TC8 mono cartridge, £6.6.0. BSR Monarch UA14 with TC8S Stereo cartridge, £7.7.0. BSR Monarch UA16 with TC8 Mono cartridge, £6.19.6. BSR Monarch UA16 with TC8S Stereo cartridge, £7.19.6.	

EARPHONES	
CR5 crystal earpiece, high impedance	6/-
MR4 magnetic earpiece, low impedance	6/-

**SEND FOR OUR 1963 COMPONENTS CATALOGUE**  
48 pages of valves and accessories. Send 1/- in stamps for your copy. Trade catalogue also available, for which please attach your business letter heading.

METERS			
MINIATURE PANEL METERS			
0-250 µA ... 39/6	0-5 mA ... 27/6	0-300 V ... 27/6	'S' meter ... 35/-
0-500 µA ... 32/6			
0-1 mA ... 27/6			
MULTI-RANGE		TESTMETERS	
Caby M1 ... ..	... ..	£2.14.0	
Caby A10 ... ..	... ..	£4.17.6	
Caby B20 ... ..	... ..	£6.10.0	
Taylor 127A... ..	... ..	£10. 0. 0	
Eagle EP10K ... ..	... ..	£4.12.6	
Eagle TK20A ... ..	... ..	£2. 9. 6	
Model 200H... ..	... ..	£5. 5. 0	

**TERMS:** Cash with Order or C.O.D. Postage and Packing Charges extra. Single valves 9d., Minimum Parcel Post charges 2/-. Please include sufficient postage with your order. Minimum C.O.D. fee and postage 3/6.

These Postal Rates apply to U.K. only. For full terms of business see inside cover of catalogue. Personal Shoppers 9 a.m. to 5 p.m. Mon. to Friday, Saturday 10 a.m. to 1 p.m.

CHASSIS	
Aluminium Undrilled with Reinforced Corner, available in the following sizes:	
6in. x 4in. x 2 1/2in. ... ..	4/6 each
8in. x 6in. x 2 1/2in. ... ..	6/3 each
10in. x 7in. x 2 1/2in. ... ..	7/3 each
12in. x 3in. x 2 1/2in. ... ..	5/9 each
12in. x 5in. x 2 1/2in. ... ..	6/9 each
12in. x 8in. x 2 1/2in. ... ..	8/6 each
14in. x 3in. x 2 1/2in. ... ..	6/- each
14in. x 9in. x 2 1/2in. ... ..	12/- each
16in. x 6in. x 2 1/2in. ... ..	9/3 each
16in. x 10in. x 2 1/2in. ... ..	14/- each

All are four-sided—ideal for radio receivers, amplifiers, power packs, etc.

**ALPHA RADIO SUPPLY CO., 103 Leeds Terrace, Wintoun Street, LEEDS 7**

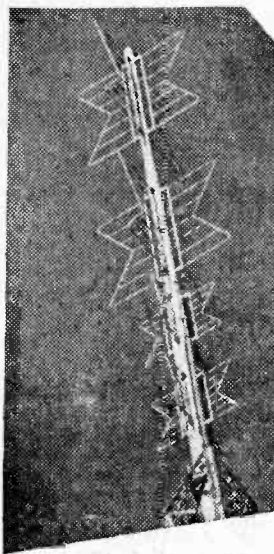

# On Your Wavelength

By THERMION

## Three Dimensional Sound

The barometer seems set fair for the loudspeaker trade.

Having recently purchased a second loudspeaker for stereo, it now seems that before long we shall require a third in order to add reverberation to mono or stereo—the total effect being Three Dimensional Sound, you lucky people!

Seriously, I was favourably impressed by a recent demonstration where part of the signal feeding the two normal loudspeakers was fed via a delay unit to a third loudspeaker located at the back of the room.

When, after listening to the two channels for a time, the third unit was brought into operation the effect was quite remarkable. As the music swelled around, the artificial reverberation added tremendous liveliness and it was not hard to imagine that one had been transported into a large auditorium. I must confess that immediately after this experience the normal two channel stereo seemed flat.

So now you know what is in store for you next!

## Power from the Air

A receiver powered from a radiated carrier wave is an intriguing prospect that will appeal to the canny no less than to the enquiring technical mind. I am informed that such a device has been tried out on the Continent with moderate success, and the licensing authority concerned has not been able to discover any grounds for declaring this an illegal operation.

The "free running" receiver in fact incorporates two receiving circuits. One is quite simple and employs a diode detector and is tuned to a high power local broadcast station. The d.c. developed across the diode load is fed into the second receiving circuit where it is used to energise transistors. This second circuit is, of course, much more sensitive and can be tuned to distant stations.

It does seem that the advantage of independence from batteries or mains supply is somewhat nullified by the need for a fairly large aerial—unless one happens to be residing under the shadow of a BBC transmitter. Still, it is an idea for experimental work.

There might even be some useful application for a parasitic receiver: think of that short-wave enthusiast living in the isolated countryside, no mains supply and batteries exhausted (last Winter for example) isolated yes—except for that solitary broadcast transmitting station over on yonder hill . . . afraid, though, there wouldn't be any DX hunting between midnight and 6.30 a.m.

**T**HE popular interest in stereo reproduction is evinced by the efforts of loudspeaker makers to achieve virtually the impossible—that is to produce a miniature hi-fi reproducer.

In the majority of homes there simply is not space for two free-standing loudspeaker enclosures of normal hi-fi proportions, which means a volume of some 5 to 10 cu. ft for each unit.

Considerable ingenuity has been used in designing two-speaker systems with cabinets measuring 20in. x 11in. x 7in. typically, suitable for standing on a bookcase or shelf, for mounting directly on the wall or even for standing on the floor; completely versatile as you see.

The snag with miniature cabinets lies in the fact that as the volume of a total enclosure is reduced, the resonant frequency of the system is raised, and with the instruments being discussed, this may be in the region of 80—100c/s.

One artifice employed to lower the enclosure impedance and thus the bass resonance is described by the makers as an "acoustic pump". This is actually a drive unit similar to the bass loudspeaker but with a modified cone. The pump is mounted on a panel which divides the interior of the cabinet into two compartments, and the speech coil is connected so that both cones move in phase. Consequently the volume of the main enclosure as "seen by the bass unit remains practically constant and this helps to lower the bass resonance.

The performance of those miniature systems that I have had an opportunity of listening to has been generally satisfactory. The tone range seems well balanced, due no doubt to some restriction of the upper frequency response to compensate for deficiencies at the other end of the scale.

This somewhat curtailed frequency range is hardly likely to give concern, except to those who have become accustomed to the extensive audio range obtained from a full-size hi-fi reproducer.

# THE MALVERN TAPE RECORDER



CONTINUED FROM PAGE 349 OF THE AUGUST ISSUE

By T. Snowball

**A**N alternative method of construction is possible using the pre-drilled paxolin sheets called "Veroboard".

These sheets are in various sizes and are  $\frac{1}{8}$  in. thick. They are drilled with small holes approximately 0.04 in. in diameter, spaced at 0.2 or 0.1 in. Small silver plated ribbed pins are inserted into these holes wherever a component needs to be anchored. This makes an admirable form of construction, easy to do, and has the advantage that the components can be laid out exactly as the circuit is drawn.

The output transistors should use the chassis as a heat sink and therefore need the mica washers for insulation. The layout is non-critical but short leads are helpful in maintaining stability. Screened leads to the volume control and record/playback switch for the boost inductor are advised. This switch is a two-wafer, miniature Yaxley type, mounted on the tapedeck.

As supplied it is a single-wafer, 4-pole 2-way, but as a 6-pole 2-way is needed, the easiest way is to add another similar wafer, with screen between. The original spindle is long enough to drive two wafers, and other odd items needed are two longer screws and washers or packing pieces to space the wafers.

The working voltage for all the capacitors as given in the components list is the minimum suitable, so of course higher voltage ones are suitable. Likewise the resistors are all  $\frac{1}{2}$ W carbon, with the exception of the higher stability ones in the preamplifier. These are preferred here because normal carbon resistors may be noisy when used in the early stages of a high-gain amplifier, also close tolerances are needed in order to obtain the correct voltages in this circuit.

**Power Unit**

The power unit chassis shown in Fig. 9 incorporates a 13V 0.3A heater transformer, such as the type normally supplied as replacement for TV sets, where the c.r.t. heater to cathode shorts or gives low emission. These transformers normally have a boost winding on

them giving about 15V r.m.s.

In the recorder the 13V tap should be suitable but a check of voltages as in Table 1 on load will soon show the correct tap to use. The h.t. rectifiers are silicon junction diodes types RS20A, SX641, ZS30B. Alternatively, germanium diodes type GEX541 or GJ3M will do. As it is a bridge circuit

TABLE 1

Typical Voltages	Record	Playback
Reservoir Capacitor, C22	11V	17V
Output Stage H.T., C23	10.5V	16.5V
Erase Stage H.T., C21	10V	17V
Boost Stage H.T., C9	9V	11V
Pre-Amp. Stage H.T., C2	9.5V	14V
<b>Total Current</b> Depends on Volume	300-500mA	12mA-300mA

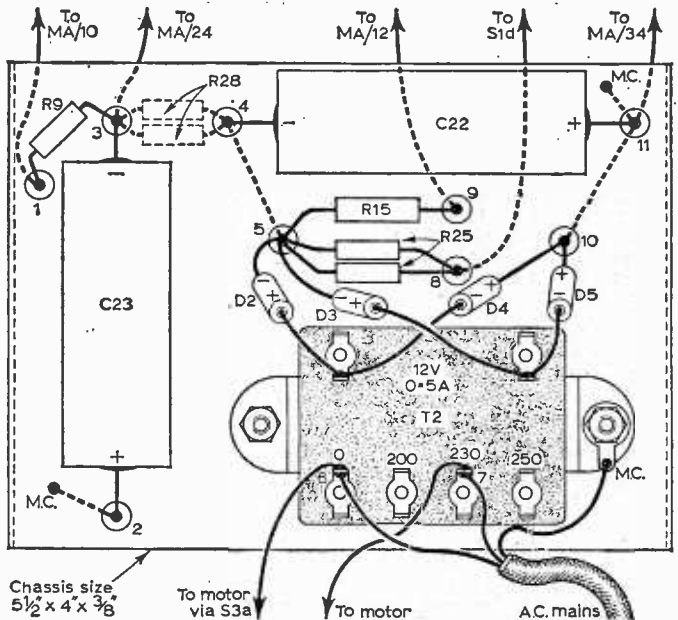

Fig. 9: The layout and wiring of the suggested power unit.



# RADIO CLEARANCE LIMITED

27 TOTTENHAM COURT ROAD, LONDON W.1

THE OLDEST COMPONENT SPECIALISTS IN THE TRADE

TRADE ENQUIRIES INVITED

Telephone: MUSEUM 9188

EST. 35 YRS.

## AGAIN CRASHING THE SOUND BARRIER!

Enormous purchases of Brand New and Guaranteed Plessey loudspeakers enable us to offer these units at THE LOWEST PRICES EVER! Don't miss this golden opportunity to obtain a first-grade permanent-magnet LOUDSPEAKER off the production line at LESS THAN THE MANUFACTURER'S COST! Read carefully the prepared list below and choose just the right speaker for the job—COMPARE THE PRICES ANYWHERE! SELLING FAST—STOCKS CHANGING RAPIDLY.

### SCHEDULE OF LOUDSPEAKERS AVAILABLE

Diameter in inches	Gauss in lines	Imped. in ohms	Price	Diameter in inches	Gauss in lines	Imped. in ohms	Price	Diameter in inches	Gauss in lines	Imped. in ohms	Price	Diameter in inches	Gauss in lines	Imped. in ohms	Price
2	7000	30	8/-	4	7000	3	8/6	5	6000	3	8/-	5	6000	25	10/8
2½	7000	35	8/8	4	9500	5	9/8	5	6000	5	8/-	5	9500	25	11/8
2½	7000	50	8/6	4	6000	25	10/6	5	7000	5	8/8	5	9500	35	11/8
2½	7000	80	8/-	4	7000	25	11/8	5	7500	5	9/-	5	10000	25	12/-
3½	8500 (E.M.I.)	13	9/8	4	6000	35	10/8	5	8500	3	9/8	6½	7000	5	11/-
3½	7000	35	8/6	4	7000	35	11/-	5	8500	5	9/8	6½	7000	5	11/-
3½	9500	50	10/8	4	9500	35	11/8	5	9500	3	10/6	6½	8500	5	11/8
4	8000	3	7/6	4	9500	5	8/-	5	9500	5	10/8	8	7000	3	12/-
4	6000	3	8/-	4 tweeter	7000	5	8/-	5	10000	3	11/8				

Elliptical Size in lines	Gauss in lines	Imped. in ohms	Price	Elliptical Size in lines	Gauss in lines	Imped. in ohms	Price	Elliptical Size in lines	Gauss in lines	Imped. in ohms	Price	Elliptical Size in lines	Gauss in lines	Imped. in ohms	Price
5 x 3	6000	3	7/8	6 x 4	8500	3	9/8	7 x 4	9500	50	11/8	8 x 2½	9500	5	10/-
5 x 3	7000	3	8/-	6 x 4	9500	3	10/-	7 x 4	10000	15	12/6	8 x 2½	10000	5	10/8
5 x 3	9000	3	8/8	6 x 4	9000	5	10/-	7 x 4	9500	3	13/8	8 x 5	6000	3	9/8
5 x 3	9000	4	8/6	7 x 3½	9500	3	10/8	8 x 2½	6000	3	8/8	8 x 5	7000	3	9/-
5 x 3	9000	5	8/8	7 x 4	7000	3	10/-	8 x 2½	7000	3	9/-	8 x 5	8500	3	9/8
5 x 3	6000	25	9/8	7 x 4	7000	5	10/-	8 x 2½	7000	5	9/-	8 x 5	9500	3	10/-
5 x 3	7000	25	10/-	7 x 4	8500	3	10/8	8 x 2½	6000	6	8/8	8 x 5	9500	3	10/-
5 x 3	9000	25	11/-	7 x 4	9500	3	11/-	8 x 2½	6000	30	9/8	8 x 5	9500	3	10/-
5 x 3	9000	35	11/-	7 x 4	9500	4	11/-	8 x 2½	8500	5	9/8	8 x 5	9500	15	13/8
6 x 4	6000	3	8/8	7 x 4	9500	5	11/-	8 x 2½	9000	3	10/-				
6 x 4	7000	3	9/-	7 x 4	9500	30	11/8	8 x 2½	9500	4	10/-				

ALLOW 2/- each Speaker for postage and packing, and please specify the exact requirements—the nearest available will be sent.

## OVER 50,000 SOLD & STILL THE DEMAND CONTINUES FOR OUR 'HEAVENLY TWINS'

Ask for a demonstration in the shop.

### "CAPRI"

Sensitive!  
Super-selective!  
Superb Speaker!  
New Price NOW ONLY **79/6**



(2/- p. & pkg.)  
Pocket Super-hot MW and Droitwich LW  
Size 4½ x 2½ x 1½ in.  
Constructional data 1/9  
Post Free.

The best and easiest transistor build-yourself sets available.

Send S.A.E. for FREE PARTS LIST

6 First Grade MULLARD Transistors, Diode(s) and all components BRAND NEW and

[GUARANTEED]

Choice of a dozen stations in daylight . . .

### "CONTESSA Mk. III" "QUEEN OF THEM ALL"

ONLY **£9.19.6** (3/6 p. & pkg.)

PORTABLE CAR RADIO  
2 WAVEBAND SUPER-HET

Construction manual 2/10 Post Free.

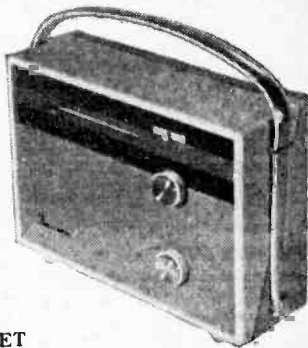

Inclusive price for all associated components, case, battery and instruction Book complete in every detail.  
ANY PARTS SOLD SEPARATELY ON THE BUILD-AS-YOU-BUY SCHEME

**CONTESSA III £9.19.6** (plus 3/6)  
**CAPRI (Battery 2/6 extra) 79/6** (plus 2/-)

### SELECTED GUARANTEED BARGAINS—BRAND NEW

Beautifully geared AM/FM 2 Gang Condensers, 4/8: AM/FM IFT's 465kc/s and 10.7 Mc/s, 4/8 pair; Magnavox Crystal Tape Recorder Mikes, 12/8; Double-tuned Transistor ferrite IFT's Q120, 470 kc/s, 5/6 pr; 3 matched IFT's and oscillator coil for Mullard transistor circuits, 10/6 the set; Plessey-Brayhead turret tuners 34/38 Mc/s, valved 9/6 each; 3 watt Stereo Amplifiers, complete, ready to switch on 79/6; Sencorell rectifiers R3ZD-D3-2-Y, 2/8 each. **DIODES**—OA70, OA79, OA81, OA90, CG46H, ORP90, GD10, 2/- each. **TITANISTOR'S**: set of 6 (RF and LF) including 1 watt matched pair, heat sink and diode, 13/6 the set; OC44 (or equiv.), 8/9; OC45 4/6; OC81 5/6; matched pair 12/-; PXC 101A 4/6, matched pair 9/6. PXA 101 3/9, AF 115 4/8, SB 905 2/-, Subrain, Germanium diode 1/3. Please send STAMPED and ADDRESSED envelope with any enquiry. We regret no catalogues—our stocks move too quickly! Kindly make provision for additional postage and packing charges to avoid delay.

TERMS: CASH WITH ORDER or C.O.D. ON ORDERS OVER 10/-.

# HOME CONSTRUCTORS LOOK!

## THE COROVER '6'

This superhet receiver uses the very latest circuitry, 6 transistors and two diodes and is fully tunable over both medium and long wavebands. First stages uses three Mullard A.E.117 alloy diffused transistors with OA79 and OA91 diodes, output—OC81D and two OC81's in push-pull. I.F. frequency 470 Kc/s. Large internal ferrite rod aerial gives excellent reception over all ranges. 3 inch high flux speaker has a maximum output of 330mW. Operates on four 1.5 v. pen torch batteries. All components are mounted on a single printed circuit board. Attractive plastic case with carrying handle—fitted sockets for personal earpieces, tape recorder and car aerial. Size 6½ x 4 x 1½ in.

**MAY BE BUILT FOR £5.76** All parts sold separately. P. & P. 4/- extra. (Data and instructions 2/6, free if all parts bought.)

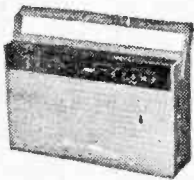

## The SPRITE

A unique Wirecomp offer. The Sprite is a six transistor superhet Miniature Pocket Radio of Commercial Quality—offered to you in three main pre-assembled units—which together with simple wiring—enable you to build it in only one hour!

Fully tunable over Long and Medium wavebands. Uses printed circuit and High sensitivity internal ferrite rod aerial. I.F. frequency 470 Kc/s. Transistors: 3 Philco 2087's, 2 Mullard OC81M's OC81DM and OA90 diode. 3 inch speaker. Works on single PP3 battery. Supplied with the complete R.F. and I.F. stages. Driver and Output stages, ready built and mounted on the printed circuit; for final assembly you only have to fit the wave-change switch, tuning condenser and drive, volume control, earphone socket and aerial rod. In very attractive plastic case, size 4 x 2½ x 1½ in. All parts sold separately.

## THE 'REALISTIC 7'

A fully transistorised Portable Receiver made to the highest professional standards—is now available to the home constructor. Comprises 7 Mullard Trans. OC34, 2 OC81's, OC71, OC81D, and 2 OC81's plus OA70 Crystal Diode. Delivers 350 milliwatt output to 4 in. high flux speaker—I.F. frequency 470 Kc/s—fully tunable over medium and long wavebands. All components mounted on single printed circuit board, size 5½ x 5½ in. Attractive two-tone plastic cabinet with carrying handle—size 7 x 10 x 3½ in. with easy to read dial and socket for car aerial, choice of Red/Grey, Blue/Grey or all Grey. Complete with full instructions. All parts sold separately.

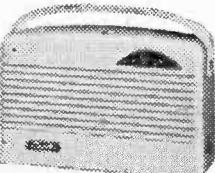

**PRICE ONLY £5.19.6** Battery 3/9 extra. P. & P. 4/6 extra. (Circuit diagram 2/6, free if all parts bought.)

## WIRECOMP'S BARGAIN PRICE 79/6

Real Calf Leather Case, wrist strap and Personal Earphone with case and Battery, 12/6 extra. P. & P. 3/6 extra. (Data and instructions 2/6, free if all parts bought.)

## WIRECOMP ELECTRONICS

378 HARROW ROAD, LONDON, W9.

TEL: CUNNINGHAM 9330

Hours of business: 9 a.m. to 6 p.m. Open all day Saturday. Opposite Paddington General Hospital. Buses 188 and 36 pass the door.

## Here's the way to BUILD A BETTER RECORDER

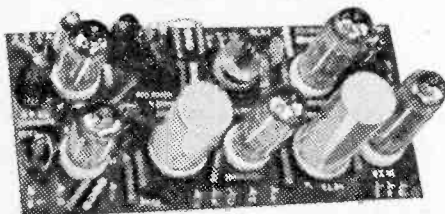

and save too!

### MODEL "D"—4 TRACK

Amplifier 8311-4-V 12 gns  
Speaker & Case assembly 5 gns  
Complete with Collaro Deck 34 gns

### MODEL "B"—2 TRACK

Amplifier 8312 8 gns  
Speaker & Case assembly 4 gns  
Complete with BSR Deck 21 gns

It's the excellence of the design and layout of the printed circuit amplifier sections of Martin Recordakits which ensure such exceptionally good standards of reproduction. It's the thoughtful way in which these Kits are presented for building that makes success assured. Everything is provided for and the finished product is one you will be proud of having built. All parts available separately.

Send coupon at once for details of all Recordakits

## MARTIN RECORDAKITS

MARTIN ELECTRONICS LTD.  
155 High St., Brentford, Middx.  
Recordakits leaflets please!

NAME \_\_\_\_\_  
ADDRESS \_\_\_\_\_  
PP.9 \_\_\_\_\_

From Radio Stockists or direct in cases of difficulty Phone ISLeworth 5885/1161

### COMMUNICATION RECEIVERS

**CR100/8MID.** Covers 60 kc/s-30 Mc/s in 6 bands. 11 valves. 2 R.F. and 3 I.F. stages. Crystal gate, B.F.O., etc. Ready for 200/250 volt a.c. mains. 21 watts output for 3Ω speaker. BRAND NEW in original packing, £35. carr. £2. S.A.E. for illustrated details.

**HRO SENIOR RECEIVERS.** Complete with 9 coils. £17.10.0. S.A.E. for full details.

**PCR-3 RECEIVERS.** 3-wave bands, medium wave and 2 short wave, from 120-13 metres. Good condition, tested 8 gns. Carr. 10/-. A.C. mains internal power supply £2 extra.

**SILICON RECTIFIERS.** Type 1EA2 (1 x 1Hn.) will handle 250 volt at up to 500 mA. Replaces any TV metal rectifier. 7/6.

**MOVING COIL PHONES.** Finest quality Canadian with Chamols ear muffs and leather-covered headband. With lead and jack plug. Noise excluding, supremely comfortable. BRAND NEW..... 22/6, post 1/6.

**AVO WIDE RANGE SIGNAL GENERATORS.** Six turret operated ranges covering 50 Kc/s to 80 Mc/s. For use on standard A.C. mains. Packed in original transit cases with accessories. Post-war type in new condition. £15. Carriage 10/-. REAL BARGAIN

**RECEPTION SETS R329/R320.** Consists of TWO identical receivers in one cabinet. EACH receiver is complete with 14 modern miniature valves (3 x 6AL5, EP91, 9 x 6X2, 2 x EB91, 2 x 12A17, Q570/20, EL91 and 5U4G) its OWN stabilised AC mains power supply and speaker. Intended for reception of one fixed frequency between 60-100 Mc/s according to crystal used but ideal for modification to 72 Mc/s or 144 Mc/s. Price complete £7.10.0 (Carr. £1) or individual receivers (less cabinet) £3.15.6 (Carr. 7/6). Circuit supplied.

**AR-88 SPARE VALVES.** Complete set of BRAND NEW individually boxed original valves (14). 50/-. P. & P. 2/6.

**RCA AR-88 SPEAKERS.** 3Ω 8in. P.M. speaker in heavy gauge black crackled steel cabinet 11 x 10 x 6in. with rubber feet. A SUPER QUALITY unit. BRAND NEW, for ONLY 65/-. P. & P. 5/-.

**AR-88 VIBRATOR PACKS.** For 6 v. operation. Complete with vibrator and O24 rectifier. BRAND NEW in original cartons. 17/6 P. & P. 5/-.

**MULTIMETER SPECIAL MODEL CT-500.** 20,000 Ω/V. DC volts: 0 to 2.5-10-50-250-500-5,000 (20K Ω/V). AC volts: 0 to 10-50-250-500-1,000 (10K Ω/V). DC Current: 0 to 50μA, 5 mA, 50mA, 500mA. RESISTANCE: 0 to 12K Ω, 120K Ω, 1.2M Ω, 12M Ω. Mid scale 60, 600, 6K, 60K ohms. Decibels -20 to +62. In neat moulded case 5¼ x 3¼ x 1½ in. with leather carrying handle, complete with batteries, leads and instructions. BRAND NEW. Fully guaranteed. 95/-. P. & P. 2/6.

CHARLES BRITAIN (RADIO) LTD.  
11 UPPER SAINT MARTINS LANE, LONDON, W.C.  
TEMPle Bar 0545 Shop Hours 9-6 p.m. (9-1 p.m. Thursday)  
Open all day Saturday.

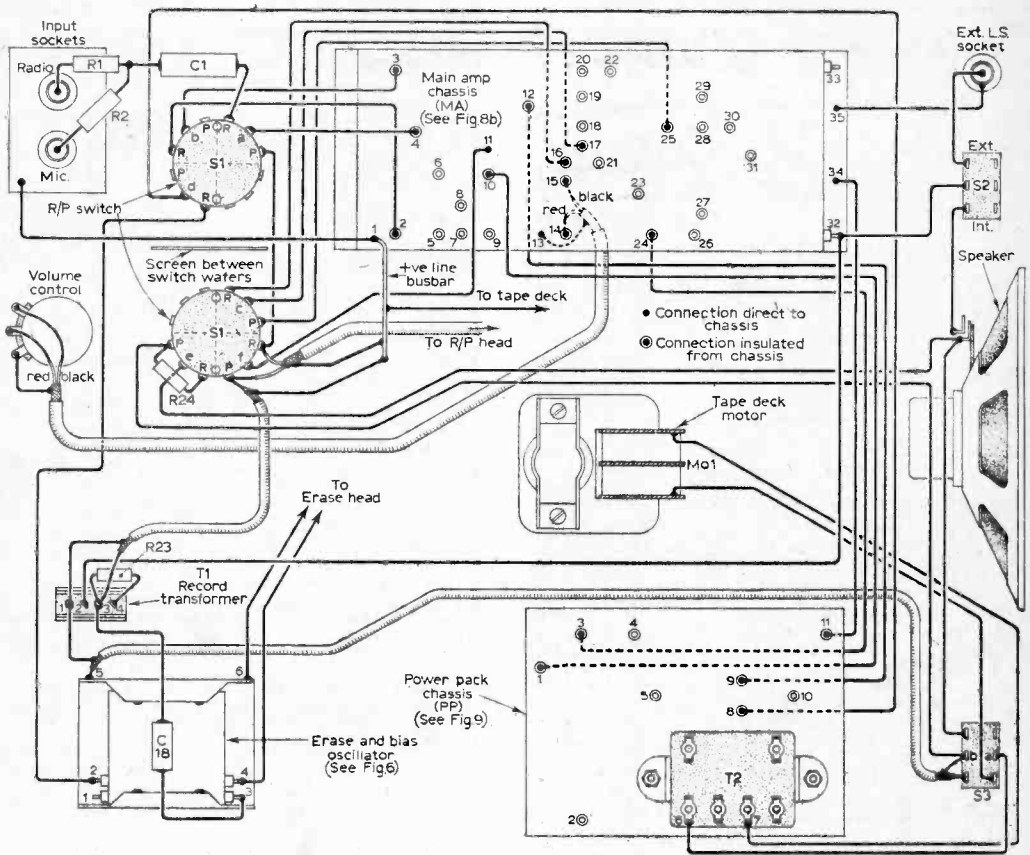

Fig. 10: The main wiring diagram.

the minimum requirement for each diode is 16V p.i.v. at 250mA.

Resistor - capacitor smoothing if used as a choke would be rather bulky. Only the two 1,000 $\mu$ F smoothing capacitors are mounted on the power unit chassis, along with the various smoothing resistors; the other 500 $\mu$ F capacitors are mounted on the record/play amplifier and on the erase chassis.

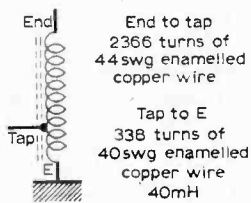

Fig. 11: Winding details of T1.

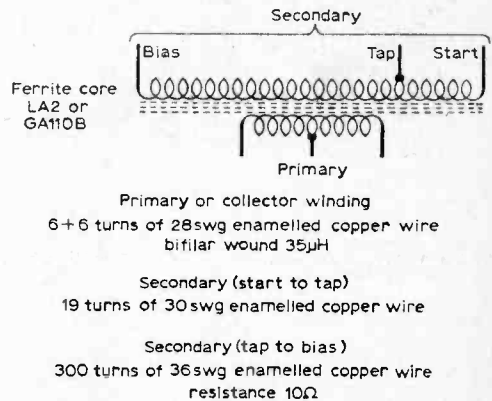

Fig. 12: The erase oscillator transformer, T3.

**Other Wiring**

Finally the motor and loudspeaker switches and the input plugs are mounted directly on the cabinet and wired up after the various chassis have been fitted. All inter-unit wiring is shown in Fig. 10.

Initial testing may be made safer by the inclusion of a 1A fuse in the secondary of the

mains transformer. Normally transistors can blow faster than a fuse, but the latter may just save the day.

—continued on page 458

# Home Inter-com Unit

By K. Herlock

**O**FTEN, constructors and handymen alike require some form of communication between house and garage or workshop. Such a form of communication can be made quite cheaply and quickly. There is no need for elaborate apparatus and as long as reliable voice inter-communication and a workable calling system is established, that is all that one requires.

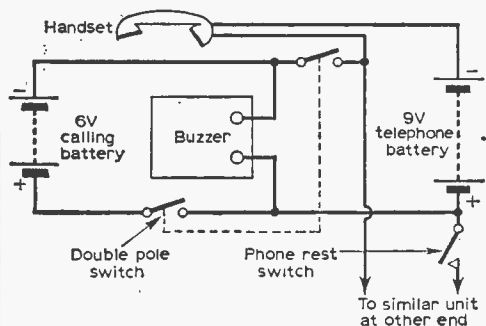

Fig. 1: The circuit of the unit.

The unit described here is very simple and, as can be seen from the circuit diagram (Fig. 1), uses only two connecting wires which need be only of thin bell-type flex. The ex-G.P.O. type handsets can be purchased quite cheaply from certain advertisers in this magazine and the phone rests can be constructed using three-ply wood.

Two batteries are employed; one for calling and one for the telephone apparatus. A double-pole switch is used, and this effectively isolates the buzzer and battery of the calling system from the telephone handsets. It can be seen from the circuit that this switch has one pole *before* the buzzer and one pole *after*; if both the poles of the switch were before the buzzer, when the telephone was in use the coil windings on the buzzer would short out the telephone.

## Making the Telephone Rest

The telephone rest can be made from a piece of thin aluminium with two small springs soldered on.

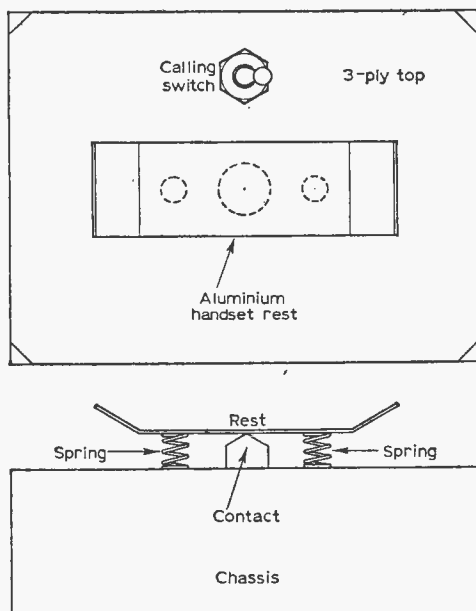

Fig. 2: Construction details of the telephone rest.

A piece of pointed brass or similar conductor is fitted to the wooden case so that it makes contact with the rest cradle when this is depressed. This is shown in Fig. 2. The wiring diagram of the unit is given in Fig. 3.

If required, a simple push-button switch could be used instead of the aluminium and brass contact switch. This type of switch would, in practice be much better than the device described here

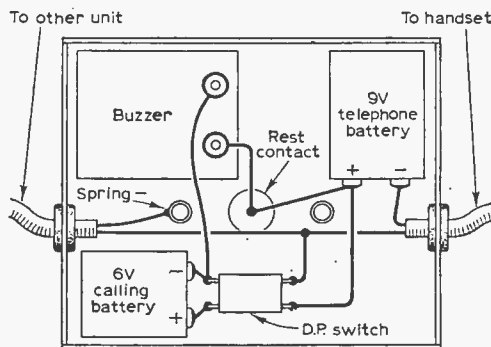

Fig. 3: The wiring diagram.

because this would cut the telephone out when it was lifted and so would have to be pushed and held with the hand. This may not be such a disadvantage as the phone would not be in use for very long at one time. But this is a matter for the individual constructor.

The whole unit may be made very compact and the connecting wires can be either laid under the ground or above.



**ANOTHER TAPE RECORDER BARGAIN**



*Mfrs. end of production  
Surplus Offer*

A 24 gns. Tape Recorder offered at the bargain price of only 15 gns. plus 10/- carr. Supplied in 3 Units already wired and tested. A Modern Circuit for quality recording from Mike, Gram or Radio, using latest B.S.R. Twin Track Monardeck Type TD2. Valve line up EF85, ECL82, EM84, EZ280 and Silicon Diode.

- 2 tone Cabinet and 8" x 5" Speaker. Size 14" x 10" x 7". **£3.10.0** +5/- Carr.
  - Wired Amplifier complete with 4 Valves, front Panel, Knobs **£5.12.6** +3/6 Carr.
  - B.S.R. Monardeck Type T.D.2 **£7.7.0** +4/6 Carr.
  - Accessories—Mike, Tape, Screened Lead, Plugs, etc. **£1.0.0** +2/- Carr.
  - COMPLETE KIT** comprising items above **15 gns.** +10/- Carr.
- Leaflet, circuits, instructions. 2/- post free

**NEW BRITISH RECORDING TAPE**

Famous Manufacturer. Bulk purchase, genuine recommended Tape Bargain. Unconditional Guarantee. Fitted Leader & Stop Folds (except 5in.).

Standard (PVC base)		Long Play (PVC base)		D'ble Play (Mylar base)	
3in.	150ft. 3/9	225ft. 4/9	300ft. 6/6	3in.	150ft. 11/6
5in.	600ft. 11/6	900ft. 15/-	1200ft. 25/-	5in.	850ft. 14/6
7in.	1200ft. 17/6	1800ft. 22/6	2400ft. 42/6	7in.	1200ft. 17/6

Post and Packing—3in. Reels. 6d. Each additional Reel, 3d. 5in. to 7in. Reels 1/- Each additional Reel, 6d.

**EMPTY TAPE REELS (Plastic):** 3in. 1/3, 5in. 2/-, 5 1/2in. 2/-, 7in. 2/3. **PLASTIC REEL CONTAINERS (Cassettes):** 5in. 1/9, 5 1/2in. 2/-, 7in. 2/3.

**Condensers—Silver Mica.** All values 2pF to 1,000pF, 6d. each. Dillo, Ceramics, 9d. Tub. 450V T.C.C. etc. 0.001 mFd to 0.01 and 0.1/350V. 9d. 0.02-0.1/600V, 1/-, 0.25 Hunts 1/6. 0.5 T.C.C. 1/9, etc. etc. Close Tol. 9/Micas—10% spF-500pF, 5d. 500-5,000pF, 1/-, 2pF-100pF, 9d. 100pF-500pF, 1ld. 575pF, 5,000pF, 1/6. Resistors—Full Range 10 ohms-10 meg. ohms 20% ± and 1W, 3d., 1W, 6d. (Midget type modern rating) 1W, 6d., 2W, 9d. Hi-Stab. 5% 1W, 1W, 6d. (100 ohms-1 meg). Other values 9d. 1/6, 1W, 1/6.

**TUB-ELECTROLYTICS-CAN**  
Electrolytic All Types New Stock  
**TUBULAR CAN TYPES**  
25/25v. 50/12v. 1/8; 8-8/450v. 4/8;  
50/50v. 100/25v. 2/-; 32-32/275v. 4/8  
3/450v. 4/350v. 2/8; 50/50/350v. 6/6  
16-16/450v. 5/6; 60/250/275v. 12/6  
32-32/450v. 6/6; 100-100/275v. 12/6  
Transistor Midget types—all values  
1 mfd to 50 mfd 1/8 ea., 100 mfd, 2/-.  
Dilo 150v. wkg. .01 to .04 mfd, 9d.,  
.05 to 1 mfd, 1/- .25 mfd, 1/3, etc.  
Enamelled Copper Wire—1lb. reels,  
14g-20g, 2/8; 22g-28g, 3/-; 30g, 3/8.

**JASON FM TUNER UNITS.**  
Designer-approved kits of parts.  
FMT1, 5 gns. 4 valves, 20/-.  
FMT2, 27. 5 valves 37/8. JTV  
MERCURY 10 gns. JTV2 £13.19.6.  
4 valves, 32/6. NEW JASON FM  
HANDBOOK, 2/8. 48 hr. Alignment  
Service, 7/6. F. & P. 2/6.

**Volume Controls—5K-2 Meg. ohms.**  
3in. Spindles. Morganite Midget  
Type 1 1/2in. diam. Guar. 1 year.  
LOG or LIN ratio less Sw. 3/-.  
DP. Sw. 4/8. Twin Stereo less Sw.  
8/8. DP. Sw. 8/-.

**TYGAN FRET (contem. pattern.)**  
12 x 12in. 2/-, 12 x 18in. 3/-.  
12 x 24in. 4/-, 18 x 24in. 6/- etc.

**BARGAIN CORNER**  
Brand New, Manufacturers Surplus  
First Grad.  
1 OC44 and 2 OC45, 15/6. 1 OC81D  
and 2 OC81, 15/8. All above plus  
OASL 36/6 post free.  
1/2 Meg. Volume Controls. DP. Sw.  
1/2in. flatted Spindle. Famous  
Manufacturers. 4 for 10/- post free.

**RECORD PLAYER CABINETS**

Cabinet Price **£3.3.0** Carr. & Ins. 5/-  
Attractive, contemporary two tone. Size  
19 1/2 x 13 1/2 ht x 8 1/2in., fitted all accessories.



**2-VALVE 2-WATT AMPLIFIER.** Twin stage ECL82 with  
vol. and neg. feedback Tone  
control. A.C. 200/250 v. with  
knobs, etc., ready wired to fit  
above cabinet inc. 6 1/2in. speaker,  
etc. £3.19.6. Carr. 2/-  
Complete Kit, including either  
B.S.R. UA14 Unit or Garrard  
"Autoslim" as ill. New reduced  
price £12.10.0, Carr. 7/6.  
Complete Kit including BSR UA14  
Unit as illus. New reduced Barga Price. £11.10.8. Carr. 7/6.

Terms C.W.O. or C.O.D. Post and Packing up to 1 lb. 7d., 1lb. 1/1.  
3lb. 1/6, 5lb. 2/-, 10lb. 2/9. Hours: 9 a.m.  
to 6 p.m.; 1 p.m. Weds.

**RADIO COMPONENT SPECIALISTS**

70 BRIGSTOCK ROAD, THORNTON HEATH,  
SURREY. Est. 1946. Telephone: THO 2188

**SPECIAL OFFER!**

OBTAINABLE ONLY FROM R. & T.V. THE

*Elegant Seven*

**COMBINED  
PORTABLE  
AND  
CAR  
RADIO**

**THE RADIO WITH  
THE STAR FEATURES**

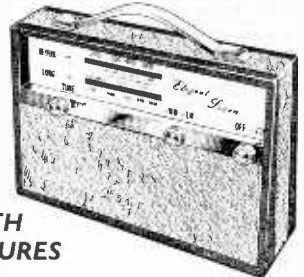

- ★ 7-transistor superhet. Output 350 mW. ★ Two-tone grey wooden cabinet, fitted handle with silver coloured fittings. Size 12 1/2 x 8 1/2 x 3 1/2in. ★ Horizontal tuning scale, size 1 1/2 x 2 1/2in., in silver with black lettering. ★ All stations clearly marked. ★ Ferrite-rod internal aerial. ★ 1F 470 Kc/s. ★ Operated from PP9 battery. ★ Full comprehensive instructions at 1 point-to-point wiring diagram. ★ Printed circuit board, back-painted with all component values. ★ Fully tunable over medium and long wavebands. ★ Car aerial socket. ★ Full after sale service.

PARTS LIST AND CIRCUIT DIAGRAM 2/8. FREE with parts.

**ONLY £5.9.6** POSTAGE & PACKING

Goods not despatched outside U.K.  
All enquiries S.A.E. Terms C.W.O.

**RADIO & T.V. COMPONENTS LTD.**  
21c HIGH STREET, ACTON, LONDON, W.3.

**● LATEST TEST METERS**

	Cash Price	Deposit	Hire	Monthly	Payments
AVO Model 8 Mark II ..	£24.0.0	£4.18.0	12 of	£1.15.	2
AVO Model 7 Mark II ..	£21.0.0	£4.4.0	12 of	£1.10.10	
AVO Multimeter Mark 4 ..	£9.10.0	£1.18.0	12 of	14/4	
T.M.K. TP10 ..	£3.19.6	£1.3.6	3 of	£1.2.0	
T.M.K. TP3S ..	£5.19.6	£1.15.6	3 of	£1.11.4	
T.M.K. Model 500 ..	£8.19.6	£1.15.6	12 of	13/8	
TAYLOR MODEL 127A ..	£10.10.0	£2.2.0	12 of	15/8	

Full details of any of the above supplied free on request.  
The AVO models 7 and 8 are both latest models from current production—not to be confused with Government surplus.

**● ILLUSTRATED LISTS**

Illustrated lists are available on LOUSPEAKERS, TAPE DECKS, TEST GEAR, GRAMOPHONE EQUIPMENT, AMPLIFIERS. Any will be sent free upon request.

**WATTS RADIO** 54 CHURCH ST., Weybridge, Surrey  
(MAIL ORDER) LTD. (Telephone: Weybridge 47556)  
Please note: Post orders only.

**IMPORTANT:**  
CLOSED FOR HOLIDAYS Aug. 7th. to 24th.

**REPANCO**

**TRANSFORMERS FOR 10 WATT  
TRANSISTOR AMPLIFIERS**

TT23 Interstage Transformer **22/6** (P.P. 1/6)

TT24 Output Transformer **22/6** (P.P. 1/6)

Send 3d. stamp for latest catalogue of REPANCO components.  
Mail order and trade:

Radio Experimental Products Ltd.  
33 Much Park St., Coventry

Wholesale and Export:  
REPANCO Ltd.  
O'Brien's Buildings, 203-269 Foleshill Road  
Coventry.



# BOOKS REVIEWED

## RADIO AND LINE TRANSMISSION: VOLUME I

By G. L. Danielson, M.Sc.(Tech), B.Sc., A.M.I.E.E., and R. S. Walker, Grad.I.E.E., Grad.Brit.I.R.E.; published by Iliffe Books Limited.

252 pages, 200 diagrams, 5½ in. x 8½ in. Price 21s.

THIS is the first volume of a new series of textbooks specially prepared for students taking the Telecommunications Technicians' examination of the City and Guilds of London Institute. It covers the complete syllabus of Radio and Line Transmission A, one of the main subjects for the second year.

Both of the authors are actively engaged in teaching the subject and their intimate knowledge of the requirements of examinees has enabled them to write what appears to be an ideal textbook. The range of subjects covered\* may indeed seem a formidable one for a book of some 250 pages—but the depth of treatment has been limited to the needs of the syllabus, to the undoubted benefit of the student. The text is largely descriptive and the lucid style makes it a pleasure to read. Mathematics have been kept to the bare essentials, and worked examples clearly indicate the use and manipulation of the equations. The text is well illustrated with line drawings. A series of questions at the end of each Chapter enables the student to test his assimilation of the foregoing text.

While unhesitatingly recommending this book to students preparing for the above examinations, one feels that it deserves an even wider readership: many others interested in radio communications, but having no inclination (or need, maybe) to discipline themselves to a course of study with a view to sitting for a specific examination, will find this a most readable textbook with no pages to be skipped.

\*The contents include an introduction to sound waves and telephones, line and radio communications systems, description of components, circuit theory, modulation and detection, aerials and power supplies.—*F.E.B.*

## RADIO UPKEEP AND REPAIRS

By A. T. Witts, A.M.I.E.E.; published by Pitman & Sons Ltd.

242 pages, 5 in. x 7½ in. Price 18s.

PUBLICATION of the ninth edition of this well-known handbook is evidence of the demand which exists for information on the essentially practical aspect of radio; also of the considerable developments in receiver design and construction that have occurred in recent years. The text has been extensively rewritten to embrace all types of broadcast receivers in current use.

In his opening words, the author refers to radio servicing as an art. This is a perfectly apt term, for servicing involves the application of fundamental principles to the solving of practical problems. Those who have mastered the rudiments at least, of circuit theory and who wish to become accomplished practitioners in this art will find Mr. Witts' book an invaluable guide and store of information.

The first chapter is devoted to essential test equipment and how to use it, and commences with a detailed description of a simple home-made multirange test meter. Basic information concerning aerials and earthing arrangements is given in the second chapter.

The longest and possibly the most important chapter deals with general principles of testing: the importance of familiarising oneself with the layout of the chassis before commencing any tests; logical sequence of voltage and current measurements, and the interpretation of these readings; and advice on the servicing of printed circuits.

Resistance checks, and signal injection and signal tracing methods with the aid of a signal generator are explained in the following chapter.

Another chapter deals with the extremely important subject of receiver circuit alignment. Detailed procedures are given for a.m. and f.m. receivers with, as indeed throughout this book, attention to both transistor and valve circuits.

The remaining chapters deal with common faults and how to clear them, special problems associated with mains supply equipment, and gramophone pick-up and turntable decks.—*R.H.*

## ELECTRONICS POCKET BOOK

Edited by J. P. Hawker and J. A. Reddihough; published by George Newnes Ltd., Southampton Street, Strand, London, W.C.2.

288 pages, 7½ in. x 5 in. Price 21s.

ALTHOUGH electronics is becoming more and more specialised, the number of up-to-date and comprehensive text books on the subject remains relatively small. For this reason alone, this book will be welcomed by all those who intend studying the subject. However, with electrical and electronic engineering rapidly becoming divorced from one another, there will be many students of radio and television who will recognise the need to expand their knowledge to embrace electronics, and for them too, this volume will be of value.

Much of the preliminary text will already be familiar to anyone who has studied radio; however only such information as is relevant to the subject is included, so that the reader can grasp the fundamentals first. Later chapters cover all the accepted aspects of electronics that are likely to occur in the industry, and, in keeping with today's trend, semiconductor devices are well to the fore with text covering the thermionic valve taking a representative minor portion of the book. Most of the text provides information on the basic techniques and circuits of electronics, which includes computers and control equipment as well as amplifier, pulse and counting circuits. A chapter on the installation and maintenance gives practical information which will be especially useful to anyone about to enter the electronics industry. Candidates for the Electronic Servicing certificate of the Radio Trades Examination Board and the City and Guilds of London Institute will find in this book much up-to-date information not included in earlier works.—*P.R.R.*

by G.M. and E.C.D.

# Semiconductors

## TALKING POINTS ON CIRCUIT PRACTICE

### No. 8—Transistor Characteristic Curves

CONTINUED FROM PAGE 357 OF THE AUGUST ISSUE

**I**N transistor circuits there may be more components than just the resistor in an RC coupler effectively in parallel with the collector load, but before we go on let us consider just one more aspect. Let us suppose that in fact we require a 2V swing in our output. How may we get back to conditions where a 2V swing is possible with the RC coupling resistor?

First, if we can create conditions in which the two resistances in parallel total the necessary value to produce a 2V swing—in this case  $1k\Omega$ —we shall be all right. Raising both values to  $2k\Omega$  would achieve this if that be feasible.

Secondly, if we can move the  $I_c$  over twice the range . . . from 0mA to 4mA, then as the load-line in Fig. 1 shows we would get a 2V swing in volts across even a  $500\Omega$  load. This would entail doubling the amount of drive available on the base in the form of incoming signal, but worse than that it would—in the purely theoretical graph we have drawn—move the characteristic into the knee-volts area on the upward swing, resulting in non-linear transfer, which rules out that expedient even were the increased drive available.

Suppose we increase the value of our supply to 8V, thus moving the entire loadline over to the right, Fig. 2. The  $1k\Omega$  load to d.c. drops 2V, so the transistor is seated d.c.-wise at 6V with 2mA standing  $I_c$  for a quiescent base-bias of  $40\mu A$ . Given sufficient drive on the base to swing the

base bias current up to  $80\mu A$ , the dynamic loadline with  $I_c$  swing up to 4mA (and down to 0mA on the opposite half of the wave) will move as shown by the solid line in the figure between A and B, driving into the  $500\Omega$  (to a.c. load) and the required voltage swing will be developed.

The d.c. loadline is superimposed in dotted line, so that we can see that the swing between A and B, which is what we obtain to a.c. over the load which at a.c. becomes  $500\Omega$ , could be obtained

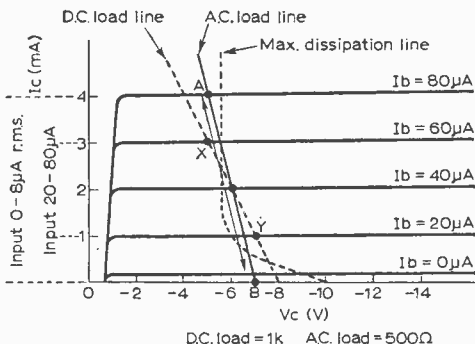

Fig. 2: Supply raised to 8V resulting in movement of load-line to the right, away from the "knee".

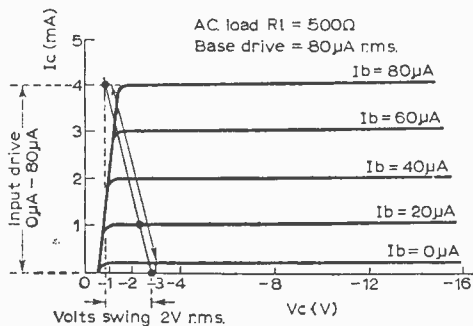

Fig. 1: Increasing the base drive current causes distortion on the upward swing, due to the "knee" of the characteristic.

under d.c. ( $1k\Omega$ ) conditions by a swing between X and Y, requiring much less drive on the base.

The method of increasing the supply voltage may not, however, be possible either.

### MAXIMUM DISSIPATION

Another of the curves published for transistors is one which plots maximum dissipation against maximum collector volts.

This is the value at which the avalanche effect commences for the particular transistor in question. We have shown it transferred to our Output Family of Curves, in Fig. 2, in the form of a dotted curve.

It is essential that the loadline shall not cut this maximum dissipation curve if the current is not to rise to fantastic values out of all relation to those we have planned for. As we have drawn it the loadline has been moved so far over to the right, by increasing the supply volts; that it does



# Just a few of our BARGAINS

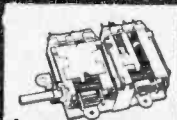

1



2



3



4



5



6



7

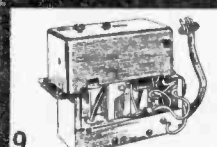

9

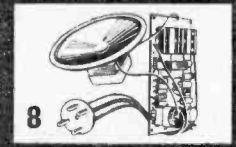

8



10

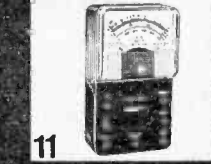

11



12

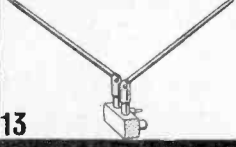

13

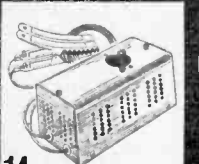

14

**RADIO & T.V.  
COMPONENTS  
[ACTON]  
LIMITED**

- 1. A.M. F.M. PERMEABILITY TUNER FOR ALL TRANSISTOR OPERATION.** Size 2½ x 2½in. approx. By famous manufacturer. A.M.-I.F. 470kc/s. F.M.-I.F. 10.7Mc/s. A.M. coverage from 1420 Kc/s-525Kc/s. F.M. coverage 108Mc/s-88Mc/s. Circuit diagram 2/6, FREE with Tuner. 25/-, plus 1/- P. & P.
- 2. TRANSISTORISED POCKET RADIO** with printed circuit, mini-speech, high gain ferrox slab aerial. No aerial or earth required. To build yourself for completely personal listening. 4½ x 3½ x 1½in. Luxembourg in favourable areas. Only 21/-. P. & P. 2/6. All parts available separately.
- 3. A.C./D.C. POCKET MULTI-METER KIT.** 2½in. moving coil meter scale, calibrated in A.C./D.C. volts, ohms and milliamps. Voltage range A.C./D.C. 0-50, 0-100, 0-250, 0-500. Milliamps 0-10, 0-100 Ohms ranges 0-10,000, 0-100,000, 19/6. P. & P. 2/-. Wiring diagram 1/- free with parts.
- 4. SIGNAL GENERATORS.** Cash £7.5.0, or 30/- deposit and 6 monthly payments of 21/6. P. & P. 6/6. Coverage 100 kc/s to 100 Mc/s on fundamentals and 100 Mc/s to 200 Mc/s on harmonics. Case 10 x 6½ x 5½in. Three miniature valves and Metal Rectifier. A.C. mains 200/250v. Internal modulation of 400 c.p.s. to a depth of 30 per cent. Modulated or unmodulated R.F. output continuously variable 100 millivolts. C.W. and mod. switch, variable A.F. output. Magic eye as output indicator. Accuracy 2 per cent.
- 5. SIGNAL GENERATORS.** Cash £5.5.0. P. & P. 6/6. Coverage 120 kc/s to 84 Mc/s. Case 10 x 6½ x 4½in. Size of scale 6½ x 3½in. 2 valves and rectifier. A.C. mains 230-250v. Internal modulation of 400 c.p.s. to a depth of 30 per cent. modulated or unmodulated R.F. output continuously variable 100 millivolts. C.W. and mod. switch variable A.F. output and moving coil output meter. Accuracy ± 2 per cent.
- 6. STAAR 45. 9 v. BATTERY RECORD PLAYER** complete with pick-up and deck. A completely portable player. Head protected by plastic dome with a brush which cleans the stylus as it rises into playing position. 45 r.p.m. Auto on-off switch governed motor, attractive two-tone grey finish, £2.9.6. P. & P. 2/-.
- 7. CARRYING CASE FOR STAAR 45 or COMPLETE KIT** beautifully styled in two tone with record compartment. Specially designed to take player and amplifier. Just screw in and connect up. All parts available separately. Case only 22/6. P. & P. 6/-. Complete kit, £5.10.0. P. & P. 6/-.
- 8. TRANSISTORISED AMPLIFIER.** suitable STAAR 45. Output 1 watt. Size 4½ x 2½in. Printed circuit, tone/volume controls plus 4 transistors. Push-pull output complete with 3½in. moving coil speaker. Built and tested, 49/6. P. & P. 2/-.
- 9. CHANNEL TUNER IF.** 16-19 Mc/s. Continuously tunable from 174-216 Mc/s. Valves required—PCP80 and PCC84 (In series). Cover BBC and ITA ranges. Also Police, Fire and Taxis, etc. Brand new by famous maker, 10/-. P. & P. 3/-.
- 10. B.S.R. MONARCH U414 WITH FULL-P HEAD.** 4-speed, plays 10 records, 12in., 10in. or 7in. at 18, 33, 45 or 78 r.p.m. Internodes 7in., 10in. and 12in. records of the same speed. Has manual play position; colour brown. Dimensions: 12½ x 10½in. Space required above baseboard 4½in., below baseboard 2½in. Fitted with FiFull-turnover crystal head, £5.19.6. P. & P. 6/6.
- 11. POCKET MULTI-METER.** Size 3½ x 2½ x 1½in. Meter size 2½ x 1½in. Sensitivity 1,000 O.P.V. on both A.C. and D.C. A.C. and D.C. volts 0-10, 0-100, 0-1,000. D.C. current 0-150 mA. Resistance 0-100K Ω Complete with test prods, battery and full instructions, 35/-. Plus 1/6 P. & P.
- 12. 8-watt PUSH-PULL 4 VALVE AMPLIFIER** plus METAL RECTIFIER. A.C. mains 200-250 v. Size 10½ x 6½ x 2½in. 5 valves. For use with all makes and types of pick-up and mike. Negative feedback. Two input mike and gram, and controls for same. Separate controls for Bass and Treble lift. Response flat from 40 cycles to 15 kc/s. 2 dB down to 20 kc/s. Output 8 watts at 5 per cent total distortion. Noise level 40 dB down all hum. Output transformer tapped for 3 and 15 ohms speech coils. For use with 8Ω, or L.F. records, musical instruments such as guitars, etc. Suitable for small halls, £3.9.6. P. & P. 6/-. Crystal mike to suit 15/-, P. & P. 2/-. 8in. P.M. Speaker to suit, 12/6. P. & P. 2/-.
- 13. INDOOR AERIAL for ITV/BBC/FM.** Complete with standard co-axial plug. Heavy chrome extending dipoles—7ft. fully extended. Plugs straight into T.V. or VHF Tuner. Fully directional, 10/6. P. & P. 1/6.
- 14. NO MORE FLAT BATTERIES.** Charge your own battery overnight with this wonderful little charger. Output 6 and 12 volts, 2 amps. Input 200-250 v. A.C. mains. Mains fuse incorporated. Attractive silver hammer finished case, 6 x 3 x 3½in. Complete with leads and battery clips only 21/-. P. & P. 3/6.

**21b HIGH STREET  
ACTON, LONDON, W.3.**

ALL ENQUIRIES S.A.E.  
GOODS NOT DISPATCHED OUTSIDE U.K.

Stamp for **DUKE & CO. (LONDON) LTD.** Phone  
 FREE 621/3 Romford Road, Manor Park, E.12 ILFord  
 LIST Liverpool St.—Manor Pk.—10 mins. 6001/2/3

**RECORD PLAYER TRANSISTOR AMPLIFIER 69/6**  
 Printed circuit, 4 transistors.  
 Size: 5in. x 3½in. x 1½in.  
 Volume Control, On and Off.  
 Post & Packing 4/6.

**TAPE CABINETS 20/-**  
 To fit B.S.R. and Collaro  
 Studio Decks. Carriage 5/-

**Regunned TV TUBES**  
 21in. 99/6 17in. 79/6  
 15, 14 and 12in.—59/6  
**Guaranteed One Year**  
 Ins. and Carr. 10/-  
 Add 10% refundable on OLD  
 TUBE. 110 Tubes in Stock.

**Ex Rental**  
 36/24, 14K P4, 141.  
 121, 31/74 and others.  
 Set tested. Carr. 5/-  
**15/-**

**TELEPHONE HANDSETS**  
**15/6** per pair. P.&P. 4/6  
 G.P.O. standard pattern. House to Workshop, garage, inter-office, etc.  
 Works off any small battery.



**SPEAKERS**  
**7/9**  
**EACH**  
 P.P. 2/3.

6in. 8in. 7in. x 4in. Money back guaranteed. Enquire for other sizes. Ex. mfd. salvage.  
**EXTENSION SPEAKERS**  
 19/9 P. & P. 3/3.  
 2 tone covered cabinet. 6in. PM speaker, switch and flex. Ideal for kitchen; sick room etc.

**COMPLETE**

14 INCH  
**£7.10.0**

100% Guaranteed.

12 months' Full Written Guarantee.

Shown working all channels in Shop.

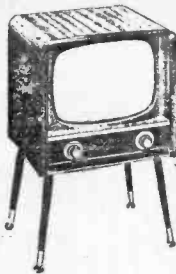

**TELEVISIONS**

17 INCH  
**£11.10.0**

Legs—39/6 per set

Part exchange allowance on ANYTHING USEFUL

Personal collection advised, or insured Carr. 14in. 20/-, 17in. 30/-.

**LISTEN TO THE WORLD on TELSTAR our I-VALVE SHORT WAVE, RADIO**

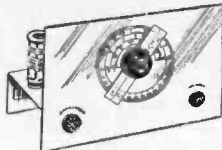

Receives speech and music from all over the world. Price includes valve and one coil covering 40-100 metres. Can be extended to cover 10-100 metres. Can be converted to 2 or 3 valve and all-mains speaker use. **Total Building Costs 35/-** P. & P. 2/-.



**THE R.C.S. PERSONAL SET**

For Private Listening  
 An amazing little set, with built-in ferrite rod aerial bringing in medium wave at wonderful volume. Sturdy case. Size only 2½ x 3½ x 1½in. Fits into the palm of the hand. Drilled chassis colour coded for easy assembly. **Total Building Costs (including earpiece) 30/-** P. & P. 2/-.

**AMAZING RESULTS from OUR LATEST**

**5-STAGE TRANSISTOR RECEIVER**

A highly sensitive receiver using top grade transistors and components. Fully tunable over medium wave. ★ Can be built in 1 hour. ★ High flux moving coil speaker. ★ Built-in ferrite rod aerial. ★ Specially designed coils for maximum signal strength. ★ Volume on/off control. ★ Eystletted circuit board. ★ Easy to follow building plans.



**Total Building Cost 50/-** P. & P. 2/6.

**R.S.C. CRYSTAL RECEIVER**

Covering medium wave band. Ideal for the beginner! All components in 8/6 P. & P. including case. (Suitable headphons 9/6). Easily converted to 1-transistor or 2-stage transistor receiver.



All parts available separately. Send S.A.E. for free layout plans and parts lists of any of the above sets.

**R.C.S. PRODUCTS (RADIO) LTD.**

11 OLIVER ROAD, LONDON, E.17

(Mail Order Only)

**A NEW-PRACTICAL WAY of UNDERSTANDING**

**Radio : Television Electronics**

including: Transistors; VHF/FM; Hi-Fi equipment; Computers; Servo-mechs; Test instruments; Photo-electrics; Nucleonics, etc.

Radiostructor—an organisation specialising in electronic training systems—offers a new self-instructional method using specially designed equipment on a "do-it-yourself" basis. You learn by building actual equipment with the big kits of components which we send you.

You advance by simple steps, performing a whole series of interesting and instructive experiments—with no complicated mathematics! Instructional manuals employ the latest techniques for showing the full story of electronics in a practical and interesting way—in fact, you really have fun whilst learning! Fill in the coupon below for full particulars.

**POST NOW**

TO RADIOSTRUCTOR (DEPT. G107) READING, BERKS.

Please send brochure, without obligation to:

★Name .....  
 Address .....

★ BLOCK CAPS PLEASE

(We do not employ representatives)

9 63

**FREE** THIS BOOK WILL INTEREST YOU!  
 LEARNING the PRACTICAL WAY

FOR ...Your Career  
 ...Your Own Business  
 ...An Absorbing Hobby

**RADIOSTRUCTOR**  
 LEADS THE WORLD  
 IN ELECTRONICS TRAINING

cut this curve and, therefore, this loadline cannot be used in practice either.

It may be that the volts output swing we require cannot be obtained at all with this particular transistor, using a dynamic load as low as 500Ω, and that if the load cannot be increased a transistor with a higher maximum dissipation must be chosen. Or a loadline may be possible midway between the extremes we have illustrated.

Referring to Fig. 3, which is the same set of curves, working the transistor at  $V_c$  quiescent = 4.5V and  $I_c$  quiescent = 1.5mA, which can be achieved by making the d.c. load = 3kΩ, then the base can move up to approximately 55μA and

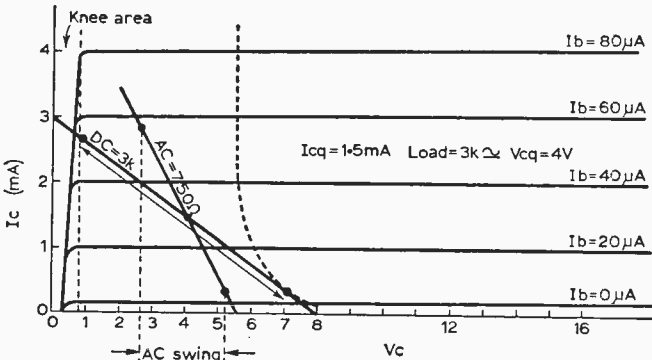

Fig. 3: Illustrating the use of higher dynamic load to avoid the avalanche effect.

down to 4μA without taking the loadline into the knee at one end or the avalanche curve at the other. The collector volts swing will be approximately from a little under 1mA to a little over 3mA, as we have drawn it, and the output voltage will swing from 1V approximately to V7, which is more than we required.

With the load reduced to a.c. by a parallel resistor as before the 3kΩ becomes 750Ω (3kΩ and 1kΩ in parallel) and this a.c. loadline is shown dotted, the volts output swing reducing to between 3V and 5V, which still gives us the required swing.

All these curves and calculations and figures are purely imaginary for the purpose of explaining how the thing works. They have no counterpart in reality, but they should enable the basic principles of output characteristic curves and loadlines to be understood.

Now to take the other angle and translate what we have learned into practical policies. We have our output curves for whatever transistor we propose to use. We understand the principle of the loadline and we appreciate that the d.c. loadline may not necessarily be the a.c. (dynamic) loadline which will represent actual conditions under signal drive.

The use of output curves can fairly be likened

to the process of evaluating  $I = E/R$ ; in other words, knowing one factor, how do we obtain the others?

This is where the greatest difficulty seems to be experienced. What is it that we know? And what is it that we want to know? We may, for instance, know approximately what the value of our input signal will be—for instance, if it is to come from a pick-up or some similar device delivering a rated output which we shall feed into the first transistor of our apparatus. Our problem may be, therefore, to work out what value of load will be required in the collector in order to accept this input and what value of standing bias to put on the base.

Or we may know what output we require—for instance, in the case of a final stage in an audio amplifier which is required to drive a loudspeaker which needs a rated input to load it; in which case we have selected a transistor which will cope with the required output and we require to work out where to "sit" it, what load to use and what input drive will be required to give it full drive . . . from which it follows also, how many prior stages are going to be necessary in order to build up to that final drive required.

And furthermore, we must distinguish between voltage output and current output and know

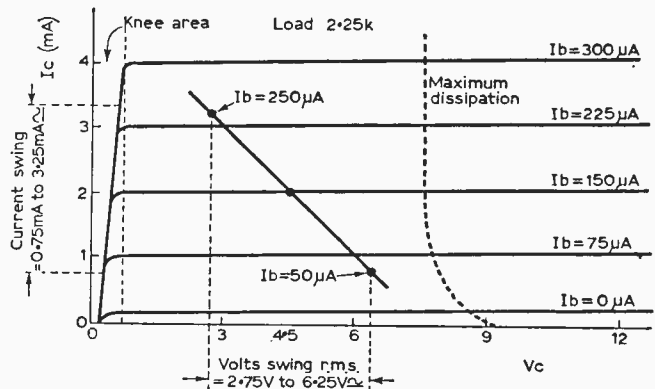

Fig. 4: Typical output curves.

which we require, for the conditions will be entirely different.

### INPUT SIGNAL KNOWN

Taking these possibilities in turn, suppose then that we have a known value of signal which we are going to feed into our transistor, and suppose we know that this available drive is such that it will swing the base of the transistor over a 200μA range. (We will see later how we relate volts input to microamps input.)

If the base must swing  $100\mu\text{A}$  above and  $100\mu\text{A}$  below a mean it is obvious that the standing bias cannot be less than  $100\mu\text{A}$ —were it, say,  $50\mu\text{A}$  the base could not swing 100 down, for it would cut out as soon as it had swung 50 down.

So we choose a value of  $150\mu\text{A}$ , or more, for our standing bias. The transistor will now handle the stated input. Presumably we know what our supply battery is going to be . . . let us say 9V. We shall select a value of collector load which will drop our transistor, d.c.-wise, to half supply voltage, as explained previously, for reasons of thermal stability.

Looking at our output curves, Fig. 4, we find that the value of  $I_c$  at base  $150\mu\text{A}$  is 2mA. We require, therefore, a collector load which will reduce 9V to 4.5V at 2mA, which is  $2.25k\Omega$ . We can now draw the loadline. The voltage swing can be read off the horizontal axis (assuming the load to a.c. is the same as the load to d.c.—if not, a dynamic loadline will have to be drawn for the a.c. load value, whatever it may be) and the current swing read off from the vertical axis . . . or calculated, since it will be the input swing multiplied by the gain of the transistor.

It can be seen at once whether the loadline, or that part of it on which we shall be operating, remains within the straight portion of the curves or not—whether it cuts into the knee-voltage area or the avalanche area on the other side. Increasing the value of the load will make the slope of the loadline incline more to the left, decreasing it will make it more vertical.

It may be that a value of 2mA standing  $I_c$  is more than would be necessary to cope with the expected input if this is to be small; in which case, since there is no value in using more current than necessary, we would increase the load so as to "sit" the transistor, say, at 1mA standing  $I_c$ , with consequent saving in current. Conversely, it could occur if the expected signal were large that a standing  $I_c$  of 2mA was insufficient to allow the output to swing sufficiently . . . in which event we would choose a higher value for standing  $I_c$  (and consequently a larger value for standing base-bias), reducing the load to the value necessary to reduce 9V to 4.5V at the larger  $I_c$ .

## PREDETERMINED OUTPUT

On the other hand, if we were dealing with an unknown input but knew what our output was desired to be, then we would proceed differently.

Let the required output be 10V r.m.s.—that is, 5+ and 5— the mean  $\pm$ . Here we must obviously have at least 10V collector maximum supply to start with and we must "seat" the transistor at a standing collector voltage of 5V, being the mean, to enable it to swing by 5V up and 5V down at any load. In practice, since we cannot use the odd few tenths of a volt below the knee-voltage, we would have to plan for more than 10V supply and a working point of more than 5V.

We might select, then, 12V for  $V_c$  and desire to work the transistor at a standing voltage of 6V. The load in the collector needed to reduce 12V to 6V will depend upon the mean quiescent  $I_c$  flowing, which we do not as yet know. But we do know that in order to provide a volts swing of 10V with a 12V supply the loadline will have to

slope at  $45^\circ$  (a glance at the various figures will illustrate this).

There are several ways we can approach this. Suppose our transistor has a maximum  $I_c$  (rated) under working conditions of 100mA. If we connect the 100mA mark on the vertical scale to the 12V point on the horizontal scale by a straight line, Fig. 5, and plan to work the transistor on the halfway point as regards  $I_c$ , namely 50mA, then collector current will be free to swing down to 0mA and up to 100mA on signal. With 50mA as the quiescent  $I_c$ , the load to drop 12V to 6V at 50mA works out at  $120\Omega$ .

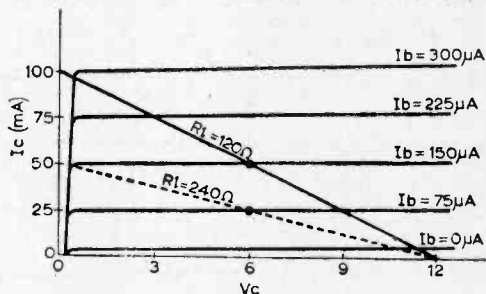

Fig. 5: Establishing the load required to give a predetermined output.

Our voltage swing will be more than the 10 we wanted without entering the knee area. And in order to obtain it a drive on the base will be needed which will move it from  $0\mu\text{A}$  to  $300\mu\text{A}$  over the mean quiescent bias of  $150\mu\text{A}$ , which corresponds to the 50mA output  $I_c$  quiescent selected.

It is true that we could obtain the same results with less drive if we slanted the loadline over to the left, but this would take it into the knee-voltage area if we went too far with that procedure as well as being non-linear.

Now in all these cases we have been assuming that we required a voltage swing in the output. For normal purposes, however, it is very rarely voltage swing that is required with transistors. As has been previously explained, the input impedance of the average transistor is so low that if much more than 1V is put on the base (with respect to emitter) the current flowing would be of a very high value indeed. With valves it is normal to use step-up transformers or other devices for inter-valve coupling because the maximum voltage gain possible is required to pass on to the following stage in the form of grid-drive. Values of 30V or more are not exceptional even in normal radio work.

Working with transistors the voltages we shall wish to pass on to the base of the following stage will be normally of the order only of millivolts. It follows from this that the voltage swing over the load in the previous collector is going to be far more than we want, and steps must be taken not to step it up but to step it down and, therefore, inter-stage transformers in transistor technique are step-down transformers, not step-up.

This has the important corollary that we do not need to worry about voltage amplification except

# EXCITING DESIGNS FOR THE TRANSISTOR ENTHUSIAST

## Two outstanding Amplifiers



### SINCLAIR TR5 5 TRANSISTOR PRE-AMP AND HALF WATT POWER AMPLIFIER

This radically new amplifier embodies the latest circuitry techniques to produce a perfectly clean half watt of audio power even from very low output sources such as low-impedance tape recorder heads, pickups and microphones. Each amplifier is supplied ready built and unconditionally guaranteed.

**CIRCUIT**—5 matched transistors and temperature compensating diode in a transformerless complementary-symmetry configuration.

**POWER OUTPUT**—500 mW undistorted into a 15 ohm speaker.

**SENSITIVITY**—0.5 mV.

**POWER GAIN**—804B (100 million times).

**FREQUENCY RESPONSE**—50 c/s to 20 kc/s  $\pm 3$ dB

**SIZE**—2 1/4 x 1 1/4 x 1/2 in.

**POWER REQUIREMENTS**—10mA quiescent and 10mA peak from 9V battery or power supply. Ideal for pick-ups, tape-heads, microphones, radio, etc.



### SINCLAIR MICRO AMPLIFIER

SMALLER THAN A 3d. PIECE!

### OUTPERFORMS AMPLIFIERS TWENTY TIMES LARGER

Using famous MAT Transistors, this micro-miniature amplifier has a power gain of 60 dB (one million times) and an output sufficient for any type of earpiece or even a loudspeaker. With a frequency response from 30 to 50,000 c/s  $\pm 1$  dB, genuine hi-fi standards are assured for audio work, whilst the keen experimenter will readily find such characteristics to advantage in other fields. Easily followed, building instructions are included as well as FREE Applications Data showing amplifier used for pick-ups, micro-radios and transmitters, microphones, phone pick-up coil, etc. Power consumption—0.4mA at 1.5V to 1mA at 9V.

**FREE** with every amplifier, circuits showing how to use it with low and high impedance pick-ups, microphones, tape heads, in various radio circuits, transmitter circuits, in guitar amplifier, as a mono or stereo hi-fi system, intercom, etc.

**BUILT and TESTED 59/6**

**UNCONDITIONALLY GUARANTEED FOR TWELVE MONTHS**

**28/6**

## Sinclair Radionics Ltd

Dept. P.W.91

69, HIXON ROAD, CAMBRIDGE

**BACKED BY FULL SERVICE FACILITIES**

Please see our advertisement on page 389

### FULLY GUARANTEED UNUSED VALVES

0B3	6/-	1E16P	15/-
0C3	5/6	F1820C	15/-
0L3	5/-	EA191	4/-
114	3/6	EA332	4/-
1N50T	9/-	EP27A	8/-
1R5	6/-	EP92	3/6
1R1	5/-	FN31	10/-
1R5	5/6	FW4500	7/-
1T4	4/-	CT33	15/-
2A3	5/-	HE13DD	6/-
2051	12/-	KT41	7/6
2052	12/-	KX4	15/-
21R2	6/-	LPX25	10/-
31R7	5/-	QP25	5/-
3R2S	15/-	Q8150/15	10/-
3D6	4/-	QV04	7-7/2
3E4	5/-	9P/3P2	3/6
4D1	4/-	TP41	5/-
4X150A50	60/-	VR53	6/-
5Y3G	4/-	VR55	6/-
5Y3GT	6/-	VR101	12/6
5Z3	6/-	VR102	12/6
6A87	4/-	VR108	3/6
6AC7	3/-	VR137	4/6
6AG6	4/-	VR138	6/-
6AH8	11/-	VR137	4/6
6AK5	5/-	VR138	6/-
6AK6	7/-	VR138	6/-
6AL5	4/-	VR138	6/-

### Z & I AERO SERVICES LTD

Retail Shop: 85 TOTTENHAM COURT ROAD, Tel LAngham 8403  
Head Office and Warehouse: 14 SOUTH WHARF RD., W.2. Tel. AAM 0181/2, 0677  
Please send all correspondence and Mail Orders to the Head Office.

**EX-ARMY TRANSMITTER-RECEIVER**  
WIRELESS SETS No. 19 Mk. II. Transmitter-Receiver assembly only. Frequency range 2 to 8 Mc/s and 2 to 240 Mc/s. Assembly consists of 2-8 Mc/s Tx-Rx; 230-240 Mc/s Tx-Rx and Intercom. Amplifier without Power Supply Unit, £2.10. P. & P. 15/-.

**PORTABLE WIRELESS SET TYPE 88B.** Portable "transceiver" providing FM Communication on 4 crystal channels in the range of 38-40 Mc/s. Price, without accessories £2.10 ea., £4.10 ea. pair. P. & P. 7/6 each.

**SEMICONDUCTOR RECTIFIERS**  
Silicon Diode BY100, 700V. p.a.v. Rectified current 450 mA. Price 8/- Post packing 1/6.  
Germanium Diode GJ7M, 70v. p.a.v. Rectified current 800 mA unmounted or 1 amp. fitted mounted. Price 3/6. Post & packing 1/6.

**4-AC. MAINS MOTOR.** 230v. A.C. Develops 5 watts at 1,450 r.p.m. Four-stage gearbox reduces speed to 7.5 r.p.m. Output shaft torque 1lb/ft. 2-minute rating. Will operate continuously at 150v. A.C. Dimensions, including gearbox not enclosed. 24 x 18 x 3 1/2 in. Price 12/6. Post & pack 2/6.

**2.25 Watt ZENNER DIODES, 5% tolerance.** VR570V, 370 mA max., 5.75v. nominal, 6/6. VR925B, 345 mA max., 6.25v nominal, 6/6. VR7B, 285 mA max., 7.0v nominal, 6/6. VR9B, 210 mA max., 9.0v nominal, 6/6. Post and packing 6d. per diode.

0A3	6/-	1R8	8/-
0A5	6/-	1R9	8/-
1A7GT	10/-	1R10	8/-
1H5GT	9/-	1R11	8/-
1U5	7/-	1R12	8/-
1X2A	7/-	1R13	8/-
1X2B	7/-	1R14	8/-
1A3	7/-	1R15	8/-
3A3	7/-	1R16	8/-
3Q4	7/-	1R17	8/-
3Q5GT	7/6	1R18	8/-
3T4	9/-	1R19	8/-
3R4G	9/-	1R20	8/-
504GB	6/-	1R21	8/-
5Z4G	7/-	1R22	8/-
68012	10/-	1R23	8/-
6A4Q	5/-	1R24	8/-
6AV6	6/-	1R25	8/-
6RA6	5/-	1R26	8/-
6RA8W	10/-	1R27	8/-
6RE6	6/-	1R28	8/-
6RH6	5/6	1R29	8/-
6RJA	6/-	1R30	8/-
6RQ4	8/-	1R31	8/-

### The following are current production brand new and fully guaranteed valves for Radio, TV and Audio uses

50L6GT	7/-	EBF83	10/-	ECH35	10/-	EF41	8/-	EL32	3/6	EM34	9/6
83	8/-	EBF89	8/-	ECH42	9/6	EF42	7/6	EL33	9/6	EM80	7/6
AZ1	9/-	EB11	12/-	ECH81	7/6	EF80	8/-	EL34	10/-	EM81	8/-
DA1	9/-	EB121	12/-	ECH83	8/-	EF83	6/6	EL36	10/-	EM84	9/6
DAF96	7/6	EBCC40	8/-	ECL80	7/6	EF86	7/6	EL37	17/6	EM85	10/-
DF96	7/6	EC070	15/-	EL93	17/6	EY31	8/-	EL38	17/6	EY31	8/-
DK93	9/-	EC081	15/-	EL94	8/-	EY86	7/-	EL41	8/-	EY86	7/-
DK96	7/6	EC082	5/-	EL95	8/-	EZ40	7/-	EL42	8/-	EZ40	7/-
DL96	7/6	EC083	6/-	EL96	8/-	EZ41	6/6	EL83	7/6	EL80	6/6
DM70	4/6	EC084	8/-	EL97	8/-	EZ41	6/6	EL84	7/-	EZ41	6/6
EAB080	7/-	EC085	15/-	EL98	10/-	EZ42	12/-	EL85	10/-	EZ42	12/-
EAF42	8/6	EC088	15/-	EL99	10/-	EZ43	12/-	EL86	11/-	EZ43	12/-
EBK41	7/6	EC090	10/-	EL99	10/-	EF183	10/-	EL87	6/6	EZ44	12/-
EB081	7/-	EC092	8/-	EL99	10/-	EF183	10/-	EL88	6/6	EZ44	12/-
EBP80	7/6	EC092	12/-	EL99	10/-	EF183	10/-	EL89	6/6	EZ44	12/-
EC183	14/-	EC093	12/-	EL99	10/-	EF183	10/-	EL90	6/6	EZ44	12/-
EF40	10/-	EC094	12/-	EL99	10/-	EF183	10/-	EL91	6/6	EZ44	12/-

WHEN ORDERING BY POST, PLEASE INCLUDE 2/6 IN THE £ FOR HANDLING AND POSTAGE

# "IT'S A FANTASTIC SUCCESS"

THE BRILLIANT NEW

# "NORCOL NOMAD"

SEVEN TRANSISTOR TWO WAVEBAND SUPERHET RADIO UNIT

BRAND NEW DESIGN FOR CAR RADIO AND GENERAL PURPOSE GIVING ONE WATT OUTPUT WHEN CONNECTED TO ANY STANDARD 3 ohm SPEAKER

This versatile unit has been designed to fit into a variety of cases and all components, down to control knobs and battery clips, are supplied together with clear illustrated plans. It gives a superb performance with dozens of stations including Luxembourg when connected to a 9 volt battery and speaker.

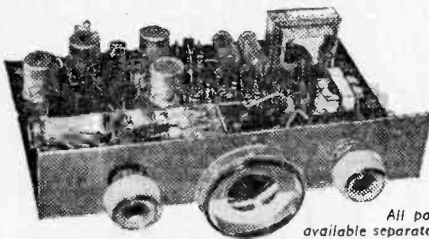

Size: 7 x 5 x 1 1/4 in. Building Plans 2/6 (Free with kit). All parts available separately.

- FEATURES**
- NEW PRINTED CIRCUIT OF OUR OWN DESIGN
  - LARGE OUTPUT TRANSFORMER
  - SEVEN FIRST GRADE TRANSISTORS
  - INTERNAL HIGH "Q" FERRITE AERIAL
  - CAR AERIAL COUPLING COIL

We are offering the above for **THE AMAZING PRICE OF £6.19.6** P.P. 2/- or at NO EXTRA COST in 3 Stages (A, B and C) of 46/6 each plus P.P. 1/6.

**ALIGNMENT SERVICE:**

COMPLETE (7 x 4 in. Elliptical Speaker 17/6)

This unit is covered by our Test and Alignment Service which also handles the **PW-6 Pocket Superhet** and **Mercury-6 Mk. II**, for which we stock all components. The charge is 12/6 plus P.P. for Test and Alignment and where fault finding and broken component replacement is required a small service charge is added. (Cases and Speakers should not be included.)

**NORCOL LTD.** 147 LONDON ROAD, YORKTOWN, ELECTRONIC COMPONENTS **CAMBERLEY, SURREY** Phone: CAMBERLEY 3743

## VALVES SAME DAY SERVICE

NEW! TESTED! GUARANTEED!

SETS	1R5, 1R5, 1T4, 354, 3V4, DAF91, DF91, DK91, DL92, DL94 ..	Set of 4 for 17/-									
1A7GT	9/-	8U4GT	9/9	50L6GT	7/-	ECC84	8/3	KT81	7/8	U78	4/-
1D5	7/6	8V8C	3/11	18B7	19/8	ECC85	7/3	MU14	5/-	U191	11/-
1H5GT	8/6	6V8GT	6/8	AC/TH1	19/8	ECF90	7/7	MX40	13/6	U221	9/8
1N5GT	8/9	6X3	4/-	AZ1	7/6	ECF82	7/8	N18	7/-	U282	14/6
1R5	5/-	6X3GT	8/9	B38	5/-	ECH35	6/8	N37	10/-	U291	9/-
1S5	4/-	6X30L2	8/6	CB11	12/-	ECH42	8/3	PC93	9/-	U301	12/6
1T4	3/4	7B7	8/-	CL33	9/6	ECH131	8/8	PC87	9/3	U801	11/-
3A5	6/9	7C5	7/9	CY1	12/6	ECL90	6/3	PC94	6/3	UABC80	5/9
3Q4	5/9	7C6	7/8	CY31	5/9	ECL92	7/9	PC85	7/6	UAF42	8/-
3S4	5/-	7H7	5/9	DAC32	8/6	ECL88	9/-	PC89	8/-	UBC41	6/11
3V4	5/9	7S7	8/-	DAF91	4/-	EP37A	6/-	PCF80	5/9	UBF80	7/6
5U4G	4/6	7T4	8/-	DAF96	6/6	EP39	3/9	PCF82	8/9	UBF89	7/3
5V4G	5/-	10C1	9/6	DAF96	6/6	EP40	11/-	PCF86	8/6	UBL21	13/8
5Y3GT	5/-	10C2	13/8	DC90	6/9	EP41	7/3	PCL32	7/3	UC92	7/8
5Z4G	8/9	10LD11	10/9	DF33	8/9	EP42	6/3	PCL83	9/-	UC884	7/8
6A1.5	8/9	12A7	4/9	DF91	3/-	EP30	4/3	PCL84	5/-	UC85	8/9
6AM6	3/8	12A7T	4/3	DF95	6/6	EP83	5/-	PCL85	8/6	UCF80	10/3
6AQ5	6/-	12AT7	4/9	DH76	4/3	EP36	6/9	PEN44	11/8	UCH21	10/8
6A76	4/9	12AX7	4/9	DH77	4/9	EP89	5/-	PEN36C	8/-	UCH42	7/8
6BA6	5/9	12K7GT	4/3	DK32	9/-	EP91	3/3	PL36	9/-	UCH81	7/6
6B8	6/9	12K8GT	8/9	DK91	5/-	EP92	2/6	PL81	7/9	UCL82	8/9
6BQ6	13/6	12Q7GT	4/3	DK92	6/9	EP181	8/9	PL32	5/9	UCL83	10/9
6BH6	5/9	12X7	8/8	DK96	7/-	EL33	7/8	PL83	5/9	UF41	7/3
6B76	5/6	14B7	14/8	DL33	7/3	EL41	7/9	PL91	6/9	UF89	6/3
6CD6P	28/6	19BC6G	13/6	DL35	6/9	EL42	8/6	PK4	8/6	UL41	7/9
6E1	8/6	20L1	15/-	DL92	5/-	EL81	5/6	PK25	8/6	UL44	7/6
6F13	9/6	20P4	14/8	DL96	6/6	EM34	7/3	PY32	9/3	UL46	9/8
6F14	9/6	20P5	14/9	DL96	6/6	EM80	6/9	PY33	10/3	UL84	6/3
6F23	9/6	25L6GT	8/-	EABC80	8/-	EM81	7/9	PY30	6/-	URIC	7/3
6K7C	1/8	27S0	17/6	EAF42	8/-	EM84	8/3	PY31	6/-	UU7	8/6
6K7GT	4/3	30FL1	10/-	EBL21	2/6	EM85	8/3	PY32	5/6	UY21	11/-
6K8C	7/9	30L15	10/3	EBC33	5/-	EM95	8/3	PY33	8/6	UY41	5/6
6K8GT	4/3	30P4	12/3	EBC41	7/3	EM97	9/9	R16	17/-	UY85	4/9
6L8G	6/6	30P19	12/3	EBF80	7/3	EM97	9/9	R16	17/-	VP48	9/6
6LD20	5/6	30PL1	10/-	EBF89	8/8	ET51	6/8	TH21C	12/8	VP49	5/6
6P25	8/-	30P4	12/3	EBL21	2/3	EY86	6/-	U24	9/9	W41	9/6
6Q7G	4/9	30PL13	10/8	ECC40	7/6	EZ49	6/-	U25	9/9	W76	4/6
6Q7GT	7/9	35A5	14/-	ECC81	4/3	EZ80	4/6	U26	8/3	W77	2/6
6SL7GT	4/9	35L9GT	7/9	ECC82	4/9	EZ81	5/6	U50	4/6	W729	14/-
6SN7GT	5/9	35Z4GT	4/11	ECC83	7/-	KT32	5/6	U52	4/3	Z77	3/3

**READERS RADIO**  
24 COLBERG PLACE, STAMFORD HILL  
LONDON N.16 STA. 4587

## RADIO AMATEUR HANDBOOK

- by A.R.R.L. Postage 2/6.
- 36/- UNDERSTANDING AMATEUR RADIO, by A.R.R.L. 18/-. Postage 1/3.
  - A BEGINNER'S GUIDE TO TELEVISION, Pub. by Newnes. 8/6. Postage 6d.
  - ELECTRONICS POCKET BOOK, by J. P. Hawker and J. A. Reddihough. 21/-. Postage 1/6.
  - BASIC INDUSTRIAL ELECTRONICS COURSE, by A. Haas. 30/-. Postage 1/6.
  - SINGLE SIDEBAND COMMUNICATIONS HANDBOOK, by H. D. Hooton. 56/-. Postage 1/6.
  - BASIC RADIO COURSE, by J. T. Frye. 30/-. Postage 1/6.
  - TRANSISTOR RADIOS, Circuitry and Servicing, by Mullard. 5/-. Postage 6d.
  - MORE ABOUT LOUDSPEAKERS, by G. A. Briggs. 1963. 8/6. Postage 6d.
  - RADIO VALVE DATA. 7th Ed. Compiled by "W.W.V.". 6/-. Postage 10d.
  - COMPLETE CATALOGUE 1/6.

**THE MODERN BOOK CO.**  
BRITAIN'S LARGEST STOCKISTS of British and American Technical Books  
19-21 PRAED STREET  
LONDON, W.2  
Phone: PADDDING 4185  
Open 6 days 9-6 p.m.

Post 6d. per valve extra.  
Any Parcel Insured Against Damage in Transit 6d. extra.  
Any C.O.D. Parcel 4/3 extra.

in special cases. Consequently it is normal to regard a transistorised amplifier in quite a different light to that of a valve amplifier. In the valve amplifier one is conditioned to think in terms of getting the maximum "gain" out of each and every stage . . . multiplying all along the line until a sizable r.m.s. voltage signal is achieved at the final output. With transistors the mind requires angling to a different approach altogether. It is necessary to think not in terms of volts but in terms of *current*.

The extent of the output current a transistor will pass is stated by the makers. In the final output stage of an amplifier intended to drive a loud-speaker we require the maximum current swing on signal possible. We select perhaps a transistor capable of running at 500mA standing  $I_c$ , going up to 1A on peak signal, and in order to swing the collector current through the whole of that range we want a drive on the base large enough to do it. We must find that drive in terms of base current, since output current will be base current multiplied by the gain of the transistor. If the rated gain be given as 1,000, 1mA base current will give 1A collector current. If 100, then 10mA base current will give 1A output.

## THE INPUT CURVE

By reference to still another of the published curves we can find out what is needed in terms of volts to put so many microamperes through the base. This is the "Input-Curve" which directly relates input volts to input current and requires no explaining except that the volts given are those directly across base/emitter. If there is a potential divider on the base which places the base at some value above earth, and an emitter resistor which puts the emitter at another value above earth, then the voltage figures given in the Input-Curve relate to the actual difference between base and emitter which must be achieved.

One hundred mV, for instance, may give a base current of  $150\mu\text{A}$  which, if the transistor gain is 100, will give  $150 \times 100 = 15,000\mu\text{A} = 15\text{mA}$  in the collector.

The base volts needed in small signal transistors will be in millivolts and this will be obtainable even taking into consideration insertion losses from the previous collector without difficulty . . . as has been said, there will be more voltage swing than one can use. One thinks, therefore, in terms of output current and the necessary base-drive to give full collector swing, the collector load having no part to play other than work the transistor at the correct d.c. condition for thermal stability, unless in final stages where matching may become necessary, i.e. where power is required.

The gain of transistors being comparatively small compared to that of valves, where orders of 30,000 and upwards are easily obtainable across the high input impedance common to valves, a considerable number of stages is normally necessary to build up the infinitesimal signals appearing in the aerial system to a final value capable of giving full collector drive to an output stage. In early stages the small input signal multiplied by the gain of the transistor, say 50, will produce only a small current swing in the output and there

is no point in running the transistor at a higher value of  $I_c$  than is needed to accommodate this. These small changes passed on to the next stage will, after insertion losses, be again amplified by 50 in the next transistor and again the collector current will be limited to a value sufficient to cope with them—so that the early stages may show a value of  $I_{cq}$  of some 1mA, increasing in the third or fourth stage perhaps to 1.5mA. Only in the ultimate or penultimate stages will collector  $I_{cq}$  reach really significant values when the signal has built up to a respectable value sufficient to cause a sizable swing in the outputs. In these stages the voltage swing may be more than we want and some means of reducing it must be used; a common method is shown in Fig. 6 where part of the load is bypassed to a.c. but the whole of it operates to set the d.c. working point.

Thus it will be seen that the first thing is to know precisely what we want from our transistor

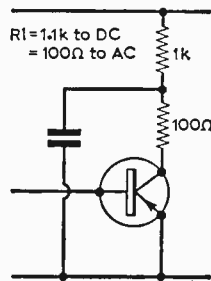

Fig. 6: Decoupling capacitor used to limit signal output, but does not affect the d.c. operating conditions.

stage. If it be a given output in terms of current swing then we can proceed simply by selecting a transistor which will handle the current specified. On the output characteristic we will join the value of the maximum milliamps

we propose to use, on the vertical scale, to the figure representing the maximum collector volts available on the horizontal. Taking half supply volts we will draw a vertical line upwards, intersecting the loadline we have drawn, and so see what value of collector current will flow at this point; from this we can calculate the value of load required, at this value of current, to drop the supply volts to half supply.

The curves will also give us the value of standing base current, which will give us the mean standing  $I_c$  at this midpoint in the loadline, and we can then arrange to feed this value of bias current into the base by referring to the input characteristic which will give us the base bias in volts necessary to produce that base current in microamps. We can also read what value of base drive from the signal will be required, in microamps, to drive the collector current full swing, and this can be converted into millivolts by reference to the input characteristic.

Hence, with some idea of what the original available drive in millivolts is likely to be, one can work out how many stages will be necessary to produce a final drive of the value needed.

Or we can work the other way round and instead of siting the transistor at the midpoint of the output current swing we can site it at the midpoint of whatever may be the known input and select the standing base bias accordingly, which will give us the  $I_c$  at that bias. Once again we calculate the load needed to reduce battery volts to half supply volts at that value of  $I_{cq}$  and draw the loadline accordingly, remembering always that the

d.c. loadline is not necessarily the one over which the a.c. signal characteristic will be developed.

It will be found that in this manner the exact values can be calculated in order to set both the d.c. and the a.c. operation of the transistor at the correct working points, so that the transistor neither bottoms at one end of its drive nor cuts out at the other, while limiting the current to no more than is necessary to achieve this. At the same time the maximum dissipation can clearly be seen, so that there is no fear of exceeding the rated limits. The loadline can then be modified as one thinks fit by altering the load value or the standing bias. There is nothing arbitrary about it except that one must know either the expected input or the required output to have a starting point.

While normally the midpoint will be the quiescent condition it is perhaps unnecessary to mention that in the case of a Class B amplifier the quiescent working point will be somewhere in the region of  $0\text{mA } I_{cq}$  and therefore maximum  $V_c$ , since the output current will move only one way on signal—upwards. And also, in the case of a transistor fed from a diode, the input signal will be one-way going, so that the working point in that case also will be chosen accordingly.

A point worth noting is that in the case of a valve, where the anode current varies if the anode voltage is varied, it is necessary to work out quite a complicated loadline. For instance, if the output curves show that with anode volts=200 at grid bias, say,  $-10\text{V}$ , the anode current will be  $100\text{mA}$ , and at grid bias  $-8\text{V}$  anode current will  $150\text{mA}$ , we cannot draw a true loadline on that basis. This is because when we reduce the grid bias from  $10\text{V}$  to  $8\text{V}$ , as the anode current increases so the anode volts decrease (by virtue of the increased voltage dropped in the load at the higher current), so that we no longer have  $200\text{V}$  on the anode but some lesser figure, which means that at grid volts  $-8\text{V}$  the anode current will not be the  $150\text{mA}$  shown in the curves but some lesser figure corresponding to the reduced anode volts.

As a transistor maintains substantially the same collector current within its range of operation at all varying values of collector voltage we do not get this phenomenon and therefore the theoretical loadline is effectively the actual one—it is not necessary to compensate for collector current changing as collector volts change by virtue of changes over the load.

This is not to say that there are not finer points to be considered in relation to variable gain at small or large signal currents, temperature effects—especially as they effect leakage current—but these are beyond the scope of an article intended only to make the basic principles understandable, and in any case they are unlikely to enter into practical consideration where the ordinary amateur is concerned, as these devices are not by any means as critical as all that.

The basic thing to remember is that you have only a handful of volts to play with but the current may be considerable . . . and when you have only some  $9\text{V}$  available to start with, a load of any sizable value in the collector is capable of dropping all those  $9\text{V}$  if the current rises to any significant sum and so leaving you with nothing to operate the transistor. Just as, if the current decreases to any considerable extent, it may leave

you with less than the range required. Therefore it is essential to work a transistor at the correct operating point on its output characteristic and to restrict the input to a value which will not overload it, a task which should present no difficulties if a loadline is drawn first.

The margins of error, of course, are less than those with valves, but this again is largely due to the fact that owing to the small supply volts it is necessary to work with small voltage swings, which means with small output loads through which, however, considerable current swings must be able to take place—the loads being sufficiently small to enable these current changes to take place without greater voltage swings taking place at the same time than the available voltage of the supply can give.

If you only have  $9\text{V}$  to start with, then a load of  $9\text{k}\Omega$  would leave you with no volts at all on your transistor as soon as the collector current rose as high as  $1\text{mA}$ . Realising that you may be working with a standing collector current of as much as  $500\text{mA}$ , rising to a full ampere on peak signal in some cases, it becomes obvious that to make this possible the collector load would have to be measured in ohms, not in kilohms. Which, of course, is why output transformers for transistors must possess negligible d.c. resistance.

Recognition of these factors will show at once why transistor technique differs from valve technique—and will show why, also, it is better to think of transistors in terms of current than in terms of volts.

It may be true that it is voltage—however small it may be—which produces current, as it is, of course, true that base bias in microamps must be caused by base bias in potential. We do have to put so many millivolts on the base in order to feed so many microamps into it, but we can far better think in terms of microamps than millivolts, if only because the microamps, multiplied by the gain of the transistor, will give us the milliamps we may expect in the output. ■

#### Have Your Magazine Delivered by Post

Many of our readers prefer to have PRACTICAL WIRELESS sent to them every month by post. This convenient way of receiving your magazine has much to commend it, and you too may like to become a subscriber. Nothing could be simpler to arrange. Just complete the subscription Order Form below and post it to the address shown. Send no money now—you will be invoiced in due course.

#### Subscription Order Form

To Subscription Manager, PRACTICAL WIRELESS (A9), Tower House, Southampton Street, London, W.C.2.

Please send me PRACTICAL WIRELESS every month for 12 months, commencing with the next issue. (One Year's Subscription costs £19.0, including postage.)

NAME .....

ADDRESS .....

.....



# ADAMIN— by LITESOLD

These new ADAMIN micro soldering instruments supplement the well-known LITESOLD models for special applications and still further extend our very comprehensive range of specialised soldering equipment.

Bit sizes now  $\frac{1}{16}$  in. to  $\frac{1}{4}$  in.



A POPULAR ADAMIN MAINS MODEL

The C10L (shown on bench stand) is probably the smallest mains voltage model in the world. Bit dia 3/32in., length 7in., weight 1oz. (less flex). Heats in 30 secs.

Brochure No. S10 sent free on request.

Sole proprietors and manufacturers:

**LIGHT SOLDERING DEVELOPMENTS LTD**

28 Sydenham Road, Croydon, Surrey

Phone: CR0ydon 8589

Grams: Litesold Croydon

## READY BUILT— READY TO GO

Listen in comfort to your favourite programmes, without annoying others with the

### “PORTO-BELLO”

Our Personal Transistor Pocket Radio designed exclusively for personal use.

Works anywhere, any time—our special circuit with built-in ferrite rod aerial ensures wonderful reception over the full medium wave band. B.B.C. Home, Light, Luxembourg and many continental stations. Completely portable, compact size only 2½ x 3½ x 1in., slips into pocket. NO EXTERNAL AERIAL OR EARTH



37/6 P.P.2/-

Requires 5/- extra. Battery 2/6 extra. REQUIRED. Condenser tuning and with “exclusive” separate fine tuning control for “spot on” station selection. Complete station separation makes this ideal for use as Tape Jack for recording or tuner unit for amplifier.

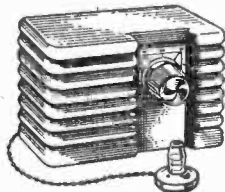

### COMMANDER IV CRYSTAL SET

Covers the full medium wave band and is ideal for use in Bedroom, etc. Requires NO batteries—lasts for ever. Operates with miniature personal carport. Attractive case and dial—a Radio set in miniature.

PRICE 10/- P. & P. 2/-

Requires 5/- extra. Both fully guaranteed.

*Transradio*

11, OLIVER ROAD, LONDON, E.17

# Make Your Ability PAY

**UNLIMITED OPPORTUNITIES** exist today for “getting on” . . . but only for the fully trained man. Let I.C.S. tuition develop your talents and help you to success.

**STUDY IS EASY** with I.C.S. guidance. The courses are thorough. Printed manuals, fully illustrated, make study simple and progress sure.

**YOUR ROAD TO SUCCESS** can start from here—today. Complete this coupon and post it to us, for full particulars of the course which interests you. MODERATE FEES INCLUDE ALL BOOKS.

## Take the right course now . . .

- |  |   |
|--|---|
| <b>ADVERTISING</b><br>Gen. Advertising, Retail & Dept. Store Copywriting.  | <b>HORTICULTURE</b><br>Complete Gardening<br>Flower & Veg. Growing  |
| <b>ART</b><br>Oil & Water Colour<br>Commercial Illustrating  | <b>MANAGEMENT</b><br>Business Management<br>Hotel Management<br>Office Management<br>Industrial Management<br>Personnel Management<br>Work Study, Foremanship   |
| <b>BUILDING</b><br>Architecture, Clerk of Wks., Buildg. Constr. & Allied Trades, Quantity Surveyg.                             | <b>MECHANICAL &amp; MOTOR ENGINEERING</b><br>Engineering Maths, Weldg. Diesel Engines and Locos. Inspection, Workshop Pract. Refrigeration, Motor Mech. Running and Maintenance (many other subjects) |
| <b>CIVIL ENGINEERING</b><br>Highway Eng., Struct. Engrg., Concrete Engineering.  | <b>PHOTOGRAPHY</b><br>Practical Photography<br>P.D.A. Examination   |
| <b>COMMERCE</b><br>Bookkeeping, Accountancy, Office Training, Costing, Secretaryship, Storekeeping<br>Shorthand & Typewriting  | <b>POLICE</b><br>Police Entrance Exam.  |
| <b>DRAUGHTSMANSHIP</b><br>Architectural, Mechanical, Maths. & Machine Drawing<br>Drawing Office Practice<br>Structural Drawing | <b>RADIO, T.V. &amp; ELECTL.</b><br>Radio Servicing & Engrg.<br>Radio Constrn. (with kits)  |
| <b>ELECTRONICS</b><br>Industrial Electronics<br>Computers & Maintenance  | <b>SELLING</b><br>Commercial Travellers<br>Sales Mangnt, Ret. Selling   |
| <b>FARMING</b><br>Arabic & Livestock<br>Farm Machinery Maint.<br>Pig & Poultry Keeping<br>Market Gardening                     | <b>WRITING FOR PROFIT</b><br>Short story Writing<br>Free-Lance Journalism<br>And many other subjects  |
| <b>FIRE ENGINEERING</b><br>I.F.E. Examinations<br>Fire Service Promotion   |   |
| <b>GENERAL EDUCATION</b><br>Good Eng., Foreign Langs.<br>G.C.E. subjects at ordinary or advanced level.                        |   |

**INTENSIVE COACHING** for all principal examinations including C.I.S., A.C.C.A., I.C.W.A., B.I.M., A.M.I. Mech. E. Brit.I.R.E., I.Q.S., City & Guilds of Lodon Institute, R.H.S., P.M.G. Certificates in Radiotelegraphy, etc.

**MEMBER OF THE ASSOCIATION OF BRITISH CORRESPONDENCE COLLEGES**

## Start today the I.C.S. way!

**INTERNATIONAL CORRESPONDENCE SCHOOLS**  
(Dept. 172)

Intertext House, Parkgate Rd., London, S.W.11

Send FREE book on \_\_\_\_\_

Name \_\_\_\_\_

Address \_\_\_\_\_

Occupation \_\_\_\_\_

9.63

**INTERNATIONAL CORRESPONDENCE SCHOOLS**

## SENSATIONAL NEW 1963 DESIGNS — BY CONCORD

### LOW PRICES ★★★ PICTORIAL STEP-BY-STEP PLANS ★★★ EASY AS A.B.C.

#### THE NEW "COSTA BRAVA"

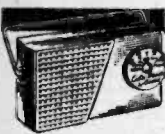

42/6

No earth or aerial required. All-transistor Radio. Revolutionary INTER-NAL FERRITE AERIAL and moving coil speaker makes this the best money...

...sensing pocket-size radio the best money...earing bargain of all time. Powerful, superb tone and clarity, ensures perfect reception for all your favourite programmes. Completely portable. Only 5 1/2 x 3 1/2 in. Form case. Available with our simple PRINTED CIRCUIT PLANS. Send 42/6, plus 2/6 P. & P. (C.O.D. 2/- extra). Satisfaction Guaranteed. (All parts available separately). FREE HIGH SENSITIVITY HIDE-AWAY EAR-PIECE GIVEN WITH EACH SET.

THE RINGO BURLGAR ALARM CLEARANCE SALE!



#### BIG PROFITS FOR YOU IF YOU BUY NOW!

Made to retail at 7 gu. you can now buy this famous Twin-gong Alarm for only 37/6...but only if you act now...stocks are strictly limited. Easily installed and operated. Switches on or off at any time. Fantastic FINAL reduction to clear (minimum order of 3). Car. Free. Free literature sent with each alarm. 37/6

#### THE NEW 4-STAGE "MINUETTE"

32/6



Build this newly-designed "MINUETTE" 4-STAGE transistor set in very strong ready drilled J L T R A MODERN CASE. size only 6x3 x 1 1/2 in. Uses three transistor and diode and SELF-CONTAINED LOUDSPEAKER. Very sensitive, ideal for office, bedroom, holidays, etc. Months and months of listening of 1/2 battery. Can be built FOR ONLY 32/6, including PROPER CASE, miniature speaker, etc. SIMPLE AS A.B.C. PICTORIAL STEP-BY-STEP PLANS etc., plus extra packing 1/6 (C.O.D. 2/- extra). Parts sold separately, priced parts list 1/-.

FREE

#### HIGH SENSITIVITY HIDE-AWAY EAR-PIECE GIVEN WITH EACH SET



#### THE MINUTE TRANSISTOR RADIO

MIAMI

ONLY 32/6

Unbelievably small—Outrageously cheap. You will be amazed at the fine quality of tone and volume of this great little radio. Only a fantastic 3d x 2 1/2 x 1 1/2 in. the MIAMI will bring you great entertainment for months on a 1/2 battery. Simple assembly plan with each set. ONLY 32/6. YES 32/6! Plus 2/6 P. & P. (C.O.D. 2/- extra). Satisfaction Guaranteed. Demonstrations given daily. Parts available separately if required.

#### SELL SAFETY TO THE MOTORIST



Bulk purchase of bankrupt stock ensures this fabulous money-making offer. AUTOMATIC CIGARETTE LIGHTER

Instantly provides ready lit cigarette without the driver taking his eyes from the road. Heavily chromium plated case holds 10. Easily and simply fitted to any car dashboard. Works off 6 or 12 volts. Retail Price 44/9. Special Clearance offer only sold in minimum lots of 6. 12/6 each. Carriage free.

#### FABULOUS ST. TROPEZ Mk.6

Pocket Radio

ONLY 18/6



NO MORE TO PAY! This fantastic offer will amaze you—the compact ST. TROPEZ measuring 4 1/2 x 3 x 1 1/2 receives perfectly in bedroom, office or garden—extra all medium ranges. Includes Luxemburg. Under 1d. per hour running cost. ANYONE can assemble it using our simple A.B.C. plan (P. & P. 2/6 extra) separately. Demonstrations daily. Satisfaction guaranteed.

### CONCORD ELECTRONICS (Dept. 14/16)

210, Church Road, Hove, Sussex

## NEW VALVES!

Guaranteed Set Tested  
24-HOUR SERVICE

1R5, 1S5, 1T4, 3S4, 3V4, DAF91, DF91, DK91, DL92, DL94, SET of 4, 18/9, DAF96, DF96, DK96, DL96, SET of 4, 25/-	DL33 7/3	PCF80 5/6
1D5 6/9	DL35 6/6	PCF82 6/6
1R5 4/9	DL92 4/9	PCL82 7/9
1R5 8/9	DL94 5/9	PCL83 8/9
1T4 2/11	EL96 6/3	PCL84 4/9
3S4 4/9	EB91 2/3	PL36 9/6
3V4 5/6	EBC41 7/-	PL81 7/6
5Y4G 4/3	EBF80 7/-	PL82 5/6
5Y6GT 5/-	EBL21 9/-	PL83 5/6
6Z4G 8/-	EC940 7/6	PL84 6/6
6K7G 1/6	ECC81 4/-	PY31 7/6
6K9G 4/-	ECC82 4/6	PY32 9/-
6Q7G 4/6	ECC83 5/9	PY80 5/9
6V8G 3/9	ECC84 6/-	PY81 5/9
6X5GT 5/8	EC285 7/-	PY82 5/3
12K7GT 3/11	ECP80 6/9	PY83 6/3
12K3GT 8/6	ECP82 7/6	U2 9/-
12Q7GT 3/11	ECH42 7/9	U26 8/6
12SN7GT 5/8	ECL80 6/-	UACB30 5/-
14ST 14/-	EL41 7/-	UAF42 7/6
35L8GT 7/6	EF80 4/-	UBC41 6/9
35Z4GT 4/9	EF85 5/-	UBC48 7/6
65A2 6/6	EF86 6/6	UC285 6/6
AC7P 19/6	EF89 4/9	UCH42 7/6
CL33 8/6	EF91 2/6	UCH81 7/6
DA32 8/3	EL41 7/6	UCH82 8/6
DAF91 3/9	EL84 5/6	UCL39 6/6
DAF96 8/3	EY51 6/3	UCL38 8/6
DE33 8/6	EY96 6/9	UF41 6/9
DF91 2/11	EZ80 5/9	UF89 6/3
DF96 6/3	EZ80 4/6	UL41 7/6
DH77 4/6	EZ81 4/3	UL84 6/3
DK32 8/9	KTW61 5/-	U8 12/6
DK91 4/9	MU14 5/-	UY21 8/-
DK92 6/9	PCC84 6/-	UY41 5/-
DK96 6/9	PCC89 7/9	UY85 4/3

Postage 6d. per valve extra. Any Parcel Insured Against Damage in Transit 6d. extra. Any C.O.D. Parcel 4/3 extra. Office address, no callers.

## GERALD BERNARD

83 OSBALDESTON ROAD,  
STOKE NEWINGTON,  
LONDON, N.16

## RADIO BOOKS BASIC

ELECTRICITY ELECTRONICS

In Simple straight-forward words and Clear Explanatory Pictures. The Reader is taken Step by Step from picture to picture. Officially used by the ARMY, NAVY and AIR FORCE, used by Trainees in the Radio and Electronic Industry.

Write for Illustrated Prospectus giving details of our 7 DAYS FREE TRIAL SCHEME. BRITISH Semi-conductor Survey 1963 18/-

HOW TO RECEIVE Foreign T.V. programmes on your T.V. set by simple modifications 5/6

22 TESTED Circuits using Micro Alloy Transistors 5/6  
BRITISH Transistor Directory (Bradley) 9/-

OSCILLOSCOPE Book USING an Oscilloscope 5/6  
OSCILLOSCOPE Equipment 5/6

MULLARD Transistor Radios 5/6  
MULLARD Ref. Transistor Circuits 13/6  
EXTRA Equipment Tape Recorder 6/6  
COIL Design and Construction 5/6  
TRANSISTOR Audio Amplifiers 6/6  
TRANSISTOR Circuits of Radio 6/6

Control of Models 8/-  
RADIO Servicing Instruments 5/8  
HIGH Fidelity 1/2 Speaker Enclosures 5/6  
BOY'S Book of Crystal Sets 3/-

SERVICING Transistor Receivers 2/-  
ELECTRONIC Novelties 5/6  
ELECTRONIC Gadgets 5/6

RADIO Valve Data "Wireless World" 7/-  
BEGINNER'S Guide to Radio 8/6  
MODERN Transistor Circuits for 8/-  
Beginners 8/-

TRANSISTOR Test Equipment 4/-  
MAGNETIC Recording 5/-

Wire and Tape 5/-  
RADIO Engineers' Pocket Book 11/6  
TRANSISTOR Circuits for the Constructor (Bradley) Nos. 1, 2, 3 and 4 4/- each

All the above books include postage. SEND STAMP FOR LISTS

### SELRAY BOOK CO.

60 HAYES HILL, HAYES, BROMLEY KENT. Tel. HURStway 1813

## H.A.C. SHORT WAVE EQUIPMENT

WHY is it that for 3 decades

#### H.A.C. SHORT-WAVE KITS

have been consistently demanded by so many constructors, amateur professionals and schoolboys. Because H.A.C. is undoubtedly the best. The circuits are simple, yet the results are fantastic. So easy to construct (or we do it for you). The secret is, of course, our vast experience, and also we use only the very highest grade of Short Wave components. (Not surplus.) We have been famous all over the world for 30 years, as suppliers of quality

#### SHORT-WAVE RECEIVERS AND KITS

H.A.C. were the original suppliers of Short-wave receiver kits for the amateur constructor. Over 10,000 satisfied customers—including technical Colleges, Hospitals, Public Schools, Halls, etc.—in fact we receive many testimonials by every post, from purchasers of H.A.C. Kits, who tell us that they regularly listen to stations from all over the world.

the North Pole, and other expeditions and all at full strength. Your success like our products is

#### GUARANTEED

Improved designs with Denco coils: One-valve kit, model "C". Price 25/- Two-valve kit, model "E". Price 50/- Super sensitive all-dry receiver. Special inc. price. Complete Kit, 77/-

All kits complete with all components, accessories and full instructions. Before ordering—call and inspect a demonstration receiver, or send for descriptive catalogue and order form to—

"H.A.C." Short Wave Products (Dept. TL)  
44 Old Bond Street, London W.1.

# T N

# rade ews

## Pick-up Arm Control

AUDIO enthusiasts will be interested in a new device made by Auriol Limited which can be added to practically any record deck incorporating manually-operated pick-up arms. Known as the Auriol "pick-up control", it pneumatically lowers the stylus on to the record at any position. The control arm is fitted above or below the pick-up arm depending on whether the record deck is a single or autochange model, the raising or lowering action of the control arm being transferred to the pick-up arm through a special clip. The control arm is accurately calibrated so that the stylus may be raised or lowered in any desired position without the danger of damage to the moving record.

The arm is easily fitted and is available in two models, at £3 11s. 6d. and £4 4s. and the makers are *Auriol (Guildford) Limited, Trading Estate, Farnham, Surrey.*



The Auriol "pick-up control" can be seen here in place on an autochange record deck.

## Diecast Instrument Box

ANY piece of home-constructed equipment (especially a test instrument) will prove more serviceable if it is assembled in a robust metal case. For some considerable time, Eddystone diecast boxes have provided the amateur constructor with just such cases and now yet another pattern is available.

This new box (catalogue No. 903) is similar in design to a previous model except that an extra 1in. has been added to its depth, making its dimensions 7½in. x 4½in. x 3in.

Aluminium alloy is the metal used for this box, which incorporates a close-fitting lid, held to the body of the box by six 4B.A. screws.

The makers of Eddystone diecast boxes are *Stratton and Co. Ltd., Eddystone Works, Alvechurch Road, Birmingham 31.*

## Transistorised C.R. Bridge

THE latest instrument from the manufacturing firm of Nombrex Limited is the transistorised C.R. bridge, model 62. This instrument employs six ranges covering resistance from 1Ω to 100MΩ and capacitance from 1pF to 100μF.

The model 62 uses a standard 9V battery and its total consumption is approximately 25mA. Printed circuit technique is used in the construction of the unit and the housing is of mild steel finished in silver-grey enamel.

The price of the model 62 C.R. bridge is £7 and the makers are *Nombrex Limited, Estuary House, Camperdown Terrace, Exmouth, Devon.*

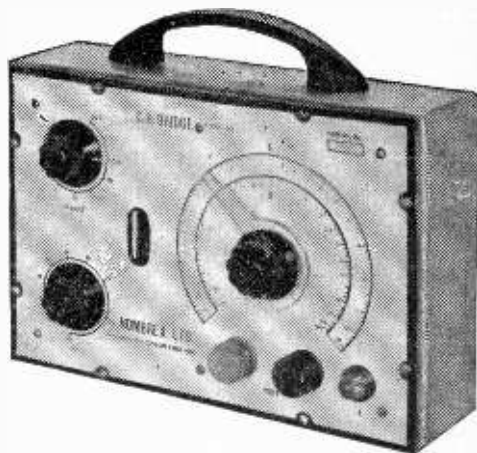

The Nombrex model 62 C.R. bridge.

## Rectifier Kit

TO cater specifically for the needs of the radio experimenter, the firm of Electro Automat Limited has introduced a kit containing everything necessary for the construction of experimental rectifier stacks. The kit will prove of interest to many amateur enthusiasts who still enjoy making their own components wherever this proves feasible.

Each kit contains three sizes of rectifier plates, contacts, washers, insulating tube, mounting spindles, etc. The standard kit costs 7 guineas and is made by *Electro Automat Limited, Swinton, Manchester.*

Continued on next page

# THE MALVERN TAPE RECORDER

CONTINUED FROM PAGE 441

### Winding details

For those who wish to undertake the winding of T1 and T3 rather than to purchase ready made components, all essential information is supplied in Figs. 11 and 12.

The winding details for the treble boost coil L1 have already appeared in the Components List.

### Recording head impedance

The formula for indicator impedance is  $XL=2\pi fL$  and not as stated on page 216 (July issue). Values for XL given in the same paragraph have however been derived using the correct formula; but they have been "rounded off" for convenience. (The exact calculated values are 125Ω, 1.25kΩ and 12.5kΩ respectively.)

The important point being illustrated is the fact that the 100kΩ feeding resistor R23 swamps out the value of the recording head inductance irrespective of its changing value (100Ω to 10kΩ approx.) with frequency.

It will be clear that the difference in recording current when using the "rounded off" values as opposed to the exact values is therefore negligible.

# TRADE NEWS

(Continued from previous page)

### Nine-transistor Portable

AMONG the latest range of Ekco receivers is the "New Verity" model PT424, nine-transistor portable. Push-button switching is employed to bring in either the medium, long or v.h.f. wave-band. The circuit features a transformerless output stage and a telescopic v.h.f. aerial adds to the set's performance.

The PT424 costs 22 guineas and is made by Ekco Radio and Television Limited, Southend-on-Sea, Essex.

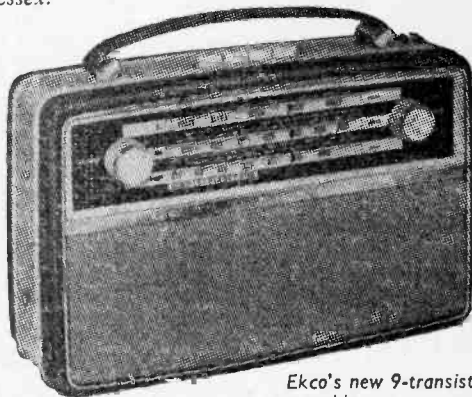

Ekco's new 9-transistor portable.

# FREE!

## OHMS LAW CALCULATOR

FOR CALCULATING CURRENTS, VOLTAGE RESISTANCE and WATTAGE in d.c. Circuits

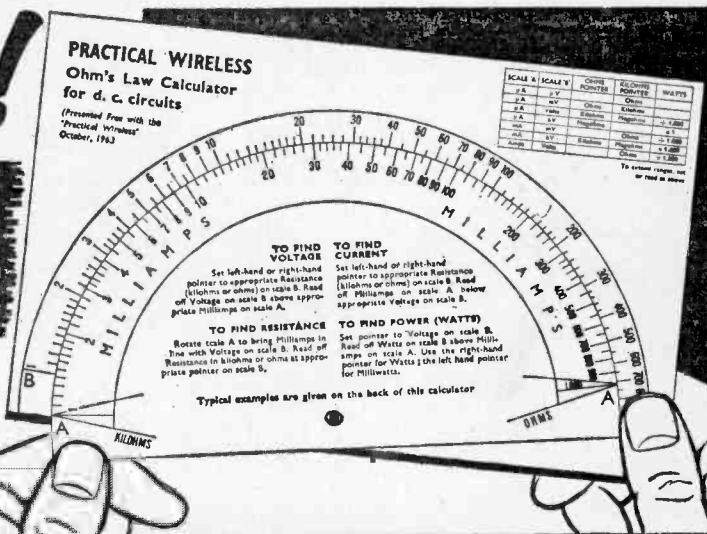

INSIDE NEXT MONTH'S

# PRACTICAL WIRELESS

ORDER FROM YOUR NEWSAGENT To-day! 2/-



# Stentorian

## NEW MODEL H. F. 1016 'MAJOR'

This new unit makes use of the high flux density available in the magnet system of the previous H.F.1016 unit. A curved diaphragm is used with a rigid centre section coupled to the voice coil. The rigid coupling and the design of the cone termination give a balanced response over the whole audio range. The unit is specially suitable for use in the smaller type of enclosure having a volume of approximately 1½ cubic feet.

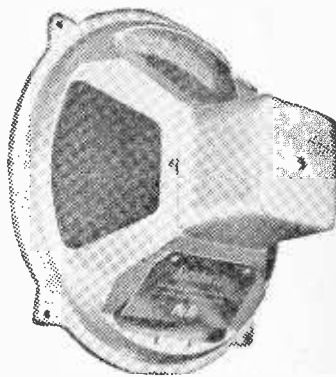

Type	Flux Density	Price	Type	Flux Density	Price
8" H.F.816*	16,000 gauss	£6.0.0	T.816	16,000 gauss	£5.13.6
8" H.F.812*	12,000 gauss	£3.12.9	T.12 tweeter	16,000 gauss	£13.4.6
8" H.F.810	10,000 gauss	£2.14.3	T.10 tweeter	14,000 gauss	£4.8.3
6" H.F.610	10,000 gauss	£2.5.0 Steel £2.6.9 diecast	T.359 tweeter	9,000 gauss	£1.10.6

\* These 2 speakers incorporate a universal impedance speech coil.

### Specification:

Chassis—die cast aluminium  
Cone—graded pulp cambric surround; Cone dia.—10 ins.; Pole dia.—1 in.; Flux density—16,000 gauss; Total flux—64,000 maxwells; Impedance—15 ohms.

Price: £8.19.6 (inc. tax)

## WHITELEY ELECTRICAL RADIO CO. LTD. MANSFIELD, NOTTS.

Telephone: MANSFIELD 1762-5

London Office: 109 Kingsway, London, W.C.2

WA3

### TEST METERS

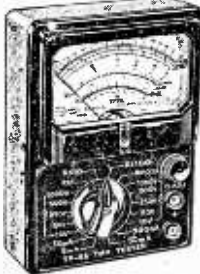

**20,000 OHMS PER VOLT MODEL TP-58** (Illustrated). Reads voltages up to 1,000 D.C. at 20,000 ohms per volt and A.C. at 10,000 o.p.v.; D.C. current to 500 mA; Resistance to 10 Megs. Capacitance to 0.1µF; Decibels from -20 to +36. Size 3¼ x 5¼ x 1¼ in. £5.19.6.

**2000 OHMS PER VOLT MODEL TP-10.** Reads A.C. and D.C. volts up to 1,000; D.C. current to 500 mA; Resistance to 1 Meg.; Capacitance to 1µF; Decibels from -20 to +18; Output jack for Audio measurements. Size 3¼ x 5 x 1¼ in. £3.19.6.

**30,000 OHMS PER VOLT MODEL 500.** Reads voltages up to 1,000 D.C. at 30,000 ohms per volt, and A.C. at 15,000 o.p.v.; D.C. current to 12 amps.; Resistance to 60 Megs; Decibels from -20 to +36. Sizes 3¼ x 5 x 2¼ in. £8.19.6.

**LAVOIE VHF WAVEMETER MODEL 105.** Coverage 375/725 Mc/s. Complete with correct Calibration Chart. First-class condition. Battery operated and portable, size 11 x 8 x 7¼ in. ONLY £3.19.6 (carriage 7/6).

**LOSSOR TYPE 1035 DOUBLE BEAM OSCILLOSCOPES.** A few only of these modern scopes, overhauled and in perfect order ONLY £45. Further details on request.

**AMERICAN DESK TELEPHONE,** complete with handset. Non-dial type, but has internal bell. Ideal for extension or inter-com. BRAND NEW. ONLY 30/- (Post 4/-).

**ACOS 39/1 STICK MIKE** with screened lead and table stand. ONLY 32/6 (Post 1/6).

**HRO SENIOR TABLE MODEL RECEIVERS.** Complete with 9 coils sets covering 50 Kcs to 30 Mc/s. Used, very good condition. Ideal. A few late Model ST with I.O. valves, £22.10.0 (carriage 30/-).

**DOUBLE BEAM OSCILLOSCOPE TUBES.** Another purchase of Type CV 1599, equivalent to Cosor 09D as used in Oscilloscopes by Cosor (339 series) and Hartley & Erskine (13 series). Listed £12. Brand new in maker's crates, 25/- (carr.5/-)

**CRYSTAL DESK MIKE** with screened lead and built-in stand. ONLY 15/- (Post 1/6).

### P.W. "CELESTE 7" RECEIVER

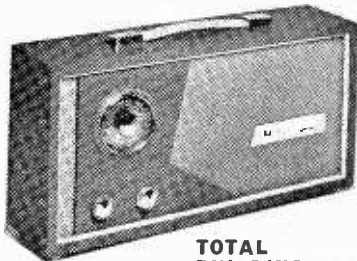

Build this latest P.W. seven transistor portable, as described in June and July issues. Medium and Long waves, with output of 1 watt from large 7 x 4 in. loudspeaker. Internal high gain aerial with car aerial socket. All components sold separately—parts list S.A.E.

**TOTAL BUILDING COST £9.19.6**

### "POCKET 4" TRANSISTOR RECEIVER



Uses miniature speaker, proper tuning condenser, and volume control. Built-in aerial makes unit efficient and portable. Ideal for the beginner. Full medium wave coverage. All components and case for only 42/6 (P. & P. 2/6). Tenpage constructional book free with parts or separately 1/6. S.A.E. for parts price list.

**PCR COMMUNICATION RECEIVERS**  
Manufactured by Pye and Philips. One of the Army's most versatile and sensitive sets. RF stage and 2 of IF using 6 British L.O. type valves. Large 180 degrees illuminated and Calibrated Dial. Flywheel tuning with locking device. Aerial trimmer. Tone and volume controls. Band switch from panel jacks for speaker or phones. In black metal case, size 17" L x 8" H x 10" D. Model PCR covers 6-18 Mc/s, 200-550 metres and 850-2,000 metres and has internal 5m. speaker. £8.19.6. Model PCR2 has similar L & M waveband coverage. Short wave 6-22 Mc/s, but no speaker. Used but excellent condition, £5.19.6. Model PCR3. As PCR2 but had 2 Short Wave Bands, 2.0-7.0 Mc/s and 7.0-23.0 Mc/s and Medium Wave Band 190-550 metres. ONLY £8.6.0. Every receiver aerial tested before despatch. Add 10/6 carr. all models. Designed to operate from bulky external power supply, but any set can be fitted with BRAND NEW COMPONENTS INTERNAL PACK for 200/250 v. A.C. at extra cost of £2. S.A.E. for illustrated leaflet.

"Practical Wireless" 6 transistor Personal Receiver. 2 hand printed circuit, etc. Building cost £7.19.6. "Pocket 4" Transistor Personal. Ideal for beginner. Building cost 42/6. All components sold separately, price lists for either of above S.A.E.

**MINIATURE MOTORS.** Ideal for models. Operates on 3-6 volts D.C. Size 1¼ x 1 x 1¼ in. plus pin. spindle. BRAND NEW, 5/- or 6 for 25/-.  
**20/- CONSTRUCTOR'S PARCEL.** Assorted colours wiring wire, solder, resistors, condensers, volume controls, tag panel. ALL NEW (Post 2/6).  
**RESISTORS.** 100 assorted values our choice. NEW 10/-.  
**CONDENSERS.** 100 assorted mica and silvermica. NEW 12/6.

### HARRIS ELECTRONICS (LONDON) LTD.

138 GRAY'S INN ROAD, LONDON, W.C.1 Telephone TErminus 7937  
Please include carriage costs on ALL items. Open until 1 p.m. Saturdays. We are 2 mins from High Holborn (Chance's Lane Sts) and 5 mins bus from King's Cross

# Lewis have the Cabinet for you

We can supply any cabinet to your own specification

This is only one example of—  
**THE LARGEST RANGE OF CABINETS IN THE COUNTRY**

Equipment is also our speciality.



The Grosvenor  
Price 18 gns.

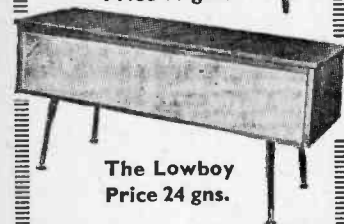

The Lowboy  
Price 24 gns.



100(P93) Chase Side, Southgate, London, N.14. Tel 3733/9666

Send today for the two new Lewis Catalogues

Designed to assist your choice of cabinet and equipment.

THE New Lewis Radio Cabinet Catalogue—the most comprehensive ever prepared. THE unique 64 page equipment catalogue.

Please send your two new catalogues enclosed in P.O. for 3/6 which will be credited against any purchase I make.

Name .....

Address .....

BLOCK CAPITALS PLEASE

## 90 DAY GUARANTEE ABSOLUTELY BRAND NEW VALUES ALWAYS IN STOCK

DAF91 5/3	EL84 7/3	U801 22/8
DF96 8/3	EY31 6/3	UABC80 8/3
DF91 5/3	EY86 8/3	UCH81 8/3
DF96 7/9	EZ40 6/-	UCL83 12/3
DK91 6/9	EZ80 5/9	UF89 7/3
DK92 6/9	PCC84 8/-	UL41 8/-
DK96 7/9	PCF80 8/-	UL84 7/9
DL92 6/9	PCL82 8/8	UUB 17/-
DL94 7/-	PCL83 10/8	1T4 5/3
DL96 7/9	PCL85 10/6	1R5 6/9
ECC81 5/9	PL81 10/3	354 6/9
ECC82 7/3	PL83 7/9	3V4 7/-
ECC83 7/3	PY33 12/-	5Y3GT 7/9
ECC84 7/3	PY81 7/-	6V6G 5/9
ECC85 7/3	PY82 6/6	20L1 18/6
ECH81 7/3	PY800 9/6	20P4 20/-
EDL90 7/6	U26 11/3	30PL1 9/9
EF93 5/-	U28 9/6	30PL1 10/8
EF96 8/9	U191 11/9	30PL13 10/3
EL41 8/-	U301 17/-	185BT 19/6

IF VALVE NOT LISTED SEND S.A.E.  
The following always in stock

Condensers - Resistors - Diodes  
Potentiometers - Speakers - Metal  
Rectifiers - All Types of Radio and TV  
Spares - L.O.P.T.S - F.O.P.T.S - Line  
and Frame Blocking Caps., Tx.  
**ANY TYPE OF TV TUBE SUPPLIED  
COMPLETELY REBUILT**

14" 90/-, 17" 115/- plus carr. & ins.  
5/- allowed in exchange on 14" tubes  
and 10/- on 17" tubes.

We specialise in second-hand spares  
Technical Advice Always Available by Phone  
TERMS: C.V.O. plus 6d. postage per valve.

C.O.D. S.A.E. for all enquiries.  
Satisfaction Assured - Return Post Service

**WITWORTH T.V. SERVICE**  
32a, All Saints Road,  
London, W.11 Tel. PARK 9972  
Open all day MON—SAT inc.

## A.R.R.L. RADIO AMATEURS HANDBOOK 1963

New edition 36/- Postage 2/3.

Electronics Pocket Book, new edition,  
by Hawker, 21/-, postage 1/-  
Beginners' Guide to Television, new  
edition, 8/6, postage 10d.  
22 Tested Circuits using Micro Alloy  
Transistors, by Sinclair, 5/-, postage 6d.  
Mullard Transistor Radios, Circuitry  
and Servicing, 5/-, postage 6d.  
Amateur Radio Call Book 1963, by R.S.G.B.  
4/8, postage 6d.  
Modern Transistor Circuits for Beginners,  
by Sinclair, 7/6, postage 6d.  
British Transistor Directory, new edition,  
by Bradley, 8/6, postage 9d.  
T.V. Fault Finding, by Data, 5/-, postage  
6d.

## UNIVERSAL BOOK CO.

12 Little Newport Street, London, W.C.2  
(adjoining Lisie Street)

**MULTIMETER KIT**  
Our 18,000 o.p.v., 25 range kit, with Weston  
50 microamp meter now only 65/- post paid.  
Send stamp only for full circuit, and details  
of other multimeters.  
Min. Rotary Switches 1p 12w, 2p 5w, 3p 4w,  
4p 3w, 4p 2w, 3/6 each, post 9d.  
WW pots, 3w. Min. pre-set TV type with  
moulded knob, all values 25Ω to 25k,  
carbon 30K-2M, 3/-, post 9d.  
WW pots, 20 5K, 7.5K, 1/8 ea., post 9d.  
Precision Wirewound Resistors, 1W,  
1Ωm to 1K, 1%, 2/6; to 5K, 3/3; to 20K, 4/-,  
1% add 3d. Your value wound to order.  
High Stab. Resistors, 1W, 1%, 2/-; 1W, 1%,  
2/6; 1W, 10%, 6d.; full range, list available.  
Special, 1W, 1% 100, 1000, 10K, 100K, 1Ω.  
Surplus High Stab. Resistors, 1/2W,  
1-5%, list available. Assorted 1%, 3/-;  
2%, 2/-; 5%, 1/3 doz., post 1/-.  
Neon Indicators, Red, amber, clear, single  
hole fixing, mains volts, 3/6, post 9d.  
2W Resistors, 100 assd., 7/6, post 2/-.

**PLANET INSTRUMENT CO.,**  
25, DOMINION AVENUE, LEEDS 7

## TRANSISTORS FROM 1/3

GREEN SPOT A.F. 3 volt. ONLY 1/3.  
YELLOW SPOT A.F. 6 volt 1/6.  
RED SPOTS. Now only 1/9 each.  
WHITE SPOTS. ONLY 2/6 each.

**MICRO-ALLOY TRANSISTORS**  
MAT100 7/9, MAT101 8/6, MAT120 7/9,  
MAT121 8/6. 22 Tested Circuits using  
Micro-Alloy Transistors 5/-.

**MULLARD TRANSISTORS**  
OC70 6/6, OC71 6/6, OC72 8/-, Matched  
Pr. 16/-, OC81 8/-, Matched Pr. 16/-, OC78  
8/-, OC44 9/3, OC45 9/-, OC170 9/6,  
OC171 10/6, AF102 27/6, AF114 11/-, AF115  
10/6, AF116 10/-, AF117 9/6, AF124 11/-,  
AF125 10/6, AF126 10/-, AF127 9/6.  
**DIODES** OA70, OA79, OA81, OA90,  
OA91 all 3/- each. BY100 13/-.  
**SURPLUS DIODES** CG3E 1/6.  
Miniature Type 3 for 2/-, 7/- doz.

**TRANSISTOR HOLDERS** 3 or 5 pin 1/4.

**REPANCO COMPONENTS**  
**TRANSISTOR TRANSFORMERS**  
TT49 Interster, TT45 Driver, TT46 Output,  
TT47 Driver. All 5/- each.  
FR2 Ferrite Rod Aerial 12/6.  
DRX1 Crystal Set Coil M. & L. 3/-.  
DRR2 Dual Range Coils 4/6.  
CHI Miniature R.F. Chokes 2/6.  
**THE HIKER**, 4 Transistor Portable.  
Step-by-Step Instructions 1/6.

ALL SENT POST FREE IN U.K. by

**PETHERICK'S RADIO SUPPLIES**  
22 High Street, Bideford, N. Devon.  
Tel.: Bideford 1217.  
S.A.E. with ALL enquiries please.

## FIRST-CLASS RADIO AND T/V COURSES... GET A CERTIFICATE!

After brief, intensely interesting study  
—undertaken at home in your spare  
time—YOU can secure a recognised  
qualification or extend your knowledge  
of Radio and T.V. Let us show you how.

**FREE GUIDE**  
The New Free Guide contains 120  
pages of information of the greatest  
importance to both the amateur and  
the man employed in the radio  
industry. Chambers College pro-  
vides first rate postal courses for  
Radio Amateurs' Exam., R.T.E.B.  
Servicing Cert., C. & C. Telecoms.,  
Grad. Brit. I.R.E. Guide also gives  
details of range of diploma courses  
in Radio/T.V. Servicing, Electronics  
and other branches of engineering,  
together with particulars of our  
remarkable Guarantee of  
**SUCCESS OR NO FEE**  
Write now for your copy of this  
invaluable publication. It may well  
prove to be the turning point in your  
career.  
**FOUNDED 1885—OVER  
150,000 SUCCESSES**

**CHAMBERS COLLEGE**  
(Incorp. National Inst. of Engineering)  
(Dept. 461), 148 HOLBORN  
LONDON, E.C.1

# CLUB

## BRADFORD RADIO SOCIETY

Hon. Sec.: E. G. Barker, G3OTO, 63 Woodcot Avenue, Baildon, Shipley, Yorkshire.

At the Society's first meeting for July, held on the 9th, members heard a lecture given by D. Millard (G3OGV) on "Tape Recorder Amplifiers". Later in the month, on the 23rd, a party of members visited a firm in Oldham.

## COVENTRY AMATEUR RADIO SOCIETY

Hon. Sec.: A. J. Wilkes, G3PQQ, 141 Overlade Crescent, Coundon, Coventry, Warwickshire.

The meeting of 8th July was the third in a series of "constructional evenings" to which members could come and use the facilities of the club specifically for the purpose of building 2m converters on the design by member G3NBQ.

For the following two weeks the Society held no meetings but 29th July was "Mobile Night on the Air".

## DERBY AND DISTRICT AMATEUR RADIO SOCIETY

Hon. Sec.: F. C. WARD, G2CVV, 5 Uplands Avenue, Littleover, Derby.

The second "Two Metre" contest was held on 6th and 7th July, and the latest d.f. practice run took place on the 24th. The meeting for 17th July was an open evening.

## NORTHERN HEIGHTS AMATEUR RADIO SOCIETY

Hon. Sec.: A. Robinson, G3MDV, Candy Cabin, Ogdon, Halifax, Yorkshire.

A committee meeting was held on 17th July, but for other members the evening took the form of a ragchew. For the last meeting of July, G8CB organised a treasure hunt.

August began with members arranging a demonstration station at the Warley Club and Institute Charity Gala. This was on 3rd August and was the first of three such stations the Society will arrange during the month.

## READING AMATEUR RADIO CLUB

Hon. Sec.: R. G. Nash, G3EJA, "Peacehaven", 9 Holybrook Road, Reading, Berkshire.

The Club Chairman addressed the assembled members at the July meeting when it was held on the 27th. The subject of his lecture was "Safety in the Shack".

## ROYSTON AND DISTRICT RADIO CLUB

G. B. Finney, 103 Cross Land, Royston, Barnsley, Yorkshire.

All visitors were welcomed at the exhibition of amateur radio equipment staged by members of this Club on 5th August. The exhibition was held in the Royston Welfare Park and the Club station (G3NAH/P) was in operation.

## SHEFFIELD AMATEUR RADIO CLUB

Hon. Sec.: D. A. Justice, G3PYL, 9 Leslie Road, Sheffield 6.

The Club met on Friday, 12th July, to hear a talk given by G3LWB on "Transistors and their Application to Amateur Radio".

## SOUTH SHIELDS AND DISTRICT AMATEUR RADIO CLUB

Hon. Sec.: Derek Forster, G3KZZ, 41 Marlborough Street, South Shields, Co. Durham.

On 7th July the Club's fifth Mobile Rally was held successfully at Bents Park Recreation Ground. Visitors from many parts of the country enjoyed a day of competitions and other events which had been arranged. Apart from the prizes for the winners of the contests held at Bents Park, awards were made for the day's longest distance contact and for the visitor who travelled the furthest to get to the rally.

## STOURBRIDGE AND DISTRICT AMATEUR RADIO SOCIETY

Hon. Sec.: R. A. G. MacIntosh, 50 Field Lane, Oldswinford, nr. Stourbridge, Worcestershire.

Saturday, 6th July, proved to be a busy day for the Society, with some members manning a working station at the Wollaston St James' Summer Fair at the same time as other members were taking part in the R.S.G.B.'s 2m Portable Contest.

## UXBRIDGE RADIO SOCIETY

Hon. Sec.: A. Duell, "Treetops", Bakers Wood, Denham, Buckinghamshire.

This Society meets on alternate Mondays at 7.30 p.m. when lectures, constructional practice, R.A.E. and Morse classes and other activities make up the programme of events to which all those interested are invited to attend. The next meeting will be held on 19th August and prospective members should contact the Secretary for details of the meeting place.

## WESSEX AMATEUR RADIO GROUP

Hon. Sec.: G. K. Fowle, 138 Surrey Road, Branksome, Poole, Dorset.

On 28th July members enjoyed a "hare and hound" d.f. contest and mobile rally which lasted throughout the afternoon.

## WEST KENT AMATEUR RADIO SOCIETY

R. Trevitt, 28 Dalves Avenue, Tunbridge Wells, Kent.

On 12th July members had a chance to sell, exchange or auction their surplus gear. Two weeks later members again brought their private equipment along to the meeting, this time to demonstrate to other members any gadget or device that they had found of use around the shack.

## COURSES OF INSTRUCTION

### WESTON-SUPER-MARE TECHNICAL COLLEGE

(Department of Engineering)

This college offers the following courses of instruction to people living locally: telecommunication technicians; radio and television servicing; electronic servicing; radio amateurs; ordinary National Certificate (electrical) and telecommunications advanced.

### HEANOR TECHNICAL COLLEGE

Ilkeston Road, Heanor, Derbyshire.

This College offers courses covering the R.A.E. and details are available from the Registrar or Mr. R. Harrod at the College.

### ILFORD LITERARY INSTITUTE

Cranbrook Road, Ilford, Essex.

A course of instruction covering the R.A.E. will begin in September and a Morse and codes of practice course will also be run in preparation for the G.P.O. test.

## A Versatile Double-Trace Oscilloscope

—continued from page 404

should be replaced by two 500k $\Omega$  resistors in series and the tube anode (A1) taken to their mid point. C1 and C3 must then be connected to earth instead of to "A1". This arrangement is not suitable for d.c. inputs for, if d.c. is now applied to a plate, it will cause a current to flow through the valves of R6 and the voltage this develops will affect both plates. (With a.c. inputs, practically all this current is by-passed through C1 or C3).

The second alternative which is suitable for d.c. inputs, is to retain the existing shift circuit, but connect the positive sides of the shift controls to earth. In this case, the shifts cover only the —X, —Y quadrant of the tube screen.

If the plates are fed from external d.c. amplifiers, the shift voltages are supplied by the amplifiers themselves, so the problem does not arise.

### Deflector Polarity

It is customary, with single-ended inputs, to arrange that positive signal applied to the "X d.c." terminal deflects the spot to the right and when applied to the "Y d.c." terminal, deflects the spot upward. This can be checked by means of a dry cell or battery. If the directions are incorrect, the leads to "D1" and "D2" or "D3" and "D4" can be reversed at the tube base.

TO BE CONTINUED



### SCREENING TAPE

**SIR,**—I have often used plywood covered with aluminium foil for a temporary chassis, with a good deal of success. However, on trying to screen wires by using strips of foil the results were not so good, as the screening invariably finished up as an inflexible tube of foil which would slide along the wire and short against a solder tag!

Although I have not had time to use the idea myself, I think the answer would be to use adhesive chrome tape which is sold in rolls and much used for embellishing motor scooters. The adhesive backing would prevent unravelling and one end could be held to the chassis by a nut and bolt thus earthing the tape and supporting the wire.—**M. FEATHERBY** (Sheffield).

### STEREO DETAILS PLEASE

**SIR,**—I intend building my own stereo tape recorder and so I was very interested in the letter of Mr. R. C. Hawkins (April issue) in which he mentions that he had built his own stereo tape equipment at a cost of only £40. I wonder if it would be possible for Mr. Hawkins to supply details of this equipment so that they could be published for the benefit of not only myself but the many other readers who might be intent on building such equipment but not sure of where to begin.—**L. J. ALLSOPP** (Canton, Cardiff).

### PROTECTION DEVICE

**SIR,**—All transistor receivers carry a notice warning the owner of the consequences of connecting the battery the wrong way round. I have often wondered that no manufacturer has adopted the idea which occurred to me some time ago, of placing a diode between the negative line of the set and the negative post of the battery. Now, with the battery connected the correct way round, current would flow through the circuit. However, if the battery were wrongly connected, then the diode would prevent any current flow, thus saving the transistors from damage.

An improvement on this idea would be an arrangement of four diodes in a bridge circuit, so that, regardless of the polarity of the battery, the receiver circuit would only receive current in the correct polarity.—**M. J. BEECHAM** (Grantham, Lincolnshire).

Whilst we are always pleased to assist readers with their technical difficulties, we regret that we are unable to supply diagrams or provide instructions for modifying commercial or surplus equipment. We cannot supply alternative details for receivers described in these pages. **WE CANNOT UNDERTAKE TO ANSWER QUERIES OVER THE TELEPHONE.** If a postal reply is required a stamped and addressed envelope must be enclosed with the coupon from page iii of the cover.

*The Editor does not necessarily agree with the opinions expressed by his correspondents*

### NOVICE LICENCES

**SIR,**—When will these merchants stop bleating and realise that the P.M.G. doesn't make licence regulations just to be awkward?

In my way of thinking, the element of common sense should be cultivated a little more. It is fairly obvious that a transmitter operated in a school or club premises is vastly different from the lone operator in his top back room and due allowance should be made in such cases. Nobody expects any group of enthusiasts to keep completely silent during operations, but one must remember that a little forethought before going on the air makes the ensuing contact all the more enjoyable. How many of us have had to listen to stations complete with one or more children shouting the odds plus TV churning away in the background?

I would suggest that the "chips" be firmly removed from various shoulders and let all those who are genuinely interested in obtaining their licences go about it in the time-honoured fashion of working for it.—**E. W. BONSON** (London E12).

*Sir,—I would be grateful if any reader could sell or loan me . . .*

. . . the September and October 1956 issues of P.W.—**R. G. JOHNSON**, 24 Tenterden Road, Sheffield 5.

. . . the issues of P.W. containing the modification details of the R1155 receiver.—**E. S. WOOD**, 18 Dover Street, Canterbury, Kent.

. . . the circuit diagram and any other information relating to the U.S. Navy receiver, model PR7NA.—**COLIN HALL**, St. Peter's College, Saltley, Birmingham 8.

. . . the September 1961, January and August 1962, February and March 1963 and the July 1960 to July 1961 issues of P.W.—**C. M. BERRY**, 15 Homefield, Boxford, Nr. Colchester, Essex.

. . . the instructions on the re-alignment of the P.C.R.3 communications receiver.—**E. STARKEY**, 35E Delhi Street, St. Thomas, Swansea, Glamorgan.

. . . the circuit and, if possible, wiring diagrams, of the American built command transmitter, CBY 52209 and accompanying modulator.—**M. LUCAS**, Cripps Hall, University Park, Nottingham.



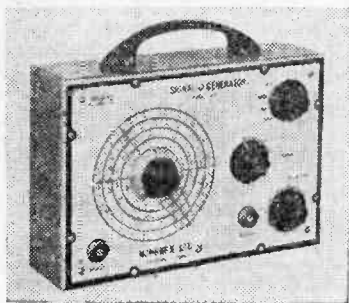

Wide-range Transistorised  
**SIGNAL GENERATOR—Model 27**  
Range 150 Kc/s to 350 Mc/s.

- ★ Accuracy better than 2%
- ★ Directly calibrated
- ★ Battery operated
- ★ Compact and light

**£7.18.6**

with test lead and battery.  
Post and Packing 3/6 extra.

Trade and Export Enquiries Invited

# NOMBREX INSTRUMENTATION

Transistor Regulated  
**POWER UNIT—Model 61**  
Regulated Output 1-15 volts

- ★ Indispensable for equipment testing
- ★ Automatic overload protection
- ★ Mains operated—negligible consumption
- ★ Eliminates expense of batteries

**£5.17.0**

Post and Packing 3/6 extra.

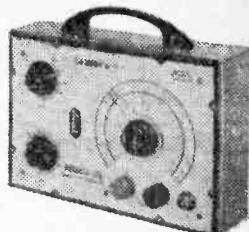

Wide-range Transistorised  
**C.R. BRIDGE—Model 62**  
6 Ranges: 1Ω to 100MΩ  
1pF to 100μF

- ★ Visual null indicator
- ★ Power Factor check
- ★ Electrolytic leakage test
- ★ Battery operated

**£7.2.3**

including battery.  
Post and Packing 3/6 extra.

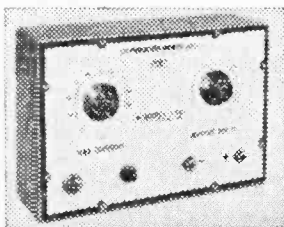

S.A.E. for full technical leaflets

**NOMBREX LTD.**

Instruments  
Division 61

ESTUARY HOUSE, CAMPERDOWN TERRACE,  
EXMOUTH, DEVON. Phone: 3515.



- **200** PAGES plus a page of useful formulae.
- Over **800** illustrations.
- Over **5000** components clearly listed and priced.

**OBTAINABLE ONLY FROM HOME RADIO OF MITCHAM**

**ONLY 2'6 PLUS 1' POST AND PACKING**

of this famous Catalogue  
**NOW READY!**

This is the 4th Edition and 8th Re-printing of our Catalogue. In addition to enlarging it we have re-arranged many sections for easier reference. Customers who purchased earlier editions will need no encouragement to obtain this one. To new customers we would point out that of 5,000 items listed all but 14 are actually in stock, and that this unique catalogue is backed by a Mail Order service second to none!

**POST COUPON TODAY**  
Write CATALOGUE on top left of envelope

Enclose P.O. 316

NAME .....

ADDRESS .....

Home Radio Ltd. (PW), 187 London Road, Mitcham, Surrey

## RECEIVERS &amp; COMPONENTS

**DIRECT TV REPLACEMENTS LTD.**, largest stockists of TV Components in the U.K. Line Output Transformers, Frame Output Transformers, Deflector Coils for most makes. Official sole suppliers for many set makers. Same Day Dispatch Service. Terms C.O.D. or C.W.O. Send S.A.E. for quotes. Day and Night Telephone GIPsy Hill 6166. 126 Hamilton Road, West Norwood, SE27.

**CONDENSERS.** Fantastic Bargain! 500,000 Miniature Condensers, 4in. long, 3/4in. diameter. Tested 750V. Capacity .0001 to .04uF, 7/6 per 100, post free. Ideal for transistor sets. MILWARD, 17 Peel Close, Drayton Bassett, Staffordshire.

**CLOSING DOWN SALE.** Thousands of Radio and TV components at giveaway prices. Constructor's parcel of condensers, resistors, wire, 1 chassis, transformers, valves, pots, only 24/-, post paid. M. SEED, 20 Lauderdale Road, Ribbleson, Preston.

**REMARKABLE** New 10W+10W Transistor Amplifier. Response 16cps to 50k/cs. distortion 0.06% at 10W. Mullard Transistor complement (16), inc. matched pairs and metalwork. 95/-. Also kits and wired version. A. KOVACS, 65 Alexandra Road, Hendon, NW4. SUN 3565.

**"TELECOMM"** v.h.f.-a.m. Monitor Receivers, fully transistorised. Type TVR, weight 3lbs. Two models 80/90Mc/s also 80/100Mc/s. Brand new, £30. **RADIO COMMUNICATIONS COMPANY**, Crewkerne, Somerset.

## Glasgow Electronic Services

21 OLD DUMBARTON ROAD, GLASGOW, G3  
Telephone WEST 2642

**SINGAL LAMP HOLDERS:** Adjustable bracket type, panel mounting, takes MES Bulbs. For panels up to 1/8in. thick. Red, Green, Amber, or Clear, 1/10. **PANEL ENCLOSED HOLDERS:** Totally enclosed, front or rear access to bulb. MES bulbs. Red, Green, Amber, Blue or Clear. For panels up to 25in. thick. Chrome metal parts, 5/4. **MINIATURE PANEL ENCLOSED HOLDERS:** As above but smaller, takes LES bulbs, 3/6. **PANEL NEON INDICATORS:** Self-contained resistor for direct mains operation. Moulded body. Red only, push fitting, 4/-. **MINIATURE NEONS:** Wire ended long life neon suitable direct wiring into equipment with appropriate series resistor. (270K for Mains), 2/-. **PILOT BULBS:** Lulliput type, 6.5V 1W or 12/14V 75W, 1/7. Standard Round MES types, first grade bulbs, as follows at 9d. ea.—2.5V .2A, 3.5V .15A, 3.5V .2A, 5V .15A, 6V .08A, 6V .115A, 6.5V .15A, 6.5V .3A, 6.5V .45A, 8V .15A, 8V .2A, 12V .1A, 12V 2.2W. Also available 20V .1A and 24/28V 2.8W at 1/7. **FUSE HOLDERS:** Panel mounting, for 1 1/2in. Fuses. Moulded body, 4/-. Miniature type, for 1/4in. Fuses, also 4/-. **MULTICORE CABLE:** Standard types: 7/0076 conductors covered by .02in. P.V.C. Whole tinned copper braided and P.V.C. sheathed overall. Cores individually coloured. 4-way 2/4, 8-way 2/7, 12-way 3/6, 20-way 4/6, all per yard. Miniature type 7/004 conductors covered .01in. P.V.C. otherwise similar to above: 4-way 1/10, 6-way 2/3, 12-way 3/4, all per yard. **MICRO SWITCHES:** Small reliable switches. SPDT contacts, rated 5A 250V A.C. Button type, 6/-; Lever type, 6/9. **50 OHM CO-AX CABLE:** 1/5 per yard post paid.

Send for our latest list—8d. post paid.

Terms of Business: Cash with Order; C.O.D. 3/- extra. Postage extra, unless otherwise stated, under £3 total value.

**RATES:** 7/3 per line or part thereof, average five words to line, minimum 2 lines. Box No. 1/- extra. Advertisements must be prepaid and addressed to Advertisement Manager, "Practical Wireless", Tower House, Southampton St., London W.C.2.

RECEIVERS & COMPONENTS  
(continued)

## NEW VALVES! GUARANTEED!

EBF80	7/6	EY51	7/6	PL81	8/6
EBF89	8/9	EY86	7/-	PY33	11/-
ECC81	4/6	EZ40	6/6	PY81	7/-
ECC82	4/9	EZ80	6/3	PY82	6/6
ECC83	6/3	PC84	6/9	U25	11/6
ECL80	5/9	PC89	8/9	UC85	7/6
ECL82	9/-	PCF80	7/9	UCH42	7/6
EF80	4/9	PCF82	7/7	UCH81	8/9
EF85	5/9	PCL83	10/3	UY45	6/6
EF86	8/9	PL84	6/6	6B7W	7/6
EL84	6/8	PL36	11/6	6X	5/-

Postage 6d. per valve extra.  
S.A.E. for full lists and discounts.  
**LEWIS ELECTRONICS**  
16 GLENWOOD GARDENS, GANTS  
HILL, ILFORD, ESSEX.  
Telephone: Crescent 5685

**SPEAKER REPAIRS.** Cones/Fields fitted. Clock coils wound. L. S. REPAIRS, Puckley, Ashford, Kent.

**ALL TYPES LINE OUTPUT TRANSFORMERS SUPPLIED (RETAIL AND TRADE).** Finest service in the country. Send S.A.E. for return of post service. Terms C.W.O. or G.O.D. Trade enquiries invited. D. AND B. TELEVISION (WIMBLEDON) LTD., 131 Kingsway Road, Wimbeldon, SW19. ChERRYWOOD 3955.

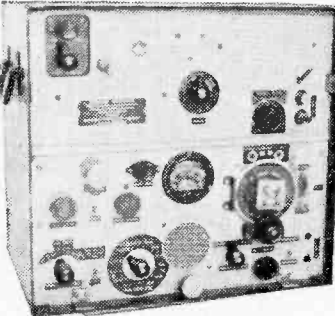
MARCONI CANADIAN  
RECEIVER No. 52  
(Brand New)

**AMATEUR SHIPPING BROADCAST**  
Magnificent 10 valve receiver in 3 wavebands covering 1.75-16Mc/s (19-170 metres), plus 3 valve crystal calibrator employing dual 100/1000kc crystal to provide marked check at 10-100-1000kc/s. 1 RF and 2 IF stages. Other refinements include valve check meter, internal 3in. speaker, RF-AF gain, Noise Limiter, BFO, Heterodyne Pitch, Wide/Narrow Bandwidth, Speaker or Phones, Man or AVC on CW and RT, Fast/Slow tuning with additional OSC. for fine adjustment. Power required: HT 160 v. 60mA, LT 12 v. 1 1/4. Circuit supplied. SIZE 15" x 12" x 15".

**BRAND NEW.** Complete with Power Pack for 115/230 v. AC mains and 12 v. DC., £12.19.6. Carr. 20/-.  
Many other surplus bargains with **PERSONAL SERVICE.** Lists 6d. S.A.E. inquiries.

**A. J. THOMPSON**  
"EILING LODGE"  
CODICOTE, HITCHIN, HERTS.  
Phone: Codicote 242.

## RECEIVERS &amp; COMPONENTS

(continued)

**EXCEPTIONAL VALUE:** Picture Tubes, brand new, Mazda 19in., CME1901, Mullard 19in., AW47-90/91, £4 10/-; Mullard 23in., AW59/90, £6 10/-; carriage (insured) paid. 12 months' guarantee. Note: All other brand new. We also supply most other sizes completely regunned at £4 17/6, guaranteed 12 months. TOMLINS, 136 Lewisham Way, New Cross, SE14. TID 3857.

## REBUILT AND RESCREENED TUBES. Famous make. 95/-.

New boxed valves, 1 year guarantee. ECC81, EF80, EB91 etc. 5/-; EY51, EY86, ECL80, PY81 etc. 7/-; PCF80, PL81, EF86, PCL82 etc. 9/-. Postage extra.

**P. BEARMAN**  
3 Park Avenue, New Barnet, Herts.  
Lists Free. Tel.: Bar 1934

**A1 POST-FREE BARGAINS.** Guaranteed Secondhand set Tested Valves: EF80, EB91, 10P1 9d. each. 3 for 1/3; L63 2/-; ECL80 2/6, 3 for 6/-; PZ20, PY81, EL38, PL33 3/6; PL83, PL82, PY80, PY82, PCF80 4/-; KT36, N37, B36, PY31, U281, U282, 20P1, 2TSU 4/6; EB41, EBC41, ECC81, ECC82, EL42, PL81, U31, UB41, UF41, UF42, UL41, UL44, UL46, UY41, 6C13, 10C2, 6L20, 20L1 5/-; 30P4, 53KU, EL33, PL36, UUT 7/-. Thousands of Valves in stock, including obsolete types. Ex-Service, reclaimed and all new B.V.A. types and makes. All **RADIO COMPONENTS**, 14 The Borough, Canterbury, Kent.

DATA TRANSISTOR  
POCKET KITS

**NO SOLDERING OR DRILLING, COMPLETELY SELF CONTAINED**

**NO AERIAL REQUIRED - MEDIUM & LONG WAVE - ASSEMBLY TOOL PROVIDED - CAN BE BUILT BY ANYONE**

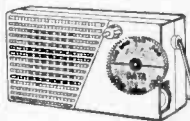

5 1/2 x 3 x 1 1/2in.

**DATA 55**  
5 SEMI-CONDUCTORS  
5 STAGES  
MOVING COIL SPEAKER  
**50/-** P.P. 2/9 extra.  
Battery 2/3 extra.

**DATA 427.** 4 TRANSISTORS, 2 DIODES, 7 STAGES, MOVING COIL SPEAKER  
**65/-** extra.  
Battery 2/3 extra. P.P. 2/9 extra.

All Parts Supplied Separately

**"DATROLA"** transistor ELECTRONIC ORGAN 2 octave. Complete and ready to play, with instructions and music. Size 14 1/2 x 5in.

£5.19.6 post free.

**DATA ELECTRONICS LTD.**  
6 HILLSIDE GDNS, EDGWARE,  
Middlesex

**RECEIVERS & COMPONENTS**  
(continued)

"HEATHKITS" can now be seen in London and purchased on easy terms. Free brochure. DIRECT TV REPLACEMENTS LTD., Dept. PW7/9, 126 Hamilton Road, West Norwood, SE27. GIPsy H11 6166.

**THE FINEST READY TO OPERATE COMMUNICATIONS RECEIVER EVER OFFERED TO THE SHORT WAVE ENTHUSIAST**



SEND SAE NOW FOR DETAILED LEAFLET or ENCLOSE 5/- for HANDBOOK

COMPLETE and CARRIAGE PAID

**CANADIAN MARCONI 52 RECEIVERS**

Set is complete with Power Unit Z.E. 12 and connecting cable, ready to operate from 230/240 V.A.C. Mains, or 12v. Battery. Ample Spare Valves stocked. Suitable Headphones 12/6 extra.

**G.W.M. RADIO LTD**  
40/42 Portland Rd. WORTHING

**FOR SALE**

**EXCEPTIONAL** Transistor Portable Tape Recorder, value £6/19/6, complete with crystal microphone, earphone, spool tape, batteries, instructions. Presentation box (extra tapes 100ft 4/6). Ideal gift. £6/19/6. Satisfaction guaranteed. Postage packing 2/6. TOMLINS, 156 Lewisham Way, New Cross, SE14.

**LOWEST PRICES — HIGHEST GRADES — ALL FULLY GUARANTEED**

**OUR LATEST SCOOP A.E.I XU611 Silicon Diode Rectifiers ★**

Size of a tag end! 350 mA, only 5/- each. 50/- doz. Limited Stocks. Diodes GEC, GEX941/2 or MAZDA Sub. Min. XD201 only 9d. each, 6/- doz.

**MULLARD TRANSISTORS**

OC44, OC45, OC81, OC81D, 3/6 each, 36/- doz. OC170, OC171, 4/- each, 44/- doz. OC26, OC35, 12/- each, 130/- doz.

Sub. Min. 1.F.S. (3) + Osc. Coil 460/475 Kc, 10/- set.

**MAZDA TRANSISTORS**

XB103, XA102, XA112, 2/- ea., 20/- doz. Red Spot Audio or White Spot R.F. 1/- ea., 10/- doz. XC141 11 watt Audio 6/- each, 64/- doz.

1,001 Other Snips. S.A.E. List UNBRANDED MAZDA TRANSISTORS. XA102, XA112, XB103, XB113, 1/3 each, 12/- doz.

**B. W. CURSONS**  
78 Broad Street, Canterbury Kent.

**FOR SALE**  
(continued)

**E. R. NICHOLLS**

**No. 1 BUMPER PARCEL**

- 100 Assorted Resistors.
- 50 Assorted Condensers.
- 1 5in. 3 ohm Flac Speaker.
- 1 Isolating Transformer.
- 4 Terminal Blocks.
- 2 Rotary Toggle Switches.
- 1 Small Chassis containing 60 components.
- 2 Westectors.
- 2 Thermistors.
- 100 Cartridge Fuses.

**No. 2 BUMPER PARCEL**

- 1 Pair Test Prods, retractable with leads and soars.
- 1 7 x 4in. 3 ohm Speaker.
- 6 Assorted Valves.
- 6 Assorted Potentiometers.
- 6 Assorted Valve Bases.
- 2 5-way Plugs and Sockets with leads.
- 4 Mixed Plugs or Sockets.
- 100 Cartridge Fuses.
- 1 Inductance Variometer.

One for 20/- Post Free, or any two parcels 35/- Post Free.

20ft. Steel Telescopic Mast, 50/-.

High Stab Resistors 6d. each.

List now ready for Paper Block Condensers, Valves, Oscillators, Test Sets. S.A.E. Please.

Mail Order and Retail Shop:  
46 Lowfield Road, off Shaw Heath, Stockport, Cheshire.

**ETCHING PRINTED CIRCUIT KIT**

Consists of Plastic Bath and Case. Size 9 x 5 x 2 in. Contents: Solvent, Etchant, Resist, 100 sq. in. Copper Laminate Board. Comprehensive book gives examples and circuit layouts. 18/6 inc. post.

**RADIOCENTRE**

94 Hurst Street, Birmingham. Dept. P

**SPECIAL OFFERS — NO INTEREST TERMS**

GARRARD Antenna Changer Cash £7.17.0 or 18/- dtpt. and 12 pynats. of 1/19 monthly.

GARRARD AT6/EV26A Cash £12.5.5 or 25/5 dtpt. and 12 pynats. of 18/4 monthly.

ARMSTRONG Jubilee Mk. II. Cash £28.5.0 or 57/- dtpt. and 12 pynats. of 42/4 monthly.

ARMSTRONG stereo 12 Mk. II. Cash £40.5.0 or 82/- dtpt. and 12 pynats. of 60/3 monthly.

A. L. STAMFORD Ltd. (Dept. G89)  
98 WEYMOUTH TERRACE, LONDON E.2  
Phone: 810 5003.

**GUITAR AMPLIFIERS WITH TREMOLO**

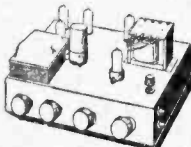

Hi Fi 15 watts. Valves ECC83, ECC83, ECF82, EL84, EL84, EZ81. Four jack inputs. Six controls: two volume, bass, treble, tremolo speed, depth. Remote

plug. 3 and 15 ohm outputs. Real value. Ready built, £11. Similar 30 watt. Valves ECC83, ECC83, ECF82, EL84, EL84, EL84, EL84, EZ81, £14. Amplifiers as prev. advert. 15 watt (illus.) Kit, £6.10.0, ready built £9.30 watt, Kit £9.10.0, ready built £12.50 watt, ready built £16.

Add carr. 7/6 any amplifier. Send for free leaflet.

**STROUD AUDIO**  
Bath Road, Stroud, Glos.

**TRANSISTOR RADIO**, brand new, worth £10. Unwanted present. £6 only. Box 48.

**FOR SALE**  
(continued)

**MULTI RANGE Test Meter**, scaled 0hms-volts MA, 17/6; Two new 12in. Hi-Fi Loudspeakers each fitted electrostatic Tweeters, 50/- each; Rectograph 500 Recorder, £50; carriage free. Insurance if required, 10/- extra, C.O.D. 2/6 extra. Letters only in first instance to ROBINSON, Highlands Caravan Park, Thorpe Road, Cacton.

**240W ELECTRIC POWER ANYWHERE ANYTIME from 12 CAR BATTERY**

WITH THE AMERICAN DYNAMOTOR UNIT

Input 12v. output 200/250w at 150 or 220 volts. Perfect for TELEVISION, POWER TOOLS and all universal AC/DC ELECTRICAL EQUIPMENT. Also universal motor power source for car, boat, camp, etc. Ideal standby coverage for all illustrated details. SCIENTIFIC PRODUCTS, CLEVELAND, OHIO

**FAULTS EASILY LOCATED** with the New Signal Injector, full inst. 50/- p.pd. S.A.E. leaflet. KINDER, 6 Hooker Rd., Heartsease, Norwich, Nfk.

**AERIALS**

**MARCONI COIL AERIAL TUNING SYSTEM**

Last few of these popular aerial matching units, containing 140ft drum of copper aerial wire and inductors feeding into a tunable matching unit, enabling your TX or RX to work to its best efficiency, originally used for the 32 TX-RX. LAST FEW NOW ONLY 27/6 cart. 5/-.

**19 SET PARTS**, all brand new. J. T. SUPPLY receiver power supply kit, 200-50 mains to 275V d.c. and 12V L.F. choke smoothed, lead and connector to set. 45/-, p.p. 5/-.

**CONNECTORS** 12-12 pin (long) 8/6, short lead 6/-, 12 pin plug and flex 5/-, 6-6 pin (long) 5/-, 6 pin and flex 3/6, post long 1/6, others 9d.

**CONTROL BOX** 8/-, Mk2 improved late double type 8/6, p.p. 1/6. Mic and Phone headset, 17/6, p.p. 1/6.

J. T. SUPPLY, Dept. N, 150 MEADOW LANE, LEEDS.

**WANTED**

**WANTED:** New Valves and Transistors, boxed or unboxed. Any quantity for cash. WITWORTH TV SERVICE, 32a All Saints' Road, North Kensington, London, W11. PARK 9972.

**A PROMPT CASH OFFER** for your surplus brand new Valves and Transistors. R.H.S., Beverley House, Mannville Terrace, Bradford 7.

**PREMIER MAGNETIC TELEVISION.** Instruction book. Box No. 40.

**WANTED VALVES ONLY**

Must be new and boxed. Payment by return.

**WILLIAM CARVIS LTD.**  
103 North Street, Leeds 7

(continued overleaf)

**WANTED**

(continued)

**ABSOLUTE TOP PRICE** paid for Valves, Transistors, Components, etc. in quantity. Try us first. Cash by return. **WOLVERHAMPTON RADIO AND TV SUPPLIES**, 42 Darlington Street, Wolverhampton. Tel.: 20315.

**WANTED: TEST GEAR.** Meters, Valves, Components, Communication Sets, Amplifiers. Letters only. **HUGGETT'S LTD.**, 2-4 Pawsen's Road, West Croydon, Surrey.

**NEW VALVES WANTED**

Any type, any quantity

**CASH PAID**

**R.S.T. Valve Mail Order Co.**,  
211A Streatham Road  
Mitcham, Surrey  
Telephone: MITCHAM 6202

**WANTED: NEW VALVES** and Transistors, any quantity **S. N. WILLETS**, 43 Spon Lane, West Bromwich, Staffs. Tel.: WES 2392.

**METAL WORK**

**METALWORK.** All types cabinets, chassis, racks etc. to your specifications. **PHILPOTT'S METALWORKS LTD.**, Chepman St., Loughborough.

**SITUATIONS VACANT**

**PUBLIC SCHOOL MAN** under 25 required as Trainee for Electronic and/or Mechanical Engineering design and development work on machines to make fibreglass products. Starting salary £3036. Write giving details of education, interests and experience to **FIBRELITE INDUSTRIES**, Trafford Hall, Chester.

**CITY AND GUILDS** (Electrical, etc.) on "no pass—no fee" terms. Over 95% successes. For details of Electrical Engineering, Applied Electronics, Automation, etc., send for our 148-page handbook, free and post free. **B.I.E.T.** (Dept. 242A), 29 Wright's Lane, London, W8.

**NORTHAMPTON COLLEGE OF ADVANCED TECHNOLOGY**  
ST. JOHN STREET, LONDON, E.C.1

**DEPARTMENT OF ELECTRICAL ENGINEERING**  
**JUNIOR LABORATORY TECHNICIANS**

Candidates should have (a) four approved G.C.E. subjects at 'C' Level or (b) have obtained or pursuing the O.N.C. course in Electrical Engineering. Junior Technicians normally receive a five-year integrated course of education and training in all branches of electrical engineering. This includes workshop processes and experience in the undergraduate teaching and special project laboratories and, where appropriate, research laboratories. Concurrently with training, each Junior Technician receives part-time day release to study for the H.N.C. or possibly H.N.D. After training the Technician would be qualified to work as Senior Technician in College, Industrial, Government and Research Association, research and development laboratories.

Applications to Head of Department for details, salary and conditions.

# Passed G.C.E.?

## READ THIS!

If you have 'O' level in five acceptable subjects including English language and mathematics: if at the same time you are between 17 and 26 and a potential leader with a strong sense of responsibility, you could be selected, this year, for a career as an aircrew officer in the Royal Air Force.

**A wide range of duties, world-wide travel.** As an aircrew officer you could fly any one of a dozen different aircraft from Comets to Lightnings, Valiants to helicopters. Your duties could range from air-sea rescue work in the Irish Sea to an air survey in the Far East. Your pay is excellent from the day you join. As a Flying Officer of 21 you would earn over £1,000 a year. Off duty, your facilities for sport are outstanding and leave is generous—six weeks in every year.

**How long do you serve?** A Direct Entry commission gives you a guaranteed, pensionable career to the age of 38 (or 16 years) with good prospects of service to 55. Or you may leave after 8 or 12 years with a tax free gratuity of up to £4,000.

**Send now for this free book!**

Send today for 'Flying and You', the illustrated guide to flying careers and life in the R.A.F. Write, giving your date of birth and details of education, to Group Captain J. W. Allan, D.S.O., D.F.C., A.F.C., Air Ministry (PW82), Adastral House, London, WC1.

**Captain of a Valiant at 25.** Flight Lieutenant Tony Banfield and his 5-man crew are members of No. 543 Squadron, Bomber Command. Their duties—photographic and radar reconnaissance—take them all over the world from the Mediterranean to Malaysia. Tony Banfield left Whitgift School with 7 'O' levels. At 17½ he joined the R.A.F. with a Direct Entry commission. This year he was selected for a permanent commission.



**The Royal Air Force**

**SITUATIONS VACANT**

(continued)

**TV AND RADIO.** A.M.Brit.I.R.E., City and Guilds, R.T.E.B. Cert., etc. on "No pass—no fee" terms. Over 95% successes. For details of exams and courses (including practical apparatus) in all branches of Radio, TV and Electronics, write for 148-page handbook—free. B.I.E.T. (Dept. 242G), 29 Wright's Lane, London, W8.

**A.M.I.Mech.E., A.M.Brit.I.R.E., City and Guilds, G.C.E., etc.** brings high pay and security. "No pass—no pay" terms. Over 95% successes. For details of exams, and courses in all branches of Engineering, Building, Electronics, etc., write for 148-page handbook—free. B.I.E.T. (Dept. 242B), 29 Wright's Lane, London, W8.

**COURSES**

**CITY AND COUNTY OF BRISTOL EDUCATION COMMITTEE**  
**BRISTOL TECHNICAL COLLEGE**  
 Principal: E. Poole, B.Sc. (Eng.), M.I.Mech.E., M.I.Prod.E.

**SCHOOL OF MARINE RADIO AND RADAR**  
 Senior Lecturer: F. E. Barltrop (ex. A.S.T. Hamble)

**MARINE RADIO OFFICERS**  
 A full-time course for prospective Radio Officers in the Merchant Navy, leading to the 2nd and 1st class P.M.G. Certificates, and the M.O.T. Radar Maintenance Certificate, is provided, and entry may be made in January, May and September of each year.

**Fees:**  
 Under 18 years of age: £2 per College Year  
 Over 18 years of age: Information from Registrar.

A six-week Course of Pre-Sea Training is also held, and entry is normally on completion of the Radar Course.

For further particulars apply:  
**Registrar, Bristol Technical College, Ashley Down, Bristol 7.**  
 Please quote ref.: PW.

**L.C.C. Wandsworth Technical College**  
**RADIO and T.V. SERVICING COURSE**  
 (City and Guilds Course 48)

The above will commence in September at the College on either one whole day per week or three evening per week.

**Enrolment from September 10th at the College.**

**EDUCATIONAL**

**RADIO OFFICERS** see the world. Immediate sea-going appointments. Our many recent successes provide additional trainee vacancies during 1963. Day and boarding students. Grants and Scholarships available. Stamp for prospectus. **WIRELESS COLLEGE, Colwyn Bay.**

**LEARN RADIO AND ELECTRONICS** the new and practical way. Hosts of absorbing experiments carried out at home under expert guidance to teach you Radio in a new, enjoyable and interesting way. Construction, servicing and fault-finding on equipment made easy for the first time! No previous experience needed. No mathematics used. Free brochure from Dept. 11, P.W., **RADIO-STRUCTOR, Reading.**

**EDUCATIONAL**

(continued)

**Radio Television & Electronics**

Learn at home with the world's largest home study organisation, **Brit.I.R.E.; City & Guilds; P.M.G.'s** certs., etc. Also Practical Courses with equipment. All books supplied. Write for **FREE prospectus** stating subjects to

**I.C.S.**

(Dept. 541), Intertext House, Parkgate Road, London, S.W.11

**BECOME "TECHNICALLY QUALIFIED"** in your spare time. Guaranteed Diploma and Exam. Home-study Courses in Radio, TV Servicing and Maintenance, R.T.E.B., City and Guilds, etc. Highly Informative 120-page Guide — **FREE!** **CHAMBERS COLLEGE** (Dept. 363), 148 Holborn, London EC1.

$$X = \frac{-b \pm \sqrt{b^2 - 4ac}}{2a}$$

**DON'T FUMBLE** with Formulae, Master Mathematics quickly and easily the Understandable Way.



The Dryden School of **UNDERSTANDABLE MATHEMATICS**  
 11F9 Dryden Chambers, Oxford St., London, W.1.

Name.....  
 Address.....  
 .....

**THE Incorporated Practitioners in Radio and Electronics (I.P.R.E.) Ltd.** Membership Conditions booklet 1/- Sample copy of I.P.R.E. Official Journal 2/- post free. Secretary, 32 Kidmore Road, Caversham, Reading, Berks.



**RADIOSTRUCTOR**  
 Dept. G77 READING, BERKS

**EDUCATIONAL**

(continued)

**"HOW AND WHY"** of Radio and Electronics made easy by a new, non-maths, practical way. Postal instruction based on hosts of experiments and equipment building carried out at home. New courses bring enjoyment as well as knowledge of this fascinating subject. Free brochure from Dept. P.W.12, **RADIOSTRUCTOR, Reading.**

**BOOKS & PUBLICATIONS**

**AUDIO**, America's foremost journal. Year's subscription 43/-, specimen copy 4/-. All American radio journals supplied—list free. **WILLEN** (Dept. 40), 61a Broadway, London, E15.

**FIND TV SET TROUBLES IN MINUTES** from that great book "The Principles of TV Receiver Servicing," 10/6 all book houses and radio wholesalers. If not in stock from Secretary, I.P.R.E., 32 Kidmore Road, Caversham, Reading, Berks.

From **GORDON J. KING LIMITED** KINGSFORD, SOUTH FURZEHAM RD BRIXHAM, Devon. Tel: Brixham 2304

**LOOK AT THIS! THE AMAZING "KING TELEBOOSTER"**

- 5-TIMES BOOST ON TWO CHANNELS (one BBC one ITA)
- SMALL UNIT, printed board, splitter and combiner.
- LOW NOISE improves set's signal/noise performance.
- BATTERY POWERED avoids internal set connections.
- SPARKLING PICTURES in fringe and weak signal areas.
- WORKS UP TO SIX SETS SIMULTANEOUSLY (on 2 stations).
- A DX TV MUST—pulls in distant stations.
- ALLOWS THE USE OF INDOOR AERIALS.
- USES LATEST VHF TRANSISTOR. Bargain price to readers of Practical Wireless. Only 75/6 complete with battery (P. & P. 2/6 extra). Please state BBC and ITA channels required. Also full range of **TECHNICAL BOOKS** and all those by the well known G. A. Briggs of audio fame—lists 1/-. (Prices of books below include P. & P.).

**(6) RADIO & TELEVISION TEST INSTRUMENTS 26/-**

Learn how test instruments work! how they are made! how to connect them and —MOST IMPORTANT— the results to expect on normal and faulty circuits.

**(7) FM RADIO SERVICING 26/- HANDBOOK**

—written for amateur and technician—Learn how to adjust sets and tuners for the top-quality, interference-free reception only FM can provide. Order now.

**ESSENTIAL SERVICING DATA (1) TV 11/9 (2) RADIO 14/9**

Major items of hundreds of sets listed. **SERVICE SHEET** library specially for the enthusiast and experimenter (radio, TV, audio & etc. lists 1/-). **FAULT DIAGNOSING SERVICE**—questionnaire form 6d. **WE SPECIALISE IN RADIO, TV AND AUDIO COMPONENTS and DATA**, including a range of **ISOLATING TRANSFORMERS**. Let us quote you.

**SERVICE SHEETS**

**SERVICE SHEETS**, also Current and Obsolete Valves, for sale. **JOHN GILBERT TELEVISION**, 1b Shepherd's Bush Road, London, W2. Phone: SHE 8441.

**SERVICE SHEETS**, Radio and Television, 3/6, post paid. **VEST AND EMERY**, 17 Hallgarth Street, Durham.

(continued overleaf)



**All you need to know for a sound grasp of electronics—in one comprehensive volume . . .**

# ELECTRONICS

## POCKET

## BOOK

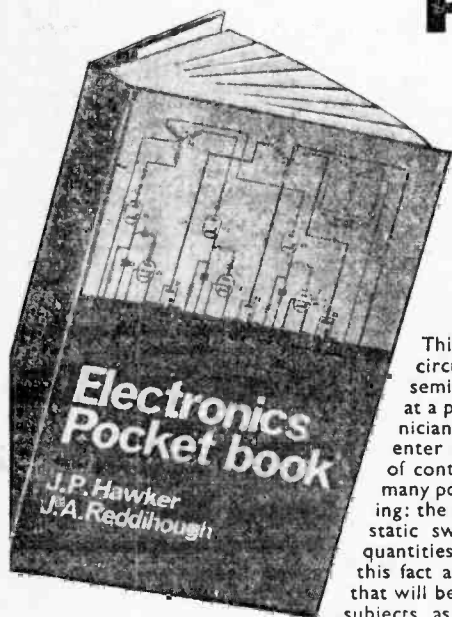

Edited by  
**J. P. Hawker**  
and **J. A. Reddihough**

*Specialist Contributors:*  
Ian D. L. Ball, B.Sc.  
Maurice C. Bumstead,  
A.M.I.E.E., A.M.Brit.I.R.E.  
John Gilbert, Assoc. Brit. I.R.E.  
Terence L. Squires, A.M.Brit.I.R.E.

This work brings together up-to-date information on the basic circuits and techniques used in electronics—with emphasis on semi-conductor devices rather than the thermionic valve. It is written at a practical level so as to be of maximum help and usefulness to technicians in the many branches of electronics and to students about to enter this rapidly expanding field. Recent developments in the fields of control engineering and automation have seen a breaking down at many points of the distinction between electronic and electrical engineering: the inclusion in this book of such subjects as the magnetic amplifier, static switching, electronic techniques of measuring various physical quantities, electro-mechanical devices and motor control systems reflect this fact and provide the reader with the wider background knowledge that will be of increasing value to him. On the purely electronics side such subjects as pulse generation, counting techniques and computers are treated in a manner that will give the reader a thorough grasp of the principles involved and will be of special value to candidates for the **Electronic Servicing** certificate of the Radio Trades Examination Board and The City and Guilds of London Institute.

**294 pages**  
**203 diagrams**

**Fully Covers . . .**

**FUNDAMENTALS:** Behaviour of Electrons in Electric and Magnetic Fields—Emission of Electrons—Conduction and Current-Voltage Relationships. **CIRCUIT ELEMENTS:** Diodes—Thermionic Triodes—Tetrodes and Pentodes—Thyratrons—The Transistor—Four-Layer Semiconductor Devices—Cathode-Ray Tubes—Electron Multipliers—Hall Multiplier—Thermistors and Non-Linear Elements—Photo-Electric Cells—Transducers. **ELECTRO-MAGNETIC DEVICES:** Solenoids—Relays. **AMPLIFIER CIRCUITS:** Voltage Amplification—Distortion—Bandwidth—Power Amplifiers—Classification of Amplifiers—Feedback—Special Circuits—D.C. Amplifiers. **PULSE CIRCUITS:** Self-Oscillating Pulse Generators—Single-Stroke Pulse Generators—Sawtooth Voltage Generators—Wide-Range Pulse Generators. **FURTHER ELECTRONIC CIRCUITS:** Electronic Switching—Diode Clamps—Phase-Sensitive Detectors—Pulse Modulation. **COUNTING DEVICES AND CIRCUITS:** Counting Circuits—Radiation Detectors. **POWER SUPPLIES:** A.C. Rectification—Rectifier Circuits—Ripple Reduction—Voltage Regulation—D.C. Convertors. **THE MAGNETIC AMPLIFIER. ELECTRONIC MEASUREMENT AND TEST GEAR:** The Moving Coil Meter—Valve Voltmeters—Resistance and Impedance Measurement—Measurement of Non-Electrical Quantities—Cathode-Ray Oscilloscopes—Frequency Measurement. **INDUSTRIAL ELECTRONIC CONTROL:** Thyatron Control—The Silicon Controlled Rectifier—Electronic Ward-Leonard Systems—The Ignitron—The Neutron—Cold-Cathode Tubes—Sensing Systems. **ELECTRONIC COMPUTERS:** Digital Computers—Analogue Computers. **INSTALLATION AND MAINTENANCE:** Installation—Maintenance. **UNITS.**

Only **2/1s.**

**FROM ALL BOOKSELLERS**

or, in case of difficulty 22s. 3d. by post from George Newnes Ltd.,  
Tower House, Southampton St., London, W.C.2.

**NEWNES**

# NOW THREE LOW COST COURSES TO HELP YOU BECOME AN EXPERT IN RADIO, ELECTRONICS, OR TELEVISION

Our now famous Electronic Course won instant acclaim when offered just over one year ago.

NOW WE ARE PROUD TO BE ABLE TO OFFER TWO NEW COMPANION COURSES IN RADIO AND T.V. FOR THE SAME REASONABLE COST.

The lessons are crystal clear, practical, easy to master and use. Early lessons make fundamentals clear even to the beginner, while other lessons will give you the practical "know-how" of an expert.

Everyone can benefit from these practical courses. No old fashioned ideas used here. Just straightforward easy to understand explanations to help you get ahead in radio, electronics or television.

Modern wireless and t.v. sets use complex circuits, but their function is based on surprisingly few principles. These principles can easily be mastered when explained clearly. That is the object of these courses. Soon you will be well on your way to becoming a first-class radio, electronics, or t.v. technician.

More and more people are needed every day to repair wireless sets, amplifiers, VHF/FM radios, televisions and electronic equipment. Are YOU prepared to get your share of the money to be earned

Just clip the coupon indicating the course required. You must be convinced that this is the best value you have ever seen in electronic, radio and t.v. training otherwise you can return the manual (or have your money refunded if sent with order) after you have examined it in your own home for a period of seven full days.

The price? Only 36/- per course, plus postage. YOU CAN QUALIFY FOR A CERTIFICATE. Details sent with each course ordered.

FREE DATA HANDBOOK WITH EVERY ORDER

## FREE TRIAL OFFER

TERMS ONLY 5/- PER WEEK!

To SIM-TECH TECHNICAL BOOKS, Dept. WA2, West End, Southampton, Hants.

Send  ELECTRONICS COURSE  RADIO COURSE  TELEVISION COURSE

for a full seven days' free trial. If not delighted I may return the course post paid without further obligation on my part. Otherwise I will pay cash or 5/- weekly until paid. (No extra for interest if paid regularly.)

Tick here if enclosing full price (we pay postage). Same 7 day money-back guarantee. Postage charges 1/6 per course. Overseas customers please send full amount (including Ireland).

Name .....  
Address .....  
City ..... County .....

## PADGETTS RADIO STORES OLD TOWN HALL, KNOWLER HILL, LIVERSEDEGE, YORKS.

Telephone: Cleckheaton 2866

**ARMY SET TYPE 19 MK. 3.** Complete with two 6K8 valves, four 6K7, one 6B8G and one 8V6. The Receiver side of the set is complete in every way including the 500 micro-amp. meter. The valves and a few parts in the "B" set have been removed. The Set is very clean inside but the outer case is soiled. We are offering a first class receiver at the special price of 32/-, carr. 10/- two for 60/-, carr. 15/- . Set less Valves 12/-, carr. 7/-.

**Valves Removed from TV Sets.** Tested on Mullard Valve Tester, and are 100% as guarantee. **POST FREE.**

ECL80	2/-	10C2	5/-	PY80	5/-
ECC82	5/-	10F1	1/-	PY81	4/-
EY51	2/6	10P13	5/-	PY82	5/-
EF80	4/6	10P14	5/-	PZ30	4/-
EB91	9d.	20D1	3/-	PCF80	4/6
EF91	9d.	20L1	5/-	PCC84	4/6
6SN7	2/9	20L1	5/-	EAC91	1/6
6F1	1/-	185BT	8/6	PL83	5/-
6F13	2/-	U281	5/-	PL33	4/-
6F14	5/-	U282	5/-	B36	4/-
6F15	5/-	U326	5/-	N97	5/-
6LD20	5/-	K336	5/-	G15	3/-
PCL82	6/-	PL81	5/-	27SU	5/-
		PL82	5/-	U12	4/-

EF80 1/6 or 10/- per doz. Grade 2 EF80 for test purposes, 4/- doz.

**New Valves Ex. Units. POST FREE.**  
ARF12 1/6, 6 for 5/6, box of 50 20/-, 1T4 2/-, AR8 2/-, ARTP2 2/-, 6T4 2/-, APP37 2/-, 6K7 2/-, 6K8 4/-, 5U4 3/-, 6SN7 3/-, 6V6 3/-, 6V6GT 4/6, VR150/30 2/6, 6C4 2/-, EL91 1/9, EF91 1/9, EF50 1/-, 6/- doz., 6F6 2/6, 5Z4 5/6, 6X5 4/6.

**H.M. Speakers.** Removed from TV Sets. All perfect condition. Rola and Plessey. 6 x 4in., 5/-; Goodman and R. and A. 7 x 4in., 6/-; Rola and R. and A. 6in. round, 3/6; 6in. Dish, round, 5/-; 8in. round, 6/-. Post on any speaker, 2/-.

**TV Tubes Picture Tested.** Reclaimed from TV Sets. 12in. 17/-, 14in. 30/-, Carr 7/6, 12 months unconditional guarantee. **TYPE 46 8FT** complete with valves, less coils, crystals, and send-receive switch, but otherwise complete in new condition. 8/6. Grade two 4/6. Post 3/9.

**Mixed Mains Droppers.** Removed from TV chassis. 10/- per doz., Post free.  
**NI-W BOXED UNITS.** Type 230. Complete with 524, Y63, magic eye, four EF50 and complete A.C. 230 volt Power Pack. 25/-, Carriage 7/6.

**11/-, 230 VOLT MOTORS.** Removed from washing machines. Tested. 25/-, Carr. 7/6.

**RES/CAP. BRIDGE 39/6**  
p. & p. 2/6  
Checks all types of resistors, condensers & RANGES  
Built in 1 hour. Direct reading.  
**READY CALIBRATED**  
Stamp for details of this and other kits.  
Please write to:  
**RADIO MAIL (Dept. PP)**  
Raleigh Mews, Raleigh Street, Nottingham

**2 METRES 4**

The thrills of VHF Amateur Radio can now be yours for as low as 39/6, complete kit, by post 2/6 extra. Tunable range 70-150 Mc/s. Write today for interesting literature, s.a.e. please. If a newcomer to Short Wave Radio, ask for free copy of world-famous "Globe-King" Short Wave Kits and other receivers. Stamp for post please, not s.a.e.

**JOHNSONS (Radio)**  
St. Martins Gate, Worcester

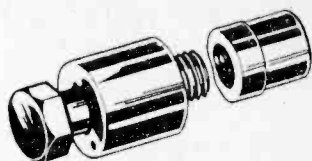

The PUNCH you need!

### HOLE PUNCHES

Instant Type	...	...	...	6/10 ea.
3/8" diameter	...	...	...	8/6 "
3/4" diameter	...	...	...	9/6 "
1" diameter	...	...	...	10/2 "
1 1/8" diameter	...	...	...	10/8 "
1 1/4" diameter	...	...	...	11/8 "
1 1/2" diameter	...	...	...	13/4 "
1 3/4" diameter	...	...	...	16/2 "
1 7/8" diameter	...	...	...	18/10 "
2" diameter	...	...	...	21/8 "
2 1/8" diameter	...	...	...	24/4 "
2 1/4" diameter	...	...	...	33/2 "

Complete Set £8.15.0.

All the above prices include postage and packing.

**Oliver & Randall Ltd**  
Dept. 7  
40 PERRY HILL, LONDON, S.E.6  
Tel.: Forest Hill 3415

**Lyons Radio Ltd.**  
3 Goldhawk Road, London W.12

**METERS.** As brand new ex Govt. Milli-ammeters; m/c type by Triplet, 21in. dia. 0/10 m.A. 12/6, 0/500 m.A. 12/6. Voltmeter: m/1 type by Westinghouse, 2in. dia., 0/15 v. AC/DG, 9/6, postage 1/6.

**INDICATOR UNITS TYPE 6.** Contain cathode ray tube type VCR97. 7 valves (3 - VR54 and 4 - VR51) and lots of useful components. In good condition. Supplied with free scope conversion details. **PRICE ONLY 35/-, carriage 9/-.** Conversion details supplied separately. 3/-

**TRANSISTOR TAPE RECORDERS.** Not kits but ready to use: **Junior Model** in sturdy plastic case 8 1/2 x 5 x 2 1/2in., handle 1 1/2in., weighs 2 1/2lb. Employs 3 transistors, with built-in 2 1/2in. dia. dynamic speaker, dual track recording, 30 mW. output, simple one knob control—Play-Record-Rewind-Stop, separate volume control. Supplied complete with crystal mike, spool of tape, empty 3in. spool, earphone for monitoring, conversion parts, instruction booklet and guarantee. Reproduces speech very well but not music. No hidden extras—nothing else to buy. **PRICE ONLY £5.12.6. Senior Model, 4 transistor version with 100 mW. output and variable speed control absolutely complete as Junior model plus adaptor for recording telephone conversations. PRICE ONLY £6.7.6. POSTAGE either type 3/6. Illustrated leaflet on receipt of S.A.E.**

**"PROGRESSIVE" SHORT WAVE RECEIVER.** Specially designed kits to enable even the beginner to construct a 1 valve short wave radio with every confidence of success. A second and then a third valve can be added, the chassis supplied being punched to take all three stages. Can be operated from dry batteries or from a simply constructed mains power unit (kit 32/6). Cost of all parts to make the **1 Valve Radio** including one plus-in coil (40-100 metres) ONLY 35/-, post 2/- . 1 to 2 Valve conversion parts. 7/6. 2 to 3 Valve conversion parts. 10/- . Extra plug-in coils: 10-20, 20-40, 100-200, 200-450 metres. 4/- each. Clear wiring diagrams and instructions supplied free with parts. 1/6 separately.



# R.S.T. VALVE MAIL ORDER CO.

Tel: MITcham 6202  
Open Daily to Callers

211a STREATHAM ROAD, MITCHAM, SURREY.

All Valves Brand New and Fully Guaranteed — Obsolete valves a speciality.  
Quotations given on any type not listed. Send S.A.E.

## Special 24 Hour Express Mail Order Service

AC2/PEN 12/6	ECC85 7/6	EY83 12/6	PCC85 9/6	TDD4 12/6	UU6 17/6	6ABGT 13/6	6P25 10/6	12Q7GT 6/6
AC2/PEN 29/6	ECC88 12/6	EY86 7/6	PCC88 12/6	TDD13C 12/6	UU8 15/6	6AC7 6/6	6P28 12/6	12S47 8/6
DD 21/6	ECC91 3/6	EY91 3/6	PCC89 8/6	TH41 20/6	UU9 7/6	6AK5 5/6	6Q7 9/6	12S17 8/6
AC/TP 29/6	ECF80 7/6	EZ35 6/6	PCF80 9/6	TH41 12/6	UY12 12/6	6ALS 4/6	6Q7GT 6/6	12S17 8/6
AC/VP1-57	ECF82 8/6	EZ40 7/6	PCF82 7/6	U10 9/6	UY21 15/6	6AMS 5/6	6Q7GT 8/6	12S7 8/6
AZ1 15/6	ECH21 21/6	EZ41 7/6	PCF84 12/6	U12 9/6	UY41 7/6	6AM6 4/6	6SA7 7/6	12S7 8/6
AZ31 9/6	ECH21 21/6	EZ80 6/6	PCF86 12/6	U19 9/6	UY85 6/6	6AQS 6/6	6SC7 8/6	12SQ7 10/6
B35 9/6	ECH42 9/6	EZ81 6/6	PCL82 9/6	U22 8/6	VM54B 12/6	6AT6 6/6	6SF5 10/6	14H7 10/6
CIC 10/6	ECH81 7/6	EI148 2/6	PCL84 7/6	U24 21/6	VP4 15/6	6AU6 9/6	6SG7 7/6	14R7 10/6
CL33 12/6	ECH83 9/6	FC2 15/6	PCL85 9/6	U25 11/6	VP4B 15/6	6BB6 3/6	6SH7 6/6	14S7 16/6
CL33 12/6	ECL80 7/6	FC2A 17/6	PCL86 12/6	U26 10/6	VR150/307/6	6BE6 6/6	6S17 6/6	14S7 16/6
CY1 15/6	ECL81 10/6	FC4 15/6	PENA4 17/6	U31 9/6	VR150/307/6	6BEG 15/6	6S17GT 6/6	19AQ5 8/6
CY31 10/6	ECL82 9/6	FW4/500 9/6	PENB4 17/6	U35 17/6	W61 11/6	6BEG 15/6	6S17GT 6/6	19B6G 15/6
D77 4/6	ECL83 10/6	GW34 10/6	PEN4DD 22/6	U37 17/6	W67 5/6	6BG7A 12/6	6S2GT 5/6	20D1 10/6
DAC32 9/6	ECL86 9/6	GZ30 10/6	PEN4YA 17/6	U47 11/6	W77 4/6	6BR7 10/6	6S2GT 5/6	20F2 17/6
DAF91 5/6	EF6 21/6	GZ32 10/6	PEN4YA 17/6	U50 7/6	W81 6/6	6BS7 12/6	6S5GT 7/6	20I1 22/6
DAF96 7/6	EF9 21/6	GZ33 19/3	PEN36C 20/6	U52 4/6	W81M 6/6	6BWS 8/6	6S6GT 4/6	20P1 15/6
DAC90 12/6	EF22 14/6	GZ34 13/6	PEN45 20/6	U76 7/6	X41 22/6	6BW7 8/6	6S6GT 4/6	20P3 24/6
DF33 9/6	EF36 4/6	GZ37 19/3	PEN45DD 25/6	U78 4/6	X61M 10/6	6C4 3/6	6S6GT 4/6	20P4 20/6
DF91 4/6	EF37A 8/6	HABC8010/6	PEN46 5/6	U145 10/6	X65 12/6	6CSGT 8/6	6X5GT 6/6	20P5 20/6
DF92 7/6	EF37A 8/6	HL41 8/6	PEN45DD 25/6	U191 13/6	X76 12/6	6C6 6/6	6X5GT 6/6	20P5 20/6
DF96 7/6	EF39 4/6	HL41DD 8/6	PEN45DD 25/6	U251 15/6	X76M 12/6	6C9 12/6	6Y5GT 8/6	20P6 20/6
DH63 6/6	EF40 15/6	HL92 8/6	PEN46 5/6	U281 15/6	X78 26/6	6CDG 27/6	6Z8 12/6	20P7 20/6
DH77 7/6	EF41 8/6	HL133DD 9/6	PEN45DD 25/6	U282 19/6	X79 40/9	6CH6 10/6	7B5 12/6	20P8 20/6
DK32 11/6	EF42 10/6	HN309 25/6	PENDD4020 20/6	U301 17/6	X81 10/6	6C4 16/6	7B7 8/6	20P9 20/6
DK91 6/6	EF50A 3/6	IW4/350 10/6	PL33 15/6	U329 15/6	Y61 10/6	6D2 4/6	7C5 8/6	20P9 20/6
DK96 7/6	EF50E 3/6	IW4/500 10/6	PL36 12/6	U339 13/6	Y63 10/6	6D6 5/6	7C6 8/6	20P9 20/6
DL33 8/6	EF80 5/6	IW4/500 10/6	PL38 21/6	U403 10/6	Z63 7/6	6E5 10/6	7D5 15/6	20P9 20/6
DL35 10/6	EF85 5/6	KT33C 8/6	PL81 9/6	U404 10/6	Z66 10/6	6F1 10/6	7D6 15/6	20P9 20/6
DL91 8/6	EF89 9/6	KT61 9/6	PL82 8/6	U801 19/6	Z77 4/6	6F6 6/9	7D8 15/6	20P9 20/6
DL92 6/6	EF91 4/6	KT66 15/6	PL83 7/6	UABC80 7/6	Z152 5/6	6F12 4/6	7H7 6/6	20P9 20/6
DL93 7/6	EF92 4/6	KT76 10/6	PL83 7/6	UAF42 8/6	OZ4 5/6	6F13 10/6	7H7 6/6	20P9 20/6
DL94 7/6	EF95 5/6	KT81 15/6	PL84 8/6	UB41 7/6	IA7 11/6	6F14 10/6	7R7 10/6	20P9 20/6
DL96 7/6	EF98 10/6	KTV61 5/6	PL80 21/6	UBC41 8/6	ICS 10/6	6F15 12/6	7Y4 6/6	20P9 20/6
EA50 2/6	EF183 10/6	L63 5/6	PL24M 13/6	UBC81 10/6	ID5 8/6	6F19 12/6	8D3 4/6	20P9 20/6
EABC80 5/6	EF183 10/6	LNI52 8/6	PX4 13/6	UBF80 8/6	ID6 10/6	6F23 10/6	9BWS 12/6	20P9 20/6
EAC91 4/6	EL3 21/6	LN309 11/6	PX25 25/6	UBF89 7/6	IH5 9/6	6F25 16/6	10C1 12/6	20P9 20/6
EAF42 9/6	EL32 4/6	LK32 8/6	PY31 15/6	UBL21 20/6	IL4 5/6	6F26 13/6	10C2 17/6	20P9 20/6
EB34 2/6	EL33 10/6	LZ319 12/6	PY32 12/6	UCC84 11/6	INS 9/6	6F33 5/6	10F1 10/6	20P9 20/6
EB41 5/6	EL34 14/6	MKT4 17/6	PY33 10/6	UCC85 7/6	IR5 6/6	6H6 2/6	10F9 12/6	20P9 20/6
EB91 4/6	EL35 10/6	M54B 17/6	PY80 7/6	UCF80 12/6	IS4 8/6	6IS 5/6	10LD11 15/6	20P9 20/6
EB91 4/6	EL35 10/6	MVS/PEN 17/6	PY81 7/6	UCH21 20/6	ISS 5/6	6ISG 4/6	10P13 15/6	20P9 20/6
EB93 21/6	EL37 17/6	MYS/PEN 17/6	PY82 8/6	UCH42 8/6	IT4 4/6	6ISGT 5/6	10P14 19/6	20P9 20/6
EB93 4/6	EL38 17/6	MUI4 9/6	PY83 6/9	UCH81 8/6	IU5 5/9	6IT 7/6	10P15 23/6	20P9 20/6
EB93 4/6	EL41 9/6	MX40 15/6	PY88 10/6	UCL82 9/6	2P 24/9	6I7G 5/6	12A 6/6	20P9 20/6
EB93 10/6	EL42 9/6	N18 8/6	PY80 10/6	UCL83 13/6	3A4 5/6	6I7GT 7/6	12AH8 9/6	20P9 20/6
EBF80 8/6	EL81 12/6	N37 14/6	PZ30 15/6	UF41 7/6	3A5 10/6	6K7 7/6	12AT6 7/6	20P9 20/6
EBF83 8/6	EL84 6/9	N78 22/6	Q595/10 15/6	UF42 7/6	3Q4 8/6	6K7G 2/6	12AT7 5/6	20P9 20/6
EBF89 8/6	EL85 10/6	N108 15/6	R2 10/6	UF80 7/6	3Q5 9/6	6K7GT 7/6	12AU6 17/6	20P9 20/6
EBL1 21/6	EL90 8/6	N369 10/6	R16 17/6	UF85 7/6	3S4 6/6	6K8 9/6	12AU7 5/6	20P9 20/6
EBL21 21/6	EL91 4/6	OD3 8/6	R19 16/6	UF86 12/6	3V4 4/6	6KBGT 9/6	12AX7 5/6	20P9 20/6
ECC35 8/6	EL95 10/6	OS4 5/6	R20 16/6	UF89 6/6	SU4 7/6	6KBGT 9/6	12BA6 7/6	20P9 20/6
ECC40 15/6	EM80 8/6	OS4 5/6	SP41 3/6	UL41 8/6	SV4G 7/9	6K25 17/6	12BE6 7/6	20P9 20/6
ECC81 5/6	EM81 8/6	OS4 5/6	SP41 3/6	UL44 20/6	5Y3G 5/6	6LI 10/6	12BH7 10/6	20P9 20/6
ECC82 5/6	EM84 9/6	OS4 5/6	SP41 3/6	UL46 14/6	5Y3GT 6/6	6L6 7/6	12C8 8/6	20P9 20/6
ECC82 5/6	EM85 10/6	OS4 5/6	SP41 3/6	UL46 14/6	5Z4G 9/6	6L7 10/6	12CGT 4/6	20P9 20/6
ECC83 7/6	EYS1 7/6	PABC80 13/6	SP61 3/6	UL85 7/6	5Z4GT 12/6	6L18 10/6	12TGT 8/6	20P9 20/6
ECC84 8/6	EY81 8/6	PCC84 8/6	T41 15/6	UM80 10/6	6A7 9/6	6L19 15/6	12TGT 5/6	20P9 20/6
				URIC 15/6	6ABG 8/6	6N7GT 9/6	12K8GT 10/6	20P9 20/6

### COMPLETE VALVE LIST FREE WITH ORDER

#### METAL RECTIFIERS

RMI 7/6	14A86	23/6	16RD 2-2-8-1	12/6 (FC142)
RM2 8/6	14A97	26/6	16RE 2-1-8-1	10/6
RM3 10/6	14A100	28/6	18RA 1-1-8-1	5/6
RM4 17/6	14RA 1-2-8-2 21/6 (FC301)		18RA 1-1-16-1	7/6 (FC116)
RM5 19/6	14RA 1-2-8-3 25/6 (FC31)		18RA 2N-1-8-1	12/6
	16RC 1-1-16-1	10/6	18RD 2-2-8-1	16/6 (FC124)

#### BRAND NEW TRANSISTORS

OC44 6/6	OC74 6/6	OC81D 6/6
OC45 7/6	OC75 6/6	OC82 8/6
OC71 5/6	OC77 6/6	OC82D 6/6
OC72 8/6	OC81 6/6	

#### SILICON RECTIFIERS

400 volts 350 mA ... .. 8/- each

TERMS OF BUSINESS C.W.O. or C.O.D.

4:2 PACKING CHARGE ON ALL C.O.D.

ORDERS. POSTAGE 6d. per VALVE

#### SETS OF VALVES

IRS, ISS, IT4, 354, 3V4	...	...	...	Set of 4, 19/-
DAF91, DF91, DK91, DL92, DL94	...	...	...	Set of 4, 19/-
DAF96, DF96, DK96, DL96	...	...	...	Set of 4, 26/6

**FROM STOCK** We can supply a complete range of Valves, Crystals, Transistors, Diodes, Miniature and Standard Components. The largest range of Components and Equipment in the Country. Latest 68 page Illustrated Catalogue 2/- post free. Includes new **HI-FI Section. Price Reductions.**

**NEW MODEL TRANSISTOR PORTABLE SIGNAL GENERATOR**

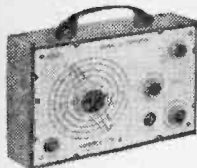

PRICE **£7.18.6**

With battery and test probe. P.P. 2/-.

A 1st class Signal Generator covering 149 Kc/s to 350 Mc/s in 8 ranges. Radio broadcasts and I.F., Amateur, VHF, Shipping, TV, etc. R.F., I.F., A.F., modulated R.F. outputs. Easy to read and use with full details. Within 2% accuracy. Size 6 $\frac{1}{2}$  x 4 $\frac{1}{2}$  x 2in. **12 MONTHS' GUARANTEE** Leaflet on Request.

**SUBSTITUTION BOXES**

- Capacitor Box. Provides 9 standard values from 0.001 to 0.22 mfd at 600 volt working, 29/6.
- Resistor Box. Provides 24 standard values at 1 watt. 15 ohms to 10 meg. 37/6.

Each box fully calibrated with insulated leads. Invaluable for service and design.

**TRANSISTORISED CAPACITANCE/RESISTANCE BRIDGE.**

1 Ohm to 100 Meg. 1 pF to 100 mfd. (Appearance as Above Generator). Leaflet on Request. PRICE **£7.2.3.** P.P. 2/-.

$\frac{1}{2}$  Track Record/Playback Tape Heads. 2 KΩ impedance, 15/-.

**SILICON RECTIFIERS 500mA**

100 PIV 3/-	1000 PIV ... 10/-
200 PIV 3/6	100 PIV 1 amp ... 4/6
300 PIV 4/6	200 PIV 6 amp ... 12/6
400 PIV 5/-	

Complete list free on request

**100 Kc/s QUARTZ CRYSTALS**

2 Pin: OCTAL or RCA ...	15/- ea.
500 Kc/s 2 Pin ...	... 15/-
455 Kc/s (AR88) ...	... 12/6
5000 Kc/s 2 Pin ...	... 10/-
10 Mc/s 2 Pin ...	... 15/-

Complete list free on request

**3 WATT 4 TRANSISTOR AMPLIFIER**

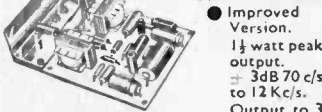

- Improved Version. 1 $\frac{1}{2}$  watt peak output. = 3dB 70 c/s to 12 Kc/s. Output to 3 ohm speaker 9 volt operated.

<b>Built and Tested</b>	<b>Kit of Parts</b>
<b>59/6 OR</b>	<b>52/6</b>
P.P. 1/6	P.P. 1/6

**FIELD STRENGTH METER**

Five channels cover 1 Mc/s to 200 Mc/s. Fitted 200 microamp meter for CW or R.F. Indication and Earphone for A.F. monitoring. Designed for checking all types of transmitters. Size 4 x 2 $\frac{1}{2}$  x 2 $\frac{1}{2}$ in. Complete. Ready to Use, with instructions and telescopic aerial, 69/6. Post Free.

<b>TRANSISTOR BABY AMPLIFIER</b>	<b>TELEPHONE AMPLIFIER</b>
As previously advertised. <b>£5.10.0</b>	Speaker output from G.P.O. phone <b>£5.10.0</b>

**POCKET RADIO BOOSTER**

Tubular unit which plugs into earphone socket of any transistor radio. Performance increase is fantastic. Ideal for home or car. 8 x 2 $\frac{1}{2}$ in. diameter, 22/6. P.P. 1/-, 9 $\frac{1}{2}$  x 3 $\frac{1}{2}$ in. diameter, 27/6. P.P. 1/-.

**TYPE 38, TRANSMITTER RECEIVER**

Complete with 5 valves. In new condition. These sets are sold without guarantee but are serviceable. **22/6** P.P. 2/6. 7.4 to 9 Mc/s. Headphones 7/6 pair. Junction Box 2/6. Throat Mike 4/6. Aerial Rod 2/6.

**DEAC RECHARGEABLE BATTERIES**

- (a) 18 volt 100mA/H 4 x 1in. diameter. Brand new sleeved, 30/-.
  - (b) As above but 150mA/H, 35/-.
- Both types easily split into any multiple of 1.2 volt. Brand new.

**RUN YOUR RADIO OR AMPLIFIER FROM MAINS BATTERY ELIMINATORS AND CHARGERS**

1. For PP3 or equivalent 9 volt Pocket Radio Battery, 18/6. P.P. 1/-.
2. For PP4, PP7, PP9, PP10, 9 volt Portable Radio and Equipment Supplies up to 300 mA, 49/6. P.P. 2/-.
3. De Luxe version of No. 1 also charges PP3 type batteries. 24/-, P.P. 1/-.
4. Rechargeable PP3 battery. Runs as long as 100 batteries. Complete with charger unit, 25/-, P.P. 1/-.

**LIGHTWEIGHT HEADPHONES**



- 2,000 OHMS 12/6
  - 4,000 OHMS 14/6
- HIGH EFFICIENCY

**METER BARGAINS**

- 50 Microamp 2in. square MC ... 35/-
- 1 mA 2in. square MC ... 25/-
- 1 mA 2 $\frac{1}{2}$ in. Flush Round ... 30/-
- 2 $\frac{1}{2}$ in. Moving Coil double range Voltmeter centre zero. 30-0-30 and 3-0-3 volts. Ideal for transistor tester or voltage measurements, 12/6. Post Free.
- 0/500μA 2in. ... 15/-
- 0/500μA 2 $\frac{1}{2}$ in., flush-mounting, D.C. 20/-
- 24-0-24 mA, 2 $\frac{1}{2}$ in. flush D.C. ... 12/6
- 0/15 volt M.I. 2 $\frac{1}{2}$ in. FR. A.C. ... 8/6

**Miniature Panel Meters**

- \*0/50μA (D.C.) 39/6 \*0/5mA (D.C.) 27/6
- \*0/500μA (D.C.) 32/6 \*0/300V (D.C.) 27/6
- \*0/1mA (D.C.) 27/6 Vu Meter 42/6
- \*S<sup>5</sup> meter 35/- All Brand New Boxed.
- \* Available Clear Plastic Front or Black Moulded. State which.

**D.C. to A.C. CONVERTER.** Converts 12 volts D.C. i.e. Car Battery, up to 230 volts A.C. 15 watts. Uses 2 power transistors in special circuit. Kit 57/6. P.P. 1/6.

**MULTI-METERS**



<b>THL33.</b> 2000Ω/V. (Illustrated.) 0/10/50/250/500/1,000 volts A.C. and D.C. 0/500μA 10/250 mA. D.C. 0/10k/100k/1 meg. etc., etc. Size 5 x 3 $\frac{1}{2}$ x 1 $\frac{1}{2}$ in. <b>75/-</b> P.P. 1/6.	<b>EP30K.</b> 30,000Ω/V. 0/1/1/10/50/250/500/1,000 volts A.C. and D.C. 0/50μA/10 mA./250 mA. D.C. 0/10k/1 meg./10 meg. etc. Size 4 $\frac{1}{2}$ x 3 $\frac{1}{2}$ x 1 $\frac{1}{2}$ in. <b>£6.19.6</b> P.P. 1/6.
<b>ITI-2.</b> 20,000Ω/V. 0/5/25/100/500/2,500 volts A.C./D.C. 0/50μA 0/2 $\frac{1}{2}$ /250 mA. D.C. 0/6k/6 meg. etc. Size 4 $\frac{1}{2}$ x 3 $\frac{1}{2}$ x 1 $\frac{1}{2}$ in. <b>5 gns.</b> P.P. 1/6.	<b>EP50K.</b> 50,000Ω/V. 0/10/50/250/500/1,000 volts A.C. and D.C. 0/25μA./2 $\frac{1}{2}$ /25/250 mA. D.C. 0/10k/100k/1 meg./10 meg. etc. Size 6 $\frac{1}{2}$ x 4 $\frac{1}{2}$ x 2 $\frac{1}{2}$ in. <b>£9.19.6</b> P.P. 2/-.
<b>PT34.</b> 1000Ω/V. 0/10/50/250/500/1,000 volts A.C./D.C. 0/1/100/500 mA. D.C. 0/100k etc. Size 3 $\frac{1}{2}$ x 2 $\frac{1}{2}$ x 1 $\frac{1}{2}$ in. <b>45/-</b> P.P. 1/6.	<b>500.</b> 30,000Ω/V. 0/1 $\frac{1}{2}$ /1 $\frac{1}{2}$ /10/25/100/250/500/1,000 volts A.C. and D.C. 0/50μA/5/50/500 mA. 0/12 amps: short test etc. 0/60μ/6 meg./60 meg. etc. Size 6 $\frac{1}{2}$ x 4 $\frac{1}{2}$ x 2 $\frac{1}{2}$ in. <b>£8.19.6</b> P.P. 2/-.
<b>TP55.</b> 20,000Ω/V. 0/10/50/250/500/1,000 volts A.C./D.C. 0/50μA/0/5/50/500 mA. D.C. 0/10k/100k/1 meg./10 meg. etc. Size 5 $\frac{1}{2}$ x 3 $\frac{1}{2}$ x 1 $\frac{1}{2}$ in. <b>£5.19.6</b> P.P. 1/6.	<b>Brand New Fully Guaranteed</b>
<b>EPI0K.</b> 10,000Ω/V. 0/5/25/100/500/1,000 volts A.C. and D.C. 0/100μA/250 mA. D.C. 0/30μ/3 meg., etc. Size 3 $\frac{1}{2}$ x 4 $\frac{1}{2}$ x 1in. <b>89/6</b> P.P. 1/6.	

**TRANSISTOR TAPE RECORDER**

The best obtainable

**WELL KNOWN "MINY" TWO TRACK RECORDER.** Features 4-Transistor push-pull amplifier, 2 motors, single switch operation, pause, speed, wind/rewind, record/playback. Can be used horizontally, vertically, carried or table top. Take it anywhere. Reduced from 12 gns. **NOW £8.19.6.** P. & P. 2/6. Fully guaranteed—complete with microphone, tape, batteries and fully detailed booklet.

**Henry's Radio Ltd**

PADDington 1008/9

303 EDGWARE RD., LONDON W.2  
Open Monday to Sat. 9-6. Thurs. 1 o'clock

PLEASE TURN TO BACK PAGE

# Practical Wireless

## BLUEPRINT SERVICE

ALL of these blueprints are drawn full-size and although the issues containing descriptions of these sets are now out of print, constructional details are available free with each blueprint except for those marked thus (\*).

Send (preferably) a postal order to cover the cost of the Blueprint (stamps over 6d. unacceptable) to PRACTICAL WIRELESS, Blueprint Dept., George Newnes, Ltd., Tower House, Southampton Street, London W.C.2.

### DOUBLE-SIDED BLUEPRINTS

Each blueprint in this series contains details of two separate instruments or items of equipment.

The Strand Amplifier ... ..	... ..	} *	5/-
The PW Signal Generator ... ..	... ..		
The Savoy VHF Tuner ... ..	... ..	} *	5/-
The Mayfair Pre-amplifier ... ..	... ..		
The Berkeley Loudspeaker Enclosure	... ..	} *	5/-
The Luxembourg Tuner ... ..	... ..		
The PW Troubadour ... ..	... ..	} *	7/6
The PW Everest Tuner ... ..	... ..		
The PW Britannic Two ... ..	... ..	} *	6/-
The PW Mercury Six ... ..	... ..		
The PW Regency ... ..	... ..	} *	5/-
The PW International Short Wave Two	... ..		

### RECEIVERS

The Tutor * ... ..	... ..	3/-
The Citizen * ... ..	... ..	5/-
Major Crystal Set ... ..	... .. PW94	2/-
Dual-wave Crystal Diode ... ..	... .. PW95	2/6
Modern One-valver ... ..	... .. PW96	2/6
Major Three ... ..	... .. PW97	3/6
Modern Two-valver ... ..	... .. PW98	3/6
Band-pass Three ... ..	... .. PW99	4/-
A.C. Coronet-4 ... ..	... .. PW100	4/-
A.C./D.C. Coronet ... ..	... .. PW101	4/-
The PW Pocket Superhet ... ..	... ..	5/-

### MISCELLANEOUS

The PW 3-speed Autogram ... ..	... ..	8/-
The PW Monophonic Electric Organ ... ..	... ..	8/-
The PW Roadfarer * ... ..	... ..	5/-
The PT Band III TV converter ... ..	... ..	1/6
The Mini-amp * ... ..	... ..	5/-
The PT Olympic * ... ..	... ..	7/6
The PT Multimeter * ... ..	... ..	5/-

### SOME EARLIER DESIGNS

THE following blueprints include some pre-war designs and are kept in circulation for those constructors who wish to make use of old components which they may have in their spares box. The majority of the components for these receivers are no longer stocked by retailers.

Experimenter's Short Wave ... ..	... .. PW30a	2/6
Midget Short Wave Two ... ..	... .. PW38a	2/6
Simple S.W. One-valver ... ..	... .. PW88	2/6
Pyramid One-valver ... ..	... .. PW93	2/6
BBC Special One-valver ... ..	... .. AW387	2/6
A One-valver for America ... ..	... .. AW429	2/6
Short-Wave World Beater ... ..	... .. AW436	3/6
Standard Four Valve S.W. ... ..	... .. WM383	3/6
Enthusiast's Power Amplifier ... ..	... .. WM387	3/6
Standard Four Valve ... ..	... .. WM391	3/6
Listener's 5-Watt Amplifier ... ..	... .. WM392	3/6

### QUERY COUPON

This coupon is available until 6th September, 1963, and must accompany all queries in accordance with the notice on our "Letters to the Editor" page.

PRACTICAL WIRELESS, SEPTEMBER, 1963.

# DRASTIC PRICE REDUCTION! CAPRI NOW 79/6 P.P. 2/-



TOTAL COST OF ALL PARTS

**£9.19.6** P.P. 3/6.

All parts sold separately.

- ★ Attractive Appearance—Reliable Design—Quality Performance ●

## UNBEATABLE FOR QUALITY AND VALUE

Fully Detailed and Illustrated Leaflet on request.

### "THE CONTESSA"

★ COMBINED PORTABLE AND CAR RADIO ★

AMAZING SENSITIVITY AND SELECTIVITY ON MEDIUM AND LONG WAVEBANDS

★ The easiest Superhet Radio to build on the market. Features clearly - marked printed circuit and packaged components with full illustrated building instructions. Full tuning of medium and long wave bands with unbeatable sensitivity and selectivity. Excellent tone and volume with over 600mW push-pull output.

★ Clearly marked horizontal station dial with slow motion tuning. Two colour Blue or Beige cabinets with Gold handles, grilles and fittings. Size 10½ x 7½ x 3½in., includes car aerial socket, recording sockets.

★ 6 Mullard Transistors and 2 Diodes.

Guaranteed the Best Obtainable

Battery 2/6 extra

### 6-TRANSISTOR SUPERHET



Size only 4½ x 2½ x 1½in.  
**REALLY POCKET SIZE!**

The most compact 6-transistor diode radio with special components available to the home constructor. Features the latest miniature components and circuit. Supplied with Mullard transistors and two-tone moulded cabinets in red/white or blue/white with gold fittings. All components are supplied in packets and clearly identified. A printed circuit is used with fully illustrated building instructions. Push-pull output coupled with a sensitive and selective circuit make "CAPRI" hard to beat. Fitted Earphone Record Socket. Full tuning on medium waves with long wave Light.

- Illustrated leaflet on request.
- Slip it into your Pocket.

## 10 WATT TRANSISTOR HI-FI AMPLIFIER



Replace that Valve Amplifier with this High Fidelity Amplifier. Call for demonstration—any time.

- 40 C/S TO 20 KC/S ±1dB
- LESS THAN 0.3% TOTAL DISTORTION
- 100mV INPUT FOR 10 WATTS OUTPUT
- MAINS OR BATTERY

Ideal for all Mono and Stereo HI-FI systems.

Supplied complete with booklet showing preamplifiers, mixers, stereo, public address, etc. Can be used with any commercially available valve or transistor preamps, tuners, etc. Can be used with batteries—any voltage 4½ to 24 volts. Booklet available separately 1/6 post free.

PERFORMANCE EQUIVALENT TO VALVE AMPLIFIERS OF FOUR TIMES THE PRICE AND MANY TIMES THE SIZE

Built ready to use

**£5.19.6**

P.P. 2/-  
OR KIT £5.15.6.  
P.P. 2/-  
(Mains Unit 69/6 extra)

## FULL FUNCTION HI-FI TRANSISTOR PREAMPLIFIER

- 6 position input selector—Trebble—Volume—Bass—Filter controls.
  - 9 to 40 volts mains or battery. Without change in performance.
  - + 12 kc/s boost at 50 c/s and 15 kc/s. — 12 kc/s cut at 50 c/s and 15 kc/s.
- A new two transistor printed circuit preamplifier designed for use with the 10 watt transistor HI-FI amplifier or any valve or transistor amplifier. Built ready to use. Panel size 9 2/4 inches. Complete with 9916 P.P. 2/- knobs and circuits.

(Available Main Aug.)

Don't be fooled by the low price of the 10 watt amplifier and preamplifier. The quality and performance are as good as anything available at four times the price—A real Hi-Fi set up.

## 7-TRANSISTOR RECORD/PLAYER/RADIOGRAM AMPLIFIER

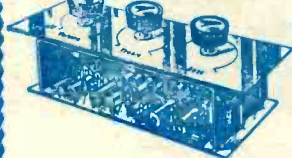

- 4 watt peak.
- Full Treble and Bass boost and cut.
- 40 c/s to 20 kc/s ±3dB.
- Inputs for Pick-ups, Radio Tuners, Microphones, mixers, etc.

Built and Ready to Use

**£5.19.6**

P.P. 2/-  
(Complete with full descriptive Booklet)

- 15 ohm Speaker (8" x 5" 22/6 extra).
  - 12 to 18 volts mains or battery.
  - Size only 6" x 2½" x 2".
- Ideal for mains or battery, portable or domestic record players, grams, etc. (Mains Unit 80/- extra). Call for demonstration.

● Booklet Free on Request ●

## "MINIRANGER"

3-Transistor Plus 2 Diodes. Smallest radio to build yourself. Printed circuit; full tuning. ONLY 3 x 2 x 1½in. Over 20 stations. Diagrams Free.

**TOTAL 49/6** P.P. 1/6.

Both Models as Previously Advertised. ● All Parts Sold Separately. ALSO IN STOCK.

## "QUINLET" POCKET RADIO

Diagrams Free. Size 5½ x 3 x 1½in. 5-Transistor, plus Diode MW/LW to build. **79/6** P.P. 2/-.



● Booklets Free on Request ● Sinclair Slimline, 49/6. P.P. 1/6. PW-6 Superhet, £7.19.6. P.P. 2/-.

## STEREO AMPLIFIERS—BRAND NEW

- (a) 2 watts each channel ... .. £9.19.6
  - (b) SA80 4 watts each channel full controls and inputs... £16.19.6
  - (c) SA150 7 " " " " " " " " £32.19.6
  - (d) SA300 15 " " " " " " " " £48.19.6
- Items b, c and d, complete in cabinets with multi-range controls and inputs. Leaflets on request—Speakers—Microphones—Amplifiers.

## 4-WAVEBAND COMMUNICATIONS RECEIVER. MODEL RX60.

● 550 kc/s to 30 M/cs.—BFO—AVC—Noise Limiter—Bandspread—"S" Meter—Telescopic Aerial. Full World Wide Coverage.

PRICE **£34**

P.P. 7/6. Instructions. BRAND NEW IN CARTONS.

P.W. CELESTE ... .. £9.19.6  
P.W. SPINETTE ... .. £10.19.6  
All parts sold separately. Leaflets on request.

THIRD CATALOGUE EDITION IN NINE MONTHS!  
NOW 68 PAGES SIZE 10 x 7½in. FULLY ILLUSTRATED AND DETAILED—NEW ITEMS—PRICE REDUCTIONS.  
ALL PARTS IN STOCK 2/- POST FREE

## Henry's Radio Ltd

303 EDGWARE ROAD, LONDON, W2  
PADdington 100B/9

Open Monday to Sat. 9-6. Thurs. 1 o'clock  
We can supply from stock most of the components and items specified on circuits published in this and other magazines and radio books. Let us quote for your circuit.

← PLEASE TURN PAGE

718