

JUNE
1963

Practical ² WIRELESS



The CELESTE

The SPINETTE

FREE inside!
DOUBLE-SIDED
BLUEPRINT

with Full Instructions to build
7-TRANSISTOR PORTABLE
WITH CAR AERIAL SOCKET

BATTERY PORTABLE
RECORD REPRODUCER

ADCOLA
DESIGNED FOR THE AMATEUR RADIO STATION

**SOLDERING
 INSTRUMENTS
 AND
 EQUIPMENT**

**DESIGNED FOR
 THE AMATEUR'S
 RADIO STATION**

ILLUSTRATED

List No. 70. $\frac{1}{8}$ " BIT
 IN
 PROTECTIVE
 SHIELD
 List No. 68



APPLY DIRECT
 FOR
 CATALOGUE
 TO

Sales and
 Service Dept.

**ADCOLA
 PRODUCTS
 LTD**

**ADCOLA HOUSE
 GAUDEN ROAD,**

LONDON, S.W.4

Telephones
 MACaulay 4272 & 3101

Telegrams
 SOLJOINT LONDON SW4

**UNUSUAL
 SINGLE SPEAKER
 SYSTEM**

**A
 CONCRETE
 COLUMN**



An inexpensive column speaker constructed from a concrete pipe and fitted with a good 8in. or 10in. unit has attracted much interest and admiration because of its clean open sound.

Complete kits of wooden fixtures are available including absorbent wadding and diffusing cone.

Price **£3.15.0** for 8" model. Recommended 8" unit—Super 8/RS/DD **£6.14.2** including purchase tax.

Price **£4.18.0** for 10" model. Recommended 10" units—Super 10/RS/DD **£10.18.8**; Golden 10/RS/DD **£7.17.5**; 10" Bronze/FSB **£4.12.9**. Prices include purchase tax.

Suitable concrete pipes can be purchased from builders' merchants at about **12/6** and **17/6**.

Descriptive leaflet free on request from:

Wharfedale
 WIRELESS WORKS LTD

IDLE BRADFORD YORKSHIRE
 Grams: Wharfedale Idle Bradford
 Phone: Idle 1235/6

R.S.T. VALVE MAIL ORDER CO.

Tel: MITcham 6202
Open Daily to Callers

211a STREATHAM ROAD, MITCHAM, SURREY.

All Valves Brand New and Fully Guaranteed — Obsolete valves a speciality.
Quotations given on any type not listed. Send S.A.E.

Special 24 Hour Express Mail Order Service

AC2/PEN 12/6	ECC85 7/6	EY83 12/6	PCC85 9/6	TDD4 12/6	UU6 17/6	6ABGT 13/6	6P25 10/6	I2Q7GT 6/6
AC2/PEN 12/6	ECC88 12/6	EY86 7/6	PCC88 12/6	TDD13C 12/6	UU8 15/6	6AC7 6/6	6P28 12/6	I2SA7 8/6
DD 21/-	ECC89 3/-	EY91 3/-	PCC89 8/6	TH41 27/6	UU9 7/6	6AK5 5/-	6Q7 9/6	I2SJ7 8/-
AC/TP 29/-	ECC80 7/6	EZ35 6/-	PCF80 9/-	TY86F 12/6	UYIN 12/6	6AL5 4/-	6Q7G 6/6	I2SK7 6/-
AC/VP1-5.7 15/-	ECH3 21/6	EZ40 7/-	PCF82 7/-	U10 9/-	UY21 15/6	6AM5 5/-	6Q7GT 8/6	I2SL7 8/6
AZ1 15/-	ECH21 21/-	EZ80 6/-	PCF84 12/6	U12 9/-	UY41 7/6	6AM6 4/-	6SA7 7/6	I2SN7 10/6
AZ31 9/6	ECH35 10/-	EZ81 6/-	PCF86 12/6	U19 9/-	UY85 6/6	6AQ5 6/6	6SC7 8/6	I2SQ7 16/6
B35 9/6	ECH42 9/6	EZ90 5/-	PCL82 9/-	U14 9/-	VMS4B 12/6	6AT6 6/6	6S5 10/6	I4H7 10/6
CIC 10/-	ECH81 7/6	EL148 2/6	PCL83 10/-	U22 8/-	VP4 15/-	6AU6 9/6	6SG7 7/6	I4R7 10/6
CCH35 20/-	ECH83 8/6	FC2 15/-	PCL85 9/-	U24 21/-	VP4A 15/-	6BBG 3/6	6SH7 6/6	I4S7 16/6
CL33 12/6	ECL80 7/6	FW4 17/6	PCL86 12/6	U25 11/-	VP4B 15/-	6BA6 6/6	6SJ7 6/6	I9AQ5 8/6
CY1 15/-	ECL81 10/-	FC4 15/-	PENA4 17/6	U31 9/-	VR105/30 7/6	6BE6 6/6	6SK7 5/6	I9BG6G 15/6
CY31 10/-	ECL82 9/6	FW4/500 9/6	PENB4 17/6	U35 17/6	VR150/30 7/6	6BG6G 15/6	6SL7GT 6/6	I20D1 10/6
D77 4/-	ECL83 10/6	FW4/800 9/6	PEN4DD 24/-	U37 17/6	W61 11/-	6B16 6/6	6SN7GT 5/6	I20D2 21/-
DAC32 9/6	ECL86 9/6	GZ30 10/6	PEN4V4 17/6	U47 11/-	W76 5/6	6B36 6/6	6SQ7 8/6	I20F2 17/6
DAF91 5/6	EF6 21/-	GZ32 10/6	PEN45D 25/-	U50 7/6	W77 4/-	6B7 10/6	6U4GT 10/6	I20L1 22/6
DAF96 7/6	EF9 21/-	GZ33 19/3	PEN45DD 20/-	U52 4/-	W81M 6/6	6B57 12/6	6U5GT 7/6	I20P1 15/6
DCC90 12/6	EF22 14/-	GZ34 13/6	PEN36C 20/-	U76 7/6	W81M 6/6	6B6G 4/6	6V6GT 8/6	I20P3 24/-
DF33 9/6	EF37 8/-	GZ37 19/3	PEN45 10/-	U78 4/6	X41 15/6	6B7 5/6	6V6GT 8/6	I20P4 20/6
DF91 4/-	EF37A 8/-	HABC80 10/6	PEN45D 10/-	U78 4/6	X61M 10/6	6C4 3/6	6X4 4/6	I20P5 20/6
DF92 7/6	EF39 4/-	HL41 8/-	PEN45DD 25/-	U145 10/6	X65 12/6	6CSGT 8/6	6X5GT 6/6	I20P6 8/6
DF96 7/6	EF40 15/-	HL41DD 8/6	PEN46 5/6	U191 13/6	X76 12/6	6C6 6/6	6X5GT 8/6	I20P7 8/6
DH63 7/6	EF41 8/-	HL33DD 9/6	PEN453DD 20/-	U251 15/-	X76M 12/6	6C9 12/6	6/30L2 10/6	I20P8 8/6
DH77 7/6	EF42 10/-	HN309 26/6	PENDD4020 20/-	U281 19/6	X78 26/6	6C9DG 27/6	7B5 12/6	I20P9 8/6
DK37 11/-	EF50A 3/6	IW4/350 10/6	PL33 15/-	U301 17/6	X79 40/9	6CH6 10/6	7B6 10/6	I20Z4 7/6
DK91 6/6	EF50E 3/6	IW4/500 10/6	PL36 12/6	U317 10/6	X81 10/6	6CWA 16/6	7B7 8/6	I20Z5 8/6
DK92 7/6	EF80 5/6	KT33C 8/-	PL38 21/-	U329 15/6	Y61 10/6	6D2 4/6	7C5 8/6	I20Z6 8/6
DK96 7/6	EF85 5/6	KT33C 8/-	PL81 9/6	U339 13/6	Y63 10/6	6D6 5/6	7C6 8/6	I20Z7 19/6
DL33 8/6	EF86 8/6	KT36 17/6	PL82 8/6	U403 10/6	Z63 7/6	6E5 10/6	7D5 15/6	I20Z8 8/6
DL35 10/6	EF89 9/6	KT61 9/6	PL83 7/6	U404 10/6	Z66 10/6	6F1 10/6	7D6 15/6	I20Z9 12/6
DL91 8/6	EF91 4/6	KT66 15/6	PL83 7/6	U801 19/6	Z77 4/6	6F6 6/9	7D8 15/6	I20Z10 10/6
DL92 6/6	EF92 4/6	KT76 10/6	PL83 7/6	UABC80 7/6	Z152 5/6	6F12 4/6	7H7 6/6	I20L1 10/6
DL93 7/6	EF95 5/6	KT81 15/6	PL84 8/6	UAF42 8/6	OZ4 5/6	6F13 10/6	7R7 10/6	I20L1 8/6
DL94 7/6	EF98 10/6	KTW61 8/6	PL82 8/6	UAF42 8/6	IA7 7/6	6F14 10/6	7S7 10/6	I20L1 11/6
DL96 7/6	EF183 10/6	L63 5/6	PL82 8/6	UBC41 8/6	IC5 10/6	6F15 12/6	7Y4 6/6	I20L1 18/6
EAS50 2/-	EF184 10/6	LN152 8/6	PL82 8/6	UBC81 10/6	ID5 8/6	6F19 12/6	8D3 4/6	I20L1 10/6
EABC80 5/-	EK32 10/6	LN309 11/6	PL82 8/6	UBF80 8/6	ID6 10/6	6F23 10/6	9BW6 6/6	I20L1 9/6
EAC91 4/-	EL3 21/6	LK19 12/6	PL82 8/6	UBF89 7/6	IH5 9/6	6F25 16/6	10C1 12/6	I20L1 17/6
EAF42 9/6	EL32 4/6	MKT4 17/6	PL82 8/6	UBL21 20/6	IL4 5/6	6F26 13/6	10C2 17/6	I20L1 11/6
EB34 2/6	EL33 10/6	MS4B 17/6	PL82 8/6	UCB84 11/6	IN5 9/6	6F33 5/6	10F1 10/6	I20L1 11/6
EB41 5/6	EL34 14/-	MVS/PEN 17/6	PL82 8/6	UCF80 12/6	IR5 6/6	6F36 2/6	10F9 12/6	I20L1 16/6
EB91 4/6	EL35 10/6	MVS/PEN 17/6	PL82 8/6	UCH21 20/6	IS4 8/6	6F35 5/6	10LD11 15/6	I20L1 15/6
EB93 21/6	EL37 17/6	MVS/PEN 17/6	PL82 8/6	UCH42 8/6	IS5 5/6	6F35 5/6	10P13 15/6	I20L1 8/6
EB93 4/6	EL38 17/6	MU14 9/6	PL82 8/6	UCH81 8/6	IU5 5/9	6F35 5/6	10P14 15/6	I20L1 7/6
EB93 4/6	EL39 9/6	MX40 15/6	PL82 8/6	UCL82 9/6	2P 24/9	6F37 5/6	11D5 23/6	I20L1 15/6
EB93 4/6	EL41 9/6	N18 8/6	PL82 8/6	UCL83 13/6	3A4 5/6	6F37 5/6	12A6 6/6	I20L1 7/6
EB93 4/6	EL42 9/6	N37 14/6	PL82 8/6	UCL83 13/6	3A5 10/6	6K7 7/6	12A8 9/6	I20L1 7/6
EB93 4/6	EL43 9/6	N78 22/6	PL82 8/6	UCL83 13/6	3Q4 8/6	6K7G 2/6	12AT7 5/6	I20L1 4/6
EB93 4/6	EL44 9/6	N8 10/6	PL82 8/6	UCL83 13/6	3Q5 9/6	6K7GT 7/6	12AU6 17/6	I20L1 10/6
EB93 4/6	EL45 9/6	N103 15/6	PL82 8/6	UCL83 13/6	354 6/6	6K8 9/6	12AU7 5/6	I20L1 30/6
EB93 4/6	EL46 9/6	N308 18/6	PL82 8/6	UCL83 13/6	3V4 7/6	6K8GT 9/6	12AX7 5/6	I20L1 8/6
EB93 4/6	EL47 9/6	N339 30/6	PL82 8/6	UCL83 13/6	5U4 4/6	6K8GT 9/6	12BA6 7/6	I20L1 7/6
EB93 4/6	EL48 9/6	N369 10/6	PL82 8/6	UCL83 13/6	5V4G 7/9	6K25 17/6	12BE6 7/6	I20L1 7/6
EB93 4/6	EL49 9/6	OD3 5/6	PL82 8/6	UCL83 13/6	5Y3G 5/6	6L1 10/6	12BH7 10/6	I20L1 8/6
EB93 4/6	EL50 9/6	OZ4 5/6	PL82 8/6	UCL83 13/6	5Y3GT 6/6	6L6 7/6	12C8 8/6	I20L1 8/6
EB93 4/6	EL51 9/6	OZ4 5/6	PL82 8/6	UCL83 13/6	5Z4G 9/6	6L7 10/6	12J5GT 4/6	I20L1 8/6
EB93 4/6	EL52 9/6	P2 10/6	PL82 8/6	UCL83 13/6	5Z4GT 12/6	6L8 10/6	12J7GT 8/6	I20L1 30/6
EB93 4/6	EL53 9/6	PABC80 13/6	PL82 8/6	UCL83 13/6	6A7 9/6	6L19 15/6	12K7GT 5/6	I20L1 6/6
EB93 4/6	EL54 9/6	PCC84 8/6	PL82 8/6	UCL83 13/6	URIC 15/6	6ABG 8/6	12K8GT 10/6	I20L1 5/6

COMPLETE VALVE LIST FREE WITH ORDER

★ METAL RECTIFIERS

RM1 7/6	14A86	23/-	16RD 2-2-8-1	12/- (FC142)
RM2 8/-	14A97	26/-	16RE 2-1-8-1	10/-
RM3 10/-	14A100	28/-	18RA 1-1-8-1	5/-
RM4 17/6	14RA 1-2-8-2	21/- (FC301)	18RA 1-1-16-1	7/- (FC116)
RM5 19/6	14RA 1-2-8-3	25/- (FC31)	18RA 2N-1-8-1	12/-
	16RC 1-1-16-1	10/-	18RD 2-2-8-1	16/- (FC124)

BRAND NEW TRANSISTORS

OC44 6/-	OC74 6/-	OC81D 6/-
OC45 7/-	OC75 6/-	OC82 8/-
OC71 5/-	OC77 6/-	OC82D 6/-
OC72 8/-	OC81 6/-	

SILICON RECTIFIERS

400 volts 350 mA 8/- each

SETS OF VALVES

1R5, 155, IT4, 354, 3V4 Set of 4, 19/-
DAF91, DF91, DK91, DL92, DL94 Set of 4, 19/-
DAF96, DF96, DK96, DL96 Set of 4, 26/6

TERMS OF BUSINESS C.W.O. or C.O.D.
3/2 PACKING CHARGE ON ALL C.O.D.
ORDERS. POSTAGE 6d. per VALVE

CAR - PORTABLE RADIO

BY FAMOUS BRITISH MANUFACTURER.
BRAND NEW AND UNUSED. FULLY GUARANTEED.



Original List Price £26.18.11

- ★ A fully transistorised Go-Anywhere portable that automatically becomes a car radio simply by sliding into a metal car-tray.
- ★ Covers full medium and long wavebands. ★ All transistor superhet.
- ★ Internal ferrite rod aerial. ★ Press button wavechange.
- ★ All connections to car battery—booster speaker—car aerial automatically accomplished by sliding into metal car-tray.

Carriage and packing 7s. 6d. extra.

PP9 Battery 3s. 9d. extra.

Supplied with full fitting and installation instructions.

SCOOP

Battery drain is exceptionally low, the life of the self-contained battery within the set is approx. 200 hours. Transistors used—1—OC44; 2—OC45; 1—OC82D; 2—OC82, and diode.

Compares with sets costing at least double. Properly installed this set will give you years of pleasure and service—both in and out of your car.

Contemporary finish in two tone red and grey Vyanide washable material. Supplied complete with car-extension loudspeaker, car-tray and full easy to follow fixing instructions.

Internal loudspeaker provides ample volume as a portable. Separate 8 x 5 inch speaker with 8 x 6 inch baffle for car fixing.

Bracket for padlock provides an effective thief deterrent. Carrying handle folds away when not in use. The scale is illuminated when the set is operating in the car-tray. Dimensions 9 1/2 ins. x 7 1/2 ins. x 3 ins.

AS A CAR RADIO THIS RECEIVER OPERATES ONLY FROM A 12-VOLT ELECTRICAL SYSTEM EITHER POSITIVE OR NEGATIVE EARTH. AS A PORTABLE IT IS POWERED BY ITS OWN INTERNAL BATTERY TYPE PP9-OR EQUIVALENT.

LASKY'S PRICE £10.19.6

Complete with Tray, all car fittings
8 in. x 5 in. car speaker and baffle

LASKY'S RADIO | 207 EDGWARE ROAD, LONDON, W.2 | 33 TOTTENHAM COURT ROAD, W.1 | 152/3 FLEET STREET, LONDON, E.C.4
Near Praed St. PADDINGTON 3271/2. | Nearest Stn. Goudge St. MUSEUM 2805 | Telephone: Fleet Street 2833.
BOTH OPEN ALL DAY SAT. Early Closing Thurs. Mail Orders to Dept. PW, Edgware Rd | Open all day Thursday. Early closing Sat.

FREE TO AMBITIOUS ENGINEERS

— THE LATEST EDITION OF ENGINEERING OPPORTUNITIES

Have you sent for your copy?
ENGINEERING OPPORTUNITIES is a highly informative 156-page guide to the best paid engineering posts. It tells you how you can quickly prepare at home for a recognised engineering qualification and outlines a wonderful range of modern Home Study Courses in all branches of Engineering. This unique book also gives full details of the Practical Radio & Electronics Courses, administered by our Specialist Electronics Training Division—the B.I.E.T. School of Electronics, explains the benefits of our Employment Dept. and shows you how to qualify for five years promotion in one year.

We definitely Guarantee
“NO PASS — NO FEE”

Whatever your age or experience, you cannot afford to miss reading this famous book. If you are earning less than £25 a week, send for your copy of “ENGINEERING OPPORTUNITIES” today—FREE.

BRITISH INSTITUTE OF ENGINEERING TECHNOLOGY (Incorporating E.M.I. Institutes)
(Dept. SE/21), 29 Wright's Lane, London, W.8

WHICH IS YOUR PET SUBJECT?

- Mechanical Eng.,
- Electrical Eng.,
- Civil Engineering,
- Radio Engineering,
- Automobile Eng.,
- Aeronautical Eng.,
- Production Eng.,
- Building, Plastics,
- Draughtsmanship,
- Television, etc.

GET SOME LETTERS AFTER YOUR NAME!

- A.M.I. Mech. E.
- A.M.I.C.E.
- A.M.I. Prod. E.
- A.M.I.M.I.
- A.I.O.B.
- A.F.R. Ass. S.
- B.Sc.
- A.M. Brit. I.R.E.
- City & Guilds
- Gen. Cert. of Education
- Etc., etc.

PRACTICAL EQUIPMENT

- Basic Practical and Theoretic Courses for beginners in Radio, T.V., Electronics, Etc.,
- A.M. Brit. I.R.E. City & Guilds
- Radio Amateurs' Exam.
- R.T.E.B. Certificate
- P.M.G. Certificate
- Practical Radio
- Radio & Television Servicing
- Practical Electronics
- Electronics Engineering
- Automation

INCLUDING TOOLS!

The specialist Electronics Division of B.I.E.T. (Incorporating E.M.I. Institutes) NOW offers you a real laboratory training at home with practical equipment. Ask for details.

B.I.E.T. SCHOOL OF ELECTRONICS

POST COUPON NOW!

Please send me your FREE 156-page
 “ENGINEERING OPPORTUNITIES”
 (Write if you prefer not to cut page)
 NAME _____
 ADDRESS _____

SUBJECT OR EXAM THAT INTERESTS ME _____ \$E/21



THE B.I.E.T. IS THE LEADING ORGANISATION OF ITS KIND IN THE WORLD

LASKY'S RADIO

GREAT 1963 PRICE REDUCTIONS BUILD YOUR SUMMER PORTABLE AT THESE VASTLY REDUCED PRICES ★ ★ ★ ★



The SPRITE

Inclusive price of
79/6
P. & P. 3/6 extra.

★ Six-Transistor Superhet Miniature Personal Pocket Radio. ★ Tunable over Long and Medium wavebands. ★ Uses PP3 battery. Ferrite Rod aerial. ★ I.F. Frequency 470 Kc/s. Transistors: 3 Philco 2067's. 2 Mullard OC81 M OC81 DM and OA90 diode. ★ 3 inch speaker. ★ Printed circuit 2 1/2 x 2 in. ★ Slow Motion Drive. ★ In Plastic Case. size 4 x 2 1/2 x 1 in.

In order to ensure perfect results, the SPRITE is supplied to you with R.F. and I.F. stages. Driver and Output stages ready built with all components ready mounted on the printed circuit. To complete assembly you only have to fit the wavechange switch, tuning condenser and drive, volume control, earphone socket and aerial rod, the remaining components all having been pre-fitted at the factory for you. The SPRITE is offered as above, pre-assembled, plus cabinet, speaker and all components for final construction, at the inclusive price of 79/6. Postage and packing 3/6 extra. Data and Instructions separately. 2/6. Refunded if parcel is purchased. Real calf leather case, wriststrap, personal earphone and case for earphone and battery 12/6 the lot extra. Make no mistake this is a SUPERHET receiver of genuine commercial quality. It is not a regenerative circuit.

TESLA "SONET"



DUO TAPE RECORDER

A continental manufactured 2-speed tape recorder with 1 1/2 x 3 1/2 in. i.p.s. Twin track recording to interlocking standards. ★ Takes 5 1/2 in. spools. ★ Fast forward and fast rewind. ★ Record level indicator. ★ Inputs for mic, radio and pick-up. For use on 110 and 200-250 v. 50 c.p.s. mains. ★ Digital position indicator. ★ In attractive wood case with metal top cover fitted with storage compartments and carrying handle. Size 13 x 10 x 7 in. High quality record-replay amplifier with internal loudspeaker provides immediate high quality reproduction. ★ Socket for external speaker. ★ Tone control: Supplied with reel of tape, empty spool, microphone and a selection of interconnecting leads, etc., with canvas waterproof cover. Brand New and Unused. Carr. and ins. 10/6.

LASKY'S PRICE 24 gns.
Carriage and Insurance 10/6.

The "REALISTIC" Seven

STAR FEATURES ★★★★★

- ★ 7 Transistor Superhet. 350 Milliwatt output into 4-inch high flux speaker.
- ★ All components mounted on a single printed circuit board, size 5 1/2 x 5 1/2 in. in one complete assembly.
- ★ Plastic cabinet, with carrying handle size 7 x 10 x 3 1/2 in. in choice of colours:
- ★ Red/Grey, Blue/Grey, all Grey.
- ★ Easy to read Dial.
- ★ External Socket for car aerial.
- ★ I.F. frequency 470 Kc/s.
- ★ Ferrite Rod internal aerial.
- ★ Operates from PP9 or similar battery.
- ★ Full comprehensive data supplied with each Receiver.
- ★ All coils and I.F.'s etc., fully wound ready for immediate assembly.

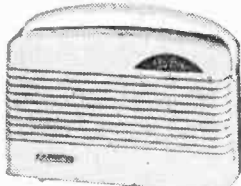

An Outstanding Receiver. Lasky's Price for the complete parcel including Transistors, Cabinet, Speaker, etc., and Full Construction Data:

£5.19.6 Postage and Packing 4/6
PP9 Battery 3/6. Data and Instructions separately 2/6. Refunded if you purchase the parcel.

Get ready NOW for the NEW TV frequencies



Lasky's first again with a U.H.F. Tuner. Complete with P.C. 88 and P.C. 86 Valves. Fully variable tuning capacitor, etc. British manufacture. New and unused size 9 1/2 x 5 1/2 x 1 1/2 in. Complete with **29/6** P. & P. 2/- valves.

CRYSTAL PICK-UP CARTRIDGES

Some at Less than Half List Price All complete with Stylus, L.P. and Standard (and Stereo where shown). Fully guaranteed, standard fitting, will fit most P.U. arms and heads. Postage 1/- each extra.

MONO Type C.T.I.	
By well known manufacturer. With two sapphire stylus	9/6
Garrard Ceramic GCE 4	15/-
Garrard Magnetic T.O.M.2	15/-
Acos GP 59	14/-
Acos GP 85/3	15/-
Acos GP 65/1	17/-
Acos 67/1	14/-
STEREO	
Acostereo 73/1 with two sapphires ..	25/-
Acostereo 73/2 with Diamond L.P./Stereo and sapphire Std.	29/6
Collaro type C. Turnover, with 2 sapphires	19/11
Collie S.C.I. Turnover with 2 sapphires	19/11
Collie S.C.I. Turnover with Diamond L.P./Stereo and sapphire Std.	25/-
Ronette Stereo O.V. Turnover, with 2 sapphires	25/-
Ronette Stereo type 105 & 106 with 2 sapphires	35/6
Ronette Stereo type 105 & 106 with Diamond L.P./Stereo and sapphire Std.	39/6

Distler Miniature Motors
6 volt battery operated 7/11. P. & P. 2/6.

The COROVER '6'

★ A 6-transistor plus 2-diode superhet receiver using the latest circuitry. ★ Three Mullard AF117 alloy diffused transistors are used with OA79 and OA91 diodes, followed by OC81 D and two OC81's in push-pull. ★ I.F. frequency 470 Kc/s. ★ Covers the full medium and long wavebands. ★ Sockets provided for personal earpiece or tape recorder, and car radio aerial. ★ Large internal ferrite rod aerial gives high sensitivity. ★ Uses four 1.5 v. pen torch batteries. ★ All components mounted on a single printed circuit. Simple stage by stage instructions. ★ Cabinet size 6 1/2 x 4 x 1 1/2 in. With carrying handle. ★ All coils and I.F.'s ready wound. ALL COMPONENTS AVAILABLE SEPARATELY. Data and instructions separately 2/6. Refunded if you purchase the parcel.

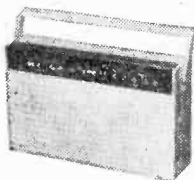

CAN BE BUILT FOR
£5.7.6
Post and packing 4/- extra.
Batteries 1/4.

TELEFUNKEN STEREO HI-FI AMPLIFIERS MODEL S82



Further Great Purchase Enables us to Offer this Excellent Unit at £5.19.6. Post 7/6.

A complete stereo amplifier of unsurpassed quality, with inputs for radio, tape recorder, F.M. tuner or any other hi-fi source, either monaural or stereo. Output power 5 watts total (2 1/2 watts each channel). With balance control. New and unused, listed at 18 gns.

LASKY'S PRICE **£5.19.6**

207 EDGWARE ROAD, LONDON, W.2. | 33 TOTTENHAM COURT ROAD, W.1.
Near Praed St. PADDINGTON 3271/2 | Nearest Stn., Gooch St. MUSEUM 2605
BOTH OPEN ALL DAY SAT. Early Closing Thurs. Mail Orders to Dept. P.W., Edgware Rd.

152/3 FLEET STREET, LONDON, E.C.4.
Telephone: Fleet Street 2833.
Open all day Thursday. Early closing Sat.

SURBITON PARK RADIO LTD.

FOR POST HASTE—POST FREE SERVICE

MARTIN RECORDAKITS

HALF TRACK

B.S.R. TD2 Monardeck, latest model 5 1/2 in. spool	£9.90
Deposit £1.00 and 9 monthly	£11.00
Tap Amplifier for B.S.R. deck, printed circuit ready wired with ECX83, EC182, FM85 and Z231. Connects with all plugs, sockets, panels, knobs, etc. The whole amplifier mounts on to the deck, making a self-contained unit	£8.80
Deposit £1.00 and 8 monthly	£11.00
Case with 7in. x 4in. speaker, in two tone grey	£4.40
Complete Kit as above	£22.00
Deposit £2.40 and 12 monthly	£18.80
The above recorder can be supplied assembled, tested and complete with tape and microphone for	£26.00
Deposit £2.10 and 12 monthly	£21.60
Collaro Studio Deck , Very latest model 3 speeds 7in. spools.	£12.10
Deposit £1.50 and 12 monthly	£10.90
Tap Amplifier for studio deck, with ready wired printed circuit control and input panels, mains and output transformers. Complete with valves, knobs, plugs, screws, etc. FFB6, ECX23, FM84, Z731, OAN1 and 2 EL81, 3 watts output. Mark eye, radio and mic. input, EX L/S socket, tone and monitor control. Can be used as an amplifier.	£11.10
Deposit £1.40 and 12 monthly	19/-
Case for above including 5in. x 3in. speaker	£5.50
Total Kit as above	£29.00
Deposit £2.10 and 12 monthly	£23.20
We can offer the above recorder, complete with tape and microphone, in a De Luxe two tone grey cabinet, assembled for	£35.00
Deposit £3.10 and 12 monthly	£21.80
This Machine is listed at 39 pns. by makers and is a very good buy. Building Instructions available at 2/6 each kit (refunded if kit bought)	

QUARTER TRACK

B.S.R. TD2	£11.11.0
Deposit £1.40 and 12 monthly	19/-
Tap Amplifier as above, but quarter track	£9.90
Deposit £1.00 and 9 monthly	£11.00
Case, two tone grey, with speaker	£4.40
Complete Kit as above	£25.00
Deposit £2.10 and 12 monthly	£21.80
Collaro Studio Deck , 4 track	£17.17.0
Deposit £1.75 and 12 monthly	£14.95
Tap Amplifier , as above, but 4 track	£12.12.0
Deposit £1.70 and 12 monthly	£10.80
Case with 9in. x 5in. speaker	£5.50
Complete Kit 4 track Collaro	£35.00
Deposit £3.10 and 12 monthly	£21.80
Tap Pre-amplifier for Collaro deck, with power supplies, ECX83, EC182, EZ90 and FM83. Radio and Mic. sockets, gives an equalised output of 400 mV/ohms	
Half Track	£8.80
Deposit £1.00 and 8 monthly	£11.00
Quarter Track	£9.90
Deposit £1.00 and 9 monthly	£11.00
Bradmatic R/PB and Erase on Collaro bracket 1 track	£11.19.6
Bradmatic R/PB , Ideal 3rd head Collaro deck 1 track	£11.12.6
Pressure pad (Studio deck only)	4/0
Brenell Mk. 5 deck , 1 track, 4 speeds	£29.8.0
Deposit £3.18 and 12 monthly	£23.97
Brenell Mk. 5 Amplifier , with power	£24.0.0
Deposit £2.90 and 12 monthly	£119.10

JASON F.M. TUNERS

FMT1, complete with valves	£6.17.6
Deposit £1.10 and 6 monthly	£11.29
FMT2, complete with valves, Less Power	£7.17.6
Deposit £1.00 and 7 monthly	£12.60
FMT2, complete with valves, Self powered	£9.15.0
Deposit £1.00 and 9 monthly	£11.18
FMT3, complete with valves, Less power	£9.12.6
Deposit £1.00 and 9 monthly	£11.14
FMT3, complete with valves, Self powered	£12.00
Deposit £1.40 and 12 monthly	19/10
Power pack kit ready drilled chassis for FMT1, etc.	£2.12.6
The instruction books are included in all kits but are otherwise 2/6.	
JTV/2, switched F.M. and TV, Sound self powered, All valves	£14.15.0
Deposit £1.96 and 12 monthly	£14.45
Mercury 2 as JTV/2 but less power, with all valves	£10.15.0
Deposit £1.18 and 12 monthly	17/10
The instruction book is again included but is otherwise 3/6.	
All the above units are available ready built and aligned. Price on request.	

RADIO TUNERS

Armstrong T4 C, V.H.F. Tuner self powered	£17.19.0
Deposit £1.19.8 and 12 monthly	£19.95
Armstrong ST3 Mk2, AM/FM self powered	£25.12.0
Deposit £2.13.0 and 12 monthly	£23.24
Armstrong AF200, AM/FM Radio chassis, Bass and Treble controls, P.U. inputs etc.	£21.4.0
Deposit £2.6.0 and 12 monthly	£14.10
Armstrong Jubilee Mk2, AM/FM Push Pull Output stage, Bass and Treble	£28.5.0
Deposit £2.16.8 and 12 monthly	£26.61
Armstrong Stereo 55, AM/FM Radio chassis, with stereo gram. Bass and Treble etc.	£29.18.0
Deposit £3.2.6 and 12 monthly	£29.95
Armstrong Stereo 12 Mk2, AM/FM Radio chassis, Stereo gram. Push pull output	£40.5.0
Deposit £4.0.8 and 12 monthly	£36.61
Brass electroon available for AF200 and Jub. Mk2	7/6
Pye HFT109, FM Tuner self powered	£23.12.6
Deposit £2.9.6 and 12 monthly	£119.00
Pye HFT113, AM/FM Tuner self powered	£28.7.0
Deposit £2.18.8 and 12 monthly	£26.61
Quad F.M. Tuner un-powered	£24.18.9
Deposit £2.13.3 and 12 monthly	£21.10

AMPLIFIERS (MONO)

Linear L45 Three valve amplifier	£5.19.6
Linear Diatonic Five valve, push pull	£12.12.0
Deposit £1.70 and 12 monthly	£10.90
Linear Concord 30 watt with case	£18.0.0
Deposit £1.16.0 and 12 monthly	£19.10
Tripletone Hi Fi Major, with Pre-amp	£15.18.9
Deposit £1.13.3 and 12 monthly	£16.10
Pye Mozart , including Pre-amp, 10 watt	£25.4.0
Deposit £2.10.6 and 12 monthly	£22.11
Leak TL 12, Main amp, only 10 watt	£18.18.0
Deposit £2.0.6 and 12 monthly	£11.11
Leak Variotone 111 Pre-Amplifier	£15.15.0
Deposit £1.11.6 and 12 monthly	£16.10
Quad Main amp, only 15 watt	£22.10.0
Deposit £2.5.0 and 12 monthly	£11.74

AMPLIFIERS (STEREO)

Dulci AC209, Integrated	£12.12.0
Deposit £1.70 and 12 monthly	£10.80
Dulci GA505, Integrated	£18.18.0
Deposit £2.0.6 and 12 monthly	£11.11
Rogers Cadet Mk2, with Pre-amplifier	£25.10.0
Deposit £2.11.0 and 12 monthly	£22.24
Leak Stereo 20 Main amplifier	£30.9.0
Deposit £3.4.6 and 12 monthly	£21.03
Leak Variotone 111 Stereo Pre-amplifier	£25.0.0
Deposit £2.10.0 and 12 monthly	£21.18
Quad 22 Stereo Control unit, Pre-amplifier	£25.0.0
Deposit £2.10.0 and 12 monthly	£21.16

GRAMOPHONE UNITS

B.S.R. UA14 TC8 cartridge	£6.19.6
Deposit £1.00 and 6 monthly	£13.30
Garrard Autoslim Mono cartridge	£7.17.0
Deposit £1.00 and 7 monthly	£12.60
Garrard Autoslim De Luxe Mono cartridge	£11.9.0
Deposit £1.6.8 and 9 monthly	£14.49
Philips AG101G with Stereo cartridge	£19.12.0
Deposit £1.7.0 and 12 monthly	£10.90
Decca Deram Arm only	£5.5.0
Decca Deram Transcription cartridge	£4.14.6
Decca Deram Auto cartridge	£3.13.8
Goldring GL58, with arm, less cartridge	£15.19.8
Deposit £1.12.0 and 12 monthly	£16.60
Goldring '88' Transcription, no pick up	£17.14.0
Deposit £1.19.0 and 12 monthly	£19.90
Goldring GL55C as GL58 but less P.U. arm	£13.1.7
Deposit £1.7.7 and 12 monthly	£11.16
Garrard 4HF with Mono cartridge	£17.0.0
Deposit £1.14.0 and 12 monthly	£18.20
Garrard Lab. Type A' Auto-changer, Mono	£10.14.9
Deposit £1.19.6 and 12 monthly	£11.29
Garrard 301	£20.12.2
Deposit £2.3.2 and 12 monthly	£11.40
Garrard 301 Strobe	£22.0.0
Deposit £2.4.0 and 12 monthly	£11.86

LOUDSPEAKERS

Goodmans Axiote 3	£5.5.7
Goodmans Axiom 10	£6.5.11
Goodmans Axiom 201	£10.7.0
Deposit £1.1.0 and 8 monthly	£15.90
Goodmans 51d/80 XL Tweeter with cross over	£7.0.0
Wharfedale RS12/DD 12in. full range	£13.10.0
Deposit £1.7.8 and 9 monthly	£14.49
Whiteley Electrical W.B. H.F. 1012 10in.	£4.7.6

48 SURBITON ROAD, KINGSTON UPON THAMES, SURREY

Established over 30 years

Telephone KIN 5549

We pay all postage and insurance. All orders despatched same day. Money refund guarantee
Hours: 9 a.m. - 6 p.m. (1 p.m. Wednesday). We do not close for lunch. Open all day Saturday.

EVEN

**BETTER
PERFORMANCE**

With the **NEW
MARK 8**

PARIISIENNE!!

THE "TEN STAR" TRANSISTOR
POCKET RADIO



**NOW
ONLY
£3.19.6**

All components supplied separately if required

- ★ No external aerial or earth required.
- ★ Free 9-volt transistor battery.
- ★ Built-in wave change switch not pre-set. Dial graduated, L. and M. waves.
- ★ Printed circuit for easy assembly including high "Q" ferrite rod aerial.
- ★ High sensitivity ear piece if required, 5/-.
- ★ Cream Polystyrene case with carrying handle.
- ★ Hi-Fi 3-inch moving coil speaker.
- ★ All new components plainly marked, including best Mullard transistors.
- ★ Fully illustrated 30-page booklet with step by step instructions, 2/9.
- ★ Comprehensive speedy after-sales service.

Money refunded if not satisfied

PLEASE SEND FOLLOWING ITEMS
TICK BOX BELOW AS REQUIRED

FULL SET OF PARIISIENNE COMPONENTS £3-19-6

EARPIECE 5/-

BOOKLET 2/9 POST FREE

NAME _____
ADDRESS _____

I ENCLOSE CHEQUE P.O. MONEY ORDER INCLUDING
2/6 P. & P. FOR £. s. d.

**WOLVERHAMPTON
RADIO AND TV SUPPLIES**

42, DARLINGTON STREET, WOLVERHAMPTON
Telephone No. 20315

P.W.f.



BENTLEY ACOUSTIC CORPORATION LTD.

THE VALVE SPECIALISTS

38 CHALCOT ROAD, LONDON, N.W.1

Telephone: PRIMROSE 9090

EXPRESS POSTAL SERVICE! ALL ORDERS DESPATCHED SAME DAY AS RECEIVED. FOR ONLY 2/6 EXTRA. TELEPHONE FOR THAT URGENT ORDER TO BE DESPATCHED IMMEDIATELY BY OUR SPECIAL C.O.D. SERVICE

0A2	15/-	6BH6	6/-	88K7	12/8	2013	12/8	AC/PEN(5)	EABCO9	6/8	EL37	23/11	KTW63	6/8	Q121	7/-	U31	Transistors
0A2	17/6	6BH6	5/8	88K7	8/8	2013	12/8	AC/PEN(5)	EAC91	4/-	EL38	12/6	KT741	6/-	Q122	12/8	U31	and diodes
0A24	5/-	6BQ5	6/8	6UG0	5/6	20P3	22/8	AC/PEN(7)	EAF42	8/3	EL41	8/-	L63	3/-	Q135	14/8	U35	0D8
0A24	6/-	6BQ5A	28/6	6UG0	6/-	20A6	22/8	AC/PEN(7)	EB34	2/8	EL42	5/-	LN309	9/8	Q150/15	U37	25/11	0D10
1A3	3/-	6BR7	8/8	6U70	8/8	25A60	8/8	AC/90	22/8	EB41	5/-	EL51	8/9	LP2	9/8	R10	U43	
1A3	6/-	6BR8	9/8	6V60	4/-	25180CT	7/-	AC/90	5/8	EB91	3/-	ET13	15/2	MP41	16/10	K12	15/8	
1A7	6/6	6BS7	25/6	6V60T	6/-	25140T16/2				EC83	23/10	EL84	6/4	EB91	12/6	R12	7/8	
1C1	8/6	6BW6	10/6	6X4	4/6	25Y5	10/6	AC/TH132/4	EBU41	7/6	EL85	10/6	MH4	7/-	R16	25/11	U47	15/8
1C2	8/6	6BW7	5/-	6X5	5/-	25Y5	10/6	AC/TP	32/4	EBU81	7/6	EL86	16/10	MH14	12/8	R17	17/8	
1C3	8/6	6BX6	5/-	6Y6	10/6	25Y40	7/-	AC/VP1	15/7	EBU90	5/6	EL91	3/6	MH14	7/8	R18	18/2	
1C6	7/6	6C4	5/-	7B6	20/8	25Z60T	8/8	ATP	5/-	EBP80	7/6	EL99	2/7	MHL0D18/8		R19	19/5	
1C9	10/6	6C5	5/6	7B7	7/8	25Z60T	8/8	ATP	5/-	EBP83	9/8	EL99	2/7	MHL0D18/8		R19	19/5	
1C9	18/6	6C5	5/6	7B7	7/8	25Z60T	8/8	ATP	5/-	EBP83	9/8	EL99	2/7	MHL0D18/8		R19	19/5	
1H6	9/6	6C8	12/6	7C8	7/6	26D7	7/-	AZ1	16/4	EBP83	9/8	EL99	2/7	MHL0D18/8		R19	19/5	
1F1	7/6	6C9	11/-	7D3	21/-	30C1	7/-	AZ1	16/4	EBP83	9/8	EL99	2/7	MHL0D18/8		R19	19/5	
1F2	3/-	6C10	9/8	7D3	21/-	30C15	10/-	B39	6/9	EBP83	9/8	EL99	2/7	MHL0D18/8		R19	19/5	
1F3	3/-	6C12	7/6	7D6	21/-	30L1	9/6	C1	12/6	EC54	6/-	EM34	9/6	N7	25/11	SP13	12/6	
1P7	12/6	6C17	10/6	7D8	21/-	30L12	12/6	C1C	12/6	EC70	12/6	EM35	12/-	N7	25/11	SP14	2/3	
1PD9	5/-	6C19G	35/8	7H7	7/3	30L12	12/6	C1C	12/6	EC70	12/6	EM35	12/-	N7	25/11	SP14	2/3	
1G6	7/-	6C16	6/-	787	34/11	30L1	6/6	C1B1	27/2	EC81	27/6	EM71	22/8	N108	29/8	SP42	12/6	
1H5	10/6	6C14	24/-	7Y4	5/-	30L15	11/-	OC133	22/8	EC89	7/6	EM80	7/6	N118	22/8	SP43	12/6	
1H5GT	8/9	6D1	19/-	8D2	3/6	30P14	12/6	OC306	6/6	EC92	10/6	EM81	8/3	N151	10/-	SP23	27/8	
1L4	3/-	6D3	18/6	8D3	3/6	30P12	12/6	OC210	11/8	EC92	11/8	EM84	8/8	N308	18/1	SP61	7/8	
1LA5	16/10	4D6	3/-	8D3	3/6	30P16	7/6	CL33	23/10	EC93	15/-	EM85	8/3	N359	15/-	T41	8/-	
1LD3	4/8	6D9	15/-	8D3	3/6	30P19	19/5	CV6	2/6	EC93	4/-	EN31	71/-	N361	16/10	TD2	12/6	
1LN5	4/8	6D5	7/-	8D7	13/7	30P11	9/5	CV3	10/6	EC93A	29/11	EN91	15/-	P69	8/8	TDD4	14/8	
1N5	10/6	6P1	4/8	8D7	13/7	30P11	9/5	CV3	10/6	EC93B	29/11	EN91	15/-	P69	8/8	TDD4	14/8	
1N5GT	8/9	6P1	4/8	8D7	13/7	30P11	9/5	CV3	10/6	EC93B	29/11	EN91	15/-	P69	8/8	TDD4	14/8	
1P1	7/-	6P6G	7/-	10C2	14/6	35A5	20/8	CYIC	18/2	EC93A	4/9	EV93	13/7	PC86	14/7	TH14	17/8	
1P1C	6/-	6P6GT	8/-	10D1	7/6	35L6T	8/8	CY31	7/6	EC93B	4/9	EV94	18/2	PC88	16/2	TH23	34/8	
1P11	7/6	6P9	12/6	10D2	11/8	35W4	8/-	DI	3/-	EC93B	6/-	EV96	8/8	PC93	13/8	TP22	15/-	
1R5	5/8	6P11	17/9	10F1	10/8	35Z3	19/2	D15	13/6	EC93B	7/6	EV97	11/8	TP23	15/-	TP24	12/6	
1R4	7/6	6P1	5/6	10F1	10/8	35Z4GT	10/8	D15	13/6	EC93B	7/6	EV97	11/8	TP23	15/-	TP24	12/6	
1R5	4/8	6P12	8/8	10F18	12/8	35Z5GT	7/-	D42	10/6	EC93B	21/10	EV97	11/8	TP23	15/-	TP24	12/6	
1T9	25/11	6P14	25/11	10LD3	8/8	408UA	18/2	D43	17/9	EC93B	3/-	EZ41	6/6	PC98	11/6	UABC80	8/-	
1T4	3/-	6P15	14/11	10LD11	11/3	41TH28/511	10/3	5	7/6	EC93B	25/11	EZ80	5/8	PC99	8/8	UAF34	7/8	
1U4	7/6	6P16	8/-	10P13	8/8	42	12/8	D77	4/-	EC93B	8/3	EZ81	5/6	PC99	8/8	UAF34	7/8	
1U5	5/3	6P17	12/6	10P14	12/4	45	10/8	D77	4/-	EC93B	8/3	EZ81	5/6	PC99	8/8	UAF34	7/8	
1Z7	17/6	6P18	14/11	11E1	17/6	30A5	21/10	DLA	22/8	EC93B	19/5	EZ90	4/6	PCF92	7/-	UHC41	7/8	
2D26	4/-	6P19	6/-	11E3	15/6	30C5	7/6	DF96	6/8	EC93B	20/10	FC13	14/6	PCF84	16/2	UHF80	7/8	
2D13C	7/6	6P23	10/6	12A6	2/3	30C5D6G35/7	DOX90	10/6		EC93B	25/11	FC13	14/6	PCF86	9/8	UHF89	7/8	
2D21	15/-	6P24	10/6	12A8	16/8	30C5D6G35/7	DOX90	10/6		EC93B	25/11	FC13	14/6	PCF86	9/8	UHF89	7/8	
2D21	15/-	6P24	10/6	12A8	16/8	30C5D6G35/7	DOX90	10/6		EC93B	25/11	FC13	14/6	PCF86	9/8	UHF89	7/8	
2K3	3/-	6P25	14/11	12AD6	10/10	33KUT	23/8	DDT4	2/8	EC93B	22/8	FC13	14/6	PCF86	9/8	UHF89	7/8	
3A4	4/-	6P6	6/6	12A6E	12/3	618P2	28/11	DET23	7/6	EC93B	8/6	GU50	41/8	PC185	10/-	UCF30	11/-	
3A5	7/6	6P6	3/-	12A7	8/7	72	6/8	DF33	7/6	EC93B	7/6	GU30	7/6	PC186	10/8	UCF21	22/8	
3B7	12/6	6P30	3/-	12A78	9/7	78	8/8	DF62	15/-	EC93B	8/6	GU32	7/6	PC188	11/4	UCF42	7/8	
3D6	4/-	6P30T	8/-	12A78	9/7	78	8/8	DF62	15/-	EC93B	8/6	GU32	7/6	PC188	11/4	UCF42	7/8	
3Q4	7/-	6P3	6/6	12A7	8/7	78	8/8	DF62	15/-	EC93B	8/6	GU32	7/6	PC188	11/4	UCF42	7/8	
3Q5	7/6	6P3	6/6	12A7	8/7	78	8/8	DF62	15/-	EC93B	8/6	GU32	7/6	PC188	11/4	UCF42	7/8	
3E4	9/-	6P70T	10/6	12A7	8/7	78	8/8	DF62	15/-	EC93B	8/6	GU32	7/6	PC188	11/4	UCF42	7/8	
3V4	6/-	6J8	12/6	12A75	11/1	85A1	55/6	DI130	15/6	EC93B	10/6	H63	12/6	PCN25	4/6	UC183	12/-	
4D1	7/6	6K6	8/-	12A75	11/1	85A1	55/6	DI130	15/6	EC93B	10/6	H63	12/6	PCN25	4/6	UC183	12/-	
4B4GT	17/6	6K70	8/-	12A75	11/1	85A1	55/6	DI130	15/6	EC93B	10/6	H63	12/6	PCN25	4/6	UC183	12/-	
4V4	14/-	6K80	4/-	12B17	8/7	90K0	67/6	DH51	25/11	EC93B	3/3	HL2	7/6	PCN46	4/8	UW89	6/8	
5U40	4/8	6K20	10/8	12E1	30/-	90CV	42/-	DH10127/11	EF37A	8/8	HL13C	3/6	PCN46	4/8	UW89	6/8		
5A43	7/6	6K20	10/8	12E1	30/-	90CV	42/-	DH10127/11	EF37A	8/8	HL13C	3/6	PCN46	4/8	UW89	6/8		
5Y3	8/8	6K20	10/8	12E1	30/-	90CV	42/-	DH10127/11	EF37A	8/8	HL13C	3/6	PCN46	4/8	UW89	6/8		
5Y3GT	5/3	6K20	10/8	12E1	30/-	90CV	42/-	DH10127/11	EF37A	8/8	HL13C	3/6	PCN46	4/8	UW89	6/8		
5A4	12/6	6L6	10/8	12K5	17/8	161	13/8	DK92	13/8	EC93B	11/8	HL33DD	7/8	PCN46	4/8	UW89	6/8	
5E2	19/5	6L70T	5/-	12K7GT	4/7	126BT	33/10	DK92	7/-	EC93B	10/6	HL33DD	7/8	PCN46	4/8	UW89	6/8	
5Z4	9/-	6L17	9/-	12K8	8/7	126BT	33/10	DK92	7/-	EC93B	10/6	HL33DD	7/8	PCN46	4/8	UW89	6/8	
6A43	7/6	6L18	7/8	12K9	11/7	1298	10/8	DL13	8/6	EC93B	9/8	HL33DD	7/8	PCN46	4/8	UW89	6/8	
6A3L2	8/-	6L18	7/8	12K9	11/7	1298	10/8	DL13	8/6	EC93B	9/8	HL33DD	7/8	PCN46	4/8	UW89	6/8	
6A7	10/8	6L03	8/-	12A47	7/7	304	15/-	DL63	12/6	EC93B	10/6	FW3	10/6	PC13	18/10	U6	11/8	
6A8	7/-	6L13	11/8	12A47	7/7	304	15/-	DL63	12/6	EC93B	10/6	FW3	10/6	PC13	18/10	U6	11/8	
6A8T	8/-	6L12D	15/7	12A47	7/7	304	15/-	DL63	12/6	EC93B	10/6	FW3	10/6	PC13	18/10	U6	11/8	
6A8T	4/-	6N7	5/-	12A47	7/7	304	15/-	DL63	12/6	EC93B	10/6	FW3	10/6	PC13	18/10	U6	11/8	
6A8S	2/8	6N70T	8/-	12A47	7/7	304	15/-	DL63	12/6	EC93B	10/6	FW3	10/6	PC13	18/10	U6	11/8	
6A9T	7/8	6N7	18/9	12K5K7	4/8	4033	12/8	DL92	9/-	EC93B	5/8	KBC32	20/5	PL82	8/-	UU10	22/8	
6A9S	8/8	6P26	12/6	12A47	7/7	4687	7/1	DL94	7/6	EC93B	3/-	KL35	8/6	PL84	7/6	UY1N	18/2	
6AK5	5/-	6P26	19/5	12A47	7/7	4687	7/1	DL94	7/6	EC93B	3/-	KL35	8/6	PL84	7/6	UY1N	18/2	
6AK6	12/6	6P24	12/6	12L40	7/8	7183	5/-	DM70	6/8	EC93B	9/8	KT2	7/6	PM85	15/2	UY41	6/-	
6AKS	9/-	6P25	5/6	12L40	7/8	7183	5/-	DM70	6/8	EC93B	9/8	KT2	7/6	PM85	15/2	UY41	6/-	
6AL5	4/-	6P25	5/6	12L40	7/8	7183	5/-	DM70	6/8	EC93B	9/8	KT2	7/6	PM85	15/2	UY41	6/-	
6AM5	4/-	6P2																

THE R.S.C. BASS-MAJOR 30 WATT GUITAR AMPLIFIER

A MULTI-PURPOSE HIGH FIDELITY, HIGH OUTPUT UNIT FOR VOCAL AND INSTRUMENTALIST GROUPS

Eminently suitable for bass guitar and all other musical instruments

- ★ Incorporating two 12in. heavy duty 25-watt high flux (17,000 lines) loudspeakers with 3in. diameter speech coils. Designed for efficiently handling full output of amplifier at frequencies down to 25 c.p.s.
- ★ Dual Cone in second speaker reproduces frequencies up to 17,000 c.p.s.
- ★ Heavily made cabinet of convenient size 24 x 21 x 14in. has an exceptionally attractive covering in two contrasting tones of Vynair.
- ★ For 200-250 v. to 50 c.p.s. A.C. mains operation.
- ★ Four jack socket inputs and two independent vol. controls for simultaneous connection of up to four instrument pick-ups or microphones.
- ★ Separate bass and treble controls providing more than adequate "Boost" or "Cut".
- ★ LEVEL frequency response throughout the audible range.
- ★ SUPERIOR TO UNITS AT TWICE THE COST.

39¹/₂ Gns.

Send S.A.E. for leaflet.
OR DEPOSIT OF £4.3.0 and 12 monthly payments of £3.9.11. Carr. 17/6.

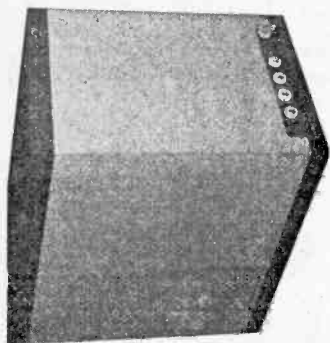

R.S.C. JUNIOR GUITAR AMPLIFIER
5-watt high quality output. Separate bass and treble "cut" and "boost" controls. Sensitivity 15 m.v. Two high impedance inputs. 10in. loudspeaker. Handsome strongly made cabinet (size 14 x 14 x 7in. approx.) finished in attractive and durable polychrome. 200-250 A.C. mains operation. DEPOSIT £1 and 9 monthly payments of £1. Carr. 7/6.

LINEAR TREMOLO/PREAMP. UNIT
Designed for introducing the Tremolo effect to any amplifier which is fitted with a reserve power supply point for smoothed H.T. and 6.3 v. A.C. L.T. This applies to practically all amplifiers of our manufacture, and to those of several other manufacturers. The unit plugs into power supply point and any input socket of amplifier. Controls are Speed (frequency of interruptions). Depth (for heavy or light effect). Volume and Switch. Three sockets are for two inputs and Foot Switch.
ONLY 4 Gns.

R.S.C. SENIOR Guitar Amplifier
14 watt high-fidelity push-pull output.

Separate bass and treble "cut" and "boost" controls. Twin separately controlled inputs so that two instruments or "mike" and pick-up can be used at the same time. Two loudspeakers are incorporated, a 12in. high flux 14 watt bass unit, and a 6 x 4in. elliptical for treble. Cabinet is well made and finished as Junior Model. Size approx. 18 x 18 x 8in.
Only 16 Gns. Carr. 10/-

Send S.A.E. for leaflet.
OR DEPOSIT 37/- and nine monthly payments of 37/-.

HEAVY DUTY LOUDSPEAKERS IN SUBSTANTIAL REXINE COVERED CABINETS. Type BG1. Suitable for Bass Guitar Speaker Unit. 15in. High Flux. 15 ohms. 25 watts. Cabinet size approx. 24 x 21 x 13in. Only 19/- gns. Or Deposit 42/- and 12 monthly payments of 34/9. Type BG2. Suitable for Bass Guitar. Super Sensitive. 15in. 15 ohms high flux speaker. Cabinet size approx. 30 x 21 x 14in. Attractive covering of two contrasting tones of Rexine and Vynair. Rating 50 watts. Only 29 gns. Or Deposit £3.7.6 and 12 monthly payments 50/-.

Type BG3/2. Suitable Bass and Lead Guitar. Two 12in. high flux 15 ohm 25 watt speakers, one with aluminium speech coil and dual code to provide smooth frequency response from 25 to 17,000 c.p.s. Cabinet size approx. 30 x 21 x 14in. Covered in two contrasting tones of grey Vynair and Rexine. Rating 50 watts. Only 29 gns. Or Deposit £3.7.6 and 12 monthly payments of 50/-.

LARGE REXINE COVERED SPEAKER CABINETS. Heavy block-board construction. Very attractive two tone covering of Rexine and Vynair. Size 30 x 21 x 16in. cut for 15in. or 18in. speaker or for two 12in. 11 gns. or Deposit 25/9 and nine monthly payments 25/9. Size 30 x 30 x 16in. cut for 15in. or 18in. speaker 13 gns. Or Deposit 30/4 and nine monthly payments 30/4. Suitable speakers available.

EX. GOVT. SELENIUM RECTIFIERS 12v 15 AMP 19/9 (BRIDGE) F.W. ONLY

HI-FI 10 WATT AMPLIFIERS
Brand new. Manufacturer's discontinued line. Fitted latest Mullard valves. Dual inputs for "mike" and gram, etc. Bass and Treble Controls. High sensitivity and quality. Output for 3 ohm or 15 ohm speaker. For 200-250 v. A.C.
£7.19.9
Carriage 4/6. Only

ANNOUNCING THE R.S.C. B20 BASS GUITAR AMPLIFIER

A highly efficient unit incorporating a massive 15 in. high flux loudspeaker specially constructed to withstand heaviest load conditions. Rating 25 watts. Individual bass and treble controls give ample "boost" and "cut". Two high impedance jack socket inputs are separately controlled. All controls are conveniently positioned in a recess on top of the cabinet. Cabinet is of substantial construction and attractively finished in two contrasting tones of Rexine and Vynair. Size approx. 24 x 21 x 13in. Operation from 200-250 v. 50 c.p.s. A.C. mains.

Send S.A.E. for leaflet.

29 2/3 Gns. Or Deposit £3.2.0 and 12 monthly payments of 56/10. Carr. 17/6.

EX. GOVERNMENT ACCUMULATORS. Size 7 1/4 x 2 1/2. 2v. 16 A.E. brand new. 6/9 each. 3 for 15/6.

EX. GOVT. SMOOTHING CHOKES. 200 mA. 3-5 H. 50 ohms. Parmeko 8/9; 100 mA. 5 H. 100 ohms 3/11; 150 mA. 10 H. 50 ohms 9/9; 80 mA. 20 H. 900 ohms 5/9; 120 mA. 12 H. 100 ohms 6/9; 50 mA. 50 H. 1,000 ohms 6/9; 100 mA. 10 H. 100 ohms 6/9; 60 mA. 5-10 H. 250 ohms 2/11.

COMPLETE POWER PACK KIT, 19/11
Consisting of Mains Trans., Metal Rectifier. Double electrolytic, smoothing choke chassis and circuit. For 200-250 v. A.C. mains. Outputs 250 v. 60mA. 6.3v. 2a.

R.S.C. POWER PACK, 39/9. Louvered metal case only 8 x 5 1/2 x 2 1/2 ins. Stove enamelled. For 200-250v. A.C. mains Output at 4 pin plug and socket 250 v. 60 mA. fully smoothed and 6.3v. 2a. Suitable for power requirements of almost any Pre-amp or Radio Tuner.

R.S.C. BABY ALARM or INTER-COMM. KIT. Complete set of parts with diagrams, etc. Housed in two polished walnut finished cabinets of pleasing design. High sensitivity. For 200-250 v. A.C. mains. Fully isolated. Controllable at both units. An intercomm. of this class would normally cost £20-£30. Only 79/6. carr. 5/- or assembled ready for use £5.15.0.

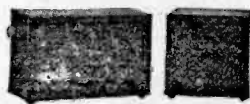

LEICESTER BRANCH NOW OPEN

TRANSISTOR SALE. Mullard OC71 3/9, OC45 4/11, OC44 4/11, OC72 4/9, OC81 4/11, OC71 6/9, Edman XA102 3/9, XB102 3/9, XA112 3/9, XB113 3/9, XB104 3/9, XC101A 3/9. Postage ed. for up to 3 Transistors.

D.C. SUPPLY KIT. 12 v. 1 a. consisting of a partially drilled metal case, mains trans. F.W. Bridge Rectifier, 2 fuseholders and fuses. Change Direction switch, variable Speed regulator and circuit. For 200-250 v. A.C. mains. Suitable for Electric Trains. Limited number available at 29/11

SELENIUM RECTIFIERS
F.W. BRIDGE 24 v. 2 amp. 14/9
6/12 v. 1 a. 3/11 24 v. 20 amp. 89/9
6/12 v. 2 a. 6/11 H.T. TYPES H.W.
6/12 v. 3 a. 9/9 150 v. 40 mA. 3/9
6/12 v. 4 a. 12/3 250 v. 80 mA. 3/11
6/12 v. 6 a. 15/3 250 v. 60 mA. 4/11
6/12 v. 10 a. 28/9 250 v. 80 mA. 5/11
6/12 v. 15 a. 35/9 250 v. 250 mA. 11/9
CONTACT COOLERS. 250 v. 50 mA. F.W. (Bridge). 10/11. 250 v. 50 mA. F.W. (Bridge). 8/11. H.W. 250 v. 60 mA. 5/11.

LINEAR TAPE PRE-AMPLIFIER
Type LP1. Switched negative feedback equalisation Positions for Record 11in. 3in., 7in. and Playback. EM84 Recording Line Indicator. Designed primarily as the link between a Collaro Tape Transcriber and a high fidelity amplifier, but suitable for almost any Tape Deck. Only 9 gns. S.A.E. for leaflet.

HUGE PURCHASE OF BRAND NEW 24 v. 20 Amp. F.W. (Bridge) SELENIUM RECTIFIERS. each **49/9**

R.S.C. (Manchester) Ltd.
LEICESTER: BIRMINGHAM: 32 High St. Half-day Thursday
6 Gt. Western Arcade Birmingham No half-day

SHEFFIELD: 13 Exchange St. Castle Market Bldgs. Sheffield Half-day Thursday
HULL: 51 Savile St., Hull

LIVERPOOL: 73 Dale St. Liverpool 2 Half-day Wednesday
BRADFORD: 56 Morley St. (above Alhambra Theatre) Bradford

MANCHESTER: 8-10 Brown St. (Market St.) Manchester 2 No half-day
LEEDS: 5-7 County (Becca) Arcade Briggate, Leeds Half-day Wed.

MAIL ORDERS to 5 County Arcade, Leeds 1. Terms: C.W.O. or C.O.D. No C.O.D. under £1. Postage 2/9 extra under £2. 4/6 extra under £5. Trade Supplied. S.A.E. with all enquiries please.

R.S.C. (Manchester) Ltd.

LEICESTER: 32 High St. Half-day Thursday

BIRMINGHAM: 6 Gt. Western Arcade (Opp Snow Hill Sta) No half-day

MAIL ORDERS to 5 County Arcade, Leeds 1. Terms: C.W.O. or C.O.D. No C.O.D. under £1. Postage 2/9 extra under £2. 4/6 extra under £5. Trade Supplied. S.A.E. with all enquiries please.

SHEFFIELD: 13 Exchange St. Castle Market Bldgs. Sheffield Half-day Thursday

HULL: 51 Savile St., Hull Half-day Thursday

LIVERPOOL: 73 Dale St. Liverpool 2 Half-day Wednesday

BRADFORD: 56 Morley St. (above Alhambra Theatre) Bradford Half-day Wednesday

MANCHESTER: 8-10 Brown St. (Market St.) Manchester 2 No half-day

LEEDS: 5-7 County (Mecca) Arcade Briggade Leeds Half-day Wed

SENSATIONAL STEREO OFFER

A complete set of parts to construct a good quality Stereo amplifier with an undistorted output total 8 watts. For A.C. mains input of 200-250 v. Including pair matched 6in. speakers. Sensitivity 130 m.v. Ganged Vol. and Tone Controls. Preset balance control. Full instructions and wiring diagrams supplied. Stereo Pickup Head 19/9 extra with above only.

R.S.C. 30-WATT ULTRA LINEAR HIGH FIDELITY AMPLIFIER A10

A highly sensitive Push-Pull high output unit with self-contained Pre-amp. Tone Control Stages. Certified performance figures compare equally with most expensive amplifiers available. Hum level 70 db down. Frequency response ±3 db. 30-30,000 c/s. A specially designed sectionally wound ultra linear output transformer is used with 807 output valves. All components are chosen for reliability. Six valves are used. EF86, ECC83, 807, 807, GZ34. Separate Bass and Treble Controls are provided. Minimum input required for full output is only 12 millivolts that **ANY KIND OF MICROPHONE OR PICK-UP IS SUITABLE.** The unit is designed for **CLUBS, SCHOOLS, THEATRES, DANCE HALLS or OUTDOOR FUNCTIONS,** etc. For use with Electronic ORGAN, GUITAR, STRING BASS, etc. For standard or tone playing records. **OUTPUT SOCKET PROVIDES L.T. and H.T. for a RADIO FEEDER UNIT.** An extra input with associated vol. control is provided so that two separate inputs such as Gram. and "Mike" can be used. Amplifier operates on 200-250 v. 50 c/s. A.C. Mains and has output for 3 and 15 ohm speakers. Complete Kit of parts with fully punched chassis and point-to-point wiring diagrams and instructions. If required perforated cover with carrying handles can be supplied for 19/9. The amplifier can be supplied, factory built with EL24 output valves and 12 months guarantee, for 14 Gns. Send S.A.E. for leaflet.

11 Gns. Carr. 10/-

TERMS: DEPOSIT 33/6 and 9 monthly payments of 33/6. Suitable microphones and speakers available at competitive prices.

WE STOCK ARMSTRONG, DULCI LINEAR and JASON EQUIPMENT GOODMAN'S W.B. and FANE SPEAKERS GARRARD and GOLORING T/ABLES

SUPERHET FEEDER UNIT. Design of a high quality Radio Tuner (specially suitable for use with our Amplifiers). Delayed A.V.C. Controls are Tuning W.Ch. and Vol. Only 250 v. 15 mA. H.T. and L.T. of 8.3 v. 1 amp. required from amplifier. Size approx. 9 x 8 x 7in. High Simple alignment procedure. Point-to-Point wiring diagrams, instructions and priced parts list with illustrations. 2/6. Total building cost £4.15.0. S.A.E. for leaflet.

R.S.C. BATTERY TO MAINS CONVERSION UNITS

Type BM1. An-odd dry battery eliminator. Size 5½ x 4 x 2in. approx. Completely replaces battery supply 1.4 v. and 90 v. where A.C. mains 200-250 v. 50 c/s is available. Suitable for all battery portable receivers requiring 1.4 and 90 v. This includes low current suction types. Complete kit with diagrams. 39/6, or ready to use, 46/6.



Type BM2. Size 8 x 5½ x 2½in. Supplies 120 v. 90 v. and 60 v. 40 mA. and 2 v. 0.4 a. to 1 amp. fully smoothed. Thereby completely replacing both H.T. batteries and L.T. 2 v. accumulators when connected to A.C. mains supply 200-250 v. 50 c/s. **SUITABLE FOR ALL BATTERY RECEIVERS** normally using 2 v. accumulators. Complete kit of parts with diagrams and instructions. 49/6, or ready to use, 59/6.

P.M. SPEAKERS. 10in. W.B. "Stentorian" 3 or 15 ohms type HF 10L2 10 watts, hi-fidelity type. Recommended for use with our All Amplifier. £4.7.6. 12in. R.A. 3 ohms 10 watts (12,000 lines). 59/6.

TWEETERS. Plessey 3in 19/9, 150 25/9.

Jason FMTI V.H.F./F.M. Radio Tuner design. Total costs of parts including valves Tuning dial. Escutcheon, etc., £8.19.9. Other Jason equipment in stock.

LINEAR L45 MINIATURE 4/5 WATT QUALITY AMPLIFIER. Suitable for any record playing unit, and most microphones. Negative feedback 12 db. Separate Bass and Treble Controls. For mains 200-250 v. 50 c/s. Output for 2-3 ohm speaker. Mullard valves E280, ECC83, EL84. Size only 7-5-5½in. high. Guaranteed 12 months. Only £5.19.6. Send S.A.E. for leaflet. Terms: Deposit 22/6 and 5 monthly payments of 22/6.

R.S.C. 4.5 WATT A5 HIGH-GAIN AMPLIFIER

A highly-sensitive 4-valve quality amplifier for the home, small club, etc. Only 50 millivolts input is required for full output so that it is suitable for use with the latest high fidelity pick-up heads, in addition to all other types of pick-ups and practically all "mikes". Separate Bass and Treble Controls are provided. These give full long-playing record equalisation. Hum level is negligible being 71 db. down 15 db. of Negative feedback is used. H.T. of 300 v. 35 mA. and L.T. of 6.3 v. 1.5 a. is available for the supply of a Radio Feeder Unit, or Tape-Deck pre-amplifier. For A.C. mains input of 200-250 v. 50 c/s. Output for 2-3 ohm speaker. Chassis is not alive. Kit is complete in every detail and includes full punched chassis (with baseplate) with Blue Hammer finish and point-to-point wiring diagrams and instructions. Optional value at only £4.15.0, or assembled ready for use 25/- extra. Plus 3/6 carr., or deposit 22/6 and 5 monthly payments of 22/6 for assembled unit.

NOW OPEN AT LEICESTER

R.S.C. GRAM. AMPLIFIER KIT. 3 watts output. Negative feedback. Controls Vol. Tone and Switch. Mains operation 200-250 v. A.C. Fully isolated chassis. Circuit, etc., supplied. Only 39/9, Carr. 3/9.

THE SKYFOUR T.R.F. RECEIVER A design of a 3 valve long and medium wave 200-250 v. A.C. Mains receiver with selenium rectifier. High gain H.F. stages and low distortion detector. Valve line-up 6K7, 5P61, 6V8G. Selectivity and quality excellent. Simple to construct. Point-to-point wiring diagrams, instructions and parts list 1/9. Maximum building costs £4.19.6. Inc. attractive Walnut veneered wood cabinet 12 x 6½ x 5½in.

MULTI-METERS, CABY MI. Sensitivity 2,000 ohms per volt. A.C. and D.C. 50/-.

A.10. Basic Meter sensitivity 155 micro-amps A.C. and D.C. ranges £4.17.6

B.20. Sensitivity up to 10,000 ohms per volt A.C. and D.C. £6.10.0. 30,000 ohms per volt £8.19.6.

R.S.C. JUNIOR HI-FI REPRODUCER. The very latest Goodmans Axlette 8 High Fidelity loudspeaker (retailing at approx. 5 gns.) fitted in a specially designed Bass Reflex cabinet 12 x 12 x 10 in. Acoustically lined and ported and finished in polished walnut veneer. Matching impedance 15 ohms. Frequency range 40-15,000 c.p.s. Power handling 6 watts nominal. Ideal for Stereo. Limited number. Carr. 4/6

8 Gns.

12in. 10 WATT HIGH QUALITY LOUDSPEAKER

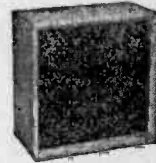

In walnut veneered cabinet. Gauss 12,000 lines. Speech coil 3 ohms or 15 ohms. Only £4.19.6 Carr. 5/-. Terms: Deposit 11/3 and 9 monthly payments of 11/3.

12in. 20 WATT HI-FI LOUD-SPEAKERS IN CABINETS. Size as above. Terms: Deposit 17/9 and 9 monthly payments of 17/9. Only £7.19.6. Carr. 8/6.

For larger types see page 103.

R.A. 12in. DUAL CONE 3 ohm 8 watt Speakers. Ideal for Stereo. Only 39/9 ea.

R.S.C. BASS REFLEX CABINETS, JUNIOR MODEL. Specially designed for W.B. HF1012 Speaker, but suitable for any good quality 10in. speaker. Acoustically lined and ported. Polished walnut veneer finish. Size 18 x 12 x 10in. Handsome appearance. Ensure superb reproduction for only £3.19.6.

STANDARD MODEL. As above but for 12in. speakers. Size 20 x 15 x 13in. For vertical or horizontal use. £5.19.6. Suitable legs with brass ferrules, 19/6 per set of 4.

R.S.C. CORNER CONSOLE CABINETS

Polished walnut veneer finish. Pleasing design. **JUNIOR MODEL.** Size 20 x 11 x 8in. for 8 x 5in. or 10 x 6in. speakers. £2.9.9.

STANDARD MODEL. Size 27 x 18 x 12in. for 8 or 10in. speakers. £4.11.9.

SENIOR MODEL. Size 30 x 20 x 15in. for 12in. Speaker. Suitable Speaker systems below. Only 7 gns.



AUDIOTRINE HI-FI SPEAKER SYSTEMS. Consisting of matched 12in. 12,000-line, 15 ohm high quality speaker; cross-over unit (consisting of choke, condenser, etc.) and Tweeter. The smooth response and extended frequency range ensure surprisingly realistic reproduction. Standard 10 watt rating £4.19.9. Carr. 5/- Or Senior 15 watt. 7/6.

AUDIOTRINE EQUIPMENT CABINETS

Size 35 x 15 x 19in. Beautiful walnut veneer finish. Elegant contemporary design. Robust construction. Uncut removable baseboard. Depth above Only 13 gns. baseboard 5". Carr. 15/-

Terms: Dep. 29/6, and 9 mthly. pymts. 29/9



AUDIOTRON HI-FI TAPE RECORDER KIT

REALISM AT INCREDIBLY LOW COST, CAN BE ASSEMBLED IN AN HOUR

Incorporating the latest Collaro Studio Tape Transcriber. The audiotrone High Quality Tape Amplifier with negative feedback equalization for each of 3 speeds. High Flux P.M. Speaker, empty Tape Spool, a Reel of Best Quality Tape and a Handsome Portable Carrying Cabinet with latest attractive two-tone polychrome finish, size 14 1/2 x 15 x 8 1/2 in. high and circuit. Total cost if purchased individually approximately £40. Performance equal to units in the £80-£80 class. S.A.E. for leaflets. **TERMS.** Deposit £2.13.9 and 12 monthly payments of 44/-. Cash price if settled in 3 months.

25 1/2 GNS. Carr. 17/6



HIGH FIDELITY 12-14 WATT AMPLIFIER TYPE A11

PUSH-PULL ULTRA LINEAR OUTPUT "BUILT-IN" TONE CONTROL PRE-AMP STAGES

Two input sockets with associated controls allow mixing of "mike" and gram, as in A.10. High sensitivity. Includes 5 valves, ECC83, ECC83, EL84, EL84, EZ81. High Quality sectionally wound output transformer specially designed for Ultra Linear operation and reliable small condensers of current manufacture. **INDIVIDUAL CONTROLS FOR BASS AND TREBLE** "Lift" and "Cut". Frequency response ± 3 D.B. 30-30,000 c/s. Six negative feedback loops. Hum level 80 D.B. down. **ONLY 23 millivolts INPUT REQUIRED FOR FULL OUTPUT.** Suitable for use with all makes and types of pick-ups and microphones. Comparable with the very best designs. For **STANDARD or LONG PLAYING RECORDS.** For **MUSICAL INSTRUMENTS** such as **STRING-BASS, GUITARS, etc.**

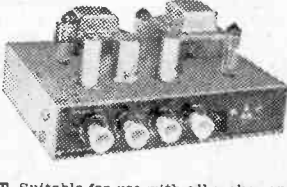

OUTPUT SOCKET with plus provides 300 v. 30 mA. and 6.3 v. 1.5 a. For supply of a **RADIO FEEDER UNIT.** Size approx. 12.9-7 in. For C. mains 200-250 v. 50 c/s. For 3 and 15 ohms speakers. Kit is complete to last nut. Chassis is fully punched. Full instructions and point-to-point wiring diagrams supplied. **Only 8 Gns. Carr. 10/-** (Or factory built 51/- extra).

If required louvered metal cover with 2 carrying handles can be supplied for 18/9. **TERMS ON ASSEMBLY LITS. DEPOSIT** 24/9 and 9 monthly payments of 24/8. Send S.A.E. for illustrated leaflet detailing Ready-to-assemble Cabinets, Speaker, Microphones, etc., with cash and credit terms.

B.S.R. MONARDECK TAPEDECKS. Speed 3 1/2 in. per sec. With high quality recording heads. £8.19.6 Carr. 5/- Cabinets to take Deck and amplifier 39/6.

R.S.C. TRANSISTORISED GRAM. AMPLIFIER. Output 1 watt, for 3 ohm speaker. Transistors Mullard OC71, OC81D, OC81, OC81. Potted Vol. Control with switch. Assembled and tested. Suitable for any normal crystal pick-up. **Only 59/9.**

R.S.C. STEREO/TW HIGH QUALITY AMPLIFIER

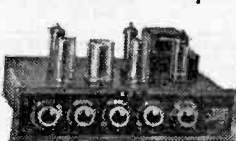

A complete set of parts for the construction of a stereophonic amplifier giving 5 watts high quality output on each channel (total 10 watts). Sensitivity is 50 millivolts, suitable for all crystal stereo heads. Ganged Bass and Treble Control give equal variation of "lift" and "cut". 10-watt amplifier. Valve line-up ECC83, ECC83, EL84, EL84, EZ81. Outputs for 2-ohm speakers. Point-to-Point wiring diagrams and instructions supplied. Send S.A.E. for leaflet. **8 Gns. Carr. 10/-** Full constructional details and price list 2/6. Carr. 10/-.

Kit can be supplied assembled ready to use for 59/6 extra.

ONLY 3 PAIRS OF SOLDERED JOINTS PLUS MAINS

SPECIAL NOTE. The Tape Decks we supply are latest models. Where customers already have a Deck or wish to use one of those being offered cheaply we can supply Kit less Deck at 13 gns. cash. 10/- Or deposit 2 gns. and 12 monthly payments 23/9. Also if required we can supply in lieu of portable cabinet and 7 x 4 in. speaker, the Equipment Cabinet illustrated at foot of opp. page and a high flux 8 x 5 1/2 in. speaker for 8 gns. extra.

HI-FI CRYSTAL PICK-UP HEADS. (Cartridges.) Acos Standard replacement for Garrard, B.S.R. and Collaro. 16/9. Acos Stereo-Monaural 59/8. Ronette Stereo-Monaural 59/8. B.S.R. Stereo 39/9. **BRADAMATIC RECORDING HEADS.** High Impedance Record/Playback 22/- Low Impedance Erase. 12/6.

PICK-UP ARMS. Complete and with latest Cosmo/h-i-f Turner Cartridge 29/11. **CRYSTAL MICROPHONES.** Hand Type NP110 14/6, R.T.C. 18/9, Acos Mic 40 26/9, Acos Mic 45 29/9, Stick type Acos 39-1 39/9, BM3 with neck band and heavy table stand 59/8. Label type 35/9. **COLLARO JUNIOR** 4-speed Single Player Unit and Crystal Pick-up with hi-fi Turnover head. **Only £13.19.6.**

B.S.R. UA14 4-sp'd AUTO-CHANGERS with hi-fi turnover head. £6.19.6 Carr. 4/6. **GARRARD AUTO-SLIM 4-SPEED AUTO-CHANGER** with high fidelity pick-up. Latest model For 200-250 v. A.C. mains. £7.19.6 Carr. 4/6. **GARRARD AT6 AUTO-SLIM DE-SPED AUTO-CHANGERS.** Turnover GCS head, for 200-250 v. A.C. mains. 11 gns.

GL3A MINIATURE 2-3 WATT GRAM AMPLIFIER. For use with any single or auto-change unit. Output for 2-3 ohm speaker. For 200-250 v. A.C. mains. Size 1 1/2 x 2 1/2 in. Controls: Vol. and Tone with switch. **Only 59/6.**

R.S.C. BATTERY CHARGING EQUIPMENT

All for A.C. Mains 200-250v., 50 c/s. Guaranteed 12 months.

HEAVY DUTY CHARGER KIT 6/12 v. 6 amps. variable output. Consisting of Mains Transformer 0-200-230-250 v. F.W. (Bridge) Selenium Rectifier; Ammeter; Variable Charge Rate Selector Panels, Plugs, Fuses, Fuseholder and circuit. 59/9. Carr. 4/6.

CHARGER KIT, 12v. 14 AMP or 24v. 7 amp. Consisting of mains trans. 200-230-250 v. F.W. (Bridge) selenium Rectifier, F. Ammeter, Fuses, Variable Resistor and Circuit. **Only 6 gns. Carr. 15/-.** Please state if 12v. or 24v. kit required.

SOLDERING IRONS. 230-250 v. 30 watts. First quality. For Radio work. 18/8. Spare elements and bits available.

Assembled 4-5 amps. 6/12 v.

Fitted Ammeter and variable charge rate selector. Also selector plug for 6 v. or 12 v. charging. Louvered steel case with stoved blue hammer finished. Fused and ready for use with mains and output leads. Carr. 5/- Terms: Deposit 13/8 and 5 monthly payments 13/3. 6/12 v. 3a., all facilities as above. **Only 59/9. Carr. 3/9.**

ASSEMBLED 12v. 10 AMP with variable charge rate adjustment, ammeter and strong louvered, stove enamelled case. Ready for use. **Only 7 gns. Carr. 10/- or in Kit Form 5 gns.**

ASSEMBLED 6/12 v. 2 amps.

Fitted Ammeter and selector plug for 6 v. or 12 v. Louvered metal case finished attractive hammer blue. Fused, ready for use with mains and output leads. Carr. 3/9 **49/9 Carr. 3/9** 6/12v. 1 amp. 27/9 Less meter.

BATTERY CHARGER KITS Consisting of Mains Transformer, F.W. Bridge, Metal Rectifier, all ventilated steel case, Fuses, Fuseholders, Grommets, panels, Heavy Duty Clips, circuit. Carr. 3/6 extra 6v. or 12v. 1 amp. 22/9 As above, with Ammeter 23/9 6 v. 2 amps. 18/9 6v. or 12v. 2 amps. 25/9 6 v. or 12 v. 2 amps. inclusive of Ammeter. 35/9 6 v. or 12 v. 4 amps. 45/9 6 v. or 12 v. 4 amps. with Ammeter and variable charge rate selector. 52/9

CHARGER AMMETERS 0-1.5 a., 0-3 a., 0-4 a., 0-7 a., 0-60 a., 0-80 ea.

R.S.C. MAINS TRANSFORMERS (FULLY GUARANTEED)

Interwound and Impregnated. **Primaries 200-230-250 v. 50 c/s. screened.**
TOP SHROUDED DROP THROUGH
 250-0-250v. 70mA. 6.3v. 2a., 0-5-6.3v. 2a. 17/9
 350-0-350v. 80mA. 6.3v. 2a., 0-5-6.3v. 2a. 18/9
 250-0-250v. 100mA. 6.3v. 2a., 6.3v. 1a. 21/9
 250-0-250v. 100mA. 6.3v. 4a., 0-5-6.3v. 3a. 23/9
 250-0-250v. 100mA. 6.3v. 4a., 0-5-6.3v. 3a. 25/9
 300-0-300v. 130mA. 6.3v. 4a., 6.3v. 1a. for Mullard 510 Amplifier. 29/9
 300-0-300v. 100mA. 6.3v. 4a., 0-5-6.3v. 3a. 26/9
 350-0-350v. 100mA. 6.3v. 4a., 0-5-6.3v. 3a. 26/9
 425-0-425v. 200mA. 6.3v. 4a., 5v. 3a. 49/9
FULLY SHROUDED UPRIGHT
 250-0-250v. 60mA. 6.3v. 2a., 0-5-6.3v. 2a. Midret type 2j-3j1n. 17/11
 250-0-250v. 100mA. 6.3v. 4a., 0-5-6.3v. 3a. 27/9
 300-0-300v. 100mA. 6.3v. 4a., 5v. 3a. 27/11
 300-0-300v. 100mA. 6.3v. 4a., C.T. 6.3v. 1a. for Mullard Amplifier. 33/9
 350-0-350v. 100mA. 6.3v. 4a., 5v. 3a. 27/11
 350-0-350v. 150mA. 6.3v. 4a., 5v. 3a. 35/9

FULLY SHROUDED (continued)-
 425-0-425v. 200mA. 6.3v. 4a., C.T. 5v. 3a. 55/-
 425-0-425v. 200mA. 6.3v. 4a., C.T. 6.3v. 59/9
 4a., C.T. 5v. 3a. 59/9
 450-0-450v. 250mA. 6.3v. 4a., C.T. 5v. 3a. 69/9
OUTPUT TRANSFORMERS
 Midret Battery Pentode 68 : 1 for 354, etc. 4/8
 Small Pentode, 5000 Ω to 3 Ω 4/8
 Small Pentode 7/8, 900 Ω to 3 Ω 4/8
 Standard Pentode 5,000 Ω to 3 Ω 5/9
 Standard Pentode 7,000 Ω to 3 Ω 5/9
 Push-Pull 8 watts, EL84, or 6V6 to 3 Ω or matched to 15 Ω 9/9
 Push-Pull 10-12 watts to match 6V6 or EL84 to 3-5 Ω or 15 Ω 19/9
 Following types for 3 and 15 Ω speakers:
 Push-Pull 10-12 watts 6V6 or EL84 18/9
 Push-Pull 15-18 watts, 6L6, KT66 22/9
 Push-Pull Mullard 510 Ultra Linear 28/9
 Push-Pull 30 watts, sectionally wound, 6L6, KT66, EL34, etc. 49/9

MIDGET MAINS Primaries 200-250 v. 50 c/s. 250 v. 60 mA. 6.3 v. 2a. 11/9
 250-0-250 v. 60 mA. 6.3 v. 2a. 12/11
 Both above size 2 1/2 x 2 1/2 in.
FILAMENT TRANSFORMERS
 All with 200-250 v. 50 c/s. primaries 6.3 v. 1.5a. 5/9; 6.3 v. 2a. 7/6; 0-4-6.3 v. 2a. 7/8; 12 v. 1 a. 7/11; 6.3 v. 3 a. 8/11; 6.3 v. 6 a. 17/6; 12 v. 1.5 a. twice, 17/6.
SMOOTHING CHOKES
 150 mA. 10 H H 250 ohms 11/9
 100 mA. 10 H 200 ohms 9/9
 80 mA. 10 H 350 ohms 5/9
 60 mA. 10 H 400 ohms 4/11
CHARACTER TRANSFORMERS
 All with 200-250 v. 50 c/s. Primaries:
 0-9-15 v. 14 a. 12/9; 0-9-15 v. 2a. 14/8; 0-9-15 v. 3 a. 16/9; 0-9-15 v. 5a. 19/9; 0-9-15 v. 6 a. 23/9; 0-9-15 v. 8 a. 28/9.
 Upright (Step up/Step down) TRANS. 0-110-120-200/250 v. 50-80 watts, 13/8; 250 watts, 38/9; 150 watts, 27/9.
MICROPHONE TRANSFORMERS
 120 : 1 high grade, clamped, 6/9; 120 : 1 Plotted, Mu-metal screened, 9/8.

UNIVERSAL AVOMETERS

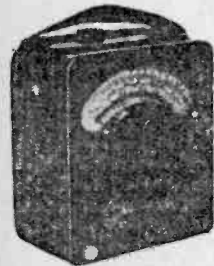

Guaranteed perfect working order. Supplied complete with leads, batteries and instructions. Model "B" 34 range £8.19.6 Model "7" 50 range £11.0.0 Registered Post 5/- extra.

MICROAMMETERS

0-500 microamps. 2Hn. circular flush panel mounting. Dials engraved, 0-15, 0-600 volts. BRAND NEW. BOXED. 15/- P.P. 1/6.

7.5 K.V.A. AUTO TRANSFORMERS

0-115-230 volts. Brand new boxed. £15. Carriage 10/-.

230/250 VOLT A.C. MOTORS
4 1/2 x 3 1/2 in. dia. 90 watts, 5,000 r.p.m. 1/2 in. spindle. 22/6. P.P. 1/6.

1 K.V.A. ISOLATION TRANSFORMERS

230 v. Pri.: 230 v. Sec. Boxed, £5 each. Carriage 10/-.

VARIAC TRANSFORMERS
24 amp., 230 volt primary, 185 to 250 volt output, £12.10.0. Carriage 10/-.

TELEPHONES TYPE "H"
Sound powered, generator bell ringing, 2 line connection. Fully tested, £4.19.6 pair. Carr. 5/-.

HELIPOTS

Available in the following sizes, 10kΩ, 50kΩ, 10k + 2kΩ. All new, boxed, 22/6 each. P.P. 1/3.

3000 WATT AUTO TRANSFORMERS

0-115-230 volts, step-up or step-down. Brand new, boxed ex U.S.A. £7.10.0 each. Carr. 10/-.

PANEL METERS

100μA	2 1/2"	F.M.	D.C.	42/6
1000μA	3"	F.M.	D.C.	62/6
1 mA	2 1/2"	F.M.	D.C.	25/-
300/30 mA	2 1/2"	F.M.	D.C.	9/6
350 mA	2 1/2"	F.M.	D.C.	10/6
300 v.	2 1/2"	Proj.	A.C.	19/6
300 v.	2 1/2"	F.M.	A.C.	25/-
500 v.	2 1/2"	F.M.	A.C.	25/-
125 v.	3 1/2"	F.M.	D.C.	32/6
1500 v.	2 1/2"	Electrostatic		25/-

FIELD TELEPHONES TYPE "F"

Suitable for many applications. Generator bell ringing, 2 line connection. With batteries and wooden carrying case, fully tested, £4.19.6 per pair. Carr. 5/-.

SUB-STANDARD D.C. AMMETERS

9 ranges, 150mA, 1.5A, 3A, 7.5A, 15A, 30A, 60A, 300A, and 450A. Housed in trunk portable case. 8 1/2 in. rml rml scale. Supplied brand new with all shunts and leather carrying case. £15 each. P.P. 10/-.

P.C.R.2 RECEIVERS

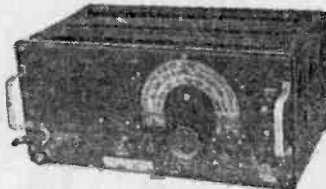

800-2,000 metres, 130-550 metres 6-22 Mc/s. output for phones or 3 Ω speaker. As new £5.19.6. Carr. 10/6. P.C.R.3 as P.C.R.2 but covers 130/550 metres, 2-7 Mc/s. 7-22 Mc/s, including top band. As new £8.8.0. Carr. 10/6. All above models can be supplied with internal power unit to operate on 200/250 v. A.C. at 39/8 extra or alternatively plug-in external power units are 35/-.

NATIONAL H.R.O. RECEIVERS



200/250 volt A.C. power packs for above receiver, also sold separately, 59/8. Carr. 5/-.

SENIOR MODEL. Supplied complete with full set of 9 coils covering 50 kc/s. to 30 Mc/s. Each receiver thoroughly checked and available as follows: TABLE MODEL. As new condition £25. TABLE MODEL. Extremely good used condition £18.19.0. RACK MODEL. Extremely good used condition £18.18.0. Carriage £1 extra.

PRECISION COMBINATION VOLTMETER/AMMETER FOR A.C. AND D.C.

Two separate instruments housed in polished wood case. 6in. scales with knife edge pointers. Ranges: Volts A.C. and D.C. 160-300-800 v. Amps. A.C. and D.C. 25-50-150-200 A. Supplied complete with all current shunts, leads and leather carrying case. Manufactured by Elliott Bros. Supplied brand new. £8.19.6 each. Carriage 7/6.

HALLICRAFTER S-36A V.H.F. RECEIVERS

F.M./A.M. 27-149 Mc/s. 110/230 volt A.C. operation. Improved version of S-27. Tested before despatch. Brand new, boxed, with instruction manual. **£40** each. Carr. £2.

MINE DETECTOR No. 4A

Will detect all types of metal. Fully portable. Complete equipment supplied tested with instructions. 39/8. Carriage. 10/6. Battery 8/6 extra.

COLLARO STUDIO TAPE TRANSCRIBOR

Brand new 1962 model. 3 speeds, 3 motors, digital counter, etc. With latest Bradmatic heads and interlock button. Supplied with spare spool, instructions, fixings, 10 kns. each. Carr. paid.

FABULOUS TAPE OFFER

Famous American Brand Tapes. Brand new, fully guaranteed. 5in.—800ft., 10/6, 5in.—300ft., 13/6, 5in.—1200ft., 17/6, 7in.—1200ft., 13/6, 7in.—1800ft., 18/6, 7in.—2400ft., 27/6, P. & P. extra. S.A.E. for full tape list.

CT-53 SIGNAL GENERATORS

Precision instruments covering 8.9 to 15.5 Mc/s. and 20 to 300 Mc/s. on 6 bands. Variable attenuator from 1 microvolt to 100 millivolts. Operation 110/200/250 volts A.C. Supplied in perfect working order. Complete with calibration charts, 19 kns. each. Carriage 10/6.



MARCONI CR100/8 RECEIVERS BRAND NEW

Packed in original transit cases and complete with handbook/manual. 60 kc/s to 30 Mc/s. 200/250 volt A.C. operation. Tested before despatch. **£35** Carriage £2.

Hours of Business: 3 LISLE STREET, 9 a.m.—6 p.m. Half Day Saturday 34 LISLE STREET, 9 a.m.—6 p.m. Half Day Thursday

JEMCO 4,000 OHM/VOLT TESTMETER

1% Precision Resistors throughout. Single control system for all ranges. Highly accurate. Sensitivity 4,000 Ω/volt A.C. and D.C.



Ranges:
D.C. volts: 0-10-50-250-500-1,000v.
A.C. volts: 0-10-50-250-500-1,000v.
D.C. current 0-250 μA
0-25-500mA
Resistance: 0-30k Ω
0-300k Ω
0-3M Ω
Decibels: -20 to +38 dB (2 ranges)

Meter sensitivity: 100 microamp. 59/8 each P.P. 2/6.

JEMCO 20,000 OHM/VOLT TESTMETER

As above but with increased sensitivity and extended resistance range (0-5M Ω). 87/8 P.P. 2/6. Either type brand new. Guaranteed with leads, prods, batteries, instructions.

L.T. METAL RECTIFIERS

All full wave, bridge connected. Brand new, guaranteed.
12/18v. 1.5A. 3/9 24/36v. 4A. 22/6
12/18v. 2.5A. 6/3 24/36v. 15A. 45/-
12/18v. 4A. 8/3 36/48v. 2A. 19/6
12/18v. 6A. 12/3 36/48v. 4A. 22/6
12/18v. 10A. 22/6 36/48v. 6A. 22/6
12/18v. 15A. 37/8 48/60v. 2A. 21/-
24/36v. 1A. 7/3 48/60v. 10A. 82/6
Please add postage.

L.T. TRANSFORMERS

All primaries tapped 200/250 volts.
1 Battery Charging, 3.5, 9 or 17 volt. 1 amp. 9/9. Ditto 2 amp., 14/3. Ditto 4 amp., 18/8. 9 or 17 volt. 6 amp. 26/-.
2 Model Type 3, 4, 5, 6, 8, 10, 12, 15, 18, 20, 24 or 30 volt. 2 amp., 18/8. Ditto 4 amp., 27/8. Ditto 5 amp., 37/8. Add Postage.

MINIATURE MODEL ACCUMULATORS

Lead Acid. BRAND NEW. 2v. 1.5 A.H., 4 x 1 1/2 x 1 1/2 in., 11b. 5/8. P.P. 1/3. 12v. 0.75 A.H., 4 x 3 x 1 1/2 in., 21b. 15/8. P.P. 1/6.

R.C.A. PLATE TRANSFORMERS

Pri. 200/250 v. sec., 2,000-0-2,000 v. 500 mA. tapped 1,500 v. New. Boxed, £6.10.0. Carriage 15/-.

DUMONT K1051P DOUBLE BEAM C.R.T.

Twin Gun. Brand new, boxed, 59/8. P.P. 3/6.

1.2 Ohm 12 Amp RHEOSTAT

Gearred slider type, new, boxed, 15/8 each. P.P. 3/6.

MARCONI TF-885 VIDEO OSCILLATORS

25c/s-5Mc/s. Supplied in guaranteed as new condition. £80 each.

H.R.O. DIALS

Brand new, 27/6. P.P. 2/6.

MINIATURE PANEL METERS

For 1 1/2 in. dia. panel hole.
0-50 μA 39/8 0-300 v. D.C. 27/6
0-500mA 32/8 "S" meter 35/8
0-1 mA 27/6 "VU" meter 42/8
0-5 mA 27/6

Send S.A.E. For Bargain Lists

G.W. SMITH & CO (RADIO) LIMITED
Phone GERRARD 8204/9155
Cables SMITHEX LESQUARE
3-34 LISLE STREET LONDON W.C2

SUCCESS

The SINCLAIR SLIMLINE has proved itself. Over a thousand constructors have already built this wonderful little receiver and dozens have written to let us know how pleased they are. The reasons for this enormous success are simple:

1. The Sinclair Slimline is the smallest receiver of them all, only 2½ x 1½ x ½in. Yet in performance and design it far surpasses sets many times as large.
2. Using only its internal ferrite rod aerial it will receive all stations on the medium wave band including Home, Light, Third, Luxembourg and dozens of continental transmissions.
3. Elegant deep royal blue case with gold lettering and calibrated dial in gold on white. Both designed by a professional artist.
4. The earpiece provided gives superb reproduction free from noise or distortion and sufficient volume even for use in a car.
5. All the components are brand new and MICRO-ALLOY TRANSISTORS are employed throughout.
6. The completely new reflex circuit developed by Sinclair Radionics engineers results in a radio with the sensitivity and selectivity of a good superhet but with no alignment problems.
7. Well illustrated, superbly clear instructions are provided.
8. A carefully designed printed circuit board, on which all the components are mounted, is supplied.
9. Assembly is perfectly straightforward and simple even for a complete beginner yet the brilliant performance will more than satisfy the expert.

A complete book on MAT'S entitled "22 TESTED CIRCUITS USING MICRO-ALLOY TRANSISTORS" is available from us at 5/9 including postage.

Prices of MAT's remain

MAT 100 and MAT 120 .. 7/9	} POST FREE
MAT 120 and MAT 121 .. 8/6	



TOTAL COST

49/6 P.P.1/6

Just two of the many letters we have received. The originals may be seen at our Cambridge office.

Dear Sirs,

I have just built your Transistor Micro-Radio the "Slimline" and I'm amazed at the results. So far I've got about 10 stations including AFN, Stuttgart and Munich. I've built many sets but this one leaves them all standing "

*Thanking you,
H.S., Watford.*

Dear Sirs,

I have received delivery of the "Sinclair Slimline" and have completed assembly. The quality of reproduction for both voice and music obtained with your circuit is so delightful that I do not overstate when I say that I have lost interest in the other more conventional transistor sets that I have built. I have one good quality sound reproducer, which I described some years ago in the technical press, but have found that I can obtain an equal effect for personal listening with the "Sinclair Slimline".

I should be favoured to receive a further kit when more are available (I assume the demand will be high and shall be glad to take my turn). I enclose a cheque in payment for this further order.

*Yours faithfully,
J.F., Glasgow.*

We would like to thank all those constructors who have written us such pleasant letters and to apologise for slight delays in delivery which have occurred owing to the overwhelming demand. However we have now increased our staff to cope with this and can give a very prompt service.

SEND FOR YOUR 'SLIMLINE' TODAY TO:—

SINCLAIR radionics LTD

69 HISTON ROAD, CAMBRIDGE

"ROAMER" 7 (5 Wavebands)

PERFORMANCE WILL AMAZE YOU!

★ (7 Transistor plus 2 Diode design)

- ★ Med/Long Waves, Trawler Band and 2 S.W. to approx. 17 metres.
 - ★ Rich-toned heavy duty 5in. Speaker
 - ★ Fine for car radio use.
 - ★ Telescopic aerial for S. Waves.
 - ★ FERRITE ROD AERIAL FOR M/L.
 - ★ Full After Sales Service.
 - ★ Air spaced ganged Tuning Condenser.
- Total cost parts **£7.9.6** P.P 5/6.
- ★ Push-Pull output for room filling volume.
 - ★ Simulated hide case with gilt trim fitted with shoulder & hand straps.
 - ★ Case size 9 x 7 x 4in. approx.
 - ★ Parts price list and data 3/-.

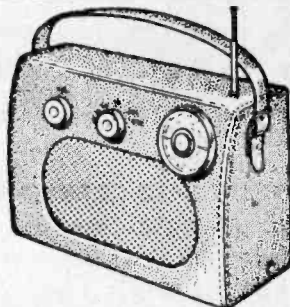

THE SUPER SEVEN

★★ (7 Transistors plus 2 Diodes)

- ★ 2 R.F. STAGES.
- ★ Coverage of Medium, Long Waves, Trawler Band.
- ★ Telescopic aerial for Trawler Band.
- ★ Use as domestic radio, car radio or fit with strap for carry-about.
- ★ No aerial required.
- ★ 3-inch speaker but will drive a larger speaker.
- ★ Push-Pull Output.

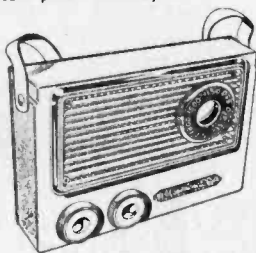

SIZE: 7½ x 5½ x 1½ in.

May be built for **£6.5.0** plus 3/6 post, etc.

PARTS PRICE LIST AND EASY BUILD PLANS 2/-

NEW TRANSONA-6

★ (6 Transistors, plus 2 Diodes, 8-Stage)
★ MW/LW

Powerful magnet 3in. high grade speaker. Push-pull transformers. This is a top performing receiver. Many stations listed in one evening including Luxembourg loud and clear. A pleasure to listen to. **FERRITE ROD AERIAL.** All parts sold separately, grille in red. Uses 9 volt battery.

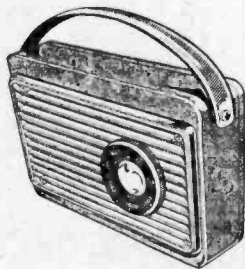

Total building cost **£3.19.6** P.P. 3/-. Size 6½ x 4½ x 1½ in.

"Luxembourg as loud as local. Your easy build diagram helped a lot... my first attempt."—H. S., Penzance, Cornwall (poor reception area).

PARTS PRICE LIST AND EASY BUILD PLANS 1/6

All components used in our receivers may be purchased separately if desired.

AFTER SALES SERVICE

Radio Exchange Co.

27 HARPUR STREET, BEDFORD

Phone: 2367
10 a.m.—1 p.m. Sat. Opp. Co-op.

"POCKET-5"

(MW/LW and TRAWLER BAND) (7 Stages)
(5 Transistors, plus 2 Diodes)

Designed round supersensitive **FERRITE ROD AERIAL** and fine tone moving coil speaker. Attractive case in black with speaker grille in red. On test, Home, Light, Radio Luxembourg and many Continental stations were received.



Total cost of all parts required **£2.19.6** P.P. 3/-.

EASY BUILD PLANS AND PARTS PRICE LIST 1/6

PUSH-PULL FIVE

(5 Transistors, plus 2 Diodes 7 Stage)

- ★ 2½in. Super-tone Loudspeaker.
- ★ Ferrite rod aerial.
- ★ Tuning condenser.
- ★ Volume control
- ★ Case with speaker grille in red.
- ★ Fully tunable over med/long waves.
- ★ Simple assembly diagrams.
- ★ 250 Milliwatts Push-pull output.

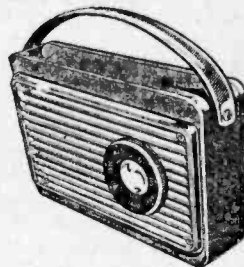

Can be built for **59/6** P.P. 3/-.

★ PARTS PRICE LIST, etc. 2/-.

"Home, Light, AFN, Lux., all at good volume."—G. P., Durham.

"ROAMER-6"

5 Wavebands
(M/L, T.B. and 2 S.W.)

Uses 6 top grade transistors plus 2 diodes. 5in. Speaker. Ferrite rod aerial for sensitivity. Telescopic aerial for short waves. Handsome case with gilt fittings size 9 x 7 x 4in. approx. Listen to stations half a world away.

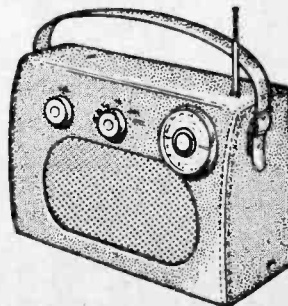

Total cost of parts **£6.19.6** Post & Packing 5/6.

Plans, parts price list 3/-.

POST FREE MAIL ORDER SERVICE

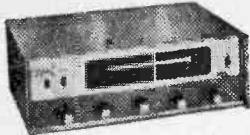

"EAGLE-PIONEER" AUDIO MASTER FM.B100

Will delight the most critical enthusiast. Has many features—tuners for MW, SW and FM, an output of 10 watts, microphone input and complete facilities for Hi-Fi reproduction and simultaneous recording on to tape. Supplied complete. Price £67.10.0. S.A.E. for leaflet.

All goods sent by return

PORTABLE MAINS SOLDERING IRON SP.1

30 watts. Features removable handle that covers tip and barrel. Complete for 18/9.



SIGNAL INJECTION PROBE IT.I.1.



Push button operation. Ideal for making rapid checks on radios, TV, Amps, tuners, etc. Price 42/6.

Full range of Eagle Products always in stock



MULTI-METERS

All complete with test leads, batteries and instructions.

Model EP.100K. 100,000 O.P.V. A handy size high sensitivity multi tester, with shockproof 9.5µA meter. Ranges D.C. volts, A.C. volts, D.C. amps, Ohms, etc. Size 5g x 3g x 2 1/4in. Originally £14.14.0. **RELEA EXCLUSIVE OFFER UNOBTAINABLE ELSEWHERE** **£6.19.6**

EP.80K. 50,000 O.P.V. complete £9.19.6
EP.80K. 30,000 O.P.V. complete £6.19.6
EP.10K. 10,000 O.P.V. in Kit form £3.9.6
TK.20A. 1,000 O.P.V. Complete £2.9.6
S.A.E. for leaflets

All goods available as previously advertised

No. 19. 2-8 Mc/s TRANSMITTER RECEIVER

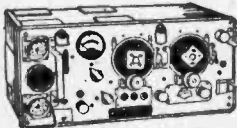

This most famous Army Trans/Receiver covers 2-8 Mc/s. (100-37 metres in two bands). Has an intercom. amplifier. Designed for 12 and 24 volt operation but supplied with "P.W." Mains conversion details. Uses a 6 valve superhet. receiver, I.F. being 465 Kc/s, and a 6 valve transmitter designed for voice and C.W. operation. Incorporates

test and tuning meter for voltage, aerial loading and current tests. Panel Controls: Frequency tuning, P.A. tuning, Gain control, MCW, CW, R/T switch, Het-tone netting, Off-on Quench aerial, AVO LT-HT—Drive tests. Supplied complete with valves and instruction book. Only 79/-.

PANEL METERS



"B" Meter Model 35/-; DC Microammeters, 5 m/s, 27/6; 300 μ A, 27/6; 0-50µA, 29/6; 0-500µA, 32/6; DC Milliammeter, 0-1mA, 27/6. Clear Plastic or Black Bakelite. Will fit 1 1/2in. dia. cut out. Also new Edgewise standard stand adaptor permitting tilting for multi-angle use. Bath chrome finish. EW.16. 0-200µA, 69/6; 0-1mA, 69/6. All boxed and fully guaranteed.

VISIT OUR HI-FI SHOWROOM AT 87, TOTTENHAM CT. RD., W.I

3-WAY SLIM CRYSTAL MICROPHONE

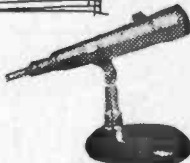

MODEL 100C. May be hand-held, floor stand or desk stand mounted or suspended by lavalier cord. Response 60-10,000 cps. Built in on/off Switch. Output level — 22dB. Omni-directional head. Clips on or off standard stand adaptor permitting tilting for multi-angle use. Bath chrome finish. Supplied complete with table stand, cable and lavalier cord. Price 48/-.

TAPE SPLICER & CUTTER. Model T.835. Cuts 2 rounded indentations in the tape splice leaving the edges of the tape which contact parts of the recorder entirely free of adhesive. As little as 1/16in. tape need be removed. Complete with instructions, 18/9.



A MINIATURE TAPE RECORDER IN KIT FORM NOW ONLY £4.19.6.

Exclusively offered complete with all accessories. No extras to buy. Consisting of three transistor amplifier, record/play, Volume control, miniature speaker, forward-stop-re-

wind switch, reel of tape and spare reel, motor, attractive coloured case, Mic. and earphone sockets, pick-up coil, mike, earphone and carrying handle supplied. Standard battery operated. Simple to put together in less than one hour. Brand new and guaranteed.



"EAGLE-PIONEER" STEREO-MASTER SM.Q141.

A masterpiece of brilliant engineering, providing for every possible modern listening feature. Comprises Hi-Fi amplifier, AM, FM, SW tuners, dual pre-amp for every known input plus multiplex system. The ultimate in Hi-Fi. Price £76.15.0. S.A.E. for leaflet.

Relda Radio

MAIL ORDERS TO: DEPT. 'P' 32A, COPTIC STREET, LONDON, W.C.1 Tel: MUSaum 9606

See our other advertisement on page 175 for more attractive items

Stern's

MULLARD DESIGNS

COMPLETE KITS OF PARTS

MULLARD 3-VALVE PRE-AMPLIFIER TONE CONTROL UNIT

Designed mainly for Mullard Range of Amplifiers, also suitable for any Amplifier requiring input up to 250mV. Incorporates 5 input Channels, including for Tape and Magnetic Pickups. Separate Bass and Treble controls. High pass filter 20 to 160 c/s. low pass filter 5-9 K/c/s. Totally enclosed in case size 111" x 41" x 41".

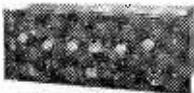

KIT OF PARTS **£10.00** ASSEMBLED & TESTED **£13.13.0**

MULLARD "5-10" MAIN AMPLIFIER



For use with MULLARD 2-stage pre-amplifier with which an undistorted power output of up to 10 watts is obtained. SPECIFIED COMPONENTS AND MULLARD VALVES including PARMEKO MAINS TRANSFORMER and choice of PARMEKO or PARTRIDGE Output Transformer.

COMPLETE KIT (Parmeko Output Trans.) **£10.00**
ASSEMBLED AND TESTED **£13.10.0**

ABOVE incorporating PARTRIDGE OUTPUT TRANS. £1.6.0 extra.

THE MULLARD 510/RC AMPLIFIER

The popular complete "5-10" Incorporates Control Unit providing up to 10 watts high quality reproduction. Specified components and new MULLARD VALVES. Includes PARMEKO MAINS TRANSFORMERS and choice of PARMEKO or PARTRIDGE Output Transformers.



COMPLETE KIT **£12.00**
ASSEMBLED AND TESTED **£16.00** With PARTRIDGE OUTPUT TRANS. £1.6.0 ex.

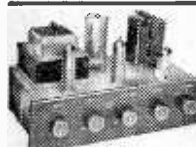

THE MULLARD 33/RC

A HIGH QUALITY AMPLIFIER DEVELOPED FROM THE VERY POPULAR 3-WATT MULLARD "3-3" DESIGN. KIT OF PARTS **£8.80**

ASSEMBLED AND TESTED **£11.10.0**

Complete to the MULLARD specification including PARMEKO OUTPUT TRANSFORMER. Switched inputs for 78 and L.P. records plus a Radio position. Extra power to drive a Radio Tuning Unit is also available.



THE "MONO-GRAM"

A small Amplifier of genuine high quality performance. Incorporates new MULLARD ECL86 Valve, separate BASS and TREBLE controls and produces up to 3 watts undistorted output. Kit of Parts **£4.10.0** Assembled and Tested **£6.0.0**

Perfectly suited for Portable Installations for which purpose we offer PORTABLE CASE (£3.10.0), the AMPLIFIER (Kit) and 8" x 5" SPEAKER (£1.0.0). All for **£9.0.0**

Alternatively with ASSEMBLED AMPLIFIER **£10.0.0**

The Case quoted above will accommodate some 4-speed Single Record Units. A larger model is available for extra 10". With this Equipment a COMPLETE PORTABLE RECORD PLAYER can be built for **£14.0.0**



MULLARD FOUR CHANNEL MIXING UNIT

Self powered Cathode follower output. Incorporates two inputs for CRYSTAL MICROPHONES, one for CRYSTAL PICK-UPS and a fourth for Radio or Tape.

KIT OF PARTS **£8.8.0** AND TESTED **£11.10.0**

Alternative Model I/L provides for one input matched for moving coil or ribbon mike £1.17.0 extra.



ARMSTRONG RADIOGRAM CHASSIS

We have the full range in stock. Prices range from £20.10.0. Full details are readily available.

Full Range of Lustraphone Moving Coil Microphones, Stands and Accessories are in stock



MULLARD'S 2-VALVE PRE-AMPLIFIER TONE CONTROL UNIT

Employing two EF86 valves and designed to operate with the Mullard MAIN AMPLIFIER but also perfectly suitable for other makes.



- ★ Equalisation for the latest R.I.A.A. characteristics.
- ★ Input for Crystal Pick-ups and variable reluctance magnetic types.
- ★ Input (a) Direct from High Imp. Tape Head. (b) From a Tape Amplifier or Pre-Amplifier.
- ★ Sensitive Microphone Channel. ★ Wide range BASS and TREBLE Controls.

KIT OF PARTS **£6.6.0** ASSEMBLED AND TESTED **£9.10.0**

PRICE REDUCTIONS

- (a) THE KIT OF PARTS to build both the "5-10" Amplifier and the 2-Valve Pre-Amplifier... **£15.15.0**
 - (a) Assembled and Tested... **£21.10.0**
 - (b) THE KIT OF PARTS to build both the "5-10" Amplifier and the 3-Valve Pre-amplifier... **£19.10.0**
 - (b) Assembled and Tested... **£25.10.0**
- With PARTRIDGE OUTPUT TRANSFORMER £1.6.0 extra.

HIGH FIDELITY LOUDSPEAKERS

WE STOCK THE COMPLETE RANGE BY GOODMANS, WHARFEDALE and W.B. STENTORIAN A few recommended examples

8 INCH TYPES	
GOODMANS "AXIETTE"	£5.5.0
W.B. HF 816	£5.19.8
WHARFEDALE "SUPER 8/RS/DD"	£6.14.0
10 INCH TYPES	
GOODMANS "AXIOM 10"	£5.16.8
W.B. MODEL HF 1016	£7.0.0
WHARFEDALE "GOLDEN 10/RS/DD"	£7.17.0
12 INCH TYPES	
GOODMANS "AXIOM 20" 15 watts	£9.15.0
GOODMANS "AXIOM 30" 12 watts	£14.0.0
W.B. MODEL HF 1214 15 watts	£10.5.8
WHARFEDALE "W12/RS"	£10.10.0
WHARFEDALE "Super 12/RS/DD"	£17.10.0

LEAK AND QUAD AMPLIFIERS IN STOCK

- LEAK "TL12 PLUS" POWER AMPLIFIER with the "POINT ONE PLUS" PRE-AMPLIFIER, 14 watts rated output... **£31.10.0**
- LEAK "TL25 PLUS" with the "POINT ONE PLUS" PRE-AMPLIFIER, 25 watts rated output... **£37.16.0**
- LEAK "STEREO 20" POWER AMPLIFIER with the "VARISLOPE STEREO" PRE-AMPLIFIER, 22 watts (11 watts per channel)... **£55.9.0**
- QUAD II POWER AMPLIFIER with QUAD II CONTROL UNIT, 15 watts output... **£42.0.0**

RECORD PLAYERS

- THE COLLARO "JUNIOR" 4-speed single player with separate crystal pick-up... **£3.10.0**
- THE NEW GARRARD "AUTOSLIM" 4-speed Autochanger with crystal pick-up... **£7.10.0**
- GARRARD "AUTOSLIM DE LUXE" 4-speed Autochanger, incorporates transcription Pick-up Arm... **£11.8.0**
- THE COLLARO "C60" 4-speed autochanger unit with Studio "O" pick-up... **£6.19.6**
- B.S.K. Model UA4, a 4-speed Mixer Autochanger with crystal pick-up... **£6.10.0**
- The new GARRARD Model 4HF High Quality Single Record Player fitted with the latest T.P.A. 12 pick-up arm and G.C.S. crystal Cartidge... **£16.17.6**
- GARRARD Model 4HF in Single Record Player fitted with high output crystal pick-up... **£5.0.0**
- PHILIPS Model AG106, A 4-speed Player can be operated both manually and automatically. Suitable for Mono or Stereo operation... Carr. and Ins. on each above 5/- extra. **£12.12.0**

Mk. 11 "Fidelity" FM TUNING UNIT

- An attractively presented Unit incorporating MULLARD PERMEABILITY TUNING HEART and corresponding Mullard valve line-up. Very suitable to operate with our Mullard Amplifiers. ASSEMBLED AND TESTED **£14.5.0**
- KIT OF PARTS **£10.10.0**

IF YOU ARE PLANNING TO INSTALL "HI-FI" and UNCERTAIN OF THE TYPE OF EQUIPMENT TO USE—OUR WIDELY EXPERIENCED TECHNICAL STAFF WILL WITH PLEASURE PUT FORWARD RECOMMENDATIONS—STATE TYPE OF INSTALLATION CONTEMPLATED AND APPROX. PRICE LEVEL. CREDIT SALE TERMS are available on all Equipment over £10.0.0. FULLY DESCRIPTIVE LEAFLETS are readily available—please enclose S.A.E.

Stern's

SPECIALISTS IN SOUND EQUIPMENT FOR OVER 25 YEARS

STEREO TAPE PRE-AMPLIFIER



MODEL STP-1. For use with current TRUVOX, BRENNELL, or COLLARO "STUDIO" and track Stereo Decks. Incorporates Ferroxcube Oscillator, 4 speed Equalisation Signal Level Meter and separate Gain Controls. Includes separate Power Unit.
KIT OF PARTS £22.00 ASSEMBLED £28.00

TAPE PRE-AMPLIFIER MULLARD'S Type "C"

Suitable for most track Mono Tape Decks. Incorporates Ferroxcube Push Pull Oscillator and 3 Speed Treble Inductor. Includes Separate Power Unit.



KIT OF PARTS £14.00 ASSEMBLED £19.10

MULLARD'S TAPE AMPLIFIER

Based on Mullard's Type "A" design and suitable for most track Mono Tape Decks. Incorporates Ferroxcube 3 speed Treble Inductor and Gilson Output Transformer. Includes separate Power Unit.



KIT OF PARTS £13.13.0 ASSEMBLED £19.0.0

STERN'S "ADD-A-DECK"

A self contained Unit consisting of Garrard Deck and matched Pre-amplifier on one chassis. Provides full tape recording facilities and replays through Pick Up Sockets of standard Radio receiver or Amplifier. PRICE includes Spool of Tape



£18.18.0

and NOW!!! STERN'S OFFER THE "EMPRESS" STEREOSCOPE UNIT

A SPECIAL BULK PURCHASE ENABLES US TO OFFER THIS HIGH GRADE STEREO PRE-AMPLIFIER AT APPROX THE MANUFACTURER'S PRODUCTION COST. IT IS ENGINEERED TO THE VERY HIGHEST TECHNICAL STANDARDS AND REPRESENTS THE ULTIMATE IN PRECISION HIGH FIDELITY EQUIPMENT FOR



EXCEPTIONAL VALUE 10 + 10 WATTS

Unquestionably the most advanced STEREOPHONIC Pre-amplifier available today. It provides the greatest range of facilities ever offered in a single unit. It incorporates full input facilities for Crystal or Magnetic Pick-Ups and Microphones. Radio Transmissions. Tape Recorders and Replay direct from high impedance Tape Heads. A miniature Cathode Ray Tube provides for VISUAL balancing of the input signals, and also for measuring the frequency response of PICK UPS and the power output in watts. The controls include Scratch and Rumble Filters. Loudspeaker phasing in conjunction with a 60 cycles per second note Channel reversal and Mixing facilities together with Function Switches, separate Volume and Baxandall Tone Controls. Size 1 1/2in. x 10 1/2in. x 4in.

OFFERED AT THE SPECIAL PRICE OF **£17.17.0**

THE EMPRESS IS PARTICULARLY SUITABLE TO OPERATE WITH OUR MULLARD "10 plus 10" POWER AMPLIFIER. AND WE OFFER THE TWO FOR ONLY **£36.0.0**

Send S.A.E. for fully descriptive technical leaflets, or call at our showrooms and hear the equipment on demonstration.

Our Technical dept. will be happy to advise on the choice of matching PICK-UPS - Microphones - Loudspeakers.

!! COMBINED PRICE OFFERS !!

Includes small charge for special testing and PRECISE MATCHING of the ASSEMBLED PRE-AMPLIFIER (or Amplifier) to TAPE DECK

STP-1 (KIT) and "STUDIO" Deck	£39.0.0 Assembled	£46.0.0
STP-1 (KIT) and Brenell Deck	£46.0.0 Assembled	£75.0.0
STP-1 (KIT) and Truvox Deck	£51.0.0 Assembled	£59.0.0
TYPE "C" (KIT) and "STUDIO" Deck	£26.10.0 Assembled	£33.0.0
TYPE "C" (KIT) and BRENNELL Deck	£43.0.0 Assembled	£50.0.0
TYPE "C" Assembled and Wearite Deck	£70.0.0 Inc. Head Lift Trans.	
HF/TR3 (KIT) and "STUDIO" Deck	£26.0.0 Assembled	£33.0.0
HF/TR3 (KIT) and BRENNELL Deck	£42.0.0 Assembled	£50.0.0
HF/TR3 Assembled and Wearite Deck	£70.0.0 Inc. Head Lift Trans.	

To build a complete TAPE RECORDER we offer HF/TR3 AMPLIFIER STUDIO DECK, PORTABLE CASE, ROLA 10 x 8in. SPEAKER MICROPHONE and 1,200ft. TAPE ALL for £35.00.

ALTERNATIVELY WE OFFER... THE COMPLETELY ASSEMBLED and GUARANTEED PORTABLE RECORDER (Model CR3/S) FOR £43.00.

MULLARD'S "10+10" STEREO AMPLIFIER

A high fidelity design providing up to 10 watts (per channel). Superb reproduction frequency response flat to within 3dB from 20 to 20,000 Hz at 10mW Total Harmonic Distortion at 10 watts 0.1%

Price (a) ASSEMBLED AM-PLIFIER (as illustrated) **£24.0.0**

(b) KIT OF PARTS **£20.0.0**

Built to the highest technical standards and presented strictly to MULLARD'S specification. Two specially designed GILSON OUTPUT TRANSFORMERS with 20% taps are used.

We can also supply the assembled MAIN AMPLIFIER only for operation with our DUAL CHANNEL PRE-AMPLIFIER. This provides a more versatile installation and is essential if a low output Magnetic Pick-up is to be used. When ordering specify loudspeaker impedance.

(a) THE ASSEMBLED MAIN AMPLIFIER and ASSEMBLED DUAL CHANNEL PRE-AMP **£34.0.0**

(b) KIT OF PARTS for both Units **£27.0.0**

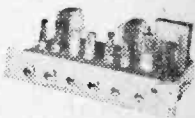

THE "TWIN THREE" STEREO AMPLIFIER

ASSEMBLED AND TESTED **£9.0.0** (Carriage and Insurance 7/6 extra)



Based on a recent design by MULLARD LTD., is ideally suited for use in Portable RECORD PLAYERS for which purpose we offer a special designed Case. Incorporates MULLARD ECL 86 Valves, separate BASS and TREBLE CONTROLS and produces up to 3 watts per channel. Frequency response is 40 c/s to 30 Kc/s, size is only 1 1/2in. x 3in. x 5in. To construct a STEREO PORTABLE RECORD PLAYER we offer: Assembled AMPLIFIER with two ROLA 8in. x 5in. LOUD-SPEAKERS and PORTABLE Case for **£16.10.0**

MULLARD DUAL-CHANNEL PRE-AMPLIFIER

A four Valve design for both STEREO-PHONIC and MONOPHONIC operation. Operates equally well with any make of Amplifier requiring an input of up to 250mV.

KIT OF PARTS **£12.10.0**

ASSEMBLED AND TESTED **£15.0.0**



THE "TUDOR" STEREO AMPLIFIER

PRICE **£15.0.0** (Carr. free)

A self-contained Amplifier designed to provide high quality stereophonic and monophonic reproduction. Each channel provides a rated output of 6 watts and for monophonic operation approx. 12 watts is produced. Separate BASS and TREBLE CONTROLS.

POSTAL ENQUIRIES and MAIL ORDERS TO STERN RADIO LTD.

6-12; TUDOR PLACE, TOTTENHAM COURT RD. LONDON, W1. TEL. MUSEUM 6128/9

DEMONSTRATION and SHOWROOMS AT...

STERN RADIO LTD.

109, FLEET ST, LONDON, EC4

TEL. FLEET ST, 5812/3

OPEN... 9 a.m. to 6 p.m. SAT. close 1 p.m.

PREMIER RADIO

23, TOTTENHAM COURT RD.

LONDON, W1. TEL. MUSEUM 6128/9

OPEN... 9 a.m. to 6 p.m. THURS. close 1 p.m.

Brand new, individually checked and guaranteed

VALVES

ACF4 6/-	ER34 1/8	EL38 12/8	PCC85 8/-	U32 5/-	3B24 5/-	6G6G 2/6	9D2 3/-	80 5/8	7191 1/9
AR8 5/-	EB333 7/6	EL41 8/-	PCC89 10/6	U901 20/-	3B28 15/-	6H6M 1/8	12A6 2/6	81 9/-	7475 1/9
ARP3 3/-	EB401 7/6	EL42 8/-	PCF80 7/-	UABC80 8/-	3B29 50/-	6J5 5/-	12AH7 5/-	84 8/-	8013A 25/-
ARP4 3/6	EB420 5/6	EL44 7/6	PCF82 8/-	UC84 7/-	3B30 7/-	6J6 3/6	12AH8 11/-	84 8/-	9001 2/-
ARP12 3/-	EBF90 9/6	EL91 4/6	PCL82 5/6	UBF90 8/6	(829B) 60/-	6J8 3/6	12AT7 5/6	85A2 7/6	9002 5/6
ARP21 7/-	EBF99 8/6	EL95 6/6	PCL83 10/-	UBF99 8/6	3Q4 6/-	6J9 6/6	12AU6 9/-	89 6/-	9003 6/6
ARP24 3/6	EC32 8/6	EM30 8/6	PCL84 9/6	UCF42 7/6	3S84 5/6	6K6GT 5/-	12AU7 6/6	90C1 8/-	9004 2/6
ARP34 4/-	EC90 20/-	EM94 9/6	PCL86 10/6	UCH81 9/-	3V4 6/-	6K7G 2/-	12AX7 7/-	210VPT	9006 2/6
ARTP1 6/-	EC91 3/-	EN31 10/-	PEN45 4/6	UCL82 9/-	5B/357M	6K7U 2/6	12AY7 10/-	7-pin	
ATP4 2/6	EC92 5/-	ESU208 6/6	PCN220A	UC135 11/-		6K8 3/6	12B6 3/6	22U7H	2/8
ATP7 5/6	EC98 5/6	EY8 8/6	PL36 10/6	UL4 7/6	5R4GY 19/-	6K8M 8/6	12H6 2/-	250TH	2/8
ATP7 5/6	EC98 5/6	EY8 8/6	PL36 10/6	UL4 7/6	5T4 9/6	6L54 6/6	12J6GT 3/6	388A 5/-	ACR1 15/-
AZ31 7/-	EC98 5/6	EY8 8/6	PL82 9/6	UL9 5/6	5U4G 5/6	6L8 9/6	12K6 4/6	393A 15/-	ACR11 15/-
B84A 5/6	EC98 5/6	EY8 8/6	PL82 9/6	UL9 5/6	5V4GT 8/6	6L6G 6/6	12K8M 7/6	703A 15/-	ACR13 50/-
BT45 15/-	EC98 5/6	EY8 8/6	PL83 9/6	UL9 5/6	5V3G 3/6	6L7G 4/6	12Q7GT 4/4	716B 60/-	CV198 15/-
BT9B 20/-	EC99 4/6	EZ40 7/6	PT25H 7/6	VP23 3/6	5Y3GT 6/6	6L8 9/6	12R2A7 7/6	717A 8/6	(06J) 55/-
BT9B 20/-	EC99 4/6	EZ40 7/6	PX4 19/-	VP41 5/6	5Z4 8/6	6L9 9/6	12R67 4/6	801 6/-	E4103/B4
CV1 3/-	EC98 5/6	EY8 8/6	PX25 9/6	VR99 8/6	5Z4G 7/6	6N7 6/6	12R67 3/6	803 22/8	5FF7 25/-
CV102 1/6	EC98 5/6	EY8 8/6	PY32 12/-	VR105/30	6AC7 3/6	6N7G 5/6	12R67 3/6	805 30/-	5BP1 25/-
CV264 20/-	EC98 5/6	EY8 8/6	PY80 6/6	VR150/30	6AG5 3/6	6P7 6/6	12R67 3/6	807 (select)	5CP1 42/6
CV4014 8/-	EC98 5/6	EY8 8/6	PY82 7/6	VR150/30	6AG7 6/6	6P7 6/6	12R67 3/6	807BR 5/-	5FF7 45/-
CV4016 7/-	EC98 5/6	EY8 8/6	PY83 7/3	V74C 25/-	6AH 10/-	6P7 6/6	12R67 3/6	808 8/6	5P7A 25/-
CV4025 10/-	EC98 5/6	EY8 8/6	PY83 7/3	V74C 25/-	6AJ4 9/6	6P7 6/6	12R67 3/6	810 80/-	VCR9 28/-
CV4046 40/-	EC98 5/6	EY8 8/6	PY83 7/3	V74C 25/-	6AJ5 8/6	6P7 6/6	12R67 3/6	812 60/-	VCR138 35/-
CV31 6/-	EC98 5/6	EY8 8/6	PZ1-35 9/6	X86 8/6	6AJ7 3/6	6P7 6/6	12R67 3/6	815 40/-	VCR139A
D1 1/6	EC98 5/6	EY8 8/6	QJ21 6/6	Y63 5/6	6AK5 5/6	6P7 6/6	12R67 3/6	822 15/-	35/-
D41 3/3	EC98 5/6	EY8 8/6	QJ25 10/6	Y66 8/6	6AK6 6/6	6P7 6/6	12R67 3/6	822A 45/-	
D77 4/3	EC98 5/6	EY8 8/6	Q30/7 7/6	Y83 5/6	6AK7 6/6	6P7 6/6	12R67 3/6	822B 15/-	
DA30 12/8	EC98 5/6	EY8 8/6	Q4/7 7/6	Y85 4/6	6AM5 6/6	6P7 6/6	12R67 3/6	822C 45/-	
DAF70 35/-	EC98 5/6	EY8 8/6	R3/10 4/6	Y86 8/6	6AM6 4/6	6P7 6/6	12R67 3/6	822D 15/-	
DAF91 6/-	EC98 5/6	EY8 8/6	REL21 25/-	Y87 8/6	6AM6 4/6	6P7 6/6	12R67 3/6	822E 15/-	
DAF96 7/6	EC98 5/6	EY8 8/6	REL21 25/-	Y87 8/6	6AM6 4/6	6P7 6/6	12R67 3/6	822F 15/-	
DD41 4/6	EC98 5/6	EY8 8/6	REL21 25/-	Y87 8/6	6AM6 4/6	6P7 6/6	12R67 3/6	822G 15/-	
DE75 15/-	EC98 5/6	EY8 8/6	REL21 25/-	Y87 8/6	6AM6 4/6	6P7 6/6	12R67 3/6	822H 15/-	
DEF20 2/-	EC98 5/6	EY8 8/6	REL21 25/-	Y87 8/6	6AM6 4/6	6P7 6/6	12R67 3/6	822I 15/-	
DF73 7/6	EC98 5/6	EY8 8/6	REL21 25/-	Y87 8/6	6AM6 4/6	6P7 6/6	12R67 3/6	822J 15/-	
DF91 4/6	EC98 5/6	EY8 8/6	REL21 25/-	Y87 8/6	6AM6 4/6	6P7 6/6	12R67 3/6	822K 15/-	
DF96 7/6	EC98 5/6	EY8 8/6	REL21 25/-	Y87 8/6	6AM6 4/6	6P7 6/6	12R67 3/6	822L 15/-	
DK96 7/8	EC98 5/6	EY8 8/6	REL21 25/-	Y87 8/6	6AM6 4/6	6P7 6/6	12R67 3/6	822M 15/-	
DL92 6/-	EC98 5/6	EY8 8/6	REL21 25/-	Y87 8/6	6AM6 4/6	6P7 6/6	12R67 3/6	822N 15/-	
DL94 6/-	EC98 5/6	EY8 8/6	REL21 25/-	Y87 8/6	6AM6 4/6	6P7 6/6	12R67 3/6	822O 15/-	
DL96 7/6	EC98 5/6	EY8 8/6	REL21 25/-	Y87 8/6	6AM6 4/6	6P7 6/6	12R67 3/6	822P 15/-	
EA50 1/6	EC98 5/6	EY8 8/6	REL21 25/-	Y87 8/6	6AM6 4/6	6P7 6/6	12R67 3/6	822Q 15/-	
EACR80 7/8	EC98 5/6	EY8 8/6	REL21 25/-	Y87 8/6	6AM6 4/6	6P7 6/6	12R67 3/6	822R 15/-	
EAC91 3/8	EC98 5/6	EY8 8/6	REL21 25/-	Y87 8/6	6AM6 4/6	6P7 6/6	12R67 3/6	822S 15/-	

MANY OTHERS IN STOCK includes Cathode Ray Tubes and Special Valves U.K. orders below £1 P. & P. 1/-; over £1 2/-; over £3 P. & P. free. C.O.D. 2/6 extra. Overseas Postage extra at cost.

"CONNECT AND FORGET—CANNOT OVERCHARGE" "ESS-TRON" MARK I AUTOMATIC BATTERY CHARGER. Initial charging rate 6-7 amps. The charging rate automatically adjusts itself to the charge in the battery. Automatic current and voltage control. Patented application of magnetic amplification to battery charging. Indicator lights show battery fully charged, receiving charge, incorrectly connected or faulty cells. Mains voltage 200/250 v. Built for 6 or 12 v. batteries. Measurements 7 x 5 x 5 1/2 in. Weight 8 1/2 lb. Price £7.19.6. P. & P. 3/6.

CR 150 DOUBLE CONVERSION COMMUNICATION RECEIVER. Range 2 to 60 Mc/s in 5 bands, 2 RF stages (EF50), 1st Frequency changer (EF50), Oscillator (EF50), 2nd frequency changer (X65 or X66), Two IF stages (KTW 63), Detector (A7C), LF stage (DH 63), Noise limiter, crystal calibration (DH 63), BFO (KTW 63) output stage (L 63), voltage stabiliser (5T 280/40), electrical band spread, "5" meter, band pass 10,000—5,000—1,500—500—100 c/s, IF 1.6 mc and 465 kc. In as new and guaranteed condition, with original mains power supply unit £70 or without power supply unit £60. Carriage 30/-.

P.C. RADIO'S Mains power supply unit for above 90/-.

CR 200 LONG WAVE RECEIVER. 15 kc—560 kc. £7.10.0. Carriage 30/-.

TELEPHONE HANDSET. Standard G.P.O. type. New 12/6. P. & P. 2/6.

R.109 RECEIVER. Covering 2-9 Mc/s. 6 v. D.C. with set of spare valves and carrier. Brand new in original packing case. £6.18.0 including delivery in U.K.

R.109A RECEIVER. Covering 2-12 Mc/s., £7.18.0.

53 TRANSMITTER SPARES. Full range. Price list on application.

H.R.O. Senior. Table Model. In excellent, fully checked, and tested condition (without coils and power pack), £15.10.0. As above but rack mounted model, £14.10.0.

Individual frequency coils for above £1 each set or set of 9 £8. Either model carriage £1.10.0.

Power pack for above. British made, A.C. 110/200/250 v., 59/6. Postage 4/-.

CARBON INSET MICROPHONE. G.P.O. type, 2/6. P. & P. 1/6.

80W 12V PETROL DRIVEN CHARGING SETS. Very compact, in fully guaranteed condition, £12.10.0, Carr. £1.

RE-ENTRANT LOUD HAILERS. 500 ohms, approx. 20w. £6.10.0. Carr. 10/-

R.107 COMMUNICATION RECEIVER. 1.2/17 mcs. 9 valves. "Wide" and "narrow" band switch. AVC and BFO, with internal speaker. 100/250 v. A.C. and 12 v. D.C. Meas: 24 x 13 x 17in. Price £13.10.0. Carriage 20/-.

BRAND NEW ORIGINAL SPARE PARTS FOR AR88 RECEIVERS.

Please write your requirements.

AERIALS 1ft. long. 2ft. long when folded, 15/-, P. & P. 2/-.

VARIOMETER FOR No. 19 SET. 10/- each. P. & P. 3/6.

DOUBLE BEAM OSCILLOSCOPE TYPE 13. 4 1/2 in. screen. Time base 2 C/S-1 Mc/s. Calibration markers 1 microsec-10 microsecs, Y2 attenuation. 115/230 v. A.C. In excellent checked condition £27.10.0. Carriage £1.

R.209 RECEPTION SET. A 10-valve high-grade Superhet Receiver with facilities for receiving R/T (A.M. or F.M.) and C.W. frequency 1 Mc/s-20 Mc/s. Hermetically sealed. Built on miniature valves and incorporating its own vibrator power supply unit driven by a 6 v. battery (2 point connector included). The set provides for reception from rod, open-wire or phone output. Dimensions: Length 12in., width 8in., depth 9in. Weight 23lb. In as new, tested, and guaranteed condition, £23.10.0, including special head-phone and supply leads. Carr. £1.

COMPLETE SET OF STRONG AERIAL RODS (American). Screw-in type MP49, 50, 51, 52, 53, total length 15ft. 10in. Top diameter 0.185in. Bottom diameter 0.615in., together with matched aerial base. MP37 with ceramic insulator, ideal for car or roof insulation, £2.10.0. Post free.

P. C. RADIO LTD
173 GOLDHAWK ROAD, W.12
Shepherd's Bush 49/6

HIGH GAIN 4-TRANSISTOR PRINTED CIRCUIT AMPLIFIER KIT Type TAI

● Peak output in excess of 1 1/2 watts. ● All standard British components. ● Built on printed circuit panel, size 6 x 3 in. ● Generous size Driver and Output Transformers. ● Output transformer tapped for 2 ohm and 15 ohm speakers. ● Transistors (GET114 or 81 Mullard OC81D and matched pair of OC81 o/p). ● 9 volt operation. ● Everything supplied, vee battery clips, solder, etc. ● Comprehensive easy to follow instructions and circuit diagram 1/8 (Free with Kit). All parts sold separately. P. & P. 2/6.

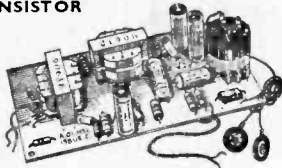

SPECIAL PRICE 45/- P. & P. 2/6.

10/14 WATT HI-FI AMPLIFIER KIT

A stylishly finished monaural amplifier with an output of 14 watts from 2 EL84s in push-pull. Super reproduction of both music and speech, with negligible hum. Separate inputs for mike and gram allow records and announcements to follow each other. Fully shrouded ultra output transformer to match 3-15 (1) speaker and 2 independent volume controls, and separate bass and treble controls are provided giving good lift and cut. Valve line-up 2 EL84s, ECC83, 6F86 and E280 rectifier. Simple instruction booklet 1/8. (Free with parts.)

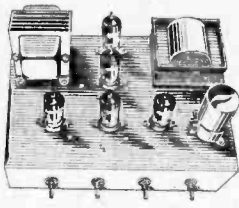

All parts sold separately.

ONLY £6.19.6 P. & P. 6/6.

AMPLIFIER ON PRINTED CIRCUIT BOARD

Two valves, 6V6s, 6U4 O.P. triode, use with 80 volt tap off motor. 28/8. P.P. 2/6 on above. Dropper res. for filaments if required. 2/8.

B.S.R. AUTO UNITS

140 v. Suitable for use with above. (Brightly coded) £4.4.0. **LARGE CABINET** Suitable for above two items. Complete with 3 ohm speaker. £3.9.8. Carr. 5/-. **Superior CABINET** Similar to above to take 8 x 16 in. speaker, with motor board, will accommodate BSR UA14 or UA16. £3.9.8. Carr. 5/6. Speaker 10/- extra. P. & P. 1/6 extra.

UNREPEATABLE OFFER! BRAND NEW 8" x 5" 3 OHM SPEAKERS
By well known maker 10 6 each.
P. & P. 1 6 per speaker
A pair of these are ideal for Stereo

BRAND NEW 3 OHM LOUDSPEAKERS

- 2 1/2 in. 12/8; 5 in. 12/6; 6 1/2 in. 15/-;
 - 8 in. 21/-; 10 in. 25/-; 12 in. 27/6;
 - Goodmans 5 in. tweeter ... 10/6
 - E.M.I. 2 1/2 in. tweeter ... 10/6
 - E.M.I. 1 1/2 in. x 8 1/2 in. high flux 32/6
 - Rolls Collection approx. 8 in. x 6 in. middle register speaker 10/6
- Also 15 ohm 12 in. 30/- P. & P. 1/6 per speaker.

RECORDING TAPE
F.V.C. base, full frequency L.P. tape, 7 in., 1800ft. (normally 50/-) 27/8; 5 1/2 in., 1300ft. (normally 35/-), 18/9; 8 in., 900ft. (normally 28/-), 18/-; P. & P. 1/- per spool. Ideal for 2 or 4 track recorder.

TAPE DECKS
COLLARO STUDIO DECK £10.10.0. plus 5/6 carr. and ins.
B.S.R. MONARDECK (Single speed) 3 1/2 in. per sec. simple control, uses 5 1/2 in. spools, £6.16.0 plus 5/6 carr. and ins. (Tapes extra on both).

SPECIAL BARGAIN OFFERS!

- TWO GANG .0006 TUNING CONDENSER.** Geared precision reduction drive. Size 2 1/2 x 2 1/2 in. Brand new and unused. 3/6 each. P. & P. 1/-. **MAINS TRANSFORMER.** Impregnated and fully shrouded. Size 4 1/2 x 2 1/2 in. Weight 6 lb. Tapped primary 205, 225, 245v. Electrostatic screen. Output 360-0-360 v., at 120 ma D.C. plus 1050 v. half wave at 3 ma D.C. 8.5 v. at 2.5 amps, centre tapped 5 v. at 2 1/2 amps and 6.3 v. at 5 amp PRICE ONLY 21/- each, P. & P. 5/-.
- CARBON MIKE INSERTS.** Brand new. 2 1/2 in. dia. 3/6, P. & P. 9d.
- GORLER F.M. TUNER HEADS.** 10.7 Mc/s I.F., 15/-, plus 1/3 P. & P. (ECC85 valve 8/6 extra).
- ELECTROSTATIC R.F. TWEETERS.** Type L.S.H. 75. Size 3 x 3 in., 2/6 each, plus 9d.
- MIDGET 2/GANG CONDENSERS.** Capacity 195 and 100 pF. Polystyrene case with built-in trimmers. Size 1 x 1 1/2 in. Not used but removed from P/C Boards. Two for 9/-, plus 1/- P. & P.
- ACOS ORYSTAL MIKES.** High Imp. For desk or hand use. High sensitivity. 18/6. P. & P. 1/8.
- SSL CRYSTAL STICK MIKE.** Listed at 45/-. Our price 18/6. P. & P. 1/6.
- TRANSISTOR DRIVER and O/P TRANSFORMERS.** (Tapped 3 ohms and 15 ohms output), plus 4 suitable Transistors giving approx. 1 watt output. 30/-. P. & P. 2/-.
3 PUSH-BUTTON TRANSISTOR SWITCH. D.P.—D.T. Each Switch 5/6 and 1/- P. & P.
- FURTHER HUGE PURCHASE**
TELEFUNKEN HI-FI STEREO AMPLIFIER. 110/250 v. A.C. input. 5 watt distorted output (10 watts nominal). Size 12 x 9 x 2 in. Weight 9 lb. Complete with spec. and instructions. Now only £5.9.6. Carr. 5/-.
Also Model 882. Similar specification but with balance control. Now only £5.19.6. Carr. 6/-.

SPECIAL PURCHASE! TURRET TUNERS

by famous maker Brand new and unused. Complete with PCC84 and PCF80 valves. 34.38 Mc/s I.F. Biscuits for Channela 1 to 5 and 8 and 9. Circuit diagram supplied. ONLY 25/- each. P.P. 2/6.

F.M. TUNER HEAD

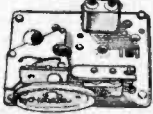

A permeability tuned tuner head by a famous maker, supplied without valve (ECC83) and drum and spindle, 18/6 plus 1/3 P. & P. Valve 8/6 extra. Drum and spindle 3/6 extra.

E.M.I. 4-speed Player and P.U.

FURTHER HUGE PURCHASE enables us to offer these **67/6 P. & P. 4/6.**



Heavy 8 1/2 in. metal turntable. Low flutter performance 200/350V shaded motor with tap at 45V for amplifier valve filament if required. Turnover LP/78 head.

RECORD PLAYER AMPLIFIER

2 valves. A.C. mains, 3 watts output, ready built, tested and complete with valves and output transformer. Size 7 in. w. x 2 1/2 in. d. x 5 1/2 in. h. 55/-, P. & P. 3/-. Suitable speakers: 6 in. 15/- or 10 x 8 in. 22/6. P. & P. 1/9 on each.

4-SPEED PLAYER UNIT BARGAINS

SINGLE PLAYERS
TU122 £20.0. Carr. 3/6.
AUTO CHANGERS
B.S.R. UA14. £6.2.6.
Latest B.S.R. UA16 £7.2.6.
Latest Garrard 'Auto-81m' £26.17.0. Carr. 5/- on each.

SPEAKER & CABINET FABRICS

Speaker fabric heavily woven in champagne and brown. 48 in. wide. Originally 35/- per yard length. **OUR SPECIAL PRICE** 22/- per yard length. P. & P. 1/6. Also Outmeal fabric for speaker or cabinet or Red rexine for cabinet. 34 in. wide. 13/6 per yard length. P. & P. 1/6.

HARVERSON'S F.M. TUNER Mk.1

- F.M. tuning head by famous maker
- Guaranteed non-droit.
- Permeability tuning.
- Frequency coverage 88-100 Mc/s. ● OA81 balanced diode output. ● Two I.F. stages and discriminator. ● Attractive maroon and gold dial (7 x 3 in. glass). ● Self powered, using a good quality mains transformer and valve rectifier. ● Valves used ECC83, two 6F80s, and E280 (rectifier). ● Fully drilled chassis. ● Size of completed tuner 8 x 4 x 5 1/2 in. ● All Parts sold separately. £5.19.6 plus 8/6 P.P. and the circuit diagram and illustrations 1/6 post free. Mark II Version as above but complete with magic eye, front panel and brackets. £6.12.6. P. & P. 8/6.

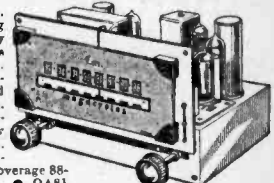

Mark III Version as Mark I but with output stage (ECL82) and tone control. £7.7.0. P. & P. 8/6. (Hanscomb Metal Cabinets. Choice of Grey, Black or Green. To fit Mark I, 25/-, P. & P. 2/6. To fit Mark II 17/6, P. & P. 2/6.

6 TRANSISTOR AND DIODE SUPERHET

A first-class 2 waveband transistor superhet in kit form. ● Printed circuit panel (size 8 1/2 x 2 1/2 in.) ● 3 pre-aligned I.F. transformers. ● High-gain Ferrite rod aerial. ● All First-grade transistors. ● Car aerial winding. ● Push-pull output. ● All parts supplied with simple instructions. All parts sold separately.



ONLY £4.5.0 P. & P. 2/6

35 OHM SPEAKERS

Suitable for use with above. 2 in. Goodmans. Ideal replacement for most pocket portables 8/8; 2 1/2 in. 10/8; 3 in. 12/8; 5 in. P.M., 17/8; 7 x 4 in. 21/-; P. & P. 1/6 per speaker.



Portable CABINET

Size approx. 9 1/2 x 6 1/2 x 3 in. Suitable for above using 2 in. speaker. 25/-; P. & P. 2/6.

COIL AND TRANSFORMER SET FOR TRANSISTOR SUPERHET

3 I.F. transformers, one oscillator coil, one driver transformer and wound Ferrite aerial (med., long and aerial coupling). 28/6 complete, post 1/- 6 transistor printed circuit, board to match, 8/6, post 9d. Circuit diagram 1/6 extra.

QUALITY RECORD PLAYER AMPLIFIER

A top-quality record player amplifier. This amplifier (which is used in 39 gm record player) employs ECC83, EL84, E280 valves. Bass, treble and volume control. On/off controls.

PRICE 69/6 P. & P. 3/6
DITTO. Mounted on board with output transformer and 6 in. speaker.
Complete at 89/6, P. & P. 4/6.

TRANSISTORS

GET15 (Matched Pair) 18/-			
OC71	5/-	PX A101	6/6
OC72	6/-	XA103	6/6
OC76	6/-	V13/10p	12/6
Set of Mullard transistors, OC44, 2—OC45, OC81D, matched pair OC81. 25/-, All Post Free.			

HARVERSON SURPLUS CO. LTD.
170 HIGH ST., MERTON, S.W.19. CHERrywood 3985/6
Open all day Saturday. Early closing Wed., 1 p.m.

A few minutes from South Wimbledon Tube Station. (Please write clearly)
Please Note: P. & P. charges quoted apply to U.K. only. P. & P. on overseas orders charged extra. (S.A.E. all enquiries).

ARMSTRONG AF208AM/FM RADIOGRAM CHASSIS

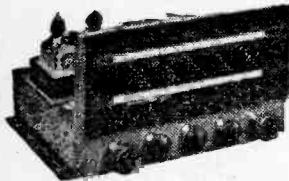

STEREO 12 Mk. 2 £20/5/-
8 watts push-pull output from each channel. 16 watts total. VHF, with automatic frequency control medium and long bands. A hi-fi system on one compact chassis.

STEREO 55 £29/18/-
Junior version of Stereo 12: 5 watts per channel. 10 watts total. VHF and medium bands; inputs for tape, pick-ups and future stereo radio.

JUBILEE Mk. 2 £28/5/-
Mono; 8 watts push-pull output; VHF, automatic frequency control, medium and long bands; Separate tone controls; Pick-up and tape inputs.

AF208 (ILLUSTRATED) £21/4/-
An AM/FM mono chassis. 5 watts output covering VHF and medium bands. An inexpensive version of the Jubilee Mk. 2.

All carriage free. Write for free literature.

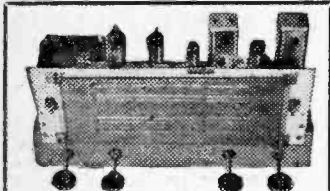

1963 RADIOGRAM CHASSIS

THREE WAVEBANDS FIVE VALVES
R.W. 16 m.—50 m. LATEST MULLARD
M.W. 200 m.—550 m. ECH81, EF89, EB81,
L.W. 800 m.—2,000 m. EL84, EZ80.
12-month guarantee.

A.C. 200/250 v. 4-way Switch; Short-Medium, Long/Gram. Ferrite Aerial A.V.C. and Negative feedback, 3 ohm output, 5 watts. Glass dial, horizontal wording, size 13in. x 4in. Aligned and calibrated. Isolated Chassis size 13 1/2in. x 9in. High x 1 1/2in. deep.

£8.19.6 Carr. & Ins. 4/6

BARGAIN SALE PRICES

New Boxed VALVES 90-day Guarantee

0Z4	5/-	6K7G	6/-	EACPC80	8/-	PCL82	10/-
1R5	6/-	6R8G	5/-	EBH1	4/-	PCL84	10/-
1R5	6/-	6L6G	8/-	EB241	8/-	PL21	10/-
1T4	3/-	6N7M	5/-	EB8C1	8/-	PL83	8/-
2X2	2/-	6Q7G	6/-	EBF80	6/-	PY33	15/-
3B4	7/-	6N8T	5/-	ECH42	9/-	PY90	7/-
3V4	7/-	6V6G	6/-	ECH81	9/-	PY81	8/-
6AQ4	7/-	6X4	5/-	EAL82	10/-	PY82	7/-
6U4	6/-	6X3	6/-	EF85	6/-	PQ25	7/-
5Y3	6/-	12AT7	7/-	EF89	8/-	8P1	3/-
5Z4	9/-	12AU7	6/-	EL32	5/-	8P81	3/-
6AC7	4/-	12AX7	7/-	EL84	7/-	U32	7/-
6AM6	4/-	12BH7	7/-	EY81	9/-	UBC41	8/-
6AT6	6/-	12K7	6/-	EY86	9/-	UBC31	8/-
6BA6	7/-	12K8	14/-	EZ40	7/-	UBF49	9/-
6BE6	5/-	12Q7	5/-	EZ80	7/-	UCH81	9/-
6BW6	7/-	25Y6G	8/-	EZ81	7/-	UCL82	10/-
6C4	5/-	35L6	9/-	HBC80	10/-	UCL83	12/-
6D6	5/-	30Z4	6/-	HV12A	5/-	UF89	9/-
6G6	4/-	807	5/-	KT83C	8/-	UL41	8/-
6H6	3/-	954	2/-	KT78	8/-	UY41	7/-
6J6	5/-	DAP96	8/-	MU14	7/-	UY85	7/-
6L6	5/-	DP84	8/-	PC84	8/-	UY9	7/-
6L7G	6/-	30Z4	6/-	PCF80	8/-	YK150	8/-
6K6	5/-	DL66	8/-	PCF82	8/-	W81	6/-

NEW ELECTROLYTICS FAMOUS MAKES

TUBULAR	TUBULAR	CAN TYPES
1/350V	2/- 50/350V	5/8 16/450V
2/250V	2/3 100/25V	3/- 32/350V
4/450V	2/3 250/25V	3/- 47/350V
8/800V	2/3 500/12V	3/- 100/270V
15/450V	3/-	5,000/5V
32/450V	3/8 1,000/12V	3/- 32+32/350V
25/25V	1/8 8+8/450V	3/8 32+32/450V
25/50V	2/- 8+16/450V	3/8 32+32+32/350V
50/25V	2/- 16+16/450V	4/3 50+50/350V
50/50V	2/- 32+32/350V	4/3 64+20/350V
50/50V	2/- 32+32/350V	4/6 100+200/275V

COMPLETE RADIO CHASSIS £4.19.6. post free

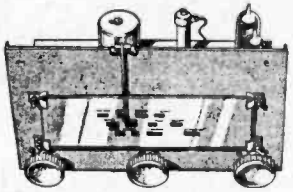

4 Mullard valves. 5in. speaker. Superhet Circuit. **BRAND NEW.** Size 9 x 6 x 5 1/2in. high. Tested by us ready for use. 200/250 v. A.C.-D.C. Mains. As illustrated with illuminated dial. Fully tunable with Medium and Long Wave. 12-month Guarantee. Only £4.19.6. post 5/-.

MAINS TRANSFORMERS 200/250 v. A.C. Postage 2/- each transformer.

STANDARD, 250-0-250, 80 mA, 6.3 v. 3.5 a. tapped 4 v. 4 a. Rectifier, 6.3 v. 1 a. 5 v. 2 a. or 4 v. 2 a. 22/6, ditto, 350-0-350 ...	29/6
MINIATURE 200 v. 20 mA, 6.3 v. 1 a. 10/8	15/8
MIDGET, 220 v. 45 mA, 6.3 v. 2 a. ...	17/8
SMALL, 220-0-220, 50 mA, 6.3 v. 2 a. ...	17/8
STD. 250-0-250, 65 mA, 6.3 v. 3.5 a. ...	17/8
HEATER TRANS. 6.3 v. 1 1/2 amp. ...	7/8
Ditto, tapped 1.4, 2, 3, 4, 5, 6.3 v. ...	8/8
Ditto, sec. 6.3 v. amp. ...	10/8
GENERAL PURPOSE LOW VOLTAGE, 2 amp. 3, 4, 5, 6, 8, 9, 10, 12, 15, 18, 24, 30 v. ...	22/6
AUTO TRANSFORMER, 150 w. ...	22/6
0, 115, 200, 230, 250 v., 500 w. ...	82/6
MULLARD "510" Mains transformer ...	30/-
PARMEKO MAINS TRANSFORMER. Made for special contract, the ratings can safely be doubled. Guaranteed 2 years. Primary 0-110-210-230-250 v. H.T. 300-0-300 v. 50 mA. L.T. 6.3 v. 1.8 amp. Size 4 x 3 1/2 x 3in. ...	17/8

INTERVAL TRANSFORMERS 31 or 51, 9/-.
O.P. TRANSFORMERS Heavy Duty 50 mA, 4/8.
Multitrio, 7/8. Multitrio heavy duty push pull. 10 w., 15/8. Miniature, 384, etc., 5/8.
L.F. CHOKES 15/10H. 60/65 mA, 5/-; 10 H., 85 mA. 10/8; 10 H., 150 mA, 14/-.

L.F. TRANSFORMERS 7/8 pair
465 K/s Slug Tuning Miniature Can, 2 x 1 1/2 x 1 1/2 High x 6 and good bandwidth. Data sheets.

FULL WAVE BRIDGE SELENIUM RECTIFIER: 2, 6 or 12 v. 1 1/2 amp., 8/9; 2 a., 11/3; 4 a., 17/6.
CHARGER TRANSFORMERS: Tapped input 200/250 v. for charging at 2, 6 or 12 v., 1 1/2 amps., 15/8. 2 amps., 17/8; 4 amps., 22/6. Circuit included.
4 AMP CAR BATTERY CHARGER with amp meter Leads, Fuse Case, etc., for 6 v. or 12 v., 6/9.
AMMETER 0 to 5 amp., 9/6.

BOOKS list S.A.E.

40 Circuits for Germanium Diodes 3/-.
"W.W." Radio Valve Data, 6/-.
High Fidelity Speaker Enclosure, 5/-.
Valve and TV Tube Equivalents, 9/6.
TV Fault Finding, 5/-.
Quality Amplifiers, 4/6.
Radio Valve Guide. Books 1, 2, 3, or 4, 5/- each.
Transistor Superhet Receivers, 7/6.
Practical Radio Inside Out, 3/6.
Master Colour Code Chart, 1/6.
Transistor Controlled Models, 7/6.
Principles of Colour TV, 18/-.

4 TRANSISTOR PUSH-PULL AUDIO AMPLIFIER

Size 3 x 1 1/2 x 1.
A ready built miniature push-pull amplifier with input and output transformers, 4 transistors. Ideal for use with record players, intercoms, BABY ALARMS, etc. Complete with full Price **47/6** instructions and circuit.
9 v. Batt. 2/3, 2 1/2in. Speaker 15/-

C.R.T. BOOSTER TRANSFORMERS

for heater cathode short circuit, or tubes with falling emission. Full instructions supplied, mains input. Type A optional 25% and 50% boost 2v. or 4v. or 6.3v. or 10.8v. or 12.6v. State voltage required. PRICE 10/6.

LOUDSPEAKERS P.M. 3 OHM 2 1/2, 3, 4in., 5 1/2in. 7 1/2in. 8in. Rola, 3/8; 8 1/2in., 16/8; 9in. Plessey 17/6; 10 x 6in 22/6; 10in. Rola, 30/-; 4in. Tweeter, 25/-; 12in. R.A. 30/-; 13 1/2 x 8in. Double Cone E.M.I. 35/-.

STENTORIAN HF.1012 10in. 3 to 15ohms, 10 w. 87/6; 35 ohm, 7 x 4in., 21/-; 5in., 17/6; 3 1/2in., 15/8.

BAKER SELHURST LOUDSPEAKERS

12in. Baker 15w. Stalwart 3 or 13 ohms, 45-13,000 c.p.s. ... 90/-
12in. Stereo Foam Suspension, 12w., 35-16,000 c.p.s. ... 88.17.6

15in. Standard H.D. 20w. 40-14,500 c.p.s. ... £28.00
12in. DeLuxe 15w. 35-17,000 c.p.s. ... £9.10.0
12in. Bass 25w. 20-15,000 c.p.s. ... £12.12.0
15in. Auditorium, 35 w. w. Bass, 20 c.p.s. to 12kc/s. £18

Details and Enclosures, plans S.A.E.

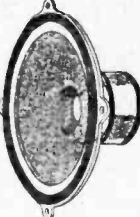

TWIN GANG TUNING CONDENSERS. 365 pF, miniature 1in. x 1 1/2in. x 1 1/2in., 10/-; 500pF Standard with trimmers, 9/-; midset, 7/6; with trimmers, 9/-; 500pF auto motion tuning, standard or midset, 9/-.

SMALL 3 gang 500 pF, 17/-. **SINGLE 365 pF, 7/8.** **SINGLE 25 pF, 50 pF, 100 pF, 160 pF, 5/8.** Solid dielectric 100, 300, 500 pF, 3/8.

CONDENSERS. New stock. 0.001 mfd. 7 kV. T.C.C. 5/8; Ditto, 20 kV, 9/8; 0.1 mfd. 7 kV, 9/8. Tubular 500 v. 0.001 to 0.05 mfd., 9d.; 0.1, 9d.; 0.25, 1/8; 0.5/0.000 v., 1/8; 0.1/350 v., 0.1/2,000 v., 0.1/1,000 v., 1/8; 0.1 mid., 2,000 volts, 3/8.

CERAMIC COND. 500 v. 0.3 pF to 0.01 mfd., 9d. **SILVER MICA CONDENSERS,** 10% 5 pF to 500 pF, 9d.; 600 pF to 3,000 pF, 1/-; Close tolerance (±1 pF) 2.2 pF to 47 pF, 1/-; Ditto 1% to 50 pF to 815 pF, 1/-; 1,000 pF to 5,000 pF, 1/8.

465 K/s SIGNAL GENERATOR Price 15/-. Uses B.F.O. Unit. ZA 30038 ready made with valve 155. **POCKET SIZE** 2 1/2 x 4 1/2 x 1 1/2 in. One resistor to change. Full instructions supplied. Battery 8/6 extra. 69V 11V. Details S.A.E.

WAVECHANGE SWITCHES

4 p. 4-way 2 water long spindle ... 8/6
2 p. 2-way, or 2 p. 6-way long spindle ... 3/6
4 p. 2-way or 4 p. 3-way long spindle ... 3/6
3 p. 4-way, or 1 p. 12-way long spindle ... 3/6

Wavechange MAKITS Wafer available: 1 p. 12 way, 2 p. 6 way, 3 p. 4 way, 4 p. 3 way, 6 p. 2 way, 1 waffer switch, 8/6. 2 waffer switch, 12/6; 3 waffer switch, 16/-; additional wafers up to 12, 3/8 each extra. Toggle Switches, s.p., 2/-; d.p., 3/6; d.p.d.t., 4/-; Rotary s.p., 3/6; d.p., 4/6.

CRYSTAL MICE INSERT, 6/6

Size 1 1/2in. dia. x 1 1/2in.
ACOS MIC. 14, insert 1 1/2in. dia. x 1 1/2in. 8/6

ACOS 39-16 LUXE STICK MIKE 35/-

TSL QUALITY STICK MIKE... 25/-

Valveholders, Pax. int. oct., 4d. EA50, 6d.; B12A, CRT, 1/3. Eng. and Amer. 4, 5 and 7 pin, 1/-; MOULDED Mazda and int. oct., 6d.; B7G, B8A, B8C, B9A, 6d. BTG with can, 1/6. B9A with can, 1/9. Ceramic EF50, B7G, B8A, int. oct., 1/-; B7G, B8A cans, 1/- each.

ADASTRA 3-3 AMPLIFIER. Ready built A.C. only. 200-250 v. Valves ECL86 and EZ80. 3 watt quality output. Mullard tone circuits, bass boost, treble and volume controls. Separate engraved front panel with de-luxe finish. Heavy duty output transformer 3 ohm. Quality mains transformer. Stove enamelled chassis size 6in. x 5in. x 3in. Bargain Price £4.19.6. Circuit supplied.

RADIO COMPONENT

Our written guarantee with every purchase
NEW COMPONENT LIST 1/-.
Bus 133 or 68 pass door
S.R. Station Selhurst

Volume Controls 80 ohm COAX

Lineal of Log Tracks Semi-air spaced 1/2 in. Stranded core. 6d. yd.
 Long spindles. Midget 40 yds. 17/6
 & K ohms to 2 Mex. 60 yds. 25/-
 L.S. 3/-; D.P. 4/6; Fringe quality
 Stereo L/R10/8; D.P. 14/6 Air speed 1/- yd.

TELESCOPIC CHROME AERIALS. 13in. extending to 43in. 3/6 ea. Coax Adaptor Plug, 1/6 extra.
TRIPLEXERS Bands I, II, III 12/6
COAX PLUG 1/- LEAD SOCKET 2/-
PANEL SOCKETS 1/- OUTLET BOXES 4/-
BALANCED TWIN FEEDER yd. 6d.; 80 or 300 ohms. DITTO SCREENED per yd. 1/6. 80 ohms only.
Wirewound Ext. Speaker Control. 10 3/4, 25 0/6 6/8.
WIRE-WOUND POTIS. 3 WATT. Pre-set Min. TV Types. All values to 10 ohms to 25 K. 3/- ca. 30 K. 50 K. 4/- (Carbon 30 K. to 2 meg. 3/-).
WIRE-WOUND 4 WATT POTIS. Plain spindle. Value 50 ohms to 50 K. 6/8; 100 K. 7/6.
PHILIPS TRIMMERS. 0.010 pF. 3-30 pF. 1/-.
TRIMMERS. Ceramic. 30, 50, 70 pF. 9d.; 100 pF. 1/0 pF. 1/3; 250 pF. 1/6; 500 pF. 750 pF. 1/9.
TV etc. TRIMMER. 1000 pF. with knobs. 2/-.
RESISTORS. Preferred values. 10 ohms to 10 meg. 1/4 w. 4/-; 1/2 w. 6d.; 1 w. 8d.; 2 w. 1/-; High Stability. 1/4 w. 1/-; 2/- Preferred values 10 1/2 to 10 meg. Ditto 50 1/2 to 22 meg. 6d.
 5 watt } WIRE-WOUND RESISTORS { 1/3
 10 watt } 10 ohms—10,000 ohms { 2/-
 15.5K to 47K 10 w. } 3/-

AMERICAN "BRAND FIVE" PLASTIC RECORDING TAPE

Double Play 7in. reel, 2,400ft. 42/-	Spare
5in. reel, 1,200ft. 25/-	Plastic
Long Play 7in. reel, 1,800ft. 25/6	Reels
6in. reel, 1,200ft. 23/6	3in. 1/6
5in. reel, 900ft. 18/6	4in. 2/-
Standard 7in. reel, 1,200ft. 25/-	5in. 2/-
5in. reel, 600ft. 16/-	7in. 2/6

"Instant" Bulk Tape Eraser and Head Defluxer, 200/250 v. A.C. 27/6. Leaflet with full details. S.A.E.

CRYSTAL SET BOOKLET 1/-
CRYSTAL DIODE G.E.C. 2/- GEX34, 4/-, OA81, 3/-
HIGH RESISTANCE PHONES. 4,000 ohms, 15/- pr.
SWITCH CLEANER. Fluid squirt sprout. 4/6 tin.

HIGH GAIN TV PRE-AMPLIFIERS
 H.A.N.D. 1 H.A.C.
 Tunable channels 1 to 5. Gain 18dB. ECC84 valve. Kit price 29/6 or 49/6 with power pack. Details 6d. (PCC84 valves if preferred). Coils only 9/6.
BAND III I.T.A.—Same prices.
 Tunable channels 8 to 13. Gain 17dB. Circuit and Coils only 9/6.

1/16in. Paxolin Panels, 10 x 8in., 2/-
 Miniature Contact Cooled Rectifiers, 250V 50mA, 7/6; 250V 60mA, 8/6; 250V 85mA, 9/6;
 Selenium Rect., 300V-85mA, 5/-
 TV etc., Silicon Sub. Min. Rectifier, 125V, 300mA, 6/6; 250V, 450mA, 10/-
 RM4-RM5, 14A100, 14A116, 10/-each. FC31, 20/-
Coils Wearite "P" Type, 3/- each.
Osmer Midget "Q" type. ad. dust core. cor. for 4/- each. All ranges. List S.A.E.
Teleton D.W.R. L. and Med. T.R.F. with reaction. 4/-, Med. wave D.R. 3/6
Ferrite Aerials. M. 8/9; M. and L. 12/6
Osmer Ferrite Rod Aerials. L. and M. (or transistor circuits), 10/- each.
Ferrite Rods. 8 x 1/2in., 2/-
H.F. Chokes. 2/6, Osmer OC1, 6/9.
T.R.F. Coils. A/H.P. 7/- pair; HAX, 3/-
Repanco DRR2. 4/6. DRX1, 2/6.
Radio Screwdriver. 5in., 6d.
Neon Mains Tester Screwdriver. 5/-
Solder Radiograde. 4d. yd. 1lb. 5/6

Aluminium Chassis, 18 s.w.g. Plain undrilled, 4 sides, riveted corners. 1 lattice fixing holes, 2 1/2in. sides, 7 x 4in. 4/6; 9 x 7in., 5/9; 11 x 7in., 6/9; 13 x 9in., 8/6; 14 x 1 1/2in., 10/6; 15 x 14in., 12/6
 Aluminium Panels, 18 s.w.g., 12 x 12in. 4/6; 14 x 9in., 4/-; 12 x 8in., 3/-; 10 x 7in., 2/3; 8 x 6in., 2/-

COMPONENT SHOP SPECIALISTS

FP, charge 1/-. C.O.D. 2/- extra.

"6 + 1" TRANSISTOR RADIO MEDIUM AND LONG WAVE KIT
 First class components to make a 6 transistor 2 waveband Superhet chassis ideal for portable or table radio. All parts including BVA transistors, ferrite aerial, with car aerial coil, printed circuit, 8 1/2in. x 2 1/2in., but EXCLUDING Speaker and cabinet.
 Speakers, 35 ohms, 7 x 4in. 21/-
 5in., 17/6. 3 1/2in., 15/6. **£4.5.0**

BULGIN PLUGS AND SOCKETS. Non-reversible P74, 2-pin, 4/3; P73, 3-pin, 4/6; P194, 6-pin, 5/6. "DOMINA" plugs, 2/6; sockets, 2/6.
JACKS. English open circuit, 2/6. Closed circuit, 4/3. Grundig type, 3-pin, 1/3. Grundig lead jack, 3/6.
JACK PLUGS. English, 3/-; Screened, 4/-; Grundig, 2-pin, 3/6.
ALADDIN FORMERS and cores, 1in., 8d.; 2in., 10d. 0.3in. FORMERS 5887 or 8 cans TV1 or 2, 2in. sq. x 2 1/2in. or 3in. sq. x 1 1/2in. 2/- with cores. 5/- 2/3.
SLOW MOTION DRIVES. 5/- 2/3.
SOLOID IRON. 250V, 200V or 230V, 24/-
ANTEX SUB-MIN IRON. 15w, 200 or 240 v., 29/6.
BENCH STAND for above, 12/6.

JASON FM TUNER COIL SET 29/-
 H.F. coil, aerial coil, oscillator coil, two i.f. transformers 10.7 Mc/s, detector transformer, heater choke. Circuit book using four 6AM6, 2/6.
Complete Jason FMT Kit. Jason chassis with calibrated dial, components and 4 valves, £6.5.0.
Model FMT5 with new shelf cabinet, 5 valves & power pack £10. Less power £8.15.0.

MAINS DROPPERS. Midget adjustable sliders 0.3A, 1,000 ohms, 5/-; 0.2A, 1,500 ohms, 6/-; 0.1A, 2,000 ohms, 5/-.
M.V.C. TRANSFORMER. 50-1 3/9.
P.V.C. Covered Wire, single or stranded, 2d. rd. Sleeving, 1 or 2 mm., 2d.; 4 mm., 3d.; 6mm., 5d. yd.
SPEAKER-FRET. Gold Cloth, 17 x 25in., 5/-; 25 x 35in., 10/-; Tygan, various colours, 52in. wide from 10/- ft.; 26in. wide from 5/- ft. Samples, S.A.E. Expanded Metal, Gold, 12 x 12in., 6/-.

RADIO AND TELEVISION SPARES
 All leading makes, volume controls, etc., line output transformers, etc. R. V. A. valves (current and obsolete types). Send S.A.E. for quotation.

WEYRAD
COILS AND TRANSFORMERS FOR 2-WAVE TRANSISTOR SUPERHETS WITH PRINTED CIRCUIT BOARD FERRITE ROD AERIAL
 Long and Medium Wave Aerial—RA2W On 6in. rod, 208P.F. tuning, with car aerial coupling coil 12/6
 Osc. Coil P50/1A.C. 178P.F. tuning, 5/4
 1st and 2nd I.F. Trans.—P50/2CC, 470kc/s 11/16in. dia. by 1in. 5/7 each
 3rd I.F. Trans.—P50/3CC, 6/-
 Spare Cores 6/- each
 Driver Transformer—LFDT4, 9/6
 Wavechange Slide Switch, 3/6
 Printed Circuit—PCA1, Size 2 1/2 x 8 1/2in. Ready drilled, and printed, 9/6
 Volume Control, 5K-DP, 4/6
 35 ohm Speakers, 3in., 15/8; 5in., 17/6; 7 x 4in., 21/-
 24 Fixed Resistors, 10/6
 18 Fixed Condensers, 21/6
 Tuning Gang with trimmers, 10/6
 6 Mullard Transistors and diode, 42/6
 Constructor's Booklet, 2/-

NEW MULLARD TRANSISTORS
 OC71 6/-, OC72 7/6, OC81D 7/6, OC81 7/6, OC44 8/9, OC45 8/6, OC871 10/6, A117 9/6
 Sub Miniature Condensers, 0.1 mFd. 30 v. 1/3, 1.2, 4, 5, 8, 16, 25, 33, 50, 100 mFd. 15 volt 2/6 ea. Transistor Holders 1/3.

H.R.C. Pocket 2 Transistor. M.W. 6 1/2 in. W. Radio Kit 29/6.
 Miniature earpiece, 7/6. Batt. 2/3.
 Circuit details, etc. S.A.E.

MONARCH RECORD PLAYER



Kit with ready built amplifier, speaker and cabinet. Carr. and ins. 5/- **£11.10.0**

Collaro deluxe auto-player kit
£11.19.6 Carr. and Ins. 5/- detail S.A.E.
COLLARO QUALITY PLUG-IN AUTO-CHANGER. 4-speed, with 4-in xtal head. Ready built 3 watt amplifier, loudspeaker and contemporary styled Portable Player Case. All items guaranteed to fit together perfectly, can be assembled in thirty minutes, full instructions supplied,
 4 Speed Autochanger, B.S.R., U.A.16 £615.0
 B.S.R., U.A.12 Stereo/Mono .. £710.0
 Garrard Automatic Changer .. £617.6
 Garrard AT6 Stereo/Mono .. £110.0
4 SPEED SINGLE PLAYERS:
 E.M.I. with auto stop .. £515.0
 E.M.I. with separate pick-up .. £57.6
 Garrard SRP10, £5,10,0; 4HP, £16,10,0

Replacement sapphire stylus available from 5/3
 Replacement Xtals from 15/-; Stereo from 31/6.
RECORD PLAYER CABINETS 70/-
 Two-tone handsome resins covered, size 18 x 14 x 8, all accessories, baffle, fret and mounting board 14in. x 13in. Space for amplifier, speaker and all modern Autochangers or single players, etc. Mounting board will be out, free of charge! for any modern record player.
RECORD PLAYER AMPLIFIER. 95/-
 2-valve 3w. A.C. amplifier and 6in. speaker all ready mounted on baffle, 18in. x 7in., 3in. deep. Wired and tested ready for use with above cabinet.

SINGLE PLAYER KITS

£7.19.6 post 5/-
 With ready-built, 2 stage, 3 watts output amplifier. High flux 5in. speaker. Handsome portable case 13 x 10 x 7 1/2in. Collaro 4-speed junior motor. LP/Std. xtal pick-up for 7, 10, and 12in. records.

GABY MULTIMETER

Moving-coil Model M.I. 54/-
 Measures D.C. or A.C. 6 v., 30 v., 120 v., 600 v., 1200 v. D.C. 30 mA, 300 mA. Ohms 0-100K. Leaflet S.A.E.

ARDENTE Transistor Transformers
 Type D3033, 7.3 CT; Push-Pull to 3 ohms (or OC72, etc.), 1 x 1 1/2in. 9/6
 Type D3034, 1.75 ICT, Push-Pull Driver for OC72, etc., 1 x 1 1/2in. 9/6
 Type D3038, 11.5 : 1 Output to 3 ohms for OC72, etc., 1 x 1 1/2in. 9/6
 Type D167, 18.2 : 1 Output to 3 ohms for OC72, etc., 1 x 1 1/2in. 12/-
 Type D239, 4.5 : 1 Driver Transformer, 10/-
 Type D240, 8.5 : 1 Driver Transformer, 10/-

ARDENTE TRANSISTOR CONTROLS
 5K or 1MΩ switched, dia. 0.9in., 5/3
 Type VC1760, 5K with switch, dia. 0.7in., 10/6
 Deaf aid earpiece xtal or magnetic, 7/6

337 WHITEHORSE ROAD WEST CROYDON
 Telephone: THO 1665

FREE THIS BOOK WILL INTEREST YOU!

LEARNING the PRACTICAL WAY

Radiostructor
EQUIPMENT-COURSES

A NEW-PRACTICAL WAY
of UNDERSTANDING

Radio - Television - Electronics

Including: Transistors; VHF/FM; Hi-Fi equipment; Computers; Servo-mechs; Test Instruments; Photo-electrics; Nucleonics, etc.

FOR...Your Career...Your Own Business...An Absorbing Hobby

Radiostructor—an organisation specialising in electronic training systems offers a new self-instructional method using specially designed equipment on a "do-it-yourself" basis.

You learn by building actual equipment with the big kits of components which we send you. You advance by simple steps, performing a whole series of interesting and instructive experiments—with no complicated mathematics! Instructional manuals employ the latest techniques for showing the full story of electronics in a practical and interesting way—in fact—you really have fun whilst learning! Post the coupon below, now, for full details.—

RADIOSTRUCTOR
LEADS THE WORLD
IN ELECTRONICS TRAINING

POST NOW

To RADIOSTRUCTOR (Dept. G28)
READING, BERKS.

Please send brochure, without obligation, to:—

★ Name _____

Address _____

6/63

★ **BLOCK CAPITALS PLEASE**
(We do not employ representatives)

Practical Wireless

Vol. XXXIX No. 676 JUNE, 1963

Editorial and Advertisement
Offices:

PRACTICAL WIRELESS

George Newnes Ltd., Tower House,
Southampton Street, W.C.2.

© George Newnes Ltd., 1963

Phone: Temple Bar 4363

Telegrams: Newnes, Rand, London,
Registered at the G.P.O. for trans-
mission by Canadian Magazine Post.

SUBSCRIPTION RATES

including postage for one year

Inland - - - - £19.0 per annum
Abroad - - - - £17.6 per annum
Canada - - - - £15.0 per annum

Contents

	Page
Editorial	117
Round the World of Wireless	118
The P.W. Spinette	120
Battery Economy	123
28Mc/s Converter	126
An Electronic Timer	128
The P.W. Celeste	133
Double Conversion Commu- nications Receiver	139
On Your Wavelength	143
Concrete Loudspeaker en- closure	144
Semiconductors	147
Morse Practice Oscillator	150
Transmitting and Receiving Aerials	153
Geiger Counter Digital Register	158
Miniature Amplifiers	169
Baby Alarm	173
Books Reviewed	174
Trade News	177
Letters to the Editor	181
Club News	182

The Editor will be pleased to consider articles of a practical nature. Such articles should be written on one side of the paper only, and should contain the name and address of the sender. Whilst the Editor does not hold himself responsible for manuscripts, every effort will be made to return them if a stamped and addressed envelope is enclosed. All correspondence intended for the Editor should be addressed: The Editor, PRACTICAL WIRELESS, George Newnes, Ltd., Tower House, Southampton Street, London, W.C.2. Owing to the rapid progress in the designs of wireless apparatus and to our efforts to keep readers in touch with the latest developments, we give no warranty that apparatus described in our columns is not the subject of letters patent.

Copyright in all drawings, photographs and articles published in PRACTICAL WIRELESS is specifically reserved throughout the countries signatory to the Berne Convention and the U.S.A. Reproductions or imitations of any of these are therefore expressly forbidden. PRACTICAL WIRELESS incorporates "Amateur Wireless."

The Transistor Revolution

THE radio hobbyist need never be lost for something to do. Whether he builds portable radios or elaborate communications receivers, matchbox-size amplifiers or high powered hi-fi set-ups, transmitters, test gear or electronic devices.

In any of these spheres of activity lies scope for experiment and improvement, due to the development of new and better components, circuitry, ideas and even new applications by the research laboratories of the industry. In fact, it is sometimes difficult to keep up-to-date on what is new.

One major development in recent years was, of course, the reappearance of the semiconductor device in the guise of the transistor. At first, many people were highly sceptical about the transistor, considering it an interesting, but limited, innovation.

And for a while it did appear that so far as the radio amateur was concerned the new device was indeed strictly limited, being suitable only for pocket portables and similar pieces of equipment where the criterion was simply that of miniaturisation.

The transistor had two big limitations—the limitation of power output obtainable and the limitation of frequency range. Thus, for a long time, transistors were used only in small, low-output, portables capable of receiving long and medium waves.

But things moved on. The laboratories produced bigger and better transistors; types that could operate on the short wave bands and, later, types suitable for use in v.h.f. receivers. And all the time the power ratings were pushed up.

Even so, there were many applications where a transistor was incapable of doing the work of a valve. But now comes a new generation of transistors. These are capable of large audio power outputs and, as they operate at higher voltages (up to 50V), conventional (stabilised) power supplies are used.

A few weeks ago, Mullard Ltd. staged an enlightening demonstration. Four unclassified stereo amplifiers were switched in turn to reproduce extracts from carefully chosen musical test pieces. The audience, comprising members of the technical press, individually awarded marks to each amplifier.

Although it was sometimes difficult to differentiate aurally, the results of this informal experiment showed that two of the amplifiers ran neck and neck for honours. The actual "winner" was then revealed as a 10+10W transistor design. The runner-up was a conventional valve counterpart!

This would have seemed impossible, or at least unlikely, a few years ago. And whatever reservations may have once existed, the semiconductor now looks all set to win its battle not only for recognition but for supremacy.

Our next issue dated July will be published on June 7th

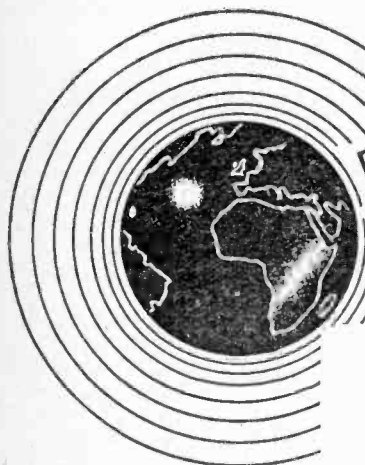

ROUND THE WORLD

of WIRELESS

NEWS AT HOME AND ABROAD

New Transmitting Station in Bahrain

HAMALA, on the Persian Gulf island of Bahrain, is now the site of the most advanced transmitting station in the whole of the Cable and Wireless Limited organisation.

The station, which is equipped with Marconi transmitters, has taken over the Bahrain-London radio-telephone/telegraph services and provision has been made for the introduction of the Aden wireless telegraphy circuit.

Below: One of the Marconi HS31 transmitters recently delivered to Bahrain.

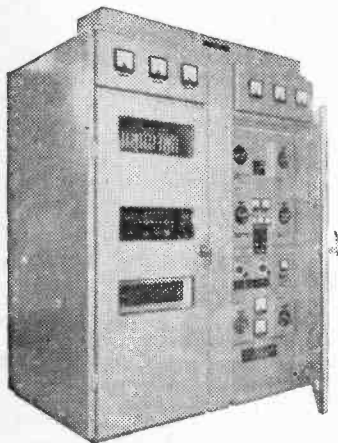

Minister Sees "Cordless" Exchange

THE Rt. Hon. Ernest Marples, Minister of Transport, recently inspected a cordless telephone exchange which has been installed in the new head office of Manchester Corporation Transport.

On this exchange (which was supplied by Standard Telephones and Cables Limited) the "switchboard operators" are all skilled traffic control engineers who are, under this system, in direct charge of the hour-by-hour running of Manchester's fleet of over 1,400 buses and trolley buses.

Besides the parent exchange in the new offices at Hyde Road, STC has also supplied three unattended satellite exchanges each of which meets the needs of two garages. Special arrangements prevent internal calls between garages and headquarters from hindering important incoming calls which may involve emergency action.

The New STC switchboard at Manchester Corporation Transport H.Q.

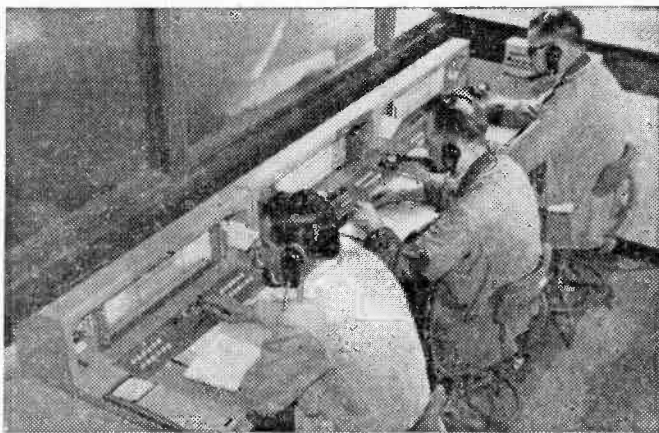

Equipment for H.M. Forces on Exhibition

AS part of the Government stand at the Radio and Electronic Equipment Exhibition, to be held at Olympia from the 21st to 24th May, the Ministry of Aviation will be showing how electronic equipment is designed and manufactured for use by H.M. Forces.

The exhibition will also provide a glimpse into the future of electronic equipment operating under the severe environmental conditions which apply in the case of airborne and space research operations and which can be expected to become more rigorous.

RADAR SPEED CHECK ON SHOW

New V.H.F. Aerial at Kinlochleven

AT the APEIX '63 Exhibition held recently at the University of London School of Pharmacy, the Marconi Company exhibited their portable electronic traffic analyser, known as "PETA".

PETA utilises the Doppler effect of frequency change in electromagnetic waves reflected from moving objects. A narrow beam of high-frequency radio energy is directed across the road at an angle, and in such a way that a vehicle entering the beam will cause some of the energy to be reflected back to the PETA aerial. This reflected energy will have suffered a change in frequency proportional to the speed of the vehicle, and by comparing the frequency of the transmitted signal with that of the reflected energy, a direct reading of miles-per-hour may be displayed on a suitably calibrated meter.



A police officer using Marconi PETA equipment.

THE BBC's new v.h.f. sound and television broadcasting station to serve Kinlochleven, Argyllshire, was brought into service on 8th April.

The television programmes are transmitted on Channel 1 and the v.h.f. sound programmes on the following frequencies: Scottish Home Service 94.1Mc/s; Light Programme 89.7Mc/s and Third Programme/Network Three 91.9Mc/s. The v.h.f. transmissions are horizontally polarised, thus requiring horizontally mounted receiving aerials.

Equipment Manufacturers reach Agreement

THE Rank Organisation and the Westrex Company Ltd., a Division of Litton Industries Inc., have announced that they have reached agreement under which the Rank Kalee Division of the Rank Organisation will be granted the sole agency for the United Kingdom and many territories overseas for the sale of sound recording and reproducing equipment manufactured by Westrex.

Microwave Network for Spain

MICROWAVE radio link equipment, worth more than £1,750,000, has been ordered by the Compania Telefonica Nacional de Espana from Standard Telephones and Cables Limited of London and its associated Company in Spain.

This equipment will provide large numbers of long distance telephone circuits over a 1,150 mile network extending to Sevilla on the southern tip of Spain, to Bilbao in the north, Valencia on the eastern coast and Coruna in the north-west.

The microwave system linking Sevilla with Leon, a route distance of some 385 miles, will be supplied and installed by STC. On the other routes, the equipment will be assembled from STC components and installed by Standard Electrica, S.A., an STC associate Company.

Right: This map shows the various routes in the microwave link system of Spain.



SPAIN ORDERS TAPE EQUIPMENT

THE Spanish National Broadcast and Television Company of Madrid has placed a substantial contract for professional tape recording equipment with EMI Electronics Ltd. The contract was secured by Iberavia Limitada, EMI's Spanish agents, and includes the supply of two EMI TR90 studio tape recorder consoles and four TR90 replay machines.

A BATTERY-OPERATED PORTABLE RECORD PLAYER

by K. L. Surrey

The P.W. Spinette

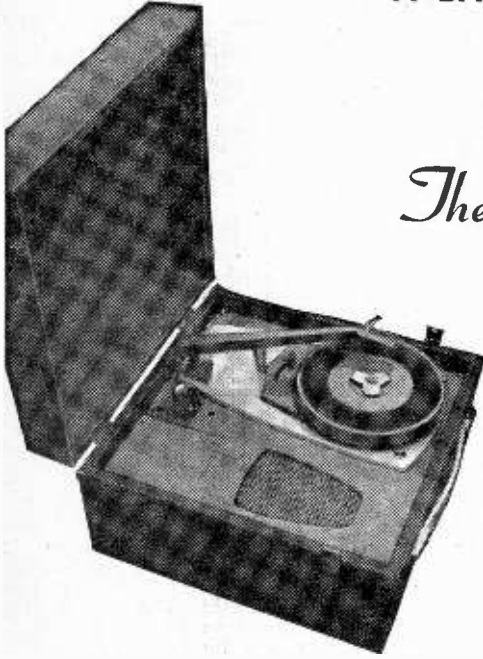

THIS is a four-transistor self-contained record reproducer, with a two-speed turntable unit, and it has a maximum output approaching 1W. Both motor and amplifier are driven from a single 9V battery, and a fairly large oval loud-speaker is incorporated.

The case is of the usual record-player type, with closing lid, and has a drawer as storage space for a number of records. Ready-sawn wooden parts are available for the case, so that construction of this item is very much simplified.

The Circuit

The amplifier circuit is shown in Fig. 1 on the blueprint presented free with this issue, and has four transistors, these being employed as amplifier, driver, and push-pull output stage. The quiescent (no signal) current consumption of this circuit is about 6mA. With moderate to average volume, the consumption is some 20-30mA, rising to 80mA or so on peaks with loud volume. As is usual with this kind of circuit, current taken from the battery depends on the setting of the volume control. The motor consumption is steady at approximately 20mA.

R1 is used to obtain a high impedance input for the pick-up, and VR1 is the volume control. Tr1 is a high gain, low noise amplifier stage. Tr2 is the driver, and Tr3 and Tr4 the output pair. Negative feedback is applied via R13 from the output transformer secondary to the collector of Tr1.

The on-off switch S1 is incorporated in the turntable unit, and controls both motor and amplifier. The pick-up arm is moved outwards to switch on. Switching off is automatic when the pick-up enters the run-in groove at the centre of a record.

Amplifier Panel

All the amplifier components are mounted on a piece of $\frac{1}{8}$ in., or similar, paxolin sheet, about 5 $\frac{1}{2}$ in. x 4in. This sheet is shown actual size in Fig. 5 with all holes indicated. If the paxolin is placed behind Fig. 5, the positions of holes can be marked by means of a sharp pointed tool.

All the small holes can then be made with a $\frac{1}{8}$ in. or similar drill. Six holes are large enough to clear 6B.A. bolts, as indicated. Four of these holes are used to secure the transistor heat sink plates. The remaining two are for wood screws to secure the amplifier in the case.

Two small slots take the lugs of the output transformer T2. These slots can be made by drilling three or four $\frac{1}{8}$ in. holes close together. Fragments of paxolin can be cleared from all holes with a larger drill.

Heat Sinks

The two heat sink plates are of 16s.w.g. aluminium, approximately 3in. x 1 $\frac{1}{2}$ in. (see Fig. 6). A flange about $\frac{1}{4}$ in. to $\frac{1}{2}$ in. wide is bent along each plate, and drilled to match the holes in the paxolin. Each plate is held with two $\frac{1}{4}$ in. 6B.A. bolts. The transistor clips are placed so that they occupy the positions shown in Fig. 2, and they are tightly bolted to the plates.

All the components shown in Fig. 2 can then be mounted. The wire ends of resistors and capacitors should not be bent sharply at right angles near the component, or they may be weakened unnecessarily. The resistors may be inserted either way round, each being checked to see that it has the correct value. All capacitors except C7 are electrolytics and must therefore be connected in the correct polarity shown in Fig. 2.

The transistors are positioned so that there is at least $\frac{1}{4}$ in. of free lead between the transistor and paxolin. If desired, thin sleeving can be placed on the

Fig. 6: The heat sink, as used for Tr3 and Tr4.

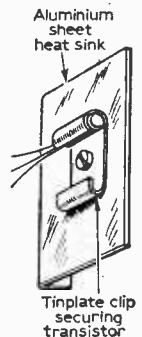

transistor leads. Failing this, a final check should be made, after wiring up, to ensure that the transistor leads are clear of each other. Emitter, base, and collector leads pass through the appropriate holes, as indicated by e, b and c.

T1 is so positioned that the coloured leads emerge as in Fig. 2. T2 is located with the two secondary leads near the panel edge; the centre tap of the primary is connected to the negative line. One outer primary lead goes to the collector of Tr3 and the other primary lead similarly provides the connecting point for the collector of Tr4.

T1 is held to the panel by its wire ends, while T2 is secured in position by twisting the lugs.

When all components have been placed as in Fig. 2, a final check of resistor values may be worth while.

Amplifier Wiring

All wiring is on the near side of the paxolin panel, as shown in Fig. 3. A simple procedure, which will help avoid errors and assure that no wire is overlooked, is to mark each lead on the diagram as it is fitted.

Thin tinned copper wire such as 26s.w.g. is convenient for the amplifier and, 1mm sleeving should be placed over all connections. The wire ends of resistors and other components are clipped off as required. Transistor leads should not be cut down unnecessarily, and joints should be soldered quickly, the iron being removed immediately the joint is made. If all leads are clean and bright, and a good cored-solder is used, with an iron which has been allowed to reach its proper working temperature, all joints should be satisfactory. If prior experience has not been gained, it is as well to leave the transistor leads until last.

Temporarily leave the secondary leads of T2 fairly long, and omit the connection from the secondary to R13. Wire one lug to the positive line, to earth the transformer core.

Motor and Switch Leads

Two of the holes, marked X in Fig. 5, are not used for components, but provide anchor points for the motor and switch lead, and outer braiding of the screened lead to the volume control. A loop of connecting wire can be passed through these holes, and the leads mentioned may be soldered on at either side of the panel.

Two pieces of thin flex, twisted together, are soldered to the secondary connecting points of T2. These will be taken to the loudspeaker.

Two further flexible leads, for motor and switch, and motor and battery negative, as in Fig. 3, are also soldered on. These will go to the turntable unit.

An insulated, screened lead about 9in. long is

prepared, and its centre conductor is soldered to the positive tag of C1. The braiding is taken to X (positive line). The other end of this screened lead may be soldered to the volume control VR1, as shown in Fig. 4.

The underside of the turntable unit is shown in Fig. 4 (not to scale). Battery positive and negative leads should be fitted with battery clips, and polarity must be correct. Interconnection between turntable unit and amplifier is left until the unit has been fitted to the motorboard. The screened pick-up lead will be connected to R1 and VR1. Positive and negative wires from the amplifier are connected to the motor as in Fig. 4. It will be seen that the positive circuit to both the motor and the amplifier is completed through the switch SL

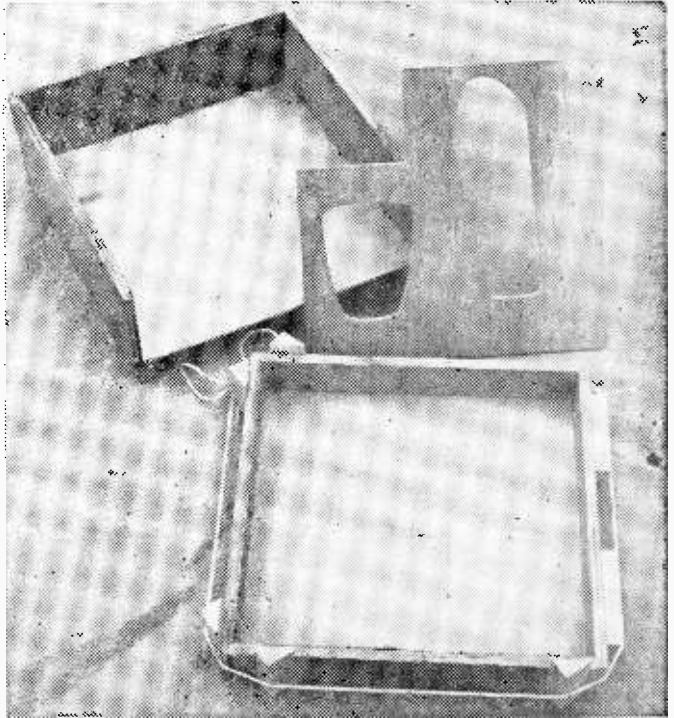

The lid under construction, with the motor deck and partially assembled case.

Initial Tests

The amplifier is first tested with no connection between R13 and T2, as described. If results are satisfactory, connect R13 as shown in Fig. 3. If this causes a reduction in volume (but improves quality) the connection is permanent. But if oscillation begins, switch off at once, and reverse the leads from the secondary of T2.

Assembling the Case

The cabinet is made from a complete kit which includes covering fabric and building instructions, the wooden parts are held together with a quick-hardening adhesive. Any good quality adhesive of

this type, and intended for wood, will be satisfactory, if used as the maker directs.

The lid is made from a piece of $\frac{1}{8}$ in. three-ply 11 in. x 11 in., with $\frac{1}{8}$ in. five-ply sides $1\frac{1}{2}$ in. deep. The lid sides consist of two pieces $10\frac{1}{8}$ in. x $1\frac{1}{2}$ in. x $\frac{1}{8}$ in., and two pieces 11 in. x $1\frac{1}{2}$ in. x $\frac{1}{8}$ in., shaped to form a corner joint. These pieces can be held firmly together by tying strong string round the whole, and pushing wooden blocks towards the corners to increase tension. These parts are assembled with the lid top on a flat surface, and weighted down until the adhesive is hard.

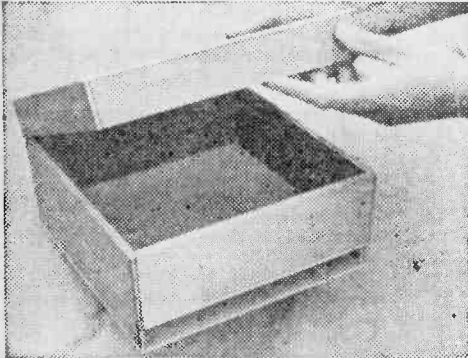

The case assembled, ready for its covering.

The case has two sides 11 in. x $4\frac{1}{2}$ in. x $\frac{1}{8}$ in., five-ply, grooved to take the false bottom, which is $10\frac{1}{8}$ in. x $10\frac{1}{8}$ in. x $\frac{1}{8}$ in. three-ply. The front is $10\frac{1}{8}$ in. x $3\frac{1}{2}$ in. x $\frac{1}{8}$ in., five-ply, and the false bottom rests flush with this. The back is $10\frac{1}{8}$ in. x $4\frac{1}{2}$ in. x $\frac{1}{8}$ in., five-ply, and the bottom is $\frac{1}{8}$ in. three-ply 11 in. x 11 in. These parts are fitted together in the same way as already described for the lid.

Two pieces $3\frac{1}{2}$ in. x $\frac{1}{2}$ in. x $\frac{1}{2}$ in. are glued to form a recess for the battery. Four angle pieces $3\frac{1}{2}$ in. x $\frac{1}{2}$ in. x $\frac{1}{2}$ in. are glued in the corners, inside. A similar piece is glued vertically near the battery space. The motorboard rests upon these five members.

The drawer front is $10\frac{1}{2}$ in. x $\frac{1}{2}$ in. x $\frac{1}{2}$ in., five-ply, and is attached to the drawer bottom, which is hardboard, $10\frac{1}{2}$ in. x $10\frac{1}{2}$ in. A countersunk 2B.A. bolt $\frac{1}{2}$ in. long is inserted centrally in the drawer bottom, projecting upwards to receive records.

The motorboard is $10\frac{1}{2}$ in. x $10\frac{1}{2}$ in. x $\frac{1}{8}$ in., three-ply, with a corner $3\frac{1}{2}$ in. x $3\frac{1}{2}$ in. removed to form the battery cover. The motorboard has an aperture large enough to receive the turntable unit, and a shaped cut-out for the loudspeaker. A $\frac{1}{2}$ in. hole is required for the volume control.

When all glued joints are completely hard, the case should be smoothed at corners and other joints, using glasspaper held on

a flat piece of wood. All dust must be cleaned away before covering the case.

Covering the Case

The author used a white and grey plastic material to cover the lid of the case, a piece 20 in. x 20 in. being required. The lid is placed centrally on this, and the material is cut so that a piece 11 in. x $4\frac{1}{2}$ in. can be folded inwards, being mitred at the corners. They also cover the insides of the side members, remaining material being turned over to the lid top inside. A piece of the same material $10\frac{1}{2}$ in. x $10\frac{1}{2}$ in. covers the inside of the lid.

The case is covered in the same way, except that the material is only turned down the sides for about 1 in. to $1\frac{1}{2}$ in. or so. In the author's model, grey and blue material was used. The material is 24 in. x 24 in. to allow the case to be covered with a single piece.

At the drawer opening, the material is carefully cut with a razor blade or sharp knife, and turned in. A little spare material is used to cover the drawer front. A small eye is screwed into the centre of the drawer front, and a hook to engage it is pivoted to the case by means of a $\frac{1}{8}$ in. screw.

The hinges keep the lid in an open position, and each is secured with four $\frac{1}{4}$ in. round-headed screws. Each of the two catches is also held with four $\frac{1}{4}$ in. countersunk-headed screws. Four small feet are attached to the case bottom, using small screws.

The carrying handle is placed $1\frac{1}{2}$ in. from the lip of the case (centrally, if case is closed) and is held with 4B.A. nuts on the inside.

A piece of material 12 in. x 12 in. is used to cover the motorboard, and is cut to clear the turntable unit opening. The material is carefully cut round the loudspeaker aperture, and a narrow strip of matching material is fixed to cover the edge of the

—continued on page 157

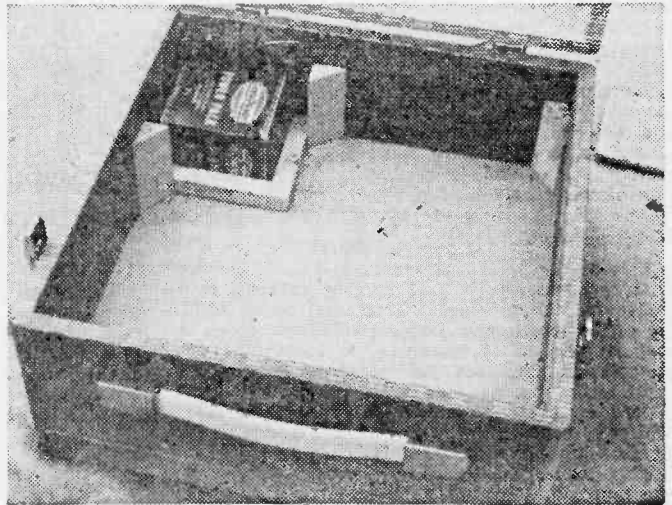

Showing the motor board supports and the battery position.

battery economy



INCREASING THE LIFE OF TRANSISTOR SET BATTERIES

By F. G. Rayer

PERSONAL portables use small batteries which can only have a reasonable life when conditions are such that the receiver draws only moderate current. With many receivers battery life is unnecessarily short, and the defect causing this may also introduce other troubles, such as high background noise, or lack of sensitivity.

The working life of the battery depends on the type of receiver, and usual volume required, but the average 6 or 7-transistor superhet should run for 25-75 hours, using a miniature battery. With larger receivers using non-miniature batteries, a life of some 100-200 hours or more is to be expected.

Battery economy is particularly worth while with a pocket receiver in frequent use. The consumption of 5-transistor t.r.f. sets will generally be much the same as with a superhet. Excessive current drain can very easily arise from incorrect resistor values. If a battery only lasts a few hours, a fault of this kind should certainly be sought, while if battery life has appeared to be satisfactory, it may still be possible to increase it considerably. Faults causing high battery drain are most likely in the audio section, but it is worth giving early stages a check.

Mixer and I.F.

Typical mixer and i.f. stages are shown in Fig. 1. A meter inserted in series with R12 should not be expected to read much more than 4mA, of which a little under 1mA will be taken by the potential dividers R1 and R2, R4, R5, and R13, and R8 and R9.

If current is high, check each stage by inserting the meter at points 1, 2 and 3. If any transistor draws excess current, its base voltage is probably too negative. With Tr1, this arises because R1 is too low in value, and R2 too high. Similarly, with TR2 (R4 and R5) and TR3 (R8 and R9).

If 20% tolerance resistors are fitted, base voltages, as measured at points 4 and 5, for example, may differ considerably. Even with 10% tolerance resistors, an unlucky combination of values may cause quite an error in base voltage.

If a high resistance voltmeter is connected from point 4 to battery positive line, point 4 should become more positive when a local station is tuned in. If not, the diode may be wired wrongly. An unnecessarily high current in Tr1 can cause noise. Current may be very low—e.g., an emitter current of 0.25-0.3mA, for OC44.

Emitter resistors R3, R7 and R11 should be checked, if necessary. Low values should increase current, because the emitter-base voltage is quite critical. If emitter resistors are reasonably near the marked values, the current in Tr1 can be reduced by increasing the value of R1, or reducing the value of R2. A simple means of checking is to shunt another resistor across R2. Or a variable resistor may be added between R1 and negative line, and a fixed resistor substituted after finding the best value.

In the same way, the value of R4 or R8 may be increased (or R9 may be reduced). Optimum values will result in low consumption, good amplification, and freedom from noise in these stages.

Driver

TR4 is the driver, in Fig. 2, and the collector current, as measured at point 6, should not exceed 1.5mA (OC71 or similar transistor), and may be 1mA or less. If the current is high, R17 should be checked. If this is correct, R15 may be rather low in value, or R16 rather high.

The base voltage must not be made too positive, in an attempt to reduce current further, or distortion will result. It may also be worth checking R12. The typical 470Ω may be increased to 680Ω

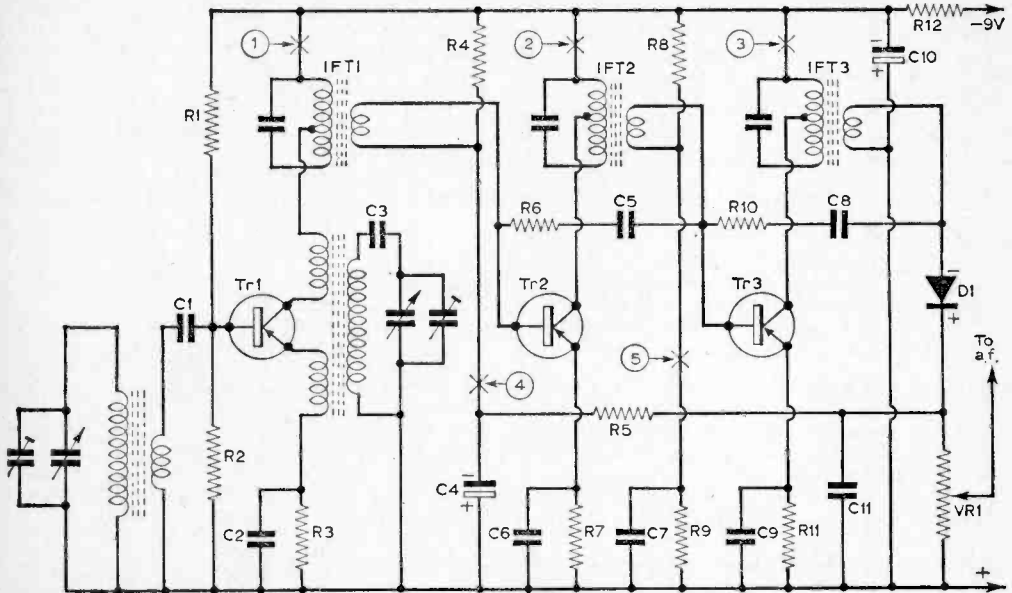

Fig. 1: The mixer and i.f. stages of a typical transistor receiver. The circled figures indicate test points referred to in the text.

in many sets, for maximum economy. In simplified receivers, R17 and C12 may be omitted. If so, the stage should give better results if these components are added, R15 and R16 being of recommended value.

Push-Pull Output

A push-pull output circuit (Fig. 2) is often employed, and wrong operation of this stage is a very frequent cause of short battery life. For OC72 and similar transistors, the combined collector current (point 7), may be only 2mA with no signal. But if R18 is too low in value, or R19 too high, point 10 is too negative.

With no signal, the current at point 8 should be approximately the same as that at point 9. With point 10 made slightly more negative, both currents (points 8 and 9) should increase by roughly the same amount. If not, the transistors are not matched. For this test, a variable resistor may be temporarily shunted across R18, care being taken not to make point 10 too negative, which could cause a very heavy current.

Reliable transistors obtained as a matched pair will be satisfactory for Tr5 and Tr6. But surplus transistors, or two transistors obtained separately, may be poorly matched and proper working of the stage at low currents, may be impossible, though results may be reasonably good at higher current values.

If consumption of the stage is too great, R18 is increased, or R19 reduced. This can be done to reduce the no-signal or low volume current without causing distortion. Normally, a current over 3-4mA should not be wanted, with no signal, and good volume obtained with current peaking up to 20mA on loud passages. With this type of output stage, current consumption increases as volume is

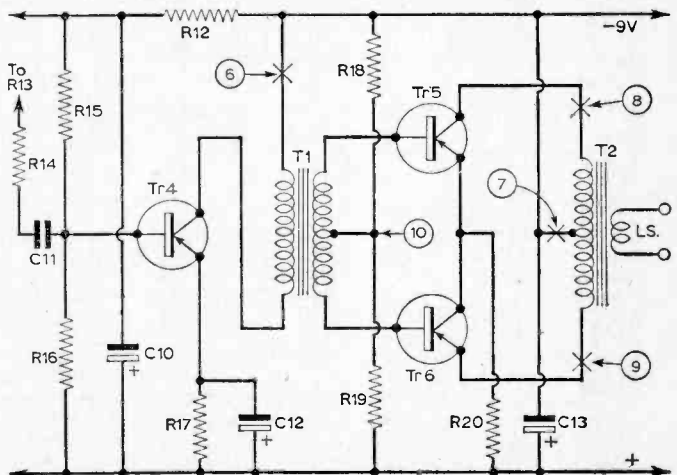

Fig. 2: A push-pull output stage.

raised. But if point 10 is too negative, current will be high, even with low volume, or no signal.

R20 tends to limit peak current. This can be observed by inserting the meter at point 7, and varying the value of R20, with the set operating at good volume. Sensitivity in the stage is high, with R20 omitted or of low value, but peak current is then also high, so R20 is generally desirable. By increasing the value of R20 the emitters become more negative, so R18 or R19 may also need subsequent modification in value. R20 is about 4.7 Ω when using OC72's.

With larger transistors current peaks may rise to 50mA or more at maximum volume and this is excessive for miniature batteries.

Single Ended Push-Pull

A circuit of this kind is shown in Fig. 3. Components in the driver stage may be the same as in Fig. 2, or R17 may be higher, with reduction in output from Tr4. Each of the output transistors Tr5 and Tr6 receives half the battery voltage. A

previously indicated—base voltage being too negative, due to unsuitable resistor values. If the speaker is connected as shown by the dotted line, meters at 8 and 9 will show the collector currents of Tr5 and Tr6, which should be approximately equal.

A six-transistor superhet using this output stage should be expected to draw about 7-8mA with no signal, rising to 15mA with reasonable volume. It is thus a useful circuit for an economical portable.

Other Points

Some receivers have a single transistor as a Class A output stage. Here, the current is fairly large (perhaps 20mA or more) even with no signal, or at low volume. This is unavoidable if reasonable loudspeaker volume is to be obtained.

If the receiver is home constructed, and space is available, the single output transistor could profitably be replaced by a push-pull stage, such as in Fig. 2 or Fig. 3, giving a larger output and reducing current drain.

In some receivers, the d.c. resistance of each half of the secondary of the driver transformer T1 is used instead of resistor R19 in Fig. 2, and resistors replacing R18 are wired

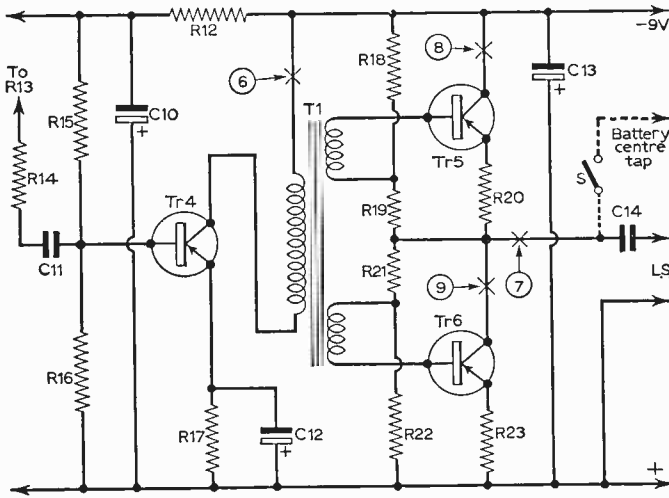

Fig. 3: The circuitry of a single ended push-pull output stage of a typical transistor receiver.

75 Ω or similar loudspeaker is used. Output is lower than with Fig. 2, but very economical working is possible, and the losses associated with the output transformer are avoided, so good volume may be obtained.

Point 7 may be regarded as the positive line for Tr5. R20 is the emitter resistor, and R18 and R19 the base bias potential divider. Tr6 is a duplication of Tr5, except that point 7 is the negative line for this transistor. The circuit may operate from a 9V supply as shown C14, being 100 μ F, or two 4.5V batteries may be employed in series, with the loudspeaker going from point 7 to the battery centre-tap thus made available.

For OC72's, R18 and R21 may be 2.7k Ω , and R19 and R22 may be 100 Ω , 5% tolerance. R20 and R23 may be 5.6 Ω .

Excess current can arise from the reasons

from base to negative line. These resistors may have to be relatively low in value, resulting in a current drain of several milliamperes. Such circuits can frequently be changed to agree

with Fig. 2 or Fig. 3.

Similarly, low value R18 and R19 will consume several milliamperes. Large power transistors are not wise for Tr5 and Tr6 when a miniature battery is to be used.

No current whatever should be drawn from the battery when the set is switched off, otherwise wiring is probably incorrect. A final test may include capacitors in parallel with the supply (such as C10 and C13). The leakage current of these should be small.

Most of the points described also apply to larger portables, except that a few extra milliamperes current consumption will be of no importance, because of the larger capacity of the battery. But even receivers of this kind should not be expected to draw more than 9-12mA, with no signal, rising to 25-35mA with good volume. ■

28Mc/s CONVERTER

Modifying the RF26 unit

By P. J. McGoldrick

MANY short-wave listeners on the amateur bands have receivers which are surplus equipment and only offer satisfactory reception to about 15Mc/s, either due to lack of sensitivity, or to their limited range. This means that for reception of the 21 and 28Mc/s amateur bands a front-end converter is needed.

Converter Action

A converter for this purpose usually follows the pattern shown in Fig. 1. If the receiver being used has satisfactory receiving characteristics at about 7Mc/s, the oscillator frequency for the 28Mc/s band can be either:

- 28+6.9Mc/s or 28-6.9Mc/s (6.9Mc/s is a quiet zone for reception).

As 21.1Mc/s is a less difficult frequency to generate, it is the obvious choice.

This oscillator is mixed with the already amplified signal at 28Mc/s to produce the 6.9Mc/s output at which the receiver is tuned.

Use of Surplus RF26 Unit

There is still on the market a surplus r.f. unit, Type 26, which sells for about 30s. This unit has the line-up of r.f. amplifier, mixer and h.f. oscillator described as being essential for a converter, but in its original form it covers frequencies much higher than those required (i.e. 50-60Mc/s).

The valve line-up of this unit is EF54 (r.f. amplifier), EF54 (mixer) and EC52 (oscillator) all using B9G valve bases. The EC52 is an exceptionally good glass envelope triode which is efficient up to some 300Mc/s. The EF54 used is akin to the famous EF50 valve.

The two controls on the front panel of the unit are the main tuning control, employing a three-gang variable capacitor with a Muirhead slow motion dial, and a small aerial trimmer control.

Modifications

The modifications needed are extremely simple and serve only to change the frequencies involved.

From the underside (Fig. 2), the three coils which require rewinding can be seen. These are L1 (directly in front of the first EF54), L2 (in front of the second EF54) and L3 (to the right of the EC52).

The new coils can be made from the details given in Table 1.

The replacement of the old coils is achieved by unsoldering them and inserting the new ones.

Power Supply

When the coil changes have been made, the power supply and the output lead to the receiver are connected to the Jones socket (Fig. 3). The aerial input is also connected, at the front panel, to the coaxial socket fitted originally.

The power supply required is 250-300V d.c. at about 30mA and 6.3V a.c. at about 1A for the heaters. This can usually be obtained from the receiver, so no separate power supply should be necessary. However, in case such requirements cannot be met by the receiver a suitable power supply is detailed (in Fig. 6).

The output lead should be coaxial cable, so that no pick-up at 6.9Mc/s occurs. The shielding of this cable should, of course, be earthed at both ends.

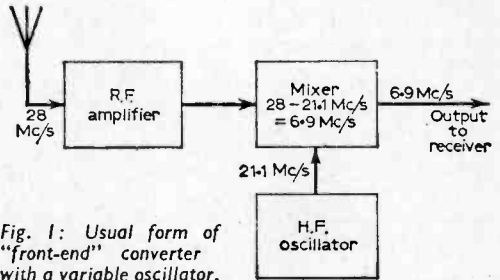

Fig. 1: Usual form of "front-end" converter with a variable oscillator.

TABLE I

L1, L2 and L3 are wound on 1/2 in. ebonite formers with 14 threads per inch, and which are 1 1/8 in. long, using 18s.w.g. wire.

	length of copper wire	approx. inductance
L1	26 1/4 in. or 66 3/4 cm	0.54 μH
L2	26 1/4 in. or 66 3/4 cm	0.54 μH
L3	20 1/4 in. or 51 1/2 cm	0.41 μH

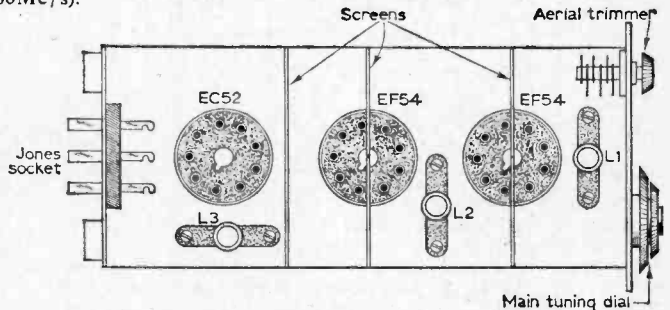
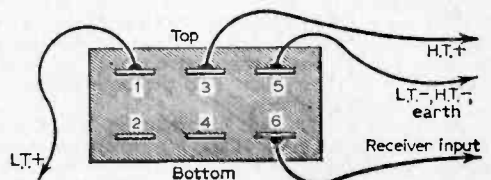

Fig. 2 (above): Underside view of the RF26 unit. Fig. 3 (below): Connections to the Jones socket (viewed from the rear).



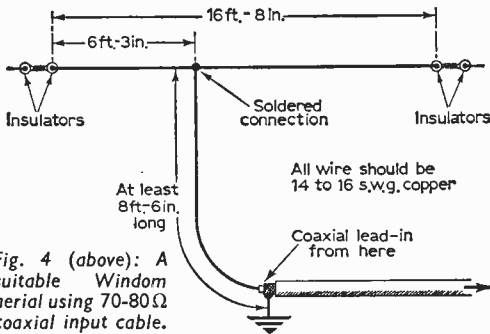
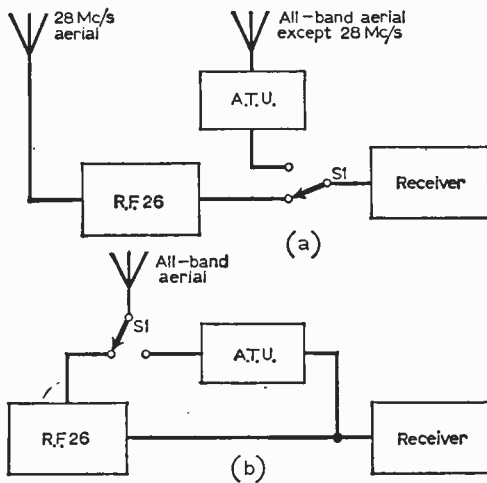

Fig. 4 (above): A suitable Window aerial using 70-80Ω coaxial input cable.

Fig. 5 (below): Methods of connecting converter and receiver to different aerial arrangements. The aerial tuning unit (A.T.U.) peaks signals on different bands.



Alignment and Use

The three ceramic trimmers which are above the three-gang variable capacitor are altered *very slightly* until the maximum noise is heard in the loudspeaker of the receiver. Accurate measuring devices such as an output meter can be used.

Between 50° and 60° on the dial 28Mc/s signals should now be audible. Finally to peak-up on a station, the aerial trimmer should be used. Full use should be made of this control for best reception and it should be noticed that its best peak position will differ from signal to signal, day to day.

The frequency of 6.9Mc/s is not a rigid one and any frequency up to about 7.1Mc/s can be used as long as this does not coincide with a strong signal.

A frequency should, however, be chosen and adhered to as any change in receiver frequencies requires an alteration of the converter's trimmers. In addition, if the same frequency is used continually, the converter can be calibrated against a standard receiver or oscillator.

The 28Mc/s band is severely affected by sunspot radiations, with the result that on some days the band may appear to be quite dead while on others signals may be strong enough to cause cross-modulation in the receiver. It is therefore

advisable to set the converter up beside a good 28Mc/s receiver to compare results.

Enhancements

When the modifications are complete, the user may like to add some "luxuries" to the unit. The first of these is control of the h.t. supply of the unit, by fitting a s.p.s.t. toggle switch on the front panel, in series with the h.t. supply, so that the main receiver can be used while the converter is at "stand-by".

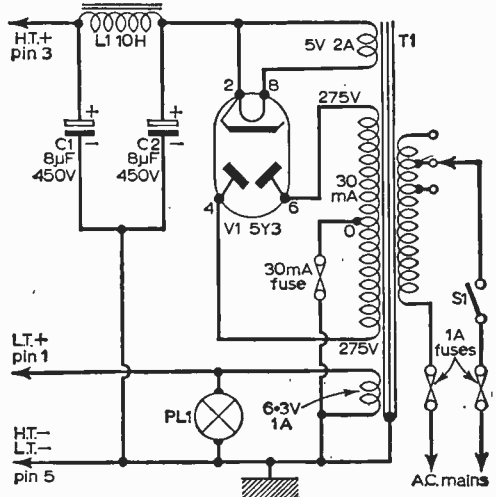
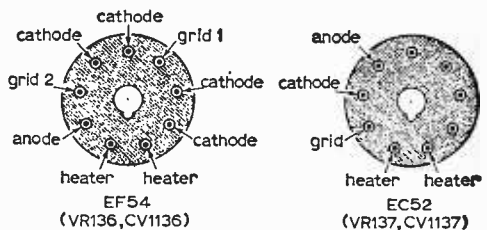

Fig. 6 (above): A suitable power supply. (T1 mains transformer with tapped primary, 200-250V; secondaries 275-0-275V, 30mA; 5V, 2A; 6.3V, 1A. L1 10H, 30mA l.f. choke).

Fig. 7 (below): The valve base connections.



If a fuse is not fitted in the receiver one should be fitted in the converter.

To improve results on 28Mc/s a separate aerial from that used on the other bands can be built. It is suggested that such an aerial can be a Window, which is particularly suitable for one band operation and very small for this band (see Fig. 4) and can be easily accommodated in a loft or on the roof of a house. The earth connection should be a large copper spike or plate buried in wet ground. All the measurements given in the diagram can be doubled. The aerial will then operate on 14Mc/s.

Figures 5(a) and (b) show arrangements for connecting separate and an all-band aerial to the receiver and converter. S1 in both cases is the aerial change-over switch, and is preferably of the knife-edge type.

an electronic timer

A RELIABLE TIMING
DEVICE FOR PHOTOGRAPHIC
AND GENERAL PURPOSES

BY D. GILSON

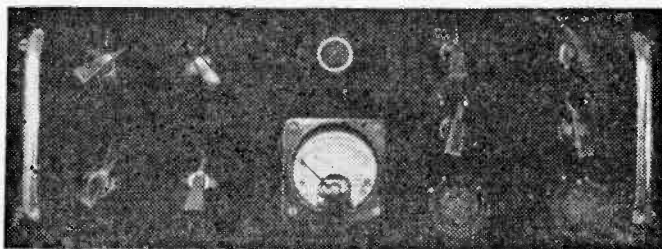

MANY people at some time or another find the need to time something. The amateur photographer needs to time his exposures on the enlarger or contact printer; and there are no doubt countless other occasions when a given interval is required to be indicated for some particular process.

The writer had such a need for a timing device, but after careful examination of the various circuits it was decided to construct one specially for the job in hand.

Firstly, it had to be portable without trailing leads or wires and on this count mains operation was ruled out. However, the case was constructed allowing ample room so that should mains operation be desired at a later date there would be sufficient space to install a power unit. The writer is acutely aware of the alarming rate at which battery valves consume the precious milliamps, and with this point in mind valves were omitted from the list of possibilities. The only choice left after such ruthless pruning was our "new" friend the transistor. In the present circuit an XB112 is used and even when working full out only consumes a modest 5 to 8mA.

Component Problems

The degree of accuracy is a problem which must necessarily arise in all matters of timing. Electronic timers make use of the charge and/or discharge of a capacitor through a resistor, and this immediately poses the question of the reliability of these two components.

As far as timers are concerned, capacitors may be divided into two main groups, paper and electrolytic. Paper capacitors are favoured where accuracy is of importance, but have the disadvantage of their bulk. A 10 μ F paper type capacitor is no small physical size, so a 100 μ F would be immense—even if one were available. Electrolytics on the other hand, can be obtained easily

and cheaply and their values, even in the 500 μ F range are still contained in a comparatively small size.

Unfortunately, electrolytics are notorious "leakers" when compared with paper dielectric capacitors and the snag is that the leak is not linear. Over a period of 30 seconds or so this may not be of sufficient consequence. However, over a period of minutes the matter might prove more serious. On the other hand, this can often be tolerated since usually the longer the timing period the greater the latitude of error. An example may help to clarify this:

Let us suppose that we can only be sure of 10% accuracy. Then, over a short timing period of, say, 20 seconds this represents an error of two seconds, i.e. 10% of 20 is two. Over two minutes however we find that for 10% accuracy we can allow 12 seconds, i.e. 10% of 120 is 12. This example is purely hypothetical and does not necessarily indicate tolerances found in practice. In the circuit to be described, accuracy is much superior to the 10% referred to in the above example.

The resistor's present little worry if of good quality, since in the present design the usual bug-bear—trackwear—is eliminated.

It might be reasoned, that a good idea would be to use a small paper capacitor and increase the value of the resistor, thereby gaining the apparent advantage of accuracy and size. However, the value of resistance required would be very large—many megohms—and would begin to compare with the internal resistances of the transistor and the capacitor itself, resulting in an unstable timing period.

Our next consideration is the relay, the current-sensitive device used to actuate the alarm and/or control external circuits. Such a device is dependent for its individual accuracy on the tension spring and wear of same, plus wear of moving parts.

RADIO-AMATEUR GEAR
EDUCATIONAL KITS



TEST INSTRUMENTS
HI-FI EQUIPMENT

With the simple English of our instructive manual, anyone can build any of our models—and save money!



S-33

We guarantee that NO electronic or soldering experience is necessary. Our simple, well illustrated manual guides you step-by-step.

6W STEREO AMPLIFIER. Model S-33. 3 w/chl. inputs for radio-tape and gram., Stereo/Mono ganged controls. Sensitivity 200 mV. ... £13.7.6



F.M. TUNER

NEW! 5W HI-FI MONO AMPLIFIER. Model MA-5. A low-price amplifier based on the S-33. Printed circuit construction... £10.19.6

TAPE RECORDING/PLAYBACK AMPLIFIER. Stereo (TA-1S) £24.10.0 Monaural (TA-1M) ... £19.2.6

STEREO CONTROL UNIT. USC-1. Luxury model with inputs to suit any pick-up or tuner ... £19.10.0

HI-FI AM/FM TUNER. Tuning range: FM 88-108 Mc/s, AM 16-50, 200-550, 900-2,000 m. Tuning heart (£4.13.6 inc. P.T.) and I.F. amplifier (£20.13.0). Printed circuit board ... Total £25.6.6

HI-FI F.M. TUNER. Tuning range 88-108 Mc/s. Tuning Unit (FMT-4U) with 10.7 Mc/s I.F. output (£2.15.0 inc. P.T.) I.F. Amplifier (FMA-4U) complete with cabinet and valves (£12.6.0). Total £15.1.0.

NEW! 6W DE LUXE AMPLIFIER. Model S-33H. An inexpensive Stereo-Mono amplifier, with high sensitivity, suitable for Decca Deram cartridge ... £15.17.6

5in. OSCILLOSCOPE. Model O-12U. Wideband amplifiers essential for TV servicing, F.M. alignment, etc. T/B covers 10 c/s-500 kc/s in 5 ranges ... £38.10.0

HI-FI 18W STEREO AMPLIFIER. Model S-99. Ganged controls. Stereo/Mono gram., radio and tape recorder inputs. P/B selection ... £27.19.6

HI-FI SPEAKER SYSTEM. Model SSU-1. Ducted port bass reflex cabinet "in the white". Two speakers. Legs 14/6 extra. Bookcase model ... £10.17.6



O-12U



SB-10U



USC-1



TA-1S



S-99



AM/FM Tuner



SSU-1

SEND FOR FREE CATALOGUE—OVER 50 MODELS TO CHOOSE FROM

SINGLE SIDE BAND ADAPTOR. Model SB-10U. May be used with most A.M. transmitters. Less than 3W R.F. input power required for 10W output. Operation on 80, 40, 20, 15 and 10 m. bands on USB, LSB, or DSB. £39.5.0

THE "MOHICAN" GENERAL COVERAGE RECEIVER. Model GC-1U. Fully transistorised. Excellent portable or general purpose receiver for the amateur and short-wave listener ... £39.17.6 See full specification leaflet.



GC-1U

SHORTWAVE TRANSISTOR PORTABLE. Model RSW-1 Two short bands, trawler and medium ... £19.17.6 (inc P.T.)

HI-FI EQUIPMENT CABINETS. Large range, in kit form or assembled and finished, available to meet various needs. Details on request ... from £6.19.6 to £29.8.0

PORTABLE SERVICE OSCILLOSCOPE. Model OS-1. Compact portable scope, ideal for servicing and general work. Printed crct. Case 7 1/2 x 4 1/2 x 12 1/2 in. long. Wt. only 10 1/2 lb. £19.19.0



DX-40U

AMATEUR TRANSMITTER. Model DX-40U. Self-contained. 80-10 m. Power input 75 w. CW., 60 w. peak, C.C. phone. Output 40 w. to aerial. Provision for V.F.O. ... £33.19.0

6 TRANSISTOR PORTABLE. Model UXR-1. Prealigned I.F. transformers, Printed circuit, 7 x 4 in. high flux speaker. Real hide case ... £12.11.0 (inc. P.T.)

VALVE VOLTMETER. Model V7A. Measures up to 1,500 volts (D.C. and R.M.S.) and 4,000 pk. to pk. Res. 0.1%±1,000MΩ. £13.18.6

ELECTRICITY MAINS EXTENSION KIT. Model PUE-1. Completely safe, ideal for garage, greenhouse, soil heating extensions. Send for full details ... £4.15.6

AMATEUR TRANSMITTER. Model DX-100U. Covers all amateur bands, 160-10 m. 150 w. D.C. input, self contained with power supply. Modulator, V.F.O. £74.19.0



DX-100U

Money Saving 'PACKAGED DEALS' of Complete Stereo equipment from £45.13.0

Please send me FREE CATALOGUE (Yes/No).....

Full details of model(s).....

NAME.....

ADDRESS.....

PW6

Assembled models also available—prices on request
Deferred terms available over £10. Free Delivery U.K.

DAYSTROM LTD.

Dept. P.W.6, GLOUCESTER, ENGLAND

A member of the Daystrom Group, manufacturers of the
WORLD'S LARGEST-SELLING ELECTRONIC KITS

AN **AEI** PRODUCT



6 ft. flexible lead with cord grip

Will give a lifetime of service

Heats up from cold in 2½ mins

25 watt model for radio work

Heat concentrated in bit

Anatomy of a Superior Soldering Iron

The Solon range of electric soldering irons includes 15 and 25 watt models for radio, TV and electronic equipment; 65 watt models for household and workshop use. Larger models up to 240 watt also available.

Select a
SOLO
N TRADE MARK

Used in industry for over 30 years
Obtainable from your usual radio or electrical supplier

18/40A

AMATEUR RADIO
CHAS. H. YOUNG LTD.

Come and See Our NEW SUPER STORE

*The Finest in the
MIDLANDS*
All the usual lines
& MANY NEW ONES

Eddystone, Armstrong,
Quad, Leak, etc.
Ex Stock.

**170-172 CORPORATION ST.
BIRMINGHAM 4**

Telephone as before: CEN 1635

JACKSON 
the big name in **PRECISION** components

Precision built radio components are an important contribution to the radio and communications industry. Be sure of the best and buy Jackson Precision Built Components.

**SL 16
DRIVE**

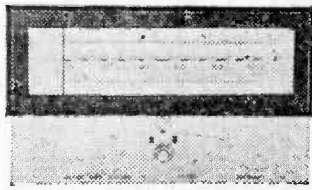

A general purpose slide rule Drive for F.M./V.H.F.

Units, short-wave converters, etc. Printed in two colours on aluminium, with a 0-100 scale and provision is made for individual calibrations. Complete with bronze escutcheon and glass.

**VISIT US AT R.E.C.M.F. EXHIBITION
STAND 268**

JACKSON BROS. (LONDON) LTD.

Dept. R.S., Kingsway-Waddon, Croydon, Surrey
Phone: Croydon 2754-5.

'Grams: Walfilco, Souphone, London

Also, there may be slight differences in the value of current at which the relay will open and close.

The above arguments may seem, to some, to present so many doubts as to make one wonder if any reasonable degree of accuracy can be attained at all, that is using readily available components, also keeping a reasonable budget and without recourse to specialised pieces of equipment. Bearing in mind all that has been said so far, the writer constructed the timer to be described with little cost and using standard components, as advertised in the pages of this magazine.

The Circuit

Referring to the circuit of Fig. 1, when the switch S1 is in the "charge" position, the transistor draws some 5-8mA pulling in the relay and registering f.s.d. in the meter. When S1 is turned to "time" the current through the relay commences to fall and its decrease can be observed on the meter. At a particular value of current, 1.5mA in the writer's case, the relay falls out and sounds the alarm.

The layout can be seen in Fig. 2. The four controls to the left of the meter cutout are the timing potentiometers. Anyone of these may be selected by the range switch S2, and each potentiometer is variable from about three seconds to two minutes. As used by the writer, three of the potentiometers are preset to a particular interval and the fourth is used as a variable. This eliminates inaccuracies due to track wear.

The method of presetting is somewhat novel, and works very well. A small pointer is made from a paper clip, first straightening it and then bending it as in Fig. 3(a). The completed pointer is then fitted on to the potentiometer thread and held in position with a locking nut (Fig. 3(b)). To calibrate or alter the timing period it is only necessary to calibrate the desired interval against a watch, loosen the locking nut, rotate the paper clip pointer until it coincides with the pointer of the knob, and tighten the locking nut. If the knobs are touched or knocked accidentally, they can be reset very simply and quickly by lining them up with the paper clip pointer again.

The four potentiometer knobs are colour-coded red, blue, white and yellow. The four positions of the range switch S2, which selects the desired timing intervals by switching into circuit the appropriate potentiometer, are similarly colour coded.

The Meter

The meter has a f.s.d. of 5mA and is shunted to read about 9mA. The original idea was that it should be used in conjunction with the variable

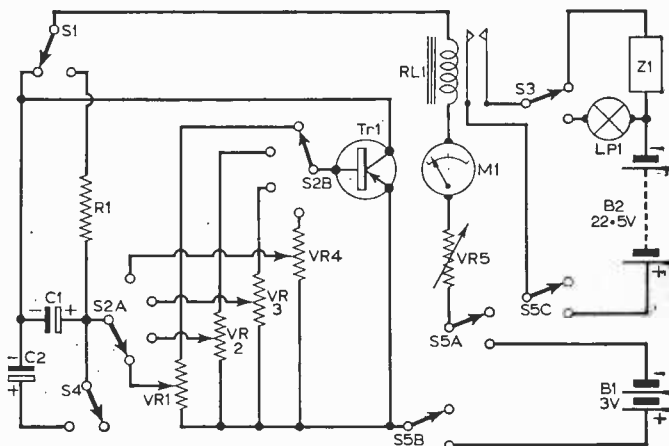
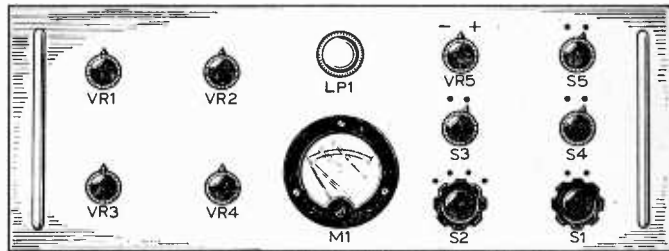

Fig. 1 (above): The circuit diagram.

Fig. 2 (below): The front panel.



resistor VR5 in order to ensure that a constant voltage is present, since if the voltage were to drop or increase then the charge of C1 (plus C2) would vary, thereby varying the timing period and distorting the accuracy of the instrument. A voltmeter suitably connected might prove preferable, but the mA meter as shown will indicate directly the current drawn by the circuit and is a further indication of the timing cycle. As explained earlier, when the needle drops to 1.5mA the relay falls out. It is important to note, however, that the relay de-energising at 1.5mA is true for the particular relay, meter, and circuit parameters in the writer's model, and this reading may vary in other models. For those not possessing a suitable meter, the circuit will of course work equally well without its inclusion.

The visual/oral switch S3 switches the alarm to either the warning light LPI above the meter to

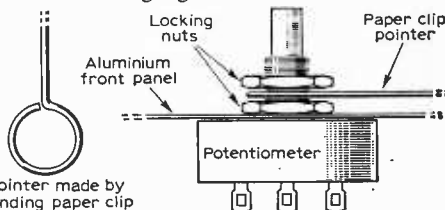

Fig. 3: Method used for assembling the potentiometers and pointers.

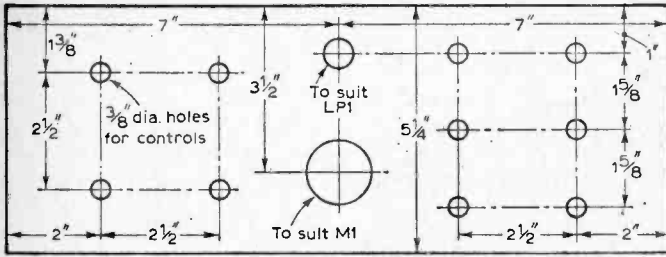

Fig. 4: The drilling details of the front panel.

give visual indication, or to the 3V Buzzer mounted underneath the front panel to give audible warning. This switch is particularly useful should the timer be used for photographic applications. If contact prints or ortho materials are to be processed, the red warning light may be used giving visual indication without fogging. If, however, panchromatic materials are used then it is only necessary to flick this switch to the "audible" position and take advantage of the buzzer to indicate the completion of the timing cycle.

External Circuits

There is no reason why the relay should not control external circuits directly and this could easily be done by selecting a relay with a further set of contacts and bringing these out to a plug at any convenient point on the case. S4 is a control marked "N" and "X2", and this merely switches a further 500µF capacitor and has the effect of doubling the timing period. It is very doubtful if the range will be exactly multiplied by two since all capacitors are plus or minus the value stated on the body or case. When one enters the realms of hundreds of µFs the plus or minus may be considerable and although switching in a capacitor in

parallel of the same value should, in theory, double the capacitance it will not be exactly so.

The remaining controls are self-explanatory. The on/off switch S5 breaks the h.t. lead and also the small battery lead from the buzzer and warning lamp to the battery B2. This last function is necessary because the circuit is so arranged as to sound the alarm when the relay is de-energised. Since the relay is de-energised when the unit is switched off the presence of this switch is obviously a desirable feature.

The range switch S2 selects the appropriate potentiometer and is colour coded to coincide with the coding on the potentiometer pointer knobs. Lastly, the switch S1 for "charge" and "time". This calls for little comment, apart from the 100Ω

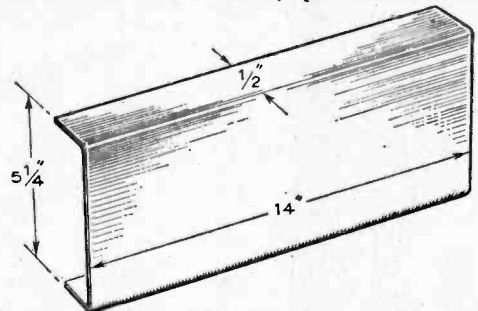
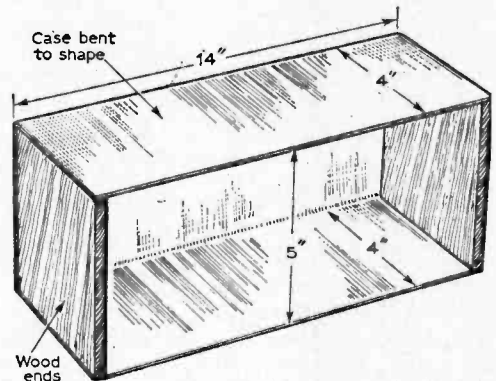

Fig. 5 (above): The overall dimensions of the front panel.

Fig. 6 (below): The construction of the cabinet.



resistor R1 in series with it. Since this switch is used constantly, the inclusion of R1 was thought necessary in order to eliminate surges and arcing at the contacts.

Construction

The unit could, of course, be smaller, very much smaller, but as explained earlier a mains power unit was envisaged at a later date and the present layout is uncramped and allows much appreciated breathing space for easy wiring and soldering. As

—continued on page 136

COMPONENTS LIST

- S1 1-pole 2-way (charge/time)
 - S2 2-pole 4-way (range selector)
 - S3 1-pole 2-way (visual/aural)
 - S4 1-pole 2-way (normal/ x 2)
 - S5 3-pole, 2-way (on/off)
-
- C1 500µF } electrolytic 25V
 - C2 500µF }
-
- M1 0.5mA shunted to read 10mA
 - RL1 Relay 2kΩ (1 break)
 - Z1 3V buzzer
 - LPI 3V 0.3A bulb
- Aluminium for case and front panel
 2 squares of wood for ends
 2 handles
 2 doz. chrome-headed screws
 10 knobs (type to individual taste)
- R1 100Ω ½ watt
 - VR1 } 2kΩ wire-wound potentiometers
 - VR2 }
 - VR3 }
 - VR4 }
 - VR5 1kΩ wire-wound potentiometer
 - B1 3V battery
 - B2 18V or 22.5V battery
 - TR1 XB112 (or equivalent)

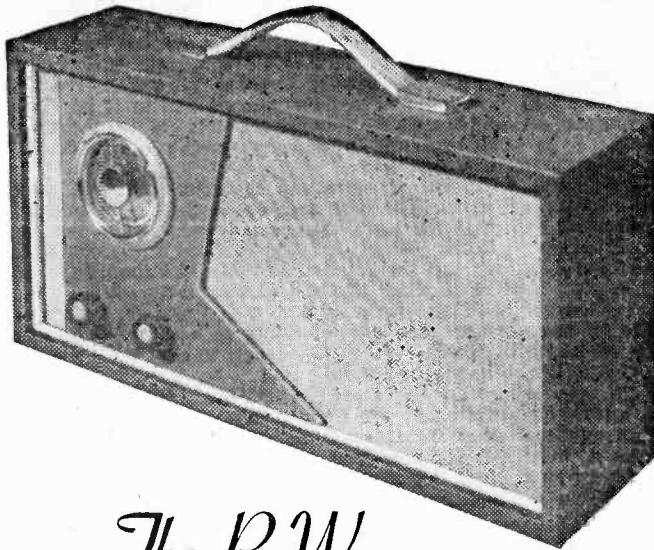

The P.W. Celeste

A SEVEN-TRANSISTOR PORTABLE RECEIVER

By K. L. Surrey

THE Celeste is a seven-transistor portable, tuning medium and long waves. It has good sensitivity and volume, an output approaching 1W being obtainable, and the 7in. x 4in. oval loud-speaker gives good quality reproduction.

Normally, the receiver operates from its internal ferrite rod aerial. However, when the directive properties of this aerial would be troublesome, or when using the set in a screened locality, an external aerial can be connected. An example of these circumstances arises when the receiver is used in a car. The external aerial coupling winding is quite separate from the other windings on the ferrite rod. One tag of this winding is connected to the "earth" line (battery positive) of the receiver, the other tag being taken to a coaxial socket situated at the side of the cabinet.

Description of the Circuit

The circuit is shown in Fig. 1 on the blueprint. Tr1 is the usual self-oscillating mixer. For m.w. reception, the l.w. portion of the ferrite rod aerial is shorted. For l.w. tuning, the ferrite rod windings are in series, and C2 and TC2 are in parallel with the oscillator coil.

Tr2 is the first i.f. amplifier, automatic volume control bias being obtained from the diode D1 and applied to the base, through R11. Tr3 is the second i.f. amplifier, and operates with fixed bias only.

The diode D1 provides demodulation. VR1 being the audio volume control (incorporating an on/off switch).

Tr4 is a low noise, high gain audio amplifier. Tr5 is the OC81D driver stage, T1 being the driver

transformer. Tr6 and Tr7 are a matched pair of OC81 output transistors, mounted on small heat sinks. The heat sinks are made from 18s.w.g., or preferably 16s.w.g., aluminium, as shown in Fig. 4.

The receiver will give exactly the same performance, at good volume, without the heat sinks but if these are temporarily omitted, maximum volume should not be used, or the output transistors will overheat.

It is advisable to obtain the package LFH which contains three specially selected and matched transistors for the a.f. stage.

Paxolin Panel

The receiver is constructed on a paxolin panel 10½in. x 6½in. and all holes should be drilled before mounting any components. The receiver is a complete, working unit when assembled on this panel. This, and the ample space available, simplifies construction and testing. When the set is inserted in its cabinet, most wiring is on that side of the panel facing the front (see Fig. 3), nearly all components being behind—that is, on the rear side of the panel.

The positions of components can be seen from Fig. 2. Resistors and capacitors are mounted by passing their wire ends through small holes. A ¼in. drill will do well for these. All electrolytic capacitors must be connected in the correct polarity, as indicated in the circuit and Fig. 2.

An ¼in. drill will be satisfactory for the 6BA bolts holding the heat sink plates, and also for the oscillator coil and IFT pins. For the IFT can tags ¼in. holes are used. The oscillator coil is placed

with its coloured identification mark facing the variable capacitor. White spot IFT's are used in first and second positions, with a blue spot IFT in the third position.

Four holes to clear 2B.A. ($\frac{3}{16}$ in.) are positioned as shown. Long bolts hold the loudspeaker in position, and the finished receiver is mounted on these bolts.

The aperture to clear the loudspeaker magnet can be made by drilling an oval of small holes, breaking out the paxolin, and clearing up with a half-round file. Alternatively, this opening can be made with an adjustable washer-type cutter, by cutting two semicircles at $3\frac{1}{4}$ in. radius, and two at $1\frac{1}{2}$ in. radius, to form the oval.

Holes $\frac{3}{16}$ in. in diameter are required for the wave-change switch S1 and VR1. The spindles of these two components should be about $1\frac{1}{4}$ in. in length and should be cut down, if necessary. This is best done by holding the unwanted end of the spindle in a vice, and using a sharp hacksaw, afterwards clearing away burr with a file. The component should be protected against metal fragments, while sawing, and the spindles should not be cut down with the components fitted to the circuit board.

The three trimmers TC1, TC2 and TC3 are mounted by passing their tags through small holes, a central hole under each trimmer clearing the adjusting screw. Short 6B.A. bolts secure two tags to take a 20s.w.g. bare "earth" circuit wire. The ferrite rod mounting is held by a short 4B.A. bolt and nut.

Particular care is necessary when mounting the variable capacitor, because if the bolts project, they may easily damage the component. Very short 4B.A. bolts are used, and they should project about the thickness of the capacitor plate. If the bolts are too long, washers should be placed under their heads.

When the panel is turned over, one end is supported by the heat sink plates. A bracket about $1\frac{1}{2}$ in. long is fitted under one bolt holding the variable capacitor. This bracket supports the other end of the panel, and prevents it resting on the transistors.

The driver transformer T1 secured by its wire ends. The insulation is removed from these, before inserting them through the holes in the panel.

The output transformer T2 has projecting feet, which pass through small slots in the panel. These slots can be made by drilling $\frac{1}{16}$ in. holes close together, and the feet are twisted to hold the transformer in place.

Wiring

A bare 20s.w.g. wire is run from the positive end of C18 to the

Fig. 4: The transistor heat sink for Tr6 and Tr7.

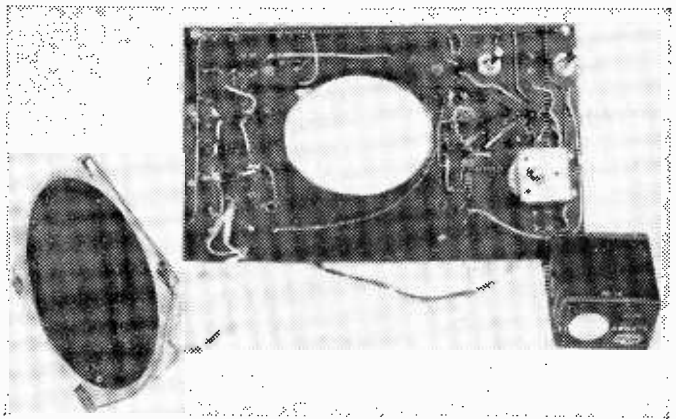

The chassis, battery and loudspeaker ready to be mounted in the cabinet.

bottom of the panel, then along near the bottom of the panel, and up to the tuning capacitor. Tags support this wire at convenient points, and it ends at one bolt securing the variable capacitor. Similar 20s.w.g. wires pass from the other bolts, to the trimmers, and to IFT2. Loops of 20s.w.g. wire under the nuts holding the volume control and wavechange switch are soldered to the earth line.

Most resistors and capacitors rest flat on the panel. The wire ends are bent at right angles, so that the leads can pass down through the small holes. Wires should not be bent immediately against the component body, nor should the bend be so sharp that the wire is fractured.

Some resistors and capacitors stand vertically. Here, the one wire end is bent at right angles, then at right angles again, so that both wires can be inserted in the holes.

The oscillator coil and the IFT's are secured by spreading out the can tags. One can tag of each component must be earthed. The earth circuit should *not* be completed by soldering one earth lead to one can tag, then running another earth lead on from the second tag. If this is done, poor contact

between tags and cans will cause noises and other trouble. Oscillator coil pin 3 must be wired directly to the gang capacitor frame tag, to avoid instability.

Transistors

There is no point in cutting the leads of these very short. If pieces of 1mm sleeving about $\frac{1}{4}$ in. long are cut, and placed on the centre transistor lead, this will prevent shorts between leads, and also hold the transistors at about the right distance from the panel.

It is essential that collector, base and emitter wires are in the correct position, as shown by c, b and e in the diagrams. With the specified transistors, a red spot indicates the collector lead. The centre lead is for base, and the remaining lead for emitter.

Soldered joints should be made fairly quickly, as lengthy heating may damage the transistors. If



the iron is clean, and has gained the correct temperature, each joint can be made in a second or so, and this will not cause damage. The same care should be taken when soldering the diode D1, and its leads should be at least 1/4 in. long. It must be connected in the polarity indicated.

The output transistors are held in clips, which are tightly bolted to the heat sinks.

Other Wiring Points

Capacitors normally have the value marked on them. Resistors are usually colour coded.

R22 and R23 should be within 5% of the marked value, so these should be checked with a meter, or have gold bands. All other resistors should be of 10% tolerance, so should have silver bands. Resistors outside this tolerance are not recommended.

Though R23 is a normal value (39Ω) some resistor stockists do not seem to have it readily available. If preferred, R22 may be 4.7kΩ 5%, and R23 may be 82Ω, 5%. It is essential, however, to select both R22 and R23 to match; that is, use 2.2kΩ and 39Ω, or 4.7kΩ and 82Ω.

Rod Aerial

Aerial connections are most easily identified by soldering coloured flex to the tags, before mounting the aerial. Connections, as seen from the tagged ends of the windings, are shown in Fig. 5. If leads are soldered on after mounting the aerial, particular care should be taken to get them correct.

The rod is attached to its mounting cradle by means of elastic or insulating tape. The coupling coil for the external aerial should be positioned close to the anchoring device on that half of the rod occupied by the l.w. coil.

Initially, both the l.w. and the m.w. tuned windings can be positioned roughly level with the ends of the rod.

The trimmers can be fully unscrewed, and the cores of the oscillator coil and the third i.f. transformers placed approximately level with the tops of the cans.

Battery and Loudspeaker Connections

Red and black flexible leads are provided for battery connection purposes. A non-reversible battery plug or clips should be added, as the battery must always be connected in the correct polarity.

Either a 9V or 7.5V battery can be used, the latter being adequate.

About 12in. of thin twin flex is soldered on for the loudspeaker connections. The receiver should be tested before inserting it in its cabinet, but all trimming and alignment can be done from behind, with the set installed.

A check should be made that all wiring is correct, and that insulated sleeving has been placed on any wires which may touch each other, or components or metal parts.

Initially, a meter should be included in one battery lead. This should indicate about 7mA to 10mA or so, with no signal, or at low volume. Current will rise to 15mA to 25mA or so, with good volume, and 45mA or more, with maximum volume. If the meter shows more than 15mA or so, at low volume, R22 and R23 may be incorrect, or a fault may be present. If the meter shows a very high current, the set should be switched off at once, and a fault traced.

Alignment Instructions

Alignment is carried out in the following order—i.f. amplifier, m.w. band, l.w. band. Satisfactory

Fig. 5: The connections to the aerial.

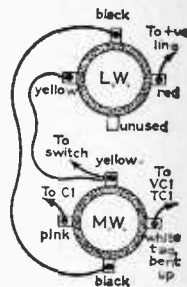

alignment is possible without a signal generator, though this item simplifies adjustments.

If a generator is available, the three IFT's are tuned to 470kc/s by rotating the cores. A strip of paxolin, filed to engage with the core slots, may be used, care being exercised to avoid breaking the cores. If no generator is to hand, tune in any station, and adjust the IFT cores for best results. Each core should tune fairly sharply. Initially the cores can be set roughly level with the can taps, before adjusting them for best volume.

Once the i.f. stages are aligned, they are left untouched. If the test signal is modulated, adjustments may be directed towards obtaining maximum current reading on a meter in one battery lead. For adjustment by ear, set VR1 at maximum volume, and reduce the generator input, or choose weak stations. More accurate adjustment is then possible.

To adjust m.w. aerial and oscillator circuits, unscrew TC1 and TC3 fully, checking that the plates are well apart. A low wavelength station (such as Radio Luxembourg, 208m) is then tuned in, and TC1 and TC3 are adjusted for best volume. If volume is too great, rotate the receiver to reduce signal pick-up, or choose a weaker station, for the reason given.

A high wavelength station is then tuned in, and the oscillator

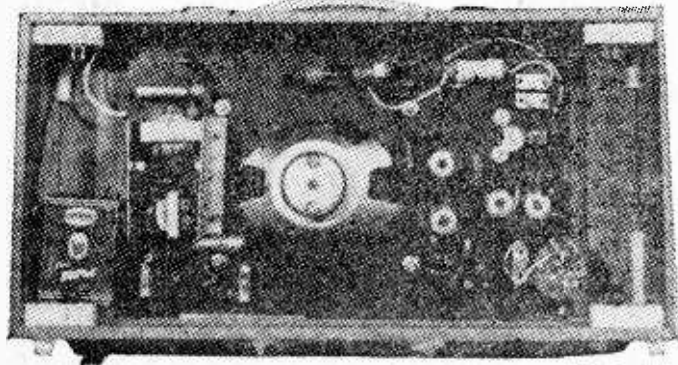

The paxolin chassis assembled in its case.

coil core is adjusted for correct band coverage, the m.w. aerial winding being moved along the rod for maximum volume.

The receiver should tune to about 550m with the gang capacitor fully closed. If this wavelength is not reached, the oscillator coil core should be screwed in slightly, and the m.w. aerial winding pushed a little farther on the rod. On the other hand, if this wavelength is exceeded, the oscillator coil core is too far in, and the m.w. aerial winding is too far on the rod. If trouble arises with these adjustments, C4 should be checked. Good alignment is possible with quite large changes in actual band coverage, but instability will arise if wrong adjustments allow the aerial circuit to tune near the intermediate frequency.

If a sufficiently low wavelength (around 200m) cannot be reached, this shows that TC1 and TC3 are probably set at too high capacity. They should then be unscrewed, and the trimming procedure repeated.

For l.w. alignment, first adjust TC2 and the l.w. winding on the rod until the Light Programme (1,500m) is found with the gang capacitor about half closed. In many areas other l.w. stations should be received. The l.w. winding can then be adjusted on the rod, for best results around 1,700 to 1,800m, while TC2 is adjusted around 1,300m. Long wave tuning coverage is also considerably influenced by the oscillator coil core position.

All adjustments can easily be given a final touch after the set is fitted in its cabinet, as cores and trimmers can be reached from behind.

A metal tool should not be used for any alignment adjustments. Rough alignment is readily made with local stations, but weak transmissions should be used for final adjustments.

If oscillation accompanies reception, this is probably due to instability in the i.f. amplifier; the first or second IFT core may be very slightly detuned to eliminate this trouble. Only a small part of a turn should be given to the cores. This action may be necessary due to slight differences in the neutralising values of components and the stray capacity effects of particular transistors.

Cabinet Fitting

The complete receiver is inserted from behind and held by nuts on the four bolts which secure the loudspeaker. Additional nuts will be required on these bolts, or spacing sleeves may be placed between loudspeaker and receiver panel.

There is sufficient free space to make fitting easy, but the receiver must be so placed that the knobs fit correctly, and do not rub the cabinet front.

The cabinet can accommodate various batteries, but a higher voltage than 9V must not be used. A reasonably large battery is more economical, as its life will greatly exceed that of a miniature battery. A 7.5V battery can be expected to give adequate volume.

Current consumption should be around 7mA to 10mA or so, with very low volume, or with no signal. If it much exceeds this, R22 and R23 should be checked. When volume is increased, current rises, being around 15mA to 25mA with good volume, and exceeding this at maximum volume.

Use in a Car

When using a portable receiver of this type in

a car, the effectiveness of the internal rod aerial is reduced considerably due to the screening effect of the vehicle body. Furthermore the directional properties of the rod are to some extent a disadvantage since the orientation of the car in relation to the transmitting station will be constantly altering.

If it is intended to use this receiver regularly in a car it is recommended that a normal type car aerial be permanently installed on the outside. Such aerials are generally equipped with a length of screened coaxial cable and fitted with a standard type coaxial plug which can be easily fitted into the socket at the side of the receiver case. When installing a car aerial follow carefully the maker's instructions.

The receiver itself is not screened, and it is possible that electrical interference may be picked up from the ignition system. This can be minimised by placing the receiver as far from the front of the car as possible.

Operation from the Mains

A mains operated power supply unit can be fitted in the right of the cabinet, viewing the receiver from behind. This allows running the receiver from the a.c. mains when indoors, while the battery can still be used for portable listening. ■

ELECTRONIC TIMER

— continued from page 132 —

will be seen from the diagrams, the construction is simple and the only component not on the front panel is the relay, which is mounted on one of the wooden walls.

A piece of aluminium for the front panel is bent as shown in Fig. 5. A further piece for the case receives treatment as Fig. 6. The side panels are made of wood, this allows chrome-headed screws to be used to fix the front panel and case together very easily. After adding the handles and "panling" the unit the wooden ends looked rather out of place so two squares of thin aluminium were cut to size and after a coat of panl were fixed in place with more chrome-headed screws.

Conclusion

In closing a few hints and observations may not come amiss. First it is as well to ascertain whether the wipers of the potentiometers are connected to the spindles. If this is so the use of insulating washers is essential in order to prevent the potentiometers shorting with one another via their spindles and the front panel. The writer found this out the hard way. A further tip is to use colour-coded wires from the potentiometers to the range switch S2 otherwise wiring up tends to become a bit confusing. The batteries used in the prototype are 4.5V cycle batteries connected in series.

Power supplies were derived from 4.5V cycle-lamp batteries. Two such batteries are used in series for B1, and a total of five for B2. These larger batteries were chosen as there is ample room in the case without the power unit, and the larger batteries have a longer life. If however a miniature version is to be constructed, then a couple of the small 9V batteries intended for transistor pocket portables might suit for B2. ■

RADIO CLEARANCE LIMITED

27 TOTTENHAM COURT ROAD, LONDON, W.1

THE OLDEST COMPONENT SPECIALISTS IN THE TRADE

TRADE ENQUIRIES INVITED

Telephone: MUSEUM 9188

EST. 35 YRS.

AGAIN CRASHING THE SOUND BARRIER!

Enormous purchases of Brand New and Guaranteed Plessey loudspeakers enable us to offer these units at THE LOWEST PRICES EVER! Don't miss this golden opportunity to obtain a first-grade permanent-magnet LOUDSPEAKER off the production line at LESS THAN THE MANUFACTURER'S COST! Read carefully the prepared list below and choose just the right speaker for the job—COMPARE THE PRICES ANYWHERE!

SCHEDULE OF LOUDSPEAKERS AVAILABLE

Diameter in inches	Gauss in lines	Imped. in ohms	Price	Diameter in inches	Gauss in lines	Imped. in ohms	Price	Diameter in inches	Gauss in lines	Imped. in ohms	Price	Diameter in inches	Gauss in lines	Imped. in ohms	Price	
2	7000	80	8/-	4	7000	25	11/8	5	8600	5	9/8	6 1/2	7000	3	11/-	
2 1/2	7000	35	9/8	4	6000	35	10/8	5	8500	3	10/8	6 1/2	7000	5	11/-	
2 1/2	7000	50	8/8	4	7000	35	11/-	5	9300	5	10/8	6 1/2	8500	3	11/8	
3	7500	60	8/-	4	8300	35	11/8	5	10000	3	11/8	6 1/2	9500	3	12/-	
3	8500	5	8/8	4	9500	35	11/8	5	12000	3	12/8	6 1/2	12000	3	13/-	
3	8500	3	8/8	4 tweeter	6000	6000	3	7/8	5	6000	25	10/8	8	6000	3	11/8
3	8500	5	8/8	4 "	7000	3	8/-	5	6000	30	10/8	8	7000	3	12/-	
3	8500	10	8/8	4 "	7000	5	8/-	5	6000	40	10/8	8	7000	5	12/-	
3 1/2	7000	35	8/8	4 "	8500	3	8/8	5	9500	25	11/8	8	8500	3	12/8	
4	5000	3	7/8	4 "	8500	5	8/8	5	9500	30	11/8	8	8500	5	12/8	
4	6000	3	8/-	4 "	9500	5	8/8	5	9500	33	11/8	8	10000	3	13/8	
4	7000	3	8/8	5	6000	3	8/-	5	9500	50	11/8	8	10000	5	13/8	
4	8500	3	9/8	5	7000	3	8/8	5	10000	25	12/-	8	10000	8	13/8	
4	9500	5	9/8	5	7000	5	8/8	5	10000	35	12/-					
4	10000	3	10/-	5	7500	3	9/-	6 1/2	6000	3	10/8					
4	6000	25	10/8	5	8500	3	9/8									

Elliptical Size in lines	Gauss in lines	Imped. in ohms	Price	Elliptical Size in lines	Gauss in lines	Imped. in ohms	Price	Elliptical Size in lines	Gauss in lines	Imped. in ohms	Price	Elliptical Size in lines	Gauss in lines	Imped. in ohms	Price
5 x 3	8000	3	7/8	6 x 4	9500	5	10/-	7 x 4	9500	50	11/8	8 x 2 1/2	9500	50	10/8
5 x 3	7000	3	8/-	6 x 4	12000	3	11/-	7 x 4	10000	3	12/-	8 x 2 1/2	10000	3	10/8
5 x 3	7000	5	8/-	7 x 3 1/2	6000	3	8/8	7 x 4	10000	5	12/-	8 x 2 1/2	10000	5	10/8
5 x 3	9000	3	8/8	7 x 3 1/2	7000	3	10/-	7 x 4	10000	15	12/8	8 x 5	6000	3	8/8
5 x 3	9000	4	8/8	7 x 3 1/2	9500	35	11/-	7 x 4	12000	3	13/-	8 x 5	7000	3	9/-
5 x 3	9000	5	8/8	7 x 4	6000	3	8/8	7 x 4	9500	3*	13/8	8 x 5	8500	3	8/8
5 x 3	8000	25	9/8	7 x 4	7000	3	10/-	8 x 2 1/2	6000	3	8/8	8 x 5	8500	5	9/8
5 x 3	7000	25	10/-	7 x 4	7000	4	10/-	8 x 2 1/2	7000	3	9/-	8 x 5	8500	35	12/8
5 x 3	7000	35	10/-	7 x 4	7000	5	10/-	8 x 2 1/2	7000	5	9/-	8 x 5	9500	3	10/-
5 x 3	9000	25	11/-	7 x 4	8500	3	10/8	8 x 2 1/2	8000	6	8/8	8 x 5	9500	15	13/8
5 x 3	9000	35	11/-	7 x 4	9500	3	11/-	8 x 2 1/2	6000	30	9/8	8 x 5	10000	3	10/8
6 x 4	6000	3	8/8	7 x 4	8500	4	11/-	8 x 2 1/2	8500	5	9/8	8 x 5	12000	3	11/-
6 x 4	7000	3	9/-	7 x 4	9500	5	11/-	8 x 2 1/2	9500	3	10/-	8 x 5	12000	5	11/-
6 x 4	8500	3	9/8	7 x 4	9500	30	11/8	8 x 2 1/2	9500	4	10/-	8 x 5	12000	15	14/8
6 x 4	9500	3	10/-	7 x 4	9500	35	11/8	8 x 2 1/2	9500	5	10/-				

ALLOW 2/- each Speaker for postage and packing and please specify the exact requirement—the nearest available will be sent.

OVER 50,000 SOLD & STILL THE DEMAND CONTINUES FOR OUR 'HEAVENLY TWINS'

Ask for a demonstration in the shop.

"CAPRI"

Sensitive!
Super-selective!
Superb Speaker!



ONLY £5.19.6

(2/- p. & pkg.)
Pocket Super-het MW and Droitwich.
Size 4 1/2 x 2 1/2 x 1 1/2 in.

The best and easiest transistor build-yourself sets available.

Send S.A.E. for FREE PARTS LIST

6 First Grade MULLARD Transistors, Diode(s) and all components BRAND NEW and GUARANTEED

Choice of a dozen stations in daylight . . .

"CONTESSA Mk III" 'QUEEN OF THEM ALL'

ONLY

£9.19.6 (3/6 p. & pkg.)

PORTABLE CAR RADIO 2 WAVEBAND SUPER-HET

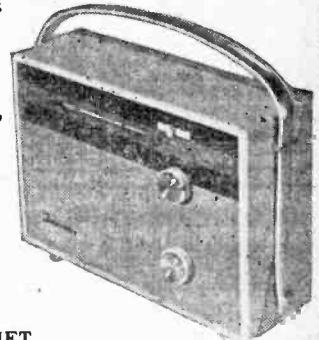

Inclusive price for all associated components, case, battery and instruction book complete in every detail. ANY PARTS SOLD SEPARATELY ON THE BUY-AS-YOU-BUILD SCHEME

CONTESSA III £9.19.6 (plus 3/6)
CAPRI £5.19.6 (plus 2/-)

SELECTED GUARANTEED BARGAINS—BRAND NEW

Beautifully geared AM/FM 2 Gang Condensers, 4/6; AM/FM IFT's 455kc/s and 10.7 Mc/s, 4/6 pair; Magnevox Crystal Tape Recorder Mikes, 12/8; Double-tuned Transistor ferroxy IFT's Q120, 470 kc/s, 5/6 pr.; 3 matched IFT's and oscillator coil for Mullard transistor circuits, 10/8 the set; Brand new Cydon turret tuners 34/38 Mc/s, valued with minimum of 10 coil sets, 12/6 each; 3 watt Stereo Amplifiers, complete, ready to switch on 75/6; Sentinels receivers R32D-D3-2-1-Y, 2/6 each; GERMANIUM DIODES—OA70, OA79, OA81, OA90, CC46H, 2/- each; TRANSISTORS: Set of 6 (R, B and L.F) including 1 watt matched pair, heat sink and diode, 13/6 the set; OC44 (or equiv.), 6/9; OC45 4/6; OC81 5/6; matched pair 12/-; PNC 101A 4/6, matched pair 9/6; PXA 101 3/9; AF 115 4/6.

Please send STAMPED and ADDRESSED envelope with any enquiry. We regret no catalogues—our stocks move too quickly! Kindly make provision for additional postage and packing charges to avoid delay. TERMS: CASH WITH ORDER or C.O.D. ON ORDERS OVER 10/-.

SPECIAL BARGAIN OFFER!

**RECORD
PLAYER
CABINETS**

Cabinet
Price
£3.3.0
Carr. &
Ins. 5/-



Contemporary style, rexine covered cabinet in two-tone maroon and cream. Size 18 1/2 x 13 1/2 x ht. 8 1/2-in. fitted with all accessories including baffle board and anodised metal fret. Space available for all modern amplifiers and autochangers, etc. Uncut record player mounting board 14 x 13 1/2-in. supplied.

2-VALVE 2-WATT AMPLIFIER. Twin stage ECL82 with vol. and neg. feedback Tone control. A.C. 200/250v with knobs, etc., ready wired to fit above cabinet, including 6-in. speaker and output transformer £3.19.6. Carr. 2/6

Comp. Record Player Kit and B.S.R. UA14 Unit. New Reduced Price **£12.10.0** Carr. 7/6

**BARGAIN
4-SPEED PLAYER
UNITS**

Single Players Carr. 4/6
Garrard SRP10 5 gns.
Collaro "Junior" 65/-
B.S.R. Latest TU12 72/6
E.M.I. Junior '985' 67/6
Auto-Changers Carr. 5/-
Collaro "C 60" £6.19.6
B.S.R. (UA14) £6.10.0
Latest Garrard Model A76 with
Transcription Arm. Plug-in
Head. Mono 9 gns.
Stereo 10 gns.
"Autoslim" Model £6.15.0

SPEAKERS P.M. 3 ohms.
2 1/2-in. EMI 17/6. 3-in. Goodmans
18/6. 5-in. Rola 17/6. 6-in. Elac
18/6. 7-in. x 4-in. Goodmans
18/6. 8-in. Rola 20/-. 10-in. Elac
25/-. 10-in. x 6-in. Goodmans
25/-. 2 1/2-in. E.M.I. Tweeter 20/6

**ENAMELED COPPER
WIRE**—1lb. reels. 14s-20s.
2/g; 22s-28s. 3/-; 30s-40s. 3/6.
Other gauges quoted for.

VALVE HOLDERS—Int. Oct. 6d. Nylon or Ceramic. E7C, B9A unskirted, 6d. E7C, B9A skirted, 1/- each; E7C with Can 1/6; B9A with Can. 1/9 etc.

KNOBs—Modern Continental types: Brown or Ivory with Gold Rings. 1 1/2-in. dia., 9d. each; 1 1/4-in., 1/- each; Brown or Ivory with Gold Centre 1 1/2-in. dia., 10d. each; 1 1/4-in., 1/3 each

LARGE SELECTION AVAILABLE.

JASON FM TUNER UNITS
Designer-approved kits of parts
FMT1, 5 gns. 4 valves, 20/-.
FMT2, £7. 5 valves, 37/6.
JTV MERCURY 10 gns.
JTV2 £13.19.6. 4 valves, 32/6.
NEW JASON FM HANDBOOK, 2/6. 48 hr. Alignment Service 7/6. P. & P. 2/6.

TYGAN FRET (contemp. pat.)
12 x 12in. 2/-. 12 x 18in. 3/-. 12 x
24in. 4/-. 18 x 24in. 6/- etc.

Condensers—Silver Mica. All values. 2pF to 1,000pF, 6d. each. Ditto. Ceramics 9d. Tub. 450V T.C.C. etc., 0.001 mfd. to 0.01 and 0.1/500V., 9d. 0.02-0.1/500V., 1/-, 0.25 Hunts 1/6. 0.5 T.C.C. 1/6, 6c. etc. Close Tol. S/Micas—10% 5pF-500pF, 3d. 600-5,000pF 1/-, 1% 2pF-100pF 9d. 100pF-500pF 11d. 575pF-5,000pF 1/6.

Resistors—Full Range 10 ohms-10 meg. ohms 20% \pm and \pm W. 3d., 1W 5d. (Midget type modern rating) 1W 6d., 2W 9d. Hi-Stab. 10% 1W 5d., 1W 7d. 5% 1W 9d., 1% 1W 1/6.

Volume Controls—5K-2 Mef.-ohms. 3in. Spindles Morganite Midget Type 1 1/4-in. diam. Guar. 1 year. LOG or LIN ratios less Sw. 3/- DP. Sw. 4/6. Twin Stereo less Sw. 6/6. DP. Sw. 8/-.

EXPANDED ANODIZED METAL. Attractive gilt finish 1/4-in. x 1/4-in. diamond mesh 4/6 sq. ft. Multiples of 6in. cut. Max. size: 4ft.

*"There is no Virtue
without Courage—
No Reward without
Labour"*

Not simply a school motto but at B.N.R.S. a creed and a way of life. We owe to it all we have and are. If you are prepared to make it your motto and live up to it, we can help you get to the top. It will take time, it will take effort, it will take courage, and as if this were not enough, YOU WILL ACTUALLY BE CHARGED FEES

If we haven't succeeded in putting you off, write for details, today, to:

Mr. J. SYKES
(M.I.E.E., M.Brit.I.R.E., M.I.N.)

Principal:

BRITISH NATIONAL RADIO SCHOOL
Red Lion Court, Stalbridge, Dorset.

Britain's premier Radio Correspondence School specialising in City and Guilds examinations.

**ADD TAPE TO YOUR HI-FI
WITH A MARTIN
RECORDAKIT**



**PRE-AMP
ASSEMBLY**

RECORDING TAPE—Reduced Prices

Famous American Columbia (CBS) Premier Quality Tape at NEW REDUCED PRICES. A genuine recommended Quality Tape—TRY IT! Brand new, boxed and fully guaranteed. Fitted with leader and stop folls.

	Standard	Long Play	Double Play
5in.	600ft. 13/-	900ft. 17/6	1,200ft. 21/6
5 1/2in.	900ft. 18/-	1,200ft. 19/6	1,800ft. 27/6
7in.	1,200ft. 21/-	1,800ft. 28/6	2,400ft. 47/6

P. & P. per reel 1/-; 6d. on each additional reel.

SPECIAL BARGAIN. 3in. Message Tape, 150ft. 3/9. P. & P. 6d. 3in. L.P. 225ft. 4/9. 3in. D.P. 30ft. 6/6.

Plastic Tape Reels 3in. 1/3, 5in. 2/-. 5 1/2in. 2/-. 7in. 2/3
Plastic Spool Containers 5in. 1/6, 5 1/2in. 2/-. 7in. 2/3

Terms C.W.O. or C.O.D. Post and Packing up to 1/2 lb., 7d., 1lb. 1/1, 3lb. 1/6, 5lb. 2/-. 10lb. 2/9. Hours: 9 a.m.—6 p.m.; 1 p.m. Weds.



**RADIO COMPONENT
SPECIALISTS**

70 BRIGSTOCK ROAD, THORNTON HEATH
SURREY. Est. 1946. Telephone: THO 2188

**AVAILABLE
WITH OR WITHOUT
DECKS FOR BUILDING
IN 3 DIFFERENT WAYS**

MARTIN RECORDAKIT PRE-AMP ASSEMBLIES are available for 2 or 4 track use with Collaro Studio Deck or B.S.R. Monardeck. Amplifying portions are supplied assembled with valves on printed circuit boards. Kits may be bought for pre-amp alone, with deck for mounting into existing cabinet, or with deck and polished wood or portable cabinet. Whichever way suits you, these Recordakits provide a wonderful way to add tape to existing installations for very little expense, and give wonderful quality.

Money Saving too!

2 Track Pre-Amp	8 gns
Kit alone	4 gns
4 Track re-Amp.	9 gns
Kit alone	5 gns
Kit with polished wood Cabinet and Deck	17 gns

**MARTIN
RECORDAKITS**

From Radio Cracksits or direct in cases of difficulty write or phone
15Leworth 5885/1161

MARTIN ELECTRONICS LTD.
155 High St., Brentford, Middx.
Latest Recordakits leaflets please!

NAME _____
ADDRESS _____
IPP.4

Continued from page 52 of the May issue.

MECHANICAL CONSTRUCTION AND LAYOUT

BY P. R. LEWIS

Double Conversion Communications Receiver

THE three-gang tuning capacitor is mounted on a "floating" plate to eliminate microphony. A cut-out is made in the main chassis and the capacitor mounting plate (some $\frac{1}{2}$ in. larger all round than the cut-out) is fastened beneath it with 4B.A. bolts, using rubber grommets between the plate and the chassis (see Fig. 3).

The capacitor mounting plate is also used to support another plate, and this is cut out to take the sockets for the plug-in coil units (see Fig. 3). Three 6-way Jones-type sockets are fastened to this plate. Precise dimensions for the cut-out are shown in the diagram and must be closely controlled to give satisfactory mating.

Plug-In Coil Units

The plug-in coil units are constructed as shown in Fig. 4. The basis of each is a $4\frac{1}{2}$ in. x $1\frac{1}{2}$ in. plate, with cut-outs to the same dimensions as on the socket mounting plate. Three 6-way Jones-type plugs are mounted on each plate and the Denco coil pins soldered to the selected terminals (full details of coil connections are supplied with the coils and the connections on to the Jones plugs are at the discretion of the constructor. However, con-

sideration of the relation between the mounted sockets and orientation of the appropriate valve-holder will soon suggest the best possible coil connections).

The screening cans supplied with the coils ($1\frac{1}{8}$ in. diameter) are drilled centrally ($\frac{1}{4}$ in. diameter hole) at the bottom to take the threaded portion of the coil former. The cans are fitted over the coils and fit snugly on the bases of the plugs. They are held in position by tightening the O.B.A. moulded nuts which fit on to the top of the coil formers.

A stout handle is fitted to each coil so to facilitate entry and extraction via the cut-out in the side of the chassis (and of course, the case).

Front Panel Composition

Layout of the front panel is shown in Fig. 5. Note from the dimensions of the panel previously given that it protrudes approximately $\frac{1}{2}$ in. beyond the main chassis at the sides and bottom to allow insertion into the case.

Note also that the two panel mounted r.f. trimmers are mounted in a small box, since it is

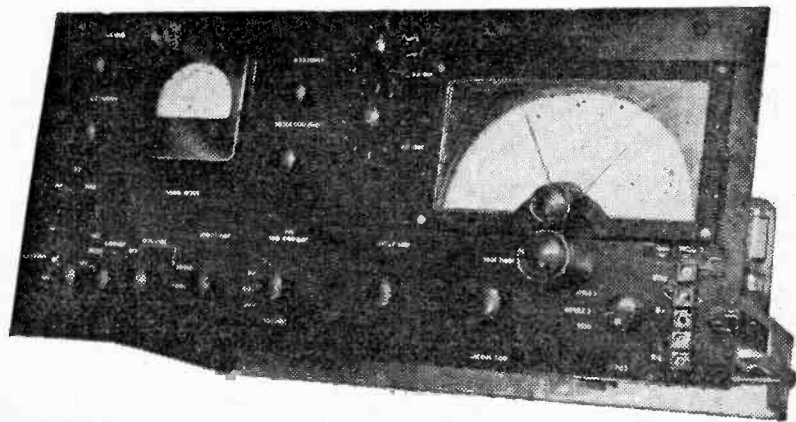

Front view of
the finished
receiver

essential that they should be screened from all other parts of the receiver and from each other. A roughly formed box constructed from 20s.w.g. tinned copper sheet to the approximate dimensions 3 1/2 in. x 1 1/2 in. x 1 in. deep and fitted with a centre partition between the two trimmers, serves the purpose adequately.

Enclosing the Receiver

A metal case is essential for good screening of the equipment. The case should be well ventilated and, to allow adequate air flow, should be mounted on rubber legs to raise the underside of the case off bench level.

The loudspeaker can be mounted in a separate case if desired. However, the author found it convenient to fix the loudspeaker inside the roof of the case, using rubber grommets between the two to damp out any resonance.

Wiring-up

All mechanical work (including mounting of valveholders, tag-strips etc.) must be completed before wiring can be commenced. (Note: the mains transformer and smoothing choke, being close together on the top of the chassis, must be orientated so that their fields are at right angles). Ceramic valveholders should be used if possible for V1, V2, V11.

Heater Supply

First connect all heater decoupling capacitors, then wire up the heater chain using twisted P.V.C. covered flex. Wire the heaters in groups (Group 1—V1, V2, V11; Group 2—V3, V4, V5, V6; Group 3—V7, V8, V9, V10; and V12 separately) taking twisted feeders from each group back to the mains transformer. This minimises inter-stage coupling in addition to avoiding overload on the heater wiring, as would occur at the end of one long chain.

Next make connections to the coil input sockets and all IFT's, following this by working along the receiver putting in all other components. Wire components directly across valveholders wherever possible and use adjacent tie-on points on the tag-strips whenever needed to avoid long leads. If these are unavoidable, do not use stiff wire. Stiff long wires are unsatisfactory since they can be made to vibrate; on the other hand stiff short leads are excellent as they cannot vibrate and should in particular be used for connection to the coil input sockets. Wire components directly associated with valveholders within 1/4 in. of the pins, particularly in the case of grid stopper resistors.

All wiring and components should be as near to chassis level as possible and should follow the

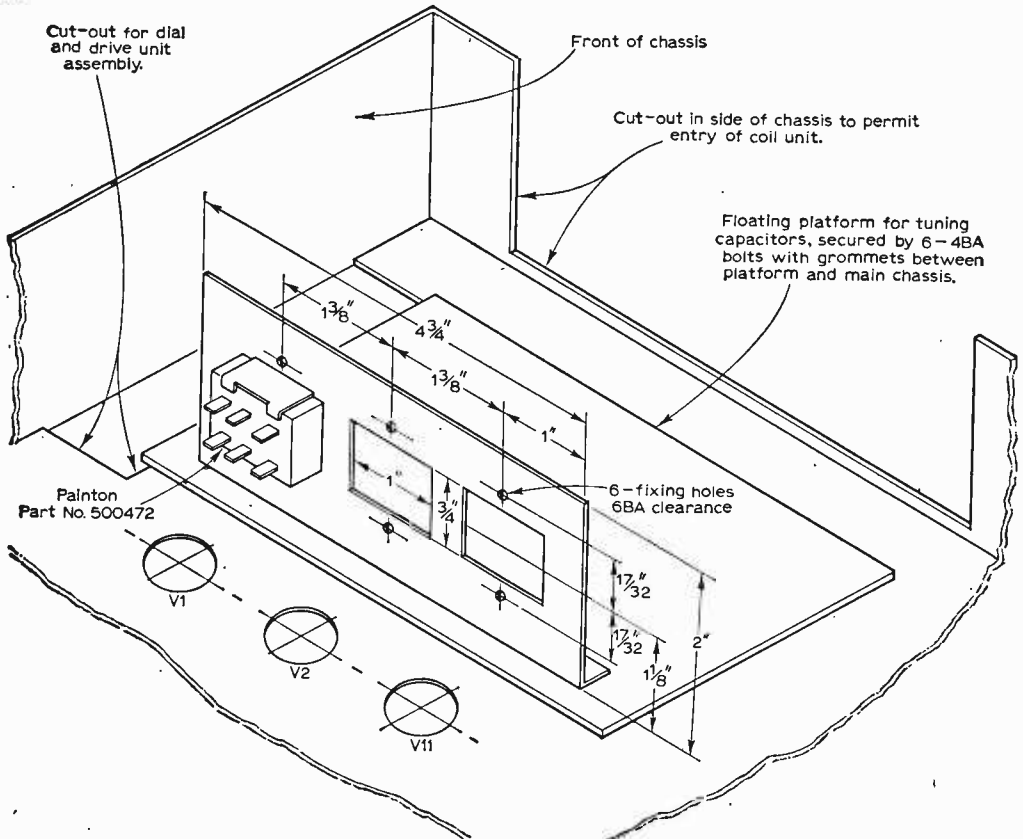

Fig. 3: Capacitor and coil mounting plate details.

COMPONENTS LIST

Resistors:

R1	10Ω
R2	10Ω
R3	200Ω
R4	22kΩ 1W
R5	33kΩ 1W
R6	10kΩ 1W
R7	22kΩ
R8	1kΩ
R9	100Ω
R10	6.8k 1W
R11	100kΩ
R12	33kΩ 2W w-w
R13	1kΩ
R14	68Ω
R15	68k 2W w-w
R16	100kΩ
R17	15kΩ 2W w-w
R18	27kΩ 1W
R19	1kΩ
R20	150Ω
R21	680Ω
R22	10Ω
R23	10kΩ 1W
R24	47kΩ
R25	47k 1W w-w
R26	33kΩ 2W w-w
R27	180Ω
R28	820Ω
R29	68Ω
R30	68kΩ 2W w-w
R31	100kΩ
R32	1MΩ
R33	2.2MΩ
R34	47kΩ 1W
R35	100kΩ
R36	100kΩ
R37	1MΩ
R38	1MΩ
R39	47kΩ

R40	180 kΩ	R49	1MΩ
R41	2.2kΩ	R50	47kΩ
R42	150Ω	R51	33kΩ ½W
R43	680kΩ	R52	1.2MΩ
R44	4.7kΩ	R53	4.7kΩ
R45	220Ω ½W	R54	220kΩ
R46	47kΩ	R55	2.7kΩ
R47	10Ω	R56	33kΩ
R48	4.7kΩ ½W	R57	2.7kΩ

All the above are 10% ½W carbon resistors, except where otherwise stated.

Variable Resistors:

VR1	25 kΩ carbon potentiometer
VR2	1kΩ wire-wound potentiometer
VR3	100Ω wire-wound
VR4	25kΩ carbon potentiometer
VR5	500kΩ carbon potentiometer
VR6	5kΩ wire-wound

Capacitors:

C1	0.001μF paper	C28	0.75μF paper 150V
C2	470pF mica or ceramic 200V	C29	0.05μF paper
C3	470pF mica or ceramic 200V	C30	0.1μF paper
C4	0.1μF paper	C31	0.01μF paper
C5	0.1μF paper	C32	0.1μF paper
C6	0.001μF mica or ceramic	C33	33pF mica or ceramic
C7	470pF mica or ceramic 200V	C34	100pF mica or ceramic
C8	470pF mica or ceramic 200V	C35	100pF mica or ceramic
C9	5pF silver mica	C36	100pF mica or ceramic
C10	0.001μF mica or ceramic	C37	0.001μF mica or ceramic
C11	0.001μF mica or ceramic	C38	0.1μF paper
C12	0.01μF paper	C39	0.001μF mica or ceramic
C13	0.1μF paper	C40	0.002μF mica or ceramic
C14	0.1μF paper	C41	0.1μF paper
C15	0.01μF paper	C42	0.002μF mica or ceramic
C16	0.01μF paper	C43	0.05μF paper
C17	0.01μF paper	C44	0.01μF paper
C18	0.1μF paper	C45	8μF electrolytic 350V
C19	0.01μF paper 200V	C46	0.1μF paper
C20	0.01μF paper 200V	C47	50μF electrolytic 12V
C21	0.1μF paper	C48	0.01μF paper
C22	300pF silver mica	C49	8μF electrolytic 350V
C23	100pF silver mica	C50	50μF electrolytic 12V
C24	100pF silver mica	C51	0.01μF paper
C25	0.01μF paper 150V	C52	340pF silver mica (Range 3) 960pF silver mica (Range 4) 2,000pF silver mica (Range 5)
C26	0.1μF paper 150V		
C27	0.35μF paper 150V		

C53	150pF silver mica
C54	47pF silver mica
C55	56pF silver mica
C56	470pF mica or ceramic 200V
C57	470pF mica or ceramic 200V
C58	0.1μF paper
C59	140pF mica or ceramic
C60	100pF mica or ceramic
C61	100pF mica or ceramic
C62	See text
C63	0.001μF mica or ceramic 200V
C64	0.1μF paper
C65	16μF electrolytic 450V
C66	32μF electrolytic 450V
C67	8μF electrolytic 350V

All the above are 500V rating, except where otherwise stated.

VC1	50pF air-spaced variable
VC2	300pF
VC4	300pF } 3-gang variable
VC6	300pF }
VC3	50pF air-spaced variable
VC5	50pF air-spaced variable
TC1	30pF concentric trimmer (one per coil-set)
TC2	30pF concentric trimmer

Transformers:

T1	Mains transformer. Normal tapped primary. Secondaries: H.T. 250-0-250V 150mA; L.T. 3.15-0-3.15v 5A
T2	Output Transformer. Primary 5,000Ω. Secondary to suit loud-speaker.
IFT1, 2, 3	I.F. transformer (Denco IFT6/1.6Mc/s)
IFT4, 5	I.F. transformer (Denco IFT11/465kc/s)

Inductors:

L1	Miniature dual-purpose coil (Denco "Blue")
L2	Miniature dual-purpose coil (Denco "Yellow")
L3	Miniature dual-purpose coil (Denco "White")
L4	2.5mH r.f. choke (Denco RFC5)
L5	B.F.O. coil (Denco B.F.O.2/465)
L6	2.5mH r.f. choke (Denco RFC5)
L7	3H choke (low current)
L8	25H choke, 150mA

Switches:

S1	2-pole, 3-way, ceramic wafer switch
S2	Single-pole, 4-way switch (Minibank C)
S3	3-pole, 4-way switch (Minibank C)
S4	4-pole, 2-way wafer switch
S5	4-pole 2-way wafer switch

Valves:

V1	EF95	V5	EF93	V10	EL84
V2	6BE6	V6	EB91	V11	EF95
V3	EF93	V7	12AT7	V12	EZ81
V4	ECH81	V8	EB91	V13	VR150/40
		V9	EF86		

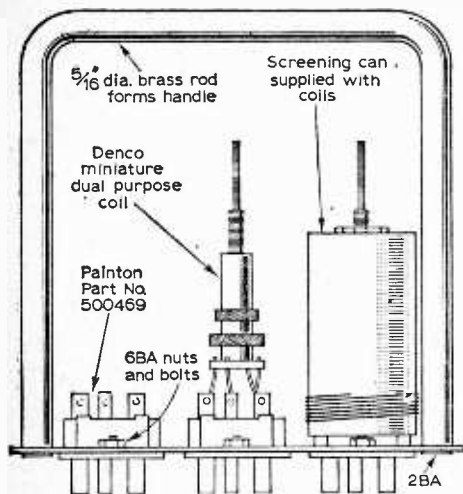

Fig. 4 (above): Side view of the plug-in coil unit.

taken through a 1/4 in. hole drilled close to V4 holder. Note that connection between triode and heptode on the ECH81 is *not* internal; pins 7 and 9 must be linked externally.

Similarly the signal meter lead from the junction of R27 and R28 is taken through the chassis up to the meter. The resistors associated with the bridge circuit are wired between the meter and the wire-wound potentiometer.

The detector switch S4 should be orientated such that the A and B wipers almost touch the output leads of IFT5.

The r.f. by-pass capacitor serving the a.f. section C48 should be wired directly to the h.t. point feeding V9 and V10.

Do not forget to make a good earth connection of several short stiff wires between the tuning capacitor plate and the main chassis. Also it is essential to earth the coil screening cans. This is most conveniently achieved by drilling the side of each can and then fastening on a solder tag with a 6B.A. bolt. The three cans of each coil set can thus be connected, the link wire then being taken to a spare pin on one of the Jones plugs and earthed via a suitable connection to the mating socket.

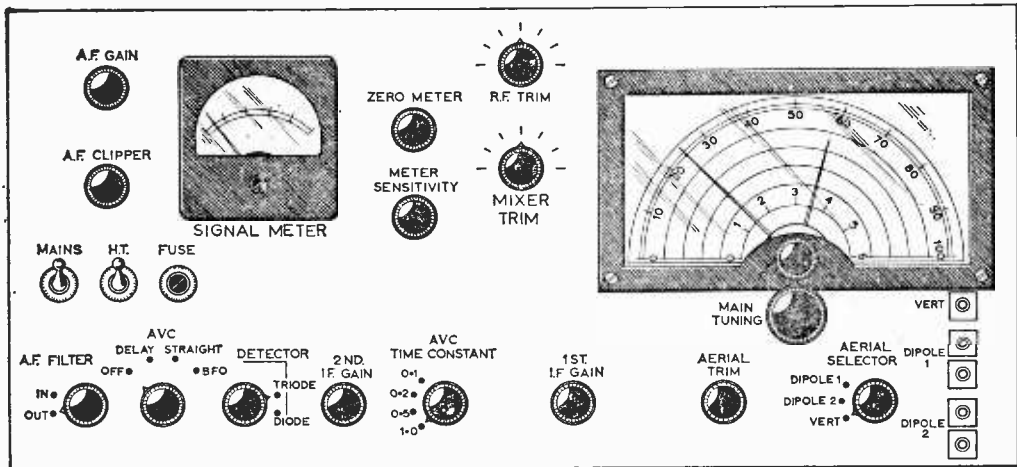

Fig. 5: The front panel layout.

direct line between soldering points. Squared off wiring, whilst looking neater, results in longer leads than necessary.

The grid leads from i.f. transformers should be screened, as of course should long leads associated with the a.f. gain control, as indicated on the circuit diagram. The a.f. choke L7 can be wound on a ferrite core since its current rating is so low. (Mullard Vinkor type LA2503, 2,800 turns of 0.002in. enamelled copper). If, however, a larger choke is used such that it has to be mounted above the chassis, then leads to this should be screened.

The leads from the screening box containing the r.f. trimmers should be low loss coaxial and must be taken as directly as possible to the first and second gangs of the tuning capacitor.

The outer braid of all screened leads should preferably be earthed at either end.

The second oscillator coil L5 is mounted on top of the chassis and connections to it should be

Oscillator Coils

The oscillator coil connections pose one small problem. The anode, earth and grid connections take up three of the six available plug pins. Following the Denco suggestion, the padder leads from the three different coils can be taken to separate pins, enabling the appropriate padding capacitors to be wired on to the corresponding socket pins. However, if it is desired to fit oscillator trimmers (see discussion in paragraph dealing with first mixer stage under Circuit Description), these must be fitted to the individual coil-sets. It is suggested that an earthing tag is fitted underneath the nut retaining the oscillator coil Jones plug. This tag can be wired to the can earthing wire (see above) and the centre connection of a Philips 3.30pF concentric trimmer soldered to it. A lead is taken from the other trimmer connection under the screening can to the grid connection of the coil.

TO BE CONTINUED

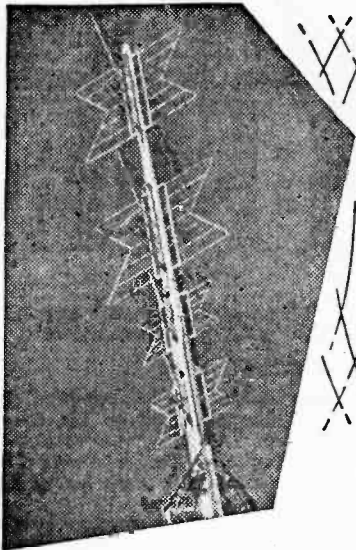

On Your Wavelength

By THERMION

SOME time ago I remarked on the need for readers writing to advertisers to make sure that a stamped addressed envelope was enclosed with any query they sent, or to comply in other ways with any requests which were made by the advertiser.

There are one or two other points about postal matters which need emphasising, and one of these may seem almost too good to be true. Twice in recent weeks advertisers have written to say that they have received orders enclosing remittances and elaborate details of requirements, but no address from which the letters had come. Naturally they are unable to forward the goods ordered and paid for, and the readers will no doubt accuse the firm of being slow or failing to meet their advertising offer.

The other point, and one which I feel is just as important, concerns requests which we have published from time to time in our Letters pages, asking for assistance from other readers—in the present case asking for back numbers. Several readers have written to say that they wrote to these enquirers, stating that they had certain of the issues available (in some cases offering them free of charge) and they did not hear anything from the enquirers, not even a postcard expressing thanks for the offer and saying that they had obtained the information or copies from some other source.

These complaints seem very justified, as the readers went to the trouble of replying to the request and even, as stated above, in some cases offering them free of charge, and one would have expected at least a word of thanks. So come along readers, try and tighten up these postal courtesies and avoid giving our readers a bad name.

Transistor Oscillators

There still seems to be a very keen interest in electronic musical instruments and I have had a few letters lately asking what transistorised electronic organs are now available. They are being

made, of course, and as mentioned previously they are on the market in other countries and I understand that there will very shortly be one on the English market, made by an English firm.

I refer, of course, to the full polyphonic type of instrument, not a single keyboard unit. There is very little difficulty in designing one of these instruments, except so far as concerns the power and the tone changer circuits. The oscillator is a simple arrangement and for anyone who is anxious to try this all that is needed is a resistor from base to battery positive and another resistor (approximately 10 times as great) between positive and emitter. The collector goes through another resistor to battery negative, and a capacitor between emitter and collector completes the circuit of the oscillator, taking the signal through a capacitor from the emitter.

For really good musical results, more elaborate arrangements are, of course, desirable, and it is possible to use these cheap components in a frequency dividing unit where a single transistor can deliver four or five notes (monophonic instrument), but I have not been able to obtain a very wide range of notes from a single transistor of the type mentioned above without running into difficulty.

More Tips

I have received quite a host of hints and tips since I started mentioning these, and some of them are good, but the majority are more or less either well-known or hopeless. One often finds a simple way of doing some job which one thinks might interest others, but this is probably the only occasion when the particular idea can be used and it is not what might be called of "general interest".

Here, however, are two simple ideas which undoubtedly will find application at some time or another in every ham "den". Firstly, the foil which is on sale in the popular stores for use in the kitchen is, in most instances, actual sheet aluminium and as such it can be used for screening—in some cases permanently.

A small piece may be wrapped round a glass valve, trapping as it is wrapped a piece of bared wire, and forms an adequate and effective screen for test purposes. It may also be laid on a piece of wood and held in place by components to form an improvised chassis—and is much cheaper. It may also be cut into narrow strips and wrapped round covered wires or leads to provide quite an effective screened cable.

Doubtless many other ideas for using this material will occur, and being actual metallic sheet it can be used in place of metallic paint which is normally useless for screening as it consists of metallic powder in a medium which, when it dries leaves the grains of metal effectively insulated. This can be proved by testing with an ohm-meter.

CONCRETE

BY E. ROWEN

SPEAKER ENCLOSURE

FOR the past 12 years I have been building amplifiers and loudspeaker cabinets in search of good sound reproduction in the home, and although this in itself is not unusual, I find that the experience gained has led me to some pretty definite conclusions, the primary one concerning the weakest link in the chain—the loudspeaker.

Nowadays you have only to thumb through any hi-fi or electronics magazine to find out that you can get true bass without boom, true treble without tizz and true middle without muddle in cabinets ranging from a square-shaped cubic foot to an elongated grandfather clock you can hang on the wall.

In the past decade I have constructed cabinets of all sizes and shapes using many kinds of materials and mathematical formulae, and I have found only one cabinet capable of giving true boomless bass. In my house now I have a concrete column, and a wooden column, and I have made reflex cabinets, sandfilled baffles, labyrinth boxes and many other types of “perfect” enclosures.

Many of these produced excellent treble, but the two pre-requisites of natural bass without loss of power are size and solidity and I maintain that only a concrete or brick enclosure will give you these.

For those readers who have not visited scores of homes and listened to hundreds of loudspeakers in cabinets ranging from beer-barrels to flower-pots; for those who have not spent scores of hours every year in plush showrooms listening to every conceivable type of unit dreamt up by imaginative but slightly-deaf draughtsmen, let me categorically and at once state that it is extremely difficult to compare two or more loudspeakers together for performance, even with instantaneous switching.

It is impossible to carry these loudspeaker sounds in your head to compare with your own loudspeakers when you get home. It is difficult in a showroom with switching facilities because no two loudspeaker units are the same, even from the same manufacturer, and I have known friends who have bought units after hearing the same type in the showroom to be bitterly disappointed when they fitted the unit in a similar cabinet at home. The results are often more like P.A. than hi-fi.

Furthermore, many cabinets are designed to suit only one type of unit, and this is annoying when a person acquires a second-hand loudspeaker—few people can afford to buy a new loudspeaker every time they want a change—and I have found from experience that the only loudspeaker cabinet

that will give a full natural range with any 12in. loudspeaker is the 9 cubic ft corner cabinet.

MERITS OF THE DESIGN

Yes, the design is not new and it is not mine. It is exactly the same as that described by Mr. Briggs of Wharfedale Wireless Works, but my version of the design has some important constructional ideas which will save the constructor some £30-£40 in cost!

To encourage readers who will at once say that 9cu. ft is too large for modern homes, may I for a moment put forward a few arguments in favour of the large cabinet?

Firstly, you cannot alter fundamental mathematics on air-loading, and for true bass you must have the requisite space. You will go on for years experimenting and wasting money to find the ultimate, and you will fail without the size and the rigidity. If you can produce true bass in tiny spaces, why don't they make 'cellos as small as violins?

Secondly, with regard to space, you will find that often the corners of a room are unused and a cabinet filling this space would be materially useful.

Thirdly, although Mr. Briggs may have designed this cabinet primarily for Wharfedale units I have tried with equal success in my cabinets units by Wharfedale, Vitavox, Duode and Goodman's and I am sure other good 12in. and 15in. units would satisfy. And, of course, your 8in. unit will sound proportionately better.

Fourthly, and perhaps most important, the concrete cabinet described requires no skill to make, costs only a few shillings, and can be made in a few hours, excepting the time allowed for the concrete to dry. It has the one advantage over the wonderful brick enclosure in that it is portable.

This article is non-technical, but I should like to mention that although the school in which I now teach has no hi-fi equipment, in my previous home town all our new schools were equipped with 9cu. ft brick enclosures in the main halls, fitted exclusively with Wharfedale 15in. whoofers and other Wharfedale units, and in every case the sound reproduction was superb. We used, of course, complementary amplifiers and equipment.

BUILDING THE FRAMEWORK

Now for the details of this cheap ultimate in loudspeaker cabinets, and let me say at once that if you don't like cutting wood you can get all this cut and shaped at any builder's yard or Do-it-yourself shop; so that all you have to do is to screw it together.

Cut the lengths of softwood as shown in the

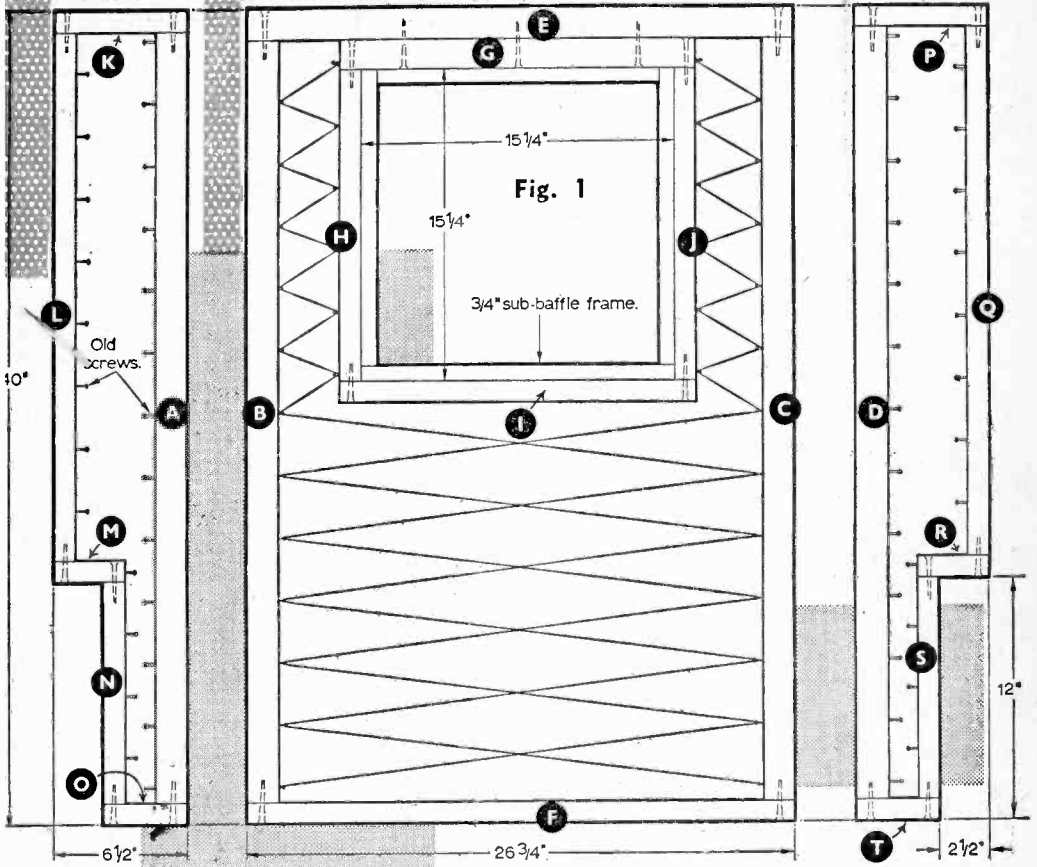

CUTTING LIST

Lid on top battens; size according to position in room.

- | | | |
|----------------------|-----------------|--------------|
| 2 off | 6 1/2 in. long | K & P |
| 2 off | 3 1/2 in. long | M & R |
| 2 off | 4 in. long | O & T |
| 2 off | 26 in. long | L & Q |
| 2 off | 12 in. long | N & S |
| All lin. x 1 1/2 in. | | |
| 1 off | 26 1/2 in. long | F |
| 1 off | 17 1/2 in. long | I |
| 2 off | 15 1/2 in. long | H & J |
| 1 off | 24 in. long | Wall battens |
| 1 off | 23 in. long | Wall battens |
| 2 off | 38 in. long | A & D |
| 2 off | 37 1/2 in. long | B & C |
| 1 off | 26 1/2 in. long | E |
| 1 off | 17 1/2 in. long | G |
- Approx. 1 gross screws and
30 feet galvanised wire

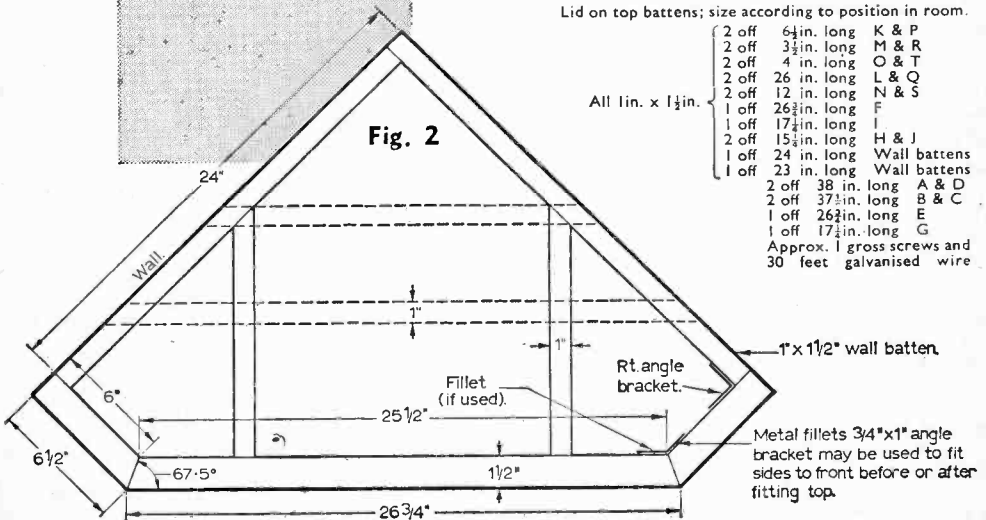

cutting list, and if you have not had this done at the shop, plane down the chamfered pieces A, B, C and D with a plane or Surform tool. Remember that pieces K, O, E, F, P, T must also be cut at the ends to fit, but this is an easy matter when A, B, C and D are cut. All pieces are butt jointed, though you can make any joint you like.

Drill holes to take 2in.—2½in. screws right through the points shown in Fig. 1, but before you glue the pieces together find all the old screws you have always wanted a use for and screw them at 3in. intervals on the inside faces of the wood as indicated in the drawing. You have no need to be exact about this, and I found that screws are better than cup-hooks. If you have no screws buy a gross of 1½in. or 1¼in. 8's or 10's at a cost of about 4s. 6d.

This done, put contact glue on all joints and screw and glue together. You can do this easily if you lay each frame on the table or floor and press against the wall or skirting board. If the ends have been cut true the whole thing will be true, but if you have clamps use them. Screw together the loudspeaker frame G, H, I and J and screw this through G, to the top member E.

Now tie galvanised wire, obtainable at any ironmonger, 16 gauge or thereabouts to the screws and stretch across the main frame as shown in Fig. 1. Keep this taut if possible—you can use pliers to do this—and if the frame is not square, tighten or loosen the screws accordingly and the wire will square the frame for you. No wire is needed in the side pieces as the screws will hold the concrete to the frame.

MIXING THE CONCRETE

The next stage is even more simple. Buy one cubic foot of *sharp* sand and ¼ bag of cement—you won't need all this but these are about the smallest amounts you can buy—from a builders' merchant (total cost 3s. 6d.) and mix on a board or concrete floor three spadefuls of sand and one spadeful of cement. Turn over at least four times.

Lay the frames on a *flat* surface and use a base of hardboard, if you have it, smooth side inwards. You need not grease this. With moderate care you can fill the frames inside the house, say on the front-room floor. Put newspapers down first.

When the frame is in position pour a kettleful of warm water into a hole you have made in the top of your little mountain of sand and cement and mix in from the outside. You may need another kettleful or more, depending on how wet your sharp sand is, but don't overdo the wetness. The drier the better with the right mixing consistency.

When the sand, cement and water are in a damp, mixable state, shovel the mixture carefully into the frames, or if you work in the house use a bucket to carry the stuff in. Don't rush, you have an hour or so to get it right.

After you have got the concrete roughly level with the top of the frames, obtain a wooden straight edge about 1 in. thick which will span the large frame and bang this up and down on the frame at the same time as you move it along to cover the whole of the concreted areas.

This presses the mixture into the corners and you finish off with a sawing movement. Leave

about four days and if you can put up with the small amount of mess you will find the area much easier to clean when the cement is hard. Wash the bucket and spade at once, of course.

ASSEMBLING THE CABINET

Again, no skill is needed to put the frame together. Plug the two wall battens to the wall at the correct height and place the end pieces against this and fix at the top with two ordinary angle brackets. The unit will stand all right, if you do not want screws in your skirting board. Before you fit the front, make the top.

This top, obviously, can be made in a similar way with concrete, but you can use any inch-thick timber or chipboard. In case the walls are not true, make a paper or cardboard template and get the wood shop to cut to size. Overlap at front and sides about half-an-inch.

An easy and secure way to fix the top is to fix to battens 1in. x 1½in. running north to south, as shown on the drawing, and at right angles to them screw one or two battens on to the first battens so that the ends fit under the wall battens, as shown dotted in Fig. 2. Screw the bottom battens to the wall battens.

Before you fit the front, place the top into position and draw a line along the inside of top members E, K and P; remove, screw two more angle brackets to the line. Replace top, put your head through the hole in the frame and screw the two angle brackets to front member E.

Finally, fit a ½in. frame to go inside the 15½in. hole to take a sub-baffle to fit the size of your loudspeaker. Bolt your loudspeaker to the baffle and screw to the ½in. frame.

Other ways of fixing the loudspeaker cabinet together will suggest themselves to many readers, but an excellent way of finishing the job off is to make a simple ½in. wooden frame to the size of the cabinet, cover this with the same material as your curtains and press this frame under the overlapping top and above a skirting board or plinth board you can put around the bottom of the cabinet.

Another way is to cover the front in veneered hardboard, or simply in veneer if your concrete is smooth enough. A more refined way, perhaps, would be to make the main frame, before concreting, in walnut or sapele hardwood, and fit hardboard *inside* the frame.

When concreted this would leave a ½in. recess which could be filled with walnut or sapele-faced veneered hardboard, thus simulating hardwood throughout. No lagging is needed in the cabinet.

You can live with this loudspeaker. No boom, no panel resonance, no coloration—you will never get tired of the superb bass. If you want more top—the modern craze—fit a tweeter to a thin frame the same shape as the cabinet.

Now forget your loudspeaker troubles and without fear compare your results with any outfit costing £100 or more. For those who must have stereo use a wooden or concrete column of any good design and mount this on castors as you are sure to find that your ears will not respond as they should, and you can wheel this cabinet about while you search for the best place to sit. ■

by G.M. and E.C.D.



SEMICONDUCTORS

TALKING POINTS ON CIRCUIT PRACTICE

No. 5—R.F. Operation of Transistors

Continued from page 62 of the May issue

THE consideration of transistors in r.f. applications, which includes their use as radio receiver "front-ends", brings us up against some factors we have not met before as well as some new effects of factors we have already dealt with.

A general discussion of some of the problems we are likely to meet, might be as well, before we start considering them in detail.

We shall want to use our transistors as a means of amplifying signals from an aerial, at reasonably high frequency, and then demodulating them to serve as the input to an audio amplifier.

The probability will be that our aerial will be of the Ferroxcube type, sensitive enough but highly critical and—compared with a normal outdoor type of aerial of course—unlikely to provide signals of any very great amplitude for us to start with, unless we are right underneath a transmitter.

It might also be as well then, if we start at the end, as it were, and deal with the demodulator, or rectifier as it is more usually termed, first.

First of all, as a transistor is not the best means of obtaining demodulation, our "rectifier" will doubtless be a diode. This fact in itself will impose some restrictions. Let us consider then the semiconductor diode.

CRYSTAL DIODES

Semiconductors, or crystal diodes are very heat-sensitive and should *never* be soldered without the use of a heat shunt of one sort or another. Nor are they perfect rectifiers since they do pass a small value of *reverse* current. But the fact which will concern us most here is their *resistance*.

Diodes of the crystal-type possess the peculiarity that they offer a considerable resistance in the *forward* direction, though of course very much less than their resistance in the reverse direction. This forward resistance reduces rapidly to an almost negligible value once current commences to flow—but initially it is definitely there and has to be taken into account, in fact there is a voltage drop across a diode even in the forward direction.

This is due to a certain phenomenon termed "hole-storage" but we need not concern ourselves with that, except to appreciate that it exists and that it lasts for a definite, if microscopic period of time from the moment current begins to flow to the moment the resistance reduces to its lowest value . . . known as the "recovery period". There is also an effect when current *ceases* to flow, which maintains an apparent current when the real current has stopped, again for a certain period of time. These periods of time are microscopic . . . but so are the time periods involved in the rectification of h.f. pulses or signals.

This initial high resistance of the semiconductor diode in the forward direction plus the time taken to overcome it does in effect mean that the diode is not a perfect rectifier of small currents, or currents which last only a microscopic period of time.

STANDING BIASING CURRENT

Conventionally the means adopted to get over this little trouble is to give the diode a *standing* current of a sufficient value to take it over its resistance "hill" into the area of low resistance the other side and maintain it there regardless of signal currents; when it becomes an efficient rectifier passing current easily in the one direction compared to an almost complete (though not quite) barrier in the opposite direction. Biased in this way it will pass either the negative side of an a.c. wave, or the positive side, according to which way it is connected of course, without any initial delay necessitated by breaking down its initial high resistance.

Failing such a standing biasing current—which is not always easy to achieve in the circuitry, the diode requires a certain strength of signal applied to it, then, if it is to be a good demodulator. Which infers several stages of r.f. amplification in front of it, because the signal obtained from the aerial in a normal transistor set will not be of very massive amplitude in the first case.

Now we come across quite a variety of what may be termed "trick" circuits, which attempt to

get useful results out of a single transistor and a diode . . . and we have already seen that a semiconductor diode requires a robust signal.

CLASSICAL T.R.F. CIRCUITS

Most of these "economy" circuits stem from old-time "single-valve" circuits which rendered yeoman service in the old days. To mention but a few, we had the Armstrong super-regenerative circuit—in which a single valve was made to operate *over* the threshold of oscillation so offering no damping whatever to the aerial circuits, and by suitable selection of grid-leak and other component values the internal heterodyne, if any, was kept above audible limits so not interfering with reception. This type of circuit is known now as a "Quench" circuit.

Then there was the "Scott-Taggart 100"; we believe the first successfully to use a single valve first as an amplifier at radio frequencies, and then by feeding the rectified audio signal back through it, again as an amplifier at audio frequencies. This we now know as the "Reflex" circuit.

REACTION CIRCUIT

And, of course, the daddy of them all; the single-valve "Reaction" circuit whereby the stage is kept just short of the oscillation point by means of a variable positive feed-back . . . a circuit capable of amazing results since the damping on the aerial system was almost zero. All these circuits have come into fashion again, with the birth of transistors. Let us examine why they do not give anything like the same results as they did with valves. There is more than one reason.

The old regenerative receivers were fashionable in the days of *air-cored*, solenoid coils; they went out of fashion when dust-cores came in. Those of our readers who understand the principles of inductance, especially self-inductance, will know that changes in the secondary are reflected *back* into the primary, and will have no difficulty in appreciating that in a practical sense the coupling between the aerial inductance and the "reaction" coils in these receivers was quite a tricky problem. There was an optimum coupling; if coupling was too tight you defeated you own ends, and if it was made even tighter, then the "reaction" capacitor tuned the aerial; also the entire set-up depended to a great extent upon the actual anode voltage used . . . the lower the better, in fact, if you wanted "smooth" control.

This in fact follows from the theory of inductance!

With solenoid air-cored coils regeneration was a practicable procedure.

DIFFICULTIES OF APPLYING REACTION

With the coming of iron-cores usable at radio frequencies the situation altered drastically; the greatly increased number of lines of linkage made

it extremely difficult to apply reaction to a dust-cored coil—which was probably pile-wound tightly on a secondary, anyhow—and retain any sort of control over it over a wide range of frequencies, though it was not impossible if only a single channel reception was concerned.

Pulling of the aerial circuit by the reflex circuit became difficult to avoid, the optimum coupling almost impossible to achieve in practice; and the whole set-up was more likely to "damp" the aerial system than undamp it.

It is equally difficult to adapt "reaction" to the modern Ferroxcube aerial, with its tightly wound primary and secondary aerial coils.

A further consideration lies in the fact that the early reflex receivers made use of what was then known as "leaky-grid" detection . . . a method difficult to describe in simple terms but which gave very great magnification on the grid of the valve itself by causing the incoming signal to charge a capacitor in the grid circuit so that the potential of the capacitor—accumulating with successive trains of incoming waves—moved the grid cumulatively so as to cause almost a cut-off in anode current before the charge was able to leak away (via the grid-leak). A time-constant of C and R is involved in this procedure, which was possible with a valve, whose input impedance was of the order of many thousands of ohms, but which has not yet been achieved successfully with the transistor whose input impedance is somewhere only about 50 ohms. A moment's consideration will show that whatever value of resistor one put in as a "grid-leak" (or baseleak), it would reduce it to 50Ω, due to the base-emitter path in parallel with it. This additional amplification . . . and it was "many times", is therefore not very practicable with transistors up to now.

There is furthermore the consideration that reflex or no reflex we just have not got a high enough impedance in the input of a transistor to enable us to develop any real work across it—these old-time circuits depended upon *voltage* variations, whereas what we have to feed a transistor with is *current* changes.

The potentials in our aerial, being waveform potentials, will be voltages; with the transistor we have to convert them to current changes . . . without a high impedance across which to achieve that conversion.

REFLEX CIRCUIT

The third form of circuit, the reflex, whereby the audio signal is brought back and fed through the first stage with the r.f. signal, so that the first stage operates at both radio and audio frequency, is more successful. It kills two birds with one stone in that it not only provides us with a stage of audio-amplification without using another transistor to do it, but by feeding the rectified audio signal—which is frequency modulated *d.c.*—back to the input and passing it, amplified now, through the diode again it provides the diode with a steady *d.c.* bias of a considerable amplitude and thus holds it well over in its region of low resistance so that the r.f. signals which it receives at the same time are dealt with under the best conditions. It

is usually combined with a form of regenerative circuit as well . . . but still suffers from the regenerative difficulties already mentioned.

Regeneration, therefore, is a tricky problem with transistors; though it *can* be done: preferably by obtaining the feedback in such a way that it does not influence the input directly—cathode (emitter) injection, for instance. But we are still left with the problem of insufficient impedance in the device itself to do any real work over.

Recognising the limitations imposed upon us by the low values of impedance associated with transistors; recognising also the limitations imposed upon regenerative procedures by the same factor and also by the problems associated with modern dust-cored coils with their high values of inductance, let us now consider some further factors associated with transistors in r.f. applications.

We know that transistors can now be bought which will operate up to far higher frequencies than we are likely to want . . . the OC170 for instance; so that presents no problem. We know also that their alpha dash, or gain, varies according to frequency. *But* the transistor has a peculiarity which is not found in valves. Owing to the fact that it is a crystal, conduction is through a solid. There is in fact a resistance path between the input and output circuits of a transistor, and there is also a capacitative path . . . which must of necessity mean that changes in the input will effect the output, *and* changes in the output will be fed back to the input side. Also, since there is capacity associated with this internal feedback path, the value of the feedback will vary with frequency.

As anything on the collector of a transistor is out of phase with anything on the base the internal feedback must be negative and must take the form of unwanted signals appearing on the input side by reflection from the output side.

NEUTRALISATION

It is normal to cancel out this unwanted feedback by providing a deliberate external feedback of the same magnitude but opposite phase — the procedure being known as neutralisation or unilateralisation. Which is much the same in fact as “reaction” or “regeneration” which is the same thing. It involves, since collector and base are out of phase, reversing the phase of the feedback, since we want a positive feedback to cancel the internal negative feedback.

We have seen that the internal feedback values depend on frequency. These values can be calculated fairly easily for a single frequency—we will go into this in a moment. To calculate them for all frequencies, i.e. all the frequencies in the broadcast band to which a receiver may be tunable, is a different matter, since they would be varying all the time.

If we are going to use a reflex circuit, with several stages of t.r.f., and a regenerative circuit, we would at once be up against the necessity for calculating what the value of internal feedback in the transistor would be at all the frequencies we might be likely to tune it to. And then to calculate the necessary values of external feedback at all these frequencies in order to cancel it.

THE SUPERHET

Which brings us to the “preferred” r.f. circuit, and also to the reasons why it is the preferred circuit.

We have considered the difficulties. Now let us consider how they look to a superheterodyne circuit . . . which is the preferred circuit.

To begin with, we postulated a highly undamped aerial circuit; an oscillator for the first stage achieves this. Next, we postulated a degree of regeneration which shall not “pull” the input tuning; an oscillator looped back to its emitter will give us this. Next, we called for several stages of amplification before the diode, this we can obtain by a couple of stages of i.f. which being periodic tuned we will not need to tune and can therefore neutralise for one frequency only. Finally, we want a robust signal to drive the diode over the hill into its low resistance area . . . the output from the local oscillator added to the signal achieves this. And finally since the i.f.’s will be transformer coupled we can reverse the phase of our neutralising feedback simply by taking it from the secondary of the transformer instead of the collector.

Thus the superheterodyne circuit solves most of our problems without any trouble to ourselves.

And since it involves inter-stage transformer coupling it solves another problem also, that of stepping down the output of one stage to drive the base of the following stage . . . all that is necessary is to make the coupling transformers of the correct step-down ratio—probably somewhere round 6:1.

With transistors, the apparently difficult is in fact the easiest. A five or six stage superhet is likely to be easier to build than either a “One-stager”, “Reflex-regenerative”, t.r.f.—or any other what-have-you! In addition to which, it will probably work—which is more than one can say about the others. For the reasons we have shown, we hope!

SERIES CONTINUED NEXT MONTH

JOIN THE PRACTICAL GROUP

PRACTICAL TELEVISION 2/-
Every Month

PRACTICAL MECHANICS & SCIENCE 2/-
Every Month
Devoted to Mechanics, Science and Invention

PRACTICAL MOTORIST 1/9
Every Month

PRACTICAL HOUSEHOLDER 1/6
Every Month

“ TEST GEAR TECHNIQUES ”

We are sorry that Part 5 of this series has been held over until the July issue, due to the indisposition of the author.

Morse Practice OSCILLATOR

By GRAHAME MEACHEN

RECENTLY the writer was asked to build an audio oscillator for Morse practice that had sufficient volume to be heard by several people in a busy clubroom. Needless to say, it also had to be cheap and portable.

AN EXPERIMENTAL CIRCUIT

An experimental oscillator, using the circuit of Fig. 1 and a standard moving-iron earpiece, proved to be suitable only for a fairly quiet room, and something with more power was needed. However, a search of the available components produced nothing more than surplus "red-spot" audio

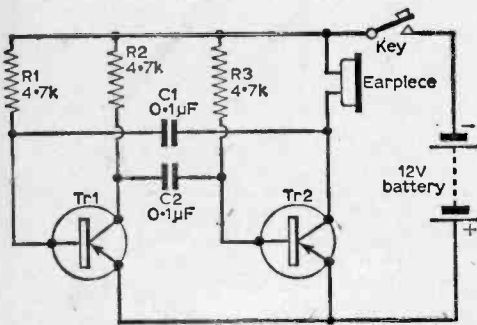

Fig. 1: The experimental circuit first used by the author.

transistors, and it was decided to see how much output could be squeezed out of these, before trying more expensive ideas.

HIGH OUTPUT CIRCUIT

The circuit of Fig. 2 was eventually determined by trial and error and the surprisingly high output turned out to be too loud for use at home, though ideal for the club; a simple switched volume control, as shown, was therefore added. This also had the effect of altering the frequency of the oscillator, but for Morse practice this was not undesirable.

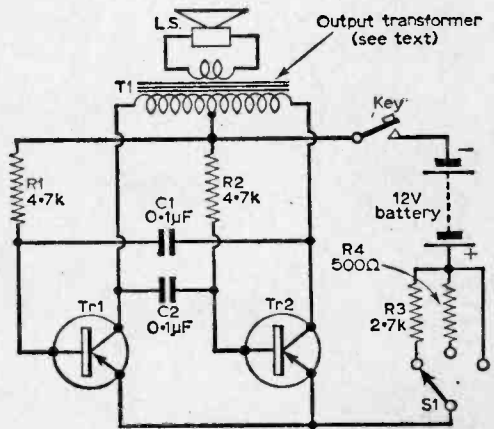

Fig. 2: A higher output oscillator.

The transformer can be any multi-ratio audio output transformer, with taps in the primary. The one actually used came out of a set nearly as old as the writer! The taps selected depend on the frequency required, and can only be found by experiment, as even transformers from the same source can give different results.

The loudspeaker used was a standard 3Ω 5in. p.m. moving coil, but any standard loudspeaker would suit. The actual circuit was built on 1½in. of 1½in. wide tagboard, which was taped to the output transformer. The batteries were two 6V PP1's, which had been taken out of a transistor superhet; they proved to have ample life remaining for this application.

In the writer's case, all the components, batteries and loudspeaker were built into a cabinet 8in. x 3in. x 5in. which was covered with rexine, but this depends entirely upon the builder's requirements. ■

PRACTICAL WIRELESS CIRCUITS

By F. J. CANN 17th Edition 17/6 by post 18/7
from
GEORGE NEWNES, LTD.,
Tower House, Southampton Street, London W.C.2.

CLYNE RADIO LTD.



18 TOTTENHAM COURT ROAD, W.1 MUSEUM 5929/0095
 162 HOLLOWAY ROAD, LONDON N.7 NORTH 6295/67
 9 CAMBERWELL CHURCH STREET, S.E.5 RODNEY 2875
 12 SUFFOLK HOUSE, GEORGE STREET, CROYDON
 10 WITTY GROVE, MANCHESTER, 4 Blackfriars 5379
All post orders, etc. to 162 HOLLOWAY ROAD, LONDON, N.7

THE COMPONENT SPECIALISTS

The "AIR KING"

Our new highly successful Six transistor luxury portable with the "SLIM LINE" look. To build yourself, with printed circuit chassis for reliability and simplicity in construction. May be used as Car Radio, with full MEDIUM wave and LONG wave coverage.

Look at these features!

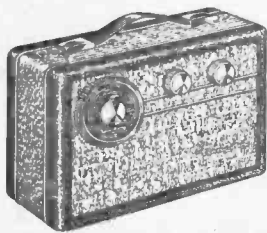

- ★ 500 milliwatt output to high flux 7 x 3in. high fidelity loudspeaker.
- ★ Six selected Mullard Transistors in latest super sensitive circuit, plus germanium diode. ★ Compact size—only 9 1/2 x 3 1/2 x 6 1/2 in. (high).
- ★ Attractive three-tone cabinet. Black, Dark Grey, and Silver Grey, with gilt control knobs and all gilt fittings.
- ★ Coax socket for car aerial.
- ★ Brand new guaranteed components.
- ★ Push pull output. ★ Automatic volume control.
- ★ Long life battery.
- ★ Super sensitive internal ferrite rod aerial.
- ★ Nothing more to buy. Cabinet included.

Special inclusive price for £7.19.6

all required components. Plus P. & P. 4/- Alignment service available. Full assembly details and individually priced parts list, all of which are available separately. price 1/6 post free.

The "HIGHWAYMAN"

At last a quality Car Radio to build yourself, at an economical price. Look at these features—

- ★ Attractive styling.
- ★ Push-pull output.
- ★ 3 latest Mullard transistors plus valves type EBF83 and ECH83.
- ★ No Buzz. High Output and sensitivity.
- ★ Printed circuit (newest type). 7" x 4" High flux p.m. speaker.
- ★ Medium and Long Waves.
- ★ Push Buttons for fingertip control
- ★ Extremely low Battery consumption (less than 1 amp).
- ★ Easy to fit any make car (Positive earth only).
- ★ 12 volt operation.
- ★ Compact size measures only 7" x 7" x 2" deep.
- ★ Easy assembly. Supplied with dial and drive already mounted.

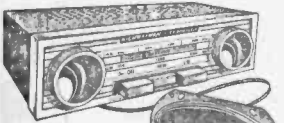

All parts available separately but if purchased at one time the whole will be supplied at a special inclusive price of only £10.19.6 Plus 4/- P. & P. Parts list and comprehensive instruction booklet 2/6 post free. (Deducted from cost if complete parcel purchased later).

NEW BRANCH CROYDON

NOW OPEN AT 12 SUFFOLK HOUSE, GEORGE ST. (One minute from East Croydon Station) OPEN ALL DAY SATURDAY

MODEL TK.20A

Size 3 1/2" x 2 1/4" x 1 1/2". Meter size 2 1/2" x 1 1/2". Sensitivity 1000 o.p.v. on both A.C. and D.C. volts. 0.05, 0.150, 0.1000 volts. D.C. Current. 0/150 mA. Resistance. 0/100K. Complete with test prods, battery and full instructions. OUTSTANDING VALUE at

42/- Plus 1/6 P. & P.



MODEL TK.50

Size 5" x 3 1/4" x 1 1/2" 1000 ohms per volt AC/DC. DC Current 1-250 mA DC and AC volts. 10, 250-500 and 1000 v. Resistance 0-10K, 0-100K. Complete with test prods, battery and full instructions. Outstanding buy at

57/6 Plus 2/6 P. & P.



The SINCLAIR SLIMLINE

A new miniature 2 TRANSISTOR printed circuit pocket radio. Completely portable and the smallest of them all—only 2 1/2" x 1 1/2" x 1 1/2". Uses latest Micro Alloy Transistors and with built in ferrite aerial will receive all stations on Medium Wave—B.B.C. 208, etc. Easy to assemble—no alignment problems. All required components, including earpiece ONLY 49/6 P. & P. 1/6.

All parts sold separately.

THE NEW "CLYMAX" !!

NEW LOW PRICE MADE POSSIBLE Through Further BULK PURCHASES !!

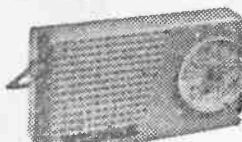

Our 6-transistor pocket size superhet for Medium and Long Wave. All required components NOW ONLY 99/6

Nothing more to buy!

Plus 3/6 P. & P.

★ Completely self contained. No external aerial or earth required. ★ Full medium wave coverage. plus switched Light Programme on Long Wave. ★ Push-pull output—250 milliwatts. ★ Matched set of latest type Mullard transistors. ★ Genuine 2in. P.M. Speaker. ★ New high-Q coils. ★ Ferrite rod aerial with high selectivity. ★ Size: 5 1/2 x 3 1/2 x 1 1/2 in. Two-tone cabinet. ★ Precision etched printed circuit with components references clearly marked. Alignment service available. All parts available separately. Full assembly instructions and individually priced parts list 2/- post free.

TAPE RECORDER CONSTRUCTORS STUDIO

LATEST COLLARO STUDIO TAPE TRANSCRIBER. Latest type incorporating Record Interlock. Lever. Button 3 motors 3 speeds, 11, 31, 71 l.p.s., takes 7in. spools. Push-button controls. **NEW LOW PRICE. OF £10.10.0 ONLY!** plus 7/6 P. & P. Usual H.P. facilities.

NEW TAPE RECORDER AMPLIFIER TYPE 8311-V. Sub-assembled—anyone can build! Printed Circuit, all components mounted and dip soldered. Already tested. Each

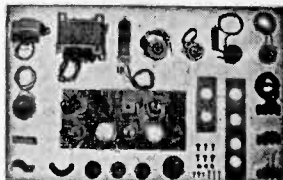

lead cut to length. All that is required to complete the tape recorder is for a few components to be mounted in the cabinet and the free ends of the leads soldered to terminals which are clearly marked, everything supplied, all you need is solder iron, pliers and screwdriver. Valve line-up: EF68, EC883, 2 x EL84, EZ81 and EM84 magic eye. Monitoring facilities, output socket for feeding to high quality amplifier, can be used as "straight" amplifier for record reproduction. **EQUALISING ON TWO SPEEDS. OUTSTANDING VALUE AT £11.11.0 plus 2/6 P. & P.** including all necessary instructions.

ATTRACTIVE TWO-TONE PORTABLE CARRYING CASE. Suitable for above amplifier and Collaro Studio deck. Fitted with 8in. x 5in. High Flux P.M. speaker for high quality reproduction. Inclusive price £5.5.0 Plus 5/- P. & P. Full list of completely priced mics. and stands on request. The above 3 items purchased at one time, SUPPLIED CARR. PAID.

NOW AVAILABLE! FOUR TRACK STUDIO DECK AS ABOVE. FITTED WITH HIGH-FI FOUR-TRACK HEADS. PRICE £13.13.6 plus 7/6 P. & P. Four track heads supplied separately, complete with mounting bracket for Studio Deck at 92/6 pair, plus 2/6 P. & P.

TAPE RECORDER AMPLIFIER 8311-IV. Exactly as 8311-V but four track, suitable for the above high-fi four-track heads. Price £12.12.0 plus 2/6 P. & P.

PRF-AMPLIFIER KIT TYPE 8312-CP. Complete high quality pre-amplifier kit for use with Collaro Studio Deck. Price £8.8.0 plus 2/6 P. & P.

N.B. Four-track deck and amplifier fit the above case without any modification whatsoever.

TAPE ! TAPE !

For the first time in this country! Canada's Hi Fi Magnetic Recording Tape. Made by "Bel-Clear" of Canada.



Following sizes available, others to follow. Brand New, NOT Sub-standard. High grade Acetate base, attractively boxed, fitted leaders, fully guaranteed.

5in., 600 ft., 12/6; 5in., 900 ft., 15/-; 5 1/2 in., 1,200 ft., 18/6; 7in., 1,200 ft., 18/6; 7in., 1,800 ft., 25/-; P. & P. 6d. per spool. 3 or more post free. (Bona fide trade inquiries invited).

SPECIAL AMERICAN MYLAR DUPONT. 5in., 1,200 ft. D.P. Top quality Brand New 25/- post free. Limited quantity only!

PLASTIC TAPE SPOOLS. Best quality. 3in., 1/3, 4in., 2/-; 5in., 2/-; 5 1/2 in., 2/6; 7in., 2/6; P. & P. 6d. per spool. Orders over £1 post free.

TELEPHONE PICK-UP COIL. Designed to feed into the microphone input of either a tape recorder or any high gain amplifier. Easily attached to telephone by rubber suction attachment. The coil is electrostatically shielded to minimise hum pick-up. When positioned on telephone this model is more than adequate for a fully modulated tape recording. Brand new complete with 5 ft. shielded cable. ONLY 14/- Post free.

HOME RADIO OF MITCHAM

Dept. P, 187 London Road, Mitcham, Surrey.
Phone: MIT 3282
Shop hours 9 a.m. to 6 p.m. Wed. 9 a.m. to 1 p.m.

HEADPHONES



Lightweight high resistance Headphones (4000 Ohms), ideal for short wave, crystal sets, tape recorders, etc. Brand new boxed 15/-, post 1/6d. Brown's type "F" 37/6, Ericsson's £4.2.6, Brown's Super "K" stereo from £6.10.0. Please add 1/6 post.

MULLARD AMPLIFIERS ON PRINTED CIRCUITS

We can supply printed circuit boards ready drilled for the following Mullard Amplifier circuits:
Mullard "3-3" 3 valve 3 watt 7/6.
Mullard "5-10" 5 valve 10 watt 12/6.
Mullard 3 watt ECL86 amplifier 7/6.
Mullard 10 watt ECL86 amplifier 12/6.
Can be used in pairs for stereo. PLEASE ADD 1/- post.

EDDYSTONE RECEIVERS & COMPONENTS

We carry the full range of the famous EDDYSTONE Receivers and Short-wave Components.
370A 5 valves 5 waveband £30.17.6 (Overseas export price £26. plus 30/- carriage).
840C 7 valves 5 wavebands £58.0.0 (Overseas shipping and insurance quoted on request).
940 11 valves 5 wavebands £125 (Overseas shipping insurance quoted on request).
Full Specifications on request. Special attention and priority for overseas orders.

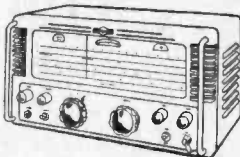

GRUNDIG JACK PLUGS

Brand new Grundig type J2 Jack plugs will fit standard Jack sockets as well. Normal price 5/-. Our Special Price 1/6 each. Add 6d. post to order. Special terms quoted for quantity.

WE ARE MAIN STOCKISTS FOR HEATHKITS

Have you got our **SUPER CATALOGUE?**
172 PAGES, 600 PICTURES, OVER 5000 Items. Price 2/6 Plus 9d. Postage.



STILL THE BEST SHORT-WAVER! GLOBE KING 100A

Explore the World from your armchair. Build this truly amazing little one-valve battery set which gives world wide reception at a minimum cost. Learn Morse and amateurs etc. Extra stage can be added later. Kit of parts with 3 coils covering 10 to 100 metres. PRICE £3.19.6, post 1/6.



EDDYSTONE 898 DIAL

Without doubt the finest slow-motion dial assembly available. Precision gear drive gives velvet smooth 110 to 1 reduction drive with vernier locking scale. Size 9 1/2 x 6 1/2 in. Full details and specification on request. PRICE £3.11.4, post 1/6 (Overseas post 7/6).

GOODMANS AXIOM 10

This is the most popular of the new GOODMANS high fidelity Loudspeakers. 10in. diameter with rigid die-cast chassis and special high flux Feroba 11 magnet system. Will handle 10 watts and has a frequency response from 40 to 15,000 cycles. Ideal for all domestic high fidelity equipment. Available 15 ohms only. Replace that old speaker with this new space age unit and hear all the notes that you are missing, and thrill to a new realism in audio. PRICE 6 GNS. plus 1/6 post.

SENSATIONAL NEW 1963 DESIGNS — BY CONCORD

LOW PRICES ★★ ★ PICTORIAL STEP-BY-STEP PLANS ★★ ★ EASY AS A.B.C.

THE NEW "COSTA BRAVA" 42/6

No earth or aerial required. All-transistor Radio. Revolutionary INTER-NAL FERRITE AERIAL and moving coil speaker makes this the best money-saving bargain of all time. Powerful, superb tone and clarity, ensures perfect reception for all your favourite programmes. Completely portable only 5 1/2 x 3 x 1 1/2 in. Two-tone case. Anyone can assemble with our simple PRINTED CIRCUIT BOARD, send £2/6, plus 2/6 P. & P. (C.O.D. 2/- extra), Satisfaction Guaranteed. (All parts available separately). FREE HIGH SENSITIVITY HIDE-AWAY EAR-PIECE GIVEN WITH EACH SET.

FREE HIGH SENSITIVITY HIDE-AWAY EAR-PIECE GIVEN WITH EACH SET



THE MINUTE TRANSISTOR RADIO MIAMI ONLY 32/6

Unbelievably small—Outrageously cheap. You will be amazed at the fine quality of tone and volume of this great little radio. Only a fantastic 3 1/2 x 2 1/2 x 1 1/2 in. the MIAMI will bring you great entertainment for months on a 1/2 battery. Simple assembly plan with each set. ONLY 32/6. YES 32/6!

Plus 3/6 P. & P. (C.O.D. 2/- extra). Satisfaction Guaranteed. Demonstrations given daily. Parts available separately if required.

THE RINGO BURGLAR ALARM CLEARANCE SALE!

BIG PROFITS FOR YOU IF YOU BUY NOW!
Made to retail at 7 gu. you can now buy this famous Ringo Alarm for only 37/6—but only if you act now! Stocks are strictly limited. Easily installed and operated. Switches on or off at any time. Fantastic FINAL reduction to clear (minimum order of 3). Car. Free. Free literature sent with each alarm. 37/6

SELL SAFETY TO THE MOTORIST

Bulk purchase of bankrupt stock ensures this fabulous money-making offer. **AUTOMATIC CIGARETTE LIGHTER** Instantly provides ready lit cigarette without the driver taking his eyes from the road. Heavily chromium plated case holds 10. Easily and simply fitted to any car dashboard. Works off 6 or 12 volts. Retail Price 44/6. Special Clearance offer only sold in minimum lots of 6. 12/6 each. Carriage free.

THE NEW 4-STAGE "MINUETTE" 32/6

Build this newly designed "MINUETTE" 4-STAGE transistor set in very strong ready drilled ULTRA-MODERN CASE, size only 6 x 3 1/2 x 1 1/2 in. Uses three transistors and diode and SELF-CONTAINED LOUDSPEAKER. Very sensitive. Ideal for office, bedroom, holidays, etc. Months and months of listening off 1/2 battery. Can be built FOR ONLY 32/6, including PROPER CASE, miniature speaker, etc. SIMPLE AS A.B.C. PICTORIAL STEP-BY-STEP PLANS etc., plus post and packing 1/6 (C.O.D. 2/- extra). Parts sold separately. priced parts list 1/-.

FABULOUS ST. TROPEZ Mk.6 Pocket Radio ONLY 18/6

No more to pay! This fantastic offer will amaze you—the compact ST. TROPEZ measuring 4 1/2 x 3 x 1 1/2 inches, perfectly in bedroom, office or garden—over all medium waves including Luxembourg. Under 1d. per hour running cost. ANYONE can assemble it using our simple A.B.C. plan (P. & P. 2/6 extra) C.O.D. extra. Parts can be bought separately. Demonstrations daily. Satisfaction guaranteed.

CONCORD ELECTRONICS (Dept. 14/15)
210, Church Road, Hove, Sussex

ALL-BAND transmitting AND receiving AERIALS

BY R. F. GRAHAM

IN many circumstances it is convenient to have a single aerial which can be used on any of the amateur bands from 3.5—28Mc/s. The aerials described here are of this type, and though primarily intended for use with a transmitter, can give very good results when receiving, so will be of interest to short-wave listeners who are anxious to obtain long distance reception.

Some of the aerials are particularly intended for the 3.5, 7, 14, 21 and 28Mc/s amateur bands, though they will generally do very well for 19, 25, 31m, and other broadcast bands.

Using aerials of the type described here, the author established two-way communication with very distant stations, including amateurs in Australia and New Zealand. For these tests, a 120W transmitter was used, with 60W modulator (e.g., the usual type of a.m. speech rig). If c.w. were employed, or single-sideband, long distance communication ability would be increased.

Similar materials may be used for the construction of any of the aerials. Enamelled, hard drawn 14s.w.g. or similar single strand copper wire is suitable. Wire of several strands, such as 7/26, has also been employed, as has hard drawn copper wire. Enamelled wire is probably best, to avoid surface oxidation.

For suspension, thin cord may be used. Very tough plastic line is also available, and does well. One or two insulators should be provided at each end of the aerial, and 4in. or similar ribbed glass or Pyrex insulators are especially suitable.

End-Fed Aerials

This simple type of aerial is shown in Fig. 1. Top and down-lead can usually be a single, uncut length of wire. The total length (top plus down-lead) can be chosen so that the aerial is approximately a half-wave, or multiple of half-waves, on each band. The feed point is then high impedance.

For this type of operation, 138ft may be used. This is approximately a half-wave on 3.5Mc/s, two half-waves on 7Mc/s, four half-waves on

14Mc/s, six half-waves on 21Mc/s, and eight half-waves on 28Mc/s.

If 1.8Mc/s operation is required, the length is near a quarter-wave and thus low impedance. The aerial is then used as a "Marconi", tuned against ground.

If 138ft cannot be erected, half this length will provide a half-wave on 7Mc/s, two half-waves on 14Mc/s etc. The feed point is high impedance on these bands, but low impedance on 3.5Mc/s. In other words, it is a Marconi on that band where it is near a quarter-wave, but a high-impedance aerial ("Hertz") on bands where it is a half-wave, or multiple of half-waves.

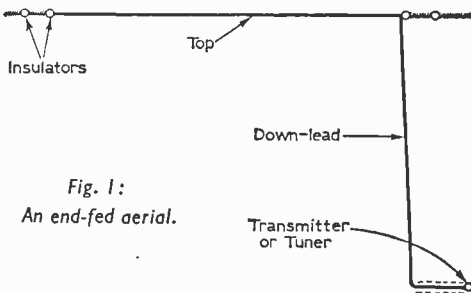

Fig. 1:
An end-fed aerial.

When the feed point impedance of the aerial falls within the range of impedances available by adjustment of the transmitter, it is possible to operate directly into the aerial. Otherwise, an aerial tuner is required. In general, the tuner is preferable, as it provides harmonic suppression.

For receiving, the aerial may be taken directly to a high impedance aerial terminal. Or a tuner may be used, with feeder to the receiver, especially if the latter has a low impedance input. Such a tuner is exactly the same as described for transmitting, except that a wide-spaced tuning capacitor is not required. For best possible reception, the tuner is almost essential.

Zepp

This type of aerial is shown in Fig. 2. Feeder A is joined to the top (aerial). Feeder B terminates at the insulator, level with feeder A. A tuner is required. The top is approximately a half-wave, or multiple of half-waves, on the required bands. For 3.5—28Mc/s, 137ft is suitable.

The feeder can be made from 14s.w.g. wire, or 7/26 or similar stranded wire, which is easier to pull straight. Ceramic spacers hold the feeder

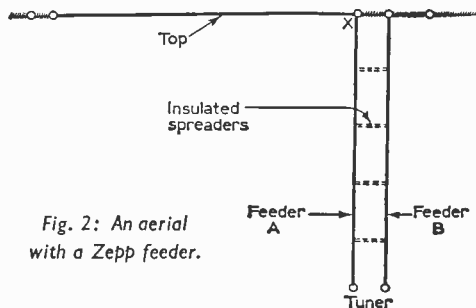

Fig. 2: An aerial
with a Zepp feeder.

wires about 4-6in. apart. The spacers may be purchased or may be cut from insulating material, such as Perspex. Sufficient spacers are used to obtain reasonably uniform spacing between the wires—that is, at least one spacer for each 3ft.

The point X is high impedance on all bands. Therefore the impedance at the tuner end of the feeder will be high impedance when the feeder length is a half-wave, or multiple of half-waves. When the feeder length is near a quarter-wave, or *odd* number of quarter-waves, the end impedance will be low. For example, a 68ft feeder will present a high impedance on 7, 14 and 28Mc/s. but low impedance on 3.5Mc/s. Intermediate lengths of feeder will present a range of impedances, but it is generally possible to match to these, with an aerial tuner.

There is some radiation from the Zepp feeder, which is not balanced, but radiation here is less than with the down-lead of the end-fed aerial. This point may be important, if interference is being caused to TV broadcast receivers nearby.

And end-fed or Zepp aerial can frequently be erected with the near suspension cord attached to a high point on the house, so that only one other support is required. Builders' merchants can usually supply flagpoles and ladder-poles, which may be attached to a 4in. x 4in. or other stout vertical post, using $\frac{1}{8}$ in. bolts.

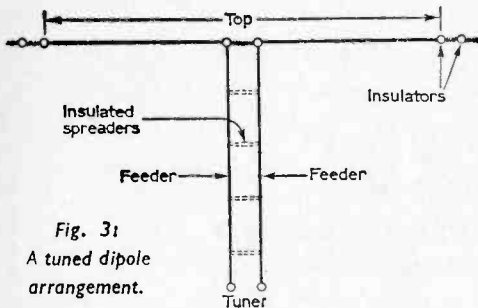

Tuned Dipole

This useful type of aerial is shown in Fig. 3. The feeder is made as for the Zepp, and the top length is generally a half-wave at the lowest operating frequency. A typical length for 3.5 to 28Mc/s is 136ft. For 7-28Mc/s 65ft can be used.

The aerial tuner is essential, and the impedance encountered at the tuner end of the feeder depends on the top length, feeder length, and operating frequency. If the top is a half-wave, its centre is low impedance. If the feeder is a quarter-wave long at this frequency, the tuner end will be high impedance. If the feeder length is a half-wave, or multiple of half-waves, the tuner end impedance will be similar to that of the centre of the aerial. A 136ft top with 68ft feeder will thus give high impedance at the tuner.

A dipole of this type can be tuned to resonance on many frequencies, if a suitably tapped coil is employed in the tuner, and can work well on many bands. For the same reason, lengths other than those found by calculation will perform well on the amateur bands. Considerable modification to

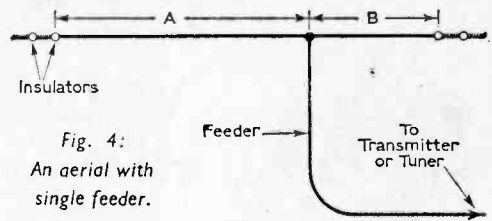

the top length is thus possible, to suit available space or supports.

Single Feeder Aerial

This type of aerial is shown in Fig. 4, and the down-lead is so attached as to provide a reasonable impedance feed on the required bands. There is also considerable radiation from the feeder, since this cannot be arranged to act as a flat or non-radiating line.

For 3.5-28Mc/s, the aerial may be 134ft long, with the feeder so arranged that A is 89ft and B 45ft. The feeder is 66 $\frac{1}{2}$ ft long. For 7-28Mc/s, the aerial may be 66 $\frac{1}{2}$ ft with a A 44ft and B 22 $\frac{1}{2}$ ft, the feeder wire being 33ft long.

It will usually be necessary to use a tuner, as for the end-fed aerial. The tuner is in any case preferable, to help suppress harmonics.

Aerial Tuners

For transmitting purposes, the aerial tuner can perform several functions. It may be required to transform the aerial impedance to an impedance suitable for the transmitter, to reduce harmonic output, or to allow the transmitter to be adjusted for a low impedance output which will in itself reduce harmonics. With Zepp or tuned doublet feeders, it is also used to change the single output of a π circuit to the double or balanced circuit needed for the two feeders.

A tuner which may be used for end-fed aerials or single feeders, or for parallel tuning of Zepp and dipole feeders, is shown in Fig. 5. Most popular transmitters have a π output able to work into 75 Ω or similar low impedance, and a short piece of 75 Ω or similar coaxial cable is taken from here to the tuner.

A variable capacitor of about 150pF is satisfactory, and wide spacing is required except for low power. The capacitor can resemble the transmitter p.a. tuning capacitor, and it should be operated by means of an insulated extension spindle. It is equally satisfactory to use a two-gang capacitor, taking one set of fixed plates to A and the other set of fixed plates to B. The rotor plates are earthed, and the centre tap of the coil is then omitted.

The tuner coil is for the required bands. A tapped coil will allow coverage of all bands from 3.5-28Mc/s. For up to 150W, 26 turns of 18s.w.g. wire, occupying about 4in. on a 2 $\frac{1}{2}$ in. diameter former, will be satisfactory. The Eddystone 1090 former is suitable.

An end-fed aerial, or single feeder, is taken to terminal A. If the impedance is not particularly great, the aerial or feeder can be tapped down the coil, as at C.

'CATHODRAY' VISCONOL CAPACITORS for the most stringent conditions



The 'Visconol' Process—exclusive to T.C.C.—means greater dependability and a longer useful life than ever before. It is the answer by the T.C.C. research engineers to the insistent demand for condensers which will stand up to higher and still higher voltages. A selection from the range is given below. Features include: low power factor; complete dielectric stability; resistant to voltage surges; ample rating at higher temperatures; proof against breakdown or flash-over. Full details on request.

Cap. in μ F.	Max. Wkg. at 60°C.	Dimens. (Overall)		T.C.C. Type No.	Price
		Length	Dia.		
0-0005	25000	5 $\frac{1}{2}$	1 $\frac{1}{2}$	CP57H00	18/-
0-001	6000	2 $\frac{1}{2}$	3 $\frac{1}{2}$	CP5500	6/-
0-001	12500	3	1 $\frac{1}{2}$	CP56V0	10/-
0-001	20000	2 $\frac{1}{2}$	1 $\frac{1}{2}$	CP56G00	10/-
0-002	18000	5 $\frac{1}{2}$	1 $\frac{1}{2}$	CP57X0	18/-
0-01	6000	3	1 $\frac{1}{2}$	CP56Q0	10/-
0-02	12500	6 $\frac{1}{2}$	2	CP58V0	20/-
0-05	6000	5 $\frac{1}{2}$	1 $\frac{1}{2}$	CP57Q0	18/-
0-1	7000	6 $\frac{1}{2}$	2	CP58Q0	20/-
0-25	1000	3	1 $\frac{1}{2}$	CP56V	10/-



THE TELEGRAPH CONDENSER CO. LTD.

RADIO DIVISION: NORTH ACTON . LONDON . W.3

Tel: ACORN 0061

WEYRAD

**6-TRANSISTOR 2-WAVE SUPERHET RECEIVER
MODIFICATIONS NOW AVAILABLE FOR 500mW OUTPUT**

- ROD AERIAL—RA2W
6 in. long, $\frac{3}{8}$ in. diameter, connections to tags on Coils. For 208 μ F tuning capacity. Complete with Car Aerial Coil 12/6
- OSCILLATOR COIL—P50/1AC
M.W. covered with 176 μ F tuning capacity, L.W. by extra padder 5/4
- I.F. TRANSFORMERS
1st and 2nd Stage—P50/2CC 5/7
(2 required)
- 3rd Stage—P50/3CC 6/-
- DRIVER TRANSFORMER—LFDT4 9/6
- OUTPUT TRANSFORMER—OPT1 10/6
- PRINTED CIRCUIT—PCA1 9/6

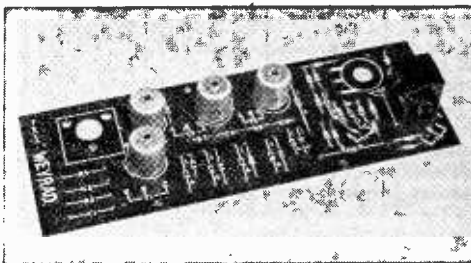

In response to many requests we have redesigned the output stages to give 500mW and to enable a standard 3 ohm Speaker to be used. Full details of the simple changes are given on a separate leaflet available on receipt of stamp.

- CONSTRUCTOR'S BOOKLET WITH FULL DETAILS 2/-
- TRANSISTOR A.F. AMPLIFIER TYPE A.F.1—LOW IMPEDANCE INPUT, 3-TRANSISTOR, 500mW OUTPUT, FULLY ASSEMBLED WITH VOLUME CONTROL 83/6

WEYMOUTH RADIO MANUFACTURING CO., LTD.
REGENT FACTORY, SCHOOL STREET,
WEYMOUTH, DORSET

P.W. MERCURY-6 MK. II
M. & LW. 6 TRANSISTOR SUPERHET.
500 mW OUTPUT.

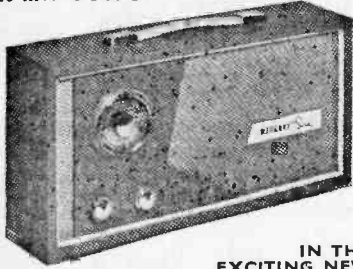

IN THE EXCITING NEW ELEGANTLY DESIGNED CABINET.

This model gives a superb performance on its 7 x 4 in. speaker and really "pulls-in" Luxemburg.
● Printed Circuit.
● High Q Internal Ferrite Aerial.
● Built in Mains Operation (30/- extra)
All parts required **£9.19.6** P.P. 3/6.
BUILDING PLANS 2/6

TELESCOPIC AERIALS

Beautifully made, ideal for portable radios. Chrome plated. 6 in. closed extending to 30 in. in 5 sections.
Bargain at **7/-**
P. & P. 9d.

NEW VALVES

25A6, VR65, 35A, ECC81, 6AM6, 6AK5.
ALL 4/- EACH
P.P. 6d.

TERRIFIC VOLUME !!

WITH THE

P.W. 6-TRANSISTOR

Medium and Long Wave Pocket Superhet

THE CONTINUED POPULARITY OF THIS FAMOUS SET IS PROOF OF ITS VERY HIGH QUALITY AND FINE PERFORMANCE

- 450 mW Push-Pull Output on 2 1/2 in. P.M. Speaker.
- Printed Circuit.
- Guaranteed first grade Miniature Components.
- High Q Internal Ferrite Rod Aerial.

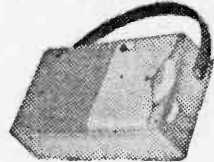

All parts required **£7.19.6** Plus 2/- P.P.
Write For Building plans 1/9 (Free with Kit).

CERAMIC

TUNING (LOW LOSS) CONDENSERS

25 pF	...	5/-
100 pF	...	5/9
140 pF	...	7/6
Solid Dielectric		
300 pF	...	3/9
500 pF	...	4/3

All 1/2 in. DIA. SPINDLE P.P. 9d.

PAY AS YOU BUILD SCHEME

AT NO EXTRA COST the above kits may be bought in 3 complete stages of 53/2 (P.W.6) or 66/6 (Mercury 6) each, plus 1/6 P.P. (state A, B or C when ordering).

ALIGNMENT SERVICE

WE GUARANTEE TO MAKE YOUR SET WORK

We offer a very comprehensive service for both the above purchased from us including fault finding at reasonable charges. Alignment only 12/6. P.P. 2/-. When sending DO NOT include speaker or case (to minimise postal damage).

NORCOL LTD
ELECTRONIC COMPONENTS

147 LONDON ROAD, YORKTOWN, CAMBERLEY, SURREY
Phone: CAMBERLEY 3743

VALVES SAME DAY SERVICE
NEW! TESTED! GUARANTEED!

SETS	1R5, 1S5, 1T4, 35A, 3V4, DAF91, DF91, DK91, DL92, DL94 ..	Set of 4 for 18/6	4 for 26/6
1A7GT 10/8	6Q7G 6/-	35Z3 15/-	ECC82 4/9
1D5 7/6	6Q7GT 8/-	35Z4GT 5/6	ECC88 7/-
1H5GT 9/-	6SL7GT 5/9	50L6GT 8/3	ECC94 7/9
1N5GT 9/-	6SN7GT 4/9	18B6T 19/6	ECC85 7/6
1R5 5/6	6U6T 8/9	AC7/TH 13/6	ECP30 7/-
1S4 8/-	6V6G 4/3	AZ1 12/6	ECP82 8/6
1S5 4/9	6V6GT 7/3	CBL1 12/-	ECH35 7/3
1T4 3/-	6X4 5/-	CCH35 13/6	ECH42 8/9
3A5 9/-	6X5GT 6/9	CL33 12/3	ECH81 7/3
3C4 7/-	6Y30L2 8/6	CY1 12/6	ECL80 7/3
354 5/9	7B7 8/-	CY31 8/6	ECL82 9/-
3V4 6/9	7C5 7/9	DAC32 9/-	EF37A 6/9
5U4G 4/6	7C6 7/6	DAF91 4/9	EF39 4/6
5V4G 8/-	7CC 7/9	DAF95 7/3	EF40 11/6
5Y3GT 6/9	7S7 9/-	DF93 9/-	EF41 7/9
5Z4G 5/9	7Y4 6/-	DF93 9/-	EF42 7/-
6AL5 3/9	10C1 12/-	DF91 3/-	EF80 4/9
6AQ5 6/3	10C2 16/6	DF96 7/3	EF85 5/-
6A7E 5/3	12A16 7/-	DH76 4/9	EF86 7/-
6B6 5/6	12A77 4/9	DH77 5/3	EF89 6/6
6B6E 5/9	12A07 4/9	DK32 19/6	EF91 3/6
6CB6G 13/6	12AX7 4/9	DK91 5/6	EF183 10/3
6BB6 6/-	12K7GT 4/9	DK92 7/6	EF184 10/3
6BL6 5/9	12K8GT 9/6	DL35 9/6	EL33 9/-
6BW6 8/-	12Q7GT 4/9	DL35 9/6	EL41 8/6
6CD6G 26/6	14S7 14/6	DL92 5/9	EL42 8/6
6F1 9/6	18B6G 13/6	DL94 6/9	EL84 6/3
6F13 9/6	20L1 17/6	DL96 7/3	EM34 7/3
6F14 9/6	20P4 19/-	EABC80 4/9	EM81 8/-
6K7G 1/11	20T6 15/9	EA42 8/6	EM80 6/9
6K7GT 5/-	25L6GT 7/-	EB91 3/9	EM85 9/9
6K8G 4/9	25Z4G 7/6	EBC33 5/-	EY51 1/6
6K8GT 9/6	27S1 17/6	EBC41 7/9	EY86 6/6
6L3G 6/6	30L15 19/3	EBF80 7/9	EZ40 6/-
6L19 10/-	30P4 12/6	EBF89 8/-	EZ41 7/6
6LD20 5/6	30P19 18/9	EBL21 13/6	EZ80 5/6
6P25 8/-	30PL13 11/-	EBL21 13/6	EZ81 5/6
6P28 11/6	35A5 14/-	ECC40 9/-	EZ82 5/6
	35L6GT 8/3	ECC81 4/9	EZ82 5/6

NEW 1963 EDITION RADIO AMATEUR HANDBOOK

by A.R.R.L.

36/- Postage 2/6.
MORE ABOUT LOUDSPEAKERS by G. A. Briggs. 1963. 8/6. Postage 9d.

SINGLE SIDEBAND COMMUNICATIONS HANDBOOK, by H. D. Hooton. 56/-. Postage 1/9

ELECTRONIC MUSICAL INSTRUMENT HANDBOOK, by N. H. Crowhurst. 20/- Postage 9d.

R.S.G.B. AMATEUR RADIO CAL BOOK, 1963 Ed. 4/6. Postage 6d.

INSTANT MATHS., by A. Cutler. 10/6. Postage 9d.

CABINET MAKING, by W. Smith. 7/6. Postage 9d.

22 TESTED CIRCUITS USING MICRO ALLOY TRANSISTOR, by C. Sinclair. 5/-. Postage 6d.

RADIO VALVE DATA, 7th Ed. Compiled by "V.V.V.". 6/-. Postage 10d.

COMPLETE CATALOGUE I

THE MODERN BOOK CO
BRITAIN'S LARGEST STOCKISTS of British and American Technical Books

19-21 PRAED STREET LONDON, W.2
Phone: PADDINGTON 4185
Open 6 days 9-6 p.m.

READERS RADIO
24 COLBERG PLACE, STAMFORD HILL LONDON N.16 STA. 4587

Post 6d. per valve extra.
Any Parcel Insured Against Damage in Transit 6d. extra.
Any C.O.D. Parcel 4/3 extra.

For use on higher frequencies, the capacitor is tapped across a suitable portion of the coil, as by connecting it to C and D. Once tappings have been located, tags may be soldered on, or a switch wired for band selection.

The coupling loop to which the transmitter is connected may consist of three turns of adequately insulated wire, close wound over the centre of the coil. If the tuner is used with a receiver, correct tuning will be shown by an increased reading on the signal strength meter of the receiver.

Low impedance feeders may be fed by taking them to turns near the centre of the coil. By this means, the tuner in Fig. 5 can be used successfully with almost any impedance feeder.

For low impedance feeders, however, series tuning is generally employed, and is more readily adjusted. A circuit for this is shown in Fig. 6. Satisfactory results are obtainable if one capacitor is omitted, though two are preferable. Points A and B are taken to the Zepp or tuned dipole feeders.

If the top length and feeder length of the Zepp or dipole are known, the need for parallel or series tuning can be anticipated, parallel tuning being used for high impedance, and series for low impedance. If the impedance is unknown, the circuit in Fig. 5 can be tried, the feeders being tapped in (C and D) if necessary. If results are still unsatisfactory, series tuning can be tried (Fig. 6) and will probably be suitable. A few odd aerial and feeder lengths are difficult to tune, and if this happens, the feeder length is best changed.

Flexible leads, with clips, will allow series or parallel tuning to be arranged in a few moments, and also allow the capacitors to be tapped in towards the centre of the coil, for higher frequencies. When best positions have been located, they should be noted for future use.

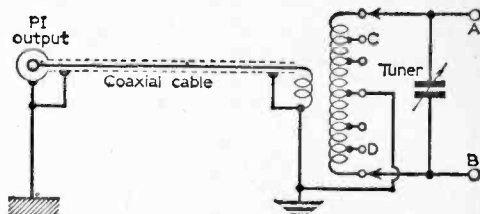
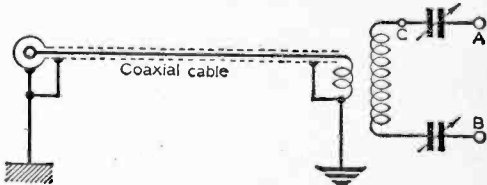

Fig. 5 (above): A tuner for high impedance. Fig. 6 (below): Series tuning.



A Marconi aerial (e.g., end-fed wire near quarter-wave long) can be fed by taking it to C, Fig. 6, and taking B to the best earth available. The unused capacitor is not required.

If a harmonic trap is employed, it can be placed in the coaxial cable, as the trap is generally for a low impedance circuit, and must be operating at the correct impedance.

An r.f. meter may be included in series with the aerial feeder, to show that the transmitter is giving its usual output. The reading will depend on impedance and output ($I^2 \times Z = W$). A meter reading up to 350mA is suitable for small power with low impedance, or moderate power with high impedance. For larger power, a 1A or 2A meter will be more suitable, or the 350mA meter may be shunted.

THE P.W. SPINETTE

—continued from page 122

aperture. A piece of loudspeaker gauze about 4½ in. x 7 in. is glued over the aperture underneath, being drawn taut. The loudspeaker is held in place by means of four ¼ in. screws, with washers. The turntable unit is positioned in its cut-out, and held with three ½ in. round-headed screws, with washers.

The volume control is fitted near the battery opening, and equipped with a knob. Leads between amplifier, loudspeaker, volume control, etc., are soldered on as previously described.

Installing the Units

After testing the equipment, the amplifier can be secured to the false bottom by means of two ½ in. screws. The motorboard is then finally placed in the case, and held by means of five ½ in. round-headed screws, with washers.

The battery cover is finished to match the motorboard, using surplus material. A small groove in the case, inside at the back, receives the cover, which is a push fit, and rests on the slightly projecting rim of the loudspeaker.

The turntable unit is adjusted for 33½ or 45r.p.m. as required, by moving the projecting arm opposite the appropriate speed. An upright crank on the unit engages with springs in the pick-up arm, to hold the arm when the record player is carried. This crank is disengaged by moving it backwards, clear of the arm.

The motor is started by raising the pick-up and moving it fully outwards. It is then brought in, and placed on the record. Switching off is automatic, when the arm has moved inwards. The pick-up should not be allowed to drop on to the record or turntable.

PARALLEL TRACKING UNIT

It has been brought to our notice that the Parallel Tracking Unit described in the March 1963 issue of PRACTICAL WIRELESS is covered by British Patent No. 917752 which is held by Mr. John A. Mackie. This device must not, therefore, be manufactured for resale except by arrangement with the Patent holder.

Geiger Counter Digital Register

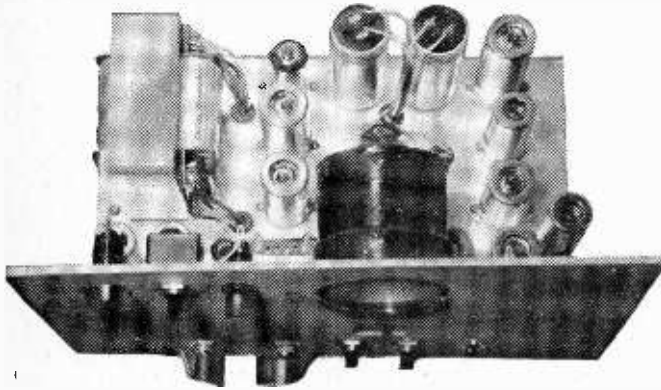

incorporating
Scaler and
Power Pack

• • •
by
E. Dexter
• • •

THIS ARTICLE DESCRIBES A DIGITAL REGISTER FOR OPERATING THE ADVANCED GEIGER HEAD DESCRIBED IN THE DECEMBER 1962 AND JANUARY 1963 ISSUES.

Continued from page 70 of the May issue

IF one is using, or intending to build, merely the simple digital counter published in P.W., February to April 1962, then the counting rate should definitely be kept down, so that errors in direct counting do not become intolerable, as can happen at fast rates of counting. Furthermore, one should make sure of obtaining a digital relay in really good condition.

The author has been making comparative measurements of several samples of these relays, and found great differences in the switching times, according to the condition. Thus cheaper samples, taken from the junk boxes on display in some surplus stores, showed switching times up to a fifth of a second, which led to over 30% error at counting rates of 100/minute.

On the other hand, really good specimens selected from the stock of a reputable firm had switching times as short as a twentyfifth of a second, leading to only about 7% error for direct counting at 100/minute. Whilst this point may not be all that important (as 20% is the common amateur tolerance for less exact work anyway, and on account of the inevitable errors in preparing specimens), for those constructors going no further than constructing the already published simple digital counter, it nevertheless receives full importance for the present high-quality counter described in this article. It is definitely necessary to make sure of obtaining a really sound digital relay; if possible, a brand-new item.

The further important observation was made during careful experiments with the prototype, that the effective switching time is dependent on the setting of the bias control in the digital counter circuit (VR2). This is because the bias setting influences the magnitude of the current pulse sent through the relay on each count.

This point was already mentioned in the text for the simple digital counter in P.W. Feb., 1962, where it was stated that the bias setting should be as high as possible without counting stopping altogether. The effective switching time then has its shortest possible value for the particular specimen of digital relay in use. When the bias setting is reduced to the point where permanent current almost commences, the current surges are so large on each count and after-effects consequently take so long to die away, that the "effective" switching time has then been observed to be anything up to double the better value at higher bias settings. The greater the pulse output amplitude from the Geiger head, the higher can the bias be set before counting ceases, and thus it is for this reason, among others, necessary to assure adequate signal amplitude from the Geiger head.

However, for the more careful work justified by the high quality of the present unit a further point observed during experiments with the prototype requires discussion. When using high-voltage Argon tubes with organic extinguisher anything up to 10% of the total pulses can be of considerably lower amplitude than the rest, so that these are missed when the bias is set critically for the full-amplitude pulses in the interests of short switching time. The demand is here contradictory to the first, so that some intermediate bias setting is more suitable. And, in fact, experience has shown that for this type of Geiger tube a bias setting midway between permanent current and no-counting gives the smallest direct counting error.

When using halogen quenched tubes such as the Mullard MX124/01 head, specified as ideal for the apparatus here described, the bias should be set as high as possible again, as such tubes give far fewer low-amplitude spurious pulses.

EASY TO BUILD



AMATEUR RADIO EQUIPMENT

CR 66 COMMUNICATIONS RECEIVER ★ **A CODAR KIT TRIUMPH**
NOW... THE FINEST KIT EVER OFFERED!

This complete'y new Communications Receiver with its many design features and handsome styling offers more in performance and quality than many higher priced units.

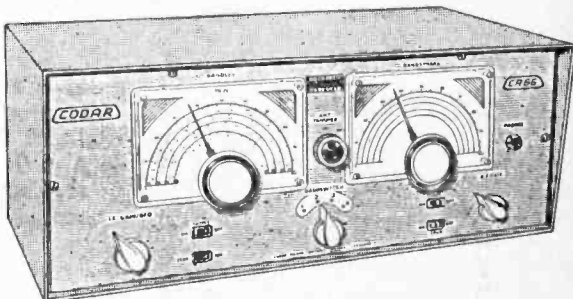

Frequency Range 540 Kc/s to 30 Mc/s in four Band-switched ranges. Separate Main Tuning and Electrical Bandsread. Entirely new design High "Q" ferrite cored Coils. Oscillator Coils fitted temperature compensated trimmers for stability. Coil Unit is wired and assembled, and with the I.F. Transformers is supplied factory aligned and tested. Low loss Trolax glass alkyl switch wafers. Controlled regenerative I.F. amp. for maximum gain and B.F.O. Panel Ant. Trimmer. Delayed A.V.C. Cathode follower output for tape recorder, etc. 3 watts output for external 2/3 ohm speaker. For panel slider switches, On-Off/Standby-Receiver/A.V.C. On-Off/Speaker On-Off Front Panel Silver and Black, control knobs Grey with Silver trim. Provision for EM 84 Signal strength indicator. Panel phone jack. Heavy gauge steel chassis, cadmium plated. Valve line-up: ECH81/EBF89/ECC81/EL84/EZ80. Instruction Manual, 17 pages. Cabinet size 16 x 6½ x 8½ins. Silver Grey. For AC 200-250 volts. (Export and Marine Model 115 volts).
 Total cost of complete Kit, less Cabinet and Indicator **£16.10.0** carr. **CR 66 Cabinet £1.15.0** Signal strength indicator with EM84 **17/6**

H. P. Terms available. Details on request.

THE NEW CR 45 ★ **NEW STYLING TOP PERFORMANCE**

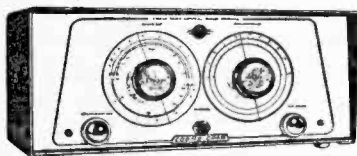

- ★ Tunes 10-2000 meters (5 Coils).
- ★ Separate electrical bandsread.
- ★ Three slow motion vernier drives.
- ★ Low loss polystyrene plug-in coils, factory aligned.
- ★ Dials calibrated in frequencies and degrees.
- ★ Power output 3 watts for 2/3 ohm speaker.
- ★ Valve line-up: ECC81/EL84/EZ80.
- ★ Front Panel Silver and Black, control knobs Grey.
- ★ Provision for panel phone jack.

Superb styling. World-wide reception. Total building cost, with 2 Coils, 25-75 and 60-175 metres. **£6.19.6** carr. 3/6
 Instruction Manual 11 pages, less Cabinet
 CR 45 Cabinet Silver Grey, 12 x 5½ x 7in. sliding door for easy coil changing **27/6** Extra coils, all ranges **4/9** each.

ALL PARTS AVAILABLE SEPARATELY

★ **THE MINI-CLIPPER**

- ★ Tunes 10-2000 metres (5 coils).
- ★ Miniature 1 valve, all band receiver.
- ★ Low loss polystyrene plug-in coils, factory aligned.
- ★ Air spaced ball bearing condensers.
- ★ Provision to add two-transistor amplifier.
- ★ Battery lasts months.

36/6



Can be built in an evening, will receive Amateur and Broadcast stations from all parts of the world. Total building cost with one coil 25-75 metres, Instruction Manual 4 pages, **36/6**, carr. 2/6. Extra coils, all ranges, 4/9 each. Electrical bandsread available. All parts available separately.

★ **THE SUPER CLIPPER** ★

- ★ Tunes 10-2000 metres (5 coils).
- ★ Large precision dial, dual slow motion drives.
- ★ Bandsread on all Bands.
- ★ High gain valve/transistor hybrid circuit.
- ★ 2 Mullard transistor amplifiers, pre-assembled and tested.
- ★ Low loss polystyrene plug-in coils, factory aligned.
- ★ Batteries last months.

88/6



Easy to assemble, this top performing All Band Receiver brings a new world of listening pleasure to your finger-tips at low cost. Total building cost with 2 Coils, 20-60 and 55-190 metres, Instruction Manual 7 pages, **88/6**, carr. 2/6. Extra Coils, all ranges, 4/9 each. Front Panel, Silver Grey, 10 x 7½in., 6/9.

Please note **NEW** address. We have now acquired new modern premises, combining all depts., offices and laboratories. New equipment under development will be announced in due course. Now available P.R.30 R.F. Preselector 1.5/30 Mc/s., greatly improves performance of any superhet receiver. CODAR Equipment is famous for Top Quality, Peak Performance and Easy-to-Follow Instructions—no guesswork. 6d. in stamps brings illustrated leaflets. Coming shortly, 70 watt 5 Band Transmitter Model No. CT80.

CODAR RADIO COMPANY

BANK HOUSE, SOUTHWICK SQUARE, SOUTHWICK, SUSSEX

G31RE

Canadian Distributors: JAYCO ELECTRONICS, TWEED, ONT.

G31PA

an *Armstrong* chassis is more than just a radiogram chassis

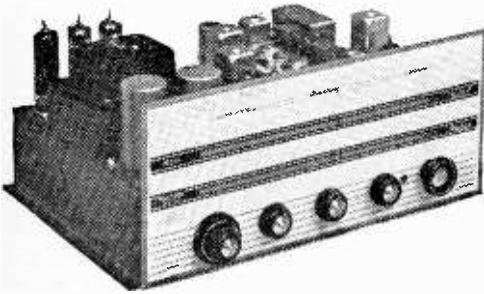

It is a carefully designed combination of tuner, control unit and amplifier in one compact unit which can be used as the basis of a complete high fidelity system. A system which can include tape recording and playback as well as radio and record reproduction.

STEREO 12 MK.2 £40.5.0

8 watts push-pull output from each channel, 16 watts total. VHF, with automatic frequency control, medium and long bands. A hi-fi system on one compact chassis.

STEREO 55 (Illustrated) £29.18.0

A junior version of the Stereo 12 Mk. 2. 5 watts per channel, 10 watts total. VHF and medium bands. Inputs for tape, pick-ups and possible future stereo radio.

JUBILEE MK.2 £28.5.0

A mono chassis of 8 watts push-pull output and covering VHF, medium and long bands. Separate tone controls. A.F.C. Pick-up and tape inputs.

AF208 £21.4.0

An AM/FM mono chassis of 5 watts output covering VHF and medium bands. An inexpensive version of the Jubilee Mk2

Post this coupon or write for catalogue or call at our showroom for full demonstration and professional advice on your installation. Open 9-5 including Saturdays.

NAME _____ PMC

ADDRESS _____

ARMSTRONG WALTERS ROAD, HOLLOWAY LONDON N.7 NORTH 3213

THE PERSONAL SET For Private Listening



An amazing little set, with built-in ferrite rod aerial bringing in medium wave at wonderful volume. Sturdy case. Size only 2 3/4" x 3 1/4" x 1". Fits into the palm of the hand. Drilled chassis colour coded for easy assembly. Total Building Costs (including earpiece)

30/- P. & P. 2/-

LISTEN TO THE WORLD on "TELSTAR" OUR EASY TO CONSTRUCT 1-VALVE SHORT-WAVE RADIO

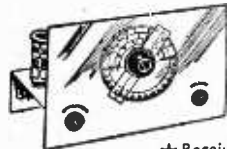

Total Building Costs

35/-
P. & P. 2/-

★ Receives speech and music from all over the world.

Construction price includes valve and one coil covering 40-100 metres. Can be extended to cover 10-100 metres. Can be converted to 2 or 3 valve. And all mains loudspeaker operation.

R.C.S. TAPE TUNER **25/-** P. & P. 1/6.

Record your favourite programmes. Variable Medium wave tuning. Triple wound Super Hi-Q coil. Chassis and components colour coded. Easily constructed. Size 3 x 1 1/4 x 1 1/4 in. All parts instructions and layout plans.

R.C.S. CRYSTAL RECEIVER

8/6 P. & P. 1/6.

Covering medium wave band. Ideal for the beginner! All components including case (suitable headphones 8/6). Easily converted to 1-transistor or 2-stage transistor receiver.

All parts available separately
Send S.A.E. for

FREE

layout plans and parts lists on any of these sets.

The new NOMBREX

TRANSISTORISED WIDE-RANGE SIGNAL GENERATOR 27 220 kc/s to 220 Mc/s

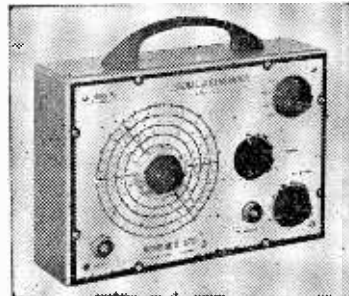

- CHECK THESE FEATURES
- COMPACT Only 6 1/2" x 4 1/2"
- PORTABLE Weight 2 lbs.
- ACCURACY! Under 2%
- ECONOMY! 9v. Battery
- DIRECT Calibration

RETAIL **£7.10.0** Post and Ins. 3/6
Battery 2/3

36" Screened Test Lead 6/3 extra
CASH WITH ORDER, REGRET NO C.O.D.

EARLY DELIVERY

Trade and Export Enquiries Invited

- S.A.E. for full technical leaflet.
- 12 Months' Guarantee.

R.C.S. PRODUCTS (RADIO) LTD
11 OLIVER ROAD, LONDON, E.17
(Mail Order Only)

NOMBREX LTD. (Instruments Division 54)
Estuary House, Camperdown Terrace, Exmouth, Devon,
England. Tel. 3515

Improvements with Scaler

The response time of the divide-by-two scaler V7 is very much shorter than that of the digital relay and is, in fact, shorter than a thousandth of a second in the here-published circuit. We may thus neglect its blockage time errors in comparison to blockage errors introduced by the much slower digital relay in the subsequent counter circuit.

The scaler itself will thus be able to count individually both members of a fast pair of pulses provided that these are at least about a thousandth of a second apart. Furthermore, as only alternate pulses are passed on from the scaler to the counter only one member of each such fast pair requires a response from the digital relay and that is now a far less stringent requirement. Only if a third pulse arrives in addition, all within the relay switching time, do we now have a blockage. Such blockages are much rarer because they now require fast triplets instead of mere fast pairs, and the former are statistically far less likely than the latter. It is very easy to understand the relative likelihood of these two events.

Triplet of Pulses

A fast triplet of pulses means that two fast pairs, in immediate succession, must take place within the switching time of the relay—i.e., each must take half the switching time on the average.

Taking our typical poor relay, to give the worst possible conditions, which had a switching time of a tenth of a second, we thus require two fast pairs of a twentieth of a second in succession if a count is to be missed during "scaling". Taking again our typical counting rate of 120 per minute (to give round figures of one count every half-second) there is "a tenth of a count every twentieth of a second" by direct proportion, which, putting it into plain words, means that the chances are *ten to one* against getting a single fast pair within a twentieth of a second.

The chances are, therefore, ten times ten to one against getting the "required" two such fast pairs in direct succession—i.e., when scaling, the digital relay will now miss only one in a hundred of the counts it is supposed to register. In other words, the counting error at 120 counts per minute, even with the assumed very poor relay, is now only 1%, whereas we had calculated it to be almost 20% under the same conditions by direct counting.

It is thus clear that *very great* benefit has been achieved by means of incorporating the scaler, much greater than the mere factor of two represented by the average frequency division. Errors at the average intended rates of counting are reduced by a factor of *not two* but about 20!

Superior Performance

Furthermore, on account of the preamplification given by V6 there is now excellent response even to pulses of slightly lower amplitude than the main pulses, so that all in all improvements in accuracy

when the binary scaler is switched into circuit are very considerable indeed. Thus, at any rate for the specified tube and head circuit, a very superior performance is to be expected.

Reasons for Direct-counting Facilities

Certainly one should normally operate with the binary scaler in circuit when using this unit with the prescribed Geiger head. The reasons should be abundantly clear from the previous paragraph. One may thus ask why a direct-counting function without the scaler has been retained also. There are several good reasons for this, all connected with universality of the unit.

Firstly it may be desired to use the unit with other heads than Geiger heads. For example, a photoelectric head to count movements on machinery by interrupting a beam of light can be fed with power from P1 equally well and send its pulses to P2. The same head can count people passing, cars passing on a road, articles passing on a conveyor belt, etc. All such uses deliver pulse sequences where fast pairs beyond the direct resolving capabilities of the relay are highly unlikely at all and thus the convenience of a continuous direct display of the total number counted are great. A suitable microphone and audio-preamplifier (which can again receive power from P1) attached to a typewriter in a suitable way can count the number of strokes per minute made, which can be useful for teaching purposes, etc. Various possible adaptations for time and motion studies will occur to those interested in that field.

Secondly, it may be desired to use the unit in conjunction with some high-voltage Geiger tubes (fed from a separate e.h.t. supply) which manifest low-voltage flimmerings between true pulses, and thus the more sensitive scaler may register a lot of unwanted spurious counts. In such cases the direct counting is the more accurate, the few flimmerings which get through also on direct counting tending to compensate the resolving limit losses. However, a type of head as discussed below in connection with Fig. 5(e) is the better solution for flimmering high-voltage tubes, the scaler then being usable again. High-voltage tubes have no great advantage over the specified low-voltage tube Mullard MX124/01 as far as the amateur is concerned, the increase of general sensitivity being in no way in proportion to the extra trouble involved with the higher voltage. The author operates also a 1.5kV tube which is barely twice as sensitive as the Mullard tube here specified. The Mullard MX124/01 is observed to give very clean definite pulses and is particularly free of small-amplitude spurious pulses.

Thirdly, the way is intended to be left open for subsequent possible use of a decimal scaler using the cathode-ray divider tube E1T from Philips. This allows only every tenth pulse to reach the counter and displays all intermediate states on a fluorescent screen and has a resolving time up to hundreds of kilocycles per second—i.e., faster than the Geiger tube itself!

It is possible to use any number of binary scaler units in cascade, to divide by any power of two

Fig. 5b-e: Possible circuit arrangements for Geiger heads (see text).

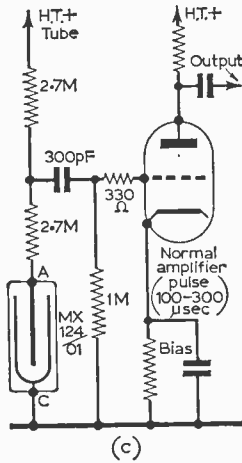
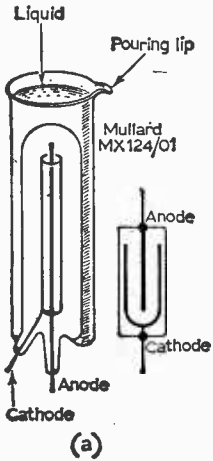

Fig. 5a (left): A section through a Geiger tube and its circuit symbol.

Fig. 5c (left).

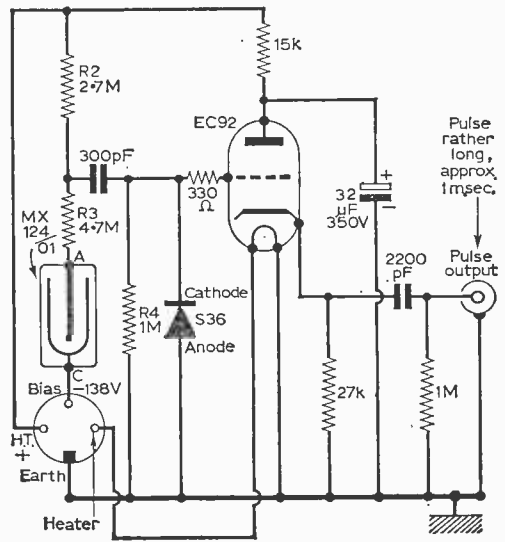

Fig. 5d (above).

Fig. 5e (below).

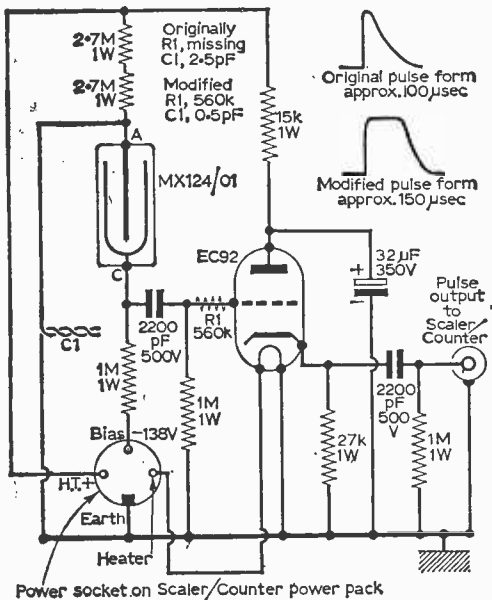
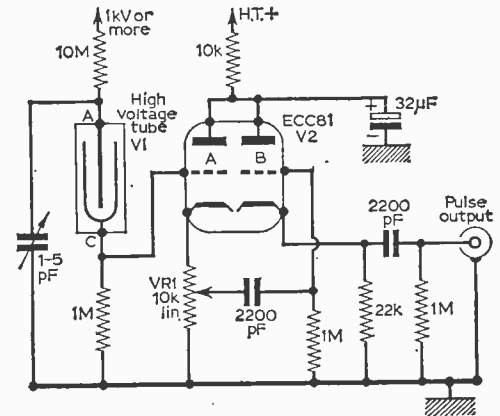

Fig. 5b: In the original form C1 (2.5pF) can be formed of 7 half-twists of 0.7mm plastic insulated tinned copper wire. In the modified form 1½ half-twists will give the correct value.



desired. Such circuits would need a buffer amplifier and negative-pulse cathode follower between each binary stage and are perfectly straightforward. However, any readers intending to go ahead with building such units to operate ahead of the present unit should not feed them from P1 as any equipment with more than 0.3A heaters and a few milliamps h.t. will seriously overload P1.

Various Geiger Heads

Since writing the original article (December, 1962) describing a Geiger head using the Mullard

PRC COMMUNICATION RECEIVERS

Manufactured by Pye and Philips. One of the Army's most versatile and sensitive sets. RF stage and 2 of I.F., using 6 British I.O. type valves. Large 180 degree illuminated and calibrated Dial. Flywheel Tuning with locking device. Aerial Trimmer, Tone and Vol. Controls. Band Switch from panel jacks for speaker or phones. In black metal case, size 17 in. L x 8 1/2 in. H x 10 1/2 in. D. Model PCR covers 6-18 Mc/s. 200-550 metres and 850-2,000 metres and has internal 6-in speaker. £8.19.6. Model PCR2 has similar L & M waveband coverage. Short wave 6-22 Mc/s, but no speaker, £5.19.8. Model PCR3, as PCR2 but has 2 short wave bands 2.7 and 7-23 Mc/s, and medium wave band 190-550 metres. ONLY 8 gns. Add 10/6 carr. all models. Designed to operate from bulky EXTERNAL power supply, but any set can be fitted with BRAND NEW COMPONENTS INTERNAL PACK for 200-250 v. A.C. at extra cost of 22.

All receivers used but excellent condition and aerial tested before despatch.

S.A.E. FOR ILLUSTRATED LEAFLET

TEST METERS FOR EVERY PURPOSE & POCKET

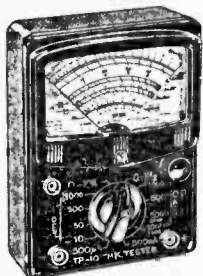

2,000 O.P.V. MODEL TP-10. Reads A.C. & D.C. Volts up to 1,000; D.C. Current to 500mA; Resistance to 1 Meg; Capacitance to 1µF; Decibels from -20 to +36; Output jack for Audio Measurements. Size 9 1/2 in. x 5 1/2 in.

£3.19.6.

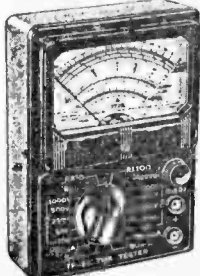

20,000 O.P.V. MODEL TP-55. Reads voltage up to 1,000 D.C. at 20,000 ohms per volt and A.C. at 10,000 o.P.V.; D.C. Current to 500mA; Resistance to 10 Megs.; Capacitance to 0.1µF; Decibels from -20 to +36. Size 9 1/2 in. x 5 1/2 in.

£5.19.6.

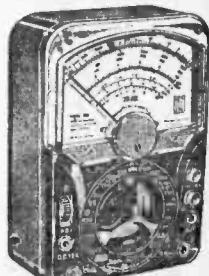

30,000 O.P.V. MODEL 500. Volts to 1,000; D.C. at 30,000 O.P.V. A.C. at 20,000; 12 Amps D.C. Current; 60 Megs Resistance; -20 to +36 Db; Internal buzzer short circuit warning. Size 3 1/2 in. x 6 1/2 in. x 2 1/2 in.

£8.19.6.

All New Stock, with leads, prods and internal batteries. 6 months' guarantee backed by full service facilities. Details S.A.E.

DOUBLE BEAM OSCILLOSCOPE TUBES, TYPE CV-1596. Equivalent to COSSOR 09D (as used in Oscilloscopes by Cossor 339 series) and Hartley & Erskine (13 series). Listed £12. BRAND NEW IN MAKER'S CRATES. ONLY 25/- (carriage 5/-).

LAVOIE UHF WAVEMETER MODEL 105. Coverage 375/725 Mc/s. Complete with correct Calibration Chart. First-class condition. Battery operated and portable, size 11 x 8 x 7 1/2 in. ONLY £3.19.6 (carriage 7/6).

HRO SENIOR TABLE MODEL RECEIVERS. Complete with 9 coil sets covering 50 Kc/s to 30 Mc/s. Used, very good condition, aerial tested. ONLY £17.10.0 (carriage, etc., 30/-). A few late Model 5T with I.O. valves, £22.10.0, plus carriage.

COMBINED VIBRATOR MAINS UNIT. The Power Pack of the Army R.107 Receiver. Has vibrator for 12 v. D.C. operation, and mains transformer for 100/250 volts A.C. Output 12.6 volts 3A L.T. and 250 v. at 100 mA H.T. Complete with vibrator, 6X5G rectifier, and connecting data. Ideal for driving T.C.S. or Type 52 Receivers, etc. or mobile equipment. BRAND NEW IN MAKER'S CARTONS ONLY 45/- (carr. 5/6).

HC21 FREQUENCY METERS. The famous American crystal controlled frequency measuring standard. Coverage 125 Kc/s - 20 Mc/s. With original Calibration Book. Perfect order. Only £16.

MINIATURE MOTORS. Ideal for models. Operates on 3-6 volts D.C. Size 1 1/2 x 1 1/2 in. plus 1/2 in. spigade. BRAND NEW 5/- or 6 for 25/-.

AVOMETER MODEL 7. Reconditioned and in perfect order with leads, internal batteries, and instructions. ONLY £11 (Reg. post 5/-).

AVOMETER MODEL 7 LEATHER CASES, fitted with carrying handle & long strap. BRAND NEW. ONLY 32/6 (post 2/6).

20/- CONSTRUCTOR'S PARCEL. Assorted colours wiring wire, solder, resistors, condensers, volume controls, tag panel. ALL NEW (Post 2/6).

RESISTORS. 100 assorted values our choice. NEW 10/-.

CONDENSERS. 100 assorted mica and silvermica. NEW 12/6.

"P.W." 6 TRANSISTOR PERSONAL RECEIVER

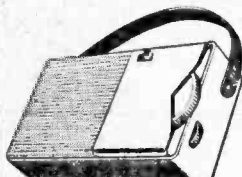

Designed by the technical staff of Practical Wireless, easy to build, using printed circuit and 1st Grade Matched Transistors and Diode. Full Medium and Long Wave coverage to internal speakers. All parts sold separately (new components only) enabling you to buy as required and full detailed price list will be sent on request. Constructional details 1/6.

Newly designed OSMOR Cabinet and reduced price. TOTAL COST INCLUDING BATTERY and CABINET NOW £7.19.6.

"P.W. TROUBADOUR 7" Parts List, S.A.E.

THE GOOD "COMPANION" Mk. II

USING TRANSFILTERS, THE LATEST MANUFACTURING TECHNIQUE TO SAVE ALIGNMENT DIFFICULTY

THE FINEST COMBINED PORTABLE AND CAR RADIO YET DESIGNED FOR THE HOME CONSTRUCTOR

★ 750 mW output.

★ 6 transistors and diode.

★ Full Medium and Long Wave coverage.

★ Quality speaker.

★ Brilliantly styled 2-tone cabinet, size 11 x 8 x 3 in.

★ Very fine tuning with calibrated dial.

★ Latest printed circuit. ★ Internal high gain aerial with car aerial socket. Easy to follow construction data (available separately 3/6). All parts sold separately and full illustrated details will be sent on request.

£9.19.6

Total Cost

With alternative luxury cabinet using 7 x 4 in. speaker, £10.19.6. Either type, plus 5/- post and ins. (Battery 3/6 extra.)

"POCKET 4" TRANSISTOR RECEIVER

Uses miniature speaker, proper tuning condenser, and volume control. Built-in aerial makes unit efficient and portable. Ideal for the beginner. Full medium wave coverage. All components and case for only 42/6 (p. & p. 2/6). Ten-page constructional book free with parts or separately 1/6. S.A.E. for parts price list.

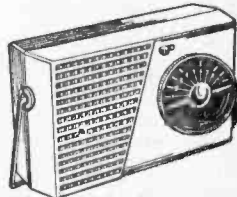

HARRIS ELECTRONICS (LONDON) LTD

138 Gray's Inn Road, London W.C.1
Phone TERMINUS 7937

Please include carriage costs on all items.
(Open until 1 p.m. Saturdays). We are 2 mins. from High Holborn (Chancery Lane Station) and 5 mins. by Bus from King's Cross.

TRANSISTOR AMPLIFIERS

1/2 WATT 3 TRANSISTOR AMPLIFIER READY BUILT



45/- Plus 1/6 P. & P.

- 1/2 w. Peak output.
- Output to 3 ohm speaker.

● Push-pull output stage. ● 9 volt operation.
A printed circuit high gain amplifier. Size 5" x 2" x 1". Three Newmarket Transistors (two NKT 251 and NKT 252). Ideal for intercom or as record player amplifier.

2 WATT 4 TRANSISTOR AMPLIFIER READY BUILT

A 2 watt 4 transistor amplifier with 2 driver and push-pull stage. Size 5" x 2" x 1 1/2". 3 ohms output, 1000 ohms input 9 volts. Battery operated.
Plus 1/6 P. & P.

62/6

Please send S.A.E. for full details of these and other transistor designs

MEL ELECTRONIC CO.

REAR OF 240 HIGH STREET
BECKENHAM, KENT

THE NEW TRANSISTOR 6 PANDORA

Designed by

Mel Electronic

USING NEW HIGH GRADE PARTS

TOTAL BUILDING COST

ONLY **£4.15.0**

p.p. 3/6



FULL AFTER SALES SERVICE

All
components
obtained
direct from
MEL
ELECTRONIC

- ★ MEDIUM WAVE & LIGHT ON LONG WAVE
- ★ 6 TRANSISTORS + DIODE
- ★ SUPERHET CIRCUIT
- ★ AUTOMATIC WAVECHANGE
- ★ 500mW PUSH-PULL OUTPUT
- ★ PRE-TINNED PRINTED BOARD
- ★ EXCELLENT RESULTS

**THE
PEMBRIDGE
COLLEGE
OF ELECTRONICS
PROVIDES TRAINING
IN RADIO
AND TELEVISION**

ATTENDING COURSE

Full-time One-Year Course in Radio and Television. College course in basic principles for prospective servicing engineers.

Next course commences 3rd September, 1963. This course is recognised by the Radio Trades Examination Board (R.T.E.B.) for the Radio and Television Servicing Certificate examinations. Provides excellent practical experience on valve and transistor radio receivers and all well-known makes of television receivers.

To:
The Pembridge College of Electronics (Dept. P11)
34a, Hereford Road, London, W.2

Please send, without obligation, details of the One-Year Course.

Name _____

Address _____

MX124/01 tube, recommended for the present register unit, the author has received criticism from the manufacturers stating that his circuit (reproduced again in Fig. 5(b), the unmodified form without R1 and with C1 in unreduced form) probably imposes too high a capacitive loading on the tube, leading to its possible early destruction. Mullards recommended the use of their own circuit, shown in Fig. 5(c) and supplied quantitative charge-per-pulse data for this circuit, showing that it causes about a hundredth of a microcoulomb to pass per pulse.

Careful measurements on the author's prototype showed that in fact this amount is with certainty also not exceeded in his circuit. The total intentional and stray capacity across the tube in the original circuit, with unreduced C1, was measured as just under 7pF, and assuming that the maximum tube voltage of 470 volts is used, and that the tube capacity is fully discharged on each pulse, only about a third of the charge per pulse stated by the manufacturers results from this source. A further source of pulse charge is by direct arrival through the two 2.7M Ω tube anode resistors, and assuming (worst conceivable conditions) that the tube represents a dead short during its ionisation time (about 100 micro-seconds), about two-thirds to one hundredth of a microcoulomb can arrive, at the very most, on this way per pulse. The total is thus at the most just about the same as for the other circuit from Mullards.

The only other factor possible is excessive initial surge current through the tube when this ionises if the capacity across it is too high. However, Mullards also speak of using a circuit where the 300pF coupling capacitor to the amplifier grid is connected straight to the tube anode, which results in a measured total tube capacity of anything up to 10pF, at any rate higher than in the author's original circuit.

Thus there seems to be no valid reason against using the author's circuit with its particular advantages for the amateur, and this has proved itself during long usage.

The inclusion of R1 and reduction of C1 to the smallest value still giving a satisfactory signal output in the circuit of Fig. 5(b) brought negligible improvement of the capacitive loading of the tube, the total measured tube capacity falling thereby from about 7pF to about 5.5pF. However, the change in pulseform is useful. It is of no interest for the present unit with its binary scaler but the modified pulseform is ideal for operating the cathode-ray decimal scaler and might possibly save the need for interposing a shaper.

The fact that the author's circuit of Fig. 5(b) uses nothing whatsoever connected to the tube anode circuit leads to unusually low anode loading and thus the outwardly disturbing feature is the need to augment this loading very slightly to get a proper signal at the cathode, as explained in the original article. The actual final loading does not appear to differ greatly from the Mullard circuit and from the point of view of tube life it would seem to be immaterial which circuit is used.

The Mullard Circuit of Fig. 5(c)

Those constructors wishing to use the Mullard circuit of Fig. 5(c) must employ the minor modifi-

cations of detail then necessary to enable operation from the power supplies as available at P1 of the unit described in this article and to reverse the polarity. The Mullard circuit as it stands gives negative pulses, whereas we require positive ones.

There are basically two ways of making these adaptations. The amplifier and tube h.t. feeds may be commoned and the tube cathode taken to the negative bias. The pulse at the amplifier anode is inverted and thus positive, therefore may be used to operate the cathode follower, which can be the second section of a double triode.

Fig. 5(d) shows another arrangement worth considering which makes do with only one triode. This receives a positive signal at its grid from the negative pulse from the tube, inverted by the overswing action of the fast silicon diode S36. The triode may thus be made the cathode follower directly. A disadvantage of this circuit is its great lengthening of the pulse.

Whatever type of head circuit is used the final stage *must* be a positive-pulse cathode follower. Any other stage with higher output impedance will not be satisfactory as the losses along the cable from the head to the register will be too high and the input circuit of V8 on direct counting would cause too high a loading, causing the signal to collapse.

It would thus seem that the original circuit of Fig. 5(b) is definitely the simplest and most recommendable for amateur usage with the register unit described in this article, whereas the Mullard circuit has possible scientific laboratory advantages where highest resolution is essential.

Gain Control

A final word about the use of high-voltage tubes. To avoid disturbance from spurious extra counts from the low-voltage flimmerings sometimes found in such tubes a gain control on the head is desirable. Fig. 5(e) shows the best way of introducing such a control, situated between two cathode followers in cascade. This is the only possible method of preserving the necessary constant low output impedance at all settings of the gain control. In using such a head the gain control VRI should be set such that flimmer-amplitudes do not operate the binary scaler, yet all proper pulses are registered. Initial setting with a new tube is easily possible by observation on an oscilloscope.

It is definitely not permissible to use a potentiometer gain control in the grid circuit of a cathode follower here as this imposes excessive capacitive loading.

Operational Stability of the Scaler

One must very carefully make certain that the scaler really does pass on *every second* pulse and not every pulse or a few of the forbidden ones in addition. Critical conditions can result as the input amplitude is reduced to a level at which V7 ceases to give proper response. This will correspond to voltage levels from the Geiger head about a fifth as large as the "normal" pulses with the

here-specified equipment. Particularly troublesome can be the high-voltage Argon tubes, which have quite a lot of spurious pulses of about this amplitude and can give rise to a number of curious effects in an improperly adjusted scaler.

As the input pulse amplitude is reduced there comes a point where the scaler V7 ceases to trip over and counting stops altogether. There is then the possibility of pulses reaching the digital counter input V8 direct through via V6, C13, C14, C15. The polarity is, of course, correct, and if the remaining amplitude getting through is sufficient the apparatus will start counting every pulse at this point *in spite of* being switched to scaling.

There are two parts to this question, firstly whether such direct through pulses can get through *at all*. They certainly *cannot* get through if the last proper pulse left V7 resting with the section on pins 1, 2, 3 conducting because the very low anode impedance of this heavily-conducting section then shorts the junction of C14 and C15 to chassis. However, if the last proper pulse left V7 resting the other way, with pins 6, 7, 8 conducting and 1, 2, 3 cut-off, there is nothing to stop pulses getting direct through to V8 from V6.

As long as the amplitude is sufficient for V7 to respond properly, the anode responses, by feedback over C16 and C18, fully neutralise any such direct-through pulses so that division is then certainly correct. When the amplitude of the input has been reduced to the point where V7 does not trip over any more its section on pins 6, 7, 8 still gives anode pulses, only these are now of insufficient amplitude to cut-on the other section. However, they are certainly still sufficient to neutralise the would-be straight-through pulses by compensating feedback over C16 and C18. Thus, even in this "dangerous" state, counting of every pulse does not take place immediately scaling ceases. There is a span of amplitudes for which no response at all results. The lower limit of this is when the amplitude is so low that positive kicks at V7 pin 6 cease also. Then, finally (but, as said, only if the resting state of V7 is with conduction at pin 6), pulses can go straight through to V8 from V6 and will cause every pulse to be counted if still of sufficient amplitude to operate the digital counter.

The simple remedy for this is to make certain that pulses of insufficient amplitude to operate V7 properly are then also with certainty of insufficient amplitude to operate V8 under any circumstances. This condition should be satisfied in Fig. 1 as published, in many cases, and is favoured by using as high-bias a setting of VR2 as possible during scaling.

However, as the direct-through amplitude is very greatly dependent on the pulse-shape from the Geiger head, trouble may be found and should be checked by using a variable-amplitude circuit such as in Fig. 5(e), checking whether at any setting of VR1 of that figure the "all-pulses counting" can be induced. If this is possible for suitable low input pulse amplitudes when the bias control VR2 is set at low bias then that should be ignored, but if it is possible at middle or high bias then a voltage-divider is necessary between C15 and R36.

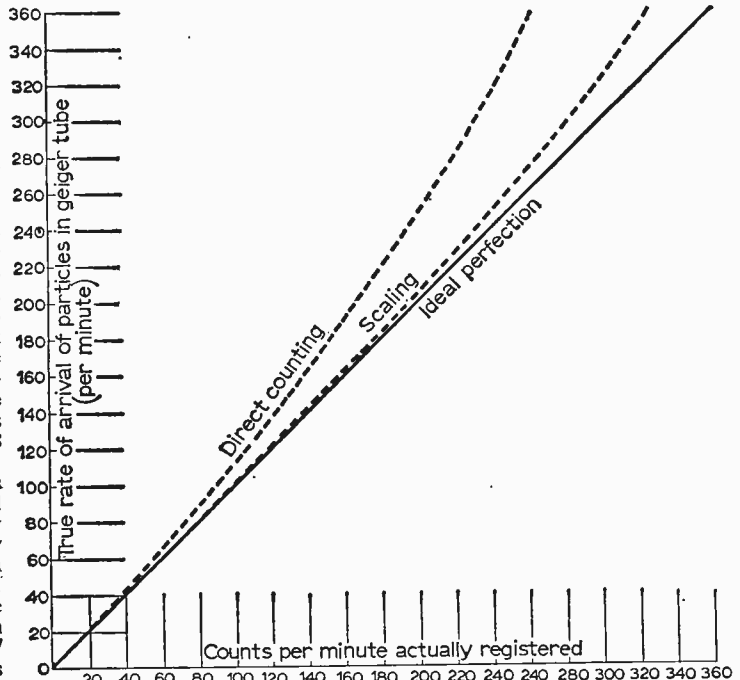

Fig. 6: Simple counting error due to switching time required by digital relay is shown in this graph, for various counting speeds. The increasing effect of this error in direct counting at high speeds is compared with the improvement upon scaling and the would-be state of perfection.

A suitable arrangement suggested for this is to reduce R36 to 68k 1 watt and wire a 470k 1 watt resistor in series from C15 to the junction of R35 and R36. It is probably of no disadvantage to incorporate this modification right from the start as experiment seems to indicate no interference whatsoever with normal performance thereby.

Arithmetical Correction for Errors

The counting deficiencies resulting from relay switching time and scaler switching time may be subsequently allowed for by using the typical graph of Fig. 6, compiled by calculation and fully confirmed by experiment, for the prototype. It is based on a switching time of 0.06 seconds as observed for the relay in the prototype. This may be taken as quite typical and even if not absolutely accurate for some other relays will certainly give improvements in the final results if used.

Just a few of our BARGAINS

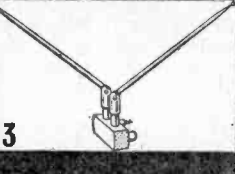
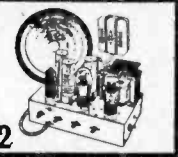
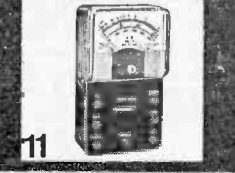
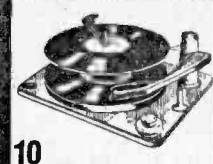
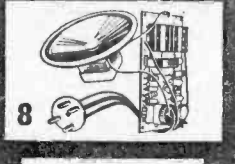
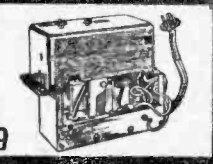
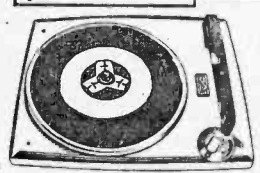
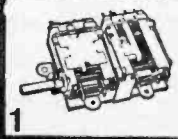

RADIO & T.V. COMPONENTS [ACTON] LIMITED

1. **A.M. F.M. PERMEABILITY TUNER FOR ALL TRANSISTOR OPERATION.** Size 2 1/2 x 2 1/2 in. approx. By famous manufacturer. A.M.-1.F. 470Kc/s. F.M.-1.F. 10.7Mc/s. A.M. coverage from 1.620kc/s-525Kc/s. F.M. coverage 108Mc/s-88Mc/s. Circuit diagram 2/6, FREE with Tuner. 25/-, plus 1/- P. & P.
2. **TRANSISTORISED POCKET RADIO** with printed circuit, mini-caps, high gain ferrox slab aerial. No aerial or earth required. To build yourself for completely personal listening. 4 1/2 x 3 1/2 x 1 1/2 in. Luxembourg in favourable areas. Only 21/-. P. & P. 2/6. All parts available separately.
3. **A.C./D.C. POCKET MULTI-METER KIT.** 2in. moving coil meter scale, calibrated in A.C./D.C. volts, ohms and milliamps. Voltage range A.C./D.C. 0-50.0-100. 0-250. 0-500. Millamps 0-10. 0-1000 Ohms ranges 0-10,000. 0-100,000, 10/6. P. & P. 2/-. Wiring diagram, 1/-, free with parts.
4. **SIGNAL GENERATORS.** Cast £7.5.0, or 30/- deposit and 6 monthly payments of 21/8. P. & P. 5/8. Coverage 100 kc/s to 100 Mc/s on fundamentals and 100 Mc/s to 200 Mc/s on harmonics. Case 10 x 6 1/2 x 5 1/2 in. Three miniature valves and Metal Rectifier. A.C. mains 200/250v. Internal modulation of 400 c.p.s. to a depth of 50 per cent. Modulated or unmodulated R.F. output continuously variable 100 millivolts. C.W. and mod. switch, variable A.F. output. Magic eye as output indicator. Accuracy 2 per cent.
5. **SIGNAL GENERATORS.** Cash £5.5.0. P. & P. 5/8. Coverage 120 kc/s to 84 Mc/s. Case 10 x 6 1/2 x 4 1/2 in. Size of scale 6 1/2 x 3 1/2 in. 2 valves and rectifier. A.C. mains 230-250 v. Internal modulation of 400 c.p.s. to a depth of 30 per cent, modulated or unmodulated R.F. output continuously variable 100 millivolts. C.W. and mod. switch variable A.F. output and moving coil output meter. Accuracy ± 2 per cent.
6. **STAAR 45. 9 v. BATTERY RECORD PLAYER** complete with pick-up and deck. A completely portable player. Head protected by plastic dome with a brush which cleans the stylus as it rises into playing position. 45 r.p.m. Auto on/off switch governed motor, attractive two tone grey finish. £29.6. P. & P. 2/-.
7. **CARRYING CASE FOR STAAR 45 or COMPLETE KIT** beautifully styled in two tone with record compartment. Specially designed to take player and amplifier. Just screw in and connect up. All parts available separately. Case only £2/6. P. & P. 4/- Complete kit £5.10.0. P. & P. 5/-.
8. **TRANSISTORISED AMPLIFIER,** suitable STAAR 45. Output 1 watt. Size 4 1/2 x 2 1/2 in. Printed circuit, tone/volume controls plus 4 transistors. Push-pull output complete with 3in. moving coil speaker. Built and tested, 40/6. P. & P. 2/-.
9. **CHANNEL TUNER 1.F.** 16-19 Mc/s. Continuously tunable from 174-218 Mc/s. Valves required—PCF89 and PCO84 (in series) Cover BBC and ITA ranges. Also Polloc, Fire and Taxis, etc. Brand new by famous maker, 10/-. P. & P. 3/-.
10. **B.S.E. MONARCH UA14 WITH FUL-PI HEAD.** 4-speed, plays 10 records, 12in., 10in. or 7in. at 16, 33, 45 or 78 r.p.m. Intermixes 7in., 10in. and 12in. records of the same speed. Has manual play position; colour brown. Dimensions: 12 1/2 x 10 1/2 in. Space required above baseboard 4 1/2 in. below baseboard 2 1/2 in. Fitted with Ful-PI turnover crystal head, £5.19.6. P. & P. 5/6.
11. **POCKET MULTI-METER.** Size 3 1/2 x 2 1/2 x 1 1/2 in. Meter size 2 1/2 x 1 1/2 in. Sensitivity 1,000 O.P.V. on both A.C. and D.C. A.C. and D.C. volts 0-15. 0-150. 0-1,000. D.C. current 0-100 mA. Resistance 0-100K Ω Complete with test prods, battery and full instructions, 26/-. Plus 1/6 P. & P.
12. **8-watt PUSH-PULL 4 VALVE AMPLIFIER plus METAL RECTIFIER** A.C. mains 200-250 v. Size 10 1/2 x 6 1/2 x 2 1/2 in. 5 valves. For use with all makes and types of pick-up and mike. Negative feed back. Two input, mike and gram, and controls for same. Separate controls for Bass and Treble lift. Response flat from 40 cycles to 15 kc/s. 2 dB down to 20 kc/s. Output 8 watts at 5 per cent total distortion. Noise level 40 dB down all burn. Output transformer tapped for 3 and 15 ohms speech coils. For use with 8Ω or L.F. records, musical instruments such as guitars, etc. Suitable for small halls, £3.19.6. P. & P. 6/-. Crystal mike to suit 15/- . P. & P. 2/-. 8in. P.M. Speaker to suit, 12/6. P. & P. 2/-.
13. **INDOOR AERIAL for ITV/BBC/FM.** Complete with standard co-axial plug. Heavy chrome extending dipole—7ft. fully extended. Plug straight into T.V. or VHF Tuner. Fully directional, 10/6. P. & P. 1/8.
14. **NO MORE FLAT BATTERIES.** Charge your own battery overnight with this wonderful little charger. Output 4 and 12 volts. 5 amp. Input 200-250 v. A.C. mains. Mains fuse incorporated. Attractive silver hammer finished case, 6 x 3 x 3 in. Complete with leads and battery clips only 21/-. P. & P. 3/6.

**21b HIGH STREET
ACTON, LONDON, W.3.**
ALL ENQUIRIES S.A.E.
GOODS NOT DESPATCHED OUTSIDE U.K.

THE LINEAR L1/10

A 10-WATT HIGH FIDELITY ULTRA LINEAR AMPLIFIER WITH INTEGRAL PRE-AMP

Full advantage has been taken of latest component miniaturisation developments to produce a 10-watt Hi-Fi push-pull amplifier incorporating tone control pre-amplifier stages within the measurements of 9 x 7 x 5ins. In addition two high impedance input sockets are provided for microphone and gram., etc. With selector switch and vol. control, five B.V.A. valves are employed ECC83, ECC83, EL84, EL84, EZ81, H.T. and L.T. power supply point is included for a radio tuner.

FREQUENCY RESPONSE

1 d.b., 30-20,000 c.p.s.

MAXIMUM POWER OUTPUT

in excess of 14 watts.

SENSITIVITY

L.P. 220 .mv. for 10 watts. 78 r.p.m. 220

m.v. for 10 watts. Radio/Microphone 40

m.v. for 10 watts.

TREBLE LIFT CONTROL

+ 10 d.b. to -22 d.b. at 12,000 c.p.s.

BASS CONTROL

+ 14 d.b. to -10 d.b. at 50 c.p.s.

HUM LEVEL

Referred to maximum output and including integral pre-amp.—70 d.b.

NEGATIVE FEEDBACK

21 d.b. in main loop.



HARMONIC DISTORTION Less than 0.1% measured at 8 watts at 1000 c.p.s. Weight 10 lbs. Power consumption 90 watts. For 200-230-250 v. 50 c.p.s. A.C. mains. Outputs for 3-and 15-ohm speakers. Chassis finish stoved Gold hammer.

HIGHEST QUALITY Retail Price
MAXIMUM RELIABILITY **13**
AT A PRICE YOU CAN **GNS.**
AFFORD

Send S.A.E. for descriptive literature

Also Available—THE L.45.A compact High Quality 4.5 watt amplifier. Size approx. 7.5-5.2in. high. Sensitivity is 28 millivolts so that the input socket can be used for either microphone or gram., tape, radio tuner etc. B.V.A. valves used are ECC83, EL84, EZ80. Controls are: Vol. Treble and Bass with mains switch. The Tone controls provide full compensation for long playing records. Output matching for 3 ohm loudspeaker. Retail price £5.19h.

THE LT45 TAPE DECK AMPLIFIER. A complete unit (power pack and oscillator incorporated) ready for connection to A.C. mains. 3 ohm loud-

speaker and practically any make of deck. Negative feedback equalisation adjustment by multi-position switch for 1, 2, 3 and 7 1/2 in. per second. Retail price 12 gns.

DIATONIC 10-14 WATT. High Fidelity amplifier with integral pre-amplifier. Retail 12 gns.

CONCHORD 30 WATT. Hi-Fi amplifier with two separately controlled inputs. Retail 16 gns.

L50 50 WATT AMPLIFIER. Size approximately 14 x 10 x 8in. Sensitivity 25 mV. Output for 3 and 15 Ω speakers. Retail price 22 gns.

L55 STEREO AMPLIFIER 5 x 5 watt 12 gns.

TRADE ENQUIRIES to

LINEAR PRODUCTS LTD.

ELECTRON WORKS, ARMLEY LEEDS

READY BUILT—READY TO GO

Listen in comfort, to your favourite stars without annoying others with

"PERSONAL TRANSISTOR POCKET PORTABLE"

Designed exclusively for personal use and supplied complete with miniature earpiece and battery. Works anywhere, any time—our special circuit with built in ferrite rod aerial ensures wonderful reception over the full medium wave band. B.B.C. Home, Light, Luxembourg and many continental stations. Completely portable, compact size, only 2 1/2 x 3 1/2 x 1/2 in., slips into pocket. NO EXTERNAL AERIAL OR EARTH REQUIRED. Condenser tuning and with "exclusive" separate fine tuning control for "spot on" station selection. Complete station separation makes this ideal for use as Tape Jack for recording or tuner unit for amplifier.

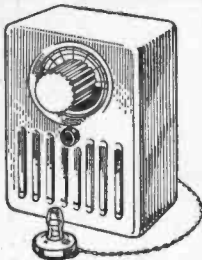

PRICE 45/- P. & P. 2/-.
fully complete including earpiece and battery.

COMMANDER IV CRYSTAL SET

Covers the full medium wave band and ideal for use in Bedroom, etc. Requires NO batteries—lasts for ever. Operates with miniature personal earpiece. Attractive case and dial—a Radio set in miniature.

PRICE 15/- P. & P. 2/-.
complete with personal earpiece and fully guaranteed.

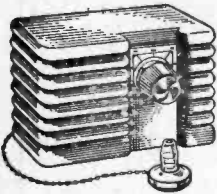

Transradio

II, OLIVER ROAD, LONDON, E17

EXPRESS ELECTRONICS ROSEDENE LABORATORIES KINGSWOOD WAY, SELSDON, SURREY

VALVES NEW TESTED AND GUARANTEED FOR THREE MONTHS

101	7/8	6BB6	5/9	12AX7	6/9	DH77	6/-	EF91	4/-	PL82	7/-
103	8/-	6BJ6	5/9	12BE6	8/8	DH142	8/8	EF92	5/8	PL83	7/8
1F1	8/-	6BR7	8/9	12BH7	10/8	DH150	10/-	EL41	9/8	PY81	6/9
1FD1	7/8	6BW6	6/8	12K5GT11-	DK91	7/8	EL44	7/-	PY82	7/8	
1FD9	7/8	6D3	4/-	12Q7GT	6/8	DL96	8/-	EM84	10/-	PY83	7/8
1P1	5/-	6F12	4/-	16A5	9/8	DL94	6/8	EY61	7/8	85A1	9/8
1P10	7/8	6H6GT	2/-	19AQ5	9/8	DL96	8/-	EY81	10/-	U32	7/8
1P11	7/8	6J7GT	7/8	25A6G	7/8	EH91	4/-	EZ40	7/8	U78	7/8
1R5	6/-	6K7G	5/8	25L6GT	7/8	EBC41	10/-	EZ80	6/-	U78	5/-
1R5	6/-	6K9G	6/-	25Z4G	9/-	EBP80	6/8	EZ81	6/8	U142	7/8
1Y4	2/9	6Q7G	5/8	30C1	7/8	ECC81	6/-	HVR2	9/8	UBC41	8/8
1U5	5/8	68L7GT	6/-	30L1	7/8	ECC82	6/8	KT33C	6/-	UCH42	8/8
3Q4	8/-	68N7GT	6/-	35L6GT	7/8	ECC83	6/8	KT86	11/8	UF41	8/8
3A4	5/8	6V6G	7/8	35W4	8/8	ECC84	7/8	N17	5/9	UL41	8/8
3V4	6/8	6X4	5/-	35Z4GT	8/-	ECP80	8/8	N18	9/-	UY41	7/8
6Y3GT	8/-	6X5G	5/8	5B3	7/8	ECP82	8/8	N19	7/8	W17	7/8
5Z4G	7/8	787	9/8	80	6/-	ECH42	9/-	PC09	7/8	W78	4/8
6A6G	6/8	8D3	4/-	DAF91	7/8	ECH81	10/-	P0C83	7/8	W142	8/8
6AL5	4/-	9D7	9/8	DAF96	8/-	ECL80	8/8	PCP80	7/8	X17	7/8
6AM6	4/-	12AD6	11/8	DCX90	12/8	ECL82	9/-	PCP82	7/8	X17	8/-
6AT5	6/-	12AK5	10/-	DP91	6/-	EP41	9/-	PCL82	8/-	X150	8/-
6BA6	6/-	12AT7	6/-	DP96	8/-	EP80	8/-	PCL84	9/-	Z77	4/-
6BE6	7/8	12AU7	6/8	DR76	7/8	EP86	9/-	PL81	12/8	ZD17	7/8

High Stability Resistors 1W 5% 50 Ω to 1M, 9d. Midget Ceramics 500 v. 9d. Coax. Super quality 1in. 9d. 7 1/2. Pugs 9d. Sockets 9d. Silicon H.T. Rects. 250v. 300 MA 1in. 7 1/2. 8/8. Contact Cooled 250v. 50 MA 6/8. 85 MA 9/8.

NEW TRANSISTORS by MULLARD. OC19, OC26, OC66, 2S/-; OC44, OC45, 9/-; OC70, OC71, 6/-; OC73, 7/8; OC72 matched in pairs. 18/-; OC74, OC75, OC78, OC81, 7/8; OC82, OC170, 9/8.

VALVES MATCHED IN PAIRS

EL34 27/8, EL84 15/-, N709 15/-, 6V6G 15/-, 6BW6 14/- per pair. Push Pull O.P. Transformer for above 3 15 Ω 14/6. P. & F. 12in. P.M. Speakers 3 Ω 24/6. Baker's "Selhurst" 12in. 15 Ω 15W, 80/- 12in. Stereo Model £7.70.

SETS OF VALVES

DK91, DP91, DAF91, DL92 or DL94, 18/6	ECH42, EF41, EBC41, 27/6
DK96, DP96, DAF96, DL96, 27/6	EL41, EZ40, 37/8
1C3, 1F1, 1FD1, 1P1, 27/8	UCH42, UF41, UBC41, 19/8
1R5, 1T4, 185, 384, or 3V4, 19/8	UL41, UY41, 35/-

Postage and packing 6d. Over £1 post free. C.O.D. 4/-

MINIATURE AMPLIFIERS

for beginners to construct

By C. Marshall

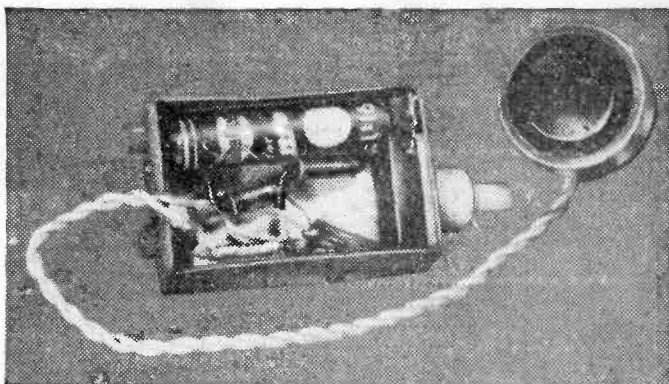

One of the author's amplifiers

THE basic circuit is shown in Fig. 1 and is a two-transistor, direct-coupled amplifier, using an absolute minimum of components.

R1 supplies the bias current for Tr1 and the collector-emitter current of Tr1 provides bias for Tr2. Any change in base current of Tr1 is amplified and applied to the base of Tr2, where it is again amplified. The two collector currents vary in phase and this causes a current change through the battery. This current gain is changed to voltage gain in the earphone connected across the output terminals. The current gain of the amplifier is the product of the current gains of the individual transistors.

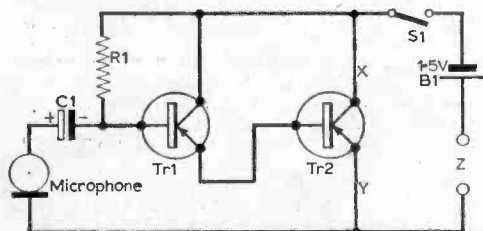

Fig. 1: A simple amplifier circuit.

The output may be taken from any of the points X, Y or Z. The output from X has the disadvantage that neither side is at earth potential, whilst the output at Y is at rather low volume and so the output at Z was chosen.

The capacitor C1 is needed when the microphone was a d.c. resistance of less than 25,000Ω. With crystal microphones C1 is not needed but otherwise the circuit remains the same.

With the pre-amplifier, as shown in Fig. 3, R2 replaces the earphone and the output is taken via the capacitor C2. The volume control is in the two-way intercom circuit only as space was available—it could quite well be excluded.

Transistors

These circuits will work well with almost any transistors, "surplus" types working perfectly well. All transistors have a maximum working

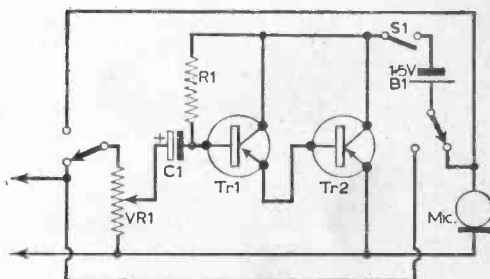

Fig. 2: An intercom amplifier circuit.

voltage which varies from type to type. Here they are tabulated for easy reference.

Spot	Maximum Voltage	Voltage Used
Green	3	1½
Yellow	6	4½
Red	12	9
Branded	25 (app.)	18

With some transistors the bias resistor R1 may have to be changed, but this is discussed more fully later.

Capacitors

C1 is the base blocking capacitor. Its value is not in any way critical. In the prototype an 8μF electrolytic capacitor was used and values down to 1μF give good quality. A 0.1μF was tried, but understandably resulted in a reduction of quality.

The capacitor C2 is to give d.c. blocking to the amplifier. For feeding a valve amplifier it should be 0.01μF and rated at 500V with high insulation

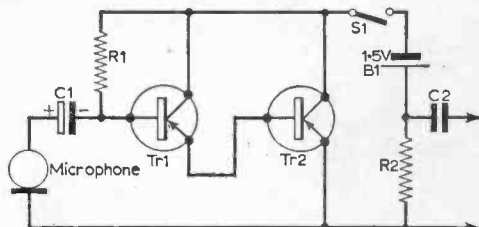

Fig. 3: A simple pre-amplifier.

for complete safety. When feeding a transistor amplifier C2 should be an 8 μ F of 15V working, but the exact value is not critical.

Resistors

R1 in Figs. 1 and 2 is about 220k Ω with a 1.5V battery. The collector current of Tr2 should be measured and, if necessary, altered by changing the bias resistor. The current required depends on the impedance of the earphone. Here is a table for different impedances of earphone:

Impedance	Current
100 Ω	5mA
250 Ω	2mA
500 Ω	1mA
1,000 Ω	0.75mA

The pre-amplifier current should be about 0.5mA. R2 has a value of 1k Ω , this value giving good volume yet leaving 1V across the transistor. The volume control is about 50k Ω .

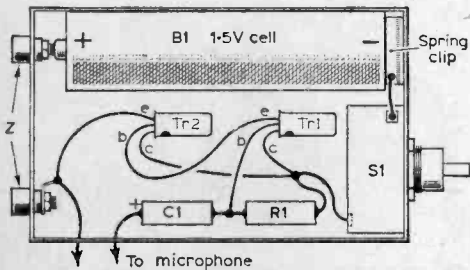
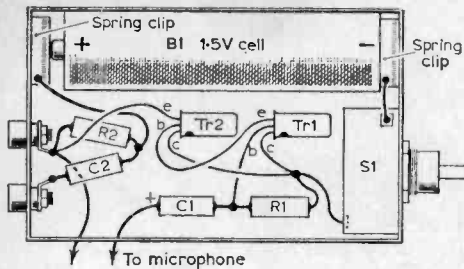

Fig. 4 (above): The wiring diagram of Fig. 1.

Fig. 5 (below): The pre-amplifier wiring diagram.



Earphone

The earphone used in the prototype was the normal single earpiece type with a d.c. resistance of 100 Ω . Earphones with a d.c. resistance of more than 1,000 Ω are not suitable for these circuits. Values of R1 are given for a 100 Ω earpiece and must be changed for other resistances. Low impedance headphones may be used if they are more convenient. A single earphone may also be used as a microphone.

Construction

The circuits in Figs. 1 and 3 are constructed in a standard size matchbox and these will be dealt with first. The exact position of the components will depend on the individual components used, but the general layout is shown in Figs. 4 and 5. A U16 1.5V battery was used because it is of the

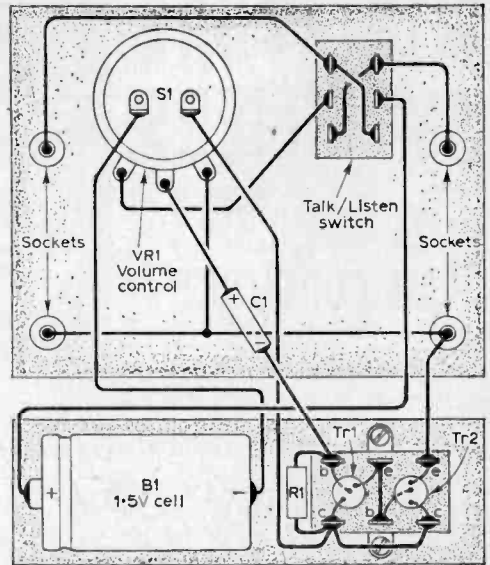

Fig. 6: The component layout of the intercom.

ideal size for fitting in the matchbox.

First the tray should be accurately marked where the holes are to be cut, two $\frac{1}{8}$ in. holes for the sockets and one $\frac{1}{4}$ in. hole for the switch. A piece of softwood should then be cut so that it just fits into the end of the tray. The holes may then be carefully drilled. Twist bits only should be used and the drill must only be turned slowly or the wood will split.

The battery contacts should now be prepared. For the one-way amplifier one of the sockets should have its tag bent at right-angles and tinned to make good contact.

For the pre-amplifier a piece of tin should be bent to form the positive contact. A similar piece of tin forms the negative contact in both cases. The two wires to the switch should be connected and the switch fastened into position.

The wiring of the small components should be followed from Figs. 4 and 5. The transistor leads should always be provided with a heat sink whilst soldering.

The two-way intercom amplifier is built on to a small panel, the switch, volume control and sockets being fastened to the front panel, the amplifier constructed on a three-way tag board fastened to the base. The U2 battery is held in place by a small rubber band. The wiring is shown in an expanded form in Fig. 6. The on/off switch is incorporated on the volume control.

When using the intercom the two earphones should be identical or too much current may flow one way and too little the other. In the author's prototype the front panel was $3\frac{1}{4}$ in. by 4in. and the base 1 $\frac{1}{2}$ in. by 4in.

The U2 battery will have a very long life in this circuit and it is most convenient to solder the leads directly to the battery.

In conclusion, a word of warning, especially for beginners—take care to connect all the transistors, capacitors and batteries the correct way round. ■

RETURN-OF-POST SERVICE

We offer a really efficient Mail Order Service on all items stocked. All cash orders are dealt with on the day of receipt. ★ Hire purchase orders are subject to slight delay but this is kept to the absolute minimum.

ILLUSTRATED LISTS

Illustrated lists are available on LOUDSPEAKERS, TAPE DECKS, TEST GEAR, GRAMOPHONE EQUIPMENT, AMPLIFIERS. Any will be sent free upon request.

STEREO COMPONENTS

Morganite ganged potentiometers as specified for the Mullard circuits. ★ Log/Anti-Log, 500k. 1 meg., 2 meg. ★ Log/Log, 50k, 250k, 1 meg., 2 meg. ★ Lin/Lin 250k, 500k, 1 meg. All 10/6 each.

TRANSISTORS

MULLARD. Current production types, not rejects. All in makers' boxes. Postage 3d. on each.
OC4, 9/8; OC45, 9/-; OC70 and OC71, 6/6; OC72, 8/-; OC72 Matched Pairs, 16/-; OC78, 9/-; OC81, 8/-; OC170, 9/6; OC171, 10/6.

AMPLIFIER KITS

We have full stocks of all components for the Mullard 510, Mullard 3-3, Mullard 2 and 3 Valve Pre-amp, Mullard Stereo, Mullard Mixer, GEC 912 Plus. Fully detailed list on any of these sent upon request.

Instructional Manuals: All Mullard Audio Circuits in "Circuits for Audio Amplifiers", 9/5. GEC912, 4/6. All post free.

TRANSISTORISE YOUR CRYSTAL SET

We have two new designs for Transistor amplifiers which can be used to greatly improve the signal from any crystal set. RLD4 Kit, one stage 12/-; RLD5 Kit, two stage 21/-; both post free. The kits are easy to build and very detailed instructions are supplied. Leaflet available.

CLOSE TOLERANCE CONDENSERS

Radio spares first grade Silver Mica. Tolerance—up to 30pf. ±1 pf. 47pf. up to 1%, 4.7, 10, 15, 18, 22, 27, 33, 39, 47, 50, 55, 68, 75, 82, 100, 120, 150, 180, 200, 220, 250, 270, 300pf. All 9/1 each.
330, 390, 470, 500, 550, 680, 800pf. All 1/- each.
1000, 1500, 1800, 2200, 2700, 3600, 4700, 5000pf. All 1/9 each. Postage extra.

RESISTORS

All preferred values from 10 ohms to 10 meg. ½ watt rating. List of values available.
Carbon. Size ¼ x 7/16 in. 10% tol. 5d. each.
High Stability. Size ¼ x 7/16 in. 5% tol. 9d. each.

Miniature Wire Wound, 5 watt, 5% tol. Size ¼ x 1/8 in. 15, 25, 30, 39, 50, 68, 75, 100, 125, 150, 180, 200, 220, 250, 270, 300, 350, 400, 470, 680, 750, 820 ohms. 1k., 1.2k., 1.5k., 1.8k., 2k., 2.2k., 2.7k., 3k., 3.3k., 3.9k., 4.7k., 5.6k., 6.8k., 8.2k. All 1/9 each. Postage extra on all above.

NEW MULLARD CONDENSERS

Mullard Miniature Foil and Polyester condensers as used in the latest TV and Transistor sets.

Miniature Foil, 30 volt working for Transistor sets. .01mfd 74/-; .022mfd, 9d.; .047mfd, 9d.; .1mfd, 11d.
Polyester Tubular Capacitors. Moulded outer case designed to withstand accidental contact with the soldering iron. Tolerance 10%. 125v. range: .01mfd, .022mfd, .047mfd, all 9d. each. .1mfd, 1/2; .22mfd, 1/3; .47mfd, 1/6; 1mfd, 3/-; 400v. range: .001mfd, .0022mfd, .0047mfd, .01mfd, .022mfd, all 9d. each. .047mfd, 1/2, .1mfd, 1/3, .22mfd, 1/6, .47mfd, 2/5. Postage extra.

MINIATURE ELECTROLYTIC CONDENSERS

Latest miniature types by Mullard and Radiospares.

RADIOSPARES. All 15 volt. 2mfd, 4mfd, 5mfd, 8mfd, 10mfd, 16mfd, 32mfd, 50mfd, 100mfd, all 2/3 each. Postage extra.

MULLARD. 2mfd, 10v, 1/10; 4mfd, 4v, 1/8; 10mfd, 16v, 1/8; 16mfd, 10v, 1/8; 25mfd, 4v, 1/8; 25mfd, 25v, 1/3; 32mfd, 40v, 1/8; 32mfd, 40v, 1/8.

TAPE RECORDING EQUIPMENT

TAPE DECKS

ALL CARRIAGE FREE Cash Price Deposit Hire Purchase Mthly/Pmts

COLLARO STUDIO. Latest model. Two track. Bradmatic Heads £10.19.6 £2. 3.6 12 of 16/4

Four Track, Marriott Hds. £17.17.0 £3.12.0 12 of 26/2

BSR TD2, Two Track £8.19.6 £1.16.6 12 of 13/7

Four Track £14.14.0 £2.18.0 12 of 21/8

MARTIN TAPE AMPLIFIER KITS

Tape Amplifiers For Collaro Deck 8311-V 2-Track £11.11.0 8311-4 V 4-Track £12.12.0

For BSR Deck 8312-M 2-Track £8. 8.0 8312-4 M 4-Track £8. 8.0

Tape Pre-Amplifiers For Collaro Deck 8312-CP 2-Track £8. 8.0 8312-4-CP 4-Track £8. 8.0

Drop through assembly for mounting 8312 Pre-Amp under Collaro Deck, £1.11.6

Carrying Cases fitted with speaker. For Collaro Studio Deck and 8311 Amplifier, £5.5.0.

For BSR TD2 Deck and 8312 Amplifier, £4.4.0.

H.P. TERMS AVAILABLE on decks, amplifiers and cases. Ask for quotation.

MULLARD TAPE PRE-AMPLIFIER KIT We stock complete kits and all separate components for the Mullard Tape Pre-Amplifier. Fully detailed list available.

* TERMS OF BUSINESS

Cash with order or C.O.D. We charge C.O.D. orders as follows: Up to £3, minimum of 4/2. Over £3 and under £5, 2/6. Over £5 and under £10, 2/8. Over £10, no charge. Postage extra on CASH orders under £3 except where stated. Postage extra on overseas orders irrespective of price.

"BRAND FIVE" RECORDING TAPE

Post free. Long Play: 900ft. (5"), 18/6; 1200ft. (5 1/2"), 23/8; 1800ft. (7"), 35/-.

PICK-UP CARTRIDGES—SPECIAL OFFER

I.S.R. TC8M (Mono) 19/6; ACOS (G.P.72) (Mono) 19/6; ACOS 73 Stereo/Mono 27/6; RONEET 115 Stereo/Mono 27/6. All post free. All Brand New and complete with fixing brackets.

JASON F.M. TUNER KITS

Kits supplied complete with every item needed including Instruction manuals. Fully detailed list available. Separate items supplied. Ask for price list. H.P. Terms available on any kit.

FMT1, £6.12.6; FMT2 (less power), £7.15.0.

FMT2 (with power), £9.12.6; FMT3 (less power), £9.9.6.

FMT3 (with power), £11.7.6. Mercury 2, £10.14.6.

JTV 2, £14.12.6.

P.W. STRAND, MAYFAIR & SAVOY UNITS

We stock parts for the P.W. Strand Amplifier, Mayfair Pre-Amplifier and Savoy FM Tuner. Detailed price lists are available.

LATEST TEST METERS

	Cash Price	Deposit	Hire Purchase Mthly/Pmts.
AVO Model 8 Mark II	£24. 0.0	£4.16.0	12 of £11.5. 2
AVO Model 7 Mark II	£21. 0.0	£4. 4.0	12 of £11.0.10
AVO Multimeter Mark 4	£10. 0.0	£1. 9.0	12 of 14/4
T.M.K. TP10	£23.18.6	£1. 3.6	3 of £1. 2.0
T.M.K. TP25	£25.19.6	£1.15.6	3 of £1.11.4
T.M.K. Model 500	£28.19.6	£1.15.6	12 of 13/8
TAYLOR MODEL 127A	£10.10.0	£2. 2.0	12 of 15/8
CARY A-10	£4.17.6	£1. 7.6	3 of £1. 6.8
CARY B-20	£8.10.0	£2. 0.0	3 of £1.13.4
CARY M-1	£2.14.0	—	—

Full details of any of the above supplied free on request. The AVO Models 7 and 8 are both latest models from current production—not to be confused with Government Surplus.

OUTPUT TRANSFORMERS

GILSON: W0896A, W0896B, 50/6, post 2/6. W0710, 55/6, post 2/6. W0892, 82/3, post free. W0767, 27/-, post 1/6. W01796A, 57/6, post 2/6. W01932, 84/-, post free.

PARTRIDGE: P3667, 75/-; P4131, 65/-; All post free.

PARMKO: P2629, 47/6; P2642, 45/-; P2643, 47/6. All plus post. 2/9. P2641, 29/6, post 2/-; P2628, 17/-, post 2/-; P2632, 41/-, post 2/6.

ELSTONE: OT/ML, 45/-, post 2/8; OT/3, 25/-, post 2/6.

MAINS TRANSFORMERS

GILSON: W0741A, 83/-, post free; W0839, 48/9, post 2/9; W01328, 58/6, post 3/6; W01288, 58/-, post 3/6; W01568, 80/-, post free; W01341 Choke, 36/-, post 2/-.

PARMKO: P2631, 35/-, post 2/9; P2630, 54/9, post 3/3; P2644, 78/6, post free; P2630, 41/-, post 3/-; P2631, 58/9, post 3/3.

ELSTONE: MT/MU, 45/-, post 3/3; MT/3M, 35/-, post 3/-; MT/510, 42/-, post 3/3.

GRAMOPHONE EQUIPMENT

ALL LATEST MODELS Cash Price Deposit Hire Purchase Mthly/Pmts. ALL POST FREE RECORD CHANGERS

GARRARD AUTOSLIM (Mono PU) £7. 2.6 £1. 8.6 12 of 11/2

GARRARD AUTOSLIM De-luxe A16 (S/M PU) £11. 9.0 £2. 6.0 12 of 16/11

GARRARD AUTOSLIM De-luxe A76 (S/M PU) £12. 5.4 £2. 9.4 12 of 18/-

B.S.R. UA14 (TC8 Mono PU) £6.19.6 £1. 7.6 12 of 11/-

B.S.R. UA14 Monarch (TC8S Stereo/LP/78) £7.19.6 £1.11.6 12 of 12/4

B.S.R. UA16 (TC8 Mono PU) £7.19.6 £1.11.6 12 of 12/4

B.S.R. UA16 (TC8 Mono PU) £8.19.6 £1.15.6 12 of 13/8

B.S.R. TU12 (TC8 Mono PU) £3.17.6 £1. 4.6 3 of £11.0

B.S.R. GU12 (TC8 Mono PU) £4.18.8 £1. 8.8 3 of £11.6

GARRARD SRP11 (Mono PU) £5. 9.11 £1.12.11 3 of £19.0

TRANSCRIPTION UNITS GARRARD 4HF (GC8 PU) £16.12.3 £3. 6.6 12 of £14.5

PHILIPS AG1016 (S/M PU) £12.12.0 £2.10.0 12 of 18/6

Many of the above can be supplied for stereo working. See our Gramophone Equipment List for details.

LOUDSPEAKERS

GOODMANS: Axtette 8in., £5.5.7; Axtom 10in., £6.5.11; 12in., Axtom 201, £10.7.0; 12in., Axtom 301, £14.10.0; 12in., Axtom 51 Bass, £13.14.0; Trebax Tweeter, £8.4.0; OS5000 Crossover unit, £1.19.0.

WHITELEY: HF106 10in., £7.0.0.; HF1012 10in., £4.7.6; HF816 8in., £6.0.0.; TS16 8in., £5.13.9; T10 Tweeter, £4.8.3; T359 Tweeter, £1.10.6; CX3009 Crossover unit, £1.11.6; CX1500 Crossover unit, £2.0.0. H.P. Terms available on all speakers.

WATTS RADIO

(MAIL ORDER) LTD.

54 CHURCH ST., WEYBRIDGE, SURREY

Telephone: Weybridge 47556

Please note: Postal business only from this address

Callers welcome by appointment

Closed for annual holidays August 7th-24th

* HIRE PURCHASE TERMS

are available on any item. Repayments may be spread over 3, 6 or 12 months. Details as follows: Three months; Deposit 6/- in the £. Service charge 5 per cent. but minimum charge of 10/-.

Six and twelve months; Deposit 4/- in the £. Service charge 10 per cent. but minimum charge 20/-.

CRYSTALS & COMPONENTS LTD



TEL: TEM.1189 2.4. EARLHAM STREET WC.2.

Near Cambridge Circus. A few minutes' walk from Leicester Square or Tottenham Court Road Underground Stations
 HOURS OF BUSINESS: 9 to 6. Saturdays 9 to 1. OPEN ALL DAY THURSDAY

CRYSTALS !!!

LARGE RANGE OF 10X, 10XJ, FT23, FT20 CRYSTALS ALWAYS IN STOCK.

Send stamped and addressed envelope for our free, comprehensive list.

TEST INSTRUMENT BARGAINS

- Sangamo Weston, brand new (not boxed), 0-750 micro amps flush, round, 3 1/2 in. dia. 49/6
 0-1 mA flush, round, 3 1/2 in. dia. 47/6
 Metro-Vic in good condition:
 0-5 mA M.C. projecting 6 in. dia. steel case 39/8 each
 0-15 mA M.C. projecting 6 in. dia. steel case 39/8 each
 0-50 mA M.C. projecting 6 in. dia. steel case 27/6 each
 0-100 mA M.C. projecting 6 in. dia. steel case 27/6 each
 P. & P. 2/- per instrument.

AR 88 LF RECEIVERS. 75-550 Kc/s. and 1.5 to 90 Mc/s. 110/240 v. A.C. input. Price from £27.10.0. (slightly soiled exterior) to £30 (as new). Carriage and packing 25/-.

DIODES. OA81, 2/9 ea., OCT1, OCT2 substitutes, 3/6 ea.

SILICON RECTIFIERS. Miniature power diodes at the right price. Leading makes. 400 P.I.V. at 650 mA. 6/- each. 800 P.I.V. at 550 mA. 7/6 each. 1,000 P.I.V. at 500 mA. 8/6 each.

L.T. TRANSFORMERS. Pri. 240 volts. Output 6.3 volts 5 amps. 8/6. Post 2/8. Pri. 240 volts. Output 17 volts 1 amp. 9/6. Post 2/-.

H.T. TRANSFORMERS. Type (350/320) Tapped 200/250 v. input. 350/0/350 v. 120 mA. 6.3 v. 3i amps. 5 v. at 2 amps. 16/6. P.P. 3/6. Type 3k. Pri. 200/250 v. Output. 350/0/350 v. 350 mA. 5 v. 3 amps. Tapped 1 v. 2 v. 2 amps. 10 kV ins. 20 v. 1 amp. 7.5 v. 1 amp. 5 kV. 5 mA. Price 25/-, P.P. 6/-.

BC610 TUNING UNITS

Choice of 5-6.35 or 6.35-8 Mc/s. These compact units (9 x 4 x 2 in.) were used as plug-in tuning boxes with the BC610 TX. Containing miniature variable condensers of 140 pfd, 100 pfd and a standard size 50 pfd. A 0-100 graduated knob dial 1 1/2 in. dia. D.P.D.T. toggle switch and several other components. Price 6/6 each. P.P. 3/-.

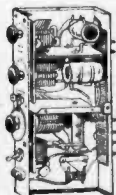

TYPE 46 SETS

Best Buy in TX/RX units in years. Complete with all accessories at rive-away price. 3-channel crystal controlled TX and RX. Supplied complete with one pair of crystals, coil box, rod aerials, leads and plugs, valves, balanced armature head set with throat-mike. Coverage: 3.8 to 4.3 Mc/s only by means of plug-in coil pack. Requires only 150 v., 15 v., and 3 v. dry batteries. Range over 10 miles under good conditions. Full instructions supplied. As new. We offer this fine unit as listed above with all accessories, at 42/6 per unit or 24 for two. Postage and packing 6/6. Set of batteries 24/- per set.

SPECIAL OFFER TYPE 46 SETS

As described above with valves, crystals and coil box but having had the original send/receive switch removed. Without other accessories. This set is supplied with a substitute switch and full wiring details at 18/6 each or 35/- per pair. P. & P. 5/6.

TERMS OF BUSINESS

CASH WITH ORDER. Handling charge of 1/6 on all orders under 20/- where P.P. is not otherwise stated.

TRANSFORMERS

Auto types—60 watt 15/6 ea., 150 watt 21/9 ea., 500 watt 52/6 ea. 3 way mounting type, primary 200/250 volts, secondary 30 volts at 2 amps, with tapings in steps of three up to the maximum 30 21/9 ea. Mains Standard Primary, 250-0-250 volts, 80 mA, 6.3 at 4 amps, 5 volts at 2 amps, both tapped 4 volts, 21/9 ea. As above with 350-0-350 volts, 21/9 ea.

PRACTICAL WIRELESS POCKET TRANSISTOR 6 SUPERHET on printed circuit board, all components available from stock, £7.19.6.

P.W. MERCURY SIX, M. & L.W. 6 TRANSISTOR SUPERHET 500 MW. output in the new elegantly designed cabinet printed circuit has a High Q internal ferrite aerial. All parts available from stock, £10.7.6.

GRAMOPHONE UNITS

BSR TU12 unit, with Mono TC8H cartridge, £3.19.6. BSR GU7 unit, with TC8M or TC8H cartridge, Mono, £4.15.0. BSR GU7 unit, with TC8S cartridge, stereo, £5.9.0. Garrard Autoslim, automatic, with GC8 Mono cartridge, £7.15.0. Garrard Autoslim, automatic, with EV26 Stereo cartridge, £8.10.0. Garrard Autoslim, De Luxe, with GC8 Mono cartridge, £11.5.0. Garrard Autoslim, De Luxe, with EV26 Stereo cartridge, £12.0.0. BSR Monarch UA14 with TC8 mono cartridge, £6.6.0. BSR Monarch UA14 with TC8S Stereo cartridge, £7.7.0. BSR Monarch UA16 with TC8 Mono cartridge, £6.19.6. BSR Monarch UA16, with TC8S Stereo cartridge, £7.19.6.



WB STENTORIAN HI-FIDELITY LOUDSPEAKERS with Universal Speech Coil, for 3, 7, 5 and 15 ohms. Model HF812 £3.12.9. HF816 £6.0.0. HF912 £3.17.0. HF1012 £4.7.6. HF1016 £7.0.0. All have die-cast chassis.

CHASSIS

Aluminium Un-drilled with Reinforced Corner, available in the following sizes:
 6 in. x 4 in. x 2 1/2 in. 4/6 each
 8 in. x 6 in. x 2 1/2 in. 6/3 each
 10 in. x 7 in. x 2 1/2 in. 7/3 each
 12 in. x 3 in. x 2 1/2 in. 5/9 each
 12 in. x 5 in. x 2 1/2 in. 6/9 each
 12 in. x 8 in. x 2 1/2 in. 8/6 each
 14 in. x 3 in. x 2 1/2 in. 6/- each
 14 in. x 9 in. x 2 1/2 in. 12/- each
 16 in. x 6 in. x 2 1/2 in. 9/3 each
 16 in. x 10 in. x 2 1/2 in. 14/- each
 All are four-sided—ideal for radio receivers, amplifiers, power packs, etc.

TERMS: Cash with Order or C.O.D. Postage and Packing Charges extra. Single valves 9d., Minimum Parcel Post charges 2/-. Please include sufficient postage with your order. Minimum C.O.D. fees and postage 3/6. These Postal Rates apply to U.K. only. For full terms of business see inside cover of catalogue. Personal shoppers 9 a.m. to 5 p.m. Mon. to Friday, Saturday 10 a.m. to 1 p.m.

READY BUILT TRANSISTOR AMPLIFIER

1/2 watt, 3 transistor amplifier. Output to 3 ohms speaker, push-pull output stage, 9 volt operation. Ideal for intercom or as record player amplifier. 39/6 plus 1/6 P.P.

1963 COMPONENTS CATALOGUE AVAILABLE Send 1/- in stamps for your copy. LOUDSPEAKER UNITS

2 1/2 in. Square Rola C25	26/10
2 1/2 in. Square EMI	18/6
3 in. Square Plessey	16/6
4 in. Square Elac Tweeter	12/6
5 in. Plessey	15/-
5 in. Round Plessey with O.P. Trans.	16/6
6 in. Round Richard Allan	16/6
8 in. Round Elac. Celestion	17/6
10 in. Round Goodman	32/6
12 in. Round Plessey	29/6
6 x 4 in. Plessey	15/6
7 x 4 in. Goodman, Plessey	15/6
8 x 5 in. Elac	19/6
8 x 6 in. Celestion	17/6
10 x 6 in. Plessey	21/-

TRANSISTORS AND DIODES

Transistors	OC171 10/6	OA85 3/-
OC35 18/-	OC201 31/-	OA91 3/-
OC36 21/6	OC202 26/-	OA95 3/6
OC44 6/-	OC71 25/-	
OC45 6/-		
OC70 6/6	Matched Pcs.	Sundry Types
OC71 5/-	2xOC72 16/-	PXA102 4/-
OC72 8/-	2xOC78 16/-	GEC51
OC73 16/-		Audio 3/6
OC75 8/-	Diodes	Red
OC77 12/-	OA5 8/-	Spot 3/6
OC78 8/-	OA10 8/-	White
OC81 8/-	OA70 3/-	Spot 5/-
OC81 8/-	OA73 3/-	GEX34 3/-
OC84 8/6	OA79 3/9	GEX35 3/-
OC170 9/6	OA81 2/6	XD201 1/-

A set of Transistors comprising 1 OC44, 2 OC45, 1 OC81D, 2 OC81, 32/6 set. Set of Audio Transistors, 1 x OC81, 2 x OC81, Driver Matched Pair, 15/6 set.

ALPHA RADIO SUPPLY CO., 103 Leeds Terrace, Wintoun Street, LEEDS 7

“Baby Alarm”

BY L. K. MARSH

THE basis of this unit is a high gain transistor preamplifier followed by a triode voltage amplifier and pentode output stage.

It was built on an old Band III add-on type of converter, which was chosen because it happened to be found in the spares box and because it had its own a.c. power pack and suitable valvebase already fitted on its chassis.

The valve in the converter was unsuitable and was replaced by the required triode-pentode, an ECL80, which is readily available cheaply. The valve requires 6.3V at 0.3A i.t. and draws around

COMPONENTS LIST	
Resistors:	
R1 100Ω	R5 270kΩ
R2 390kΩ	R6 10MΩ
R3 100kΩ	R7 470Ω
R4 6.8kΩ	R8 150kΩ
(All resistors ½W)	
Capacitors:	
C1 100μF, 6V	C4 0.005μF
C2 0.05μF	C5 0.005μF
C3 100μF, 12V	C6, 7 32+32μF, 350V
Variable Resistor:	
VR1 250kΩ with d.p. switch	
Miscellaneous:	
L1 Small i.f. choke (60mA)	
F1 1A fuse	
T1 Midget output transformer to suit speaker	
T2 Mains transformer: secondaries—200V at 60mA; 6.3V at 0.3A	
MR1 Metal rectifier (200V, 60mA)	
V1 ECL80	
Tr1 Any “surplus” a.f. type	

20mA h.t.; the transistor draws negligible current, of course. This power requirement can be provided very simply.

The microphone used with the finished device is a low impedance moving coil type which matches directly to the transistor base input.

Construction

In the writer's case, using the add-on converter unit as a basis, all unwanted parts were removed, leaving the power pack, valveholder and coaxial sockets. Starting from scratch, however, should present no difficulties, for there are few components involved and these can be grouped logically round the major parts. Keep the input leads away from the power pack and ensure that the transistor is not placed near any excessive heat, e.g. near the ECL80 valve.

Testing

Connect a low impedance microphone to the input socket. Connect the extension loudspeaker to the output socket via a suitable length of flex. The writer has the unit placed near to the baby's cot with about 6in. of lead for the microphone; the loudspeaker is downstairs and is connected by plastic-covered flex.

Ample gain should be obtained with the volume control about threequarters advanced. Earthing was found essential to remove traces of hum and mains pick-up noise. If three-pin wiring is available this should, of course, be used.

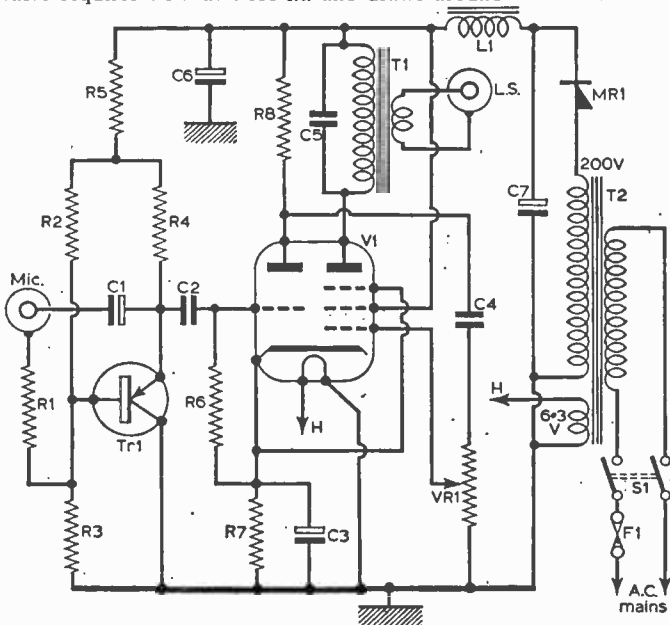

Fig. 1: The circuit diagram.

BOOKS REVIEWED

RADIO ASTRONOMY FOR AMATEURS

By Frank W. Hyde; published by Lutterworth Press. 236 pages, 5½ x 8½ ins. Price 25s.

FOR those wanting to try something new, radio astronomy is both a challenge and an opportunity. This comparatively new science is rapidly gaining in importance and much useful work is within the scope of the amateur for a modest outlay.

The author, an acknowledged authority on the subject, has struck just the right balance and level in his treatment. Not too advanced to deter the newcomer; not too elementary to turn away the more experienced.

The book can be divided into three main sections. The first group of chapters deals with basic astronomy. The second group covers basic electronics. The third group describes practical equipment, such as receivers, aeri-als, etc. Much of the explanatory electronics will be "old hat" to readers of this magazine but it takes up very little of the bulk of the book.

What is left is fascinating. A newcomer to astronomy could hardly find a more lucid general introduction than is provided in this book. And the chapters on extra-terrestrial and solar radiations are of absorbing interest.

From the practical aspect, complete circuits are provided for receiving equipment and the matter of aerial construction is described in detail. There is a useful section on operating the equipment, and a handy bibliography is provided for further reading.

There are few serious amateur radio astronomers at the moment, but their ranks will undoubtedly grow. Here is an excellent introduction to this new field.—W.N.S.

WORKED RADIO CALCULATIONS

By Alfred T. Witts, A.M.I.E.E.; published by Sir Isaac Pitman & Sons Ltd.

184 pages, 4½ x 7½ ins. Price 15s.

HERE is a welcome third edition of what has become an established standard. For those not familiar with the book, it consists of graded practical examples of the various mathematical problems encountered by radio service engineers, wireless operators, students and experimenters.

Not a few amateurs find that many of the necessary mathematical calculations, that must be made, provide a stumbling block. This need not be so, and this book goes far to killing the bogey. In fact the presentation and treatment is such that many readers will wonder why they ever thought radio calculations were difficult!

The author assumes that the reader is conversant with the general theory, and so explanatory notes have been reduced to the barest minimum. This has enabled him to set out the relevant data in a clear uncluttered manner. The approach is to pose

a brief problem and then to show how this is resolved. These are essentially *practical* calculations, of the kind constantly met with in any home constructional work.

There are ten sections, each dealing with a specific type of calculation, including a newly added, and valuable section dealing with transistor circuits. Whether a professional or an amateur, this book will be invaluable and a great time saver. Highly recommended.—W.N.S.

RADIO DATA REFERENCE BOOK

Compiled by G. R. Jessop, A.M.Brit.I.R.E.; published by Radio Society of Great Britain.

136 pages, 75 diagrams, 5½ x 8½ ins. Price 12s. 6d.

THIS is a new RSGB publication bringing together in convenient form, essential reference data for the radio engineer, designer and amateur. In general, the data are presented in the form of curves, tables and charts, with only sufficient text to permit its effective use.

The material provided includes general formulae, but is mainly directed towards the amateur transmitter since sections are provided for pi-network tank circuits, wide band couplers, voltage multiplier circuits, modulation transformer ratios, aerial design information and so forth. For those experimenting with transmitters, this book provides in a convenient form much material that would otherwise be found scattered in various reference books.—D.C.

THE PYE BOOK OF SCIENCE

Published by Vista Books and the Pye Group

158 pages, 8½ x 11 ins. Price 25s.

TODAY the challenge of space is a great stimulant for further scientific advancement and it seems fitting that the first article in this book should deal with space travel. However fanciful this glimpse into the future may seem, the other articles are very much down to earth and bear witness to the tremendous advance science has made in recent times.

This book has been very carefully written to inform the layman in the simplest and clearest manner of some of these achievements. Each chapter is admirably illustrated with photographs and diagrams.

Not surprisingly, many of the subjects included have a common bond—electronics. Representative of these are: industrial and other special applications of radio telephony and closed-circuit television equipment; radiotelescopes; computers; and that ubiquitous device which has made so much possible—the transistor.

Some of the many other aspects of scientific progress described are: the atom and how it is harnessed to provide power; plastics; the hovercraft; spare-part surgery; and modern aids to archaeology.—F.E.B.

POST FREE MAIL ORDER SERVICE

VERNIER DIALS

Precision vernier dials with approx. 8 to 1 ratio. Surface mounting. Accurately centred metal insert for pin shaft. Reads counter clockwise 0-100 in 180°.



Model T.501 1 1/4" dia. 12/6
Model T.502 2" dia. 14/-
Model T.503 3" dia. 16/-

All goods sent by return

MICROPHONES AND STANDS



M.C.70 (illus.) CRYSTAL 360 deg. pick up. Response 60-12,000 cps. Price 59/6.
100.C 3 way SLIM CRYSTAL Response 60-10,000 cps. Price 48/-.
DM.11 DYNAMIC with base. Response 60-12,000 cps. Price 35.5.0.
DM.176 LIGHTWEIGHT DYNAMIC. Response 150-9,000 cps. Price 35/6.
BM.36R MAGNETIC LABEL TYPE. 1 1/2in. dia. Price 12/6.
S.A.E. for leadets.

FS.3. TELESCOPIC FLOOR STAND. 3 section chrome plated with heavy base. 57/6.

All goods available as previously advertised

HI-FI SPEAKERS



CK.300. 12in. Two Way. Crisp clean frequency response from 30-16,000 cps. 15 watt. 16 ohms. Price 12 gns.
CR.12AE. 12in. Two Way. True HI-FI and superb stereo at low cost. Response 30-16,000 cps. 10 watt. 16 ohms. Price 8 gns.
CR.30AE. 12in. Three Way. Advanced triaxial design giving full 3 speaker performance. Response 30-16,000 cps. 10 watts. 16 ohms. Price 10 gns.
S.A.T. 8in. Two Way (illus.). Dual cone construction ensures wide range response. 60-16,000 cps. 6 watt. 16 ohms. Price 81/-.
TP.26G. 2 1/2in. 75 ohm speaker. Price 11/-.
S.A.E. for leadets.

Full range of Eagle Products always in stock

R.F. FIELD INDICATOR

RF.40. Designed for checking the radiation from a transmitting antenna. The sensitivity can be controlled by adjustment of panel control the antenna length or by increasing distance from the radiator. Freq. range 1-250 Mc/s. 200V A D.C. Meter. Complete as illus. with instructions. Price 69/6.



TOOL KITS

6 Piece Screw Driver Set, Model 3360. Consisting of mechanics, electricians, Phillips, midjet and stubby types. Magnetised blades of tempered, hardened tool steel. Unbreakable, flameproof and shockproof plastic handles. Display bagged. Price 8/-.
Multi Purpose Tool Set, Model 7900. Consisting of insulated plastic handle, 5 interchangeable screw driver bits, including Phillips type, one hammer, 5 hexagon sockets (1/4"-7/16") and extension bar. Complete in Vinyl roll case. Price 12/6.
CRYSTAL MIKE INSERTS
Model M.C.1. Precision disc type. Output—53dB. Response: 100-6,000 cps. Price 5/-.



PICK-UP ARM COMPLETE



Transcription type. Wired for stereo and complete with LP/78 Stereo/Mono turn-over cartridge. Price 33.7.0.

HI-FI AMPLIFIERS

SA.80 Integrated Stereo Amplifier. 4 x 4 watt. The perfect choice for a low cost HI-FI stereo system. Dual pick-up and tuner inputs. Supplied complete for only

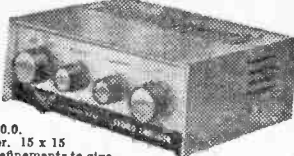

29.10.0.
SA.300 Integrated Stereo Amplifier. 15 x 15 watt. Incorporates all the latest refinements to give you professional quality HI-FI reproduction. Modestly priced at 592.10.0. S.A.E. for leaflets.

VISIT OUR HI-FI SHOWROOM AT 87, TOTTENHAM CT. RD., W.I

TRANSISTOR RADIO ESSENTIALS

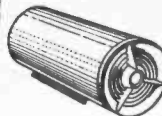

T.S.80 Booster Speaker. Fits into earpiece socket of most miniature radios and tape recorders. Double the volume and a HI-FI Stereo effect that will amaze you, 9 1/2 x 3 1/2in. PRICE 29/-

L.A.6P A.C. Adaptor. Enables 9 v. battery sets to be run off A.C. mains, also reactivates old 9 v. batteries. PRICE 24/6

5-STAGE TRANSISTOR RADIO

Completely portable, has the appearance of sets costing considerably more and works equally well. Incorporates telescopic aerial and ferrite rod to really pull in those stations, genuine 2 1/2in. speaker also earpiece with ear curl for personal listening. G.E.C. transistors, tuning control, volume control with switch etc. Attractive case size 5 1/2 x 3 1/2 x 1 1/2in. Can be built in one hour. ALL PARTS SOLD SEPARATELY. PRICE 47/6.



Relda Radio Ltd.

MAIL ORDERS TO: DEPT. 'P' 32A, COPTIC STREET, LONDON, W.C.1 Tel: MUSEum 9606

See our other advertisement on page 109 for more attractive items



Trade News

Stereo Headphones

AT the Audio Festival and Fair held in London, Standard Telephones and Cables Ltd. exhibited prototype models of stereo headphones and two new microphones. These new headphones have been designed by STC for listening to stereo reproduction to provide high-fidelity listening. The manufacturers are *Standard Telephones and Cables Ltd., Connaught House, 63 Aldwych, London, W.C.2.*

Transistor Car Radio

JUST recently the Clarion Trading Co. Ltd., of Tokyo, has started exporting its Clarion 85A car radio to Great Britain. The sole distributing agents of this product in this country are University Electrics Ltd.

The model 85A is a compact, all-transistor receiver which will be found small enough to fit into a car with even the most limited amount of space available for a radio. The radio forms a fixed installation in the car and operates from the 12V supply. It tunes over the whole medium wave-band and has an output of over 1W.

The 85A costs £13 15s. and comes complete with dashboard suspension plate, connecting leads, etc. The distributors are *University Electrics Ltd., 7 Hertford Street, London, W.1.*

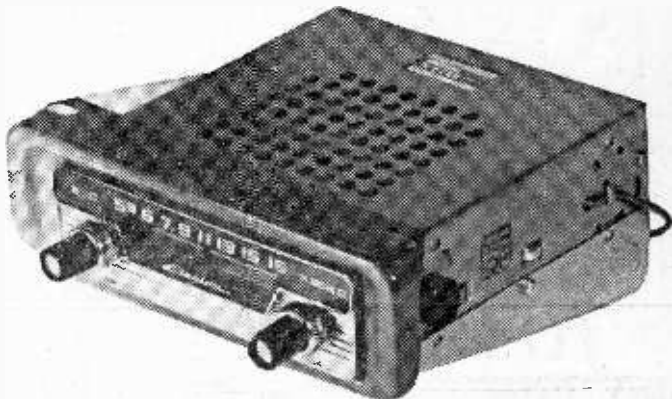

On sale for the first time in the U.K., the Clarion-85A car radio.

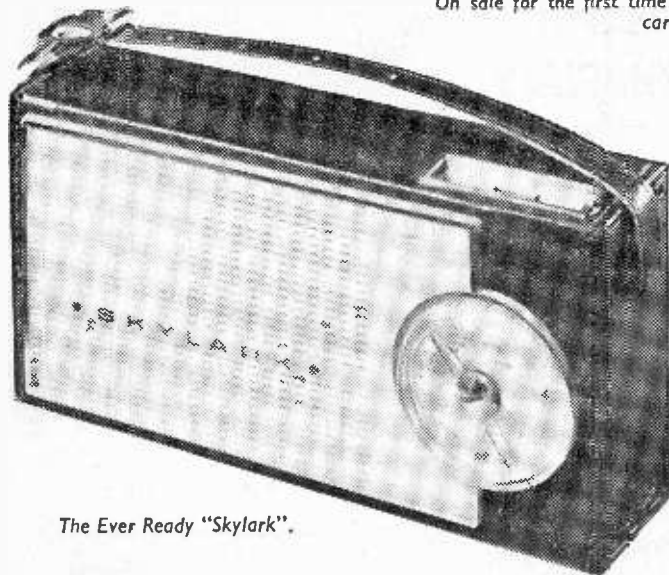

The Ever Ready "Skylark".

Portable Receiver

THE latest portable receiver from the Ever Ready Co. (Great Britain) Ltd. is the "Skylark". This set provides loud-speaker or earpiece reception and for this incorporates a special earpiece compartment as well as a 3in. diameter loudspeaker.

The "Skylark" measures on 7½in. x 3½in. x 2¼in. and is a six transistor superhet design using a printed circuit form of construction. The retail price of this receiver is 11½ guineas and the manufacturers are the *Ever Ready Co. (Great Britain) Ltd., Hercules Place, London, N.7.*

Transparent Case Meters

THE recently announced new range of moving-coil meters from Taylor Ltd. have been made available in modern transparent mouldings.

The new range is called the "Clarity" range and the meters come in three different sizes with scale length of 2½ in., 3 in. and 4 in. Ranges commence from 10µA and the meters are also available as milliammeters, ammeters, voltmeters, etc.

The meter movement incorporated in the "Clarity" range can withstand overloads of up to 10,000% without damage to the coil or pointer. This new range of meters comes from Taylor Electrical Instruments Ltd., Montrose Avenue, Slough, Berkshire.



The latest tape recorder from Brenell Ltd.

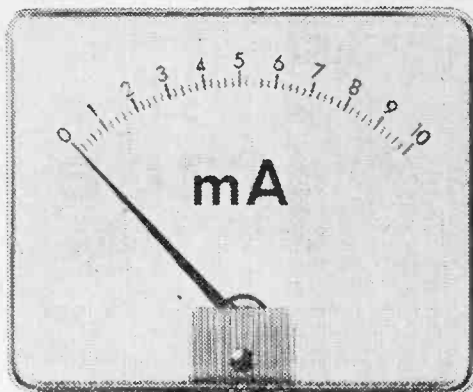

One of the new meters of the "Clarity" range, made by Taylor Ltd.

Latest Tape Recorder

SEEN for the first time at the recent Audio Festival and Fair was a new model Brenell tape recorder. This is the Mk 5 series 2 and incorporates a four-speed, three-motor tape deck. This model is a successor to the Mk 5 machine and has a new amplifier in its design.

Two models of this recorder are available, one incorporating a magic eye indicator at 69 guineas and one with a recording level meter at an extra 5 guineas. The makers of this new recorder are Brenell Engineering Co. Ltd., 1a Doughty Street, London, W.C.1.

JUST OUT!

2 NEW HANDBOOKS FOR EVERY ENTHUSIAST

★ TRANSISTOR RADIO CIRCUITS

Full constructional articles on seven different receivers, plus articles on basic principles of semiconductors and practical aspects of servicing.

★ TEST GEAR FOR AMATEURS

Principle contents include a wide range of signal generators suitable for a.m. and f.m. receiver alignment and servicing applications and for audio equipment testing.

3'6

GET YOURS TODAY!

EACH



BRAND NEW AM/FM (V.H.F.) RADIOGRAM CHASSIS AT £12.12.0 (Carriage Paid)

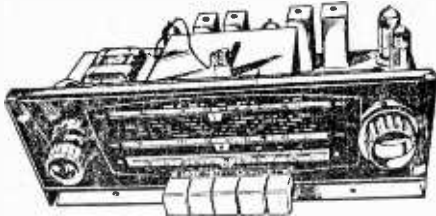

A.C. ONLY. Chassis size 15 x 6 1/2 x 5 1/2 in. high. New manufacture. Dial 14 1/2 x 4 in. in 2 colours, predominantly gold. Pick-up Ext. Speaker, Ac. E., and Dipole Sockets. Five push buttons—O.P.F., L.W., M.W., F.M. and Gram. Aligned and tested. O.P. Transformer. Tone Control. 1000-1800 M.; 200-500 M.; 88-98 Mc/s. Valves E280 rect.; ECH81, EF89, EAB080, EL84, EC085. Negative feed-back circuit. Speaker and Cabinet to fit chassis (table model), 47/6 (post 5/-). 9 x 6 in. ELLIPTICAL SPEAKER, 20/-, to purchasers of this chassis. **TERMS:** (Chassis) £3.10.0 down and 5 monthly payments of £2. Cheap Room Dipole for V.H.F., 12/6. Feeder 6d. yd. Circuit diagram 2/6.

SELF-POWERED VHF TUNER CHASSIS. Covering 88-95 Mc/s. Mullard permeability Tuner. Dims. 10 1/2 x 4 1/2 x 5 in. high EC085 and 3—EF91 and 2 diodes. Metal Rectifier. Mains transformer. Fully wired and tested. Only £7.7.0 (carr. paid). Room dipole 12/6 Feeder 6d. yd.

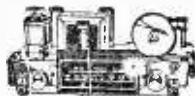

PUSH-PULL AMPLIFIER £5.5.0

(5/- Carr.)

Brand new 200-240 A.C. mains. Bass, treble and vol. controls. With valves E280, EC083 and 2-EL84 giving full 8 w. Chassis 12 x 3 1/2 x 3 1/2 in. With op. trans. for 2-3 ohm speaker. Front panel (normally screwed to chassis) can be removed and used as "flyingpanel." Stereo version 2 x 4 w. same price. Fixed panel. Tone & Vol. Controls.

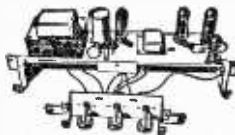

(normally screwed to chassis) can be removed and used as "flyingpanel." Stereo version 2 x 4 w. same price. Fixed panel. Tone & Vol. Controls.

TAPE RECORDER AMPLIFIER

Type TR1. Fully built, high gain, low noise, printed circuit. Attractive grey and gold front panel 13 x 3 in. Height 5 1/2 in. overall. Front to back 5 1/2 in. Vol. and on/off tone. Mike, radio and ext. speaker jacks. Valves EC083, ECL82, E280. Mains trans. Ready to bolt to B.R.R. Deck. Complete with switch wafer wired. Our Price **ONLY £5.15.0** (6/- Packing and Carr.). Also available for Collaro Deck at 5/- extra.



6-TRANSISTOR AND DIODE KITS

All brand new parts. Rexine and Vynair Cabinets. Different colours. All holes drilled in printed circuit boards. Full M.W. and L.W. coverage. Car aerial socket. Alignment service, 12/6, inc. return post. All parts supplied separately. Built in 2 1/2 hours. 500 mW. output. Booklet 2/6, refunded on purchase of kit.

THE "SCALA"



"Scala" Kit £4.19.6. (Post 3/-). Size 8 1/2 x 2 x 5 1/2 in. high and 3 1/2 in. speaker; or fully built £7.10.6.

THE "MILAN"

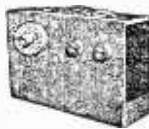

"Milan" Kit £5.17.6. (Post 3/6). Size 9 x 3 1/2 x 7 in. and 8 x 2 1/2 in. speaker.

ALL ITEMS ARE NEW AND FULLY BUILT UNLESS OTHERWISE STATED. TESTED BEFORE DESPATCH. Terms Available on Items over £5. Send 6d. (stamps will do) for 20-page illustrated catalogue. Delivered by return U.O.D. 2/- extra.

ALL ITEMS GUARANTEED 12 MONTHS VALVES 3 MONTHS

GLADSTONE RADIO

"SCALA"; CAMP RD., FARNBOROUGH, Hants.

(Farnborough 3371)

FARNBOROUGH CLOSED SATS.

TECHNICAL TRAINING in radio television and electronics

Whether you plan to have your own business, to become an electronics engineer, to take up a career in industry, or to brush-up your knowledge and study new developments, transistors, etc., an I.C.S. Course will help you to success. You learn at home in your own time, under expert tuition. Moderate fees include all books.

EXAMINATION COURSES FOR:-

C. & G. Radio and TV Servicing Certificate (R.T.E.B.)

C. & G. Radio Amateurs' Exam. (Amateurs' Transmitting Licence) P.M.G. Certificates in Radiotelegraphy

British Institution of Radio Engineers, C. & G. Telecom. Technician's Cert. Gen. Cert. of Education etc.

LEARN AS YOU BUILD

Practical Radio Servicing Course

A basic course in radio electronic and electrical theory backed by thorough practical training. You build radio receivers, signal generator and multimeter.



Post this Coupon TODAY! for FREE book on careers in Radio, and full details of other I.C.S. Courses

INTERNATIONAL CORRESPONDENCE SCHOOLS

(Dept. 171), Intertext House, Parkgate Road, London, S.W.11.

Please send book on _____

Name _____ Age _____ (Block Letters Please)

Address _____

Occupation _____ 6.63

INTERNATIONAL CORRESPONDENCE SCHOOLS

SOLDERING EQUIPMENT



by **LITESOLD**
PRECISION SOLDERING
 for the
ELECTRONICS INDUSTRY

Comprehensive range - Robust & reliable
 - Light weight - Rapid heating - Bit sizes
 3/32in. to 3/8in. - 'Permalbit' or Copper
 bits - All voltage ranges 6/7v. to 230/
 250v. - Prices from 21/-.

- Also
- Plastic Cable Strippers
 - Miniature Solder Pots
 - Heat Guards
 - Long Life Bits

Illustrated is the 25w. 3/16in. replaceable
 bit model with safety shield.

ADAMIN—new range of precision
 micro-soldering instruments—
 Have you had details?

Brochure No. S10 sent free on request,
 Sole proprietors and manufacturers:

LIGHT SOLDERING DEVELOPMENTS LTD.
 28 Sydenham Road, Croydon, Surrey
 Phone: CR0ydon 8589. Grams: Litesold Croydon

P.W. MERCURY SIX 14½ x 6 x 3½
 25/-



5½ x 3½ x 2
 12/6

P.W. POCKET S'HET

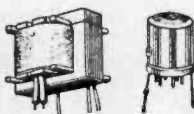

**After Sales
 Fault-finding
 Service**

3 IFS & Osc. 22/-
 Driver & Output 16/3

For above & similar transistor circuits on printed
 board.

Constructional Booklets 2/6 ea.

OSWOR

418 BRIGHTON ROAD
 S. CROYDON, SURREY

NEW VALVES !

Guaranteed Set Tested
24-HOUR SERVICE

1R5.	1S5.	1T4	3S4.	3V4.	DAF91.	DF91.
DK91.	DL92.	DL94.	SET of 4.	25/6.		
DAF96.	DF96.	DK96.	DL96.			
OA2	10/6	DL33	7/3	PCF80	6/6	
1D5	6/9	DL35	7/3	PCF82	6/9	
1R5	5/3	DL92	4/9	PCL82	7/-	
1S5	4/3	DL94	6/3	PCL83	8/9	
1T4	2/11	DL96	6/9	PCL84	5/6	
3S4	4/9	EB91	3/-	PENND4020		
3V4	6/3	EBC41	7/6		17/8	
5U4G	4/6	EBF80	7/3	PL36	9/-	
5Y3GT	5/3	ERL21	9/-	PL81	8/-	
5Z4G	8/-	ECC40	9/-	PL82	6/-	
6K7G	1/9	ECC61	4/8	PL83	6/-	
6K9G	4/6	ECC82	4/8	PL84	7/-	
6V6G	5/6	ECC83	5/9	PY31	7/8	
6C9T	4/-	ECC94	7/-	PY32	6/6	
6X5GT	5/6	ECC85	7/3	PY80	6/-	
12K7GT	4/3	ECF80	6/9	PY81	6/-	
12K9GT	9/-	ECF82	8/-	PY82	5/6	
12Q7GT	4/6	ECH42	7/9	PY83	6/9	
12SN7GT	6/3	ECL80	6/3	U25	10/3	
1497	14/-	EF41	7/6	U26	8/3	
36L6GT	7/9	EP80	4/3	UABC80	6/-	
35Z4GT	5/-	EP85	5/-	UAF42	7/6	
8A2	7/6	EP86	6/9	UBC41	7/-	
AC/TP	21/-	EP89	5/9	ULF30	7/6	
CL33	8/6	EP91	2/9	UCC85	7/8	
DAC32	8/9	EL41	7/8	UCH42	7/6	
DAF91	4/3	EL84	6/-	UCL81	7/8	
DAF96	6/9	EY31	6/9	UCL82	9/-	
DF83	8/6	EY86	6/3	UCL83	11/6	
DF91	2/11	EZ40	5/9	UF89	6/3	
DF96	6/9	EZ80	5/3	UL41	6/9	
DK77	5/-	EZ81	5/-	UL84	6/3	
DK33	9/-	KTWS1	5/3	UY21	9/-	
DK91	5/3	MU14	6/6	UY41	5/6	
DK92	6/11	PCC84	6/3	UY45	5/6	
DK96	8/9	PCP89	7/9	UY85	5/6	

Postage 6d. per valve extra. Any Parcel
 Insured Against Damage in Transit 6d. extra
 Any C.O.D. Parcel 4/3 extra.
 Office address, no callers.

GERALD BERNARD
 83 OSBALDESTON ROAD,
 STOKE NEWINGTON,
 LONDON N.16

Precision Wirewound Resistors 1W.
 1 ohm to 1K. 1% 2/9; to 5K 3/3; to 20K 4/-;
 1% add 3d. Your value would to order.
1% High Stab Resistors, 1W 2/-, good
 stocks all standard values and many others.
 List of values on request. Special 1W 1%
 100 ohms. 10K, 100K, 1/8 each.
Surplus High Stab Resistors. 1/2W.
 1-5%. 1% 9d., list of available values on
 request. Assorted 1% 3/-; 2% 2/-; 5% 1/3
 per dozen, post 1/-
Instrument Rectifiers. New Salford 1mA
 or 5mA bridge 8/6. Ex-Govt. 50-250µA 3/6.
Noughts and Crosses Machine. Full
 circuit and instructions for our fabulous
 new design. 3/6.
18,000 o.p.v. Multimeter Kit 89/-. See last
 month's issue for details, or send 9d. for
 circuit, price list instructions and scale.
WW Pots. 200, 5K, 7.5K, 1/8 ea., post 9d.
2W Resistors. 30 ass'd. 2/6, post 1/6.
TX Chassis. Small batt. 5 valve, 65 parts
 inc. mike tran, less valves 2/6, post 1/6.
Dropper 350 2W slider. 1/6, post 1/-

PLANET INSTRUMENT CO.,
 25, DOMINION AVENUE, LEEDS 7

A.R.R.L. RADIO AMATEURS HANDBOOK 1963

New edition 38/-. Postage 2/3.

British Transistor Directory, new edition
 by Bradley, 8/6, postage 9d.
Transistor Circuits Manual No. 5 by
 Sinclair, 5/-, postage 6d.
Radio Valve and T.V. Tube Equivalents,
 new edition by Babani, 3/6, postage 6d.
More about Loudspeakers, new edition
 by Briggs, 7/6, postage 1/-.
Cabinet Making by Wheeler Smith, new
 edition, 7/6, postage 9d.
Amateur Radio Handbook, new edition
 by R.S.G.B., 34/-, postage 2/6.
Radio Valve Data by Wireless World, 6/-,
 postage 10d.
Amateur Radio Call Book by R.S.G.B.,
 1963 edition, 4/6, postage 6d.

UNIVERSAL BOOK CO.
 12 Little Newport Street, London, W.C.2
 (adjoining Lisle Street)

TRANSISTORS FROM 1/3

GREEN SPOT A.F. 3 volt, ONLY 1/3
YELLOW SPOT A.F. 6 volt 1/6.
RED SPOTS. Now ONLY 1/9 each.
WHITE SPOTS. ONLY 2/6 each.

MICRO-ALLOY TRANSISTORS
 MAT100 7/9, MAT101 8/6, MAT120 7/9,
 MAT121 8/6. 22 Tested Circuits using
 Micro-Alloy Transistors 5/-.

MULLARD TRANSISTORS
 OC70 6/6, OC71 6/6, OC72 8/-, Matched
 Pr. 16/-, OC81 8/-, Matched Pr. 16/-, OC78
 8/-, OC44 9/3, OC45 9/-, OC170 9/6,
 OC171 10/6, AF102 27/6, AF114 11/-, AF115
 10/6, AF116 10/-, AF117 9/6, AF124 11/-,
 AF125 10/6, AF126 10/-, AF127 9/6.
DIODES OA70, OA79, OA81, OA90,
 OA91 all 3/- each. BY100 13/-.

SURPLUS DIODES CG12E 1/6.
 Miniature Type 3 for 2/-, 7/- Doz.
TRANSISTOR HOLDERS 3 or 5 pin 1/6.

REPANCO COMPONENTS TRANSISTOR TRANSFORMERS

TT49 Interstage, TT45 Driver, TT46 Output,
 TT47 Driver. All 5/- each.
 FR2 Ferrite Rod Aerial 12/6.
 DRX1 Crystal Set Coil M. & L. 3/-.
 DRR2 Dual Range Coils 4/6.
 CHI Miniature R.F. Chokes 2/6.

THE HIKER. 4 Transistor Portable.
 Step-by-Step Instructions 1/6.

ALL SENT POST FREE IN U.K. by

PETHERICK'S RADIO SUPPLIES

22 High Street, Bideford, N. Devon
 Tel.: Bideford 1217
 S.A.E. with All enquiries please.



LETTERS TO THE EDITOR

ECHO CHAMBER SPRINGS

SIR,—Since publication of my article "Electromechanical Echo Unit" in your April issue, I have received some useful information from Messrs. Terry and Sons (the spring manufacturers) at Redditch, Worcestershire. This firm can supply a suitable tempered spring for use in the delay unit of this chamber. The specifications of this spring are: wire diameter 0.01in.; outside diameter $\frac{1}{8}$ in.; body length at initial tension 8in. The price of this spring is 7s. 6d. nett.

This spring gives excellent results and is far superior to the "fire element" used in the prototype unit.—B. L. PHILLIPS (Preston, Lancashire).

PLUG-IN TRANSISTORS

SIR,—As a keen radio constructor, I feel that there is a very worthwhile market for an enterprising manufacturer to produce plug-in transistors. I know that there are transistor holders already on the market, but I am thinking of a pin and socket arrangement. This would not only enable the transistors to be used many more times, but would, of course, eliminate heat dangers (heat shunts seem to have a habit of not performing their duty successfully!). Also, if suitably made, they would prevent transistor leads being connected incorrectly.

Naturally the price of a plug-in component would be a little more, but I think the advantages of such a system would outweigh the extra cost.—W. A. BEAUMONT (Hatfield, Hertfordshire).

MINUETTE PRAISE

SIR,—I have now completed three receivers using the design given in your January 1962 issue—the P.W. Minuette. I have constructed them both as the original circuit and also as the reflexed version which was described later, and both designs deserve much praise.

I have only had to use a 4in. length of ferrite rod and cheap transistors, including some surplus types and I have always achieved satisfactory results.—A. J. SIMMONDS (Welling, Kent).

NOVICE LICENCES

SIR,—I would like to know why the Post Office in this country should be so much against a "novice licence" such as our friends in the USA enjoy. This would surely have several advantages, one being a probable increase in radio club memberships, which at the moment always seem low due to lack of interest.

Whilst we are always pleased to assist readers with their technical difficulties, we regret that we are unable to supply diagrams or provide instructions for modifying commercial or surplus equipment. We cannot supply alternative details for receivers described in these pages. WE CANNOT UNDERTAKE TO ANSWER QUERIES OVER THE TELEPHONE. If a postal reply is required a stamped and addressed envelope must be enclosed with the coupon from page iii of the cover.

The Editor does not necessarily agree with the opinions expressed by his correspondents

Secondly, it would, almost overnight, remove the large number of "pirates", so saving the GPO much time and expense.

Also, an enthusiast having first obtained his novice licence (which would, of course, allow for only modest transmissions) would be encouraged to work for a full licence.—E. R. WILES (Wilden, Bedfordshire).

[We make no apology for once again publishing correspondence on this subject, as so many people appear to feel so strongly for and against it. Also, Mr. Wiles has put forward one or two interesting points in favour of these licences.—Ed.]

LANGUAGE BARRIER

SIR,—Your correspondent Mr. A. Jameson (March issue) rightly stresses the great advantages which a knowledge of Esperanto would offer all radio amateurs. Being by far the easiest language to learn, genuine conversation on all subjects with foreign amateurs could then replace the present stereotyped QSO's to which so many non-English speaking amateurs are so often limited, due to difficulties they experience with our language.

Esperanto is already widely used by operators in some parts of Europe, South America and elsewhere, and the British Esperanto Association in London, would I am sure, be glad to help.—R. E. WOOD (Cambridge).

CORRIGENDUM

General Purpose Communications Receiver

There is a small wiring error in the circuit diagram of Fig. 2 on page 799 (January issue). The left-hand contact on S2C should be linked to the rotor of this switch. The circuit will then function as described in the text, i.e. position 1—"marker on, limiter off"; position 2—"limiter on"; position 3—"limiter off".

Musical Alarm

IMPORTANT NOTE

It must be emphasised that this device (page 1116, April issue) is intended for use only with portable *battery powered* receivers, particularly transistor types which operate from low voltage batteries. The alarm must *not* be employed to switch the supply input to a mains operated receiver.

CLUB

AMATEUR RADIO MOBILE SOCIETY

Hon. Sec.: G3FPK, 79 Murchison Road, London, E.10.

The Society was well represented at Trentham Gardens for this year's North Midlands Mobile Rally, which was staged on April 21st.

A magnet for mobile amateurs from all over Europe, the U.B.A.'s Mobile Rally, at Verviers, Belgium, attracted a large contingent of A.R.M.S. members. It was held on 28th April.

Future Event:

May 11th—First London Single Sideband Dinner.

COVENTRY AMATEUR RADIO SOCIETY

Hon. Sec.: A. J. Wilkes, G3PQQ, 141 Overslade Crescent, Coundon, Coventry, Warwickshire.

The "open night" meeting of 1st April was followed later in the month by a film show held on the 22nd.

"Two metre contests" was the subject under discussion at the meeting on the 29th.

DERBY AND DISTRICT AMATEUR RADIO SOCIETY

Hon. Sec.: F. C. Ward, G2CVV, 5 Uplands Avenue, Little-over, Derby.

On April 17th a number of members assembled at the appointed place for the start of the first d.f. practice run of the season.

On May 1st a sale of surplus items of equipment was held.

Future Event:

May 8th—Safety in the shack and home.

FLINTSHIRE RADIO SOCIETY

Hon. Sec.: A. Antley, "Fairholme", Fairfield Avenue, Rhyl, Flintshire.

After the slow morse practice at 7.30 p.m., L. W. Barnes (GW3PCZ/T) continued his series of lectures—"Simple Hints and Kinks"—at the meeting for April, held on the 29th.

ISLE OF WIGHT RADIO SOCIETY

Hon. Sec.: Capt. E. C. Dolling, "Sweet Briars", New Road, Wootton Bridge, I.W.

The committee recently decided to intensify its recruiting campaign and therefore anyone interested in joining the society should visit the Social Club, Lower St. James Street, Newport, where meetings are held every other Friday evening.

The secretary also invites radio clubs wishing to hold field days in the Isle of Wight to contact him for assistance in planning the events.

LINCOLN SHORT WAVE CLUB

Hon. Sec.: A. D. Taylor, G3OSB, 34 St. Peter's Avenue, Lincoln.

Any local short wave enthusiasts are invited to the meetings of this club, which are held on the first Wednesday of each month in the Lincoln Technical College.

LOTHIANS RADIO SOCIETY

Hon. Sec.: W. T. Sutherland, GM3JWS, 47 Great King Street, Edinburgh 3.

"Ancient Radio at Sea" was the title of the lecture given by T. Spiers at the first meeting in April. Later in the month on the 25th, Sandy Laurie gave a talk on "Monkey Glands for the H.R.O." and also gave a demonstration of T.V.I. proofing.

MANSFIELD AMATEUR RADIO SOCIETY

Hon. Sec.: M. Dawson, 35 Ellesley Road, Welbeck Colliery Village, Mansfield, Nottinghamshire.

This new society has been formed to serve the needs of local amateur enthusiasts and information about the club can be obtained from the secretary. The weekly meetings are held at the Hope and Anchor Inn, Union Street, Mansfield.

NORTHERN HEIGHTS AMATEUR RADIO SOCIETY

Hon. Sec.: A. Robinson, G3MDW, Candy Cabin, Ogdon Halifax, Yorkshire.

The most important Society event for April was the Annual General Meeting, which was held on the 10th. On 17th April the "Amateur Sound Licence" was the subject of a discussion.

READING AMATEUR RADIO CLUB

Hon. Sec.: R. G. Nash, G3EJA, "Peacehaven", 9 Holybrook Road, Reading, Berkshire.

This club reports good attendance at all meetings. On April 27th, the meeting was devoted to a spares sale.

Future Event:

May 25th—Receivers.

STOURBRIDGE AND DISTRICT AMATEUR RADIO SOCIETY

Hon. Sec.: R. A. G. MacIntosh, 50 Field Lane, Oldswinford, Stourbridge, Worcestershire.

At the recent Annual General Meeting, G3CLG was elected President, G3HGI vice-president, G2OG treasurer and BR520894 secretary.

WESSEN AMATEUR RADIO GROUP

Hon. Sec.: G. J. Fowle, 138 Surrey Road, Branksome, Poole, Dorset.

The film show and lecture given by G. J. Fowle was held on April 1st. On the 8th, the Group took part in an inter-group quiz with the Southampton R.S.G.B. Group.

On April 20th members visited the Worcester P.O. radio station.

WORCESTER AND DISTRICT AMATEUR RADIO CLUB Y.M.C.A., Henwick Road, Worcester.

At the Hobbies Exhibition held in Worcester on 18th, 19th and 20th April, the Club operated a station on 160, 20 and 2 metres under the call sign GB3WOR.

An Audio Absorption Wattmeter

With regard to the article that commenced on page 718 of the December 1962 issue, the voltage figures given in Tables 1, 2 and 3 in the text should

be reduced by a factor of 1.11. This is necessary because no account was taken of the Form Factor for an alternating current. The amended Table 1 is reproduced below. Tables 2 and 3 should be amended in a similar manner.

Table 1

Impedance							
3Ω				15Ω			
Voltage	Power	Voltage	Power	Voltage	Power	Voltage	Power
3.48	5	7.79	20	7.79	5	15.59	20
3.11	4	6.97	16	6.97	4	13.95	16
2.70	3	6.03	12	6.03	3	12.08	12
2.20	2	4.93	8	4.93	2	9.86	8
1.56	1	3.48	4	3.48	1	6.97	4
1.10	0.5	2.47	2	2.47	0.5	4.93	2

CAR OWNERS — LOOK!

SUPER CAR-PORTABLE RADIO OFFER



**By Famous British Manufacturer—
Brand New and Unused. Fully
Guaranteed. Original List Price
£26.18.11**

A fully transistorised Go-Anywhere portable that automatically becomes a real car radio simply by sliding into the car-holder tray. Full Medium and Long waveband coverage—Press button wavechange—Transistors used: 1—OC44; 2—OC45's; 1—OC82D; 2—OC82's and one diode. Internal ferrite rod aerial—Internal loudspeaker provides ample volume as a portable. Separate 8 x 5in. speaker is used in the car (supplied complete with 8 x 5in. baffle for easy fixing). Battery drain is exceptionally low, the life of the set's self-contained battery is approx. 200 hrs. Attractive finish in two-tone red and grey Vynalide washable material. Carrying handle folds away when not in use. Tuning scale is illuminated when set is operating in the car-tray. Size 9½ x 7½ x 3in. Bracket for padlock provides an effective thief deterrent. Compares with sets costing at least double. Properly installed this set will give you years of pleasure and service—both in and out of your car. Note: as a car radio this receiver operates ONLY from a 12-volt electrical system (positive or negative earth). As a portable it is powered by its own internal battery. All connections to car battery, speaker and aerial are automatically made simply by sliding into car-tray.

**WIRECOMP'S
PRICE**

£10.19.6

**COMPLETE WITH METAL TRAY, ALL CAR
FITTINGS, 8 x 5in. CAR SPEAKER & FULL
EASY-TO-FOLLOW FIXING INSTRUCTIONS. PP9 Battery 3/9 extra. P. & P. 7/6 extra**

LOOK AT OUR NEW PRICES!

THE COROVER '6'

This superb receiver uses the very latest circuitry, 6 transistors and two diodes and is fully tunable over both medium and long wavebands. First stage uses three Mullard AF117 alloy diffused transistors with OA79 and OA91 diodes. Output—OC81D and two OC81's in push-pull. I.F. frequency 470 Kc/s. Large internal ferrite rod aerial gives excellent reception over all ranges. 3 inch high flux speaker has a maximum output of 30mW. Operates on four 1.5 v. pen torch batteries. All components are mounted on a single printed circuit board. Attractive plastic case with carrying handle—fitted sockets for personal earpieces, tape recorder and car aerial. Size 8½ x 4 x 1½in.

MAY BE BUILT FOR £5.7.6 All parts sold separately. P. & P. 4/- extra. (Data and instructions 2/6, free if all parts bought.)

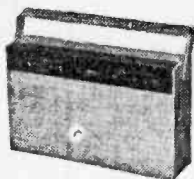

BUILD IT — TODAY!



The SPRITE

A unique Wirecomp offer. The Sprite is a six transistor superbet Miniature Pocket Radio of Commercial Quality—offered to you in three main pre-assembled kits—whilst together with simple wiring—enable you to build it in only one hour!

Fully tunable over Long and Medium wavebands. Uses printed circuit and High sensitivity internal ferrite rod aerial. I.F. frequency 470 Kc/s. Transistors: 3 Philips 267's, 2 Mullard OC81M's, OC81DM and OA90 diode. 3 inch speaker. Works on single PP3 battery. Supplied with the complete R.F. and I.F. stages. Driver and Output stages, ready built and mounted on the printed circuit; for final assembly you only have to fit the wave-change switch, tuning condenser and drive, volume control, earphone socket and aerial rod. In very attractive plastic case, size 4 x 2½ x 1½in. All parts sold separately.

THE 'REALISTIC 7'

A fully transistorised Portable Receiver made to the highest professional standards—is now available to the home constructor. Comprises 7 Mullard Trans. OC44, 2 OC45's, OC71, OC81D and 2 OC81's plus OA70 Crystal Diode. Delivers 350 milliwatt output to 4in. high flux speaker—I.F. frequency 470 Kc/s.—fully tunable over medium and long wavebands. All components mounted on single printed circuit board, size 5½ x 3½in. Attractive two-tone plastic cabinet with carrying handle—size 7 x 10 x 3½in. with easy to read dial and socket for car aerial, choice of Red/Grey, Blue/Grey or all Grey. Complete with full instructions. All parts sold separately.

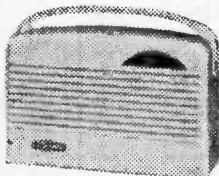

WIRECOMP'S PRICE ONLY £5.19.6 Battery 3/9 extra. P. & P. 4/6 extra. (Circuit diagram 2/6, free if all parts bought.)

WIRECOMP'S BARGAIN PRICE

79/6

Real Calf Leather Case, wrist strap and Personal Earphone with case and Battery, 12/6 extra.

P. & P. 3/6 extra. (Data and instructions 2/6, free if all parts bought.)

WIRECOMP ELECTRONICS

378 HARROW ROAD, LONDON, W9.

TEL: CUNNINGHAM 9530

Hours of business: 9 a.m. to 5 p.m. Open all day Saturday, Opposite Paddington General Hospital.

Buses 18B and 36 pass the door.

NOTICES

AUDIX B.B. LIMITED, of STANSTED, ESSEX, manufacturers of Audio and Sound Reproduction Equipment are Sole U.K. Distributors of Microphones. Accessories and Products manufactured by A. B. Pearl of Sweden and that no other Company has the right to act in this capacity.

RECEIVERS & COMPONENTS

British Components at Japanese Prices

Miniature Transformers 5/-
TT45 Driver TT46 Output, TT47
Driver, TT49 interstage.

NEW: TT52 matching 3 ohm
speaker input

TT53 matching crystal
mike input (6/-).

R.F. CHOKES, 2/6. CH1 2.5 mH

NEW: CH2 5mH, CH3 7.5mH,
CH4 10mH

REPANCO LTD.

203-269 Foleshill Road
COVENTRY

A.1. POST FREE Bargains. Guaranteed set tested Valves: EB91, EP80, 10P1, 9d. each, three for 1/6; L63 2/3; ECL80 2/6, three for 6/6; P230 3/6; EL38, PL33, PY31 3/6; PL32, PL33, PY30, PY82, PCF80 4/-; N37, 2T5U, PY31, 20P1, U281, U282, U191, KT36 4/6; 0P13, ECC31, ECC82, 10C2, 20L1, U31, PL81 5/-; 30P4, EL33, PL36, U07, 53KU 7/6; U801 8/3; 20P3 14/8. Transistors: brand new B.V.A.: OC71 5/-; OC72 6/-; OC44 6/-; OC45 7/-; OC170 9/6; OC171 10/6; AF115 10/-; AF114 11/-; AF115 10/6; AF117 9/6; 2,000 ohm phones 13/6 pair; stereo phones 27/6 pair; lin. brown knobs three for 4/-; Tuning conds., 0001mf 3/-; 0003 3/9; 0005 4/-; midjet type same price. **A.1. RADIO COMPONENTS**, 14 The Borough, Canterbury, Kent.

MARCONI CANADIAN
RECEIVER No. 52

(Brand New)

Magnificent 10 valve receiver in 3 wavebands covering 1.75-16Mc/s (19-170 metres), plus 3 valve crystal calibrator employing dual 100/1000kc crystal to provide marker check at 10-100-1000kc/s. 1 RF and 2 IF stages. Other refinements include valve check meter, internal 3in. speaker, RF-AF gain, Noise Limiter, BFO, Heterodyne Pitch, Wide/Narrow Bandwidth, Speaker or Phones, Man or AVC on CW and RT. Fast/Slow tuning with additional Oc. for fine adjustment. Power required: HT 160v 60mA, LT 12v 1/4. Circuit supplied.

RECEIVER (less case used) £4.19.6, carr. 15/6. Complete with Power Pack for 115/230 AC.

BRAND NEW. Mains and 12v d.c., £12.19.6, carr. 20/-.

Many other surplus bargains with **PERSONAL SERVICE**. Lists 6d. S.A.E. inquiries.

A. J. THOMPSON

"EILING LODGE"
CODICOTE, HITCHIN, HERTS.
Phone: Codicote 242.

RATES: 7/3 per line or part thereof, average five words to line, minimum 2 lines. Box No. 1/- extra. Advertisements must be prepaid and addressed to Advertising Manager "Practical Wireless", Tower House, Southampton St., London W.C.2.

RECEIVERS & COMPONENTS

(continued)

NEW VALVES! GUARANTEED!
DELIVERY BY RETURN!

EFB80	7/6	EL84	6/6	PCL84	7/3
EFB89	8/9	EY51	7/6	PL81	8/6
EMCC81	4/6	EY86	7/-	PY32	11/-
ECL80	5/9	EZ40	6/6	PY81	7/-
ECL82	9/-	PCC84	6/9	U25	11/6
EF85	5/9	PCC89	9/3	UY85	6/6
EF86	8/9	PCF82	7/-	6X4	5/-

Postage 6d. per valve extra.

S.A.E. FOR LIST OF OVER 200 TYPES
Over 10,000 valves in stock

LEWIS

46 WOODFORD AVENUE, GANTS
HILL, ILFORD, ESSEX
Telephone: Crescent 5685

EXCEPTIONAL VALUE: Picture Tubes, brand new, Mazda 19in., CML901, Mullard 19in., AW47-90/91, £4 10/-; Mullard 23in., AW59/90, £6 10/-; carriage (insured) paid, 12 months' guarantee. Note: All brand new. We also supply most other sizes completely regunned at £4/17/6, guaranteed 12 months. TOMLINS, 156 Lewisham Way, New Cross SE14. TLD 3857.

Glasgow Electronic Services

21 OLD DUMBARTON ROAD, GLASGOW G3
Telephone WEST 2642

Standard L.F. Transformers, 3:1 e.t. sec., 12/- ea; 5:1 e.t. sec., 12/6 ea. Midjet L.F. Intermediate Transformers, 3:1 ratio, 7/9 ea; 5:1 ratio, 8/- ea. Midjet L.F. Smoothing Chokes, 5H, 40mA, 6/- ea; 10H, 30mA, 6/- ea. Repanco L.F. Transistor Transformers, TT45, TT46, TT47, TT48, 5/- ea. Silenco Rectifiers, 125V r.m.s. in 500mA, 8/- ea; 250V r.m.s. in 500mA, 11/9 ea. Metal Rectifiers, 250V r.m.s. in at 250mA, 16/- ea; 125V r.m.s. in at 60mA, 6/- ea; 125V r.m.s. in at 120mA, 8/- ea. L.T. Rectifiers, 18V r.m.s. in 1A, 3/9 ea; 22V r.m.s. in at 2A 16/- ea. Meter Rectifiers, 10/9 ea. for 1, 5 or 10mA movement—state which required. Micro Switches, button or lever types, s.p.d.t. contacts rate 5A, 250V a.c. at 6/- and 8/9 ea. respectively. Morse Keys, ex W.D., with normal and back spacer contacts, 2/9 ea. Gaby Test Meter, 15 ranges to 1,200V, a.c. and d.c. to 300mA d.c., to 100k resistance, only 54/- ea. Jackson C804 Short Wave Variables, 250P, 6/9 ea; 500P, 6/9 ea; 750P, 7/3 ea; 1000P, 7/3 ea; 1500P, 8/- ea. Jackson Callband Dial, a mechanical bandspread dial, ratios 6:1 and 48:1, complete ready for own calibration, 25/- ea. Aco 40 Xtal Mike, 20/3 ea. Aco 45 Xtal Mike, 21/9 ea. Japanese Steik Mike, metal screened body, built-in switch, complete cable, lavaliere cord, etc., a beautiful job, 35/9 ea. Miniature Panel Meters, clear plastic cases, jewelled bearings, accuracy 2%, silvered dial, black numerals, 0-50 uA, 38/9 ea; 0-500 uA, 39/9 ea; 0-1mA, 97/9 ea; 0-5mA, 27/9 ea. Model 9000 Multimeter, 19 ranges, to 2,500V d.c. at 20,000 ohm per volt, 1,000V a.c. at 10,000 ohm per volt, coil, range current, resistance and capacitance ranges. A superb buy at 110/-. 814s Switches, subminiature, 2/3 ea; miniature, 2/6 ea. Miniature Edey V.C., 3k, 5k or 10k, less switch, 3/4; same values, with d.p. switch, 5/4 ea. Green Panels, miniature, 6-pin, 9d. ea; 18-pin, 9/6 ea. Transistors, 3 taze, 3d, ea; 7 taze 5d, ea; 28 taze, 1/4 ea. Osmor Chassis Cutters, cut 2 sizes with one punch and die, No. 1, 1" x 1", 23/-; No. 2, 1" x 1", 24/9; No. 3, 1 1/2" x 1 1/2", 27/3; No. 4, 1 1/2" x 2", 26/3 ea.

Terms of business: Cash with order. O.O.D. 3/- extra; postage extra under £3 total value. General list stamp 6d.

RECEIVERS & COMPONENTS

(continued)

DIRECT TV REPLACEMENTS LTD., largest stockists of TV Components in the U.K. Line Output Transformers, Frame Output Transformers, Deflector Coils for most makes. Official sole suppliers for many set makers. Same Day Dispatch Service. Terms C.O.D. or C.W.O. Send S.A.E. for quotes. Day and Night Telephone TIDeway 6666, 138 Lewisham Way, SE14.

HALF PRICE Transistors, Mullard OC44, OC45, OC81, OC81D, OC170, OC171, all 4/6 each, min. 4 doz. lots: OC28, OC36 12/6 each. Post. pd. C.W.O. **RADIOMEX**, 184 Kingston Road, Portsmouth.

BARGAIN IN V.H.F.
RECEIVERS

Ex-police, crystal controlled in approx. range 80 to 90 Mc/s. Built in 230v. A.C. Power Pack and 6in. Speaker. On 19in. rack panel 8 1/2in. high, dust cover. Valves 4 of KTW63, 3 of Z80 (EF50), D63, D163, KT63, 5U4G. Suitable for modification for 4 metres, etc. Supplied in good used condition, less crystal, **ONLY £3**, carriage paid. **NO FURTHER DETAILS AVAILABLE.**

CANADIAN MARCONI 52
RECEIVERS

1.75 to 16 Mc/s, £5.10.0, or complete with 230v. A.C. power unit, two pairs headphones and spare valves, etc., £9.10.0, carriage 1/-.
Send S.A.E. for leaflet.

G.W.M. RADIO LIMITED

40/42 Portland Road, Worthing, Sussex.

"HEATHKITS" can now be seen in London and purchased on easy terms. Free brochure, **DIRECT TV REPLACEMENTS LTD.**, Dept. P.W.7/9, 138 Lewisham Way, SE14. TIDeway 6666.

TRANSISTOR PARTS for 10.7Mc/s. matched set oscillator, three I.F. and discriminator transformers, plus audio drive transformer, plus misc. parts, 18/6 set. **RADIO SALES**, 11a Roe Green Lane, Hatfield, Herts.

ULTRA LINEAR AMPLIFIERS

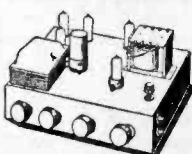

High Fidelity, 15 watts. Valves ECC83, ECC83, EL84, EL84, 2x2. Two inputs. Sensitivity 10 milli-volts. Bass & Treble controls, 3 & 15 ohms output. Kit, £6.10.0, plus 6/-

carr. Factory built, 29 plus 5/- carr. Similar 30 watt with 7 valves. Kit £9.10.0, plus 7/6 carr. Factory built, £12.10, plus 7/6 carr. Leaflet free.

COMPONENT BARGAINS. Transistors, genuine Mullard OC45, OC71, OC77, 3/9. S/H Speakers, 7 x 4in., 6in., 4/-, post 2/- or post up to 8 for 4/-; Turret tuners, for 16 Mc/s I.F. with plugs to convert BBC sets to I.T.A. any two coil strips fitted from channels 2, 3, 5, 10, 11, 12, 7/6, post 2/-. **Electronics**, 25/25v. 9d., 50+50+32/350v. 2/6, 40+80+20/450v. 3/-. Resistors 3/- doz. Bargain lists free.

STROUD AUDIO

Bath Road, Stroud, Glos.
Tel. Stroud 783.

RECEIVERS & COMPONENTS
(continued)

ALL TYPES LINE OUTPUT TRANSFORMERS SUPPLIED (RETAIL AND TRADE). Finest service in the country. Send S.A.E. for return of post service. Terms C.W.O. or C.O.D. Trade enquiries invited. **D AND B TELEVISION (WIMBLEDON) LTD.**, 131 Kingston Road, Wimbledon, SW19. CHerrywood 3955.

SPEAKER REPAIRS. Cones/Fields fitted. Clock coils wound. **L. S. REPAIRS,** Pluckley, Ashford, Kent.

FOR SALE

AMATEUR LICENCE Morse Course. The new Rhythm Method of teaching takes the 'Gruddery' out of learning Morse and is the quickest known! For full explanatory booklet: 6d. stamp G3CHS, 45 Green Lane, Purley, Surrey.

ALUMINIUM, BRASS, Copper and Bronze in sheet, rod, strip, tube, also Stainless Steel sheet. Any size cut. Complete price list 1/- **SLATER METALS (N.F.) LTD.**, 1 Slater Street, Liverpool 1.

GRUNDIG MA1 Transistor Tape Pre-amplifiers, suitable for use as microphone transformer, pick-up and tape head booster. Listed at 44 gns., offered at £2/17/6. Send for full details and free lists. **LEE ELECTRONICS,** 400 Edgware Road, W2 (Paddington 5521).

Corvair 6-Transistor Pocket Radios with all accessories, only 95/- each.

Sp1 Mains Soldering Irons, 15/- each.

T.V./F.M. Telescopic Aerials, 7/- ea.

BUMPER BARGAIN PARCELS
All Brand New. Not Ex-Gov. Contents plus many more items: 100 mixed resistors, 100 mixed condensers, volume controls, pre-set pots, tag strips, etc. This is a must, only 20/- post free.

100% Tested and Fully Guaranteed Transistors by Mullard and Mazda. All Brand New and these are not seconds.

OC44, OC45, OC81, OC81D, 3/6 each; OC170, OC171, 4/- each; ORP60, 7/- each; OC26, 12/- each; Red Spots, 1/3 each; XB103, XA102, 2/3 each; XC141, 6/6 each; XD210 Sub. Min. Diodes, 9d. each, 6/- doz.

S.A.E. FOR FREE BARGAIN LISTS

B. W. CURSONS
78 BROAD STREET
CANTERBURY, KENT

FOR SALE (continued)

XB103 Audio Transistors. All checked on our transistor tester. 3/6 each, 3 for 9/-.	SUB-MIN Earpieces. 3-5d with Lead and Jack Plug. 4/6 each, 3 for 12/-.	PLASTIC BOXES 3 1/2 x 2 1/4 x 1 1/2 in. "Snap Top" lid. 2/4 each, 3 for 6/-.
Tiny Resistors. 10Ω-10MΩ. 3d.	12 of one value 2/6.	
Postage 6d. per order.	STUART SPARES	34 Essex Rd., RUSHDEN, NORTHANTS.
	DI	Send 6d. stamp for Catalogue.

SPECIAL OFFERS — NO INTEREST TERMS
GARRARD Autotum Changer Cash £7.17.0 or 16/- dpt. and 12 pymts. of 11/9 monthly.
ARMSTRONG Jubilee Mk.11. Cash £28.5.0 or 67/- dpt. and 12 pymts. of 42/4 monthly.
ARMSTRONG Stereo 55. Cash £29.18.0 or 60/- dpt. and 12 pymts. of 44/10 monthly.
ARMSTRONG Stereo 12 Mk.11. Cash £40.5.0 or 82/- dpt. and 12 pymts. of 60/3 monthly.
A. L. STAMFORD Ltd. (Dept. F20)
36 WEYMOUTH TERRACE, LONDON E2
Phone: SHO 5903.

EXCEPTIONAL Transistor Portable Tape Recorder, value £6/19/6. complete with crystal microphone, earphone, spools, tape, batteries, instruction, presentation box (extra tapes 100ft. 4/6). Ideal gift. £6/19/6. Satisfaction guaranteed. Postage packing 2/6. **TOMLINS,** 156 Lewisham Way, New Cross, SE14.

ETCHING PRINTED CIRCUIT KIT

Consists of Plastic Bath and Case. Size 9 x 5 x 2 in. Contents: Solvent, Etchant, Resist, 100 sq. in. Copper Laminate Board. Comprehensive book gives examples and circuit layouts. 18/6 inc. post.

RADIOCENTRE
94 Hurst Street, Birmingham. Dept. P

WIRELESS EQUIPMENT B10 MK2 F.X.4840-4475 Mc/s. (6.2-6.7cm). First Government release of the B10 wireless equipment containing four independent units all working from 230 volts A.C., this equipment is of very recent manufacture still being used in the forces consists as follows.

Transmitter 10Mk2, power 230 volt A.C. stabilised HT, 12 valve transmitter with built-in wave meter variable tuned, tuning meter, £45.0. Carr. 7/6.

Reception Set R10, this set uses 18 valves having an I.F. input of 45 Mc/s manual tuning or built-in auto. tuning by internal motor, £47.6. Carr. 7/6.

Power Unit for receiver input 230 volts A.C. output (1) HT - 400 volts, F.V. valve rectifier (2) Bias—50 volts, both HT and bias supply are double choke smoothed, autotune motor transformer, channel switch plus output stage, £3.10.0. Carr. 7/6.
Oscillator testing No. 10, enabling the equipment to be used from a telephone line etc. 230 volts A.C. input having an internal F.V. HT supply, testing unit etc., £25.0. Carr. 7/6.

All these units are enclosed in a metal case size 17 1/2 x 8 x 10 in. All are brand new, we only have a limited quantity, circuit supplied with each unit. Carr. paid if all 4 units ordered. S.A.E. with all enquiries.

J. T. SUPPLY (Dept. N),
309 MEANWOOD ROAD : LEEDS 7

HOLIDAY NEWS. Electric Razor, 12V d.c. 230V a.c. inverter. "The Hiker" Portable. See your dealer. **REPANCO,** Coventry.

E. R. NICHOLLS BUMPER PARCEL

- 100 Assorted Resistors.
- 50 Assorted Condensers.
- 1 5in. 3 ohm Elac Speaker.
- 1 Isolating Transformer.
- 4 Terminal Blocks.
- 2 Rotary Toggle Switches.
- 1 Small Chassis containing 60 components.
- 2 Westcoats.
- 2 Thermistors.
- 100 Cartridge Fuses.

All for 20/- Post Free in U.K.
20ft. Steel Telescopic Mast. 50/-
High Stab Resistors 6d. each.
List now ready for Paper Block Condensers, Valves, Oscillators, Test Sets. S.A.E. Please.

Mail Order and Retail Shop:
46 Lowfield Road, off Shaw Heath, Stockport, Cheshire.

MISCELLANEOUS

CASES, CHASSIS, PANELS, CABINETS, FLUO-LAIR FITTINGS, etc. Any metal, any design to your drawings. Unpainted or Quality Stove Enamelled in ANY type of finish. Reasonable Prices. "One Offs" with pleasure. All work guaranteed. Also Engraved Labels on "Traffic" Black on White, White on Black. Quantity Orders Welcome. Trade Enquiries Invited.

J. WATSON
40 MOUNT PLEASANT STREET
OLDHAM, LANCs.

PWPWPW Printed Wiring. Prof work. Prac Wires ccts—any design, assembly or advice. Full details 6d. Box 46.

ELECTRONIC MUSIC?

Then how about making yourself an electric organ? Constructional data available—full circuits, drawings and notes! It has 5 octaves, 2 manuals and pedals with 24 stops—uses 41 valves. With its variable attack you can play Classics and Swing.

Write NOW for free leaflet and further details to **C. & S., 20 Maude Street, Darlington, Durham.** Send 2d. stamp.

SOUND RECORDINGS

TAPE BARGAINS in all sizes. Example: Top brand 5 1/2 in. 1,200ft. 19/6 p. and p. 1/3 S.A.E. for list. Large choice of New and Used Recorders. **E. C. KINGSLEY AND CO.,** 132 Tottenham Court Road, London, W1. EUS 6500.

(continued)

AERIALS

140ft. AERIAL INSTALLATIONS

First Government release of these brand new Marconi coil Aerial tuning systems, enabling operators to work their Receivers or Transmitters to their best efficiency. Containing a drum of 140ft. Copper aerial wire with insulators, etc., leading into the matching unit, size 13in. x 8½in. x 9½in., with slow motion tuning using Nos. 0-999. Originally intended for the 52TX-RX, a must for any poor reception areas and serious operators.

300 ONLY, 35/-

Post 5/-, two post free.

Dept. N., J. T. SUPPLY

309 Meanwood Road, Leeds 7

WANTED

A PROMPT CASH OFFER for your surplus brand new Valves and Transistors, R.H.S., Beverley House, Manville Terrace, Bradford 7.

ABSOLUTE TOP PRICES paid for Valves, Transistors, Components, etc., in quantity. Try us first. Cash by return. WOLVERHAMPTON RADIO AND TV SUPPLIES, 42 Darlington Street, Wolverhampton. Tel.: 20315.

WANTED VALVES ONLY

Must be new and boxed
Payment by return.

WILLIAM CARVIS LTD.
103 North Street, Leeds 7

WANTED: TEST GEAR. Meters, Valves, Components, Communication Sets, Amplifiers. HUGGETS LTD., 2-4 Pawson's Road, West Croydon, Surrey.

WANTED: NEW Valves and Transistors, any quantity. S. N. WILLETS, 43 Spon Lane, West Bromwich, Staffs. Tel.: WES2392.

NEW VALVES WANTED

Any type, any quantity

CASH PAID

R.S.T. Valve Mail Order Co.,
211A Streatam Road
Mitcham, Surrey
Telephone: MITCHAM 6202

METAL WORK

METALWORK. All types cabinets, chassis, racks, etc., to your specifications. PHILPOTTS'S METALWORKS LTD., Chapman St., Loughborough.

SERVICE SHEETS

TRADE SERVICE SHEETS offered by retired engineer. If I haven't got it you won't get it. All 4/- each by return. Please include large S.A.E. Mail orders only. ETZIONI, 80 Merrion Avenue, Stanmore, Middx.

SERVICE SHEETS for all makes of Radio and TV, 1930-1962. Prices from 1/- with free fault-finding guide. Catalogue of 6,000 models 1/6. 125 Radio/TV sheets covering many popular models 20/-. S.A.E. inquiries: HAMILTON RADIO, Western Road, St. Leonards, Sussex.

WHY TOLERATE DELAY when we can supply your Radio or TV Service Sheet by return of post at 4/- each plus postage. List 1/-. Also Manuals for sale and hire. List 1/- S.A.E. with inquiries, please. Mail orders only to S.P. DISTRIBUTORS, 44 Old Bond Street, London, W1.

FAULT-FINDING FILES showing common faults that each receiver is prone to and other useful servicing information 2/- each. List 9d. plus postage. Mail orders only. S.P. DISTRIBUTORS, 44 Old Bond Street, London, W1.

SERVICE SHEETS: Radio, TV, 5,000 models. List 1/-. S.A.E. inquiries: TELRAY, 11 Maudland Bank, Preston.

SERVICE SHEETS also Current and Obsolete Valves for sale. JOHN GILBERT TELEVISION, 1b Shepherd's Bush Road, London, W2. Phone: SHE 8441.

SERVICE SHEETS, Radio and TV, 4/- each. List 1/-. All orders dispatched on day received. Also Manuals for sale and hire. List 1/-. S.A.E. please: SULTAN RADIO, 29 Church Road, Tunbridge Wells, Kent.

SERVICE SHEETS Radio and TV, 4/- each post free. All types. Send S.A.E. for inquiries. D. AND B. TELEVISION (WIMBLEDON) LTD., 131 Kingston Road, Wimbledon SW19. CHE 3955.

BOOKS & PUBLICATIONS

THOUSANDS OF BARGAINS can be found weekly in the Radio, TV, Mechanics and Scientific Sections of EXCHANGE AND MART, 5d. every Thursday.

PIN-POINT TV TROUBLES IN TEN MINUTES. The title can be imitated but the contents never! The book that really tells you how to fix televisions. Over 340 cross-indexed pages. MUST be able to earn you more than its cost within two weeks or your money refunded. Price 33/- incl. postage. Write for free trial to SIM-TECH BOOKS, West End, Southampton, Hants.

FIND TV SET TROUBLES IN MINUTES from that great book "The Principles of TV Receiver Servicing", 10/6 all book houses and radio wholesalers. If not in stock from Secretary, I.P.R.E., 32 Kidmore Rd., Caversham, Reading, Berks.

SITUATIONS VACANT

A.M.I.Mech.E., A.M.Brit.I.R.E., City and Guilds, G.C.E., etc. brings high pay and security. "No pass-no pay" terms. Over 95% successes. For details of exams. and courses in all branches of Engineering, Building, Electronics, etc., write for 148-page handbook, free. B.I.E.T. (Dept. 242B), 29 Wright's Lane, London W8.

TV AND RADIO. A.M.Brit.I.R.E., City and Guilds, R.T.E.B. Cert., etc. "no pass-no fee" terms. Over 95% successes. For details of exams. and courses (including practical apparatus) in all branches of Radio, TV and Electronics write for 148-page handbook, free. B.I.E.T. (Dept. 242G), 29 Wright's Lane, London, W8.

CITY AND GUILDS (Electrical, etc.) on "no pass-no fee" terms. Over 95% successes. For details of Electrical Engineering, Applied Electronics, Automation, etc., send for our 148-page handbook, free and post free. B.I.E.T. (Dept. 242A), 29 Wright's Lane, London W8.

EDUCATIONAL

LEARN RADIO AND ELECTRONICS the new and practical way. Hosts of absorbing experiments carried out at home under expert guidance to teach you Radio in a new, enjoyable and interesting way. Construction, servicing and fault-finding on equipment made easy for the first time! No previous experience needed. No mathematics used. Free brochure from: Dept. 11, P.W., RADIO-STRUCTOR, Reading.

BECOME "TECHNICALLY QUALIFIED" in your spare time. Guaranteed Diploma and Exam. Home-study Courses in Radio, TV, Servicing and Maintenance, R.T.E.B., City and Guilds, etc. Highly informative 120-page Guide—FREE! N.I.E. (Dept. 363), 148 Holborn, London, EC1.

THE Incorporated Practitioners in Radio and Electronics (I.P.R.E.) Ltd. Membership conditions booklet 1/-. Sample copy of I.P.R.E. Official Journal 2/- post free. Secretary, 32 Kidmore Road, Caversham, Reading, Berks.

Radio Television & Electronics

Learn at home with the world's largest home study organisation, Brit.I.R.E.; City & Guilds; P.M.G.'s certs., etc. Also Practical Courses with equipment. All books supplied.

Write for FREE prospectus stating subjects to

I.C.S.

(Dept. 541), Intertext House, Parkgate Road, London, S.W.11.

(continued)

EDUCATIONAL
(continued)

THE MORSE CODE

can be memorised in less than one hour by the Coros System,

3/9 post free.

COROS

20 St Mary Street, Bridgwater.

"HOW AND WHY" of Radio and Electronics made easy by a new, non-maths, practical way. Postal instruction based on hosts of experiments and equipment building carried out at home. New courses bring enjoyment as well as knowledge of this fascinating subject. Free brochure from: Dept. P.W.12, RADIOSTRUCTOR, Reading.

$$X = \frac{-b \pm \sqrt{b^2 - 4ac}}{2a}$$

DON'T FUMBLE with Formulae. Master Mathematics quickly and easily the Understandable Way.



The Dryden School of **UNDERSTANDABLE MATHEMATICS**

11F6 Dryden Chambers, Oxford St., London, W.1.

Name _____
Address _____

RADIO OFFICERS see the world. Immediate sea-going appointments. Our many recent successes provide additional trainee vacancies during 1963. Day and boarding students. Grants and Scholarships available. Stamp for prospectus. **WIRELESS COLLEGE, Colwyn Bay.**

£'s MADE

By repairing Radio and TV Sets as a job or as a spare time business. Our practical course will show you the way. No previous experience is required.

SEND FOR FREE BOOK TODAY!

RADIOSTRUCTOR
Dept. G77 **READING, BERKS**

NOW ANYONE CAN AFFORD TO TRAIN TO BE AN EXPERT IN RADIO and ELECTRONICS

EVEN QUALIFY FOR A CERTIFICATE

It's the most exciting news of the year! Just imagine. You can get 35 large, fact-packed lessons for little more than 1/- per lesson! The lessons are crystal clear, practical, easy to master and use. Early lessons make fundamentals clear even to the beginner, while other lessons will give you the practical "know-how" of an expert.

Compares favourably with some courses costing ten times as much. You save because you receive all the lessons at one time and are not required to purchase equipment you do not need.

This is a real home-study course that has been bound into one giant 8 x 11in. 216 page manual. Each page is divided into two columns. A wide column features the text, while a narrow column at the side has the instructor's comments, helpful suggestions and additional pictures to simplify the difficult parts.

Everyone can benefit from this practical course! No old-fashioned (or pseudo modern) methods used here, just straight forward, easy to understand explanations to help you make more money in electronics.

As an optional extra, you may pay a further fee if you wish to take the Sim-Tech radio and electronics examination. Students who attain a minimum of 60% correct answers can qualify for a certificate of proficiency in basic radio and electronics. Details sent with each course ordered.

You must be convinced that this is the best value you have ever seen in electronic training, otherwise you can return the manual (or have your money refunded if sent with order) after you have examined it in your own home for a period of seven days.

The price! Only 36/-, plus postage.

FREE TRIAL OFFER!

To **SIM-TECH TECHNICAL BOOKS**, Dept. WA12, Gater's Mill, West End, Southampton, Hants.

RUSH Radio and Electronics Course for seven days examination. If I keep the course I can either pay 37/6d. cash or 12/6d. deposit after seven days and two payments of 12/6d. monthly. Otherwise I will return the course post-paid and owe nothing.

SAVE! Send only 36/- if paying cash with order. (We pay postage.) Same 7-day-money-back guarantee.

Name _____
Address _____
City _____ County _____

Lewis have the Cabinet for you

We can supply any cabinet to your own specification

This is only one example of—**THE LARGEST RANGE OF CABINETS IN THE COUNTRY**

Equipment is also our speciality.



The Grosvenor
Price 15 gns.

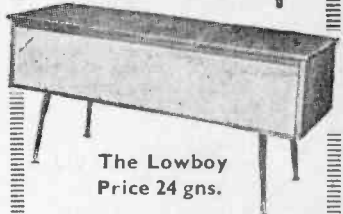

The Lowboy
Price 24 gns.

LEWIS radio

100 (P63) Chase Side, Southgate, London, N.14. Tel 3733/9666

Send today for the two new Lewis Catalogues

Designed to assist your choice of cabinet and equipment.

THE New Lewis Radio Cabinet Catalogue—the most comprehensive ever prepared. THE unique 64 page equipment catalogues.

Please send your two new catalogues enclosed in P.O. for 3/6 which will be credited against any purchase I make.

Name _____
Address _____
BLOCK CAPITALS PLEASE

OUTSTANDING OFFER! TAPE DECKS ONLY £5

(carriage paid)

B.S.R. MONARDECK

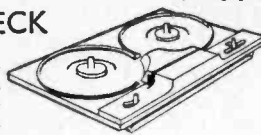

Surplus manufacturer's stock. 3 1/2 I.P.A. Fast forward and rewind. Takes up to 5 1/2 in. spools. For 200-250 v. A.C. mains. Fitted with 4-track heads. Low control knobs. Order now, while stocks last.

Tates

Dept. P.W.L. 5 Cromwell Street, SWINDON, Wilts.

A complete driving course for only 21s.!

THE LEARNER DRIVER

by Norman Sullivan



The book for everyone wishing to complete a learner driving course successfully. Covers every conceivable phase of learning to drive, everything necessary to pass the Driving Test. The author, an R.A.C. Registered Instructor, reveals the secrets of 25 years of successful instructing. A complete up-to-date driving course in one master volume.

304 pages - 162 illustrations

21s. FROM ALL BOOKSELLERS

... or, in case of difficulty 22s. 3d. by post from C. ARTHUR PEARSON LTD., Tower House, Southampton Street, London, W.C.2.

PEARSON

BBC · ITV · F.M. AERIALS



B.B.C. (BAND 1). Telescope loft. 19/6. External. S/D. 26/3.
I.T.V. (BAND 3). 3 Element loft array. 24/-. Wall mounting. 3 Element. 33/9. 5 Element. 41/3.
COMBINED B.B.C. + I.T.V. Loft 1+3 Element, 41/3. 1+5 Element, 48/9. Wall mounting. 1+3 Element, 58/9. 1+5 Element, 63/9. Chimney and mast mounting units also available.
F.M. (BAND 2). Loft "H". 28/-. 3 Element loft. 52/6. S/D loft. 12/6. External S/D. 26/3. State channel when ordering. C.W.O. or C.O.D. P.P. 2/6. Coaxial cable. 8d. yd. Coaxial plugs. 1/3. Send 6d. stamps for illustrated lists.

K.V.A. ELECTRONICS (Dept. P.W.)
 3B, Godstone Road, Kenley, Surrey.

REPANCO TRANSFORMERS FOR 10 WATT TRANSISTOR AMPLIFIERS

Type TT23 Interstage Transformer Ratio 4:1+1
 Secondary Resistance 2+2 ohms **22/6**
 Primary Resistance 3.5 ohms (P.P. 1/6)
 Secondary Bifilar Wound
Type TT24 Output Transformer Ratio 1.3+1.3:1+1
 Secondary Resistance 0.2+0.2 ohms **22/6**
 Primary Resistance 0.6+0.6 ohms (P.P. 1/6)

Primary Bifilar Wound. 15 ohm or 3.5 ohm output

Stack Size of Both Types 2 1/2" x 2 1/2" x 1 1/2"

Boxed Complete with 10 watt Amplifier Circuit

RADIO EXPERIMENTAL PRODUCTS LIMITED

33 MUCH PARK STREET, COVENTRY Telephone 27141

H.A.C. SHORT-WAVE EQUIPMENT

WHY is it that for 3 decades

H.A.C. SHORT-WAVE KITS

have been consistently demanded by so many constructors, amateurs, professionals and schoolboys. Because H.A.C. is undoubtedly the best. The circuits are simple, yet the results are fantastic. So easy to construct (or we do it for you). The secret is, of course, our vast experience, and also we use only the very highest grade of Short Wave components. (Not surplus.) We have been famous all over the world for 30 years, as suppliers of quality

SHORT-WAVE RECEIVERS AND KITS

H.A.C. were the original suppliers of Short-Wave receiver kits for the amateur constructor. Over 10,000 satisfied customers—including technical Colleges, Hospitals, Public Schools, Hams, etc.—in fact we receive many testimonials by every post, from purchasers of H.A.C. kits, who tell us that they regularly listen to stations from all over the world.

AUSTRALIA & AMERICA

the North Pole, and other expeditions and all at full strength. Your success like our products is

GUARANTEED

Improved designs with Denco coils: One-valve kit, model "C". Price 25/- Two-valve kit, model "E". Price 50/- Super sensitive all-day receiver. Special inc. price. Complete Kit, 77/-

All kits complete with all components, accessories and full instructions. Before ordering—call and inspect a demonstration receiver, or send for descriptive catalogue and order form to—

"H.A.C." Short Wave Products

Dept. T.H.

44 Old Bond Street, London W.1.

PADGETTS RADIO STORES

OLD TOWN HALL,
 KNOWLER HILL,
 LIVERSEDGE, YORKS.

Telephone: Cleckheaton 2866

COMPLETE TV SETS UNTESTED

Bush 14in. 13 channels, TV24C .. 30/-
 Bush 14in. 13 channels, TV43 .. 70/-
 Bush 14in. 13 channels, TV53 .. 75/-
 Pye 14in. 13 channels, V14C console .. 50/-
 Pye 14in. 13 channels, VT4 .. 50/-
 Philips 14in. 2 and 10 channels, 1446 .. 35/-
 We have 17in. TV Sets with rough cabinets, coils fitted 2 and 10, at 50/- Carriage on any TV Set 10/- per B.R.S. Well packed but sent at owner's risk.

Valves Removed from TV Sets. Tested on Mullard Valve Tester, and are 100% as new. Three months unconditional guarantee. POST FREE.

ECL80	4/-	10C2	5/-	PY80	5/-
ECC82	5/-	10P1	1/-	PY81	4/-
EY51	2/6	10P13	5/-	PY82	5/-
EBP80	4/6	10P14	5/-	PZ30	4/-
EB91	9d.	20D1	3/-	PCF80	4/6
EF91	9d.	20P1	5/-	PC84	4/6
6SN7	2/9	20L1	5/-	PCL85	2/6
696	2/-	185BT	8/6	PL83	5/-
6F1	1/-	U281	5/6	PL33	4/-
6F13	2/-	U282	5/-	536	4/-
6F15	5/-	U329	5/-	N37	5/-
6F15	5/-	KT33	5/-	GJ5	3/-
6LD20	5/-	PL81	5/-	27SU	5/-
PCL82	6/6	PL82	5/-	U12	4/-

EF80 1/6 or 10/- per doz. Grade 2 EF80 for test purposes, 4/- doz.

New Valves Ex Units. POST FREE.
 ARP12 1/6, 6 for 5/6, box of 50 20/-, IT3 2/-, AR3 2/-, APT2 2/-, APT1 2/-, APT3 2/-, 6K7 2/-, 6K8 4/-, 6L6M 7/-, 6V6 3/-, 6V6GT 4/6, VR150/30 2/6, 6C4 2/-, EL91 1/9, EF91 1/9, EF50 1/-, 6/- doz., 6F6 2/6, 5Z4 5/6, 6X5 4/6.

P.M. Speakers. Removed from TV Sets. All perfect condition. Rola and Plessey, 6 x 4in., 5/-; Goodman and R. and A. 7 x 4in. 6/-; Rola and R. and A. 6in. round, 3/6; 6in. Dish, round, 5/-; 6in. round, 6/-; Post on any speaker, 2/-.

TV Tubes Picture Tested. Reclaimed from TV Sets. 12in. 17/-, 14in. 80/-, Carr. 7/6. 6 months unconditional guarantee.

TYPE 46 SET complete with valves, less coils, crystals, and send-receive switch, but otherwise complete in new condition. 8/6. Grade two 4/6. Post 3/9.

WAVE METER BOX complete with Muirhead slow motion drive, 6/6. Post 3/6.
NEW BOXED UNITS. Type 230. Complete with 5Z4, Y63, magic eye, four EF50 and complete A.C. 230 volt Power Pack. 25/-, Carriage 7/6.

RES/CAP. BRIDGE 39/6

p. & p. 2/6

Checks all types of resistors, condensers 6 RANGES

Built in 1 hour. Direct reading.

READY CALIBRATED

Stamp for details of this and other kits.

Please write to:

RADIO MAIL (Dept. PM)

Raleigh Mews, Raleigh Street, Nottingham

STOCK TAKING SALE WHOLESALE PRICES

4-TRANSISTOR AMP. 200mV. Push-pull, type EG-2004, give away price, 39/11 (AS SOLD AT 52/9).
 REPANCO TRANSISTOR CIRCUITS & PLANS. Four different. 2/6
 REPANCO FR2 AERIAL. 10/-
 SOLID DIELECTRIC TUNING CONDS. 0.0001mFd. 2/8; 0.0003mFd. 3/3.
 CRYSTAL DIODES. 1/- each
 RESISTORS 10%, 5d. each. 1k Hi Stab 2%, 6d. each.
 CONDENSERS 16 + 16mFd. 450v., 3/3; 50mFd. 12v. 1/3; 0.1mFd 1000v., 10d.; 1B "00" 208/176. W/scr. 9/11.
 "SYNCHROTAPE" RECORDING TAPE, 800ft. 11/1
 P.W. 8/HET CABINETS. 5/11
 WHITE SPOT TRANS., 2/3; RED SPOT 3/3.
OAKFIELD RADIO
 121 MACCLESFIELD ROAD, HAZEL GROVE STOCKPORT

RADIO BOOKS

BASIC ELECTRICITY ELECTRONICS

In Simple straight-forward words and Clear Explanatory Pictures. The Reader is taken Step by Step from picture to picture.

EARN WHILE YOU PAY
FOR ONLY 2/6 PER WEEK
Officially used by the ARMY, NAVY and AIR FORCE, used by Trainees in the Radio and Electronic Industry.
Write for FREE Illustrated Prospectus giving details of instalment plan!

- 22 TESTED Circuits using Micro Alloy Transistors 5/6
- AT A GLANCE Valve and T.V. Tube equivalents 4/-
- BRITISH Transistor Directory (Bradley) 9/-
- OSCILLOSCOPE Book Using an Oscilloscope 5/6
- OSCILLOSCOPE Equipment 5/6
- MULLARD Transistor Radios 5/6
- MULLARD Ref. Transistor Circuits 13/6
- EXTRA Equipment Tape Recorder 6/6
- COIL Design and Construction 5/6
- TRANSISTOR Superhet 8/-
- TRANSISTOR Audio Amplifiers 6/6
- TRANSISTOR Circuits for Radio Control of Models 8/-
- PLD Servicing Instruments 5/6
- HIGH Fidelity L/Speaker Enclosures 5/6
- BOY'S Book of Crystal Sets 3/-
- SERVICING Transistor Receivers 8/-
- ELECTRONIC Novelties 5/6
- ELECTRONIC Gadgets 5/6
- RADIO Valve Data "Wireless World" 7/-
- BEGINNERS' Guide to Radio 8/6
- MODERN Transistor Circuits for Beginners 8/-
- TRANSISTOR Test Equipment 4/-
- MAGNETIC Recording. Wire and Tape 5/-
- COLOR Television. 40 Colour plates 17/-
- RADIO Engineers' Pocket Book 11/6
- TRANSISTOR Circuits for the Constructor (Bradley) Nos. 1, 2, 3 and 4. each 4/-

All above books include postage. SEND STAMP FOR LISTS.
SELRAY BOOK CO.
60 HAYES HILL, HAYES, BROMLEY KENT. Tel. URBatway 1818

FIRST-CLASS RADIO AND T.V COURSES..

GET A CERTIFICATE

After brief, intensely interesting study—undertaken at home in your spare time—YOU can secure a recognised qualification or extend your knowledge of Radio and TV. Let us show you how.

FREE GUIDE

The New Free Guide contains 120 pages of information of the greatest importance to both the amateur and the man employed in the Radio industry. N.I.E. provides first-rate postal courses for Radio Amateurs' Exam., R.T.E.B. Servicing Cert., C. & G. Telecoms., Grad. Brit. I.R.E. Guide also gives details of range of diploma courses in Radio TV Servicing, Electronics and other branches of engineering, together with particulars of our remarkable Guarantee of

SUCCESS OR NO FEE

Write now for your copy of this invaluable publication. It may well prove to be the turning point in your career.
FOUNDED 1885—OVER 150,000 SUCCESSSES

NATIONAL INSTITUTE OF ENGINEERING

(Dept. 461), 148 HOLBORN LONDON, E.C.1

D. & B. TELEVISION

Wimbledon LIMITED

131 & 131a, Kingston Road, South Wimbledon, London, S.W.19

PHONE: CHERRYWOOD 3935
Open MONDAY to SATURDAY, 10 a.m. to 7 p.m. (Except Wednesday, 1 p.m.)
Nearest Tube: South Wimbledon (North Line)
COMPARE OUR PRICES
For the Finest in the Country
YOUR PROBLEMS ARE OUR BUSINESS
MOST LINE-OUTPUT TRANSFORMERS

BRAND NEW VALVES			
CY31	14/8	E240	6/3
D191	5/6	E241	6/3
D196	8/-	E280	6/-
DAF91	5/6	E281	6/-
DAF96	8/-	E282	6/-
D177	4/8	G234	12/6
DK91	7/-	KT30C	6/-
DK92	7/-	PKC84	8/3
DK96	8/-	PKC85	8/3
D192	7/-	PCX89	8/3
D194	7/3	PCF80	8/3
D196	8/-	PCF82	8/6
EABC80	7/3	PCF86	10/6
EAF42	9/-	PCL82	9/3
EB91	3/8	PCL83	10/9
EM33	4/8	PCL84	9/-
EBCL41	9/-	PCL85	14/3
RF180	5/-	PL36	12/-
EBF89	8/-	PL38	18/8
ECF81	6/-	PL81	10/8
ECF82	7/6	PL82	7/6
ECF83	7/6	PL83	8/-
ECF84	7/6	PL84	8/-
ECF85	7/6	PY31	12/-
EF90	8/-	PY32	10/6
EF92	9/-	PY90	8/-
EGH42	9/-	PY81	7/3
EGH91	7/6	PY82	6/-
ECL80	8/3	PY83	8/-
ECL82	9/-	U24	10/-
ET36	4/-	U25	11/6
EP29	4/-	U26	9/-
EP80	6/3	U31	7/-
EP85	7/6	U37	12/6
EP86	9/-	U38	8/-
EP89	8/3	U191	12/-
EP91	3/9	U301	18/6
EP92	4/-	U801	25/-
EL32	4/3	UA843	8/-
EL33	9/-	UBC41	8/-
EL34	7/6	UCF80	10/6
EM34	6/3	UL41	8/-
EM80	6/9	UL48	8/-
EY51	8/6	U8	17/8
EY88	8/6	UY41	6/9

We pride ourselves that we can obtain and supply any T.V. spare. Please ask us for ANY component you may require we are almost certain to have them.

TERMS: S.A.E. all Inquiries. C.O.D. 3/- extra. C.W.O. Postage on Valves 6d. each. C.R.T.s 12/6 inc. Insurance.
SATISFACTION ASSURED. Return Post Service

SOUTHERN RADIO SUPPLY LTD.

11 LITTLE NEWPORT STREET LONDON W.C.2 GER 6653

All goods still available as previously advertised

2 METRES!

The thrills of 144 Mc/s can now be yours for only 39/6, complete kit! Tunable range 150-100 Mc/s. simplified construction, etc., write today for descriptive literature, also if a newcomer-beginner to Amateur Radio ask for free copy of the world-famous "Globe-King" kits and receivers—stamp to cover postage costs appreciated. Write now to makers:

JOHNSONS (Radio)
St. Martins Gate, Worcester

ULTRA VIOLET BULBS

Easy to use source of UV for dozens of practical and experimental uses.
12 volt 36 watt AC/DC SBC 9/6. P. & P. 1/-
12 volt 60 watt AC/DC SBC 9/6. P. & P. 1/-
Transformer to suit the above: Input 200-240 A.C. Output 12 volt A.C. 36 watt, 16/8. P. & P. 2/6. Input 200-240 A.C. 12 volt A.C. 60 watt, 22/8. P. & P. 3/6.

Set of 4 colours FLOUORESCENT Paint, Red, Yellow, Green and Blue in 1 oz. tins. Ideal for use with the above Ultra Violet Bulbs. 9/6. P. & P. 1/6.

BUILD AN EFFICIENT STROBE UNIT FOR ONLY 37/6.

The ideal instrument for workshop, lab. or factory. This wonderful device enables you to "freeze" motion and examine moving parts of stationery. We supply a simple circuit diagram and all electrical parts including the NSP2 Strobe tube which will enable you to easily and quickly construct a unit for infinite variety of speeds, from 1 flash in several seconds to several thousands per minute. New modified circuits bring price down to 37/6 plus 3/- P. & P.

NSP2 CV2396 STROBOTRON FLASH-TUBE made by Ferranti, brand new, 1.0. base. Price 15/- P. & P.

MAGNETIC COUNTERS 10 IMPULSES PER SECOND

Very latest High Speed type ex P.O. guaranteed perfect. Type No. 100B, coil 2,300 ohms. for 48 volt D.C. operation (will work on 36 volt D.C. general size 4 x 1 x 1 in. Also available, type 101A which can be used as an interesting accessory with our Strobe unit. Either type price 15/- P. & P. 1/6.



Variable Voltage Transformer

Input 230 v. A.C. Output 0-250 v. at 2.5 amp. Fully shrouded. New. £5.10.6. inc. carriage. Also available from stock, 5, 8, 10 and 20 amp. Write for details.

4,000 Ohm Headphones, brand new (imported). 12/6 each pair. P. & P. 1/6.

SIEMENS H.S. RELAY. Very latest type, sealed. 199E2. 1,700 ohms plus 1,700 ohms single C/O contacts. Price 16/8 each, plus P. & P.

6 VOLT 40 AH ACCUMULATOR, in metal case with leather carrying handle. New. Price 27/8, carriage 8/-.

500 MICROAMP SUB-MINIATURE M/C METER. 1 1/2 in. diameter, flush mounting, single hole fixing. Scaled 0-1 mA. Supplied with Resistor for use as 1mA if required. 25/6 plus 1/- P. & P.

250 VOLT A.C. GEARED MOTORS. Type B16G 80 r.p.m., 26 lb. inch, £1.19.6. P.P. 2/- Type D16G 5 r.p.m., 1.7 lb. inch, £2.9.6. P.P. 2/6. Type D16G, 13 r.p.m., 1.45 lb. inch, £2.12.6. P.P. 2/6.

12 v. D.C. Reversible Motor with tremendous power weight ratio. 3 position switch. Weight 2.1 ounces. Size 1 1/2 in. dia. Speed 7,000 r.p.m. Self lubricating. 15/- plus 1/- P. & P.

AVO METER MODEL 7. Individually tested on all ranges and guaranteed. Inclusive of Test Leads. £11.0.0 each. P. & P. 5/- Case 20/-.

MINIATURE LEAD ACID ACCUMULATOR (Brand New) 2V, 1.5 A.H. Size 4 x 1 1/2 in. Wt. approx. 1 lb. 16/8 for 3. P. & P. 1/6. 12V, 0.75 A.H. Size 4 x 3 x 1 1/2 in. Wt. approx. 2 lb. (can be used as double 6V). 15/6 each. P. & P. 1/6.

TRANSISTORS			
OC30	10/-	OC78	6/-
OC41	7/-	OC77	9/-
OC45	5/-	OC139	12/-
OC45	9/-	OC170	9/6
M.Pair		OC171	10/6
OC71	5/-	OC200	10/6
OC72	7/-	OC201	21/-
OC72	14/-	OC202	8/-
OC73	6/-	OC104	6/-
OC75	7/-	OC105	10/-
Get 114	5/-		
Get 573	12/6		
Get 573	25/-		
M.Pair			
2N135A	4/-		
2N458	20/-		
28505	30/-		
28503	10/-		
SB345	7/6		
TK20B	4/-		

SERVICE TRADING CO.

All Mail Orders also callers.
47-49 High Street, Kingston on Thames
Tel.: KINGSTON 9450
Personal callers only
9 Little Newport Street, London W.C.2
(off Leicester Square)
Tel.: GERARD 0576

A NO. 4 SET

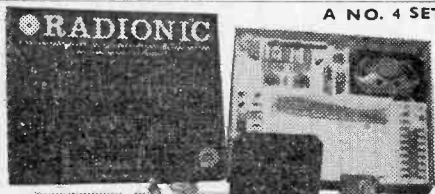

RADIONIC CONSTRUCTIONAL AND EXPERIMENTAL SYSTEM

SENSATIONAL! NEW! SIMPLE!

The Radio and Electronic construction system you have been waiting for. With top quality components mounted on colour-coded plastic bases, perforated transparent panel, perforated brass connecting strip and screw connections for positive contact you can quickly build any circuit and check it at a glance. Peak performances achieved.

NO SOLDERING—NO SPECIAL SKILLS—NO MAINS—FULLY ENGINEERED—COLOUR-CODED MOUNTINGS—FIRST CLASS COMPONENTS—MULLARD TRANSISTORS—PROGRESSIVE—FLEXIBLE—EXPERIMENTAL—INSTRUCTIONAL—IDEAL RESEARCH FACILITY—RADIONIC NEWS LETTER.

Set No. 1. £5.18.6.

14 Circuit Sheets.
Diode Detector and two Amplifier stages;
Transistor Detector and Amplifier; Multi-vibrator;
Regenerative Receivers;
Earphone operation.

Set No. 3. £10.19.6.

22 Circuit Sheets.
High quality Push-Pull Amplifier and 11,000 lines 7x4 inch 3 Ω loudspeaker convert circuits 1-20 to loudspeaker operation.
Amplifier can be operated from microphone or gramophone pick-up.

Set No. 2. £6.19.6.

20 Circuit Sheets.
Circuits of Set No. 1 plus capacity reaction;
T.R.F. and Reflex Receivers;
Earphone operation.

Set No. 4. £14.19.6.

26 Circuit Sheets.
Builds high quality six transistor superheterodyne receivers, as well as circuits of sets 1-3.

Postage and Packing extra on each of the above.

Sets or Separate Components available direct from Radionic Products Limited; Sets also available from authorised Retailers. **TRADE ENQUIRIES ARE INVITED.**

Full Details and price lists from:

RADIONIC PRODUCTS LIMITED

ADASTRAL HOUSE, NUTFIELD, Nr. REDHILL, SURREY

Telephone: Redhill (RL6) 5050 Telex: 21433

6-TRANSISTOR SUPERHET

4-STAGE REFLEX



COMMUNICATION RECEIVERS
CR100/8 MOD. Covers 80 kc/s-30 Mc/s in 6 bands. 11 valves, 2 R.F., and 3 I.F. stages. Crystal gate, E.P.O., etc. Ready for 200/250 volt a.c. mains. 2½ watts output for 3 Ω speaker. **BRAND NEW**, in original packing. £35, carr. £2. S.A.E. for illustrated details.

HRD SENIOR RECEIVERS. Complete with 9 coils, £17.10.0. S.A.E. for full details.
PCR-3 RECEIVERS. 3-wave bands, medium wave and 2 short wave, from 120-13 metres. Good condition, tested 8 gns. Carr. 10/-. A.C. mains internal power supply £2 extra.

SILICON RECTIFIERS. Type 1EA2 (1 x 1½ in.) will handle 250 volts at up to 500mA. Replaces any TV metal rectifier. 7/6.

MOVING COIL PHONES. Finest quality Canadian with Chamois ear muffs and leather-covered headband. With lead and jack plug. Noise excluding, supremely comfortable. **BRAND NEW.** £2/6, post 1/6.

AVO I, C & R BRIDGE. Capacity 5 pF to 50 mF. Resistance 5 Ω to 50 Ω. Inductance can be measured against external standard. Balance is indicated on a meter which can be used as a valve voltmeter from 0.1 to 15 v. Leakage test and Power Factor scale. A.C. mains operation. Tested and guaranteed and in superlative condition. £9.10.0, plus 5/- P. & P.

WAVEMETER W-1191A. A crystal checked, self-contained heterodyne frequency meter similar to the BC-221. Covers 100Kc/s to 20Mc/s (harmonics to 40Mc/s). Requires 60V HT and 2V LT acc. Output signal has optional modulation for use as Sig. Gen. Accuracy 0.1%. Complete with instructions, individual calibration charts, valves and Leclor's crystal, in **BRAND NEW** condition. 79/6, carr. 5/6. Complete set of 4 spare Valves, 10/- extra.

AERIAL KITS. Comprising seven 4ft. aerial rods making a 16ft. and a 12ft. aerial. There is also an aerial base with a ground spike. All in a steel carrying tube with web strap. 22/6, carr. 4/-.

POWER UNIT TYPE ZE-12. The original power supply for the Canadian 52 set receiver. Operates from AC mains 115/230 and also from 12V car batt. if desired. With connector for 52 set. **BRAND NEW.** 59/6, carr. 5/6. Spare valves for 52 Set. 8 x ARP-3, 2 x 12X4, 3 x 12SC7. **BRAND NEW/BOXED.** £1.

MULTIMETER SPECIAL. MODEL CT-500. 20,000 Ω/V. DC volts: 0 to 2.5-10-50-250-500-5,000 (20K Ω/V). AC volts: 0 to 10-50-250-500-1,000 (10K Ω/V). DC Current: 0 to 50 μA, 5mA, 50mA, 500mA. RESISTANCE: 0 to 12K Ω, 120K Ω, 1.2M Ω, 12M Ω. Mid scale 60, 600, 6K, 60K ohms. Decibels -20 to +62. In neat moulded case 5½ x 3½ x 1½ in., with leather carrying handle, complete with batteries, leads and instructions. **BRAND NEW.** Full guaranteed. 95/- P. & P. 2/6.

CHARLES BRITAIN (RADIO) LTD.

11 Upper Saint Martins Lane, London, W.C.2

TEMPLE Bar 0545

Shop Hours 9-6 p.m. (9-1 p.m. Thursday),
Open all day Saturday.

DUKE & CO. (LONDON) LTD.

621/3 Romford Road, Manor Park, E.12
Liverpool St.—Manor Pk.—10 mins.

Phone
ILFord
6001/2/3



COMPLETE TELEVISIONS

14 INCH 100% 17 INCH
£7.10.0 Guaranteed £11.10.0

12 months' Full Written Guarantee.

Shown working all channels in Shop. Legs—39/6 per set.

Personal collection advised, or insured. Carr. 14in., 20/-, 17 in., 30/-

Part exchange allowance on ANYTHING USEFUL



SPEAKERS 7/9 each

6in. 8in. 7in. x 4in. Money back guaranteed. Other sizes, few only.
Ex. mfd. salvage. P.P. 2/3.

EXTENSION SPEAKERS 19/9

2-tone covered cabinet, PM speakers, switch and flex. Ideal for kitchen, sick-room, etc. P.P. 3/3.

Tape Recorder Cabinet 20/- to take B.S.R. or Collaro Studio Deck. Two tone colours. P. & P. 5/-.

Condensers. 100—10/- New Assorted electrolytics & P.Fs.

Regunnd TV TUBES
21 in. 99/6 17 in. 79/6
15, 14 and 12in.—59/6
GUARANTEED ONE YEAR
Ins. and Carr. 10/6.
Add 10/- refundable on OLD TUBE. 110° Tubes in Stock.

Ex Rental T.V. Tubes
36/24, 14K P4, 141,
121, 31/74 and others.
Set tested. Carr. 5/-

VALVES 9d. each. 40—£1
Thousands of Valves available P.P. on 1-4 6d., 12 1/6
LATEST LIST (stamps only)

TELEPHONE HANDSETS 15/6 pair.

G.P.O. standard pattern. House to Workshop, garage, inter-office, etc. Works off any small battery. P. & P. 4/6.

Tubes

HIGHEST QUALITY—
COMPARE OUR PRICES

Carr. & Ins. 12/6	GUARANTEED		NEW TYPES
	6 Months	12 Months	
MOST MULLARD, MAZDA, COSSOR, EMITRON, EMISCOPE, BRIMAR, FERRANTI TYPES PROCESSED IN OUR OWN FACTORY	12in. £2. 0.0	£3. 0.0	MW 31/74 £3.15.0
	14in. £2.10.0	£3.10.0	MW 36/24 £4.15.0
	15-17in. £3. 5.0	£4. 5.0	CRM 172 MW 48/84
	21in. £3.15.0	£5.15.0	£6.0.0

4ft FLUORESCENTS
G.E.C. BLENDORA 40 watt elegant shining complete with starting equipment. Beautiful contemporary finish. P. & F. 4/-
39/-

100 RESISTORS 6/6
Excellent. Sizes 4-3 watt.

100 CONDENSERS 10/-
Miniature Ceramic and Silver Mica Condensers. 3 pF to 0.000 pF. LIST VALUE OVER £5.

12 POTS. Popular values. 5K to 2 Meg. Unused, mited, preset, long arc, switched, etc.
CONDENSERS. 25 Mixed. Electrolytic. Many popular sizes. 1st Value £5. Our Price **10/-**

SILICON RECTS.
250V 500mA standard TV replacement. Top quality 8/6 (3 for 24/-).

13 CHANNEL T.Vs.
Table Models. Famous Makes. Absolutely Complete. These sets are unequalled in value due to huge purchase direct from source. They are untested and not guaranteed to be in working order. Carr. etc. 15/-.
12in. **£2.19.0** 17in. **£6.19.0**

SPECIAL TEMPORARY OFFER.
Due to huge Bulk Special Purchase we are offering MW 31/74 Tubes at the unrepeatable price of 29/- MW 36/24 ditto. 38/- P.P. 12/6. The above are guaranteed for 6 months.

P.M. SPEAKERS. 3 ohm
Top Makers.
6in. **7/6** 5in. **8/6**
8in. **7 x 4in. 8/6**

VALUE!
4 watt AMPLIFIERS
excellent amplifier with high gain preamp stage, 10P3 driving 10P14 output stage, complete with 8in. tone base, Tone control, negative feedback, ready for immediate use, individually tested. Amazing volume and clarity. Ideal for guitars, record players, etc. In small halls, baby alarms etc. Easily worth £5. Our price whilst stocks last. Carr. Packing, etc. 7/6. **45/-**

CO-AX. low loss, 8d. yd., 25 vils., 11/6, 50 vils., 22/-, 100 vils., 42/6. Co-ax. 50 vils. yds. Wall outlet boxes 3/6

ALL WAVE RADIOS

Guaranteed 3 Months

VERDI 55. FULL 5 VALVE A.C. MAINS SUPER-SENSITIVE SUPERHET.
High quality modernistic panel and gold cabinets. Very compact. Wavebands 18-50m 180-550m, 700-2000m, ferrite aerial and throat aerial. Smooth slide motion tuning High fix 4in. speaker. AMAZING S.W. PERFORMANCE. CLARITY, VOLUME. Standard miniature valves. Easily serviced. Standard layout. Truly unusual value and UNRIVALLED FEATURES absolutely **7 2 Gns.**



VERDI 54. As above but medium and long wave only. **6 1/2 Gns.** each.
VERDI 53. As above but medium and short wave only. **6 1/2 Gns.** each.

HIGH STAB. RESISTORS. 250,000 in stock including 1% Tolerance. 100's of values. A must for high grade equipment, our selection 50 for 8/- Your selection (min. qty. 4) 6d. each.

3 VALVE AMPLIFIERS. Kit of new parts, consisting chassis mains and output transformers, valves (6E1, 6X4, 6X5) and all components. With full instructions for making high gain amplifier with separate bass and treble controls, negative feedback, etc. Truly unusual value at **29/-**

AM/FM RADIOS

Fantastic offer. 7 valves plus 3 diodes. Contemporary Cabinet. Top quality and finish. A.P.C. A.V.C. Absolutely complete. Guaranteed 3 months. **£11**

14in. TVs. Carr. 12/6. With CRM 14 Tubes. Absolutely complete, tested for raster. Famous make, large purchase enables us to offer them at **£4.19.0**

TELEPHONE C.O.D. ORDERS DISPATCHED THE SAME DAY.

TRANSISTORS
Guaranteed Top Quality
Huge reductions. Red Spot standard L.F. type now only 1/6; White Spot R.P. 2/-; Mullard Matched Output Kits (OC81D and 2-OC81A), 12/6. Receiver Kits, OC44, OC46 (2), OC81D, OC81E, etc. Transistors.
AF17 7/- OC44 5/6 OC81D 5/6 AF127 9/6 OC45 6/- OC170 8/6 OC28 12/6 OC75 5/6 OC171 8/6 OC36 14/- OC81 5/6 XB104 5/6

6 TRANSISTOR SCOOP
Receiver sets, top make, guaranteed, equivalent OC44, OC45 (2), OC81D, OC81 (2). **12/6**

★ GUARANTEED VALVES ★

by return of post
THE MOST ATTRACTIVE COMPETITIVE VALVE LIST IN THE COUNTRY
All valves are new and unused unless otherwise advised

POST 3 MONTHS' FREE TRANSIT INSURANCE. Satisfaction or Money back Guarantee on Goods if returned within 14 days.

1 Valve 6d., 2-11, 1/-	FREE	TRANSIT	INSURANCE.	Satisfaction	or Money back	Guarantee	on Goods if	returned	within 14	days.	
0Z4	4/6	6K7	5/9	90D1	8/9	DL32	9/-	EZ40	6/6	E92	6/9
1A7GT	4/6	6K7G	2/-	20F2	9/6	D192	5/6	EZ41	6/9	E94	12/6
1CG5GT	7/6	6K8GT	4/6	20L1	16/6	D184	8/6	EZ80	5/9	U25	10/6
1D5	7/-	6K8G	5/-	20P1	9/6	D196	7/6	EZ81	6/-	U26	8/6
1D6	9/6	6K8GT	8/3	20P3	12/6	E450	1/3	EW4/500	7/-	U31	17/6
1H5GT	9/9	6K25	8/6	18P4	6/6	EAC30	6/6	EZ82	6/6	U33	14/6
6A	3/-	6L1	9/6	20P5	15/-	EAC91	4/6	GZ32	5/6	U35	12/6
1LD5	4/6	6L6	7/6	25A6G	8/-	EAF42	6/3	GZ34	11/6	U37	26/6
1LN5	4/6	6L6G	8/6	26L6GT	7/9	EB34	1/3	HK90	9/6	U50	4/9
1N5GT	8/9	6L18	7/9	26V5G	8/-	EB41	5/6	HL41DD	8/6	U52	4/9
1R5	5/6	6L19	12/6	25Z4G	7/-	EB1	3/6	HM309	19/-	U76	5/6
1D5	5/6	6L20	7/6	25Z5	8/6	EB33	4/9	HVR2	9/-	U78	4/6
1S4	7/6	6N7	7/6	25Z6G	8/-	EB41	7/6	KT32	6/9	U107	12/6
1S5	4/6	6P1	0/8	27S10	17/6	EB081	7/9	KT33C	4/-	U191	11/6
174	3/-	6P25	9/6	30C1	0/9	EBF80	7/6	KT36	14/-	U291	9/6
2D21	5/6	6P28	9/9	30C15	11/6	EBF53	9/6	KT44	6/-	U382	15/6
3A4	3/6	6Q3	5/6	30F5	6/6	EB08	7/6	KT45	8/6	U301	12/6
3A5	8/9	6Q7GT	8/-	30P1	9/6	EBL21	9/9	KT61	8/6	U309	6/6
3D6	4/-	6R7G	9/-	30L1	6/6	EBL11	17/6	KT63	4/6	U329	9/6
3Q4	7/-	6SA7	5/9	30L15	8/9	EC02	4/9	KT66	13/6	U339	11/6
384	6/-	6SC7	4/9	30P4	9/6	EC51	4/6	KT76	8/6	U404	9/6
3V4	6/6	6SG7	7/6	30P22	7/6	EC02	9/6	KT81	6/6	U401	19/6
3V4G	9/6	6SH7	3/-	30P19	13/6	EC31	7/6	KT82	6/6	U4BC30	7/6
5T4	8/-	6S17	5/-	30P13	9/6	EC32	4/6	KT65	5/9	U4F42	7/-
5U4G	4/9	6SK7	5/-	30P13	9/6	EC33	4/6	KT263	11/-	U441	7/6
5V4G	7/6	6SL7GT	5/9	30C5	9/6	EC34	9/6	L83	3/-	UB41	7/6
5Y3G	9/6	6SS7GT	4/6	35L6GT	8/-	EC35	5/9	LN152	6/6	UB32	7/9
5Y3GT	5/6	6ST7	4/6	35P22	8/6	EC36	9/6	LN114	11/-	UBF90	7/6
5Y4G	9/6	6SN7	3/6	35Z4G	5/6	EC81	4/9	N37	10/6	UBF99	7/6
5Z4	9/-	6U4GT	9/6	35Z5GT	7/-	EC02	8/9	N78	13/-	UBL21	12/6
6Z4G	7/-	6V8G	4/6	41	6/6	EC03	6/-	N108	13/-	U092	8/6
6Z4GT	9/6	6V8GT	6/-	42	6/6	EC04	7/6	N152	8/6	UC034	12/6
6X0L2	9/6	6X3G	5/-	50C2	5/6	EC35	7/6	PC044	6/6	UC042	18/6
6A4	3/6	6X3G	5/-	50C5	8/6	EC08	11/6	PC1	2/9	UCF80	13/6
6A7	9/-	6X5GT	5/6	50L6GT	7/6	ECF80	8/3	PABC80	8/-	UCH21	9/3
6A8G	7/6	6X8G	7/6	53K1	9/6	ECF82	8/3	PC78	11/6	UCH24	7/3
6A8GT	12/6	7B5	9/-	61B7	17/6	ECH21	11/6	PC87	9/6	UCB61	7/9
6AC7	6/6	7B7	7/9	61SPT	11/-	ECH35	7/6	PC044	6/6	UC042	18/6
6AG5	2/6	6C5	7/3	60B7	13/6	ECH42	9/6	PC085	7/9	UCL83	12/6
6AG7	2/6	6C7	7/6	75	5/6	ECR81	7/-	PC088	11/9	UF41	7/6
6AK5	5/-	7H7	7/6	75	5/6	ECH83	8/6	PC089	8/6	UF42	6/6
6AL5	3/3	7S7	8/9	80	5/6	ECLO6	9/6	PC199	13/6	UF80	7/6
6AM6	3/-	7Y4	5/-	83	9/6	EC32	5/6	PCF80	6/9	UF45	9/9
6AQ5	6/-	7Z4	5/-	18S2T	19/6	ECF83	10/6	PCF82	7/6	UF86	14/6
6AT6	5/-	8D3	3/-	18S2A7A	19/6	EC186	10/3	PCF84	12/-	UF89	7/-
6AU6	7/-	10C1	11/6	807(A)	5/-	EF22	2/-	PCF86	11/-	UL41	7/6
6AV6	5/6	10C2	14/6	807E	4/9	EF36	3/3	PC182	7/3	UL44	14/6
6B7	5/6	10P1	4/9	813	4/9	EF7A	7/6	PC183	6/6	UL45	9/9
6B8G	3/-	10P9	10/6	832	14/-	EF93	4/6	PLS24	7/3	UL84	7/-
6BA6	5/6	10F18	10/-	866A	12/6	EF40	11/-	PLC85	10/6	UM80	9/6
6BE6	3/6	10LD11	14/6	954	3/9	EF41	8/6	PLC86	10/6	UR1C	7/6
6BG6G	6/-	10P13	8/6	955	2/3	EF42	6/9	PE225	3/9	U06	12/6
6BH6	8/-	10P14	9/6	956	2/3	EF60-BR16	6/6	PE245	8/6	U17	9/6
6BR6	5/6	10P18	6/6	955	8/6	EF61(A)	2/6	PE246	6/6	U18	13/6
6BR7	8/6	12A6	2/3	9783	7/6	EF54	3/3	PL36	9/6	UY1N	11/6
6BR8	9/6	12A8H	9/-	9901	3/6	EF41	8/6	PL63	9/6	UY21	6/6
6BW6	6/9	12A7E	6/6	9902	4/9	EF55	6/-	PL38	17/6	UY41	6/6
6BW7	5/-	12A7	5/6	9903	5/9	EF58	7/6	PL81	8/6	UY85	6/-
6C4	2/3	12A16	9/-	ATP4	2/9	EF89	6/9	PL82	6/6	UY88	6/-
6C5	3/6	12A17	6/-	AZ31	7/6	EF91	3/-	PL83	6/6	VP28	2/9
6C6	3/6	12A16	6/9	AZ41	7/-	EF92	3/-	PL84	7/6	VP41	6/6
6C9	11/-	12A27	6/6	836	6/9	EF183	9/9	PL890	8/3	VR105	6/6
6CD8G	17/6	12BA6	7/-	C1C	8/6	EF184	8/6	PM84	9/6	VR150	6/6
6CH8	8/6	12C18	6/6	CC35	13/6	EF82	6/6	PK22	12/6	W6	4/6
6D2	3/3	12BH7	8/9	CL33	3/3	EL32	3/9	PK25	9/-	WS1	7/6
6D3	9/6	12C8	5/6	CY31	7/6	EL33	3/-	PY31	8/-	XB11	11/6
6D6	3/-	12E1	17/6	DT7	3/3	EL34	11/6	PY32	10/6	XB3	8/6
6F1	4/9	12H18	1/9	DA30	11/6	EL35	6/-	PY33	11/-	X65	11/6
6F6	7/6	1215GT	7/3	DA02	8/9	EL35	12/6	PK2	12/6	W6	4/6
6F6G	4/6	12T1	8/6	DAF91	7/6	EL41	2/6	PY81	6/9	X76M	11/6
6F13	4/9	12K7GT	4/6	DAF96	7/3	EL42	7/9	PY82	5/9	X78	21/6
6F14	9/6	12K8	9/9	DF33	8/9	EL81	8/9	PY83	6/9	X79	21/6
6F15	9/6	12K8GT	9/9	DF91	3/-	EL84	8/6	PY88	9/-	XB11	9/6
6F19	6/-	12Q7GT	4/6	DF98	7/3	EL85	8/9	PF800	9/6	X88	9/6
6F32	4/6	12S7	7/-	DF99	7/6	EL85	8/9	PF2	9/6	Z83	4/9
6F33	4/-	12S7G	4/6	DI63	6/6	EL95	6/6	R19	9/6	Z86	8/6
6H5	1/6	12SH7	3/6	DI76	4/6	EM34	8/6	RL18	11/-		
6J5	4/3	12S17	5/6	DK32	9/6	EM89	7/9	SP41	2/3		
6J6G	3/-	12S17G	4/6	DK91	5/6	EM81	8/6	SP61	2/-		
6K5	4/6	12S7GT	6/9	DK92	7/6	EM84	8/6	SP25	15/6		
6L6	3/6	12S27	8/6	DK96	7/3	EM85	9/6	SD150	4/6		
6L7	8/6	13D3	5/6	DL33	7/6	EN31	16/-	T41	6/6		
6J7G	4/9	14S7	14/6	DL35	7/6	EY51	7/6	TD4	8/6		
6J7GT	7/6	19A45	7/9	DL83	8/-	EY86	7/3	U14	7/6		
6K6GT	6/-	19B6G	14/-	DL75	8/-	EY88	9/6	U18	7/6		

Post: 2 lbs. 2/-, 4 lbs. 2/6, 7 lbs. 3/6, 15 lbs. 4/-, etc. (C.O.D. 2/- extra). ALL ITEMS LESS 5% AND POST FREE IN DOZENS. Send 6d. for list of 1,000 numbers.

TECHNICAL TRADING CO.

RETAIL SHOP
350-352 FRATTON ROAD, PORTSMOUTH
MAIL ORDER ONLY DEVONIAN COURT,
PARK CRESCENT PLACE, BRIGHTON 7, SUSSEX.

★ TRANSISTORS ★ ZENERS ★ VALVES ★ QUARTZ CRYSTALS ★ THESE ARE OUR SPECIALITIES!

EQUIVALENTS, DIAGRAMS, DETAILS AND INFORMATION IN OUR LATEST 54-page CATALOGUE, 1/6 Post Free

TRANSISTOR PORTABLE SIGNAL GENERATOR



PRICE
£7.10.0
P.P. 2/6

A 1st class Signal Generator covering 220 Kc/s to 200 Mc/s in 8 ranges. Radio broadcasts and I.F., Amateur, VHF. Shipping, TV, etc. R.F., I.F., A.F., modulated R.F. outputs. Easy to read and use, with full details. Within 2% accuracy. Size 6 1/2 x 4 1/2 x 2 1/2 in. **12 MONTHS' GUARANTEE** Leaflet on Request.

FIELD STRENGTH METER

Five channels cover 1 Mc/s to 200 Mc/s. Fitted 200 microamp meter for CW or RF. Indication and Earphone for AF monitoring. Designed for checking all types of transmitters. Size 4 x 2 1/2 x 2 1/2 in. Complete Ready to Use, with instructions. 6/9 Post Free. Ideal for 27 Mc/s.

A SELECTION FROM OUR STOCKS

Full Details in our Latest Illustrated Catalogue. 1/6 Post Free.

- 1. 2,000 ohm Head Phones ... 12/6
- 4,000 ohm Head Phones ... 14/-
- Stereo Phones 2 x 8 ohm ... 27/6
- 2. Make your own printed circuits. Full details with 3 boards 6 x 3 in. etc. 19/6
- 3. Crystal Microphones (P.P. 1/6 any type)
 - Acos 39-1 Stick Microphone ... 32/6
 - Acos 40 Desk Microphone ... 15/-
 - Acos 45 Hand Microphone ... 25/-
 - Lapel/Hand Microphone ... 15/-
 - MC 24 Stick Microphone ... 25/-
 - 100C Stick with Stand ... 39/6
 - BM3 Stick with Stand ... 52/6
- 4. Transistor Megaphone £12.10.0.
- 5. 250 mW 4-Transistor Amplifier, built ready to use ... 47/6 P.P. 1/6
- 6. Complete Test Lead Kits ... 8/6
- 7. Miniature Vernier Dial 8 : 1 reduction marked 0/100 for 1/4 in. spindles, 1/4 in. diam. 12/6; 2 in. diam. 14/-; 3 in. diam. 16/-.
- 8. 931A Photomultiplier. Brand new with base ... 60/-

DEAC RECHARGEABLE BATTERIES

- (a) 18 volt 100mA/H 4 x 1 in. diameter. Brand new sleeved, 30/-.
 - (b) As above but 150mA/H, 35/-.
- Both types easily split into any multiple of 1.2 volt. Brand new.

- 9. CV2886 (M2H) Liquid Sampling Geiger Tube, 370 volts. 22/6. P.P. 1/-.
- 10. Antex Miniature Mains Soldering Iron, 3/4 in. bit, 29/6. P.P. 1/-.
- Pocket Iron with Pouch, 30 watt, 220/250 volt. 18/6.
- Solon 15 watt 3/4 in. bit, 22/6. P.P. 1/-.
- 11. Pocket Radio Booster Unit, for any radio. Improves output and quality. Size 9 1/2 x 3 1/2 in. dia., 27/6. P.P. 1/-.
- Size 8 x 2 1/2 in. dia., 25/-.
- 12. 125 mW 9 volt Sub-min. 3-Transistor Amplifier. 2 x 1 x 1 in. 45/-.

RUN YOUR RADIO OR AMPLIFIER FROM MAINS BATTERY ELIMINATORS AND CHARGERS

- 1. For PP3 or equivalent 9 volt Pocket Radio Battery, 18/6. P.P. 1/-.
- 2. For PP4, PP7, PP9, PP10, 9 volt Portable Radio and Equipment Supplies up to 300 mA. 49/6. P.P. 2/-.
- 3. De Luxe version of No. 1 also charges PP3 type batteries. 24/-.
- 4. Rechargeable PP3 battery. Runs as long as 100 batteries. Completed with charger unit, 25/-.

SILICON RECTIFIERS 500mA

100 PIV	3/-	1000 PIV	... 11/-
200 PIV	3/6	100 PIV 1 amp	... 4/6
300 PIV	4/6	200 PIV 6 amp	... 12/6
400 PIV	5/-		

REMEMBER—All our transistors and devices are 100% 1st Grade and Fully Guaranteed. We can advise as to the correct type to use.

NEW TRANSISTOR, VALVE, CRYSTAL AND RECTIFIER CATALOGUE NOW READY. 9d. POST FREE.

- 13. Telephone Coil for any amplifier or Recorder, 12/6, or fitted Miniature Jack Plug, 14/-.
- 14. Crystal Contact Microphone for guitars, etc., 12/6.
- 15. Personal Earphones: 600 ohm 10/6, 1,000 ohm 12/6, Crystal 8/6, 8/10 ohm 9/6. Fitted leads, jack plugs and sockets.
- 16. 2-pole 2-way Miniature Honeywell Micro Switches, 7/6.
- 17. Transistor Baby Alarm, as previously advertised, £5.10.0. P.P. 2/-.
- 18. 4-Transistor 2-way Intercom., £7.10.0. 2-Transistor 2-way Intercom., 89/6.
- 19. Miniature Multi-section Telescopic Aerials: 14in. 3/6; 38in. 6/6; 42in. 10/6; 64in. 17/6.
- 20. Miniature 3-Press Button Switches, 6 pole 2-way and on/off 5/-.
- 21. Transistor Signal Injector 42/6. For circuit testing and checking.
- 22. Bin. 15 ohm double cone Hi-Fi Speaker, 84/-.

Complete range of Speakers stocked. 23. 12-way Selector Tube GS12C (CV1740) 25/- each.

- 24. Quartz Fibre Pocket Dosimeters 0/150R and 0/500R. 12/6 each.
- 25. 6-Transistor speaker superhet pocket radio ready to use. Complete with leather case, phone, etc., etc. 99/6 P.P. 2/-.
- 26. Dramatic medium impedance double winding record/playback tape head on mounting plate. Complete with erase head. 29/6. P.P. 1/-.
- 27. Sub-Miniature Jack Plug and Socket. 2/6. Sub-Miniature Screened Plug, 2/-.
- 28. Standard Jack Plug, 2/6. Standard Screened Jack Plug, 3/6.
- 29. New Telephone Amplifier in moulded cabinets, 79/6.
- 30. Tuning Indicator and Battery Level Meter. Miniature Meter (400 µA) for Recorders, Transmitters, etc., etc., 24/6.

ALL PARTS IN STOCK FOR WEYMOUTH (WEYRAD) MED/LONG AND MED/SHORT RECEIVERS.

METER BARGAINS

- 50 Microamp 2 in. square MC ... 35/-
- 1 mA 2 in. square MC ... 25/-
- 1 mA 2 1/2 in. Flush Round ... 30/-
- 2 1/2 in. Moving Coil double range Voltmeter centre zero. 30-0-30 and 3-0-3 volts. Ideal for transistor tester or voltage measurements, 12/6. Post Free.
- 0/500 Microamp, 2 1/2 in., flush-mounting. D.C. ... 20/-
- 2 1/2-0-2 1/2 mA, 2 1/2 in. flush D.C. ... 12/6
- 0/40/120 mA 2 in. D.C. ... 10/-
- 0/15 volt M.I. 2 1/2 in. FR. A.C. ... 8/6

Miniature Panel Meters

- *0/50µA (D.C.) 39/6 *0/5mA (D.C.) 27/6
 - *0/500µA (D.C.) 32/6 *0/300V (D.C.) 27/6
 - *0/1mA (D.C.) 27/6 Vu Meter 42/6
 - "S" Meter 35/-.
- All Brand New Boxed. * Available Clear Plastic Front or Black Moulded. State which.

SUBSTITUTION BOXES

- Capacitor Box. Provides 9 standard values from 0.001 to 0.22 mfd at 600 volt working, 29/6.
 - Resistor Box. Provides 24 standard values at 1 watt. 15 ohms to 10 meg., 37/6.
- Each box fully calibrated with insulated leads. Invaluable for service and design.

- 31. Crystal Microphone Inserts: 2in. 10/6; 1 1/2 in. 7/6; 3/4 in. 3/6; Acos 39-1 15/-.

- 32. Stereo Amplifier, 2 watts each channel. Brand new, 79/6. P.P. 2/-.

- 33. Precision Geared Preset Controls. 46 turns from end to end of track. 10K ohm and 30K ohm types, 12/6 each.

- 34. Type 38 Transmitter/Receiver. 5-valve, 7.4-9 Mc/s, 22/6. P.P. 2/6 (sold without guarantee).

- 35. Valve Voltmeter, AC/DC/Resistance, etc. £9.19.6. P.P. 5/-.

MINIATURE LEDEX SWITCHES

24 volt D.C. rotating switches, fitted actuator at each end of bank of contacts. Uses standard switch wafers. 5 Bank or 8 Banks of Contacts 45/-.

- 36. STC FIS Thermistors, 6/-, RS3 15/-.
- 37. ORP12 L DR Cell, 12/6; ORP60 Cell, 9/6; OCP71 Photo Strans, 27/6.
- 38. 1/2 Track Record/Playback Tape Heads. 2K ohms impedance, 15/-.
- 39. Personal Earphones with Jack Plug and Socket. 8/10 ohm 6/6; 600 ohm 9/6; 1000 ohm 10/6; Crystal 6/6.
- 40. 7 x 7 in. Printed Circuit Panels for etching, 5/-, post free.
- 41. Recording Tape. 5 in. 600ft., 12/6; 5 in. 900ft., 15/-; 7 in. 1200ft., 18/6; 7 in. 1800ft., 25/-.
- 42. Garrard Mains Single Player, 4-speed GC8 head £5.9.6. P.P. 3/6.
- 43. D.C. to A.C. Converter. 12 volts D.C. i.e. Car Battery up to 230 volts A.C. 15 watts. Uses 2 power transistors in special circuit. Kit 57/6. P.P. 1/6.

Henry's Radio Ltd

PADddington 1008/9

303 EDGWARE RD., LONDON W2

Open Monday to Sat. 9-6, Thurs. 10'clock

PLEASE TURN TO BACK PAGE

Practical Wireless

BLUEPRINT SERVICE

ALL of these blueprints are drawn full-size and although the issues containing descriptions of these sets are now out of print, constructional details are available free with each blueprint except for those marked thus (*).

Send (preferably) a postal order to cover the cost of the Blueprint (stamps over 6d. unacceptable) to PRACTICAL WIRELESS, Blueprint Dept., George Newnes, Ltd., Tower House, Southampton Street, London W.C.2.

DOUBLE-SIDED BLUEPRINTS

Each blueprint in this series contains details of two separate instruments or items of equipment.

The Strand Amplifier	}	*	5/-
The PW Signal Generator			
The Savoy VHF Tuner... ..	}	*	5/-
The Mayfair Pre-amplifier			
The Berkeley Loudspeaker Enclosure	}	*	5/-
The Luxembourg Tuner			
The PW Troubadour	}		7/6
The PW Everest Tuner			
The PW Britannic Two	}	*	6/-
The PW Mercury Six			
The PW Regency	}	*	5/-
The PW International Short Wave Two			

RECEIVERS

The Tutor *	3/-
The Citizen *	5/-
Junior Crystal Set	PW94 2/-
Dual-wave Crystal Diode	PW95 2/6
Modern One-valver	PW96 2/6
All-dry Three	PW97 3/6
Modern Two-valver	PW98 3/6
A.C. Band-pass Three	PW99 4/-
A.C. Coronet-4	PW100 4/-
A.C./D.C. Coronet	PW101 4/-
The PW Pocket Superhet	5/-

MISCELLANEOUS

The PW 3-speed Autogram	8/-
The PW Monophonic Electric Organ ...	8/-
The PW Roadfarer *	5/-
The PT Band III TV converter	1/6
The Mini-amp *... ..	5/-
The PT Olympic *	7/6
The PT Multimeter *	5/-

SOME EARLIER DESIGNS

THE following blueprints include some pre-war designs and are kept in circulation for those constructors who wish to make use of old components which they may have in their spares box. The majority of the components for these receivers are no longer stocked by retailers.

Experimenter's Short Wave	PW30a	2/6
Midget Short Wave Two	PW38a	2/6
Simple S.W. One-valver	PW88	2/6
Pyramid One-valver	PW93	2/6
BBC Special One-valver	AW387	2/6
A One-valver for America	AW429	2/6
Short-Wave World Beater	AW436	3/6
Standard Four Valve S.W.	WM383	3/6
Enthusiast's Power Amplifier	WM387	3/6
Standard Four Valve	WM391	3/6
Listener's 5-Watt Amplifier	WM392	3/6

QUERY COUPON

This coupon is available until 7th June, 1963, and must accompany all queries in accordance with the notice on our "Letters to the Editor" page.

PRACTICAL WIRELESS, JUNE, 1963

Published on the 7th of each month by GEORGE NEWNES, LIMITED, Tower House, Southampton Street, London, W.C.2 and printed in England by WATMOUGHS LIMITED, Idle, Bradford; and London. Sole Agents for Australia and New Zealand: GORDON & GOTCH (A/asia), Ltd. South Africa and Rhodesia: CENTRAL NEWS AGENCY, LTD. East Africa: EAST AFRICAN STANDARD LTD. Subscription rate including postage for one year: Inland £1.9.0. Abroad £1.7.6 (Canada £1.5.0.). Registered at the General Post Office for the Canadian Magazine Post.

**PLEASE NOTE OUR
NEW ADDRESS**

Just 200 yds. from our old address

Henry's Radio Ltd.
303 EDGWARE ROAD, LONDON W2
PADDINGTON 1008/9
Open Monday to Sat. 9-6. Thurs. 1 o'clock

NEW SUMMER CATALOGUE

54 PAGES 10½ x 7½ in.
Fully detailed and illustrated 1/6 post free

**"CAPRI" POCKET-6
6-TRANSISTOR SUPERHET**



Size only
4½ x 2½ x 1½ in.
**REALLY
POCKET
SIZE!**

The most compact 6-transistor and diode radio with speaker available to the home constructor. Features the latest in miniature components and circuitry. Supplied with Mullard transistors and two-tone moulded cabinets in red/white or blue/white with gold fittings. All components are supplied in packets and clearly identified. A printed circuit is used with fully illustrated building instructions. Push-pull output coupled with a sensitive and selective circuit make the "CAPRI" hard to beat. Fitted Earphone, Record Socket. Full tuning on medium waves with long wave Light.

Illustrated leaflet on request.

TOTAL COST £5.19.6 P.P. 2/-

● Slip it into your Pocket ●

**4 WATT PEAK OUTPUT
TRANSISTOR AMPLIFIER**

Order Now! New design 7-transistor amplifier and pre-amplifier. Separate treble, volume and bass controls. Small size 5½ x 2½ x 2in. Excellent quality. £5. 10. 0. P.P. 2/- Mains Unit 50/- extra

THE "CONTESSA"

★ COMBINED PORTABLE AND CAR RADIO ★

AMAZING SENSITIVITY AND SELECTIVITY ON MEDIUM AND LONG WAVEBANDS

★ The easiest Superhet Radio to build on the market. Features clearly-marked printed circuit and packaged components with full illustrated building instructions. Full tuning of medium and long wave bands with unbeatable sensitivity and selectivity. Excellent tone and volume with over 600mVW push-pull output.

★ Clearly marked horizontal station dial with slow motion tuning. Two colour Blue or Beige cabinets with Gold handles, grilles and fittings. Size 10½ x 7½ x 3½ in., includes car aerial socket, recording sockets.

★ 6 Mullard Transistors and 2 Diodes. Guaranteed the Best Obtainable

● Attractive Appearance—Reliable Design—Quality Performance ●

UNBEATABLE FOR QUALITY AND VALUE

Fully Detailed and Illustrated Leaflet on request.



TOTAL COST OF ALL PARTS

£9.19.6 P.P. 3/6

"MINIRANGER"

3-Transistor Plus 2 Diodes. Small-est radio to build yourself. Printed circuit; full tuning. ONLY 3 x 2 x ¾ in. Over 20 stations. Diagrams Free.

TOTAL COST 4/9 P.P. 1/6

**"QUINTET"
POCKET
RADIO**

Diagrams Free. Size 5½ x 3 x 1½ in. 5-Transistor, plus Diode MW/LW to build.

7/9 P.P. 2/-



BOTH MODELS AS PREVIOUSLY ADVERTISED

● ALL PARTS SOLD SEPARATELY BOOKLETS FREE ON REQUEST ●

**¾ WATT 4 TRANSISTOR
AMPLIFIER**

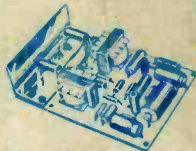

● Improved Version
1½ watt peak output.

± 3dB 70c/s to 12 kc/s.

Output to 3 ohm speaker
9 volt operated.

Details on request.

Built and Tested Kit of Parts

5/9/6 OR 5/2/6

P.P. 1/6 P.P. 1/6

BATTERY RECORD PLAYERS



● 6-7½ volt Garrard turntable with crystal pick-up. Plays 45 r.p.m. Ideal for amplifier on left. 55/- P.P. 1/6

● Suitable cabinet for amplifier and player, 17/6 P.P. 2/-.

● G.C. 9 volt 45 r.p.m. and 33 r.p.m. Player, 9/9/6 P.P. 2/-.

● B.S.R. 9 volt 4-Speed "Hi-Grade" Turntable with turn-over Crystal Pick-up. £6.5.0. P.P. 2/6.

ORDER NOW!

**10 WATT TRANSISTOR
HI-FI AMPLIFIER**

(As per W/W Nov. 1961)

6 Transistors and Rectifier built on to printed circuit 4 x 2½ inches. Power transistors bolted to heat plate. Sensitivity 100mV into 33 Kohm. Output 10 watts for 3 ohm speaker or 4 watts for 15 ohm. Operates from 20 to 30 volts D.C.

£5.19.6 P.P. 2/6.

Mains unit 95/- extra.

Detailed book free.

● Use 2 for Stereo!

MULTI-METERS



THL33. 20,000 V
(Illustrated.)
0/10/50/250/500/1,000 v. A.C.
and D.C.
0/500µA/10/250 mA. D.C.
0/10k/100k/1 meg. etc., etc.
Size 5 x 3½ x 1½ in.

75/- P.P. 1/6.

ITI-2. 20,000 V.
0/5/25/250/500/2,500 v. A.C./D.C.
0/50µA. 0/2½/250 mA. D.C.
0/6k/6 meg. etc.
Size 4½ x 3½ x 1½ in.

5 gns. P.P. 1/6.

TE10. 10,000 V as above.
89/6 P.P. 1/6.

PT34. 10,000 V.

0/10/50/250/500/1,000 v. A.C./D.C.
0/1/100/500 mA. D.C.
0/100k etc.
Size 3½ x 2½ x 1½ in.

45/- P.P. 1/6.

500. 30,000 V.

0/¼/1/2½/10/25/100/250/500/1,000 v. A.C. and D.C.
0/50µA/5/50/500 mA. 0/12 amps.
0/60k/6 meg./60 meg. etc.
Size 6½ x 4½ x 2½ in.

£8.19.6 P.P. 2/-.

TP55. 20,000 V.
0/10/50/250/500/1,000 v. A.C./D.C.
0/50µA/0/5/50/500 mA. D.C.
0/10k/100k/1 meg./10 meg. etc.
Size 5½ x 3½ x 1½ in.

£5.19.6 P.P. 1/6.

ALL METERS SUPPLIED COMPLETE WITH BATTERIES, TEST LEADS AND INSTRUCTIONS. SEE LATEST CATALOGUE FOR FULL DETAILS.

Brand New—Fully Guaranteed

PLEASE TURN PAGE