

MAY
1963

Practical ²⁻ WIRELESS

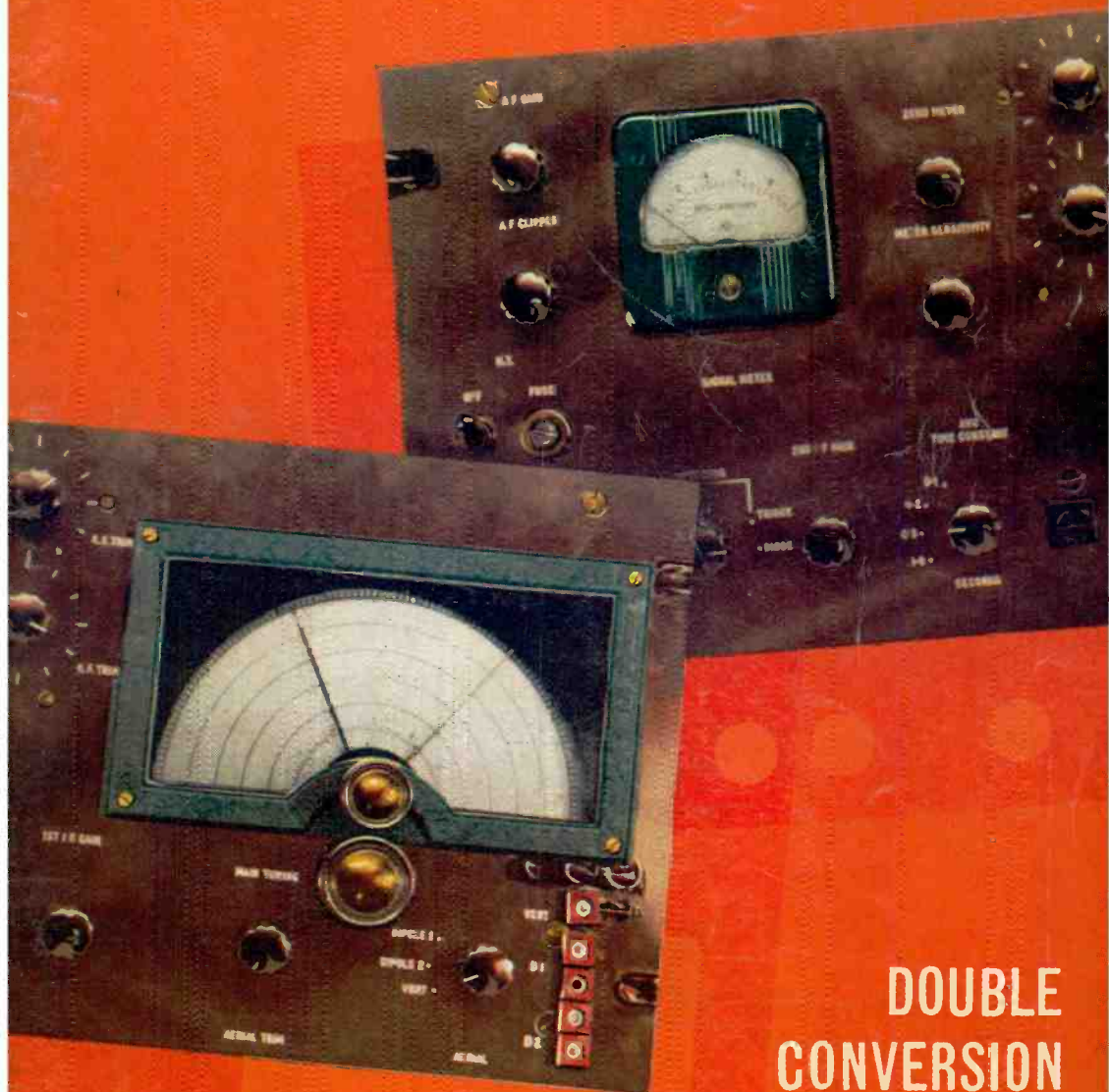

DOUBLE
CONVERSION
COMMUNICATIONS
RECEIVER

Model 8 Universal AVOMETER



Designed for Dependability

The Model 8 Universal Avo Meter is a high sensitivity multi-range a.c./d.c. electrical testing instrument providing thirty ranges of readings on a 5-inch hand calibrated scale. Range selection is effected by two rotary switches for a.c. and d.c. respectively.

The instrument has a sensitivity of 20,000 ohms per volt on d.c. voltage ranges and 1,000 ohms per volt on a.c. from the 100-volt range upwards, and meets the accuracy requirements of B.S.S.89/1954 for 5-inch scale length portable industrial instruments. It is robust, compact, and simple to operate, and is protected by an automatic cut-out against damage through inadvertent electrical overload.

VOLTAGE		CURRENT		RESISTANCE	
D.C.	A.C.	D.C.	A.C.		
2.5V	2.5V	50µA	100mA	First indication 0.5Ω	
10V	10V	250µA	1A	Maximum indication 20MΩ	} using internal batteries
25V	25V	1mA	2.5A	0—2,000Ω	
100V	100V	10mA	10A	0—200,000Ω	
250V	250V	100mA	—	0—20mΩ	
500V	—	1A	—	0—200MΩ	
1,000V	1,000V	10A	—		
2,500V	2,500V				
				DECIBELS	
				—15 dB to —15 dB	

Various external accessories are available for extending the above ranges of measurement. Leather carrying cases are also available if required.

Dimensions: 8½" x 7¼" x 4½". Weight: 6½ lb.

Write for fully descriptive Folder or for complete Catalogue of AVO Instruments.



AVO LTD

AVOCET HOUSE, 92-96 VAUXHALL BRIDGE ROAD,
LONDON, S.W.1 **M** Tel: VIctoria 3404 (12 lines)

ADCOLA
ESTABLISHED 1938
100, GERRARD STREET, W. LONDON, W.1

SOLDERING INSTRUMENTS

EQUIPMENT FOR THE RADIO AMATEUR

ILLUSTRATED

List 64.
¾" DETACHABLE BIT
IN
PROTECTIVE SHIELD
List 700

BRIT. & FOR. PATS.

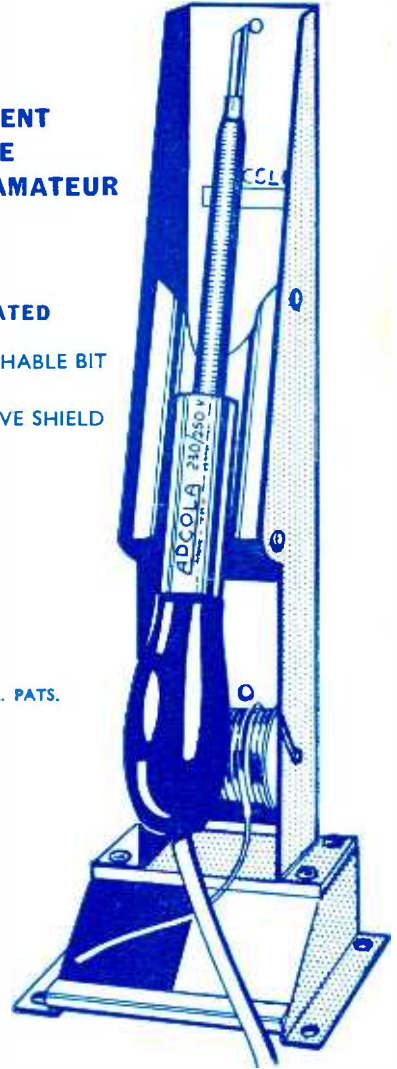

Sales & Service

APPLY DIRECT FOR CATALOGUE
TO

ADCOLA PRODUCTS LTD

ADCOLA HOUSE

GAUDEN ROAD, LONDON, S.W.4

Telephones

MACaulay 4272 & 3101

Telegrams

SOLJOINT LONDON SW4

Stern's

MULLARD DESIGNS

COMPLETE KITS OF PARTS

MULLARD 3-VALVE PRE-AMPLIFIER TONE CONTROL UNIT

Designed mainly for Mullard Range of Amplifiers, also suitable for any Amplifier requiring input up to 250mV. Incorporates 5 input Channels, including for Tape and Magnetic Pick-ups. Separate Bass and Treble controls. High pass filter 20 to 100 c/s. low pass filter 5-9 Kc/s. Totally enclosed in case size 114" x 44" x 4".



KIT OF PARTS **£10.00** ASSEMBLED & TESTED **£13.13.0**

MULLARD "5-10" MAIN AMPLIFIER

For use with MULLARD 2-stage pre-amplifier with which an undistorted power output of up to 10 watts is obtained. SPECIFIED COMPONENTS AND MULLARD VALVES including PARMEKO MAINS TRANSFORMER and choice of PARMEKO or PARTRIDGE Output Transformer.



COMPLETE KIT (Parmeko Output Trans.) **£10.0.0**
ASSEMBLED AND TESTED **£13.10.0**

ABOVE incorporating PARTRIDGE OUTPUT TRANS. £1.6.0 extra.

THE MULLARD 510/RC AMPLIFIER

The popular complete "5-10" incorporating Control Unit providing up to 10 watts high quality reproduction. Specified components and new MULLARD VALVES. Includes PARMEKO MAINS TRANSFORMERS and choice of PARMEKO or PARTRIDGE Output Transformers.

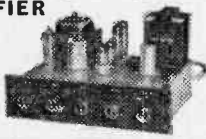

COMPLETE KIT **£12.0.0**
ASSEMBLED AND TESTED **£16.0.0**

With PARTRIDGE OUTPUT TRANS. **£1.6.0** ex.

THE MULLARD 33/RC

A HIGH QUALITY AMPLIFIER DEVELOPED FROM THE VERY POPULAR 3-WATT MULLARD "3-3" DESIGN. KIT OF PARTS **£8.8.0**

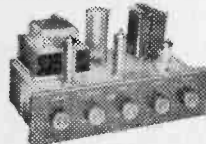

ASSEMBLED AND TESTED **£11.10.0**

Complete to the MULLARD specification including PARMEKO OUTPUT TRANSFORMER. Switched inputs for 78 and 45. Extra power to drive a Radio Tuning Unit is also available.



THE "MONO-GRAM"

A small Amplifier of genuine high quality performance. Incorporates new MULLARD ECL86 Valve, separate BASS and TREBLE controls and produces up to 3 watts undistorted output. Kit of Parts **£4.10.0** Assembled and Tested **£6.0.0**

Perfectly suited for Portable Installations for which purpose we offer PORTABLE CASE (£3.10.0) the AMPLIFIER (Kit) and 8" x 5" SPEAKER (£1.0.0). All for **£9.0.0**

Alternatively with ASSEMBLED AMPLIFIER **£10.0.0**

The Case quoted above will accommodate some 4-speed Single Record Units. A larger model is available for extra 10/- With this Equipment a COMPLETE PORTABLE RECORD PLAYER can be built for **£14.0.0**



MULLARD FOUR CHANNEL MIXING UNIT

Self powered Cathode follower output. Incorporates two inputs for CRYSTAL MICROPHONES, one for CRYSTAL PICK-UPS and a fourth for Radio or Tape.

KIT OF PARTS **£8.8.0**

Alternative Model I/L provides for one input matched for moving coil or ribbon mike **£11.7.0** extra.

ASSEMBLED AND TESTED **£11.10.0**



ARMSTRONG RADIOGRAM CHASSIS

We have the full range in stock. Prices range from £20.10.0. Full details are readily available.



Full Range of Lustraphone Moving Coil Microphones, Stands and Accessories are in stock

MULLARD'S 2-VALVE PRE-AMPLIFIER TONE CONTROL UNIT

Employing two EF88 valves and designed to operate with the MULLARD MAIN AMPLIFIER but also perfectly suitable for other makes.



- ★ Equalisation for the latest R.L.A. characteristics.
- ★ Input for Crystal Pick-ups and variable reluctance magnetic types.
- ★ Input (a) Direct from High Imp. Tape Head. (b) From a Tape Amplifier or Pre-Amplifier.
- ★ Sensitive Microphone Channel. ★ Wide range BASS and TREBLE Controls.

KIT OF PARTS **£6.6.0** ASSEMBLED AND TESTED **£9.10.0**

PRICE REDUCTIONS

- (a) THE KIT OF PARTS to build both the "5-10" Amplifier and the 2-Valve Pre-Amplifier... **£15.10.0**
- (a) Assembled and Tested... **£21.10.0**
- (b) THE KIT OF PARTS to build both the "5-10" Amplifier and the 3-Valve Pre-amplifier... **£19.10.0**
- (b) Assembled and Tested... **£25.10.0**
- With PARTRIDGE OUTPUT TRANSFORMER **£1.6.0** extra.

HIGH FIDELITY LOUDSPEAKERS

WE STOCK THE COMPLETE RANGE BY GOODMANS, WHARFEDALE and W.B. STENTORIAN

A few recommended examples

8 INCH TYPES	
GOODMANS "AXIOMITE"	£5.5.0
W.B. HF 816	£5.19.8
WHARFEDALE "SUPER 8/RS/DD"	£6.14.0
10 INCH TYPES	
GOODMANS "AXIOM 10"	£5.18.8
W.B. MODEL HF 1016	£7.6.0
WHARFEDALE "GOLDEN 10/RS/DD"	£7.17.0
12 INCH TYPES	
GOODMANS "AXIOM 20" 15 watts	£9.15.0
GOODMANS "AXIOM 30" 20 watts	£14.0.0
W.B. MODEL HF 1216 15 watts	£10.5.8
WHARFEDALE "W12/RS"	£10.10.0
WHARFEDALE "Super 12/RS/DD"	£17.10.0

LEAK AND QUAD AMPLIFIERS IN STOCK

- LEAK "TL12 PLUS" POWER AMPLIFIER with the "POINT ONE PLUS" PRE-AMPLIFIER, 14 watts rated output... **£31.10.0**
- LEAK "TL25 PLUS" with the "POINT ONE PLUS" PRE-AMPLIFIER, 28 watts rated output... **£37.16.0**
- LEAK "STEREO 20" POWER AMPLIFIER with the "VARISLOPE STEREO" PRE-AMPLIFIER, 22 watts (11 watts per channel)... **£55.9.0**
- QUAD POWER AMPLIFIER with QUAD II CONTROL UNIT, 15 watts output... **£42.0.0**

RECORD PLAYERS

- THE COLLARO "JUNIOR" 4-speed single player with separate crystal pick-up... **£3.10.0**
- THE NEW GARRARD "AUTOSLIM" 4-speed Autochanger with crystal pick-up... **£7.10.0**
- GARRARD "AUTOSLIM DE LUXE" 4-speed Autochanger, incorporates transcription Pick-up Arm... **£11.8.0**
- THE COLLARO "C60" 4-speed autochanger unit with Studio "O" pick-up... **£6.19.6**
- R.S.R. Model UA4, a 4-speed Mixer Autochanger with crystal pick-up... **£6.10.0**
- The new GARRARD Model 411F High Quality, Single Record Player fitted with the latest T.P.A. 12 pick-up arm and G.C.S. crystal Cart-ridge... **£16.17.6**
- GARRARD Model S.L.P. 10 Single Record Player fitted with high output crystal pick-up... **£5.0.0**
- PHILIPS Model AG1016, A 4-speed Player can be operated both manually and automatically. Suitable for Mono or Stereo operation... **£12.12.0**
- Carr. and Ins. on each above 5/- extra.

Mk. 11 "Fidelity" FM TUNING UNIT

- An attractively presented Unit incorporating MULLARD PERMEABILITY TUNING HEART and corresponding Mullard valve line-up. Very suitable to operate with our Mullard Amplifiers. KIT OF PARTS **£10.10.0** ASSEMBLED AND TESTED **£14.5.0**

IF YOU ARE PLANNING TO INSTALL "HI-FI" and UNCERTAIN OF THE TYPE OF EQUIPMENT TO USE—OUR WIDELY EXPERIENCED TECHNICAL STAFF WILL WITH PLEASURE PUT FORWARD RECOMMENDATIONS—STATE TYPE OF INSTALLATION CONTEMPLATED AND APPROX. PRICE LEVEL. CREDIT SALE TERMS are available on all Equipment over £10.0.0. FULLY DESCRIPTIVE LEAFLETS are readily available—please enclose S.A.E.

Stern's

SPECIALISTS IN SOUND EQUIPMENT FOR OVER 25 YEARS

STEREO TAPE PRE-AMPLIFIER



MODEL STP-1. For use with current TRUVOX, BRENNELL, or COLLARO "STUDIO" 1 and 1 track Stereo Decks. Incorporates Ferroxcube Oscillator, 4 speed Equalisation Signal Level Meter and separate Gain Controls. Includes separate Power Unit.
KIT OF PARTS £22.0.0 ASSEMBLED £28.0.0

TAPE PRE-AMPLIFIER MULLARD'S Type "C"

Suitable for most 1 track, Mono Tape Decks. Incorporates Ferroxcube Push-Pull Oscillator and 3 Speed Treble Inductor. Includes Separate Power Unit.



KIT OF PARTS £14.0.0 ASSEMBLED £19.10.0

MULLARD'S TAPE AMPLIFIER



Based on Mullard's Type "A" design and suitable for most 1 track Mono Tape Decks. Incorporates Ferroxcube 3 speed Treble Inductor and Gilson Output Transformer. Includes separate Power Unit.

KIT OF PARTS £13.13.0 ASSEMBLED £19.0.0

STERN'S "ADD-A-DECK"

A self contained Unit consisting of Garrard Deck and matched Preamplifier on one chassis. Provides full tape recording facilities and replays through Pick-up Sockets or standard Radio receiver or Amplifier. PRICE includes Spool of Tape



£18.18.0

and NOW!!! STERN'S OFFER THE "VICEROY" and "EMPRESS" STEREOSCOPE UNITS

A SPECIAL BULK PURCHASE ENABLES US TO OFFER THIS HIGH GRADE STEREOPHONIC PRE-AMPLIFIER AT APPROX. THE MANUFACTURER'S PRODUCTION COST. IT IS ENGINEERED TO THE VERY HIGHEST TECHNICAL STANDARDS AND REPRESENTS THE ULTIMATE IN PRECISION HIGH FIDELITY EQUIPMENT FOR DOMESTIC INSTALLATIONS.



EXCEPTIONAL VALUE
 10 + 10 WATTS
AUDIO PERFECTION - REMARKABLE FLEXIBILITY THE "EMPRESS"

Unquestionably the most advanced self-powered STEREOPHONIC Pre-amplifier available today, it provides the greatest range of facilities ever offered in a single unit. It incorporates full input facilities for Crystal or Magnetic Pick-ups and Microphones, Radio Transmissions, Tape Recorders and Replay direct from high impedance Tape Heads. A miniature Cathode Ray Tube provides for VISUAL balancing of the input signals, and also for measuring the frequency response of PICK-UPS and the power output in watts. The controls include Scratch and Rumble Filters, Loudspeaker phasing in conjunction with a 50 cycles per second note, Channel reversal and Mixing facilities together with Function Switches, separate Volume and Baxandall Tone Controls. Size 14in. x 10in. x 4in.

OFFERED AT THE SPECIAL PRICE OF **£17.17.0**
 LIST PRICE £40.19.0.

The Empress is designed to operate with any good quality Stereophonic Power Amplifier requiring an input between 100mV/Volts and 3 Volts and is particularly suitable to operate with our MULLARD "10+10" POWER AMPLIFIER—WE OFFER IT together with the "10+10" for only.....

!! COMBINED PRICE OFFERS !!

Includes small charge for special testing and PRECISE MATCHING of the ASSEMBLED P.x.E-AMPLIFIER (or Amplifier) to TAPE DECK

STP-1 (KIT) and "STUDIO" Deck	£39.0.0	Assembled	£48.0.0
STP-1 (KIT) and Brenell Deck	£28.0.0	Assembled	£75.0.0
STP-1 (KIT) and Truvox Deck	£51.0.0	Assembled	£59.0.0
TYPE "C" (KIT) and "STUDIO" Deck	£26.10.0	Assembled	£33.0.0
TYPE "C" (KIT) and BRENNELL Deck	£43.0.0	Assembled	£50.0.0
TYPE "C" Assembled and Wearite Deck	£70.0.0	Inc. Head Lift Trans.	
HF/TR3 (KIT) and "STUDIO" Deck	£28.0.0	Assembled	£33.0.0
HF/TR3 (KIT) and BRENNELL Deck	£43.0.0	Assembled	£50.0.0
HF/TR3 Assembled and Wearite Deck	£70.0.0	Inc. Head Lift Trans.	

To build a complete TAPE RECORDER we offer HF/TR3 AMPLIFIER STUDIO DECK, PORTABLE CASE, ROLA 10 x 8in. SPEAKER MICROPHONE and 1,200ft. TAPE ALL for £35.0.0. ALTERNATIVELY WE OFFER... THE COMPLETELY ASSEMBLED and GUARANTEED PORTABLE RECORDER (Model CR3/S) FOR £43.0.0.

Stereo Amplifiers

MULLARD'S "10+10" STEREO AMPLIFIER

A high fidelity design providing up to 10 watts (per channel), Superb reproduction frequency response flat to within 1db from 3 c/s to 60 Kc/s at 30mV Total Harmonic Distortion at 10 watts 0.1%.

Price (a) ASSEMBLED AMPLIFIER (as illustrated) **£24.0.0**

(b) KIT OF PARTS..... **£20.0.0**

Built to the highest technical standards and presented strictly to MULLARD'S specification. Two specially designed GILSON OUTPUT TRANSFORMERS with 20% taps are used.

We can also supply the assembled MAIN AMPLIFIER only for operation with our DUAL CHANNEL PRE-AMPLIFIER; this provides a more versatile installation and is essential if a low output Magnetic Pick-up is to be used. When ordering specify loudspeaker impedance.

(a) THE ASSEMBLED MAIN AMPLIFIER and ASSEMBLED DUAL CHANNEL PRE-AMP..... **£34.0.0**

(b) KIT OF PARTS for both Units..... **£27.0.0**

THE "TWIN THREE" STEREO AMPLIFIER

ASSEMBLED AND TESTED

£9.0.0 (Carriage and Insurance 7/6 extra)



Based on a recent design by MULLARD LTD., is ideally suited for use in Portable RECORD PLAYERS for which purpose we offer a specially designed Case; incorporates MULLARD ECL86 Valves, separate BASS and TREBLE CONTROLS and produces up to 3 watts per channel. Frequency response is 40 c/s to 30 Kc/s, size is only 11in. x 3in. x 5in. To construct a STEREO PORTABLE RECORD PLAYER we offer: The above AMPLIFIER with two ROLA 8in. x 5in. LOUD-SPEAKERS and PORTABLE CASE for..... **£16.10.0**

MULLARD DUAL-CHANNEL PRE-AMPLIFIER

A four Valve design for both STEREOPHONIC and MONOPHONIC operation. Operates equally well with any make of Amplifier requiring an input of up to 250 mV.

KIT OF PARTS **£12.10.0**

ASSEMBLED AND TESTED **£15.0.0**



THE "TUDOR" STEREO AMPLIFIER

PRICE **£15.0.0** (Carr. free)

A self-contained Amplifier designed to provide high quality stereophonic and monophonic reproduction. Each channel provides a rated output of 6 watts and for monophonic operation approx. 12 watts is produced. Separate BASS and TREBLE CONTROLS.

CREDIT SALE TERMS

ON ALL EQUIPMENT OVER £10

POSTAL ENQUIRIES and MAIL ORDERS TO

STERN RADIO LTD.
 6-12, TUDOR PLACE, TOTTENHAM COURT RD.
 LONDON, W1. TEL. MUSEUM 6128/9

DEMONSTRATION and SHOWROOMS AT ...

STERN RADIO LTD.
 109, FLEET ST. LONDON, EC4
 TEL. FLEET ST. 5812/3

PREMIER RADIO
 23, TOTTENHAM COURT RD.
 LONDON, W1. TEL. MUSEUM 6128/9

OPEN... 9 a.m. to 6 p.m. SAT. close 1 p.m.

OPEN... 9 a.m. to 6 p.m. THURS. close 1 p.m.

SURBITON PARK RADIO LTD.

FOR POST HASTE—POST FREE SERVICE

MARTIN RECORDAKITS

HALF TRACK

B.S.R. TD2 Monardeck, latest model 5 1/2 in. spool	£9.90
Deposit £1.0.0 and 9 monthly	£1.1.0
Tape Amplifier for B.S.R. deck, printed circuit ready wired, with EOC83, ECL82, EM85 and EZ81. Complete with all plugs, sockets, panels, knobs, etc. The whole amplifier mounts on to the deck, making a self-contained unit	£8.8.0
Deposit £1.0.0 and 6 monthly	£1.1.0
Case with 7 in. x 9 in. speaker, in two tone grey	£4.4.0
Complete Kit as above	£22.0.0
Deposit £2.4.0 and 12 monthly	£1.16.6
The above recorder can be supplied assembled, tested and complete with tape and microphone for	£25.0.0
Deposit £2.10.0 and 12 monthly	£2.1.0
Collaro Studio Deck. Very latest model 3 speeds 7 in. spools	£12.10.0
Deposit £1.5.0 and 12 monthly	£1.0.8
Tape Amplifier for studio deck, with ready wired printed circuit control and input panels, mains and output transformers. Complete with valves, knobs, plugs, sockets, etc. EFM8, EOC83, EM84, EZ81, OA81 and 2 EL54, 3 watta output. Magic eye, radio and mic. inputs, E/L 8 socket, tone and monitor controls. Can be used as an amplifier	£11.11.0
Deposit £1.4.0 and 12 monthly	19/-
Case for above including 9 in. x 5 1/2 in. speaker	£5.5.0
Total Kit as above	£29.0.0
Deposit £2.10.0 and 12 monthly	£2.9.2
We can offer the above recorder, complete with tape and microphone, in a De Luxe two tone grey cabinet, assembled for	£35.0.0
Deposit £3.10.0 and 12 monthly	£2.18.2
This Machine is listed at 39 gas. by makers and is a very good buy. Building Instructions available at 2/6 each kit (refunded if kit bought)	

QUARTER TRACK

B.S.R. TD2	£11.11.0
Deposit £1.4.0 and 12 monthly	19/-
Tape Amplifier as above, but quarter track	£9.9.0
Deposit £1.0.0 and 9 monthly	£1.1.0
Case, two tone grey, with speaker	£4.4.0
Complete Kit as above and 12 monthly	£21.8
Deposit £2.10.0 and 12 monthly	£2.1.8
Collaro Studio Deck, 4 track	£17.17.0
Deposit £1.17.6 and 12 monthly	£1.9.5
Tape Amplifier, as above, but 4 track	£12.12.0
Deposit £1.7.0 and 12 monthly	£1.0.8
Case with 9 in. x 5 in. speaker	£5.5.0
Complete Kit 4 track Collaro	£25.0.0
Deposit £3.10.0 and 12 monthly	£2.1.2
Tape Pre-amplifier for Collaro deck, with power supplies, EOC83, ECL82, E280 and EM85, Radio and Mic. sockets, gives an equalised output of 400 mV/ohm	
Half Track	£6.8.0
Deposit £1.0.0 and 6 monthly	£1.1.0
Quarter Track	£9.9.0
Deposit £1.0.0 and 9 monthly	£1.1.0
Marriott Tape Heads, 4 track type L/RP8/7 and L/ES/9 Record/Playback and Erase with mounting bracket for Studio deck	
Pair Complete (Marriott list price is £8.14.0)	£4.4.0
Bradmatic R/PB and Erase on Collaro bracket & track	£1.19.6
Bradmatic R/PB, Ideal 3rd head Collaro deck & track	£1.12.6
Pressure pad (Studio deck only)	4/6
Brenell Mk. 5 Amp. 4 track, 4 speeds	£29.9.0
Deposit £3.1.6 and 12 monthly	£2.8.7
Brenell Mk. 5 Amplifier, with power	£24.0.0
Deposit £2.8.0 and 12 monthly	£1.19.10

JASON F.M. TUNERS

FMT1, complete with valves	£26.17.8
Deposit £1.1.0 and 6 monthly	£1.2.9
FMT2, complete with valves, Less Power	£27.17.8
Deposit £1.0.0 and 7 monthly	£1.2.6
FMT2, complete with valves, Self powered	£20.15.0
Deposit £1.0.0 and 9 monthly	£1.1.8
FMT3, complete with valves, Less power.	£29.12.6
Deposit £1.0.6 and 9 monthly	£1.1.4
FMT3, complete with valves, Self powered	£12.0.0
Deposit £1.4.0 and 19 monthly	19/10
Power pack kit ready drilled chassis for FMT1, etc.	£2.12.6
The instruction books are included in all kits but are otherwise 2/6.	
JTV/2, switched F.M. and T.V. Sound self powered. All valves	£14.15.0
Deposit £1.9.6 and 12 monthly	£1.4.5
Mercury 2 as JTV/2 but less power, with all valves	£10.15.0
Deposit £1.1.6 and 12 monthly	17/10
The instruction book is again included but is otherwise 3/6.	
All the above units are available ready built and aligned. Price on request.	

AMPLIFIERS (MONO)

Linear L45 Three valve amplifier	£5.19.6
Linear Distonic Five valve, push pull	£12.12.0
Deposit £1.7.0 and 12 monthly	£1.0.8
Linear Concord 30 watt with case	£18.0.0
Deposit £1.16.0 and 12 monthly	£1.9.10
Tripletone Hi Fi Major, with Pre-amp	£15.19.9
Deposit £1.15.3 and 12 monthly	£1.6.1
Pye Mozart, including Pre-amp, 10 watt	£25.4.0
Deposit £2.10.6 and 12 monthly	£2.1.11
Leak TL 12, Main amp. only 10 watt	£18.18.0
Deposit £2.0.6 and 12 monthly	£1.11.1
Leak Varislope 111 Pre-amplifier	£15.15.0
Deposit £1.11.6 and 12 monthly	£1.6.1
Quad Main amp. only 15 watt	£22.10.0
Deposit £2.5.0 and 12 monthly	£1.17.4

AMPLIFIERS (STEREO)

Dulci AC202, Integrated	£12.12.0
Deposit £1.7.0 and 12 monthly	£1.0.8
Dulci GA505, Integrated	£18.19.0
Deposit £2.0.6 and 12 monthly	£1.11.1
Rogers Cadet Mk2, with Pre-amplifier	£25.10.0
Deposit £2.11.0 and 12 monthly	£2.2.4
Leak Stereo 20 Main amplifier	£30.9.0
Deposit £3.4.8 and 12 monthly	£2.10.3
Leak Varislope 111 Stereo Pre-amplifier	£25.0.0
Deposit £2.10.0 and 12 monthly	£2.1.6
Quad 22 Stereo Control unit, Pre-amplifier	£25.0.0
Deposit £2.10.0 and 12 monthly	£2.1.6

RADIO TUNERS

Armstrong T4 C. V.H.F. Tuner self powered	£17.19.0
Deposit £1.10.6 and 12 monthly	£1.9.5
Armstrong ST3 Mk2, AM/FM self powered	£25.12.0
Deposit £2.13.0 and 12 monthly	£2.2.4
Armstrong AP208 AM/FM Radio chassis, Bass and Treble controls, P.U. inputs etc.	£21.4.0
Deposit £2.6.0 and 12 monthly	£1.14.10
Armstrong Jubilee Mk2, AM/FM Push-pull output stage, Bass and Treble	£28.5.0
Deposit £2.16.6 and 12 monthly	£2.6.11
Armstrong Stereo 55, AM/FM Radio chassis, with stereo gram. Bass and Treble etc.	£29.18.0
Deposit £3.2.6 and 12 monthly	£2.9.5
Armstrong Stereo 12 Mk2, AM/FM Radio chassis, Stereo gram. Push-pull output stage	£40.5.0
Deposit £4.0.8 and 12 monthly	£3.6.11
Brass escutcheon available for AP208 and Jub. Mk2	7/6
Pye HFT109, FM tuner self powered	£28.12.6
Deposit £2.9.6 and 12 monthly	£1.19.0
Pye HFT113, AM/FM Tuner self powered	£28.7.0
Deposit £2.11.6 and 12 monthly	£2.6.11
Quad F.M. Tuner un-powered	£24.18.9
Deposit £2.13.3 and 12 monthly	£2.1.1

GRAMOPHONE UNITS

B.S.R. UA14 TC8 cartridge	£6.19.6
Deposit £1.0.0 and 6 monthly	£1.3.3
Garrard Antosium Mono cartridge	£7.17.0
Deposit £1.0.0 and 7 monthly	£1.2.6
Garrard Antosium De Luxe Mono cartridge	£11.9.0
Deposit £1.6.8 and 9 monthly	£1.4.9
Philips AG1016 with Stereo cartridge	£12.12.0
Deposit £1.7.0 and 12 monthly	£1.0.8
Decca Deram Arm only	£6.7.0
Decca Deram Transcription Cartridge	£4.14.6
Decca Deram Auto cartridge	£3.13.6
Golding GL59, with arm, less cartridge	£15.19.8
Deposit £1.12.0 and 12 monthly	£1.6.6
Golding '38 Transcription, no pick up	£17.14.0
Deposit £1.19.0 and 12 monthly	£1.9.0
Golding GL55X as GL59 but less P.U. arm	£13.17.0
Deposit £1.7.7 and 12 monthly	£1.1.6
Garrard 4HF with Mono cartridge	£17.0.0
Deposit £1.14.0 and 12 monthly	£1.8.2
Garrard Lab. Type 'A' Auto-changer, Mono	£19.14.9
Deposit £1.19.0 and 12 monthly	£1.12.9
Garrard 301	£20.12.2
Deposit £2.3.2 and 12 monthly	£1.14.0
Garrard 301 Strobe	£22.0.0
Deposit £2.4.0 and 12 monthly	£1.16.6

LOUDSPEAKERS

Goodmans Axiette 8	£6.5.7
Goodmans Axiom 19	£6.5.11
Goodmans Axiom 201	£10.7.0
Deposit £1.6.8 and 12 monthly	£1.5.0
Goodmans SL20 XL Tweeter with cross over	£7.0.0
Wharfedale RS12/DD 12 in. full range	£11.10.0
Deposit £1.7.6 and 9 monthly	£1.4.9
Whiteley Electrical W.B. H.F. 1012 10 in.	£4.7.6

48 SURBITON ROAD, KINGSTON UPON THAMES, SURREY

Established over 30 Years

Telephone KIN 5549

We pay all postage and insurance. All orders despatched same day. Money refund guarantee.

Hours: 9 a.m.—6 p.m. (1 p.m. Wednesday). We do not close for lunch. Open all day Saturday.

Make Your Ability PAY

UNLIMITED OPPORTUNITIES exist today for "getting on" . . . but only for the fully trained man. Let I.C.S. tuition develop your talents and help you to success.

STUDY IS EASY with I.C.S. guidance. The courses are thorough. Printed manuals, fully illustrated, make study simple and progress sure.

YOUR ROAD TO SUCCESS can start from here—today. Complete this coupon and post it to us, for full particulars of the course which interests you. **MODERATE FEES INCLUDE ALL BOOKS.**

Take the right course now . . .

ADVERTISING
Gen. Advertising, Retail & Dept.
Store Copywriting.

ART
Oil & Water Colour
Commercial Illustrating

BUILDING
Architecture, Clerk of Wks., Buildg.
Constn. & Allied Trades, Quantity
Survey.

CIVIL ENGINEERING
Highway Eng., Struct. Engrg.,
Concrete Engineering

COMMERCE
Bookkeeping, Accountancy, Office
Training, Costing, Secretaryship,
Storekeeping
Shorthand & Typewriting

DRAUGHTSMANSHIP
Architectural, Mechanical, Maths.
& Machine Drawing
Drawing Office Practice
Structural Drawing

ELECTRONICS
Industrial Electronics
Computers & Maintenance

FARMING
Arabic & Livestock
Farm Machinery Maint.
Pig & Poultry Keeping
Market Gardening

FIRE ENGINEERING
I.F.E. Examinations
Fire Service Promotion

GENERAL EDUCATION
Good Eng., Foreign Langs.
G.C.E. subjects at ordinary or
advanced level

MEMBER OF THE ASSOCIATION OF BRITISH CORRESPONDENCE
COLLEGES

INTENSIVE COACHING for all principal examinations
including C.I.S., A.C.C.A., I.C.W.A., B.I.M., A.M.I.Mech.E.
Brit.I.R.E., I.Q.S., City & Guilds of London Institute,
R.H.S., P.M.G. Certificates in Radioteletography etc.

HORTICULTURE
Complete Gardening
Flower & Veg. Growing

MANAGEMENT
Business Management
Hotel Management
Office Management
Industrial Management
Personnel Management
Work study, Foremanship

**MECHANICAL & MOTOR EN-
GINEERING**
Engineering Maths., Weldg.
Diesel Engines and Locos.
Inspection, Workshop Pract.
Refrigeration, Motor Mech.
Running and Maintenance (many
other subjects)

PHOTOGRAPHY
Practical Photography
P. D.A. Examination

POLICE
Police Entrance Exam.

RADIO, T.V. & ELECTL.
Radio Servicing & Engrg.
Radio Constn. (with kits)

SELLING
Commercial Travellers
Sales Mangnt, Ret. Selling

WRITING FOR PROFIT
Short Story Writing
Free-Lance Journalism

And many other subjects

Start today the I.C.S. way!

INTERNATIONAL CORRESPONDENCE SCHOOLS
(Dept. 172)
Intertext House, Parkgate Rd., London, S.W.11

Send FREE book on _____

Name _____

Address _____

Occupation _____

5.63

INTERNATIONAL CORRESPONDENCE SCHOOLS

MICRO-AMPLIFIER

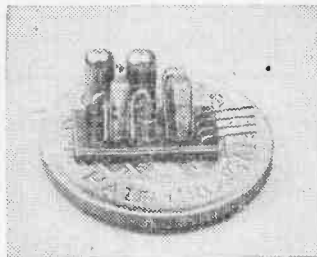

ACTUAL SIZE

SMALLEST OF
ITS TYPE IN
THE WORLD



Out-performs
amplifiers 20
times as large.



Overall size:
3" x 3" x 1/2"

28/6 plus 1/6
P. & P.

- 1) Power gain—60dB (1,000,000 times).
- 2) Frequency response 30 c/s to 50 kc/s \pm 1 dB.
- 3) Works on any voltage from 1.3 to 9V.
- 4) Drives any earpiece or small loudspeaker.
- 5) Simple to build with ordinary tools.
- 6) Uses **Micro-Alloy** transistors throughout.
- 7) Free applications data gives circuits for using micro-amp. in micro-radios, transmitters, etc.

MICRO-ALLOY TRANSISTORS

MAT100 7/9 MAT101 8/6
MAT120 7/9 MAT121 8/6

- ★ Easily the best for all A.F., R.F. and V.H.F. applications
- ★ Extremely high gains, typical betas of 150.
- ★ Cut-off frequencies of 120 Mc/s.
- ★ Gold plated for protection and soldering.

SEND FOR COMPLETE BOOK ON MATS

**"22 TESTED CIRCUITS USING
MICRO-ALLOY TRANSISTORS"**

ONLY 5/9 including postage.

This book includes new circuits for amplifiers,
transmitters, micro-radios, F.M. tuners, etc.

All mail orders and callers to:—

SINCLAIR RADIONICS

TRADE ENQUIRIES INVITED

BREAKTHROUGH

- ★ IN SIZE
- ★ DESIGN
- ★ PERFORMANCE
- ★ QUALITY
- ★ VALUE

THE

**SINCLAIR
SLIMLINE**



The **Sinclair Slimline** is the smallest receiver of them all, only $2\frac{3}{4} \times 1\frac{5}{8} \times \frac{5}{8}$ in. Yet it far surpasses in performance sets many times as large. Using only its internal ferrite rod aerial, it will receive all stations on the medium wave band including **Home, Light, Third, Luxembourg** and dozens of continental transmissions.

The case is in deep royal blue with gold lettering and the calibrated dial is in gold on white. Both were designed by a professional artist.

The earpiece provided gives superb reproduction free from noise or distortion and the volume is sufficient even for use in a car.

The receiver uses a completely new reflex circuit developed by engineers at Sinclair Radionics Ltd. All the components used are brand new and **MICRO-ALLOY TRANSISTORS** are employed throughout. The result is a radio with the sensitivity and selectivity of a good superhet but with no alignment problems.

The components are mounted on a printed circuit board, and clear, detailed instructions are provided. Assembly is perfectly straightforward and simple even for a beginner, yet the brilliant performance will more than satisfy the expert.

LIMITED

TEL. CAMBRIDGE 53965

**69, HISTON Rd.
CAMBRIDGE**

TOTAL COST

49/6 P.P. 1/6

← FROM

Brand new, individually checked and guaranteed

VALVES

Table listing various vacuum tubes (valves) such as AC/P4, AR8, ARP3, etc., with their respective specifications and prices.

AND MANY OTHERS IN STOCK, INCLUDING CATHODE RAY TUBES AND SPECIAL VALVES. All U.K. Orders below £1, 1/- P. & P. 2/6 over £1. Orders over £3, P. & P. free. C.O.D. 2/6 extra. Overseas Postage extra at costs.

BRAND NEW ORIGINAL SPARE PARTS FOR AR88 RECEIVERS. Please write your requirements. MARCONI RECEIVER TYPE CR 100/2 tested and aligned £32.10. Carr. £1. TELEPHONE HANDESET. Standard G.P.O. type. New 12/-. P. & P. 2/-. CONNECTORS FOR TCS RECEIVER, TRANSMITTER AND REMOTE CONTROL, with original plugs on both ends. New £1.17.6 each P. & P. 2/6. SPECIALLY BUILT POWER PACK for TCS receivers, 230 volts A.C. mains, including 6XSGT valve, £3.10. Carr. £3/-. R.109 RECEIVER. Covering 2-8 Mc/s. 6 v. D.C. with set of spare valves and carrier. Brand new in original packing case. £6.18.0 including delivery in U.K. R.109A RECEIVER. Covering 2-12 Mc/s., £7.18.0. "CONNECT AND FORGET—CANNOT OVERCHARGE" "ESS-TRON" MARK I AUTOMATIC BATTERY CHARGER. Initial charging rate 6-7 amps. The charging rate automatically adjusts itself to the charge in the battery. Automatic current and voltage control. Patented application of magnetic amplification to battery charging. Indicator lights show battery fully charged, receiving charge, incorrectly connected or faulty cells. Mains voltage 200/250 v. Built for 6 or 12 v. batteries. Measurements 7 x 5 x 5 1/2 in. Weight 8 1/2 lb. Price £7.19.6. P. & P. 3/6.

53 TRANSMITTER SPARES, Full range. Price list on application. H.R.O. Senior. Table Model. In excellent, fully checked, and tested condition (without coils and power pack), £15.10.0. As above but rack mounted model, £14.10.0. Individual frequency coils for above £1 each set or set of 9 £8. Either model carriage £1.10.0. Power pack for above. British made, A.C. 110/200/250 v., 59/6. Postage 4/-. CARBON INSET MICROPHONE. G.P.O. type, 2/6. P. & P. 1/6. 80W 12V PETROL DRIVEN CHARGING SETS. Very compact, in fully guaranteed condition, £12.10.0, Carr. £1. RE-ENTRANT LOUD HAILERS. 500 ohms, approx. 20w. £6.10.0. Carr. 10/-. R.107 COMMUNICATION RECEIVER. 1.2/17 mcs. 9 valves. "Wide" and "narrow" band switch. AVC and BFO, with internal speaker. 100/250 v. A.C. and 12 v. D.C. Meas: 24 x 13 x 17in. Price £13.10.0. Carriage 20/-. SHEPHERD'S BUSH 4946

P. C. RADIO LTD 170 GOLDHAWK ROAD, W.12 Shepherd's Bush 4946

AERIALS 1ft. long. 2ft. long when folded, 15/-. P. & P. 2/-. VARIOMETER FOR No. 19 SET. 10/- each. P. & P. 3/-. DOUBLE BEAM OSCILLOSCOPE TYPE 13. 4 1/2 in. screen. Time base 2 C/S-1 Mc/s. Calibration markers 1 microsecond microsecs, Y2 attenuation. 115/230 v. A.C. In excellent checked condition £27.10.0. Carriage £1. R.209 RECEPTION SET. A 10-valve high-grade Superhet Receiver with facilities for receiving R/T (A.M. or F.M.) and C.W. frequency 1 Mc/s.-20 Mc/s. Hermetically sealed. Built on miniature valves and incorporating its own vibrator power supply unit driven by a 6 v. battery (2 point connector included). The set provides for reception from rod, open-wire or dipole aerial with built-in loud-speaker or phone output. Dimensions: Length 12in., width 8in., depth 9in. Weight 23lb. In as new, tested and guaranteed condition, £23.10.0, including special head-phone and supply leads. Carr. £1. RECEIVER TYPE R.206. Frequency 0.55 Mc/s to 30 Mc/s in 6 bands. 100-250 v. A.C. or 12 v. D.C. Loudspeaker in power supply unit. High performance super-heterodyne, eleven valves including a separate local oscillator valve, beat oscillator valve and two valve: (Amplifier and Detector) in the A.B.C. system. In very good condition £20.10.0, including power pack. Carriage and Packing 15/-. Photo Tubes CMGB 9/- GS16 12/6 Special Valves 2J31 45/- 3A/1481 45/- 3J192/E 7/4 £37.10 4J31 43/- 4J50 43/- 723A/B 50/- 725A 30/- 726A 27/6 ACT6 160/- CV190 3/- CV980 3/- KR6/3 70/- L57B 30/- WL417A 15/-

RETURN-OF-POST SERVICE

We offer a really efficient Mail Order Service on all items stocked. All cash orders are dealt with on the day of receipt. ★ Hire purchase orders are subject to slight delay but this is kept to the absolute minimum.

● ILLUSTRATED LISTS

Illustrated lists are available on LOUDSPEAKERS, TAPE DECKS, TEST GEAR, GRAMOPHONE EQUIPMENT, AMPLIFIERS. Any will be sent free upon request.

● STEREO COMPONENTS

Morganite ganged potentiometers as specified for the Mullard circuits. ★ Log/Anti-Log, 500k, 1 meg., 2 meg. ★ Log/Log, 50k, 250k, 1 meg., 2 meg. ★ Lin/Lin 250k, 500k, 1 meg. All 10/6 each.

● TRANSISTORS

MULLARD. Current production types, not rejects. All in makers' boxes. Postage 3d. on each. OC4, 9/8; OC25, 9/-; OC70 and OC71, 8/6; OC72, 8/-; OC72 Matched Pairs, 16/-; OC78, 8/-; OC81, 8/-; OC10, 9/6; OC171, 10/6.

● AMPLIFIER KITS

We have full stocks of all components for the Mullard 510, Mullard 3-3, Mullard 2 and 3 Valve Pre-amp, Mullard Stereo, Mullard Mixer, GFC 912 Plus. Fully detailed list on any of these sent upon request.

Instructional Manuals: All Mullard Audio Circuits in "Circuits for Audio Amplifiers", 9/5. GEC912, 4/6. All first free.

● TRANSISTORISE YOUR CRYSTAL SET

We have two new designs for Transistor amplifiers which can be used to greatly improve the signal from any crystal set. RLD4 Kit, one stage 12/-; RLD5 Kit, two stage 21/-; both post free. The kits are easy to build and very detailed instructions are supplied. Leaflet available.

● CLOSE TOLERANCE CONDENSERS

Radiospares first grade Silver Mica. Tolerance—up to 39pf. +1 pf. 47pf. up +1%. 4.7, 10, 15, 18, 22, 27, 33, 39, 47, 50, 56, 68, 75, 82, 100, 120, 150, 180, 200, 220, 250, 270, 300pf. All 9d. each. 330, 390, 470, 500, 556, 680, 800pf. All 1/- each. 1000, 1500, 1900, 2200, 2700, 3600, 4700, 5000pf. All 1/9 each. Postage extra.

● RESISTORS

All preferred values from 10 ohms to 10 meg. 1/2 watt rating. List of values available. Carbon. Size $\frac{1}{2} \times \frac{3}{4}$ in. 10% to 5%, each. High stability. Size $\frac{1}{2} \times \frac{3}{4}$ in. 5% to 10%, 9d. each. Miniature Wire Wound, 5 watt, 5% tol. Size $\frac{1}{2} \times \frac{1}{2}$ in. 15, 25, 30, 39, 50, 68, 75, 100, 125, 150, 180, 200, 220, 250, 270, 300, 350, 400, 470, 680, 750, 820 ohms. 1.2k., 1.5k., 1.8k., 2.2k., 2.7k., 3k., 3.3k., 3.9k., 4.7k., 5.6k., 6.8k., 8.2k. All 1/6 each. Postage extra on all above.

● NEW MULLARD CONDENSERS

Mullard Miniature Foil and Polyester condensers as used in the latest TV and Transistor sets. Miniature Foil, 30 volt working for Transistor sets. .01mfd, 71d.; .022mfd, 9d.; .047mfd, 9d.; .1mfd, 11d. Polyester Tubular Capacitors. Moulded under case designed to withstand accidental contact with the soldering iron. Tolerance 10%. 15v. range. .01mfd, .022mfd, .047mfd, all 9d. each. .1mfd, 1/2; .22mfd, 1/3; .47mfd, 1/6; .1mfd, 3/-; .400v. range. .001mfd, .0022mfd, .0047mfd, .01mfd, .022mfd, all 9d. each. .04mfd, 1/2; .1mfd, 1/3; .22mfd, 1/6; .47mfd, 2/5. Postage extra.

● MINIATURE ELECTROLYTIC CONDENSERS

Latest miniature types by Mullard and Radiospares. RADSPAR 18k., 15 v. All 15 volt. 4mfd, 5mfd, 8mfd, 10mfd, 16mfd, 32mfd, 50mfd, 100mfd, all 2/3 each. Postage extra. MULLARD, 2mfd, 10v, 1/9; 4mfd, 4v, 1/9; 10mfd, 16v, 1/8; 16mfd, 10v, 1/8; 25mfd, 4v, 1/8; 25mfd, 25v, 1/3; 32mfd, 40v, 1/8; 32mfd, 40v, 1/8.

● TAPE RECORDING EQUIPMENT

TAPE DECKS	Cash Price	Deposit	Hire Purchase	Mthly/Pmts
ALL CARRIAGE FREE				
COLLAUTO STUDIO. Latest model: Two track. Broadcast matie Heads				
Four Track, Marriott Hds.	£17.17.0	£3.12.0	12 of	26/2
BSR TD2, Two Track	£8.19.6	£1.16.8	12 of	13/7
Four Track	£14.14.0	£2.18.0	12 of	21/8

● MARTIN TAPE AMPLIFIER KITS

Tape Amplifiers For Collaro Deck 8311-V 2-Track £11.11.0 8311-4-V 4-Track £12.12.0 For BSR Deck 8312-M 2-Track £8. 8.0 8312-4-M 4-Track £9. 9.0 Tape Pre-Amplifiers For Collaro Deck 8312-CP 2-Track £8. 8.0 8312-4-CP 4-Track £9. 9.0 Drop through assembly for mounting 8312 Pre-Amp under Collaro Deck. £1.11.6. Carrying Cases fitted with speaker. For Collaro Studio Deck and 8311 Amplifier, £5.5.0. For BSR TD2 Deck and 8312 Amplifier, £4.4.0. H.P. TERMS AVAILABLE on decks, amplifiers and cases. Ask for quotation.

MULLARD TAPE PRE-AMPLIFIER KIT We stock complete kits and all separate components for the Mullard Tape Pre-Amplifier. Fully detailed list available.

★ TERMS OF BUSINESS

Cash with order or C.O.D. We charge C.O.D. orders as follows: Up to £3, minimum of 3/2. Over £3 and under £5, 1/6. Over £5 and under £10, 1/8. Over £10, no charge. Postage extra on CASH orders under £3 except where stated. Postage extra on overseas orders irrespective of price.

● "BRAND FIVE" RECORDING TAPE

Post free. Long Play: 300ft. (5"), 18/6; 1200ft. (51"), 23/6; 1800ft. (7"), 35/-.

● PICK-UP CARTRIDGES—SPECIAL OFFER

B.S.R. TC8M (Mono) 19/6; AVO GP672 (Mono) 12/6; HONETTE 1058 (Stereo/Mono) 27/6. All post free. All Brand New and complete with fixing brackets.

● JASON F.M. TUNER KITS

Kits supplied complete with every item needed including instruction manuals. Fully detailed list available. Separate items supplied, ask for price list. H.P. Terms available on any kit.

FMT1, £6.12.6; FMT2 (less power), £7.15.0. FMT2 (with power), £9.12.6; FMT3 (less power), £9.9.6. FMT3 (with power), £11.7.6. Mercury 2, £10.14.6. JTV2, £14.12.6.

● P.W. STRAND, MAYFAIR & SAVOY UNITS

We stock parts for the P.W. Strand Amplifier, Mayfair Pre-Amplifier and Savoy FM Tuner. Detailed price lists are available.

● LATEST TEST METERS

	Cash Price	Deposit	Hire Purchase	Mthly/Pmts.
AVO Model 8 Mark II	£24. 0.0	£4.18.0	12 of	£1.15. 2
AVO Model 7 Mark II	£21. 0.0	£4. 4.0	12 of	£1.10.10
AVO Multimeter Mark 4	£9.10.0	£1.19.0	12 of	1/4
T.M.K. TP10	£3.19.6	£1. 3.6	3 of	£1. 2.0
T.M.K. TP55	£5.19.6	£1.15.6	3 of	£1.11.4
T.M.K. Model 500	£8.19.6	£1.15.6	12 of	13/8
TAYLOR MODEL 127A	£10.10.0	£2. 2.0	12 of	15/8
CABY A-10	£4.17.6	£1. 7.6	3 of	£1. 6.6
CABY B-29	£5.10.0	£2. 0.0	3 of	£1.13.4
CABY M-1	£2.14.0	—	—	—

Full details of any of the above supplied free on request. The AVO Models 7 and 8 are both latest models from current production—not to be confused with Government Surplus

● OUTPUT TRANSFORMERS

GILSON: W0696A, W0696B, 50/6, post 2/6. W0710, 55/8, post 2/6. W0892, 62/3, post free. W0767, 27/-; post 1/6. W01766A, 57/6, post 2/6. W01952, 84/-, post free.

PARTRIDGE: P3667, 75/-; P4131, 65/-; P5202, P5203, £25.18.6. All post free.

PARMEKO: P2629, 47/6; P2642, 45/-; P2643, 47/6. All plus post 2/9. P2641, 29/6, post 2/-; P2928, 17/-, post 2/-; P2632, 41/-, post 2/6. ELSTONE: OT/M, 45/-, post 2/9; OT/3, 25/-, post 2/6.

● MAINS TRANSFORMERS

GILSON: W0741A, 63/-, post free; W0839, 48/9, post 2/9; W01328, 58/6, post 3/6; W01288, 58/-, post 3/6; W01566, 80/-, post free; W01341, Choke, 36/-, post 2/-.

PARMEKO: P2631, 35/-, post 2/9; P2630, 54/9, post 3/3; P2644, 76/6, post free; P2930, 41/-, post 3/-; P2631, 58/9, post 3/3. ELSTONE: MT/MU, 45/-, post 3/3; MT/3M, 35/-, post 3/-; MT/610, 42/-, post 3/3.

● GRAMOPHONE EQUIPMENT

ALL LATEST MODELS	Cash Price	Deposit	Hire Purchase	Mthly/Pmts.
ALL POST FREE				
RECORD CHANGERS				
GARRARD AUTOSLIM (Mono PU)	£7. 2.6	£1. 8.8	12 of	11/2
GARRARD AUTOSLIM De-luxe AT6 (Mono PU)	£11. 9.0	£2. 6.0	12 of	16/11
GARRARD AUTOSLIM De-luxe AT6 (S/M PU)	£12. 5.4	£2. 9.4	12 of	18/-
B.S.R. UA16 (TC8 Mono PU)	£6.19.6	£1. 7.6	12 of	11/-
B.S.R. UA14 Monarch (TC8 Stereo/LP/78)	£7.19.6	£1.11.6	12 of	12/4
B.S.R. UA16 (TC8 Mono PU)	£7.19.6	£1.11.6	12 of	12/4
B.S.R. UA16 (TC8 Stereo/LP/78)	£8.19.6	£1.15.6	12 of	13/8

● SINGLE RECORD PLAYERS

B.S.R. TU12 (TC8 Mono PU) £3.17.6 £1. 4.6 3 of £1.1.0
B.S.R. GU7 (TC8 Mono PU) £4.18.8 £1. 8.8 3 of £1.6.8

GARRARD SRP10 (Mono PU) £5. 9.11 £1.12.11 3 of £1.9.0

● TRANSCRIPTION UNITS

GARRARD 41P (GC8 PU) £16.12.6 £3. 6.8 12 of £14.5
PHILIPS AG106 (S/M PU) £12.12.0 £2.10.0 12 of 18/6

Many of the above can be supplied for stereo working. See our Gramophone Equipment List for details.

● LOUDSPEAKERS

GOODMANS: Axielte 8in., £5.5.7; Axiom 10in., £6.5.11; 12in., Axiom 20, £10.7.0; 12in., Axiom 30, £14.10.0; 12in., Audiom 51 Bass, £8.14.0; 12in., Audiom 61 Bass, £13.14.0; Trebax Tweeter, £6.4.0; X05000 Crossover unit, £1.19.0. WHITELEY: HF106 10in., £7.0.0; HF102 10in., £4.7.6; HF816 8in., £6.0.0; T816 8in., £5.3.6; T10 Tweeter, £4.8.3; T359 Tweeter, £1.10.6; CX3000 Crossover unit, £1.11.6; CX1500 Crossover unit, £2.0.0. H.P. Terms available on all speakers.

★ HIRE PURCHASE TERMS

are available on any item. Repayments may be spread over 3, 6 or 12 months. Details as follows: Three months; Deposit 6/- in the £. Service charge 5 per cent, but minimum charge of 10/-. Six and Twelve months; Deposit 4/- in the £. Service charge 10 per cent, but minimum charge 20/-.

WATTS RADIO

(MAIL ORDER) LTD.
54 CHURCH ST., WEYBRIDGE, SURREY
Telephone: Weybridge 47556

Please note: Postal business only from this address
Callers welcome by appointment

POST FREE MAIL ORDER SERVICE

TRANSISTOR RADIO ESSENTIALS

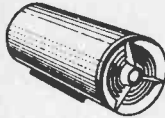

T.S.80 Booster Speaker. Plugs into earpiece socket of most miniature radios and tape recorders. Doubles the volume and a Hi-Fi Stereo effect that will amaze you, 9s 3 3/4in.

PRICE 29/-

LA.6P A.C. Adaptor. Enables 9 v. battery sets to be run off A.C. mains, also re-activates old 9 v. batteries.

PRICE 24/6

All goods sent by return

MINIATURE COMPONENTS



BH.9 v. Battery Connector for P.P.3, T.6003, etc. 1/- each. BP.31 Standard Shilded chrome barrel plug, screw terminals, 3/- each. P.31 Standard black bakelite barrel plug, 2/6 each. T.104 Toggle Switch B.P.S.T. with on/off plate, 2/- each. MR.60 Magnetic earphones. 250 ohm with earcurl, lead and plug, 6/- each.

S.A.E. for Miniature Component Leaflet

HI-FI AMPLIFIERS



SA.80 Integrated Stereo Amplifier. 4 x 4 watt. The perfect choice for a low cost, Hi-Fi stereo system. Dual pick-up and tuner inputs. Supplied complete for only £2.10.0.

SA.300 Integrated Stereo Amplifier. 15 x 15 watt. Incorporates Hi-Fi reproduction. Modestly priced at £32.10.0. S.A.E. for leaflets.

All goods available as previously advertised

Full range of Eagle Products always in stock

MULTI-METERS



Model EP.100K. 100,000 O.P.V. A handy size high sensitivity multi meter, with shockproof 9.5µA meter. Ranges D.C. volta, A.C. volta, D.C. amps, Ohms, etc. Size 5 1/2 x 3 1/2 x 2 1/2in. Originally £14.14.0.

RELDA EXCLUSIVE OFFER UNOBTAINABLE ELSEWHERE

£6.19.6

EP. 10K. 10,000 O.P.V. in Kit form £3.9.6.
TK. 20A. 1,000 O.P.V. complete £2.9.6.

Leaflets available.



R.F. FIELD INDICATOR FL.30H. Designed for checking the radiation from a transmitting antenna. The sensitivity can be controlled by adjustment of panel control the antenna length or by increasing distance from the radiator. Freq. range 1-200 Mc/s. 200µA D.C. Price 89/8.

Meter. Complete as illus. with instructions.

VISIT OUR HI-FI SHOWROOM AT 87, TOTTENHAM CT. RD., W.I

HI-FI SPEAKERS

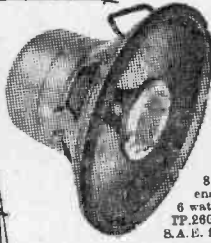

CX. 300. 12in. Two Way (illus.). Crisp clean frequency response from 30-16,000 cps. 15 watt. 16 ohms. Price 12 gns.
CR.12AE. 12in. Two Way. True Hi-Fi and superb stereo at low cost. Response 30-16,000 cps. 10 watt. 16 ohms. Price 10 gns.
CR.30AE. 12in. Three Way. Advanced triaxial design giving full 3 speaker performance. Response 30-16,000 cps. 10 watts. 16 ohms. Price 10 gns.
S.A.T. 6in. Two Way. Dual cone construction ensures wide range response. 50-16,000 cps. 6 watt. 16 ohms. Price 81/-.
TP.26G. 2 1/2in. 75 ohm speaker. Price 11/-, S.A.E. for leaflets.

MICROPHONES



M.C.70 (illus.) CRYSTAL. 360 deg. pick up. Response 50-12,000 cps. Price 59/6.
100.C3 3 way 8LIM CRYSTAL. Response 60-10,000 cps. Price 49/-.
DM.11 DYNAMIC with base. Response 60-12,000 cps. Price £5.5.0.
DM.17S LIGHTWEIGHT DYNAMIC. Response 150-9,000 cps. Price 39/6.
BM.36R MAGNETIC LAPEL TYPE. 1 1/2in. dia. Price 12/6.
S.A.E. for leaflets.

5-STAGE TRANSISTOR RADIO

Completely portable, has the appearance of sets costing considerably more and works equally well. Incorporates telescopic aerial and ferrite rod to really pull in those stations. genuine 2 1/2in. speaker also earpiece with ear curl for personal listening. G.E.C. transistors, tuning control, volume control with switch etc. Attractive case size 5 1/2 x 3 1/2 x 1 1/2in. Can be built in one hour. ALL PARTS SOLD SEPARATELY PRICE 47/6.

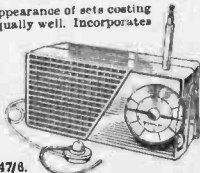

Relda Radio

MAIL ORDERS TO: DEPT. 'P' 32A, COPTIC STREET, LONDON, W.C.1 Tel: MUS um 9606

INTRODUCING THE R.S.C. BASS-MAJOR 30 WATT GUITAR AMPLIFIER

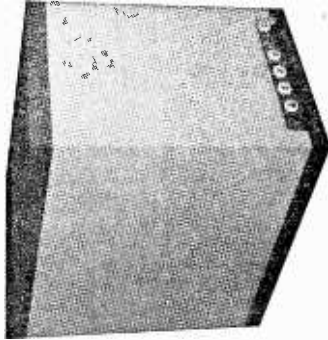

A MULTI-PURPOSE HIGH FIDELITY, HIGH OUTPUT UNIT FOR VOCAL AND INSTRUMENTALIST GROUPS
Eminently suitable for bass guitar and all other musical instruments

- ★ Incorporating two 12in. heavy duty 25-watt high flux (7,000 lines) loudspeakers with 2in. diameter speech coils. Designed for efficiently handling full output of amplifier at frequencies down to 25 c.p.s.
- ★ Dual Cone in second speaker reproduces frequencies up to 17,000 c.p.s.
- ★ Heavily made cabinet of convenient size 24 x 21 x 14in. has an exceptionally attractive covering in two contrasting tones of Vynair.
- ★ For 200-250 v. to 50 c.p.s. A.C. mains operation.
- ★ Four jack socket inputs and two independent vol. controls for simultaneous connection of up to four instrument pick-ups or microphones.
- ★ Separate bass and treble controls providing more than adequate "Boost" or "Cut".
- ★ LEVEL frequency response throughout the audible range.
- ★ SUPERIOR TO UNITS AT TWICE THE COST.

39½ Gns. Send S.A.E. for leaflet.
 OR DEPOSIT OF £4.3.0 and 12 monthly payments of £3.9.11. Carr. 17/6.

R.S.C. JUNIOR GUITAR AMPLIFIER
 5-watt high quality output. Separate bass and treble "cut" and "boost" controls. Sensitivity 15 m.v. Two high impedance inputs. 10in. loudspeaker. Handsome strongly made cabinet (size 14 x 14 x 7in. approx.) finished in attractive and durable polychrome. 200-250 A.C. mains operation. **£8.19.6** Or DEPOSIT £1 and 9 monthly payments of £1. Carr. 7/6.

LINEAR TREMOLO/PREAMP. UNIT
 Designed for introducing the Tremolo effect to any amplifier which is fitted with a reserve power supply point for smoothed H.T. and 6.3 v. A.C. L.T. This applies to practically all amplifiers of our manufacture, and to those of several other manufacturers. The unit plugs into power supply point and any input socket of amplifier. Controls are Speed (frequency of interruptions), Depth (for heavy or light effect), Volume and Switch. Three sockets are for two inputs and Foot Switch. **4 Gns.** ONLY

LEICESTER BRANCH NOW OPEN

TRANSISTOR SALE. Mullard OCT1 3/9, OC45 4/11, OC44 4/11, OC72 4/9, OC81 4/11, OC71 8/9, Ediswan XA101 3/9, XB102 3/9, XA112 3/9, XB113 3/9, XB104 3/9, XC101A 9/9. Postage 6d. for up to 3 Transistors.

D.C. SUPPLY KIT. 12 v. 1 a. consisting of a partially drilled metal case, mains trans., F.W. Bridge Rectifier, 2 fuseholders and fuses, Change Direction switch, variable Speed regulator and circuit. For 200-250 v. A.C. mains. Suitable for Electric Trains. Limited number available at 29/11

SELENIUM RECTIFIERS
 F.W. BRIDGE 24 v. 2 amp .. 14/9
 6/12 v. 1 a. .. 3/11 24 v. 20 amp. .. 89/9
 6/12 v. 2 a. .. 6/11 H.T. TYPES H.W.
 6/12 v. 3 a. .. 9/9 150 v. 40 mA .. 3/9
 6/12 v. 4 a. .. 12/3 250 v. 50 mA .. 3/11
 6/12 v. 6 a. .. 15/9 250 v. 60 mA .. 4/11
 6/12 v. 10 a. .. 26/9 250 v. 80 mA .. 5/11
 6/12 v. 15 a. .. 35/9 250 v. 250 mA .. 11/9
CONTACT COOLED. 250 v. 75 mA. F.W. (Bridge), 10/11. 250 v. 50 mA. F.W. (Bridge), 8/11. H.W. 250 v. 60 mA. 5/11.

LINEAR TAPE PREAMPLIFIER
 Type LP1. Switched Negative feedback combination. Positions for Record 1in, 3in, 7in, and Playback. EM84 Recording Level Indicator. Designed primarily as the link between a Collaro Tape Transcriber and a high fidelity amplifier, but suitable for almost any Tape Deck. Only 9 gns. S.A.E. for leaflet.

HUGE PURCHASE OF BRAND NEW 24 & 20 Amp. F.W. (BRIDGE) SELENIUM RECTIFIERS. each **59/9**

R.S.C. SENIOR Guitar Amplifier
 10 watt high-fidelity push-pull output.

Separate bass and treble "cut" and "boost" controls. Twin separately controlled inputs so that two instruments or "mike" and pick-up can be used at the same time. Two loudspeakers are incorporated, a 12in. high flux 14 watt bass unit, and a 6 x 4in. elliptical for treble. Cabinet is well made and finished as Junior Model. Size approx. 18 x 13 x 8in. Only **15 Gns** Carr. 10/- Send S.A.E. for leaflet. Or DEPOSIT 34/9 and nine monthly payments of 34/9



R.S.C. SUPER HI-FI 15-watt
 An exceptionally efficient high fidelity Guitar Amplifier incorporating a heavy 20-watt speaker with excellent frequency response. Individual bass and treble controls give amp "boost" and "cut". Two high impedance jack socket inputs are separately controlled. If required one or two additional inputs can be provided at a cost of 7/6 per extra socket. Cabinet is of substantial construction and attractively finished in two tones of polychrome. Size approx. 20 x 18 x 10in. Operation from 200-250 v. 50 c.p.s. A.C. mains. Please do not compare this unit with others of similar rating until you have heard the difference. Send S.A.E. for leaflet.

22 Gns. Or Deposit 51/6 and nine monthly payments of 51/6. Carr. 12/6.

LARGE REXINE COVERED SPEAKER CABINETS. Heavy block-board construction. Very attractive two tone covering of Rexine and Vynair. Size 30 x 21 x 16in. cut for 15in. or 18in. speaker or for two 12in. 11 gns. or Deposit 25/9 and nine monthly payments 25/9. Size 30 x 30 x 16in. cut for 15in. or 18in. speaker 13 gns. or Deposit 30/4 and nine monthly payments 30/4. Suitable speakers available.

EX. GOVT. SELENIUM RECTIFIERS 12v 15 AMP 19/9 (BRIDGE) F.W. ONLY

R.S.C. GRAM AMPLIFIER KIT. 3 watts output. Negative feedback. Controls Vol. Tone and Switch. Mains operation 200-250 v. A.C. Fully isolated chassis. Circuit, etc., supplied. Only 39/9, Carr. 3/9.
HI-FI 10 WATT AMPLIFIERS
 Brand new. Manufacturer's discontinued line. Filtered latest Mullard valves. Dual inputs for "mike" and gram., etc. Bass and Treble Controls. High sensitivity and quality. Output for 3 ohm or 15 ohm speaker. For 230-250 v. A.C. Carriage 4/6. Only **£7.19.9**

THE SKYFOUR T.R.F. RECEIVER
 A design of a 3 valve long and medium wave 200-250 v. A.C. Mains receiver with selenium rectifier. High gain H.F. stage and low distortion detector. Valve line-up 6K7, SP61, 6V6G. Selectivity and quality excellent. Simple to construct. Point-to-Point wiring diagrams, instructions and parts list 1/9, maximum building costs £4.19.6. Inc. attractive Walnut veneered wood cabinet 12 x 6 x 5 1/2 in.

MULTI-METERS. CABY ML. Sensitivity 2000 ohms per volt. A.C. and D.C. 54/-.
A.10. Basic Meter sensitivity 155 micro-amps A.C. and D.C. ranges £4.17.6 H.20. Sensitivity up to 10,000 ohms per volt A.C. and D.C. £6.10.0.

EX. GOVERNMENT ACCUMULATORS. Size 7 1/2 x 4 x 2in. 2v. 16 A.H. brand new. 8/9 each. 3 for 15/6.

EX. GOVT. SMOOTHING CHOKES. 200 mA. 3-5 H. 50 ohms. Farneko 8/9; 100 mA. 5 H. 100 ohms 3/11; 150 mA. 10 H. 50 ohms 9/9; 80 mA. 20 H. 900 ohms 5/9; 120 mA. 12 H. 100 ohms 8/9; 50 mA. 5 H. 1,000 ohms 6/9; 100 mA. 10 H. 100 ohms 6/9; 60 mA. 5-10 H. 250 ohms 2/11.

COMPLETE POWER PACK KIT, 18/11
 Consisting of Mains Trans., Metal Rectifier. Double electrolytic, smoothing choke chassis and circuit. For 200-250 v. A.C. mains. Outputs 250v. 60mA. 6.3v. 2a.

R.S.C. POWER PACK, 39/9. Louvered metal case only 8 x 5 1/2 x 2 1/2 in. Stove enamelled. For 200-250v. A.C. mains Output at 4 pin plug and socket 250 v. 60 mA, fully smoothed and 6.3v. 2a. Suitable for power requirements of almost any Pre-amp or Radio Tuner.

R.S.C. BABY ALARM or INTER-COMM. KIT. Complete set of parts with diagrams, etc. Housed in two polished walnut finished cabinets of pleasing design. High sensitivity. For 200-250 v. A.C. mains. Fully isolated. Controllable at both units. An intercomm. of this class would normally cost £20-£30. Only 79/6, carr. 5/- or assembled ready for use £5.15.0.

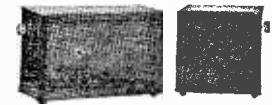

R.S.C. (Manchester) Ltd.		MAIL ORDERS to 5 County Arcade, Leeds 1. Terms: C.W.O. or C.O.D. No C.O.D. under £1. Postage 2/9 extra under £2. 4/6 extra under £5. Trade Supplied. S.A.E. with all enquiries please.											
LEICESTER:	BIRMINGHAM:	SHEFFIELD:	HULL:	LIVERPOOL:	BRADFORD:	MANCHESTER:	LEEDS:						
32 High St.	6 Gt. Western Arcade Birmingham	13 Exchange St. Castle Market Bldgs. Sheffield	51 Savile St. Hull	73 Dale St. Liverpool 2	56 Morley St. (above Alhambra Theatre) Bradford	8-10 Brown St. (Market St.) Manchester 2	5-7 County (Mecca) Arcade Briggate, Leeds	No half-day			Half-day Wed.		
No half-day		Half-day Thursday	Half-day Wednesday		No half-day		Half-day Wed.						

R.S.C. (Manchester) Ltd.
LEICESTER: BIRMINGHAM:
 32 High St. 4 Gt. Western
 Half-day Arcade
 Thursday (Opp Snow Hill Sta.) No half-day

MAIL ORDERS to 5 County Arcade, Leeds 1. Terms: C.W.O. or C.O.D. No C.O.D. under £1. Postage 2/9 extra under £2. 4/6 extra under £5. Trade Supplied. S.A.E. with all enquiries please.

SHEFFIELD: 13 Exchange St. Castle Market Bldgs. Sheffield
 Half-day Thursday

HULL: 51 Savile St., Hull
 Half-day Thursday

LIVERPOOL: 73 Dale St. Liverpool 2
 Half-day Wednesday

BADFORD: 56 Morley St. (above Alhambra Theatre) Bradford
 No half-day

MANCHESTER: 8-10 Brown St. (Market St.) Manchester 2
 No half-day

LEEDS: 5-7 County (Mecca) Arcade Briggate, Leeds
 Half-day Wed.

SENSATIONAL STEREO OFFER

A complete set of parts to construct a good quality Stereo amplifier with an undistorted output total 6 watts. For A.C. mains input of 200-250 v. Including pair matched 6In. speakers. Sensitivity 130 m.v. Gated Vol. and Tone Controls. Preset balanced control. Full instructions and wiring diagrams supplied. Stereo Pickup Head 19/9 extra with above only.

R.S.C. 30-WATT ULTRA LINEAR HIGH FIDELITY AMPLIFIER A10

A highly sensitive Push-Pull high output unit with self-contained Pre-amp. Tone Control Stages. Certified performance figures compare equally with most expensive amplifiers available. Hum level 70 db down. Frequency response ± 3 db. 30-30,000 c/s. A specially designed sectionally wound ultra linear output transformer is used with 807 output valves. All components are chosen for reliability. Six valves are used EF86, EF86, ECC83, 907, 907, GZ34. Separate Bass and Treble Controls are provided. Minimum input required for full output is only 12 millivolts so that ANY KIND OF MICROPHONE OR PICK-UP IS SUITABLE. The unit is designed for CLUBS, SCHOOLS, THEATRES, DANCE HALLS or OUTDOOR FUNCTIONS, etc. For use with Electronic ORGAN, GUITAR, STRING BASS, etc. For standard or long-playing records. OUTPUT SOCKET PROVIDES L.T. and H.T. for a RADIO FEEDER UNIT. An extra input with associated volume control is provided so that two separate inputs such as Gram. and "Mike" can be mixed. Amplifier operates on 200-250 v. 50 c/s. A.C. Mains and has output for 8 and 15 ohm speakers. Complete Kit of parts with fully punched chassis and point-to-point wiring diagrams and instructions. If required perforated cover with carrying handles can be supplied for 10/9. The amplifier can be supplied, factory built with EL34 output valves and 12 months guarantee, for 14 r/s.

11 Gns.
 Carr. 10/-
 TERMS: DEPOSIT 33/9 and 9 monthly payments of 33/9.
 Suitable microphones and speakers available at competitive prices.

WE STOCK ARMSTRONG, DULCI AND JASON EQUIPMENT GOODMAN'S AND W.B. SPEAKERS GARRAID AND GOLDRING TABLES

SUPERHET FEEDER UNIT. Design of a high quality Radio Tuner (specially suitable for use with our Amplifiers). Delayed A.V.C. Controls are Tuning W/CB. and Vol. Only 250 v. 15 mA. H.T. and L.T. of 8.3 v. 1 amp. required from amplifier. Size approx. 9 x 6 x 7 in. high Simple alignment procedure. Point-to-Point wiring diagrams, instructions and priced parts list with illustrations. 2/3. Total building cost 24.15.0. S.A.E. for leaflet.

R.S.C. BATTERY TO MAINS CONVERSION UNITS

Type BM1. An all-dry battery eliminator. Size 5 1/2 x 4 1/2 in. approx. Completely replaces battery supplying 1.4 v. and 90 v. where A.C. mains 200-250 v. 50 c/s is available. Suitable for all battery portable receivers requiring 1.4 and 90 v. This includes low consumption types. Complete kit with diagrams, 39/9, or ready to use, 46/6.



Type BM2. Size 8 x 5 1/2 x 2 1/2 in. Supplies 120 v. 90 v. and 80 v. 40 mA. and 2 v. 3.1 a. to 1 amp. Fully smoothed. Thereby completely replacing both H.T. batteries and L.T. 2 v. accumulators when connected to A.C. mains supply 200-250 v. 50 c/s. SUITABLE FOR ALL BATTERY RECEIVERS normally using 2 v. accumulators. Complete kit of parts with diagrams and 11 instructions. 49/9, or ready for use, 56/6.

P.M. SPEAKERS. 10In. W.B. "Stentorian" 3 or 15 ohms type HF 1012 10 watts, hi-fidelity type. Recommended for use with our All Amplifier, £4.7.6. 12In. R.A. 3 ohms 10 watts (12,000 lines), 59/6.

TWEETERS. Plessey 3In 19/9, 15n 25/8.

Jason FMT1 V.H.F./F.M. Radio Tuner design. Total cost of parts including valves Tuning dial, Escutcheon, etc., £6.19.8. Other Jason equipment in stock.

LINEAR L45 MINIATURE 4/5 WATT QUALITY AMPLIFIER. Suitable for any record playing unit, and most microphones. Negative feedback 12 db. Separate Bass and Treble Controls. For mains 200-250 v. 50 c/s. Output for 2-3 ohm speaker. Mullard valves 6Z90, ECC83, EL34. Size only 7-5-5 1/2 in. high. Guaranteed 12 months. Only £5.19.6. Send S.A.E. for leaflet. Terms: Deposit 22/6 and 5 monthly payments of 22/6



200-250 v. 50 c/s. Output for 2-3 ohm speaker. Chassis is not alive. Kit is complete in every detail and includes full punched chassis (with baseplate) with blue hammer finish and point-to-point wiring diagrams and instructions. Exceptional value at only £4.15.0, or assembled ready for use 25/- extra. Plus 3/6 carr., or deposit 22/6 and 5 monthly payments of 22/6 for assembled unit.

NOW OPEN AT LEICESTER

AUDIOTRINE HIGH FIDELITY REPRODUCERS THE DUO/10. Consisting of a 12In. 12,000 line Speaker with heavy four layer voice coil, the Audiotrine cross-over unit, and a 4In. Diameter Tweeter Unit incorporated in the extremely attractive Audiotrine Senior Corner Console Cabinet as described below. Matching impedance 15 ohms. Power handling 10 watts nominal, 14 watts peak. Frequency range 40-18,000 c.p.s. Deposit 27/9 and nine monthly payments of 27/8.

THE DUO/20. Incorporating a 12In. High Flux 20 watt Speaker with 2In. Diameter Speech Coll. (Total Flux 160,000 lines), the Audiotrine cross-over unit, and a highly sensitive Tweeter unit, in the Audiotrine Senior Corner Console Cabinet. Matching impedance 15 ohms. Peak Power Output 25 watts. Frequency range 30- ONLY 14 Gns. 18,000 c.p.s. Deposit 33/9 and nine monthly payments 34/9.

R.S.C. JUNIOR HI-FI REPRODUCER. The very latest Goodmans Axette 8 High Fidelity loudspeaker (retailing at approx. 5 gns.) fitted in a specially designed Bass Reflex cabinet 12In. x 18In. x 10In. Acoustically lined and ported and finished in polished walnut veneer. Matching impedance 15 ohms. Frequency range 40-15,000 c.p.s. Power handling 8 watts nominal. Ideal for Stereo. Carr. 4/6. Limited number. 8 Gns.

12In. 10 WATT HIGH QUALITY LOUDSPEAKER

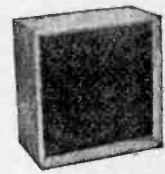

In walnut veneered cabinet. Gauss 12,000 lines. Speech coil 3 ohms or 15 ohms. Only 24.19.8. Carr. 5/-. Terms: Deposit 11/3 and monthly payments of 11/3. **12In. 20 WATT HI-FI LOUDSPEAKERS IN CABINETS.** Size 18 x 18 x 10In. Finish as above. Terms: Deposit 17/9 and 9 monthly payments of 17/9. Only £27.8. Carr. 8/6.

RASS GUITAR LOUDSPEAKER IN CABINET. 15In. 50 watt, highly sensitive unit in Rexine covered acoustically lined cabinet. Deposit £3.7.6 and 12 monthly payments of 22.10.0. Carr. 15/-

R.S.C. 4-5 WATT AS HIGH-GAIN AMPLIFIER

A highly-sensitive 4-valve quality amplifier for the home, small club, etc. Only 50 millivolts input is required for full output so that it is suitable for use with the latest high fidelity pick-up heads, in addition to all other types of pick-ups and practically all "mikes". Separate Bass and Treble Controls are provided. These give full long-playing record equalisation. Hum level is negligible being 71 db. down 15 db. of negative feedback is used. H.T. of 300 v. 25 mA. and L.T. of 8.3 v. 1.5 a. is available for the supply of a Radio Feeder Unit, or Tape-Deck pre-amplifier. For A.C. mains input of 200-250 v. 50 c/s. Output for 2-3 ohm speaker. Chassis is not alive. Kit is complete in every detail and includes full punched chassis (with baseplate) with blue hammer finish and point-to-point wiring diagrams and instructions. Exceptional value at only £4.15.0, or assembled ready for use 25/- extra. Plus 3/6 carr., or deposit 22/6 and 5 monthly payments of 22/6 for assembled unit.

R.S.C. BASS REFLEX CABINETS JUNIOR MODEL. Specially designed for W.B. HF1012 Speaker, but suitable for any good quality 10In. speaker. Acoustically lined and ported. Polished walnut veneer finish. Size 18 x 12 x 10In. Handsome appearance. Ensure superb reproduction for only £23.8.6.

STANDARD MODEL. As above but for 12In. speakers. Size 20 x 15 x 13In. For vertical or horizontal use. 25.19.6. Suitable legs with brass ferrules, 10/6 per set of 4.

R.S.C. CORNER CONSOLE CABINETS

Polished walnut veneer finish. Pleasing design. **JUNIOR MODEL.** Size 20 x 11 1/2 in. for 8 x 5 in. or 10 x 8 in. speakers. £23.9.0. **STANDARD MODEL.** Size 27 x 18 x 12In. for 8 or 10In. speakers. £4.11.9. **SENIOR MODEL.** Size 30 x 20 x 15In. for 12In. Speaker. Suitable Speaker systems below. Only 7 gns.



AUDIOTRINE HI-FI SPEAKER SYSTEMS. Consisting of matched 12In. 12,000 line, 15 ohm high quality speaker; cross-over unit (consisting of choke, condenser, etc.) and Tweeter. The smooth response and extended frequency range ensure surprisingly realistic reproduction. Standard 10 watt rating £4.10.8. Carr. 5/-. Or Senior 15 watt 7 gns. Carr. 7/6.

AUDIOTRINE EQUIPMENT CABINET. Size 36 x 15 x 13In. Beautiful walnut veneered finish. Elegant contemporary design. Robust construction. Unique removable alu. baseboard. Depth above baseboard 5 1/2 in. Carr. 15/-. Terms: Dep. 25/0, and 12 monthly pymts. 29/9



AUDIOTRON HI-FI TAPE RECORDER KIT 25 1/2 GNS. Carr. 17/6

REALISM AT INCREDIBLY LOW COST, CAN BE ASSEMBLED IN AN HOUR

Incorporating the latest Collaro Studio Tape Transcriber. The audiotone High Quality Tape Amplifier with negative feedback equalisation for each of 3 speeds, High Flux P.M. Speaker, empty Tape Spool, a Reel of Best Quality Tape and a Handsome Portable carrying Cabinet with latest attractive two-tone polychrome finish, size 14 1/2 x 15 x 5 1/2 in. high and circuit. Total cost if purchased individually approximately £40. Performance equal to units in the £80-£90 class. S.A.E. for leaflets. TERMS. Deposit £213.9 and 12 monthly payments of 44/-. Cash price if settled in 3 months.

HIGH FIDELITY 12-14 WATT AMPLIFIER TYPE A11

PUSH-PULL ULTRA LINEAR OUTPUT "BUILT-IN" TONE CONTROL PRE-AMP STAGES

Two input sockets with associated controls allow mixing of "mike" and gram., as in A.10. High sensitivity. Includes 5 valves, ECC83, ECC83, EL84, EL84, E281. High Quality sectionally wound output transformer specially designed for Ultra Linear operation and reliable small condensers of current manufacture. INDIVIDUAL CONTROLS FOR BASS AND TREBLE "Lift" and "Cut". Frequency response ± 3 D.B. 30-30,000 c/s. Six negative feedback loops. Hum level 60 D.B. down. ONLY 23 millivolts INPUT required for FULL OUTPUT. Suitable for use with all makes and types of pick-ups and microphones. Comparable with the very best designs. For STANDARD or LONG PLAYING RECORDS. For MUSICAL INSTRUMENTS such as STRING, BASS, GUITARS, etc. OUTPUT SOCKET with plug provides 300 v. 30 mA, and 6.3 v. 1.5 a. For supply of a RADIO FEEDER UNIT. Size approx. 12-6-7 1/2 in. For A.C. mains 200-250 v. 50 c.p.s. Output for 3 and 15 ohms speakers. Kit is complete to last nut. Chassis is fully punched. Full instructions and point-to-point wiring diagrams supplied. Only 8 Gns. 10/- (Or factory built 51/- extra.) If required louvered metal cover with 2 carrying handles can be supplied for 18/9. TERMS ON ASSEMBLED UNITS. DEPOSIT £4/9 and 9 monthly payments of 24/6. Send S.A.E. for illustrated leaflet detailing Ready-to-assemble Cabinets, Speaker, Microphones, etc., with cash and credit terms.

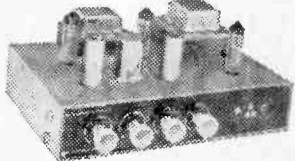

ONLY 3 PAIRS OF SOLDERED JOINTS PLUGS MAINS

SPECIAL NOTE. The Tape Decks we supply are latest models. Where customers already have a Deck or wish to use one of those being offered cheaply we can supply Kit less Deck at 13 gns. carriage. Or deposit 2 gns. and 12 monthly payments 28/9. Also if required we can supply in lieu of portable cabinet and 7 x 4 in. speaker, the Equipment Cabinet illustrated at foot of opp. page and a high flux 8 x 5 1/2 in. speaker for 81 gns. extra.

HI-FI CRYSTAL PICK-UP HEADS. (Cartridges) Acos Standard replacement for Garrard, B.S.R. and Collaro, 18/9. A.S. Stereo-Monaural 49/9. Rhetone Stereo-Monaural 59/9. B.S.R. Stereo 59/9. DYNAMIC RECORDING HEADS. High Impedance Record/Playback 22/- Low Impedance Erase, 12/6.

PICK-UP ARMS. Complete and with latest Acos/hi-Turnover Cartridge 22/11. CRYSTAL MICROPHONES. Hand type NF110 14/9, R.T.C. 18/9. Acos Mic 40 25/9, Acos Mic 45 29/9. Stick type Acos 35-1 39/9, BM3 with neck band and heavy table stand 58/9. Label type 35/9.

CALLER'S UNIT. 4-speed Single Player Unit and Crystal Pick-up with hi-fi Turnover head. Only £219.6.

H.S.R. UA14 4-sp/4 AUTO-CHANGERS with hi-fi turnover head, 26.19.6. Carr. 4/6. GARRARD AUTO-SLIM 4-SPEED AUTO-CHANGER with high fidelity pick-up. Latest model For 200-250 v. A.C. mains, 27.19.6. Carr. 4/6.

GARRARD AT6 AUTO-SLIM DELUXE 4-SPEED AUTO-CHANGERS. Turnover, CCB head, for 200-250 v. A.C. mains, 11 gns. GEA MINIATURE 2-3 WATT GRAM AMPLIFIER. For use with any single or auto-change unit. Output for 2-3 ohm speaker. For 200-250 v. A.C. mains, 11 x 2 x 2 1/2 in. Controls: Vol. and Tone with switch. Only 58/6.

B.S.R. MONAIDDECK TAPE DECKS. Speed 3 1/2 in. per sec. With high quality recording heads, 26.19.6. Carr. 5/-. Cabinets to take Deck and amplifier 37/6.

R.S.C. TRANSISTORISED GRAM AMPLIFIER. Output 1 watt, for 16 ohm speaker. Transistors Mullard OC71, OC81D, OC81, OC81. Fitted Vol. Control with switch. Assembled and tested. Suitable for any normal crystal pick-up. Only 59/9.

R.S.C. STEREO/TEN HIGH QUALITY AMPLIFIER

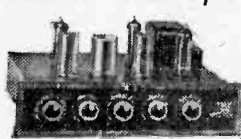

A complete set of parts for the construction of a stereo-ophonic amplifier giving 5 watts high quality output on each channel (total 10 watts). Sensitivity is 50 millivolts, suitable for all crystal stereo heads. Ganged Bass and Treble Control give equal variation of "HF" and "cut". Provision is made for use as straight (monaural) 10-watt amplifier. Valve line-up ECC83, ECC83, EL84, EL84, E281. Outputs for 2-3 ohm speakers. Point-to-point wiring diagrams and instructions supplied. Send S.A.E. for leaflet. Full constructional details and price list 2/6. Carr. 10/-.

Kit can be supplied assembled ready to use for 58/6 extra.

R.S.C. BATTERY CHARGING EQUIPMENT

All for A.C. Mains 200-250v., 50 c/s. Guaranteed 12 months.

HEAVY DUTY CHARGER KIT 6/12 v. 6 amps. variable output. Consisting of Mains Transformer 0-200-230-250 v. F.W. (Bridge) Selenium Rectifier, Ammeter, Variable Charge Rate Selector Panels, Plugs, Fuses, Fuseholder and circuit, 58/9. Carr. 4/6.

CHARGER KIT, 12v. 14 AMP or 24v. 7amp. Consisting of mains trans. 200-230-250 v. F.W. (Bridge) selenium Rectifier, F. Ammeter, Fuses, Variable Resistor and Circuit. Only 6 gns. Carr. 15/-. Please state if 12v. or 24v. kit required.



Assembled 4-5 amps. 6/12 v.

Fitted Ammeter and variable charge rate selector. Also selector plug for 6 v. or 12 v. charging. Louvered steel case with stoved blue hammer finished. Fused and ready to use with mains and output leads. Carr. 9/9. Terms: Deposit 13/3 and 5 monthly payments 13/5. 6/12 v. 3a., all facilities as above. Only 59/9. Carr. 3/6.

ASSEMBLED 6/12 v. 2 amps. Fitted Ammeter and selector plug for 6 v. or 12 v. Louvered metal case. Finished attractive hammer blue. Fused, ready to use with mains and output leads Carr. 5/6 49/9 6/12 v. 1amp. 27/9 Less meter.

BATTERY CHARGER KITS Consisting of Mains Transformer, F.W. Bridge, Metal Rectifier, well ventilated steel case. Fuses, Fuse-holders, Crommelin panels, Heavy Duty Circuit, Carr. 3/6 extra. 6v. or 12v. 1 amp. 22/9 As above, with Ammeter 28/9 6 v. 7 amps. 18/9 6v. or 12v. 2 amps. 15/9 6 v. or 12 v. 2 amps. inclusive of Ammeter. 75/9 6 v. or 12 v. 4 amps. 45/9 6 v. or 12 v. 4 amps. with Ammeter and variable charge rate selector. 52/9

SOLDERING IRONS. 230-250 v. 30 watts. First quality. For Radio work, 18/9. Spare elements and bits available.

ASSEMBLED 12v. 14 Amp. with variable charge rate adjustment, ammeter and stoved louvered, stove enamelled case. Ready for use. Only 7 gns. Carr. 10/- or in Kit Form 5 gns.

R.S.C. MAINS TRANSFORMERS (GUARANTEE FULLY)

Interleaved and Impregnated. Primary 230-245-250 v. 50 c/s. Screened TOP SHROUDED DROP THROUGH 250-0-250v. 70mA. 6.3v. 2a. 0.5-6.3v. 1a 17/6 350-0-350v. 80mA. 6.3v. 2a. 0.5-6.3v. 1a 18/9 250-0-250v. 100mA. 6.3v. 2a. 0.5-6.3v. 1a 21/9 250-0-250v. 130mA. 6.3v. 3.5a. C.T. 15/9 250-0-250v. 100mA. 6.3v. 4a. 0.5-6.3v. 3a 25/9 350-0-350v. 130mA. 6.3v. 1a. 6.3v. 1a. 3a Mullard 510 Amplifier. 20/9 350-0-350v. 100mA. 6.3v. 4a. 0.5-6.3v. 3a 26/9 350-0-350v. 100mA. 6.3v. 4a. 0.5-6.3v. 3a 26/9 350-0-350v. 150mA. 6.3v. 4a. 0.5-6.3v. 3a 27/9 425-0-425v. 200mA. 6.3v. 4a. 5v. 3a. 4C/9 FULLY SHROUDED UPRIGHT 250-0-250v. 60mA. 6.3v. 2a. 0.5-6.3v. 2a 17/11 250-0-250v. 100mA. 6.3v. 4a. 0.5-6.3v. 3a 27/6 300-0-300v. 100mA. 6.3v. 4a. 5v. 3a. 27/11 300-0-300v. 130mA. 6.3v. 4a. C.T. 6.3v. 1a. for Mullard Amplifier 23/9 350-0-350v. 100mA. 6.3v. 4a. 5v. 3a 27/11 350-0-350v. 150mA. 6.3v. 4a. 5v. 3a 28/9

FULLY SHROUDED (continued) 425-0-425v. 200mA. 6.3v. 4a. C.T. 5v. 3a 55/- 425-0-425v. 200mA. 6.3v. 4a. C.T. 6.3v. 4a. C.T. 5v. 3a. 59/9 450-0-450v. 250mA. 6.3v. 4a. C.T. 5v. 3a 69/9 OR TYPED TRANSFORMERS Midget Battery Pentode 66 : 1 for 3S4. etc. 4/6 Small Pentode, 5,000 Ω to 3 Ω 4/6 Small Pentode 7/8, 000 Ω to 3 Ω 4/6 Standard Pentode 5,700 Ω to 3 Ω 5/9 Standard Pentode 7,000 Ω to 3 Ω 5/9 10,000 Ω to 3 Ω 5/9 Push-Pull 8 watts, EL84, or 876 to 3 Ω or matched to 15 Ω 1/9 Push-Pull 10-12 watts to match 6V6 or EL84 to 0-5 Ω or 15 Ω 0/9 Following types for 3 Ω and 15 Ω speakers: Push-Pull 10-12 watts 6V6 or EL84 ... 18/9 Push-Pull 15-18 watts, 6L6, KT66 ... 22/9 Push-Pull Mullard 510 Ultra Triode 22/9 Push-Pull 20 watts, sectionally wound, 6L6, KT66, EL34, etc. 49/9

EDGE MAINS Primaries 200-250 v. 50 c/s. 50 v. 50 mA. 6.3 v. 2a. 11/9 250-0-250v. 80 mA. 6.3 v. 2a. 12/11 Both above size 2 1/2 x 2 1/2 x 2 1/2 in. FILAMENT TRANSFORMERS All with 200-250 v. 50 c/s. primaries 6.3 v. 1.5a. 5/8; 7.1 v. 2a. 7/8; 0-1-6.3 v. 2a. 7/8; 12 v. 1.1a. 8/11; 6.3 v. 3 a. 9/11; 6.5 v. 6 a. 17/6; 12 v. 1.5 a. twice 17/6. SMOOTHING CHOKES 150 mA. 7-10 H 250 ohms 11/9 100 mA. 10 H 400 ohms 8/9 60 mA. 10 H 350 ohms 5/9 60 mA. 10 H 400 ohms 4/11 CHARGER TRANSFORMERS All with 200-230-250 v. 50 c/s Primaries: 0-6-15 v. 1.1 a. 12/1; 0-9-15 v. 2a. 14/9; 0-9-15 v. 3a. 16/1; 0-15 v. 5a. 18/9; 0-9-15 v. 2a. 28/9; 0-9-15 v. 2a. 28/9. A TO (Step up/Step down) TRANS. 0-110/120-230/250 v. 50-80 watts. 15/9; 250 watts. 36/1; 150 watts. 97/6. MICROPHONE TRANSFORMERS 120 : 1 high grade, clamped. 8/9; 120 : 1 Plotted. Mu-metal screened. 9/9.

CLYNE RADIO LTD.



18 TOTTENHAM COURT ROAD, W.1 MUSeum 5929/0095
162 HOLLOWAY ROAD, LONDON N.7 NORth 6295/6/7
9 CAMBERWELL CHURCH STREET, S.E.5 RODney 2875
12 SUFFOLK HOUSE, GEORGE STREET, CROYDON
10 WITTHY GROVE, MANCHESTER, 4 Blackfriars 5379

All post orders, etc. to 162 HOLLOWAY ROAD, LONDON, N.7

The "AIR KING"

Our new highly successful Six transistor luxury portable with the "SLIM LINE" look. To build yourself, with printed circuit chassis for reliability and simplicity in construction. May be used as Car Radio, with full MEDIUM wave and LONG wave coverage.

Look at these features!

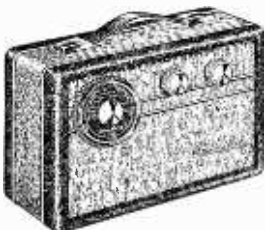

- ★ 500 milliwatt output to high flux 7 x 3 1/2 in. high fidelity loudspeaker.
- ★ Six selected Mullard Transistors in latest super sensitive circuit, plus germanium diode. ★ Compact size—only 9 1/2 x 30 x 6 1/2 in. (high).
- ★ Attractive three-tone cabinet. Black, Dark Grey, and Silver Grey, with gilt control knobs and all gilt fittings.
- ★ Coax socket for car aerial.
- ★ Brand new guaranteed components.
- ★ Push pull output.
- ★ Automatic volume control.
- ★ Long life battery.
- ★ Super sensitive internal ferrite rod aerial.
- ★ Nothing more to buy. Cabinet included.

Special inclusive price for **£7.19.6** all required components, Plus P. & P. 4/-.

Alignment service available. Full assembly details and individually priced parts list, all of which are available separately, price 1/6, post free.

The "HIGHWAYMAN"

At last a quality Car Radio to build yourself, at an economical price. Look at these features:—

- ★ Attractive styling.
- ★ Push-pull output.
- ★ 3 latest Mullard transistors plus valves type EBF83 and EC163.
- ★ No Buzz. High Output and sensitivity.
- ★ Printed circuit (newest type). 7" x 4" High flux p.m. speaker.
- ★ Medium and Long Waves.
- ★ Push Buttons for fingertip control.
- ★ Extremely low Battery consumption (less than 1 amp).
- ★ Easy to fit any make car (Positive earth only).
- ★ 12 volt operation.
- ★ Compact size measures only 7" x 7" x 2" deep.
- ★ Easy assembly. Supplied with dial and drive already mounted.



All parts available separately but if purchased at one time, the whole will be supplied at a special inclusive price of only **£10.19.6** Plus 4/- P. & P.
Parts list and comprehensive instruction booklet 2/6, post free. (Deducted from cost if complete parcel purchased later).

THE COMPONENT SPECIALISTS

CROYDON

NOW OPEN AT
12 SUFFOLK HOUSE, GEORGE ST.
(One minute from East Croydon Station)
OPEN ALL DAY SATURDAY



MODEL TK.20A

Size 3 1/2" x 2 1/2" x 1 1/2". Meter size 2 1/2" x 1 1/2". Sensitivity 1000 o.p.v. on both A.C. and D.C. volts, 0/15, 0/150, 0/1000 volts. D.C. Current, 0/150 mA. Resistance, 0/100 K. Complete with test probe, battery and full instructions. **OUTSTANDING VALUE at 42/-** Plus 1/6 P. & P.

The SINCLAIR SLIMLINE

A new miniature 2 TRANSISTOR printed circuit pocket radio. Completely portable and the smallest of them all—only 2 1/2" x 1 1/2" x 1". Uses latest Micro Alloy Transistors and with built in ferrite aerial will receive all stations on Medium Wave—B.C., 2W, etc. Easy to assemble—no alignment problems. All required components, including earpiece **ONLY 49/6** P. & P. 1/6.

All parts sold separately.

THE NEW "CLYMAX" !!

NEW LOW PRICE MADE POSSIBLE Through Further BULK PURCHASES !!



Our 6-transistor pocket size superbet for Medium and Long Wave. All required components **NOW ONLY 99/6**

Nothing more to buy! Plus 3/6 P. & P.

- ★ Completely self contained. No external aerial or earth required.
- ★ Full medium wave coverage, plus switched Light programme on Long Wave.
- ★ Push-pull output—250 milliwatts.
- ★ Matched set of latest type Mullard transistors.
- ★ Genuine 2in. P.M. Speaker.
- ★ New high-Q coils.
- ★ Ferrite rod aerial with high selectivity.
- ★ Size: 5 1/2 x 3 1/2 x 1 1/2 in.
- ★ Two-tone cabinet.
- ★ Precision etched printed circuit with components references clearly marked.
- ★ Alignment service available. All parts available separately. Full assembly instructions and individually priced parts list. 2/- post free.

The well-known BRAYHEAD TRANSITRONIC "SUPER 60" RADIO KIT.



A complete kit to make your own transistorised Transmitter and Receiver. No soldering required. 7 different circuits to build. In original manufacturers coloured box with instructions. Ideal gift for the electronically minded youngster. (As nationally advertised at £5.4.8).

FEW ONLY AT **49/6** P. & P. 4/-

TAPE RECORDER CONSTRUCTORS

LATEST COLLARO STUDIO TAPE TRANSCRIBOR. Latest type incorporating Record, Interlock, Lever, Button, 3 motors 3 speeds 1 1/2, 3 1/2, 7 1/2 i.p.s., takes 7in. spools. Push-button controls. **NEW LOW PRICE OF £10.10.0 ONLY!** plus 7/6 P. & P. Usual H.P. facilities.

NEW TAPE RECORDER AMPLIFIER TYPE 831-V. Sub-assembled—anyone can build! Printed Circuit, all components mounted and dip soldered. Already tested. Each

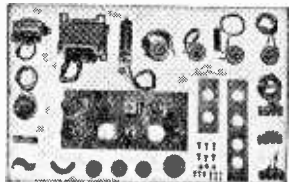

lead cut to length. All that is required to complete the tape recorder is for a few components to be mounted in the cabinet and the free ends of the leads soldered to terminals which are clearly marked, everything supplied, all you need is solder iron, pliers and screwdriver. Valve line-up: EF86, ECC83, 2 x EL84, EZ81 and EM84 magic eye monitoring facilities, output socket for feeding to high quality amplifier, can be used as "straight" amplifier for record reproduction. **EQUALISING ON TWO SPEEDS, OUTSTANDING VALUE AT £11.11.0** plus 2/6 P. & P. including all necessary instructions.

ATTRACTIVE TWO-TONE PORTABLE CARRYING CASE. Suitable for above amplifier and Collaro Studio deck. Fitted with 9in. x 5in. High Flux P.M. speaker for high quality reproduction. Inclusive price £5.5.0 plus 5/- P. & P. Full list of competitive priced mics. and stands on request. The above 3 items purchased at one time, SUPPLIED CARR. PAID.

NOW AVAILABLE: FOUR TRACK STUDIO DECK AS ABOVE, FITTED WITH HIGH-FI FOUR-TRACK HEADS. PRICE £13.19.6 plus 7/6 P. & P. Four track heads supplied separately, complete with mounting bracket for Studio Deck at 92/6 pair, plus 2/6 P. & P.

TAPE RECORDER AMPLIFIER 831-4V. Exactly as 831-V but four track, suitable for the above high-fidelity four-track heads. Price £12.12.0 plus 2/6 P. & P.

PRE-AMPLIFIER KIT TYPE 832-CP. Complete high quality pre-amplifier kit for use with Collaro Studio Deck. Price £8.8.0 plus 2/6 P. & P.

N.B. Four-track deck and amplifier fit the above case, without any modification whatsoever.

TAPE ! TAPE !

For the first time in this country! **Canada's Hi Fi Magnetic Recording Tape.** Made by "Bel-Clear" of Canada.

Following sizes available, others to follow. **Brand New, NOT Sub-standard.** High grade Acetate base, attractively boxed, fitted leaders, fully guaranteed.

5in. 600 ft., 12/6; 5in. 900 ft., 15/-; 7in. 1,200 ft., 18/6; 7in. 1,800 ft., 25/-; P. & P. 6d. per spool. 3 or more post free. (Bona fide trade inquiries invited).

SPECIAL AMERICAN MYLAR DUPONT. 5in. 1,200 ft. D.P. Top quality Brand New 25/-, post free. Limited quantity only!

PLASTIC TAPE SPOOLS. Best quality. 3in., 1/3, 4in., 2/-; 5in., 2/-; 5in., 2/3, 7in., 2/6; P. & P. 6d. per spool. Orders over £1 post free.

TELEPHONE PICK-UP COIL. Designed to feed into the microphone input of either a tape recorder or any high gain amplifier. Easily attached to telephone by rubber suction attachment. The coil is electrostatically shielded to minimise hum pick-up. When positioned on telephone (this model is more than adequate for a fully modulated tape recording. Brand new complete with 5 ft. shielded cable. **ONLY 14/-**. Post free.



New 10th Edition
Newnes Great
Profit Maker!

COMPLETE IN 6 VOLUMES



Radio & TV Servicing

DATA FOR MODELS RIGHT BACK TO 1956

This New 10th Edition provides all the technical information you need for quicker repair work now and for years ahead! It gives you full servicing data and specialist repair methods for the popular models marketed by 70 principal makers and companies since 1956. It is essential to the shrewd repair man because people are keeping their sets longer. If you have never before examined this famous reference work now is your opportunity. See the new edition for a week on free examination without obligation to buy.

TELEVISION · RADIO · RADIOGRAMS · CAR RADIOS
TAPE RECORDERS · RECORD REPRODUCERS

DATA FOR ALL THESE MAKES—Alba, Ambassador, Argosy, Armstrong, Baird, Beethoven, Berec, Brayhead, B.R.C., B.S.R., Bush, Capitol, Champion, Channel, Collaro, Cossor, Cyldon, Dansette, Decca, Defiant, Dynatron, E.A.R., Eddystone, Ekco, Elizabethan, Emerson, E.M.I., Emisonic, English Electric, Ever Ready, Ferguson, Ferranti, Fidelity, Ford Motor Co., Garrard, G.E.C., Gramdeck, Grundig, H.M.V., Invicta, K-B, McCarthy, McMichael, Marconiphone, Masteradio, Motorola, Murphy, Pageant, Pam, Perdio, Peto Scott, Philco, Philips, Pilot, Portadyne, Portogram, Pye, Radiomobile, Raymond, Regentone, R.G.D., Roberts' Radio, Sobell, Sony, Sound, Spencer-West, Stella, Stereosound, Strad, Ultra, Vidor, Walter, Webcor. Includes 50-page supplementary section of older models.

PLUS 2 YEARS' FREE POSTAL ADVISORY SERVICE

More than 4,000 Circuits and Component
Layout Diagrams · 2,250 Popular Models

Use it FREE for 7 days
to prove its value

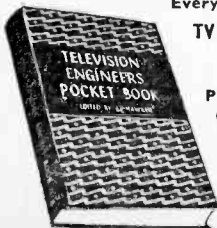

Every purchaser receives a Free copy of
TV ENGINEERS POCKET BOOK
 (Value 12/6)

272 PAGES : OVER 200 PRACTICAL ILLUSTRATIONS
 Concise information on installing, fault-tracing and repairing, servicing equipment, alignment, etc.
 An invaluable companion to your set for on-the-spot repairs
Hurry - Post Coupon Today

George Newnes Ltd., 15-17 Long Acre, London, W.C.2.
 Send me Newnes RADIO AND TELEVISION SERVICING (in 6 Volumes) and TV ENGINEERS POCKET BOOK without obligation to purchase. I will return them in 8 days or send 15/- deposit 8 days after delivery, then twenty monthly subscriptions of 15/-, paying £15. 15s. in all. Cash price in 8 days is £15

Name and Address in block letters please

Mr., Mrs., Miss _____

Address _____

Occupation _____

Signature _____

Parent's _____ Mr., Mrs.

Signature if you are under 21. _____

Tick ✓ where applicable

The address on left is—

My Property	<input type="checkbox"/>
Rented unfurnished	<input type="checkbox"/>
Parents' Home	<input type="checkbox"/>
Furnished Accom.	<input type="checkbox"/>
Temporary Address	<input type="checkbox"/>

(RV)533/59



CAR PORTABLE Radio SCOOP!!!

Brand new and unused - by famous British Manufacturer.
Fully guaranteed. Original list price £26.18.11

A FULLY TRANSISTORISED GO-ANYWHERE PORTABLE THAT AUTOMATICALLY BECOMES A CAR RADIO SIMPLY BY SLIDING INTO A METAL CAR-TRAY.
★ Covers full medium and long wave band. ★ All transistorised superb. ★ Internal ferric rod aerial. ★ Press button and wave change.
★ All connections to car battery—booster speaker—car aerial automatically accomplished by sliding into metal car-tray.

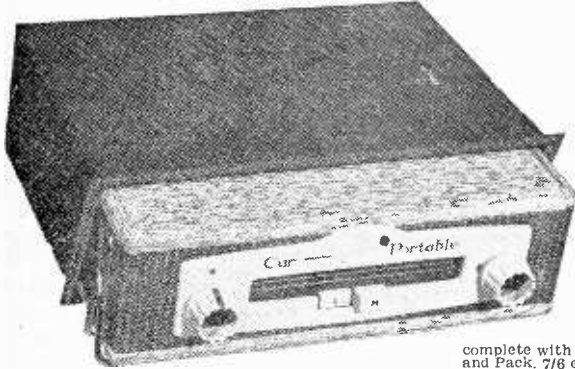

Battery drain is exceptionally low—the life of the self-contained battery within the set is approx. 200 hrs. Transistors used: 1 OC44; 2 OC45; 1 OC82D; 2 OC82 and Diode. Compares with set costing at least double. Properly installed this set will give you years of pleasure and service both in and out of your car.

Contemporary finish in two tone red and grey vinyl. washable material. Supplied complete with car extension loudspeaker, car-tray and full easy-to-follow fixing instructions.

Internal loudspeaker provides ample volume as a portable. Separate 8 x 5in. speaker with 8 x 6in. baffle, for car fixing.

Bracket for padlock provides an effective thief deterrent. Carrying handle folds away when not in use. The scale is illuminated when the set is operating in the car-tray. Dimensions 9½ x 7½ x 3in.

As a car radio this receiver operates only from a 12 v. electrical system, either positive or negative earth. As a portable it is powered by its own internal battery type PP9 or equivalent.

LASKY'S PRICE £10.19.6

complete with tray, all car fittings, 8 x 5in. car speaker and baffle. Carr. and Pack. 7/6 extra. PP9 Battery 3/9 extra. Supplied with full fitting and installation instructions.

33 TOTTENHAM COURT ROAD, W.1.

207 EDGWARE ROAD, W.2.

2 mins. Oxford Street, Nearest Station, Goadge Street. MUSEUM 2605 Five yards from Praed Street. PADDINGTON 3271/2
Both addresses open all day Saturday. Close 1 p.m. Thursday.

152/3 FLEET STREET, E.C.4. FLEET St. 2833.

Open all day Thurs.

PLEASE ADDRESS ALL MAIL ORDERS TO OUR HEAD OFFICE:—207 EDGWARE ROAD, W.2.

SENSATIONAL NEW 1963 DESIGNS — BY CONCORD

LOW PRICES ★ ★ ★ PICTORIAL STEP-BY-STEP PLANS ★ ★ ★ EASY AS A.B.C.

THE NEW "COSTA BRAVA"

42/6



No earth or aerial required. All-transistor Radio. Revolutionary INTERNAL FERRITE AERIAL and moving coil speaker makes it is

sensational pocket-size radio the best money-saving bargain of all time. Powerful, superb tone and clarity, ensures perfect reception for all your favourite programmes. Completely portable, only 5½ x 3 x 1½in. Two-tone case. Anyone can assemble with our simple PRINTED CIRCUIT PLAN, send 42/6, plus 2/6 P. & P. (C.O.D. 2/- extra). Satisfaction Guaranteed. (All parts available separately). FREE HIGH SENSITIVITY HIDE-AWAY EAR-PIECE GIVEN WITH EACH SET.



BIG PROFITS FOR YOU IF YOU BUY NOW!

Made to retail at 7 gns. you can now buy this famous Twin-bong Alarm for only 37/6—but only if you act now . . . stocks are strictly limited. Easily installed and operated. Switches on or off at any time. Fantastic FINAL reduction to clear (minimum order of 3). Carr. Free. Free literature sent with each alarm. **37/6**

THE NEW 4-STAGE "MINUETTE"

32/6

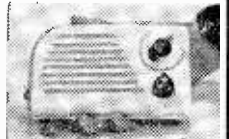

Build this newly-designed "MINUETTE" 4-STAGE transistor set in very strong ready drilled U.L.T.R.A.-MODERN CASE.

size only 6 x 3½ x 1in. Uses three transistors and diode and SELF-CONTAINED LOUDSPEAKER. Very sensitive, ideal for office bedroom, holidays, etc. Months and months of listening on 1/2 battery. Can be built FOR ONLY 32/6, including PROPER CASE, miniature speaker, etc. SIMPLE AS A.B.C. PICTORIAL STEP-BY-STEP PLANS etc. plus post and packing 1/6 (C.O.D. 2/- extra). Parts sold separately, priced parts list 1/-.

FREE HIGH SENSITIVITY HIDE-AWAY EAR-PIECE GIVEN WITH EACH SET

THE MINUTE TRANSISTOR RADIO MIAMI ONLY 32/6



Unbelievably small—Outrageously cheap. You will be amazed at the fine quality of tone and volume of this great little radio. Only a fantastic 3½ x 2½ x 1½in. the MIAMI will bring you great entertainment for months on a 1/2 battery. Simple assembly plan with each set. ONLY 32/6. YES 32/6! Plus 2/6 P. & P. (C.O.D. 2/- extra). Satisfaction Guaranteed. Demonstrations given daily. Parts available separately if required.

BELL SAFETY TO THE MOTORIST

Bulk purchase of bank-rupt stock ensures this fabulous money-making offer.

AUTOMATIC CIGARETTE LIGHTER

Instantly provides ready lit cigarette without the driver taking his eyes from the road. Heavily chromium plated case holds 10. Easily and simply fitted to any car's dashboard. Works off 6 or 12 volts. Retail Price 44/8. Special Clearance offer only paid in minimum lots of 6. **12/6** each.

FABULOUS ST. TROPEZ Mk.6 Pocket Radio

ONLY 18/6

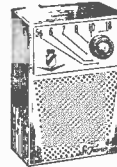

NO MORE TO PAY
This fantastic offer will amaze you—the compact ST. TROPEZ measuring 4½ x 3 x 1½ receives perfectly in bedroom, office or garden—over all medium waves including Luxembourg. Under 1d. per hour running cost. ANYONE can assemble it using our simple A.B.C. plan (P.&P.2/- extra). C.O.D. extra. Parts can be bought separately. Demonstrations daily. Satisfaction guaranteed.

CONCORD ELECTRONICS (Dept. 14/14)

210, Church Road, Hove, Sussex

LASKY'S RADIO

"BUILD YOURSELF" TRANSISTOR RADIOS GREAT 1963 PRICE REDUCTIONS

Now large purchases of components and reductions in purchase tax at the beginning of the year enable you to build your transistor radio at these vastly reduced prices.



The SPRITE

Inclusive price of

79/6

P. & P. 3/6 extra.

- ★ Six-Transistor Superhet Miniature Personal Pocket Radio. ★ Tunable over Long and Medium wavebands. ★ Uses PP3 battery. Ferrite Rod aerial. ★ I.F. Frequency 470 Kc/s. Transistors: 3 Philco 2087's 2 Mullard OC81 M, OC81 DM and OA90 diode. ★ 3 inch speaker.
- ★ Printed circuit 2 1/2 x 2 1/2 in. ★ Slow Motion Drive. ★ In Plastic Case, size 4 x 2 1/2 x 1 1/2 in.

In order to ensure perfect results, the SPRITE is supplied to you with R.F. and I.F. stages. Driver and Output stages, ready built with all components ready mounted on the printed circuit. To complete assembly you only have to fit the wavechange switch, tuning condenser and drive volume control, earphone socket and aerial rod, the remaining components all having been pre-fitted at the factory for you. The SPRITE is offered as above, pre-assembled, plus cabinet, speaker and all components for final construction, at the inclusive price of 79/6. Postage and packing 3/6 extra. Data and instruction separately, 2/6. Refunded in parcel if purchased. Real calf leather case, wriststrap, personal earphone and case for earphone and battery 12/6 the lot extra. Make no mistake this is a SUPERHET receiver of genuine commercial quality. It is not a regenerative circuit.

TESLA "SONET"

DUO TAPE RECORDER



A continental manufactured 2-speed tape recorder with 1 1/2 x 3 1/2 in. i.p.s. Twin track recording to international standards. ★ Takes 5 1/2 in. spools. ★ Fast forward and fast rewind. ★ Record level indicator. ★ Inputs for mic. radio and pick-up. For use on 110 and 200/250 v. 50 c.p.s. mains. ★ Digital position indicator. ★ In attractive wood case with metal top cover fitted with storage compartments and carrying handle. Size 13 x 10 x 7 1/2 in. High quality record-replay amplifier with internal loudspeaker provides immediate high quality reproduction. ★ Socket for external speaker. ★ Tone control: Supplied with reel of tape, empty spool, microphone and a selection of interconnecting leads, etc., with canvas waterproof cover. Brand New and Unused. Carr. and Ins. 10/6.

LASKY'S PRICE 24 gns.

The "REALISTIC" Seven

STAR FEATURES ★★★★★

- ★ 7 Transistor Superhet. 350 Milliwatt output into 4-inch high flux speaker.
- ★ All components mounted on a single printed circuit board, size 5 1/2 x 5 1/2 in. in one complete assembly.
- ★ Plastic cabinet, with carrying handle size 7 x 10 x 3 1/2 in. in choice of colours:
- ★ Red/Grey, Blue/Grey, all Grey.
- ★ Easy to read Dial.
- ★ External Socket for car aerial.
- ★ I.F. frequency 470 Kc/s.
- ★ Ferrite Rod internal aerial.
- ★ Operates from PP9 or similar battery.
- ★ Full comprehensive data supplied with each Receiver.
- ★ All coils and I.F.'s etc., fully wound ready for immediate assembly.

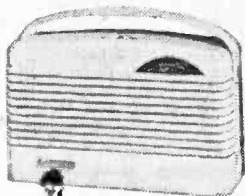

An Outstanding Receiver. Lasky's Price for the complete parcel including Transistors, Cabinet, Speaker, etc., and Full Construction Data: **£5.19.6** Postage and Packing 4/6 PP9 Battery 3/9. Data and instructions separately 2/6, refunded if you purchase the parcel.



Get ready
NOW for the
NEW TV
frequencies

Lasky's first again with a U.H.F. Tuner. Complete with P.C. 88 and P.C. 86 Valves. Fully variable tuning capacitor, etc. British manufacture. New and unused size 41 x 51 x 1 1/2 in. Complete with valves. **29/6** P. & P. 2/-

CRYSTAL PICK-UP CARTRIDGES

Lowest Prices Ever!

All complete with Stylus, L.P. and Standard (and Stereo where shown). Fully guaranteed, standard fitting, will fit most P.U. arms and heads. Postage 1/- each extra.

MONO

TYPE C.T.1. By well known manufacturer. With two sapphire styli/1.	12/8
Garrard GCE.4	15/-
Ronette Studio O	15/-
Acos GP.65/3	15/-
Acos GP.65/1	17/-
Acos 67/1	17/-
Acos GP.61/1	18/-

STEREO

Acostereo 73/1 with two sapphires...	25/-
Acostereo 73/2 with Diamond L.P./Stereo and sapphire Std.	28/6
Collaro type C. Turnover, with 2 sapphires	25/6
Coliel S.C.1. Turnover with 2 sapphires	24/6
Coliel S.C.1. Turnover with Diamond L.P./Stereo and sapphire Std.	29/6
Ronette Stereo O.V. Turnover, with 2 sapphires	29/6
Ronette Stereo type 105, with 2 sapphires	35/6
Ronette Stereo type 105, with Diamond L.P./Stereo and sapphire Std.	39/6

Distler Miniature Motors

6 volt battery operated 7/11. P. & P. 2/6.

The COROVER '6'

- ★ A 6-transistor plus 2-diode superhet receiver using the latest circuitry. ★ Three Mullard AF117 alloy diffused transistors are used with OA79 and OA91 diodes, followed by OC81D and two OC81's in push-pull. ★ I.F. frequency 470 Kc/s. ★ Covers the full medium and long wavebands. ★ Sockets provided for personal earpiece or tape recorder, and car radio aerial. ★ Large internal ferrite rod aerial gives high sensitivity. ★ Uses four 1.5 v. pen torch batteries. ★ All components mounted on a single printed circuit. Simple stage by stage instructions. ★ Cabinet size 6 1/2 x 4 x 1 1/2 in. With carrying handle. ★ All coils and I.F.'s ready wound. ALL COMPONENTS AVAILABLE SEPARATELY. Data and instructions separately 2/6. Refunded if you purchase the parcel.

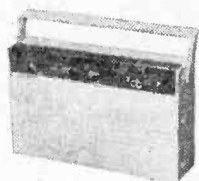

CAN BE BUILT FOR

£5.7.6

Post and packing 4/- extra. Batteries 1/4.

TELEFUNKEN STEREO HI-FI AMPLIFIERS MODEL S82



Further Great Purchase Enables us to Offer this Excellent Unit at £5.19.6. Post 7/6.

A complete stereo amplifier of unsurpassed quality, with inputs for radio, tape recorder, F.M. tuner or any other hi-fi source, either monaural or stereo. Output power 5 watts total (2 1/2 watts each channel). With balance control. New and unused, listed at 16 gns.

LASKY'S PRICE **£5.19.6**

207 EDGWARE ROAD, LONDON, W.2. | 33 TOTTENHAM COURT ROAD, W.1. | 152/3 FLEET STREET, LONDON, E.C.4.
Near Praed St. PADDINGTON 3271/2 | Nearest Stn., Gooage St. MUSEUM 2605
BOTH OPEN ALL DAY SAT Early Closing Thurs. Mail Orders to Dept. P.W., Edgware Rd.

Telephone: Fleet Street 2833.
Open all day Thursday. Early closing Sat.

ARMSTRONG AF208AM/FM RADIOGRAM CHASSIS

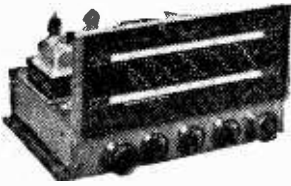

STEREO 12 Mk. 2 £40/5/-
3 watts push-pull output from each channel, 16 watts total; VHF, with automatic frequency control medium and long bands; A hi-fi system on one compact chassis.

STEREO 55 £29/18/-
Junior version of Stereo 12; 5 watts per channel, 10 watts total; VHF in medium bands; Inputs for tape, pick-ups and future stereo radio.

JUBILEE Mk. 2 £28/5/-
Mono; 8 watts push-pull output; VHF, automatic frequency control, medium and long bands; Separate tone controls; Pick-up and tape inputs.

AF208 (ILLUSTRATED) £21/4/-
An AM/FM mono chassis of 5 watts output covering VHF and medium bands. An inexpensive version of the Jubilee Mk. 2
All carriage free. Write for free literature.

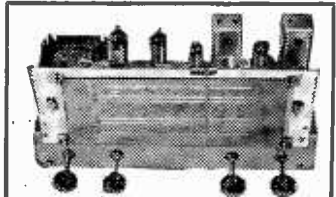

1963 RADIOGRAM CHASSIS
THREE WAVEBANDS FIVE VALVES
S.W. 16 m.—50 m. LATEST MULLARD
M.W. 200—550 m. ECH81, EF89, ECR81,
L.W. 800 m.—2,000 m. EL84, E280.
12-month guarantee.

A.C. 200/250 v. 4-way Switch; Short-Medium, Long/Gram, Ferrite Aerial A.V.C. and Negative feedback; 3 ohm output, 5 watts. Glass dial, horizontal winding, size 13in. x 4in. Aligned and calibrated. Isolated Chassis size 13 1/2in. x 9in. high x 5 1/2in. deep.
£8.19.6 Carr. & Ins. 4/6

BARGAIN SALE PRICES

New Boxed VALVES 90-day Guarantee

OZ4	5/-	16K7G	5/-	16AC80	8/-	16CL82	10/-
1K5	6/-	9K83G	5/-	9B81	4/-	9CL84	10/-
1S5	8/-	6L80	8/-	6BC41	8/-	6PL4	10/-
1T4	3/-	6N7M	5/-	6BC81	8/-	6FL83	8/-
2X2	2/-	6Q7G	6/-	6BF80	6/-	6PY33	15/-
384	7/-	68N7	5/-	6CH42	9/-	6PY30	7/-
3V4	7/-	6V6G	5/-	6CH81	8/-	6PY81	8/-
3Q4	7/-	6X1	5/-	6CL82	10/-	6PY82	7/-
5U4	6/-	6X3	6/-	6E85	6/-	6PQ25	7/-
5Y3	6/-	12AT7	6/-	6E89	8/-	6SP41	3/-
3Z4	9/-	12AU7	6/-	6EL32	5/-	6SP61	3/-
6AC7	4/-	12AX7	7/-	6EL84	7/-	6U22	7/-
6AM6	4/-	12BH7	7/-	6EY31	9/-	6UBC41	8/-
6AT9	6/-	12L7	5/-	6EY86	9/-	6UBC81	9/-
6BA8	7/-	12K3	14/-	6EY40	7/-	6UBP89	9/-
6BE6	5/-	12Q7	5/-	6EZ81	7/-	6UCL81	10/-
6BW6	7/-	125Y5G	9/-	6EZ81	7/-	6UCL82	10/-
6C4	5/-	35L6	9/-	16AC8010	10/-	6UCL83	12/-
6E6	5/-	35Z4	8/-	16V12A	5/-	6UP89	9/-
6G6	4/-	50Y7	5/-	6K393	8/-	6U141	8/-
6H6	3/-	6Y4	2/-	6K776	8/-	6UY11	7/-
6J5	5/-	6DAF9	8/-	6MU14	7/-	6UY85	7/-
6J6	5/-	6P96	8/-	6PCC84	8/-	6UR9	7/-
6J7G	6/-	6K96	8/-	6PUP80	8/-	6VR150	7/-
6K6	5/-	6L96	8/-	6PUP82	8/-	6W41	6/-

NEW ELECTROLYTICS IN FAMOUS MAKES

TUBULAR	TUBULAR	CAN TYPES	
1/350V	2/-	50/350V	5/8
2/350V	2/8	100/25V	3/-
4/450V	2/3	250/25V	3/-
8/450V	2/3	500/12V	3/-
16/450V	3/-	1,000/12V	3/-
32/450V	3/6	+8/450V	3/6
25/50V	1/8	+8/16/450V	3/6
50/25V	2/-	16+16/450V	4/8
50/50V	2/-	32+32/350V	4/8

COMPLETE RADIO CHASSIS £4.19.6. post free

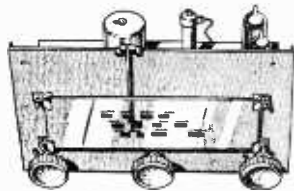

4 Mullard valves, 5in. speaker. Superhet Circuit. BRAND NEW. Size 9 x 6 x 5 1/2in. high. Tested by us ready for use. 200/250 v. A.C.-D. Mains. As illustrated with illuminated dial. Fully tunable with Medium and Long Wave. 12-month Guarantee. Only £4.19.6 post 3/-.

MAINS TRANSFORMERS 230/250 v. A.C. Postage 2/- each transformer.

STANDARD, 250-0-250, 80 mA, 6.3 v. 3.5 a. Tapped 5 v. 4 a. Rectifier, 6.3 v. 1 a. 5 v.	29/6
2 a. or 4 v. 2 a. 28/6, ditto 350-0-350	29/6
MINIATURE 200 v. 20 mA 6.3 v. 1 a.	10/6
MIDGET, 220 v. 45 mA, 6.3 v. 2 a.	15/6
SMALL, 220-0-220, 50 mA 6.3 v. 2 a.	17/8
STD, 250-0-250, 65 mA, 6.3 v. 3.5 a.	17/6
HEATER TRANS. 6.3 v. 1 1/2 amp.	7/6
Ditto tapped 1.4, 2, 3, 4, 5, 6.3 v.	8/6
Ditto, sec. 6.3 v. 4 amp.	10/6
GENERAL PURPOSE LOW VOLTAGE, 2 amp. 2, 4, 5, 6, 8, 9, 10, 12, 15, 18, 24, 30 v.	22/6
AUTO TRANSFORMER, 150 w. 0.115, 200, 230, 250 v., 500 w.	22/6
MULLARD "610" Mains transformer	30/-
PARMEKO MAINS TRANSFORMER. Made for special contract, the ratings can safely be doubled. Guaranteed 2 years. Primary 0-110-210-230-250 v. H.T. 300-0-300 v. 50 mA. L.T. 6.3 v. 1.8 amp. Size 4 x 3 1/2 x 3in.	17/8

INTERVALVE TRANSFORMER: 3:1 or 5:1. 9:0-0 P.P. TRANSFORMERS. Heavy Duty 50 mA, 4/6. Multitrate, 7/6. Multitrate heavy duty push pull 10 w., 15/6. Miniature, 8/4 each, 5/8.
L.F. CHOKES 15/10H. 60/65 mA, 5/-; 10 H., 85 mA, 10/6; 10 H., 150 mA, 10/6.

L.F. TRANSFORMERS 7/6 pair

465 kc/s Tuning Miniature Can, 2 x 1 1/2 in. High Q and good bandwidth. Data sheets.

FULL WAVE BRIDGE SELENIUM RECTIFIER: 2, 6 or 12 v. 1 1/2 amp, 8/0, 2 a., 11/3; 4 a., 17/-.
CHARGER TRANSFORMERS. Tapped input 200/250 v. for charging at 2, 6, 12 v. 1 1/2 amp, 15/6. 2 amps., 17/6; 4 amps., 22/6. Circuit included.
4 AMP CAR BATTERY CHARGER with amp. meter Leads, Fuse Case, etc., for 6 v. or 12 v., 09/9.
AMMETER 0 to 5 amp, 9/6.

BOOKS list S.A.E.

40 Circuits for Germanium Diodes 3/-.
"V.V." Radio Valve Data, 6/-.
High Fidelity Speaker Enclosure, 5/-.
Valve and TV Tube Equivalents, 9/6.
TV Fault Finding, 5/-.
Quality Amplifiers, 4/6.
Radio Valve Guide. Books 1, 2, 3, 3/- each.
Transistor Superhet Receivers, 7/6.
Practical Radio Inside Out, 3/6.
Master Colour Code Chart, 1/6.
Transistor Controlled Models, 7/6.
Principles of Colour TV, 15/-.
4 TRANSISTOR PUSH-PULL AUDIO AMPLIFIER size 3 x 1 1/2 x 1.
A ready built miniature push-pull amplifier with input and output transformers 4 watt istors. Ideal for use with record players, intercoms, BABY ALARMS, etc. Complete with full instructions and circuit.
Price 52/9 v. Batt. 2/3, 2 1/2in. Speaker 15/-.

C.R.T. BOOSTER TRANSFORMERS

for heater cathode short circuit, or tubes with falling emission. Full instructions supplied. Mains input. Type A optional 25% and 50% boost, 2v. or 4v. or 6.3v. or 10.v. or 12.5v. State voltage required. PRICE 10/6.

LOUDSPEAKERS P.M. 3 OHM. 2 1/2, 3, 4in. 5in. Rola, 7in. x 4in. Rola, 15/6; 6 1/2in. Rola, 1/6; 8in. Presley 17/6; 10 x 6in. 2/6; 10in. Rola 30/-; 4in. Tweeter, 25/-; 12in. R.A. 30/-; 13 1/2 x 8in. Double Cone E.M.I. 45/-.
STENTONIAN HF.1012. 10in. 3 to 15 ohms, 10 w. 87/6; 35 ohm, 7 x 4in., 1-1/2 5in., 17/8; 3 1/2in. 15/6.

BAKER SELURST LOUDSPEAKERS

12in. Baker 15w. Stalwart 3 or 15 ohms 45-13.900 c.p.s. ... 80/-
12in. Stereo Foam Suspension, 12w., 35-16.000 c.p.s. ... 86/10.0
12in. Standard H.D. 20w. 10-14.5/90 c.p.s. ... 28.0.0
13in. Auditorium 85 w. Bass, 20 c.p.s. to 12kc/s. £13
Details and Enclosures plans S.A.E.



TWIN GANG TUNING CONDENSERS. 365 pF, miniature 1in. x 1 1/2in. x 9/8, 0/-; mid. 7/6, 9/6, 10/6; 500pF slow motion tunna, standard or midket, 9/6. SMALL 3 gang 500 pF, 17/-, SINGLE 365 pF 7/6. SINGLE 25 pF, 50 pF, 100 pF, 160 pF, 5/6. Solid dielectric 100 300, 500 pF, 3/6.

CONDENSERS. New stock. 0.001 mid. 7/6. T.C.C. 5/6; Ditto 2 1/2 x 1 1/2, 9/6. Tubular 500 v. 0.001 to 0.05 mid. 9d., 0.1, 1/-, 0.25, 1/6; 0.5/500 v., 1/8; 0.1 mid., 2,000 volts 3/6. CERAMIC CONDS. 500 v. 0.3 pF to 0.01 mid., 8d. SILVER MICA CONDENSERS. 10% 5 pF to 50 pF 9d.; 500 pF to 3,000 pF, 1/-. Close tolerance (±1 pF) 2.2 pF to 47 pF, 1/-. Ditto 1% to 50 pF to 815 pF 1/-; 1,000 pF to 3,000 pF 1/8.

465 kc/s SIGNAL GENERATOR Price 15/-. Uses B.F.O. Unit, ZA 30038 ready made with valve IS5. POCKET SIZE 2 1/2 x 4 x 1in. One resistor to change, full instructions supplied. Battery 9/6 extra. 69V 1 1/4V. Details S.A.E.

WAVECHANGE SWITCHES

3 p. 4-way 2 water ion spindle ... 6/6
3 p. 2-way or 2 p. 6-way ion spindle ... 3/6
4 p. 2-way or 4 p. 3-way ion spindle ... 3/6
3 p. 4-way, or 1 p. 2-way ion spindle ... 3/6

Wavechange "MAKITS" Wafers available: 1 p. 12 way, 2 p. 6 way, 3 p. 4 way, 4 p. 3 way, 6 p. 2 way, 1 water switch, 8/6; 2 water switch, 12/6; 3 water switch, 15/-; additional wafers up to 12, 3/6 each extra. Toggle Switches, s.p., 2/-; d.p., 3/6; d.p.d., 4/-; Rotary s.p., 3/6; d.p., 4/6.

CRYSTAL MIKE INSERT, 6/6

Size 1in. dia. x 1in.
ACOS MIC. 14, insert 1 1/2in. dia. x 1in. 8/6
ACOS 39-1 DE LUXE STICK MIKE 25/-
INSUL QUALITY STICK MIKE... 25/-

Valveholders. Pax. int. oct. 4d. EA50, 6d. B12A, CRT, 1/3. Engl. and Amer. 4-5 and 7 pin. 1-. MOULDED Mazda and int. oct. 6d.; BTG, BSA, BSG, BFA, 6d. BTG with can, 1/6. BSA with can, 1/8. Ceramic EF30, BTG, BSA, int. oct. 1/-. BTG, BSA cans, 1/- each.

ADAstra 3-3 AMPLIFIER. Ready built. A.C. only. 200-250 v. Valves ECL86 and E280, 3 watt quality output. Mullard tone circuits. Bass boost, treble and volume controls. Separate engraved front panel with de-luxe finish. Heavy duty output transformer 3 ohm. Quality mains transformer. Stove enamelled chassis size 6in. x 5in. x 3in. Bargain Price £4.19.6 Circuit supplied.

THE ORIGINAL

RADIO COMPONENT

Our written guarantee with every purchase NEW COMPONENT LIST 1/-.

Bus 133 or 68 pass door S.R. Station Selhurst

Volume Controls

Linear of Log Tracks
Long spindles. Midjet
5 K ohms to 2 Meg.
L.S. 3/-; D.P., 4/6/-
Stereo 1/810/-; D.P. 14/8

80 ohm COAX

80 ohm spaced in.
stranded core. 6d.yd.
40 yds. 17/6
60 yds. 25/-
Fringe quality
Air spaced 1/-yd.

TELESCOPIC CHROME AERIALS. 13in. extending to 43in. 8/6 ea. Coax Adaptor Plug, 1/8 extra.
TRIPLEXERS Bands I, II, III. 18/0
COAX PLUG 1/- LEAD SOCKET 2/-
PANEL SOCKETS 1/- OUTLET BOXES 4/-
BALANCED TWIN FEEDER yd. 8d. 80 or 300 ohms.
DITTO SCREENED per yd. 1/6. 80 ohms only.
Wirewound Ext. Speaker Control, 10 Ω 3/-, 25 Ω 6/6.
WIRE-WOUND POTS. 3 WATT. Pre-set Min. TV Types. All values to 10 ohms to 25 K., 3/- ea. 30 K., 30 K., 4/-. (Car on 30 K. to 2 meg. 3/-).
WIRE-WOUND 4 WATTS Pots. Long spindles. Value 50 ohms to 50 K. 6/6; 100 K. 7/6.
PHILIPS TRIMMERS 0-10 pF. 3-30 pF. 1/-.
TRIMMERS. Ceramic. 30. 50. 70 pF. 8d.; 100 pF. 150 pF. 1/3; 250 pF. 1/6; 500 pF. 750 pF. 1/9.
TV sets. TRIMMER, 1000 pF. with knobs, 2/-.
RESISTORS. Preferred values, 10 ohms to 10 meg. 1/4 d.; 1 w. 4d.; 1 w. 8d.; 1 w. 8d.; 2 w. 1/-.
High Stability. 1/4 w. 1%. 2/-. Preferred values 10 ohms to 10 meg. Ditto 5% to 22 meg., 9d.

5 watt } WIRE-WOUND RESISTORS } 1/3
10 watt } 10 ohms—10,000 ohms } 2/-
15 watt } } 2/-
12.5K to 47K 10 w. } 3/-

AMERICAN "BRAND FIVE" PLASTIC RECORDING TAPE

Double Play 7in. reel, 2,400ft. 90/-	5in. reel, 1,200ft. 37/6	Plastic Reels
Long Play 7in. reel, 1,800ft. 35/-	5in. reel, 900ft. 23/6	3in. 1/6
5in. reel, 900ft. 18/6		4in. 2/-
Standard 7in. reel, 1,200ft. 25/-	5in. reel, 600ft. 16/-	5in. 2/-
		7in. 2/6

"Instant" Bulk Tape Eraser and Head Deftener 200/250 v. A.C. 27/6. Leaflet with full details. S.A.E.

CRYSTAL SET BOOKLET, 1/-.
HIGH RESISTANCE PHONES. 4,000 ohms, 15/- pr.
SWITCH CLEANER. Field squirt sprout, 4/6 tin.

HIGH GAIN TV PRE-AMPLIFIERS BAND I R.F.C.

Tunable channels 1 to 5. Gain 18dB. ECC84 valve. Kit price 29/6 or 49/6 with power pack. Details 6d. (PCC84 valves if preferred). Coils only 9/6.
BAND III I.T.A.—Same prices. Tunable channels 8 to 13. Gain 17dB. Circuit and Coils only 9/6.

1/16in. Paxolin Panels, 10 x 8in., 2/-.
Miniature Contact Cooled Rectifiers. 250V 50mA, 7/6; 250V 60mA, 8/6; 250V 85mA, 9/6; Selenium Rect., 300V-85mA, 5/-.
TV etc., Silicon Sub. Min. Rectifier, 125V, 300mA, 8/6; 250V, 450mA, 10/-.
RM3 RM5 14A10 14A116 10/-each. FC31, 20-03 Coils Wearite "P" Type, 3/- each.
Osmor Midjet "Q" type, ad. dust core, from 4/- each. All ranges. List S.A.E.
Teleton D.V.R. L. and Med. T.R.F. with reaction, 4/-. Med. wave D.R., 3/8.
Ferrite Aerials, M., 8/8; M. and L., 12/6.
Osmor Ferrite Rod Aerials, L. and M. for transistor circuits, 10/- each.
Ferrite Rods, 8 x 1in., 3/-.
H.F. Chokes, 2/6. Osmor QCI, 6/9.
I.R.F. Coils, A/HF, 7/- pair; HAX, 3/-.
Repanco DRR2, 4/-; DRX1, 2/6.
Radio Screwdriver, 5in., 6d.
Neon Mains Tester Screwdriver, 5/-.
Solder Radiograde, 4d. yds., 1lb. 5/-.
Black Crackle Paint, Air drying, 3/- tin.

Aluminium Chassis, 18 s.w.g. Plain undrilled, 4 sides, riveted corners, lattice fixing holes, 2 1/2in. sides, 7 x 4in. 4/8; 9 x 7in. 5/9; 11 x 7in. 6/9; 13 x 9in. 8/6; 14 x 11in., 10/6; 15 x 14in., 12/6.
Aluminium Panels, 18 s.w.g., 12 x 12in., 4/6; 14 x 9in., 4/-; 12 x 8in., 3/-; 10 x 7in., 2/6; 8 x 6in., 2/-.

"6 + 1" TRANSISTOR RADIO MEDIUM AND LONG WAVE KIT

First class components to make a 6 transistor 2 waveband superhet chassis. Ideal for portable or table radio. All parts including BVA transistors, ferrite aerial, with car aerial coil, printed circuit, 8 1/2in. x 2 1/2in., but EXCLUDING speaker and cabinet. Speakers, 35 ohms, 7 x 4in. 21/- 5in., 17/6, 9 1/2in., 15/6. **£4.50**

BULGIN PLUGS AND SOCKETS. Non-reversible P74, 2-pin, 4/8; P73, 3-pin, 4/6; P194, 6-pin, 5/6. JACKS. English open circuit, 2/6. Closed circuit, 4/3. Grundig type, 3-pin, 1/3. Grundig lead Jack 3/6. JACK PLUGS. English, 3/-; Screened, 4/-; Grundig, 3-pin, 3/6.

ALADDIN FORMERS and cores, 1in., 8d.; 1in., 10d. 0.3in. FORMERS 5937 or 6 cans TV1 or 2, 1in., 8 x 2 1/2in. or 1in. 5d. x 1 1/2in. 2/- with cores. SLOW MOTION DRIVES. 6: 1 2/3. SOLON IRON, 25W, 200V or 230V, 24/-.
ANTEX SUB-MIN IRON 15w, 200 or 240 v., 29/6.
BENCH STAND for above 12/6.

JASON FM TUNER COIL SET 29/-.
H.F. coil, aerial coil, oscillator coil, two i.f. transformers, 70.7 Mc/s. detector transformer, heater choke. Circuit book using four 6AM6, 2/6.
Complete Jason FMTI Kit. Jason chassis with calibrated dial, components and valves 25/-.
Model FMT2 with new shell cabinet, 5 valves & power pack £10. Less power £8.15.0.

MAINS DROPPERS. Midjet adjustable sliders 0.2A, 1,000 ohms, 5/-; 0.2A, 1,200 ohms, 6/-; 0.15A, 1,500 ohms, 5/-; 0.1A, 2,000 ohms, 5/-.
MIKE TRANSFORMER. 50-1, 3/6.
P.V.C. Covered Wire, single or stranded, 2d. yd. Slewing, 1 or 2 mm. 2d.; 4 mm., 3d.; 6 mm., 5d. yd.
SPEAKER-FRET. Gold Cloth 17 x 25in., 5/-; 25 x 35in., 10/-.
Tygan, various colours, 62in. wide from 10/-; 26in. wide from 6/- ft. Samples, S.A.E.
Expanded Meta. Gold, 12 x 12in., 6/-.

RADIO AND TELEVISION SPARES

All leading makes, volume controls, etc., line output transformers, etc., H. V. A. valves, (current and obsolete types). Send S.A.E. for quotation.

WEYRAD

COILS AND TRANSFORMERS FOR 2-WAVE TRANSISTOR SUPERHETS WITH PRINTED CIRCUIT AND FERRITE ROD AERIAL

Long and Medium Wave Aerial—RA2W On 6in. rod, 208P tuning, with car aerial coupling coil. 12/6
Osc. Coil P50/AC, 176pF tuning. 5/4 1st and 2nd I.F. Trans.—P50/2CC, 470K/c/s 1/16in. dia. by 1in. 5/7 each
3rd I.F. Trans.—P50/3CC. 6/-
Spare Cores 6d. each
Driver Transformer—LFDT4. 9/6
Wavechange Slide Switch. 3/6
Printed Circuit—PCAI. Size 2 1/2 x 8 1/2in. Ready drilled, and printed. 9/6
Volume Control, 5K-5P. 4/6
35 ohm Speakers, 3in., 15/6; 5in., 17/6; 7 x 4in., 21/-
24 Fixed Resistors. 10/6
16 Fixed Condensers. 2/6
Tuning Gang with trimmers. 10/6
6 Mullard Transistors and diode. 42/6
Constructor's Booklet. 2/-

NEW MULLARD TRANSISTORS
OC71 6/-, OC72 7/6, OC81D 7/6, OC81 7/6, OC44 8/6, OC45 8/6, OC101 10/6, AF117 9/6
Sub Miniature Condensers, 0.1 mFd. 30 v. 1/3; 1, 2, 4, 5, 8, 16, 25, 30, 50, 100 mFd. 15 volt 2/6 ea. Transistor Holders 1/3.

B.R.C. Pocket 2 Transistor. M.W. and L.W. Radio Kit, 22/6.
Miniature transformer 7/6. Batt. 2/3.
Circuit details, etc., S.A.E.

MONARCH RECORD PLAYER

Kit with ready built amplifier, speaker and cabinet. Carr. and Ins. 5/- **£11.10.0**



Garrard deluxe auto-player kit

£11.19.6 Carr. and Ins. 5/- Detail S.A.E.

GARRARD QUALITY AUTO-CHANGER, 4-speed, with plug-in xtal head. Ready built 3 watt amplifier, Loudspeaker and contemporary styled Portable Player Case. All items guaranteed to fit together perfectly, can be assembled in thirty minutes, full instructions supplied.

4 Speed Autochanger, B.S.R., U.A.14	£8.15.0
B.S.R., U.A.12 Stereo/Mono	£7.10.0
Garrard Autoslim Changer	£8.17.6
4 SPEED SINGLE PLAYERS	
E.M.I. with auto stop	£5.15.0
E.M.I. with separate pick-up	£3.7.6

RECORD PLAYER CABINETS 70/-

Replacement sapphire styli available from 5/3.
Replacement Xtals from 15/-; Stereo from 31/8.

Two-tone handsome zirconie covered, size 18 x 14 x 8, all accessories, baffle, fret and mounting board 14in. x 13in Space for amplifier, speaker and all modern Autochangers or single players, etc. Mounting board will be cut, free of charge for any modern record player.

RECORD PLAYER AMPLIFIER 95/-
2-valve 3w. A.C. amplifier and 6 1/2in. speaker all ready mounted on baffle, 12in. x 7in., 3in. deep Wired and tested ready for use with above cabinet.

SINGLE PLAYER KITS

£7.19.6 post 5/-.

With ready-built, 2 stage, 3 watts output amplifier. High flux 5in. speaker. Handsome portable case 18 x 10 1/2 x 7 1/2in. Collaro 4-speed Junior Motor, LF/Std. xtal pick-up for 7, 10, and 12in. records.

CABY MULTIMETER

Moving-coil Model M.I. 54/-

Measures D.C. or A.C. 6 v., 30 v., 120 v., 600 v., 1200 v. D.C. 30 mA, 300 mA. Ohms 0-100K. Leaflet S.A.E.

ARDENTE Transistor Transformers

Type D3035, 7.3 CT: Push-Pull to 3 ohms for OC72, etc., 1 x 1 x 1in. 9/6
Type D3034, 1.75: 1CT. Push-Pull Driver for OC72, etc., 1 x 1 x 1in. 9/6
Type D3058, 11.5: 1 Output to 3 ohms for OC72, etc., 1 x 1 x 1in. 9/6
Type D187, 18.2: 1 Output to 3 ohms for OC72, etc., 1 x 1 x 1in. 12/-
Type D239, 4.5: 1 Driver Transformer, 10/-
Type D240, 8.5: 1 Driver Transformer, 10/-

ARDENTE TRANSISTOR CONTROLS

5K or 1MΩ switched, dia. 0.9in., 5/3
Type VC1760, 5K with switch, dia. 0.7in., 10/6
Deaf aid earpiece xtal or magnetic, 7/6

COMPONENT SHOP SPECIALISTS

337 WHITEHORSE ROAD WEST CROYDON

Telephone: **THO 1665**
(Export welcome. Send remittance and extra postage no C.O.D.).

P.P. charge 1/- C.O.D. 2/- extra.

**RADIO-AMATEUR GEAR
EDUCATIONAL KITS**



**TEST INSTRUMENTS
HI-FI EQUIPMENT**

With the simple English of our instruction manual, anyone can build any of our models—and save money!



S-33

We guarantee that NO electronic or soldering experience is necessary. Our simple, well illustrated manual guides you step-by-step.

6W STEREO AMPLIFIER. Model S-33. 3 w/chl. Inputs for radio-tape and gram., Stereo/Mono ganged controls. Sensitivity 200 mV. £13.7.6

NEW! 5W HI-FI MONO AMPLIFIER. Model MA-5. A low-priced amplifier based on the S-33. Printed circuit construction £10.19.6

TAPE RECORDING/PLAYBACK AMPLIFIER. Stereo (TA-IS) £24.10.0 Monaural (TA-IM) £19.2.6

STEREO CONTROL UNIT. USC-I. Luxury model with inputs to suit any pick-up or tuner £19.10.0

HI-FI AM/FM TUNER. Tuning range: FM 88-108 Mc/s, AM 16-50, 200-550, 900-2,000 m. Tuning heart (£4.13.6 inc. P.T.) and I.F. amplifier (£20.13.0). Printed circuit board. Total £25.6.6



SB-10U



USC-I



TA-IS



S-99



AM/FM Tuner



SSU-I



F.M. TUNER

HI-FI F.M. TUNER. Tuning range 88-108 Mc/s. Tuning Unit (FMT-4U) with 10.7 Mc/s I.F. output (£2.15.0 inc. P.T.) I.F. Amplifier (FMA-4U) complete with cabinet and valves (£12.6.0). Total £15.1.0.

NEW! 6W DE LUXE AMPLIFIER. Model S-33H. An inexpensive Stereo-Mono amplifier, with high sensitivity, suitable for Decca Deram cartridge £15.17.6

5in. OSCILLOSCOPE. Model O-12U. Wideband amplifiers essential for TV servicing, F.M. alignment, etc. T/B covers 10 c/s-500 kc/s in 5 ranges £38.10.0

HI-FI 18W STEREO AMPLIFIER. Model S-99. Ganged controls. Stereo/Mono gram., radio and tape-recorder inputs. P/B selection £27.19.6

HI-FI SPEAKER SYSTEM. Model SSU-I. Ducted port bass reflex cabinet "in the white". Two speakers. Legs 14/6 extra. Bookcase model £10.17.6

SEND FOR FREE CATALOGUE—OVER 50 MODELS TO CHOOSE FROM

SINGLE SIDE BAND ADAPTOR. Model SB-10U. May be used with most A.M. transmitters. Less than 3W R.F. input power required for 10W output. Operation on 80, 40, 20, 15 and 10 m. bands on USB, LSB, or DSB. £39.5.0

THE "MOHICAN" GENERAL COVERAGE RECEIVER. Model GC-1U. Fully Transistorised. Excellent portable or general purpose receiver for the amateur and short-wave listener £39.17.6 See full specification leaflet.



GC-1U

SHORTWAVE TRANSISTOR PORTABLE. Model RSW-1 Two short bands, trawler and medium £19.17.6

HI-FI EQUIPMENT CABINETS. Large range, in kit form or assembled and finished, available to meet various needs. Details on request from £6.19.6 to £29.8.0

PORTABLE SERVICE OSCILLOSCOPE. Model OS-1. Compact portable scope, ideal for servicing and general work. Printed crct. Case 7½ x 4½ x 12½ in. long. Wt. only 10½ lb. £19.19.0



DX-40U

AMATEUR TRANSMITTER. Model DX-40U. Self-contained. 80-10 m. Power input 75 w. CW., 60 w. peak, C.C. phone. Output 40 w. to aerial. Provision for V.F.O. £33.19.0

6 TRANSISTOR PORTABLE. Model UXR-1. Prealigned I.F. transformers, Printed circuit, 7 x 4 in. high flux speaker. Real hide case £12.11.0

VALVE VOLTMETER. Model V7A. Measures up to 1,500 volts (D.C. and R.M.S.) and 4,000 pk. to pk. Res 0.1Ω-1,000Ω. £13.18.6

ELECTRICITY MAINS EXTENSION KIT. Model PUE-1. Completely safe, ideal for garage, greenhouse, soil heating extensions. Send for full details £4.15.6

AMATEUR TRANSMITTER Model DX-100U. Covers all amateur bands, 160-10 m. 150 w. D.C. input, self contained with power supply. Modulator, V.F.O. £74.19.0



DX-100U

Money Saving 'PACKAGED DEALS' of Complete Stereo Equipment from £45.13.0

Please send me **FREE CATALOGUE** (Yes/No).....

Full details of model(s).....

NAME

ADDRESS

PWS

Assembled models also available—prices on request. Deferred terms available over £10. Free Delivery U.K.

DAYSTROM LTD.

Dept. P.W.5, GLOUCESTER, ENGLAND

A member of the Daystrom Group, manufacturers of the WORLD'S LARGEST-SELLING ELECTRONIC KITS

Practical Wireless

Vol. XXXIX No. 675 MAY, 1963

Editorial and Advertisement
Offices:

PRACTICAL WIRELESS

George Newnes Ltd., Tower House,
Southampton Street, W.C.2.

© George Newnes Ltd., 1963

Phone: Temple Bar 4363

Telegrams: Newnes, Rand, London,
Registered at the G.P.O. for trans-
mission by Canadian Magazine Post.

SUBSCRIPTION RATES

including postage for one year

Inland - - - £1.9.0 per annum
Abroad - - - £1.7.6 per annum
Canada - - - £1.5.0 per annum

Contents

	Page
Editorial	21
Round the World of Wireless ...	22
Electronic Photo-flash Unit ...	24
Test Gear Techniques	26
Fitting an Earphone	31
Simple BFO Unit	32
Miniature Test Oscillator ...	35
Quality Amplifier and Tuner ...	40
On Your Wavelength	47
Double Conversion Communica- tions Receiver... ..	48
The Twin-Unit Two	53
Semiconductors	58
Geiger Counter Digital Register	65
Making Tin Plate Chassis ...	73
Club News	78
Trade News	81
Letters to the Editor	82

The Editor will be pleased to consider articles of a practical nature. Such articles should be written on one side of the paper only, and should contain the name and address of the sender. Whilst the Editor does not hold himself responsible for manuscripts, every effort will be made to return them if a stamped and addressed envelope is enclosed. All correspondence intended for the Editor should be addressed: The Editor, PRACTICAL WIRELESS, George Newnes, Ltd., Tower House, Southampton Street, London, W.C.2. Owing to the rapid progress in the designs of wireless apparatus and to our efforts to keep readers in touch with the latest developments, we give no warranty that apparatus described in our columns is not the subject of letters patent.

Copyright in all drawings, photographs and articles published in PRACTICAL WIRELESS is specifically reserved throughout the countries signatory to the Berne Convention and the U.S.A. Reproductions or imitations of any of these are therefore expressly forbidden. PRACTICAL WIRELESS incorporates "Amateur Wireless."

Something for Everyone

IT is a truism that you cannot please everyone; that in attempting to do so you inevitably end up by pleasing nobody. For in striking any compromise between conflicting interests each loses part of its substance so that, in the event, such a solution is not entirely satisfactory to anyone.

These thoughts result from a recent question on the requirements of the average PRACTICAL WIRELESS reader. The fact is, of course, that there is no average reader, but a great many types of reader.

Coming back to the opening paragraph it is obvious how difficult it is to strike a reasonable balance when planning issues without making compromises that leave everybody unsatisfied!

There are those who like building radio sets. There are audio fans. There are those interested in test gear. Some like electronic gadgets and novelties. Others want theory articles.

Each of these main groups can easily be sub-divided. Whereas, for instance, one reader wants valve circuits, another will prefer transistor designs. Where one reader wants high quality local station sets, another will be more interested in sensitive short wave receivers.

And to complicate matters further, the readership of PRACTICAL WIRELESS embraces the whole scale of enthusiasts from the raw beginner to the experienced constructor and experimenter.

It will be obvious that the number of permutations possible makes it extremely difficult to produce issues of sufficient variety to take in all types of article required to suit varying degrees of knowledge and yet with something to please the specialists.

If you do not see an article to suit your particular requirements in any one issue, we hope you will bear these facts in mind! For a fair assessment of coverage, an issue taken at random is no criterion. The balance may be one way in one issue, but more heavily biased in another direction in the next issue. Overall, in a series of issues, it will be found that most interests get a fair share of the space.

Even taking one issue in isolation, we attempt the impossible! In this issue, for instance, there are two radio receivers—a simple set suitable for the beginner and a multivalve communications receiver for the advanced constructor. For audio fans there is the concluding article describing a hi-fi radiogram. Test gear enthusiasts have a useful test oscillator. Two articles are angled towards the interest in electronics—the geiger counter digital register and a photo-flash unit. The two theory articles are not merely text-book material but informative text of practical merit. And there are three unclassified articles to add a spice of variety.

We are always extremely interested to receive suggestions (and criticisms!) from readers on the contents of the magazine and this helps considerably in deciding on the balance. For while it probably cannot be done, we will always strive to maintain a compromise that will please everyone!

Our next issue dated June will be published on May 7th.



ROUND THE WORLD of WIRELESS

NEWS AT HOME AND ABROAD

Broadcast Receiving Licences

THE following statement shows the approximate number of Broadcast Receiving Licences in force at the end of January, 1963, in respect of wireless receiving stations situated within the various Postal Regions of England, Wales, Scotland and Northern Ireland. The numbers include Licences issued to blind persons without payment.

Region	Total
London	604,581
Home Counties	583,923
Midland	411,197
North Eastern	428,907
North Western	368,393
South Western	335,057
Wales and Border Counties	184,832
Total England and Wales	2,896,790
Scotland	303,572
Northern Ireland	103,736
Grand Total	3,304,098

Travelling Wave Tubes for Canada

THE firm of R.C.A. Victor Company of Montreal has placed an order with Mullard Ltd. for travelling wave tubes to be used in a 3,300 mile Montreal-Vancouver microwave communications link for which R.C.A. Victor is supplying the radio equipment.

Success with New Laser

SCIENTISTS at Standard Telecommunication Laboratories in Harlow, Essex, recently succeeded in making their version of a new kind of laser work for the first time.

The new laser is the result of months of research into the semiconductor gallium arsenide, and first experiments produced line narrowing, the threshold effect and space coherence together with polarisation effects—all the criteria of successful laser action.

Big Valve Tester for Big Valves

THE huge vapour-cooled transmitting valves, built by the Machlett Laboratories Division of the Raytheon Company for the Voice of America's newest station in North Carolina, required the construction of a special large-size

valve tester. This was built to Machlett's specifications by the Votator Division of Chemtron Corp., and can deliver continuous power of 1,200,000W.

Special safeguards were built into the tester to short-circuit the tube being tested in ten-millionths of a second and thus protect it should trouble develop. The tester corrects faults in less than a hundredth of a second, so that power surges are unnoticed elsewhere in the plant or in the adjoining community, while a copper cage around the tester shields the high frequency radio emissions and prevents radio or television interference in homes nearby.

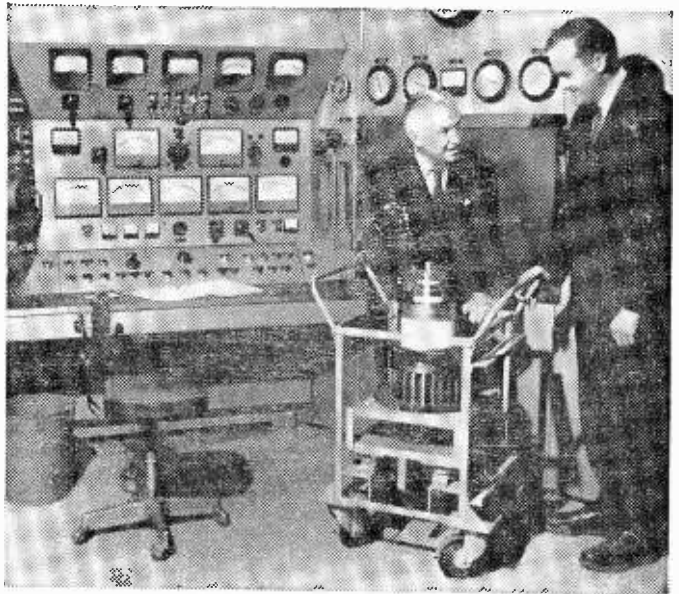

A Machlett vapour-cooled valve being wheeled inside its giant valve tester.

Over 400 Miles of Wiring

FOR the complete rewiring of the electrical system in the Royal Albert Hall, London, some 750,000 yards—or over 400 miles—of cables of various types were manufactured and supplied by British Insulated Callender's Cables Limited. This scheme, which has been carried out progressively over the last ten years and is now completed, also involved improvements and additions to the old system, certain sections of which had not been rewired since 1908.

The demands on the Hall's electrical system are numerous and varied by the very nature of the different kinds of events which are held there. For example, in addition to normal lighting and power, separate services are required for the organ blower, the BBC's control room on the Balcony floor, TV and film lighting facilities, for special effects lighting round the Gallery and under the Arena floor.

Where formerly there was one a.c. mains supply intake there are now two—the original one on the north side, still served by one 200kVA feeder, and a new intake switchroom on the south side containing six similar feeders.

Advances in Radar Techniques

A DEVELOPMENT in radar techniques, which, if applied to existing civil and military air traffic control systems, would considerably speed operations, was recently announced by the Marconi Company.

Following original research at the Marconi Laboratories by C. Cockerell and C. D. Colchester, research, which has been going on for the past six years at the Marconi Research and Development Laboratories, has resulted in the design of a special type or radar aerial head.

The "secret" of the new techniques lies in the fact that, unlike conventional equipments, the transmission does not take place on one fixed frequency but is swept through a band of frequencies for the purpose of height-finding. This, in conjunction with the new aerial, has the effect of electronically tilting the transmitted beam through an arc in the vertical plane and thus obviates the need for the mechanical movement of the whole aerial head, as in the current operational practice.

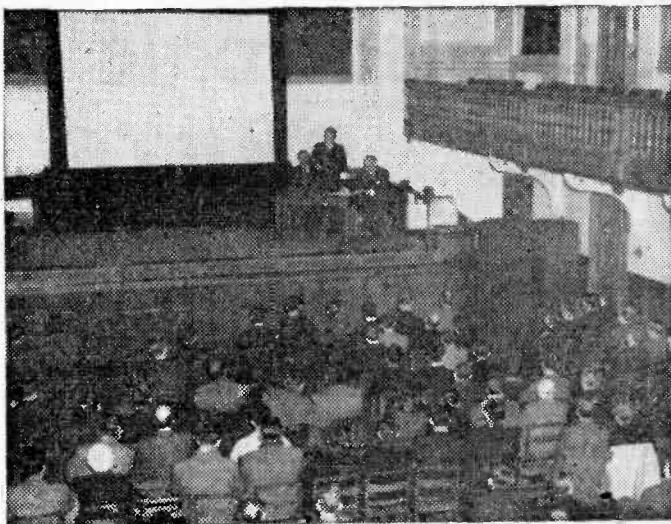

Part of the audience at the recent P.W. film show.

The new system confers at least two important advantages. It enables height-finding, range and bearing information to be derived from one radar instead of the two conventionally employed, and, perhaps even more important, it can provide height information at a very much faster rate than is possible with present equipment.

New Cable Ship Ordered

A DIESEL-ELECTRIC cable maintenance ship of about 4,300 gross tons has been placed on order by Cable and Wireless Ltd. The new ship will be capable of handling all types of submarine cable, including telephone cable with submarine amplifiers inserted.

She will be fully air-conditioned to work in tropical waters as well as temperate climates and will have a cable capacity of 30,000cu.ft or 350 miles of lightweight coaxial cable.

Conference on Microwave Valves

THE Electronics Division of the Institution of Electrical Engineers is organising a conference on the design and use of microwave valves which will be held at the institution headquarters at Savoy Place, London, W.C.2, from Wednesday, October 16th, until Friday, October 18th, 1963.

This conference aims at providing a meeting point for the requirements of the system's designer and the possibilities held out by the valve engineer.

The proceedings of the conference will fall into three main headings: signal amplification and physical measurements, radar and communications and industrial applications and it is evident from the many contributions already offered that amplification, millimetre waves, microwave relay systems, radar modulators and duplexing systems will be dealt with. Also attention will be given to such devices as linear beam valves, travelling wave tubes, klystrons and crossed field valves, all of which are of particular importance in radar and its allied applications.

Tape-Recording Equipment for Beirut

THE new Beirut commercial recording studios of Levant Forlkloric Arts Ltd. will shortly be taking delivery of a five-channel audio mixing control console, two TR90 stereophonic tape recorders and ancillary studio equipment from EMI Electronics Ltd.

Main use of the equipment will be for producing master recordings on magnetic tape for broadcast commercials, feature programmes, general copying and dubbing.

The mixing unit provides the means to control and mix the outputs from up to four microphones and one line level source into one common output, and includes full monitoring and talk-back facilities.

electronic PHOTO FLASH UNIT

BY C. M. FRETTER

MANY readers of this magazine have as a second hobby one which has greatly increased in popularity over the past few years; namely, photography. All such readers will recognise the value of an electronic photo-flash unit, permitting the taking of indoor flash pictures without the expense of flash bulbs which cost about a shilling per photograph. The running cost of the equipment about to be described is negligible.

This unit is constructed using modern semiconductor devices which can be easily obtained for a reasonable price. It is, therefore, very reliable and once built should give long and faithful service with little or no maintenance. It has a power output of 75J and a recycling or recharging time of about 12 seconds.

CIRCUIT

The circuit (shown in Fig. 1) is quite simple and comprises a d.c. converter of the push-pull transistor type feeding energy to the storage capacitor C2, which is discharged through the flash tube FT1 when a high voltage pulse is present at the trigger electrode.

The trigger voltage is obtained by switching capacitor C3, which has become charged through R6 from the main h.t. supply, across the primary of T2. C3 now discharges through the primary of T2, which, having a high step up ratio, produces the necessary 4-5kV pulse at the trigger electrode.

TRANSFORMERS

Both transformers for this unit may be made without any special tools, and providing a little care is exercised in construction, a really good job can be achieved. Materials required to make these transformers are shown in Table I.

2in. high stack of 'Mumetal' laminations having a centre limb size of approximately $\frac{3}{8}$ in. x $\frac{1}{4}$ in.
 Piece of ferrite rod $\frac{3}{8}$ in. dia. x $\frac{1}{4}$ in. long.
 Cardboard to make formers.
 20ft. 18s.w.g. enamelled copper wire.
 20ft. 30s.w.g. enamelled copper wire.
 4oz. reel of 38s.w.g. silk covered enamelled copper wire.
 10ft. 30s.w.g. silk covered enamelled copper wire.
 Small reel Sellotape or similar adhesive tape.
 A small length of insulating paper cut to fit the width of the cardboard bobbin for T1.
 2 yards of Empire Tape cut as above paper.

TABLE I

CONVERTER TRANSFORMER

The secondary winding of T1 (1,840 turns) is wound in two sections of 920t, the two primary windings being sandwiched between them (see Fig. 2). These windings must be wound on carefully, the ends fixed with adhesive tape and brought out through holes drilled in the cardboard former.

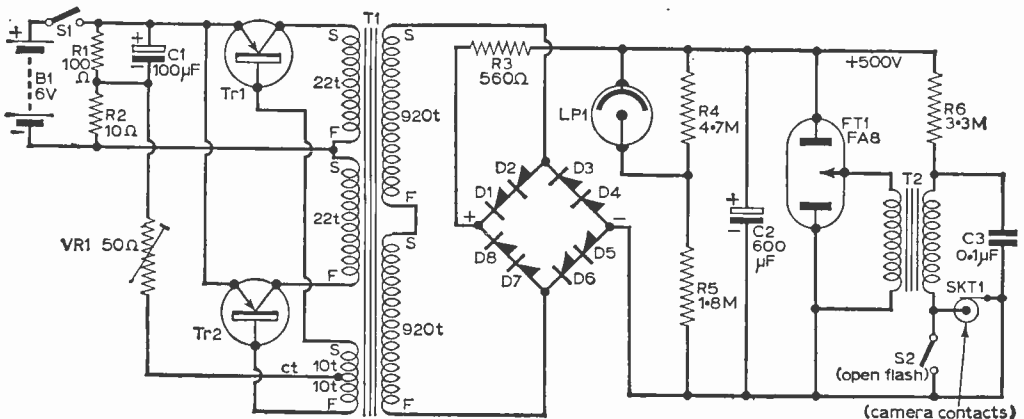

Fig. 1 The circuit diagram of the unit.

COMPONENTS LIST

Resistors: (All $\frac{1}{2}$ W carbon)

R1 100 Ω R3 560 Ω R5 1.8M Ω

R2 10 Ω R4 4.7M Ω R6 3.3M Ω

RV1 50 Ω pre-set potentiometer w.w.

Capacitors:

C1 100 μ F electrolytic 12V

C2 600 μ F electrolytic 500V (Daly PFM66/28)

C3 0.1 μ F 500V

Transistors:

Tr1, Tr2 OC28, OC29 or OC35

Miscellaneous:

FT1 FA8 flash tube; SKT1 coaxial socket;

LPI neon lamp (striking voltage 190); S1 on/off

switch; S2 press "on" push button switch;

B1 three portable accumulators (Exide MFB9);

D1 to D8 silicon rectifiers ZS73 or SX632;

T1 and T2 see text.

The primary winding of 22+22 turns is wound in a special manner known as bifilar winding. This is achieved by taking two lengths of wire and winding them on simultaneously side by side to form a flat layer one wire thick across the length of the former. If 22 double turns cannot be accommodated in this length on the core you have obtained, part of a second layer may have to be wound over the first. As with the secondary windings the ends must be fixed with adhesive tape and brought out through holes drilled in the former.

The second primary winding of 10+10 turns may be wound as 20 turns tapped in the centre, the tap being brought out through yet another hole in the bobbin. This winding will go on in one layer and is therefore fairly easy to wind. The ends are fixed and brought out as before.

The second half of the secondary is then wound on it in the same way as the first half. Between every winding and the next two layers, insulation in the form of Empire Cloth is wound on the end fixed with adhesive tape.

TRIGGER PULSE TRANSFORMER

This transformer is much simpler to wind, the whole operation taking only about an hour. The primary winding of 85t is wound on to the card former so that it occupies a few layers along the whole length of the former. The ends of the windings are fixed with adhesive tape and brought out through holes drilled in the former.

The secondary winding is wound over the primary, the ends fixed with adhesive tape and brought out through holes drilled in the former. To assist in winding on this large number of turns quickly, a wheel brace having a high gear ratio may be used. It is only necessary to count the handle revolutions and multiply by the gear ratio to arrive at the number of turns wound.

MECHANICAL CONSTRUCTION

It is not intended to lay down a fixed method of construction for this unit as most constructors will have their own ideas about cases in which to mount the completed equipment. There are, how-

ever, a number of design features which should be closely followed when the unit is built.

The transistors Tr1 and Tr2 should be mounted on a pair of heat sinks having a total surface area of approximately 18 sq. in. each. These are made from $\frac{1}{8}$ in. thick aluminium and are therefore to be approximately 3in. x 3in. The transistors must be mounted in the centre of these sheet heat sinks and the heat sinks must be insulated from all other components in the unit.

When mounted in a case, ventilation should be provided so that the heat sinks remain cool. The cases of the transistors specified are the collector connections and therefore solder tags must be provided to fit under the heads of the fixing bolts.

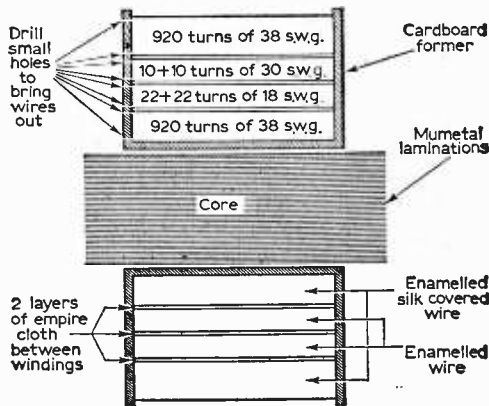
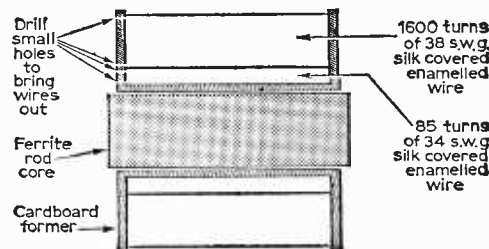

Fig. 2 (above): A section through T1.

Fig. 3 (below): The windings of T2.



OPERATING INSTRUCTIONS

Before switching-on for the first time, an ammeter should be connected in series with the battery. With the switch S1 closed, the current should rise to a maximum value and RV1 should be adjusted to limit this value to 4A.

When C2 is fully charged LPI lights up and then the unit is ready to be fired. The camera is then connected to SKT1 and as the shutter is released, or as the open flash button, S2, is closed, the flash tube strikes, giving a high intensity flash.

WARNING

Since the potentials encountered in this equipment are dangerous it is advised that all wiring on and after the secondary of T1 should be adequately insulated to prevent accident.

TEST GEAR techniques

PART 4 - A.M. SIGNAL GENERATORS

H. W. Hellyer

SIGNAL generators, nowadays, vary from the pocket-sized test source, to sophisticated instruments with very close standards, choice of modulation, and built-in measuring devices. The instruments we shall consider are those which provide a controlled signal source over a particular range of frequencies.

The types are: radio frequency signal generator, with variable frequency and amplitude, modulated by a fixed audio tone; the audio generator, and the frequency modulated sweep oscillator, or "wobbulator".

Modern instruments of the r.f. type usually cover a range of frequencies from the broadcast intermediate frequencies to the television bands. Thus, a coverage of from 100kc/s to 250Mc/s may be quoted in the specifications.

But what is important to the service engineer is the accuracy of the signal, in terms of output voltage as well as frequency. Many instruments described as signal generators are no more than ambitious test oscillators—very useful in their own right, but without the known depth of modulation, frequency stability and output regularity of the true sig. gen.

At the upper frequencies, where such accuracy is more difficult to obtain, it is all the more important. Some instruments, rated at 200Mc/s output, for example, rely upon the harmonics of the basic oscillator from above 100Mc/s. Using these harmonics can be more exacting, and misleading results are possible unless the user is wholly accustomed to his test gear.

For the amateur, who may have recourse to the signal generator only occasionally, as a frequency check, or to align a piece of equipment he has built, the "simple" test oscillator has its pitfalls.

Colpitt's Oscillator

The standard signal generator has, first, a frequency generating source, variable in switched ranges to give as wide as possible a sweep of the dial cursor. A common circuit is the well-known Colpitt's oscillator, such as illustrated in Fig. 17a.

Here, a.c. is coupled back to the tuned circuit, which consists of a pair of variable capacitors (which may be a single, tapped unit) C1 and C2, across the coil L. The reactance of the coil and the two capacitors determines the oscillator frequency.

The feedback, via Cf is across the load of C2, and the voltage is determined by the ratio of C1 to C2. The phase of the feedback is correct for maintaining oscillation, as the anode and the grid of the triode valve V1 are connected, virtually, to opposite ends of the tuning coil.

By switching various coils into circuit, and altering the values of the tuning capacitors by adding presets, a wide range of frequencies is attainable.

Hartley Oscillator

Another widely used circuit, which needs only the one tuning capacitor, and lends itself to easier construction, is the Hartley, as in Fig. 17b. In this oscillator, the coil is tapped to form L1 and L2, the feedback being via Cf, across L2, with C1 acting as the tuning capacitor.

In each case, the output is taken from the anode circuit, and a modulating signal can be coupled to the load to give the minimum shunting effect to the oscillator. This is easy to state, but not always so easy to design and build, and several refinements will be found in the commercial instrument.

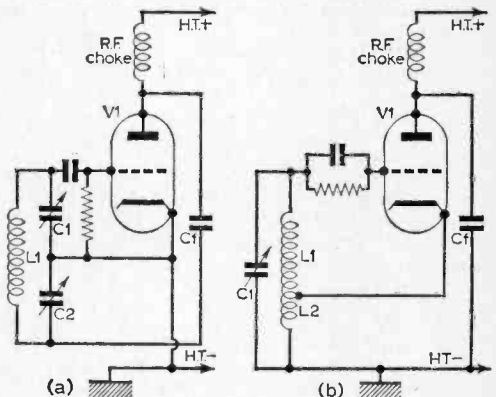

Fig. 17a: Colpitt's oscillator; b: the Hartley oscillator.

The output, with its modulation, is fed to an attenuator, to enable controlled amplitude of applied signal. Obviously, the amount of r.f. applied to the attenuator must be constant, despite the different settings of the output loading, and so it is necessary to have a "Set Carrier" control, and, preferably, some means of monitoring the signal.

In addition, although the depth of modulation is fixed, usually at about 30%, it is an advantage to make the instrument more versatile by varying the modulator through the audio range of frequencies.

In either case, a separate output is required for audio frequencies. Another output socket is connected to the high level part of the oscillator circuit to give a full r.f., which can be very useful

for forcing a signal through a completely misaligned receiver.

Basic Generator

We now have an instrument something like the block diagram of Fig. 18, with a "high r.f." and "attenuated r.f." output, plus an "audio" output, with a switch that has three positions.

The first position gives an unmodulated r.f., a carrier wave, or c.w., the second position a c.w. which is now modulated, (m.c.w.), to a depth of 30% by the a.f. oscillator at a fixed frequency, and a third position giving a variable audio output, both in frequency and level.

Also incorporated is a monitoring device, which may be a simple meter, or a valve-voltmeter circuit that can further extend the usefulness of the instrument, and an attenuator that is continuously variable by switched steps and intermediate variable control.

Before discussing the applications of such an instrument it may be as well to mention the added facility of a crystal controlled check source, and to say a bit more about the attenuator.

The accuracy of the signal generator can be checked against an external standard, such as a broadcast signal. But this is not always convenient, and by far the best alternative method is to beat the basic signal of the signal generator with the output of a crystal controlled oscillator, and calibrate by tuning for a null point, either by metering or by listening in headphones.

Crystal Oscillator

The crystal controlled oscillator, either as the basis of a beat frequency oscillator or as a wavemeter, will be considered in more detail at a later stage.

The principle is simple enough: a crystal of quartz or Rochelle salts has a piezo-electric effect, a familiar example being the action of a pick-up cartridge of a gramophone. A varying pressure applied to two faces of a block of crystal will produce a varying voltage across those faces.

Further, an alternating voltage applied to the faces (by means of metal plates in close contact) will cause the crystal to vibrate. According to the

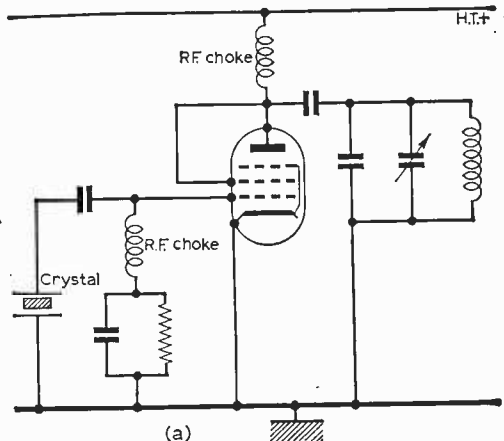

Fig. 19a (above): A simple crystal oscillator circuit.

Fig. 19b (below): The Franklin type crystal oscillator.

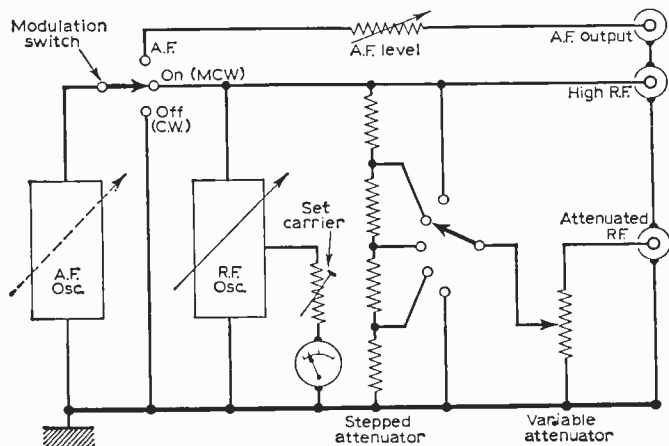
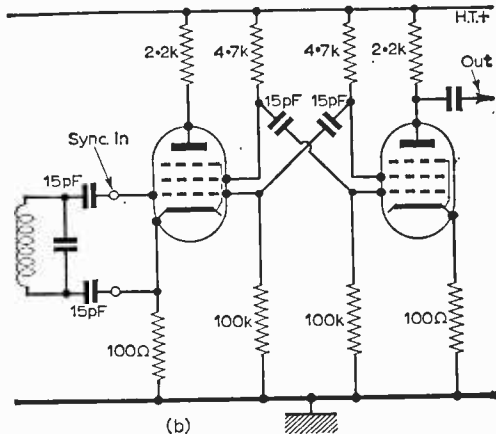

Fig. 18: The basic generator circuit.

dimensions of the block of crystal, the thinner the block, the higher the natural frequency of vibration, a compact unit of exceptional stability can be made, with a set fundamental frequency.

An oscillator circuit, built around this unit, has the advantage of a fixed and stable frequency, rich in harmonics, of high output power, and—what is important—its frequency is not affected by changes in loading.

Such a circuit is shown in Fig. 19a. This is the crystal equivalent of the simple TATG oscillator, with a pentode valve, connected as a triode to obtain a high grid-anode capacitance for greater feedback.

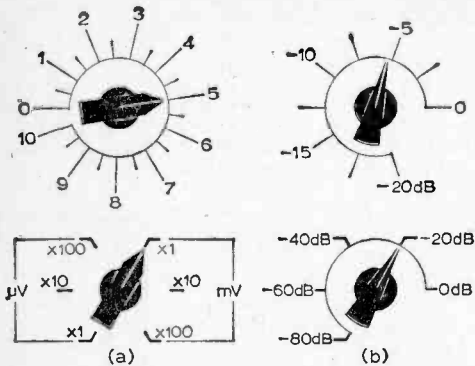

Fig. 20: Two examples of attenuator control markings.

The anode circuit is made variable, and, in fact, is normally tuned to a higher frequency than the crystal fundamental, to achieve better stability of operation. But for the purpose of calibrating a signal generator, it is better to use a circuit a little more refined.

The Franklin type crystal oscillator of Fig. 19b has several advantages. Its natural frequency can be arranged as very nearly the fundamental frequency of the crystal—in this case 100kc/s. When the crystal is lightly coupled to the input terminals, the multivibrator locks into step, producing a square waveform, rich in harmonics.

Unless the signal generator is drastically out of calibration, it should be easy to tune in to a number of points throughout the normal i.f. and broadcast range, and assess the accuracy of the signal generator tuning. If a calibrator of this type is constructed, care should be taken to keep circuit capacitances to a minimum. Normal accuracy of calibration is $\pm 1\%$.

The Attenuator

The attenuator is an extremely important part of the signal generator circuit. Normally, the r.f. output of the signal generator is in the region of 100mV. This is available at the "high r.f." output socket, but for alignment, stage gain checking and other tests, it is necessary to reduce this output in measured steps.

Thus, the attenuator is usually designed to give, say, 20dB steps, with a variable control of similar amount, to give a completely variable reduction from maximum to minimum, with the controls marked in such a way that this reduction can be read off as a relative voltage to the output of the instrument.

For an instrument with dB steps, a setting of -20dB of the step attenuator and full minimum, i.e. -20dB of the variable attenuator produces $20+20\text{dB}$ attenuation. This is one hundredth of the r.f. output voltage, so the terminal voltage is 1mV if the full r.f. is 100mV.

But the voltage step controls are usually marked as "multipliers", with the $\times 1$ position as the lowest output. This may be an equivalent of $1\mu\text{V}$, and each step may be a $\times 10$ increase, with the variable control also $\times 10$.

So a similar reading (1mV) would be obtained when the controls were in the "Microvolts $\times 100$ " step and the $\times 10$ setting of the fine control, or "Millivolts $\times 1$ " step and the $\times 1$ setting of the fine control. Fig. 20 gives pictorial views of the two types of marking, set for a 5mV output.

Importance of Screening

The minimum possible output depends upon the design of the instrument, and in particular, its screening. The residual radiation from a general purpose signal generator may well be in the region of $1\mu\text{V}$.

Thus, the lower limit of sensitivity checks is determined by the amount of signal that "escapes" from the test gear. It is therefore most important that the screening of the instrument itself and the connecting leads is not affected.

If a signal generator has been dismantled, ensure that every screw is replaced in its metal outer case—tedious though this may seem! Very often, the removable "lid" of a signal generator will be found to have a double shell, with spring clamp fitting as well as the securing screws.

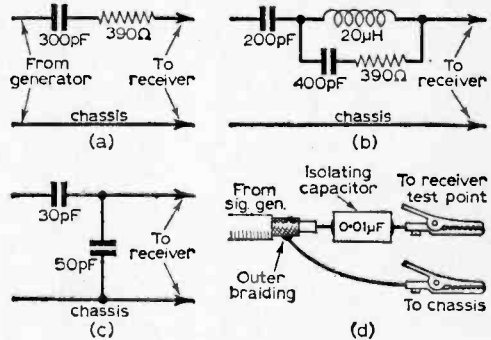

Fig. 21: "Dummy aeriols."

Make certain that this spring fitting is clean and tight. If necessary, rub them down with fine sandpaper, finishing with a wipe of carbon tetrachloride to remove residual grease and dust.

The mains lead is a potent source of radiation, and mains decoupling components should never be disturbed—if, for example, a filter capacitor is replaced in a mains decoupling unit, the connections should be made off in exactly the same way as the original, and the replacement capacitor connected to the same fixing points.

Very often, it will be found that the mains lead is fed to the instrument via a feed-through capacitor. Care should be taken not to disturb this arrangement, and the "can" into which the mains filter is inserted should be effectively earthed in the correct position on the instrument.

Keep the mains lead away from the body of the instrument and from output connections.

While on the subject of output connections, it may be as well to mention probes. These are simply devices designed to match the output impedance of the signal generator, normally in the region of 75Ω , to the input circuit under test.

From this it follows that the probe will differ for various check points. It may consist of a simple series circuit of capacitor and resistor, as in

Fig. 21a, suitable for applying the signal to the broadcast receiver aerial. This is a form of "dummy aerial".

A more sophisticated version for medium frequencies is shown in Fig. 21b while Fig. 21c gives a suitable dummy aerial for matching to the aerial of a car radio, and Fig. 21d shows the input connections for i.f. alignment of an a.m. receiver.

Which brings us to the practical problem of test gear applications. The prime function of a signal generator is to provide a signal source to the equipment under test; a signal that is controlled and measurable.

The resulting output from the amplifier or radio receiver is then measured and comparisons can be made while adjustments are carried out. Perhaps the best way of demonstrating this is to run briefly through a specimen procedure of alignment.

Fig. 22 is a skeleton circuit of a conventional a.m. receiver. Using only a signal generator and an output meter, the following method of adjusting the tuned circuits for maximum response would be adopted.

Preparations for Alignment

First, connect the output meter across the output transformer, as shown. This output meter can be an ordinary a.c. voltmeter, if a specially designed instrument is not available. (Output meters will be discussed in greater detail in a subsequent article.)

Note the inclusion of the load resistor, R1. This ensures that the output transformer "sees" the correct impedance, and allows the loudspeaker to be disconnected. The fixed audio tone of the signal generator, usually 400c/s, can be wearisome.

It is interesting to note, however, that variations in output level quite clearly registered by the meter are extremely difficult to detect by ear—proof that the hit-or-miss method of aural alignment is not so effective as we delude ourselves into believing when working in haste!

If an output meter, or its substitute, are not readily available, an alternative method of reading the output level is by connecting the high resistance voltmeter or valve-voltmeter across the detector load resistance, as shown in Fig. 22.

As the tuned circuits are brought into alignment, the voltage across the detector load resistance

increases. This is the rectified i.f. signal; from which it follows that an unmodulated input would also produce a voltage across the detector load.

Therefore a frequency meter or a simple calibrated oscillator can be used for alignment with this method of output registration. But meter response to the signal tends to be sluggish. A better, if less convenient, alternative is to insert a microammeter in series with the load.

The next precaution to be taken, before actually applying the signal generator, is to short-circuit the a.g.c. line, as shown at point A, *not* across the load resistor.

With some a.g.c. circuits, a simple short-circuit of this nature can upset the valve-operating conditions; this is especially true where delayed a.g.c. and stepped bias circuits are used, and in these cases it is necessary to render the a.g.c. inoperative in a different way, such as by disconnecting the anode of the a.g.c. rectifier.

Next, render the local oscillator inoperative. A simple method is to short-circuit the oscillator section of the two-gang tuning capacitor as at point B. Before doing this, ensure that there is no d.c. on the fixed plates; if so, use a 0.1µF paper capacitor to shunt the oscillator grid. Switch to the lowest frequency band of the receiver (long wave) and fully close the tuning capacitor.

Normal safety precautions must be taken. If an a.c./d.c. receiver is being tested, the polarity of the mains connection should be checked to ensure that the chassis is at "neutral" potential. Where earthing connections are available, both the signal generator and the receiver must be properly earthed.

As a final precaution, connect the signal generator to the receiver with 0.05µF paper capacitors of at least 500V d.c. rating, in both the live and the earthy lead. Avoid the danger of shocks that can be caused by touching the chassis with one hand and the generator with the other.

Connect the generator input to the mixer grid, via its isolating capacitor, switch to the appropriate frequency range, and allow both the set and the generator to warm up thoroughly—at least 15 minutes is necessary to obviate drift due to the varying capacitance of leads, components and valves when hot.

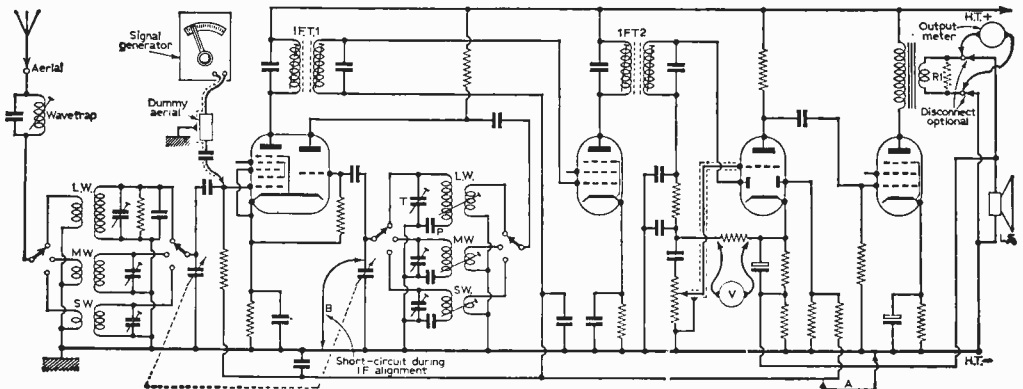

Fig. 22—A skeleton circuit of a conventional a.m. receiver.

If the correct intermediate frequency is not known, and if the set is not suspected of having been "got at", it should be possible to ascertain the correct i.f. by swinging the tuning of the signal generator around the likely range and noting the output readings, watching for an obvious peak.

I.F.'s have been settled at 470kc/s for some time now, but a few receivers may still be found whose transformers are tuned to 455 or 465kc/s. If conventional tuning is employed, a more precise method is to feed a signal of approximate frequency to the receiver, and tune the secondary of the 1st transformer, altering the input frequency, but not the level, and re-tuning until a definite peak is found.

Staggered i.f.'s, which were once common practice, are less often used in modern receivers. But care should be taken not to peak the tuning too fiercely, with the resultant danger of instability. In such cases, it is necessary to refer to the maker's published data, and tune each winding to the correct resonance point.

I.F. Alignment

Assuming that the circuit is conventional, the tuning procedure is to adjust from back to front, i.e., secondary of the second transformer, then its primary, then secondary and primary of the first transformer, for maximum output reading, reducing the input from the signal generator to the minimum workable value, to avoid overloading and possible misleading results.

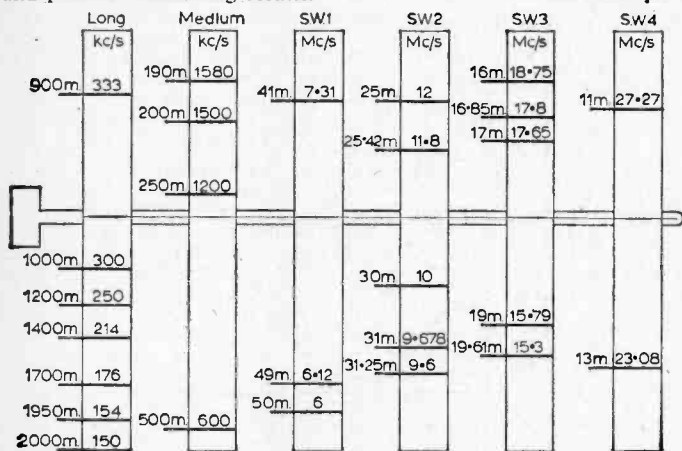

Fig. 23: Long, medium and short wave check points.

Before leaving the i.f. setting, transfer the signal generator input to the receiver's aerial and adjust the wavetrap for minimum output. It will probably be necessary to force the full r.f. input, via the dummy aerial, to obtain any breakthrough.

R.F. Alignment

With the signal generator input, via the dummy aerial, connected to the receiver's input (aerial and earth) sockets, next tune the oscillator and aerial circuits in the following sequence.

Switch to long wave, tune to a convenient point near the high frequency end of the band, and adjust the oscillator trimmer T (Fig. 22) for the correct frequency. Where two "peaks" are found,

adjust to the outer, (i.e., the first peak reached when screwing the plates of the trimmer T from the open towards the close position).

Adjust the long wave aerial trimmer for maximum output, without altering the frequency setting of either generator or receiver.

Retune to the low frequency end of the band, and adjust the slug of the oscillator coil, or, where fitted, the padding capacitor D. It may be necessary to "rock" the dial of the signal generator through a few kc/s while making this adjustment, to find the position of best output. Then return to the high frequency end of the band and check the calibration, re-trimming if necessary, finally re-checking the aerial circuit alignment again for maximum output.*

On medium waves, a similar procedure is followed. First, trim the h.f. end of the band, then pad or tune the coil at the low frequency end, returning to the h.f. end for minor re-setting. Throughout these operations, the generator output should be progressively reduced to avoid overloading.

At the high frequency end, the trimmer has the most effect, and at the low frequency end of each band, the coil core or padder should be adjusted—always returning to the h.f. end for a re-check.

Many modern receivers do not use padders on medium and short wave bands, and often there will be no provision for coil tuning on short waves; the calibration having been carried out at the factory by adjustment of the spacing of the coil turns.

On a number of models, calibration check points are marked on the scale pan, dial drum or the dial itself, and should be used. But for general guidance, a scale of Long, Medium and Short Wave check points, in wavelength and frequency, is given in Fig. 23.

This by no means exhausts the subject of alignment, or the description of signal generator applications. More will be said when we come to the frequency modulated instrument, and the audio generator, in the next part of this series, and later, when the oscilloscope and its applications are considered.

TV Alignment

Alignment of television receivers, which is an extension of the foregoing notes, is dealt with more completely in a self-contained article which will appear in the May issue of our companion journal, *Practical Television*.

* Footnote: Where an image rejector is fitted, this will normally be adjusted for minimum response at a frequency of twice the intermediate frequency from a strong local station. For example, for a receiver with 465kc/s i.f., inject a strong 247m, 1215kc/s signal and tune the set to 1056m, 284kc/s, adjusting for minimum output.)

If the local oscillator circuits are interdependent, if may be necessary to align the medium wave first.

PART 5 OF THIS SERIES APPEARS NEXT MONTH

FITTING AN EARPHONE



Many transistor portable radio sets are not provided with a socket for an earphone. Here is a simple method of adding this facility.

by K. Royal

ALTHOUGH the majority of currently manufactured transistor receivers feature an earphone socket, many of the earlier models, of which many thousands are in active use, have no such refinement. As there are often occasions when it is desirable to employ a transistor portable as a "personal" receiver, we are sure that many readers will be interested to discover the best way of connecting an earphone to a transistor set which was not designed originally for such an addition.

REQUIREMENTS

There are four essential requirements related to the exercise: one, there should be adequate earphone volume; two, the action of plugging-in the earphone jack plug should automatically switch off the loudspeaker; three, the earphone circuit should not disturb the normal operating conditions of the transistors; and four, earphone operation should considerably reduce the drain on the batteries.

The first three of these requirements could be met by connecting an earphone jack socket in the loudspeaker circuit so that when the jack plug is inserted the loudspeaker is disconnected and its place taken by the earphone loaded with a resistor of suitable value to maintain correct matching in the collector circuit of the output transistors.

The earphone then, in effect, would act so far as the circuit is concerned exactly like the loudspeaker. There would be more than adequate volume, and the battery power consumption would be related to the volume level used, as it is on all transistor sets employing a Class B output stage. Thus, as only a small volume level would normally be used on the earphone, the consumption should be somewhat less than what it would be with the loudspeaker connected. Unfortunately, this is not strictly true, since quite a lot of power is dissipated across the load-matching resistor, in parallel with the earphone.

Another idea which is sometimes adopted by experimenters is to arrange the jack plug/socket action to connect the earphone to the collector circuit of the driver transistor while at the same time removing the loudspeaker and in its place connecting an equivalent value load resistor.

This set-up is highly inefficient, for to secure sufficient earphone volume it is necessary to have a fairly high setting of the volume control and, even though the push-pull output transistors are disconnected from the loudspeaker, audio power is still being dissipated across the resistive load and the battery drain is comparable—if not greater—than when the loudspeaker is used. In other words, power is being thrown away unnecessarily.

OUTPUT MUTING

By far the best idea is to arrange for the output transistors and associated circuit to be muted as a whole when the earphone is plugged in. This will leave the driver stage fully operational, and from

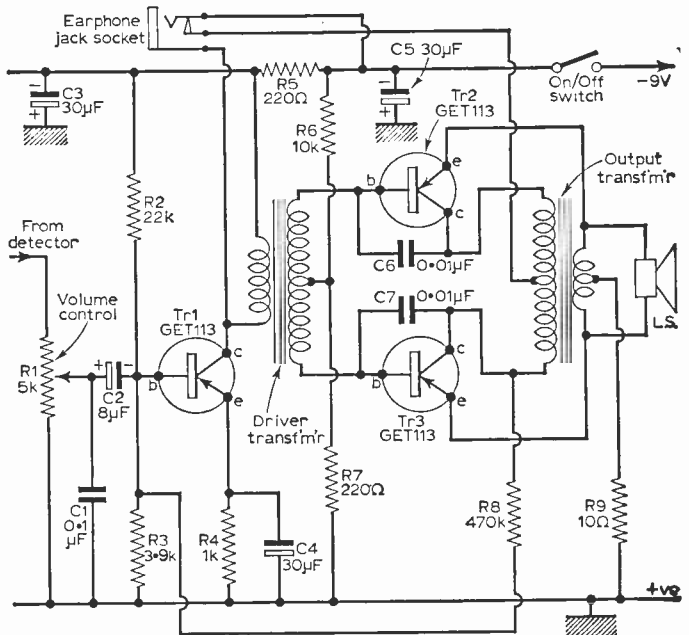

Fig. 1: The driver and output stages of a typical transistor receiver.

this the small amount of power to provide adequate earphone volume can readily be obtained.

Fig. 1 shows the driver and output stages of a typical transistor receiver. Here Tr1 is the audio driver transistor, while Tr2 and Tr3 are the push-pull output pair set-up in Class B mode. Signal from the detector diode is fed to the volume control, from whence audio of the required level is tapped and fed to the base of Tr1. The collector of this transistor is loaded in the usual manner with the primary of the driver transformer.

Audio signal is induced into the centre-tapped secondary and the bases of Tr2 and Tr3 are fed in the conventional anti-phase manner from this winding. The collectors of Tr2 and Tr3 are applied across the primary of the output transformer, and are energised battery-wise from the centre-tap. The secondary of the transformer is connected across the loudspeaker speech coil.

REFINEMENTS

The circuit shown features various refinements from the negative feedback aspect, but in the main is typical of many sets; and in any case, the principle as described will not differ substantially.

It will be seen that the earphone jack is of the type which has short-circuit contacts when the jack plug is removed, which open circuit when the plug is inserted. Such jack plugs and sockets are readily available in miniature form from most radio dealers.

The signal contacts of the jack socket are con-

nected between the collector of the driver transistor Tr1 and the battery negative line, while the short-circuiting contact is connected to the centre tap of the primary of the output transformer.

Now, in the position illustrated, with the jack plug removed from the jack socket, the receiver functions in the ordinary manner, for there is no earphone load across the driver transistor collector and battery voltage is still being applied to the primary of the output transformer through the short-circuit contacts in the jack socket.

JACK SWITCHING

However, when the jack plug is inserted the earphone is connected between the collector of Tr1 and the battery circuit, and good quality, loud sound will be heard in the earphone, controllable in the ordinary way by the volume control. At the same time the hitherto shorting contacts will open and remove voltage from the tap on the primary of the output transformer, thereby quelling collector voltage on the output transistors. This action will, of course, remove the major power-consuming circuit from the batteries while obviously killing the loudspeaker circuit.

The power consumption thus drops from about 25-30mA at average loudspeaker listening level to about 5mA at all levels on the earphone—a power saving that is well worthwhile.

The earphone should be of the high or average impedance type, quite a range of which is available on the surplus and other markets. ■

Simple BFO Unit

BY S. G. WOOD

FACED with the necessity of converting an ordinary broadcast receiver for the reception of c.w. the following small unit was constructed. Built around a small triode of the 6J5 or 6C5 class, very few components are required.

The circuitry—as Fig. 1 shows—is quite orthodox, and the items needed are all standard. An i.f. transformer removed from an old broadcast set with a range around 465kc/s was used in the author's unit, but any similar i.f. transformer would suffice, provided it is of suitable inductance.

The other components comprise a fixed capacitor of 100pF and another of 0.001μF, a couple of ½W resistors of 47kΩ and 10kΩ respectively, A standard octal valveholder and a small panel mounting on/off switch complete the list.

There is nothing at all critical about the general lay-out of the b.f.o., and the entire unit may well be tucked away in any odd corner of the main receiver chassis, as space permits. Assuming the builder to have at least some experience of radio construction, it is not proposed to give too explicit details. However, the usual care should be taken as regards insulation of all H.T. points, and good strong soldered joints are, of course, essential.

If on "testing out" the unit, difficulty is experienced in obtaining a strong "beat note", then a short length of insulated wire may be con-

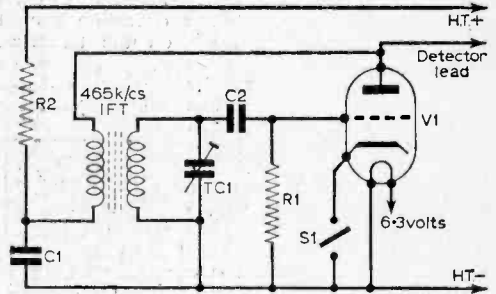

Fig. 1: The circuit of the unit.

nected from the anode circuit of the oscillator (as shown), with its "free" end wrapped round the detector lead a few turns to provide capacitive coupling. Ensure that no bare wire is allowed to make contact.

The above "pick-up" wire will not always be necessary and sufficient r.f. "pick-up" may find its way through the normal power supply channels.

Should it be desired to vary the pitch of the beat note, then a small trimmer of around 40 or 50pF could be wired across the secondary of the i.f. transformer on the b.f.o.—this is a worthwhile "refinement" but is not essential!

In conclusion it may be mentioned that the writer has been using this particular arrangement in conjunction with an old type b.c. receiver and 160m converter for several months with most satisfactory results. ■

RADIO CLEARANCE LIMITED

27 TOTTENHAM COURT ROAD, LONDON, W.1

THE OLDEST COMPONENT SPECIALISTS IN THE TRADE

TRADE ENQUIRIES INVITED

Telephone: MUSEUM 9188

EST. 35 YRS.

AGAIN CRASHING THE SOUND BARRIER!

Enormous purchases of Brand New and Guaranteed Plessey loudspeakers enable us to offer these units at THE LOWEST PRICES EVER! Don't miss this golden opportunity to obtain a first-grade permanent-magnet LOUDSPEAKER just off the production line at LESS THAN THE MANUFACTURER'S COST! Read carefully the prepared list below and choose just the right speaker for the job—COMPARE THE PRICES ANYWHERE!

SCHEDULE OF LOUDSPEAKERS AVAILABLE

Diameter in inches	Gauss in lines	Imped. in ohms	Price	Diameter in inches	Gauss in lines	Imped. in ohms	Price	Diameter in inches	Gauss in lines	Imped. in ohms	Price	Diameter in inches	Gauss in lines	Imped. in ohms	Price
2	7000	80	8/6	4	7000	25	11/8	5	8500	5	9/6	6 1/2	7000	3	11/-
2 1/2	7000	35	8/8	4	6000	35	10/8	5	9500	3	10/6	6 1/2	8500	3	11/8
2 1/2	7000	50	8/8	4	7000	35	11/-	5	8500	5	10/6	6 1/2	9500	3	12/-
2 1/2	7000	80	8/-	4	9500	35	11/8	5	10000	3	11/6	6 1/2	9500	3	12/8
3	7500	5	8/6	4	9500	35	11/8	5	12000	3	12/6	6 1/2	10000	3	12/8
3	8500	3	8/6	4	6000	3	7/6	5	6000	25	10/8	6 1/2	12000	3	15/-
3	8500	5	8/6	4	7000	3	8/-	5	6000	30	10/6	8	8000	3	11/8
3	8500	10	8/6	4	7000	5	8/-	5	6000	40	10/8	8	7000	3	12/-
3 1/2	7000	35	8/8	4	8500	3	8/6	5	9500	25	11/8	8	7000	5	12/-
4	5000	3	7/6	4	8500	5	8/6	5	9500	30	11/8	8	8500	3	12/6
4	6000	3	8/-	4	9500	3	9/8	5	9500	35	11/8	8	8500	5	12/6
4	7000	3	8/8	5	6000	3	8/-	5	6000	60	10/6	8	10000	3	12/6
4	8500	3	8/8	5	7000	3	8/6	5	9500	50	11/8	8	10000	3	12/6
4	8500	5	9/8	5	7000	5	8/6	5	10000	25	12/-	8	10000	5	13/6
4	10000	3	10/-	5	7500	3	9/-	5	10000	35	12/-	8	12000	3	14/6
4	6000	25	10/8	5	8500	3	9/8	6 1/2	6000	3	10/8	8	12000	3	14/6
Elliptical Size	Gauss in lines	Imped. in ohms	Price	Elliptical Size	Gauss in lines	Imped. in ohms	Price	Elliptical Size	Gauss in lines	Imped. in ohms	Price	Elliptical Size	Gauss in lines	Imped. in ohms	Price
5 x 3	6000	3	7/6	6 x 4	9500	5	10/-	7 x 4	9500	50	11/8	8 x 2 1/2	9500	30	10/6
5 x 3	7000	3	8/-	6 x 4	12000	3	11/-	7 x 4	10000	3	12/-	8 x 2 1/2	10000	50	10/6
5 x 3	7000	5	8/6	7 x 3 1/2	6000	3	9/8	7 x 4	10000	5	12/-	8 x 2 1/2	9500	3	10/6
5 x 3	9000	3	8/6	7 x 3 1/2	7000	3	10/-	7 x 4	10000	15	12/8	8 x 2 1/2	10000	5	10/6
5 x 3	9000	4	8/6	7 x 3 1/2	9500	35	11/-	7 x 4	12000	3	13/-	8 x 5	6000	3	8/8
5 x 3	9000	5	8/6	7 x 4	6000	3	9/8	7 x 4	9500	3*	13/8	8 x 5	7000	3	9/8
5 x 3	6000	25	9/8	7 x 4	7000	3	10/-	8 x 2 1/2	6000	3	9/8	8 x 5	8500	3	9/8
5 x 3	7000	25	10/-	7 x 4	7000	4	10/-	8 x 2 1/2	7000	3	9/8	8 x 5	8500	5	9/8
5 x 3	7000	35	10/-	7 x 4	7000	5	10/-	8 x 2 1/2	7000	5	9/8	8 x 5	8500	35	12/6
5 x 3	9000	25	11/-	7 x 4	8500	3	10/8	8 x 2 1/2	6000	6	8/8	8 x 5	9500	3	10/8
5 x 3	9000	35	11/-	7 x 4	9500	3	11/-	8 x 2 1/2	6000	30	9/8	8 x 5	9500	15	13/8
6 x 4	6000	3	8/8	7 x 4	9500	4	11/-	8 x 2 1/2	8500	3	9/8	8 x 5	10000	3	10/8
6 x 4	7000	3	8/8	7 x 4	9500	5	11/-	8 x 2 1/2	9500	3	10/8	8 x 5	12000	3	11/-
6 x 4	8500	3	9/8	7 x 4	9500	30	11/8	8 x 2 1/2	9500	4	10/-	8 x 5	12000	5	11/-
6 x 4	9500	3	10/-	7 x 4	9500	35	11/8	8 x 2 1/2	9500	5	10/-	8 x 5	12000	5	11/-

ALLOW 2/- each Speaker for postage and packing and please specify the exact requirement—the nearest available will be sent.

OVER 50,000 SOLD & STILL THE DEMAND CONTINUES FOR OUR 'HEAVENLY TWINS'

Ask for a demonstration in the shop.

"CAPRI"

Sensitive!
Super-selective!
Superb Speaker!



ONLY **£5.19.6**

(2/-p. pkg.)
Pocket Super-het MW and Droitwich.
Size 4 1/2 x 2 1/2 x 1 1/2 in.

The best and easiest transistor build-yourself sets available.

Send S.A.E. for FREE PARTS LIST

6 First Grade MULLARD Transistors, Diode(s) and all components BRAND NEW and GUARANTEED

Choice of a dozen stations in daylight . . .

"CONTESSA Mk III"
'QUEEN OF THEM ALL'

ONLY

£9.19.6

(3/6 p. pkg.)

PORTABLE CAR RADIO
2 WAVEBAND SUPER-HET

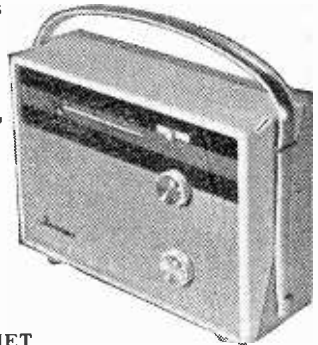

Inclusive price for all associated components, case, battery and instruction book complete in every detail.
ANY PARTS SOLD SEPARATELY ON THE BUY-AS-YOU-BUILD SCHEME

CONTESSA III £9.19.6 (plus 3/6)
CAPRI £5.19.6 (plus 2/-)

SELECTED GUARANTEED BARGAINS—BRAND NEW

Beautifully geared AM FM 2 Gang Condensers, 4/6; AM/FM IFT's 463kc/s and 10.7 Mc/s, 4/6 pair; Magnevox Crystal Tape Recorder Mikes, 12/6; Double-tuned Transistor IFT's Q120, 470 kc/s, 5/6 pr; 3 matched IFT's and oscillator coil for Mullard resistor Circuits, 15/8 the set; Brand new Cylodon turret tuners 34/38 Mc/s, valved with minimum of 10 coil sets, 12/6 each; 3 watt Stereo Amplifiers, complete, ready to switch on 79/6; Sentercel rectifiers R3/2D-D3-2-1Y, 2/6 each. GERANIUM DIODES—OA70 OA79, OA11, OA90, CG46H, 2/- each. TRANSISTORS: Set of 6 (RF and LF) including 1 watt matched pair, heat sink and diode, 15/6 the set; OC44 (or equiv.), 6/9, OC45 4/6, OC81 5/6; matched pair 12/-, PXC 101A 4/6, match pair 9/6, PXA 101 3/9, AF 113 4/6.

Please send STAMPED and ADDRESSSED envelope with any enquiry. We regret no catalogues—our stocks move too quickly! Kindly make provision for additional postage and packing charges to avoid delay.

TERMS: CASH WITH ORDER or C.O.D. ON ORDERS OVER 10/-.

an *Armstrong* chassis is more than just a radiogram chassis

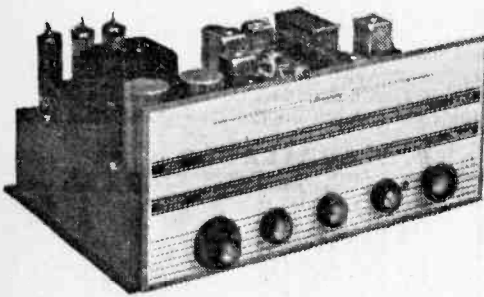

It is a carefully designed combination of tuner, control unit and amplifier in one compact unit which can be used as the basis of a complete high fidelity system. A system which can include tape recording and playback as well as radio and record reproduction.

Post this coupon or write for catalogue or call at our showroom for full demonstration and professional advice on your installation. Open 9-5 including Saturdays.

NAME _____ PMC
ADDRESS _____

ARMSTRONG WALTERS ROAD, HOLLOWAY LONDON N.7 NORTH 3213

STEREO 12 MK.2 £40.5.0

8 watts push-pull output from each channel, 16 watts total. VHF, with automatic frequency control, medium and long bands. A hi-fi system on one compact chassis.

STEREO 55 (Illustrated) £29.18.0

A junior version of the Stereo 12 Mk. 2. 5 watts per channel, 10 watts total. VHF and medium bands. Inputs for tape, pick-ups and possible future stereo radio.

JUBILEE MK.2 £28.5.0

A mono chassis of 8 watts push-pull output and covering VHF, medium and long bands. Separate tone controls. A.F.C. Pick-up and tape inputs.

AF208 £21.4.0

An AM/FM mono chassis of 5 watts output covering VHF and medium bands. An inexpensive version of the Jubilee Mk2

LISTEN TO THE WORLD on "TELSTAR" OUR EASY TO CONSTRUCT I-VALVE SHORT-WAVE RADIO



Total Building Costs

35/-

P. & P. 2/-

★ Receives speech and music from all over the world.

Construction price includes valve and one coil covering 40-100 metres. Can be extended to cover 10-100 metres. Can be converted to cover 2 or 3 valve. And all mains loudspeaker operation.

R.C.S. CRYSTAL RECEIVER

8/6 P. & P. 1/6.

Covering medium wave band. Ideal for the beginner! All components including case (suitable headphones 8/6). Easily converted to 1-transistor or 2-stage transistor receiver.

R.S.C.

TAPE TUNER

25/- P. & P. 1/6.

Record your favourite programmes. Variable Medium wave tuning. Triple wound Super Hi-Q coil. Chassis and components colour coded. Easily constructed. Size 3 x 1 1/2 x 1 in. All parts instructions and layout plans.

All parts available separately
Send S.A.E. for

FREE

layout plans and parts lists on any of these sets.

THE PERSONAL SET For Private Listening



An amazing little set, with built-in ferrite rod aerial bringing in medium wave at wonderful volume. Sturdy case. Size only 1 1/2 x 3 x 4 in. Fits into the palm of the hand. Drilled chassis colour coded for easy assembly. Total Building Costs (including earpiece)

32/6 P. & P. 1/-

R.C.S. PRODUCTS (RADIO) LTD.
11 OLIVER ROAD, LONDON, E.17
(Mail Order Only)

EXPRESS ELECTRONICS ROSEDEAN LABORATORIES KINGSWOOD WAY, SELSDON, SURREY

VALVES NEW TESTED AND GUARANTEED FOR THREE MONTHS

1C1	7/6	6H8H	5/9	12AX7	6/9	DH77	6/-	EF91	4/-	PL89	7/-
1C3	8/-	6BJ6	6/9	12BH6	8/8	DH142	8/6	EF92	6/6	PL88	7/6
1F1	8/-	6D8T	8/9	12BH7	10/6	DH150	10/-	FL41	9/0	PY81	6/9
1F3	7/6	6BW6	6/8	12K84T11/-		DK91	7/6	EI84	7/-	PY82	7/6
1FD1	8/-	6B7W	7/-	12Q7GT	7/6	DK90	8/-	EM84	10/-	PY83	7/6
1FD9	7/6	6D2	4/-	12SN7	8/-	DL82	6/9	EM85	10/-	R19	10/6
1P1	8/-	6F12	4/-	16A5	9/-	DL84	6/6	EY81	7/6	45A1	9/6
1P10	7/6	6H9GT	2/-	19A45	9/6	DL96	8/-	EY81	10/-	U92	8/6
1P11	7/6	6J7GT	7/6	25A6G	7/6	E841	4/-	EZ40	7/6	U76	7/6
1S5	8/-	6K7G	5/6	2516GT	7/6	EBC41	10/-	EZ80	8/-	U78	5/6
1S5	8/-	6K8G	6/-	35Z4G	9/-	EB980	8/6	FZ81	6/9	U142	7/6
1T4	2/9	6Q7G	5/6	30C1	7/6	ECC81	8/-	HVR2	9/6	UCH41	8/6
1U6	5/6	6SL7GT	6/-	30L1	7/6	ECC82	6/9	KT330	6/-	UCH42	9/6
3Q4	8/-	6SN7GT	6/-	35L0GT	7/-	ECC83	6/9	KT66	11/6	UF41	8/6
384	8/9	6V6G	7/6	35W4	8/6	ECC84	7/6	N17	5/0	UL41	8/6
3V4	6/6	6X4	5/6	35Z4CT	8/-	ECP80	8/6	N18	8/-	UY41	7/6
5Y3QT	8/-	6X6G	8/9	6T83	7/6	ECP82	8/-	N19	7/6	W17	7/6
5Z4G	7/6	78T	9/6	80	6/-	ECH42	9/-	N709	7/6	W76	4/8
6AK6	6/6	8D3	4/-	D F91	7/6	ECH81	10/-	PCF84	7/6	W142	8/6
6AL5	4/-	9D7	9/6	DAF96	8/-	ECL80	8/6	PCF80	7/6	X17	7/6
6AM6	4/-	12AD6	11/6	DC590	12/6	ECL82	9/-	PCF82	7/6	X142	8/-
6AT6	6/-	12A18	10/-	D F91	3/-	EP41	9/-	PCF82	8/-	X150	9/-
6BA6	5/-	12A7T	8/-	DF90	8/-	EP80	8/-	PCF84	9/-	Z77	4/-
6BE9	7/-	12A2T	6/6	D176	7/6	EP86	8/-	PL81	12/6	ZD17	7/6

High Stability Resistors 1W 5% 50 to 1M. 9d. Midget Ceramics 500 v. 9d. Coax. Super quality 1in. 6d. Plugs 9d. Sockets 9d. Silicon H.T. Resist. 250v. 300 MA 1in. x 1in. 8/6. Contact Cooled 250v. 30 MA 8/6. 85 MA 8/6.

NEW TRANSISTORS BY MULLARD. OC19, OC26, OC80, 25/-; OC44, OC45, 9/-; OC70, OC71, 8/-; OC72, 7/6; OC73 matched in pairs, 18/-; OC74, OC75, OC78, OC81, 7/6; OC82, OC170, 9/6.

VALVES MATCHED IN PAIRS

EL34 27/6, EL84 15/-, N709 16/-, 6V6G 15/-, 6BW6 14/- per pair. Push Pull O.P. Transformer for above 3 1/2 x 1 1/2, P. & P. 1/6. 12in. P.M. Speakers 3 1/2 3/4". Baker's "Belmar" 12in. 15 1/2 15W. 80/-, 12in. Stereo Model, 27.7.0.

SETS OF VALVES

DK91, DF91, DAF91, DL92 or DL94, 19/3	ECH42, EF41, EBC41
DK96, DF96, DAF96, DL96	EL41, EZ40, 37/6
1C3, 1F1, 1FD1, 1P1, 27/6	UCH42, UF41, UBC41
1R5, 1T4, 1S5, 384, or 3V4, 19/6	UL41, UY41, 35/-

Postage and packing 6d. Over £1 post free. C.O.D. 2/6

MINIATURE TEST OSCILLATOR

by R. Leyland

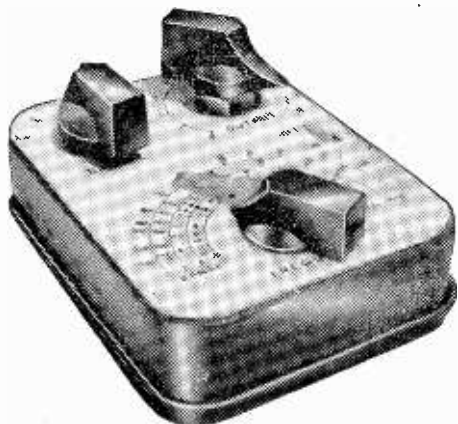

VERY compact pieces of equipment are nowadays made possible by using miniature components. These concentrate the required circuit constants into a limited space without the loss of efficiency by incorporating low-loss cores and dielectrics. The construction of an r.f. oscillator with a frequency coverage of from 160kc/s to 10Mc/s in four switched bands is therefore practicable with dimensions as small as 5in. x 3in. x 1½in.

SCREENING

The Miniature Oscillator is similar in power to the oscillating frequency-changer of an average transistor radio (which is only partially screened) so screening is required more to enable the output to be controlled rather than to avoid interference. Even a double-screened oscillator has a small external field, so it is a question of attenuation rather than of complete elimination.

Reducing the space occupied by an oscillator circuit decreases its radiation, and as the transistor oscillator does not need ventilation or an external power supply, screening is less of a problem and filters in supply leads are not necessary.

The residual field of this oscillator, although distinctly perceptible, is not troublesome, and the output comes, as it should, almost entirely through the output socket. To reduce this residual field still further, an extra screen was fitted internally around the coil turret and earthed at the output socket.

Tinplate boxes are not only easy to obtain, but are more effective against the stray magnetic induction field of the oscillator than non-ferrous metal of the same thickness. The case of the oscillator was made from a box of first-aid dressings, the sides being increased in height by soldering double strips of tinplate around them.

This can be done quite neatly using two strips meeting in the middle of the two shorter sides. The other dimensions of the box are preserved so that the lid continues to be a good fit. The soldered joint is not noticeable when the oscillator case is painted.

Single-point earthing is a sound principle for the avoidance of chassis loops and the earthing point should be at the output socket. However, the use of the earthing tag at the side of the output potentiometer, linked by a short connection to the main earthing tag, is convenient and has very little effect upon the r.f. leakage.

In this particular oscillator, the projecting shaft of the tuning capacitor is not earthed to the case and is at a small r.f. potential relative to the case. Thus it may be expected to radiate slightly, but the radiation is negligible, which is fortunate as there would not be room for an insulated shaft coupler.

What residual field exists is probably due to the thin gauge of the tinplate box. However, the presence of an induction field does not imply widespread radiation, for the induction field, in contrast with the radio wave, decreases rapidly with distance from the oscillator.

The considerable difference made by the screening can be observed by noting the increase of radiation when the lid is removed. Removing the lid slightly increases coil inductance, so the oscillator requires to (apparently) a slightly higher frequency on the tuning dial.

OSCILLATOR CIRCUIT

Choice of the type of oscillator was guided mainly by experiment. This form of oscillator (Fig. 1) appeared less affected than some others by changes in battery voltage, and gave no trouble from squegging. It is about as simple an arrangement as could be devised and reliable enough for general testing purposes. The current drawn from the battery is small and after a small initial frequency drift of a few minutes after switching on, the frequency remains steady for a considerable period. A valve oscillator, unless well ventilated, can drift for much longer during the warming-up period.

A minor aberration that has not been accounted for, and does not appear to be due to looseness of

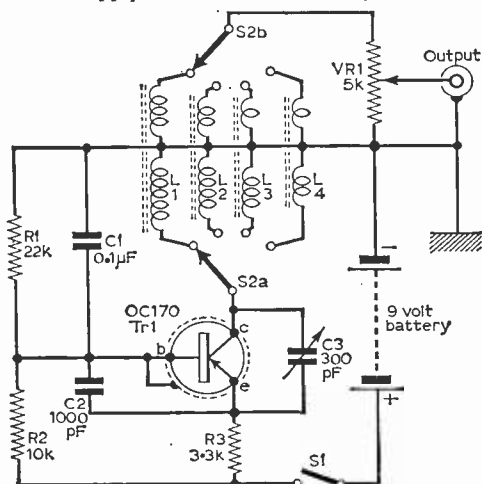

Fig. 1: Circuit diagram of the oscillator.

the knob on the shaft, is that the position of a given frequency is slightly higher on the scale when approached from below.

It was convenient to earth the negative line (collector supply for a p-n-p transistor) to the case, and as the base of the transistor is connected to the negative line via a 0.1μF capacitor C1 the circuit can be described as "grounded-base".

The emitter is therefore the driven electrode, with its waveform in phase with that of the collector, and is fed from a capacitive tapping on the tuned circuit which comprises L in parallel with C1, C2, C3 in series. Of these, C1 acts as a short circuit at r.f., leaving the smaller values C2, C3, in series, as the effective tuning capacitance.

The miniature tuning capacitor, C3, is a solid dielectric capacitor of low-loss construction. Its maximum value of 300pF is reduced by C2 (1,000pF) in series with it to 231pF, giving a maximum (including stray capacitance) of 254pF. Its minimum capacitance is 7pF, but strays in the rest of the circuit increase this to 30pF, so the capacitance ratio is 8.4:1 and the frequency coverage of each range (the square root of the capacitance ratio) is approximately 2.9:1.

A wider tuning range on each band could be obtained by using the 500pF version of this capacitor. This has a minimum capacitance of 9pF, so the minimum circuit capacitance would be 33pF and the maximum (in circuit) 365pF, yielding a tuning ratio of about 3.3:1 or 14% more.

Ideally, separate capacitance trimmers on each band should be incorporated to equalise the minimum capacitances and make the scale shape the

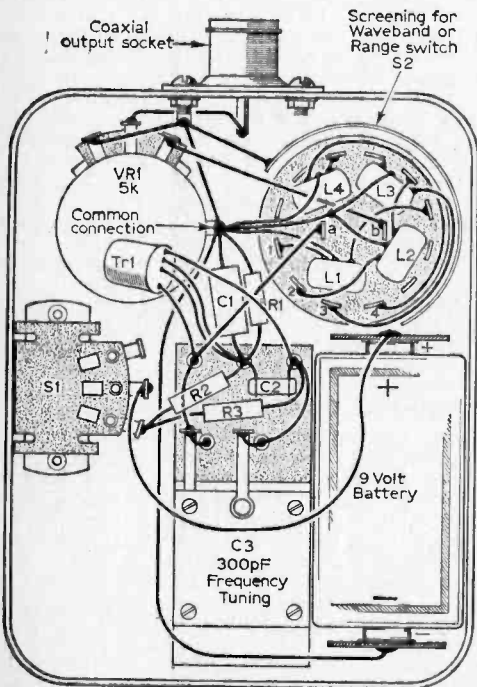

Fig. 2: Interior view showing layout and wiring.

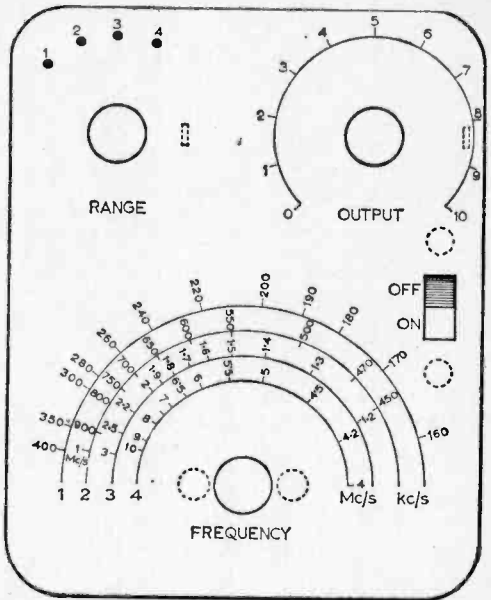

Fig. 3: Oscillator scale plate. This is made up from 18s.w.g. aluminium covered with drawing paper.

same on each band. There is room on the connector board for one miniature ceramic trimmer, but it seemed necessary to avoid increasing the minimum capacitance as it would further restrict the tuning range, so this trimmer was omitted.

It might seem that C2 should be variable as well as C3, but a fixed value of 1,000pF serves quite well. This value gives a sufficiently uniform performance and does not reduce the maximum frequency of oscillation as the higher value would.

ADDITIONAL RANGES

The wavechange switch only accommodates four toroidal coils, but in any case it was found that further ranges would only have been possible by making circuit modifications. For example, at lower frequencies the collector would have to be tapped down the coil to match it to the high circuit impedance. Otherwise oscillation stops at high L/C ratio, i.e., towards minimum capacitance on the tuning range.

Tapping the collector down the tuned circuit is also desirable to reduce the effect of the transistor on the oscillator frequency and waveform, but it requires more complicated coils and switching arrangements and is not applicable on the highest frequency range where the impedance of the tuned circuit is lower.

At still higher frequencies, phase shift inside the transistor appears to dictate another modified circuit arrangement, and this again cannot be included without undesirable complexity of switching, but the transistor used did not have a particularly high cut-off frequency, and a higher range might have been possible with a suitable transistor.

The stabilising arrangement is of the orthodox form employing a potential divider, R1 and R2, to set the base voltage to about a third of the battery

voltage. The emitter voltage is only slightly less and the emitter resistor, R3 sets the emitter current accordingly to a value of about 1mA.

Oscillation increases and decreases the transistor current to some extent on the different ranges, but even in the absence of oscillation, the collector current would remain stabilised, which is an advantage with transistors that might have an exceptionally large leakage current, or if oscillation should stop at a low capacitance setting.

The oscillator is unmodulated and would have to be used mainly with visual indication, i.e. a meter reading the d.c. output of the detector of a receiver. An external modulating unit could, however, be connected if required. There is also the possibility of including a modulating circuit in the vacant corner of the oscillator.

OUTPUT

The coupling coils are wound to give an output of about 200mV r.m.s. on each range, but on range 4, the output is slightly higher. A potentiometer VR1 is included to enable the output to be adjusted when connected to a resistive load, which can be as low as 200Ω, but preferably higher to reduce the shift of oscillator frequency. The scale divisions 0-10 are arbitrary and facilitate setting of the output control. They do not represent values of output. The potentiometer only gives a small range of control, and if necessary can be supplemented by plugging an external attenuator into the output socket.

Output varies over the tuning range to some extent, but is nearly constant on one half-cycle. This is due to the limiting action of the transistor on positive-going half-cycles at the collector when the collector-emitter voltage approaches zero.

A certain amount of waveform distortion is inevitable in the absence of any other form of amplitude control, and is not easily reduced while maintaining oscillation over the entire range. Waveform distortion is equivalent to the presence of harmonics, which have their uses in calibrating the oscillator, etc.

A high Q-value in the tuned circuit reduces the amplitude of harmonics relative to the fundamental, and the flattening of alternate peaks is more marked in the waveform at the emitter than at the collector. It also appears to be less on the higher ranges, where harmonics are probably more

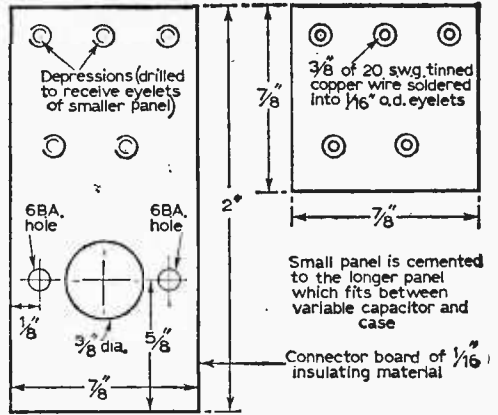

Fig. 5: Connector board, made up of 1/16 in. insulating material.

heavily attenuated. Harmonics on range 4 are not strong enough to produce TV interference even without screening.

In measuring the output on the lower ranges, it would be necessary to filter out the harmonics to obtain the actual amplitude of the fundamental.

MINIATURE COIL TURRET

The coil turret with its four ranges is probably as small as can be made with available components, and its construction requires a certain amount of skill in winding the coil for range 1, and also in attaching leads to the coil.

A cylindrical screen completely enclosing the coil turret would probably reduce r.f. leakage to minute proportions, but owing to the close proximity of the battery, it was only possible to partly surround the switch and coils by an internal screen.

However, it is doubtful whether the most painstaking precautions against r.f. leakage are worthwhile in a small test oscillator, and the existing internal screen could be omitted if preferred. It consists of a curved 2 1/2 in. x 1 in. strip of tinplate, carefully insulated with plastic insulating tape to avoid short-circuits.

The miniature wavechange switch is 2-pole 6-way but only four of the six positions are used. Originally it was intended to include more ranges. If a 3-pole 4-way switch is used, the wiring will be somewhat different. In the 6-way switch, the contacts for each coil are diametrically opposite.

THE COILS

In a miniature oscillator, the coils should be of types that achieve the maximum inductances in a limited space, and should also have a low external field so that they can be placed inside a screening box with little loss of efficiency or change of inductance. Also their close proximity in a coil turret must not result in absorption trouble from self-resonance of coils not in circuit. Although the coils in this oscillator have not been screened from each other, capacitive coupling between them is too small for absorption effects to occur from this cause.

Pot cores or toroids could be used, but the latter are smaller and have a more efficient magnetic

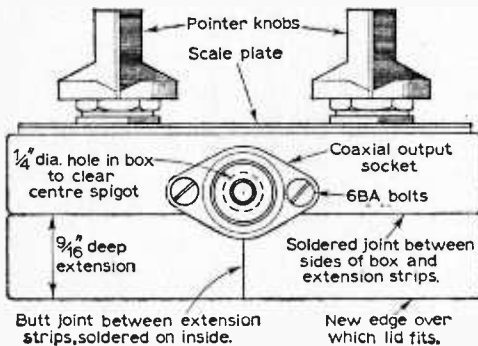

Fig. 4: End view of the oscillator.

circuit. They are not, however, suitable where the highest stability is required because, lacking an air gap, they have a larger variation with temperature and d.c. magnetisation.

The toroidal cores used were actually ferrite cups of the type used in miniature i.f. transformers, and can be obtained from a miniature pot core assembly such as Neosid Type 1. The inductance for a given number of turns is about 1½ times as large as for the miniature pot core, notwithstanding the smaller amount of ferrite material. This makes it possible to obtain a fairly high Q-value with random winding using single strand conductors.

A disadvantage of toroids in some applications is that their inductance cannot be adjusted by screwing a core in and out, but in a variable-frequency oscillator it is quite satisfactory to set the inductance to a fixed value by initially adjusting the number of turns.

Winding the miniature toroids is easy up to about 90 turns, but the 270 turn coil obviously calls for a special technique. A two-part core would be one solution, but breaking the core and

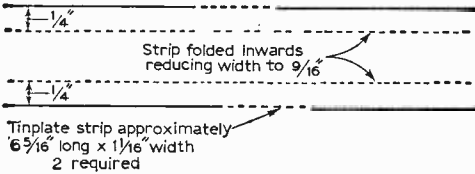

Fig. 6: Extension for sides of box.

cementing it together after winding would be somewhat risky. The method actually used was to wind a hank of 6yd of 42s.w.g. d.s.c. wire on a 3in. diameter tube, and then to wax it into a bundle narrow enough to pass through the core. About a yard is unwound at a time by remelting the wax with a barrel of a soldering iron. Each ten turns is noted by entering a mark in a column on a sheet of paper. Any tangles or kinks that occur must be carefully undone. The main coil and coupling coil are wound on opposite sides of the ferrite ring, at the semi-circular notches.

The formula for the inductance of the miniature toroids was found to be: $L=0.06 N^2 \mu H$.

Thus with $N=270$ turns, the inductance is 4.4mH. The actual coil in the oscillator has 265 turns.) With 90 turns the inductance is 490μH.

For the 90 turn coil, 61in. of 42s.w.g. d.s.c. wire should suffice; and for the 30 turn coil 22in. of 38s.w.g. The 10 turn coil is of 26s.w.g. but here the inductance is lower than given by the formula, probably because instead of being pile-wound, the turns have been spread out in a single layer.

Leads of thicker wire (26s.w.g.) have to be attached to L2, L3 and L4 to anchor the coils in position. The soldered joints are insulated with folded squares of ½in. plastic insulating tape. Each lead should be sleeved with a characteristic colour to avoid confusion. One lead is common to both coils.

The three insulated joins of each coil are laid axially across the outside of the ring cores, and a strip of the plastic insulating tape is wound firmly

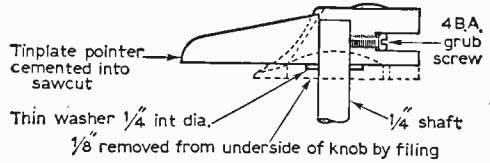

Fig. 7: Section through modified pointer knob.

round the circumference and the overlap on each side pressed in towards the centre. Then a ½in. square of the plastic tape is applied on both sides to seal the coil completely in a plastic jacket.

There are more professional ways of encasing the coils, by dipping or moulding them in polyester resin, but for just a few coils this trouble seemed unnecessary.

The common lead of each coil goes to the earthing point, while the other two leads go to the appropriate switch tags which in a 2-pole, 6-way switch are radially opposite each other.

CONNECTIONS

The connecting points for the transistor and associated resistors and capacitors are on a small panel of 1/8in. insulating material cemented to a longer strip which is fastened to the case by the tuning capacitor.

The tags are made of pieces of 20s.w.g. copper wire soldered into small eyelets in the 1/8in. insulating material, and provide a very satisfactory and simple means of anchoring components. The introduction of this connector board may increase dielectric losses at minimum capacitance, but probably very little.

Soldering should be carried out rapidly and the transistor leads gripped with radio pliers until the joint cools to keep heat from reaching the transistor. The leads should not be cut and are shortened only to the extent that they encircle the tags. The two outer leads are sleeved.

Transistors of the four-lead type such as OC170 and OC171 have one lead in electrical connection to the metal cylinder of the transistor. This lead can be connected to the base in the grounded-base circuit, the two centre leads being wired to the same tag. The case of the transistor can then be insulated with transparent adhesive tape to avoid a possible short-circuit through contact with some other part of the oscillator.

The incorporation of a five-pin holder for the transistor would, in addition to safeguarding the transistor during soldering, offer a means of testing other transistors and finding their maximum

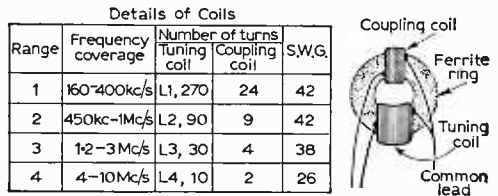

Fig. 8: Details of coils.

frequency of oscillation. The three centre connections of the five-pin holder, connected together would serve as terminals for base and screen leads.

Special care should be taken with the three miniature resistors. The body of the resistor should not be held when forming the leads, nor should one lead be held when bending the other. It is best to hold one lead near the resistor with small pliers while forming that lead to the required shape.

A small on/off switch was fitted towards the side of the oscillator. This is of the 1-pole 2-way type with one contact left unused. The miniature potentiometer could be obtained combined with on/off switch if preferred. This would make it possible to transfer the battery to the other side where it would have slightly more room in the lengthwise direction. The on/off markings would then, of course, require to be transferred to the zero portion of the potentiometer dial.

The 9V battery (type PP4 or DT4) fits into the space on one side of the tuning capacitor. Owing to the lack of room, the large tags had to be broken off the battery connectors to avoid the risk of short-circuits, and as a further precaution, the exposed surfaces of metal of the connectors were insulated with plastic insulating tape after soldering leads to them.

CALIBRATION

It is convenient to fit a removable scale made of 18s.w.g. or thinner aluminium. Drawing paper can be fixed to this with adhesive. After marking on the scales with indian ink, a clear adhesive can be applied to the surface forming a protective plastic coating.

The shaft of the tuning capacitor projects only about 1/8 in. after passing through the combined thickness of connector panel, box, and scale plate, and the only solution seemed to be to file 1/16 in. off the underside of the knob. This was done in a vice with some folded paper wadding to avoid damage. A further need was for the pointer to sweep four scales at once, and so a slit was sawn in the front of the knob and a strip of metal cemented into it to serve as a pointer of the anti-parallax type. Clear plastic knobs combining some form of cursor line seem only to be available in larger sizes and mainly in construction kits for radio sets.

To ensure a positive grip on the shaft, the up-to-date method of having a flat portion on the shaft with the end-screw fixing would have been preferable, because looseness of the knob on the shaft

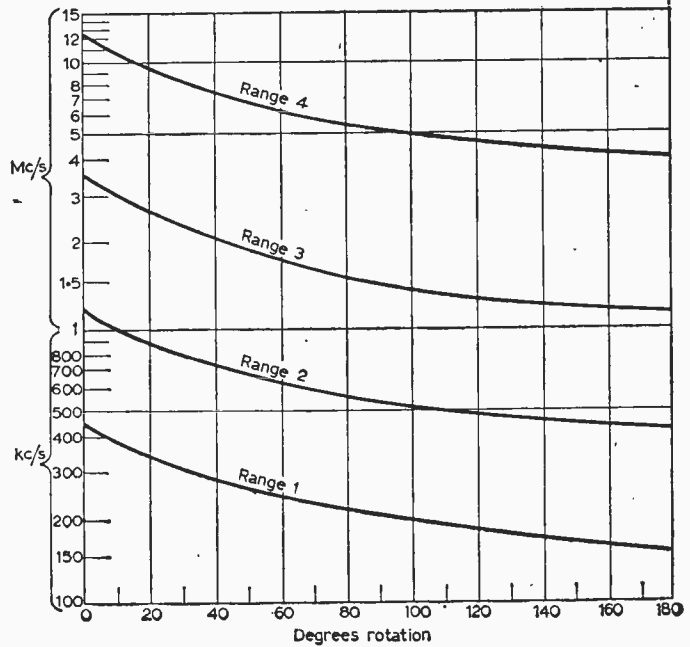

Fig. 9: Calibration chart for oscillator.

is liable to produce errors both in calibration and in using the oscillator. But there is the associated problem of finding a suitable pointer knob.

The ideal method of calibration is by means of a crystal calibrator, using harmonics of a 100k/cs and a 1Mc/s crystal. The alternative is a calibration to be carried out. The alternative is a more random method using the frequencies of known radio stations as standards. With this, discrepancies are more likely to creep in.

Range 1 is easiest to calibrate because its harmonics give numerous whistles on medium wave stations. It is only necessary to attach a few inches of insulated wire to a plug fitted into the coaxial output socket and to bring the oscillator close to a radio receiver. For weak harmonics it may be necessary to entwine this wire with the aerial wire of the receiver to increase the coupling.

Taking three known medium wave stations, "A", "B" and "C", one can mark all the positions where harmonics of the oscillator coincide with the one of these stations to give whistles (actually the whistle drops in pitch and becomes inaudibly sub-sonic at exact coincidence of frequency).

Dividing the frequency of each station by 1, 2, 3, 4 . . . in turn, the order of successive whistles can be tabulated as in the example below.

By comparing the sequence of whistles on the radio stations, and especially by noting any near coincidences (for two stations) that occur—there

—continued on page 52

A	f _A			f _A /2	f _A /3		f _A /4		f _A /5		f _A /7		f _A /8
B		f _B			f _B /2		f _B /3					f _B /5	
C			f _C			f _C /2			f _C /3			f _C /4	

By A. Cole

Quality Amplifier

Continued from page 1107 of the April issue

COMPLETING THE TUNER AND INSTALLING THE UNITS IN THE CABINET

and tuner

THE proper degree of a.f.c. is that which just still allows automatic re-capture after momentary removal of the aerial for all settings of the range of lock-in of a station. If this cannot be achieved then the a.f.c. is excessive, and must be reduced by turning VR2 slider closer to V8 anode.

If, on the other hand, tuning is virtually impossible, every station slipping away again before it is properly tuned in, then the polarity of the a.f.c. is incorrect. The connections between pins 7, 5 of V6 and the relevant tags on f.m./IFT5 should simply be exchanged to effect a cure.

Note that the specified value of C56 should be strictly adhered to, as this capacitor sets the time-constant of the a.f.c. Too small a value would allow hum and audio to frequency modulate the local oscillator; too high a value could cause the circuit to hunt, leading to strong motor-boating.

V.H.F. Alignment

Only a conventional signal generator and an ordinary multimeter of about 1,000 Ω /V are required. Connect the multimeter (25 or 50V d.c. range across C43. Radiate from the dummy aerial of the signal generator, set accurately to 10.7Mc/s, close into the wiring around the i.f. stage furthest from the ratio-detector which still gives a visible meter deflection.

Peak the slugs of all f.m. i.f.t.'s *except* the diode winding of IFT5 (bottom slug). Adjust the other slugs starting from V5 anode and working backwards. If at any stage the circuit bursts into oscillation (*sudden* high meter-reading), reduce the value of the damping resistor across the winding whose slug was adjusted just before oscillation commenced. The final *percentage* reduction should be twice that just sufficient to remove oscillation.

If no damping resistor is shown for the winding in question use 4.7k Ω . However, the damping arrangements shown in Fig. 9 should be sufficient to prevent the i.f. amplifier going into oscillation.

Reduce the signal generator output as the peaking proceeds, and take the point of injection right back to a couple of loops of wire round the ECC85 in the r.f. head as soon as possible. Keep the meter reading below 5V at all times, to avoid limiter action. When the amplifier is peaked-up, including the top and bottom i.f. slugs on the r.f. head, turn

up the signal-generator output until limiter action sets in at V5, V6, i.e. no further increase of output. The limited maximum rectified output across C43 should read about 15V.

Remove the meter from C43, and connect across the track of VR2, using the 50V d.c. range. Tune the r.f. head right off all stations, and note the meter reading exactly. Now feed in an i.f. signal at 10.7Mc/s, again by means of a loop round the ECC85 V1. The meter reading may rise or fall; adjust the diode coil of IFT5 (bottom slug) until the original reading is restored *exactly*. This should be about 20V.

Check that detuning the signal-generator slightly either side causes the meter reading to rise or fall, respectively, by about 4V, before returning to the original centre reading with further detuning. The f.m. alignment is then complete.

Ignoring the switching for the present, the arrangement for the medium and long wave stations is seen to be a more or less conventional superhet comprising a triode-hexode frequency changer, pentode i.f. amplifier and double-diode-triode functioning as detector, a.v.c. diode and a.f. amplifier. The only significant basic addition not present in most domestic superhets is the high-gain tuned r.f. stage.

Screening in the R.F. Stage

To ensure stability in the r.f. stage a brass-foil screen is inserted between the front and rear two wafers of S1. This foil is clamped between the bushes on the switch assembly bolts and has in its centre the smallest possible hole drilled to allow clearance of the spindle without scraping. The foil is earthed to chassis through a wire going to a soldering-tag near the switch.

Wires from the switch wafers go in a bunch through a grommet close by, to the r.f. grid coils on the other side of the chassis.

L5 to L8 are the r.f. anode coils and associated hexode grid coupling coils.

Note the convenient layout in relation to the two i.f. transformers, FM/IFT1 and 2, required when V2 serves as first i.f. amplifier on f.m. Also, the arrangement in relation to S2 (a.m./f.m. switch) for shorting-out the aerial coils on f.m.

FREE THIS BOOK WILL
INTEREST YOU!

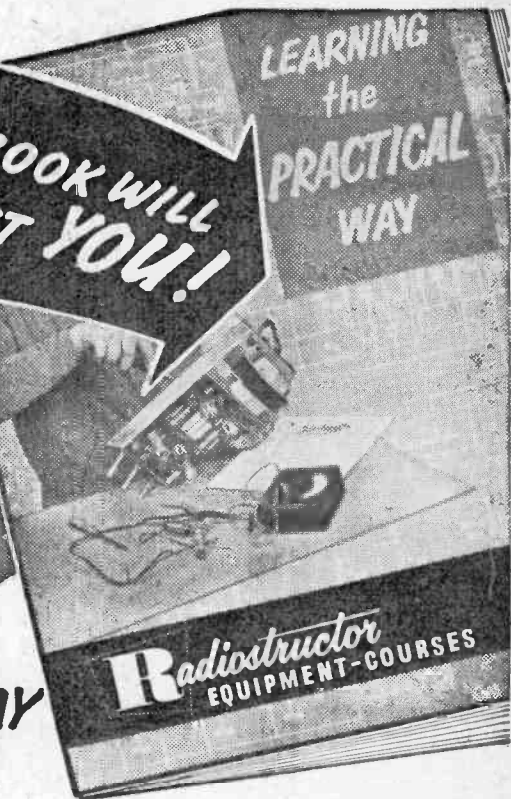
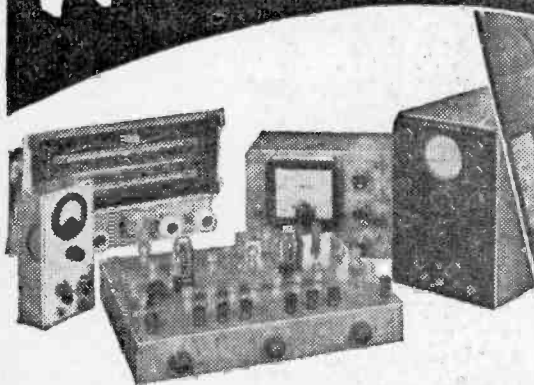

**A NEW-PRACTICAL WAY
of UNDERSTANDING**

Radio - Television - Electronics

Including: Transistors; VHF/FM; Hi-Fi equipment; Computers; Servo-mechs; Test instruments; Photo-electrics; Nucleonics, etc.

FOR ...Your Career...Your Own Business...An Absorbing Hobby

Radiostructor—an organisation specialising in electronic training systems offers a new self-instructional method using specially designed equipment on a "do-it-yourself" basis.

You learn by building actual equipment with the big kits of components which we send you. You advance by simple steps, performing a whole series of interesting and instructive experiments—with no complicated mathematics! Instructional manuals employ the latest techniques for showing the full story of electronics in a practical and interesting way—in fact—you really have fun whilst learning! Post the coupon below, now, for full details.—

RADIOSTRUCTOR
LEADS THE WORLD
IN ELECTRONICS TRAINING

POST NOW

To RADIOSTRUCTOR (Dept. G28)
READING, BERKS.

Please send brochure, without obligation, to:—

★ Name _____

Address _____

5/63

★ **BLOCK CAPITALS PLEASE**
(We do not employ representatives)

AN **AEI** PRODUCT

6 ft. flexible lead
with cordgrip

Will give a lifetime
of service

Heats up from cold
in 2½ mins

25 watt model
for radio work

Heat concentrated
in bit

Anatomy of a Superior Soldering Iron

The Solon range of electric soldering irons includes 15 and 25 watt models for radio, TV and electronic equipment; 65 watt models for household and workshop use. Larger models up to 240 watt also available.

Select a
SOLON
TRADE MARK

Used in industry for over 30 years
Obtainable from your usual radio or electrical supplier

13/40A

BRAND NEW AM/FM (V.H.F.) RADIOGRAM CHASSIS AT £12.12.0 (Carriage Paid)

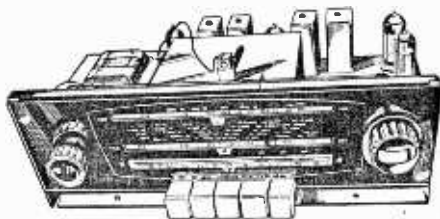

A.C. ONLY. Chassis size 15 x 6½ x 5½in. high. New manufacture. Dia 1¼ x 4in. in 2 colours, predominantly gold. Pick-up Ext. Speaker. Ae., E., and Dipole Sockets. Five push buttons—OFF, L.W., M.W., F.M. and Gram. Aligned and tested. O.P. Transformer. Tone Control. 1800-1900 M. - 200-500 K. - 88-92 Mc/s. Valves E250 rect.; ECH81, EP90 EABC80, EL84, ECC83. Negative feedback circuit. Speaker and Cabinet to fit chassis (table model), 47/6 (post 4/-). 9 x 6in. ELLIPTICAL SPEAKER, 20/-, to purchasers of this chassis. TERMS: (Chassis) £3.10.0 down and 5 monthly payments of £2. Cheap Room Dipole for V.H.F., 12/6. Feeder 6d. yd. Circuit diagram 2/6.

SELF-POWERED VHF TUNER CHASSIS. Covering 88-95 Mc/s. Mutual permeability Tuner. Dials. 10½ x 4½ x 5in. high ECC83 and 3—EP91 and 2 diodes. Metal Rectifier. Mains transformer. Fully wired and tested Oms 7.7.0 (carr paid). Vynair Cabinet included. Room dipole 12/6. Feeder 6d. yd.

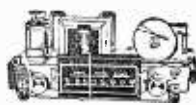

PUSH-PULL AMPLIFIER £5.5.0

(5/- Carr.)

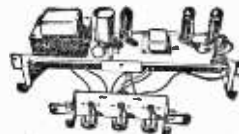

Brand new 200-240 A.C. mains. Bass, treble and vol. controls. With valves E250, ECC83 and 2-EL84 giving full 8 w. Chassis 12 x 3½ x 3½in. With o.p. trans. for 2-3 ohm speaker. Front panel (normally screwed to chassis) may be removed and used as "flying panel." Stereo version 2 x 4 w, same price. Fixel panel. "Tone & Vol. Controls."

TAPE RECORDER AMPLIFIER

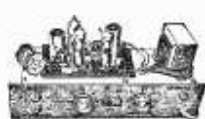

Type TR1. Fully built, high gain, low noise, printed circuit. Attractive grey and gold front panel 13 x 3in. Height 5½in. overall. Front to back 5½in. Vol. and on/off tone, Mike, radio and ext. speaker jacks. Valves ECC83, ECL82, E250. Mains trans. Ready to bolt to B.S.K. Deck. Complete with switch wiring. Our Price ONLY £5.15.0 (6/- Packing and Carr.). Also available for Coliar Deck at 5/- extra.

6-TRANSISTOR AND DIODE KITS

All brand new parts. Rexine and Vynair Cabinets. Different colours. All holes drilled in printed circuit boards. Full M.W. and L.W. coverage Car aerial socket. Alignment service, 17/6, inc. return post. All parts supplied separately. Built in 2/3 hours. 500 mW. output. Booklet 2/6, refunded on purchase of kit.

THE "SCALA"



"Scala" Kit £6.5.0. (Post 2/-). Size 9½ x 2 x 5½in. high and 3½in. speaker fully built £7.10.0

THE "MILAN"



"Milan" Kit £6.12.6. (Post 3/6). size 9 x 3½ x 7in. and 8 x 2½in. speaker.

ALL ITEMS ARE NEW AND FULLY BUILT UNLESS OTHERWISE STATED. TESTED BEFORE DESPATCH.

Terms Available on items over £5. Send 6d. (stamps will do) for 20-page illustrated catalogue. Delivered by return C.O.D. 2/- extra.

ALL ITEMS GUARANTEED 12 MONTHS VALVES 3 MONTHS

GLADSTONE RADIO
"SCALA", CAMP RD., FARNBOROUGH,
Hants.

(Farnborough 3371)

FARNBOROUGH CLOSED SATS

The constructor is advised not to make any drastic departures from the component arrangement shown in Figs. 2, 3. The flying junctions of components should not be taken to extra soldering tags, as leads could become too long.

An aluminium screen about three-quarters the chassis depth in height is bolted to the centre of the chassis. This screen prevents interaction of the four stages through feedback on f.m., when all four operate at the same frequency of 10.7Mc/s. Feedback through the switch leads on S2 is then avoided by the fact that these switch leads are all at r.f.-earth potential on f.m. On a.m. they are no longer all at earth, but then V2 and V4 operate at different frequencies, while V5 is disconnected from the h.t. supply, so that instability is not possible.

Note that S2e switches h.t. either to the a.m. local oscillator or to the v.h.f. limiter stage. S2a improves the efficiency of V2 as an i.f. amplifier, and keeps the 10.7Mc/s signals out of the a.m. tuner coil banks and switching. Furthermore, in

shorting-out the a.m. aerial circuits, it prevents spurious injections of direct 10.7Mc/s signals from the a.m. aerial.

S2d shorts out the second a.m. IFT primary, to prevent 10.7Mc/s i.f. signals reaching the a.m. detector on f.m. operation. S2c and S2f remove a.v.c. on f.m. function, to give maximum gain, and thus powerful limiter-saturation. On a.m., however, powerful delayed a.v.c. is applied to three stages, which levels out highly-fluctuating signals.

Coil Modification

In case of oscillator failure on the Luxemburg channel, the simplest and quickest cure will be to strip off all existing windings from the QO8 m.w. oscillator coil and wind on enamelled-copper wire windings, using 0.3mm diameter wire. First 58 turns, pile-wound, as oscillator grid coil. Then a layer of P.V.C. tape, and on top a neat layer of 20 turns close-wound (same wire) as anode coil. The senses of the two windings should be the

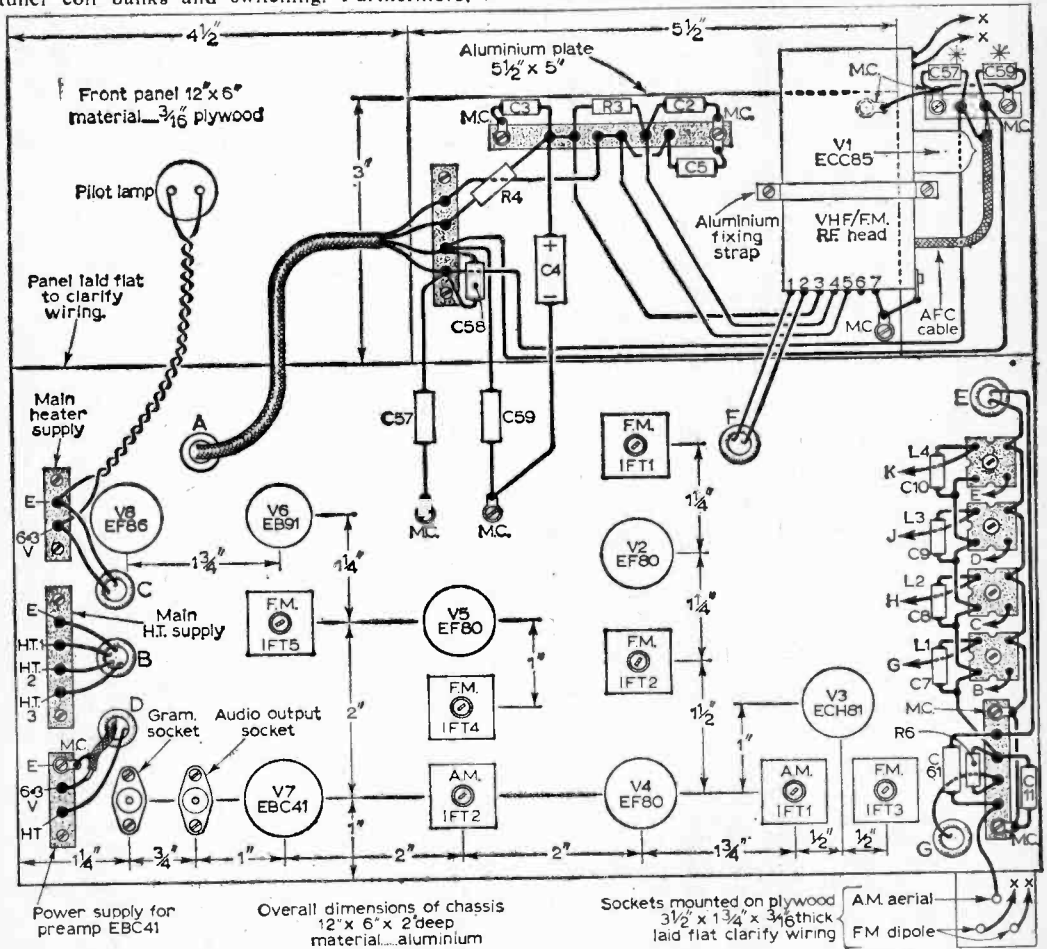

Fig. 12: The above-chassis and panel layout and wiring diagram. Dimensions are also shown. *C57 and C59 may be connected at either or both positions indicated.

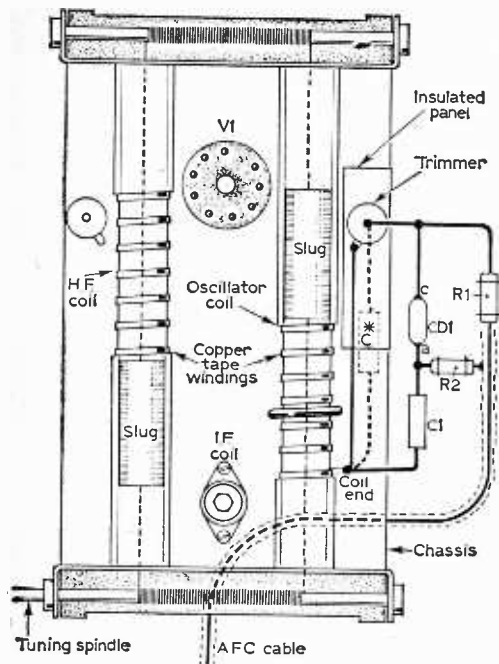

Fig. 13: The connections of the a.f.c.-components on the f.m.-head.

same as viewed from Tags 2 and 3 (see numbering of L12 in Fig. 1).

Such a rewound coil is used on the Luxemburg channel for L12 in the prototype, and the quoted value for C28 satisfies such a coil. Each channel has a separate set of three coils, using fixed parallel capacitors and preset tuning on the coil slugs. If other ranges are desired, the values of the fixed parallel capacitors can be modified.

Power Supplies

Three separate h.t. supplies of 200 to 300V, loadable to about 20 to 25mA each, are ideally required, and an additional low-power supply (about 1mA at 300V) for V7 triode. It is permissible to common all four h.t. supplies on to a power-pack of about 300V 60mA output. The heater requirements are about 3A at 6.3V.

The ideal power supplies are included on the chassis of the already published main amplifier specially designed for this radiogram combination. On Fig. 1 of that article (January 1963) the relevant h.t. outputs are to be seen. Note the remarks regarding the h.t. earth, heater earth and signal earth lines between the two chassis, made in the text of that article.

The h.t. and heater feeds for V7 triode here must be taken from the amplifier/power pack chassis as follows: h.t. from the junction C2/D1; l.t. from the 6.3V 2A winding on T1. In other words, V7 must still receive supplies when the rest of the tuner is switched off for pick-up gramophone function, because this valve is still required as an audio pre-amplifier.

Type of Cabinet

No particular model is specified for the cabinet. The particular cabinet used consisted of a simple polished wood "box" on ornamental legs, divided into two sections of about equal volume by a removable horizontal wooden insert-board. This insert is used as mounting plate for the control panel, tuner chassis, record player mechanism and aluminium heat shield.

Suitable windows are cut out of the wooden plate for the electrical controls and the turntable mechanism. The amplifier control panel and tuner are then fixed to the back of the respective windows by means of wood screws. The amplifier and power pack unit is bolted in position on the cabinet base and joined through the firmly anchored bunch of cables to the control panel.

The tuner chassis hangs with the valves horizontal, and the amplifier power pack chassis is so positioned that it comes under the aluminium heat shield preventing scorching of the wood above due to heat from the output valves. This heat shield should be mounted with screws and

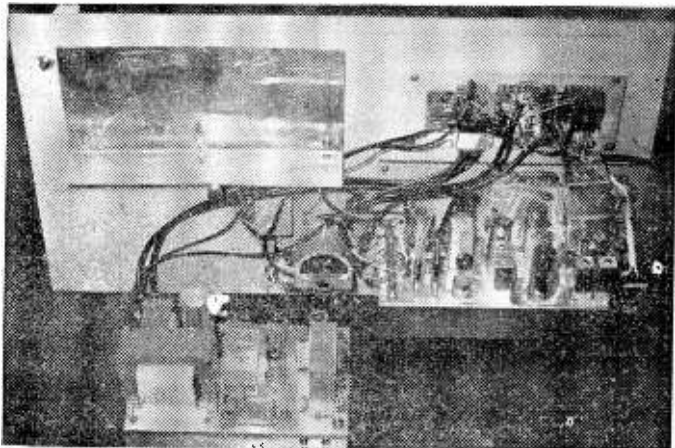

This illustration shows the tuner, control panel and record deck fitted to the mounting board and the amplifier connected by flying leads. Note also the aluminium heat shield.

stand-off washers or bushes so that it leaves an air gap between its upper side and the wooden plate, and bent such that it slopes gently upwards towards the back of the cabinet where the ventilation holes are situated. These measures are essential to prevent overheating of the complete assembly.

Electrical Connections

Mains feed for the gram motor is taken from the soldering tags provided. The earth tag should be connected to the metalwork of the mechanism

and to the amplifier heat shield. If the motor has only twin flex, a separate earth wire must be run.

Leads from the soldering tags marked "Earth-Bus" and "H.T. 1, 2 and 3" should be taken through a substantial 4-core flexible cable to the tags on the tuner marked "E, HT1, HT2, HT3" respectively. The two tags on the control panel labelled "Heaters" are connected to the corresponding "Main Heaters" tags (tuner wiring diagram). The lead coming from the switch wafers on the control panel is the one going to the main heater tag labelled "6.3V A.C." on the tuner wiring diagram.

The "Preamp EBC41" supply tags shown on the tuner above chassis wiring diagram are connected to the control panel by a three-core flexible

power cable as follows: "E" and 6.3V A.C." across the pilot lamp on the control panel (observe correct polarity in relation to the main heater connections). The tag labelled "H.T." is connected through to the wiper labelled "h" on S2 on the control panel, i.e. to h.t.+1, ahead of S2.

A piece of coaxial cable is soldered with one end to the signal input terminal tags on the control panel and the other to a suitable coaxial plug for plugging into the "Main Amplifier" socket on the tuner chassis. The pick-up lead is also terminated by a coaxial plug for insertion into the Gram P.U. socket on the tuner chassis.

All this wiring may be done after the units have been fixed to the wooden plate.

COMPONENTS LIST

Resistors:

- | | |
|----------------|-----------|
| R1 56kΩ 1/4W | R26 47Ω |
| R2 56kΩ 1/8W | R27 68kΩ |
| R3 6.8kΩ 2W | R28 470kΩ |
| R4 2.2kΩ | R29 1kΩ |
| R5 5kΩ 5W w.w. | R30 1kΩ |
| R6 470kΩ | R31 6.8kΩ |
| R7 470kΩ | R32 6.8kΩ |
| R8 4.7kΩ | R33 470kΩ |
| R9 240Ω | R34 1MΩ |
| R10 47kΩ | R35 1MΩ |
| R11 1kΩ | R36 56kΩ |
| R12 4.7kΩ | R37 27kΩ |
| R13 47kΩ | R38 2.2kΩ |
| R14 4.7kΩ | R39 1MΩ |
| R15 220Ω | R40 470kΩ |
| R16 47kΩ | R41 270kΩ |
| R17 82kΩ | R42 56kΩ |
| R18 240Ω | R43 100kΩ |
| R19 47kΩ | R44 150kΩ |
| R20 4.7kΩ | R45 10kΩ |
| R21 4.7kΩ | R46 1kΩ |
| R22 47kΩ 2W | R47 68kΩ |
| R23 100kΩ | R48 68kΩ |
| R24 47kΩ | R49 4.7kΩ |
| R25 100kΩ | R50 4.7kΩ |

All resistors ±10%, 1 watt, carbon, unless otherwise stated.

Capacitors:

- | | |
|---------------|---------------|
| C1 8pF C | C24 100pF C |
| C2 2500pF P | C25 100pF C |
| C3 2500pF P | C26 110pF C |
| C4 16μF EH | C27 220pF C |
| C5 2500pF P | C28 100pF C |
| C6 8μF EH | C29 0.15μF P |
| C7 330pF C | C30 0.015μF P |
| C8 200pF C | C31 0.05μF P |
| C9 350pF C | C32 0.05μF P |
| C10 56pF C | C33 0.02μF P |
| C11 0.1μF P | C34 8μF EH |
| C12 0.1μF P | C35 See below |
| C13 2000pF P | C36 50pF C |
| C14 0.015μF P | C37 0.05μF P |
| C15 0.01μF P | C38 2500pF P |
| C16 0.05μF P | C39 2500pF P |
| C17 330pF C | C40 300pF C |
| C18 200pF C | C41 300pF C |
| C19 350pF C | C42 300pF C |
| C20 150pF C | C43 25μF EL |
| C21 0.1μF P | C44 470pF C |
| C22 2500pF P | C45 0.1μF P |
| C23 0.015μF P | C46 2500pF P |

- | | |
|--------------|--------------|
| C47 0.1μF P | C55 0.1μF P |
| C48 830pF P | C56 50pF C |
| C49 200pF C | C57 2500pF P |
| C50 200pF C | C58 0.5μF P |
| C51 25μF EL | C59 2500pF P |
| C52 100pF C | C60 2500pF P |
| C53 0.15μF P | C61 0.01μF P |
| C54 8μF EH | |

C=Ceramic, 500V

P=Non-inductive good-quality Paper, 500V

EH=Electrolytic, 350V.

EL=Electrolytic, 30V.

C35=Only required if anode circuit of V5 refuses to peak to 10.7Mc/s. Then about 8pF ceramic.

Variable Resistors:

- | | |
|----------------|----------------|
| VR1 500kΩ log. | VR2 5kΩ linear |
|----------------|----------------|

Valves:

- | | |
|------------|----------|
| V1 ECC85 | V5 EF80 |
| V2 EF80 | V6 EB91 |
| V3 ECH81 | V7 EBC41 |
| V4 EF80 | V8 EF86 |
| CDI BA1100 | |

Inductors:

- L1 Osmor QA9
- L2, 3, 4 Osmor QA8
- L5 Osmor QHF9
- L6, 7, 8 Osmor QHF8
- L9 Osmor QO9
- L10, 11, 12 Osmor QO8
- AM/IFT 1, 2 465kc/s I.F. transformers.
- FM/IFT 1, 2, 3, 4: 10.7Mc/s I.F. transformers.
- FM/IFT5 Ratio-detector coil can, 10.7Mc/s.

Switches:

- S1 Ceramic rotary switch, 4 position. 3 wafers, 2 poles on each.
- S2 Ceramic rotary switch, 2 position. 2 wafers, 3 poles on each.

Miscellaneous:

- Chassis (aluminium) 12" x 6", 2" deep.
- 1/8" Plywood panel, 12" x 6".
- Extra small pieces of Chassis and Panel material and brass foil.
- 3 insulated wanderplug sockets.
- 7 1/2" rubber grommets.
- Tagstrip, solder, solder tags, wire, screened cable, bolts, etc.
- 5 Ceramic Noval Valveholders with cans.
- 1 Ceramic B7G Valveholder with can.
- 1 Ceramic BBA Rimlock Valveholder.
- 1 Panel Pilot-lamp.
- 4 Pointer knobs.
- "Heathkit" FM/RF-Head, Type FMT/4U.

External Connections

The three-core mains lead should be soldered to the mains input tagstrip on the control panel, and also securely clamped at a suitable position on the cabinet. Apart from this, only aerial and loudspeaker wiring remains to be completed.

Loudspeaker Connections

To obtain the best possible quality an external speaker is recommended.

The optimum matching impedance is 7 ohms, but can easily be changed to any other desired value by choosing a different output transformer in the main amplifier. In the prototype a pair of WB Stentorian HF1016 loudspeakers, each 15Ω impedance, housed in corner-cabinets, are connected in parallel to the amplifier output, matching 7 ohms.

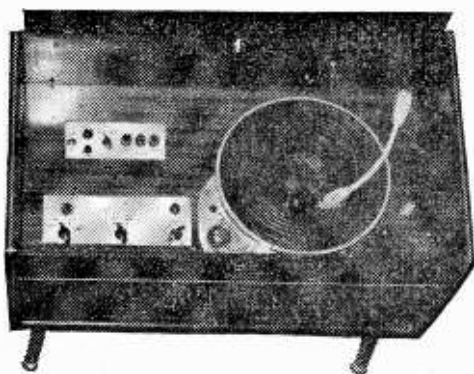

The radiogram completed.

These speakers should be positioned, relative to the listener, in roughly the same manner as the two speakers of a good stereo installation. This should here achieve a good "body" for the sound reproduction, spread out evenly in front of the listener. If the reproduction is little better or even weaker than that of a single speaker, or confused, then the phasing is wrong; reverse the connections to one of the speakers.

The simplest test is to observe the cones of the two speakers connected in parallel to a dry-cell (or a maximum of three such cells if needed). The relative phasing is correct if both cones move the same way. Do not operate the amplifier on strong signals without a speaker connected.

Aerial Connections

For a.m. reception, a few inches of wire will bring in the local stations, as the sensitivity is extremely high. However, to make best use of the gain reserves and a.g.c. a good aerial, such as a conventional long-wire, should be used.

The desired station for a switch position on the tuner should be tuned in by adjusting the core of the corresponding oscillator coil, then peaking the mixer coil and aerial coil, in that order. Only the oscillator coil will show sharp tuning.

If the station drifts slightly with time, so that side band splash is heard, only the oscillator coil need be retrimmed. If the drift is frequent, it will be necessary to seal the oscillator coil slugs with a suitable wax.

V.H.F. Aerial

Use the best possible aerial for f.m. reception. The tuner has an exceedingly silent background on f.m.

If the input signal is below a minimum usable strength, the volume will not deteriorate as much as the quality. Severe distortion is probably a sign of insufficient input signal voltage though it could be due to instability or misalignment of the f.m. tuned circuits.

Performance should normally be satisfactory either with a twin feeder or a coaxial downlead from the aerial, but readers are advised to make their own experiments. In either case, always try the effect of reversing the connections to the two f.m. aerial sockets.

Microphony

The audio frequency gain of the complete apparatus is very high. The arrangements are such that trouble from valve microphony is still not noticeable with good valves, and the hum level when both volume controls are at maximum is just still tolerable for good listening.

Both volume controls (Tuner, Control Panel) are always operative, and either permits turning the volume to zero irrespective of the position of the other. Correct operation is to adjust the main amplifier volume control on the control panel to about half or two-thirds, and then set the desired output volume on the tuner chassis volume control.

Microphony may also result from the pickup cartridge acting as a microphone. At maximum gain feedback howl may be set up when the pick-up arm is resting on the stationary turntable, acting as "diaphragm". If trouble is experienced even when the pick-up arm is resting on its supporting pillar, then a cut-out switch must be incorporated, or the signal plug removed from the tuner chassis when operating on radio.

Maximum available gain is only likely to be required on f.m. reception where the audio output of the ratio detector is very weak (100mV or so) even though 15V or more rectified carrier may be present. On a.m. reception or record reproduction, nowhere near the maximum available gain is required. Do not over-drive the main amplifier for long periods, as this can cause the screen grids of the output valves to run red hot, leading to early destruction of these valves.

Tone Controls

The range of the treble control is sufficient to suppress heterodyne whistles on a.m. reception at night, or scratching from old gramophone records. The action of the Bass Control, however, may be imperceptible on many types of music, for it is intended only remove the extreme bass in excessively "thumpy" music. ■

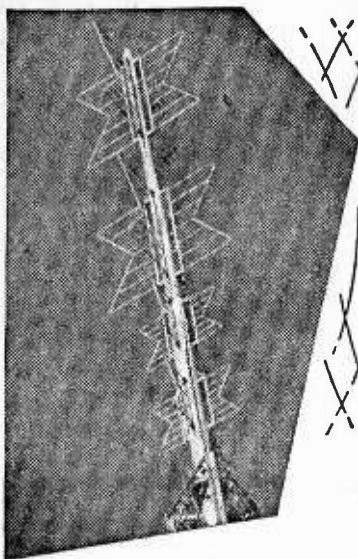

On Your Wavelength

By THERMION

taining these hints, all of exactly the same idea—generally the use of an old valve base as a plug adapter, or the use of a ball-point pen case as a test prod.

Undoubtedly every reader is aware of the latter and it would be surprising if any experimenter has not used this idea—especially as the prods can be made from red and black discarded pens.

Here is another idea, using these pen cases which might be new to some, but I am afraid at the moment I do not have any other interesting hints, either of my own or from readers. The new idea (at least, it is new to me) is to take one of these pens, remove the ink chamber from inside, and to replace it by an ordinary pipe cleaner of the type consisting of twisted wires with cotton material between them. These are flexible and will be found just to go through the opening in the point.

The pen is then filled or partly filled with "switch cleaner" (not carbon tet. as this has been found to attack certain parts of a radio), and the protruding end of pipe-cleaner—at the top—is bent over and folded and pushed into the top of the pen as a "cork".

This then forms a very useful servicing adjunct for multi contact switches etc., sufficient cleaner seeping round the protruding pipe-cleaner to clean up contacts and if necessary it can be pulled out a little longer and used to take away the dust from between the vanes of a variable condenser which has become noisy. Screw on the cap and it will not leak and can prove a most useful accessory.

"Quality" Reproduction

Finally, this month I must remind readers that the reproduction of hi-fi music is not such a simple matter as many imagine. Letters are often received asking what tweeter or loudspeaker cabinet to make in order to enable a reader to obtain improved top or bass with their existing set.

They may have heard a modern set on a hi-fi installation and think that similar results could be obtained by adding a tweeter or making a bass resonance cabinet. This is often a fallacy, and it must be borne in mind that very often, especially with old sets, a tweeter would be a waste of money.

It will only reproduce what is fed to it, and although this can go up to 20,000c/s it may be easily possible that the set cuts off even below 10,000c/s and due to its design there may be no response above that frequency so that the tweeter will have nothing to do.

The same remarks apply to the low notes. You may get a more round or smoother tone, but unless other factors are taken into account do not expect that by making a bass reflex or similar cabinet that you will get hi-fi results.

MY remarks in the February issue about modern "music" have proved more apt than I thought. Although I have not mentioned this subject for a very long time, acting partly on the assumption that everyone is entitled to his own taste in music, as well as on the number of complaints I had received from readers about this inclusion in my notes, it seems that there is still a very lively interest in the notes.

From the readers who call me a "square" to those who have no interest whatsoever in music, there are endless points of view. Of course, there is a great deal of truth in the old saying that "It takes all sorts to make a world" and "One man's meat is another man's poison", and I don't envy the broadcasting authorities their task of trying to put on programmes to please everyone.

They must have a wonderful time sorting their daily mail, as each programme is undoubtedly followed by letters attacking it and letters applauding it.

But on this question of modern "music" I am certainly not alone and many of the modern so-called tunes are simply tuneless to me, and I am not tone deaf. There is, apart from the needless repetition about which I previously spoke, no "structure" if I might use the term.

The tunes seem quite obviously to be almost the ramblings of an untrained guitar player, who has simply picked on a selection of notes which are easily fingered, and put words to it and bang! it gets into the Top Ten. I wonder why this is?

Another Hint

My two hints at the end of the last copy have brought some interesting letters and several readers ask for more. Although we did at one time publish a page of such notes from readers, it was eventually found that there were insufficient new ideas, and each post usually contained dozens of letters con-

Double Conversion Communications Receiver

BY P. R. LEWIS

THE starting point for this receiver was the circuit supplied by the manufacturers of a set of short wave coils. Curiously, the circuit was little different from those of any standard broadcast receiver, except for the addition of an r.f. stage and the use of an intermediate frequency of 1.6Mc/s.

Not unexpectedly, performance was not particularly good on the short waves. Sensitivity and selectivity were poor, noise level on weaker signals was high and there was a tendency towards instability when a further i.f. stage was added later in an attempt to increase the gain.

Accordingly, by study of the deficiencies of this receiver and with reference to an excellent series of articles on communication receivers which appeared in PRACTICAL WIRELESS between October 1954 and March 1955, a list was compiled of the various desirable features necessary to give high performance on the short waves. The main points are listed below:

(A) **High Efficiency Front End** using plug-in coils if mechanical work required would not be too awkward, and using a "flat-out" r.f. amplifier, provided adequate control could be maintained without a.g.c. fed onto this stage.

(B) **Separate First Oscillator** to give better freedom from "pulling" of the oscillator frequency by strong signals, and to allow more control over the amplitude of the oscillator output fed to the mixer.

(C) **Retention of 1.6Mc/s Intermediate Frequency** to give adequate image frequency rejection, but,

(D) **Introduction of a Second I.F. Frequency of 465kc/s** to give extra gain without instability and greater freedom from adjacent channel interference.

(E) **Some type of I.F. Filter** to reduce bandwidth. This is best introduced as near the beginning of the i.f. strip as possible (i.e. at 1.6Mc/s) and therefore another i.f. stage as this frequency could be added to make up the gain.

(F) **A Flexible A.G.C. System.**

(G) **A Sensitive Detector**, possibly in addition to a normal diode detector.

(H) **An Audio Noise Limiter.**

All these features are, in fact, incorporated in

the receiver to be described, a block diagram of which is shown in Fig. 1.

The receiver has a specification better than those of commercial sets selling at over £100. Provided that the smaller components are already to hand in the "spares-box" and that the mechanical construction can be dealt with by the experimenter, it can be built for as little as £25.

CIRCUIT DESCRIPTION

The circuit (Fig. 2) uses Denco Miniature Dual Purpose Coils (Ranges 3, 4, 5), giving an overall coverage of from 1.67—31.5Mc/s. Since the first i.f. frequency is 1.6Mc/s, the *white* oscillator coils must be used. The coils are designed for plug-in applications but, for ease of band-changing, they are mounted in complete sets of three (see paragraph on Construction), and so a separate plug-in unit is used for each tuning range.

Aerial Switching

Provision is made for switching in different aerials, the author using either a vertical wire trimmed by VC1, or one of a pair of loft dipoles sited at right angles (more fully described in PRACTICAL WIRELESS June, 1957).

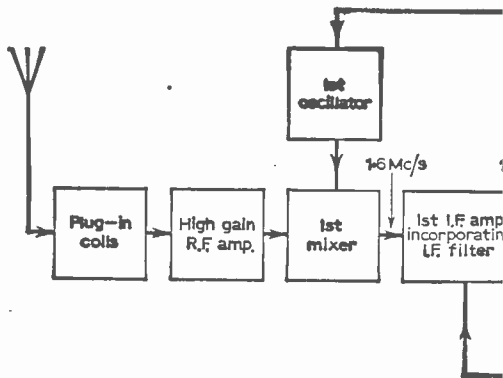
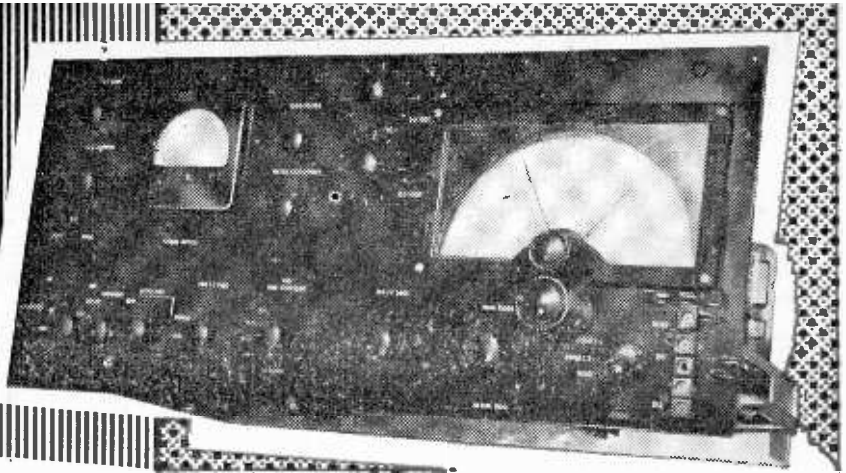

Fig. 1: A block diagram of the receiver.

ion
ions
ver



Radio Frequency Amplifier

The r.f. stage employs an EF95 (6AK5), a high-slope low-noise pentode operating under maximum gain conditions. No a.g.c. is applied to this stage as this would inevitably worsen the signal-noise ratio. No overloading has been experienced, even on strong signals, although if it was desired to use broadcast band coils, the insertion of a $50k\Omega$ r.f. gain control in series with the cathode resistor R3 would be almost essential, as it would also be if reception of S.S.B. transmissions was attempted.

The r.f. amplifier and first mixer grid coils are trimmed by the panel-mounted variable capacitors VC3 and VC5. This feature not only saves a number of trimmers but, more important, enables maximum efficiency to be attained at all points on the band. This would not be possible using conventional trimming without the expense of a very high quality ganged tuning capacitor and the labour of adjusting capacitor vanes to give perfect tracking.

First Mixer Stage

A 6BE6 is used for the first mixer since it gives almost complete freedom from "pulling" of the oscillator frequency by strong signals.

Another EF95 strapped as a triode serves as the first oscillator, giving the high output needed for optimum conversion efficiency, this factor being maintained over the whole frequency band by the loading of the oscillator anode with an r.f. choke, L4. The output to the mixer is taken from the top of the anode circuit, this once again reducing any tendency towards "pulling", although in some cases it might be necessary to take the output from the oscillator anode (see paragraph on alignment).

The circuit diagram shows a 30pF Philips concentric type trimmer (TC1) across the oscillator section of the main tuning gang. This is really only necessary to aid tracking if it is desired to use a dial already marked in frequency. If calibration is purely arbitrary, as with a 0—100 scale, this trimmer can be left out. The author did this on the first model after some experiment.

To combat r.f. instability, the heaters of the valves already mentioned are decoupled to either side (as are those of the second mixer and the b.f.o. valves) and 10Ω stopper resistors are freely employed in grids and anodes.

Intermediate Frequency Stages

The i.f. filter consists of a pair of i.f. transformers back to back, loosely top-coupled by C9, which can be made variable if it is desired to alter the bandwidth. However the value of 5pF chosen gives good results and the device as a whole compares well, considering its low cost, with the more expensive crystal filter.

One other device for narrowing the bandwidth was tried—the system popular in the USA of applying reaction to an i.f. stage. In this system the anode is loosely coupled to the grid of the valve, usually by connecting an inch or so of stiff wire to the anode pin and bending it over towards the grid connection. Feedback is controlled by the usual i.f. gain control. The author found this system to be rather vicious, turning the plate of the detector valve red-hot and burning out the IFT.

Both i.f. amplifiers (V3—1.6Mc/s and V5—465kc/s) are EF93's with similar circuitry. The cathode voltages are partially stabilised by resistors taken from the top of the gain controls to the h.t. rail (R15, R30). This prevents flutter due to unstable operation when the a.g.c. system is operating.

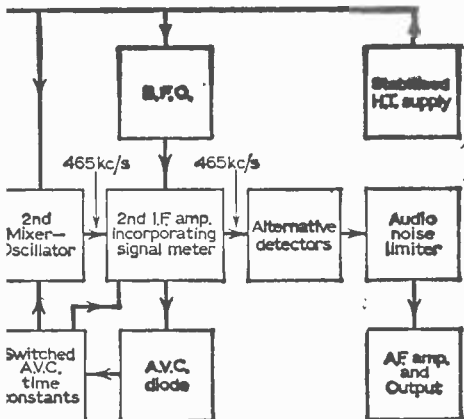

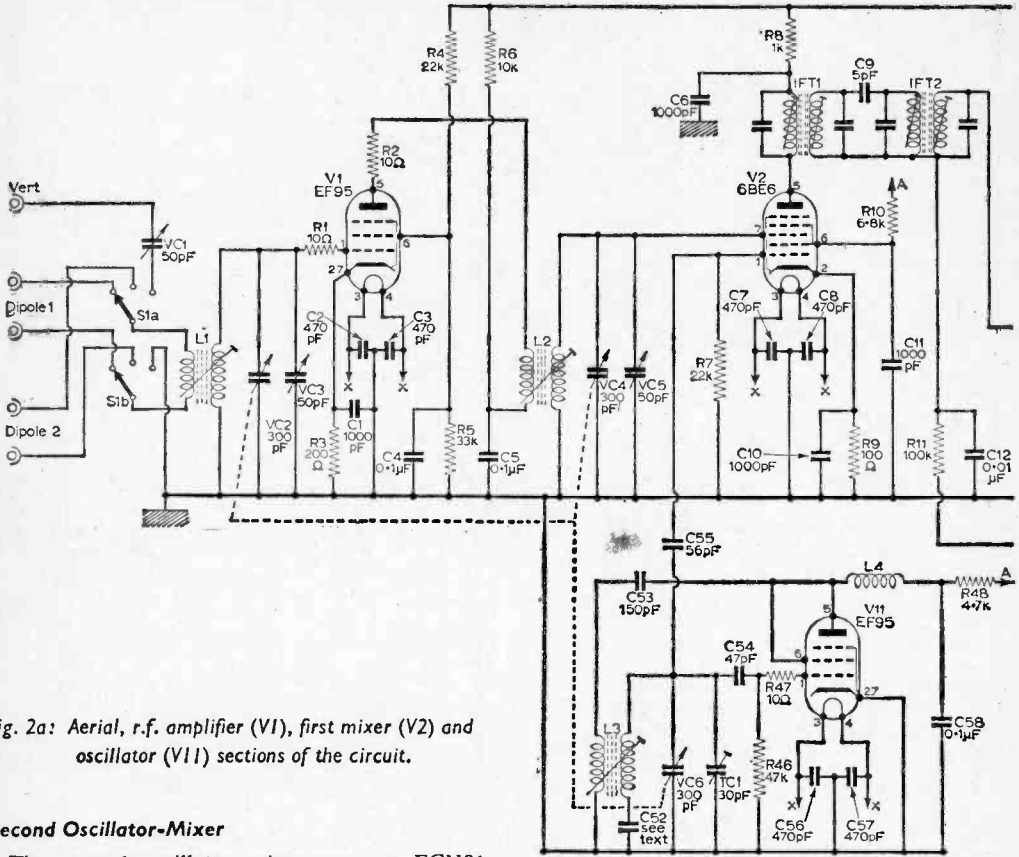

Fig. 2a: Aerial, r.f. amplifier (V1), first mixer (V2) and oscillator (V11) sections of the circuit.

Second Oscillator-Mixer

The second oscillator mixer uses an ECH81. The oscillator coil is a Repanco R03, designed for use over the 1.3—4.3Mc/s range. Since the incoming 1.6Mc/s i.f. is not at the extreme of this range, the coil tunes to the required 2.065Mc/s with a 300pF capacitor across it, this arrangement being preferred, in the interests of stability, to the use of a standard m.w. oscillator coil with very little capacitance in parallel.

The second i.f. amplifier V5 incorporates the Signal Strength meter, which consists of a 0—1mA meter used in a bridge circuit. This mode of operation has the advantage of a positive-going reading with increase of signal strength.

All r.f. and i.f. stages are separately decoupled from the h.t. supply, giving the best possible freedom from interaction between stages.

Alternative Signal Detectors

The selection of detectors is governed by S4 which gives choice of diode detection (V6a) with adequate r.f. filtering (R31, C34, C35), or of grid detection by a triode (V7a), the latter giving higher sensitivity on weak signals.

Automatic Gain Control

The a.g.c. diode (V6b) can be operated with the cathode at earth potential for straight a.g.c., or with a bias of approximately 2V positive derived

from the divider R54, R55 across the 150V supply to give delayed a.g.c.

The a.g.c. can also be shorted out, this being done anyway when the b.f.o. (V7b) is operated. The four modes of operation are controlled by S3.

The a.g.c. time constant (normally about 0.15 seconds in a broadcast receiver) can be varied by S3 from 0.1 to 1.0 second to counteract various types of fading.

The a.g.c. voltage is not fed on to the r.f. amplifier for reasons already mentioned, nor on to the first mixer since this could worsen the conversion efficiency. However, control is extremely good with the arrangement as shown and no amplification of the a.g.c. is needed.

Noise Limiter

The noise filter and crash limiter circuit is a slight variant on that described in PRACTICAL WIRELESS June, 1955, and is very effective on phones. It consists of a high-pass filter, a full-wave clipper, V8 (clipping level controlled by VR6) and a low-pass filter. The filter and limiter can be switched in and out by S5.

Audio Circuit

The a.f. section uses an EF86 (V9) and an EL84 (V10) under normal conditions. The phone take-

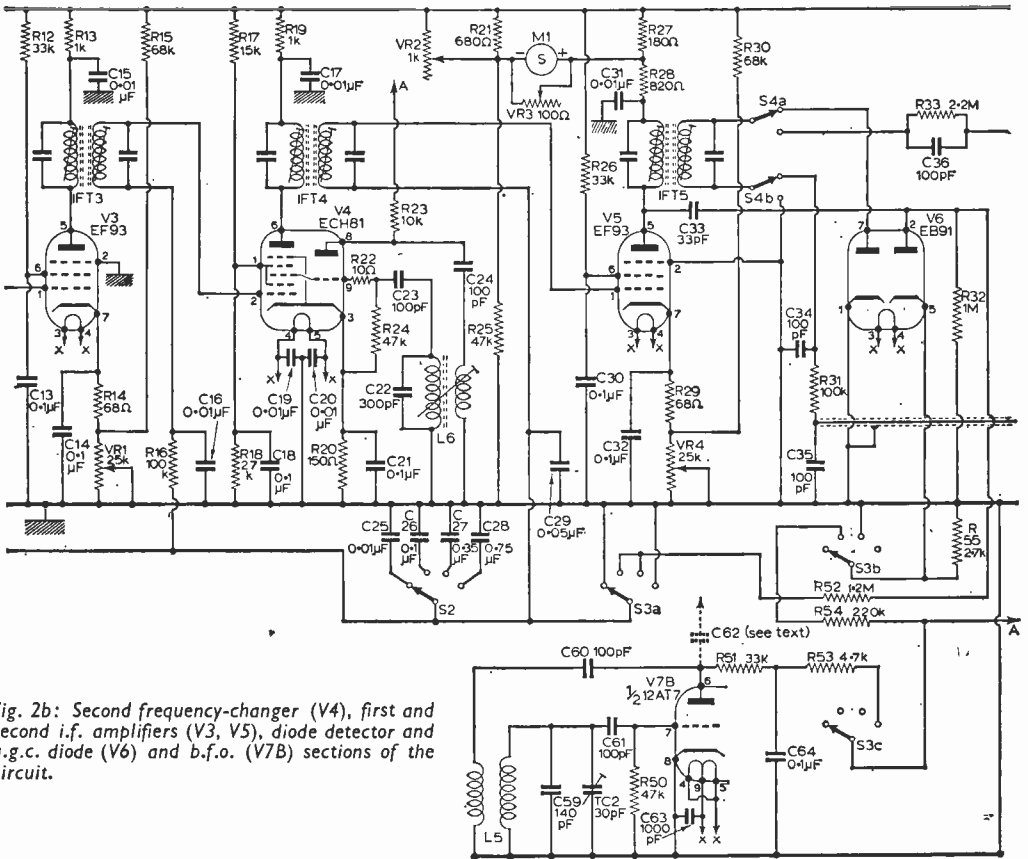

Fig. 2b: Second frequency-changer (V4), first and second i.f. amplifiers (V3, V5), diode detector and a.g.c. diode (V6) and b.f.o. (V7B) sections of the circuit.

off point comes before the output valve and is arranged so that the signal grid of the EL84 is taken to earth when using headphones. Thorough decoupling is employed in these stages; of particular importance are the r.f. by-pass across the output transformer primary (C51) and the r.f. decoupling for the h.t. feed to this section (C48).

Power Supplies

The power supplies are derived from the centre-tapped secondary of the mains transformer T1 via an EZ81 rectifier (V12). The h.t. switch S6 is two-way, wired such that some current is taken from the rectifier (via R56) even when the main h.t. rail is disconnected. This avoids damage to the cathode of the rectifier valve which might otherwise occur due to sudden imposition of high load. The 6.3V heater winding is centre-tapped to minimise hum. If a centre-tapped winding is not available, a 50Ω wire-wound potentiometer can be connected across the winding, the wiper contact going to earth and the control being adjusted for minimum hum.

A 150V gas-filled stabiliser V13 (VR150/40, QS150/40 or CV216) provides a stabilised supply for the oscillators and the first mixer screen.

MECHANICAL CONSTRUCTION AND LAYOUT

With a receiver of this size, it is not possible in the space available to give exact constructional

details, and indeed, each experimenter will have his own ideas on the subject.

However, to achieve the desired results, particularly in avoiding instability caused by r.f. feedback from the later stages to the front-end of the receiver, certain points must be observed when deciding the layout.

Ideally, the receiver should be laid out in a straight line. This is normally impossible but nevertheless a close approach to ideal can be made by using an L-shaped layout, the front-end and i.f. strip being kept close to the front panel, thus ensuring short connections to most of the major controls.

Chassis and Front Panel

A strong and adequately sized chassis should be used, although it need not be too deep, since wiring-up would be awkward. A depth of 2½in. is adequate to accommodate the Yaxley type switches, which are the deepest components.

The chassis measures 17in. x 9½in. x 2½in. and 14s.w.g. aluminium is used throughout. The front panel consists of a piece of ¼in. aluminium, 18½in. x 8½in.

Long tag strips are arranged to "run alongside" at all stages, providing convenient distribution points for the h.t. rails and the a.g.c. line, and useful soldering points where needed.

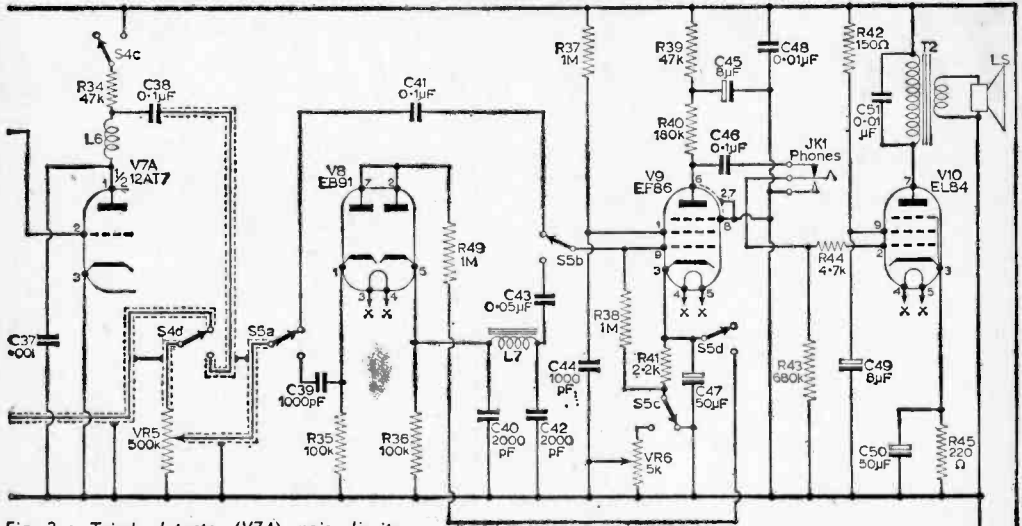
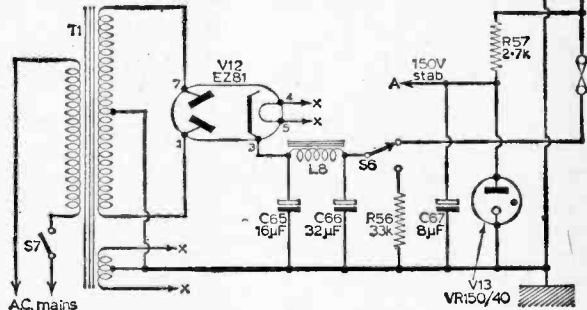

Fig. 2c: Triode detector (V7A), noise limiter (V8), a.f. amplifiers (V9, V10) and power supplies (V12, V13) stages.

The layout followed eliminates the need for valve screening cans in many cases, since the IFT cans perform this function. However cans are needed for V1, V2, V6, V7 and V11. Inter-stage screening on the underside of the chassis was not found to be necessary (see section of Setting-up and Alignment in future article). No separate earth bar is needed with the gauge of metal used for the chassis.

TO BE CONTINUED



MINIATURE TEST OSCILLATOR

— continued from page 39

are three in this table—the positions can be identified.

These frequencies, however, even if well distributed over the scale, will not be suitable as scale divisions. To enable the positions of the scale divisions to be ascertained and as a check on the frequencies that have been found, it is necessary to draw a graph.

The use of a logarithmic frequency scale enables the graph for all four scales to be accommodated on a single diagram (Fig. 9), and assuming "lumped" circuit constants, the four graphs would have the same shape if the stray capacitances, including the self-capacitances of the coils, were equalised on the four ranges.

On range 2 there will be fewer whistle positions unless short wave stations are used and these are more difficult to identify with an ordinary receiver. Although the oscillator is unmodulated, it is also possible to detect its presence at points on the receiver dial where there are no whistles by a certain amount of "noise-modulation" which its output contains. This will not necessarily be the fundamental, as modulation acts equally on fundamental and on higher harmonics.

On range 4, if a length of wire is connected to the output to strengthen harmonics, whistles, mostly very faint, can be produced on TV sound if an indoor aerial is connected to the TV receiver and the oscillator is brought close enough. The tuning of the oscillator will be exceedingly sharp and care will be necessary if all the whistle positions are to be located. It will then be necessary to identify at least one of these positions on the short wave band of a broadcast receiver, because otherwise one has the shape of the graph without knowing its correct position on the chart.

There are one or two points to bear in mind:

(a) At an oscillator frequency in the region of 450kc/s (assumed to be the intermediate frequency of the receiver), whistles will be produced indiscriminately on all the stations.

(b) On short wave stations, whistles will probably occur in parts adjacent to each other on the oscillator scale. The weaker one will represent second-channel breakthrough and can be ignored.

(c) The receiver should be tuned right on the station to make sure that the whistle is not due to some adjacent station.

(d) The whistles become quieter the higher the order of the harmonic involved, i.e. the lower the fundamental or first harmonic frequency of the oscillator.

The Twin-Unit Two

PART TWO

A PAIR OF EASILY MADE MATCHING UNITS WHICH COMPRISE A SIMPLE RECEIVER AND A POWER UNIT

by
A. Sydenham

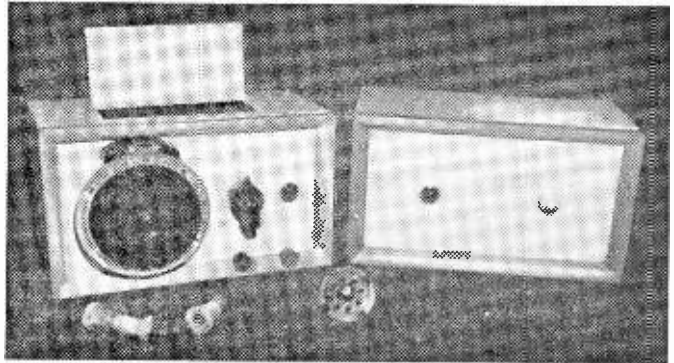

Continued from page 1122 of the April issue.

THE power unit (Unit "B") is very simple—see Fig. 7—a small mains isolating transformer of the type used for pre-amplifiers and the like providing the necessary safety and supplying 6.3V for the valve heaters and panel lamps in addition to a higher voltage which is rectified by V1. Rough d.c. appearing at the rectifier cathode is applied to a filter consisting of R2, C1A and B which smooths it sufficiently before passing it to a socket into which external apparatus of a simple nature such as Unit "A" may be plugged.

Maker's Range No.	Coverage	
	Metres	* Mc/s
2	195—560	0.515—1.545
3	57—180	1.6 —5.3
4	20— 60	5.0 —15

Table 1—Coil ranges.

bulb may be wired in at point "X" to protect the h.t. winding against overload.

Safety Measures

A warning lens is fitted to the front panel together with the on/off switch, while a fixed resistor, R1, provides a discharge path for C1A and B should the external apparatus be removed too soon at any time. If a more rugged unit is desired V1 may be replaced by a miniature contact cooled rectifier unit. Also as a safety measure a torch

The Panel and Chassis

The overall dimensions of the panel are identical with those used for the receiver unit (see Fig. 4) except that the drilling is different, only two holes being needed—viz., for the lens and the switch. The chassis is slightly larger, however (see Fig. 8), and the outlet socket SK1, which is a standard

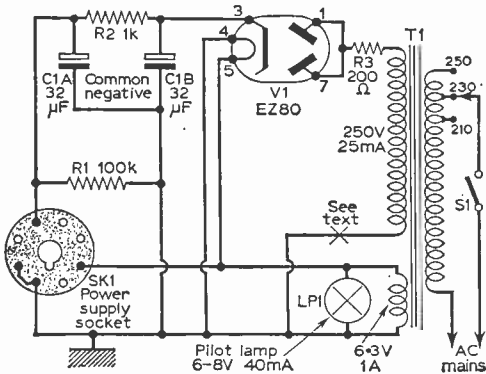
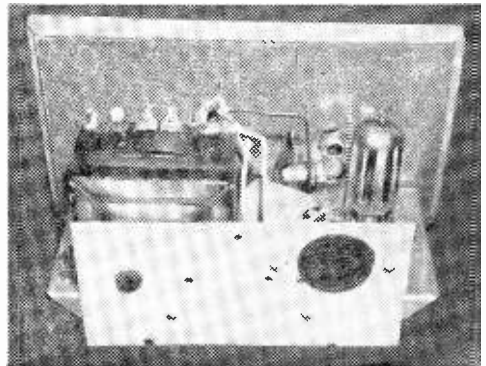

Fig. 7: The circuit of the power unit.



The power-pack complete.

international octal valveholder, is located on a small sub-panel affixed to the rear flange. Both above and below chassis plans are shown in Figs 9 and 10 respectively and it will be noted that leads are anchored to a tag strip, etc., since spare tags on the valve-holder must not be used for this purpose.

Fig. 8: The drilling details and dimensions of the power-pack chassis and rear panel.

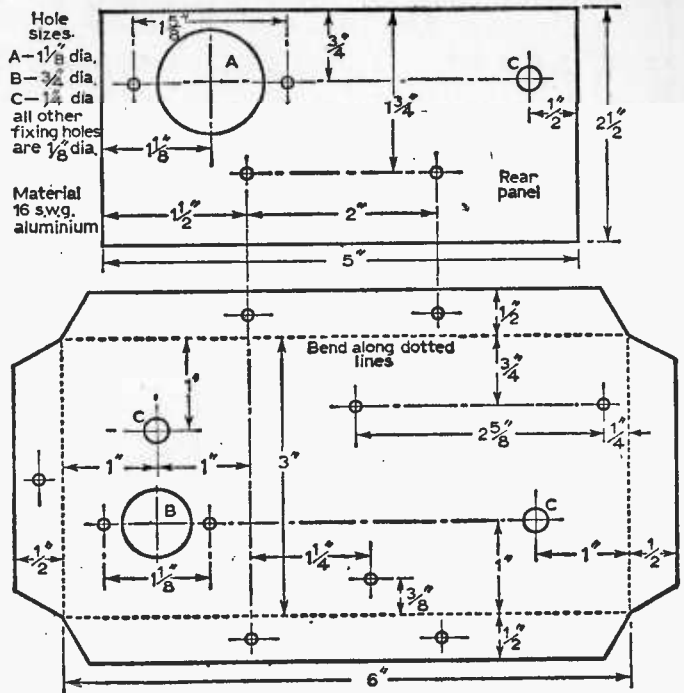

Various types of mains transformer exist suitable for use here, therefore some slight wiring variations are likely with respect to this item. Rigid wiring is essential and the whole must be thoroughly tested for faults prior to bringing it into use.

Testing

Provided no wiring or other faults exist the two units

RECEIVER COMPONENTS LIST

Resistors:

R1	22k Ω 1W	R5	1M Ω
R2	2.2k Ω 1W	R6	47k Ω
R3	47k Ω	R7	1k Ω
R4	1M Ω	R8	22k Ω

(All $\frac{1}{2}$ W, except where otherwise indicated)
VR1 50k Ω potentiometer, wire-wound 3W

Capacitors:

C1	2 μ F electrolytic 300V
C2	1,000pF ceramic or mica
C3	100pF ceramic or mica
C4	50pF ceramic or mica
C5	500pF ceramic or mica
C6	0.01 μ F ceramic or paper
C7	1,000pF ceramic or mica
C8	25 μ F electrolytic 6V
C9	0.01 μ F ceramic or paper
VCI	500pF variable
TCI	60pF trimmer

Miscellaneous:

L1	Miniature coils (Denco, yellow) Range 2: 0.5—1.5Mc/s (580—194 metres) 3: 1.6—5.3Mc/s (180—57 metres) 4: 5—15 Mc/s (60—20 metres)
L2	R.F. choke—see text
VI	ECC81
PL1	Octal plug—see text
LP1	Lamp 6—8V 0.04A

Phone sockets (Radiospares). Two noval (B9A) valveholders. Tag strip. Two spire clips. Lamp holder and lens. Chassis 5 x 2 x $\frac{1}{2}$ in.

POWER UNIT COMPONENTS LIST

Resistors:

R1	100k Ω $\frac{1}{2}$ W	R3	200 Ω $\frac{1}{2}$ W
R2	1k Ω 1W		

Capacitors:

C1A	32 μ F	} electrolytic 350V
C1B	32 μ F	
TI	Mains transformer. Tapped primary. Secondaries: 0—250V 25mA; 6.3V 1A.	
VI	EZ80	
SI	Toggle on/off switch	
LPI	Lamp 6—8V, 0.04A	

Miscellaneous:

Tag strip, 3-way. Stand-off insulator. Lamp holder and lens. One noval (B9A) and one 1.0 valveholder (SK1). Chassis 6 x 3 x $\frac{1}{2}$ in. Spire clip.

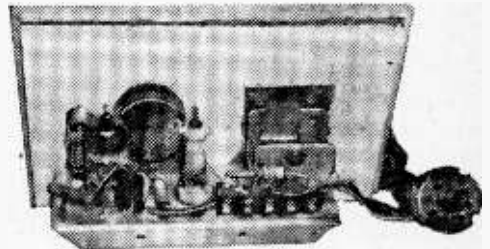

A rear view of the receiver unit.

PORTABLE OR CAR RADIO

"ROAMER" 7 (5 Wavebands) PERFORMANCE WILL AMAZE YOU!

★ (7 Transistor plus 2 Diode design)

★ Med/Long Waves, Trawler Band and 2 S.W. to approx. 17 metres.

★ Rich-toned heavy duty 5in. Speaker.

Total cost parts **£7.9.6** P.P. 5/6.

★ Fine for car radio use.

Less Case **£6.9.6**

★ Telescopic aerial for S. Waves.

★ FERRITE ROD AERIAL FOR M/L.

★ Push-Pull output for room filling volume

★ Full After Sales Service.

★ Two tone Cabinet with gilt trim

★ Air spaced ganged Tuning Condenser.

★ Case size 12 x 8½ x 3½in.

★ Parts price list and data 3/.



THE SUPER SEVEN

★ ★ (7 Transistors plus 2 Diodes)

★ 2 R.F. STAGES.

★ Coverage of Medium, Long Waves, Trawler Band.

★ Telescopic aerial for Trawler Band.

★ Use as domestic radio, car radio or fit with strap for carry-about.

★ No aerial required.

★ 3-inch speaker but will drive a larger speaker.

★ Push-Pull Output.

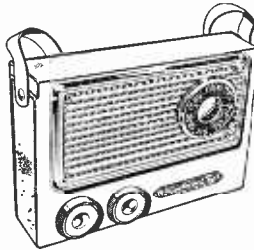

SIZE: 7½ x 5½ x 1½in.

May be built for **£6.5.0** plus 3/6 post, etc.

PARTS PRICE LIST AND EASY BUILD PLANS 2/.

NEW TRANSONA-6

★ (6 Transistors, plus 2 Diodes, 8-Stage)

★ MW/LW

Powerful magnet 3in. high grade speaker. Push-pull transformers. This is a top performing receiver. Many stations listed in one evening including Luxembourg loud and clear. A pleasure to listen to. **FERRITE ROD AERIAL.** All parts sold separately, grille in red. Uses 9 volt battery. Sockets for car aerial.



Total building cost **£3.19.6** P.P. 3/-. Size 6½ x 4½ x 1½in.

"Agreeably surprised with Trawler Band reception. Luxembourg as loud as local. Your easy build diagram helped a lot... my first attempt."—H. S., Penzance, Cornwall (poor reception area).
PARTS PRICE LIST AND EASY BUILD PLANS 1/6

All components used in our receivers may be purchased separately if desired.

AFTER SALES SERVICE

Radio Exchange Co.

27 HARPUR STREET, BEDFORD

Phone: 2367

10 a.m.—1 p.m. Sat. Opp. Co-op.

"POCKET-5"

(MW/LW and TRAWLER BAND) (7 Stages)
(5 Transistors, plus 2 Diodes)

Designed round supersensitive **FERRITE ROD AERIAL** and fine tone moving coil speaker. Attractive case in black with speaker grille in red. On test Home, Light Radio Luxembourg and many Continental stations were received.

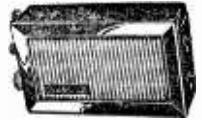

Total cost of all parts required **£2.19.6** P.P. 3/.

EASY BUILD PLANS AND PARTS PRICE LIST 1/6

PUSH-PULL FIVE

(5 Transistors, plus 2 Diodes 7 Stage)

★ 2½in. Super-tone Loudspeaker.

★ Ferrite rod aerial.

★ Tuning condenser.

★ Volume control.

★ Case with speaker grille in red.

★ Fully tunable over med/long waves.

★ Simple assembly diagrams.

★ 250 Milliwatts Push-pull output.



Can be built for **59/6** P.P. 3/.

★ PARTS PRICE LIST, etc. 2/.

"Home, Light, AFN, Lux., all at good volume."—G.P. Durham.

"ROAMER-6"

5 Wavebands (M/L, T.B. and 2 S.W.)

Uses 6 top grade transistors plus 2 diodes. 3in. Speaker. Ferrite rod aerial for sensitivity. Telescopic aerial for short waves. Handsome case with gilt fittings size 6½ x 4½ x 1½in. approx. Listen to stations half a world away.

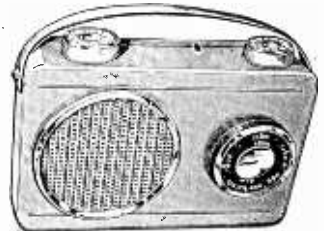

Total cost of parts **£6.9.6** Post & Packing 3/.

Plans, parts price list 3/.

HOME RADIO of MITCHAM

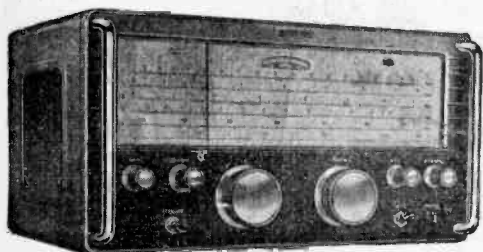

FOR ALL

EDDYSTONE

SHORT WAVE RECEIVERS & COMPONENTS

MODEL 840C

Eight-valve Superhet Communications Receiver in modern styling and presentation. Built to highest engineering standards to provide a receiver of excellent performance at a moderate price. Built-in speaker and jack for phones. 5 Wavebands covering 10 metres (30 Mc/s) to 550 metres (480 kc/s). A.C. or D.C. mains, 110 and 200/250 volts. Full specification on request.

PRICE £58.0.0, carriage paid U.K.

Export packing, full insurance and freight overseas £6 extra.

MODEL 870A

A very compact high performance All-Wave Receiver that is equally at home ashore or afloat. Five wavebands covering 12.5 to 2000 metres. Wide clear scale with vernier logging device. Built-in speaker and attractive two-tone cabinet. Five valve circuit with high efficiency coils. A.C. or D.C. mains, 110 and 200/250 volts.

PRICE £30.17.6, carriage paid U.K.

Export price £26, plus 30/- packing and carriage.

187 LONDON ROAD, MITCHAM, SURREY. Shop hours 9 to 6 (Weds., 1 p.m.)

Phone: MIT 3282.

LOOK AT OUR NEW PRICES! BUILD IT TODAY!

THE COROVER '6'

This superhet receiver uses the very latest circuitry, 6 transistors and two diodes and is fully tunable over both medium and long wavebands. First stage uses three Mullard AF.117 alloy diffused transistors with OA.79 and OA.91 diodes, output—OC.81D and two OC.81's in push-pull. I.F. frequency 470 Kc/s. Large internal ferrite rod aerial gives excellent reception over all ranges. 3 inch high flux speaker has a maximum output of 330mW Operates on four 1.5 v. pen torch batteries. All components are mounted on a single printed circuit board. Attractive plastic case with carrying handle—fitted sockets for personal earpieces, tape recorder and car aerial. Size 6½ x 4 x 1½ in.

MAY BE BUILT FOR **£5.7.6** All Parts sold separately. P. & P. 4/- extra. (Data and instructions 2/6, free if all parts bought.)

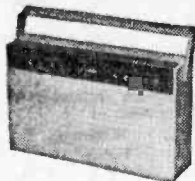

The SPRITE

A unique Wirecomp offer. The Sprite is a six transistor superhet Miniature Pocket Radio of Commercial Quality—offered to you in three main pre-assembled units—which together with simple wiring—enable you to build it in only one hour!

Fully tunable over Long and Medium wavebands. Uses printed circuit and High sensitivity internal ferrite rod aerial. I.F. frequency 470 Kc/s. Transistors: 3-Philco 2067's, 2-Mullard OC81M, OC81DM and OA90 diode. 3 inch speaker. Works on single PP3 battery. Supplied with the complete R.F. and I.F. stages, Driver and Output stages, ready built and mounted on the printed circuit; for final assembly you only have to fit the wave-change switch, tuning condenser and drive, volume control, earphone socket and aerial rod. In very attractive plastic case, size 4 x 2½ x 1½ in. All parts sold separately.

THE 'REALISTIC 7'

A fully transistorised Portable Receiver made to the highest professional standards—is now available to the home constructor. Comprises 7 Mullard Trans. OC44, 2OC45's, OC71, OC81D, and 2OC81's plus OA70 Crystal Diode. Delivers 350 milliwatt output to 4in. high flux speaker—I.F. frequency 470 Kc/s.—fully tunable over medium and long wavebands. All components mounted on single printed circuit board, size 5½ x 5½ in. Attractive two-tone plastic cabinet with carrying handle—size 7 x 10 x 3½ in. with easy to read dial and socket for car aerial, choice of Red/Grey, Blue/Grey or all Grey. Complete with full instructions. All parts sold separately.

WIRECOMP'S PRICE-ONLY **£5. 19. 6** Battery 3/6 extra.

P. & P. 4/6 extra. (Circuit diagram 2/6, free if all parts bought).

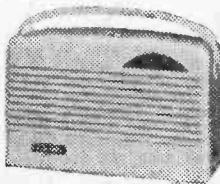

WIRECOMP'S BARGAIN PRICE

79/6

Real Calf Leather Case, wrist strap and Personal Earphone with case and Battery. 12/6 extra.

P. & P. 3/6 extra. (Data and instructions 2/6, free if all parts bought.)

WIRECOMP ELECTRONICS

378 HARROW ROAD, LONDON, W9.

TEL: CUNNINGHAM 9530

Hours of business: 9 a.m. to 6 p.m. Open all day Saturday, Opposite Paddington General Hospital Buses 18B and 36 pass the door.

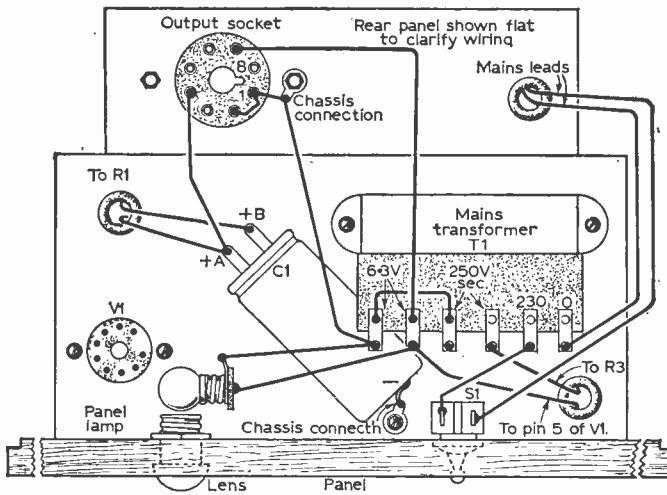
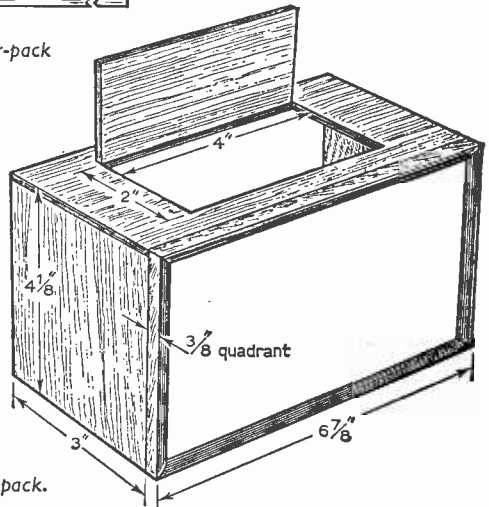

Fig. 9: The above-chassis layout of the power-pack

may be interconnected, phones plugged in, an aerial connected (a "Windom" type being suitable), etc. A coil from the range shown in Table 1 is then inserted in the socket provided.

Care should be taken to ensure that the locating lug on the coil base coincides with the spare or

Fig. 11 (right): Details of a suitable cabinet for both the powerpack and receiver units. The hinged lid is only used with the receiver section.



blank pin position on the valveholder (see Fig. 1). The mains plug may then be inserted in its socket, VC1 rotated to minimum and S1 closed, when the two warning lenses should become illuminated.

Fig. 10: The underchassis wiring of the power-pack.

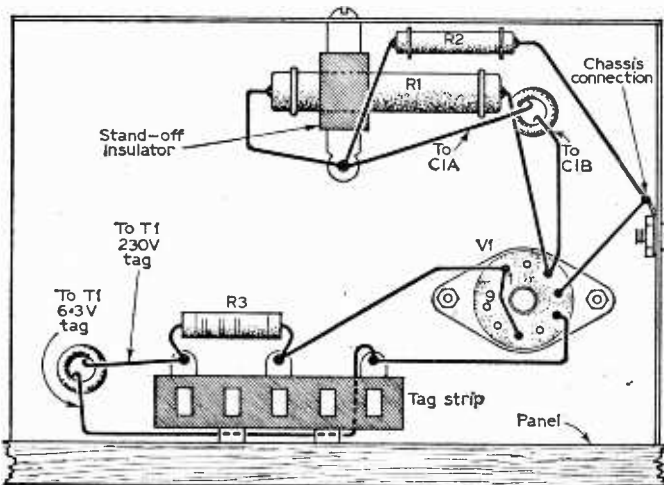

Simple Cabinets for the Units

Suitable cabinets may be constructed from plywood or even hardboard and the external dimensions are shown in Fig. 11. Both cabinets are identical in size but a hinged lid is fitted to Unit "A" to permit coil changing, thus providing safety and obviating the need for fiddling about at the back. It might be found more convenient to use a larger aperture here or even to arrange for the whole top to lift up; furthermore, if difficulty is experienced in exchanging coils it is possible to extend either the coil brass stem or fit an extension to the former via the polystyrene locking nut.

The cabinets are easily held together with pins and glue and may be finished to individual taste.

by G.M. and E.C.D.

semiconductors

TALKING POINTS ON CIRCUIT PRACTICE

No. 4—More on Audio Amplifiers

Continued from page 1100 of the April issue

EXAMPLES given in the previous article in this series have emphasised the fact that it is vitally important to make sure that one's input is phased the correct way with regard to the basic working point of the collector load line.

But this does in effect bring us to a point where the mental approach to transistor work becomes important.

A very cursory examination of the facts we have stated above will cause the reader to reach the conclusion that in actual practice the r.m.s. voltage swing across the collector load—which normally in valve practice we try to make as large as possible—is going to be very much more than we can possibly pass on to the following stage in the form of base drive.

Consider a stage in which the collector is going to swing, across its load, to the value of some 3 or 4V r.m.s. with signal. Now consider this voltage swing transferred to the base of a following transistor with a gain of 50, the base being biased with a standing current of some 150 μ A. Suppose the internal base/emitter resistance of the transistor to be of the order of 50 Ω . This resistance will have in parallel with it values of R1 and R2—which we may ignore because, whatever values they are, in parallel with 50 Ω the ultimate resistance in the circuit will be approximately 50 Ω . There might be resistance in series, which would alter the case, but suppose there is not—the effective resistance, therefore, is approximately 50.

How many amperes will a voltage of, say, 3V put through the base of a transistor whose internal base resistance is 50 Ω ? The answer to that is 3/50A, which is far more than the base can possibly take. Assume the base drive to be only 1V r.m.s. One volt through 50 Ω is 1/50A, equals 20mA. With a gain of 50 this is 50 \times 20mA in the collector=1,000mA=1A.

Let us not press these figures too far, remembering that a transistor is not resistive—that is, does not project a constant resistance under all conditions; nevertheless we are now able to understand why it is found convenient to regard the transistor as a current amplifier rather than as a voltage amplifier.

REDUCING THE VOLTAGE

The fact is that with a loading in the collector of any sizeable value, such as we should need for thermal stabilisation anyhow, we are going to get far more voltage developed across it on signal than we can use. In consequence we have to reduce this voltage before we can pass it on as drive to the next stage, which can hardly be called amplification.

There are various ways of doing this. One is to introduce an interstage coupling transformer with a stepdown ratio, the normal method. Another is to consider the insertion of the coupling capacitor in RC circuits as a source of loss—but this is not satisfactory as a capacitor is reactive to frequency and we want power loss evenly over all frequencies. An excellent method is that shown in Fig. 1 where a load is used sufficiently large to ensure the correct d.c. conditions, but the greater part of it is earthed to a.c. by a decoupling capacitor, leaving only a few ohms across which a.c. potentials will develop.

It is now obvious that with an internal base resistance of a transistor of the order only of ohms, as against many thousand ohms with valves, the drive volts we are going to be able to put on it without driving totally prohibitive values of current through it are going to be severely limited, to a value very much smaller than we will normally get from the collector of the preceding stage; therefore in terms of volts we are certainly not amplifying.

But there is direct current amplification within the transistor itself. Small values of input current resulting in large values of output current. It is therefore current we are amplifying. We need volts to do it but they are microscopic—it is the steadily increasing current swing in each succeeding output that we are using, NOT the voltage swing.

The expert deals with this situation as follows. He reasons like this:

We require a current of, say, 50mA standing in the output circuit so that we can drive a loud-speaker or what-have-you with a current swinging through 100mA (assuming a transistor that will take 100mA), that is to a value of 50 below the Iq

*These are the sort of people
who are learning from . . .*



THE COMMON  CORE SERIES
OF ILLUSTRATED TRAINING MANUALS

BASIC ELECTRICITY

(5 PARTS)

Over 630 pages - Over 600 Illustrations

BASIC ELECTRONICS

(6 PARTS)

Over 670 pages - Over 700 Illustrations

*. . . and these are the sort of things
they have said*

"... I have all the previous sets, namely: 'Basic Electricity', 'Basic Electronics' and 'Basic Synchros & Servomechanisms' and will mention that it's truly one of the best I've studied ..."

"... I have found 'Basic Electricity' and 'Basic Electronics' excellent publications ..."

"... Wish to congratulate you for publishing one of the best-ever series dealing with this complex subject ..."

*"The Picture-Caption" method presents a new way
of LEARNING BY LOOKING whose one aim is
TO MAKE YOU SEE _____ UNDERSTAND*

_____ REMEMBER _____

COUPON - SEND NOW!

OR ASK YOUR BOOKSELLER

To THE TECHNICAL PRESS LTD.
112 Westbourne Grove, London, W.2.
Please send me your FREE prospectus describing
the COMMON-CORE SERIES.

NAME _____

ADDRESS _____



NEW *Thoresby* RANGE OF SPEAKER AND EQUIPMENT CABINETS

THORESBY BASS REFLEX CONSOLE CABINET *(illustrated)*
Height 31" x Width 19½" x Depth 18". Price in Mahogany—£12.12.0
Walnut 7/6 extra.

THORESBY HI-FI EQUIPMENT CONSOLE *(illustrated)*
Height 31" x Width 19½" x Depth 18". Price in Mahogany—£14.14.0
Walnut 10/- extra.

THORESBY BASS REFLEX CORNER CONSOLE
Height 31" x Width 19½" x Depth 17". Price in Mahogany—£11.0.0
Walnut 5/- extra.

Some of the wide range of Stentorian speakers

See and Hear the full range of Stentorian products at the
AUDIO FAIR
Stand 42
Demonstration Room 415

Type	Flux Density	Price
8" H.F.816	16,000 gauss	£6.0.0
8" H.F.812	12,000 gauss	£3.12.9
8" H.F.810	10,000 gauss	£2.14.3
6" H.F.610	10,000 gauss	£2.5.0 Steel £2.6.9 diecast

WHITELEY ELECTRICAL CO. LTD.

MANSFIELD . NOTTS

Telephone: Mansfield 1762/5
London Office: 109 Kingsway, London, W.C.2.



The new NOMBREX

TRANSISTORISED WIDE-RANGE
SIGNAL GENERATOR 27
220 kc/s to 220 Mc/s



CHECK THESE FEATURES

COMPACT
Only 6½" x 4½"

PORTABLE
Weight 2 lbs.

ACCURACY
Under 2%

ECONOMY
9v. Battery

DIRECT
Calibration

S.A.E. for full technical leaflet.

12 Months Guarantee.

RETAIL £7.10.0 Post and Ins. 3/6
Battery 2/3

36" Screened Test Lead 6/3 extra

CASH WITH ORDER, REGRET NO C.O.D.

EARLY DELIVERY

Trade and Export Enquiries Invited

NOMBREX LTD. (Instruments Division 52)

Estuary House, Camperdown Terrace, Exmouth, Devon,
England. Tel. 3515

P.W. MERCURY SIX

14½ x 6 x 3½
48/-



Ready for 7" x 4" speaker

5½ x 3½ x 2
12/6

P.W. POCKET S'HET

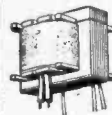

After Sales Fault-finding Service

3 IFS & Osc. 22/- set
Driver & Output 16/3 pair

For above & similar transistor circuits on printed board.

OSMOR

418 BRIGHTON ROAD
S. CROYDON, SURREY
CRO 5148

and to a value of 50 above the I_q , respectively 0mA on the one hand and 100mA on the other. What value of drive current do we require in the base to obtain a standing collector current of 50mA?

If the gain of the transistor is 50, then we need $50/50\text{mA} = 1\text{mA}$ through the base.

But this is not quite accurate—we must correct for leakage current which flows even with no base bias at all. If I_{co} is given as $150\mu\text{A}$, therefore, the collector current we must induce is 50mA less $150\mu\text{A}$ and correspondingly the base current we shall require is the base current which will induce 50mA less the base current necessary to produce $150\mu\text{A}$ of it, which already exists as a leakage.

Unless we are designing for precision apparatus, or the values of I_{co} are high, we can safely neglect this correction for practical purposes. We need 1mA therefore through the base.

Now willy-nilly we must return to our volts, microscopic though they are, since we cannot get current without potential even if we can have potential without current. How many volts then do we need on the base to drive 1mA through it? Or, rather, how many microvolts?

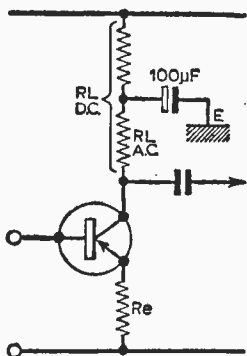

Fig. 1: A method of reducing the voltage developed across the collector on signal by using a large by-pass capacitor across the greater part of the load.

But before we proceed to examine this question we must pause to realise that our volts must come from a source which is capable of supplying 1mA. To explain what is meant, using the potential divider method we could place a potential on the base of the right value, but if we made R_1 and R_2 of the order of megohms, right potential or wrong potential, we would not get 1mA through the transistor, for the potential divider would just not produce it. As soon as the current tried to flow so many volts would drop across the divider that the base potential would drop to zero.

The divider therefore must be capable of supplying 1mA and this condition is achieved if we make it bleed ten times the base current required (we usually have to settle for much less). With the divider passing 10mA, 1mA could be supplied to the base and varied considerably without the actual potential at the junction of the divider varying very much, since this would be controlled mainly by the current flowing through the divider as a whole rather than the much smaller amount taken by the base itself.

We still want to know how many microvolts to place on the base, however, to put 1mA through it.

CALCULATING THE BASE POTENTIAL

This potential will obviously be a product of the resistance in the base circuit. First we have the internal resistance of the transistor itself, say 50Ω . Calculate therefore the volts required to put 1mA through 50Ω . Next we have the resistance in the emitter (R_e) if one is used. Calculate the volts required to put 1mA through R_e and add that to the first calculation. Finally, since there must be a circuit, the current must return to the base via R_2 (and R_1 in parallel since we have seen already that as seen by the base they are in parallel). How many volts do we need to put our 1mA through R_1 and R_2 in parallel, being the resistance in the base . . . (and any series resistance, if any)? The sum of these calculations should give us the total potential required to be applied to the base in order to get a current of 1mA flowing through it, and in the collector a current of 50mA. In the emitter there will be 51mA of course since the emitter carries the base current as well.

The answer may well be in the order of some $150\text{--}200\mu\text{V}$. Which is, as has been said, very much less than the voltage swing likely to be existing on the collector of the preceding stage.

The mathematical formula for calculating V_{bb} (volts on base) is given in Table 1.

Similarly we may calculate what value of base drive in volts will overdrive the transistor, and thus ascertain what r.m.s. potentials (peak) we require from the preceding stage having regard to the expected insertion losses of the capacitor coupling or transformer coupling or whatever is used. There will be no point in having a higher value of standing collector current in the preceding stage (or, indeed, in any) than may be necessary to supply the voltage swing required in conjunction with whatever load we may have.

Table 1: MATHEMATICAL FORMULAE

Volts on Base (V_{bb})

$$V_{bb} = I_b R_b + V_{be} + I_e R_e;$$

where I_b = base current

R_b = external base resistance

V_{be} = base/emitter volts required

I_e = emitter current

R_e = emitter resistance.

For a current swing in the collector I_s around I_q , the base swing needed will be I_s/α ; and the base voltage: $I_s R_b + V_{be}$.

MATCHING CALCULATIONS

Class "A" Output

$$R_l = V_{cc}/I_q \text{ where}$$

R_l is the load required in the collector.

V_{cc} is the supply volts.

I_q is the standing quiescent collector current.

Transformer ratio is

reflected load

$$\frac{\text{total } R \text{ of secondary and speaker}}{\text{where reflected load is } R_l \text{ minus primary resistance of transformer.}}$$

Class "B"

$$R_c = R_p + m^2 R_s$$

where R_c is load impedance per transistor

R_p = resistance of primary.

R_s = resistance of secondary and speaker

turns ratio = $m + m : 1$

In consequence, one sees the stages of a transistor amplifier as a succession of stages in which the output *current* progressively is larger, as stage by stage the current swing produced by the signal input becomes larger needing more standing current to accommodate it. The voltages are negligible owing to the extremely small value of the input resistance of transistors. Perhaps this will answer the question why we do regard the transistor as a current amplifier rather than a voltage amplifier though, in fact, with an associated load it can of course amplify voltages as well . . . but they need to be very small voltages indeed in normal configurations. You can get large voltage swings *out* of a transistor, but without special circuitry you cannot apply them *to* one. You can apply up to 20mA of current to them, however, which at a gain of 50 gives $20 \times 50 \text{mA out} = 1\text{A}$. Some transistors will do even better than this. Quite apart from the question of linearity then it should now be obvious why it is conventional practice to use the transistor as a current amplifier rather than as a voltage device.

It is no part of our design here to go into various audio amplifier circuits. Let us say that Class A gives higher fidelity than Class B but lower efficiency, some 50% only. The transistors are biased to the mid-point of the load line so as to take both incremental and decremental current swing, therefore each amplifies the whole input wave, the result being additive and in phase in the output circuit. This necessitates a standing collector current of some 50 to 500mA, according to output required, and the battery drain is therefore heavy. This need not matter if the supply is drawn from the mains, but you cannot supply transistors from the mains without special circuitry, which is not inexpensive.

TRANSISTOR TRANSFORMERS

A word now about transformers and matching. Transistor transformers are different from valve transformers . . . for the transistor we need a step-down ratio as has been shown, for one thing. For another, we are transforming current, there is no voltage swing. But the important factor is again paucity of supply. Suppose an output transformer with a primary resistance of $3,000\Omega$ at a current of 50mA and a supply of -9V . At 50 mA $3,000\Omega$ will drop 150V . . . and we had only nine to start with. Hence it is self-evident the first requirement in a transistor transformer is a low d.c. primary resistance . . . it should be somewhere around 1Ω ; which implies a secondary d.c. resistance of something like one tenth of an ohm.

The driver transformer can be less rigorous as the currents involved will be smaller . . . here a resistance of some $30.0\text{-}30\Omega$ is not uncommon, with a secondary resistance of 1.5Ω . There are transformers on the market with these values, but up to now no output transformers suitable for transistor work have been made commercially. Circuits are published which do away with the need for an output transformer, perhaps because of this. The Majestic Winding Co. of Bournemouth wound an O.P. transformer to specification for the writer and would doubtless do the same for anyone else who desired one.

The usual considerations of matching, leakage

inductance, saturation and so on apply. Matching formulae are given in Table 1.

HEAT-SINKS

Finally a word about thermal conditions. In ultimate stages of audio amplifiers the currents can be considerable, and the heating effects therefore also considerable. To ensure the transistor does not exceed its rated thermal limits it may be bolted to a heat-sink which is a square of metal with good heat dissipating qualities. The sink acts as a radiator of heat, and the whole, transistor and sink, are mounted in free air so that maximum circulation of air takes place around it. If the metal body of the transistor is an electrode, as in the case of the OC22 for instance, measures must be taken to insulate the transistor (or the sink) electrically . . . but not thermally. This is achieved by using a thin mica washer between transistor and sink. The sink must be smoothed and polished first, all burrs removed from where the holes for fixing have been drilled, as the slightest roughness, even if imperceptible to the eye, is usually sufficient to penetrate the thin mica washer and produce a short-circuit between the base of the transistor and the sink.

If reasonable precision is required, calculations will be made on the basis of mean or average values for alpha, remembering that this can vary considerably from transistor to transistor. It will be necessary to consider what will happen also if alpha happens to be much less than the mean value taken . . . or, much more. And it will be necessary to decide whether alpha should be taken . . . or alpha bar.

It is impossible in an article of this scope to go into all the possibilities on a non-mathematical basis. The implications of leakage current, transistor, spreads, thermal instability and so on have been discussed before; as also has leakage current. None of these can be calculated without mathematics. In most cases they will not need calculating so long as sufficient margin is left for safety. On the basis of what has been said the reader should be reasonably equipped to understand more complicated text books on the subject if he feels he would like to go more deeply into it.

As we said at the commencement, there are no great problems involved in using transistors as audio amplifiers—if the right approach is made. Remember it is increasing *current* swings we want—and these will be obtained with very small voltage amplification.

SERIES CONTINUED NEXT MONTH

JOIN THE PRACTICAL GROUP

PRACTICAL TELEVISION	2/-
Every Month	
PRACTICAL MECHANICS & SCIENCE	2/-
Every Month	
Devoted to Mechanics, Science and Invention	
PRACTICAL MOTORIST	1/9
Every Month	
PRACTICAL HOUSEHOLDER	1/6
Every Month	

MULLARD 3-3 HI-FI AMPLIFIER

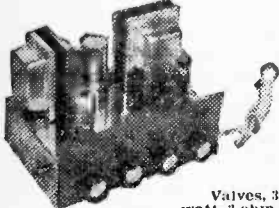

Valves, 3 watt, 3 ohm, and 15 ohm. Output.

A really first-class Amplifier giving Hi-Fi quality at a reasonable cost. Mullard's latest circuit. Valve line up: EF86, EL84, EZ81. Extra HT and LT after Tuner Unit addition. This is the ideal companion Amplifier for FM tuner units.

TECHNICAL SPECIFICATION—Freq. Response: +1dB, 40G/s-25 Kc/s. Tone controls: Max. Treble Cut 12 dB. at 10 Kc/s. Max. Bass Boost 14 dB. at 80 c/s. Sensitivity: 100 mV. for 3 w. output. Output Power (at 400 c/s): 3 w. at 1% total harmonic distortion. Hum and Noise Level: At least 70 dB. below 3 w.

COMPLETE KIT (inc. Valves, all components, wiring diagram and special quality sectional Output Trans.). **ONLY £219.6.** Carr. 5/- Complete wired and tested, 8 gns. **Bronze Escutcheon Panel, Printed Vol., Treble, Bass, On-Off, supplied with each Kit.**

Wired O/P socket power and additional smoothing for Tuner Unit, 10/6 extra. Recommended Speakers—WB HF1012 95/-, Goodmans AXIOM 110 £5, etc.



BARGAIN 4-SPEED PLAYER UNITS

Single Players Carr. 3/6.
Garrard SRP10 £25.50
Collaro "Junior" 65/-
B.S.R. Latest TU12 67/8
E.M.I. Junior 965 72/6
Auto-Changers Carr. 5/6
Collaro "C60" £26.19.6
B.S.R. (UA14) £26.10.0
Garrard "Auto-slim" £26.15.0
£15.10.0 Carr. 7/6.
Garrard 4HF

Volume Controls—5K-2 Meg-ohms. 3in. Spindles Morganite Midget Type 1in. diam. Guar. 1 year. LOG or L1N ratios less Sw. 3/-, DP Sw. 4/6. Twin Stereo less Sw. 6/6. DP. Sw. 8/-.

COLLARO STUDIO TAPE RECORDER KIT

SPECIAL BARGAIN OFFER. Comp. Kit only Carr. 12/8. £25.0.0

Famous mfrs. surplus offer—Listed 42 wns. A quality Tape Recorder Kit based on Mullard famous design—EF86, ECC83, EL84, EM84 and Rectifier. Specially designed Kit for Collaro latest Studio Deck. Freq. response ±3 dB. 60c/s—10Kc/s—. Amp. and Power Pack already wired, inter unit wiring only required. Cabinets size: 18 x 18 1/2 x 6in. finished in contemporary 2-tone and Tech. Speaker Escutcheon, Magic Eye Indicator 6 and Tech. H/Book, supplied free with kit. Send 2/6 now for full details of to-day's outstanding Tape Recorder Bargain.

Cabinet £23.15.0. P. & P. 6/6.
Amplifier Kit £28.19.6. P. & P. 5/-
Speaker 7 x 4 1/8". P. & P. 2/-.
If above items are purchased together.

£12.19.6 P. & P. 10/-

RECORD PLAYER CABINETS

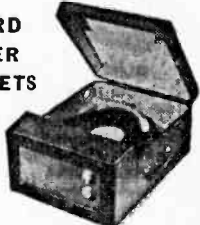

Cabinet Price £3.3.0 Carr. & Ins. 5/-

Contemporary style, rexine covered cabinet in two tone maroon and cream. Size 18 1/2 x 13 1/2 x ht. 8in., fitted with all accessories including baffle board and anodised metal fret. Space available for all modern amplifiers and autochangers, etc. Uncut record player mounting board 14 x 13in. supplied. **2-VALVE 2-WATT AMPLIFIER** Twin stage ECL82 with vol. and neg. feedback Tone control. A.C. 200/250 v. with knobs, etc., ready wired to fit above cabinet. £2.17.6. P. & P. 1/6.
6in. Spkr. & Trans. 22/-, P. & P. 2/- Complete Kit including either B.S.R. UA14 Unit or Garrard "Auto-slim" as ill., £12.10.0, carr. 7/6.

JACK PLUGS. Standard 2/1 Irganic Type. 2/6. Screened Ditto, 3/3. Miniature 1/1, 2/3. Screened Ditto, 2/6.

ENAMELLED COPPER WIRE—1lb. reels, 14g-20g, 2/6; 22g-28g, 3/-; 30g-40g, 3/9. Other gauges quoted for.

Ersin Multicore Solder 60/40 3d. per yard. 1lb. 2/6, etc.

Condensers—Silver Mica. All values 2Pf to 1,000Pf. 6d. each. Ditto. Ceramics 8d. Tub. 450V T.C.C., etc. 0.001 mfd. to 0.01 and 0.1/350V. 9d. 0.02. 0.1/500V. 1/-, 0.25 Hints. 1/6. 0.5 T.C.C. 1/9, etc. Close Pol. 5Micas—10% 5Pf-500Pf, 8d. 500-1000Pf 1/-, 1% 2Pf-100Pf. 9d. 100Pf-500Pf. 11d. 575Pf-5,000Pf. 1/6. **Resistors**—Full Range 10 ohms to 10 meg-ohms 20% 1 and 1/2 W 3d., 1 W 5d. (Midget type modern rating) 1W 6d., 2W 9d., 1/2-Watt 10% 1W 5d., 1W 7d., 5% 1W 9d., 1% 1W 1/6.

JASON FM TUNER UNITS
Designer-approved kits of parts:
FM71, 5 gns. 4 valves, 20/-, EMT2, 5 valves, 37/6.
JTV1 MERCURY 10 gns.
JTV2 £13.19.6 4 valves 32/6.
New JASON FM HANDBOOK, 2/6. 48 hr. Alignment Service 7/6. P. & P. 2/6.

TYGAN FRET (contemp. pat.) 12 x 12in. 2/-, 12 x 18in. 3/-, 12 x 24in. 4/-, 18 x 24in. 6/- etc.

Speaker Fret—Expanded bronze anodised metal 1in. x 1in. diam. diamond mesh, 20g sq. ft. Multiples of 6in. out max width 4 ft.

Electrolytics	All Tubular	Types New Stock	Can Types
25/25V	1/9	8+6/450V	4/6
50/50V	1/8	16+16/400V	5/6
100/25V	2/-	32+32/275V	4/6
8/450V	2/3	50+50/350V	6/6
16/450V	3/8	60+25/0	12/6
16+16/45V	5/6	100+200/0	
32+32/450V	6/6	275V	12/6

Transistor Components

Midget I.F.'s—485 Kc/s. 9/16in. dia. 5/8 Osc. Coil—M/W. 9/16in. dia. 5/3 Osc. Coil—M. & L.W. 5/9 Midget Driver Trans. 3.5:1 6/9 Midget O/Put Trans. P.P. to 3 ohms. 6/8 Ferrite Aerial M. & L. W. Car aerial coil. 9/3.

Elect. Condenser—Midget Type 1mf-50mf. ea. 1/8. 100mf. 2/- 12V max. Condensers—0.1mf. to .04mf. 9d. .05mf. to .1mf. 1/- .25mf. 1/3. 5mf. 1/6.

Tuning Condensers—JB "OO" 200Pf. + 175 Pf 9/6, with Turners 9/6. Single 385Pf 7/6. Sub min. fin. J.B. Dille min. .0001. .0003 or .0005 7/- each.

Midget Vol. Control—with edge control knob. 5K ohms with switch, 4/8. Less switch 3/8. **Speakers P.M.**—2in. Plessey 75 ohms 15/8. 2in. Continental 8 ohms 13/8. 2in. E.M.I. 3 ohms 17/6. 7 x 4in. Plessey 35 ohms 23/6.

Ear Plug Phones—Min. Continental type, 3ft. lead. Jack plug and socket. High Imp. 8/- Low Imp. 7/6.

SPECIAL BARGAIN OFFER

A self-contained Portable Unit incorporating latest BSR 4-speed Auto Changer Record Player and famous High Fidelity "Ful-Fi" Xtal Pick up with Turnover Cartridge, fitted with LP and 78 Sapphire Styl. Internal 2-Valve Amplifier of modern design with variable Tone and Volume Controls. This, together with a quality P. Speaker, ensures a high standard of reproduction. The whole is housed in a robust wooden Cabinet attractively styled in 2-Tone contemporary leather cloth with contrasting polka dot relief.



Kit consists of 3 sub assemblies already wired. Grub screw connections between Units only necessary—absolutely no soldering. Originally built to be sold at 17 gns. Recommended Buy!

Standard Model Price **£11.10.6** Carr. & Ins. 7/6
Autochanger Unit—BSR Model UAX0 Amplifier—valves UCL82, UY85 and 7 x 4in. Elliptical Speaker. Cabinet size 17 x 14 x 8in.

RECORDING TAPE—Reduced Prices

Famous American Columbia (CBS) Premier Quality Tape at **NEW REDUCED PRICES**. A genuine recommended Quality Tape—TRY IT! Brand new, boxed and fully guaranteed. Fitted with leader and stop (ols).

	Standard	Long Play	Double Play
5in.	800ft. 13/-	900ft. 17/8	1,200ft. 31/6
5in.	900ft. 18/-	1,200ft. 19/6	1,800ft. 37/6
7in.	1,200ft. 21/-	1,800ft. 29/8	2,400ft. 47/6

P. & P. per reel 1/- 6d. on each additional reel.
SPECIAL BARGAIN. 3in. Message Tape, 150ft. 3/9. P. & P. 6d.
3in. L.P. 235ft. 4/9. 3in. D.P. 300ft. 6/6.
Plastic Tape Reels
Plastic Spool Containers

COAX 80 OHM CABLE
High grade low loss Cellular air spaced Polythene—1in. diameter. Stranded cond. Famous mfrs. Now only 6d. per yard. Bargain Prices—Special Lengths—
20 yd. 9/-, P. & P. 1/6.
40 yd. 17/6, P. & P. 2/-.
60 yd. 25/-, P. & P. 3/-.
Coax Plugs 1/-. Sockets 1/-. Couplers 1/3. Outlet Boxes 4/6



VALVES

New Boxed	All Guaranteed	Transistor Bargains
11Y 6/-	ECC83 8/-	OC44 8/6
1R3 7/8	ECL82 10/8	OC45 9/-
1A5 7/6	ECL80 10/8	OC18 7/8
384 7/8	EF80 8/-	OC18 15/8
3V4 7/6	EF84 12/8	XA101 10/6
DAF96 9/-	EL84 8/6	XA101 9/6
DF96 9/-	EM81 8/6	EL848 10/8
DK96 9/-	EY81 9/8	XC101 8/6
DL86 9/-	EY86 10/-	PY81 9/8
OC81 8/6	EZ81 7/8	PY82 7/8
OC82 8/6	GZ32 12/6	U25 12/6

Send for detailed bargain lists. 3d. stamp. We manufacture all types Radio Main. Transf. Chokes, Quality O/P Trans., etc. Enquiries invited for Specials. Prototypes with small production runs. Quotations by return.

RADIO COMPONENT SPECIALISTS

70 Brigstock Rd., Thornton Heath, Surrey. Hours: 9 a.m.-6 p.m. 1 p.m. Wed. THO 2188. Terms C.W.O. or C.O.D. Post and Packing up to 4lb. 9d., 1lb. 1/3, 3lb., 2/9; 5lb., 2/9; 8lb., 3/6.

TELESCOPIC AERIALS

Beautifully made, ideal for portable radios. Chrome plated. 6½" closed extending to 30" in 5 sections.

Bargain at **7/-**
P. & P. 9d.

4½" closed extending to 26" in 6 sections. Slides right into radio case with only ¾" showing.
P. & P. 9d. **14/6**

The NORPAK MAINS POWER PACK KIT FOR TRANSISTOR RADIOS

Operates your radio direct from mains. Miniature Size—4 x 2 x 1½ in. In attractive two-tone plastic case. Assembled in an hour. Normal output 9 v. 100 mA. (Adjustable) Full Mains Transformer. Full wave silicon diodes. Cartridge fuse.

Complete Kit with Plans **35/-** Plus 1/6 P.P.
(Ready assembled 45/-).

A WIDE RANGE OF ELECTRONIC COMPONENTS ALWAYS IN STOCK.

P.W. MERCURY-6 MK. II M. & LW. 6 TRANSISTOR SUPERHET. 500 mW OUTPUT.

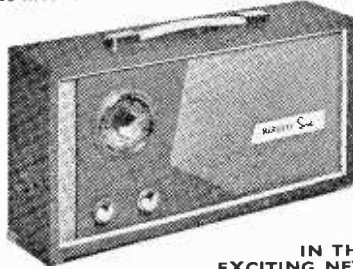

IN THE EXCITING NEW ELEGANTLY DESIGNED CABINET.

This model gives a superb performance on its 7 x 4 in. speaker and really "pulls-in," Luxemburg.

- Printed Circuit.
 - High Q Internal Ferrite Aerial.
 - Built in Mains Operation (30/- extra)
- All parts required **£10.76** P.P. 3/6.

PW6 POCKET SUPERHET

MEDIUM AND LONG WAVE RADIO

Every month this fine Radio continues to be proclaimed by our customers as a winner. It packs the stations in at terrific volume everywhere.

Parts available separately.

- 450 mW Push-Pull Output on 2½ inch P.M. Speaker.

- Printed Circuit.

- Guaranteed First-Grade Miniature Components.

- High Q Internal Ferrite Rod Aerial.

All parts Required **£7.19.6** Plus 2/6 P.P.

Building plans 1/9 (Free with Kit).



PAY AS YOU BUILD SCHEME

AT NO EXTRA COST the above kits may be bought in 3 complete stages of 53/2 (P W 6) or 69/2 (Mercury 6) each plus 1/6 P.P. (state A, B or C when ordering).

ALIGNMENT SERVICE

We offer a very comprehensive service for both the above purchased from us including fault finding at reasonable charges. Alignment only 12/6. P.P. 2/-. When sending DO NOT include speaker or case (to minimise postal damage).

WE GUARANTEE TO MAKE YOUR SET WORK

NORCOL LTD 147 LONDON ROAD, YORKTOWN, CAMBERLEY, SURREY
ELECTRONIC COMPONENTS Phone: CAMBERLEY 3743

ATTENDING COURSE

- (A) Full-time One Year Course in Radio and Television. College course in basic principles for prospective servicing engineers. Next course commences 25th April, 1963. This course is recognised by the Radio Trades Examination Board (R.T.E.B.) for the Radio and Television Servicing Certificate examinations. Provides excellent practical experience on valve and transistor radio receivers and all well-known makes of television receivers.

HOME-STUDY COURSES

- (B) Courses in Radio, Telecommunications and Mathematics for the City and Guilds Telecommunication Technicians' Certificates.

To: The Pembridge College of Electronics.
(Dept. P11), 34a Hereford Road, London, W.2
Please send, without obligation, details of
A— B— (Please tick.)

Name _____

Address _____

THE
PEMBRIDGE
COLLEGE
OF ELECTRONICS
OFFERS TRAINING
IN RADIO
TELEVISION
AND ELECTRONICS

Geiger Counter Digital Register

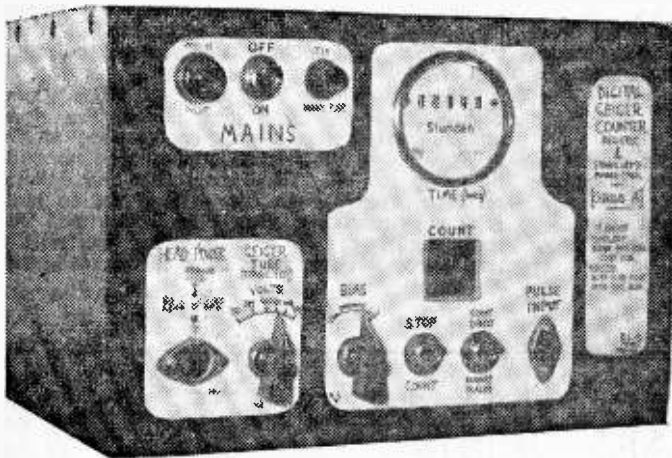

incorporating
Scaler and
Power Pack

• • •
by
E. Dexter
• • •

THIS ARTICLE DESCRIBES A DIGITAL REGISTER FOR OPERATING THE ADVANCED GEIGER HEAD DESCRIBED IN THE DECEMBER 1962 AND JANUARY 1963 ISSUES.

Continued from page 1094 of the April Issue

THE S3 position labelled "count direct" causes the digital counter to function exactly as in the original publication, and the new items V6, V7 may be treated as absent. Switching over to the other position, labelled "binary scaler", the following changes take place: A1 breaks the direct pulse feed to the cathode, and any remnant leaking past the self-capacity of the switch is shorted out by B2. Also, B2 shorts the cathode resistor of V8, pin 8, causing this valve to jump to saturation current in the steady state, with the anode voltage low. B1 having opened, the grid pin 7 on V8 is now free to accept pulses from V7 via C15, and A2 having closed, V6 and V7 now receive h.t. and can operate. Upon switching over to binary scaling, V7 will oscillate violently for about a couple of seconds, until C19 has charged. It is thus necessary to switch S3 before setting S2 to "start", to avoid a huge initial spurious count.

As pulses are now fed into the grid of V8 instead of the cathode, as formerly, we need *negative* polarity to get again the required positive polarity at V8 anode pin 6 for operating the further stages of the counter. This is the reason why B2 has been made to short the cathode resistor, and run the valve at high standing current—so that negative pulses at the grid can cut it off, giving strong positive pulses at the anode, as required. Only negative pulses from V7, via C15, have any effect. Positive ones are ineffective, as they can hardly further increase V8 anode pin 6 current, as this valve is resting without bias already; and even such slight increases as do take place appear with the wrong polarity at the anode, so that they do not operate V9.

However, there is one danger to be watched. If positive (i.e. unwanted) pulses from V7 cause over-swing, due to excessive grid current at V8 pin 7, a sufficiently great inverted post-pulse can result to fire V9 for a count. It is a further function of the grid-stopper R35 to prevent this effect.

OSCILLOSCOPE TESTS

After completing the unit, it should be set operating with its Geiger head and in the "binary scaler" setting. Using an oscilloscope with sine-wave or elliptical timebase, so as not to lose anything in the flyback-time (e.g. Audiron on "Bridge" setting), touch the probe also on to P2. Observe that only alternate pulses are properly and accurately registered. Any trace of response to some, or all of the alternate forbidden pulses means that V8 is probably also responding to some positive pulses from V7, due to the just-mentioned grid current over-swing inverting polarity. In such cases R35 must be increased and R36 decreased until the trouble ceases with certainty.

It is *not* possible to check simply by means of attempting to get the registered "direct" count twice as large as the "scaled" count under otherwise the same conditions, as the very purpose of the scaler is to pick up those fast pairs of pulses lost in a direct count due to the inertia of the simple circuit. Thus the scaled count will normally be more than half of the direct count. However, for the pure cosmic background count of the specified MX124/01 tube, the difference should be very small, and thus any great differences there observed probably indicate that something is wrong.

With other tube types, again, this may not be true, as some tubes show a number of low-amplitude head-flimmerings which are missed by the direct counting, but registered by the faster and more sensitive scaler. This question will receive further discussion below; let it suffice for the present to repeat that an oscilloscope is the only certain test. Remember to use Y-gain on the scope to show up any low-amplitude head-flimmerings that may be present.

THE BINARY SCALER CIRCUIT

The electronic generic name of this circuit is "bistable multivibrator", which already describes its function. This circuit is also known as a Schmidt trigger. It is used a great deal in electronic computers, the same as, in a simple way, its present function represents.

other triode is cut off. This condition is quite stable, for any length of time whatsoever, until the grids are suitably disturbed by feeding in pulses on C13/C18. If these "disturbing pulses" are positive, both the cut-off and the conducting triode can respond, and mutual interference due to the normal multivibrator cross-coupling (C14/C16) takes place. The net results will be unpredictable and erratic.

However, if the "disturbing pulses" are negative, clear-cut results are obtained. The triode already cut off certainly cannot respond to the negative pulse, but the conducting triode responds by being cut off. This is a stable and definite response, even though the pulse is fed to both grids simultaneously; always the triode that was conducting is cut off, and the other one initially unaffected. But the immediate consequence is that

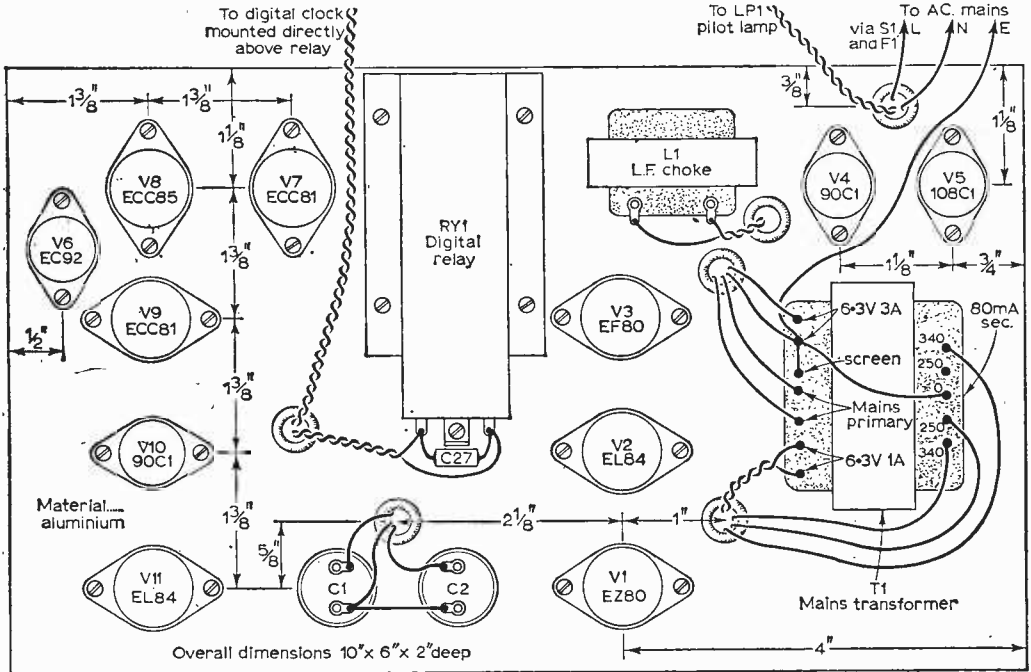

Fig. 3: Above-chassis layout and wiring, showing main drilling dimensions.

As its name suggests, it possesses two conditions for stable resting states, and on account of the absolute symmetry around the two triodes concerned, there is absolutely equal probability for either resting state being taken up. But once one state is taken up, this is maintained until the circuit is suitably disturbed to cause it to jump over to the other state.

One stable state is when one triode is cut off and the other drawing heavy current. The other stable state is simply with the roles of the two valves exchanged. Suppose either one triode is the one conducting heavily at any one time. The anode voltage will be low, and thus the grid of the other triode, being on a bleeder from the first anode, will be low, lower than the high common cathode voltage developed across C19. Consequently the

cutting-off of the initially conducting triode gives a large positive pulse at its anode, which immediately cuts-on the other triode, by normal multivibrator action. And there the circuit stays put for any length of time, the two triodes having exchanged roles. The arrival of the next negative "disturbing pulse" causes the roles to change back again, and so on.

DIVIDED OUTPUT

Considering the resulting effects at either anode, it is clear that anode current starts and stops coincident with the arrival of alternate negative pulses at the grids respectively. The anode pulse is thus negative for one input pulse, positive for the next, negative for third, and so on. As already explained, the digital counter is arranged to give

HIGH GAIN 4-TRANSISTOR PRINTED CIRCUIT AMPLIFIER KIT Type TAI

● Peak output in excess of 15 watts. ● All standard British components. ● Built on printed circuit panels, size 6 x 3 in. ● Generous size Driver and Output Transformers. ● Output transformer tapped for 3 ohm and 15 ohm speakers. ● Transistors (GET114 or 81 Mullard OC81D and matched pair of OC81 o/p). ● 9 volt operation. ● Everything supplied, wire battery clips, solder, etc. ● Comprehensive easy to follow instructions and circuit diagram 1/6, (Free with Kit).

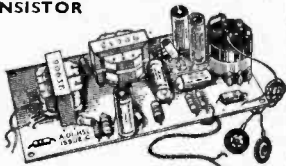

SPECIAL PRICE
45/-
P. & P. 2/6.

10/14 WATT HI-FI AMPLIFIER KIT

A stylishly finished monaural amplifier with an output of 14 watts from 2 EL84 in push-pull. Super reproduction of both music and speech, with negligible hum. Separate inputs for mike and gram allow records and announcements to follow each other. Fully shrouded ultra output transformer to match 3-16 ohm speaker and 2 independent volume controls, and separate bass and treble controls are provided giving good lift and tone. Valve line-up 2 EL84s, ECC83, EL84 and EZ80 rectifier. Simple instruction booklet 1/6. (Free with parts.)

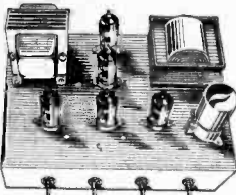

ONLY £6.19.6 P. & P. 6/6.

AMPLIFIER ON PRINTED CIRCUIT BOARD

Two valve. UY85, UL84 O.P. trans., use with 80 volt tap of motor. 39/6. 1/6 in. above. Dropper for filaments if required. 2/6.

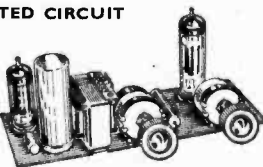

B.S.R. AUTO UNITS
160 v. Suitable for use with above. (Slightly soiled.) £4.4.0. P. & P. 5/-.

LARGE CABINET Suitable for above two items. Complete with 3 ohm speaker. £3.9.6. Carr. 5/-.

Superior CABINET Similar to above to take 8 x 5 in. speaker, with motor board, will accommodate BSR UA14 or UA16. £3.9.6. Carr. 5/6. Speaker 15/- extra. P. & P. 1/6 extra.

BRAND NEW 3 OHM LOUDSPEAKERS

- 2 1/2 in. 12/6; 5 in. 12/6; 6 1/2 in. 15/-;
 - 8 in. 21/-; 10 in. 26/-; 12 in. 27/6.
 - Goodmans 5 in. tweeter .. 10/6
 - E.M.I. 2 1/2 in. tweeter .. 10/6
 - E.M.I. 1 1/2 in. x 3 1/2 in. high flux 32/6
 - Kola Celestion approx. 9 in. x 5 in. middle register speaker 10/6
- Also 15 ohm 12 in., 30/- P. & P. 1/6 per speaker.

RECORDING TAPE

P.V.C. base, full frequency L.P. tape. 7 in. 1,800ft. (normally 50/-) 27/6; 5 1/2 in. 1,200ft. (normally 35/-) 18/6; 5 in. 900ft. (normally 25/-) 15/- P. & P. 1/- per spool. Ideal for 2 or 4 track recorder.

TAPE DECKS
COLLARO STUDIO DECK
£10.10.0, plus 5/6 carr. and ins. B.S.R. MONARDECK (Single speed) 3 1/2 in. per sec. simple control, uses 2 1/2 in. spools, £6.15.0 plus 5/6 carr. and ins. (Tapes extra on both).

SPECIAL BARGAIN OFFERS!

- MAINS TRANSFORMER.** Impregnated and fully shrouded. Size 4 1/2 x 3 1/2 in. Weight 6 lbs. Tapped primary 200, 225, 245v. Electrostatic screen. Output 360-0-360 v. at 120 m/a D.C. plus 1050 v. half wave at 3 m/a D.C. 6.3 v. at 3.5 amps, centre tapped 5 v. at 2 1/2 amps and 6.3 v. at .6 amps. PRICE ONLY 21/- each. P. & P. 5/-.
- CARBON MIKE INSERTS.** Brand new, 2 1/2 in. dia., 3/8, P. & P. 9d.
- GORLER F.M. TUNER HEADS.** 10.7 Mo/s I.F., 15/-, plus 1/9 P. & P. EL085 valve 5/6 extra.
- ELECTROSTATO H.F. TWEETERS.** Type L.S.H. 75. Size 3 x 3 in., 2/6 each, plus 9d. P. & P.
- MIDGET 2/OANO CONDENSERS.** Capacity 105 and 100 pF. Polystyrene case with built-in trimmer. Size 1 x 1 1/2 in. Not used but removed from P/C Boards. Two for 9/-, plus 1/- P. & P.
- AC08 CRYSTAL MIKES.** High imp. For desk or hand use. High sensitivity. 18/6. P. & P. 1/6.
- TSL CRYSTAL STICK MIKE.** Listed at 45/-. Our price 18/6. P. & P. 1/6.
- TRANSISTOR DRIVER and O/P TRANSFORMERS.** (Tapped 3 ohms and 15 ohms output), plus 4 suitable Transistors giving approx. 1 watt output. 30/-, P. & P. 2/-.
- 3 PUSH-BUTTON TRANSISTOR SWITCH.** D.P.—D.T. Each Switch 5/6 and 1/- P. & P.
- FURTHER HUGE PURCHASE**
- TELEFUNKEN HI-FI STEREO AMPLIFIER.** 110/250 v. A.C. input. 5 watt undistorted output (10 watts nominal). Size 12 x 9 x 2 1/2 in. Weight 9 lb. Complete with spec. and instructions. Now only £5.9.6. Carr. 5/6.
- Also Model 882.** Similar specification but with balance control. Now only £5.19.8. Carr. 5/-.

SPECIAL 1 PURCHASE! TURRET TUNERS

by famous maker Brand new and unused. Complete with PC084 and PCF80 valves. 34-38 Mc/s I.F. Biscuits for Channels 1 to 5 and 8 and 9. Circuit diagram supplied. ONLY 25/- each. P.P. 2/6.

F.M. TUNER HEAD

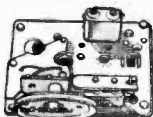

A permeability tuned tuner head by a famous maker, supplied without valve (ECC85) and drum and spindle, 18/6, plus 1/9 P. & P. Valve 9/6 extra. Drum and spindle 3/6 extra.

E.M.I. 4-speed FURTHER HUGE PURCHASE enables us to offer these **67/6** P. & P. at



Heavy 8 1/2 in. metal turntable. Low flutter performance 200/250V shaded motor with tap at 45V for amplifier valve filament if required. Turnover LP/78 head.

RECORD PLAYER AMPLIFIER

2 valve, A.C. mains, 3 watts output, ready built, tested and complete with valves and output transformer. Size 7 in. w. x 2 1/2 in. d. x 5 1/2 in. h. 55/-, P. & P. 3/-.

Suitable speakers: 6 in. 15/- or 10 x 6 in. 22/6. P. & P. 1/6 on each.

4-SPEED PLAYER UNIT BARGAINS.

SINGLE PLAYERS
TU/12. £3.10.0. Carr. 3/6.

AUTO CHANGERS
B.S.R. UA14. £8.2.6.
Latest B.S.R. UA16. £7.2.6.
Latest Garrard "Auto-Slim". £6.17.0. Carr. 5/- each.

LOUDSPEAKER SILKS

Heavily woven in champagne and brown. 48 in. wide. Originally 35/- per yard length.

OUR SPECIAL PRICE 12/- per yard length. P. & P. 1/6. Also Red and Rexine. Dark Grey and Oatmeal fabrics for cabinet covering, 5 1/2 in. wide, 13/6 per yard length. P. & P. 1/6.

HARVERSON'S F.M. TUNER Mk.1

● F.M. tuning head by famous maker. ● Guaranteed non-drift. ● Permeability tuning. ● Frequency coverage 88-100 Mc/s. ● OA81 + balanced diode output. ● Two I.F. stages and discriminator. ● Attractive maroon and gold dial (7 x 3 in. glass). ● Self powered, using a good quality mains transformer and valve rectifier. ● Valves used ECC85, two EF80s, and EZ80 (rectifier). ● Fully drilled chassis. ● Size of completed tuner 8 x 6 x 5 1/2 in. ● All parts sold separately. £5.19.6, plus 5/6 P.P. and ins. Circuit diagram and illustrations 1/6 post free. Mark II Version as above but complete with magic eye, front panel and brackets. £6.12.6. P. & P. 8/6.

Mark III Version as Mark I but with output stage (ECL82) and tone control. £7.7.0. P. & P. 8/6. Handsome Metal Cabinets. Choice of Grey, Black or Green. To fit Mark I, 25/-, P. & P. 2/6. To fit Mark II 17/6, P. & P. 2/6.

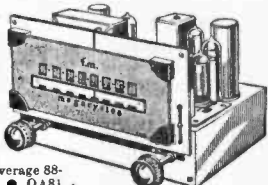

6 TRANSISTOR AND DIODE SUPERHET

A first-class 2 waveband transistor superhet in kit form. ● Printed circuit panel (size 8 1/2 x 2 1/2 in.) ● 3 pre-aligned I.P. transformers. ● High-gain Ferrite rod aerial. ● All First-grade transistors. ● Car aerial winding. ● Push-pull output. ● All parts supplied with simple instructions.

All parts sold separately

ONLY £4.5.0 P. & P. 2/6

35 OHM SPEAKERS

2 in. Goodmans. Ideal replacement for most pocket portables 9/6; 2 1/2 in. 10/6; 3 1/2 in. 12/6; 5 in. P.M. 17/6; 7 x 4 in. 21/6.

Portable CABINET

Size approx. 9 1/2 x 6 1/2 x 3 1/2 in. Suitable for above using 3 1/2 in. speaker. 25/-, P. & P. 2/-.

COIL AND TRANSFORMER SET FOR TRANSISTOR SUPERHET

3 I.F. transformers, one oscillator coil, one drive transformer and wound Ferrite aerial (med., long and aerial coupling). 28/6 complete, post 1/-.

6 transistor printed circuit, board to match, 8/6, post 5d. Circuit diagram 1/6 extra.

QUALITY RECORD PLAYER AMPLIFIER

A top-quality record player amplifier. This amplifier (which is used in a 29 gm. record player) employs ECC85, EL84, EZ80 valves. Bass, treble and volume On/off controls.

PRICE 69/6 P. & P. 3/6

DITTO. Mounted on board with output transformer and 6 1/2 in. speaker.
Complete at 89/6, P. & P. 4/6

TRANSISTORS

GET15 (Matched Pair) 15/-

OC71 5/- FXA301 6/8
OC73 6/- XA403 6/8
OC76 6/- V1510p 12/6

Set of Mullard 6 transistors 25/-, Set of G.E.C. 1,374; 2,873; 3, 81 or GET114, 20/-, All Post Free.

HARVERSON SURPLUS CO. LTD.

170 HIGH ST., MERTON, S.W.19. CHERRYWOOD 3985/6
Open all day Saturday. Early closing Wed., 1 p.m.

A few minutes from South Wimbledon Tube Station. (Please write clearly)
Please Note: P. & P. charges quoted apply to U.K. only. P. & P. on overseas orders charged extra.

WEYRAD

6-TRANSISTOR 2-WAVE SUPERHET RECEIVER MODIFICATIONS NOW AVAILABLE FOR 500mW OUTPUT

ROD AERIAL—RA2W 6 in. long, 3/8 in. diameter, connections to tags on Coils. For 208pF tuning capacity. Complete with Car Aerial Coil	12/6
OSCILLATOR COIL—P50/1AC M.W. covered with 176pf tuning capacity, L.W. by extra padder	5/4
I.F. TRANSFORMERS 1st and 2nd Stage—P50/2CC	5/7 (2 required)
3rd Stage—P50/3CC	6/-
DRIVER TRANSFORMER—LFDT4	9/6
OUTPUT TRANSFORMER—OPT1	10/6
PRINTED CIRCUIT—PCA1	9/6

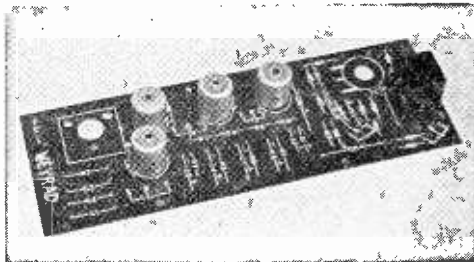

In response to many requests we have redesigned the output stages to give 500mW and to enable a standard 3 ohm Speaker to be used. Full details of the simple changes are given on a separate leaflet available on receipt of stamp.

CONSTRUCTORS BOOKLET WITH FULL DETAILS	2/-
TRANSISTOR A.F. AMPLIFIER TYPE A.F.1—LOW IMPEDANCE INPUT, 3-TRANSISTOR, 500mW OUTPUT, FULLY ASSEMBLED WITH VOLUME CONTROL	63/6

WEYMOUTH RADIO MANUFACTURING CO., LTD.
REGENT FACTORY, SCHOOL STREET,
WEYMOUTH, DORSET

YOURS FREE FOR 7 DAYS

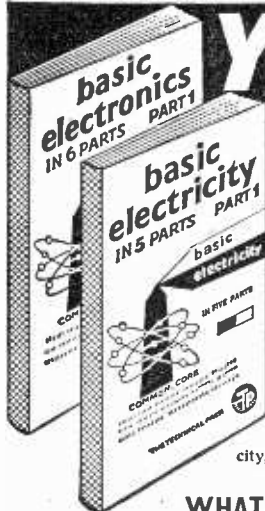

The New 'Picture-Book' way of learning **BASIC ELECTRICITY** (5 VOLS.) **BASIC ELECTRONICS** (6 VOLS.)

You'll find it easy to learn with this outstandingly successful new pictorial method—the essential facts are explained in the simplest language, one at a time; and each is illustrated by an accurate, cartoon-type drawing.

The books are based on the latest research into simplified learning techniques. This has proved that the Pictorial Approach to learning is the quickest and soundest way of gaining mastery over these subjects.

The series will be of exceptional value in training mechanics and technicians in Electricity, Radio and Electronics.

WHAT READERS SAY

"... I am delighted with these books and have learnt more about Radio in two hours than I have by other methods in two weeks. Congratulations..." K.M.Y. "... I wish to congratulate you on these 'Best ever' series..." B.P. "... I consider the manuals are truly the best I have ever studied..." S.A.S.

A TECHNICAL PRESS PUBLICATION

To Selray Book Co.,
60 Hayes Hill, Hayes, Bromley, Kent

Please send me Without Obligation to Purchase, Basic Electricity/Basic Electronics on 7 Days Free Trial. I will either return set, carriage paid, in good condition within 8 days or send down payment of 10/- (Basic Electricity) followed by 6 monthly payments of 10/-. Down payment of 12/- (Basic Electronics) followed by 6 monthly payments of 12/-. Alternatively, I will send 63/- (Basic Electricity—5 parts), 75/- (Basic Electronics—6 parts) post free.

Tick against set required (only one set allowed on free trial).
BASIC ELECTRICITY BASIC ELECTRONICS

Signature _____
(If under 21, signature of parent or guardian)

BLOCK LETTERS BELOW
Name _____
FULL POSTAL Address _____

POST NOW FOR THIS OFFER!!

no response to the positive pulses, counting only the alternate negative ones. The "divide-by-two" process is thus fully explained.

It is unimportant from which anode C15 is coupled to the digital counter proper, as an important feature of the circuit is its *absolute symmetrical equivalence* of its two stages. Indeed maintenance of this symmetry is an important factor for getting proper operation, any gross asymmetry easily leading to "preference" for one state, and erratic division in consequence. For this reason, the "dummy" around D4 is included on the other anode, to simulate the loading imposed by the true output coupling over C15.

PARASITICS

Wiring layout is a less important factor than component values for symmetry maintenance. Thus it is certainly necessary to obtain *matched pairs* of components for all circuitry around V7, yet conditions for layout are far more liberal, as is seen in Fig. 2. Naturally, if we wanted to use the stage for the highest counting-rate of which it is capable, which is probably several megacycles per second, layout would then be equally critical. But that is not the case here; the circuit as specified here is aimed at a resolution of around a millisecond. However, one factor can give trouble, again through the constant danger of parasitics inherent in the use of modern high-slope miniature valves.

Parasitic oscillations at v.h.f., in common with all oscillations, give grid current in the valves concerned, and any starting, stopping or amplitude-changes of these oscillations cause corresponding grid current changes, manifest as being equivalent

to voltage pulses at the grid. It is thus clear that if a bistable multivibrator as here under discussion also suffers from v.h.f. parasitics, a variety of peculiar forms of unpredictable behaviour can result.

The annoying thing about this trouble, as far as the uninitiated experimenter is concerned, is that none of the "normal" symptoms of v.h.f. oscillation may be present in most cases, the circuit just refusing to behave as it ought to, even though everything has been checked and re-checked as far as the multivibrator characteristics are concerned. Thus one can waste many hours in a futile search to exasperation, unless one has realised from past experience that such troubles are almost always the result of strong v.h.f. parasitic oscillations—and a couple of grid stoppers almost always effect a complete cure immediately!

LAYOUT

The layout of the wiring around V7 influences the generation of would-be parasitics far more than anything else at the intended operating frequencies. Thus, as soon as the grid stoppers R18, R25 and R28 are inserted, the circuit is extremely tolerant as regards layout. If any instability should be found in V9, it might be better to try increasing the anode resistors rather than inserting stoppers at the grids of this valve. R4, R6, R7 and R51 serve similar functions in the Power-Supply.

Note that grid-stoppers are grid-stoppers, and thus are fully useless unless inserted *absolutely directly* at the grid pin concerned. Even a small fraction of an inch of connecting wire in between is far too long in many cases. One must cut off the connecting wire of the resistor very short, bend

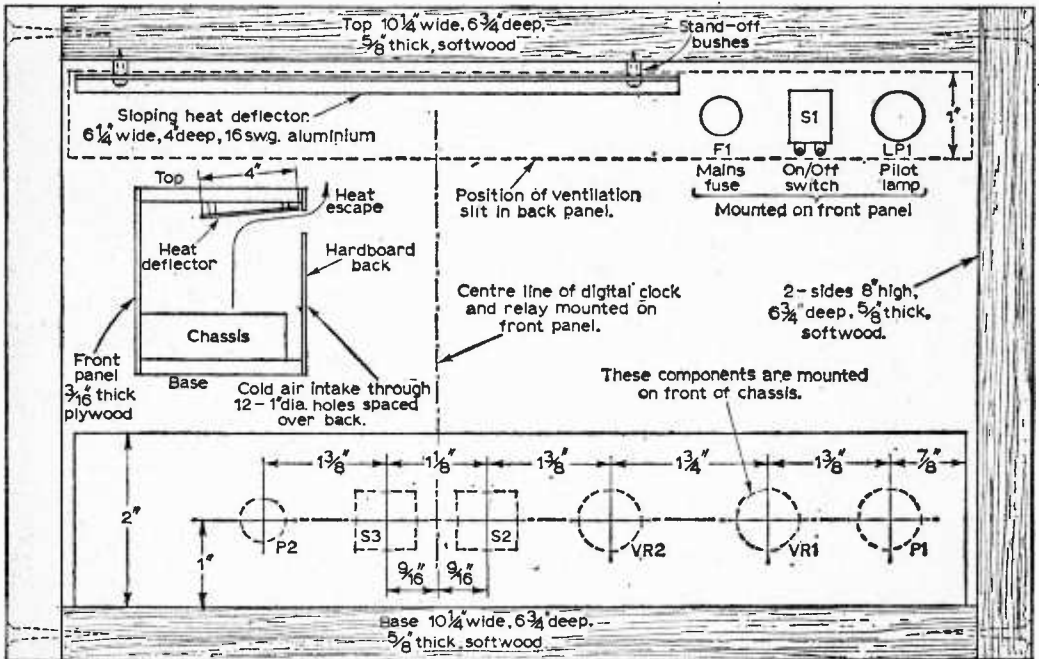

Fig. 4: Back view of cabinet with the chassis in position. The panel drilling must mate with the chassis front flap drilling so that the components concerned clamp the chassis and front panel together as one integral unit. Note the important ventilation measures indicated.

a hook with long-nosed pliers, and solder directly on to the grid pin at the valveholder. Nothing else will do.

PURPOSE OF THE BINARY SCALER

The purpose of the binary scaler is to enable greater counting accuracy to be achieved at speeds approaching the limit of resolution of the mechanical digital relay.

If we were dealing with the counting of a sequence of pulses from a low-frequency oscillator, having a *perfectly regular* sequence, the accuracy of counting would be equally good, however closely the pulse frequency approached the limit of resolution of the digital relay, and in this sense a scaler would be fully superfluous as long as the frequency did not exceed the capabilities of the relay. Inclusion of the scaler would then increase the maximum registrable frequency by a factor of *exactly* two.

However, in Geiger counters we are dealing with an *irregular* sequence of pulses having a mean average frequency characteristic of the intensity of radiation, yet having a randomly fluctuating ("statistical") momentary frequency. Thus, to compensate for the randomly present long intervals between successive pulses, there will be many short intervals representing a momentary frequency much greater than the average.

Such "fast pairs" of pulses will be beyond the resolving capabilities of the mechanical relay, even though the average rate is still well within its capabilities. A fast pair may even temporarily jam the relay, until the next pulse comes, so that *both*

pulses of the pair are lost. The higher the average rate, therefore, the greater the chances of fast pairs arriving, and thus the counts registered will be too low by an increasing percentage as the average rate increases.

DIRECT COUNTING ERRORS

We can make a simplified quantitative examination of the practical consequences. Suppose that the switching time of the digital relay in the simple direct digital counter is "*t*" seconds, where *t* is some definite fraction of a second. Suppose the *true rate* at which particles of atomic radiation are arriving in the Geiger tube is *N* per minute, i.e. *N*/60 per second. Then, because each particle causes a "blockage" for *t* seconds, the counter is blocked for a portion *Nt*/60 of a second in each second, i.e. it is inoperative for $(100Nt/60)\%$ of the time, which therefore gives the percentage error by which the resulting actually registered count will come out lower than it ought to be.

Taking a simple example of a tenth of a second for "*t*", and a "true" counting rate of 100 per minute for *N* (the value, approximately, to be aimed at in preparing concentrated rainfall-samples for monitoring with this apparatus), we see that the error for direct counting is about 17%, which is considerable—though tolerable, because errors in preparation of rainfall samples are likely to be no less than this, and the strength of a chain is only equal to the strength of its weakest link! However, for even faster rates of counting, which are likely to be encountered, errors in direct counting become intolerable.

CONTINUED NEXT MONTH

FREE Inside NEXT MONTH'S PRACTICAL WIRELESS



DOUBLE-SIDED

BLUEPRINT

with instructions to build

1

7-TRANSISTOR PORTABLE/CAR RADIO

Easy to build. Can be used as a normal portable or in the car from readily available cabinet and accessories. LW/MW. Large elliptical speaker. Full instructions for building

2

TRANSISTORISED PORTABLE RECORD REPRODUCER

Incorporates Class B push-pull output; large elliptical speaker; record storage space. 33½ and 45 r.p.m. Case-size 11" x 11" x 6". Cabinet and accessories readily available

DON'T MISS IT! — ORDER YOUR COPY TODAY!

UNIVERSAL AVOMETERS

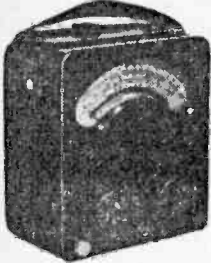

Guaranteed perfect working order. Supplied complete with leads, batteries and instructions. Model "D" 34 range £8.19.6 Model "7" 50 range £11.0.0 Registered Post 5/- extra.

MICROAMMETERS

0-500 microamps. 2 1/2 in. circular flush panel mounting. Dials engraved. 0-15. 0-600 volts. BRAND NEW. BOXED. 15/- P.P. 1/-

7.5 K.V.A. AUTO TRANSFORMERS

0-115-230 volts. Brand new boxed, £15. Carriage 10/-.

230/250 VOLT A.C. MOTORS
4 1/2 x 3 1/2 in. dia., 90 watts, 5,000 r.p.m. Hn. spindle. 22/6. P.P. 1/6.

1 K.V.A. ISOLATION TRANSFORMERS

230 v. Pri.; 230 v. Sec. Boxed, 25 each, Carriage 10/-.

VARIAC TRANSFORMERS
24 amp., 230 volt primary, 185 to 250 volt output, £12.10.0. Carriage 10/-.

TELEPHONES TYPE "L"

Generator Bell Ringing, 2 line connection. With batteries, fully tested, 69/6 per pair. Carriage 5/-.

HELIPOTS

Available in the following sizes. 10k Ω , 50k Ω , 10k + 2k Ω . All new, boxed, 22/6 each. P.P. 1/3.

3000 WATT AUTO TRANSFORMERS

0-115-230 volts, step-up or step-down. Brand new, boxed extra. U.S.A. £7.10.0 each. Carr. 10/-.

PANEL METERS

100 μ A	2 1/2" F.M.	D.C.	42/6
100 μ A	3 1/2" F.M.	D.C.	62/6
1 mA	2 1/2" F.M.	D.C.	25/-
30/0/30 mA	2 1/2" F.M.	D.C.	9/6
350 mA	2 1/2" F.M.	D.C.	10/6
300 v.	2 1/2" Prof.	A.C.	19/6
300 v.	2 1/2" F.M.	A.C.	25/-
500 v.	2 1/2" F.M.	A.C.	25/-
120 v.	3 1/2" F.M.	D.C.	32/6
1500 v.	2 1/2"	Electrostatic	25/-

FIELD TELEPHONES TYPE "F"

Suitable for many applications. Generator bell ringing, 2 line connection. With batteries and wooden carrying case, fully tested, £4.19.6 per pair. Carr. 5/-.

SUB-STANDARD D.C. AMMETERS

9 ranges. 150mA, 1.5A, 3A, 7.5A, 15A, 30A, 60A, 300A, and 450 amp. Housed in teak portable case, 8 1/2 in. mirror scale. Supplied brand new with all shunts and leather carrying case, £15 each. P.P. 10/-.

A.R.88 L.F. RECEIVERS

Frequency coverage 75-350 kc/s and 1.5-30.5 Mc/s. Operation 110/230 watt A.C. Fitted with "S" meter. Offered in perfect working order, fully checked. £35. Carriage 30/-.

P.C.R.2 RECEIVERS

800-2,000 metres, 190-550 metres 6-22 Mc/s. output for phones or 3 Ω speaker. As new £5.19.6. Carr. 7/6. P.C.R.3 as P.C.R.2 but covers 190/550 metres, 2-7 Mc/s, 7-22 Mc/s, including top band. As new, £8.8.0. carr. 7/6. All above models can be supplied with internal power unit to operate on 200/250 v. A.C. at 39/6 extra or alternatively plug-in external power units are 35/-.

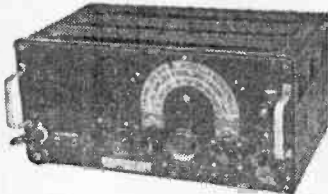

NATIONAL H.R.O. RECEIVERS

BRAND NEW! Senior model, table mounting. Complete with a full set of 9 coils covering 50 kc/s to 30 Mc/s. Supplied complete in original transit cases, £25. Carr. 20/-.



PRECISION COMBINATION VOLTMETER/AMMETER FOR A.C. AND D.C.

Two separate instruments housed in polished wood case, 6 1/2 in. scales with knife edge pointers.



Ranges: Volts A.C. and D.C. 160-300-600 v. Amps. A.C. and D.C. 25-50-150-200 A. Supplied complete with all current shunts, leads and leather carrying case. Manufactured by Elliott Bros. Supplied brand new. £9.19.6 each. Carriage 7/6.

MINE DETECTOR No. 4A

Will detect all types of metal. Fully portable. Complete equipment supplied tested with instructions. 39/6. Carriage, 10/6. Battery 8/6 extra.

COLLARO STUDIO TAPE TRANSCRIBER

Brand new 1962 model, 3 speeds, 3 motors, digital counter, etc. With latest Bradmatic heads and interlock button. Supplied with spare spool, instructions, fixings. 10 gns. each. Carr. paid.

FABULOUS TAPE OFFER

Famous American Brand Tapes. Brand new, fully guaranteed. 5in.-600ft., 10/6. 5in.-800ft., 13/6. 5in.-1200ft., 17/-, 7in.-1200ft., 23/6. 7in.-1800ft., 18/6. 7in.-2400ft., 30/- P. & P. extra. S.A.E. for full tape list.

CT-53 SIGNAL GENERATORS

Precision instruments covering 8.9 to 15.6 Mc/s. and 20 to 300 Mc/s. on 5 bands. Variable attenuator from 1 microvolt to 100 millivolts. Operation 110/200/250 volts. A.C. Supplied in perfect working order. Complete with calibration charts. 19 gns. each. Carriage 10/6.



PRECISION A.C. AND D.C. VOLTMETERS

Two ranges. 160 and 320 volts, 8 inch mirror scale with knife edge pointer. Housed in polished wood case. Ideal for schools, labs., etc. Supplied brand new. £5.19.6 each. P.P. 3/6.

6 inch PANEL METERS

Hermetically sealed. 6 1/2 in. scales. Available 100 amp. A.C. or 300 amp D.C. Brand new, boxed, 65/- P.P. 5/-.

DELCO 24 VOLT D.C. MOTORS

Shunt wound, 5,400 r.p.m. Torque 4 1/2 oz. Double spindle, smooth running, extremely powerful. Also runs on 12 volts. BRAND NEW 10/6 each. P.P. 2/-.

MINIATURE MODEL ACCUMULATORS

Lead Acid. BRAND NEW. 2v. 1.5 A.H., 4 x 1 1/2 x 1 1/2 in., 11b., 5/6. P.P. 1/3. 12v. 0.75 A.H., 4 x 3 x 1 1/2 in., 2lb., 15/6. P.P. 1/6.

I.M.A. METER RECTIFIERS

Westinghouse, F.W. Bridge, 3/6. P.P. 6d.

Hours of Business: 3 LISLE STREET, 9 a.m.—6 p.m. Half Day Saturday
34 LISLE STREET, 9 a.m.—6 p.m. Half Day Thursday

JEMCO 4,000 OHM/VOLT TESTMETER

1% Precision Resistors throughout. Single control system for all ranges. Highly accurate. Sensitivity 4,000 Ω /volt A.C. and D.C.



Ranges:
D.C. volts: 0-10-50-250-500-1,000 v.
A.C. volts: 0-10-50-250-500-1,000 v.
D.C. current: 0-250 μ A
0-25-500mA
Resistance: 03-0k Ω
0-300k Ω
0-3M Ω
Decibels: -20 to +36 dB (2 ranges).
Meter sensitivity: 100 microamp. 59/8 each P.P. 2/6.

JEMCO 20,000 OHM/VOLT TESTMETER

As above but with increased sensitivity and extended resistance range (0-5M Ω). 97/6 P.P. 2/6. Either type brand new. Guaranteed with leads, prods, batteries, instructions.

L.T. METAL RECTIFIERS

All full wave, bridge connected. Brand new, guaranteed.
12/18v. 1.5A. 2/6 24/36v. 4A. 22/6
12/18v. 2.5A. 6/3 24/36v. 1.5A. 45/-
12/18v. 4A. 8/3 36/48v. 2A. 19/6
12/18v. 6A. 12/3 36/48v. 4A. 29/6
12/18v. 10A. 22/3 36/48v. 6A. 32/6
12/18v. 15A. 37/6 48/60v. 2A. 81/-
24/36v. 1A. 7/3 48/60v. 10A. 82/6
Please add postage.

L.T. TRANSFORMERS

All primaries tapped 200/250 volts. 1 Battery Charging. 3.5, 9 or 17 volt, 1 amp., 9/8. Ditto 2 amp. 14/3. Ditto 4 amp., 16/8. 9 or 17 volt, 8 amp., 26/-.
2 Model Type 3, 4, 5, 6, 8, 10, 12, 15, 18, 20, 24 or 30 volt, 3 amp., 18/6. Ditto 4 amp., 27/6. Ditto 5 amp., 37/6. Add Postage.

AUTO TRANSFORMERS

Step-up, step-down, tapped 0-115-200-230-250 volts. 15w., 9/-; 60w., 12/6; 150w., 18/6; 200w., 27/6; 300w., 42/6; 500w., 67/6; 1,000w., 99/6; 1,500w., £6.19.6. P.P. extra.

R.C.A. PLATE TRANSFORMERS

Pri. 200/250 v. sec. 2,000-0-2,000 v. 500 mA. Tapped 1,500 v. New. Boxed, £6.10.0. Carriage 15/-.

DOUMONT K1051I DOUBLE BEAM C.R.T.

Twin Gun. Brand new, boxed, 59/8. P.P. 3/6.

1.2 Ohm 12 Amp RHEOSTAT

Gehrd slider type, new boxed, 15/6 each. P.P. 3/6.

MARCONI TF-885 VIDEO OSCILLATORS

25c/s-5Mc/s. Supplied in guaranteed as new condition. £90 each.

CADMIUM SULPHIDE PHOTOCELLS

Very sensitive, full data supplied, 12/6 each. P.P. 6d.

MINIATURE PANEL METERS

For 1 1/2 in. dia. panel hole.
0-50 μ A 39/6 0-300 v. D.C. 27/6
0-500 μ A 32/6 "S" meter 35/-
0-1 mA 27/6 "VU" meter 42/6
0-5 mA 27/6

GW SMITH & CO (RADIO) LIMITED
Phone: GERRARD 8204/9155
Cables: SMITHEX LESQUARE
3-34 LISLE STREET LONDON W.C.2

FOR THE TAPE RECORDING ENTHUSIAST

a new Recorder

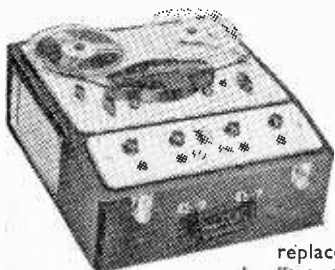

THE MARK 5
Series 2
at 69 gns

This new machine replaces the MARK 5 and offers a number of improvements both in appearance and electrically. The amplifier has been redesigned to give an improved frequency response at all speeds on both record and playback. The output remains the same at 4 watts.

a new Deck

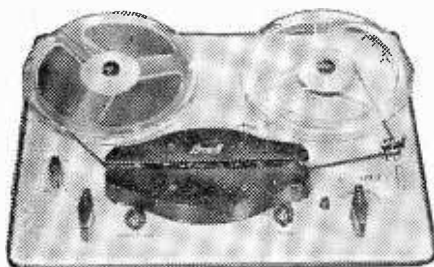

at 31 gns

and a new Amplifier

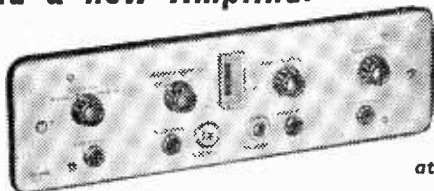

at £26

AUDIO FAIR Booth No. 53
Demonstration Room 236

by

Brenell

BRENELL ENGINEERING COMPANY LIMITED
1a Doughty Street, London, W.C.1. HOLborn 7356
GD 397

SOLDERING EQUIPMENT

by



PRECISION SOLDERING
for the
ELECTRONICS INDUSTRY

Comprehensive range—Robust & reliable
- Light weight - Rapid heating - Bit sizes
3/32in. to 3/8in. - 'Permabit' or Copper
bits - All voltage ranges 6/7v. to 230/
250v. - Prices from 21/-.

Also

- Plastic Cable Strippers
- Miniature Solder Pots
- Heat Guards
- Long Life Bits

Illustrated is the 25w. 3/16in. replaceable
bit model with safety shield.

ADAMIN— new range of precision
micro-soldering instruments—
Have you had details?

Brochure No. S10 sent free on request.
Sole proprietors and manufacturers:
LIGHT SOLDERING DEVELOPMENTS LTD.
28 Sydenham Road, Croydon, Surrey
Phone: CROydon 8589 Grams: Litesold Croydon



COMPLETE TELEVISIONS

14 INCH	100% Guaranteed.	17 INCH
£7.10.0		£11.10.0

12 months' Full Written
Guarantee.

Shown working all channels in Shop
Legs—39/6 per set.

Personal collection advised, or insured.
Carr. 14in., 20/-, 17in., 30/-.
Part exchange allowance on
ANYTHING USEFUL



Regunned TV TUBES
21 in. 99/6 17 in. 79/6
15, 14 and 12in.—59/6
GUARANTEED ONE YEAR
Ins. and Carr. 10/6.
Add 10/- refundable on OLD
TUBE. 110° Tubes in Stock.

15/-
Ex Rental
36/24, 14KP4, 141,
121, 31/74 and others.
Set tested. Carr. 5/-.

VALVES 9d. each. 40—£1
Thousands of Valves available
P.P. on 1—4 6d., 12 1/6
LATEST LIST (stamps only)

EXTENSION SPEAKERS **29/9**
2-tone covered cabinet, 6in.
PM speakers, switch and flex.
Ideal for kitchen, sick-room,
etc. P.P. 3/3.

TELEPHONE HANDSETS
15/6 pair.
G.P.O. standard pattern.
House to Workshop,
garage, inter-office, etc.
Works off any small battery.
P. & P. 4/6.

Tape Recorder Cabinet 20/-
to take B.S.R. or Collaro
Studio Deck. Two tone
colours P. & P. 5/-. See lists

Condensers. 100—10/-. New.
Assorted electrolytics and P.F.s.



SPEAKERS
7/9 each

6in. 8in. 7in. x
4in. Money
back guaranteed.
Other
sizes, few only.

Ex. mfd. salvage. P.P. 2/3.

DUKE & CO. (LONDON) LTD.
621/3 Romford Road, Manor Park, E.12
Liverpool St.—Manor Pk.—10 mins.

Phone
ILFord
6001/2/3

Making TIN PLATE

AN ECONOMICAL ALTERNATIVE TO ALUMINIUM CHASSIS

BY L. E. PROFAZE

VARIOUS suppliers offer a wide range of relatively cheap aluminium chassis which are widely used by constructors because they offer advantages to the experimenter in that the metal is easy to work, has an attractive appearance and when folded into box form presents a stable base for radio construction.

One great disadvantage with aluminium is that it cannot be easily soldered. Methods do exist, but they do not lend themselves as readily to good electrical joints as does conventional tin/lead solder which is unsuitable for aluminium, and making earth connections via tags bolted to an aluminium chassis may introduce instability due to imperfect connection through surface oxide layer or the loosening of the fixing screws.

As an alternative material, the use of tin plate offers some distinct advantages insofar that it is very cheap, plentiful, can be cut and bent very easily and does not require a special soldering technique. It is not as stiff as the thicker aluminium normally used for chassis and therefore the finished article tends to be a bit flexible—a condition not always acceptable in radio equipment—but the inclusion of screens both above and below chassis and the fixing of large surface area components will often contribute sufficiently to the stiffness of the assembly to overcome this objection.

By soldering screens in position a very high degree of electrical separation between compartments results, but it should be borne in mind that as the material is of a ferrous character it may have a profound effect on the operation of components sensitive to magnetic influence and should therefore be used with discretion in such situations.

Tools and Equipment

Only simple tools are required to fashion tin plate: a soldering iron, either electric or gas heated, of ample thermal capacity, resin-cored solder of the variety normally used for radio work, a pair of tin snips (or in fact a strong pair of scissors could be used), some pieces of hardwood strip about 1 in. x ¼ in. and several large spring paper clips (bulldog clips). A couple of small screw clamps would be an additional asset.

Having decided on the size of the chassis the overall size of the piece of tin plate required should be cut from the sheet. This size is determined by adding to the width and length twice the depth of the side and marking out should follow the pattern of Fig. 1.

Chassis

At the inner corners of the four shaded sections mark with a centre punch (a nail sharpened to a point will do as an alternative) and drill a small hole about a ⅛ in. diameter, then with tin snips cut away the four shaded portions. Make certain the cuts are in line with the folding lines as this will aid in producing a neat finish.

A little practice when using the snips will show how to avoid bending the metal which is to form the chassis, rest one blade of the cutters against the metal which is to be retained and cut with the other, any distortion will then only be in the waste. You should now have a shape as in Fig. 2.

Bending the Tin Plate

This is now ready for folding and you will require two lengths of hardwood strip and the vice or clamps. Cut the hardwood at least as long as the dimension A in Fig. 2 and position one on each side of the sheet adjacent to the folding line and clamp securely. The first bend may now be made and with a little care and practice it will be found simple to form a very neat bend.

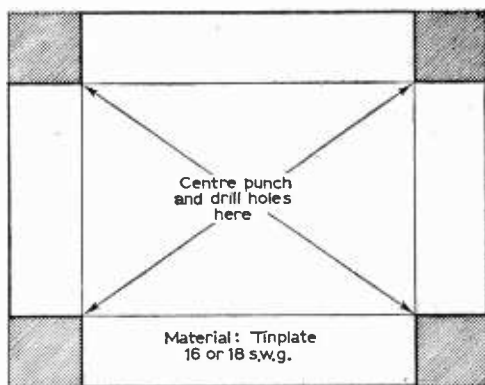

Fig. 1: Cutting the chassis.

This whole procedure can now be repeated on the other long side. For the two short sides the technique is identical except that one piece of hardwood must be cut so that it may be accommodated within the two folded long sides. At this stage the chassis will present a conventional appearance and it only remains to solder the corners to impart additional strength.

With thin metal of this type the application of a hot soldering iron causes expansion and distortion and it is necessary to employ a jig to locate and hold the sides for a neat finish. A suitable jig is

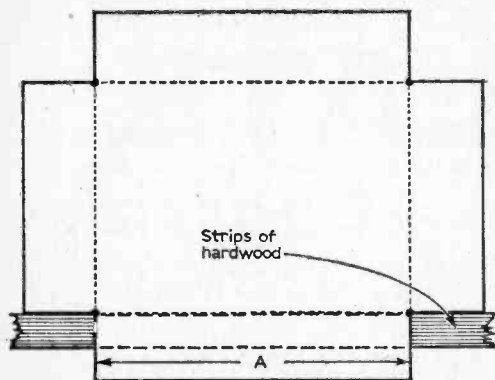

Fig. 2: Bending the cut tin plate

made from two pieces of planed wood joined at right angles to form an L shape into which one corner of the chassis can rest. Its size should be governed by the depth of chassis and in general wood measuring about 2in. x $\frac{3}{4}$ in. will suffice.

Locate the chassis and secure both sides with bulldog clips (the arrangement can be seen in Fig. 3 although for simplicity only one clip is shown here) and stand the assembly so that the inside of the corner joint forms a trough into which the solder will run. Tilt the chassis backwards a trifle so that the solder is encouraged to stay within the confines of the chassis walls. Before applying the solder it is sound practice to ensure that the metal surface is clean by rubbing the area with a small ball of steel wool.

With a clean hot iron it is a simple task to run in a quantity of solder sufficient to build up a firm reinforcement for the corner. A little practice is required to get the knack of this operation but if the rules of good soldering are adhered to and adequate solder used it will be found both a simple and satisfying process.

Mounting the Components

Attaching many of the main components is most satisfactorily accomplished by soldering them in position. Holes for valveholders can be made normally with a chassis punch after deciding upon the correct orientation of the valveholder, it can be soldered to the chassis by applying the iron and solder to the fixing lugs which are provided for normal bolting to the chassis. The lugs should of course have been previously cleaned with steel wool.

All leads to earth as well as components such as grid resistors can be soldered direct to the chassis, this being desirable from the point of view of electrical efficiency and stability as well as taking much less time than by earthing with the

usual bolted tags. The less-cluttered appearance below chassis can be seen from Fig. 4.

Components such as resistors or capacitors should be secured as normal with soldering tags of which there are many varieties available. A very useful type is that which can be purchased in strips about 1ft long and is composed of a paxolin strip holding a series of tags, every third one having an extension for mounting. Such a strip can be cut according to the length needed and fixed to the chassis by soldering the mounting feet.

Again, should the original position be incorrect an adjustment is rendered easy by unsoldering rather than unscrewing and re-drilling and so maintaining a tidy appearance.

Cutting Holes

Experience has shown that some advantage accrues in marking out the position of the main components before bending the chassis sides, and holes for valveholders, potentiometers and variable capacitors etc., should be cut whilst the sheet is still flat. Small holes present no difficulty but when drilling large ones the process is not quite so simple when only hand tools are employed.

The most satisfactory way to achieve an undistorted hole is to clamp the sheet between two pieces of material having the density of perspex or ebonite and then drilling right through, however this is not always convenient especially when the

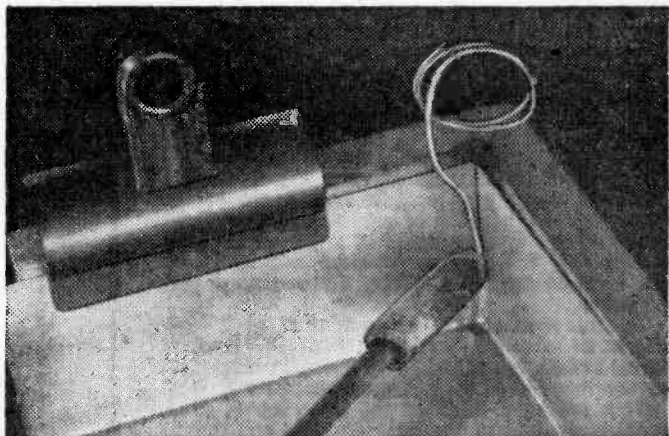

Fig. 3: Soldering the corner joints.

chassis has been formed and already supports a number of other components.

Some of the larger holes can be camouflaged by using non-slip washers for potentiometer shafts and chassis cutters automatically remove the burred material surrounding the initial hole. In other cases the edges of holes can be tidied up quite effectively with the aid of fine round or half-round files.

A word of warning is needed here for care when handling tin plate which has been cut or drilled for the edges are very sharp and produce deep cuts if the precaution of rounding edges with fine emery cloth is overlooked.

Complex screen arrangements and varying degrees of rigidity, special purpose brackets or

MAILPLAN

Immediate Despatch Service! Best value for money!
 Dept. PW 138 Lewisham Way, New Cross,
 London, S.E. 14. TlDeway 6667

Terms of business—Cash with order or C.O.D.

TWO SENSATIONAL TRANSISTORISED INTERCOMS

HANDY INTERPHONE

For Home, Workshop, Office, two-way calling. Consumes current only when talking or calling. Housed in attractive plastic cabinets with chrome stands. Completely portable. Master and sub-station. Replacement battery only 2/6.

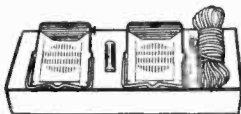

MAILPLAN PRICE
89/6 Incl. PP3 battery, and 25 yds. lead with plugs. P. & P. 3/-.
 (Today's value 8 gns.)

7 Station De Luxe Transistorised Intercom

The very latest in Office and Factory communication. Calling is audio and visual. Battery operated but consumes current only when calling or talking. Neat compact attractive units up to 6 extensions supplied separately. Battery life 300 hours.

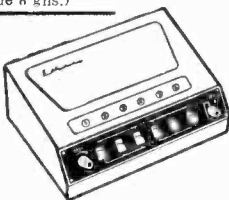

Master **14 GNS.** Post free.
 Extension **2 gns.** Post free.

HAVE THE PRICE OF OTHER MAKES

Construct your own Record Player, Intercom, Tape Recorder, etc., with the

PK.543 SUBMINIATURE 4-TRANSISTOR PUSH-PULL AUDIO AMPLIFIER 52/6

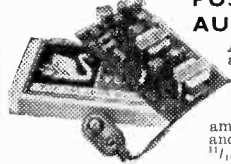

An assembled and wired miniature amplifier incorporating output transformer, and 4 transistors, class B, 200 m. watts. All connections for battery, speaker and volume control. The quality is amazing. Complete with instructions and circuit P217A. Size 3 x 1 1/16 x 1 1/16 in.

8 ohm speaker to suit above. 21" Flux density. 7,800 Gauss. Power, 200 mW. **16/6** P. & P. 1/-

THE FINEST STEREO AMPLIFIER EVER PRODUCED AT THIS PRICE!

The SA 300 Integrated Stereo Amplifier, astonishingly versatile, luxury styling, designer-built for the enthusiast with a professional audio engineer specification and incomparable performance. No effort has been spared to make this superb new dual 15-watt stereo amplifier more than worthy of a place in the finest Hi-Fi system. Lavish and comprehensive controls permit precise adjustment of balance, volume and tonal characteristics through the entire audio spectrum. Frequency range ± 0.5 dB 30 to 25,000 c.p.s. You must read the full specification for yourself. Ask now for illustrated literature. Price, complete with installation and operation manual. **£32.10.0**

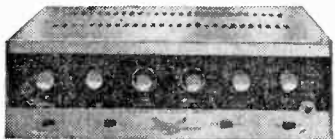

PORTABLE SOLDERING IRON Model SPI 30 Watt 230 Volts

(Size 10 1/2 in. 6 1/2 in. when not in use.) Designed on an entirely new principle for light-weight applications. Highly stable heat characteristics ensure long life. Removable handle permits iron to be carried safely even while hot. Supplied complete with Vinyl bag, lead and plug. Spares available. Element 4/6. P. & P. 6d.

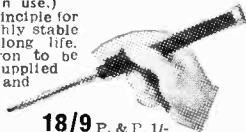

18/9 P. & P. 1/-

A HIGH QUALITY PROFESSIONAL MIKE

DM.11 MICROPHONE with Base. A flexible, newly designed, dynamic microphone integrated with a matching desk stand. Professional quality, ideal for tape recording, public address, broadcasting and communications. Ruggedly constructed, removable base for desk or hand use. 360° swivel ball joint allows tilting in any direction. 9" high, body dia. 2" tapering to 1". Base 5" dia. Magnificently finished in mist blue with chrome trimming. Complete with shielded cable stand. Fully guaranteed.



AT LOW CCST **5 GNS.**

SERVICE ENGINEERS!

The most useful tool that money can buy...

the D900

TRANSISTOR TESTER/ POWER SUPPLY

LABOUR SAVING SPEEDY SIMPLE

ONLY £10 Ask for full technical specification?

Checks Alpha gain (Current gain—AC)

Checks Beta gain (Current gain under DC conditions).

Measures Leakage currents between Collector/Base and Collector/Emitter at any voltage between zero and 25 V. Specially designed for all receivers using PNP Transistors. Size 3 1/2 x 3 x 2 1/2 in.

NOW you can carry out fast testing of transistors and miniature transistor receivers without removing transistors from circuit. Self-contained signal tracing oscillator, self-contained variable power supply.

Miniature Clear Plastic Panel Meters

FOR YOUR HOME-BUILT TEST EQUIPMENT

DC MICROAMMETERS Model MR.25 0 to 50µA .. 39/6
 Model MR.250 0 to 500µA .. 52/6
DC MILLIAMMETER Model MR.21 0 to 1 mA .. 27/6
 All models Individually Boxed and Fully Guaranteed. P. & P. 2/6 each.

"S" METER MODEL SR.2P. Standard "Ham" Signal strength indicator. Calibrated in "S" units from 0-9 with scale terminating in -10 to +30 dB calibrations. Additional full scale calibrations pt 0-5+0-10 in linear scale divisions, 35V.
VU METER MODEL VR.1P. Calibrated and damped in accordance with standard VU Meter Practice. Upper scale reads -20 to +3VU. Lower scale 0-100% modulation. Uses precision carbon film multiplier resistor and full wave rectifiers. 42/6.



SKANTEST—THE LOWEST PRICED L.O.P.T. TESTER

Tests TV Windings for shorting turns by unique pulse method. This compact instrument can save you pounds. It detects a single shorting turn in a line output transformer, deflector coil or other Windings. The pulses provided by the instrument detect intermittent faults. In position one, the continuity of the winding is checked; in position two, high impedance coils and in position three, low impedance coils. Once you have used the Skantest you will regard it as a must in TV Servicing.

Exclusive Mailp'an Offer **99/6** P. & P. 2/9

MULLARD TAPE RECORDER AMPLIFIER

Printed circuit board and set of 27 capacitors ranging from 50 + 50µF at 350 v. to 47 pF. **28/-** plus 1/6 P.P.



MODEL V-7A/F VALVE VOLTMETER

Equal to many higher priced instruments. Gold-plated printed-circuit. High input impedance (11 megohms). The V-7A measures A.C. volts (0-1.5, 5, 15, 50, 150, 500, 1,500) R.M.S. and A.C. volts (0-4, 14, 40, 140, 400, 1,400 and 4,000) pk-to-pk. D.C. volts (0-1.5, 5, 15, 50, 150, 500, 1,500) Ohms (with 10 ohms centre) X1, X10, X100, X1,000, X10K, X100 Kand X1 megohm. **£19.18.6** Complete with 32-page handbook

MODEL V-7A (in kit form) **£13.18.6.**

M178 CRYSTAL LAPEL MIKE 17/6

100-8,000 cps. 1 1/2 in. diam., 5ft. lead. P. & P. 1/-.

MAXI-Q
REG. _J

"THOUGH THE WORKING WEEK IS SHORTER WITH WAGES AND MATERIALS EVER MORE COSTLY"

Thanks to you, our Customers who purchase in ever-increasing numbers, we are still able to offer the finest ever coils without increased prices.

Coverage from 3.8 to 2,000 metres in 7 ranges—Each coil is packed in an aluminium container which may be used as a screening can for the coil itself—Brass threaded, adjustable iron cores—Colour coded moulded polystyrene formers—Chassis/Plug-in Technical Bulletin, DTB.4 1/6—Colour Code Identified Coils: BLUE Signal Grid Coil with Aerial Coupling winding—YELLOW Signal Grid Coil with intervalve coupling winding—GREEN Grid Coil with reaction and coupling windings—RED Superhet Oscillator for I.F. of 465 Kc/s—WHITE Superhet Oscillator for 1.6 Mc/s. Prices range from 4/1 to 4/9 each. Five-Colour Glass Scale, Back Plate, Pointer, Pulleys and Cord for use with 315 pF tuning condensers. Coverage (1) 150-400 Kc/s.; (2) 530-1,600 Kc/s.; (3) 1.5-4 Mc/s.; (4) 4-12 Mc/s.; (5) 10-30 Mc/s.; Price 19/-.

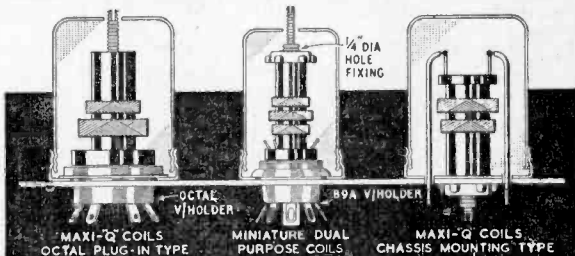

GENERAL CATALOGUE covering full range of components send 1/6d. in stamps or P.O.

PLEASE SEND S.A.E. WITH ALL ENQUIRIES

DENCO (CLACTON) LTD. (Dept. P.W.) 357/9 Old Road, Clacton-on-Sea, Essex
STOP PRESS: S.B. DECODER TRANSFORMERS—26/- each.

FULLY GUARANTEED NEW VALVES	
OA2	6/-
OB2	6/-
OC2	6/-
OD2	5/-
OZ4	5/-
IA3	3/-
IA3GT/6A5	6/-
IA7GT	10/-
IG6GT/G7	6/-
IE5GT	9/-
IIA	3/-
IN5GT	9/-
IL5	6/-
IS4	5/-
IS5	5/6
IT4	4/-
IT5GT	9/-
IU4	7/-
IU5	7/-
I22	22/6
1X2B	7/-
2A3	5/-
2D21	6/-
2E26	20/-
2X3	3/-
3A4	4/-
3A5	7/-
3A8GT	9/-
3E23	15/-
3D6	4/-
3E29	50/-
3Q4	7/-
3B4	5/-
3V4	6/6
4X150A	50/-
5B4GY	9/-
5B4WGA	6/5
5T4	15/-
5U4GB	9/-
5V4C	9/-
5Y3G	9/-
5Y3GT	6/-
5Z3	6/-
5Z4	9/-
5Z4G	9/-
6X00L2	10/-
6A8M3	9/-
6A8	5/-
6A8MG	7/-
6A8B4	6/6
6A8T	7/-
6AG5	3/-
6AG7	6/-
ECH81	7/6
ECH83	8/-
ECL80	7/6
ECL82	8/6
ECL83	14/-
EF3	12/-
EF3A	8/-
EF3	8/-
EF35	10/-
EF40	10/-
EF41	8/-
EF42	7/6
EF50	1/6
EF55	8/-
EF60	7/-
EF65	6/6
EF70	8/-
EF75	8/-
EF80	10/-
EF81	10/-
EF82	7/-
EF83	10/-
EF84	13/-
EF85	11/-
EF86	11/-
EF87	11/-
EF88	11/-
EF89	11/-
EF90	11/-
EF91	11/-
EF92	11/-
EF93	11/-
EF94	11/-
EF95	11/-
EF96	11/-
EF97	11/-
EF98	11/-
EF99	11/-
EF100	11/-
EF101	11/-
EF102	11/-
EF103	11/-
EF104	11/-
EF105	11/-
EF106	11/-
EF107	11/-
EF108	11/-
EF109	11/-
EF110	11/-
EF111	11/-
EF112	11/-
EF113	11/-
EF114	11/-
EF115	11/-
EF116	11/-
EF117	11/-
EF118	11/-
EF119	11/-
EF120	11/-
EF121	11/-
EF122	11/-
EF123	11/-
EF124	11/-
EF125	11/-
EF126	11/-
EF127	11/-
EF128	11/-
EF129	11/-
EF130	11/-
EF131	11/-
EF132	11/-
EF133	11/-
EF134	11/-
EF135	11/-
EF136	11/-
EF137	11/-
EF138	11/-
EF139	11/-
EF140	11/-
EF141	11/-
EF142	11/-
EF143	11/-
EF144	11/-
EF145	11/-
EF146	11/-
EF147	11/-
EF148	11/-
EF149	11/-
EF150	11/-
EF151	11/-
EF152	11/-
EF153	11/-
EF154	11/-
EF155	11/-
EF156	11/-
EF157	11/-
EF158	11/-
EF159	11/-
EF160	11/-
EF161	11/-
EF162	11/-
EF163	11/-
EF164	11/-
EF165	11/-
EF166	11/-
EF167	11/-
EF168	11/-
EF169	11/-
EF170	11/-
EF171	11/-
EF172	11/-
EF173	11/-
EF174	11/-
EF175	11/-
EF176	11/-
EF177	11/-
EF178	11/-
EF179	11/-
EF180	11/-
EF181	11/-
EF182	11/-
EF183	11/-
EF184	11/-
EF185	11/-
EF186	11/-
EF187	11/-
EF188	11/-
EF189	11/-
EF190	11/-
EF191	11/-
EF192	11/-
EF193	11/-
EF194	11/-
EF195	11/-
EF196	11/-
EF197	11/-
EF198	11/-
EF199	11/-
EF200	11/-
EF201	11/-
EF202	11/-
EF203	11/-
EF204	11/-
EF205	11/-
EF206	11/-
EF207	11/-
EF208	11/-
EF209	11/-
EF210	11/-
EF211	11/-
EF212	11/-
EF213	11/-
EF214	11/-
EF215	11/-
EF216	11/-
EF217	11/-
EF218	11/-
EF219	11/-
EF220	11/-
EF221	11/-
EF222	11/-
EF223	11/-
EF224	11/-
EF225	11/-
EF226	11/-
EF227	11/-
EF228	11/-
EF229	11/-
EF230	11/-
EF231	11/-
EF232	11/-
EF233	11/-
EF234	11/-
EF235	11/-
EF236	11/-
EF237	11/-
EF238	11/-
EF239	11/-
EF240	11/-
EF241	11/-
EF242	11/-
EF243	11/-
EF244	11/-
EF245	11/-
EF246	11/-
EF247	11/-
EF248	11/-
EF249	11/-
EF250	11/-
EF251	11/-
EF252	11/-
EF253	11/-
EF254	11/-
EF255	11/-
EF256	11/-
EF257	11/-
EF258	11/-
EF259	11/-
EF260	11/-
EF261	11/-
EF262	11/-
EF263	11/-
EF264	11/-
EF265	11/-
EF266	11/-
EF267	11/-
EF268	11/-
EF269	11/-
EF270	11/-
EF271	11/-
EF272	11/-
EF273	11/-
EF274	11/-
EF275	11/-
EF276	11/-
EF277	11/-
EF278	11/-
EF279	11/-
EF280	11/-
EF281	11/-
EF282	11/-
EF283	11/-
EF284	11/-
EF285	11/-
EF286	11/-
EF287	11/-
EF288	11/-
EF289	11/-
EF290	11/-
EF291	11/-
EF292	11/-
EF293	11/-
EF294	11/-
EF295	11/-
EF296	11/-
EF297	11/-
EF298	11/-
EF299	11/-
EF300	11/-

Z & I AERO SERVICES LTD
Retail Shop: 85 TOTTENHAM COURT ROAD
Tel: LANGHAM 8403

Head Office and Warehouse: 14 SOUTH WHARF RD., W.C. Tel: AMB 0151/2, 0677
Please send all correspondence and Mail Orders to the Head Office.

NUVISTORS
6CW4 (6.3V.) or CW4 (2V.) 14/-
7586—General Purpose Medium Triode 22/6
7593—General Purpose High Triode 22/6
Bases for the above 2/9 each.

TRANSISTORS
Mullard Top Quality: OC44 7/6; OC45 6/6; OC78 7/-;
OC78D 7/-; OC81 7/-; OC81D 7/-; OC72 8/-; Pair of
Matched OC78 or OC81 13/-; Set of two OC78 and one
OC78D or Set of two OC81 and one OC81D 18/-;
Substandard Transistors, perfect to use on reduced volt-
age: OC44 3/-; OC45 3/-; Brand New R.C.A. Transis-
tors: 2N410 (OC45) 5/-; 2N412 (OC44) 5/-; White Spot
2/8; Red Spot 2/8; Yellow Spot 1/10; Green Spot 1/10.
Texas transistors: 2N404 40/-; 2N4012 14/-.

OUTDOOR SECTIONAL AERIALS
"ELECTRON" ROD AERIALS: 3 strong tubular light
alloy 3ft. long screw-in sections, insulated aerial base
and mounting bracket suitable for wall or window sill
mounting. Brand new. Complete down lead.
15/-, postage, etc., 5/-.

CATHODE RAY TUBES
3BP1 22/6; Bases 3/6
ACR10, 2in. screen, equivalent to VCR139A, 20/- ea.
913 R.C.A. 1in. screen miniature medium persistence
tube integral with metal screen. Overall length 4 1/2in.
450 v. E.H.T. 6.3 v. htr. I.O. Base. 60/-

HEADPHONE CORDS
3 ft. long, with wire loop ends, suitable for a/cies
connections of carbonets, terminated with P.O.
Red plug. 5/-. P.F. 9d.
PLEASE ADD 2/6 in £ on all PURCHASES FOR
POSTAGE AND PACKING.

combinations of chassis can result from the application of simple geometric and engineering principles. The small bracket shown in Fig. 4 is typical, the shaft bearing originated in a defunct potentiometer. A right angle bend or two partitions set at right angles can impart a remarkable degree of stiffness whilst performing the function of electrical screening.

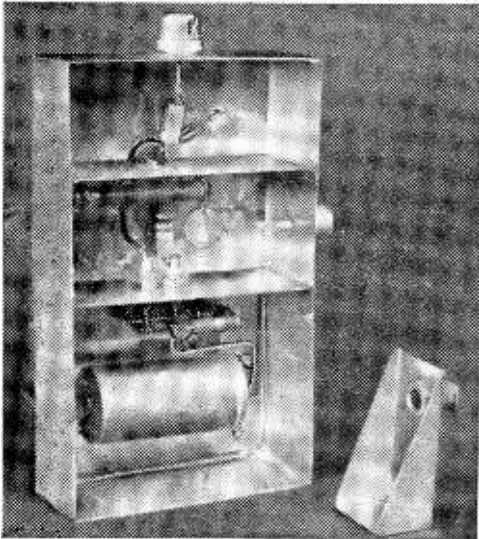

Fig. 4: A finished chassis and a strengthening bracket.

Permanently Fixed Nuts

It very often occurs as a piece of equipment progresses that it is necessary to remove temporarily a particular section or major component which during the earlier stages of construction was easily accessible but later becomes crowded in with other components so that although the fixing nuts can be removed quite easily, replacing them becomes a task requiring both ingenuity and patience. If before fixing, the nuts (preferably of brass) are soldered in position the screws can be used as normally with the advantage that their subsequent removal and re-entry is rendered easy.

When soldering brass nuts some solder will inevitably enter the thread but this yields to the introduction of the appropriate tap. This method may also be used for the linking up of two or more sub-chassis to form a complex final assembly which would otherwise be unwieldy if built as a whole.

The complete unit constructed by this method presents a perfectly satisfactory appearance and should perform well electrically. There is the additional reward of achievement and considerable economy together with the convenience of being able to produce a tailored chassis without delay, even if this idea is only used as a stand-by measure for the production of prototype units or temporary experimental set-ups.

The ease with which tin plate can be fashioned makes it an attractive material for many radio and electronic purposes, whilst this is not the limit of its scope as will become apparent to anyone who is converted to its use.

CORRIGENDA

Electro-Mechanical Echo Unit

The diagram given below should be substituted for the circuit of a power unit which appeared on page 1114 (April 1963 issue).

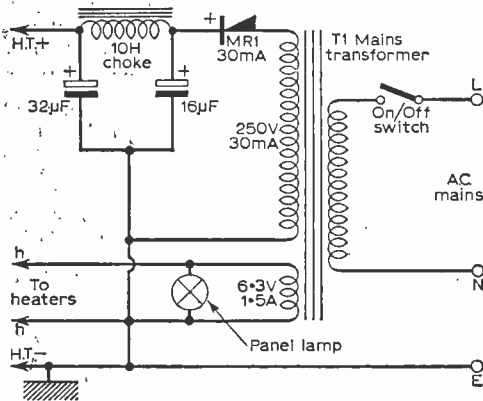

Fig. 3 (above): The power unit.

A Simple Filter Network

In Fig. 3, page 824 of the January 1963 issue, the heater wiring of the ECC83 valve should be amended as follows: link together pins 4 and 5, disconnect pin 9 from chassis. One side of the 6.3V supply is now applied to pins 4, 5 and the other side to pin 9.

Amend the Components List to read: C7 4,700pF ceramic or mica.

Test Gear Techniques

In the Equivalences Table on page 900 (February 1963 issue) the resonant frequency (fr) is given in Megacycles, not in kilocycles as stated in the footnote to the formula

$$f_r = \frac{1}{2\pi\sqrt{LC}}$$

PRACTICAL WIRELESS CIRCUITS

17th Edition

By F. J. CAMM

17/6 by post 18/7

from

GEORGE NEWNES, LTD.,

Tower House, Southampton Street, London W.C.2.

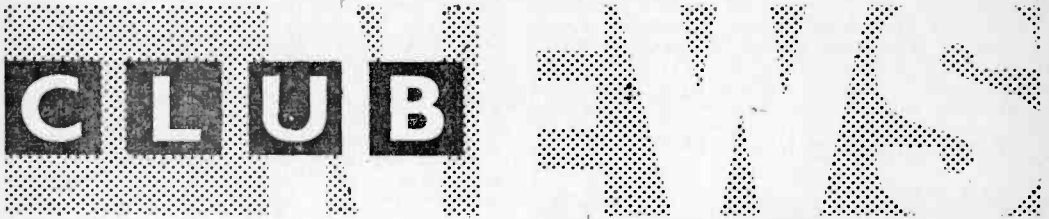
**CLIFTON AMATEUR RADIO SOCIETY**

Hon. Sec.: C. Godsmark, G3IWL, 211 Manwood Road, London, S.E.4.

On March 15th members enjoyed a lecture by G3NWF, when his subject was "Transistor Transmitters". The demonstration which followed was also well received.

The April meeting took the form of a quiz, with G3OGE putting the questions. The members' scores from this quiz count in the annual club championship.

COVENTRY AMATEUR RADIO SOCIETY

Hon. Sec.: A. J. Wilkes, G3PQQ, 141 Overslade Crescent, Coundon, Coventry, Warwickshire.

At the first meeting in March, G3CZS elaborated on the account he gave last September of his continental holiday of 1962, when he met many foreign amateurs through the International Ham Hop Club.

March 18th was Junior Quiz Night and on the 25th, G3NAP gave an interesting talk on "Mobile Operation".

DERBY AND DISTRICT AMATEUR RADIO SOCIETY

Hon. Sec.: F. C. Ward, G2CVV, 5 Uplands Avenue, Littleover, Derby.

The lecture given by G3FOP on March 13th—"Car Radio Interference Problems"—proved of interest to all those members who attended. After an "open evening" on the 20th, the Hot Pot Supper of the 27th went down very well.

A sale of surplus items of equipment was held on April 3rd.

FLINTSHIRE RADIO SOCIETY

Hon. Sec.: A. Antley, "Fairholme", Fairfield Avenue, Rhyl, Flintshire.

The only meeting of this Society in March was held on the 25th, and after the usual Morse practice there followed an interesting lecture by L. W. Barnes called "Simple Hints and Kinks".

This was followed by another lecture—"Fault Finding"—which was given by J. T. Lawrence.

GRIMSBY AMATEUR RADIO SOCIETY

Hon. Sec.: B. Walster, 47 Richard Street, Grimsby, Lincolnshire.

Those wishing to join in the Grimsby Society's "Old-fashioned Hamfest" to be held on May 12th at Cleethorpes, should contact the secretary, Mr. Walster. The tickets, which include the cost of high tea and car parking facilities, cost 10s. each.

LOTHIANS RADIO SOCIETY

Hon. Sec.: W. T. Sutherland, GM3JWS, 47 Great King Street, Edinburgh 3.

The subject of Mr. Russell's lecture, which he gave on March 14th, was the "History of Automobile Communications". The lecture on the 28th—"Electronics"—was the result of the combined efforts of GM3OWI and GM3LCP.

MEDWAY AMATEUR RECEIVING AND TRANSMITTING SOCIETY

Hon. Sec.: P. J. Pickering, G3ORP, 101 Chatham Road, Maidstone, Kent.

On March 4th members had a chance to discuss the future dates on which their fortnightly meetings should be held. Later in the month there was a constructional competition open to all members: this was on the 18th.

April 1st was "Tramps' Night", when members began the month's programme of events with a very enjoyable evening.

MELTON MOWBRAY AMATEUR RADIO SOCIETY

Hon. Sec.: D. W. Litley, G3DFD, 23 Melton Road, Asfordby Hill, Melton Mowbray, Leicestershire.

On March 14th, the Rev. A. W. Shepherd was host to those members of the Society who made a visit to his shack, and on the 21st he was again kept busy with a demonstration of amateur radio at Grimston.

Future Event: April 18th—"Transmitter Construction for N.F.D." by G3OWR.

MIDLAND AMATEUR RADIO SOCIETY

K. Morton, G3OVQ, 58 Burns Road, Coventry, Warwickshire.

The Rally Organising Committee of the North Midlands Mobile Rally has announced the date for the event as April 21st. This rally, which is organised jointly by the Midland and Stoke-on-Trent Amateur Radio Societies, will be held at Trentham Gardens, Trentham, Staffordshire.

Attendance figures for this rally last year mounted to more than 4,000 and it is hoped to better this number this year. Talk-in stations will be G3GBU/A on 160m, and G3MAR/A on 2m.

MIDLAND RADIO CONTEST CLUB (G3RSR)

Hon. Sec.: J. J. Lockyer, G3OYA, 153 Ivor Road, Birmingham, 11.

As the name suggests, the main aim of members of this society is to enter as many contests as possible. The society has its own clubroom at an ideal site on a hill eight miles out of Birmingham, and meetings are held on the first Friday in each month at this H.Q.

MID-WARWICKSHIRE AMATEUR RADIO SOCIETY

Hon. Sec.: T. Inkester, 13 Dormer Place, Leamington Spa, Warwickshire.

At the recent Annual General Meeting, this Society elected its officers for 1963. Those members who wish to sit the R.A.E. can take advantage of the course of instruction in radio theory, which the Society arranged with the Mid-Warwickshire College of Further Education.

NORTHERN AMATEUR RADIO MOBILE SOCIETY

Hon. Sec.: B. Crisp, G3LHQ, Ashmount, Moorhouse Lane, Birkenshaw, Near Bradford, Yorkshire.

The date for the Northern Mobile Rally, which is organised by this Society, is announced as being Sunday, May 26th. Once again this event will be held in the grounds of Harewood Park, near Leeds.

—continued on page 82

R.S.G.B. Contests for April: Low Power Contest (April 6th and 7th) and D/F Qualifying event (April 21st).

"INSTANT AMATEURS"

THERE is no short-cut to becoming a licensed amateur transmitter. This is a fact we are constantly repeating for people who write to the Editor wanting to know "where can I get a transmitting licence, and how much will it cost?" Not that we resent these enquiries, as most often the writer is a very young enthusiast who has just had his first success with a crystal set and now wants to "spread his wings" somewhat. However, it is as well for any potential ham to bear this fact always in mind, as there is no stimulus for pre-R.A.E. studying in searching for an easy way to get a "ticket".

Many argue that the R.A.E. is unwarranted and licences should be issued on demand, or that certain concessions should be made so that the public could make use of part of the frequency spectrum, on similar lines to the American Citizen's Band. But whatever the rights and wrongs of these arguments may be, the fact remains that under the present system the law requires that anyone wishing to use a radio transmitter, must take and pass tests, not, as most opposers to the schemes seem to think, to keep the number of licensed amateurs down to a manageable few, but to satisfy the authorities that those using the allotted frequencies will not abuse the privilege.

Then what is the use of all this argument?—just so much wasted time which could have better been spent studying. As far as we know, there is no product at present on the market promising "instant amateurs", and so concentrated effort seems to be the only sure way to that precious licence.

EASY TO BUILD



AMATEUR RADIO EQUIPMENT

CR 66 COMMUNICATIONS RECEIVER ★ A CODAR KIT TRIUMPH

NOW ... THE FINEST KIT EVER OFFERED!

This completely new Communications Receiver with its many design features and handsome styling offers more in performance and quality than many higher priced units.

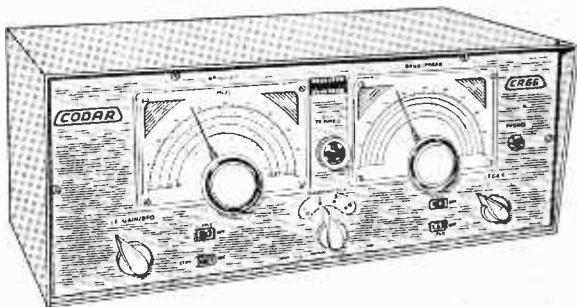

Frequency Range 540 Kc/s to 30 Mc/s in four Band-switched ranges. Separate Main Tuning and Electrical Bandsread. Entirely new design High "Q" ferrite cored Coils. Oscillator Coils fitted temperature compensated trimmers for stability. Coil Unit is wired and assembled, and with the I.F. Transformers is supplied factory aligned and tested. Low loss Trolax glass alkylid switch wafers. Controlled regenerative I.F. amp. for maximum gain and B.F.O. Panel Ant. Trimmer. Delayed A.V.C. Cathode follower output for tape recorder, etc. 3 watts output for external 2/3 ohm speaker. Four panel slider switches, On-Off/Standby-Receiver/A.V.C. On-Off/Speaker On-Off. Front Panel Silver and Black, control knobs Grey with Silver trim. Provision for EM84 Signal strength indicator. Panel phone jack. Heavy gauge steel chassis, cadmium plated. Valve line-up: ECH81/EBF89/ECC81/EL84/EZ80. Instruction Manual, 17 pages. Cabinet size 16 x 6½ x 8½ ins. Silver Grey. For AC 200-250 volts. (Export and Marine Model 115 volts.) Total cost of complete Kit, less Cabinet and Indicator **£16.10.0** carr. 6/-

CR 66 Cabinet **£1.15.0** Signal strength indicator with EM84 **17/6**

H. P. Terms available. Details on request.

THE NEW CR 45 ★ NEW STYLING TOP PERFORMANCE

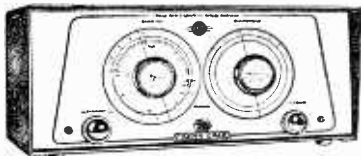

- ★ Tunes 10-2000 metres (5 Coils).
- ★ Separate electrical bandsread.
- ★ Three slow motion vernier drives.
- ★ Low loss polystyrene plug-in coils, factory aligned.
- ★ Dials calibrated in frequencies and degrees.
- ★ Power output 3 watts for 2/3 ohm speaker.
- ★ Valve line-up: ECC81/EL84/EZ80.
- ★ Front Panel Silver and Black, control knobs Grey.
- ★ Provision for panel phone jack.

Superb styling. World-wide reception. Total building cost, with 2 Coils, 25-75 and 60-175 metres.

Instruction Manual 11 pages, less Cabinet

£6.19.6 carr. 3/6

CR 45 Cabinet Silver Grey, 12 x 5½ x 7in. sliding door for easy coil changing

27/6

Extra coils, all ranges

4/9 each.

ALL PARTS AVAILABLE SEPARATELY

★ THE MINI-CLIPPER ★

- ★ Tunes 10-2000 metres (5 coils).
- ★ Miniature 1 valve, all band receiver.
- ★ Low loss polystyrene plug-in coils, factory aligned.
- ★ Air spaced ball bearing condensers.
- ★ Provision to add two-transistor amplifier.
- ★ Battery lasts months.



36/6

Can be built in an evening, will receive Amateur and Broadcast stations from all parts of the world. Total building cost with one coil 25-75 metres, Instruction Manual 4 pages, 36/6, carr. 2/6. Extra coils, all ranges, 4/9 each. Electrical bandsread available. All parts available separately.

★ THE SUPER CLIPPER ★

- ★ Tunes 10-2000 metres (5 coils).
- ★ Large precision dial, dual slow motion drives.
- ★ Bandsread on all Bands.
- ★ High gain valve/transistor hybrid circuit.
- ★ 2 Mullard transistor amplifiers, pre-assembled and tested.
- ★ Low loss polystyrene plug-in coils, factory aligned.
- ★ Batteries last months.



88/6

Easy to assemble, this top performing All Band Receiver brings a new world of listening pleasure to your finger-tips at low cost. Total building cost with 2 Coils, 20-60 and 55-190 metres, Instruction Manual 7 pages, 88/6, carr. 2/6. Extra Coils, all ranges, 4/9 each. Front Panel. Silver Grey, 10 x 7½ in., 6/9.

Please note NEW address. We have now acquired new modern premises, combining all depts., offices and laboratories. New equipment under development will be announced in due course. Now available P.R.30 R.F. Preselector 1.5/30 Mc/s., greatly improves performance of any superhet receiver. CODAR Equipment is famous for Top Quality, Peak Performance and Easy-to-Follow Instructions—no guesswork. 6d. in stamps brings illustrated leaflets.

CODAR RADIO COMPANY

BANK HOUSE, SOUTHWICK SQUARE, SOUTHWICK, SUSSEX

G31RE

Canadian Distributors: JAYCO ELECTRONICS, TWEED, ONT.

G31PA

TRANSISTOR AMPLIFIERS

1/2 WATT 3 TRANSISTOR AMPLIFIER READY BUILT

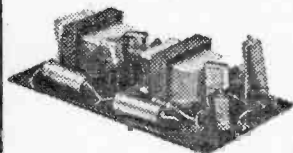

45/-

Plus 1/6 P. & P.

- ⊕ 1/2 w. Peak output.
- ⊙ Output to 3 ohm speaker.

- Push-pull output stage.
- ⊙ 9 volt operation.

A printed circuit high gain amplifier. Size 5" x 2" x 1". Three Newmarket Transistors (two NKT 251 and NKT 252). Ideal for intercom or as record player amplifier.

2 WATT 4 TRANSISTOR AMPLIFIER READY BUILT

A 2 watt 4 transistor amplifier with 2 driver and push-pull stage. Size 5" x 2" x 1 1/4". 3 ohms output, 1000 ohms input 9 volts. Battery operated.

Plus 1/6 P. & P.

62/6

Please send S.A.E. for full details of these and other transistor designs

MEL ELECTRONIC CO.

REAR OF 240 HIGH STREET
BECKENHAM, KENT

THE NEW TRANSISTOR 6 PANDORA

Designed by

Mel Electronic

USING NEW HIGH GRADE PARTS

TOTAL BUILDING COST

ONLY £4.15.0

p.p. 3/6

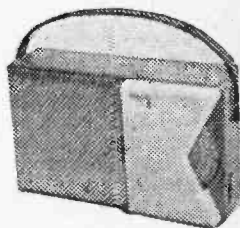

FULL AFTER SALES SERVICE

All components obtained direct from MEL ELECTRONIC

- ★ MEDIUM WAVE & LIGHT ON LONG WAVE
- ★ 6 TRANSISTORS + DIODE
- ★ SUPERHET CIRCUIT
- ★ AUTOMATIC WAVECHANGE
- ★ 500mW PUSH-PULL OUTPUT
- ★ PRE-TINNED PRINTED BOARD
- ★ EXCELLENT RESULTS

FREE TO AMBITIOUS ENGINEERS

— THE LATEST EDITION OF ENGINEERING OPPORTUNITIES

Have you sent for your copy?

ENGINEERING OPPORTUNITIES is a highly informative 156-page guide to the best paid engineering posts. It tells you how you can quickly prepare at home for a recognised engineering qualification and outlines a wonderful range of modern Home Study Courses in all branches of Engineering. This unique book also gives full details of the Practical Radio & Electronics Courses, administered by our Specialist Electronics Training Division—the B.I.E.T. School of Electronics, explains the benefits of our Employment Dept. and shows you how to qualify for five years promotion in one year.

We definitely Guarantee "NO PASS — NO FEE"

Whatever your age or experience, you cannot afford to miss reading this famous book. If you are earning less than £25 a week, send for your copy of "ENGINEERING OPPORTUNITIES" today—FREE.

BRITISH INSTITUTE OF ENGINEERING
TECHNOLOGY (Incorporating E.M.I. Institutes)
(Dept. SE/21), 29 Wright's Lane, London, W.8

WHICH IS YOUR PET SUBJECT?

Mechanical Eng.,
Electrical Eng.,
Civil Engineering,
Radio Engineering,
Automobile Eng.,
Aeronautical Eng.,
Production Eng.,
Building, Plastics,
Draughtsmanship,
Television, etc.

GET SOME LETTERS AFTER YOUR NAME!

A.M.I. Mech. E.
A.M.I.C.E.
A.M.I. Prod. E.
A.M.I.M.I.
A.I.O.B.
A.F.R. Ae. S.
B.Sc.
A.M. Brit. I.R.E.
City & Guilds
Gen. Cert. of Education
Etc., etc.

PRACTICAL EQUIPMENT

Basic Practical and Theoretic Courses for beginners in Radio, T.V., Electronics, Etc., A.M. Brit. I.R.E. City & Guilds Radio Amateurs' Exam. R.T.E.B. Certificate P.M.G. Certificate Practical Radio Radio & Television Servicing Practical Electronics Electronics Engineering Automation

INCLUDING TOOLS!

The specialist Electronics Division of B.I.E.T. (Incorporating E.M.I. Institutes) NOW offers you a real laboratory training at home with practical equipment. Ask for details.

B.I.E.T. SCHOOL OF ELECTRONICS



POST COUPON NOW

Please send me your FREE 156-page "ENGINEERING OPPORTUNITIES" (Write if you prefer not to cut page)

NAME

ADDRESS

SUBJECT OR EXAM THAT INTERESTS ME SE 21

THE B.I.E.T. IS THE LEADING ORGANISATION OF ITS KIND IN THE WORLD

T rade N ews

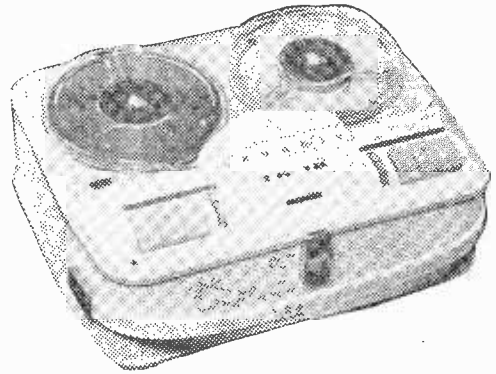

The model TK18 tape recorder from Grundig Ltd.

TAPE RECORDER

THE model TK18 tape recorder is a new single-speed model from Grundig (Great Britain) Ltd. This recorder incorporates as a recording level control, a "Magic Ear". This is an automatic sensing unit which has a specially designed control valve which feeds information to all three amplifier stages, including the frequency correction network.

The frequency of the TK18 is 40 to 12,000c/s, and the running time per tape is one hour each track. The internal loudspeaker is a 5½ in. x 4½ in. elliptical type and a moving coil microphone is supplied. The valve line-up of the amplifier is ECC83, ECL86, EM84 and the output power is 2.5W.

The price of the TK18 is 39 guineas and the makers are Grundig (Great Britain) Ltd., Newlands Park, Sydenham, London, S.E.26.

RECORD CHANGER

AT the recent international radio and electronics exhibition held in Paris, Telefunken exhibited a wide range of their valves, semiconductors, components, tuners and record player chassis. Among these was the TW504 record changer. The de Luxe version of this model is presented in a polished wood cabinet with a hood of smoked glass.

The Telefunken agents for the U.K. are Welmecc Corporation Ltd., 147-148 Strand, London, W.C.2.



A new miniature microphone made by Amplivox Limited.

MINIATURE MICROPHONE

A NEW development of Amplivox Limited is a miniature hand microphone, which is called the Mini-Mike. This can be used at the lapel as both microphone or reproducer.

Although very small, the Mini-Mike contains a sensitive electro-magnetic capsule having a sensitivity of -79dB referred to 1V/dyne/cm² at 1,000c/s. Single and double pole finger-tip switching enables this microphone to be used with pocket transmitters and as a useful accessory for miniature tape recorders and dictating machines.

The manufacturers are Amplivox Limited, Bersford Avenue, Wembley, Middlesex.

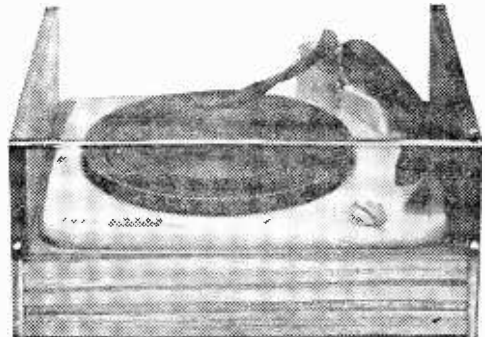

This new record changer is made by Telefunken.

Letters to the Editor

The Editor does not necessarily agree with the opinions expressed by his correspondents

Whilst we are always pleased to assist readers with their technical difficulties, we regret that we are unable to supply diagrams or provide instructions for modifying commercial or surplus equipment. We cannot supply alternative details for receivers described in these pages. **WE CANNOT UNDERTAKE TO ANSWER QUERIES OVER THE TELEPHONE.** If a postal reply is required a stamped and addressed envelope must be enclosed with the coupon from page iii of the cover.

LANGUAGE BARRIER

SIR,—I must agree with Mr. A. Jameson (Letters to the Editor, March) on the use of Esperanto for communication between amateurs on short waves. It is an ideal language for this purpose and can easily be studied at home.

Berne, Hilversum, Vienna, Rome, Paris, and some South American transmitters already use Esperanto as well as their national languages for some of their broadcasts.—**J. BROWNLEE** (Hexham, Northumberland).

SIR,—With reference to Mr. A. Jameson's letter (March, '63) concerning the use of Esperanto for radio amateurs, he does not appear to be aware that for some considerable length of time amateurs have been communicating universally without the use of this language. From his short wave listening, Mr. Jameson should have realised that most foreign amateurs are sufficiently educated so as to speak English almost fluently. (I have frequently found this the case).

Also, if a message is sent in French, it is generally meant for a Frenchman, or if in Spanish for a Spaniard, etc. So why waste time trying to learn a language which would probably cause more confusion than ever.—**N. COLLISTER** (Gloucester).

NORTHERN COMRADESHIP

SIR,—I have found reason to agree with the observations expressed on the Club News page in the March issue. In Walthamstow, a London borough of many thousands, no radio club has been possible for years. I have attempted to work on behalf of the club movement in this area for some years now, and always the members tend to visit any particular club meeting only if the subject is directly suitable for them. I don't think this is basically selfishness, but reflects a general impatience on the part of the "rushed" nature of Southern living.

Also members often admit to me that they don't visit the club to meet others, but at the Northern Polytechnic College, where we have now established a radio club and where a great number of members are *Northern* amateurs working as students in London, they do state that they go to a club primarily to meet people and hear about their work.—**K. L. SMITH** (London, E.17).

MODERN ENGLISH USAGE

SIR,—I am writing about a word used very frequently and which has puzzled me a lot. The word is "transistorised".

I ask myself, is a valve set "valve-ised"? And as I think of this I become convinced that the English language is being slowly murdered, and so I will relate what happened to my receiver when it was serviced recently.

The set, having gone faulty, was taken away by a man in his "petrolised" vehicle, or maybe it was a "dieselised" vehicle. Anyway, he probed around in this set, first in the "resistorised" section, then in the "condenserised" part, and finally found the trouble in the "valve-ised" section. I can only add that when I received his bill I was *paralysed!*—**C. H. OGILVIE** (South Shields, Co, Durham).

MISSING CLUB

SIR,—Some eighteen months ago, when I moved from London to my present address, there came to light along with many other forgotten treasures, my old B.L.D.L.C. membership certificate, dated April 4th, 1939, and my lapel badge. This set me wondering what became of the British Long Distance Listeners Club and recently I got round to going through my back numbers of PW to find out.

The last club notes to be published were in the issue dated May 1943, yet nowhere can I find notice of the club being wound up or suspended. Neither do there seem to have been any letters from members querying the future of the club. The very last reference of all seems to be in a letter to the Editor, published in the issue of August 1946.

There must have been a good reason why the B.L.D.L.C. was not started up again after the last war, but I'm sure many present-day readers besides myself who were members of the club would be interested to know the story of the club's shutdown.—**F. ALLAN HERRIDGE** (Basingstoke, Hampshire).

CLUB NEWS continued from page 78

PURLEY AND DISTRICT RADIO CLUB
Hon. Sec.: E. R. Honeywood, G3GKF, 105 Whytecliffe Road, Purley, Surrey.

On March 1st, G3OST gave an interesting talk on "Communication Receivers", and on March 15th, a spares sale was held.

SOUTH MANCHESTER RADIO CLUB
Hon. Sec.: M. Barnsley, G3HZM, "Greenways", 11 Cemetery Road, Denton, Manchester, Lancashire.

G3HZM's lecture on March 15th he called "More on a.c. Theory". Later in the month, on the 29th, the annual Hot Pot Supper was held and enjoyed by all who went.

SPEN VALLEY AMATEUR RADIO SOCIETY
Hon. Sec.: L. A. Metcalfe, 1A Moorlands Road, Birkenshaw, Bradford, Yorkshire.

On March 21st, members paid a visit to a nearby electronics firm, and on 4th April "Aerial Problems" were discussed by Mr. A. R. Bailey.

PCR COMMUNICATION RECEIVERS

Manufactured by Pye and Philips. One of the Army's most versatile and sensitive sets. RF stage and 2 of I.F., using 6 British I.O. type valves. Large 180 degrees illuminating and calibrated Dial. Flywheel Tuning with locking device. Aerial Trimmer. Tone and Vol. Controls. Band Switch 1.0m panel jacks for speaker or phones. In black metal case, size 17in. L x 8in. H x 10in. D. Model PCR covers 6-18 Mc/s. 200-550 metres and 850-2,000 metres and has internal 5-in. speaker. £8.19.6. Model PCR2 has similar L & M waveband coverage. Short wave 6-22 Mc/s, but no speaker, £5.19.6. Model PCR3, as PCR2 but has 2 short wave bands 2.7 and 7-23 Mc/s, and medium wave band 190-350 metres. ONLY 8 gns. Add 10/6 carr. all models. Designed to operate from bulky EXTERNAL power supply, but any set can be fitted with BRAND NEW COMPONENTS INTERNAL PACK for 200-250 v. A.C. at extra cost of £2.

All receivers used but excellent condition and aerial tested before despatch.

S.A.E. FOR ILLUSTRATED LEAFLET

TEST METERS FOR EVERY PURPOSE & POCKET



2,000 O.P.V. MODEL TP-10. Reads A.C. & D.C. Volts up to 1,000; D.C. Current to 500mA; Resistance to 1 Meg; Capacitance to 1µF; Decibels from -20 to +36; Output jack for Audio Measurements. Size 3 1/2 in. x 5 1/2 in. £2.19.6.



20,000 O.P.V. MODEL TP-5S. Reads voltage up to 1,000 D.C. at 20,000 ohms per volt and A.C. at 10,000 o.p.v.; D.C. Current to 500mA; Resistance to 10 Megs.; Capacitance to 0.1µF; Decibels from -20 to +36. Size 3 1/2 in. x 5 1/2 in. £5.19.6.



30,000 O.P.V. MODEL 500. Volts to 1,000; D.C. at 30,000 O.P.V. A.C. at 20,000; 12 Amps D.C. Current; 60 Megs Resistance; -20 to +56 Dbs; Internal buzzer short circuit warning. Size 3 3/4 in. x 6 5/8 in. x 2 1/2 in. £8.19.6.

All New Stock, with leads, prods and internal batteries, 6 months' guarantee backed by full service facilities. Details S.A.E.

DOUBLE BEAM OSCILLOSCOPE TUBES, TYPE CV 1596 Equivalent to COSSOR 06D as used in Oscilloscopes by Cossor 339 series) and Hartley & Erskine (13 series). Listed £12. BRAND NEW IN MAKER'S CRATES. ONLY 25/- (carriage 6/-).

LAVOIE CIP WAVEMETER MODEL 105. Coverage 375/72. Mc/s. Complete with correct Calibration Chart. First-class condition. Battery operated and portable, size 11 x 8 x 7 1/2 in. ONLY £3.19.6 (carriage 7/6).

IRO SENIOR TABLE MODEL RECEIVERS. Complete with 9 coil sets covering 50 Kc/s to 30 Mc/s. Used, very good condition aerial tested. ONLY £17.10.0 (carriage, etc., 30/-). A few late Model 51 with I.O. valves, £22.10.0, plus carriage.

COMBINED VIBRATOR MODEL/MAINS UNIT. The Power Pack of the Army R.107 Receiver. Has vibrator for 12 v. D.C. operation, and mains transformer for 100/250 volts A.C. Output 12.6 volts 3 A. L.T. and 250 v. at 100 mA H.T. Complete with vibrator, 6X5G rectifier, and connecting data. Ideal for driving T.C.S. or Type 52 Receivers, etc., or mobile equipment. BRAND NEW IN MAKER'S CARTONS ONLY 45/- (carr. 5/6).

BC221 FREQUENCY METERS. The famous American crystal controlled frequency measuring standard. Coverage 125 kc/s - 20 Mc/s. With original Calibration Book. Perfect order. Only £16

MINIATURE MOTORS. Ideal for models. Operates on 3-6 volts DC. Size 1 1/2 x 1 x 1 1/8 in. plus 1/4 in. spindle. BRAND NEW 5/- or 6 for 25/-.

AVOMETER MODEL 7. Reconditioned and in perfect order with leads, internal batteries, and instructions. ONLY £11 (Reg. post 5/-).

AVOMETER MODEL 7 LEATHER CASES. fitted with carrying handle & long strap. BRAND NEW. ONLY 32/6 (post 2/6).

20/- CONSTRUCTOR'S PARTS. Assorted colours wiring wire, solder, resistors, condensers, volume controls, tag panel. ALL NEW. (Post 2/6).

RESISTORS. 100 assorted values our choice. NEW 10/-.

CONDENSERS. 100 assorted mica and silvermica. NEW 12/6.

"P.W." 6 TRANSISTOR PERSONAL RECEIVER

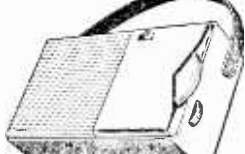

Designed by the technical staff of Practical Wireless, easy to build, using printed circuit and 1st Grade Matched Transistors and Diode. Full Medium and Long Wave coverage to internal speakers. All parts sold separately (new components only) enabling you to buy as required and full detailed price list will be sent on request. Constructional details 1/6.

Newly designed OSMOR Cabinet and reduced price. TOTAL COST INCLUDING BATTERY and CABINET NOW £7.19.6.

"P.W. TROUBADOUR 7" Parts List, S.A.E.

THE GOOD "COMPANION" Mk. II

USING TRANSFILTERS, THE LATEST MANUFACTURING TECHNIQUE TO SAVE ALIGNMENT DIFFICULTY

THE FINEST COMBINED PORTABLE AND CAR RADIO YET DESIGNED FOR THE HOME CONSTRUCTOR

★ 750 mW output.

★ 6 transistors and diode.

★ Full Medium and Long Wave coverage.

★ Quality speaker.

★ Brilliantly styled 2-tone cabinet, size 11 x 8 x 3in.

★ Very fine tuning with calibrated dial.

★ Latest printed circuit. ★ Internal high gain aerial with car aerial socket. Easy to follow construction data (available separately 3/6). All parts sold separately and full illustrated details will be sent on request.

Total Cost

£9.19.6

With alternative luxury cabinet using 7 x 4in. speaker, £10.19.6. (Either type, Plus 5/- post and ins. (Battery 3/6 extra.)

"POCKET 4" TRANSISTOR RECEIVER

Uses miniature speaker, proper tuning condenser, and volume control. Built-in aerial makes unit efficient and portable. Ideal for the beginner. Full medium wave coverage. All components and case for only 42/6 (p. & p. 2/6). Ten-page constructional book free with parts or separately 1/6. S.A.E. for parts price list.

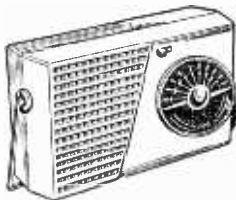

HARRIS ELECTRONICS (LONDON) LTD

138 Grays Inn Road, London W.C.1
Phone TERminus 7937

Please include carriage costs on all items.
(Open until 1 p.m. Saturdays). We are 2 mins. from High Holborn (Chancery Lane Station) and 5 mins. by Bus from King's Cross.

RECEIVERS & COMPONENTS

EXCEPTIONAL VALUE: Picture Tubes, brand new Mazda 19in., CME1901, Mullard 19in., AW47-00/91, £4 10/-; Mullard 23in., AW59/90, £6 10/-; carriage (insured) paid, 12 months' guarantee. Note: All brand new. We also supply most other sizes completely regummed at £4/17/6, guaranteed 12 months. TOMLINS, 156 Lewisham Way, New Cross, SE14, TID 3857.

TR1986 AUXILIARY EQUIPMENT. dual control unit 393 with two 10-way channel sel. S.W. and one 5-way function S.W. 7s.
Relay unit 122 with 26C4 valves and nine relays enables two TR1986 units to be used as relay station 15/-.
Modulator 7477 with six 12AT7, four 6AQ4 valves and one relay. Size 5 1/2 in. x 6 in. x 7 in. Enables TR1976 to be used for homeing, 25/-.

TX type 87 with three 3A4, one 1L4 and 1x1al (approx 10Mc/s) output on 60Mc/s complete 15/-, less valves and xtal three for 10/-.
AMP433 with three IT4, two 1L4 and two crystal diodes complete 10/-, less valves, three for 10/-.
TR1920 Tx/Rx 115-145Mc/s complete with 21 valves and one xtal, tested £6, untested £4/10/-.
100B Inverter 24V d.c. input 115V a.c. 400c/s three phase output 30/-.
Wanted: SCR522 and SCR269 maintenance manuals, also many others W.H.Y. All items carriage paid. CLARKE, 29 Leightinmork Avenue, Ballymena, N. Ireland.

ALL TYPES LINE OUTPUT TRANSFORMERS SUPPLIED (RETAIL AND TRADE) Finest service in the country. Send S.A.E. for return of post service. Terms C.W.O. or C.O.D. Trade enquiries invited. D. AND B. TELEVISION (WIMBLEDON) LTD., 131 Kingston Road, Wimbledon, SW19, CHerrywood 3955.

DIRECT TV REPLACEMENTS LTD., largest stockists of TV Components in the U.K. Line Output Transformers, Frame Output Transformers, Deflector Coils for most makes. Official s/g suppliers for many set makers. Same Day Dispatch Service. Terms C.O.D. or C.W.O. Send S.A.E. for quotes. Day and Night Telephone TIDeway 6666. 138 Lewisham Way, SE14.

CANADIAN MARCONI 52 RECEIVERS

Canadian Marconi 52 Receivers, 173 to 16 Mc/s as previous advert. Good working order. £5.10.0, carriage 1/-.
Receiver 48, American version of the 18 set Covers 6 to 9 Mc/s, 6 valves, B.F.O. R.F. Stage. Power required L.T. 3 v. at 150 mA. H.F. 150 v. at 8 mA. Complete with Handbook, 42/6. Headphones to suit, lightweight "Deaf Aid" type with lead and plug 6/6. 10 spare valves in steel case 10/-.
Partly stripped transmitter chassis 10/-.
500 Microamp 2in. meter 9/6. 1000 kc/s crystal 7/6. All above in new condition. Postage 2/6 per order.
Valves AR8, ARP12, ATP4, 1/-, post 9d. 6 or more free. Aerial insulators 3in. pyrex ribbed 9d., post 1/-, 6 or more free.
Send S.A.E. for detailed leaflet on 48 or 52 set.

G.W.M. RADIO LIMITED

40/42 Portland Road, Worthing, Sussex.

RATES: 7/3 per line or part thereof, average five words to line, minimum 2 lines. Box No. 1/- extra. Advertisements must be prepaid and addressed to Advertisement Manager "Practical Wireless", Tower House, Southampton St., London W.C.2.

RECEIVERS & COMPONENTS (continued)

ULTRA LINEAR AMPLIFIERS

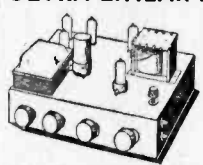

High Fidelity. 15 watts. Valves ECC83, ECC83, EL84, EL84, E281. Two inputs. Sensitivity 10 millivolts. Bases & Treble controls. 3 & 15 ohms output. Kit, £6.10.0, plus 5/- carr. Factory built, £9 plus 5/- carr. Similar 30 watt £12 plus 7/6 carr. Leadet free. Same day despatch.

STROUD AUDIO

Bath Road, Stroud, Glos. Tel. Stroud 783.

HALF PRICE Transistors. Mullard OC44, OC45, OC81, OC81D, OC170, OC171, all 4/6 each, min. 1 doz. lots; OC26, OC36 12/6 each. Post 9d. C.W.O. RADIOMEX, 184 Kingston Road, Portsmouth.

CASH DISCOUNTS on Branded Tape Recorders, Radio, etc. List S.A.E. BOYLAN, Duke Street, Warrenpoint, N. Ireland.

Glasgow Electronic Services

21 OLD DUMBARTON ROAD, GLASGOW G8 Telephone WEST 2642

Standard L.F. Transformers, 81 c.t. sec. 12/- ea; 5:1 c.t. sec. 12/6 ea. Midget L.F. Intervalve Transformer, 3:1 ratio 7/6 ea; 5:1 ratio, 8/- ea. Midget L.F. Smoothing Chokes, 5H 40mA, 6/- ea; 10H, 30mA, 6/- ea. Repanco L.F. Transistor Transformers, TT45, TT46, TT47, TT49, 5/- ea. Silicon Rectifiers, 125V r.m.s. in 500mA, 8/- ea; 250V r.m.s. in 500mA, 11/6 ea. Metal Rectifiers, 250V r.m.s. in at 250mA, 16/- ea; 125V r.m.s. in at 60mA, 6/- ea; 125V r.m.s. in at 120mA, 8/- ea. L.T. Rectifiers, 18V r.m.s. in 1A, 8/6 ea; 22V r.m.s. in at 2A, 15/- ea. Meter Rectifiers 10/9 ea. for 1, 5 or 10mA movements—state which required. Micro Switches, button or lever types, s.p.d.t. contacts rated 5A, 250V a.c. at 6/- and 8/9 ea. respectively. Morse Keys, ex W.D. with normal and back spacer contacts, 2/8 ea. Cady Test Meter, 13 ranges, to 1200V a.c. and d.c. to 300mA d.c., to 100k resistance only 54/- ea. Jackson 0804 Short Wave Variators, 25pF, 6/9 ea; 50pF, 6/9 ea; 75pF, 7/3 ea; 100pF, 7/3 ea; 150pF, 8/- ea. Jackson Casiband Dial, a mechanical bandspread dial, ratios 6:1 and 4:1, complete ready for own calibration, 28/- ea. Acos 40 Xtal Mike, 20/3 ea. Acos 45 Xtal Mike, 21/9 ea. Japanese Stok Mike, metal screened body, limit-in switch, complete cable, lavaliere cord, etc., a beautiful job, 39/6 ea. Miniature Panel Meters, cast plastic cases, jewelled bearings, accuracy 2%, silvered dials, black numerals. 0-50 μ A, 38/6 ea; 0-500 μ A, 32/8 ea; 0-1mA, 27/8 ea; 0-5mA, 27/8 ea. Model 2003 Multimeter, 19 ranges, to 2,500V d.c. at 20,000 ohms per volt, to 1,000V a.c. at 10,000 ohms per volt, plus current, resistance and capacitance ranges. A superb buy at 110/-. Slide Switches, sub-miniature, 2/3 ea; miniature, 2/6 ea. Miniature Edge V.C., 3k, 5k or 10k, less switch, 1/4; same valves, with d.p. switch, 5/4 ea. Group Panels, miniature 6-way, 9d. ea; 18-way, 2/8 ea. Tagstrips, 3 tags, 3d. ea; 7 tags, 5d. ea; 28 tags, 1/3 ea. Osmor Chassis Cutters, out 2 sizes with one punch and die. No. 1, 1/- & 1/4; No. 2, 1/- & 1/4; 26/9; No. 3, 1/- & 1/4; 27/8; No. 4, 1/- & 2/-, 36/3 ea.

Terms of business: Cash with order; C.O.D. 2/- extra; postage extra under £3 total value. General list stamp please.

RECEIVERS & COMPONENTS (continued)

"HEATHKITS" can now be seen in London and purchased on easy terms. Free brochure. DIRECT TV REPLACEMENTS LTD., Dept. P.W.7/9, 138 Lewisham Way, SE14. TIDeway 6666.

SPEAKER REPAIRS. Cones/Fields fitted. Clock coils wound. L. S. REPAIRS, Pluckley, Ashford, Kent.

TRANSISTORS. Marked and tested, packets of 10; unmarked but tested, packets of 16; unmarked and untested, packets of 40. Duds suitable as Diodes, packets of 80. All packets 20/- each. Any two packets 37/6. C.W.O. K. R. WHISTON, Dept. TPW, New Mills, Stockport.

REPANCO LTD. 1963 Catalogue and list of circuits to build. S.A.E. 203 Foleshill Road, Coventry.

NEW VALVES! GUARANTEED! DELIVERY BY RETURN!

EFB90	7/6	EL84	0/6	PCL84	7/3
EFB91	8/9	EY51	7/6	PL81	8/6
ECC81	4/6	EY86	7/-	PY32	11/-
ECL80	5/9	E240	6/6	PY81	7/-
ECL82	9/-	PC884	6/9	UJ25	11/6
EF85	5/9	PC889	9/3	UY85	6/6
EF86	8/9	PCF82	7/-	6X4	5/-

Postage 6d. per valve extra. S.A.E. FOR LIST OF OVER 200 TYPES Over 10,000 valves in stock

LEWIS

40 WOODFORD AVENUE, GANTS HILL, ILFORD, ESSEX Telephone: Crescent 5685

A.1. POST FREE Bargains. Valves set tested: EF50 three for 1/8; EB91, EF80, EF91 9d.; 6P1, 10P1 1/-; 1L6 2/6; ECL80 2/9; P230 3/6; B36, E138, PL33, PY81 4/-; PCF80, PL32, PL33, PY80, PY82 4/3; N37 4/6; PL38, 10C2, 275U 4/9; PY31, U281, 10P13, 6K25 5/6; 10P14, 20L1, 20P1 5/-; PY32, U31 6/-; 20P4, 30P4 7/6; EL33, PL36, UU7, 53KU 8/-; U801 8/3; 20P3 15/-.
Six Transistor Portables 1-1/16in. x 4-7/16in. x 2-7/16. black, coral, grey or jade, in leather case with battery, earphone and case, polishing cloth and instructions, ready made £5/12/6. A.1. RADIO COMPONENTS, 14 The Borough, Canterbury, Kent.

PHYLLIS' ENTERPRISES LIMITED

Importers and Exporters of Radio, Electronic Equipments and Associated Parts

Invite enquiries as per above from bona fide firms of importers from East, Middle East and Far East Countries.

Ex Army and bulk stock of reputable manufacturers in A.1. condition available at competitive prices. Price list forwarded on request. Write to Reg. Office:

9 Newbury St., London, E.C.1. England.

FOR SALE

AMATEUR LICENCE Morse Course. The new Rhythm Method of teaching takes the drudgery out of learning Morse and is the quickest known for full explanatory booklet. 6d stamp G3CHS. 45 Green Lane, Purley, Surrey.

**E. R. NICHOLLS
47 Middle Hillgate**

BUMPER PARCEL

- 100 Assorted Resistors.
- 50 Assorted Condensers.
- 1 5in. 3 ohm Elac Speaker.
- 1 Isolating Transformer.
- 4 Terminal Blocks.
- 2 Rotary Toggle Switches.
- 1 Small Chassis containing 60 components.
- 2 Westectors.
- 1 Thermistors.
- 100 Cartridge Fuses.
- All for 20/- Post Free in U.K.
- 20ft. Steel Telescopic Mast. 50/-.
- High Stab Resistors 8d. each.
- List now ready for Paper Block Condensers, Valves, Oscillators, Test Sets. S.A.E. Please.

Mail Order To:
33/35 Carrington Field Street,
Stockport, Cheshire.

ALUMINIUM, BRASS, Copper and Bronze in sheet, rod, strip, tube, also Stainless Steel sheet. Any size cut. Complete price list 1/-. **SLATER METALS (N.F.) LTD.**, 1 Slater Street, Liverpool 1.

SPECIAL OFFERS - NO INTEREST TERMS
GARRARD Autophon Changer Cash £7.17.0 or 12/- dpt. and 12 pymts. of 11/6 monthly
ARMSTRONG Jubilee Mk.II. Cash £28.5.0 or 57/- dpt. and 12 pymts. of 42/4 monthly.
ARMSTRONG Stereo 55. Cash £29.18.0 or 60/- dpt. and 12 pymts. of 44/10 monthly.
ARMSTRONG Stereo 12 Mk.II. Cash £40.5.0 or 82/- dpt. and 12 pymts. of 60/3 monthly
A. L. STAMFORD Ltd. (Dept. F29)
38 WYMOUTH TERRACE, LONDON E.2
Phone: 8HO 5008

BUILDING YOUR OWN ORGAN. We have for disposal a few obsolete wire organs. Wealth of parts, including keyboards, consoles, pedal boards, transformers, condensers, and other valuable electronic components. Write for details and prices. Box No. 41.

WIRELESS EQUIPMENT B10 MK2 F.X.4840-4475 Mc/s. (6.2-6.7cm). First Government release of the B10 wireless equipment containing four independent units all working from 230 volts A.C., this equipment is of very recent manufacture still being used in the forces consists as follows.
Transmitter 10Mk2, power 230 volt A.C. stabilised HT, 12 valve transmitter with built-in wave meter variable tuned, tuning meter, £45.0. Carr. 7/6.
Reception Set R10, this set uses 18 valves having an i.f. input of 45 Mc/s manual tuning or built-in auto. tuning by internal motor, £417.5 Carr. 7/6.
Power Unit for receiver input 230 volts A.C. output (1) H.T. +300 volts F.W. valve rectifier (2) Bias -50 volts, both HT and bias supply are double choke smoothed, auto-tune motor transformer, channel switch plus output stage, £3.10.0. Carr. 7/6.
Oscillator testing No. 10, enabling the equipment to be used from a telephone line etc., 230 volts A.C. input having an internal F.W. HT supply, testing unit etc., £25.0. Carr. 7/6.
All these units are enclosed in a metal case size 1 1/2 x 8 x 10in. All are brand new, we only have a limited quantity circuit supplied with each unit. Carr. paid if all 4 units ordered S.A.E. with all enquiries.

J. T. SUPPLY (Dept. N),
309 MEANWOOD ROAD : LEEDS 7

FOR SALE

(continued)

EXCEPTIONAL Transistor Portable Tape Recorder, value £8/19/6. complete with crystal microphone, earphone, spools, tape, batteries, instructions, presentation box (extra tapes 100ft. 4/6). Ideal gift. £6/18/6. Satisfaction guaranteed. Postage, packing 2/6. **TOMLINS**, 156 Lewisham Way, New Cross, SE14.

TRANSISTORS 100% TESTED
Red Spot Audio, 1/6 each, 14/- doz.
A.E.I. Branded Audio XB103 and R.F. XA102, 2/3 each, 25/- doz.
XC141 (11 watt) Audio, 6/6 each, 12/- pair.

TRANSISTOR ELECTROLITICS

8µF, 25µF, 50µF, 1/3 each, 12/- doz.
Low imp. earpieces 3/6 ea. 8 for 20/-
300 mixed small resistors ... 20/-
150 mixed small PµFF Cons. 20/-

B. W. CURSONS

78 BROAD STREET
CANTERBURY, KENT

WANTED

A PROMPT CASH OFFER for your surplus brand new Valves and Transistors. R.H.S., Beverley House, Mannville Terrace, Bradford 7.

NEW VALVES WANTED

Any type, any quantity

CASH PAID

R.S.T. Valve Mail Order Co.,
211A Streatham Road,
Mitcham, Surrey
Telephone: MITCHAM 6202

ABSOLUTE TOP PRICES paid for Valves, Transistors, Components, etc., in quantity. Try us first. Cash by return. **WOLVERHAMPTON RADIO AND TV SUPPLIES**, 43 Darlington Street, Wolverhampton. Tel.: 20315.

**WANTED
VALVES ONLY**

Must be new and boxed.
Payment by return.

WILLIAM CARVIS LTD.
103 North Street, Leeds 7

WANTED: TEST GEAR. Meters, Valves, Components, Communication Sets, Amplifiers. **HUGGETS LTD.**, 2-4 Pawson's Road, West Croydon, Surrey.

WANTED: NEW Valves and Transistors, any quantity. S. N. WILLETTS, 43 Spon Lane, West Bromwich, Staffs. Tel.: WES2392.

MISCELLANEOUS

ELECTRONIC MUSIC?

Then how about making yourself an electric organ? Constructional data available—full circuits, drawings and notes! It has 5 octaves, 2 manuals and pedals with 24 stops—uses 41 valves. With its variable attack you can play Classics and Swing.

Write NOW for free leaflet and further details to C. & S., 20 Maude Street, Darlington, Durham. Send 2d. stamp.

YOUNG MAN, interested in Radio/Electronics wishes to share practical experience with partner (professional or amateur). I am in beginner level, partner should be in advance level. Write: C. L. MIDDELKUTTER, 23 Lothair Road, Ealing, W5.

CASES, CHASSIS, PANELS, CABINETS, TUBULAR FRAMES, etc. Any metal, any design to your drawings. Unpainted or Quality Stove Enamelled in Any type of finish. Reasonable Prices. "One Offs" with pleasure. All work guaranteed. Also Engraved Labels on "Trafficite" Black on White, White on Black. Quantity Orders Welcome. Trade Enquiries Invited.

J. WATSON
40 MOUNT PLEASANT STREET
OLDHAM, LANCs.

SERVICE SHEETS

TRADE SERVICE SHEETS offered by retired engineer. If I haven't got it you won't get it! All 4/- each by return. Please include large S.A.E. Mail orders only. **ETZIONI**, 80 Merrion Avenue, Stanmore, Middx.

SERVICE SHEETS for all makes of Radio and TV, 1930-1962. Prices from 1/- with free fault-finding guide. Catalogue of 6,000 models 1/6. 125 Radio/TV sheets covering many popular models 20/-. S.A.E. inquiries: **HAMILTON RADIO**, Western Road, St. Leonards, Sussex.

WHY TOLERATE DELAY when we can supply your Radio or TV Service Sheet by return of post at 4/- each plus postage. List 1/-. Also Manuals for sale and hire. List 1/-. S.A.E. with inquiries, please. Mail orders only to S.P. DISTRIBUTORS, 44 Old Bond Street, London, W1.

FAULT-FINDER FILES showing common faults that each receiver is prone to and other useful servicing information 2/- each. List 9d. plus postage. Mail orders only. S.P. DISTRIBUTORS, 44 Old Bond Street, London, W1.

SERVICE SHEETS: Radio, TV, 5,000 models. List 1/-. S.A.E. inquiries: **TERRAY**, 11 Maudland Bank, Preston.

SERVICE SHEETS, also Current and Obsolete Valves for sale. **JOHN GILBERT TELEVISION**, 1b Shepherd's Bush Road, London, W12. Phone: SHE 8441.

SERVICE SHEETS. Radio and TV, 4/- each. List 1/-. All orders dispatched on day received. Also Manuals for sale and hire. List 1/-. S.A.E. please: **SULTAN RADIO**, 29 Church Road, Tunbridge Wells, Kent.

(Continued overleaf)

AERIALS

140ft. AERIAL INSTALLATIONS

First Government release of these brand new Marconi coil Aerial tuning systems, enabling operators to work their Receivers or Transmitters to their best efficiency. Containing a drum of 140ft. Copper aerial wire with insulators, etc., feeding into the matching unit, size 13in x 8½in. x 9½in., with slow motion tuning using Nos. 0-999. Originally intended for the 52TX-RX, a must for any poor reception areas and serious operators.

300 ONLY, 35/-

Post 5/-, two post free.

Dept. N., J. T. SUPPLY

309 Meanwood Road, Leeds 7

SOUND RECORDINGS

TAPE BARGAINS in all sizes. Example: Top brand 5¼in 1,200ft 19/6, p. and p. 1/3. S.A.E. for list. Large choice of New and Used Recorders. E. C. KINGSLEY AND CO., 131 Tottenham Court Road, London, W1. EUS 6500.

BOOKS & PUBLICATIONS

THOUSANDS OF BARGAINS can be found weekly in the Radio, TV, Mechanics and Scientific Sections of **EXCHANGE AND MART**, 5d. every Thursday.

PIN-POINT TV TROUBLES IN TEN MINUTES. The title can be imitated but the contents never! The book that really tells you how to fix televisions. Over 340 cross-indexed pages. MUST be able to earn you more than its cost within two weeks or your money refunded! Price 33/-, incl. postage. Write for free trial to **SIM-TECH BOOKS**, West End, Southampton, Hants.

FIND TV SET TROUBLES IN MINUTES from that great book "The Principles of TV Receiver Servicing," 10/6 all book houses and radio wholesalers. If not in stock from Secretary, I.P.R.E., 20 Fairfield Rd., London, N8.

AUDIO. America's foremost journal. Year's subscription 35/-; specimen copy 4/-. All American radio materials supplied—list free. **WILLEN** (Dept. 40), 61a Broadway, London E15.

EDUCATIONAL

LEARN RADIO AND ELECTRONICS the new and practical way. Hosts of absorbing experiments carried out at home under expert guidance to teach you Radio in a new, enjoyable and interesting way. Construction, servicing and fault-finding on equipment made easy for the first time! No previous experience needed. No mathematics used. Free brochure from: Dept. 11, P.W., **RADIOSTRUCTOR**, Reading.

BECOME "TECHNICALLY QUALIFIED" in your spare time. Guaranteed Diploma and Exam.. Home-study Courses in Radio, TV, Servicing and Maintenance, R.T.E.B., City and Guilds, etc. Highly informative 120-page Guide—FREE! **N.I.E.** (Dept. 363), 148 Holborn, London, EC1.

EDUCATIONAL

(continued)

THE Incorporated Practitioners in Radio and Electronics (I.P.R.E.) Ltd. Membership conditions booklet 1/-. Sample copy of I.P.R.E. Official Journal 2/- post free. Secretary, 20 Fairfield Road, London, N8.

Radio Television & Electronics

Learn at home with the world's largest home study organisation, Brit.I.R.E.; City & Guilds; P.M.G.'s certs., etc. Also Practical Courses with equipment. All books supplied.

Write for **FREE prospectus** stating subjects to

I.C.S.

(Dept. 541), Intertext House,
Parkgate Road, London, S.W.11.

"**HOW AND WHY**" of Radio and Electronics made easy by a new, non-math, practical way. Postal instruction based on hosts of experiments and equipment building carried out at home. New courses bring enjoyment as well as knowledge of this fascinating subject. Free brochure from: Dept. P.W.12, **RADIOSTRUCTOR**, Reading.

Individual Tuition in Radio, Transistor or Television Servicing. Courses prepared personally by a R.T.E.B. qualified Engineer with over 25 years' experience in service work. Local Students Fees 5/- per hour. Postal Students 6/- per lesson. Special coaching for R.T.E.B. Intermediate and Final Examinations.

J. SHARP

19 Aberdeen Terrace, Bradford 7, Yorks.

RADIO OFFICERS see the world. Immediate sea-going appointments. Our many recent successes provide additional trainee vacancies during 1963. Day and boarding students. Grants and Scholarships available. Stamp for prospectus. **WIRELESS COLLEGE**, Colwyn Bay.



By repairing Radio and TV Sets as a job or as a spare time business. Our practical course will show you the way. No previous experience is required.

**SEND FOR
FREE BOOK
TODAY!**

RADIOSTRUCTOR

Dept. G77

READING, BERKS

EDUCATIONAL

(continued)

$$X = \frac{-b \pm \sqrt{b^2 - 4ac}}{2a}$$

DON'T FUMBLE with Formulae. Master Mathematics quickly and easily the Understandable Way.

**1st lesson
and details
FREE**

The Dryden School of
UNDERSTANDABLE MATHEMATICS

■ IIFS Dryden Chambers, Oxford ■
■ St., London, W.1. ■
■ Name..... ■
■ Address..... ■
■ ■
■ ■
■ ■

METAL WORK

METALWORK. All types cabinets, chassis, racks, etc., to your specifications. **PHILPOTT'S METALWORKS LTD.**, Chapman St., Loughborough.

SITUATIONS VACANT

A.M.I.Mech.E., A.M.Brit.I.R.E., City and Guilds, G.C.E., etc., brings high pay and security. "No pass—no pay" terms. Over 95% successes. For details of exams. and courses in all branches of Engineering, Building, Electronics, etc., write for 148-page handbook, free. **B.I.E.T.** (Dept. 242B), 29 Wright's Lane, London W8.

TV AND RADIO. **A.M.Brit.I.R.E.,** City and Guilds, R.T.E.B. Cert., etc., on "no pass—no fee" terms. Over 95% successes. For details of exams. and courses (including practical apparatus) in all branches of Radio, TV and Electronics write for 148-page handbook, free. **B.I.E.T.** (Dept. 242G), 29 Wright's Lane, London, W8.

CITY AND GUILDS (Electrical, etc.) on "no pass—no fee" terms. Over 95% successes. For details of Electrical Engineering, Applied Electronics, Automation, etc., send for our 148-page handbook, free and post free. **B.I.E.T.** (Dept. 242A), 29 Wright's Lane, London W8.

RADIO/RADAR TECHNICIANS

("Technical Officers")

required for Department of Transport and Power, Dublin (at least two vacancies). Age Limit: 50 years with extensions.

Salary Scale: £540-£1,000. Entry up to £870 in certain circumstances. Experience in the maintenance of V.H.F. Radio and/or Radar Equipment is essential (e.g. Television, Radio Navigational aids or V.H.F. Communications). Application forms, etc. from

Secretary, Civil Service Commission,
45 Upper O'Connell Street, Dublin 1.
Latest time for receiving completed application forms:

5 p.m. on 26th April, 1963.

Just a few of our BARGAINS

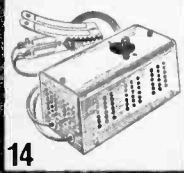
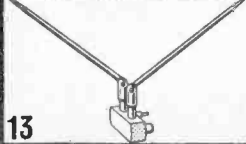
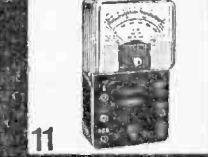
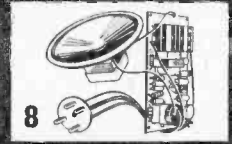
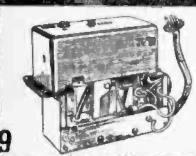
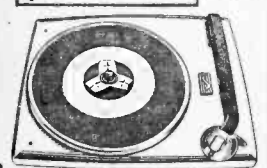
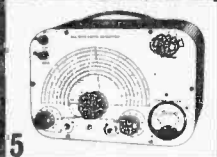

1. **SUPER 5 TRANSISTOR POCKET RADIO INCORPORATING PRINTED CIRCUIT & MINI-EARPIECE.** No Aerial or Earth required. 4 1/2 x 3 1/2 x 1 1/2in. Output 200 m.w. 5 first quality transistors. High flux moving coil speaker. M/L Internal high gain ferrox aerial. £2.19.6. P. & P. 3/6. Circuit diagram 1/6, free with parts. All parts available separately.
2. **TRANSISTORISED POCKET RADIO** with printed circuit, mini-carpiece, high gain ferrox slab aerial. No aerial or earth required. To build yourself for completely personal listening. 4 1/2 x 3 1/2 x 1 1/2in. Luxembourg in favourable areas. Only £1/- . P. & P. 2/6. All parts available separately.
3. **A.C. D.C. POCKET MULTI-METER KIT.** 2in. moving coil meter scale, calibrated in A.C./D.C. volts, ohms and milliamperes. Voltage range A.C./D.C. 0-50.0-100, 0-250, 0-500. Milliamps 0-10, 0-100. Ohms ranges 0-10,000, 0-100,000, 10/5. P. & P. 2/- . Wiring diagrams 1/-, free with parts.
4. **SIGNAL GENERATORS.** Cash £7.5.0, or 30/- deposit and 6 monthly payment of 21/6. P. & P. 5/6. Coverage 100 kc/s to 100 Mc/s on fundamentals and 100 Mc/s to 200 Mc/s on harmonics. Case 10 x 6 1/2 x 5 1/2in. Three miniature valves and Metal Rectifier. A.C. mains 200/250v. Internal modulation of 400 c.p.s. to a depth of 30 per cent. Modulated or unmodulated R.F. output continuously variable 100 millivolts. C.W. and mod. variable A.F. output. Magic eye as output indicator. Accuracy 2 per cent.
5. **SIGNAL GENERATORS.** Cash £5.5.0. P. & P. 5/6. Coverage 120 kc/s to 84 Mc/s. Case 10 x 6 1/2 x 4 1/2in. Size of case 6 1/2 x 3 1/2in. 2 valves and rectifier. A.C. mains 230-250 v. Internal modulation of 400 c.p.s. to a depth of 30 per cent, modulated or unmodulated R.F. output continuously variable 100 millivolts. C.W. and mod. switch variable A.F. output and moving coil output meter. Accuracy ± 2 per cent.
6. **STAAR 45, 9 v. BATTERY RECORD PLAYER** complete with pick-up and deck. A completely portable player. Head protected by plastic dome with a brush which cleans the stylus as it rises into playing position. 45 r.p.m. Auto on/off switch governed motor, attractive two tone grey finish, £2.9.6. P. & P. 2/-.
7. **CARRYING CASE for STAAR 45 or COMPLETE KIT** beautifully styled in two tone with record compartment. Specially designed to take player and amplifier. Just screw in and connect up. All parts available separately. Case only 22/6. P. & P. 4/- . Complete kit £5.10.0. P. & P. 5/-.
8. **TRANSISTORISED AMPLIFIER,** suitable STAAR 45. Output 1 watt. Size 4 1/2 x 2 1/2in. Printed circuit, tone/volume controls plus 4 transistors. Push-pull output complete with 3in. moving coil speaker. Built and tested, 49/6. P. & P. 2/-.
9. **CHANNEL TUNER 1F.** 16-19 Mc/s. Continuously tunable from 174-216 Mc/s. Valves required—PCF80 and POC84 (in series). Cover BBC and ITA ranges. Also Police, Fire and Taxis, etc. Brand new by famous maker, 10/- . P. & P. 3/-.
10. **B.S.R. MONARCH UA14 WITH FUL-PI HEAD.** 4-speed, plays 10 records, 12in., 10in. or 7in. at 16, 33, 45 or 78 r.p.m. Intermixes 7in., 10in. and 12in. records of the same speed. Has manual play position; colour brown. Dimensions: 12 1/2 x 10 1/2in. Space required above baseboard 4 1/2in., below baseboard 2 1/2in. Fitted with Ful-PI turnover crystal head, £5.19.6. P. & P. 5/6.
11. **POCKET MULTI-METER.** Size 3 1/2 x 2 1/2 x 1 1/2in. Meter size 2 1/2 x 1 1/2in. Sensitivity 1,000 O.P.V. on both A.C. and D.C. A.C. and D.C. volts 0-15, 0-150, 0-1,000. D.C. current 0-150 mA. Resistance 0-100K Ω. Complete with test prods, battery and full instructions, 35/- . Plus 1/6 P. & P.
12. **8-watt PUSH-PULL 4 VALVE AMPLIFIER plus METAL RECTIFIER.** A.C. mains 200-250 v. Size 10 1/2 x 6 1/2 x 2 1/2in. 5 valves. For use with all makes and types of pick-up and mike. Negative fed back. Two input, mike and gram, and controls for same. Separate controls for Bass and Treble lift. Response flat from 40 cycles to 15 kc/s. 2 dB down to 20 kc/s. Output 8 watts at 5 per cent total distortion. Noise level 30 dB down all hum. Output transformer tapped for 3 and 16 ohms speech coils. For use with Std. or L.P. records, musical instruments such as guitars, etc. Suitable for small halls. £3.19.6. P. & P. 6/- . Crystal mike to suit 15/- . P. & P. 2/- . 5in. P.M. Speaker to suit, 12/6. P. & P. 2/-.
13. **INDOOR AERIAL for ITV/BBC/FM.** Complete with standard co-axial plug. Heavy chrome extending dipoles—7ft. fully extended. Plugs straight into TV or VHF Tuner. Fully directional, 10/6. P. & P. 1/6.
14. **NO MORE FLAT BATTERIES.** Charge your own battery overnight with this wonderful little charger. Output 6 and 12 volts, 2 amps. Input 200-220 v. A.C. mains. Mains fuse incorporated. Attractive silver hammer finished case, 6 x 3 x 8ins. Complete with leads and battery clips only 21/- . P. & P. 3/6.

RADIO & T.V. COMPONENTS
[ACTON]
LIMITED

21b HIGH STREET
ACTON, LONDON, W.3.

ALL ENQUIRIES S.A.E.
GOODS NOT DESPATCHED OUTSIDE U.K.

TRANSISTORS AND DIODES



Transistors

CO35	18/-
OC36	21/6
OC44	6/-
OC45	6/-
OC70	6/6
OC71	5/-
OC72	8/-
OC73	16/-
OC75	8/-

Trans.—cont.

OC77	12/-	2xOC72	16/-	OA91	3/-
OC78	8/-	2xOC78	16/-	OA95	3/6
OC81	8/-				
OC84	8/6				
OC170	9/6				
OC171	10/6				
OC201	31/-				
OC202	26/-				
OC271	25/-				

A set of Transistors comprising 1 OC44, 2 OC45, 1 OC81D, 2 OC81, 3/6 set.

Set of Audio Transistors, 1 x OC81, 2 x OC81, Driver Matched Pair, 15/6 set.

TERMS: Cash with Order or C.O.D. Postage and Packing Charges extra. Single valves 9d., Minimum Parcel Post charges 2/-. Please include sufficient postage with your order. Minimum C.O.D. fee and postage 3/6. These Postal Rates apply to U.K. only. For full terms of business see inside cover of catalogue. Personal Shoppers 9 a.m. to 5 p.m. Mon. to Friday, Saturday 10 a.m. to 1 p.m.

LEATHERCLOTH COVERED RECORD PLAYER CASES
2 SIZES AVAILABLE

Suitable for single player unit, etc. Size 14½ x 13 x 6½in. supplied with uncut motorboard, carrying handle, gold trim, available in red/grey and two-tone grey.

PRICE 44/-
plus 4/6 carriage.

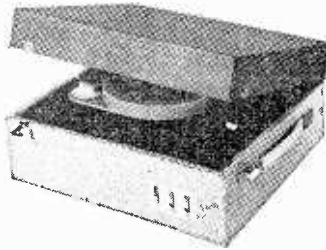

LEATHERCLOTH CASE. As above but suitable for automatic record player, size 14½ x 14½ x 8½in., available in blue/grey, red/grey. Price 44/-. Uncut motorboard.

MINIATURE PANEL METERS

Quality Panel Meters—All having D'Arsonval movements, dual bearings, 2% full scale accuracy, silver dials, black numerals and pointers, from zero adjustment screws.

GRAMOPHONE UNITS AUTOCHANGE

BSR Monarch UA14, 4 speed motor, Full-Fi turnover crystal cartridge, attractively styled in two-tone grey. £6.6.0.

BSR Monarch UA16, the latest model now available at £7.10.0.

Both the above can be fitted with stereophonic cartridge at slight extra cost.

Garrard Autoslim. 6½in. in depth, 6½ lbs. in weight, designed to occupy as small a space as possible, automatic selection of all sizes of records, will also play manually, one piece pick-up arm wired for stereo, monoversion. £7.7.0. Stereoversion. £7.19.6.

MR.2P CLEAR PLASTIC METRES

1½in. square front, 1½in. overall front to back with 1½in. behind panel including ½in. terminals. Requires 1½in. diameter hole in panel, four corner holes with 1½in. centre. Terminal polarity clearly marked. Supplied complete with mounting screws, individually boxed and guaranteed.

Model	Range	Price
MR.2P	0-50µA	39s. 6d.
MR.2P	0-500µA	32s. 6d.
MR.2P	0-1mA	27s. 6d.
MR.2P	0-5mA	27s. 6d.
MR.2P	0-300V	27s. 6d.
SR.2P	"S" Meter	35s. 0d.

48-page General Catalogue available. Send 1/- in stamps.

ALPHA RADIO SUPPLY CO. LTD., 103, Leeds Terrace, Wintoun Street, LEEDS, 7

ELECTRONIC MUSICAL INSTRUMENT HANDBOOK

by N. H. Crowhurst.

Fully explains the operation, use and repair of all types of instruments including carillons, the Martenot Ondioline, Theremin, and other music and rhythm synthesizers.

Postage 6d.

BRITISH TRANSISTOR DIRECTORY by E. N. Bradley, 8/6. Postage 6d.

THE RADIO AMATEUR'S HANDBOOK by A. R. R. L. 1963. 36/-, Postage 2/6.

THE 6th AUDIO ANTHOLOGY. Pub.: Radio Mag. Inc. 32/-, Postage 1/6.

PIN POINT TRANSISTOR TROUBLES IN 12 MINUTES. Coyne Pub. 47/6. Postage 1/-.

PRINCIPLES OF COLOUR TELEVISION by G. N. Patchett, 16/-, Postage 6d.

WORLD RADIO TV HANDBOOK 1963. 22/-, Postage 1/-.

RADIO VALVE DATA Compiled by "WW". 7th Ed. 6/-, Postage 10d.

COMPLETE CATALOGUE 1/-.

THE MODERN BOOK CO.

BRITAIN'S LARGEST STOCKISTS of British and American Technical Books

19-21 PRAED STREET LONDON, W.2

Phone: PADdington 4185

Open 6 days 9-6 p.m.

Lyons Radio Ltd.

3 Goldhawk Road, London W.12

MAINS TRANSFORMERS. Auto-wound, Input 200 v. Output 230 v., 275 watts. Using two connected in series (Wiring details supplied) can be used for either 200 v. or 230 v. Input to give 100 v. or 115 v. output. Fully shrouded with fixing feet. Overall size 4 x 3½ x 3½ins. Brand new Manufacturers surplus. "SNIP PRICE" ONLY 7/6 each. Postage 2/6 one, 3/8 two. Bulk purchase enquiries invited. State qty. of interest for best quote.

AERIAL RODS. Set consists of 3 copper-plated tapering steel section each 4ft. making up a 12ft. aerial or the ever popular fishing rod. PRICE ONLY 7/6, carriage 2/6.

MOUNTING BASE, for rods, made of hard rubber with metal fixing plate surround. PRICE ONLY 3/-. If supplied separately, post 1/9.

RAY 5 RADIO RECEIVERS. Special purpose 11 valve fixed frequency (26.5 Mc.) housed in black crackle case 12 x 9 x 8ins., fitted with 24 v. D.C. Dynamotor. 7.8 Mc. crystal and output level meter etc. Valve line-up: 12S, J7, 12J5, 6H6, 12A8, 6AC7, 12SR7, 3-6AB7, 2-12SN7. New condition. "GIVE AWAY PRICE" ONLY 35/-, carriage 9/6. Circuit diagram and notes 2/6, supplied separately, post 6d.

DESK TELEPHONES. Normal Post Office pattern, two make a first-rate intercom. set, requiring only a torch battery plus twin connecting flex. Comprise hand set on usual black stand with cord, fitted 10 digit dial (Not used for intercom). Ringing facility not provided. In good condition and tested. PRICE ONLY 19/6 each, post 1 or more 3/6.

½ H.P. MOTORS. 200/250 v. A.C. mains. split phase induction type by Crompton Parkinson. Spindle 2 x 1 ins. dia., 1440 r.p.m., reversible. With mounting base and bosses for horizontal or vertical mounting. As new and unused. BARGAIN PRICE ONLY 75/-, carriage 9/-.

POSTAL BARGAIN SALE. Send for free Sales List, S.A.E. appreciated.

H.A.C. SHORT-WAVE EQUIPMENT

WHY is it that for 3 decades

H.A.C. SHORT-WAVE KITS have been consistently demanded by so many constructors, amateurs, professionals and schoolboys. Because H.A.C. is undoubtedly the best. The circuits are simple, yet the results are fantastic. So easy to construct (or we do it for you). The secret is, of course, our vast experience, and also we use only the very highest grade of Short Wave components (Not surplus). We have been famous all over the world for 30 years, as suppliers of quality

SHORT-WAVE RECEIVERS AND KITS

H.A.C. were the original suppliers of Short-Wave receiver kits for the amateur constructor. Over 10,000 satisfied customers—including Technical Colleges, Hospitals, Public Schools, Hams, etc.—in fact we receive many testimonials by every post, from purchasers of H.A.C. Kits, who tell us that they regularly listen to stations from all over the world.

AUSTRALIA & AMERICA the North Pole, and other expeditions, and all at full strength. Your success like our products is

GUARANTEED

Improved designs with Denco coils: One-valve kit, model "C". Price 25/- Two-valve kit, model "E". Price 50/- Super sensitive all-dry receiver. Special inc. price. Complete Kit, 77/-

All kits complete with all components, accessories and full instructions. Before ordering call and inspect a demonstration receiver, or send for descriptive catalogue and order form to—

"H.A.C." Short Wave Products (Dent, TII)
44 Old Bond Street, London W.1.



FOR .. Your Career
 .. Your Own Business
 .. An Absorbing Hobby

RADIOSTRUCTOR

**LEADS THE WORLD
 IN ELECTRONICS TRAINING**

A NEW-PRACTICAL WAY of UNDERSTANDING Radio : Television Electronics

including: Transistors; VHF/FM; Hi-Fi equipment; Computers; Servo-mechs; Test instruments; Photo-electrics; Nucleonics, etc.

Radiostructor—an organisation specialising in electronic training systems—offers a new self-instructional method using specially designed equipment on a “do-it-yourself” basis. You learn by building actual equipment with the big kits of components which we send you. You advance by simple steps, performing a whole series of interesting and instructive experiments—with no complicated mathematics! Instructional manuals employ the latest techniques for showing the full story of electronics in a practical and interesting way—in fact, you really have fun whilst learning! Fill in the coupon below for full particulars.

POST NOW

TO RADIOSTRUCTOR (DEPT. G40)
 READING, BERKS.

Please send brochure, without obligation to!

★ Name) **BLOCK**
 Address) **CAPS**
) **PLEASE**
 (We do not employ representatives) 5/63

4 - TRANSISTOR AMPLIFIER

- ★ 200 mW push/pull output.
 - ★ Matches 3 ohm speaker.
 - ★ Printed circuit construction.
 - ★ Fully wired and tested.
 - ★ Separate inputs for mike and pick-up or radio, etc.
- 39/11**
 COMPLETE
- Extra components if required
 ★ 5k Volume Control with switch 5/-.
 ★ 2in. 111-flux speaker 20/-.

OAKFIELD RADIO
 121 Macclesfield Road, Hazel Grove,
 Stockport, Cheshire
MAIL ORDER ONLY

Everyman's guide to
 astronomy—a fascinating
 book—

FOCUS ON STARS

Julius D. W. Staal, F.R.A.S.

Today, probably more than ever before, astronomy is a vital study. This fascinating book by a distinguished astronomer is an account of the universe which will be a practical inspiration to both the layman and the amateur astronomer. The reader will experience a real pioneering excitement as astronomical calculations are made step by step and the wonderful workings of the heavens are unfolded. Clear and simple diagrams are used to illustrate the cause of the tides, the complex motion of the earth, the seasons of the other solar planets, eclipses, the nature of galaxies. Monthly star charts give a unique all-the-year-round guide. The author was previously at the London Planetarium.

296 pages, 16 plates, numerous figures and 12 star charts.

40s. FROM ALL BOOKSELLERS

... or, in case of difficulty, 41s. 6d., by post from George Newnes Ltd., Tower House, Southampton St., London, W.C.2.

NEWNES

LOOK!

TRANSISTORS 1/3

GREEN SPOT A.F. 3 volt. Only 1/3
 YELLOW SPOT A.F. 6 volt 1/6.
 RED SPOTS. Now ONLY 1/9 each.
 WHITE SPOTS. Only 2/6 each.

REPANCO

TRANSISTOR TRANSFORMERS
 TT49 Interstage 5/-, TT45 Driver Transformer 5/-, TT46 Output Transformer 5/-, TT47 Driver Transformer 5/-, CH1 Miniature R.F. Chokes 2/6, FR2 Ferrite Rod Aerials 12/6.
 S.A.E. for REPANCO 1963 Catalogue.

MULLARD TRANSISTORS

OC70 6/6, OC71 6/6, OC72 8/-, OC81 8/-, Matched Pairs 16/-, OC78 8/-, OC44 9/3, OC45 9/-, OC170 9/6, OC171 10/6, AF102 27/6, AF114 11/-, AF115 10/6, AF116 10/-, AF117 9/6, AF124 10/-, AF125 10/6, AF126 10/-.

DIODES OA70, OA79, OA81, OA90 or OA91. All 3/- each.

BTH Diodes Type CG12E 1/6 each. Miniature Surplus Diodes 3 for 2/-, 7/- doz.

TRANSISTOR HOLDERS 3 or 5 pin 1/-, **DRX1 CRYSTAL SET COIL M & L** with CIRCUIT 3/- each.

ALL SENT POST FREE IN U.K. by

PETHERICK'S RADIO SUPPLIES

22 High Street, Eideford, N. Devon
 Tel.: Bideford 1217
 S.A.E. with ALL inquiries please.

BBC · ITV · F.M. AERIALS



B.B.C. (BAND 1). Telescope loft, 19/6. External S/D, 26/3.
ITV (BAND 3). 3 Element loft array, 24/-, 5 Element, 32/6. Wall mounting, 3 Element, 33/6. 5 Element, 41/3.
COMBINED B.B.C. + I.T.V. Loft 1+3 Element, 41/3. 1+5 Element, 48/6. Wall mounting, 1+3 Element, 56/3. 1+5 Element, 63/8. Chimney and mast mounting units also available.
F.M. (BAND 2). Loft "H" 28/-, 3 Element loft, 52/6. S/D loft, 12/6. External S/D, 26/3. State channel when ordering. C.W.O. or C.O.D. P.P. 2/6. Coaxial cable, 8ft. yd. Coaxial plugs, 1/3. Send 6d. stamps for illustrated lists.

K.V.A. ELECTRONICS (Dept.P.W.)
 3B, Godstone Road, Kenley, Surrey.

ERSIN MULTICORE SOLDERS

for a first class joint every time

Wherever precision soldering is essential, manufacturers, engineers and handymen rely on MULTICORE. There's a MULTICORE SOLDER just made for the job you have in hand. Here are some of them.

THE NEW HANDY DISPENSER

Easy to find in the tool box—simple to use. The solder is in a continuous coil which can be used direct from the handy free-standing dispenser—in fact, it is virtually a third hand for those tricky soldering jobs. Containing 15 feet 5-core 18 s.w.g. Ersin Multicore Savbit alloy. 2/6



HOME CONSTRUCTORS 2/6 PACK



The Home Constructors Pack contains 32 ft. of 22 s.w.g. 60/40 alloys, which is especially suitable for printed circuits soldering.

BIB WIRE STRIPPER AND CUTTER

Strips insulation without nicking wire, cuts wire cleanly, splits extruding flex. 3/6 each



MULTICORE SOLDERS LTD

MULTICORE WORKS, HEMEL HEMPSTEAD, HERTS. (BOXMOOR 3638)

CMMS.11

P.C.R. COMMUNICATIONS RECEIVER
Type PCR-1. Has self contained speaker. Covers 850-2000, 200-550 and 16-50 metres. AS NEW CONDITION. £6.19. 6
Type PCR-2. Requires external speaker. Covers 850-2000, 200-500 and 13-50 metres. USED (Good condition). £5.19. 6
Type PCR-3. Requires external speaker. Covers 200-500, 120-43 and 43-13 metres. USED (Good condition). £8.8. 0
Carriage (any type) 10/6. Full details S.A.E. Any model fitted with BRAND NEW INTERNAL POWER SUPPLY, guaranteed ready for use on A.C. mains. £2 extra.

SILICON RECTIFIERS. Type 1E2 (1 x in.) will handle 250 volts at up to 50mA. Replaces any TV metal rectifier. 7/6.

MOVING COIL PHONES. Finest quality Canadian with Chamol's ear muffs and leather-covered headband. With lead and jack plug. Noise excluding, supremely comfortable. BRAND NEW £22/6. post 1/6.

AVO L.C.R. BRIDGE. Capacity 5 pFd to 50 mFd. Resistance 5 Ω to 50 Ω. Inductance can be measured against external standard. Balance is indicated on a meter which can be used as a valve voltmeter from 0.1 to 15 v. Leakage test and Power Factor scale. A.C. mains operation. Tested and guaranteed and in superlative condition. £9.10.0. plus 1/- P. & P.

WAVEMETER W-91A. A crystal checked, self-contained heterodyne frequency meter similar to the BC-221. Covers 100Kc/s to 20Mc/s (harmonics to 40Mc/s). Requires 50V HT and 2V LT acc. Output signal has optional modulation for use as Sig. Gen. Accuracy 0.1%. Complete with instructions, individual calibration charts valves and 1Mc/s crystal, in BRAND NEW condition. 79/6. carr. 5/6. Complete set of 4 spare valves. 10/- extra.

AERIAL KITS. Comprising seven 4ft. aerial rods making a 16ft. and a 12ft. aerial. There is also an aerial base with a ground spike. All in a steel carrying tube with web strap. 25/6. carr. 4/-.
POWER UNIT TYPE 7A/12. The original power supply for the Canadian 52 set receiver. Operates from AC mains 115/230 and also from 12V car batt. if desired. With connector for 52 set. BRAND NEW. 59/6. carr. 5/6. Spare valves for 52 Set. 8 x ARP-3, 2 x 12Y4, 3 x 12SC7. BRAND NEW/BOXED. £1.

MULTIMETER SPECIAL. MODEL CT-500. 20,000 Ω/V. DC volts: 0 to 2.5-10-50-250-500-5,000 (20K Ω/V). AC volts: 0 to 10-50-250-500-1,000 (10K Ω/V). DC Current: 0 to 10 microAm 5mA, 50mA, 300mA. RESISTANCE: 0 to 12K Ω, 120K Ω, 1.2M Ω, 12M Ω. Mid scale 60, 600, 6K, 60K ohms. Decibels -20 to +62. In neat moulded case 5 1/2 x 3 1/2 in., with leather carrying handle, complete with batteries, leads and instructions. BRAND NEW. Fully guaranteed. 95/- P. & P. 2/6.

CHARLES BRITAIN (RADIO) LTD.

11 Upper Saint Martins Lane, London, W.C.2

TEMPLE Bar 0545

Shop Hours 9-6 p.m. (9-1 p.m. Thursday).
Open all day Saturday.

FIRST-CLASS RADIO AND T.V. COURSES... GET A CERTIFICATE!

After brief, intensely interesting study—undertaken at home in your spare time—YOU can secure a recognised qualification or extend your knowledge of Radio and TV. Let us show you how.

FREE GUIDE

The New Free Guide contains 120 pages of information of the greatest importance to both the amateur and the man employed in the Radio industry. N.I.E. provides first-rate postal courses for Radio Amateurs' Exam., R.T.E.D. Servicing Cert., C. & G. Telecoms., Grad. Brit. I.R.E. Guide also gives details of range of diploma courses in Radio/TV Servicing, Electronics and other branches of engineering, together with particulars of our remarkable Guarantee of

SUCCESS OR NO FEE

Write now for your copy of this invaluable publication. It may well prove to be the turning point in your career.
FOUNDED 1885—OVER 150,000 SUCCESSSES

NATIONAL INSTITUTE OF ENGINEERING
(Dept. 461), 148 HOLBORN LONDON, E.C.1

S. Africa: P.O. Box 8417, Jo'burg.
Australia: P.O. Box 4570, Melbourne.

A.R.R.L. RADIO AMATEURS HANDBOOK 1963

New edition, S/B 36/-, Postage 2/3

British Transistor Directory, new edition by Bradley, 8/6, postage 9d.
World Radio and T.V. Handbook 1963, by Johansen, 22/-, postage 1/-.
Single Switchboard, new edition, by A.R.R.L., 19/6, postage 1/-.
Amateur Radio Handbook, by R.S.G.B., 34/-, postage 2/6.
32 Tested Circuits using Micro Alloy Transistor Circuits, by Sinclair, 5/-, postage 6d.
Mullard Reference Manual of Transistor Circuits, 12/6, postage 1/-.
Amateur Radio Call Book 1963, by R.S.G.B. 4/6, postage 6d.
More about Loudspeakers, by Briggs. New edition, 8/6, postage 1/-.

UNIVERSAL BOOK CO.

12 Little Newport Street, London, W.C.2 (adjacent Lisle Street)

RECEIVE LOUD & CLEAR INDOOR AERIAL

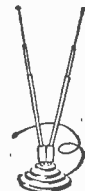

ONLY 16/6 P.P. 2/-
Scientifically designed and made by craftsmen. Telescopic rods of brass for easy pick-up, chromium plated for beauty. Each rod extends to 3ft. 6in. and can be swivelled, making your aerial fully directional. Perfect for ITV, BBC, AFM and F.M. reception. Attractive base.

Money refund guarantee
MARLBOROUGH CABLES & ENGINEERING LTD.
Elcot Lane, Marlborough, Wiltshire

NEW VALVES!

Guaranteed Set Tested

24-HOUR SERVICE

1R5, 1S5, 1T4, 3S4, 3V4, DAF91, DF91, DK91, DL92, DL94, SET of 4, 18/-	DAF96, DF96, DK96, DL96, SET of 4, 25/6.	
0A2 10/6	DL35 8/6	PCF82 7/6
1D5 7/-	DL92 5/11	PC122 7/6
1R5 5/3	DL84 6/6	PC183 6/6
1S5 4/3	DL96 6/6	PC184 6/3
1T4 3/3	EB91 3/9	PENDD4020
354 5/11	EB41 7/6	PL76 17/6
SV4 6/6	EBF59 7/6	PL36 9/6
5U4G 4/6	EB21 12/6	PC121 8/-
5Y3GT 5/3	ECC40 13/-	PL82 6/-
5Z4G 8/6	ECC81 4/6	PL83 6/6
6K7G 1/9	ECC82 4/6	PL84 8/-
6K9G 4/9	ECC83 6/3	PY31 7/6
847G 5/6	ECC94 7/6	PY32 9/6
6V6G 4/-	ECC95 7/6	PY80 7/-
6X5GT 6/6	ECF90 6/9	PY81 6/3
12K7GT 4/3	ECF82 8/3	PY82 5/9
12K8GT 9/-	ECH42 7/9	PY83 7/-
12Q7T 4/6	ECL80 6/9	U25 11/-
12SN7GT 7/3	U24 7/9	U32 8/9
35L6GT 8/-	EF80 4/3	UAB80 8/-
35Z4GT 5/-	EF85 5/9	UAF42 7/6
85A2 7/6	EF96 8/6	UBC41 7/6
AC/TP 21/-	EF89 5/9	UBF80 8/-
CLC 9/6	EF91 2/9	UC1 8/-
DAC32 8/9	EL41 7/8	UCH21 11/6
DAF91 4/3	EL84 6/3	UCH42 7/6
DAF96 6/9	EY51 6/9	UCH81 7/9
DF33 8/9	EY86 6/9	UCL82 9/3
DF91 3/3	EZ40 5/9	UL63 13/-
DF96 6/6	EZ80 5/9	UF4 6/9
DH77 6/-	EZ81 5/6	UF89 6/9
DK32 10/6	KTW61 5/3	UL41 7/-
DK91 5/3	MU14 5/6	UL84 6/6
DK92 7/6	PCC94 6/9	UY21 10/-
DK96 7/6	PCC99 6/9	UY41 5/6
DL33 7/6	PCF80 6/9	UY85 8/3

Postage 6d. per valve extra. Any Parcel Insured Against Damage in Transit 6d. extra. Any C.O.D. Parcel 3/- extra. Office address, no callers.

GERALD BERNARD

(Note: new address—formerly of Leeds)
83 OSBALDESTON ROAD,
STOKE NEWINGTON, LONDON N.16

Lewis have the Cabinet for you

We can supply any cabinet to your own specification. This is only one example of—
THE LARGEST RANGE OF CABINETS IN THE COUNTRY
Equipment is also our speciality.

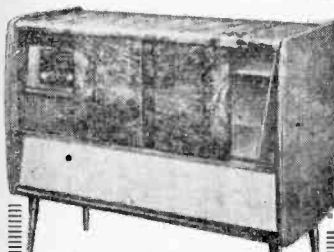

The Grosvenor
Price 15 gns.

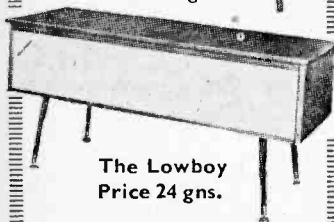

The Lowboy
Price 24 gns.

LEWIS radio

100 (P53) Chase Side, Southgate, London, N.14. Tel 3733/9666

Send today for the two new Lewis Catalogues

Designed to assist your choice of cabinet and equipment.

THE New Lewis Radio Cabinet Catalogue—the most comprehensive ever prepared. The unique 64 page equipment catalogues.

Please send your two new catalogues enclosed in P.O. for 3/6 which will be credited against any purchase I make.

Name _____

Address _____

BLOCK CAPITALS PLEASE

D. & B. TELEVISION (Wimbledon) LIMITED

131 & 131a, Kingston Road, South Wimbledon, London, S.W.19

PHONE: CHERRYWOOD 3965

Open MONDAY to SATURDAY, 10 a.m. to 7 p.m. (Except Wednesday, 1 p.m.)

Nearest Tube: South Wimbledon (North Line) COMPARE OUR PRICES

For the Finest in the Country
YOUR PROBLEMS ARE OUR BUSINESS
MOST LINE-OUTPUT TRANSFORMERS

BRAND NEW VALVES					
CV31	14/6	EZ40	6/3	384	7/-
DF91	5/6	EZ41	6/5	3V4	7/-
DF96	6/-	EZ80	6/-	5U4G	7/-
DAF91	-5/6	EZ81	6/-	5Y3	8/-
DAF96	6/-	GZ32	9/6	5Z4G	9/6
DH77	4/6	GZ34	12/6	6AT6	6/-
DK31	7/-	KT33C	6/-	6FL	8/-
DK92	7/-	PCC84	8/3	6FL3	8/6
DK96	8/-	PCC85	8/3	6FL5	11/6
DL92	7/-	PCC89	8/9	6L1	10/-
DL94	7/3	PCF80	8/3	6L18	9/6
DL96	8/-	PCF82	9/6	6X4	4/3
EAB280	7/3	PCF86	10/6	6X5	5/6
EAF42	9/-	PCL82	8/3	6V6	6/-
EB91	3/6	PCL83	10/9	6SN7	5/6
EB333	4/6	PCL84	9/-	6Q7G	6/6
EB341	9/-	PCL85	14/3	6R7	6/6
EBF80	8/-	PL36	12/-	7H7	8/6
EBF89	8/-	PL38	15/6	7C5	8/-
ECC81	6/-	PL81	10/6	7C6	8/6
ECC82	7/8	PL82	7/6	7H7	7/3
ECC83	7/6	PL83	8/-	10C2	15/-
ECC84	7/8	PL84	8/-	10P1	5/6
ECC85	7/6	PV31	12/-	10P13	8/9
ECP80	9/-	PV32	10/8	10P14	12/9
ECP82	9/-	PY40	6/-	12AU7	5/6
ECH42	9/-	PY81	7/3	12AT7	5/3
ECH81	7/6	PY82	6/-	12AX7	5/6
ECL80	8/3	PY83	8/-	12X7GT	5/-
ECL82	9/-	U4	10/-	13X7GT	6/3
EF36	4/-	U25	11/6	20D1	8/6
EF39	4/-	U26	9/-	20F2	12/3
EF80	5/3	U31	7/-	20L1	19/6
EF85	7/6	U37	12/6	20P1	12/6
EF86	9/-	U30	8/-	20P3	19/6
EF89	8/3	U191	12/-	20P4	22/-
EF91	3/9	U301	10/6	20P5	19/6
EF92	4/-	U801	25/-	30P1L1	10/-
EL29	4/3	UAF42	8/-	30P4	19/6
EL33	4/-	UB41	8/-	30P12	9/6
EL44	7/6	UCP80	10/6	35L6GT	8/3
EM34	6/3	UL41	3/-	35Z4	6/6
EM80	8/6	UL46	8/-	185BT	22/-
EY51	8/6	U8	17/6	807	7/6
EY86	8/6	UY41	6/9		

We pride ourselves that we can obtain and supply any T.V. spare. Please ask us for ANY components you may require we are almost certain to have them.

TERMS: S.A.E. all inquiries. C.O.D. 3/- extra. C.W.O. Postage on Valves 6d. each.

C.R.T.'s 12/6 Inc. insurance. SATISFACTION ASSURED. Return Post Service

RES/CAP. BRIDGE 39/6

Checks all types of resistors, condensers 6 RANGES

Built in 1 hour. Direct reading.

READY CALIBRATED

Stamp for details of this and other kits.

Please write to: RADIO MAIL (Dept. PL)

Raleigh Mews, Raleigh Street, Nottingham

18,000 O.P.V. MULTIMETER KIT

Ranges 0-0.25 and 2.5V D.C.; 10, 25, 100, 250, 500, 1000V A.C. D.C. and output volts; 100 ohms to 10 Meg. (2 ranges); 0.25, 2.5, 25, 250 mA D.C. (2.5A range 4/- extra). Kit comprises new 3 x 2 1/2 in. Weston 0-50uA m.c. meter and all parts except case and battery. Shunts ready adjusted to 1% HIGH stability .1% multipliers (4% stability as stocks permit). Price 69/-, post free. Multimeter scale fixed to meter 2/6 extra. Circuit scale, etc., 9d., free with kit.

NOUGHTS AND CROSSES MACHINE

This is a fantastic device which will play a game against you, and NEVER LOSE. It is a thinking machine, with a brain, yet is simple, using switches and lamps only. Full circuit, instructions, and details of 250 REWARD to first person to beat the machine. 3/6.

High Stab. 1% Resistors, 2/-, S.A.E. for new list of new and surplus. 1% from 9d. 1W 1% and 1/2% Wirewound Resistors. Your value would be order

PLANET INSTRUMENT CO. 25 DOMINION AVENUE, LEEDS 7

A NEW BOOK MORE ABOUT LOUDSPEAKERS by G. A. BRIGGS

136 pages 112 illustrations

Publication date
15th March 1963

Price only
8/6
(9/6 post free)



Since the 5th edition of *Loudspeakers* was published in 1958 there have been many new developments, particularly in relation to cones, diaphragms, magnets, cross-over networks, enclosures and absorbers. This book deals with these trends in non-technical terms.

CONTENTS

- Chapter 1 The General Situation
- 2 Magnets
- 3 Response and Impedance Curves
- 4 Transient Response
- 5 Distortion
- 6 Load Matching
- 7 Adding a Speaker
- 8 Crossover Networks
- 9 Listening Tests
- 10 Stereo
- 11 Cabinets
- 12 Mesh
- 13 Various Models

Sold by bookshops and radio dealers or in case of difficulty may be ordered direct from the publishers.



WHARFEDALE WIRELESS WORKS LTD. IDLE, BRADFORD, YORKSHIRE

Tel. Idle 1235/6

Grams: 'Wharfed' Idle, Bradford.

NOW ANYONE CAN AFFORD TO TRAIN TO BE AN EXPERT IN RADIO and ELECTRONICS

EVEN QUALIFY FOR A CERTIFICATE

It's the most exciting news of the year! Just imagine. You can get 35 large, fact-packed lessons for little more than 1/- per lesson! The lessons are crystal clear, practical, easy to master and use. Early lessons make fundamentals clear even to the beginner, while other lessons will give you the practical "know-how" of an expert.

Compare favourably with some courses costing ten times as much. You save because you receive all the lessons at one time and are not required to purchase equipment you do not need.

This is a real home-study course that has been bound into one giant 8 x 11 in. 216 page manual. Each page is divided into two columns. A wide column features the text, while a narrow column at the side has the instructor's comments, helpful suggestions and additional pictures to simplify the difficult parts.

Everyone can benefit from this practical course. No old fashioned (or pseudo modern) methods used here. Just straight forward, easy to understand explanations to help you make more money in electronics.

As an optional extra, you may pay a further fee if you wish to take the Sim-Tech radio and electronics examination. Students who attain a minimum of 80% correct answers can qualify for a certificate of proficiency in basic radio and electronics. Details sent with each course ordered.

You must be convinced that this is the best value you have ever seen in electronic training otherwise you can return the manual (or have your money refunded if sent with order) after you have examined it in your own home for a period of seven days.

The price? Only 36/-, plus postage.

FREE TRIAL OFFER!

To SIM-TECH TECHNICAL BOOKS, Dept. Wall, Gater's Mill, West End, Southampton, Hants.

RUSH Radio and Electronics Course for seven days examination. If I keep the course I can either pay 37/6d. cash or 12/6d. deposit after seven days and two payments of 12/6d. monthly. Otherwise I will return the course post-paid and owe nothing.

SAVE! Send only 36/- if paying cash with order. (We pay postage.) Same 7-day-money-back guarantee.

Name _____
Address _____
City _____ County _____

PADGETTS RADIO STORES OLD TOWN HALL, KNOWLER HILL, LIVERSEDGE, YORKS.

Phone: Cleckheaton 2866

Bomb Computers in new condition. Full of gears, motors, etc. 30/-. Carr. B.R.S. 10/-.

P.M. Speakers, all 3 ohms. Removed from TV sets. perfect condition. Rola 6 x 4 in., 5/-. Goodmans 7 x 4 in., 6/-. Philips 5 in. round, 5/-. Rola R and A round, 3/6. 6 in. dish, 5/-. 8 in. round, 6/-. Post extra on any speaker 2/-. Up to six can be sent for 3/6.

Germanium Diodes. 4/6 per doz. Post free.

New Miniature Panel Meters. 0-1 mA, 22/6. Post 1/3.

New Boxed Valves. Post Free. ARP12. 1/6. 6 for 5/6. Box of 50. 20/-, X41, 4/-, 6K7, 2/-, 6L6 Metal 7/-, 6V6CT 5/-, VR150/30 3/6, 6C4 2/-, 6X4 5/-, 6Y-do. 6V5 3/-. EL91 1/6. Also new valves ex-units, EF91 1/9. EB91 1/9. 524 5/6. 6X5 4/6. 12A6 Metal 2/6. 5U4 2/6. 6J6 2/6. 807USA 5/-, 6V6 3/-. 6V6CT 4/-. AC/2 pen 4/-. 12AT7 2/6. EF50 6/- per doz., 1/9 each. 6F6 2/9.

Valves removed from TV sets, all post free. all tested on a Mullard valve tester and are 100% as new. They carry a three months Guarantee. We also have a large stock of old type radio valves and other TV valves not listed.

ECL80 4/-. ECC82 5/-. EL38 4/-. EY51 2/6. EB90 4/6. EB91 9d. EF91 9d. 6F1 1/-, 6F13 2/-, 6F14 5/-. 6L20 5/-. 6SN7 2/9. 6Y6 2/6. 6G6 2/6. PCL82 6/-. 10C2 5/-. 10F1 1/-. 10P13 5/-. 10P14 5/-. 20D1 3/-. 20P1 5/-. 20L1 5/-. 185BT 2/6. U281 5/-. U282 5/-. U329 5/-. KT36 5/-. PL81 5/-. PL82 5/-. PY81 4/-. FY82 5/-. FY80 5/-. FZ89 4/-. FC80 4/6. PC884 4/6. PCL85 6/-. PL83 5/-. PL33 4/-. B36 4/-. N37 5/-. L63 3/-. 6J5 3/-. 2TSU 5/-. U12 4/-. EF80 1/6. 10/- per doz. Grade 2 6d., 4/- per doz.

Perfect Reclaimed Tubes. 6 months guarantee. 12in. 17/-, 14in. 30/-, Carr. and Ins. 7/6.

Tube Unit complete with VCR97 and Valves in good condition. 22/6, carr. 7/6.

Magic Eye with holder. Removed from New Unit, Y63. 5/-. Post 1/3.

Ex R.A.F. Unit Mains Transformer. 230 v. Prim. Sec. 250-250 v. 6.3 v. Sec. 5 volts 5/-, Post 2/6.

TV Tubes. Completely rebuilt and refaced. 12 months guarantee. Old glass not required. 12, 14, 15 and 17ins. Any make. Special trade price of £3.15.0. Carr. and Ins. 7/6. Passenger train 12/6.

SOUTHERN RADIO SUPPLY LTD.

11 LITTLE NEWPORT STREET
LONDON W.C.2. GER 6653

All goods still available
as previously advertised

2 METRES!

The thrills of 144 Mc/s can now be yours for only 39/6, complete kit! Tunable range 150-100 Mc/s, simplified construction, etc., write today for descriptive literature, also if a newcomer-beginner to Amateur Radio ask for free copy of the world-famous "Globe-King" kits and receivers—stamp to cover postage costs appreciated. Write now to makers:

JOHNSONS (Radio)
St. Martins Gate, Worcester

ULTRA VIOLET BULBS

Easy to use source of UV for dozens of practical and experimental uses.

12 volt 36 watt AC/DC SBC 6/6. P. & P. 1/-, 12 volt 60 watt AC/DC SBC 8/6. P. & P. 1/-, Transformer to suit the above: Input 200-240 A.C. Output 12 volt A.C. 36 watt, 18/6, P. & P. 2/6. Input 200-240 A.C. 12 volt A.C. 60 watt, 22/6. P. & P. 3/6.

Set of 4 colours **FLUORESCENT Paint**. Red, Yellow, Green and Blue in 1/2 oz. tins (ideal for use with the above Ultra Violet Bulbs, 9/6. P. & P. 1/6).

BUILD AN EFFICIENT STROBE UNIT FOR ONLY 37/6.

The ideal instrument for workshop, lab, or factory. This wonderful device enables you to "freeze" motion and examine moving parts of stationery. We supply a simple circuit diagram and all electrical parts including the NSP2 Strobe tube which will enable you to easily and quickly construct a unit for infinite variety of speeds, from 1 flash in several seconds to several thousands per minute. New modified circuits bring price down to 37/6 plus 3/- P. & P.

NSP2 CV2296 STROBOTRON FLASH-TUBE made by Ferranti, brand new, I.O. base. Price 15/- P. & P. 1/-.

MAGNETIC COUNTERS 10 IMPULSES PER SECOND

Very latest HIGH Speed type ex P.O. guaranteed perfect, type No. 100B, coil 2,300 ohms, for 48 volt D.C. operation (will work on 36 volt), overall size 4 x 1 x 1 in. Also available, type 101A which can be used as an interesting accessory with our Strobe unit. Either type price 15/-, P. & P. 1/6.



Variable Voltage Transformer



Input 230 v. A.C. Output 0-280 v. at 2.5 amp. Fully shrouded. New. £5.19.6. inc. carriage. Also available from stock, 5, 8, 10 and 20 amp. Write for details.

4,000 Ohm Headphones, brand new (imported). 12/6 each pair. P. & P. 1/6.

SIEMENS H.S. RELAY. Very latest type, sealed. H96E. 1,700 ohms plus 1,700 ohms, single C/O contacts. Price 16/6 each, plus 1/6 P. & P.

Miniature LEDEN Switch. 24 volt D.C. operation. Two bank 11 position plus Homing Contact. A miniature and compact form of unselector. Ex brand new equipment. 32/6. P. & P. 2/-.

500 MICROAMP SUB-MINIATURE M/C METER. 1 1/2 in. diameter, flush mounting, single hole fixing. Scaled 0-1 mA. Shaded with Resistor for use as IMA if required. 29/6 plus 1/- P. & P.

230 VOLT A.C. GEARED MOTORS. Type B16G 80 r.p.m., 26 lb. inch, £119.6. P. & P. 2/-. Type D16G 5 r.p.m., 1.7 lb. inch, £29.6. P. & P. 2/6. Type D16G, 13 r.p.m., 1.45 lb. inch, £2.12.6. P. & P. 1/6.

12 v. D.C. Reversible Motor with tremendous power weight ratio: 3 position switch. Weight 2.1 ounces. Size 1 1/2 x 1 1/2 in. dia. Speed 7,000 R.P.M. Self lubricating. 15/-, plus 1/-, P. & P.

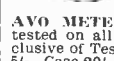

AVO METER MODEL 7. Individually tested on all ranges and guaranteed. Inclusive of Test Leads. £11.0.0 each. P. & P. 5/-. Case 20/-.

MINIATURE LEAD ACID ACCUMULATORS (Brand New) 2V, 1.5 A.H. Size 4 x 4 x 1 1/2 in. Wt. approx. 1 lb, 16/6 for 3, P. & P. 1/6. 12V, 0.75 A.H. Size 4 x 3 x 1 1/2 in. Wt. approx. 2 lb. (can be used as double 6V), 15/6 each, P. & P. 1/6.

TRANSISTORS

OC30	10/-	OC75	7/-	Get 114	5/-
OC41	7/-	OC76	8/-	Get 573	12/6
OC42	5/-	OC77	9/-	Get 573	25/-
OC43	9/-	OC139	1/-	M/Pair	
		OC170	9/6	1N135A	4/-
OC71	5/-	OC171	10/6	2N458	20/-
OC72	7/-	OC200	10/6	2S005	30/-
OC73	14/-	OC201	21/-	2S013	100/-
		M/Pair		Get 104	6/-
OC73	6/-			SB345	7/6
				Get 105	10/-
				TK20B	4/-

SERVICE TRADING CO.

All Mail Orders also cashers. - - -
47-49 High Street, Kingston on Thames
Tel.: KINGSTON 9450
Personal callers only
9 Little Newport Street, London W.C.2
(off Leicester Square)
Tel.: GERARD 0576

CRYSTALS & COMPONENTS LTD



TEL: TEM.1189 2.4. EARLHAM STREET WC.2.

Near Cambridge Circus. A few minutes walk from Leicester Square or Tottenham Court Road Underground Stations
HOURS OF BUSINESS: 9 to 6. Saturdays 9 to 1. OPEN ALL DAY THURSDAY

CRYSTALS !!!

LARGE RANGE OF 10X, 10XJ, FT24, FT24 CRYSTALS ALWAYS IN STOCK.

Send stamped and addressed envelope for our free, comprehensive list.

TEST INSTRUMENT BARGAINS

- Sangamo Weston, brand new (not boxed), 0.750 micro amps flush, round, 3 1/2 in. dia. 1 mA flush, round, 3 1/2 in. dia. 49/6
 - Metro-Vic in good condition 47/6
 - 0-5 mA M.C. projecting 6in. dia. steel case 39/6 each
 - 0-15 mA M.C. projecting 6in. dia. steel case 39/6 each
 - 0-50 mA M.C. projecting 6in. dia. steel case 27/6 each
 - 0-100 mA M.C. projecting 6in. dia. steel case 27/6 each
- P. & P. 2/- per instrument.

BRAND NEW TAPE RECORDING HEADS. For single, centre track recording and playback. With leads and 4-pin plug, 12/6. Postage 1/6.

DIODES. OA81, 2/9 ea., OC71, OC72 substitutes, 3/6 ea.

SILICON RECTIFIERS. Miniature power diodes at the right price. Leading makes, 100 P.I.V. at 650 mA, 6/- each, 500 P.I.V. at 200 mA, 3/6 each, 800 P.I.V. at 550 mA, 7/6 each, 1,000 P.I.V. at 500 mA, 8/6 each.

L.T. TRANSFORMERS. Pri. 240 volts. Output 6.3 volts 5 amps, 8/6, post 2/6. Pri. 240 volts. Output 17 volts 1 amp., 9/6, post 2/-.

H.T. TRANSFORMERS. Tapped 200/250 volts primary. Output 250/0/250 v. 60 mA, 6/3 v. 4 amps., 9/6. P.P. 2/6. Type (350/320) Tapped 200/250 v. input, 350/0/350 v. 120 mA, 6.3 v. 31 amps. 5 v. at 2 amps., 16/6. P.P. 3/6. Type 5k. Pri. 200/250 v. Output, 350/0/350 v. 350 mA, 5 v. 3 amps. Tapped 4v. 2v. 2amps. 10 kv. ins. 20 v. 1 amp. 7 v. 1 amp. 5 kv. 5 mA. Price 25/-, P.P. 6/-.

BC610 TUNING UNITS

Choice of 5-6.35 or 6.35-8 Mc/s. These compact units (9 x 4 x 2 in.) were used as plug-in tuning boxes with the BC610 TX. Containing miniature variable condensers of 140 pfd, 100 pfd and a standard size 50 pfd. A 0-100 graduated knob dial 1 in. dia. D.P. D.T. toggle switch and several other components. Price 6/6 each. P.P. 3/-.

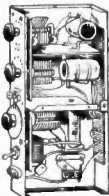

TYPE 46 SETS

Best Buy in TX/RX units in years. Complete with all accessories at give-away price. 3-channel crystal controlled TX and RX. Supplied complete with one pair of crystals, coil box, rod aerials, leads and plugs, valves, balanced armature head set with throat-mike. Coverage: 3.6 to 4.3 Mc/s only by means of Plug-in coil pack. Requires only 150 v., 15 v., and 3 v. dry batteries. Range over 10 miles under good conditions. Full instructions supplied. As new. We offer this fine unit as listed above with all accessories, at 42/6 per unit or 24 for two. Postage and packing 6/6. Set of batteries 24/- per set.

SPECIAL OFFER TYPE 46 SETS

As described above with valves, crystals and coil box but having had the original send/receive switch removed. Without other accessories. This set is supplied with a substitute switch and full wiring details at 18/6 each or 35/- per pair. P. & P. 5/6.

TERMS OF BUSINESS

CASH WITH ORDER. Handling charge of 1/6 on all orders under 20/- where P.P. is not otherwise stated.

VALVES SAME DAY SERVICE

NEW! TESTED! GUARANTEED!

SETS 1R5, 1R5, 1T4, 3S4, 3V4, DAF91, DF91, DK91, DL92, DL94 .. Set of 4 for 19/-
DAF96, DF96, DK96, DL96 4 for 28/6

1A7GT 11/-	6P25 8/-	30P19 17/6	EBF89 8/9	EZ40 6/9	U52 4/6
1D5 7/6	6P28 11/6	30PL13 12/6	EEL21 13/6	EZ41 7/6	U78 5/-
1H5GT 9/-	6Q7G 6/-	35L6GT 8/3	EEL31 17/6	EZ80 6/3	U191 13/6
1N5GT 9/-	6Q7GT 8/-	35Z3 15/-	ECB40 13/6	EZ81 6/3	U261 9/6
1R5 6/-	6SL7GT 5/9	35Z4GT 5/6	ECC31 4/9	CZ32 8/6	U282 15/-
1S4 8/-	6SN7GT 4/9	50L6GT 8/3	ECC83 7/-	KT61 9/6	U291 16/6
1R5 5/6	6U4GT 9/9	185B7 21/6	ECC84 7/9	MU14 6/6	U301 15/-
174 3/6	6V6G 4/6	AC/TH1 19/6	ECC85 7/9	MX40 13/6	U801 19/6
1U5 5/9	6V6GT 7/3	AZ1 12/6	ECC86 7/9	N18 7/-	UAB80 7/6
3A5 9/-	6X4 5/-	CBL1 13/-	ECC87 8/6	N37 7/6	UA42 8/3
3A4 7/-	6X5GT 6/9	CC35 13/6	ECH35 7/3	PC84 7/6	UBC41 8/9
3S4 6/-	6X0L2 8/6	CL33 12/3	ECH42 8/9	PC85 9/6	UBF80 8/3
3V4 7/-	7B6 9/-	CY1 12/6	ECH41 7/9	PC88 12/6	UBF89 8/3
5U4G 4/6	7B7 8/-	CY31 8/6	ECL30 7/6	PC89 8/9	UBL21 14/6
5V4G 8/-	7C5 7/9	DAC32 9/-	ECL82 9/-	PCF90 7/9	UC84 13/3
5Y3GT 6/-	7C6 7/6	DAF91 5/3	EF3A 6/9	PCF92 8/-	UC85 13/3
5Y4G 9/-	7H7 7/6	DAF96 7/6	EP39 4/6	PCF86 9/6	UCP80 14/6
6A5 3/9	7S7 9/-	DC90 9/-	EP40 11/6	PCL82 9/-	UCH21 13/6
6A6 3/6	7Y4 6/-	DF33 9/-	EP41 7/9	PCL83 10/6	UCH42 8/-
6A9G 6/3	10C1 12/-	DF91 3/6	EP91 7/9	PCL84 10/6	UCB11 8/9
6A78 6/-	10C2 12/6	DF96 7/6	EP80 6/9	PC45 10/6	UCB2 8/9
6B8A 5/9	10LD11 11/6	DH76 4/9	EP85 5/9	PEN36C 8/-	UCL83 13/3
6BE8 5/9	12A76 7/-	DH77 6/6	EP86 8/9	PL36 11/6	UF41 7/6
6BG6G 14/6	12A7V 4/9	DH81 9/-	EP89 6/3	PL81 9/6	UF89 7/-
6BF6 6/-	12A7U 4/9	DK32 11/-	EP91 3/6	PL82 7/6	UL41 8/-
6B16 5/9	12A X7 4/9	DK91 13/-	EP83 8/6	PL83 7/6	UL44 10/6
6BW6 6/-	12K8GT 4/9	DK92 7/6	EP184 11/6	PL94 8/6	UL46 9/6
6CD6G 27/3	12K8GT 9/6	LK96 7/6	EL33 9/6	PX4 10/6	UL84 6/6
6F1 10/-	12Q7GT 4/9	DL33 8/-	EL41 8/6	PX25 2/-	URIC 8/-
6F13 9/6	1487 14/6	DL35 9/6	EL42 8/6	PY32 11/-	UU7 8/6
6F14 9/6	16B3GG 14/6	DL36 6/-	EL84 6/6	PY90 7/6	UY21 12/6
6K7G 11/1	20L1 7/6	DL94 7/-	EM34 7/3	PY81 7/-	UY31 6/6
6K7GT 9/-	20P4 20/-	DL96 7/6	EM80 8/-	PY82 6/6	UY85 6/6
6K8G 5/-	20P3 15/9	EABC80 4/9	EM81 8/6	PY83 7/9	VP4B 9/6
6K8GT 9/-	25L6GT 7/-	EAF42 8/6	EM84 9/6	TH21C 15/-	VP41 5/-
6K25 10/6	25Z4G 7/6	EB91 3/9	FM85 9/9	U24 15/6	W46 4/9
6L6G 6/6	30S1 17/6	EB33 5/-	KT32 8/6	U25 12/-	W77 3/9
6L19 10/-	30L15 10/3	EB34 8/-	EY41 7/6	U26 9/3	W29 14/-
6LD20 7/9	30P4 12/6	EBF80 8/-	EY86 7/-	U50 5/6	Z77 3/6

RADIO BOOKS BASIC ELECTRICITY ELECTRONICS

In simple straight-forward words and Clear Explanatory Pictures, The Reader is taken Step by Step from picture to picture.

LEARN WHILE YOU PAY FOR ONLY 2/6 PER WEEK. Officially used by the ARMY, NAVY and AIR FORCE, used by Trainees in the Radio and Electronic Industry.

Write for FREE Illustrated Prospectus giving details of installment plan!

- 23 TESTED Micro Alloy Transistors 5/6
- AT A GLANCE Valve and T.V. Tube equivalents 4/-
- BRITISH Transistor Directory (Bradley) 5/6

- OSCILLOSCOPE Book USING an Oscilloscope 5/6
- OSCILLOSCOPE Equipment 5/6
- MULLARD Transistor Radios 5/6
- MULLARD Rect. Transistor Circuits 13/6
- EXTRA Equipment Tape Recorder 6/6
- COIL Design and Construction 5/6
- TRANSISTOR Superhet 8/-
- TRANSISTOR Audio Amplifiers 6/6
- TRANSISTOR Circuits for Radio 8/-

- RADIO Servicing Instruments 8/6
- HIGH Fidelity L/Speaker Enclosures 5/6
- BOYS' Book of Crystal Sets 3/6
- SERVICING Transistor Receivers 8/-
- ELECTRONIC Novelties 5/6
- ELECTRONIC Gadgets 5/-
- RADIO Valve Data "Wireless World" 7/-
- BEGINNERS' Guide to Radio 8/6
- MODERN Transistor Circuits for Beginners 8/-
- TRANSISTOR Test Equipment 4/-
- MAGNETIC Recording Wire and Tape 5/-

- COLOUR Television, 40 Colour plates 17/6
- RADIO Engineers' Pocket Book 11/6
- TRANSISTOR Circuits for the Constructor (Bradley) Nos. 1, 2, 3 and 4/- each

All above books include postage. SEND STAMP FOR LIST. **SELRAY BOOK CO.** 60 HAYES HILL, HAYES, BROMLEY KENT. Tel. HURStway 1515

READERS RADIO
24 COLBERG PLACE, STAMFORD HILL
LONDON N.16 STA. 4587

Post Gd. per valve extra.
Any Parcel Insured Against Damage in Transit 6d. extra.
Any C.O.D. Parcel 3/- extra.

★ TRANSISTORS ★ ZENERS RECTIFIERS ★ VALVES ★ QUARTZ CRYSTALS ★ THESE ARE OUR SPECIALITIES
EQUIVALENTS, DIAGRAMS, DETAILS AND INFORMATION IN OUR LATEST 54-page CATALOGUE. 1/6 Post Free

TRANSISTOR PORTABLE SIGNAL GENERATOR



PRICE
£7.10.0

P.P. 2/6

A 1st class Signal Generator covering 220 Kc/s to 200 Mc/s in 8 ranges. Radio broadcasts and I.F., Amateur, VHF, Shipping, TV, etc. R.F., I.F., A.F., modulated R.F. outputs. Easy to read and use with full details. Within 2% accuracy. Size 6½ x 4½ x 2in.

12 MONTHS' GUARANTEE
Leaflet on Request.

FIELD STRENGTH METER

Five channels cover 1 Mc/s to 200 Mc/s. Fitted 200 microamp meter for CW or RF. Indication and Earphone for AF monitoring. Designed for checking all types of transmitters. Size 4 x 2½ x 2½in. Complete Ready to Use, with instructions. 69/6 Post Free.

A SELECTION FROM OUR STOCKS

Full Details in our Latest Illustrated Catalogue. 1/6 Post Free.

- 2,000 ohm Head Phones ... 12/6
4,000 ohm Head Phones ... 14/-
Stereo Phones 2 x 8 ohm ... 27/6
- Make your own printed circuits. Full details with 3 boards 6 x 3in. etc. 19/6
- Crystal Microphones (P.P. 1/6 any type)
Acos 39-1 Stick Microphone ... 32/6
Acos 40 Desk Microphone ... 15/-
Acos 45 Hand Microphone ... 25/-
Lapel/Hand Microphone ... 15/-
MC 24 Stick Microphone ... 25/-
100C Stick with Stand ... 39/6
BM3 Stick with Stand ... 52/6
- Transistor Megaphone £12.10.0.
- 250 mW 4-Transistor Amplifier, built ready to use ... 47/6 P.P. 1/6
- Complete Test Lead Kits ... 8/6
- Miniature Vernier Dial 8 : 1, reduction marked 0/100 for ¼in. spindles, 1¼in. diam. 12/6; 2in. diam. 14/-; 3in. diam. 16/-.
- 931A Photomultiplier. Brand new with base ... 60/-

DEAC RECHARGEABLE BATTERIES

- 18 volt 100mA/H 4 x 1in. diameter. Brand new sleeved, 30/-.
 - As above but 150mA A/H, 35/-.
- Both types easily split into any multiple of 1.2 volt. Brand new.

- CV2886 (M2H) Liquid Sampling Geiger Tube, 370 volts. 22/6. P.P. 1/-.
- Antex Miniature Mains Soldering Iron, ⅜in. bit. 29/6. P.P. 1/-.
Pocket Iron with Pouch, 30 watt, 220/250 volt. 18/6.
Solon 15 watt ⅜in. bit. 22/6. P.P. 1/-.
- Pocket Radio Booster Unit, for any radio. Improves output and quality. Size 9½ x 3½in. dia., 27/6. P.P. 1/-.
Size 8 x 2½in. dia., 25/-, P.P. 1/-.
Ideal for using pocket radios in car.
- 125 mW 9 volt Sub-min. 3-Transistor Amplifier. 2 x 1 x 1in. 45/-.

RUN YOUR RADIO OR AMPLIFIER FROM MAINS BATTERY ELIMINATORS AND CHARGERS

- For PP3 or equivalent 9 volt Pocket Radio Battery, 18/6. P.P. 1/-.
- For PP4, PP7, PP9, PP10, 9 volt Portable Radio and Equipment Supplies up to 300 mA. 49/6. P.P. 2/-.
- De Luxe version of No. 1, also charges PP3 type batteries. 24/- P.P. 1/-.
- Rechargeable PP3 battery. Runs as long as 100 batteries. Completed with charger unit, 25/- P.P. 1/-.

SILICON RECTIFIERS 500mA

100 PIV	3/-	1000 PIV	... 10/-
200 PIV	3/6	100 PIV 1 amp	... 4/6
300 PIV	4/6	200 PIV 6 amp	... 12/6
400 PIV	5/-		

REMEMBER—All our transistors and devices are 100% 1st Grade and Fully Guaranteed. We can advise as to the correct type to use.

- Telephone Coil for any amplifier or Recorder, 12/6, or fitted Miniature Tack Plug, 14/-.
- Crystal Contact Microphone for guitars, etc., 12/6.
- Personal Earphones: 600 ohm 10/6, 1,000 ohm 12/6, Crystal 8/6, 8/10 ohm 9/6. Fitted leads, jack plugs and sockets.
- 2-pole 2-way Miniature Honeywell Micro Switches, 7/6.
- Transistor Baby Alarm, as previously advertised, £5.10.0. P.P. 2/- Also Telephone Amplifier £5.10.0. P.P. 2/-.
- 4-Transistor 2-way Intercom., £7.10.0.
- 2-Transistor 2-way Intercom., 89/6.
- Miniature Multi-section Telescopic Aerials: 14in. 3/6; 38in. 6/6; 42in. 10/6; 64in. 17/6.
- Miniature 3-Press Button Switches, 6 pole 2-way and on/off, 5/-, P.P. 9d.
- Transistor Signal Injector, 42/6. For circuit testing and checking.
- 22in. 15 ohm double cone Hi-Fi Speaker, 84/-.

- Complete range of Speakers stocked.
- 12-way Selector Tube, GS12C (CV1740), 25/- each.
 - Quartz Fibre Pocket Dosimeters 0/150R and 0/500R, 12/6 each.
 - 6-Transistor speaker superhet pocket radio ready to use. Complete with leather case, phone, etc., etc., 99/6 P.P. 2/- Fully guaranteed.
De Luxe version 5 gns. P.P. 2/-.
 - Bradematic medium impedance double winding record/playback tape head on mounting plate. Complete with erase head. 29/6. P.P. 1/-.
 - Sub-Miniature Jack Plug and Socket, 2/6. Sub-Miniature Screened Plug, 2/-.
 - Standard Jack Plug, 2/6. Standard Screened Jack Plug, 3/6.
 - New Telephone Amplifier in moulded cabinets, 79/6.
 - Tuning Indicator and Battery Level Meter. Miniature Meter (400 µA) for Recorders, Transmitters, etc., etc., 24/6.

ALL PARTS IN STOCK FOR WEYMOUTH (WEYRAD) MED/LONG AND MED/SHORT RECEIVERS.

METER BARGAINS

- 50 Microamp 2in. square MC, 35/-
1 mA 2in. square MC ... 25/-
1 mA 2½in. Flush Round ... 30/-
2½in. Moving Coil double range Voltmeter centre zero. 30-0-30 and 3-0-3 volts. Ideal for transistor tester or voltage measurements, 12/6. Post Free.
0/500 microamp, 2½in., flush-mounting. D.C. ... 20/-
2½-0-2½mA, 2½in. flush D.C. ... 12/6
0/40/120mA 2in. D.C. ... 10/-
0/15 volt M.I. 2½in. FR. A.C. ... 8/6

Miniature Panel Meters

- *0/50µA (D.C.) 39/6 *0/5mA (D.C.) 27/6
*0/500µA (D.C.) 32/6 *0/300V (D.C.) 27/6
*0/1mA (D.C.) 27/6 Vu Meter 42/6
"S" Meter 35/- All Brand New Boxed.
* Available Clear Plastic Front or Black Moulded. State which.

SUBSTITUTION BOXES

- Capacitor Box. Provides 9 standard valves from 0.001 to 0.22 mfd at 600 volt working, 29/6.
 - Resistor Box. Provides 24 standard values at 1 watt. 15 ohms to 10 meg., 37/6.
- Each box fully calibrated with insulated leads. Invaluable for service and design.

- Crystal Microphone Inserts: 2in. 10/6; 1¼in. 7/6; ½in. 3/6; Acos 39-1 15/-.
- Stereo Amplifier, 2 watts each channel. Brand new, 79/6. P.P. 2/-.
- Antex Precision Soldering Iron. 220/250 volt. AC/DC. Fitted quick release ⅜in. bit. Ideal for all transistor work, 29/6.
- Type 38 Transmitter/Receiver. 5-valve, 7.4-9 mc/s, 22/6. P.P. 2/6 (sold without guarantee).
- Valve Voltmeter, AC/DC/Resistance, etc. £9.19.6. P.P. 5/-.

MINIATURE LEDEX SWITCHES

24 volt D.C. rotating switches, fitted actuator at each end of bank of contacts. Uses standard switch wafers. 5 Bank or 8 Banks of Contacts 45/-.

- STC F15 Thermistors, 6/-, R53 15/-
- ORP12 L DR Cell, 12/6; ORP60 Cell, 9/6; OCP71 Photo Trans., 27/6.
- ¾ Track Record/Playback Tape Heads. 2K ohms impedance, 15/-.
- Personal Earphones with Jack Plug and Socket, 8/10 ohm 6/6; 600 ohm 9/6; 1000 ohm 10/6; Crystal 6/6.
- 7 x 7in. Printed Circuit Panels for etching, 5/-, post free.
- Recording Tape. 5in. 600ft., 12/6; 5in. 900ft., 15/-; 7in. 1200ft., 18/6; 7in. 1800ft., 25/-.
- Garrard Mains Single Player, 4-speed GCB head. £5.9.6. P.P. 3/6.
- D.C. to A.C. Converter. 12 volts D.C. i.e. Car Battery up to 230 volts A.C. 15 watts. Uses 2 power transistors in special circuit. Kit 57/6. P.P. 1/6.

Henry's Radio Ltd

PADDINGTON 1008/9

303 EDGWARE RD., LONDON W.2
Open Monday to Sat. 9-6, Thurs. 1 o'clock

PLEASE TURN TO BACK PAGE

Practical Wireless

BLUEPRINT SERVICE

ALL of these blueprints are drawn full-size and although the issues containing descriptions of these sets are now out of print, constructional details are available free with each blueprint except for those marked thus (*).

Send (preferably) a postal order to cover the cost of the Blueprint (stamps over 6d. unacceptable) to PRACTICAL WIRELESS, Blueprint Dept., George Newnes, Ltd., Tower House, Southampton Street, London W.C.2.

DOUBLE-SIDED BLUEPRINTS

Each blueprint in this series contains details of two separate instruments or items of equipment.

The Strand Amplifier	}	*	5/-
The PW Signal Generator			
The Savoy VHF Tuner	}	*	5/-
The Mayfair Pre-amplifier			
The Berkeley Loudspeaker Enclosure	}	*	5/-
The Luxembourg Tuner			
The PW Troubadour	}		7/6
The PW Everest Tuner			
The PW Britannic Two	}	*	6/-
The PW Mercury Six			
The PW Regency	}	*	5/-
The PW International Short Wave Two			

RECEIVERS

The Tutor *	3/-
The Citizen *	5/-
Junior Crystal Set	PW94 2/-
Dual-wave Crystal Diode	PW95 2/6
Modern One-valver	PW96 2/6
All-dry Three	PW97 3/6
Modern Two-valver	PW98 3/6
A.C. Band-pass Three	PW99 4/-
A.C. Coronet-4	PW100 4/-
A.C./D.C. Coronet	PW101 4/-
The PW Pocket Superhet	5/-

MISCELLANEOUS

The PW 3-speed Autogram	8/-
The PW Monophonic Electric Organ	8/-
The PW Roadfarer *	5/-
The PT Band III TV converter	1/6
The Mini-amp *... ..	5/-

SOME EARLIER DESIGNS

THE following blueprints include some pre-war designs and are kept in circulation for those constructors who wish to make use of old components which they may have in their spares box. The majority of the components for these receivers are no longer stocked by retailers.

Experimenter's Short Wave	PW30a	2/6
Midget Short Wave Two	PW38a	2/6
Simple S.W. One-valver	PW88	2/6
Pyramid One-valver	PW93	2/6
BBC Special One-valver	AW387	2/6
A One-valver for America	AW429	2/6
Short-Wave World Beater	AW436	3/6
Standard Four Valve S.W.	WM383	3/6
Enthusiast's Power Amplifier	WM387	3/6
Standard Four Valve	WM391	3/6
Listener's 5-Watt Amplifier	WM392	3/6

QUERY COUPON

This coupon is available until 7th May, 1963, and must accompany all queries in accordance with the notice on our "Letters to the Editor" page.

PRACTICAL WIRELESS, MAY, 1963

Published on the 7th of each month by GEORGE NEWNES, LIMITED, Tower House, Southampton Street, London, W.C.2, and printed in England by WATMOUGHS LIMITED, Idle, Bradford; and London. Sole Agents for Australia and New Zealand: GORDON & GOTCH (A/asia), Ltd., South Africa and Rhodesia; CENTRAL NEWS AGENCY, LTD. East Africa; EAST AFRICAN STANDARD LTD. Subscription rate including postage for one year: Inland £1.8.0. Abroad £1.7.6 (Canada £1.5.0.). Registered at the General Post Office for the Canadian Magazine Post.

**PLEASE NOTE OUR
NEW ADDRESS**

Just 200 yds. from our old address

Henry's Radio Ltd.
303 EDGWARE ROAD, LONDON W2
PADdington 100B/9
Open Monday to Sat. 9-6. Thurs. 1 o'clock

NEW SUMMER CATALOGUE

54 PAGES 10½ x 7½ in.
Fully detailed and illustrated 116 post free

**"CAPRI" POCKET-6
6-TRANSISTOR SUPERHET**



Size only
4½ x 2½ x 1½ in.

**REALLY
POCKET
SIZE!**

The most compact 6-transistor and diode radio with speaker available to the

home constructor. Features the latest in miniature components and circuitry. Supplied with Mullard transistors and two-tone moulded cabinets in red/white or blue/white with gold fittings. All components are supplied in packets and clearly identified. A printed circuit is used with fully illustrated building instructions. Push-pull output coupled with a sensitive and selective circuit make the "CAPRI" hard to beat. Fitted Earphone/Record Socket. Full tuning on medium waves with long wave Light.

Illustrated leaflet on request.

TOTAL COST £5.19.6 P.P. 2/-

Slip it into your Pocket

**4 WATT TRANSISTOR
AMPLIFIER**

Order Now! New design 7-transistor amplifier and preamplifier. Separate treble, volume and bass controls. Small size Excellent quality. £5.10.0. P.P. 2/-.

THE "CONTESSA"

**★ COMBINED PORTABLE AND
CAR RADIO ★**

AMAZING SENSITIVITY AND SELECTIVITY ON MEDIUM AND LONG WAVEBANDS

★ The easiest Superhet Radio to build on the market. Features clearly marked printed circuit and packaged components with full illustrated building instructions. Full tuning of medium and long wave bands with unbeatable sensitivity and selectivity. Excellent tone and volume with over 600MWV push-pull output.

★ Clearly marked horizontal station dial with slow motion tuning. Two colour Blue or Beige cabinets with Gold handles, grilles and fittings. Size 10½ x 7½ x 3½ in., include car aerial socket, recording sockets.

★ 6-Mullard Transistors and 2-Diodes. Guaranteed the Best Obtainable

Attractive Appearance—Reliable Design—Quality Performance

UNBEATABLE FOR QUALITY AND VALUE

Fully Detailed and Illustrated Leaflet on request.



**TOTAL COST
OF ALL PARTS**

£9.19.6 P.P. 3/6.

"MINIRANGER"

3-Transistor Plus 2-Diodes. Smallest radio to build yourself. Printed circuit full tuning. ONLY 3 x 2 x ¾ in. Over 20 stations. Diagrams Free.

TOTAL COST 4/9.6 P.P. 1/6

**"QUINTET"
POCKET
RADIO**

Diagrams Free. Size 5½ x 3 x 1½ in. 5-Transistor, plus Diode MW/LW to build.

7/9.6 P.P. 2/-.



BOTH MODELS AS PREVIOUSLY ADVERTISED

ALL PARTS SOLD SEPARATELY BOOKLETS FREE ON REQUEST

MULTI-METERS



THL33. 20,000Ω/V.
0/10/50/250/500/1000 v. A.C.
and D.C.
0/500μA/10/250 mA. D.C.
0/10k/1000k/1 meg. etc., etc.
Size 5 x 3½ x 1½ in.
7/5/- P.P. 1/6.

ITI-2. 20,000Ω/V.
0/5/25/250/500/2,500 v. A.C./
D.C.
0/50μA. 0/2½/250 mA. D.C.
0/6k/6 meg. etc.
Size 4½ x 3½ x 1½ in.
5 gns. P.P. 1/6.

TE10. 10,000Ω/V as above
8/9/6 P.P. 1/6.

PT34. 10,000Ω/V.
0/10/50/250/500/1,000 v. A.C./
D.C.
0/1/100/500 mA. D.C.
0/100k etc.
Size 3½ x 2½ x 1½ in.
4/5/- P.P. 1/6.

500. 30,000Ω/V.
0/½/1/2½/10/25/100/250/500
/1,000 v. A.C. and D.C.
0/50μA/5/50/500 mA. 0/12
amps.
0/60k/6 meg./60 meg. etc.
Size 6½ x 4½ x 2½ in.
£8.19.6 P.P. 2/-.

TP55. 20,000Ω/V.
0/10/50/250/500/1,000 v.
A.C./D.C.
0/50μA/0/5/50/500 mA. D.C.
0/10k/100k/1 meg./10 meg.
etc.
Size 5½ x 3½ x 1½ in.
£5.19.6 P.P. 1/6.

**ALL METERS SUPPLIED
COMPLETE WITH BATTERIES,
TEST LEADS
AND INSTRUCTIONS.
SEE LATEST CATALOGUE
FOR FULL
DETAILS.**

Brand New—Fully Guaranteed

PLEASE TURN PAGE

**4 WATT 4 TRANSISTOR
AMPLIFIER**

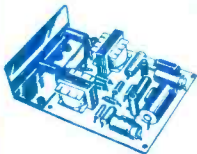

Improved Version
1½ watt peak output.
± 3dB 70c/s to 12 kc/s.
Output to 3 ohm speaker
9 volt operated.
Details on request.

Built and Tested Kit of Parts
5/9/6 OR 5/2/6
P.P. 1/6 P.P. 1/6

BATTERY RECORD PLAYERS



6-7½ volt Garrard turntable with crystal pick-up. Plays 45 r.p.m. ideal for above amplifier. 5/5/- P.P. 1/6.

Suitable cabinet for amplifier and player, 1/7/6. P.P. 2/-.

G.C. 9 volt 45 r.p.m. and 33 r.p.m. Player, £5.5.0. P.P. 2/-.

B.S.R. 9 volt 4-Speed "Hi-Grade" Turntable with turn-over Crystal Pick-up. £6.5.0. P.P. 2/6.



**'TRANSFIVE'
PORTABLE
RADIO**

Total Cost of all Parts
£5.19.6
P.P. 2/6.

A 7-stage push-pull output printed circuit portable radio of attractive appearance. Features 5in. speaker, clearly marked printed circuit panel, ferrite aerial, carded components and fully detailed and illustrated building instructions. Size 8½ x 6½ x 3½ in.

★ Plans Free on Request ★