

MARCH  
1963

# *Practical* 2/- **WIRELESS**

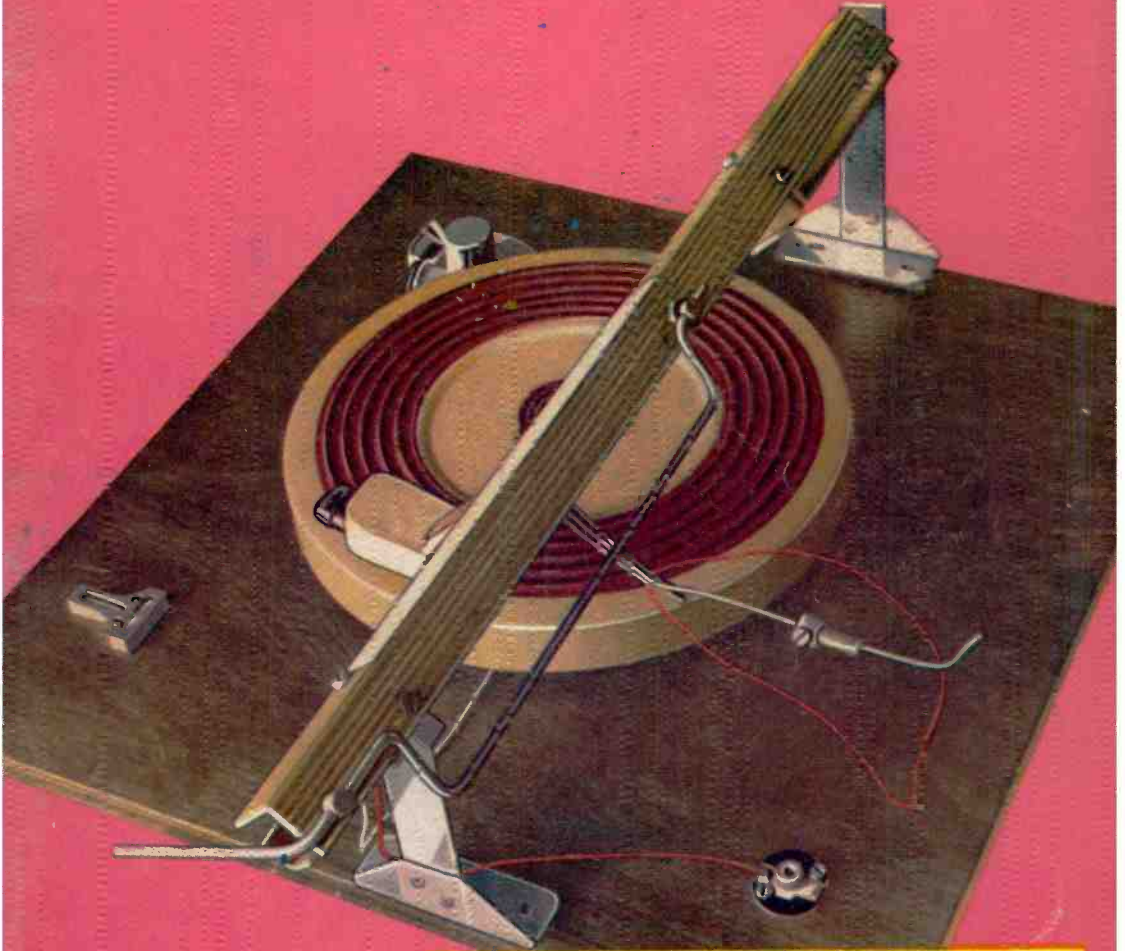

**PARALLEL  
TRACKING  
UNIT**  
for low  
record wear

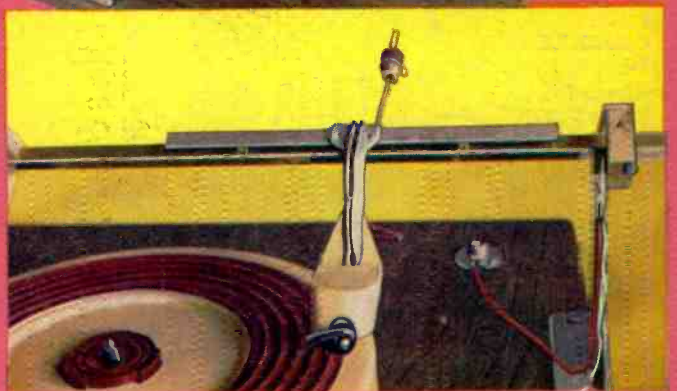

# ADCOLA

REGISTERED TRADE MARK  
Largest Franchise Group

## SOLDERING INSTRUMENTS AND EQUIPMENT

DESIGNED FOR  
THE AMATEUR'S  
RADIO STATION

### ILLUSTRATED

List No. 70.  $\frac{1}{8}$ " BIT  
IN  
PROTECTIVE  
SHIELD  
List No. 68

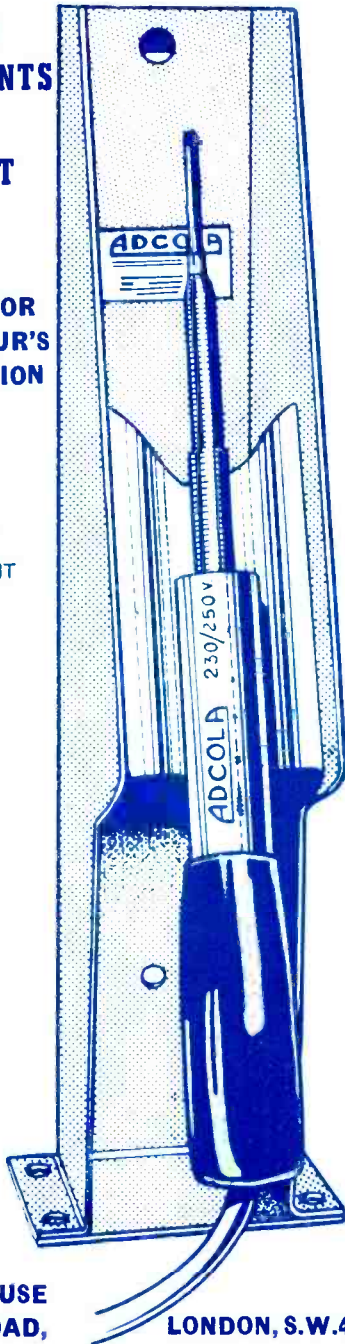

APPLY DIRECT  
FOR  
CATALOGUE  
TO

Sales and  
Service Dept.

**ADCOLA  
PRODUCTS  
LTD**

**ADCOLA HOUSE  
GAUDEN ROAD,**

**LONDON, S.W.4**

Telephones  
MACaulay 4272 & 3101

Telegrams  
SOLJOINT LONDON SW4

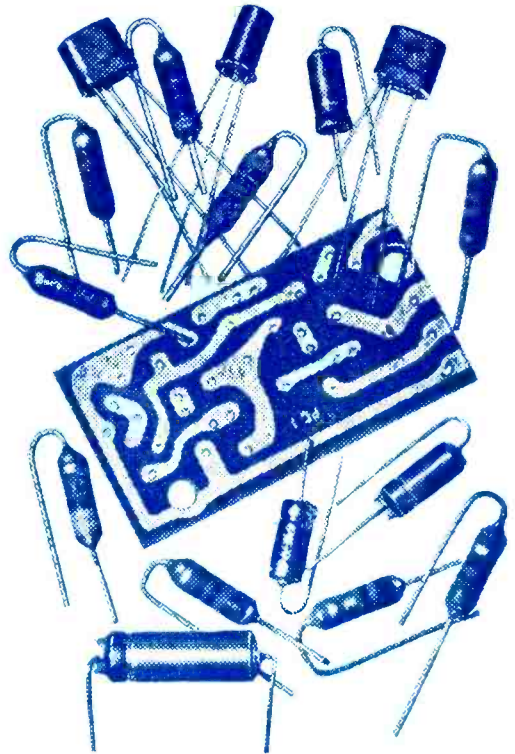

**seventeen into one**



**will go**

**pre-assembled packaged circuits by Pye Industrial Electronics save space, time, and money**

The P.C.1, first of a new range! This transformer-less 125mW-9V audio amplifier circuit provides a pre-assembled block for simplifying the design and assembly of laboratory equipment and intercomm sets etc. The unit uses Newmarket matched npn/pnp audio transistors in complementary symmetry circuits to achieve low distortion (typically 2% total) medium high sensitivity (50mV max out of 600 ohms for 50mW out) and low standby battery current (typically 4mA). Measuring only 2" x 1" x  $\frac{3}{8}$ " the P.C.1. is guaranteed for one year.

Write for full technical data to:

**Pye Industrial Electronics Ltd, Exning Road,  
Newmarket.**

Telephone: Newmarket 3381

**NI**

# ★ VALVES ★

By return of post:

## THE MOST COMPREHENSIVE COMPETITIVE VALVE LIST IN THE COUNTRY

**10% DISCOUNT**  
SPECIAL OFFER TO PURCHASERS OF SIX VALVES marked in block type (15% in dozen). Post: 1 valve, 6d., 2-11, 1/-.

**NEW LOW PRICES GUARANTEED 3 MONTHS**

**FREE TRANSIT INSURANCE.** All valves are new or of fully guaranteed ex-Government origin. Satisfaction or Money Back Guarantee. Goods if returned unused within 14 days.

024	6/-	6J50T	4/-	138A7	7/-	DF96	7/8	EM94	8/-	T41	7/8
145GT	7/-	6J5	7/8	12847	5/-	DP37	5/8	EM85	10/-	TD4D	7/8
147GT	11/-	6J7	8/8	128H7	3/6	DH63	6/-	EN31	16/-	U14	8/-
145GT	9/-	6J7G	4/9	128J7	5/6	DH76	5/-	EY61	7/8	U18	8/-
1D5	8/-	6J7GT	7/6	128K7	4/8	DK32	11/-	EY66	7/8	U22	6/9
1D6	9/8	6J8	9/8	128N7GT	7/8	DK91	5/6	EZ35	6/8	U24	11/8
1H6GT	9/8	6K6GT	9/8	13D5	3/4	DK92	7/4	EZ26	6/8	U25	11/8
1L4	3/8	6K7	5/8	14S7	14/8	DK96	7/8	EZ20	6/8	U28	6/9
1L1D5	3/8	6K7G	2/8	19A5G	7/8	DL33	3/-	EZ41	7/-	U31	7/-
1L1D5	4/8	6K7GT	4/8	19B66	18/-	DL35	5/-	EZ90	6/-	U33	14/-
1N6GT	9/8	6K8GT	8/9	20D1	9/8	DL63	6/-	EZ81	6/8	U35	12/6
1R5	5/8	6K25	7/8	20E2	9/8	DL75	6/-	FW4500	8/-	U37	28/-
1S4	8/-	6L1	12/-	20L13	18/-	DL90	5/8	FW4500	8/-	U50	50/-
1S8	4/8	6L6G	6/8	20P1	8/9	DL91	8/-	GT1C	10/8	U52	9/-
1T4	3/8	6L18	9/-	20P3	12/6	DL92	6/-	GZ32	8/8	U78	5/8
2A3	6/8	6L19	11/-	20P4	18/-	DL94	6/8	GZ34	12/8	U78	5/8
2A7	9/8	6L13	8/-	20P5	15/-	DL96	7/8	HL41DD8	6/8	U91	12/6
2A21	5/-	6L1D12	1/8	25A6G	8/-	EABC80	9/8	HN309	19/-	U281	9/8
3A4	4/8	6LXGT	5/8	25B6G	9/8	EAC51	5/8	IS15	10/8	U292	12/-
3D5	9/-	6N7	7/8	25L6GT	7/8	EAK42	4/-	1W4350	7/8	U301	15/-
3D8	4/8	6P1	7/8	25Y5G	8/-	E841	7/-	1W4500	7/8	U309	6/9
3Q4	7/-	6P25	8/8	25Z4G	7/-	E891	3/-	KLL32	8/8	U329	6/9
3Q5GT	8/-	6P28	12/6	25Z5	8/-	EBC33	4/8	KT32	6/8	U339	11/-
384	9/-	6Q76	8/-	25Z6G	8/-	EBC41	8/-	KT33	4/8	U301	18/-
5V4	6/8	6R3	12/6	20L13	18/-	ECC38	6/-	EBC34	12/6	U339	11/-
6R4G	12/6	6R7G	8/8	30C15	11/8	EBF80	7/8	EBC34	12/6	U339	11/-
5T4	8/-	68A7	5/8	30P5	6/-	EBF83	9/8	ET45	8/8	UB41	7/8
5U4G	4/8	6807	4/9	30FL1	8/8	EBF89	8/8	ET61	8/8	UBC41	7/8
5V4G	7/8	6817	3/-	30L1	6/8	EBL21	12/8	ET63	5/8	UBC41	9/8
5Y3G	5/8	68K7	5/-	30L15	6/8	EBL31	17/8	ET76	8/8	UBF80	8/8
5Y3GT	5/8	68L7GT	5/8	30P4	14/8	EBL31	4/8	ETW61	5/8	UBF89	7/8
5Y4G	11/-	68N7GT	4/8	30P12	7/8	ECC31	7/8	ETW62	5/8	UBL21	14/8
5Z4	11/-	6887	5/8	30P16	6/8	ECC32	4/-	ETW63	5/8	UCR4	14/8
5Z4G	7/8	6897	3/8	30P19	17/8	ECC38	4/8	ETZ63	5/8	UCR85	7/6
5Z4GT	11/-	6G4GT	10/8	30P13	9/8	ECC34	8/-	LE3	2/8	UCP90	15/-
6B12	9/-	6V66	6/8	35L13	18/-	ECC38	6/-	LX156	7/-	UCH21	12/-
6A6	4/8	6V6GT	6/8	35L16GT	8/8	ECC40	14/-	MU14	7/8	UCH42	7/8
6A7	10/-	6X2	7/8	35T	25/-	ECC81	6/8	N7	11/-	UCH81	8/8
6A8G	8/8	6X4	8/-	35W4	6/8	ECC82	8/-	N75	13/-	UCH82	9/8
6A9GT	13/8	6X56	5/-	35Z4GT	4/8	ECC83	6/8	NT08	18/-	UCH83	13/8
6B12	7/-	6X6GT	5/8	35Z5GT	4/8	ECC84	8/-	N132	8/8	UP41	7/8
6AC7	3/8	6Y6G	7/8	41	7/8	ECC85	7/8	P41	4/8	UF42	7/8
6AG5	3/-	7A7	8/8	42	7/8	ECC89	16/-	P41	2/8	UF80	7/8
6A17	7/8	7B7	9/-	50C5	11/-	ECC91	4/-	PABC80118	UF85	7/8	
6AK5	5/-	7B7	9/8	50C18	19/-	ECC90	8/8	PC084	6/8	UF86	14/8
6AL5	3/-	7C6	7/8	35L16GT	8/8	ECC82	8/8	PC085	5/8	UF89	7/8
6A6	3/-	7C8	7/8	35L16GT	8/8	ECC83	10/8	PC088	14/-	UL41	7/8
6AQ5	6/-	7H7	7/8	53KU	10/8	ECH35	7/8	PC089	9/-	UL44	11/8
6AT6	5/8	7K7	9/8	618PT	11/-	ECH42	5/8	PC089139	UL46	9/8	
6AU6	7/8	7Q7	8/8	62BT	13/8	ECH81	7/8	PC089	7/8	UL84	7/8
6BT	8/8	7S7	9/-	73	6/8	ECH83	9/8	PC089	7/8	UM40	9/8
6B4G	3/-	7V7	7/8	78	6/8	ECL80	7/8	PC134	18/-	UR1C	8/-
6BA6	5/8	7Y4	6/8	80	5/8	ECL82	5/8	PC086	12/8	U16	12/6
6BE6	5/8	7Z4	7/-	83	9/8	ECL83	11/8	PC132	7/8	U17	9/8
6B6G	15/-	8D3	3/-	145HT	19/8	ECL86	10/8	PC133	10/8	U18	17/-
6BH6	6/-	10K1	11/8	803	19/8	EFC22	7/-	PC134	10/8	UY18	11/8
6R6	6/-	10C2	14/8	807(A)	5/-	EFC36	8/8	PC135	11/8	UY21	15/-
6BK7	9/8	10C4	8/-	808	7/8	EFC39	4/8	PC136	12/8	UY41	6/8
6BW6	7/8	10P1	5/8	813	55/-	EFC40	12/-	PCN45	8/8	UY85	6/8
6BW7	5/8	10P9	10/8	832	14/-	EFC41	8/-	PCN46	5/-	VP41	5/8
6BX6	4/8	10P18	10/-	866A	11/8	EFC42	7/8	PL38	8/8	VR105	5/8
6C4	2/8	10L14	7/-	954	2/-	EFC50-BR2	PL36	8/8	VR150	5/8	
6C5	5/8	10L18	7/8	956	1/8	EFC50-USA	PL36	14/-	W41	11/8	
6C8	3/8	10LD11	11/8	5763	9/8	3/-	PL81	8/8	W76	4/8	
6C9	11/-	10LD12	8/-	9001	4/-	EFC54	3/8	EL82	6/8	W81	7/8
6C6DG	10/8	10P13	11/-	9002	4/8	EFC53	4/8	PL83	6/8	X41M	11/8
6C8H6	7/8	10P14	9/-	ATP4	2/8	EFC55	6/8	PL84	8/-	X53	8/8
6D3	3/-	10P15	3/4	AZ31	8/8	EFC56	8/8	PL85	8/8	X55	11/-
6D6	4/8	12A6	1/8	AZ41	11/-	EFC59	6/8	PL84	12/8	X66	11/8
6D8	4/3	12A8H	9/-	B36	7/8	EFC61	3/-	PX25	9/8	X76M	11/8
6F1	4/8	12AT6	7/8	C1C	9/8	EFC92	4/8	PY31	9/-	X78	21/-
6F6G	5/8	12AT7	5/8	CB11	20/8	EFC96	3/-	PY32	10/-	X79	16/8
6F12	3/-	12AUG	9/8	CB30	21/8	EFC85	14/-	PY33	11/8	X41M	8/-
6F13	6/8	12A17	7/8	CC35	14/8	EF184	12/8	PY81	6/8	Y3	6/8
6F14	9/8	12A27	6/8	CL33	9/8	EL32	4/8	PY82	6/-	Z63	4/8
6F15	9/8	12BA6	7/8	CY31	9/-	EL33	7/8	PY83	7/-	Z68	9/8
6F16	8/-	12BB6	7/8	D77	3/8	EL35	7/-	PY88	9/8	Z152	4/8
6F19	6/8	12BH7	9/8	D155	5/8	EL41	8/-	ZP30	9/8	Z719	4/8
6F23	6/8	12C8	6/8	D30	12/8	EL42	8/8	R18	11/8	ZU12	11/8
6F24	12/-	12E17	17/8	DAC32	9/8	EL81	11/-	R19	11/-	Transistors:	
6F25	13/-	12I3GT	4/8	DAPF1	4/8	EL83	11/-	RL18	9/-	OC26	15/-
6F32	6/8	12K7GT	4/8	DAPF6	7/8	EL84	7/-	SP41	2/8	OC44	8/-
6F33	6/8	12K8	11/-	DET9	2/8	EL81	4/8	SP42	2/8	OC45	6/-
6J5	4/8	12K8GT	9/8	DF33	9/8	EM80	7/8	SP43	2/8	OC81	5/8
6J5G	3/-	12Q7GT	8/-	DF61	8/8	EM81	8/8	SU2150	4/8	OC81D	5/8

## Tubes

Carr. & ins. 12/6

		GUARANTEED		NEW TYPES
		6 Months	12 Months	MW 31/74
MOST MULLARD, MAZDA, COSSOR, EMITRON, EMI, SCOPA, BRIMAR, FERRANTI TYPES, PROCESSED IN OUR OWN FACTORY	12in.	£2. 0. 0	£3. 5. 0	£4-0-0
	14in.	£2.10. 0	£3.15. 0	MW 36/24
	15-17in.	£3. 5. 0	£4.10. 0	£5-0-0
	21in.	£3.15. 0	£5.15. 0	CRM 172
				MW 43/84
				£6-0-0

**IVORY GOLD KNOBS** 1" Diameter, half price 1/2, 5 for 4/8; 3" 1/2, 5 for 4/-; top quality 1" sp. grub screws.

**SPECIAL TEMPORARY OFFER.** Due to huge Bulk Special Purchase we are offering MW 31/74 Tubes at the unrepeatable price of 29/-, MW 36/24 ditto, 39/-. P.P. 12/6. The above are guaranteed for 6 months.

**RECTIFIERS.** 250 v., 80 mA, 5/-; RM2, 6/8; RM3, 7/8; RM4, 19/8; RM5, 19/8; 14A86, 17/-; 14A97, 19/8; 14A100, 19/8; 16CR1-1-161, 7/8; 18A11-1-161, 6/8; 18RD2-2-81, 14/-; 14RA1-2-2, 17/-; 14RA1-2-8-3, 20/8; **ELECTRIC MOTORS.** AC/DC 3-96 volts. Totally enclosed standard mounting, powerful, V pulley, spare brushes, Zinc, zinc. **7/6**

**14in. TVs.** Carr. 12/6. 13CH with CRM 141 Tubes. Absolutely complete, tested for raster. Famous make, large purchase enables us to offer them at **£4.19s.**

**MICA CONDENSERS.** Ceramic and Silver Mica. All values, 8d. ea., 6/- doz. **CONDENSERS.** 25 Mixed, Electrolytic. Many popular sizes. List Value 55. Our Price 10/-.

**TRANSISTOR SNIPS**  
Huge reductions. Red Spot standard L.F. type now only 1/8; White Spot R.F. 2/-; Mullard Matched Output Kits (OC81D and 2-OC81's), 12/6. Receiver Kits, OC44, OC45(2), OC81D, OC81(2), six transistors. **25/-**

**TRANSISTOR CONDENSERS.** Latest single-ended sub-miniature 50pF 1V, 1/-; 50pF 5V, 1/3; 100pF 3V, 1/3; 300pF 1V, 1/8; 1000pF 5V, 1/8; 1200pF 5V, 2/-.

**RESISTORS.** All values, carbon 1-2 watt, 6d. ea., 4/6 doz. **3 VALVE AMPLIFIERS.** Kit of new parts, consisting chassis mains and output transformers, valves (P61, 6V6G, 6X54) and all components. With full instructions for making high gain amplifier with separate base and treble controls, negative feedback, etc. Truly unusual value at 28/-.

**NEW SPEAKER CABINETS.** Covered in attractive Rexine, Gold Metal front 11". Or complete with 7 x 4 speaker, 19/-. P.P. 1/6.

**4-SPEED RECORD PLAYERS.** Latest Turntable, together with lightweight stator, auxiliary dual spindle crystal turn-over pick-up head. Amazing value (pick-up only 19/-). **£210.0** Carr. 3/-.

**VOLUME CONTROLS.** All values, less switch, 3/-, with switch 4/8.

**NUVISTORS**  
Latest American, 6CW4, amazing V.H.F. performance, see Practical Television article (Dec.), 17/8.

**PORTABLE RECORD PLAYERS.** Takes all sizes Records, all speeds, amplifier, auto-changer, Garrard new "Slimline" Gram. In two-tone case. **14gns.**

**HIGHEST QUALITY—COMPARE OUR PRICES**

**VALVE HOLDERS.** B76, 6d. ea., with Screen 8d. ea., B9A 6d. ea., with Screen 8d. ea. Int. Octal 6d., Mazda Octal 4d., B8A 6d. (less 15% in dozens).

**SILICON RECTS.**  
250V 600mA standard TV replacement. Top quality 8/8 (3 for 24/-).

**COSSOR D.B. SCOPE TUBES.** Type 09J Split Beam. Ideal for building your own quality oscilloscope whilst stocks last. **55/-**

**TAPE AMPLIFIERS.** Professional quality, famous make (listed) approx. 235 very compact, two inputs, mixing, record/playback, erase. Requiring only deck, speaker, mike, grey **£9.10s.**

**P.M. SPEAKERS.** 3Ω Top Makes. 8in. **7/6** 7 x 4in. **8/6**

**VALUE!**  
**4 watt AMPLIFIERS**  
excellent amplifier with high gain preamp stage, (103 driving 20P3 output stage, complete with 8in. speaker. In attractive 2-tone case. Tone control, negative feedback, ready for immediate use, individually tested. Amazing volume and clarity, ideal for guitars, record players, P.A. In small hols, baby alarms etc. Lastly worth 25. Our price whilst stocks last. Carr. **45/-** Picking etc. 7/6.

**12 POTS.** Popular values, 5K. to 2 Meg. Unused, mixed, pre-set, long sp., switched, etc. **4/6**

**CO-AX.** low loss, 6d. yd., 25 yds, 11/6, 50 yds, 22/-, 100 yds, 42/6. Co-ax Plugs 1/3. Wall outlet boxes 3/6

**100 RESISTORS 6/6**  
Excellent, sizes 1-4 watt.

**100 CONDENSERS 10/-**  
Miniature Ceramic and Silver Mica Condensers, 3 pF to 5,000 pF. LIST VALUE OVER 25.

**PORTABLE RECORD PLAYERS.** E.M.I. turntable, complete in excellent modern carrying case with amplifier and 7 x 4 speaker. Amazing value. **£7.10s.** Carr. 6/-.

**GARRARD TA MK. II PLAYERS.** Latest quality deck at a most competitive price. **£7.19s.**

**P.V.C. CONNECTION WIRE.** 100 yds. 30 mill: special Price 7/8, 200 yds. 30 mill: special price, 12/8, 25ft. Coil, 1/7. 5 Coils different colours, 4/-, Connecting tex. Prices as above.

**TELEPHONE C.O.D. ORDERS DISPATCHED THE SAME DAY.**

</

**ARMSTRONG AF208AM/FM RADIOGRAM CHASSIS**

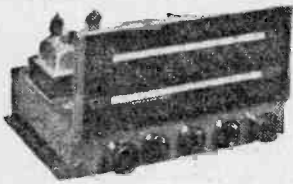

★ Full VHF Band (87-108 Mc/s and Medium Band, 187-570M) ★ 7 Valves ★ 5 Watts Output  
★ 15dB Negative Feedback ★ Separate wide range Bass and Treble Controls ★ 2 Compensated Pick-up Inputs ★ Frequency Response 30-22,000 c.p.s. +2dB ★ Tape Record and Playback Facilities ★ Continental Reception of Good Programme Value ★ For 3, 7 and 15 ohm speakers. Send S.A.E. for leaflet.

**£21.40** Carr. Free

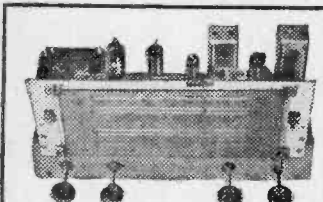

**1963 RADIOGRAM CHASSIS**

THREE WAVEBANDS FIVE VALVES  
S.W. 16 m.—50 m. LATEST MULLARD  
M.W. 200 m.—550 m. ECH81, EFS9, EB3C81,  
L.W. 800 m.—2,000 m. EL84, E280.  
12-month guarantee.  
A.C. 200/250 v. 4-way Switch; Short-Medium,  
Long Gram. A.V.C. and Negative feedback.  
3 ohm output, 5 watts. Chassis 12 1/2 x 5 1/2 x 2 1/2 in.  
Glass dial, horizontal or vertical wording, size  
10in. x 4 1/2 in. Aligned and calibrated. Isolated  
Chassis.

**£8.19.6** Carr. & Ins. 4/6

**BARGAIN SALE PRICES**

New Boxed VALVES 90-day Guarantee

OZ4	5/-	6K7G	5/-	EAB090	8/-	PCL82	10/-
1R5	6/-	6K84	5/-	EB01	4/-	PCL84	10/-
1R5	6/-	6L6G	8/-	EB34	8/-	PL81	10/-
1T4	3/-	6N7M	5/-	EB81	4/-	PL83	8/-
2X2	2/-	6Q7G	6/-	EBF90	9/-	PY33	15/-
394	7/-	68N7	5/-	ECH42	9/-	PY80	7/-
3V4	7/-	6V0G	5/-	ECH81	9/-	PY91	8/-
3Q5	7/-	6X4	5/-	FCL92	10/-	QY22	7/-
5Y4	6/-	6X5	6/-	EFS8	8/-	QY25	7/-
5Y3	6/-	12A7	6/-	EFS9	8/-	SP41	3/-
5Z4	8/-	12A7	6/-	EL32	5/-	SP61	3/-
6AC7	4/-	12AX7	7/-	EL84	7/-	U22	7/-
6AM6	4/-	12BH7	7/-	EY51	9/-	UB34	8/-
6AT6	6/-	12K7	5/-	EY68	9/-	UB31	9/-
6BA8	7/-	12K8	14/-	EZ40	7/-	UBF89	9/-
6BE8	5/-	12Q7	5/-	EZ80	7/-	UC881	9/-
6BW6	7/-	25Y6G	9/-	EY91	7/-	UCL82	10/-
6C4	5/-	31A	8/-	HAB9010	10/-	UCL83	12/-
6D8	6/-	35Z4	8/-	HUB92	5/-	UR89	6/-
6G6	4/-	807	5/-	KT33C	8/-	UL41	9/-
6H6	3/-	94	2/-	KT76	8/-	UY41	7/-
6J5	5/-	DAF96	8/-	MD14	7/-	UY85	7/-
6K6	5/-	DF96	8/-	PC384	8/-	UJ09	7/-
6L7G	8/-	DX96	8/-	PCF90	8/-	VR150	7/-
6K8	5/-	DL96	8/-	PCF82	8/-	W81	6/-

**L.F. TRANSFORMERS 7/6 pair**  
465 K/s Sing Tuning Miniature Can. 2 x 1 1/2 x 1 1/2 in.  
High Q and good bandwidth. Data sheets.

**NEW ELECTROLYTICS FAMOUS MAKES**

TUBULAR	TUBULAR	CAN TYPES			
1350V	2/-	50/350V	5/6	16450V	5/-
2350V	2/3	100/25V	3/-	32/350V	4/-
4450V	2/3	250/25V	3/-	47/350V	6/8
8450V	2/3	500/12V	3/-	100/270V	5/6
16450V	3/6	1,000/12V	3/-	5,000/6V	5/-
32450V	3/6	1,000/12V	3/-	32+32/350V	6/-
25/25V	1/8	84+84/50V	3/8	32+32/450V	6/-
25/50V	2/-	84+16/450V	3/8	32+32+82/350V	7/-
50/25V	2/-	36+16/450V	4/3	50+60/350V	7/-
60/50V	2/-	32+32/350V	4/8	100+200/275V	12/8

**COMPLETE RADIO CHASSIS £4.19.6. post free**

4 Mullard valves, 5in. speaker.  
Superhet Circuit. BRAND NEW.  
Size 9 x 6 x 5 1/2 in. high. Tested by us ready  
for use. 200/250 v. A.C.-D.C. Mains.

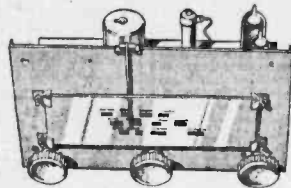

**DE LUXE MODEL** as illustrated with  
illuminated dial. Fully tunable with  
Medium and Long Wave. 12-month Guar-  
antee. Only £4.19.6 post 5/-.

**MAINS TRANSFORMERS 200/250 v. A.C.**  
Postage 2/- each transformer.

STANDARD, 250-0-250, 80 mA, 6.3 v. 3.5 a.  
tapped 4 v. 4s. Rectifier, 6.3 v. 1 a. 5 v.  
2 a. or 4 v. 2 a. 22/6 ditto, 550-0-550 ... 29/6  
MINIATURE 200 v. 20 mA, 6.3 v. 2 a. ... 10/6  
MIDGET, 220 v. 45 mA, 6.3 v. 2 a. ... 15/8  
SMALL, 220-0-220, 50 mA, 6.3 v. 2 a. ... 17/6  
STD., 250-0-250, 65 mA, 6.3 v. 3.5 a. ... 17/6  
HEATER TRANS, 6.3 v. 1 1/2 amp. ... 7/6  
Ditto, tapped 1.4, 2, 3, 4, 5, 6.3 v. ... 8/6  
Ditto, sec. 6.3 v. 4 amp. ... 10/6  
GENERAL PURPOSE LOW VOLTAGE, 2 amp.  
2, 3, 4, 5, 6, 9, 10, 12, 15, 18, 24, 30 v. ... 22/6  
AUTO TRANSFORMER, 150 w. ... 22/8  
L15, 200, 230, 250, 500 w. ... 23/6  
MULLARD "510" Mains transformer ... 30/-  
PARMEKO MAINS TRANSFORMER. Made for  
special contract, the ratings can safely be  
doubled. Guaranteed 2 years. Primary 0-110-  
210-230-250 v. H.T. 300-0-300 v. 50 mA. L.T.  
6.3 v. 1.8 amp. Size 4 x 3 1/2 x 3 1/2 in. Weight 6lb.  
Post ... 17/8  
MANS POWER PACK. Size 3 1/2 x 4 1/2 x 1 1/2 in.  
with mains transformer, metal rectifier and  
condensers to provide smoothed H.T. output  
220 v. 45 mA. D.C. L.T. 6.3 v. 2 a. Centre  
tapped. All ready built on a strong metal chassis.  
Brand New. Bargain. Post 2/6 ... 29/6

**INTERVAL TRANSFORMERS 3:1 or 6:1, 9/-**  
O.P. TRANSFORMERS. Heavy Duty 50 mA, 4/8.  
Multiratio. 7/6. Multi-ratio heavy duty push pull,  
10 v. 15/8. Miniature. 384, etc. 5/8.  
L.F. CHOKES 15/10H, 60/65 mA, 5/-; 10 H., 85 mA,  
10/8; 10 H., 150 mA, 14/-.  
**FULL WAVE BRIDGE SELENIUM RECTIFIER:**  
2 1/2 or 12 v. 1 1/2 amp. 8/3; 2 a., 11/3; 4 a., 17/8.  
**CHARGER TRANSFORMERS.** Tapped input 200/  
250 v. for charging at 2, 3, 6 or 12 v. 1 1/2 amps. 15/6.  
2 amps. 17/8; 4 amps. 22/6. Circuit included.  
**4 AMP CAR BATTERY CHARGER** with amp.  
meter Leads, Fuse Case, etc. for 6 v. or 12 v.. 69/9.  
**AMMETER 0 to 5 amp. 9/6.**

**BOOKS list S.A.E.**

40 Circuits for Germanium Diodes 3/-.  
"W.W." Radio Valve Data, 6/-.  
High Fidelity Speaker Enclosure, 5/-.  
Valve and TV Tube Equivalents, 9/6.  
TV Fan Findings, 5/-.  
(quality Amplifiers, 4/6.  
Radio Valve Guide. Books 1, 2, 3  
or 4, 5/- each.  
Transistor Superhet Receivers, 7/6.  
Practical Radio Inside Out, 3/6.  
Master Colour Code Chart, 1/8.  
Transistor Controlled Models, 7/6.

**4 TRANSISTOR PUSH-PULL AUDIO**

Size 8 x 1 1/2 x 1. **AMPLIFIER**  
A ready built miniature push-pull amplifier with  
input and output transformers. 4 transistors.  
Ideal for use with record players, intercoms,  
BABY ALARMS, etc. Complete with full  
instructions and circuit.  
Price **52/6** 9v. Batt. 2/3, 2 1/2 in. Speaker 15/-

**C.R.T. BOOSTER TRANSFORMERS**

for heater cathode short circuit, or  
tubes with failing emission. Full  
instructions supplied, mains input.  
Type A optional 25% and 50% boost.  
2v. or 4v. or 6.3v. or 10.5v. or 12.6v.  
State voltage required. PRICE 10/6.

**LOUDSPEAKERS P.M. 3 OHM.** 2 1/2, 3, 4in., 19/6,  
5in. Rola, 17/8; 8in. Plessey, 19/6; 7in. x 4in. Rola,  
13/-; 6 1/2 in. Rola, 15/6; 10 x 6in. 27/8; 10in. Rola,  
30/-; 4in. Teco, 25/-; 12in. R.A. 30/-;  
13 1/2 x 8in., Double Cone K.M.I. 45/-

**STENTORIAN HF1012.** 10in. 3 to 15 ohms, 10 v. 95/-;  
35 ohm, 7 x 4in., 25/-; 5in., 22/8; 3 1/2 in., 18/8.

**BAKER SELHURST LOUDSPEAKERS**

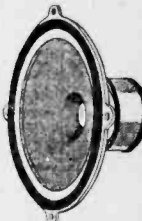

Details S.A.E.  
12in. Baker 15w. Stalwart  
3 or 15 ohms, 45-13,000  
c.p.s. ... 90/-  
12in. Stereo, Foam Suspension,  
12w., 35-18,000  
c.p.s. ... £8.17.8  
12in. Baker Ultra Twelve,  
20 c.p.s. to 25 khz. £17.10.0  
15in. Auditorium, 35 w.,  
Bass, 20 c.p.s. to 12khz. £18  
Details and Enclosure  
plans S.A.E.

**TWIN GANG TUNING CONDENSERS.** 365 pF,  
miniature lin. x 1 1/2 in. x 1 1/2 in., 10/-, 500pF Standard  
with trimmers, 9/-; midget, 7/6; with trimmers, 9/-;  
500pF slow motion tuning, standard or midget, 9/-.  
**SMALL 3 gang 500 pF, 17/- SINGLE 365 pF 7/6.**  
**SINGLE 35 pF, 50 pF, 100 pF, 160 pF, 5/6.**  
Solid dielectric 100, 300, 500 pF, 3/6  
**CONDENSERS.** New stock. 0.001 mfd., 7 kV.  
T.C.C. 5/6; Ditto, 20 kV, 9/6; 0.1 mfd., 7 kV, 9/6.  
Tubular 500 v. 0.001 to 0.05 mfd., 9d., 0.1, 1/-;  
6.25, 1/8; 0.5/500 v., 1/9; 0.1/350 v., 9d.; 0.1/2,000 v.  
0.1/1,000 v., 1/9; 0.1 mfd., 2,000 volts, 3/6.  
**CERAMIC COND.** 500 v., 0.3 pF to 0.01 mfd., 9d.  
**SILVER MICA CONDENSERS,** 10% p.p. to 500 pF  
9d.; 600 pF to 3,000 pF, 1/-; Close tolerance  
(±1 pF) 2.2 pF to 47 pF, 1/-. Ditto 1% 50 pF  
to 815 pF, 1/-; 1,000 pF to 5,000 pF, 1/8.

**465 K/s SIGNAL GENERATOR**

Price 15/-. Uses B.F.O. Unit, ZA 30038  
ready made with valve IS5. **POCKET**  
SIZE 2 1/2 x 4 1/2 x 1 1/2 in. One resistor to  
change. Full instructions supplied.  
Battery 8/6 extra. 69V 1/4. Details S.A.E.

**WAVECHANGE SWITCHES**

8 p. 4-way 2 water long spindle ... 6/8  
4 p. 2-way, or 2 p. 6-way long spindle ... 3/8  
4 p. 2-way or 4 p. 3-way long spindle ... 3/8  
3 p. 4-way, or 1 p. 12-way long spindle ... 2/6  
**Wavechange "MAKITS"** wafers available:  
1 p. 12 way, 2 p., 6 way, 3 p., 4 way,  
4 p. 3 way, 6 p. 2 way, 1 waffer switch, 8/6;  
2 waffer switch, 12/6; 3 waffer switch, 16/-;  
additional wafers up to 12. 3/6 each extra.  
Toggle switches, s.p., 3/6; d.p., 3/6;  
d.p.d.t., 4/-; Rotary s.p., 3/6; d.p., 4/6.

**CRYSTAL MIKE INSERT, 6/6**

Size 1 x 1 1/2 in., or 1 1/2 in. dia.  
**ACOS MIC.** 60, insert 1 1/2 in. dia. .... 8/6

**ACOS 39-1 DE LUXE STICK MIKE 35/-**  
**TSL QUALITY STICK MIKE..... 25/-**

**Valveholders.** Pax. int. oct., 4d. EA50,  
9d. B12A, CRT, 1/3. Ensl. and Amer. 4,  
5 and 7 pin. 1/-, MOUNTED Mazda and  
int. oct., 6d. B7G, B8A, B8C, B9A, 9d.  
BTG with can, 1/6. B9A with can, 1/9.  
Ceramic EF50, BTG, B9A, int. oct., 1/-.  
BTG, B9A cans, 1/- each.

**HI-FI AMPLIFIER** Ready built.

A.C. only. 200-250 v. Valves 6CL88 a 6X4  
E280. 3 watt quality output. Mullard  
tone circuits, bass boost, treble and  
volume controls. Separate engraved  
front panel with de-luxe finish. Heavy  
duty output transformer 3 ohm,  
Quality mains transformer. Stone  
enamelled chassis size 6in. x 5in. x 3in.  
Circuit supplied.

**THE ORIGINAL RADIO COMPONENT**

Our written guarantee with every purchase. **NEW COMPONENT LIST 1/-.**  
Bus 133 or 68 pass door  
S.R. Station Selhurst

**Volume Controls** **80 ohm COAX**

Linear of Log Tracks, Semi-air spaced jtn. Stranded core. 40 x 1.76 6d.yd. 5 K ohms to 2 Meg. 60 yds. 25/- L/P, 3/-; D.P., 4/6; Stereo L/8/10/6; D.P./14/8

**TELESCOPIC CHROME AERIALS.** 15m. extending to 43in., 8/6 ea. Coax Adaptor Plus, 1/6 extra. **TRIPLEXERS Bands I, II, III** 12/6 **COAX PLUS** 1/- **LEAD SOCKET** 1/2- **PANEL SOCKETS 1/2- COULET BOXES** 4/- **BALANCED TWIN FEEDER** yd. 8d. 30 or 300 ohms. **DITTO SCREENED** per yd. 1/8. 80 ohms only. **Wirewound Ext. Speaker Control.** 10  $\Omega$  3/-, 25  $\Omega$  6/6. **WIRE-WOUND POTS. 3 WATT.** Pre-set Min. TV Types. All values to 10 ohms to 25 K. 3/- ea. 30 K, 50 K, 4/-; (Carbon 30 K., to 2 meg., 3/-). **WIRE-WOUND 4 WATT Pots.** Long spindle. Value. 50 ohms to 50 K., 8/6; 100 K., 7/6. **PHILIPS TRIMMERS.** 0-10 pF, 3-30 pF 1/-. **TRIMMERS.** Ceramic, 30, 50, 70 pF. 9d.; 100 pF, 150 pF, 1/3; 250 pF, 1/6; 500 pF, 750 pF, 1/9. **TV etc. TRIMMER.** 100 pF, with knobs 2/-. **RESISTORS.** Preferred values. 10 ohms to 10 meg., 1/ w. 4d.; 1/ w. 4d.; 1 w. 6d.; 14 w., 9d.; 2 w., 1/ High Stability. 1/ w., 1%, 2/-. Preferred values 10  $\Omega$  to 10 meg. Ditto 5%, 10  $\Omega$  to 22 meg., 9d. **WIRE-WOUND RESISTORS** 1/8 10 watt 10 ohms—10,000 ohms 2/- 15 watt 25K to 47K 10 w. 3/-

**AMERICAN "BRAND FIVE" PLASTIC RECORDING TAPE**

Double Play 7in. reel, 2,400ft. 60/-	Spare
5in. reel, 1,200ft. 37/8	Plastic
Long Play 7in. reel, 1,800ft. 35/-	Reels
5 1/2in. reel, 1,200ft. 23/8	4in. 2/-
5in. reel, 900ft. 18/8	5in. 2/-
Standard 7in. reel, 1,200ft. 25/-	5 1/2in. 2/-
5in. reel, 600ft. 18/-	7in. 2/6

"Instant" Bulk Tape Eraser and Head Defluxer, 200/250 v. A.C., 27/6. Leaflet with full details. S.A.E.

**CRYSTAL SET BOOKLET, 1/-.**  
**CRYSTAL DIODE G.E.C., 2/-.** GEX34, 4/-. OA81, 3/-.  
**HIGH RESISTANCE PHONES, 4,000 ohms, 15/-.**  
**SWITCH CLEANER.** Fluid squirt spout, 4/6 tin.

**HIGH GAIN TV PRE-AMPLIFIERS BAND I B.B.C.**

Tunable channels 1 to 5. Gain 18dB. ECC84 valve. Kit price 29/6 or 49/6 with power pack. Details 6d. FCC84 valves if preferred. Coils only 9/6 **BAND III L.T.A.—Same prices.** Tunable channels 8 to 13. Gain 17dB. Circuit and Coils only, 9/6.

1/16in. Facolin Panels, 10 x 8in., 2/-. **Miniature Contact Cooled Rectifiers, 250V 50mA, 7/6; 250V 80mA, 8/6; 250V 85mA, 9/6; Selenium Rect., 300V-85mA, 5/-.** 1V etc. Silicon Sub-Min. Rectifier. 125V. 300mA, 6/6; 250V. 300mA, 14/6. **RM4, RM5, 14A100, 14A116, 10/-**—each FC31, 20/- **Osms Weartie "P" type, 3/-** each. **Osmor Midget "Q" type, ad.** dust core, from 4/- each. All ranges. List S.A.E. **Teletron D.W.R., L. and Med. T.R.F.** with reaction, 4/-. Med. wave D.R., 3/6. **Ferrite Aerials, M., 8/6; M. and L., 12/6.** **9smor Ferrite Rod Aerials, L. and M.** for transistor circuits, 10/- each. **Ferrite Rods, 8 x 1in., 3/-.** **H.F. Chokes, 2/6.** **Osmor QC1, 6/6.** **T.R.F. Coils, A/HF, 7/-** pair; HAX, 3/-; **Repanco DRR2, 4/-.** **DRXL, 2/6.** **Radio Screwdriver, 5in., 6d.** **Neon Mains Tester Screwdriver, 5/-.** **Solder Radiograde, 4d. yd., 1lb. 5/-.** **Black Crackle Paint.** Air drying, 3/- tin.

**Aluminium Chassis, 18 s.w.g.** Plain undrilled, 4 sides, riveted corners, lattice fixing holes, 2 1/2in. sides, 7 x 4in. 4/6; 9 x 7in., 5/9; 11 x 7in., 6/6; 13 x 9in., 8/6; 14 x 11in., 10/6; 15 x 14in., 12/6. **Aluminium Panels, 18 s.w.g., 12 x 12in., 4/6; 14 x 9in., 4/-; 12 x 8in., 3/-; 10 x 7in., 2/8; 8 x 6in., 2/-.**

**"6 + 1" TRANSISTOR RADIO MEDIUM AND LONG WAVE KIT**

First class components to make a 6 transistor 2 wave band superhet chassis. Ideal for portable or table radio. All parts including 6VA transistors, ferrite aerial with car aerial coil, printed circuit, 8 1/2in. x 2 1/2in., but EXCLUDING speaker and cabinet. Simple instructions 1/6 (Free with kit). **Speakers, 35 ohm, 7 x 4in. 25/- 5in., 22/6, 31in., 19/6.** **£4.5.0**

**BULGIN PLUGS AND SOCKETS.** Non-reversible P74, 2-pin, 4/3; P73, 3-pin, 4/6; P194, 6-pin, 5/6.

**JACKS.** English open circuit, 2/6. Closed circuit, 4/3. Grundig type, 3 pin, 1/3. Grundig lead jack, 3/6.

**JACK PLUGS.** English, 3/-; Screened, 4/-; Grundig, 3 pin, 3/6.

**ALADDIN FORMERS** and cores, 1in., 8d.; 1in. 10d. 0.3in. **FORMERS** 5937 or 8 cans TV1 or 2, 2in. sq. x 2 1/2in. or 2in. sq. x 1 1/2in., 2/- with cores.

**SLOW MOTION DRIVES.** 6:1 2/3.

**SOLON IRON, 25W, 200V or 230V, 24/-.**

**AUTO SUB-MIN IRON** 15w. 200 or 240 v., 29/6.

**BENCH STAND** for above, 12/6.

**JASON FM TUNER COIL SET**

29/-, H.F. coil, aerial coil, oscillator coil, two I.L. transformers 10.7 Mc/s. detector transformer and heater choke. Circuit and component book using four 6AM6, 2/6. (Complete Jason FMT Kit, Jason chassis with calibrated dial, components and 4 valves, 26.5.0. Power pack 29/6 extra. Model FMT2 with new shelf cabinet, 5 valves & power pack £10.

**MAINS DROPPERS.** Mid-range adjustable sliders, 0.3A, 1,000 ohms, 5/-; 0.2A, 1,200 ohms, 5/-; 0.15A, 1,500 ohms, 5/-; 0.1A, 2,000 ohms, 5/-.

**MIKE TRANSFORMER.** 50-1, 3/9.

**P.V.C. Covered Wire,** single or stranded, 2d. yd. Slewing, 1 or 2 mm., 2d.; 4 mm., 3d.; 6 mm., 5d. yd.

**SPEAKER FRET.** Gold cloth, 17 x 25in., 5/-; 25 x 35in., 10/-. **TYNSL,** various colors, 52in. wide from 10/-; 1/2, 26in. wide, from 5/- ft. Samples, S.A.E. Expanded Metal, Gold, 12 x 12in., 6/-.

**TELEVISION REPLACEMENTS**

**Line Output Transformers** from 45/- each, NEW Stock and other timebase components. Most makes available. S.A.E. with all enquiries.

**WEYRAD**

**COILS AND TRANSFORMERS FOR 2-WAVE TRANSISTOR SUPERHETS WITH PRINTED CIRCUIT AND FERRITE ROD AERIAL**

**Long and Medium Wave Aerial—RA2W** On 6in. rod, 208pF tuning, with car aerial coupling coil 12/6 **Osc. Coil P50/1AC, 178pF tuning.** 5/4 **1st and 2nd I.F. Trans.—P50/2CC, 470k $\Omega$ s** 1/16in. dia. by pin. 5/7 each **3rd I.F. Trans.—H50/3CC.** 6/- **Spare Cores** 6d. each **Driver Transformer—LFDT4.** 9/6 **Wavechange Slide Switch.** 3/6 **Printed Circuit—PCAL.** Size 21 x 8 1/2in. Ready drilled, and printed. 4/6 **Volume Control, 5K-DF.** 4/6 **35 ohm Speakers, 3in., 19/6; 5in., 22/6:** 7 x 4in., 25/- **24 Fixed Resistors.** 10/6 **16 Fixed Condensers.** 21/- **Tuning Gang with trimmers.** 10/6 **6 Mullard Transistors and diode.** 42/8 **Constructor's Booklet.** 2/- **500mW 3 OHM MODIFICATION KIT** 12/-

**NEW MULLARD TRANSISTORS**

OC71 6/-, OC72 7/6, OC8D 7/6, OC81 7/6, OC44 8/6, OC45 8/6, OC171 10/6, AF17 9/6 **Sub Miniature Condensers, 0.1 mFd.** 30 v. 1/3, .2, 4, 5, 10, 20, 50, 100 mFd. 15 volt 2/6 ea. Transistor Holders 1/3.

**B.B.C. Pocket 2 Transistor. M.W. and L.W. Radio Kit, 92/6.** **Miniature earpiece, 7/6.** **Batt. 2/3.** **Circuit details, etc. S.A.E.**

**MONARCH RECORD PLAYER**

Kit with ready built amplifier, speaker and cabinet. Carr. and ins. 5/- **£11.10.0**



**Garrard deluxe auto-player kit**

**£11.19.6** Carr. and ins. 5/- details S.A.E.

**GARRARD QUALITY AUTO-CHANGER, 4-speed,** with plug-in xtal head. Ready built 3 watt amplifier, Loudspeaker and contemporary styled Portable Player Case. All items guaranteed to fit together perfectly, can be assembled in thirty minutes, full instructions supplied.

**MAGNAVOX—COLLARO 4 speed** Stereo/Monaural Autochanger, Diamond Stylus and Record dust cleaning attachment .. .. £7.17.6 **4 Speed Autochanger, B.S.R., U.A.14** £6.15.0 **B.S.R., U.A.12 Stereo/Mono** .. .. £7.10.0 **Garrard Autoslim Changer** .. .. £6.17.6

**4 SPEED SINGLE PLAYERS:** **E.M.I. with auto stop** .. .. £5.15.0 **E.M.I. with separate pick-up** .. .. £3.7.6 **Record player cabinets with room for amplifier and speaker** .. .. 70/- **2 valve 3 watt A.C. amplifier and speaker wired and tested to fit above cabinet.** .. 95/-

Replacement sapphire stylus available from 5/3, Replacement Xtal from 15/-; Stereo from 31/6.

**SINGLE PLAYER KITS**

**£7.19.6** post 5/-.

With ready-built, 2 stage, 3 watts output amplifier. High flux 5in. speaker. Handsome portable case 13 x 10 1/2 x 7 1/2in. Collaro 4-speed junior motor, LF/5td. xtal pick-up for 7, 10, and 12in. records.

**CABY MULTIMETER**

**Moving-coil Model M.C. 54/-** Measures D.C. or A.C. 6 v., 30 v., 120 v., 600 v., 1200 v. D.C. 30 mA, 300 mA, Ohms 0-100K. Leaflet S.A.E.

**ARDENTE Transistor Transformers**

Type D3035, 7.3 CT; Push-Pull to 3 ohms for OC72, etc., 1 x 1 x 1 in. 9/6 **Type D3034, 1.75 : 1CT.** Push-Pull Driver for OC72, etc., 1 x 1 x 1 in. 9/6 **Type D3058, 11.5 : 1** Output to 3 ohms for OC72, etc., 1 x 1 x 1 in. 5/6 **Type D167, 18.2 : 1** Output to 3 ohms for OC72, etc., 1 x 1 x 1 in. 12/6 **Type D236, 4.5 : 1** Driver Transformer. 10/- **Type D240, 8.5 : 1** Driver Transformer. 10/-

**ARDENTE TRANSISTOR CONTROLS**

5K or 1M  $\Omega$  switched, dia. 0.9in., 5/3 **Type VC1700, 5K** with switch, dia. 0.7in., 10/6 **Deaf aid earpiece xtal or magnetic, 7/6**

**COMPONENT SHOP SPECIALISTS**

**337 WHITEHORSE ROAD WEST CROYDON**

Post 1/-, unless otherwise stated.

Telephone: THO 1665 (Export welcome. Send remittance and extra postage).

# SURBITON PARK RADIO LTD.

## FOR POST HASTE—POST FREE SERVICE

### MARTIN RECORDERKITS

#### HALF TRACK

B.S.R. TD8 Monardeck, latest model 5 1/2 in. spool	£9.9.0
Deposit £1.0.0 and 9 monthly	£1.1.0
<b>Tape Amplifier</b> for B.S.R. deck, printed circuit ready wired, with EOC88, ECL82, EM83 and E281. Complete with all plugs, sockets, paper, knobs, etc. The whole amplifier mounts onto the deck, making a self-contained unit.	£8.8.0
Deposit £1.0.0 and 9 monthly	£1.1.0
Case with 7 in. x 4 in. speaker, in two tone grey	£4.4.0
Complete Kit as above	£22.0.0
Deposit £2.4.0 and 12 monthly	£11.0.6
The above recorder can be supplied assembled, tested and complete with tape and microphone for	£25.0.0
Deposit £2.10.0 and 12 monthly	£21.8.6
<b>Collaro Studio Deck</b> , Very latest model 3 speeds 7 in. spools	£12.10.0
Deposit £1.5.0 and 12 monthly	£1.0.8
<b>Tape Amplifier</b> for studio deck, with ready wired printed circuit control and input panels, main and output transformers. Complete with valves, knobs, plugs, screws, etc. EF98, EOC88, EM84, E281, OA81 and 2 EL84, 3 watts output. Magic eye, radio and mic. inputs, EX L/S socket, tone and monitor controls. Can be used as an amplifier.	£11.11.0
Deposit £1.4.0 and 12 monthly	19/-
Case for above including 9 in. x 5 in. speaker	£5.5.0
Total Kit as above	£29.0.0
Deposit £2.10.0 and 12 monthly	£9.8.2
We can offer the above recorder, complete with tape and microphone. In a De Luvre two tone grey cabinet, assembled for	£35.0.0
Deposit £3.10.0 and 12 monthly	£2.18.2

This Machine is listed at 39 gns. by makers and is a very good buy. Building Instructions available at 2/6 each kit (retuned H kit bought)

#### QUARTER TRACK

B.S.R. TD2	£11.11.0
Deposit £1.4.0 and 12 monthly	19/-
<b>Tape Amplifier</b> as over, but quarter track	£9.9.0
Deposit £1.0.0 and 9 monthly	£1.1.0
Case, two tone grey, with speaker	£4.4.0
Complete Kit as above	£25.0.0
Deposit £2.10.0 and 12 monthly	£2.1.6
<b>Collaro Studio Deck</b> , 4 track	£17.17.0
Deposit £1.18.6 and 12 monthly	£1.9.5
<b>Tape Amplifier</b> , as over, but 4 track	£12.12.0
Deposit £1.7.0 and 12 monthly	£1.0.8
Case with 9 in. x 5 in. speaker	£5.5.0
Complete Kit 4 track Collaro	£35.0.0
Deposit £3.10.0 and 12 monthly	£2.18.2
<b>Tape Pre-amplifier</b> for Collaro deck, with power supplies, EOC88, ECL82, E290 and EM83. Radio and Mic. sockets, gives an equalised output of 400 m/Volts	£8.5.0
<b>Half Track</b>	£8.5.0
Deposit £1.9.0 and 8 monthly	£1.1.0
<b>Quarter Track</b>	£9.8.0
Deposit £1.0.0 and 9 monthly	£1.1.0
<b>Marriott Tape Heads</b> , 4 track type L/PS/7 and L/ES/9 Record/Playback and Erase with mounting bracket for studio deck	£4.4.0
Pair Complete (Marriott list price is £9.14.0)	£4.4.0
Marriott 2 track type R/PP/1 Record/Playback only with bracket for studio deck. Ideal 3rd head	£1.12.6
Pressure pad (studio deck only)	4/0
<b>Brenell Mk. 5 deck</b> , 4 track, 4 speeds	£28.8.0
Deposit £3.1.8 and 12 monthly	£2.8.7
<b>Brenell Mk. 5 Amplifier</b> , with power supply	£24.0.0
Deposit £2.8.0 and 12 monthly	£1.19.10

#### JASON F.M. TUNERS

<b>FMT1</b> , complete with valves	£6.17.6
Deposit £1.1.0 and 6 monthly	£1.2.9
<b>FMT2</b> , complete with valves, Less Power	£7.17.6
Deposit £1.0.0 and 7 monthly	£1.2.6
<b>FMT3</b> , complete with valves, Self powered	£9.15.0
Deposit £1.0.0 and 9 monthly	£1.1.8
<b>FMT3</b> , complete with valves, Less power	£9.12.8
Deposit £1.0.8 and 9 monthly	£1.1.4
<b>FMT3</b> , complete with valves, Self powered	£12.0.0
Deposit £1.4.0 and 12 monthly	19/10
Power pack kit ready drilled chassis for FMT1, etc.	£2.12.6
The instruction books are included in all kits but are otherwise 5/6.	
<b>JTV2</b> , switched F.M. and TV. Sound self powered. All Valves	£14.15.0
Deposit £1.9.6 and 18 monthly	£1.4.5
<b>Mercury 2</b> as JTV/2 but less power, with all valves	£10.15.0
Deposit £1.1.8 and 12 monthly	17/10

The instruction book is again included but is otherwise 3/6 each. All the above units are available ready built and aligned. Price on request.

#### RADIO TUNERS

<b>Armstrong T4 C. V.H.F. Tuner</b> , self powered	£19.19.0
Deposit £2.8.6 and 12 monthly	£1.12.9
<b>Armstrong ST3 Mk. 2 AM/FM Tuner</b> , self powered	£27.18.0
Deposit £2.16.6 and 12 monthly	£2.6.1
<b>Armstrong AF208 AM/FM Radio chassis</b> , Bass and Treble control, P.U. inputs, etc.	£22.18.0
Deposit £2.8.8 and 12 monthly	£1.17.8
<b>Armstrong Jubilee Mk. 2 AM/FM with Push-pull output</b>	£30.12.0
Deposit £3.4.0 and 12 monthly	£2.10.8
<b>Armstrong Stereo 55 AM/FM Radio Chassis</b> , Separate tone and volume controls	£32.15.0
<b>Armstrong Stereo 12 Mk. 2 AM/FM Radio chassis</b> , Push-pull output stage, both channels	£43.10.0
Deposit £4.7.0 and 12 monthly	£3.12.4
Brass dial escutcheon is available for AF208 and Jubilee. Price 7/6	
<b>Quad, F.M. Tuner</b>	£28.1.9
Deposit £2.17.9 and 12 monthly	£2.6.6

#### AMPLIFIERS (MONO)

<b>Linear L45 Three valve amplifier</b>	£5.19.6
<b>Linear Distoic Five valve, Push-pull</b>	£12.12.0
Deposit £1.7.0 and 12 monthly	£1.0.5
<b>Dulco DP15 Main amplifier, Five valve, Push-pull</b>	£15.15.0
Deposit £1.11.8 and 12 monthly	£1.6.1
<b>Dulco DP15 Pre Amplifier</b> , suitable magnetic pickups	£9.9.0
Deposit £1.0.0 and 9 monthly	£1.1.0
<b>Leak TL12 Main amplifier only</b>	£18.18.0
Deposit £2.0.6 and 12 monthly	£1.11.1
<b>Leak Variolone Pre-amplifier</b>	£15.15.0
Deposit £1.11.8 and 12 monthly	£1.8.1
<b>Quad Main amplifier</b>	£22.10.0
Deposit £2.5.0 and 12 monthly	£1.17.4

#### AMPLIFIERS (STEREO)

<b>Dulco AC208, Integrated</b>	£12.12.0
Deposit £1.7.0 and 12 monthly	£1.0.8
<b>Dulco GA505, Integrated</b>	£18.18.0
Deposit £1.0.8 and 12 monthly	£1.11.1
<b>Dulco Stereo Five, Pre amplifier</b>	£11.11.0
Deposit £1.4.0 and 12 monthly	19/-
<b>Leak Stereo 20, Main amplifier</b>	£30.9.0
Deposit £3.4.8 and 12 monthly	£2.10.3
<b>Leak Variolone Stereo Pre amplifier</b>	£25.0.0
Deposit £2.10.0 and 12 monthly	£2.1.6
<b>Quad 22 Stereo Control Unit</b>	£25.0.0
Deposit £2.10.0 and 12 monthly	£2.1.6

#### GRAMOPHONE UNITS

<b>B.S.R. UA 14 TC8/H</b>	£7.15.0
Deposit £1.0.0 and 7 monthly	£1.2.3
<b>Garrard TPA12 arm and shell</b> less cartridge	£4.11.9
<b>Garrard Antinom with mono cartridge</b>	£3.14.6
Deposit £1.1.0 and 8 monthly	£1.1.0
<b>Garrard Autosim De Luxe with mono cartridge</b>	£12.14.8
Deposit £1.8.6 and 12 monthly	£1.1.1
<b>Philips AG1016 with stereo cartridge</b>	£13.13.0
Deposit £1.10.0 and 12 monthly	£1.2.4
<b>Decca Derram Pickup Arm</b>	£5.16.6
<b>Decca Ceramic transcription</b>	£5.5.0
<b>Decca Changer Model</b>	£4.4.0
<b>Goldring Lenco GL 58, less cartridge</b>	£17.15.5
Deposit £1.15.11 and 12 monthly	£1.9.5
<b>Garrard 3HF with mono cartridge</b>	£13.19.0
Deposit £2.1.6 and 12 monthly	£1.11.2
<b>Garrard Lab. Type "A" with mono cartridge</b>	£21.18.0
Deposit £2.7.4 and 12 monthly	£1.16.1
<b>Garrard 301</b>	£22.18.3
Deposit £2.8.9 and 12 monthly	£1.17.9
<b>Garrard 301 Stereo</b>	£24.10.3
Deposit £2.9.0 and 12 monthly	£2.0.8

#### LOUDSPEAKERS

<b>Goodmans Axiette 8</b>	£5.17.7
<b>Axiom 10</b>	£7.0.0
<b>Axiom 20</b>	£10.7.0
Deposit £1.1.0 and 8 monthly	£1.5.9
<b>5K/20YL</b>	£7.0.0
<b>Wharfedale Super 8/PS/L</b>	£6.9.11
<b>Super 3</b>	£6.9.11
<b>RS12/DD</b>	£11.10.0
Deposit £1.7.8 and 9 monthly	£1.4.9

**48 SURBITON ROAD, KINGSTON-UPON-THAMES, SURREY**

Established over 30 Years

Telephone KIN 5549

**We pay all postage and insurance.**

**All orders despatched same day.**

**Money refund guarantee.**

**Hours: 9 a.m.-6 p.m. (1 p.m. Wednesday). We do not close for lunch. Open all day Saturday.**

Luxembourg is guaranteed also A.F.N., plus dozens of other Continental programmes. The Complete novice will build this set in 3 hours and it will work and its volume will astound you. This kit was specially flown to Europe by Boeing 707 jet for testing and it never failed to pick up programmes anywhere.

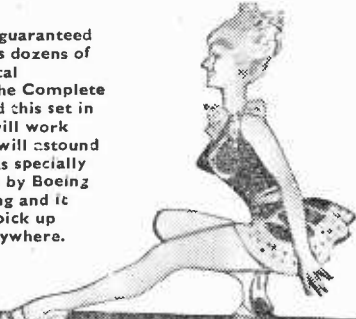

**ROPE IN LUXEMBOURG!  
LIKE THE LIGHT PROGRAMME**

WITH THE FANTASTIC TWIN WAVE BAND

**PARISIENNE!!**

**A SUPERB POCKET TRANSISTOR**

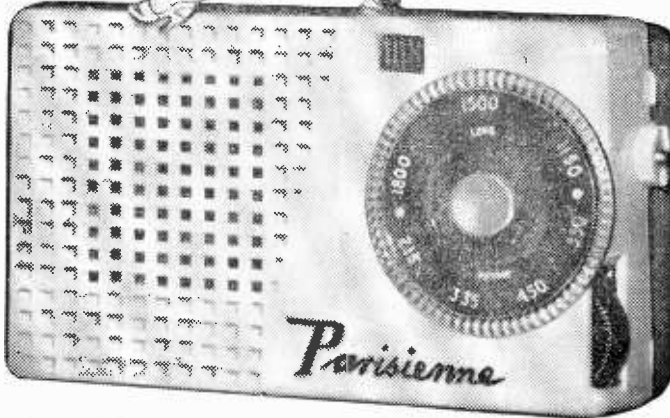

Note:—These star items, starred because they are above any other kit available.

- ★ Elegant dial graduated long and M waves.
- ★ Built in wave change switch not preset.
- ★ Printed circuit for easy assembly.
- ★ "S" ferrite rod aerial.
- ★ Earphone if required, 5/- extra.
- ★ Choice of colour red blue or cream.
- ★ Chrome carrying handle.
- ★ British 3" moving coil speaker.
- ★ Brand new components.
- ★ Best Mullard and Newmarket transistors.

A fully illustrated 30 page booklet, complete with step-by-step assembly instructions and all other data, comes to you for only 2/9 extra; PP4 press-stud type battery 2/3; post and packing on the lot 2/6.

*This amazing little set for home or car*  
**HAS TO BE HEARD TO BE BELIEVED**  
We will supply **ALL** components at a total cost of only  
**YOU CAN'T GO WRONG !**

**£3.19.6 !!!**

**SO GET WITH IT !!**  
*and build yourself this superb little set NOW*  
**PUT THE WORLD IN YOUR POCKET**

Second-to-none after sales service and all your components factory new, plainly marked and fully guaranteed  
**ALL COMPONENTS SUPPLIED SEPARATELY IF REQUIRED**

THIS IS THE FINEST BARGAIN EVER OFFERED ON MAIL ORDER

**A Seven Transistor.** Long, Med. wave superhet, by well known British manufacturer. Size only 4 x 3 x 1in. Absolutely complete and tested, in genuine morocco leather case, normal price 10½gns. The most compact set you have seen made like a watch. Money back guarantee. Price **£6.10.0.** P.P. 2/6. Personal earphones, 7/- extra.

TRADE ENQUIRIES W'LCOMED  
USUAL DISCOUNT ON ANY LINES

Transistor Soldering Irons, 9/6, 17/6, 24/-, 29/6. P.P. on each 1/6.

**THE LATEST UP-TO-DATE TAPE RECORDER TO HIT THE BRITISH MARKET**

**WONDERFUL MUSIC REPRODUCTION**

Complete with Batteries, Mike, Tape, Earphone and Guaranteed.

**£6.19.6**

NO POSTAGE  
No Hidden Extras at all.

Money Back Guarantee if Not Satisfied.

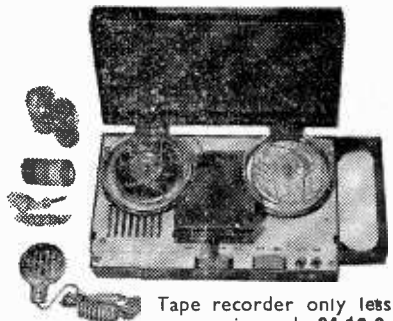

Tape recorder only less accessories, only **£4.12.6**

**WOLVERHAMPTON RADIO & TV SUPPLIES, 42 Darlington St., Wolverhampton**

Terms:—C.W.O. to avoid delay. All orders mailed by return, subject to stocks surviving the onslaught! And see us if you can. Fuller details and/or prices by request, write (S.A.E.) or call. Tel: Wolverhampton 20315. Suppliers to Forces clubs, educational authorities, schools, etc.

# Stems

## MULLARD DESIGNS

COMPLETE KITS OF PARTS

### MULLARD 3-VALVE PRE-AMPLIFIER TONE CONTROL UNIT

Designed mainly for Mullard Range of Amplifiers, also suitable for any Amplifier requiring input up to 250mV. Incorporates 5 input Channels, including for Tape and Magnetic Pickups, Separate Bass and Treble controls. High pass filter 20 to 180 c/s, low pass filter 5-9 Kc/s. Totally enclosed in case size 11 1/2" x 4 1/2" x 4".



KIT OF PARTS **£10.10.0** ASSEMBLED & TESTED **£13.13.0**

### MULLARD "5-10" MAIN AMPLIFIER

For use with MULLARD 2-stage pre-amplifier with which an undistorted power output of up to 10 watts is obtained. SPECIFIED COMPONENTS AND MULLARD VALVES including PARMEKO MAINS TRANSFORMER and choice of PARMEKO or PARTRIDGE Output Transformer.

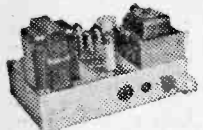

COMPLETE KIT (Parmeko Output Trans.) **£10.00**  
ASSEMBLED AND TESTED **£13.10.0**

ABOVE Incorporating PARTRIDGE OUTPUT TRANS. **£1.6.0 extra.**

### THE MULLARD 510/RC AMPLIFIER

The popular complete "5-10" Incorporates Control Unit providing up to 10 watts high quality reproduction. Specified components and new MULLARD VALVES. Includes PARMEKO MAINS TRANSFORMERS and choice of PARMEKO or PARTRIDGE Output Transformers.



COMPLETE KIT **£12.0.0**  
ASSEMBLED AND TESTED **£16.0.0** With PARTRIDGE OUTPUT TRANS. **£1.6.0 ex.**

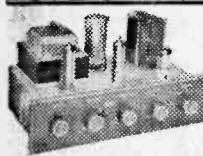

### THE MULLARD 33/RC

A HIGH QUALITY AMPLIFIER DEVELOPED FROM THE VERY POPULAR 3-WATT MULLARD "3-3" DESIGN.

ASSEMBLED AND TESTED **£11.10.0**

Complete to the MULLARD specification including PARMEKO OUTPUT TRANSFORMER. Switched inputs for 78 and L.P. records plus a Radio position. Extra power to drive a Radio Tuning Unit is also available.



### THE "MONO-GRAM"

A small Amplifier of genuine high quality performance. Incorporates new MULLARD ECL36 Valve, separate BASS and TREBLE controls and produces up to 3 watts undistorted output.

Kit of Parts **£4.10.0** and Tested **£6.10.0**

Perfectly suited for Portable installations for which purpose we offer PORTABLE CASE (£3.10.0), the AMPLIFIER (Kit) and 8" x 5" SPEAKER (£1.0.0). All for **£9.0.0**

Alternatively with ASSEMBLED AMPLIFIER **£9.10.0**

The Case quoted above will accommodate some 4-speed Single Record Units. A larger model is available for extra 10%. With this Equipment a COMPLETE PORTABLE RECORD PLAYER can be built for **£13.10.0**



### MULLARD FOUR CHANNEL MIXING UNIT

Self powered Cathode follower output. Incorporates two inputs for CRYSTAL MICROPHONES, one for CRYSTAL PICK-UPS and a fourth for Radio or Tape.



KIT OF PARTS **£8.8.0** ASSEMBLED AND TESTED **£11.10.0**

Alternative Model I/L provides for one input matched for moving coil or ribbon mike **£1.7.0 extra.**

### SENSATIONAL BARGAINS !!

A BULK PURCHASE ENABLES US TO OFFER THESE TWO GRUNDIG MODELS AT APPROX. HALF PRICE. Each are Fully Guaranteed.

### THE GRUNDIG "MINI-BOY"

THE "LITTLE" SET with "BIG" PERFORMANCE LIST PRICE IS **£26.5.0**

OUR PRICE ONLY **£10.10.0**

INCLUDING SPEAKER ENCLOSURE

A six Transistor (plus two Diodes) Portable covering the Medium Waveband. Small enough to slip into Handbag or Pocket (4" x 2" x 1") but when at home "big set" performance is obtained simply by slipping the set into the companion Speaker Enclosure (size 9 1/2" x 3 1/2" x 1 1/2").

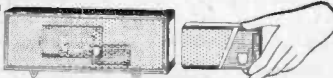

### MULLARD'S 2-VALVE PRE-AMPLIFIER TONE CONTROL UNIT

Employing two EF86 valves and designed to operate with the Mullard MAIN AMPLIFIER but also perfectly suitable for other makes.



- \* R.I.A.A. characteristics.
- \* Input for Crystal Pick-ups and variable reluctance magnetic types.
- \* Input (a) Direct from High Imp. Tape Head. (b) From a Tape Amplifier or Pre-Amplifier.
- \* Sensitive Microphone Channel. \* Wide range BASS and TREBLE Controls.

KIT OF PARTS **£6.6.0** ASSEMBLED AND TESTED **£9.10.0**

### PRICE REDUCTIONS

- (a) THE KIT OF PARTS to build both the "5-10" Amplifier and the 2-stage Pre-Amplifier... **£15.15.0**
- (b) The "5-10" and the 2-stage Pre-Amplifier both Assembled and Tested... **£21.10.0**
- With PARTRIDGE OUTPUT TRANSFORMER **£1.6.0 extra.**

### HIGH FIDELITY LOUDSPEAKERS

WE STOCK THE COMPLETE RANGE BY GOODMAN'S, WHARFEDALE and W.B. STENTORIAN. A few recommended examples

8 INCH TYPES	
GOODMANS "AXIETTE" .....	£5.6.0
W.B. HF 816 .....	£6.0.0
WHARFEDALE "SUPER 8/RS/DD" .....	£6.15.0
10 INCH TYPES	
GOODMANS "AXIOM 10" .....	£6.0.0
W.B. MODEL HF 1016 .....	£7.0.0
WHARFEDALE "GOLDEN 10/RS/DD" .....	£7.17.6
12 INCH TYPES	
GOODMANS "AXIOM 20" 15 watts .....	£10.7.0
GOODMANS "AXIOM 30" 20 watts .....	£14.10.0
W.B. MODEL HF 1214 15 watts .....	£10.5.6
WHARFEDALE "W12/RS" .....	£10.10.0
WHARFEDALE "Super 12/RS/DD" .....	£17.10.0

### LEAK AND QUAD AMPLIFIERS ARE IN STOCK

- LEAK "TL/12 PLUS" POWER AMPLIFIER with the "POINT ONE PLUS" PRE-AMPLIFIER, 14 watts rated output... **£31.10.0**
- LEAK "TL/25 PLUS" with the "POINT ONE PLUS" PREAMPLIFIER, 28 watts rated output... **£37.16.0**
- LEAK "STEREO 20" POWER AMPLIFIER with the "VARISLOPE STEREO" PREAMPLIFIER, 22 watts (Q1 watts per channel)... **£55.9.0**
- QUAD II POWER AMPLIFIER with QUAD II CONTROL UNIT, 15 watts output... **£42.0.0**

### RECORD PLAYERS

- THE COLLARO "JUNIOR" 4-speed single player with separate crystal pick-up... **£3.10.0**
- THE "NEW" GARRARD "AUTOSLIM" 4-speed Autochanger with crystal pick-up... **£7.13.0**
- GARRARD "AUTOSLIM DE LUXE" 4-speed Autochanger, Incorporates transcription Pick-up Arm... **£11.9.0**
- THE COLLARO "080" 4-speed autochanger unit with Studio "O" pick-up... **£7.5.0**
- B.S.R. Model UA14, a 4-speed Mixer Autochanger with crystal pick-up... **£6.19.6**
- The new GARRARD Model 41F High Quality Single Record Player fitted with the latest P.A. 12 pick-up arm and G.C.S. crystal Cartridge... **£17.0.0**
- GARRARD Model S.R.P.10. Single Record Player fitted with high output crystal pick-up PHILIPS Model AG1016. A 4-speed Player can be operated both manually and automatically. Suitable for Mono or Stereo operation. Carr. and Ins. on each above 5/- extra... **£5.12.6**
- PHILIPS Model AG1016. A 4-speed Player can be operated both manually and automatically. Suitable for Mono or Stereo operation. Carr. and Ins. on each above 5/- extra... **£12.5.0**

### HOME CONSTRUCTORS !!

A Range of "Easy to Assemble" Prefabricated Cabinets

Designed by the W.B. "STENTORIAN" COMPANY for "Hi-Fi" Loudspeaker systems or to accommodate high quality equipment. FULL RANGE IN STOCK, please enclose S.A.E. for descriptive leaflets.

IF YOU ARE PLANNING TO INSTALL "Hi-Fi" and UNCERTAIN OF THE TYPE OF EQUIPMENT TO USE—OUR WIDELY EXPERIENCED TECHNICAL STAFF WILL WITH PLEASURE PUT FORWARD RECOMMENDATIONS—STATE TYPE OF INSTALLATION CONTEMPLATED AND APPROX. PRICE LEVEL.

HIRE PURCHASE TERMS are available on all Equipment over £10.0.0.

FULL DESCRIPTIVE LEAFLETS are readily available—please enclose S.A.E.



# Stern's

## SPECIALISTS IN SOUND EQUIPMENT FOR OVER 25 YEARS

### !! COMBINED PRICE OFFERS !!

Includes small charge for special testing and PRECISE MATCHING OF THE ASSEMBLED

#### STEREO TAPE PRE-AMPLIFIER



**MODEL STP-1.** For use with current TRUVOX, BRENNELL, or COLLARO "STUDIO" and 1 track Stereo Decks. Incorporates Ferro-cube Oscillator, 4 speed Equalisation Signal Level Meter and separate Gain Controls. Includes separate Power Unit.  
**KIT OF PARTS £22.0.0**      **ASSEMBLED £28.0.0**

#### MULLARD'S TYPE "C" TAPE PRE-AMPLIFIER



Suitable for most 1/2 track, Mono Tape Decks. Incorporates Ferro-cube Push Pull Oscillator and 3 Speed Treble Inductor. Includes separate Power Unit.  
**KIT OF PARTS £14.0.0**      **ASSEMBLED £18.10.0**

#### MULLARDS TAPE AMPLIFIER

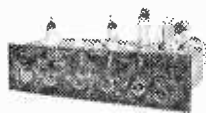

**MODEL HF/TR3**  
 Based on Mullard's Type "A" design and suitable for most 1/2 track Mono Tape Decks. Incorporates Ferro-cube 3 speed Treble Inductor and Gilson Output Transformer. Includes separate Power Unit.  
**KIT OF PARTS £13.13.0**      **ASSEMBLED £19.0.0**

#### STERN'S "ADD-A-DECK"

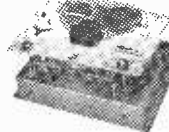

A self contained Unit consisting of Garrard Deck and matched Pre-amplifier on one chassis. Provides full tape recording facilities and replays through Pick Up Sockets of standard Radio receiver or Amplifier.  
**PRICE includes Spool of Tape £18.18.0**



#### TUDOR AM/FM TUNING UNIT

A SELF-POWERED HIGH FIDELITY TUNER OF OUTSTANDING DESIGN. PROVIDES FULL COVERAGE OF THE VHF/FM TRANSMISSION and also the LONG and MEDIUM WAVEBANDS **PRICE ONLY £19.19.0**      Deposit £4 and 12 months £21.9.4  
 Operates perfectly with the STERN-MULLARD AMPLIFIERS and contains matching FRONT PANEL in Black/Gold or White/Black. Also operates equally well with any Amplifier requiring input of 100 to 350 mVolts.

#### Mk. 11 "Fidelity" FM TUNING UNIT

An attractively presented Unit incorporating MULLARD FEASIBILITY TUNING HEART and corresponding Mullard valve line-up. Very suitable to operate with our Mullard Amplifiers.  
**KIT OF PARTS £10.10.0**      **ASSEMBLED AND TESTED £14.5.0**

**Full Range of Lustraphone Microphone Stands and Accessories are in stock**



#### THE "TUDOR" STEREO AMPLIFIER

A self contained Amplifier designed to provide high quality stereophonic and monophonic reproduction. Each channel provides a rated output of 6 watts and for monophonic operation approx. 12 watts is produced. Separate BASS and TREBLE CONTROLS.  
**PRICE £18.18.0**

STP-1 (Kit) and "STUDIO" Deck	£39.0.0	Assembled	£46.0.0
STP-1 (Kit) and Brenell Deck	£66.0.0	Assembled	£75.0.0
STP-1 (Kit) and Truvox Deck	£51.0.0	Assembled	£59.0.0
TYPE "C" (Kit) and "STUDIO" Deck	£28.10.0	Assembled	£33.0.0
TYPE "C" (Kit) and BRENNELL Deck	£43.0.0	Assembled	£50.0.0
TYPE "C" Assembled and Wearite Deck	£70.0.0	Inc. Head Lift Trans	
HF/TR3 (Kit) and "STUDIO" Deck	£28.0.0	Assembled	£33.0.0
HF/TR3 (Kit) and BRENNELL Deck	£43.0.0	Assembled	£50.0.0
HF/TR3 Assembled and Wearite Deck	£70.0.0	Inc. Head Lift Trans.	

To build a complete TAPE RECORDER we offer HF/TR3 AMPLIFIER STUDIO DECK, PORTABLE CASE, ROLA 10 x 6in. SPEAKER, MICROPHONE and 1.200ft. TAPE ALL FOR £35.0.0.

#### ARMSTRONG RADIOGRAM CHASSIS

We have the full range in stock. Prices range from £20.10.0. Full details are readily available.



#### Stereo Amplifiers

##### MULLARDS "10 x 10" STEREO AMPLIFIER

A high fidelity design providing up to 10 watts (per channel). Superb reproduction frequency response flat to within 3db from 3 c/s to 60 Kc/s at 50 mW Total Harmonic Distortion at 10 watts 0.1%  
**1/2 (a) ASSEMBLED AMPLIFIER (as illustrated) £24.0.0**  
**£20.0.0**



(b) KIT OF PARTS.....  
 Built to the highest technical standards and presented strictly to MULLARD'S specification. Two specially designed GILSON OUTPUT TRANSFORMERS with 20% taps are used. We can also supply the assembled MAIN AMPLIFIER only for operation with our DUAL CHANNEL PRE-AMPLIFIER; this provides a more versatile installation and is essential if a low output Magnetic Pick-up is to be used. When ordering specify loudspeaker impedance.  
**(a) THE ASSEMBLED MAIN AMPLIFIER and ASSEMBLED DUAL CHANNEL PRE-AMP..... £34.0.0**  
**(b) KIT OF PARTS for both Units..... £27.0.0**

#### THE "TWIN THREE" STEREO AMPLIFIER

**ASSEMBLED AND TESTED £9.0.0** (Carriage and Insurance 7/6 extra)



Based on a recent design by MULLARD LTD., is ideally suited for use in PORTABLE RECORD PLAYERS for which purpose we offer a specially designed Case; incorporates MULLARD ECL 86 Valves, separate BASS and TREBLE CONTROLS and produces up to 3 watts per channel. Frequency response is 40 c/s to 30 Kc/s, size is only 11lin. x 3lin. x 5in. To construct a STEREO PORTABLE RECORD PLAYER we offer: ASSEMBLED AMPLIFIER with two ROLA 8in. x 5in. LOUD-SPEAKERS and PORTABLE CASE for..... **£16.10.0**

#### MULLARD DUAL-CHANNEL PRE-AMPLIFIER

A four Valve design for both STEREO-PHONIC and MONOPHONIC operation. Operates equally well with any make of Amplifier requiring an input of up to 250 mV.  
**KIT OF PARTS £12.10.0**      **ASSEMBLED AND TESTED £15.0.0**



**H.P. ON ALL EQUIPMENT OVER £10**

**POSTAL ENQUIRIES and MAIL ORDERS TO . . . STERN RADIO LTD.**  
 6-12, TUDOR PLACE, TOTTENHAM COURT RD. LONDON, W1. TEL. MUSEUM 6128/9

**DEMONSTRATION and SHOWROOMS AT . . . STERN RADIO LTD.**  
 109, FLEET ST. LONDON, EC4  
 TEL. FLEET ST. 5612/3  
 OPEN... 9 a.m. to 5 p.m. SAT. close 1 p.m.

**PREMIER RADIO**  
 23, TOTTENHAM COURT RD. LONDON, W1. TEL. MUSEUM 6128/9  
 OPEN... 9 a.m. to 5 p.m. THURS. close 1 p.m.

# RETURN - OF - POST SERVICE

We offer a really efficient Mail Order Service on all items stocked. All cash orders are dealt with on the day of receipt.

★ Hire purchase orders are subject to slight delay but this is kept to the absolute minimum.

## ILLUSTRATED LISTS

Illustrated lists are available on LOUDSPEAKERS, TAPE DECKS, TEST GEAR, GRAMOPHONE EQUIPMENT, AMPLIFIERS. Any will be sent free upon request.

## STEREO COMPONENTS

Morganite ganged potentiometers as specified for the Mullard circuits. ★ Log/Anti-Log, 500k, 1 meg., 2 meg. ★ Log/Log, 50k, 250k, 1 meg., 2 meg. ★ Lin/Lin 250k, 500k, 1 meg. All 10/6 each.

## TRANSISTORS

MULLARD. Reduced prices. Current production types, not rejects. All in makers' boxes. Postage 3d. on each.  
OC44, 9/3; OC45, 9/-; OC70 and OC71, 6/6; OC72, 8/-; OC72 Matched Pairs 18/-; OC73, 8/-; OC81, 8/-; OC170, 9/6; OC171, 10/6.

## AMPLIFIER KITS

We have full stocks of all components for the Mullard 510, Mullard 3-3, Mullard 2 and 3 Valve Pre-amp, Mullard Stereo, Mullard Mixer, GEC 912 Plus. Fully detailed list on any of these sent upon request.  
Instructional Manuals: All Mullard Audio Circuits in "Circuits for Audio Amplifiers", 9/5. GEC912, 4/6. All post free.

## TRANSISTOR YOUR CRYSTAL SET

We have two new designs for Transistor amplifiers which can be used to greatly improve the signal from any crystal set. RLD4 Kit, one stage 12/-; RLD5 Kit, two stage 21/-; both post free. The kits are easy to build and very detailed instructions are supplied. Leaflet available.

## NEW MULLARD CONDENSERS

We now stock the following range of the new Mullard Miniature Foil and Polyester condensers as used in the latest TV and Transistor sets. Fully detailed list available giving full technical information and dimensions.  
Miniature Foil. 90 volt working for Transistor sets. .01mfd. 7/4/-; .022mfd. 9d.-; .047mfd. 9d.-; .1mfd. 11d.  
Polyester Tubular Capacitors. Moulded outer case designed to withstand accidental contact with the soldering iron. Tolerance 10%. 125v. range. 0.2mfd. .022mfd. .047mfd. all 9d. each. 1mfd. 1/2-; 2.2mfd. 1/3-; 4.7mfd. 1/6-; 10mfd. 3/-; 400v. range. .001mfd. .0022mfd. .0047mfd. .01mfd. .022mfd. all 9d. each. .047mfd. 1/2-; .1mfd. 1/3-; .22mfd. 1/6-; .47mfd. 2/5-. Postage extra.

## TAPE RECORDING EQUIPMENT

TAPE DECKS	Cash Price	Hire Purchase
	Deposit	Mthly/Pmts.
ALL CARRIAGE FREE		
B.S.R. TD2	£8.19.6	£1.18.6 12 of 13/7
Latest COLLARO Studio	£10.19.6	£2.3.6 12 of 16/4

**TAPE AMPLIFIERS**  
We now stock the Martin Recorder Kits. These are partly assembled kits for complete tape recorders. The Amplifier Printed Circuit panels are completely wired, but the assembly of this and external components is left to the constructor. Very complete instructions are supplied. Send for leaflet.

**MODEL C** for Collaro Studio Deck, £11.11.0.  
**MODEL B** for BSR TD2 Deck, £8.8.0.  
**CARRYING CASES.** Smart carrying cases are available to take the above amplifiers and decks. Fitted with speaker. For Model C Amplifier and Collaro Deck, £5.5.0.  
For Model B Amplifier and BSR Deck, £4.4.0.  
H.P. Terms available for amplifiers, cases and decks.

**MULLARD TAPE C. PRE-AMPLIFIER.** We stock complete kits and all components. Send for list.  
**MARTIN.** Pre-amp kit for Collaro Studio Deck, £8.8.0.

**"BRAND FIVE" RECORDING TAPE** Post free.  
Long Play: 900ft. (5"), 18/6; 1200ft. (5 1/2"), 23/6; 1800ft. (7"), 35/-.

## JASON F.M. TUNER KITS

Kits supplied complete with every item needed including instruction manuals. Fully detailed list available. Separate items supplied, ask for price list. H.P. Terms available on any kit.  
FMT1, £8.12.6; FMT2 (less power), £7.15.0.  
FMT2 (with power), £9.12.6; FMT3 (less power), £9.9.6.  
FMT3 (with power), £11.7.6; Mercury 2, £10.14.6.  
JTV 7/4, £14.12.6.

★ **TERMS OF BUSINESS**  
Cash with order or C.O.D. We charge C.O.D. orders as follows:  
Up to £3, minimum of 3/2. Over £3 and under £5, 1/6. Over £5 and under £10, 1/8. Over £10, no charge. Postage extra on CASH orders under £3 except where stated. Postage extra on overseas orders irrespective of price.

## P.W. STRAND, MAYFAIR & SAVOY UNITS

We stock parts for the P.W. Strand Amplifier, Mayfair Pre-amplifier and Savoy F.M. Tuner. Detailed price lists are available.

## "P.W. MERCURY"

P.W. Mercury. (Osborn printed circuit version), including Mullard first grade transistors and instruction manual. Complete set of parts £9.19.6. Instruction manual available separately at 2/6 post free. Separate components supplied. Send for list.

## LATEST TEST METERS

	Cash Price	Deposit	Hire Purchase
			Mthly/Pmts.
AVO Model 8 Mark II	£24. 0.0	£4.16.0	12 of £1.15. 2
AVO Model 8 with leather carrying case	£27.18.0	£5.12.0	12 of £2. 0.11
AVO Model 7 Mark II	£21. 0.0	£4. 4.0	12 of £1.10.10
AVO Multimeter	£9.10.0	£1.18.0	12 of 1/4/4
AVO Multimeter with leather carrying case	£11. 9.0	£2. 5.0	12 of 17/-
TAYLOR MODEL 17A	£10.10.0	£2. 2.0	12 of 15/8
CABY A-10	£4.17.6	£1. 7.6	3 of £1. 6.8
CABY B-2	£6.10.0	£2. 0.0	3 of £1.13.4
CABY M-1	£2.14.0		

Full details of any of the above supplied free on request. The AVO Models 7 and 8 are both latest models from current production—not to be confused with Government Surplus.

## OUTPUT TRANSFORMERS

GILSON: W0896A, W0896B, 50/8, post 2/6. W0710, 55/8, post 2/6. W0892, 62/3, post free. W0767, 27/-, post 1/6. W01766A, 57/8, post 2/6. W01932, 84/-, post free.  
PARTRIDGE: P3687, 75/-; P4131, 65/-; P5202, P5203, £5.18.6. All post free.  
PARMEKO: P2629, 45/6; P2642, 43/3; P2643, 45/6. All plus post 2/6. P2644, 28/3, post 2/-; P2928, 15/3, post 2/-; P2832, 39/3, post 2/6.  
ELSTONE: OT/MU, 45/-, post 2/6; OT/3, 25/-, post 2/6.

## MAINS TRANSFORMERS

GILSON: W0741AB, 63/-, post free; W0839, 48/9, post 2/9; W01326, 58/6, post 3/6; W01288, 58/-, post 3/6; W01566, 80/-, post free; W01341, Choke, 36/-, post 2/-.  
PARMEKO: P2631, 33/9, post 2/9; P2630, 52/6, post 3/3; P2644, 73/6, post free; P2630, 39/3, post 3/-; P2931, 54/6, post 3/3.  
ELSTONE: MT/MU, 45/-, post 3/3; MT/3M, 35/-, post 3/-; MT/510, 42/-, post 3/3.

## MARTIN STEREO AMPLIFIER KITS

Printed circuit, already wired and tested. Only requires wiring to mains and output transformers. Complete kit with plastic esutcheon and full instructions. £8.6.0.

## GRAMOPHONE EQUIPMENT

ALL LATEST MODELS	Cash Price	Deposit	Hire Purchase
ALL POST FREE			Mthly/Pmts

**RECORD CHANGERS**  
GARRARD AUTOSLIM £7.2.6 £1.8.0 12 of 11/2  
GARRARD AUTOSLIM De-luxe (Mono PU) £11.9.0 £2.6.0 12 of 16/11  
GARRARD AUTOSLIM De-luxe (Stereo/Mono PU) £12.5.4 £2.9.4 12 of 18/-  
B.S.R. UA1 (TC8 Mono PU) £8.19.6 £1.7.6 12 of 11/-  
B.S.R. UA1 (Monoton (TC8 Stereo/127/78) £7.19.6 £1.11.6 12 of 12/4  
**SINGLE RECORD PLAYERS**  
B.S.R. TUP (TC8 Mono PU) £3.17.8 £1.4.5 3 of 21/-  
B.S.R. G.U7 (TC8 Mono PU) £4.18.5 £1.5.3 3 of £1.6.8  
**TRANSCRIPTION UNITS**  
GARRARD IHE (GC8 PU) £13.2.8 £3.4.8 12 of £1.3/-  
PHILIPS AG106 £12.6.0 £2.10.0 12 of 18/-  
Many of the above can be supplied for stereo working. See our Gramophone Equipment List for details.

## LOUDSPEAKERS

GOODMANS: Axiote 8in., £5.5.8; Axiom 10in., £6.8.0; 12in., Axiom 30i, £10.7.0; 12in., Axiom 30i, £14.10.0; 12in., Axiom 51 Bass, £5.14.0; 12in., Axiom 61 Bass, £13.14.0; Trebas Tweeter, £6.4.0; N50000 Crossover unit, £1.19.0.  
WHITELEY, £6.4.0; HF106 10in., £6.19.11; HF102 10in., £4.7.6; HF816 8in., £5.19.11; TN16 8in., £5.13.7; T10 Tweeter, £4.8.3; T359 Tweeter, £11.10.0; CX3000 Crossover unit, £1.11.6; CX1500 Crossover unit, £2.0.0. H.P. Terms available on all speakers.

# WATTS RADIO

(MAIL ORDER) LTD.

54 CHURCH ST., WEYBRIDGE, SURREY

Telephone: Weybridge 47556

Please note: Postal business only from this address  
Callers welcome by appointment

★ **HIRE PURCHASE TERMS**  
are available on any item. Repayments may be spread over 3, 6 or 12 months. Details as follows:  
Three months: Deposit 6/- in the £. Service charge 5 per cent. but minimum charge of 10/-.  
Six and Twelve months: Deposit 4/- in the £. Service charge 10 per cent. but minimum charge 20/-.

# INCREASE YOUR KNOWLEDGE

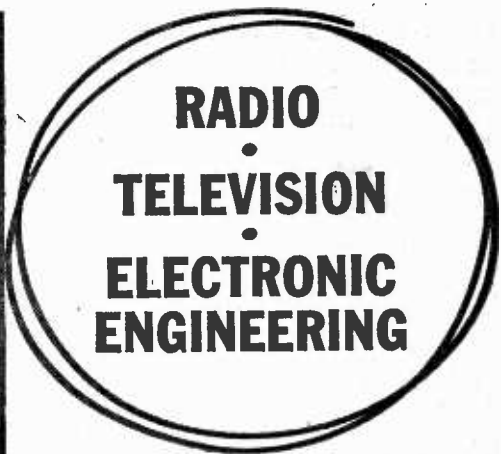

MEMBER OF THE ASSOCIATION  
OF BRITISH CORRESPONDENCE COLLEGES

**CHOOSE THE RIGHT COURSE FROM:**

RADIO AND TELEVISION ENGINEERING, INDUSTRIAL TELEVISION, RADIO AND TELEVISION SERVICING, RADIO SERVICE AND SALES VHF/FM ENGINEERING, ELECTRONICS, COMPUTERS AND PROGRAMMING, ELECTRONIC TECHNICIANS, SERVO MECHANISMS, TELEMETRY, COLOUR TV, INSTRUMENTATION, AND PRINCIPLES OF AUTOMATION.

**ALSO EXAMINATION COURSES FOR:**

A.M.Brit.I.R.E.; City and Guilds Telecom. Technicians, C. & G. Radio and T.V. Servicing (R.T.E.B.), and P.M.G.'s Certificates. C. & G. Radio Amateurs' Certificates.

**LEARN AS YOU BUILD**

Practical Radio Courses: Gain a sound knowledge of Radio as you build YOUR OWN 5-valve superhet radio receiver, Signal Generator and High-quality Multitester. At the end of the course you have three pieces of permanent and practical equipment and a fund of personal knowledge and skill. ICS Practical Radio Course opens a new world to the keen Radio amateur.

**THERE IS AN ICS COURSE FOR YOU**

Whether you need a basic grounding, tuition to complete your technical qualifications, or further specialised knowledge, ICS help you with a course individually adapted to your requirements.

There is a place for you among the fully-trained men. They are the highly paid men—the men of the future. If you want to get to the top, or to succeed in your own business, put your technical training in our experienced hands.

ICS Courses are written in clear, simple and direct language, fully illustrated and specially edited to facilitate individual home study. You will learn in the comfort of your own home—at your own speed. The unique ICS teaching method embodies the teacher in the text; it combines expert practical experience with clearly explained theoretical training. Let ICS help you to develop your ambitions and ensure a successful future. Invest in your own capabilities.

**FILL IN AND POST THIS COUPON TODAY**

You will receive the FREE ICS Prospectus listing the examinations and ICS technical course in radio, television and electronics. PLUS details of over 150 specialised subjects.

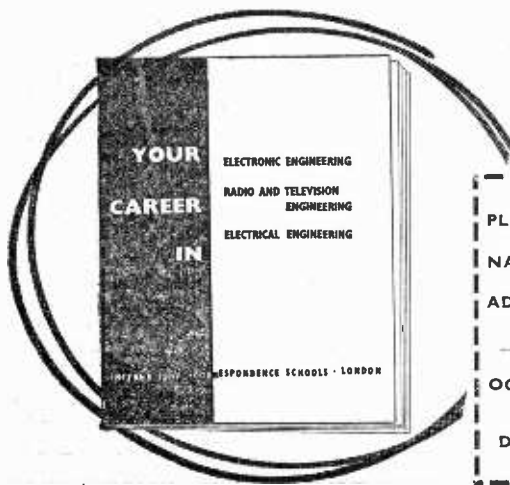

PLEASE SEND FREE BOOK ON \_\_\_\_\_

NAME \_\_\_\_\_

ADDRESS \_\_\_\_\_

OCCUPATION \_\_\_\_\_ AGE \_\_\_\_\_

INTERNATIONAL CORRESPONDENCE SCHOOLS  
Dept. 170, INTERTEXT HOUSE, PARKGATE RD, London SW11

8.63

# BENTLEY ACOUSTIC CORPORATION LTD.

THE VALVE SPECIALISTS

38 CHALCOT LANE, LONDON, N.W.1

Telephone: PRIMROSE 9090

EXPRESS POSTAL SERVICE! ALL ORDERS DESPATCHED SAME DAY AS RECEIVED. FOR ONLY 2/6 EXTRA TELEPHONE FOR THAT URGENT ORDER! YOUR ORDER IS TO BE DESPATCHED IMMEDIATELY BY OUR SPECIAL C.O.D. SERVICE

### \* INDICATES VALVES WITH NEW TYPE CHEMICAL CATHODE FOR EXTRA LIFE AND RELIABILITY

0A2	17/6	6BQ7A	22/6	6887	8/-	28LAGT11/6	AC9GVM	EB34	2/6	EL35	19/6	KTW61	6/8	PY800	13/-	U25*	17/6	GD9	4/-			
0B2	17/6	6BR7*	9/-	6UAGT	12/6	25U4GT10/2	15/-	EB41	8/6	EL37	23/11	KTW62	7/6	PZ30	19/6	U26*	9/-	GD10	4/-			
0Z4	5/-	6BR8*	15/2	6VSG	7/6	25Y5	10/6	EL38	18/6	EL38	18/6	KTW63	6/8	QP21	7/-	U31*	11/6	GD12	4/-			
1A5	3/-	6B87	25/-	6W7G	8/6	25YG 19/5	AC/TP	23/4	EL41*	8/-	KTZ41	8/-	QP22B	12/6	U33*	29/1	GD15	8/-				
1A6	5/-	6B87*	10/6	6V8G	4/6	25Z40 11/6	AC/VP	15/-	EL42*	10/-	L63	6/6	QP25	14/6	U35*	29/1	GD16	4/-				
1A7	12/-	6BW7*	6/-	6V8GT	8/8	25Z55 10/6	AC/VP	22/8	EL41*	16/2	LP2	9/6	Q8100	13/6	U37*	32/4	GET102	8/6				
1C1	6/-	6B3X	5/-	6X4	4/6	25Z6GT 9/6	AC/VP	22/8	EL43	19/6	ME41	16/10			U41	19/6	GET108	6/6				
1C2	10/6	6C4	5/-	6X5	5/-	27SU 25/11	AF13	20/-	EL44*	5/-	ME91	16/10	R16	15/6	U43	8/6	GET104/10	9/6				
1C3	8/6	6C8	6/6	6Y8	10/6	28D7	7/-	ATP4	5/-	EL45	10/6	M14	7/-	R12*	8/6	U45	15/6	GET106/17/8	9/6			
1C5	12/6	6C8	6/6	6Y8	20/6	30C1*	7/6	AZ1	18/3	EL46	18/10	MHD4	12/6	R16	25/11	U47	17/6	GET113	8/6			
1C6	10/6	6C8	12/6	6Y7	8/6	30C15 12/6	AZ31	10/6	EL48	13/7	EL49	5/-	MHL4	7/6	R17	17/6	U50	5/6	GET114	6/6		
1D5	18/2	6C9*	13/6	6Z5	8/6	30F8*	6/-	AZ41*	13/7	EL49	5/-	MHL4	7/6	R18	18/2	U52	4/6	GET1210/2	9/6			
1D6	10/6	6C10	9/6	6Z8	8/-	30FL1*	9/6	B36	9/-	EL49	5/-	MHL4	7/6	R19	19/5	U54	18/6	GET173	9/3			
1F1	7/6	6C12*	13/7	6Z7	8/-	30FL12 12/6	R103	7/6	EC31	13/7	EL49	5/-	M16	6/6	R52	12/6	U78	9/-	GET13	9/6		
1F2	3/-	6C17	10/6	6Z8	34/11	30L1*	7/6	C1	12/6	EC32	5/6	EL49	5/-	MS4B	22/3	HG1/240	5/6	GET13	9/6			
1F3	3/-	6CD6G	35/8	7Y4	7/6	30L1*	9/-	C1C	12/6	EC33	12/6	EL49	5/-	MS4	20/3	54/-	U107	19/5	GEX35	3/6		
1F7	15/-	6CH6	7/6	8D2	3/6	30P1*	15/-	GBL1	27/2	EC34	6/-	EM4	17/6	MX20/14/8	RK34	7/6	U191*	16/2	GEX36	10/6		
1FD9	5/-	6CWH	24/-	8D3	3/6	30P12*	7/6	OGH35	22/8	EC70	12/6	EM34	9/6	MX40 25/11	9130	22/6	U201	16/2	GEX45	6/6		
1G6	17/6	6D	31/-	9BWB	14/11	30P16	7/6	OK306	6/6	EC91	27/8	EM35	7/6	N37*	25/11	9P48	25/10	U251*	14/-	GEX44	27/6	
1H5	10/6	6D*	15/6	9P1	4/-	30P19	19/6	CP2	23/10	EM11	22/8	EM11	22/8	N73*	29/1	9P32	12/6	U281*	7/6	GEX56	15/6	
1H6	14/-	6D*	6/6	9P2	4/-	30P19	19/6	EL33	13/6	EM80	9/-	N108*	29/1	9P41	3/6	U282*	22/6	AF102	27/6			
1L16	16/10	6D3	15/-	10C1*	12/6	30PL13	10/6	CV6	2/6	EM81	9/6	N118*	22/8	9P42	12/6	U291	11/6	AF114	11/-			
1L2	5/-	6E5	12/6	10C2*	25/11	30PL14	21/4	CV63	10/6	EM84	10/6	N151	10/6	9P61	3/6	U301*	22/8	AF115	10/6			
1L6	5/-	6F1*	10/-	10D1	7/6	33A3	20/6	CV271	10/6	EM85	18/10	N308*	20/1	9P25	27/2	U329*	14/2	AF116	10/6			
1N1	10/6	6F5	12/6	10E1	13/6	38AGT	7/6	CV18	10/6	EM86	16/6	N361	6/6	9P48	12/6	U381*	14/2	AF117	10/6			
1P1	7/6	6FG7	7/-	10F1	10/6	33W4	7/6	CV1C	18/2	EM91	15/6	N369*	16/10	9P49	9/-	U403	16/2	AF118	20/6			
1P10	6/-	6FG8T	8/-	10F9*	11/6	33Z3	18/2	CV31	11/-	EM93	8/6	P61	3/6	TDD	12/6	U404	6/6	AF127	12/-			
1P11	7/6	6F8	12/6	10F18*	11/6	32ZAGT	6/-	D1	3/-	EM94	17/6	PABC80		TDD1	12/6	U801*	29/1	MAT100	7/6			
1E5	9/-	6F11*	17/6	10LD3	8/6	33ZGT	9/-	D15	13/6	EM95	18/10	N308*	20/1	U2025	27/2	U329*	14/2	AF118	10/6			
1B4	9/-	6F12	3/6	10LD11	15/7	40S1A	18/2	D42	10/6	EM96	16/6	N361	6/6	9P48	12/6	U381*	14/2	AF117	10/6			
1B5	5/-	6F13	10/6	12AGT	14/11	118T3AGT	14/11	D42	10/6	EM97	16/6	N361	6/6	9P48	12/6	U381*	14/2	AF117	10/6			
1T2	25/11	6F14*	25/11	10P14*	18/6	43	22/8	D77	4/-	EM98	16/6	N361	6/6	9P48	12/6	U381*	14/2	AF117	10/6			
1T4	3/-	6F15*	14/11	11E1	17/6	43	22/8	D77	4/-	EM99	16/6	N361	6/6	9P48	12/6	U381*	14/2	AF117	10/6			
1U7	12/6	6F16	8/-	11E3	15/-	50A5	21/10	DAP91	5/-	EM99	16/6	N361	6/6	9P48	12/6	U381*	14/2	AF117	10/6			
1U9	5/-	6F17	12/6	12A6	5/6	50C5	20/10	DAP96	7/6	EM99	16/6	N361	6/6	9P48	12/6	U381*	14/2	AF117	10/6			
2A7	10/6	6F18	14/11	12A8	19/6	30CD6G35/7	DDC90	10/6	ECF40	10/6	EM99	16/6	N361	6/6	9P48	12/6	U381*	14/2	AF117	10/6		
2P9	5/-	6F19	10/6	12AGT	14/11	52K1	14/4	D14	12/6	EM99	16/6	N361	6/6	9P48	12/6	U381*	14/2	AF117	10/6			
2D12C	7/6	6F23*	10/6	12AG16	10/6	52K1	14/4	D14	12/6	EM99	16/6	N361	6/6	9P48	12/6	U381*	14/2	AF117	10/6			
2D21	15/-	6F24*	9/6	12A6E	13/7	68K1	25/11	DDT4	12/6	EM99	16/6	N361	6/6	9P48	12/6	U381*	14/2	AF117	10/6			
2P	25/11	6F32	10/6	12A7	8/6	72	4/6	DET26	7/6	EM99	16/6	N361	6/6	9P48	12/6	U381*	14/2	AF117	10/6			
3X3	4/6	6F33	7/6	12A8*	12/6	77	8/-	DF33	10/6	EM99	16/6	N361	6/6	9P48	12/6	U381*	14/2	AF117	10/6			
3A4	5/-	6G6	6/6	12A8*	12/6	78	6/6	DF65	15/6	EM99	16/6	N361	6/6	9P48	12/6	U381*	14/2	AF117	10/6			
3A5	10/6	6H6	3/6	12AT*	5/-	80A	9/6	DF72	23/10	EM99	16/6	N361	6/6	9P48	12/6	U381*	14/2	AF117	10/6			
3B7	12/6	6J5G	5/-	12AU*	22/8	83	15/-	DF91	3/-	EM99	16/6	N361	6/6	9P48	12/6	U381*	14/2	AF117	10/6			
3D6	5/-	6J5GT	6/-	12AU*	7/6	88V	19/6	DF96	7/6	EM99	16/6	N361	6/6	9P48	12/6	U381*	14/2	AF117	10/6			
3Q4	7/6	6J6	3/-	12AV	12/4	86A1	55/6	DF97	9/-	EM99	16/6	N361	6/6	9P48	12/6	U381*	14/2	AF117	10/6			
3Q5	9/6	6J7G	4/6	12AX*	7/6	85A2	18/-	DF80	15/6	EM99	16/6	N361	6/6	9P48	12/6	U381*	14/2	AF117	10/6			
384	6/-	6J7GT	10/6	12BA*	3/6	90AG	27/6	DF83	13/-	EM99	16/6	N361	6/6	9P48	12/6	U381*	14/2	AF117	10/6			
3V4	7/6	6J8	12/6	12BE*	8/6	90A	9/6	DF75	5/6	EM99	16/6	N361	6/6	9P48	12/6	U381*	14/2	AF117	10/6			
4D1	7/6	6K6	8/-	12BH*	20/6	90GC	37/6	DF77	6/-	EM99	16/6	N361	6/6	9P48	12/6	U381*	14/2	AF117	10/6			
6R4G	17/6	6K7G	2/-	12R1	30/6	90CV	37/6	DF81	25/11	EM99	16/6	N361	6/6	9P48	12/6	U381*	14/2	AF117	10/6			
6V4G	4/6	6K7G	6/-	12E6	3/6	90C1	16/6	DF101/27/11	EP6	22/8	EM99	16/6	N361	6/6	9P48	12/6	U381*	14/2	AF117	10/6		
5V4G	10/-	6K9G	5/-	12J5GT	4/6	150B2	16/6	DF107	18/6	EM99	16/6	N361	6/6	9P48	12/6	U381*	14/2	AF117	10/6			
6Y3	6/-	6K8GT	10/6	12J7GT	5/6	150C2	15/6	DK2	12/6	EM99	16/6	N361	6/6	9P48	12/6	U381*	14/2	AF117	10/6			
7Y4	12/6	6K25	19/5	12K5	17/6	161	13/6	DK10	21/10	EM99	16/6	N361	6/6	9P48	12/6	U381*	14/2	AF117	10/6			
6Z3	18/5	6L1*	22/8	12K7GT	5/6	185BT	35/10	DK91	6/-	EM99	16/6	N361	6/6	9P48	12/6	U381*	14/2	AF117	10/6			
6Z4	9/-	6L8G	7/6	12K8GT14/6		185BT	35/10	DK92	10/6	EM99	16/6	N361	6/6	9P48	12/6	U381*	14/2	AF117	10/6			
6A8/2	10/6	6L8G	10/6	12K9GT	8/6	301	38/10	DK96	8/6	EM99	16/6	N361	6/6	9P48	12/6	U381*	14/2	AF117	10/6			
6A7	10/6	6L7GT	7/6	12K47	8/6	304	12/6	DL33	8/6	EM99	16/6	N361	6/6	9P48	12/6	U381*	14/2	AF117	10/6			
6B3	9/-	6L17	8/6	12K5GT	8/6	304	12/6	DL33	8/6	EM99	16/6	N361	6/6	9P48	12/6	U381*	14/2	AF117	10/6			
6AB7	5/-	6L18*	13/-	12Q7	7/6	305	13/6	DL93	10/6	EM99	16/6	N361	6/6	9P48	12/6	U381*	14/2	AF117	10/6			
6AC7	4/-	6L19*	22/8	12M7	8/6	306	13/6	DL66	17/6	EM99	16/6	N361	6/6	9P48	12/6	U381*	14/2	AF117	10/6			
6AG5	5/6	6L13	8/-	12M7	8/6	807	6/-	DL65	15/6	EM99	16/6	N361	6/6	9P48	12/6	U381*	14/2	AF117	10/6			
6AG7	7/6	6L13	11/6	12M8	6/6	4033	12/6	DL72	15/6	EM99	16/6	N361	6/6	9P48	12/6	U381*	14/2	AF117	10/6			
6AJ5	8/6	6L13*	15/7	12M7	11/6	4657	21/6	DL75	30/6	EM99												

**UNIVERSAL AVOMETERS**



Guaranteed perfect working order. Supplied complete with leads, batteries and instructions. Model "1" 34 range £8.19.8 Model "7" 50 range £11.0.0 Registered Post 5/- extra.

**MICROAMMETERS**

0-500 microamps. 2 1/2 in. circular flush panel mounting. Dials engraved. 0-15, 0-300 volts. BRAND NEW, BOXED. 15/- P.P. 1/-.

**7.5 K.V.A. AUTO TRANSFORMERS**

0-115-230 volts. Brand new boxed, £15. Carriage 10/-.

**230/250 VOLT A.C. MOTORS**  
4 1/2 x 3 in. dia., 90 watts, 5,000 r.p.m. 1/2 in. spindle. 22/6, P.P. 1/6.

**1 K.V.A. ISOLATION TRANSFORMERS**

230 v. P.R.I. 230 v. Sec. Boxed, £5 each. Carriage 10/-.

**VARIAC TRANSFORMERS**

24 amp., 230 volt primary, 185 to 250 volt output, £12-10.0. Carriage 10/-.

**TELEPHONES TYPE "L"**

Generator Bell Ringing, 2 line connection. With batteries, fully tested. 69/8 per pair. Carriage 5/-.

**100 AMP A.C. METERS**

Nalder Thompson 6 in. scale. Brand new, boxed, 65/- P.P. 3/6.

**3000 WATT AUTO TRANSFORMERS**

0-115-230 volts, step-up or step-down. Brand new, boxed ex-U.S.A. £7.10.0 each. Carr. 10/-.

**PANEL METERS**

100uA	2 1/2"	F.M.	D.C.	42/6
100uA	3"	F.M.	D.C.	62/6
1 mA	2 1/2"	F.M.	D.C.	25/-
30/0/30 mA	2 1/2"	F.M.	D.C.	9/6
350 mA	2 1/2"	F.M.	D.C.	10/6
300 v.	2 1/2"	Proj.	A.C.	19/8
300 v.	2 1/2"	F.M.	A.C.	25/-
500 v.	2 1/2"	F.M.	A.C.	25/-
120 v.	3 1/2"	F.M.	D.C.	32/6
150 v.	2 1/2"	Electrostatic	25/-	

**FIELD TELEPHONES TYPE "F"**

Suitable for many applications. Generator bell ringing, 2 line connection. With batteries and wooden carrying case, fully tested, £4.19.6 per pair. Carr. 5/-.

**WANTED. ALL GOOD QUALITY COMMUNICATION RECEIVERS AND TEST EQUIPMENT.**

**R.107 COMMUNICATION RECEIVERS**

Frequency coverage from 1.2 to 17.5 Mc/s continuously on three bands. Completely self contained with built-in speaker and power unit to operate from A.C. mains or 12 volt D.C. OPERATED BRAND NEW, FULLY CHECKED. £12-10.0. Carriage 30/-.

**P.C.R.2 RECEIVERS**

850-2,000 metres. 190-550 metres 6-22 Mc/s. output for phones or 3  $\Omega$  speaker. As new £5.19.6. Carr. 7/6. P.C.R.3 as P.C.R.2 but covers 190/550 metres. 2-7 Mc/s. 7-22 Mc/s. including top band. As new, £8.8.0. carr. 7/6. All above models can be supplied with internal power unit to operate on 200/250 v. A.C. at 39/8 extra or alternatively plug-in external power units are 35/-.



**NATIONAL H.R.O. RECEIVERS**



BRAND NEW! Senior model. table mounting. Complete with a full set of 9 coils covering 50 kc/s to 30 Mc/s. Supplied complete in original transit cases. £25. Carr. 20/- Power units to operate direct from 200/250 volt. A.C. 59/8 extra.

**PRECISION COMBINATION VOLTMETER/AMMETER FOR A.C. AND D.C.**



Two separate instruments housed in polished wood case. 6 in. scales with knife edge pointers. Ranges: Volts A.C. and D.C. 160-300-600 v. Amps. A.C. and D.C. 25-50-150-200 A. Supplied complete with all current shunts, leads and leather carrying case. Manufactured by Elliott Bros. Supplied brand new. £9.19.6 each. Carriage 7/6.

**MINE DETECTOR No. 4A**

Will detect all types of metal. Fully portable. Complete equipment supplied tested with instructions. 39/6. Carriage. 10/6. Battery 8/6 extra.

**COLLAR STUDIO TAPE TRANSCRIBOR**

Brand new 1962 model, 3 speeds, 3 motors, digital counter, etc. With latest bradmatic heads and interlock button. Supplied with spare spool, instructions, fixings. 10 sms. each. Carr. 6d.

**FABULOUS TAPE OFFER**

Famous American Brand Tapes. Brand new, fully guaranteed. 5in.—600ft., 10/8, 5in.—900ft., 13/6, 5in.—1200ft., 17/-, 7in.—1200ft., 13/6, 7in.—1800ft., 18/6, 7in.—2400ft., 30/- P. & P. extra. S.A.E. for full tape list.

**CT-53 SIGNAL GENERATORS**

Precis on instruments covering 8.9 to 15.5 Mc/s. and 20 to 300 Mc/s. on 6 bands. Variable attenuator from 1 microvolt to 100 millivolts. Operation 110/200/250 volts. A.C. Supplied in perfect working order. Complete with calibration charts. 19 sms. each. Carriage 10/6.



**PRECISION A.C. AND D.C. VOLTMETERS**

Two ranges, 160 and 320 volts, 8 inch mirror scale with knife edge pointer. Housed in polished wooden case. Ideal for schools, labs., etc. Supplied brand new. £5.19.6 each. P.P. 3/6.

**NATIONAL H.R.O. RECEIVERS MODEL ST**

Uses metallised octal base valves. Few only available BRAND NEW with 9 coils covering 50 kc/s to 30 Mc/s. £30. Carr. 20/- Power unit for 200/250 v. A.C. operation. 59/8 extra.

**DELCO 24 VOLT D.C. MOTORS**

Shunt wound, 5,400 r.p.m. Torque 4 in. oz. Double spindle. Smooth running, extremely powerful. Also runs on 12 volts. BRAND NEW 10/6 each. P.P. 2/-.

**MINIATURE MODEL ACCUMULATORS**

Lead Acid, BRAND NEW. 2v. 1.5 A.H., 4 x 1 1/4 x 1 1/4 in., 11b., 5/6, P.P. 1/3. 12v. 0.75 A.H., 4 x 3 x 1 1/4 in., 21b., 15/6. P.P. 1/6.

Hours of Business: 3 LISLE STREET, 9 a.m.—6 p.m. Half Day Saturday  
34 LISLE STREET, 9 a.m.—6 p.m. Half Day Thursday

**JEMCO 4,000 OHM/VOLT TESTMETER**

1% Precision Resistors throughout. Single control system for all ranges. Highly accurate. Sensitivity 4,000  $\Omega$ /volt. A.C. and D.C.



Ranges:  
D.C. volts:  
0-10-50-250-500-1,000v.  
A.C. volts:  
0-10-50-250-500-1,000v.  
D.C. current:  
0-250 vA  
0-25-500mA  
Resistance:  
33-0k  $\Omega$   
0-300k  $\Omega$   
0-3M  $\Omega$   
Decibels:  
-20 to +36 dB (2 ranges).

Meter sensitivity: 100 microamp. 59/8 each P.P. 2/6.

**JEMCO 20,000 OHM/VOLT TESTMETER**

As above but with increased sensitivity and extended resistance range (0-5M  $\Omega$ ). 97/8 P.P. 2/6. Either type brand new. Guaranteed with leads, prods, batteries, instructions.

**L.T. METAL RECTIFIERS**

All full wave, bridge connected. Brand new, guaranteed.  
12/18v. 1.5A, 3/9 24/36v. 4A, 22/6  
12/18v. 2.5A, 6/8 24/36v. 15A, 14/6  
12/18v. 4A, 8/6 36/48v. 2A, 19/6  
12/18v. 6A, 12/3 36/48v. 4A, 29/6  
12/18v. 10A, 22/6 36/48v. 6A, 32/6  
12/18v. 15A, 37/8 48/60v. 2A, 21/-  
24/36v. 1A, 7/8 48/60v. 10A, 82/6  
Please add postage.

**L.T. TRANSFORMERS**

All primaries tapped 200/250 volts. 1 Battery Charging. 3.5, 3 or 17 volt. 1 amp., 9/9. Ditto 2 amp. 14/3. Ditto 4 amp., 16/6, 9 or 17 volt. 6 amp., 26/-.  
2 Model Type 3, 4, 5, 6, 8, 10, 12, 15, 18, 20, 24 or 30 volt, 2 amp., 18/6. Ditto 4 amp., 27/6. Ditto 5 amp., 37/8. Add Postage.

**AUTO TRANSFORMERS**

Step-up, step-down, tapped 0-115-200-230-250 volts. 15w., 8/-; 60w., 12/6; 150w., 18/6; 200w., 27/6; 300w., 42/6; 500w., 67/8; 1,000w., 99/8; 1,500 w., £8.19.6. P.P. extra.

**R.C.A. PLATE TRANSFORMERS**

Pri. 200/250 v. sec. 2,000-0-2,000 v. 500 mA, tapped 1,500 v. New. Boxed, £6.10.0. Carriage 15/-.

**DUMONT KI051PI DOUBLE BEAM C.R.T.**

Twin Gun. Brand new, boxed, 59/8. P.P. 3/6.

**1.2 Ohm 12 Amp RHEOSTAT**

Geared slider type, new boxed, 15/8 each. P.P. 3/6.

**PAINTON 100K  $\Omega$  3 1/2 DIA. INSTRUMENT PDS.**

Fully screened, precision wirewound, 10/6 each. P.P. 1/3.

**CADMIUM SULPHIDE PHOTOCELLS**

Very sensitive, full data supplied, 12/6 each. P.P. 6d.

**MINIATURE PANEL METERS**

For 1 1/2 in. dia. panel hole.  
0-50 uA 39/8  
0-300 v. D.C. 27/8  
0-500uA 39/8  
0-1 mA 27/8  
"VU" meter 42/8  
0-5 mA 27/8

Send S.A.E. For Bargain Lists

**GW SMITH & CO (RADIO) LIMITED**  
Phone: GERRARD 8204/9155  
Cables: SMITHEX LESQUARE  
3-34 LISLE STREET, LONDON, W.C.2

# RELDA METER SENSATION!

10,000 O.P.V. multi-tester in semi-assembled kit form. only **69/6**  
 Ranges: D.C. voltage: 0-6-30-120-600-1,000 v. (10,000 o.p.v.).



A.C. voltage: 0-6-30-120-600-1,200 v. (10,000 o.p.v.).  
 D.C. current: 0-120µA, 0-12-300 mA.  
 Resistance: 0-20K, 0-2 Meg. (150 ohm, 15K at centre scale).  
 Decibels: -20 to +63dB (600 ohms 1 mW., odbm = 0.775V).  
 Accuracy: D.C. voltage and current ±2% f.s. A.C. voltage ±4% f.s. Resistance ±3% of total scale length.  
 Size: 4 1/4 in. x 3 1/4 in. x 1 in. Complete with test leads, battery and instructions.  
 Few only available, rush your order now while stocks last.



MODEL TK20A 1,000 O.P.V. on AC and DC  
 Extremely compact wide range multi-tester. A most useful instrument for hobbyists, experimenters and technicians who require a reliable tester at a budget price. Operation is extremely easy, simply plug leads into desired scale and you are ready to go.

**RANGES**  
 D.C. voltage: 0-15-150-1,000 v. (1,000 o.p.v.).  
 A.C. voltage: 0-15-150-1,000 v. (1,000 o.p.v.).  
 D.C. current: 0-10 mA.  
 Resistance: 0-100K.  
 Size: 3 1/4 x 2 1/4 x 1 in.

Complete with battery, test leads and instructions. **49/6** fully guaranteed.

## LAPEL MICROPHONE BM.36R

Precision engineered Magnetic Microphone—for lapel or hand use. Only 1 1/4 in. diameter. Exceptionally sensitive. Chrome plated case and clip includes 5ft. shielded cable. **Only 12/6.**



## MINIATURE COMPONENTS

- As previously advertised
- LT44/700 Sub-miniature driver and output transformers 8/- pr. 2/6 ea.
  - P.31 Standard Jack plug PS.35 Sub-miniature plug and socket 2/6 pr.
  - CB.25 "Tiny" plug and socket 2/6 pr.
  - CH.305 Chrome mini-ature plug and socket 3/6 pr.
  - CR/5 Crystal earpiece 6/- ea.
  - MR.4 Magnetic earpiece 6/- ea.
  - LM.179 Crystal lapel microphone 14/- ea.
  - SS.219 Standard slide switch D.P. D.T. 2/6 ea.
  - T.104 S.P. S.T. Toggle switch 2/6 ea.
  - SS.371 Miniature slide switch 2/6 ea.
  - SF.20 High resistance headphones 14/6 ea.
  - LA.6P 9 v. battery eliminator 29/6 ea.
  - 8A.7 8 in. double cone hi-fi speaker 92/6 ea.
  - T.65 Tape splicer and cutter 18/9 ea.
  - SF.5000 Stereo headphones 27/6 ea.
  - AR.13 Test lead kit 9/8 ea.
  - PVC.105 260 pF tuning condenser 5/- ea.
  - ITL.7 Injection Probe 42/6 ea.
- Please add P. & P. on above.

# INTEGRATED STEREO AMPLIFIER MODEL S.A.300

Engineered for the professional . . . designed for the home.

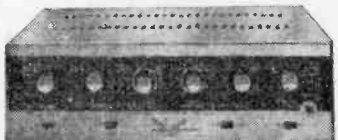

A completely new dual 15 watt stereo amplifier for professional quality reproduction, remarkable versatility and new distinctive styling—worthy of a place in the finest stereo Hi-Fi system, a full range of front panel controls and switches permit adjusting volume, balance and tonal characteristics through every delicate shading of the entire audio range.

Just look at these features:

- ★ Speaker Phasing Switch. ★ Hum Balance Controls. ★ Loudness Switch. ★ Rumble Filter. ★ Integrated Tone Controls. ★ Volume-Balance Controls. ★ Stereo Headphone Sockets. ★ Input Selector and Switch. ★ Multi Outputs. ★ Superb Styling. Brief spec.: Output 30 W (15 watts per channel). Frequency response ± 0.5 dB, 30 to 25,000 cps. Controls: Selector, bass, treble, volume, balance, stereo normal, stereo invert, monaural channel 1, monaural channel 2, rumble filter, loudness, speaker phasing, h.c.m. adjusters, power switch. Value line up: 2-12 AX7, 4-6 BM8, 1-6 CA4.

**£32.10.0**

## No. 19. 2-8 Mc/s TRANSMITTER RECEIVER

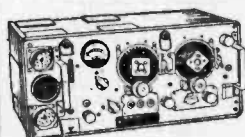

This most famous Army Trans/Receiver covers 2-8 Mc/s. (150-37 metres in two bands). Has an intercom, amplifier. Designed for 12 and 24 volt operation but supplied with "P.W." Mains conversion details. Uses a 6 valve superhet receiver, I.F. being 465 Kc/s, and a 6 valve transmitter designed

for voice and C.W. operation. Incorporates test and tuning meter for voltage, aerial loading and current tests. Panel Controls: Frequency tuning, P.A. tuning, Gain control, MCW, CW, R/T switch, Het-tone netting, Off-on Quench aerial, AVC LT-HT—Drive tests. Supplied complete with valves and instruction book.

## R.101 TUNING AND BATTERY INDICATOR.

This ultra-miniature tuning and battery indicator is easily mounted into portable radios or tape recorders for indicating tuning centre and residual capacity of batteries. Galvanometer movement assures complete accuracy. Insulation resistance between case and terminals: 20 Megohms/500V. Sensitivity: 400 uA. Solder terminals are provided at rear. Plastic case cover. Complete with example circuit for use. Size: 1 x 1 in. Price 24/6.

## SIMPLE TO BUILD

**FUN TO OWN!!!**

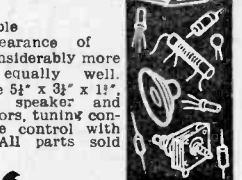
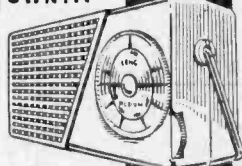

**FEW ONLY LEFT ONLY 65/-**  
 Don't be disappointed—Order Now Carriage 10/.

## VERNIER DIALS



Precision vernier dials with approx. 8 to 1 ratio. Surface mounting. Accurately centred metal insert for 1/4 in. shaft. Reads counter clockwise 0-100 in 180°.

- Model T.501 1 1/4" dia. 12/6
- Model T.502 2" dia. 14/-
- Model T.503 3" dia. 16/-

## A 5 STAGE TRANSISTOR RADIO

which can be built in one hour and will give you endless amount of pleasure. Completely portable has the appearance of sets costing considerably more and works equally well. Attractive case 5 1/4" x 3 1/4" x 1 1/4", genuine 2 1/2 in. speaker and G.E.C. transistors, tuning condenser, volume control with switch, etc. All parts sold separately.

**ONLY 37/6** P. & P. 2/6.

## "KEW" PANEL METERS



"S" Meter Model. 35/-; DC Microammeters, 5 mA. 27/8; 300 v. 27/8; 0-50µA. 39/8; 0-500µA. 32/8; DC Milliammeter, 0-1mA. 27/6. Available in Clear Plastic or Black Bakelite. Will fit 1 1/4 in. dia. cut out. State choice when ordering. All models individually boxed and fully guaranteed. P. & P. 2/6 each.

MAIL ORDERS TO  
 (DEPT. P.), 32a COPTIC STREET,  
 LONDON, W.C.1.

**Relda Radio**

CALLERS WELCOME AT  
 87 TOTTENHAM COURT ROAD,  
 LONDON, W.1. MUS 9606

# INTRODUCING THE R.S.C. BASS-MAJOR 30 WATT GUITAR AMPLIFIER

A MULTI-PURPOSE HIGH FIDELITY, HIGH OUTPUT UNIT  
FOR VOCAL AND INSTRUMENTALIST GROUPS

Eminently suitable for bass guitar and all other musical instruments.

- ★ Incorporating two 12in. heavy duty 25-watt high flux (17,000 lines) loudspeakers with 2in. diameter speech coils. Designed for efficiently handling full output of amplifier at frequencies down to 25 c.p.s.
- ★ Sensitive tweeter unit reproduces frequencies from 3,000 c.p.s. up to 18,000 c.p.s.
- ★ Heavily made cabinet of convenient size 24 x 21 x 14in. has an exceptionally attractive covering in two contrasting tones of Vynair.
- ★ For 200-250 v. to 50 c.p.s. A.C. mains operation.
- ★ Four jack socket inputs and two independent vol. controls for simultaneous connection of up to four instrument pick-ups or microphones.
- ★ Separate bass and treble controls providing more than adequate "Boost" or "Cut".
- ★ LEVEL frequency response throughout the audible range.
- ★ SUPERIOR TO UNITS AT TWICE THE COST.

**39<sup>1</sup>/<sub>2</sub> Gns.** S.A.E. for leaflet.  
OR DEPOSIT OF £4.3.0 and 12 monthly payments of £3.9.11. Carr. 17/6.

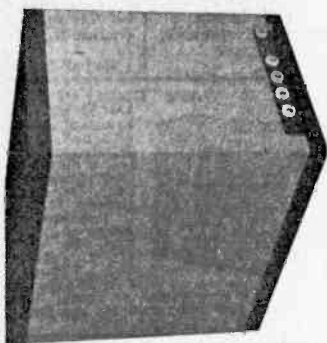

**R.S.C. JUNIOR GUITAR AMPLIFIER**  
5-watt high quality output. Separate bass and treble "cut" and "boost" controls. Sensitivity 15 m.v. Two high impedance inputs. 10in. loudspeaker. Handsome, strongly made cabinet (size 14 x 14 x 7in. approx.) finished in attractive and durable polychrome. 200-250 A.C. mains operation. **£8.19.6** Or DEPOSIT £1 and 9 monthly payments of £1. Carr. 7/6.

**LINEAR TREMOLO/PREAMP. UNIT**  
Designed for introducing the Tremolo effect to any amplifier which is fitted with a reserve power supply point for smoothed H.T. and 8.3 v. A.C. L.T. This applies to practically all amplifiers of our manufacture, and to those of several other manufacturers. The unit plugs into power supply point and any input socket of amplifier. Controls are Speed (frequency of interruptions), Depth (for heavy or light effect), Volume and Switch. Three sockets are for two inputs and Foot Switch. **4 Gns.** ONLY

**R.S.C. SENIOR 10-watt GUITAR AMPLIFIER**

High-fidelity push-pull output. Separate base and treble "cut" and "boost" controls. Twin separately controlled inputs so that two instruments or "mike" and pick-up can be used at the same time. Two loudspeakers are incorporated, a 12in. high flux 14 watt bass unit, and a 6 x 4in. elliptical for treble. Cabinet is well made and finished as Junior Model. Size approx. 18 x 18 x 8in. Only

**15 Gns.** Carr. 10/- S.A.E. for leaflet.  
Or DEPOSIT 34/9 and nine monthly payments of 34/9.

**R.S.C. SUPER HI-FI 15-watt**

An exceptionally efficient high fidelity Guitar Amplifier incorporating a heavy 20-watt speaker with excellent frequency response. Individual bass and treble controls give ample "boost" and "cut". Two high impedance Jack Socket inputs are separately controlled. If required one or two additional inputs can be provided at a cost of 7/6 extra socket. Cabinet is of substantial construction and attractively finished in two tones of polychrome. Size approx. 20 x 13 x 10in. Operation from 200-250 v. 50 c.p.s. A.C. mains. Please do not compare this Unit with others of similar rating until you have heard the difference. S.A.E. for leaflet.

**22 Gns.** Or Deposit 51/6 and nine monthly payments of 51/6. Carr. 12/6.



**TRANSISTOR SALE.** Mullard OC71 3/9, OC45 4/11, OC44 4/11, OC72 4/9, OC81 4/11, OC71 8/9, Ediswan KA101 3/9, XB102 3/9, XA112 3/9, XB113 3/9, XB104 3/9, XC101A 3/9. Postage 6d. for up to 3 Transistors.

**D.C. SUPPLY KIT.** 12 v. 1 a. consisting of a partially drilled metal case, mains trans., F.W. Bridge Rectifier, 2fuseholders and fuses. Change Direction switch, variable Speed regulator and circuit. For 200-250 v. A.C. mains. Suitable for Electric Trains. Limited number available at 29/11

**SELENIUM RECTIFIERS**  
F.W. BRIDGE 24 v. 2 amp .. 14/9  
8/12 v. 1 a. .. 3/11 250 v. 60 mA .. 89/9  
8/12 v. 2 a. .. 6/11 H.T. TYPES H.W.  
6/12 v. 3 a. .. 9/9 150 v. 40 mA .. 3/9  
6/12 v. 4 a. .. 12/3 250 v. 50 mA .. 3/11  
6/12 v. 6 a. .. 15/3 250 v. 60 mA .. 4/11  
6/12 v. 10 a. .. 25/9 250 v. 80 mA .. 5/11  
6/12 v. 15 a. .. 35/9 250 v. 250 mA .. 11/9

**CONTACT COOLED, 250 v. 75 mA, F.W. (Bridge), 10/11, 250 v. 60 mA, F.W. (Bridge), 8/11. H.W. 250 v. 60 mA, 5/11.**

**LINEAR TAPE PRE-AMPLIFIER**  
Type LP/1, Switched Negative feedback equalisation Positions for Record 11in, 3in., 7in. and Playback. EM84 Recording Level Indicator. Designed primarily as the link between a Collaro Tape Transcriber and a high fidelity amplifier, but suitable for almost any Tape Deck. Only 9 gns. S.A.E. for leaflet.

**EX. GOVT. SELENIUM RECTIFIERS 12v 15 AMP (BRIDGE) F.W. ONLY** **19/9**

**HUGE PURCHASE OF BRAND NEW 24 v. 20 Amp. F.W. (BRIDGE) SELENIUM RECTIFIERS. each** **59/9**

**R.S.C. GRAM. AMPLIFIER KIT.** 3 watts output. Negative feedback. Controls Vol. Tone and Switch. Mains operation 200-250 v. A.C. Full isolated chassis. Circuit, etc., supplied. Only 39/9. Carr. 3/9.

**HI-FI 10 WATT AMPLIFIERS**  
Brand new. Manufacturer's discontinued line. Fitted latest Mullard valves. Dual inputs for "mike" and gram., etc. Bass and Treble Controls. High sensitivity and quality. Output for 3 ohm or 15 ohm speaker. For 230-250 v. A.C. Carriage 4/6. Only **£7.19.9**

**THE SKYFOUR T.R.F. RECEIVER**  
A design of a 3 valve low and medium wave 200-250 v. A.C. Mains receiver with selenium rectifier. High gain H.F. stage and low distortion detector. Valve line-up 6K7, 6F61, 6V6G. Sensitivity and quality excellent. Simple to construct. Point-to-Point wiring diagrams, instructions and parts list, 1/9, maximum building costs £4.19.6, inc. attractive Walnut veneered wood cabinet 12 x 6 1/2 x 5 1/2 in.

**MULTI-METERS. CABY MI.** Sensitivity 2,000 ohms per volt. A.C. and D.C. 50/- A.10. Basic meter sensitivity 150 micro-amps A.C. and D.C. ranges £4.17.6. D.20. Sensitivity up to 10,000 ohms per volt A.C. and D.C. £6.10.0.

**EX. GOVERNMENT ACCUMULATORS.** Size 7 1/2 x 4 x 2 1/2. 2v. 16 A.H., brand new, 6/9 each, 3 for 15/6.

**EX. GOVT. SMOOTHING CHOKES.** 200 mA, 3-5 H, 50 ohms, Parmeco 8/9; 100 mA, 5 H, 100 ohms 9/11; 150 mA, 10 H, 50 ohms 9/9; 60 mA, 20 H, 300 ohms 5/9; 120 mA, 12 H, 100 ohms 8/9; 50 mA, 50 H, 1,000 ohms 6/9; 100 mA, 10 H, 100 ohms 6/9; 60 mA, 5-10 H, 250 ohms 2/11.

**COMPLETE POWER PACK KIT, 19/11**  
Consisting of Mains Trans., Metal Rectifier, Double electrolytic smoothing choke chassis and circuit. For 200-250 v. A.C. mains. Outputs 250v. 60mA. 6.3v. 2a.

**R.S.C. POWER PACK, 39/9.** Louvred metal case only 8 x 5 1/2 x 2 1/2ins. Stove enamelled. For 200-250v. A.C. mains Output at 4 pin plug and socket 250 v. 60 mA, fully smoothed and 8.3v. 2a. Suitable for power requirements of almost any Pre-amp or Radio Tuner.

**R.S.C. BABY ALARM or INTER-COMM. KIT.** Complete set of parts with diagrams, etc. Housed in two polished walnut finished cabinets of pleasing design. High sensitivity. For 200-250v. A.C. mains. Fully isolated. Controllable at both units. An intercomm. of this class would normally cost £20-£30. Only 79/6, carr. 5/- or assembled ready for use £5.15.0



**NEW BRANCH OPENING**  
**32 HIGH STREET, LEICESTER**  
**LATE FEBRUARY**

**R.S.C. (Manchester) Ltd.** MAIL ORDERS to 5 County Arcade, Leeds 1. Terms: C.W.O. or C.O.D. No C.O.D. under £1. Postage 2/9 extra under £2. 4/6 extra under £5. Trade Supplied. S.A.E. with all enquiries please.

<b>BIRMINGHAM:</b> 6 Gc. Western Arcade Birmingham No half-day	<b>SHEFFIELD:</b> 13 Exchange St. Castle Market Bldgs. Sheffield Half-day Thursday	<b>HULL:</b> 51 Saville St. Hull	<b>LIVERPOOL:</b> 73 Dale St. Liverpool 2 Half-day Wednesday	<b>BRADFORD:</b> 56 Morley St. (above Alhambra Theatre) Bradford	<b>MANCHESTER:</b> 8-10 Brown St. (Market St.) Manchester 2 No half-day	<b>LEEDS:</b> 5-7 County (Mecca) Arcade Briggate, Leeds Half-day Wed.
--	--	--	---	---	---	---

**R.S.C.** (Manchester) Ltd.

MAIL ORDERS to 5 County Arcade, Leeds 1. Terms: C.W.O. or C.O.D. No C.O.D. under £1 Postage 2/9 extra under £2. 4/6 extra under £5. Trade Supplied. S.A.E. with all enquiries please.

**BIRMINGHAM:** 6 Gt. Western (Opp Snow Hill Stn)

**SHEFFIELD:** 13 Exchange St. Castle Market Bldgs.

**HULL:** 51 Savile St.

**LIVERPOOL:** 73 Dale St. (8 mins. from Lime St. or Exchange Stations)

**BRADFORD:** 56 Morley St. (above Alhambra Theatre)

**LEEDS:** 5-7 County (Mecca) Arcade, Briggate

**MANCHESTER:** 8-10 Brown St. (Market St.)

Half-day Thurs.

Half-day Wednesday

No half-day

**SENSATIONAL STEREO OFFER (4 Gns.)**

A complete set of parts to construct a good quality Stereo amplifier with an undistorted output total 6 watts. For A.C. mains input of 200-250 v. Including pair matched 6In. speakers. Sensitivity 139 m.v. Ganged Vol. and Tone Controls. Preset balance control. Full instructions and wiring diagrams supplied. Stereo Pickup Head 1/9 extra with above only.

**R.S.C. 30-WATT ULTRA LINEAR HIGH FIDELITY AMPLIFIER A10**

A highly sensitive Push-Pull high output unit with self-contained Pre-amp. Tone Control Stages. Certified performance figures compare equally with most expensive amplifiers available. Hum level 70 db down. Frequency response ±3 db. 30-30,000 c/s. A specially designed sectionally wound ultra linear output transformer is used with 807 output valves. All components are chosen for reliability. Six valves are used EP86, EP86, ECC83, 807, 807, GZ34. Separate Bass and Treble Controls are provided. Minimum input required for full output is only 12 millivolts so that ANY KIND OF MICROPHONE OR PICK-UP IS SUITABLE. The unit is designed for CLUBS, SCHOOLS, THEATRES, DANCE HALLS or OUTDOOR ENTERTAINMENTS, etc. For use with Electronic ORGAN, GUITAR, STRING BASS, etc. For standard or long-playing records. OUTPUT SOCKET PROVIDES L.T. and H.T. for a RADIO FEEDER UNIT. An extra input with associated vol. control is provided so that two separate inputs such as Gram, and "Mike" can be mixed. Amplifier operates on 200-250 v. 50 c/s. A.C. Mains and has output for 8 and 15 ohm speakers. Complete kit of parts with fully punched chassis and point-to-point wiring diagrams and instructions. If required, perforated cover with carrying handles can be supplied for 1/9. The amplifier can be supplied, factory built with EL34 output valves and 12 months guarantee, for 14 Gns.

**11 Gns.** Carr. 10/-

Terms: DEPOSIT 33/9 and 9 monthly payments of 3/9. Suitable microphones and speakers available at competitive prices.

**WE STOCK ARMSTRONG, DULCI AND JASON EQUIPMENT GOODMAN AND W.B. SPEAKERS GARRARD AND GOLDRING TABLES**

**SUPERHIT FEEDER UNIT.** Design of a high quality Radio Tuner specially suitable for use with our Amplifiers. Delayed A.V.C. Controls are Tuning, W.Ch. and Vol. Only 250 v. 15 mA. H.T. and L.T. of 6.3 v. 1 amp. required from amplifier. Size approx. 9 x 6 x 7 1/2 in. High. Simple alignment procedure. Point-to-Point wiring diagrams, instructions and priced parts list with illustrations. 2/6. Total building cost £4.15.0. S.A.E. for leaflet.

**R.S.C. BATTERY TO MAINS CONVERSION UNITS**

Type BM1. An all-dry battery eliminator. Size 5 1/2 x 4 1/2 x 2 1/2 in. approx. Completely replaceable battery supplying between 90 v. where A.C. mains 200-250 v. 50 c/s is available. Suitable for all battery portable receivers requiring 1.4 and 90 v. This includes vacuum tube and transistor types. Complete kit with diagrams. 3/9, or ready to use, 4/6/6.



Type BM2. Size 8 x 5 1/2 x 2 1/2 in. Supplies 120 v. 90 v. and 60 v., 40 mA. and 2 v. 0.4 a. to 1 amp. fully smoothed. Thereby completely replacing both H.T. batteries and L.T. 2 v. accumulators when connected to A.C. mains supply 200-250 v. 50 c/s. SUITABLE FOR ALL BATTERY RECEIVERS normally using 2 v. accumulators. Complete kit of parts with diagrams and instructions. 4/9, or ready for use, 5/9/6.

**P.M. SPEAKERS.** 10in. W.B. "Stentorian" 3 or 15 ohms type HF 1012 10 watts, hi-fidelity type. Recommended for use with our All Amplifier. £4.12.9. 12in. R.A. 3 ohms 10 watts (12,000 lines). 5/9/6.

**TWEETERS.** Plessey 3Ω 19/9, 15Ω 25/9.

**Jason FATTI V.H.F./F.M. Radio Tuner design.** Total costs of parts including valves Tuning dial, Escutcheon, etc., £6.19.9. Other Jason equipment in stock.

**LINEAR L45 MINIATURE 45 WATT QUALITY AMPLIFIER.** Suitable for any record playing unit, and most microphones. Negative feed-back 12 db. Separate Bass and Treble Controls. For mains 200-250 v. 50 c/s. Output for 2-3 ohm speaker. Mullard valves E280, ECC83, EL84. Size only 7-5-5 1/2 in. high. Guaranteed 12 months. Only £5.19.6. Send S.A.E. for leaflet. Terms: Deposit 22/6 and 5 monthly payments of 22/6.

**R.S.C. 4-5 WATT AS HIGH-GAIN AMPLIFIER**



A highly-sensitive 4-valve quality amplifier for the home, small club, etc. Only 50 millivolts input is required for full output so that it is suitable for use with the latest high fidelity pick-up heads, in addition to all other types of pick-ups and practically all "mikes". Separate Bass and Treble Controls are provided. These give full long-playing record equalisation. Hum level is negligible being 71 db. down 15 db. of negative feedback is used. H.T. or 300 v. 25 mA. and L.T. or 6.3 v. 1.5 a. is available for the supply of a Radio Feeder Unit, or Tap-Deck pre-amplifier. For A.C. mains input of 200-250 v. 50 c/s. Output for 2-3 ohm speaker. Chassis is not alive. Kit is complete in every detail and includes fully punched chassis (with base plate) with Blue hammer finish and point-to-point wiring diagrams and instructions. Exceptional value at only £4.15.0, or assembled ready for use 25/- extra. Plus 3/6 carr., or deposit 22/6 and 5 monthly payments of 22/6 for assembled unit.

**R.S.C. PORTABLE GUITAR AMPLIFIERS NOW ON PAGE 883.**

**AUDIOTRINE HIGH FIDELITY REPRODUCERS THE DUO/10.** Consisting of a 12in. 12,000 line speaker with heavy four layer voice coil, the Audiotrine cross-over unit, and a 4in. Diameter Tweeter Unit incorporated in the extremely attractive Audiotrine Senior Corner Console Cabinet as described below. Matching impedance 15 ohms. Power handling 10 watts nominal, 14 watts peak. Frequency range 40-18,000 c.p.s. Deposit 27/9 and nine monthly payments of 27/9.

**12 Gns.**

**THE DUO/20.** Incorporating a 12in. High Flux 20 watt Speaker with 2in. Diameter Speech Coil. (Total Flux 160,000 lines), the Audiotrine cross-over unit, and a highly sensitive Tweeter unit. In the Audiotrine Senior Corner Console Cabinet. Matching impedance 15 ohms. Peak Power Output 25 watts. Frequency range 30-18,000 c.p.s. Deposit 33/9 and nine monthly payments 33/9.

**R.S.C. JUNIOR HI-FI REPRODUCER.** The very latest Goodmans Axlette 8 High Fidelity Loudspeaker, retaining at approx. 5 Gns.) fitted in a specially designed Bass Reflex cabinet size 12in. x 18in. x 10 in. Acoustically lined and ported and finished in polished walnut veneer. Matching impedance 15 ohms. Frequency range 40-15,000 c.p.s. Power handling 6 watts nominal. Ideal for Stereo. Limited number.

**8 Gns.** Carr. 4/6

**12in. 10 WATT HIGH QUALITY LOUDSPEAKER**

In walnut veneered cabinet. Gauss 12,000 lines. Speech coil 3 ohms or 15 ohms. Only £4.19.6 Carr. 5/-. Terms: Deposit 11/3 and 9 monthly payments of 11/3. 12in. 20 WATT HI-FI LOUDSPEAKERS. Size Cabinets. 18 x 18 x 10in. Finish as above. Terms: Deposit 17/9 and 9 monthly payments of 17/9. Only £7.19.6. Carr. 4/6.

**BASS GUITAR LOUDSPEAKER IN CABINET.** 15in. 50 watt, highly sensitive unit in rexine covered acoustically lined cabinet. Deposit £3.7.6 Carr. 9 Gns. of £3.7.6. Carr. 15/-

**R.S.C. BASS REFLEX CABINETS, JUNIOR MODEL.**

Specially designed for W.B. HF1012 Speaker, but suitable for any good quality 10in. speaker. Acoustically lined and ported. Polished walnut veneer finish. Size 19 x 12 x 10in. Handsome appearance. Ensure superb reproduction for only £3.19.6.

**STANDARD MODEL.** As above but for 12in. speakers. Size 20 x 15 x 13in. Especially recommended for Audiotrine Loudspeaker systems. For vertical or horizontal use. £5.19.6. Suitable legs with brass ferrules. 1/9/6 per set of 4.

**R.S.C. CORNER CONSOLE CABINETS**

Polished walnut veneer finish. Pleasing design. JUNIOR MODEL. Size 20 x 11 x 8in. for 8 x 5in. or 10 x 6in. speakers. £2.9.9. STANDARD MODEL. Size 27 x 18 x 12in. for 8 or 10in. speakers. £4.11.9. SENIOR MODEL. Size 30 x 20 x 15in. for 12in. speaker. Suitable Speaker systems below Only 7 Gns.

**AUDIOTRINE HI-FI SPEAKER SYSTEMS.** Consisting of matched 12in. 12,000 line, 15 ohm high quality speaker; cross-over unit (consisting of choke, condenser, etc.) and Tweeter. The smooth response and extended frequency range ensure surprisingly realistic reproduction. Standard 10 watt ratings £4.19.9. Carr. 5/-. Or Senior 15 watt 7 Gns. Carr. 7/6.

**AUDIOTRINE EQUIPMENT CABINETS**

Size 36 x 15 x 18in. Beautiful walnut veneered finish. Elegant contemporary design. Robust construction. Uncut removable baseboard. Depth above baseboard 5 1/2". Only 12! Gns. Carr. 15/-





# AUDIOTRON HI-FI TAPE RECORDER KIT 25<sup>1</sup> GNS. Carr. 17/6

REALISM AT INCREDIBLY LOW COST, CAN BE ASSEMBLED IN AN HOUR

Incorporating the latest Collaro Studio Tape Transcriber, the Audiotrone High Quality Tape Amplifier with negative feedback equalization for each of 3 speeds, High Flux P.M. Speaker, empty Type Spool, a Real of Best Quality Tape and a Handsome Portable carrying Cabinet with latest attractive two-tone polychrome finish, size 14 1/2 x 8 1/2 in. high, and circuit. Total cost if purchased individually approximately £40. Performance equal to units in the £60-£80 class. S.A.E. for leaflets. TERMS: Deposit £2.13.9 and 12 monthly payments of 44/- Cash price if settled in 3 months.



ONLY 3 PAIRS OF SOLDERED JOINTS PLUS MAINS

**SPECIAL NOTE.** The Tape Decks we supply are latest models. Where customers already have a Deck or wish to use one of those being offered cheaply we can supply Kit less Deck at 13 gns. carr. 10/-. Or deposit 2 gns. and 12 monthly payments 23/9. Also if required we can supply in lieu of portable cabinet and 7 x 4 in. speaker, the Equipment Cabinet illustrated at foot of opp. page and a high flux 8 1/2 x 5 1/2 in. speaker for 8 gns. extra.

## HI-FI CRYSTAL PICK-UP HEADS.

(Cartridges.) Acoos Standard replacement for Garrard, B.S.R. and Collaro, 19/9. Acoos Stereo-Monaural 49/9. Ronette, Stereo-Monaural 59/6. B.S.R. Stereo 39/9.

## HEMATIC RECORDING HEADS.

High Impedance Record/Playback 22/- Low Impedance Erase, 12/6.

## PICK-UP ARMS.

Complete and with latest Acoos/h-i Turnover Cartridge 29/11.

## CRYSTAL MICROPHONES.

Hand type NP110 14/9, R.T.C. 19/9, Acoos Mic 40 28/6, Acoos Mic 45 29/9. Stick type Acoos 33-1, 39/9. BM3 with neck band and heavy table stand 59/9. Lapel type 35/9.

## COLLARO JUNIOR 4-speed Single Player Unit and Crystal Pick-up with hi-Fi Turnover head. Only £3.19.6.

## COLLARO CONQUEST 4-SPEED AUTO-CHANGER with high fidelity Studio pick-up. Latest model. For 200-250 v. A.C. mains. £2.19.6 Carr. 5/6.

## COLLARO RC 457 4-SPEED MIXER AUTO-CHANGERS.

Turnover Studio head, for 200-250 v. A.C. £2.19.6 Carr. 4/6.

## B.S.R. C414 4-speed hi-Fi AUTO-CHANGERS with hi-Fi Turnover head. £6.19.6 Carr. 4/6.

## MINIATURE 2-3 WATT GRAM AMPLIFIER.

For use with any single or auto-change unit. Output for 2-3 ohm speaker. For 200-250 v. A.C. mains. Size 1 1/2 x 2 1/2 in. Controls: Vol. and Tone with switch. Only 59/6.

## HIGH FIDELITY 12-14 WATT AMPLIFIER TYPE A11

PUSH-PULL ULTRA LINEAR OUTPUT "BUILT-IN" TONE CONTROL PRE-AMP STAGES



Two input sockets with associated controls allow mixing of "mike" and gram., as in A.11. High sensitivity. Includes 5 valves, ECC83, ECC83, EL84, EL84, EZ81. High Quality sectionally wound output transformer specially designed for Ultra Linear operation and reliable small condensers for current matching. INDIVIDUAL CONTROLS FOR BASS AND TREBLE "Lift" and "Cut". Frequency response ± 3 db. 30-30,000 c/s. Six negative feedback loops. Hum level 60 db. down. ONLY 23 millivolts INPUT required for FULL OUTPUT. Suitable for use with all makes and 23 types of pickups and microphones. Comparable with the very best designs. For STANDARD or LONG PLAYING RECORDS. For MUSICAL INSTRUMENTS such as STRING BASS, GUITARS, etc.

OUTPUT SOCKET with plug provides 300 v. 30 ma. and 6.3 v. 1.5 a. For supply of a RADIO FEDER UNIT. Size approx. 12-9/16 in. For A.C. mains 200-250 v. 50 c/s. Output for 2 and 15 ohms speakers. Kit is complete to last nut. Chassis is fully punched. Full instructions and point-to-point wiring diagrams supplied. Only 8 Gns. Carr. (Or factory built 51/- extra.)

If required louvred metal cover with 2 carrying handles can be supplied for 15/9. TERMS ON ASSEMBLED UNITS. DEPOSIT 24/9 and 9 monthly payments of 24/9. Send S.A.E. for illustrated leaflet detailing Ready-to-assemble Cabinets, Speaker, Microphones, etc., with cash and credit terms.

**B.S.R. MONARDECK TAPEDECKS.** Speed 3 1/2 in. per sec. With high quality recording heads. £6.19.6. Carr. 5/-. Cabinets to take Deck and amplifier 39/6.

**R.S.C. TRANSCRIBED GRAM. AMPLIFIER.** Output 1 watt. for 3 ohm speaker. Transistors Mullard OC71, OC81D, OC81, OC81. Fitted Vol. Control with switch. Assembled and tested. Suitable for any normal crystal pick-up. Only 59/9.

## R.S.C. STEREO/TEN HIGH QUALITY AMPLIFIER

A complete set of parts for the construction of a stereophonic amplifier giving 5 watts high quality output on each channel (total 10 watts). Sensitivity is 50 millivolts, suitable for all crystal stereo heads. Ganged Bass and Treble Control give equal variation of "Lift" and "cut". Provision is made for use as straight (monaural) 10-watt amplifier. "Live line-up" ECC83, ECC83, EL84, EL84, EZ81. Outputs for 2-3 ohm speakers. Point-to-Point wiring diagrams and instructions supplied. Send S.A.E. for leaflet. Full constructional details and price list 2/6. Carr. 10/-.

8 Gns.

Kit can be assembled ready to use, 59/6 extra.

## R.S.C. BATTERY CHARGING EQUIPMENT

### HEAVY DUTY CHARGER KIT

6/12 v. 6 amps. variable output. Consisting of Mains Transformer 0-200-230-250 v. F.W. (Bridge) Selenium Rectifier; Ammeter; Variable Charge Rate Selector Panels, Plug/Fuseholder, Fuseholder and circuit. 59/9. Carr. 4/6.

### CHARGER KIT, 12v. 14 AMP or 25v. 7 amp.

Consisting of mains trans. 200-230-250 v. F.W. (Bridge) selenium Rectifier, F. Ammeter, Fuses, Variable Resistor and Circuit. Only 6 gns. Carr. 2/6. Please state if 12 v. or 24 v. kit required.

### SOLDERING IRONS.

230-250 v. 30 watts. First quality. For Radio work. 19/8. Spare elements and bits available.

## R.S.C. MAINS TRANSFORMERS (GUARANTEED)

- Interleaved and Impregnated. Primaries 200-230-250 v. 50 c/s. Screened TOP SHROUDED DROP THROUGH
- 250-0-250v. 70mA. 6.3v. 2a. 0-5-6.3v. 2a 17/9
  - 350-0-350v. 80mA. 6.3v. 2a. 5v. 2a ... 15/9
  - 250-0-250v. 130mA. 6.3v. 2a. 6.3v. 1a ... 21/9
  - 250-0-250v. 100mA. 6.3v. 3.5e. C.T. ... 19/9
  - 250-0-250v. 100mA. 6.3v. 4a. 0-5-6.3v. 3a 26/9
  - 300-0-300v. 130mA. 6.3v. 4a. 6-6.3v. 1a. for Mullard 510 Amplifier ... 26/9
  - 300-0-300v. 100mA. 6.3v. 4a. 0-5-6.3v. 3a 26/9
  - 350-0-350v. 150mA. 6.3v. 4a. 0-5-6.3v. 3a 29/9
  - 425-0-425v. 200mA. 6.3v. 4a. 5v. 3a ... 49/9
- FULLY SHROUDED UPRIGHT**
- 250-0-250v. 60mA. 6.3v. 2a. 0-5-6.3v. 2a ... 17/11
  - 250-0-250v. 100mA. 6.3v. 4a. 0-5-6.3v. 3a 27/9
  - 300-0-300v. 100mA. 6.3v. 4a. 0-5-6.3v. 3a 27/11
  - 300-0-300v. 130mA. 6.3v. 4a. C.T. 6.3v. 1a. for Mullard Amplifier ... 33/9
  - 350-0-350v. 100mA. 6.3v. 4a. 5v. 3a ... 27/11
  - 350-0-350v. 150mA. 6.3v. 4a. 5v. 3a ... 35/9

### Assembled 4-5 amps. 6/12 v.

Fitted Ammeter and variable charge rate selector. Also selector plug for 6 v. or 12 v. charging. Louvred steel case with stoved blue hammer finished. Fused and ready for use with mains and output leads. Carr. 5/9. Terms: Deposit 13/3 and 5 monthly payments 13/3. 6/12 v. 3a., all facilities as above. Only 59/9. Carr. 3/6.

**ASSEMBLED 12v. 10 Amp with variable charge rate adjustment, ammeter and strong louvred, stove enamelled case. Ready for use. Only 7 gns. Carr. 10/- or in Kit Form 5 gns.**

### ASSEMBLED 6/12 v. 2 amps.

Fitted Ammeter and selector plug for 6 v. or 12 v. Louvred metal case finished attractive hammer blue. Fused, ready for use with mains and output leads. Carr. 4/9. 6/12 v. 1amp. 2/79 Less meter.

All for A.C. Mains 200-250v. 50 c/s. Guaranteed 12 months.

### BATTERY CHARGER KITS

- Consisting of Mains Transformer, F.W. Bridge, Metal Rectifier, well ventilated steel case. Fuses. Fuse-holders. Grommets, panels. Heavy Duty Circuit. Carr. 3/6 extra.
- 6v. or 12v. 1 amp. .... 22/9
  - As above, with Ammeter 28/9
  - 6 v. 2 amps. .... 19/9
  - 6v. or 12v. 2amps. .... 25/9
  - 6 v. or 12 v. 2 amps. inouers size of Ammeter. .... 35/9
  - 6 v. or 12 v. 4 amps. .... 45/9
  - Ammeter and variable charge rate selector. .... 59/9
- CHARGER AMMETERS:**
- 0-1.5 a., 0-3 a., 0-4 a., 0-7 a., 0-2.5 a., 0-80 a. 8/9.

### MIDGET MAINS Primaries 200-250 v

- 50-0-250 v. 60 mA. 6.3 v. 2a. ... 11/9
  - 250-0-250 v. 60 mA. 6.3 v. 2a. ... 12/11
- Both above size 2 1/2 x 2 1/2 in.

### FILAMENT TRANSFORMERS

- All with 230-250 v. 50 c/s. primaries 6.3 v.
- 1.3a. 5/9; 6.3 v. 2a. 7/8; 6.3 v. 2a. 7/9; 12 v. 1 a. 7/11; 6.3 v. 3 a. 8/11; 6.3 v. 6 a. 17/6; 12 v. 1.5 a. twice, 17/6.

### SMOOTHING CHOICES

- 10 H H 250 ohms ... 11/9
- 100 mA. 10 H 200 ohms ... 8/9
- 80 mA. 10 H 350 ohms ... 5/9
- 60 mA. 10 H 400 ohms ... 4/11

### CHARGER TRANSFORMERS

- All with 230-250 v. 50 c/s. primaries
- 0-9-15 v. 1 a. 12/9; 0-9-15 v. 2a. 14/9; 0-9-15 v. 3 a. 16/9; 0-9-15 v. 5 a. 19/9; 0-9-15 v. 6 a. 23/9; 0-9-15 v. 8 a. 28/9.

### AUTO STOP/STEP DOWN TRANS.

- 0-110-120-230v. v. 50-80 watts. 13/9.
- 250 watts. 39/9. 150 watts. 27/9.

### MICROPHONE TRANSFORMERS

- 120 x 1 high grade, clamped. 6/9; 120 x 1 Potted. Mu-metal screened. 9/9.

## "ROAMER 7" (5 Wavebands)

★ (7 Transistor plus 2 Diode designs)

★ Med/Long Waves, Trawler Band and 2 S.W. to approx. 17 metres.

- ★ Rich-toned 5in. Speaker.
- ★ Sockets for car radio use.
- ★ Telescopic aerial for S. Waves.
- ★ FERRITE ROD AERIAL FOR M/L.
- ★ Full After Sales Service.
- ★ Air spaced gauged Tuning Condenser.
- ★ Uses latest Mullard Transistors.

Total cost of parts **£7.9.6** P.P. 5/6.

- ★ Push-Pull output for room-filling volume.
- ★ Two tone Cabinet with gilt trim.
- ★ Case size 12 x 8½ x 3½in.
- ★ Parts price list and data 3/-.



PERFORMANCE WILL AMAZE YOU!

## THE SUPER SEVEN

★★ (7 Transistors plus 2 Diodes)

- ★ 2 R.F. STAGES.
- ★ Mullard and Surface Barrier Transistors.
- ★ Coverage of Medium, Long Waves, Trawler Band.
- ★ Use as domestic radio, car radio or fit with strap for carry-about.
- ★ No aerial required.
- ★ 3-inch speaker but will drive a larger speaker.
- ★ 400 milliwatts output stage.



May be built for **£5.19.6** SIZE: 7½ x 5½ x 1½in. plus 3/6 post, etc.

PARTS PRICE LIST AND EASY BUILD PLANS 2/-

## NEW TRANSONA-6

★ (6 Transistors, plus 2 Diodes)  
★ M/L & T. BAND

400 Mw Mullard push-pull output Transistors. Powerful magnet 3in. high grade speaker. Push-pull transformers. This is a top performing receiver. Many stations listed in one evening including Luxembourg loud and clear. A pleasure to listen to. FERRITE ROD AERIAL. All parts sold separately, including pale blue gleaming polystyrene case with duo-diffusion grilles in red. Uses 9 volt battery. Sockets for car aerial.

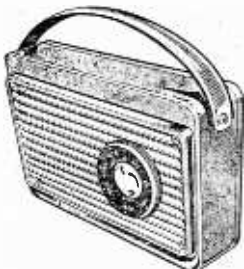

Total building cost **£4.19.6** P.P. 3/-, Size 6½ x 4½ x 1½in.

"Agreeably surprised with Trawler Band reception. Luxembourg as loud as local. Your easy build diagram helped a lot... my first attempt."—H. S., Penzance, Cornwall (poor reception area). PARTS PRICE LIST AND EASY BUILD PLANS 1/6

All components used in our receivers may be purchased separately if desired.

AFTER SALES SERVICE

## Radio Exchange Co.

27 HARPUR STREET, BEDFORD

Phone: 2367  
Closed 1 p.m. Sat. Opp. Co-op.

## BEGINNERS POCKET 5

(M/W/LW and TRAWLER BAND) (7 Stages)  
(5 Transistors, plus 2 Diodes)

Designed round supersensitive FERRITE ROD AERIAL and 3in. moving coil speaker. Attractive case in black with speaker grille in red. On test Home, Light, Radio Luxembourg and many Continental stations were received. Miniature earpiece free. Alternate larger case 6½ x 4½ x 1½in. for easier assembly.

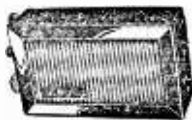

Total cost of all parts **£2.19.6** P.P. 3/-  
EASY BUILD PLANS AND PARTS PRICE LIST 1/6

## "THE MELODY 6"

- ★ Ferrite rod aerial.
- ★ 6 new type transistors and top quality components. Attractive case in blue and red and carrying strap with gold trim.
- ★ 3in. Speaker.
- ★ M.W./L.W.
- ★ No aerial require!

**£3.19.6**

P.P. 3/-  
Price list and plans, 2/-.



## "ROAMER-6"

PUSH-PULL OUTPUT

5 Wavebands  
(M/L, T.B. and 2 S.W.)

Uses 6 top grade transistors plus 2 diodes. 3in. Speaker. Ferrite rod aerial for sensitivity. Telescopic aerial for short waves. Handsome case with gilt fittings size 6½ x 4½ x 1½in. approx. Listen to stations half a world away.

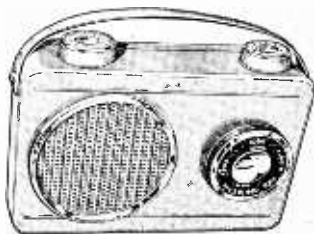

Total cost of parts **£6.9.6** Post & Packing 3/-  
Plans, Parts price list 3/-.

**HARVERSON'S F.M. TUNER Mk.I**

● F.M. tuning head by famous maker. ● Guaranteed non-drift. ● Permeability tuning. ● Frequency coverage 88-100 Mc/s. ● OAR1 balanced diode output. ● Two I.F. stages and discriminator. ● Attractive maroon and gold dial (7 x 3in. glass). ● Self powered, using a good quality mains transformer and valve rectifier. ● Valves used ECC85, two EFS80s, and EZ90 (rectifier). ● Fully drilled chassis. ● Size of completed tuner 5 1/2 x 6 1/2 in. ● All parts sold separately. £5.19.6, plus 8/6 P.P. and Ins. Circuit diagram and illustrations 1/6 post free. Mark II Version as above but complete with magic eye, front panel and rackets. £6.12.6. P. & P. 8/6. Mark III Version as Mark I but with output stage (ECL82) and tone control. £7.7.0. P. & P. 8/6. Handsome Metal Cabinets. Choice of Grey, Black or Green. To fit Mark I. 25/-, P. & P. 2/6. To fit Mark II, 17/8, P. & P. 2/6.

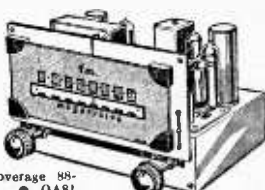

**10/14 WATT HI-FI AMPLIFIER KIT**

A stylishly finished monaural amplifier with an output of 14 watts from 2 EL84s in push-pull. Super reproduction of both music and speech, with negligible hum. Separate inputs for mike and gram allow records and announcements to follow each other. Fully shrouded ultra output transformer to match 2-13 speaker and 2 independent volume controls, and separate bass and treble controls are provided giving good lift and cut. Valve line-up 2 EL84s, ECC85, EFS80 and EZ90 rectifier. Simple instruction booklet 1/6. (All parts sold separately.)

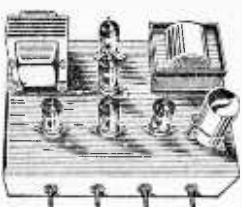

ONLY £6.19.6 P. & P. 6/6.

**STEREO AMPLIFIER Bargain Offer**

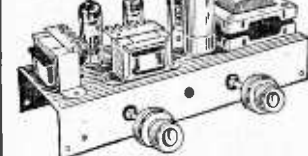

★ 4 watts per channel. ★ Full tone and volume controls. ★ Complete with sockets, etc. 89/6 P. & P. 2/6.

**SPECIAL PURCHASE! TURRET TUNERS**

by famous maker. Brand new and unused. Complete with PCC84 and PCF80 valves, 34-38 Mc/s I.F. Biscuits for Channels 1 to 5 and 8 and 9. Circuit diagram supplied. ONLY 25/- each, P.P. 2/6.

**F.M. TUNER HEAD**

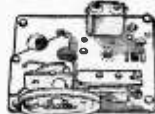

A permeability tuned tuner head by a famous maker, supplied without valve (ECC85) and drum and spindle. 18/6, plus 1/9 P. & P. Valve 8/6 extra. Drum and spindle 3/6 extra.

**6 TRANSISTOR AND DIODE SUPERHET**

A first-class 2 waveband transistor superhet in kit form. ● Printed circuit panel (size 8 1/2 x 2 1/2 in.) ● 3 pre-aligned I.F. transformers. ● High-gain Ferrite rod aerial. ● First-grade G.E.C. transistors. ● Car aerial winding. ● Push-pull output. ● All parts supplied with simple instructions.



All Parts sold separately ONLY £4.5.0 P. & P. 2/6

2 1/2in. 35 ohms speaker, 10/6; 3 1/2in. 35 ohms speaker, 18/6; 35 ohms 6in. P.M., 18/6; 7 x 4in. 35 ohms speaker, 21/-, P. & P. 1/6 per speaker.

**Portable CABINET**

Size approx. 9 1/2 x 6 1/2 x 3 1/2 in. Suitable for above using 3 1/2in. speaker. 25/-, P. & P. 2/6.

**COIL AND TRANSFORMER SET FOR TRANSISTOR SUPERHET**

3 I.F. transformers, one oscillator coil, one driver transformer and wound Ferrite aerial (med., long and aerial coupling). 25/6 complete, post 1/-, 6 transistor printed circuit board to match. 8/6, post 9d. Circuit diagram 1/6 extra.

**QUALITY RECORD PLAYER AMPLIFIER**

A top-quality record player amplifier. This amplifier (which is used in 29 amp. record player) employs ECC83, EL84, EZ90 valves. Bass, treble and volume. On/off controls.

PRICE 69/6 P. & P. 3/6

DITO. Mounted on board with output transformer and 6 1/2in. speaker. Complete at 89/6, P. & P. 4/6

**TRANSISTORS**

GET16 (Matched Pair) 15/-

OCT1	..	5/-	PXA101	..	8/6
OC72	..	6/-	XA108	..	6/6
OC78	..	11/-	V1810p	..	12/6

Set of Mullard 6 transistors 25/-. Set of G.E.C. 1,874; 2872; 3, 81 or GET114, 20/-. All Post Free.

**BARGAIN OFFER!**

TELEFUNKEN HI-FI STEREO AMPLIFIER. 110/250 v. A.C. input. 5 watt undistorted output (10 watts nominal). Size 12 x 9 x 2 1/2 in. Weight 9 lb. Complete with spec. and instructions. £5.19.6 Carr. 5/-.

Also Model 888. Similar specification but with balance control. £6.19.6.

**AMPLIFIER ON PRINTED CIRCUIT BOARD**

Two valve. UY85, UL84 O.P. traas, use with 80 volt tap of motor. 89/6. P.P. 2/6 on above. Dropper res. for filaments if required. 2/6.

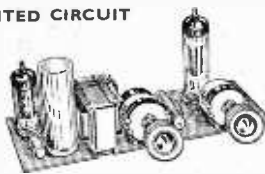

B.S.R. AUTO UNITS 160 v. Suitable for use with above. (Slightly soiled.) £5.5.0. P. & P. 5/-. LARGE CABINET suitable for above two items. Complete with 3 ohm speaker. £39.8. Carr. 5/-.

Superior CABINET similar to above to take 8 x 5in. speaker, with motor board, will accommodate BSR UA14 or UA16. £39.8. Carr. 5/6. Speaker 15/- extra. P. & P. 1/6 extra.

**BRAND NEW 3 OHM LOUDSPEAKERS**

2 1/2in. 12/8; 5in. 12/8; 6 1/2in. 15/-; 10in. 21/-	12in. 27/8; Goodmans 9in. tweeter ..	10/6
E.M.I. 2 1/2in. tweeter ..	..	10/6
Goodmans 10in. x 6in. ..	..	22/6
E.M.I. 1 1/2in. x 8 1/2in. high flux ..	..	32/6
Rohr. Celestion approx. 9in. x 6in. middle register speaker ..	..	10/6

Also 15 ohm 12in., 30/- P. & P. 1/6 per speaker.

**4-SPEED PLAYER UNIT BARGAINS**

SINGLE PLAYERS TU/12, £3.15.0. Carriage 3/6. AUTO CHANGERS B.S.R. UA14, £6.19.6. Latest B.S.R. UA16, £7.19.6. Latest Garrard "Auto-Slim" £7.15.0. Carr. 5/- on each.

**RECORDING TAPE**

P.V.C. base, full frequency L.P. tape, 7in., 1800ft. (normally 50/-) 27/8; 5 1/2in., 1,200ft. (normally 35/-), 18/9. P. & P. 1/- per spool. Ideal for 2 or 4 track recorder.

**TAPE DECKS**

B.S.R. Monardeck (Single speed) 34in. per sec. simple control, uses 6 1/2in. spools, £8.15.0, plus 5/6 carr. and ins. (Tapes extra on both). COLLARO STUDIO DECK £10.10.0, plus 5/6 carr. and ins.

**RECORD PLAYER AMPLIFIER**

2 watt output. Ready built with valves and 6 1/2in. speaker, tone and volume controls. Mounted on panel 13 x 7 1/2in. 75/- P. & P. 2/-. Heavy 8 1/2in. metal turntable. Low flutter performance 200/250V shaded motor with tap at 45V for amplifier valve filament if required. Turnover LP/73 head.

**TRANSISTOR PERSONAL RADIOS**

Complete with leather case, personal earphone and PP3 battery. Will receive Luxembourg etc. loud and clear.

SIX TRANSISTOR TYPE Size 4 x 2 1/2 x 1 1/2 in. £5.9.6.

EIGHT TRANSISTOR TYPE Size 4 1/2 x 2 1/2 x 1 1/2 in. £6.9.6.

Both plus P. & P. 2/6.

**LOUDSPEAKER SILKS**

5 1/2in. wide. Heavily woven in Ivory and gold. Originally 85/- per yard length. OUR SPECIAL PRICE 13/8 per yard length. P. & P. 1/6. Also Rect. Rexine. Dark Grey and Oatmeal fabrics for cabinet covering, 5 1/2in. wide, 13/6 per yard length. P. & P. 1/6.

**HARVERSON SURPLUS CO. LTD.**

170 HIGH ST., MERTON, S.W.19. Cherrywood 3985/6. Open all day Saturday. Early closing Wed., 1 p.m.

A few minutes from South Wimbledon Tube Station. Please Note: P. & P. charges depend apply to U.K. only. P. & P. on overseas orders charged extra. Please write clearly.



**Complete FM (V.H.F.) AM RADIO FOR £11.10**

(carr. paid)  
Brand new set, in superb walnut cabinet (size 19 x 8½ x 14½ in. high). Covering 80-100 Mc/s., 16-49 M. and 200-500 M. Mains trans. 200-250 V. with 2 tappings. Ferrite rod aerial for A.M. Controls: volume on/off, tone tuning, w/change. Gram and ext. speaker position provided. Valves 12AT7, 12AH8, 6BJ6, EABC80, 6BW6 and metal rectifier. Fully guaranteed. Today's Value, £20.

**TAPE-TOP QUALITY BOXED-GUARANTEED.** 4in.—600ft., 12/6; 5in.—1200ft., 30/-; 5½in.—900ft., 15/-; 1200ft., 17/6; 1800ft., 35/-; 7in.—1200ft., 17/6; 1800ft., 28/6; 2400ft., 45/- (all plus 1/- post, 6 or more post free).

**THE "MILAN" 6-TRANSISTOR AND DIODE PORTABLE COMPLETE KIT FOR ONLY £6.12.6** (post 3/6)

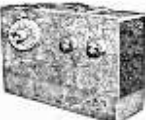

500mW push-pull output. Ferrite rod aerial. Car aerial socket and coil. M.W. and L.W. full coverage. Operates on two 4.5v. cells. Printed circuit board 8½ x 2½ in. All holes drilled and component positions marked. Instructions 2/6 for 16 p. (refunded on purchase of kit). Size 9 x 3½ x 7in. 8 x 2½ in. P.M. high quality speaker. Attractive Vynair covered cabinet, two tone. Two batteries 5/6 the pair (Ever Ready 126). Mullard transistors OC44, 2 x OC45, OC81D, and 2 x OC81. Top grade Weymouth Radio coils and transformers. Alignment service if required 17/6 (inc. post). Write for list of prices. All parts supplied separately. Built in two hours.

**BUILD YOUR OWN RECORD PLAYER Price £11 carr. paid**

**Fully built 2-valve amplifier**  
B.S.R. 4-sp. autochanger, case 17 x 15 x 8½ in. Assembled in 15 mins. Similar cabinet for tape recorder with plain board only £3, carr. paid. Attractive colours.

**3-valve amplifier 15/- extra**

**AUTOMATIC RECORD CHANGERS—LATEST MODELS.** 4 SPEED CRYSTAL CARTRIDGE. All 5/- extra carr. B.S.R. UA14, £6.10.0. Garrard Slimline, Mono £7. Stereo, £5.0. Motor Board for UA8, UA20, UA14, Slimline, 5/- (post 1/6) or 3/8 post paid when purchased with Autochanger.

**TELEFUNKEN STEREO AMPLIFIERS.** 2 ECL82—2 x 24 watts, 12 x 9 x 2 in. piano keys, £7, post paid. Complete with power.

**SELF-POWERED VHF TUNER CHASSIS**  
Covering 88-95 Mc/s. Mullard permeability Tuner. Dims. 10½ x 4½ x 5 in. high. ECC85 and 3—EF91 and 2 diodes. Metal Rectifier, Mains transformer. Fully wired and tested. Only £27.0 (carr. paid). Some tarnished chassis otherwise O.K. £6.6.0.

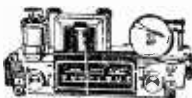

Vynair Cabinet included. Room dipole 12/6. Feeder, 6d. yd.

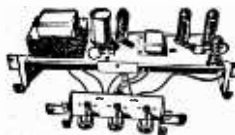

**PUSH-PULL AMPLIFIER £5.50**

(5/- Carr.)

Brand new 200-240 A.C. mains. Bass, treble and vol. controls. With valves EZ80, EC808 and 2-EL84 giving full 5 w. Chassis 12 x 2½ x 3½ in. With on/off trans. for 2-ohm speaker. Front panel (normally screwed to chassis) can be removed and used as "lying panel." Stereo version 2 x 4 w. same price.

**TAPE RECORDER AMPLIFIER**



Type TR1. Fully built, high gain, low noise, printed circuit. Attractive grey and gold front panel 13 x 3½ in. Height 5½ in. overall. Front to back 5½ in. Vol. and on/off tone. Mike. radio and ext. speaker jacks. Valves FC83 ECL82, EZ80. Mains trans. Ready to bolt to B.S.R. Deck. Complete with 4 inch water wire. Our Price ONLY £5.15.0 (6/- Packing and Carr.). Also available for Collaro Deck at 5/- extra.

Transistor Set Battery Eliminator. Converts your 6 transistor receiver to mains operation. With hex lead and battery charging attachment. For Miniature Sets, size 1½ x 1 x ½ in. Price 18/6. For Larger Sets, 3 x 1½ x ½ in. Price 24/6.

**TRANSISTOR COMPONENTS**

M.W. and L.W. ferrite rod aerial, with car coupling coil. For 200mF condenser, 8/-; Occ. coil: 1st, 2nd and 3rd I.F.'s, all 5/8 ea.; 1 driver trans. 7/6; min. 64mF 10v; 10mF 16v; 30mF 6v; all 1/9 ea.; Tuning cond. 208mF + 176pF 8/8; post 9d. on all orders.

**BRAND NEW AM/FM (V.H.F.) RADIOGRAM CHASSIS AT £12.12.0 (Carriage Paid)**

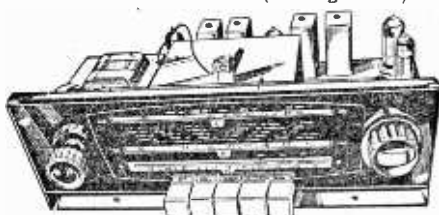

A.C. ONLY. Chassis size 15 x 6½ x 5½ in. high. New manufacture. Dial 14½ x 4 in. in 2 colours, predominantly gold. Pick-up, Ext. Speaker, Ae. E. and Dipole Sockets. Five push buttons—OFF, L.W., M.W., P.M. and Gram. Aigued and tested. O.P. Transformer. Tone Control. 1000-1900 M.; 200-500 M.; 88-98 Mc/s. Valves EZ80 rect.; ECH81, EF91, EABC80, EL84, EC85. Speaker and Cabinet to fit chassis (table model), 47/6 (post 4/-). 9 x 6 in. ELLIPTICAL SPEAKER, 20/-, to purchasers of this chassis. TERMS: (Chassis) £3.10.0 down and 5 monthly payments of £2. Cheap Room Dipole for V.H.F., 12/6. Feeder 6d. yd. Circuit diagram 2/6.

**"SCALA" 6-TRANSISTOR and DIODE KIT FANTASTIC VALUE £6.5.0** (Post 3/-)

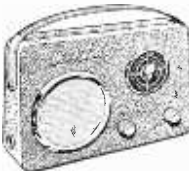

All Brand New Parts—attractive cabinet—choice of 6 colours: 8½ x 2 x 5½ in. high. Ferrite aerial, printed circuit, good styling, 3½ in. speaker, fully tunable L.W. and M.W., 400 M.W. push-pull output. All parts supplied separately. Write for Price List. Construction Book and Circuit, 2/6 (refunded when kit purchased). Or fully built at £7.10.6 (battery 2/6).

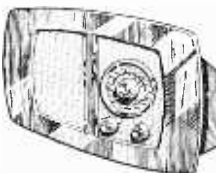

**TABLE MODEL TRANSISTOR SET £7.14.0 (carr. paid)**

6 transistors and diode, 5in. speaker, superhet circuit, Cabinet 13 x 7½ x 4½ in., battery included. Fully tunable L.W. and M.W. Polished walnut front. Cabinet 13 x 7½ x 4 in.

**SUPERIOR GRAMPHONE AMPLIFIER**

Valves 1Y85, UP80 and UL84. Mains trans. 200-240 ac. Covered baffle 13½ x 7½ in. (6½ in. speaker) or 11 x 7½ in. (8 x 5 in. speaker), 3 front controls bass, treble, on-off/vol. 74/- (post 4/-) either type. Rexine cabinet to fit, with carrying handle, and lid (detachable) 14 in. or 12 x 8½ x 5 in., 16/- extra.

**GRAMPHONE AMPLIFIER.** With 5in. SPEAKER Baffle 12½ x 6 in. ECL82 and Rectifier, tone and Volume. On/off switch. Useful for Stereo, 57/- (post 4/-).

**5 WATT AMPLIFIER**

Our price ONLY 56/- (post 4/-). NEW MANUFACTURE: valves EF91 and EL84 with metal rectifier; 6 x 4 x 12 in. high (5in. over EL84). Mains trans. and o.p. with vol. and tone controls; on-off; co-ax input.

**COLLARO STUDIO TAP TRANSCRIBOR, 8 MOTORS, 3 SPEED.** 1½, 3½ and 7½ L.P.S. Push buttons, £10.7.6 (10/- carr.) inc. spool.

**BATTERY ELIMINATOR**

For 4 Low Consumption Valve (96 range) 90v. 15 mA and 1.4v. 125mA, 45/- (2/6 post). 200-250v. A.C. Also for 250mA, 1.4v. and 90v. 15mA at same price. Two separate units to replace existing batteries.

**BATTERY RADIO**

Valves DK96, DF96, DAF96, DL96. Two short Wavebands 16 to 49 M and 25 to 75 M. Size 10½ x 4½ x 5 in. £4.6.6, carr. paid. M.W. and S.W., £4.11.6 carr. paid.

**ALL ITEMS ARE NEW AND FULLY BUILT UNLESS OTHERWISE STATED. TESTED BEFORE DESPATCH.**  
Terms Available on Items over 85. Send 6d. (stamps will do) for 20-page illustrated catalogue. Delivered by return. C.O.D. 2/- extra.

**ALL ITEMS GUARANTEED 12 MONTHS VALVES 3 MONTHS**

**GLADSTONE RADIO "SCALA", CAMP RD., FARNBOROUGH, Hants.**

(Farnborough 3371) and at 247 New Road, Copnor, Portsmouth.  
FARNBOROUGH CLOSED SATS.—PORTSMOUTH WEDS.

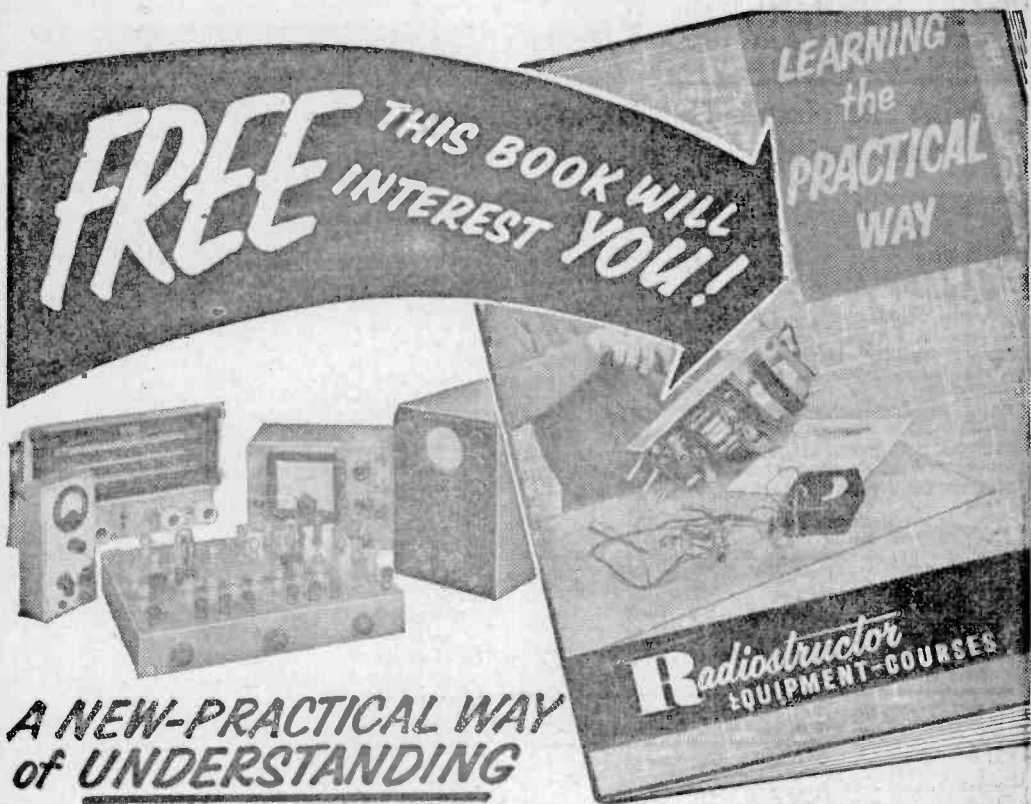

**A NEW-PRACTICAL WAY  
of UNDERSTANDING**

# Radio - Television - Electronics

Including: Transistors; VHF/FM; Hi-Fi equipment; Computers; Servo-mechs; Test Instruments  
Photo-electrics; Nucleonics, etc.

**FOR...Your Career...Your Own Business...An Absorbing Hobby**

Radiostructor—an organisation specialising in electronic training systems offers a new self-instructional method using specially designed equipment on a "do-it-yourself" basis.

You learn by building actual equipment with the big kits of components which we send you. You advance by simple steps, performing a whole series of interesting and instructive experiments—with no complicated mathematics! Instructional manuals employ the latest techniques for showing the full story of electronics in a practical and interesting way—in fact—you really have fun whilst learning! Post the coupon below, now, for full details.

**RADIOSTRUCTOR**  
*LEADS THE WORLD*  
**IN ELECTRONICS TRAINING**

**POST NOW**

To RADIOSTRUCTOR (Dept. G82)  
 READING, BERKS.

Please send brochure, without obligation, to:

★ Name \_\_\_\_\_

Address \_\_\_\_\_ 3/63

★ **BLOCK CAPITALS PLEASE**  
 (We do not employ representatives)

**RADIO-AMATEUR GEAR  
EDUCATIONAL KITS**



**TEST INSTRUMENTS  
HI-FI EQUIPMENT**

*With the simple English of our instruction manual, anyone can build any of our models—and save money!*



S-33

We guarantee that NO electronic or soldering experience is necessary. Our simple, well illustrated manual guides you step-by-step.

**6W STEREO AMPLIFIER.** Model S-33. 3 w/chl. Inputs for radio-tape and gram., Stereo/Mono ganged controls. Sensitivity 200 mV. ... £13.7.5



F.M. TUNER

**HI-FI F.M. TUNER.** Tuning range 88-108 Mc/s. Tuning Unit (FMT-4U) with 10.7 Mc/s I.F. output (£2.15.0. inc. P.T.) I.F. amplifier (FMA-4U) complete with cabinet and valves (£12.6.0). Total £15.1.0.

**NEW! 5W HI-FI MONO AMPLIFIER.** Model MA-5. A low-priced amplifier based on the S-33. Printed circuit construction ... £10.19.6

**TAPE RECORDING/PLAYBACK AMPLIFIER.** Stereo (TA-IS) £24.10.0 Monaural (TA-IM) ... £19.2.6

**STEREO CONTROL UNIT, USC-1.** Luxury model with inputs to suit any pick-up or tuner ... £19.10.0

**SINGLE SIDE BAND ADAPTOR.** Model SB-10U. May be used with most A.M. transmitters. Less than 3W R.F. input power required for 10W output. Operation on 80, 40, 20 15 and 10m bands on USB, LSB, or DSB. £39.5.0

**NEW! 6W DE LUXE AMPLIFIER.** Model S-33H. An inexpensive Stereo-Mono amplifier, with high sensitivity, suitable for Decca Deram cartridge ... £15.17.6

**5in. OSCILLOSCOPE.** Model O-12U. Wideband amplifiers essential for TV servicing, F.M. alignment, etc. T/B covers 10 c/s-500 kc/s in 5 ranges ... £38.10.0

**HI-FI 18W STEREO AMPLIFIER.** Model S-99. Ganged controls. Stereo/Mono gram., radio and tape recorder inputs. P/B selection ... £27.19.5

**HI-FI SPEAKER SYSTEM.** Model SSU-1. Ducted port bass reflex cabinet "in the white". Two speakers. Legs 14/6 extra. Bookcase model ... £10.17.6



SSU-1



SB-10U



USC-1



TA-IS



O-12U



S-99



AM/FM Tuner

**SEND FOR FREE CATALOGUE—OVER 50 MODELS TO CHOOSE FROM**

**THE "MOHICAN" GENERAL COVERAGE RECEIVER.** Model GC-1U. Fully Transistorised. Including 4 piezo-electric transistors. Excellent portable or general purpose receiver for the amateur and short-wave listener. ... £39.17.6

**HI-FI AM/FM TUNER.** Tuning range: FM 88-108 Mc/s, AM 16-50, 200-550, 900-2,000 m. Tuning heart (£4.13.6 inc. P.T.) and I.F. amplifier (£20.13.0). Printed circuit board. Total £25.6.6

**RECORD PLAYERS & DO-IT-YOURSELF ACCESSORIES** also available.

**SHORTWAVE TRANSISTOR PORTABLE.** Model RSW-1 Two short bands, trawler and medium ... £19.17.6

**HI-FI EQUIPMENT CABINETS.** Large range, in kit form or assembled and finished, available to meet various needs. Details on request from ... £6.19.6 to £29.8.0

**PORTABLE SERVICE OSCILLOSCOPE.** Model OS-1. Compact portable scope, ideal for servicing and general work. Printed crct. Case 7½ x 4½ x 12½in. long. Wt. only 10½lb. £19.19.0



DX-40U

**AMATEUR TRANSMITTER.** Model DX-40U. Self-contained. 80-10 m. Power input 75 w. CW., 60 w. peak, C.C. phone. Output 40 w. to aerial. Provision for V.F.O. ... £33.19.0



GC-1U

**6 TRANSISTOR PORTABLE.** Model UXR-1. Prealigned I.F. transformers, Printed circuit, 7 x 4in. high flux speaker. Real hide case ... £12.11.0

**VALVE VOLTMETER.** Model V7A. Measures up to 1,500 volts (D.C. and R.M.S.) and 4,000 pk to pk. Res 0.1Ω-1,000MΩ. £13.18.6

**AUDIO SIGNAL GENERATOR.** Model AG-9U. 10 c/s-100 kc/s, switch selected. Distortion less than 0.1%. 10 v. sine wave output metered in volts and dB's. ... £21.9.6

**AMATEUR TRANSMITTER.** Model DX-100U. Covers all amateur bands, 160-10 m. 150 w. D.C. input, self contained with power supply. Modulator, V.F.O. £74.19.3



DX-100U

**Money Saving 'PACKAGED DEALS' of Complete Stereo Equipment from £45-13-0**

Please send me **FREE CATALOGUE** (Yes/No).....

Full details of model(s).....

NAME .....

ADDRESS .....

PW3

Assembled models also available—prices on request. Deferred terms available over £10. Free Delivery U.K.

**DAYSTROM LTD.**

Dept. P.W.3, GLOUCESTER, ENGLAND

A member of the Daystrom Group, manufacturers of the **WORLD'S LARGEST-SELLING ELECTRONIC KITS**

# Practical Wireless

Vol. XXXVIII No. 673 MARCH, 1963

Editorial and Advertisement  
Offices:

**PRACTICAL WIRELESS**

George Newnes Ltd., Tower House,  
Southampton Street, W.C.2.

© George Newnes Ltd., 1963

Phone: Temple Bar 4363

Telegrams: Newnes, Rand, London,  
Registered at the G.P.O. for trans-  
mission by Canadian Magazine Post.

## SUBSCRIPTION RATES

including postage for one year

Inland - - - - £1.9.0 per annum  
Abroad - - - - £1.7.6 per annum  
Canada - - - - £1.5.0 per annum

## Contents

	Page
Editorial ... ..	989
Round the World of Wireless	990
Tremolo Unit ... ..	992
Short-wave Converter ...	994
Home-movie Amplifier ...	997
Protecting the P.A. ... ..	999
Test Gear Techniques ... ..	1004
Mains Superhet Receiver ...	1011
Parallel Tracking Unit ... ..	1016
Quality Amplifier and Pre-amp	1019
On Your Wavelength ... ..	1022
Semiconductors ... ..	1025
Distortion ... ..	1033
The Auditor ... ..	1038
Trade News ... ..	1045
Club News ... ..	1046
Letters to the Editor ... ..	1049

The Editor will be pleased to consider articles of a practical nature. Such articles should be written on one side of the paper only, and should contain the name and address of the sender. Whilst the Editor does not hold himself responsible for manuscripts, every effort will be made to return them if a stamped and addressed envelope is enclosed. All correspondence intended for the Editor should be addressed: The Editor, PRACTICAL WIRELESS, George Newnes, Ltd., Tower House, Southampton Street, London, W.C.2. Owing to the rapid progress in the designs of wireless apparatus and to our efforts to keep readers in touch with the latest developments, we give no warranty that apparatus described in our columns is not the subject of letters patent.

Copyright in all drawings, photographs and articles published in PRACTICAL WIRELESS is specially reserved throughout the countries signatory to the Berne Convention and the U.S.A. Reproductions or imitations of any of these are therefore expressly forbidden. PRACTICAL WIRELESS incorporates "Amateur Wireless."

## Changing Pattern

FROM time to time we hear the opinion expressed that radio construction is a dying art, that the modern enthusiast is more an assembler than an experimenter, that the profusion of easily obtainable components and sub-assemblies makes things too easy, that—in short—Fing's ain't what they used to be!

Well, of course, they are not. They never were! But we see the reasoning behind this sort of argument. In the early days, a great deal of ingenuity was necessary in order to build anything at all. The professionals knew very little more than some amateurs—often less! Parts were scarce, and so was money. In fact many constructors had to make some of their own components, either through financial or practical necessity.

As interest grew and the numbers of amateur enthusiasts increased, so did the quantity and range of components available. During the 30's, amateur radio was a rapidly developing market and manufacturers did their best to meet the demands. However, most enthusiasts of that time were still mainly experimenters since they usually designed their own equipment or modified published designs to suit their own personal requirements.

But in the immediate post-war years, vast quantities of war surplus equipment flooded the market. While much of this could be stripped down to obtain a wealth of components at almost "give away" prices, some of it was, with slight modification, ready for use as workable items.

This claim the cynics, was the death knoll of true amateur radio construction. For perhaps the first time, amateur transmitting stations, for example, went on the air using not only ready-built receivers and transmitters but also using professionally built accessories such as frequency meters.

In terms of convenience and economy, converted surplus equipment was a wonderful opportunity. But on the other hand it provided the temptation to take the easy way out. The trend has continued and many amateur transmitters could more aptly be called operators than experimenters.

Although there have always been kits, the radio constructor of today has "never had it so good", with a profusion of all kinds of kits for specific designs and a wealth of components. This, it is suggested, leads to a more dependent attitude than that of past years, when the constructor had to be much more self-reliant.

On the other hand, there are nowadays many times more actively interested than even ten years ago. This may mask the enthusiasts who still design their own equipment and experiment with unusual circuits and applications.

From the hard practical viewpoint there is less incentive these days to do things the hard way, for the amateur can no longer vie with the professional—highly trained and with modern laboratory facilities. The days of major break-throughs by amateurs are, perhaps, gone for ever.

Nevertheless, while there will always be a great number of constructors who prefer to build from existing designs, there will always be those who like to work everything out themselves.

Our next issue dated April will be published on March 7th.

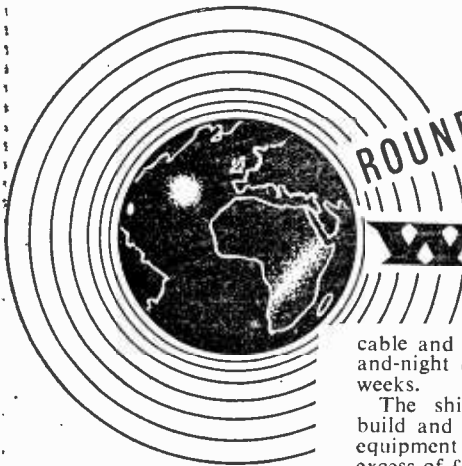

# of WIRELESS

## NEWS AT HOME AND ABROAD

### Broadcast Receiving Licences

THE following statement shows the approximate number of Broadcast Receiving Licences in force at the end of November, 1962, in respect of wireless receiving stations situated within the various Postal Regions of England, Wales, Scotland and Northern Ireland. The numbers include Licences issued to blind persons without payment.

	Total
London .. .. .	624,774
Home Counties .. .. .	577,542
Midland .. .. .	419,491
North Eastern .. .. .	443,472
North Western .. .. .	379,779
South Western .. .. .	341,801
Wales and Border Counties .. .. .	191,473
<b>Total England and Wales .. .. .</b>	<b>2,975,340</b>
Scotland .. .. .	312,542
Northern Ireland .. .. .	107,203
<b>Grand Total .. .. .</b>	<b>3,395,090</b>

### World's Fastest Cable-laying Ship

THE C.S. "Mercury", the world's fastest cable-laying ship with a speed on passage of 17½ knots, sailed from London shortly before the New Year on her first commission—the laying of a 1,000-nautical-mile section of the 8,000-mile Commonwealth trans-Pacific (COMPAC) telephone cable.

She was built for Cable and Wireless Ltd., owners of the British share in Commonwealth telephone cable, and was completed in September last year. Later in the year she completed loading 1,200 nautical miles of

cable and 49 repeaters in a day-and-night operation lasting three weeks.

The ship cost £2,000,000 to build and the total value of the equipment she now carries is in excess of £2,500,000. Each of the submerged repeaters (or valve amplifiers) costs £20,000.

### British Equipment in use at Goonhilly and New Jersey

IMPORTANT communication equipment built by Standard Telephones and Cables Limited came into service recently on both sides of the Atlantic with the launching of the N.A.S.A. Project Relay satellite from Cape Canaveral.

At Goonhilly Downs in Cornwall, a powerful STC transmitter links the British Post Office radio station with the satellite. At Nutley, New Jersey, the ITT-Federal Laboratories use STC

multiplexing equipment which combines the 12 telephone circuits used in the RELAY experiments into one complex broadband signal.

The National Aeronautics and Space Administration (N.A.S.A.) has appointed STC's associate company, ITT-Federal Laboratories, as the prime contractor for the complete series of telecommunication tests to be carried out using RELAY. Besides its main radio station at Nutley, some nine miles west of New York, ITT-Federal have designed and built a complete "packaged" ground station, the first of which has been set up near Rio de Janeiro in Brazil.

The GPO's Goonhilly station will play an important role in this series of experiments using satellite radio propagation paths between Nutley and Goonhilly, and also between Rio and Goonhilly.

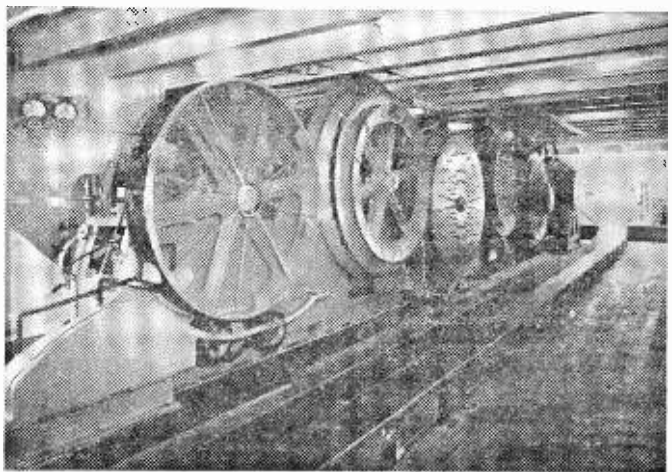

The after cable-laying machinery on C.S. "Mercury" looking aft. The foreground shows the splaying stool and diverter bar for the by-passing of repeaters.



The STC transmitter at Goonhilly operates in the 2,000Mc/s frequency band with an output power of 10kW.

At Nutley, the STC multiplexing equipment, built at North Woolwich, London, combines twelve high quality telephone circuits, each containing frequencies in the band 300c/s to 3,400c/s, into a composite broadband signal of 60kc/s to 108kc/s for modulating the transmitter.

### Revolutionary Telephone Exchange

ONE of the Post Office's latest telephone exchanges is claimed to be the most revolutionary in Europe. The exchange, which is installed at Highgate Wood, London, is constructed on a fully electronic system which will enable it to operate a million times faster than the ordinary electro-mechanical exchange. It will also be more efficient and cheaper to run, and once it has proved itself, the electronic system will be introduced throughout the country and thousands of exchanges will be affected.

### R/T Equipment for Civil Defence

THE Home Office have awarded a contract to Pye Telecommunications Limited of Cambridge for 300 450Mc/s point-to-point radiotelephone equipments for use in Police, Fire and Civil Defence.

Radio links based on this equipment, which is of new design, will handle speech or speech-plus-telemetry and are expected to find wide application in home and overseas markets. The emphasis in design has been placed on extreme reliability and ease of maintenance, and extensive use of solid state devices has been made.

### Anglo-American Communications Alliance

A TEN-YEAR agreement has recently been concluded between Pye Telecommunications Limited and the Aircraft Radio Corporation of Boonton, New Jersey, under which the Aircraft Radio Corporation will market Pye Communications' products throughout the United States. A wide range of communication products is to be marketed and great emphasis is



The ITT-Federal Laboratories' ground station at Nutley, New Jersey, U.S.A., showing the 40ft. diameter steerable parabolic reflector aerial system.

being placed on Pye's new range of fully transistorised mobile radio telephone equipment. The Aircraft Radio Corporation is a subsidiary of the Cessna Aircraft Company.

Under the agreement, Pye has reciprocal rights to manufacture and sell ARC airborne products and the two companies will cooperate closely in design, manufacture and marketing of a wide range of communication products.

### Radar for Burmese Aircraft

AN order for type E190 light-weight transistorised weather radar systems has been received by Ekco Electronics Ltd., and these are for installation in three Fokker Friendship aircraft being built for Union of Burma Airways. The equipment ordered includes the optional extra drift unit to provide measurement of drift angle using Doppler techniques.

These radar installations will assist safe, comfortable flying by

providing accurate indication of turbulent cloud formations up to 150 miles in the path of the aircraft, enabling the pilot to take any necessary avoiding action.

### New Assembly Methods

A NOVEL method of assembling a compact electronic unit has been devised at the National Engineering Laboratory, East Kilbride. Wander plugs are fitted to the sides of suitable lengths of plain Veroboard on which the components are mounted and wired. Each board has the same number of plugs, which are mounted in exactly the same positions on each. This allows one board to be mounted directly on to another by engaging one set of plugs into the corresponding ones on the other board.

This method of assembling provides easy access to each component and avoids the use of large numbers of plug and socket joints.

# A TRANSISTORISED TREMOLO UNIT

BY P. L. TAYLOR

## A TRANSISTORISED TREMOLO UNIT FOR ELECTRIC GUITARS

**T**HE function of the tremolo unit when used in conjunction with an electronic musical instrument is to modulate the signal from the instrument with a low frequency of approximately 5-15c/s. This produces a plaintive effect reminiscent of the human voice which adds expression to the tone of the music.

The normal valve operated type of tremolo unit consists of a low frequency oscillator, the output of which is mixed with the signal from the instrument in a "gating" circuit. The unit is usually introduced between the instrument and power amplifier and operates at a low level of signal.

This type of unit has the disadvantages of relatively large size and of needing an isolated and very well smoothed power supply. The unit to be described measures 5½ in. x 2½ in. x 2 in. (conveniently pocket sized) is driven from a 9V PP4 battery and uses three transistors.

### The Circuit

Tr1 and Tr2 are coupled in a multivibrator circuit using 2µF capacitors, C1 and C2 to supply the low frequency signal. VR1 is the frequency control and VR2 controls the amplitude of signal fed to Tr3 and hence the depth of modulation.

The output of the multivibrator is a square wave having harmonics which extend into audio frequencies, and if the output were mixed directly with the signal, the harmonics of the square wave would come through the amplifier as an unpleasant train of clicks.

To remove these high frequencies the low pass filter R7, C3, R8, C4 is introduced to integrate the square wave and provide a smoothly varying voltage across C4.

This voltage provides the power supply for Tr3,

a single transistor amplifier operated at very low collector current. Since the gain of the amplifier varies with the h.t. voltage, the low frequency ripple appearing on the h.t. supply to Tr3 will cause the amplitude of the output signal to fluctuate in the desired manner.

Since the collector current in Tr3 is low the noise introduced by the circuit is negligible, and the gain of the circuit is approximately unity,

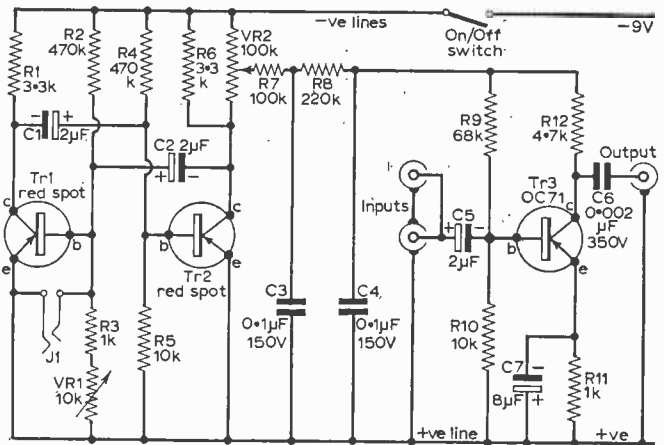

Fig. 1: The circuit of the unit.

allowing the unit to be inserted between instrument and amplifier without alteration of gain controls.

### Construction

The unit is constructed in a small plastic case using normal sized potentiometers. The construction is uncritical and the circuit would lend itself to miniaturisation techniques.

The components are assembled on a small strip of tag-board as in the wiring diagram. The usual precautions should be observed when wiring tran-

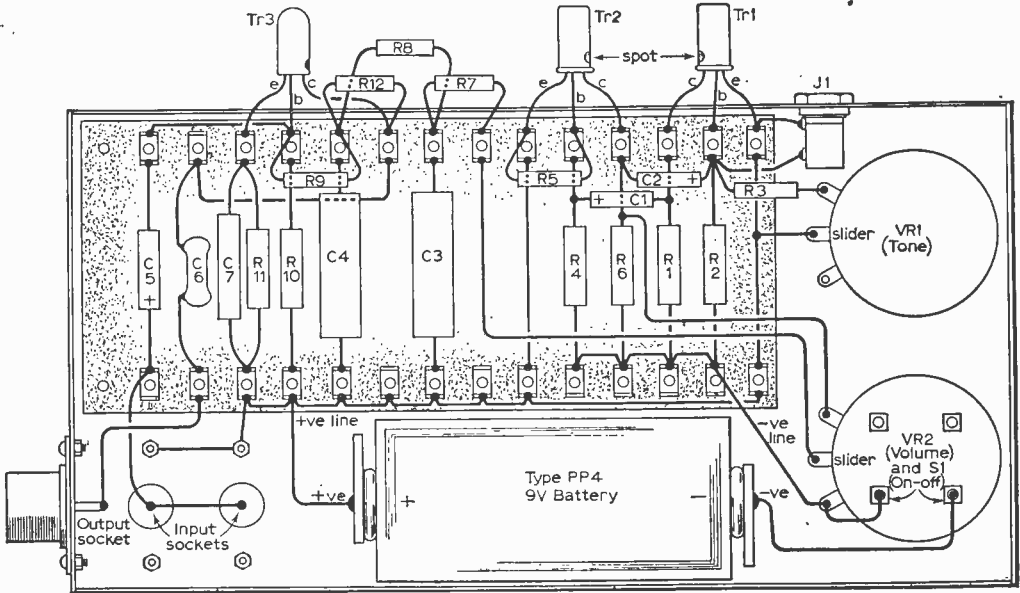

Fig. 2: The wiring diagram.

sistors and small electrolytics to avoid overheating the components.

Two coax sockets are provided for inputs. The sockets are not isolated from each other since electric guitar volume controls are usually connected "wrong way round" enabling direct mixing of the two circuits without interaction.

The inside of the plastic case should be covered with aluminium foil which is earthed to prevent pick-up. A layer of polythene sheet is used to insulate the underside of the tag-board from the screening.

COMPONENTS LIST			
<b>Resistors:</b>			
R1	3.3kΩ	R7	100kΩ
R2	470kΩ	R8	220kΩ
R3	1kΩ	R9	68kΩ
R4	470kΩ	R10	10kΩ
R5	10kΩ	R11	1kΩ
R6	3.3kΩ		
(All resistors 1/4W., 10%)			
<b>Capacitors:</b>			
C1	2μF, 12V	C5	2μF, 12V
C2	2μF, 12V	C6	0.002μF, 350V
C3	0.1μF, 150V	C7	8μF, 12V
C4	0.1μF, 150V		
<b>Transistors:</b>			
Tr1	Red spot surplus type		
Tr2	Red spot surplus type		
Tr3	OC71		
<b>Potentiometers:</b>			
VR1	10kΩ	VR2	100kΩ

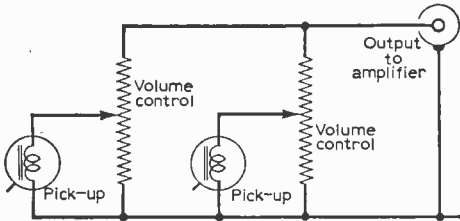
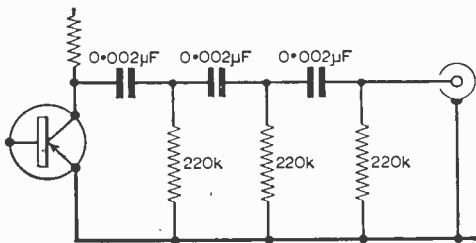

Fig. 3 (above): Electric guitar volume controls connected to permit direct mixing of signals from two pick-ups.

Fig. 4 (below): A high pass filter for use after the tremolo unit.



Components C5, C6 and C7 are deliberately made small in order to introduce a measure of bass cut, but if the unit is to be used with an amplifier with strong bass response some trouble may be experienced with the low frequency signal coming through the amplifier as a "thumping" sound. This may be improved by the use of a high pass filter after the unit (Fig. 4).

If necessary the unit may be used with a foot switch plugged into the miniature jack, which is connected between the base of Tr1 and earth. This prevents the multivibrator from oscillating until the switch is opened. Thus the vibrato effect can be added at any time without using the hands.

The unit has given good service when used in conjunction with the author's electric guitar, and results obtained will justify the effort involved in its building.

# short-wave CONVERTOR

By F. NEVILLE HART

**T**HIS small transistor convertor can be connected "in front" of any medium-wave superhet to provide coverage of the short-wave bands. The coils used are for an immediate frequency of 1.6Mc/s and when the main receiver is tuned to this frequency, at the low end of the m.w. band, the combination forms a "double superhet". In other words, the mixer of the superhet receives the output from the convertor and heterodynes it to the normal i.f. of 465kc/s, or whatever it happens to be. It will be seen that due to the double conversion, selectivity is greatly improved.

Although the Denco coils specified are designed for a valve mixer circuit, slight modification in the form of an extra winding on each coil will permit these to be used in this transistor circuit. With care in adjusting, coverage can be obtained from 19 to 50m. The 16m band can also be received, but possibly with some sacrifice of strength on the 20m amateur band.

The coils are designed to plug into B9A (noval) valveholders, and other ranges can be tried if desired.

If other coil ranges are used, the pins for padders on the mixer coils fit into different numbers. This is because each range has a different padder value, so by this means the respective padder will be in circuit. In the circuit here described, however, only pin 4 is used.

The circuit is a normal auto-dyne transistor mixer Tr1, and the output from the collector is fed into the secondary winding of an ordinary medium-wave aerial coil acting here as an i.f. coil. This coil is inserted in an empty i.f. can for screening. The converter output is taken to the main receiver through a small capacitor C11 and the chassis is connected through C13 to the main chassis, effectively preventing pick-up of medium-wave stations.

Should a powerful m.w. station break through or make a carrier "squeak" the main tuning dial can be shifted slightly to a silent position. Little difference is caused by this to the tuning and, in fact, the main tuning dial can be used as a vernier control for more accurate tuning.

The convertor works satisfactorily with a supply of

4.5V and there is no point in using a higher voltage, as this will only increase background noise and transistor hiss.

## Aerial Coil

A Denco range 4 (Blue) coil is used here. The existing connections are: primary winding (8) aerial, (9) earth; secondary winding (1) earth, (6) grid.

An extra winding is added for the base circuit of Tr1, in the following manner.

As two additional pins are required in the positions of 3 and 4, straighten out a wire paper clip, hold with a pair of pliers in a gas flame, and when

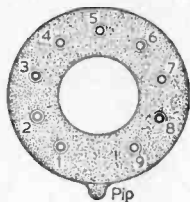

Looking at open end of coil former

The numbers refer to the noval base numbering of pins

The pip simulates the valve base locating spigot

Fig. 1: The arrangement of pin numbers on the coils.

the end is just red hot, push it carefully into the pins-end of the plastic former, having first marked the position.

Do this with the coil former pin-side up on a piece of metal, so that when the hot wire goes through it does not penetrate too far and damage the existing coil. When the plastic cools, it will contract and the wire be firmly fixed in position. See that only sufficient wire is protruding on the upper side on which to solder the new coil.

Cut the wire to similar length of the existing pins. Solder and wind on one turn of 34s.w.g.

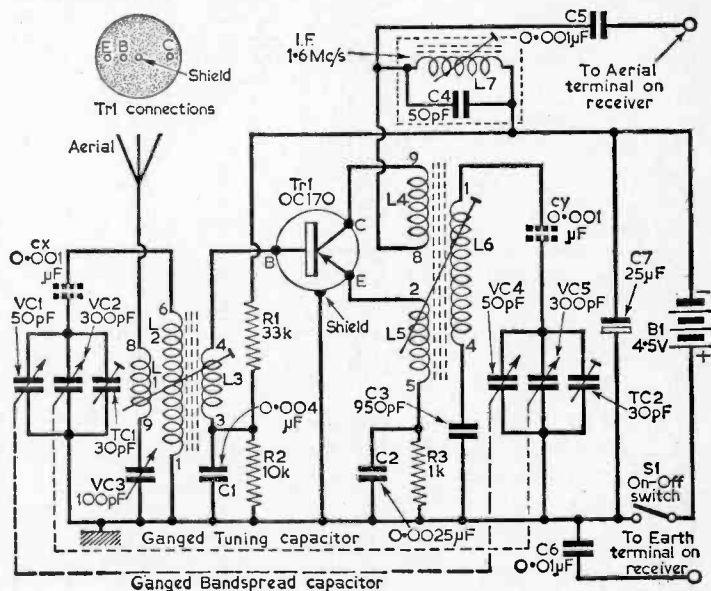

Fig. 2: The circuit of the convertor.

cotton covered enamelled wire over the main coil, near the bottom, and in a clockwise direction from pin 4 to pin 3' (looking at pins-end).

**Mixer Coil**

The Denco range 4 (White) is a superhet oscillator coil and the existing grid winding pins 1 and 4; coupling coil pins 8 and 9.

As with the aerial coil, two extra pins are added to this coil former: one in the position as 2, the other as pin 5. Solder on  $2\frac{1}{2}$  turns of 34s.w.g. wire. Wind tightly on the outside (top) of the uppermost anode coil, clockwise from pin 5 to pin 2 (looking at former from pins-end). The  $\frac{1}{2}$  turn is the distance between the two extra pins. Pin 2 is the emitter connection, and pin 5 that of the emitter resistor and capacitor.

The layout and wiring of the converter is simple and straightforward, though the usual care in "soldering in" the transistor is needed, using long nosed pliers as a heat-sink, with an elastic band over the handle to leave the hands free. The transistor should always be mounted last.

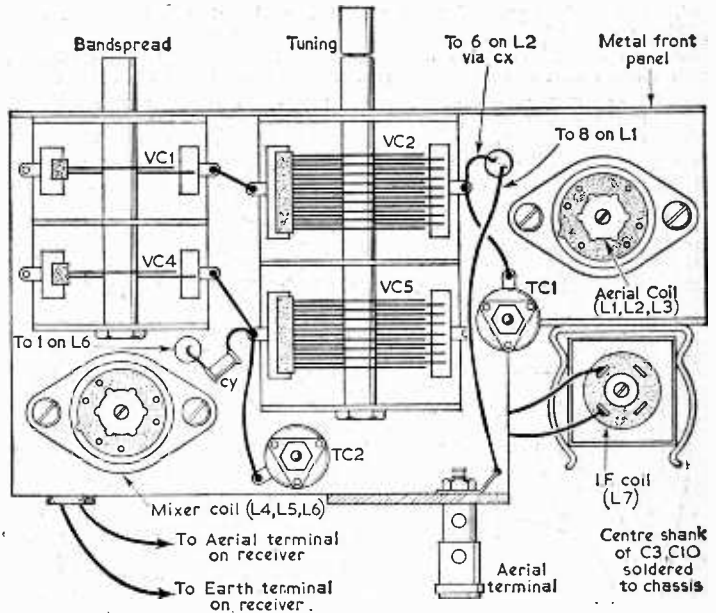

Fig. 4: The layout of the major components.

The series earth variable capacitor VC3 is not absolutely essential, but it helps to separate stations on the highest frequencies, and to reduce the volume of powerful ones. The prototype converter was made on an old valve set chassis. Some constructors may prefer to

mount the components on paxolin, but a metal front panel is essential to avoid hand capacity effects.

When used with a battery set, an earth connection to the converter is an advantage, but this connection should be avoided with a mains set as there is a strong risk of damaging the transistor by a.c. flowing from the main receiver despite the series capacitors.

The battery holder is a piece of paxolin with two small angle brackets screwed on as contacts. When the battery is inserted it is kept in place with an elastic band. The negative (long brass contact) is bent right over against the side to avoid wrong connection. Consumption is under 2mA, so battery life is long.

A bandspread, two-gang capacitor is essential. Even with a slow-motion spindle or an epicyclic tuning gear on the main capacitor, tuning is too sharp to do without a bandspread con-

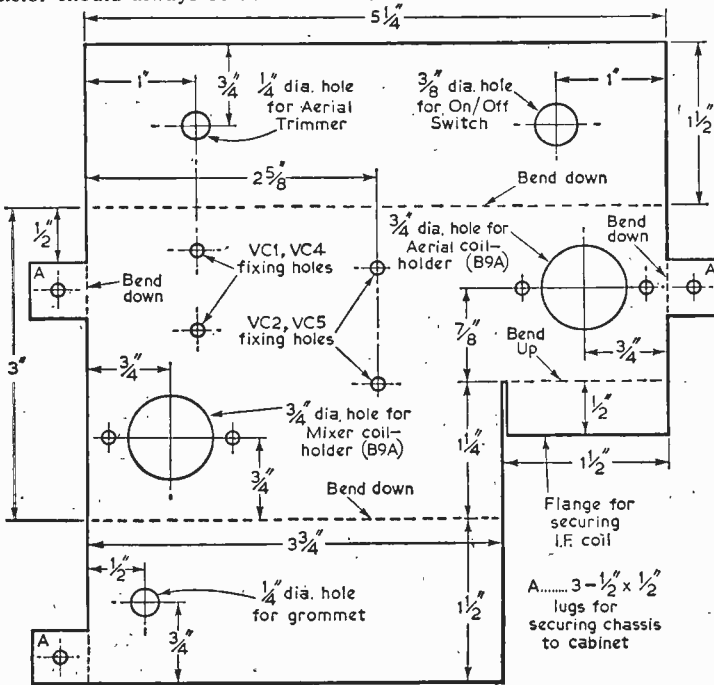

Fig. 3: Details of the chassis.

trol. If a 300pF ganged tuning capacitor is not handy, a 500pF gang may be used provided that a 1,000pF fixed capacitor is inserted in series with each section of the gang, as indicated with dotted

lines on the circuit diagram.

**To Operate**

Set dial of main set to lowest wavelength (about 187.5m). Connect aerial to converter output to aerial socket on main receiver. Tune in Radio Paris on 49m band or some other strong station. Adjust L7 for maximum output. This is not critical. The setting of the "slug" in the aerial coil is practically "all out" and that of the mixer about 6-8 turns "in". The mixer trimmer TC2 should be set about halfway in and the aerial trimmer TC1 somewhat further "out". Careful turn-by-turn adjustment of these is needed to keep the transistor in oscillation at the highest frequency end.

If the emitter coil L5 has been wound right, there should be oscillation and stations heard on most of the dial. With patient trimming the range of the converter can be arranged to extend from 49m (maximum capacity) to 16m with

the tuning capacity at minimum.

Should there be any tendency to overload the input of the main receiver, the value of C5 should be reduced to about 50pF.

**COMPONENTS LIST**

**Resistors:**

- R1 33k $\Omega$     R2 10k $\Omega$     R3 1k $\Omega$
- All 20%, 1/4W carbon.

**Capacitors:**

- C1 4,000pF ceramic or mica
- C2 2,500pF ceramic or mica
- C3 950pF ceramic or mica (750 + 200pF)
- C4 50pF ceramic or mica
- C5 1,000pF ceramic or mica
- C6 0.01 $\mu$ F paper or plastic foil
- C7 25 $\mu$ F electrolytic 12V
- VC1, VC4 50 + 50pF two-gang tuning capacitor
- VC2, VC5 300 + 300pF two-gang tuning capacitor
- TC1 30pF concentric type trimmer
- TC2 30pF concentric type trimmer
- VC3 100pF concentric type trimmer

**Coils:**

- L1-3 Aerial coil. Denco range Blue (see 4 text)
- L4-6 Mixer coil. Denco range 4 White (see text)
- L7 I.F. coil. Weymouth or similar M.W. coil with screening can.

**Miscellaneous:**

- Tr1 OC170    B1 4.5V dry battery
- S1 Single-pole, on/off switch
- Two B9A valveholders (non-skirted). Aerial terminal. Slow-motion drive for VC2, VC5. Knobs. Tag strips, etc.

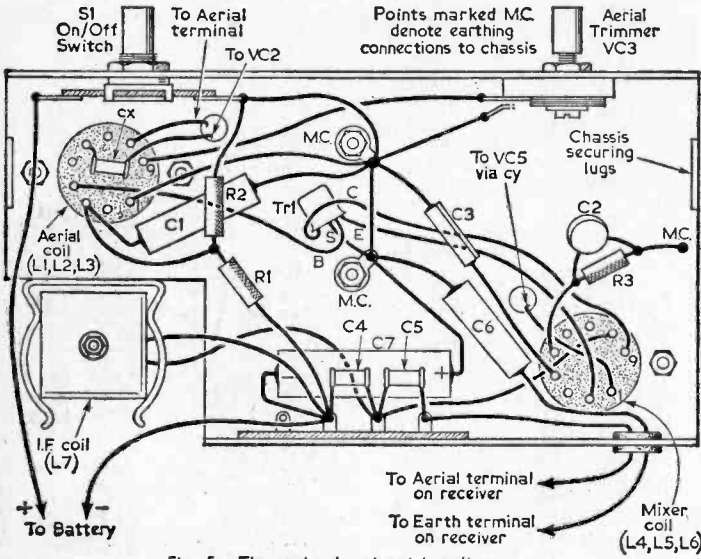

Fig. 5: The underchassis wiring diagram.

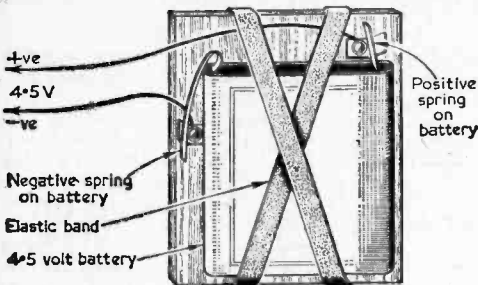
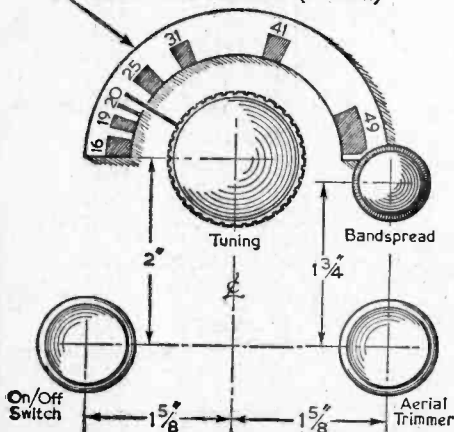

Fig. 6 (above): Mounting the battery.

Fig. 7 (below): The layout of the front panel. scale marked out in wavebands (in metres)



# Home-movie amplifier

A GENERAL PURPOSE 4W AMPLIFIER WITH MIXING AND OTHER SPECIAL FACILITIES  
(Continued from page 922 of the February issue)

By S. COLLINS

FOR constructors who like to complete the mechanical work before getting down to the actual wiring up the three variable controls can be fitted in the positions as shown, although it may be found easier to wire if the switched control is left until a little later in the proceedings. It is advisable before fitting the controls to cut the spindles down to  $\frac{3}{8}$  in. long and also the graduated dials should be placed in position under the securing nuts.

It may be found necessary to make a different "flat" on the control spindles so that the pointer knobs accurately line up with the maximum and minimum positions on the dials.

Before fitting the 12-way group board it should be carefully wired up at the back as shown in Fig. 3, using either 22s.w.g. p.v.c.-insulated wire or 22s.w.g. tinned copper wire and 1mm sleeving according to preference. It is suggested that to avoid the possibility of mistakes it is advisable to mark one end of the group board with a dab of paint, or to cut a small "V" slot as shown, and also to number the tags.

When wiring this group board please note that the wires should be passed through the eyelet hole and then soldered to the outer tag, thus leaving

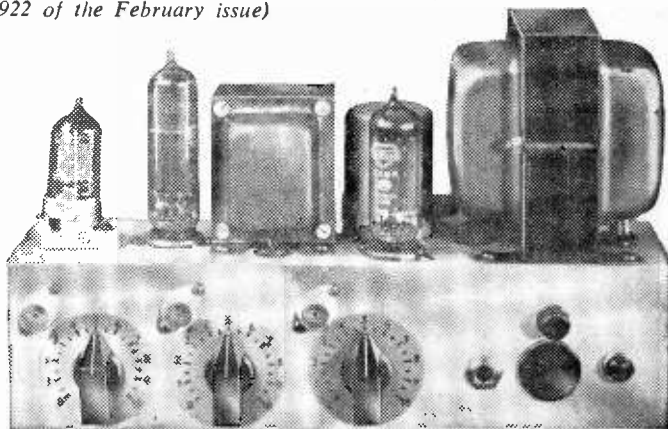

The finished amplifier

the inner one for mounting the various components. It is most important to check carefully the wiring of this part since once it is in position and the rest of the wiring completed it will be difficult to alter it without considerable dismantling.

Most of the components can also be fitted to the group board before it is mounted on to the chassis, but leave out C6, R2 and R3 until later as this will facilitate fixing.

To fit the group board first pass two  $\frac{3}{8}$  in. 4B.A. screws through the chassis from the outside and place a thin paxolin backplate over them inside the chassis and secure it by means of 4B.A. nuts. The group board is now fitted and also secured by

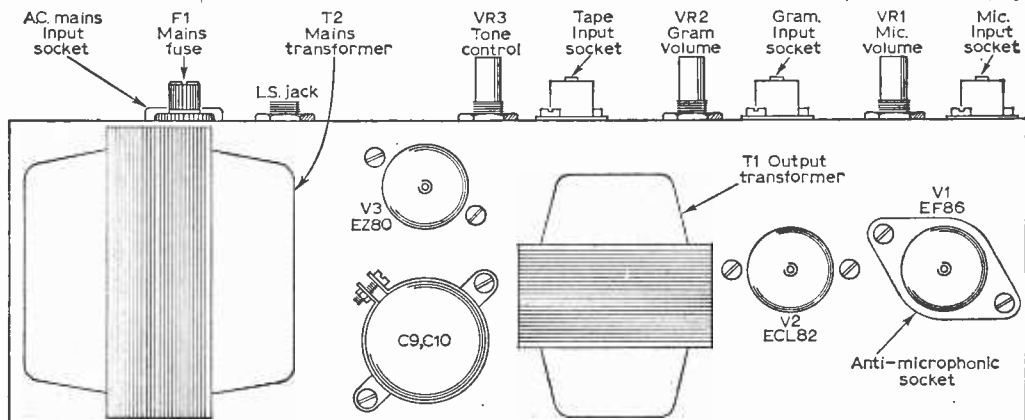

Fig. 71 An above-chassis view of the amplifier.





# Protecting the p.a.

METHODS OF KEEPING THE ANODE CURRENT IN POWER AMPLIFIER STAGES OF TRANSMITTERS WITHIN SAFE LIMITS ————— BY G30GR

**I**N many transmitters the power amplifier stage can easily draw a destructive anode current, if adjustments or operating conditions are incorrect. This is particularly so with some of the modern, high efficiency valves, such as the 6146, when normally run at near maximum ratings. Means of keeping anode current within limits, when tuning up or adjusting aerial loading, thus serve to protect the p.a. stage, and are very helpful with home-designed equipment, or when using a transmitter for the first time. It may also be possible to work at reduced power, which is quite a useful feature.

The p.a. screen grid input and dissipation may be found from  $V \times I$  in the usual way, where  $V$  is the screen grid voltage, and  $I$  the screen grid current: e.g., assume an 807 or 6146 valve draws 10mA at 150V; screen grid input =  $150 \times 0.01 = 1.5W$ . Maximum dissipation is 3.5W for an 807, and 3W for a 6146.

Running the valve with excessive screen grid current or voltage can obviously cause the maximum rating to be exceeded. If component values are so arranged that the screen grid input is correct when the p.a. is fully loaded by the aerial, the dissipation may still be too high during tuning up periods, when the anode current is low. This is

particularly likely when the screen grid supply is obtained from a low voltage power pack, so that the voltage remains constant, even when large currents are drawn. If the screen grid is supplied from the high voltage line, via a dropping resistor, an increase in screen grid current will cause a drop in screen grid voltage, thus keeping dissipation down. This method is usually adopted in phone transmitters using anode and screen grid modulation. A check on screen grid input, with the stage loaded to draw a range of anode currents, can be made. If there is any chance of the screen grid input being too high, with light loading (low anode current) then loading adjustments must be carried out rapidly.

The anode input is similarly  $V \times I$ . For example, if the stage draws 100mA at 600V, this is 60W input. The r.f. output of the stage may be found from  $12 \times Z$ , where  $I$  can be measured with a thermocouple (r.f.) meter, and  $Z$  is a known impedance—usually made up from carbon resistors. Power lost as heat etc. in the stage is the difference between input and output: e.g., if the input is 60W and output 40W, 20W will be lost in the stage, and most of this will cause heating of the p.a. anode. Efficiency in the stage can be found by dividing output by input. In the example, as a percentage:

$$\frac{40 \times 100}{60} = 66\%$$

60

Maximum anode dissipation is 25W for an 807 and 20W for a 6146. When the p.a. anode circuit is tuned off resonance, the r.f. output of the stage is low, and the anode current high. If this persists for other than a very brief interval, the valve will be damaged. This can be avoided by correct tuning methods, and by reducing power during tuning up, if desired.

The p.a. circuit is always tuned to the point which causes the valve to draw least anode current. If this current is too low, loading is increased, anode tuning again being adjusted to resonance (lowest current). With the popular type of  $\pi$ -output circuit, loading is increased by adjusting the output capacitor (or aerial loading capacitor) to a lower value. Loading up thus commences with this capacitor fully closed. Anode current on resonance will then be low, and no harm arises provided screen grid dissipation is not exceeded, as mentioned.

With a new transmitter or home wound coils, an initial check to see that the anode circuit can be suitably tuned, and to find the capacitor setting for light loading, will help avoid possible damage. Tetrodes and pentodes are frequently used, without neutralising. If grid drive is applied, a slight

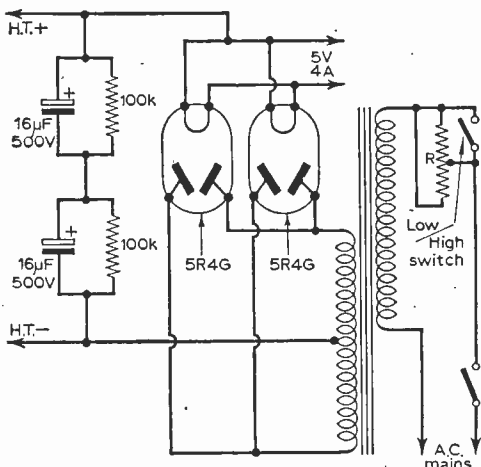

Fig. 1: Typical 600V 400mA power pack, with primary switch.

dip in grid current can be observed when the anode circuit is tuned to resonance. It is then safe to apply anode and screen grid voltages. The valve must never receive screen grid voltage alone.

**Reduced Power**

It is often convenient to tune up the p.a. at reduced voltage. If the high voltage supply is obtained from a transformer employed for this purpose only, the h.t. voltage can be reduced by reducing the primary voltage. A variac is ideal for this, though relatively expensive.

Another method of reducing the primary voltage is shown in Fig. 1. This is a typical 600V, 400mA power pack. A 0.3A mains dropper, as employed for a.c.-d.c. sets, was found suitable for R. One clip is used as a centre tap, and two outer clips are joined, to bring two halves of the resistor in parallel as shown. The switch is opened for low power working and closed for normal power. For smaller power packs R would need to be of higher value.

An advantage of this arrangement is that the modulating impedance of the stage can remain little changed with the lower input. The modulating impedance is anode voltage/current—e.g., for a pair of 807 or 6146 valves drawing 200mA at 600V it would be:

$$\frac{600}{0.2} = 3,000\Omega.$$

The stage input is  $600 \times 0.2 = 120W$ . Assuming R causes anode voltage to drop to 400V and the stage is then loaded to 130mA, input is then  $400 \times 0.13 = 52W$  and the modulating impedance is  $400/0.13 = 3,080\Omega$ . It is thus possible to use the existing modulator, with a good impedance match, reducing gain to avoid over modulation.

It is convenient to load the stage to full input with the low/high switch closed, then open the switch and note the input. When tuning up subsequently, the stage can be loaded to the noted input with the switch open, and it may then be closed, for full input.

With the switch in the low position, the off-resonance current of the p.a. will be much reduced, so that the valve or valves are protected during tuning up and load adjustments.

With R added as in Fig. 1, the power pack voltage depends on the current drawn. That is, the supply no longer has good regulation. Despite this, the arrangement was found to work satisfactorily. If the transformer has heater windings, the resistor must be included in series with the h.t. circuit.

Another method of keeping down the off-tune current is shown in Fig. 2. R1 and R2 are the normal screen grid circuit resistors, and R3 is introduced when the switch is opened. Its value is found by trial. With a phone transmitter, the

modulating impedance is increased. In the example given, the modulating impedance was  $3,000\Omega$ . If R3 gives half-power working, the modulating impedance is then  $600/0.1 = 6,000\Omega$  instead of  $3,000\Omega$ .

In many transmitters, bias for the p.a. is obtained by the voltage drop in a grid resistor, through which grid current flows. For example, a 6146 operated with a  $20k\Omega$  grid resistor, and 2.5mA grid current, will receive  $R \times I$ , or 50V bias. The method is simple and effective, but has the disadvantage that no bias is obtained if the grid drive ceases, due to any fault in the oscillator, multiplier or driver stages.

If ample h.t. voltage is available, protective bias may be obtained from a cathode resistor, R1 in Fig. 3. For satisfactory working on the h.f. bands, leads to C1 must be short. With a 6146, disc capacitors may be wired from the cathode tags of the valveholder, as shown.

Cathode bias is wasteful of h.t. voltage. It is convenient for a low power transmitter, but not for high power. On the l.f. bands, the lack of a very short, direct connection from cathode to chassis is also less important. A 10W top-band transmitter can readily employ cathode bias.

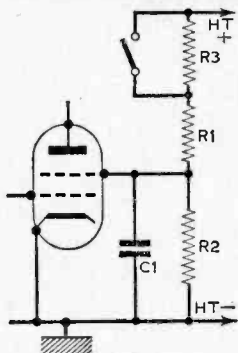

Fig. 2: A method of reducing s.g. voltage.

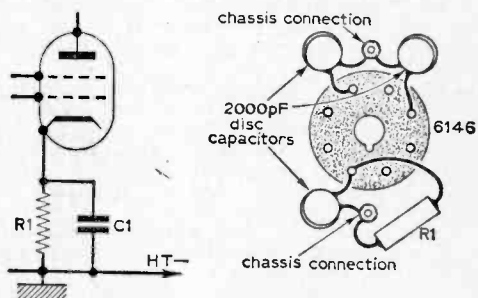
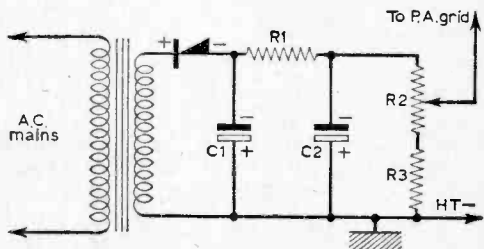

Fig. 3 (above): Protective cathode bias.

Fig. 4 (below): A pack for fixed bias.



For high power, fixed bias from a bias pack is satisfactory, and a circuit such as that in Fig. 4 can be used. R1 can be about  $1k\Omega$  to  $5k\Omega$  and R2 may be  $5k\Omega$  to  $10k\Omega$  or so, with R3 being around  $5k\Omega$ . A reasonably large bleeder current will result in a more stable supply, so resistor values should not be unnecessarily large. A total of  $10k\Omega$  will give a bleeder current of 8mA with a 80V supply. If the rectifier is reasonably large, a bleeder current of 20mA or 25mA may be adopted. R2 allows the p.a. grid voltage to be adjusted as needed. The same pack can supply bias to the modulator output stage. C1 and C2 can be about 150V working, and  $50\mu F$  or larger.

**PCR COMMUNICATION RECEIVERS**

Manufactured by Pye and Philips. One of the Army's most versatile and sensitive sets, RF stage and 2 of I.F., using 6 British 110. Type valves. Large 180 degree illuminating and calibrated Dial. Flywheel Tuning with locking device. Aerial Trimmer. Tone and Vol. Controls. Band Switch from panel jacks for speaker or phones. In black metal case, size 17in. L x 4in. H x 10in. D. Model PCR covers 6-18 Mc/s. 200-550 metres and 850-2,000 metres and has internal 5-in. speaker. £8.19.6. Model PCR2 has similar L & M waveband coverage. Short wave 6-22 Mc/s, but no speaker, £5.19.6. Model PCR3, as PCR2 but has 2 short wave bands 2-7 and 7-23 Mc/s. and medium wave band 190-550 metres. ONLY 8 gas. Add 10/6 carr. all models. Designed to operate from bulky EXTERNAL power supply, but any set can be fitted with BRAND NEW COMPONENTS INTERNAL PACK for 200-250 v. A.C. at extra cost of £2.

All receivers used but excellent condition and aerial tested before despatch.  
S.A.E. FOR ILLUSTRATED LEAFLET

**TEST METERS FOR EVERY PURPOSE & POCKET**

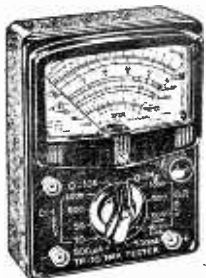

**2,000 O.P.V. MODEL TP-10.** Reads A.C. & D.C. Volts up to 1,000; D.C. Current to 500mA; Resistance to 1 Meg; Capacitance to 1µF; Decibels from -20 to +36; Output jack for Audio Measurements. Size 3 1/2 in. x 6 in. x 1 1/2 in. £3.19.6.



**20,000 O.P.V. MODEL TP-5S.** Reads voltage up to 1,000 D.C. at 20,000 ohms per volt and A.C. at 10,000 o.p.v.; D.C. Current to 500mA; Resistance to 10 Megs.; Capacitance to 0.1µF; Decibels from -20 to +36. Size 3 1/2 in. x 5 1/2 in. x 1 1/2 in. £5.19.6.



**30,000 O.P.V. MODEL 500.** Volts to 1,000; D.C. at 30,000 O.P.V. A.C. at 20,000; 12 Amps D.C. Current; 60 Megs Resistance; -20 to +56 dBs; Internal buzzer short circuit warning. Size 3 1/2 in. x 6 1/2 in. x 2 1/2 in. £8.19.6.

All New Stock, with leads, prods and internal batteries, 6 months' guarantee backed by full service facilities. Details S.A.E.

**DOUBLE BEAM OSCILLOSCOPE TUBES, TYPE CV1536.** Equivalent to COSSOR 09D as used in Oscilloscopes by Cossor (339 series) and Hartley & Erskine (13 series). Listed £12. BRAND NEW IN MAKER'S CRATES. ONLY 25/- (carriage 5/-).

**LA VOIE UHF WAVEMETER MODEL 105.** Coverage 375/725 Mc/s. Complete with correct Calibration Chart. First-class condition. Battery operated and portable, size 11 x 6 x 7 1/2 in. ONLY £3.19.6 (carriage 7/6).

**HRO SENIOR TABLE MODEL RECEIVERS.** Complete with 9 coil sets covering 50 Kc/s to 30 Mc/s. Used, very good condition, aerial tested. ONLY £17.10.0 (carriage, etc., 30/-). A few late Model 51 with I.O. valves, £22.10.0, plus carriage.

**COMBINED VIBRATOR/MAINS UNIT.** The Power Pack of the Army R107 Receiver. Has vibrator for 12 v. D.C. operation, and mains transformer for 100/250 volts A.C. Output 12.6 volts 3 A. L.T. and 250 v. at 100 mA H.T. Complete with vibrator, 6X5G rectifier, and connecting data. Ideal for driving T.C.S. or Type 52 Receivers, etc., or mobile equipment. BRAND NEW IN MAKER'S CARTONS ONLY 45/- (carr. 5/6).

**R107 RECEIVER R.F. UNIT.** Brand new tuning sections of the famous R107 receiver. A 3-stage unit, complete with 4 gang condensers and dial. Calibrated 1.2 to 17.5 Mc/s in 3 bands, coil pack and wave-change switch, aerial trimmer. Less valves. Ideal front end for constructing a superhet receiver. Complete R107 circuit supplied. BRAND NEW IN MAKER'S CARTONS. ONLY 35/- Carr. 5/-.

**AVOMETER MODEL 7.** Reconditioned and in perfect order with leads, internal batteries, and instructions. ONLY £11. (Reg. post 5/-).

**AVOMETER MODEL 7 LEATHER CASES,** fitted with carrying handle & long strap. BRAND NEW. ONLY 32/6 (post 2/6). **20/- CONSTRUCTOR'S PARCEL.** Assorted colours wiring wire, solder, resistors, condensers, volume controls, tag panel. ALL NEW. (Post 2/6).

**RESISTORS,** 100 assorted values our choice. NEW 10/- **CONDENSERS,** 100 assorted mica and silvermica. NEW 12/6.

**"P.W." 6 TRANSISTOR PERSONAL RECEIVER**



Designed by the technical staff of Practical Wireless, easy to build, using printed circuit and 1st Grade Matched Transistors and Diode. Full Medium and Long Wave coverage to internal speaker. All parts sold separately (new components only) enabling you to buy as required and full detailed price list will be sent on request. Constructional details 1/6.

Newly designed OSMOR Cabinet and reduced price. TOTAL COST INCLUDING BATTERY and CABINET NOW £7.19.6. "P.W. TROUBADOUR 7" Parts List, S.A.E.

**THE "GOOD COMPANION" Mk. II**

USING TRANSFILTERS, THE LATEST MANUFACTURING TECHNIQUE TO AVOID ALIGNMENT DIFFICULTY

THE FINEST COMBINED PORTABLE and CAR RADIO YET DESIGNED FOR THE HOME CONSTRUCTOR

★ 750 mW output.

★ 6 transistors and diode.

★ Full Medium and Long Wave coverage.

★ Quality speaker.

★ Brilliantly styled 2-tone cabinet, size 11 x 8 x 3in.

★ Very fine tuning with calibrated dial.

★ Latest printed circuit. ★ Internal high gain aerial with car aerial socket. Easy-to-follow construction data (available separately 3/6). All parts sold separately and full illustrated details will be sent on request.

Total Cost

**£9.19.6**

With alternative luxury cabinet using 7 x 4in. speaker, **£10.19.6.** Either type, plus 5/- post and ins. (Battery 3/6 extra.)

**"POCKET 4"**

**TRANSISTOR RECEIVER**

Uses miniature speaker, proper tuning condenser, and volume control. Built-in aerial makes unit efficient and portable. Ideal for the beginner. Full medium wave coverage. All components and case for only 42/6 (p. & p. 2/6). Ten-page constructional book free with parts or separately 1/6. S.A.E. for parts price list.



**HARRIS ELECTRONICS (LONDON) LTD**

**138 Grays Inn Road, London W.C.1**

Phone TERminus 7937

Please include carriage costs on all items. (Open until 1 p.m. Saturdays) We are 2 mins. from High Holborn (Chancery Lane Station) and 5 mins. by Bus from King's Cross.

**NEW**

from



Modern styling in light grey with black engraving

Constructed to withstand adverse climatic conditions

Ever ready case, including leads, prods and clips.

Improved internal assemblies

New standard of accuracy, using an individually calibrated scale plate:  
d.c. ranges 2.25% of f.s.d.  
a.c. ranges 2.75% of f.s.d.

Re-styled scale plate for easy, rapid reading.



AVO are proud to present an entirely new version of the now famous Multiminor, styled on modern lines, with new high standards of accuracy, improved internal assemblies, and incorporating panclimatic properties.

The new Mark 4 Multiminor, which supersedes all previous models is supplied in an attractive black carrying case, which also houses a pair of leads with interchangeable prods and clips. The whole is packed in a strikingly handsome "Astralux" carton. Two kinds of real leather cases are also available if required.

# MULTIMINOR *Mk4*

D.C. Current: 100 $\mu$ A f.s.d. — 1A f.s.d. in 5 ranges.  
A.C. Voltage: 10V f.s.d. — 1,000 f.s.d. in 5 ranges.  
D.C. Voltage: 2.5V f.s.d. — 1,000 f.s.d. in 6 ranges.  
D.C. Millivolt range: 0 — 100mV. f.s.d.

RESISTANCE: 0-2M $\Omega$  in 2 ranges, using 1.5V cell.  
SENSITIVITY: 10,000 $\Omega$ /V on d.c. Voltage ranges.  
1,000 $\Omega$ /V on a.c. Voltage ranges.

Write for  
full details.

**AVO LTD** AVOCET HOUSE 92-96 VAUXHALL BRIDGE RD LONDON SW1

Tel: VICTORIA 3404

**M group**

MM14

## NEW MERCURY SIX CASE

The result of a cross section of opinion of amateur constructors. A quiet yet really attractive contemporary design.

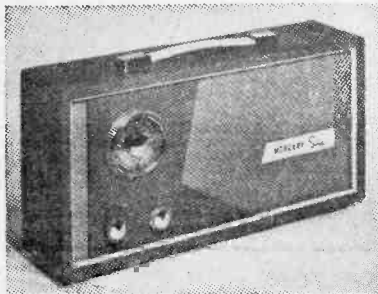

Size 4½ x 7½ x 4in.

Price 48/-.

Suitable for many other transistor receivers currently offered, and plenty of room for 9 x 4in. speaker for quality.

Coloured illustration on request.

Mercury 6 Booklet 2/6.

Trade and Retail.

**OSMOR** 418 BRIGHTON ROAD  
S. CROYDON CRO 5148

**R-107 POWER UNITS.** A complete sub-chassis from the R-107 set. Operates from AC mains 110/200-250 and can also be used from a 12v car battery. Output 250V HT and 12v LT. Ideal for 52 set (Instructions and resistor supplied). Complete with circuit input plugs, 6X5G rect. and vibrator. Unused, tested and in original cartons. 45/- carr. 5/-.

**R-107 R.F. UNIT.** As well as a replacement front end for the R-107 this unit will make a good front end for a home constructed receiver. The RF. mixer and oscillator coils with the associated tuning condenser, dial and dual ratio drive covers 1.2 Mc/s to 17.5 Mc/s in 3 wavebands. IF output is 465 Kc/s. Less valves with circuit. New and unused. Real bargain. 35/- carr. 5/-.

**SILICON RECTIFIERS.** Type 1EA2 (1 x in.) will handle 250 volts at up to 500 mA. Replaces any TV metal rectifier. 7/6.

**H.R.O. RECEIVERS—SENIOR MODEL M.X.** Complete with 5 coils from 50 Kc/s—30 Mc/s. A superb communications receiver. Guaranteed in brand new condition. £25, carr. 30/-.  
**POWER UNIT 50/8,** extra carr. 5/6.

**AVO L, C & R BRIDGE.** Capacity 5 pfd. to 50 mfd. Resistance 5  $\Omega$  to 50  $\Omega$ . Inductance can be measured against external standard. Balance is indicated on a meter which can be used as a valve voltmeter from 0.1 to 15 v. Leakage test and Power Factor scale. A.C. mains operation. Tested and guaranteed and in superlative condition £9.10.0. plus 5/- P. & P.

### PCR COMMUNICATIONS RECEIVER

**Type PCR.** Has self contained speaker. Covers 850-2000, 200-350 and 18-50 metres. AS NEW CONDITION ..... £6.19.6  
**Type PC1-2.** Requires external speaker. Covers 850-2000, 200-500 and 13-50 metres. USED (Good condition) ..... £5.19.6  
**Type PCR-3.** Requires external speaker. Covers 200 to 500, 120 to 43 and 43 to 13 metres. Used (Good condition) ..... £8.8.0  
Carriage (any type) 10/6. Full details S.A.E. Any model fitted with BRAND NEW INTERNAL POWER SUPPLY, guaranteed ready for use on A.C. mains. £2 extra.

**AERIAL KITS.** Comprising seven 4ft. aerial rods which will make a 18ft. and a 12ft. aerial. There is also an aerial base with a ground spike. All contained in a steel carrying tube with webb strap. 22/6 plus 4/- carr.

**WESTON ANALYSER MODEL 772 TYPE 6 (U.S.A.).**  
A.C./D.C. VOLTS 0-2.5, 10, 50, 250 & 1000. D.C. CURRENT 0-100mA  
1mA, 10mA, 50mA, 250mA, 1A, & 10A. OHMS 0-30M $\Omega$  (in 4 ranges). SENSITIVITY 20,000 $\Omega$ /volt or 1000 $\Omega$ /volt by selector switch. Provision for use as output meter (dB). In handsome oak carrying case 14 1/2 x 8 1/2 in. Complete with leads, batteries and instructions. FULLY GUARANTEED £7.10.0. P. & P. 5/-.

## CHARLES BRITAIN (RADIO) LTD.

11 Upper Saint Martins Lane, London, W.C.2  
TEmple Bar 0545.

Shop Hours 9-6 P.m. (9-1 P.m. Thursday).  
Open all day Saturday.

Small transformers with an output of around 90V, as used for h.t. eliminators, will do well. The voltage should be a little higher than the maximum needed, as it can be easily reduced by means of R2. Capacitors need insulating from the chassis, as the bias supply is negative.

**Screen Clamp Circuit**

A screen grid clamp valve may be employed to protect the p.a. if grid drive fails, and also with buffer keying. A typical circuit is shown in Fig. 5. The clamp valve can be any audio output tetrode or pentode, such as the 6BW6, 6V6, 6L6, etc.

R1 and R2 are the usual screen grid potential divider. When drive is present, grid current in the 4.7kΩ grid resistor provides bias for the clamp valve, the 500kΩ potentiometer allowing adjustment of grid voltage. In these circumstances, the clamp valve passes very little current.

When grid drive ceases, either due to a fault, or because a buffer stage is keyed, grid current no longer flows through the 4.7kΩ resistor, and negative bias is no longer applied to the clamp valve control grid. The clamp valve thus passes a large anode current, causing considerable voltage drop in R1, so that the p.a. screen grid voltage falls. The 500kΩ potentiometer is adjusted so that the p.a. anode current is almost zero, when drive is removed. The circuit is automatic, and may be used with a c.w. transmitter, as mentioned, or with anode and screen grid modulation.

Heavy currents can be avoided by including suitable h.t. circuit fuses at a convenient point in the power pack. These fuses may be chosen so that they will blow if the current reaches a level likely to damage the p.a. valves. A 150mA fuse may be adopted for a single 6146, or a 300mA fuse for a pair of 6146's. Fuses afford no protection against excessive anode dissipation due to wrong tuning of the p.a. But they are useful as protection against any fault which would result in a very heavy anode current, which could otherwise persist until the valves or power pack were damaged.

It is quite usual to employ a single meter, for grid current, anode current, and possibly other

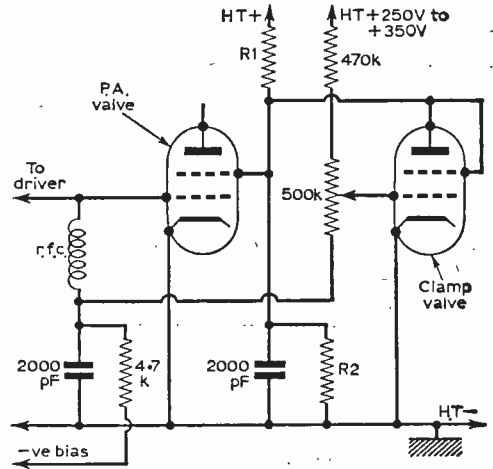

Fig. 5: A screen clamp valve circuit.

purposes, a switch selecting the appropriate circuits. If space permits, it is useful to have separate meters, so that grid and anode currents can be observed at once, or simultaneously. This is particularly important if any adjustment to anode tuning and loading considerably influences the grid current.

If little space is available, a miniature meter may be needed, and these are readily obtainable. Surplus meters are relatively inexpensive, but require more space. A meter which gives roughly a half-scale reading, with normal current, is convenient: e.g., a 10mA instrument for a pair of 807 or similar valves operated with 4mA to 6mA grid current, or a 250mA meter for anode currents around 100mA to 200mA, and so on. Sensitive meters may, of course, be shunted in the usual way, to increase the current range. A by-pass capacitor is included in parallel with each meter.

**HOME-MOVIE AMPLIFIER**

(Continued from page 998)

from No. 1 putting in the final small components. This stage has very high gain and particular care should be taken here with the wiring. The following points should be noted: the centre spigot of the valvholder must be earthed, the screening skirt of this valvholder must also be connected to earth, the wire from pin 8 to the earth tag should have a small single loop made in it to allow slight movement of the anti-microphonic valvholder.

Having completed the wiring to this stage, carefully check it against the diagram. It is also useful to compare it with the theoretical circuit.

Carry out the same procedure for the next stage, V2, noting that in this case the centre spigot is taken to one of the cathodes (pin 8). Do not overlook C7 0.05μF, which should be connected between tags Nos. 4 and 8 at the chassis end of the group board.

This almost completes the wiring. The earthing link from No. 1 tag of the group board to the centre earthing tag of the five-way strip should be inserted, making sure that it is well clear of the 1.5kΩ resistor which not only carries the h.t. positive but also gets quite hot in operation.

All that now remains is to insert the valves into their correct positions, screw in the 6.5V 0.3A pilot bulb, wire up the three-core mains lead, keeping the green lead for earth, and connect the loudspeaker into the jack socket.

The microphone circuit will give good results with any high impedance microphone, but it has been designed particularly for a normal crystal type. Care should be taken, particularly in small rooms, not to turn the microphone volume up too far as feedback will occur, causing a loud howl.

For cine work it will be found best to have the loudspeaker close to the screen, and facing the audience. The amplifier and microphone should be placed near to the projector, although if the projector is a noisy one the microphone should be screened from it.

# TEST GEAR techniques

## PART 2 - MORE ABOUT METERS

H. W. Hellyer

INDIVIDUAL volt and ampere meters are rarely found around the wireless workshop. They have their uses: mainly in specific applications, such as vehicle system testing, or in the industrial field as indicating devices, part of a static monitor. More widely employed, because of its versatility, is the multimeter, with a number of ranges for measuring volts, amperes and ohms. It may be a small pocket instrument, suitable for direct current readings only, the dozen or so ranges selected by plug-and-socket connections, or it may be a comprehensive "bench" type, with fifty or more ranges, a.c. and d.c., a wide scope of resistance checks and additional facilities such as high-voltage, capacity and "Q" measurement.

### The Multimeter

Whatever the design of the multimeter, its accuracy and its dependability as a measuring instrument rely upon the quality of the basic movement, as described in Part One. Sensitivity of the meter determines its usefulness as an indicator of correct voltage, and limits the lowest scale. A typical multirange testmeter may have a sensitivity of 20,000 $\Omega$  per volt on d.c., with a movement requiring only 50 micro-amperes for full scale deflection. (The same instrument would have a sensitivity of perhaps as little as 1,000 $\Omega$  per volt on a.c.)

The principle of using a multirange meter on the highest voltage range, where a choice is available, to obtain the most favourable ohms per volt loading of the circuit (see Part One), is correct—but another factor should be considered. That is the accuracy of the meter.

For example, a meter with a stated accuracy of 2% could indicate between 98 and 102V when exactly 100V is applied to it, on the 100V range. In other words, this is a full-scale accuracy figure, and if half the voltage is applied, with the meter switched to the same range, a variation between 48 and 52V may be noted, which is a 4%, plus or minus, error. At the lower end of the scale, the error factor is even greater. Therefore, it is better to use a meter on the range that gives a deflection as near the upper end of the scale as possible.

From this, it can be seen that much depends on the circuit in which the meter is connected, and

its sensitivity, in interpreting the error factor. In other words, one must grow used to one's meter and allow for the inevitable discrepancies.

### A.C. Measurements

This is even more apparent when using a multimeter for a.c. tests in radio work. Here there are two more factors to consider. First, the shunting effect of the bridge rectifier and components reduces the meter sensitivity, and second, the frequency response of the instrument determines its accuracy of reading. The average multimeter is not intended to be used at much above 5kc/s for very accurate results, and is generally employed for measuring such things as heater voltage and current, at mains frequency, 50c/s. For higher frequency work, such as the measurement of stage gain in radio and audio frequency stages, an electronic meter is very much more accurate and trustworthy. This type of instrument will be discussed later.

### Resistance Testing

An important function of the multimeter is the ohms range, or ranges. By fitting a battery in the meter, and arranging variable resistors to bring the meter movement to full-scale deflection when the circuit is completed, i.e. terminals short-circuited, zero ohms, then introducing the unknown resistance in place of the short-circuit, the reduced current can be indicated as a proportion of full-scale deflection, and read off directly from a scale—which will now appear in reverse to the voltage and current scales.

It will also appear non-linear, the divisions becoming progressively more cramped as maximum resistance, i.e. minimum current flow, is approached. The resistance will be zero at full-scale deflection, infinity at minimum deflection. The highest resistance reading that can usefully be indicated depends upon the sensitivity of the meter, and the battery voltage. But addition of an external battery extends the range of the instrument and alternative methods of connecting meter, battery and variable shunt can "open out" the lower range, enabling a reading of smaller resistance values.

This is seen more clearly in Fig. 4. Here there

are three alternative ways of connecting a basic meter movement for resistance testing. At (a) we have the normal "series" arrangement, as R1 and R2 are comparable, the value of R1 being such as to afford protection to the meter, preventing a current in excess of full-scale deflection flowing even when the battery is fully charged and previously described. If the values of resistors R1, R2 at minimum, then half-scale deflection, in ohms, will be  $R1 + R2$ .

Where a meter is being adapted, it may be necessary to compute values of resistance for readings of current. This can be done if the full-scale deflection of the meter is known, and its internal resistance.

**Calculating the Internal Resistance**

To calculate internal resistance,  $R_m$ , connect the meter across a suitable supply, using it as a

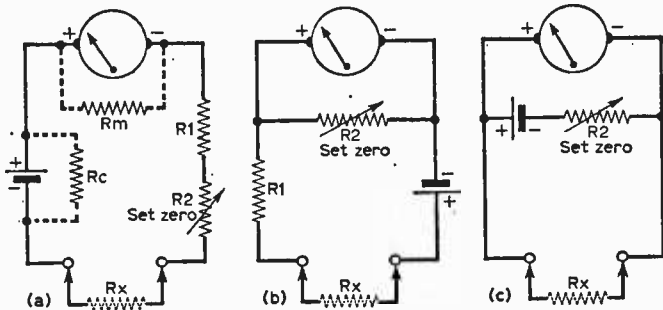

Fig. 4: Three ways of connecting a basic meter movement for resistance testing.

voltmeter, and note the reading. Then connect a known resistor in series and note the new reading. If this resistor is called R, and the first and second readings  $V1$  and  $V2$ ,

$$R_m = \frac{V2 \times R}{V1 - V2}$$

Then, referring again to Fig. 4, the value of an unknown resistor  $R_x$  across the test terminals can be calculated, using the following formula,

$$R_x = \frac{R \text{ (total)} \times \text{f.s.d.} - R \text{ (total)}}{I}$$

where the total resistance is the sum of  $R1$ ,  $R2$ , the internal resistance of the meter and the cell resistance. With a new cell, the last factor could be ignored for practical purposes. F.S.D. is the current required for full-scale deflection and  $I$  the new current reading obtained when the short-circuit across the test terminals is replaced by  $R_x$ .

A more accurate arrangement is shown in Fig. 4(b). Here, the meter is connected as a voltmeter, with  $R2$ , the "Set Zero" control shunting the meter movement.  $R1$  is again the limiting resistor. The formula for calculating  $R_x$  is:

$$R_x = \frac{\text{f.s.d.}}{(I-1)} \times R1.$$

With this type of ohmmeter, greater accuracy is possible at the lower portion of the scale, which is

also less cramped, but the sub-divisions are limited by the meter characteristics. Increasing the battery voltage allows an extension of the range and greater accuracy of higher resistance readings.

**The Insulation Tester**

To check lower values of resistance, a slightly different arrangement is needed, as shown at (c).

This is the basic "insulation" tester.  $R2$  and the battery are shunted across the meter, as is the test resistor,  $R_x$ . The set zero is adjusted with the terminals open-circuited, and readings increase from left to right. Greatest accuracy is obtained at the lower values. Connecting a test resistor across the terminals equal to the internal resistance of the meter,  $R_m$ , gives a half-scale deflection. From this we can see that the formula for interpolation (reading current as resistance directly), will be:

$$R_x = \frac{R_m \times I}{(\text{f.s.d.} - I)}$$

The normal arrangement for ohms measurement in the commercial multimeter is as shown in (b). When adding a battery for the extension of ohms ranges, it is merely necessary to connect it in series at the terminals, taking care to observe correct polarity.

Other methods of measuring resistance, such as the Wheatstone bridge, will be dealt with as different instruments are described.

**Precautions**

When making resistance tests in a receiver, ensure that power supplies are switched off and electrolytic capacitors are discharged before connecting the ohmmeter leads. It will be noted that the connection of an ohmmeter across an electrolytic capacitor will give a reading which "kicks" towards full-scale (low resistance) and slowly falls away. See Fig. 5(a). This is because the capacitor is partially charged by the ohmmeter battery, the charge leaking away through the discharge path of the meter resistance, its rate giving an indication of the "goodness" of the component. Larger capacities give a larger "kick" and a slower falling away.

This phenomenon is more noticeable on the higher resistance ranges, and provides a useful quick test for the engineer, but the presence of electrolytic capacitors in a circuit should not be overlooked as false readings can result.

**Semiconductors**

Similarly, a crystal diode in a series circuit will give a resistance reading that varies with the applied voltage. This is because the diode tends to pass current in the direction shown by the arrow in Fig. 5(b). Thus, a low resistance reading will be noted, whereas a high resistance will be indicated if the meter is connected with polarity as shown in (c).

Enlarging upon this theme, we can observe that transistors are also semiconductors and behave in

similar manner to crystal diodes when the ohmmeter is connected to their leads. First, note that a meter with a battery voltage greater than 3V should not be used for making resistance checks around a transistor radio. But, if this stricture is noted, it is possible to make a rough test of a transistor while fault finding, as shown in Fig. 6.

Here, it will be noted that the polarity of the meter is indicated. This can be quickly verified by connecting the meter test leads across a semi-conductor diode and noting that a low reading is obtained when the meter lead carrying negative potential is connected to the cathode (red end).

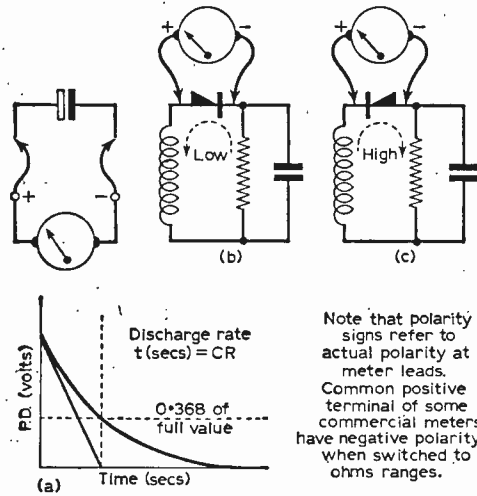

Fig. 5 (above): Connecting an ohmmeter across an electrolytic capacitor and a diode.

Fig. 6 (right): Making a quick transistor test.

These transistor tests are only a guide, with comparative readings taken by a 20,000Ω/V meter on the highest ohms range.

**Choice of Instrument**

The multimeter has a number of other uses. Mention will be made of these at the appropriate stage of our discussion. At this point it is only necessary to add that money spent on the purchase of a good quality instrument is never wasted.

However, there are factors affecting one's choice, quite apart from quality. These are to some extent determined by the nature of the work being done. For example, a meter that is ideal on the bench may not be robust enough, or may have too (mechanically) sensitive a movement for work in the field. It is false economy to buy a meter with a number of facilities, then use it only for checking one's car battery. On the other hand, a good meter with fewer ranges can often be adapted quite cheaply and accurately for the occasional reading beyond its scale.

Remember that the a.c. ranges on a multimeter are less sensitive than the d.c., because of the shunting effect of the non-linear rectifier. Also, the

frequency response on these ranges is not intended to cover audio or r.f. measurements accurately, for which special instruments are needed, as will be discussed later.

When using the meter for measuring unknown quantities, protect it by beginning at the highest range, then reduce until the pointer gives an indication within the normal scale limits. Avoid the damaging practice of causing the pointer to "slam" against its stops. Even with an overload of the mechanical type shown in Fig. 7, there is danger of bending the delicate pointer before the trip mechanism operates.

**Overload Protection**

The mechanism of Fig. 7 is that of the popular AVO meters, where a momentary overload results

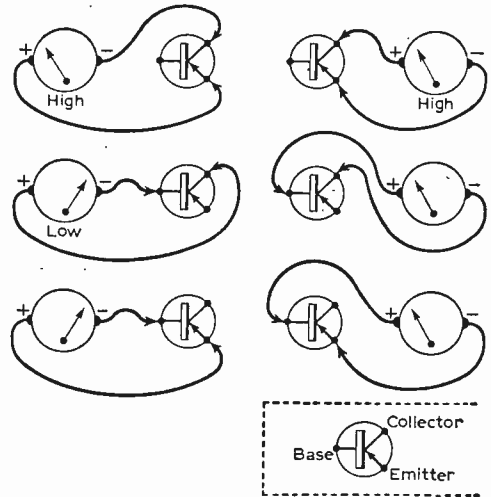

in the spring tripping of the spindle S by the action of toggles T, push rod P, and jewel crank lever L and the reset arm R which engages a recess in the knob spindle. The spindle is attached to a former on which circuit contacts C are mounted. Re-making the circuit is simply done by pressing the re-set knob to engage the recess in the spindle with the sprung lever L.

Other forms of cut-out work on the electrical principle, with a rectifier of specially chosen characteristics shunting the meter and carrying excess current resulting from an overload. The difficulty here is that if the overload is prolonged, or too great, the shunts themselves are damaged and have to be replaced. This is a job for the specialist; fitting of an incorrect value will upset the meter characteristics. Even the fitting of the correct shunt normally requires that the meter shall be re-calibrated. The moral, obviously, is "Don't risk that overload".

**Moving Iron Meters**

All that has been said previously relates to the moving coil meter. It must not be thought, however, that the alternative type, the moving iron meter, has been completely superseded. It has its uses, and the very definite advantage is that it is



suitable for a.c. measurements, as reversal of polarity does not prevent its functioning.

The meter movement has a fixed coil, through which the current to be measured flows. A soft-iron armature is mounted at the centre of this coil and interaction of the field of the coil and the magnetism induced in the armature cause deflection. This deflection is not linear, as with the moving coil type meter, the scale divisions widening as they approach full-scale deflection.

Although basically, this deflection non-linearity is proportional to the square of the current

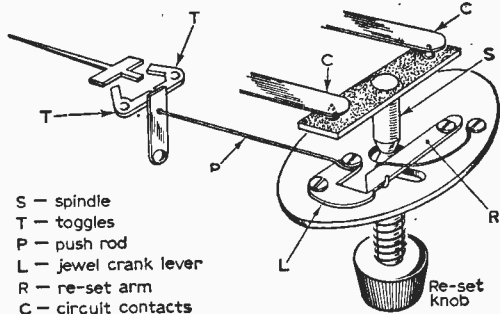

Fig. 7: A mechanical type of overload.

(Square-Law), variations in design enabling the armature to become magnetically saturated at low current values result in scales that, although cramped at the extreme left, are nearly linear over the rest of the scale.

Two types of moving iron instrument are used, the attraction and repulsion. The former is as described above, the two fields attracting. The latter has a fixed and a moving soft-iron piece, with the field from the coil inducing similar fluxes in each, causing repulsion and a swing of the lightly mounted moving armature.

Their special advantages are cheapness, robust construction and a.c. characteristics that are better than d.c. Disadvantages, as compared with the moving coil type, are, lower accuracy, higher required f.s.d. current, reactance error with frequency variation and susceptibility to external magnetic fields.

**Electrostatic Voltmeter**

Another "universal" instrument with a special application is the electrostatic voltmeter. This operates on an entirely different principle, independent of current. For this reason, it is employed where the loading on the circuit must be negligible—as, for example, measuring e.h.t. voltages of a television receiver, across the high impedance circuits commonly used in flyback systems.

The voltage is applied to two sets of plates, rather like the tuning capacitor of a radio receiver. One set of plates is fixed, the other is pivoted and the pointer is secured at the pivot. Fine hairsprings provide mechanical balancing, as with the instruments described previously, and the tension of these can be adjusted to zero the movement.

A voltage applied to the two plates in close proximity causes electrostatic attraction, and thus the moving plates tend to swing, the torque being

proportional to the actuating voltage—but in practice, some initial torque is needed to overcome the mechanical suspension drag, and at the lower end of the scale the readings will be closer together.

One disadvantage is that low voltages cannot be measured by this method with any great accuracy. Another is that this is essentially a single-scale instrument. Any additional resistive multiplier defeats the no-loading characteristic, and adding a capacitive divider for a.c. measurement increases the loading, as the electrostatic voltmeter acts as a capacitance across an a.c. circuit. For the same reason, its frequency response is poor.

**Bridge Rectifier**

The foregoing notes have described meters that can be used to measure alternating currents and voltages, but with less sensitivity than is sometimes desirable.

The multimeter usually employs a bridge rectifier circuit for the conversion of the applied a.c. to a d.c. suitable to operate the meter movement. A typical circuit is shown in Fig. 8, with the four rectifier elements of the bridge called A, B, C and D. When a.c. is applied to the left-hand terminals, points X and Y of the circuit become alternatively positive and negative, and for periods of a half-cycle, current flows in one direction only.

Thus, when X is positive with respect to Y, current flow follows the dotted arrows, from Y, through C to the meter, and through A to the positive point X. Thus, the left-hand terminal of the meter is the negative pole. Now, when the a.c. reverses and X is negative with respect to Y, the current path is from X through D to the meter, through B to Y, so that the left-hand terminal of the meter is again negative. Thus, the meter measures a d.c. proportional to the applied a.c. The reason for the particular current paths is the non-linear characteristic of the semi-conductor rectifiers, which have a low "forward" resistance, allowing the easy passage of current and a high "back" resistance, impeding the current flow.

But it must be remembered that no semi-conductor is perfect, and a shunting effect on the meter is caused by leakage paths in an unwanted direction. Hence the loss in sensitivity when such an instrument is used on a.c. The frequency response is also affected by the rectifier.

Further, semi-conductors are prone to damage from overload, and suffer when sharply peaked transients are applied, such as may be caused by the making and breaking of a circuit. Switching both of the meter and the apparatus under test should be avoided when the meter is connected. This is important on both

a.c. and d.c. Although all reputable makes of multimeter have protection devices, swamp resistors, surge limiters and overload shunts, it is impossible to protect the meter completely, and the careful user will be rewarded

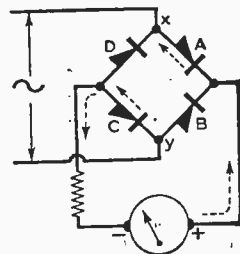

Fig. 8: A typical bridge rectifier circuit.

with a longer, more consistently-accurate life of his instrument.

### Thermo-couples

An instrument that is widely used for measuring a.c. over a wide range of frequencies is the thermo-couple meter. Several types are available on the surplus market and can find an application in experimental work.

The basic movement is a moving coil, often a millivoltmeter, responsive to as little as 300mA. This is used to measure the d.c. produced by the heating effect of an alternating current on the junction of two dissimilar metals. Iron and eureka are two of the metals widely used and several thermo-couples may be used in conjunction.

These instruments are accurate up to quite high frequencies and some which use antimony with platinum and copper with constantan have a relatively high thermo-electric power. As the e.m.f. at the junction is proportional to the heat and thus to  $I^2$  the instrument is a square-law device. Thus the scale is cramped to the left, progressively widening toward the high-current readings. Pointer movement tends to be sluggish as compared with the meters previously discussed.

### Hot-wire ammeter

This instrument is somewhat similar but employs the principle of metallic expansion under heat. It has a piece of fine, high-resistance wire through which the current passes and to which is attached a pulley via an isolating metal strip. As the current through the wire increases, expansion causes it to "sag", allowing the take-up wire to draw on the pulley and move the pointer. Movement is necessarily sluggish and mechanically the instrument is delicate besides being very susceptible to overloading. At higher frequencies skin effect introduces serious errors and further errors occur if the waveform being tested is not sinusoidal. This type of meter has largely been superseded by the thermo-couple except for some special laboratory applications.

### The valve voltmeter

The use of a meter in a circuit makes some difference to the circuit characteristics whether voltage or current is being measured. One authority has stipulated that his ideal meter must have "infinite impedance on both a.c. and d.c., a frequency response extending up to 300Mc/s and a reasonable indication at about 10 microvolts".

This ideal may be asking too much but the modern valve voltmeter comes remarkably close to such perfection. An input impedance of 10 megohms or more is almost as good as an infinite impedance for practical purposes and is quite common. This is attained by feeding the voltage being tested into the grid circuit of a valve, which can be operated in such conditions as to present a high impedance and very little circuit loading as a result.

Some shunt capacitance is inevitable; the connecting leads themselves have a shunting effect. But a low-loss "probe" can be made which rectifies the a.c. voltage to be tested at the point of measurement, then applies the rectified voltage

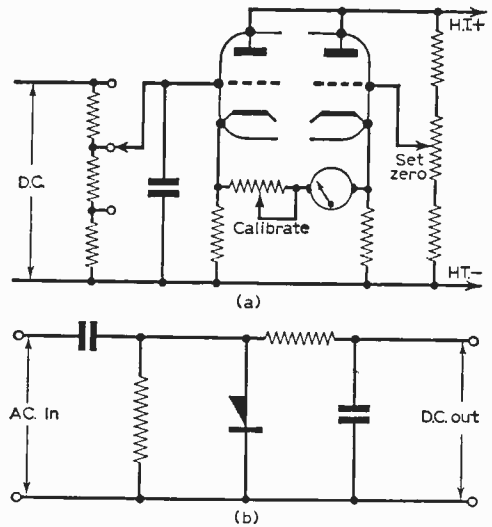

Fig. 9(a) The basic principle of the valve voltmeter; (b) a.c. probes.

(now d.c.) to the instrument, several valve stages being used both to amplify this voltage and act as "buffer" stages to the meter. A carefully constructed probe can allow a.c. measurements up to 300Mc/s with very little loss, while a useful indication of about 100 microvolts is not uncommon even on standard instruments.

The basic principle of the valve voltmeter can be seen from Fig. 9(a), which shows two halves of a double-triode valve in a balanced circuit. Actually they form a bridge across the h.t. supply with the meter reading a difference in cathode voltage. Thus when each triode passes the same current the cathodes are at the same potential and the meter reads zero. The bias of the second triode is altered by the set zero control and the bridge is balanced, but when a d.c. voltage is applied at the input terminals, effectively across the grid circuit of V1, the balance is upset, cathode voltages differ, and the meter indicates the change which is proportional to the input.

The valve voltmeter and its wide applications will be dealt with at greater length in the next part of the series.

A.C. probes, which differ in detail from that shown in Fig. 9(b), will also be discussed. Many probes now used are unsuitable for high-frequency work and it is necessary to go a little deeper into the effect upon components and circuitry of higher frequency, non-sinusoidal waveforms. It will be noted that the probes supplied with several of the better-class commercial valve voltmeters and electronic testmeters are considerably more complicated than that illustrated and also that the circuitry of the meter has been developed to a high degree of accuracy, stability and economy.

Power supply circuits are necessary for these meters and several refinements are employed to improve stability. It is hoped that a discussion of these points will be of assistance both to users of commercial equipment and to potential constructors.

(To be continued)



## SEND FOR OUR 1963 COMPONENTS CATALOGUE

48 pages of valves and accessories. Send 1/- in stamps for your copy. Trade catalogue also available, for which please attach your business letter heading.

### POTENTIOMETERS

A range of Ardenite miniature potentiometers is available. In the circular type adjustment of the control is made by rotating the peripheral ring.

Type VC.1041, less switch, diameter 0.680in., width less pins 0.170in., available in the following values: 5,000 ohms semi-log, 1 megohm semi-log, 7/6.

Type VC.1545, with switch, diameter 0.900in., width with pins 0.490in., available in the following values: 5 K ohm semi-log, 20 Kohm semi-log, 1 Megohm semi-log, 5/3.

Type VC.1760, with switch, diameter 0.720in., width with pins 0.378in., available in the following values: 5 Kohm semi-log, 20 Kohm semi-log, 1 Mohm semi-log, 10/6.

### CHASSIS

Aluminium Undrilled with Reinforced Corner, available in the following sizes:

6in. x 4in. x 2 1/2in.	...	...	4/6 each
8in. x 6in. x 2 1/2in.	...	...	6/3 each
10in. x 7in. x 2 1/2in.	...	...	7/3 each
12in. x 7in. x 2 1/2in.	...	...	5/9 each
12in. x 5in. x 2 1/2in.	...	...	6/9 each
12in. x 8in. x 2 1/2in.	...	...	8/6 each
14in. x 8in. x 2 1/2in.	...	...	6/0 each
14in. x 9in. x 2 1/2in.	...	...	12/- each
16in. x 6in. x 2 1/2in.	...	...	9/3 each
16in. x 10in. x 2 1/2in.	...	...	14/- each

All are four-sided—ideal for radio receivers, amplifiers, power packs, etc.

OUR NEW 60-PAGE  
**HI-FI CATALOGUE**  
IS NOW AVAILABLE  
SEND  
**2/6**  
PLUS 6d. POSTAGE

## LOUDSPEAKERS

All 3 ohm IMPEDANCE

Round Types—1 1/2in. 17/6; 2 1/2in. 17/6; 5in. 15/-; 6 1/2in. 16/6; 8in. 17/6; 12in. 29/6.

Square Types—2 1/2in. 18/6; 3in. 19/6; 4in. Tweeter 12/6.

Elliptical Types—6in. x 4in. 15/6; 7in. x 4in. 15/6; 8in. x 6in. 17/6; 10in. x 6in. 21/-.

We also have in stock TSL Lorenz LPH65 37/8; WB HF812 £4.1.3; WB HF912 £4.6.0; WB HF1012 £4.17.6; 12in. RTC 15 ohms unit 105/-.

### LOUDSPEAKERS BY WHARFEDALE

8in. Bronze/RS. 10,500 gauss. Roll surround. Resonance 50/55 c/s. Impedance 10/15 ohms. Total £4.4.6.

8in. Bronze FS/AL. 10,500 gauss. Aluminium voice coil, foam surround. Impedance 2/3 or 12/15 ohms. Resonance 50/55 c/s. Total £4.4.6.

Super 8 RS/DD. 14,500 gauss. Fitted roll surround and double diaphragm. Resonance 50/55 c/s. Impedance 10/15 ohms. Total £7.9.5.

Super 10/RS/DD. 16,000 gauss. Fitted roll surround and double diaphragm. Impedance: 10/15 ohms only. Resonance 38/43 c/s. Total £12.3.7.

Golden 10/RS/DD. 14,500 gauss. Fitted roll surround and double diaphragm. Impedance 10/15 ohms. only. Resonance 38/43 c/s. Total £8.15.5.

10in. Bronze/RS. 10,500 gauss. Roll surround. Resonance 35/40 c/s. Impedance 10/15 ohms only. Total £5.3.3.

10in. Bronze/FSB. 10,500 gauss. Foam surround. Impedance 2/3 or 12/15 ohms. Resonance 38/43 c/s. Total £5.3.3.

## RECTIFIERS

Rectifiers suitable for Battery Chargers 12 volt output, 2 amp 7/-, 4 amp 12/6 and 6 amp 15/6.

### TRANSISTORS AND DIODES

Transistors	OC75 8/-	OC77 12/-	OC78 8/-	OC81 8/-	OC84 8/6	OC170 9/6	OC171 10/6	OC201 3/6	OC202 21/-	OC71 5/-	OC72 8/-	OC73 16/-	OA73 3/-	OA79 3/9	OA81 2/6	OA85 3/-	OA91 3/-	OA95 3/6	GECSI Audio 3/6	Red Spot 3/6	White Spot 5/-	GEX34 3/-	GEX35 3/-	XD201 1/-
			Matched Pns.	2xOC72 16/-	2xOC78 16/-	Diodes	OAS 6/-	OA10 8/-	OA70 3/-	Sundry Types	PXA102 4/-													

A set of Transistors comprising 1 OC44, 2 OC45, 1 OC81D, 2 OC81, 32/6 set. Set of Audio Transistors, 1 x OC81, 2 x OC81, Driver Matched Pair, 15/6 set.

### ALUMINIUM PANELS

For use with our chassis, as front panels base plates, etc. Available in the following sizes:

14 x 9in.	4/- each
12 x 12in.	4/6 each
12 x 8in.	3/- each
10 x 7in.	2/3 each

### THORESBY BASS REFLEX. CONSOLE CABINET (C.15)

This cabinet is designed for Stentorian 8in. or 10in. Loudspeakers and there is also provision for fitting tweeter unit if desired. Size: Height 31in. x width 19 1/2in. x depth 18in.

Price in Mahogany £12.12.0.  
Price in Walnut 7/6 extra.

### THE "WEYRAD" SUPERHET TRANSISTOR RECEIVER FOR LONG AND MEDIUM WAVES

The following components are available from stock:

M.W. Oscillator Coil P50/1AC 5/4. Rod Aerial RA2VW 12/6. 1st and 2nd I.F. Trans. P50/2CC (2 required) 5/7. Driver Transformer LFDT4 9/6. 3rd I.F. Transformer P50/3CC 6/-. Printed circuit PCA1 9/6. Literature for complete range of "WEYRAD" components available on request.

### THORESBY HI-FI EQUIPMENT CONSOLE (C.16)

This takes most makes of tape-deck or record player, amplifier, pre-amplifier control unit and radio tuner.

Size: Height 31in. x width 19 1/2in. x depth 18in.  
Price in Mahogany £14.14.0.  
Price in Walnut 10/- extra.

### LOUDSPEAKER CABINETS

Baffle type, walnut finish:—	
Type suitable for an 8in. unit	... 21/-
Type suitable for a 10in. unit	... 25/6
Type suitable for a 7in. x 4in. unit	17/6

### AUTOMATIC RECORD CHANGERS

BSR UA14	... ..	£6.19.6
Collaro C60	... ..	£7.19.6
Garrard Autoslim	... ..	£7.19.6

### SINGLE PLAYERS

EMT 4-Speed with pick-up	... ..	£3.15.0
BSR GU6	... ..	£4.19.6
Garrard TA Mk II	... ..	£8.10.0
EMI Battery Version	... ..	£5.9.6

**ALPHA**  
RADIO SUPPLY CO.



103 LEEDS TERRACE  
WINTOUN STREET  
LEEDS 7

**TERMS:** Cash with Order or C.O.D. Postage and Packing Charges extra. Single valves 9d., Minimum Parcel Post charges 2/-. Please include sufficient postage with your order. Minimum C.O.D. fees and postage 3/6. These Postal Rates apply to U.K. only. For full terms of business see inside cover of catalogue. Personal shoppers 9 a.m. to 5 p.m. Mon. to Friday, Saturday 10 a.m. to 1 p.m.

# Armstrong QUALITY TUNERS

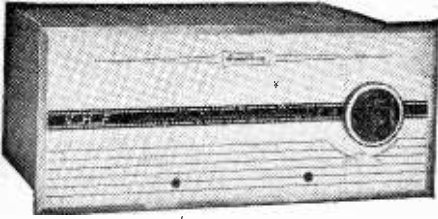

## Designed to match any amplifier or tape recorder

**T4B FM TUNER** (illustrated) £20.8.0

**T4C FM TUNER** (without case) £17.19.0

**ST3 MK.2 AM/FM TUNER** £25.12.0

We also make a wide range of high fidelity amplifiers and tuner-amplifiers, both mono and stereo, all of which offer top quality performance at reasonable prices.

The T4B model (and uncased version—T4C) is a self-powered high fidelity FM Tuner. Automatic frequency control ensures complete stability and the cathode follower stage, together with the variable output control, enables it to be used with any amplifier or tape recorder. All these features are to be found also in the ST3 Mk.2 AM/FM Tuner together with coverage of the medium and long wavebands. The AM section includes a ferrite aerial and two IF stages ensuring good Continental reception and there is a miniature bright-line indicator for easy tuning.

The case of the T4B Tuner is covered in maroon vinyl-hide, making an attractive shelf-mounted unit.

Write for descriptive literature (quoting Dept. PMT) to

**ARMSTRONG, WALTERS ROAD, LONDON, N.7.**

**NORTH 3213**

## VALVES SAME DAY SERVICE NEW! TESTED! GUARANTEED!

**SETS** 1R5, 1S5, 1T4, 3S4, 3V4, DAF91, DF91, DK91, DL92, DL94 .. Set of 4 for 19/-  
DAF96, DF96, DK56, DL96 .. .. . 4 for 28/6

1A7GT 11/-	6LD20 8/-	30L15 11/-	6BC33 5/-	EY51 7/6	U26 12/-
1D5 7/6	6P23 8/6	30P4 12/6	EBC41 8/-	EY86 7/6	U26 9/3
1H3GT 9/-	6P23 11/6	30PL13 12/3	EBF30 8/-	EZ40 6/9	U30 5/6
1N5GT 9/-	6Q7G 6/-	35A5 15/9	EBF89 8/9	EZ41 7/-	U52 4/6
1R5 6/-	6Q7GT 8/-	35L6GT 8/3	EBL21 13/6	EZ80 6/9	U73 4/6
1S4 8/-	6SL7GT 5/9	35Z3 15/-	EBL31 17/-	EZ81 6/6	U191 14/6
1S5 5/3	6SN7GT 4/9	35Z4GT 5/6	ECC40 15/6	GZ32 8/6	U281 10/6
1T4 3/6	6U4G T 9/9	50L63 6/9	ECC81 4/9	KT61 9/6	U282 15/-
1U5 5/9	6V6G 4/8	185BT 21/8	ECC82 4/9	KTT1 8/-	U291 16/6
2P 22/6	6V6GT 7/3	AZ1 12/6	ECC83 7/-	MU14 6/6	U301 17/-
3A5 9/-	6X4 4/6	AZ1 9/6	ECC84 7/9	MX40 13/6	U801 21/-
3Q4 7/-	6X3GT 6/9	CBL1 12/-	ECC85 7/9	no id	UABC80 6/6
3S4 6/-	6X3L2 9/-	CBH35 13/6	ECP80 7/-	N37 11/-	UAF42 8/3
3V4 7/-	7B6 8/-	CL33 12/3	ECP82 8/6	PCC84 7/6	UBC41 7/9
5U4G 4/6	7B7 8/-	CY1 12/6	ECH35 7/3	PCC89 9/3	UBF80 8/3
5V4G 8/-	7C 7/9	CY31 8/6	ECH42 8/9	PCF80 7/9	UBF89 8/-
5Y3GT 8/-	7C6 7/6	DAC32 9/-	ECH81 7/9	PCF82 5/-	UBL21 14/6
6B46 9/-	7HT 7/6	DAF91 5/3	ECL80 7/6	PCF36 8/6	UCC34 13/3
6AL5 3/9	7S7 8/-	DAF96 7/6	ECL82 9/9	PCL82 9/-	UCC85 7/6
6AM6 3/6	7Y4 6/-	DCC90 9/-	ECL83 7/6	PCL83 10/6	UCF90 14/6
6AQ5 6/3	10C1 12/-	DF33 9/-	EF9 15/-	PCL84 7/-	UCH21 13/6
6AT8 6/-	10C2 16/6	DF91 3/6	EF37A 1/9	PCL85 10/6	UCH42 8/-
6B46 5/9	12A T6 7/-	DF96 7/6	EF39 4/6	PENA4 11/-	UCH81 8/9
6BE8 6/6	12A T7 4/9	DH76 4/9	EP40 11/6	PEN36C 8/-	UCL33 13/3
6BG6G 14/6	12A U7 4/9	DH77 6/-	EF41 7/9	PL36 11/6	UCL83 13/3
6BH6 6/3	12A X7 4/9	DH81 9/-	EF42 7/6	PL81 9/6	UF41 7/6
6BU6 5/9	12KTGT 4/9	DK32 11/-	EF80 4/9	PL32 7/-	UF89 7/-
6BW6 8/-	12K9GT 9/6	DK91 6/-	EF85 5/9	PL83 7/6	UL41 8/-
6CD8G 27/3	12TGT 4/9	DR36 7/6	EF86 8/9	PL84 8/6	UL84 6/6
6F1 10/-	14S7 15/6	DL96 7/6	EF89 7/6	PL820 12/6	UL1C 8/-
6F13 9/6	19BG6G 14/6	DL33 3/6	EF91 3/6	PX4 10/-	UUT 7/6
6F14 9/6	20F2 17/-	DL35 9/6	EL33 6/6	PX25 9/-	UY21 11/-
6KTG 11/1	20L 17/6	DL92 6/-	EL41 9/6	PY32 11/6	UY41 6/6
6KWS 6/6	20P3 18/9	DL94 7/-	EL42 9/-	PY30 7/6	UY85 6/6
6K8G 5/-	20P4 20/-	DL96 7/6	EL84 9/6	PT81 7/-	VP4B 9/6
6K8GT 9/-	20P5 15/9	DM70 6/6	EM34 7/3	PY82 6/6	VP41 5/6
6K25 12/6	25L6GT 7/-	EAB80 4/9	EM80 8/-	PY83 7/9	W76 5/6
6L3 6/6	25Z4 7/6	EAF42 8/6	EM81 8/6	PZ30 12/6	W77 3/9
6L18 10/-	27SU 17/6	EB91 3/9	EM84 9/6	TH21C 15/-	Z77 3/6

## FIRST-CLASS RADIO AND T/V COURSES... GET A CERTIFICATE!

After brief, intensely interesting study—undertaken at home in your spare time —YOU can secure a recognised qualification or extend your knowledge of Radio and TV. Let us show you how.

**FREE GUIDE**  
The New Free Guide contains 123 pages of information of the greatest importance to both the amateur and the man employed in the Radio industry. N.I.E. provides first-rate postal courses for **Radio Amateurs' Exam., R.T.F.B. Servicing Cert., C. & G. Telecoms., Grad. Brit. I.R.E. Guide** also gives details of range of diploma courses in **Radio/TV Servicing, Electronics** and other branches of engineering, together with particulars of our remarkable Guarantee of

**SUCCESS OR NO FEE**  
Write now for your copy of this invaluable publication. It may well prove to be the turning point in your career.  
**FOUNDED 1885—OVER 150,000 SUCCESSSES**

**NATIONAL INSTITUTE OF ENGINEERING**  
(Dept. 461), 148 HOLBORN LONDON, E.C.1  
S. Africa: P.O. Box 8417, Jo'burg.  
Australia: P.O. Box 4570, Melbourne.

**READERS RADIO**  
24 COLBERG PLACE, STAMFORD HILL LONDON, N.16 STA. 4587

Post 6d. per valve extra.  
Any Parcel Insured Against Damage in Transit 6d. extra.  
Any C.O.D. Parcel 3/- extra.

# MAINS superhet RECEIVER

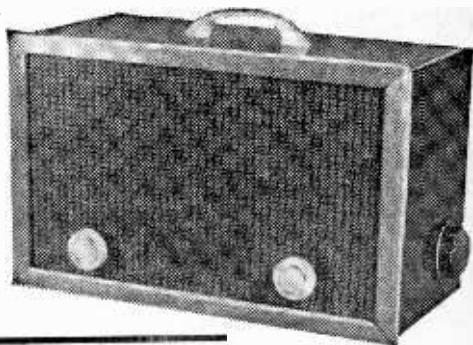

by V. E. Holley

**T**HIS handy little receiver will give a good account of itself in the less favourable reception areas where simpler sets are inadequate. A directional aerial enhances the selectivity of the superhet circuit so that a good performance on the crowded medium waveband is obtained without excessive sideband cutting.

### Mixer and I.F. Stages

Referring to Fig. 1, it will be seen that the signal from the ferrite rod aerial is applied via the switch S1, to the grid of a frequency changer valve, 12AH8, the capacitor C1 being included so that the lower ends of the aerial windings can be returned to earth and a.g.c. can be applied in the parallel mode to the grid.

Switches S2 and S3 select the oscillator coil appropriate to each waveband and signal and oscillator frequencies are combined in the valve to produce in the anode circuit the difference frequency of 465kc/s. The valve V2, which accepts

and amplifies the signal at intermediate frequency, is a high slope variable-mu pentode, 6BA6, in a conventional circuit, the screen receiving its supply through the voltage dropping resistor R5, decoupled by capacitor C11.

This network also supplies the screen of V1 but as the valves work at different frequencies, there is no inter-action.

### Detection and A.G.C.

It was intended to use a pair of germanium diodes here until it was noticed that a double diode valve and its base could be obtained ex-equipment at considerably less cost. The constructor who has diodes of the GEX34 type available, however, may substitute them directly for V3 in Fig. 1 without any alteration in the performance of the receiver. (The red ends of the diodes correspond to the cathodes of the 6AL5.)

A.G.C. voltage is derived from the primary of the second i.f. transformer. The voltage available

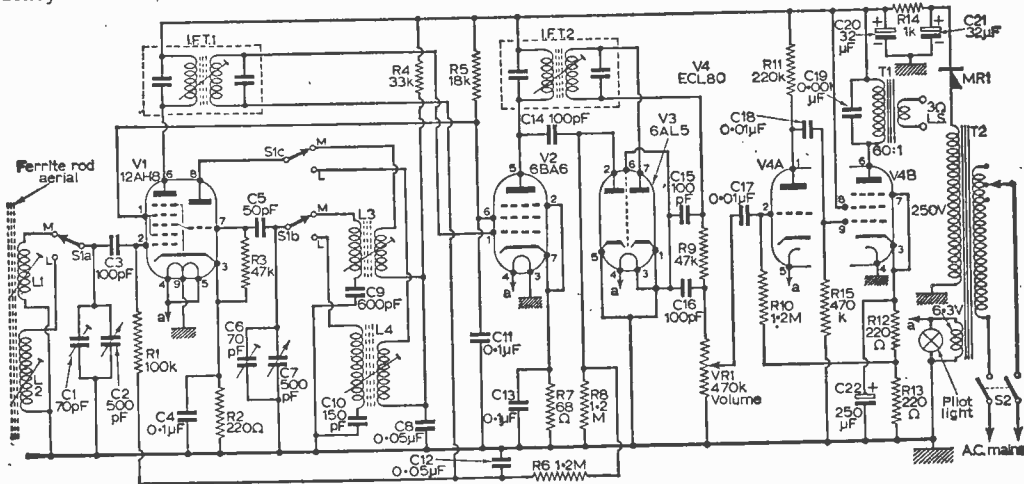

Fig. 1: The circuit.

at this point is considerably greater than that at the secondary, making the gain control that much more effective. The insulation of the capacitor C14 is important and a good quality mica component should be used.

Resistor R8 is the a.g.c. diode load and the filter R6, C12, removes the i.f. and audio components before the voltage is applied to the grids of the controlled valves. It will be noticed that the sensitivity to weak signals is limited by the absence of a delay voltage in the a.g.c. system, but a receiver of this sort would not normally be used for reception of weak and distant transmissions.

The second diode in V3 demodulates the signal for a.f. amplification, the filter network C15, R9, removing the now unwanted intermediate frequency before the signal is passed via the volume control, VR1, to the a.f. and output stages.

**A.F. Stages**

Portability imposes its limitations and in order to keep the power-pack down to a reasonable size and weight, a.f. amplification and power output are obtained from a triode-pentode valve ECL80, which has only a modest current requirement.

The triode section is employed as a resistance coupled amplifier with an anode load of

220kΩ, while to provide the optimum bias, the grid resistor of 1.2MΩ is returned to a tapping on the cathode resistor instead of to earth as would be done if there were a separate triode cathode.

The pentode section provides a power output of about 1½W. The optimum load is 11,000Ω and for a 3Ω loudspeaker, the output transformer ratio should be about 60 to 1. Connected across the primary is a capacitor, C19, which corrects the response at the higher audio frequencies. The cathode network which is common to both sections of the valve, must be bypassed by a large capacitance and C22 should not be less than 250µF.

The overall gain of the two stages, though adequate, is not high and no trouble is likely to be experienced with hum. The residual hum level of the receiver is very low and can be reduced to inaudibility if desired by some additional smoothing in the anode circuit of V4A, as shown in Fig. 2.

**Power Supply**

An h.t. supply of about 45mA at 200V is required and the valve heaters and dial light need 1.5A at 6.3V. A double wound miniature mains transformer reduces mains borne interference to a minimum and makes the chassis safe to handle at all times.

It has a 250V half-wave secondary which feeds a contact cooled metal rectifier, MR1. Smoothing is provided by the resistor R14 and the two electrolytic capacitors, C20 and C21, which may of course, be one double component if desired.

Many miniature transformers do not have tapped primaries, so that the h.t. secondary voltage may vary somewhat with the mains voltage. The

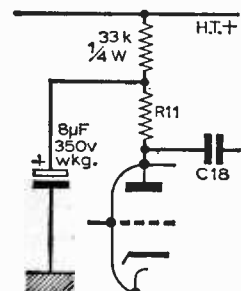

Fig. 2 (above) : Additional smoothing to reduce residual hum.

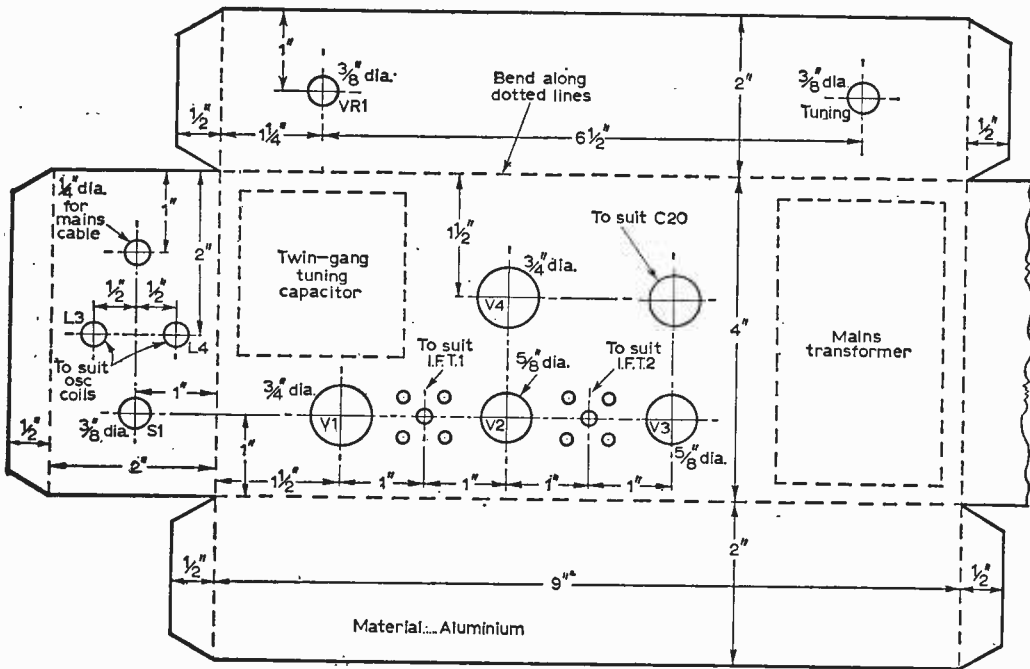

Fig. 3: The chassis drilling details.

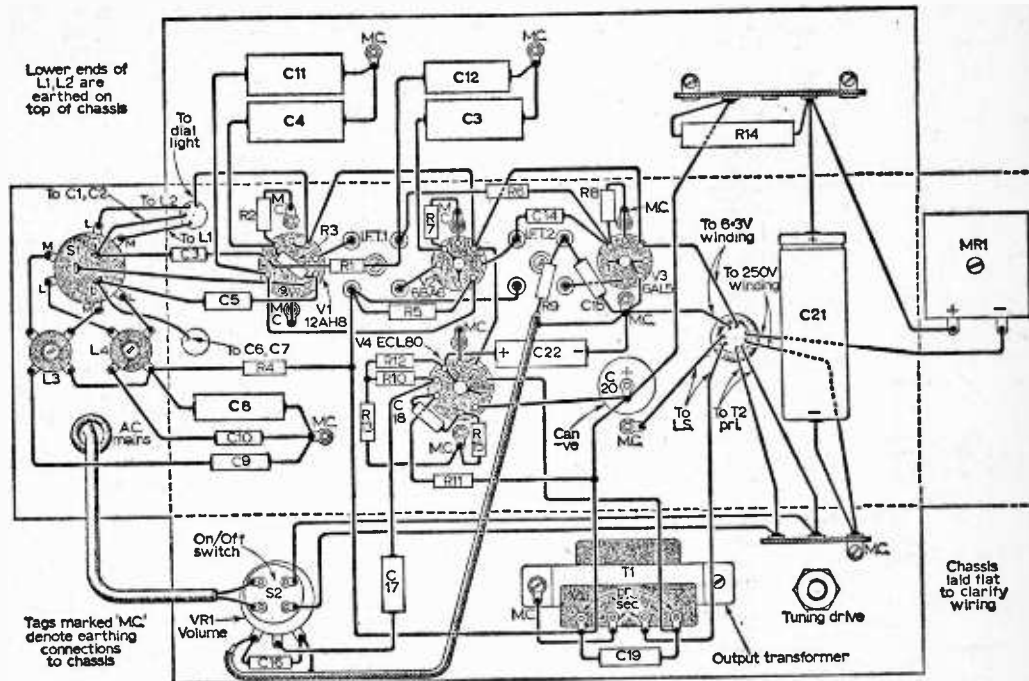

Fig. 4: The complete wiring diagram.

value of R14 may therefore need to be adjusted to produce the correct h.t. line voltage of 200 in the receiver. Mains switching is incorporated with VR1.

**Components**

To simplify alignment, fixed padding capacitances are used in the oscillator circuits, but this will be satisfactory only if the oscillator coils are designed for use with the particular ferrite rod aerial employed and the capacitances are those recommended by the manufacturer.

The values shown in Fig. 1 for C9 and C10 are typical but not universal. The mains transformer must be a miniature and the i.f. transformer should not be larger than 1in. square. All the other components can be standard and, as there is nothing critical about them, the constructor can use anything he has to hand which is electronically suitable and can be fitted in.

**Construction**

The receiver is constructed on a chassis of 18s.w.g. sheet aluminium, 9in. x 4in. x 2in., the details of which are given in Fig. 3.

A rough wooden box should then be made in which the chassis can be suspended upside down by its end flanges while the wiring is carried out. Tinned copper wire of 22s.w.g. is suitable for this, covered with sleeving in the case of connections more than 1in. or so in length.

Fig. 4 shows all the under chassis wiring with the connections opened out for clarity. The only really critical point is the lead to the grid of V2; if instability is experienced, it will almost certainly be due to pick up here and screening may be required even though the lead is short.

**Aerial**

The method of securing the aerial will vary somewhat according to the fittings if any, supplied with it. If there are none, a satisfactory arrangement is a bracket of 18s.w.g. aluminium to the measurements given in Fig. 5. Fit rubber grommets in the two 3/8in. holes and pass the aerial rod through them. This assembly can conveniently be supported, as in the illustration, at a height of about 4 1/2in. above the chassis on a strip of 16 gauge aluminium 5in. x 1in., having 1/2in. turned at right angles at the bottom for bolting to the deck of the chassis.

**Tuning Drive**

The not inconsiderable expense of a tuning drive and scale is avoided by the arrangement shown in Fig. 6. The drive spindle is a discarded volume control with the body removed and carries a brass pulley from a well-known constructional toy drilled out and soldered to it.

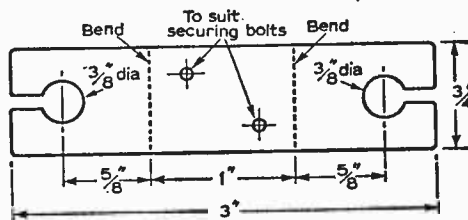

Fig. 5: Details of the aerial mounting bracket.

The drive cord is taken via two more pulleys (a) and (b) fitted to the chassis, to a 2½ in. drive drum on the tuning capacitor, engaging on the way with a cursor which is free to move along the length of an aluminium plate, 5 in. x 1¼ in., secured to the front chassis runner. The plate should be mounted on two 1 in. long bolts and positioned by distance pieces or nuts far enough from the chassis runner to permit the drive cord to

there are no shorts in the h.t. wiring. Power can then be applied and the presence of voltages at the valve electrodes verified with the meter. Measure the h.t. rail voltage. It should be between 200 and 210V and if it is not, the value of R14 should be altered to bring it within this range.

#### I.F. Alignment

If pre-tuned transformers have not been used, it

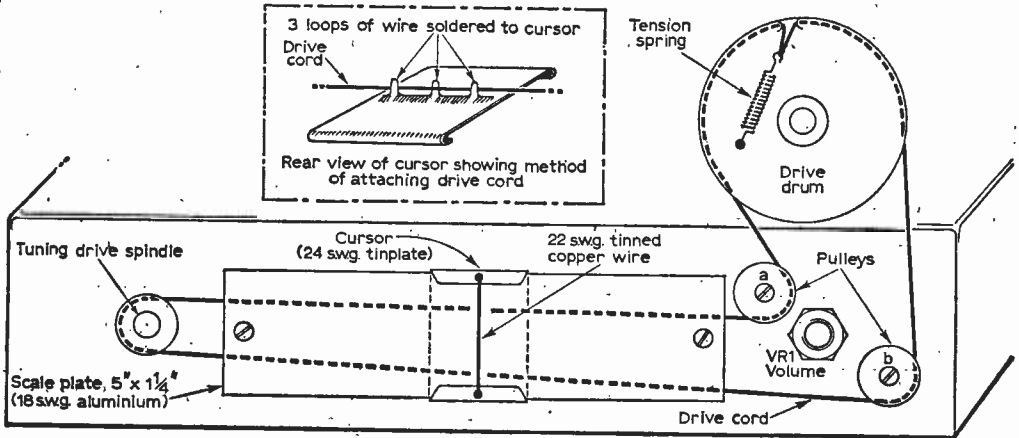

Fig. 6: The tuning drive assembly.

pass freely behind it. The exact position of pulley (b) in Fig. 6 is unimportant but (a) should be positioned so that the upper drive cord which engages the cursor is horizontal. The cursor is of 24s.w.g. tin plate.

Any arbitrary horizontal scale can be affixed to the aluminium plate or, alternatively, the plate can be painted matt black and the scale can

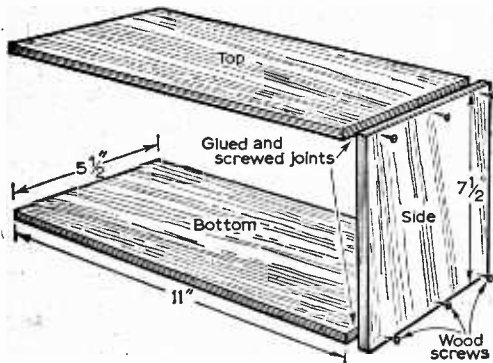

Fig. 7: The construction of the cabinet.

be engraved on the perspex window in the front of the cabinet. This was done in the prototype, using a section of a scale on perspex found in a piece of ex-Government equipment.

#### Testing

Before switching on, apply a meter on a high ohms range between C21 and chassis to see that

will be necessary first to align the i.f. amplifier with the aid of a signal generator. Inject a signal of 465kc/s at the grid of V1 and adjust the transformer cores for maximum response; the best indication of resonance is a high resistance d.c. voltmeter connected across VR1, positive to chassis, but if this is not available, a modulated signal can be used and the result observed with an output meter or judged by the sound output from the speaker. Keep the generator signal to the minimum necessary for adequate response.

#### R.F. Alignment

Start with the medium waveband. Normal coverage for a circuit of this sort with a 500pF tuning capacity, is from 1550kc/s to 515kc/s, and the first step is to obtain this. Set the medium wave aerial coil about ¼ in. from the end of the rod, open the gang capacitor fully and inject a 1,550kc/s signal by bringing the generator output lead into the vicinity of the aerial. Tune for maximum response with the trimmers C1 and C6.

Next, close the capacitor fully, inject at 515kc/s and adjust the core of L3 and the position of the aerial coil upon the rod for optimum response; secure the coil in position with a little beeswax. It now remains to track the oscillator. Using a signal of 1,450kc/s, manipulate the tuning capacitor and the trimmer C6 to find the combination of settings for maximum response; note the scale position carefully (point A). (If the scale is not fitted, mark the position of the cursor on the scale plate).

Inject now at 600kc/s and by manipulation of the tuning capacitor and the core of L3, again find the optimum combination and note the scale reading (point B). Repeat the adjustments at both



**COMPONENTS LIST**

**Resistors:**

R1 100kΩ	R9 47kΩ
R2 220Ω	R10 1.2MΩ
R3 47kΩ	R11 220kΩ
R4 33kΩ ½W	R12 220Ω
R5 18kΩ 1W	R13 220Ω
R6 1.2MΩ	R14 1kΩ 5W
R7 68Ω	R15 470kΩ
R8 1.2MΩ	VR1 470kΩ log.

(All ½W except where otherwise specified)

**Capacitors:**

C1 70pF trimmer	C11 0.1μF
C2 500pF gang	C12 0.05μF
C3 100pF	C13 0.1μF
C4 0.1μF	C14 100pF (mica)
C5 50pF	C15 100pF
C6 70pF trimmer	C16 100pF
C7 500pF gang	C17 0.01μF
C8 0.05μF	C18 0.01μF
C9 600pF	C19 0.001μF

C10 150pF	C20 32μF electrolytic
C21 32μF electrolytic	
C22 250μF electrolytic, 15V	

(350V wkg. unless otherwise stated)

**Valves:**

V1 12AH8, B9A base.
V2 6BA6, B8G base
V3 6AL5, B7G base or two diodes GEX34 or similar
V4 ECL80, B9A base

**Dial Light:**

6.3V 0.3A

**Rectifier:**

250V, 50mA contact cooled

**Transformers:**

Mains 250V, ½-wave, 45mA, 6.3V, 1.5A.  
Output Ratio 60 : 1 for 3Ω speaker.  
I.F. 465Kc/s miniature (2 required).

**Coils:**

Ferrite rod aerial for long and medium wavebands with oscillator coils to suit.

points till no further improvement can be obtained, finishing off at point A.

Turn now to the long waveband. Close the gang capacitor fully, inject a signal of 175kc/s and adjust the core of L4 and the position of the aerial coil for maximum response. Tune in the Light programme on 200kc/s and check that the capacitor and the core of L4 are in optimum combination. Seal L2 in position with wax. Do not alter the settings of the trimmers C1 and C6.

transmissions at or near the ends of the band from which a close approximation can be made. The frequencies of the transmissions selected for alignment points A and B are not unduly critical or difficult to find; Radio Luxembourg (1439kc/s) and the BBC Third programme (647kc/s) will be suitable in many areas.

On the long waveband, set L2 about ¼in. from the end of the rod and manipulate the tuning capacitor and the core of L4 for optimum reception of the Light programme on 200kc/s. Adjust L2 for maximum and repeat once; fix L2 in position.

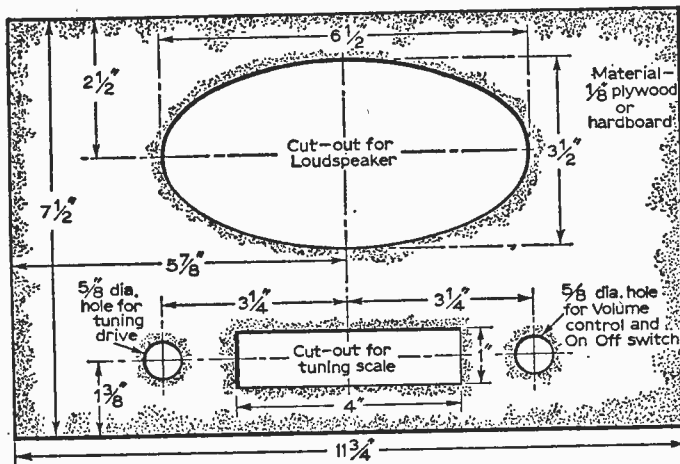

Fig. 8: Details of the front of the cabinet.

**Alignment with no generator**

This can be accomplished satisfactorily provided the i.f. transformers are pre-tuned. Commence with the medium wave signal and oscillator circuits as already described, using identifiable broadcast transmissions in place of the generator signals.

It will not be possible, of course, to check the coverage exactly but it is usually possible to find

top and sides of the cabinet with laminated plastic as used on kitchen working surfaces, etc.

The top should be cut first, very slightly longer than the cabinet and ¼in. wider than the depth, so that when fixed, there will be an overhang of ¼in. at the rear, into which the back of the cabinet can be fitted. Fix it with the special impact adhesive sold for the purpose, taking care that the two

(Continued on page 1030)

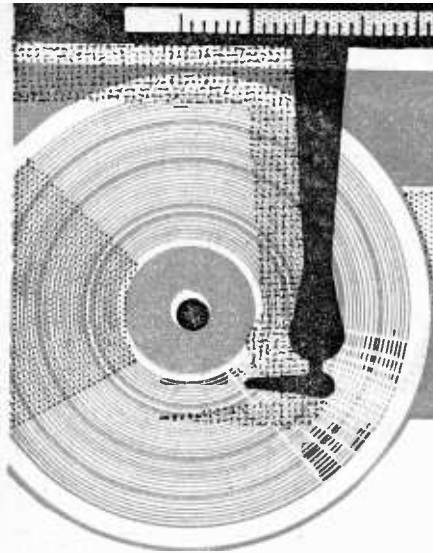

# PARALLEL TRACKING UNIT

by E. H. GREEN

## Advantages of the Design

In the unit described here the tracking error has been eliminated and the record wear is about one-eighth of the normal value. The weight of the whole moving system is below 1½oz, including bearings, crystal cartridge and counterweight. Due to the method of construction it is impossible to measure any side load required to move the pick-up, thus the record wear is due solely to the tracking weight and the small inertia forces.

Due to the small inertia of the pick-up arm in the vertical direction the distortion due to the "pinch" effect is reduced. It is recognised that the pinch effect is a greater source of distortion than the tracking error.

The unit may be expected to give excellent

ALL disc records are produced by the cutting head moving across the record in a straight line passing just in front of the turntable spindle; this being for accuracy of movement and differential groove spacing. Most pick-ups move over an arc of a circle, this bringing in a tracking error which is to a certain extent counteracted by offsetting the head angle and making the needle swing slightly forward of the centre spindle, as shown in Fig. 1.

As the pick-up arm is increased in length the tracking error is reduced and an arm of infinite length, or parallel tracking, would produce no error.

## Record Wear

There are two types of record wear, assuming the stylus is in good condition; (1) that due to the stylus downward pressure on the record and (2) that due to the stylus side load, moving the whole weight of the pick-up together with the bearing friction. The latter cause is sometimes in more expensive units, counteracted by offsetting the pick-up bearings, but there is still the inertia of the arm to overcome due to the acceleration of the arm inwards. The inertia loads of standard pick-ups, although small, are nevertheless quite real.

The value of the side force due to bearing friction is quoted as between 0.3 and 0.5 grammes in commercial pick-ups, which is more than the inertia loads, this being eliminated in the present design.

It is known that since the centre hole of a record is larger than the centre spindle of the turntable, in most cases a slight oscillatory motion of the stylus takes place. This motion must be transferred through the stylus to the arm and in doing so exerts a force on the record groove to counteract the inertia force of the pick-up arm. The weight of an average hi-fi tracking arm varies from about 5oz upwards to 11lb or more and, although the stylus pressure may be only five grammes, this whole weight must be moved bodily across the record together with the oscillatory motion. The main record wear is thus due to inertia forces and not the tracking weight.

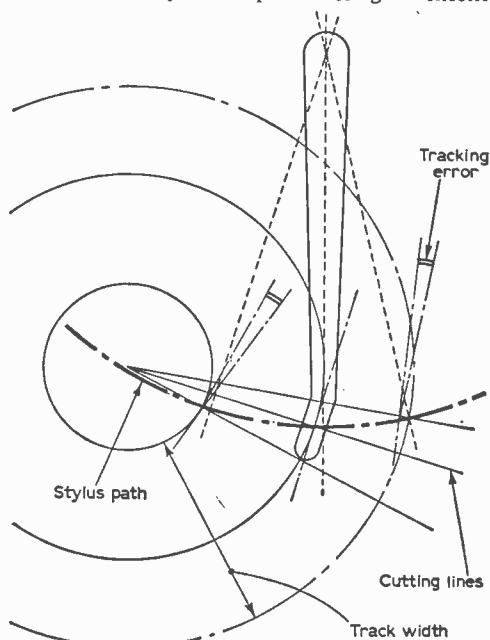
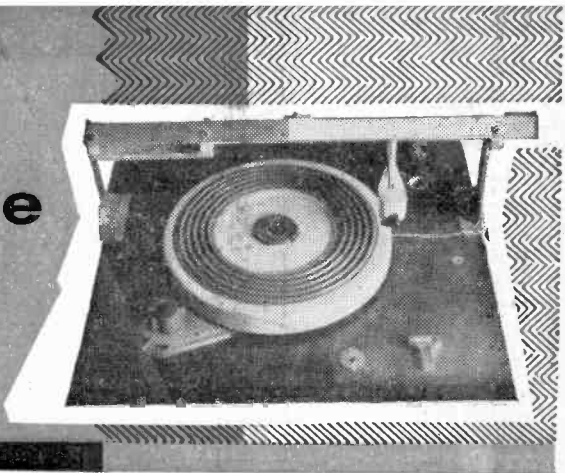

Fig. 1: Illustrating the tracking error to which the normal type of pick-up is subjected.



# to minimise record wear



reproduction and reduced record "talk" from the needle, this latter being mainly due to the tracking error. However, a certain amount of adjustment is usually needed in setting up the equipment and eliminating any resonance in the moving part, particular attention being paid to the cartridge housing. An additional facility of the unit is that it enables the stylus to be put down anywhere on the record and removed without the risk of

square blocks which are attached to the main V-bed. One of the brackets has an elongated hole to allow for horizontal alignment, a detailed sketch being shown in Fig. 4.

All materials are light alloy and the V-bed may be made by either bending a strip or by using a piece of corner angle as used in furniture manufacture. If these are not available brass may be used, but steel or any ferrous metal is not recom-

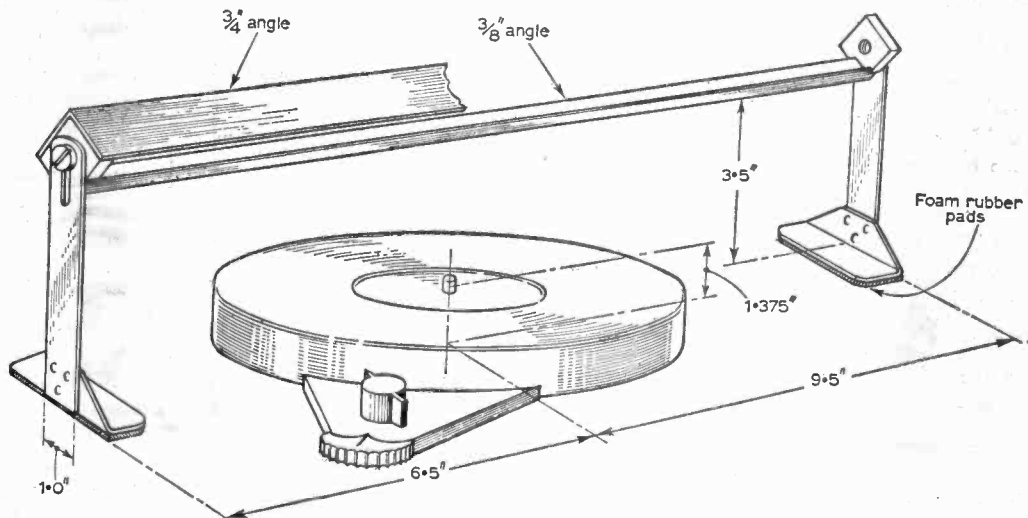

Fig. 2: The general construction of the cartridge running angle.

damage, as is easily done with conventional arms. It was found to perform very well with stereo cartridges and is useful for dubbing into a tape recorder, almost any passage being easily "logged" by the pick-up and scale.

## The Basic Design

The cartridge is mounted on a small arm attached to a running angle and a larger V-bed is fixed across the turntable as shown in Fig. 2. Two small ball bearings are placed between the two units and the pick-up runs on these, being counter-balanced by a thin wire and a small weight.

The main framework consists of two vertical brackets fixed to the motor board carrying two

mended as it will induce hum into the pick-up leads.

The ball bearings are 1/4 in. car hub types and should have a very good surface finish.

## The Pick-up Assembly

The pick-up assembly is shown in the dimensioned drawing in Fig. 3, all the pieces being 20s.w.g. alloy. Small triangular stops are glued in position as shown to limit the travel of the



**continued over**

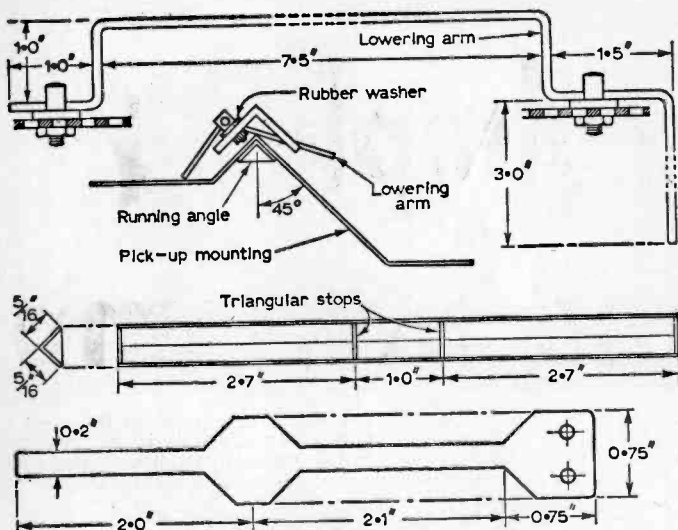

Fig. 3: Details of the lifting mechanism.

balls, the dimensions given being adequate to cover the standard 12in. l.p. with  $\frac{1}{4}$ in. ball bearings. If the balls are of a different size the lengths can be calculated as follows: length of half-section = half travel length across record plus ball diameter. If the difference is too great the dimensions of the running angle and V-bed may need adjusting.

The bent arm is glued to the running angle as shown, the angles being only approximate. The glue used may be either clear Bostic or Araldite, care being taken to clean all the surfaces thoroughly if the latter is used.

**The Lifting Mechanism**

A bent piece of thick wire pivots on the top cover and bears on the rear of the pick-up assembly, the movement of the lever raising or lowering the pick-up. The wire, shown in Fig. 3 is long enough to allow the pick-up to be placed on the record in any position, a rubber washer

supplying the friction to keep the wire in place.

**The Cartridge Assembly and Mounting**

The cartridge used in the original unit was the GC8, but the dimensions used will suit most turnover units. The lead-out wires are of 40s.w.g. enamelled or cotton covered wire and they are glued to the arm and led over the top of the running angle. Bostik or rubber solution being used for this purpose. After leaving the pick-up the wires are parted in a semicircle, as can be seen in the photographs, and pass through a small hole in the base-board. The wires should have sufficient length not to foul the movement of the pick-up along the bed for the width of the record.

The assembly is now placed in position on the base-board, small pieces of thin foam plastic being placed between the brackets and the board to spring the unit slightly. Place a record on the table and lower the pick-up on to it; ensure that the needle is running upright and not "digging in". The V-bed and running angle should be polished before assembly and occasionally during use as any roughness on these surfaces will impede the movement of the pick-up. Position the V-bed so the needle runs along a path exactly through the centre of the turntable spindle.

**The Cartridge Housing**

When the assembly has been finally positioned the cartridge is covered with a balsa wood and cardboard housing as shown in the photographs, the size being adequate to cover the turnover unit and is better to be larger than really necessary. The balance weight is mounted on a thin wire glued to the rear of the pick-up, the weight being a small collar and grub screw.

**Final Adjustments and Testing**

Before any record is played the balance weight is adjusted to give about five grammes or less as recommended by the pick-up cartridge manufacturer. It is possible to reduce the weight to zero, but a limit will be reached when the needle will jump out of the groove on loud passages as the reaction of the needle is not horizontal but has a vertical component which tends to push the needle out of the groove. On the front of the top cover is glued a scale marked in tenths of an inch and showing the let-down positions for 7, 10 and 12in. records, the marks corresponding to a line on the pick-up.

It is important to push the pick-up to the centre, beyond

(Continued on page 1050)

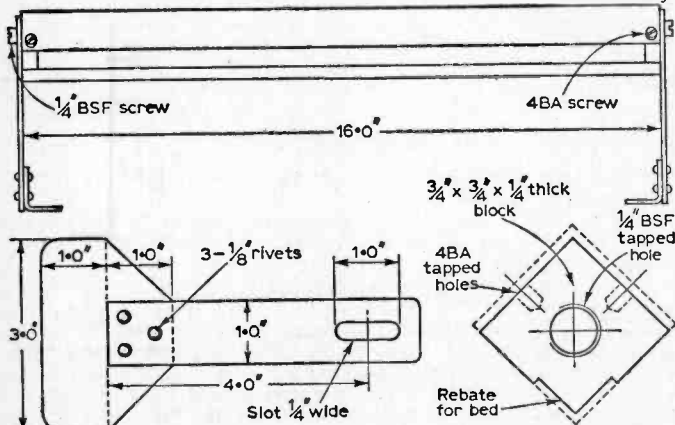

Fig. 4: Details of the running angle and its supports.

By A. Cole

# Quality Amplifier

(Continued from page 911 of the February issue)

## THE PRE-AMPLIFIER

# and pre-amp

**T**HE pre-amplifier to be described is intended for those constructors who have built the main amplifier described in the two previous issues, but do not wish to build the tuner to be described in next month's issue, either because they already have another tuner they wish to use, or because they just desire a powerful gramophone-record or tapedeck amplifier system.

As was mentioned in the first article the sensitivity of the main amplifier is hardly sufficient for many high-fidelity pick-ups, so that for such a pre-amplifier is required, if one desires to maintain the high quality given by these types and not to revert to pick-ups of lower quality but higher output voltage.

The one-valve pre-amplifier here described is also usable for a large variety of general purposes requiring additional input amplification at audio frequencies, and on account of its simplicity and reasonably small size it may usually be mounted within the cabinet of equipment requiring it, and can be fed from the internal power-supplies of such equipment. A pre-amplifier of this type would also form a most useful "experimental brick" to have available in the workshop.

There is thus certainly every good reason for including this small article within this series. However, it is not intended to continue and conclude this text just with a description of the function of a single-valve audio-amplifier stage. This is so elementary, that very little would need to be said, and such theory has often enough appeared adequately-phrased for the beginner in other parts of this journal. It is, therefore, intended to devote the rest of this article to a clear discussion of some important points involved in the use of even such a simple circuit, which are probably by no means such common knowledge as the functioning of the pre-amplifier itself.

### Hum Reduction

The heater supply for the pre-amplifier should come from a heater winding on the power supply which is not in any way connected to chassis, the commoning to chassis for one side being carried out at the pre-amplifier, as shown in the wiring diagram, Fig. 2. There is no danger to equipment if the heaters do not obey this specification, being already earthed at the main chassis since the supply is common to the valves there too, but hum

levels are likely to be raised somewhat then. The h.t. negative should be earthed at all chassis involved, serving as the inter-chassis earthing.

Minimum hum is theoretically obtained if the screening of the cable from the preamplifier output (P2) to the main amplifier is earthed only to the main amplifier chassis, and if the screening of the input cable to the pre-amplifier is earthed to the pre-amplifier chassis at P1 and forms the only earth connection path for the input signal source. In the former case, for the output cable from pre-amplifier to main amplifier, there is in practice very little difference if the screening is earthed at both ends, which is probably more convenient in fitting the plugs. As far as hum alone is concerned, this is usually true also for the pre-amplifier input cable. But there is another most important consideration demanding that the cable

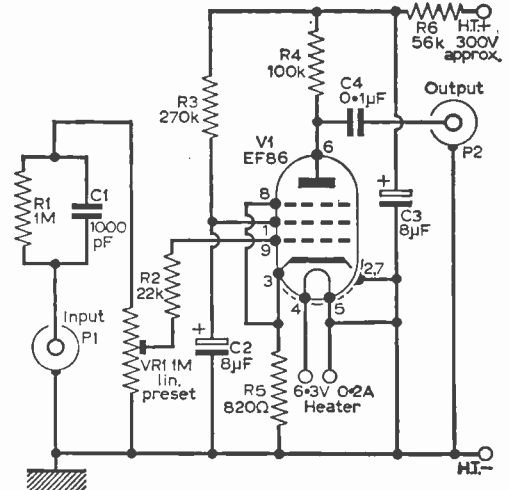

Fig. 61 The pre-amp circuit.

feeding the input signal to the pre-amplifier, to P1, should have its screening earthed to the pre-amplifier chassis at P1 and should carry earth connection to the signal source on its screening, the signal source receiving no other earth whatsoever.

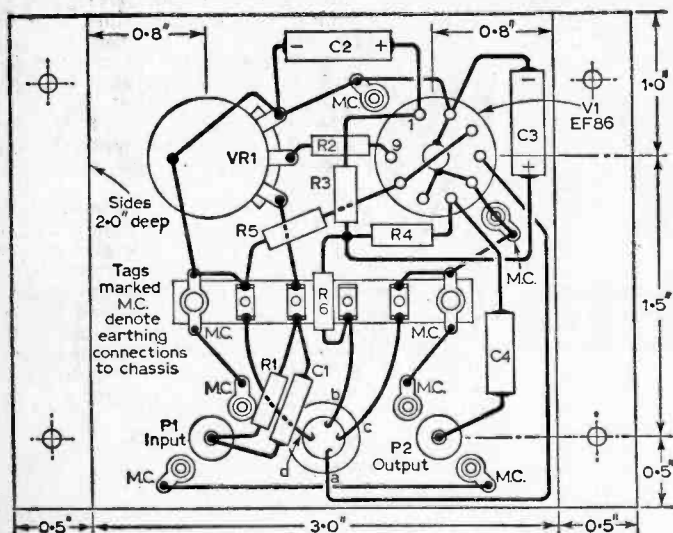

Fig. 71 The complete wiring diagram.

### Positive Feedback Loops

Failure to observe this last condition runs the danger of causing the whole system to go into violent oscillation, because of positive feedback applied between the main amplifier output and the pre-amplifier input via crossed multiple earths. The frequency of this oscillation will normally be high, and is very often even supersonic, so that it is manifested merely as a reduction in tone quality and early failure of the output valves in the main amplifier, for reasons explained below, if one does not observe the output on an oscilloscope.

In less severe cases oscillation may not be permanently present, but may be triggered off by some transients of the signal proper, especially on bass-transients, then dying out after a few cycles. The actual feedback frequency is often not audible, but, because it over drives the amplifier, it cross

modulates with bass and treble present in the signal proper being amplified, giving severely bad tone on transients.

If the input stage of a high-gain amplifier system receives any sort of casual, haphazard earthing, a part of its actual effective earth-path may turn out then to be common to the actual effective earth-path of the output load (loudspeakers) of the main amplifier. A voltage developed across this wire will be applied to the amplifier input and thus the conditions for instability are present.

The size of the unwanted feedback-voltage will be directly proportional to the loudspeaker current and to the self-resistance of the common earthing section. If we have an output power of 20W peak feeding a 5Ω loudspeaker system, the loudspeaker current will be 2A. If the input sensitivity of the main amplifier

plus pre-amplifier is 2MV for full power output, it only needs a thousandth of an ohm common earth-resistance in the loop to cause instability. A mere inch of connecting wire can have this resistance or more, so that instability is virtually unavoidable if the pre-amplifier input is given a multiple earth connection. The reason for the specified earthing method should now have been made quite clear.

### Pre-amplifier Earthing

If the main amplifier is used alone, the required input for full output power is about 200mV, so that some two or three yards of common earthing are needed before a feedback voltage of this magnitude is set up.

If the full-power output of the amplifier were less, loudspeaker current maxima are less, so that for the same gain, larger earthing loops are tolerable before instability occurs. It is thus clear that the dangers of this form of instability are particularly great for high power output (push pull) amplifiers, as soon as these are brought to high gain by fixing up a pre-amplifier at the input. More cases of failure, or disappointment at result poorer than expected, in high power audio amplifiers may probably be attributed to this cause than to any other single cause except v.h.f. parasites due to improperly designed grid circuits.

The only certain way of avoiding this trouble in a high power amplifier with pre-amplifier is to give the entire pre-amplifier input grid circuit only one single earthing point, located near the valveholder on the pre-amplifier chassis. The many earthing tags on the tiny chassis of the pre-amplifier (Fig. 7) are for better contact, and are to be considered a single point at the frequencies concerned, though this would no longer be true at v.h.f., where true single contacts would be needed, and are familiar practice.

### Dangers of Over-Drive

An important point in the operation of

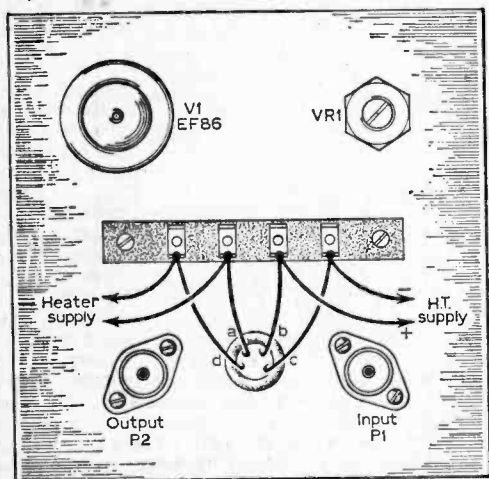

Fig. 81 The above-chassis layout of components.

Class-A or Class-B push-pull audio amplifier using high power valves other than triodes is that strong over-drive, especially such as present if the amplifier is unstable and goes into oscillation, causes the severest strain on the output valves. This is because inductive transfers of surges, via the output transformer windings, can totally remove all anode voltage from each valve on a portion of each cycle. This results in powerful current-pulses on the screens, possibly far beyond the peak ratings of the valves. This is easily observed as a powerful glow in the over-driven valves, due to the screen-grids going bright red-hot. Readers who have observed this phenomenon may have been very puzzled, as a meter in the main h.t. supply shows a decrease of total current rather than an increase, but at any rate little significant change, in a class-A push-pull stage.

It is thus most necessary to avoid permanent supersonic instability, quite apart from the deterioration of tone thereby caused, for such instability causes a permanent condition of over-drive in the output stage, giving very much shortened valve life. Overdrive on a signal is also to be avoided.

#### Pre-set Volume Control

For this reason the volume control on the pre-amplifier is made a pre-set type. The proper and correct adjustment of this control is one giving just full-power output at the maximum setting of the main amplifier volume control, with the intended signal source (pick-up) feeding the pre-amplifier.

This setting also minimises dangers of instability, because the total gain is thereby set at a level no more than absolutely necessary.

#### Output Cathode Resistor

The value of the cathode resistor, R25 in Fig. 6 (see January issue), for the main amplifier push-pull output stage has a strong influence on the amount of damage done by prolonged overdrive. If the small value of  $90\Omega$  is used, as specified, to keep the amplifier operating entirely in Class-A, and so give the very best tone quality, dangers of

overdrive are unfortunately at their greatest. The completed amplifier, once a pre-amplifier is fitted and everything finalised in the manner it is intended to be used, should then be checked for supersonic instability with an oscilloscope connected to the output, for all possible settings of the controls. The correct setting of VR1 on the pre-amplifier, to make overdrive impossible with the intended signal source, is also then most important.

Dangers are reduced if R25 is raised to the value of  $130\Omega$  in Fig. 6 of the main amplifier, though strong overdrive still gives noticeable glow on the screens of the output valves. The actual usable output power is in fact increased by this change, but the quality very slightly reduced. It is probably advisable to use the higher value,  $130\Omega$ , for R25 in all cases where various undefined signal sources are to be used, making it impossible to set VR1 on the pre-amplifier to a position preventing overdrive on stronger sources, yet giving adequate output on the weaker ones.

#### Input Signal Equaliser

The network connected between P1 and the top of VR1 in the pre-amplifier should suit the type of pick-up or other signal source which it is intended to employ. The components C1, R1 here specified are to match the Collaro "Studio TX88" pick-up used in the prototype. Manufacturers' instructions should be followed for other pick-up types; and the value of VR1 may be changed if other values are specified. A linear potentiometer should be used for the preset volume control.

#### Other Valves

No other common valve is so well-suited for this pre-amplifier as the EF86, which is specially designed for this function. It has low microphony and special internal-screening. If other types are desired, then the triode-section of double-diode-triode types used in normal superhets in the detector/a.v.c. first a.f. stage are the next most advisable.

(To be continued)

### The World's Largest Valve

What is thought to be the largest thermionic valve in the world will be used for research into the upper atmosphere—sponsored by the Minister of Aviation—at Great Baddow, near Chelmsford. It is 18ft long, over 7ft high, 6ft wide and weighs  $4\frac{1}{2}$  tons. The task of constructing the valve was that of the Admiralty's Microwave Electronics Division of the Services Electronic Research Laboratory at Harlow, Essex.

The valve is a travelling wave tube and will provide 100MW pulses of energy at a frequency of 420Mc/s. Power is obtained by interaction between a radio wave travelling along inside the valve and a beam of electrons travelling at about the same speed. By suitable design it can be arranged that the electrons give up about half of their energy to the radio wave, and thus a very high power can be obtained if a high energy electron-beam is used. To obtain 100MW of radio power, a 250MW beam is necessary, in which the electrons are travelling at  $\frac{4}{5}$ ths the speed of light. The electrons are accelerated to this velocity by means of a modulator which gives pulses of up to 500,000V. at 500A

Practical men know that they save time, and trouble, and money by tackling a job in a practical way.

For every practical man who's seeking a home, or planning a holiday, or looking for a business to buy, here's the modern practical way of going about it. It's a great new weekly called **Property Advertiser & Holiday Guide** and every week it offers you hundreds of opportunities for homes, holidays and businesses from all over the country.

What's more, a new easy-reference system makes sure you find what you want quickly.

**Property Advertiser & Holiday Guide** is the really practical paper with the national coverage. It's from Newnes—the publishers of the famous "Practical" series. Price 4d. every Friday, everywhere!

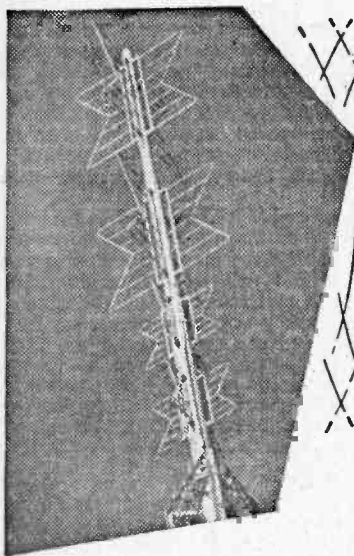

# On Your Wavelength

By THERMION

I MUST commence this month's remarks by thanking all those readers who have sent me copies of the notes which I referred to in the last issue. They had apparently written for details and after making the necessary notes had sent them on thinking I would be interested.

It was very good of them and the thought is appreciated, but as will be seen from the page I had already had details of this particular device. My main interest in this connection is, of course, with the electronic type of device which utilises the more or less standard "Yes" "No" circuits, these being so arranged that they act as switches for the various channels, and so far all those which I have seen have been terribly expensive to make up.

It will be obvious that the first circuit may consist of two relays, transistors or valve circuits only, to provide one of two channels, but then to provide any degree of selection the next channel must consist of at least three circuits, and so on, doubling up in places to provide the necessary alternative routes. This naturally leads to multiple relays or transistors, etc. and the expense steps up alarmingly.

## Old Components

As I have mentioned before, this interest in electronic devices of various types has led to the need to find various components which are not apparently now available, and I become more surprised every day at the number of various bits and pieces which at one time were commonplace but which now, due apparently to the increasing use of transistors and the consequent reduction in size of components, have apparently ceased to be made.

Two items which I recently wanted for a small unit were an ordinary audio transformer and some  $\frac{1}{2}$ W carbon resistors. Many of the shops which I visited only stocked transistor type transformers, and I was informed at two or three shops that the larger "old-fashioned" component was no longer

being made!

The same remarks apply to the carbon resistor. These now all seem to be the miniature ceramic-cased component and it is impossible to modify the value slightly as one could do with the older component, by filing away or scraping the component. Of course, r.c. coupling is now more or less universal in most valve equipment, as it is productive of much higher quality, but the old audio transformer used to be very useful in some circuits.

Those who can remember the early Ferranti components, with their sectionalised windings will probably hold that they gave as high quality as a modern r.c. circuit, without any of the latter's drawbacks, and I wonder if the Rev. Bonavia Hunt has changed his views on this particular item?

For many test set-ups, a 3d. carbon resistor which can be changed in its value is a much more interesting proposition than a 3s. 6d. variable component—and it takes up much less room. No, the modern experimenter seems to be at a much greater disadvantage than many of us "old stagers", who not only had to find out things for ourselves, but had the bits and pieces and the wherewithal with which to do it.

## Two Hints

Now to end this month with two hints which may be found of use by some of those who find their main interest in "do it yourself experimenting". The first concerns the drilling of a chassis after a set has been made up and is working—perhaps for some form of modification.

A hole may be needed in the chassis, and there is a risk of the aluminium dust or drilling swarf getting into awkward or unwanted places in the set. The problem is how to keep it all together till the drilling is completed.

I get the necessary tools together and just before drilling the new hole, put a fairly large dab of Evostik or other rubber cement on both sides of the chassis, round the punch mark where the hole is to be drilled.

Immediately start the drilling, and as the cement is not too quick drying, all the chips and dust remain held fast by the cement.

When the hole is completed leave it for the cement to dry, and then carefully lift the edge of the "dab" with a penknife and peel it off, when it will bring away all the unwanted mess with it.

The other hint is to use a rubber grommet for holding resistors and small diameter capacitors when they may have to pass through a metal screen, and this will hold them firmly (if they are chosen of suitable size) enabling wiring to be carried out to them, removing their weight from the wiring with consequent reduction in the risk of broken connections, and if needed provide all-important screening in the wiring. Just small points but they can be very useful at times.



# R.S.T. VALVE MAIL ORDER CO.

Tel: MITcham 6202  
Open Daily to Callers

211a STREATHAM ROAD, MITCHAM, SURREY.

All Valves Brand New and Fully Guaranteed — Obsolete valves a speciality.  
Quotations given on any type not listed. Send S.A.E.

### Special 24 Hour Express Mail Order Service

AC2/PEN 21/-	ECC85 7/6	EY83 12/6	PCC84 8/6	TDD13C	UU9 7/6	6AK8 7/6	6P28 12/6	12S17 8/-
AC2/PEN 21/-	ECC88 12/6	EY86 7/-	PCC85 9/6	17/6	UYIN 12/6	6AL5 4/-	6Q7 9/6	12SK7 6/-
DD 21/-	ECC91 3/-	EY91 3/-	PCC88 12/6	TH41 27/6	UY21 15/6	6AM5 5/-	6Q7G 6/6	12SN7 10/-
AC/TP 32/-	ECF80 7/6	EZ35 6/-	PCC89 8/6	TY86F 12/6	UY41 7/6	6AM6 4/-	6Q7GT 8/6	12SQ7 8/6
AC/VP1-5-7	ECF82 8/6	EZ40 7/-	PCF83 9/-	U10 9/-	UY85 7/-	6AQ5 6/6	6SA7 7/-	14H7 10/-
	ECH3 21/6	EZ41 7/-	PCF82 7/6	U12 9/-	VMS4B 12/6	6AQ3 9/3	6SC7 8/6	14H7 10/-
AZ1 17/6	ECH21 21/-	EZ80 6/6	PCF84 12/6	U14 9/-	VP4 15/-	6AT6 6/6	6SF5 10/-	14R7 10/-
AZ31 15/-	ECH35 10/-	EZ81 6/6	PCF86 12/6	U22 8/-	VP4A 15/-	6AU6 9/-	6SG7 7/-	14S7 16/-
B36 9/-	ECH42 9/6	EZ90 7/-	PCL82 9/-	U24 21/-	VP4B 15/-	6BBG 3/-	6SH7 6/-	19AQ5 8/-
CIC 10/-	ECH81 8/-	E1148 2/-	PCL83 11/6	U25 12/6	VR105/30 7/-	6BA6 6/-	6SJ7 6/6	19BG6G 15/-
CBL31 21/6	ECH83 8/6	FC12 15/-	PCL84 10/6	U26 10/-	VR150/30 7/-	6BE6 6/-	6SK7 5/6	20D1 10/-
CCH35 21/6	ECL80 8/-	FC2A 17/6	PCL85 10/6	U31 9/-	W61 11/-	6BG6G 15/-	6LS7GT 6/-	20D2 21/6
CL33 15/-	ECL81 10/-	FC4 15/-	PCL86 12/6	U35 17/6	W75 5/-	6BH6 8/-	6SN7GT 5/6	20F2 17/6
CY1 15/-	ECL82 9/6	FC13 15/-	PENA4 17/6	U37 17/6	W77 4/-	6BJ6 6/-	6SQ7 8/6	20L1 24/-
D77 4/-	ECL83 10/6	FC13C 17/6	PENB4 17/6	U43 8/6	W31 6/-	6BQ7A 12/6	6U4GT 10/-	20P1 15/-
DAC32 9/6	ECL86 10/6	FW4/500 9/-	PEN4DD 24/-	U47 12/6	W81M 6/-	6BR7 10/6	6U5G 7/6	20P3 24/-
DAF91 6/6	EF6 21/6	FW4/800 9/-		U50 7/-	X41 15/-	6BS7 12/6	6V6G 4/6	20P4 23/6
DAF96 8/6	EF22 14/-	GZ30 10/6	PEN4VA 24/-	U52 4/-	X61M 10/-	6BW6 8/-	6V6GT 8/-	20P5 24/-
DCC90 12/6	EF36 4/-	GZ32 10/6	PEN36C 20/-	U76 7/6	X65 12/6	6BW7 5/-	6X4 4/6	25A6 8/-
DF33 10/6	EF37 8/-	GZ33 19/3	PEN45 10/-	U78 4/6	X76 12/6	6C4 3/6	6X5G 6/6	25L6 8/-
DF91 4/-	EF37A 8/-	GZ34 13/6	PEN45DD 25/-	U145 10/6	X76M 12/6	6CSGT 8/-	6X5GT 8/6	25Y5 8/-
DF92 7/2	EF39 4/-	GZ37 19/3		U19 15/6	X78 24/6	6C6 6/6	6/30L2 10/-	25Y5G 8/-
DF96 0/-	EF40 15/-	H41 8/-	PEN46 5/-	U251 12/6	X81 42/6	6C9 12/6	7B5 12/6	25Z4 7/6
DF97 11/6	EF41 8/-	HL41DD 8/6	PEN45DD 20/-	U281 15/-	X81 10/-	6CD6G 27/6	7B6 10/-	25Z5 8/-
DH63 6/-	EF42 10/-	HL192 8/6		U302 19/6	Y61 10/-	6CH6 10/-	7B7 8/6	25Z6 8/6
DH77 7/-	EF50A 3/6	HL13DD 9/6	PEN40 20/-	U321 12/6	Y63 10/-	6D1 4/6	7C5 8/6	27SU 19/6
DK32 11/6	EF50E 3/6	HN309 26/6	PENDD4020 20/-	U329 12/6	Z63 7/6	6D6 5/6	7C6 8/6	30C1 9/-
DK91 7/6	EF85 5/-	IW4/350 10/-		U339 15/6	Z66 10/-	6E5 10/-	7D5 15/-	30C15 12/6
DK92 8/6	EF86 9/-	IW4/500 10/-	PL33 20/-	U403 10/-	Z77 4/-	6F1 10/6	7D6 15/-	30F5 10/-
DK96 8/6	EF86 9/-	IW4/500 10/-	PL36 12/6	U404 10/-	Z152 5/-	6F5 6/6	7D8 15/-	30FL1 10/6
DL33 0/6	EF39 9/-	KT33C 3/-	PL38 21/6	U801 19/9	OZ4 5/-	6F12 4/-	7H7 7/6	30L1 8/6
DL35 10/6	EF91 4/-	KT36 17/6	PL81 11/6	UABC80 7/-	IA7 11/6	6F13 10/-	7R7 10/-	30L15 11/6
DL91 8/0	EF92 4/-	KT55 17/6	PL82 8/-	UAF42 8/6	ICS 10/6	6F14 10/-	7S7 10/-	30P4 20/-
DL92 6/6	EF95 5/-	KT61 7/6	PL83 10/6	UB41 7/6	ID5 8/6	6F15 12/6	7Y4 7/6	30P12 10/-
DL93 7/0	EF98 10/-	KT66 15/-	PL84 8/6	UBC41 8/6	ID6 10/-	6F19 12/6	8B3 4/-	30P16 21/-
DL94 7/6	EF183 10/6	KT76 10/-	PL80 10/6	UBC81 10/-	IHS 9/6	6F23 10/6	9BW6 12/6	30P19 9/-
DL96 8/0	EF184 10/6	KTW61 8/-	PM24M 13/6	UBF80 8/6	IL4 5/-	6F25 16/6	10C1 12/6	30PL1 15/-
EAS0 2/-	EF32 8/6	KTW61 8/-	PX4 15/-	UBF89 7/6	ILN5 4/6	6F26 13/6	10C2 17/6	30PL13 16/6
EAC80 5/-	EL2 25/-	L63 5/6	PX25 25/-	UBL21 20/-	IN5 9/6	6F33 5/6	10F1 10/-	30PL14 15/-
EAC91 4/-	EL3 21/6	LN152 8/-	PY31 15/-	UCB84 10/6	IRS 7/6	6H6 2/-	10FI 12/6	35A5 17/6
EAF42 9/6	EL6 21/-	LN309 11/6	PY32 12/6	UCB85 7/6	IS4 8/-	6J5 5/6	10F9 12/6	35L6GT 7/6
EB34 2/6	EL32 4/6	LZ319 12/6	PY33 12/6	UCF80 12/6	IS5 4/-	6J5G 4/6	10LD11 15/-	35W4 8/6
EB41 5/-	EL34 15/-	M4B 17/6	PY33 12/6	UCH21 20/-	IT4 4/-	6J5GT 5/-	10P13 15/-	35Z4 7/6
EB91 4/-	EL35 10/-	MVS/PEN 17/6	PY80 7/6	UCH42 9/6	IU5 5/9	6J7 7/6	10P14 19/-	35Z5 8/6
EBC3 21/-	EL37 17/6		PY81 7/6	UCH81 8/-	2P 24/9	6J7GT 7/6	11D5 23/6	40SUA 15/-
EBC33 4/6	EL38 19/6	MVS/PENB 17/6	PY83 8/-	UCL82 10/-	3A4 5/-	6K7 7/6	12A48 9/-	41STH 21/-
EBC41 8/6	EL41 10/-		PY88 7/-	UCL83 13/6	3A5 10/-	6K7GT 2/6	12A68 9/-	42 12/6
EBC81 10/-	EL42 10/-	MU14 15/-	PY300 10/-	UF41 7/6	3Q4 8/-	6K8 9/6	12AT6 7/6	50C5 10/-
EBF80 8/6	EL81 12/6	MX40 15/-	PZ30 15/-	UF42 7/6	3Q5 9/-	6K8G 5/-	12AT7 5/-	50C5 10/-
EBF83 8/6	EL84 6/9	N18 8/-	QS95/10 10/-	UF80 7/-	3S4 7/-	6K8GT 9/6	12AU6 17/6	50CD6G 27/6
EBF39 8/-	EL85 10/-	N37 14/-	QS150/15 10/-	UF89 6/6	3V4 7/6	6K8GT 9/6	12AU7 5/-	50L6 8/6
EBL1 21/-	EL90 8/6	N78 17/6	R2 10/-	UL41 8/-	5U4 4/-	6K8GT 9/6	12AX7 5/-	53KU 12/6
EBL21 21/6	EL91 4/-	N108 15/-	R3 10/-	UL44 20/-	5V4G 7/9	6K8GT 9/6	12BA6 7/6	75 8/-
ECC35 8/-	EM80 10/6	N308 20/-	R16 17/6	UL46 14/6	5Y3G 8/6	6L1 10/-	12BE6 7/6	78 7/6
ECC40 8/-	EM81 8/6	N339 30/-	R19 16/-	UL84 7/-	5Y3GT 8/6	6L6 7/6	12BH7 10/-	80 9/-
ECC81 5/-	EM84 9/6	N369 10/6	R20 16/-	UL85 7/6	5Z4G 9/6	6L7 10/-	12C8 8/6	85 17/6
ECC82 5/-	EM85 10/-	OD3 5/-	S41 3/6	UM80 13/6	5Z4GT 12/6	6L18 10/-	12J5GT 4/-	85A2 12/6
ECC83 7/6	EY51 8/6	OD4 5/6	S41 3/6	URIC 15/-	6A7 9/6	6L19 15/-	12J7GT 8/6	185BT 30/-
ECC84 8/6	EY81 8/6	P2 10/-	T41 19/-	UJ6 19/-	6A8G 8/6	6L34 9/6	12K7GT 5/-	30S 13/-
		PABC80 13/-	TDD4 12/6	UUB 15/-	6AC7 6/6	6N7GT 9/6	12Q7GT 10/-	807B 5/-
					6AK5 5/-	6P25 10/6	12SA7 8/6	807A 6/-

### METAL RECTIFIERS

RMI 5/3	14A86 17/6	16RD-2-2-8-1 12/-
RM2 7/6	14A97 25/-	16RE 2-1-8-1 8/6
RM3 7/9	14A100 27/-	18RA 1-1-8-1 4/6
RM4 14/-	14RA 1-2-8-2 17/6 (FC301)	18RA 1-1-16-1 6/6 (FC116)
RM5 19/6	14RA 1-2-8-3 19/- (FC31)	18RA 1-2-8-1 11/-
	16RC 1-1-16-1 8/6	18RD 2-2-8-1 15/- (FC124)

TERMS OF BUSINESS C.W.O. or C.O.D.  
3/2 PACKING CHARGE ON ALL C.O.D.  
ORDERS. POSTAGE 6d. per VALVE

### TRANSISTOR BARGAINS

OC44 6/-	OC75 6/-	OC82 8/-
OC45 7/-	OC77 6/-	OC82D 8/-
OC71 5/-	OC81 6/-	
OC74 6/-	OC8D 6/-	

### SILICON RECTIFIERS

400 volts 350 mA ... .. 12/6 each

### SETS OF VALVES

IR5, 155, IT4, 354, 3V4 ... ..	Set of 4, 19/6
DAF91, DF91, DK91, DL92, DL94 ... ..	Set of 4, 19/6
DAF96, DF96, DK96, DL96 ... ..	Set of 4, 27/6

# WEYRAD

## 6-TRANSISTOR 2-WAVE SUPERHET RECEIVER MODIFICATIONS NOW AVAILABLE FOR 500mW OUTPUT

<b>ROD AERIAL—RA2W</b>	
6 in. long, 3/8 in. diameter, connections to tags on Coils. For 208pF tuning capacity. Complete with Car Aerial Coil ... .. 12/8	
<b>OSCILLATOR COIL—P50/1AC</b>	
M.W. covered with 176pF tuning capacity, L.W. by extra padder ... .. 5/4	
<b>I.F. TRANSFORMERS</b>	
1st and 2nd Stage—P50/2CC ... ..	5/7
(2 required)	
3rd Stage—P50/3CC ... ..	6/-
<b>DRIVER TRANSFORMER—LFD4</b> ... ..	9/6
<b>OUTPUT TRANSFORMER—OPT1</b> ... ..	10/6
<b>PRINTED CIRCUIT—PCA1</b> ... ..	9/6

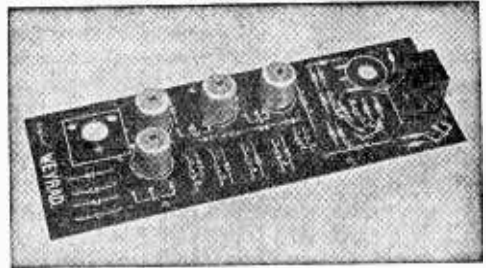

In response to many requests we have redesigned the output stages to give 500mW and to enable a standard 3 ohm Speaker to be used. Full details of the simple changes are given on a separate leaflet available on receipt of stamp.

<b>CONSTRUCTORS BOOKLET WITH FULL DETAILS</b> ... ..	2/-
<b>TRANSISTOR A.F. AMPLIFIER TYPE A.F.1—LOW IMPEDANCE INPUT, 3-TRANSISTOR, 500mW OUTPUT, FULLY ASSEMBLED WITH VOLUME CONTROL</b> ... ..	63/6

**WEYMOUTH RADIO MANUFACTURING CO., LTD.**  
REGENT FACTORY, SCHOOL STREET,  
WEYMOUTH, DORSET

# FREE TO AMBITIOUS ENGINEERS

— THE LATEST EDITION OF ENGINEERING OPPORTUNITIES

**Have you sent for your copy?**  
**ENGINEERING OPPORTUNITIES** is a highly informative 156-page guide to the best paid engineering posts. It tells you how you can quickly prepare at home for a recognised engineering qualification and outlines a wonderful range of modern Home Study Courses in all branches of Engineering. This unique book also gives full details of the Practical Radio & Electronics Courses, administered by our Specialist Electronics Training Division—the B.I.E.T. School of Electronics, explains the benefits of our Employment Dept. and shows you how to qualify for five years promotion in one year.

**We definitely Guarantee**  
**“NO PASS—NO FEE”**

Whatever your age or experience, you cannot afford to miss reading this famous book. If you are earning less than £25 a week, send for your copy of “ENGINEERING OPPORTUNITIES” today—FREE.

**BRITISH INSTITUTE OF ENGINEERING TECHNOLOGY (Incorporating E.M.I. Institutes)**  
(Dept. SE/21), 29 Wright's Lane, London, W.8

**WHICH IS YOUR PET SUBJECT?**

- Mechanical Eng..
- Electrical Eng..
- Civil Engineering.
- Radio Engineering.
- Automobile Eng..
- Aeronautical Eng..
- Production Eng..
- Building, Plastics, Draughtsmanship, Television, etc.

**GET SOME LETTERS AFTER YOUR NAME!**

- A.M.I. Mech. E.
- A.M.I.C.E.
- A.M.I. Prod. E.
- A.M.I.M.I.
- A.I.O.B.
- A.F.R. Ae.S.
- B.Sc.
- A.M. Brit. I.R.E. City & Guilds
- Gen. Cert. of Education Etc., etc.

**PRACTICAL EQUIPMENT**

- Basic Practical and Theoretic Courses for beginners in Radio, T.V., Electronics, Etc., A.M. Brit. I.R.E. City & Guilds Radio Amateurs' Exam.
- R.T.E.B. Certificate P.H.G. Certificate Practical Radio
- Radio & Television Servicing Practical Electronics Electronics Engineering Automation

**INCLUDING TOOLS!**

The specialist Electronics Division of B.I.E.T. (Incorporating E.M.I. Institutes) NOW offers you a real laboratory training at home with practical equipment. Ask for details.

**B.I.E.T. SCHOOL OF ELECTRONICS**



**POST COUPON NOW!**

Please send me your FREE 156-page “ENGINEERING OPPORTUNITIES”

(Write if you prefer not to cut page)

NAME \_\_\_\_\_

ADDRESS \_\_\_\_\_

SUBJECT OR EXAM THAT INTERESTS ME \_\_\_\_\_ SE/21

**THE B.I.E.T. IS THE LEADING ORGANISATION OF ITS KIND IN THE WORLD**

by C.M. and E.C.D.

# semiconductors

## TALKING POINTS ON CIRCUIT PRACTICE

### No. 2—Calculating D.C. Values

**I**N the first article of this series, the general principles of D.C. Stabilisation of Transistors were explained. It is now proposed to explain how circuit values may be calculated.

In Fig. 1 is shown a transistor in grounded-emitter mode;  $R_e$  is the emitter resistor,  $R_c$  the collector load and the  $R_b$  the base resistance (consisting in this circuit of  $R_1$  and  $R_2$  in parallel—as viewed by the base they are in parallel because if you short-circuit the supply battery for a moment it will be seen that they both go to the same point).

Suppose a sine wave applied across base and emitter at the points X-X. The negative half of the wave will move the base negatively across its standing bias and this will induce a rise in collector current by virtue of the properties of transistors.

The positive half of the wave will act similarly but will decrease the value of the collector current. (Note that polarities are reversed compared with valves.)

Thus a sine wave will appear in the collector circuit. It will, however, be of greater amplitude than the sine wave on the base. Amplification will have taken place. This is because the base admittance of the transistor is of only a few ohms resistance whereas the output resistance is several thousands of ohms: a small variation in base bias has influenced a large variation in collector current.

#### Transistor Gain

The amplification factor, which in transistor technique is referred to as the "gain" of the transistor, is the ratio of output current divided by input current and depends on the ratio of output resistance divided by input resistance—and it is given the symbol  $\alpha$ . To make this clear: if a base

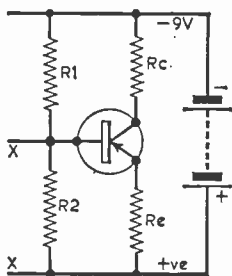

Fig. 1: A Transistor in grounded-emitter mode of operation.

input of 100mA induces a collector output current of 1000mA then the ratio is  $1000/100=10$ , which is the  $\alpha$  for that transistor.

Now let us suppose a case where the input sine wave is so greatly amplified that the negative half of the input wave causes a great increase in collector current that the load in the collector drops all the available voltage (only a meagre 9V anyhow) leaving the collector itself at no volts. Conversely, the positive half of the input wave reduces the collector current so much that none flows at all.

In the former case the transistor is termed "bottomed", in the latter it is "cut-off". In neither condition can it function properly. What occurs is that the incoming wave will move the collector current up to a point where it cuts off or bottoms as the case may be, beyond those points no further increase positively or negatively will be reproduced in the collector circuit, so that the wave in the collector circuit will appear as in Fig. 2 with the peaks of the waves "clipped".

Distortion will appear before the actual clipping point is reached, on the negative half cycle of the input wave, because of the "knee-volts" factor, see Fig. 3. Though from approximately 0.5 to 9V the characteristic is a straight line, below 0.5V on the collector it becomes hopelessly non-linear. As the increasing flow of current through the collector load on the negative half of the wave drops more and more volts, before the collector actually reaches zero volts it reaches the point where the non-linear characteristic sets in. The voltage should not in fact be dropped even as far as the knee-volts point but on peak signals should be kept a tenth or so of a volt above it.

Either the incoming signal, therefore, must be kept *small* enough not to swing the output current so far that the consequent voltage drop across the collector load will drop the collector volts to the small value represented by the knee-volts point; or else the constants of the collector circuit must be adjusted to be sufficiently large (disregarding the load) that it can *take* the swing, without distorting or clipping.

In order to know what the current swing in the collector circuit is going to be for a given current swing of signal on the base, we have to know the amplification factor of the transistor  $\alpha$ .

Unfortunately with transistors this is just what we don't know, because the gain of a transistor depends on the ratio of its input and output impedances and both these vary according to the amount of current passing through them, according to frequency and according to temperature. A transistor is "non-resistive"; it does NOT obey Ohm's Law. That is the first thing we have to realise.

If the "gain" varies, as it must if the resistances determining it vary, what value can we state for  $\alpha$ ?

There are, in fact, a lot of values for  $\alpha$  in any one transistor, and they will be different again if you change the transistor.

#### Different Gain Symbols

This has necessitated a symbol for  $\alpha$  which will state, within limits, under what conditions the value of it was measured. Thus, in order to show that  $\alpha$  was measured in grounded emitter mode and not in grounded base mode for instance, we prime it with a dash  $\alpha'$ . In order to show that it was measured at zero frequency (d.c.) we put a small nought below it:  $\alpha'_0$ . And if it was measured at large current values and not small ones, we would put a bar over it:  $\bar{\alpha}'_0$ . To cover the differences between various individual transistors the makers themselves publish three different figures for  $\alpha$ : the smallest you are likely to find, the average, and the highest. They also state the temperature conditions.

The fact that the base admittance resistance (the resistance in the base-emitter path) is not a constant value has another important effect, in an a.c. sense. It will distort the incoming signal if steps are not taken to prevent or minimise it, because it requires a constant resistance to give a faithful rendering in terms of voltage changes across it, and if the resistance itself is varying anything can happen, and usually does!

In order to minimise this, the resistance of the source which is driving the base should be very much higher than that of the base itself, so that the proportion of stable resistance to that of unstable, in effect, swamps out the unstable part.

A transistor is usually driven by the output circuit of a previous transistor and in this case satisfactory conditions are created because the output resistance of a transistor is high—several thousand ohms, as against the base resistance of the transistor it is driving, which is something like 50 $\Omega$  or so only.

In fact, the output resistance of a transistor is effectively, in r.c. conditions, that of the collector load resistor because this is in parallel with the output resistance of the transistor itself, as seen by the collector (short circuit the supply battery again, to see this). But as the collector load resistance is usually several thousand ohms it is still sufficiently high to drive a following base with minimum distortion.

#### Thermal Stabilization

Now let us examine the effect of these facts.

The collector load resistance, as stated in the previous article, should drop half the supply volts in order to secure effective thermal stabilisation. But to calculate the ohms necessary to do this we

must know the amount of current that will be flowing.

Most transistor circuits for small signal conditions adopt a nominal value of 1mA for the current in the collector circuit. It may be a little less in earlier stages in cascade, where the input signal is still small, and a shade higher in later stages where a bigger signal must be handled, but 1mA is the standard.

Given a collector current of 1mA we can evaluate the collector load as 4,500 $\Omega$ ; that is, the value necessary to drop 9 to 4.5V at 1mA. This however includes the emitter resistor if one is fitted, which will have to be subtracted to get the actual collector load value, since the emitter resistor is in the collector circuit also.

The larger the value of the emitter resistor the

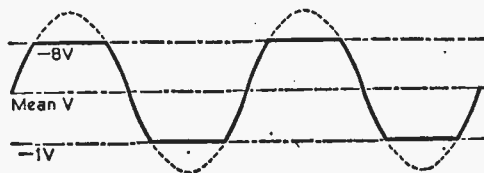

Fig. 2: A collector circuit waveform illustrating the clipping effect due to "bottoming" and to "cut-off"

better the stability, but we cannot let it drop too many volts when we only have 9V to start with. We found that if the emitter resistor drops from half to one volt we shall have reasonable working conditions. To drop 1V at 1mA requires 1,000 $\Omega$ . This subtracted from the 4,500 $\Omega$  leaves 3,500 $\Omega$  for the collector load resistor itself.

We come now to the values of R1 and R2, the potential divider. As seen by the base, these resistors are in parallel (short-circuit the supply battery again and you see that both go to the same point).

The value of Rb, as we have seen, should for good stability be at least ten times that of Re—which is 1,000 $\Omega$ . Rb must therefore be approximately 10,000 $\Omega$ .

How to split up two resistors which are 10,000 $\Omega$  in parallel sum, so that they will give us the 100 $\mu$ V, approximately, required on the base a bias?

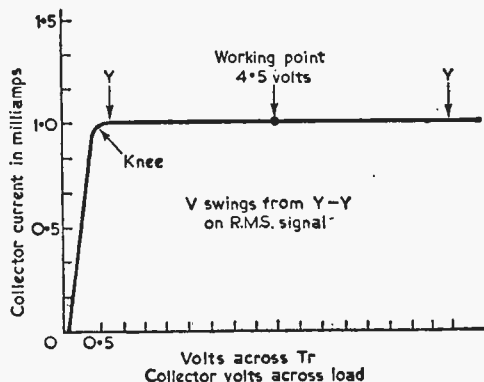

Fig. 3: Typical collector current v. collector volt characteristics.

Brand new, individually checked and guaranteed

**VALVES**

AL60	6/-	EABC80	7/3	EP72	5/-
AR8	5/-	EAC91	3/6	ESU208	6/-
ARDD5	2/-	EAC91W	7/6	EY51	8/-
ARP3	3/-	EB34	1/6	EY86	8/-
ARP4	3/6	EB91	3/9	EY91	3/-
ARP12	3/-	EBC33	7/1	EZ40	7/-
ARP21	5/6	EBC41	7/9	EZ40	7/-
ARP24	3/6	EBC90	5/-	EZ80	6/-
ARP34	4/-	EC52	8/-	EZ81	6/9
ARTH2	7/-	EC70	10/-	FW4/500	6/6
ATP4	2/9	EC93	20/-	GI/236G	9/-
ATP7	5/6	EC91	3/-	GL20/1B	9/-
AUI	5/-	ECC81	5/6	G1450	10/-
AU4	5/-	ECC82	6/6	G1464A	10/-
AW3	4/-	ECC83	7/1	GU20/2140	9/-
AZ31	7/-	ECC84	7/-	GZ32	9/-
BS4A	5/6	ECC85	8/-	H63	7/-
BT45	15/-	ECC91	4/-	HK54	5/-
BT9B	20/-	EFC80	10/6	HL23	6/1
BT83	22/6	EFC82	8/6	HL23DD	6/1
CV54	5/-	ECH81	7/6	HVR2	12/6
CV71	3/-	ECL80	7/6	KRN2A	19/-
CV102	1/-	ECL82	8/6	KT32	8/6
CV264	20/-	EF36	3/6	KT8	22/6
CV4014	8/-	EF37A	7/1	KT33C	4/-
CV4015	7/-	EF39	4/-	KT44	6/3
CV4025	10/-	EF50	1/6	KT63	5/-
CV4346	40/-	EF54	3/3	KT76	10/-
CY1	6/-	EF55	5/-	KTW61	6/-
D1	1/6	EF70	4/-	KTW62	6/1
D41	3/3	EF73	6/-	KTW63	6/6
D77	4/3	EF80	5/6	KTZ41	6/-
DA30	12/6	EF85	6/6	KTZ63	8/-
DAF70	35/-	EF86	7/-	MH4	3/6
DAF91	6/-	EF89	7/-	MH41	5/-
DAF96	7/6	EF91	2/6	ML4	4/-
DD41	4/-	EF92	3/-	ML6	6/-
DET5	15/-	EF95	5/-	M5/PEN	6/-
DET19	3/6	EL32	3/9	OB3	7/-
DET20	2/1	EL33	7/-	OC3	5/6
DF39	4/-	EL35	6/-	OD3	6/-
DF72	7/6	EL41	8/-	OZ4	4/-
DF91	4/-	EL42	8/-	PCC84	7/-
DF96	7/6	EL84	7/-	PCC85	8/-
DK96	7/3	EL91	4/6	PCF80	7/-
DL92	6/-	EM80	8/-	PCF82	8/-
DL94	6/-	EM84	9/-	PCL82	0/6
DL95	7/6	EN31	10/-	PCL83	10/-
EA50	1/6	EP71	6/6	PCL84	9/-

PEN45	4/6	VP23	3/-	6AK7	6/-
PEN46	5/-	VP41	5/6	6AM5	5/-
PEN65	6/6	VR99	8/-	6AM6	4/-
PEN220A	3/-	VR105/305	5/6	6AQ5	7/-
PL36	10/6	VR150/30	6/-	6AT6	5/-
PL81	9/-	VT4C	25/-	6B7	5/-
PL82	8/-	VU39	6/-	6B8B	2/6
PL83	8/-	W31	7/-	6BA6	5/-
PT15	10/-	X66	6/-	6C4	2/6
PT25H	7/6	Y63	5/-	6C5	6/-
PX4	19/-	Y65	4/-	6CFG	4/-
PX25	9/-	Y66	8/-	6CG6	3/-
PY32	12/-	Z31	6/-	6C8G	5/-
PY80	6/9	IA3	2/-	6D6	3/-
PY81	7/-	IA5GT	5/-	6F5G	5/3
PY82	7/-	IC5GT	7/6	6F6G	4/-
PY83	7/3	ID8GT	6/-	6F7	5/-
PZ1-35	9/-	IE7G	7/5	6F5GT	5/9
QP21	6/-	IG6GT	6/-	6F8G	5/-
QPS5	5/-	IL4	3/-	6F12	4/6
Q255/10	6/9	ILD5	5/-	6F13	5/-
QV04/7	7/-	IR5	6/-	6F33	3/6
R3	6/-	IS4	5/-	6G6G	2/6
R3/10	4/-	IS5	5/6	6H6M	1/6
REL21	25/-	IT4	4/-	6J5	3/6
RK34	2/6	IW4	6/-	6J5G	3/-
RX235	10/-	ZA3	5/-	6J6	3/6
SP2	3/6	ZA5	6/-	6J7G	5/-
SPI3C	4/6	ZA6	7/-	6K6GT	6/-
SP41	2/6	ZC34	2/6	6K7G	2/-
SP61	2/-	ZC42	25/-	6K7GT	4/9
STV280/40	5/-	ZC46	30/-	6K8G	5/9
		ZX2	4/-	6K8GT	8/3
STZ280/80	5/-	3A4	5/-	6K8M	0/6
		3B7	5/-	6L5G	6/-
		3B24	5/-	6L6	9/-
		3E29	6/-	6L6G	6/-
		TP25	15/-	(829B)	60/-
		TT11	3/-	3Q4	6/-
		TT15	25/-	3S4	6/-
		TT20	16/-	3V4	6/-
		U12/14	5/-	5R4GY	9/-
		U17	5/-	5T4	9/-
		U18	6/6	5U4G	5/-
		U27	8/-	5V4G	8/-
		U52	5/-	5Y3G	3/-
		UCH42	7/6	5Y3GT	6/-
		UBF80	8/6	5Z4	6/-
		UL11	5/-	5Z4G	7/-
		UL12	5/-	6AB7	4/-
		UL41	7/-	6AC7	3/-
		UL84	7/6	6AG5	3/-
		UU9	5/6	6AG7	6/-
		UY41	6/-	6AJ7	3/-
		UY85	6/6	6AK5	5/-

6V6GT	6/-	77	6/-	9001	3/-
6X4	5/-	78	7/-	9002	5/6
6X5GT	4/6	80	5/6	9003	6/-
6Y6G	6/-	81	9/-	9004	2/6
6Z4	5/-	82	8/-	9006	2/6
7B7	7/6	84	8/-		
7C6	6/-	85A3	15/-		
7C7	5/-	89	6/-		
7H7	7/3	210VPT			
7Q7	7/1	7-pin	2/6		
7V7	5/-	220TH	4/-		
7Y4	5/-	250TH	£9		
7Z4	4/-	350B	8/-		
8D2	2/6	363A	5/-		
9D2	3/-	393A	15/-		
12A6	2/6	705A	15/-		
12AH7	5/-	715B	60/-		
12AT7	5/6	717A	8/6		
12AU6	9/-	801	6/-		
12AV7	6/6	803	22/6		
12AX7	7/-	805	30/-		
12C8	3/-	807 (select)	5/6		
20E	20/-	807B	5/-		
12H6	2/6	807B	5/-		
12J5GT	3/6	808	9/-		
12J7GT	8/-	810	80/-		
12K7GT	4/6	813	60/-		
12K8M	7/6	815	40/-		
12Q7GT	4/4	816	30/-		
12SA7	7/-	829A	30/-		
12SC7	4/-	832	15/-		
12SG7	3/-	832A	35/-		
12SH7	3/-	843	7/4		
12SJ7	5/-	866A	14/-		
12SK7	3/6	930	8/-		
12SL7	5/9	954	4/-		
12SN7	5/9	955	2/6		
12SR7	5/-	956	2/-		
12T4	2/-	957	5/-		
14L7	7/-	958A	4/-		
15D2	6/-	1616	3/-		
20A2	17/6	1619	5/-		
21B6	9/-	1625	6/-		
25L6GT	7/9	1626	4/6		
30	5/-	1629	4/6		
35L6GT	8/-	4043C	13/6		
35T	17/6	4063	8/-		
35Z4GT	7/-	6064	10/-		
6S17Y	6/6	6065	8/-		
6SK7	5/-	6120	4/-		
6SL7GT	6/6	6121	8/-		
6SN7GT	4/6	6173	1/9		
6SQ7	6/-	6175	3/-		
6SS7	3/-	6176	5/6		
6V6G	4/-	6177	5/-		

<b>Cathode Ray Tubes</b>	
ACR1	15/-
ACR11	15/-
ACR13	50/-
CC995	15/-
CV1596	
(09J)	55/-
E4103/84	
VCR97	25/-
VCR98	28/-
VCRX258	
(with scanning coil)	45/-
VCR138	30/-
VCR139A	
(ted)	5/6
3FP7	25/-
5BP1	35/-
5CP1	42/6
5FP7	45/-
5FP7A	25/-
7BP7	40/-
12DP7	60/-
<b>Photo Tubes</b>	
CMG8	9/-
GS16	12/6
<b>Special Valves</b>	
2J31	45/-
3A/1481	45/-
3J192/E	
	£37.10
4J31	£35
4J50	£35
5D21	£3
723A/B	50/-
725A	30/-
726A	27/6
ACT6	160/-
CV193	30/-
CV238	70/-
CV980	3/-
KR6/3	£4
L57B	30/-
WL417A	15/-

AND MANY OTHERS IN STOCK, INCLUDING CATHODE RAY TUBES AND SPECIAL VALVES. All U.K. Orders below 10/-, 1/- P. & P. 2/6 over 10/-, Orders over £3, P. & P. free. C.O.D. 2/6 extra. Overseas Postage extra at costs.

**BRAND NEW ORIGINAL SPARE PARTS FOR AR88 RECEIVERS.**

Please write your requirements. **MARCONI RECEIVER TYPE CR 100/2** tested and aligned £32.10.0 Carr. £1. **TELEPHONE HANDSET.** Standard G.P.O. type. New 12/-, P. & P. 2/-. **CONNECTORS FOR TCS RECEIVER, TRANSMITTER AND REMOTE CONTROL,** with original plugs on both ends. New £1.17.6 each P. & P. 2/6.

**SPECIALLY BUILT POWER PACK** for TCS receivers, 230 volts A.C. mains, including 6X5GT valve, £3.10.0. Carr. 5/-. **R.109 RECEIVER.** Covering 2-8 Mc/s. 6 v. D.C. with set of spare valves and carrier. Brand new in original packing case. £6.18.0 including delivery in U.K. **R.109A RECEIVER.** Covering 2-12 Mc/s., £7.18.0.

**"CONNECT AND FORGET—CANNOT OVERCHARGE"—"ESSTRON" MARK I AUTOMATIC BATTERY CHARGER.** Initial charging rate 6-7 amps. The charging rate automatically adjusts itself to the charge in the battery. Automatic current and voltage control. Patented application of magnetic amplification to battery charging. Indicator lights show battery fully charged, receiving charge, incorrectly connected or faulty cells. Mains voltage 200/250 v. Built for 6 or 12 v. batteries. Measurements 7 x 5 x 5 1/2 in. Weight 8 1/2 lb. Price £7.19.6. P. & P. 3/6.

**53 TRANSMITTER SPARES.** Full range. Price list on application.

**H.R.O. Senior. Table Model.** In excellent, fully checked, and tested condition (without coils and power pack), £15.10.0. As above but rack mounted model, £14.10.0.

Individual frequency coils for above £1 each set or set of 9 £8. Either model carriage £1.10.0.

Power pack for above. British made, A.C. 110/200/250 v., 59/6. Postage 4/-.

**CARBON INSET MICROPHONE,** G.P.O. type, 2/6. P. & P. 1/6.

**COLLINS VARIABLE CONDENSERS.** Size 3 1/2 x 1 1/2 x 1 1/2 in. 250pF. Ideal TX Pi output circuits. 8/6. P. & P. 1/6.

**80W 12V PETROL DRIVEN CHARGING SETS.** Very compact, in fully guaranteed condition, £12.10.0, Carr. £1.

**RE-ENTRANT LOUD HAILERS.** 500 ohms, approx. 20w. £6.10.0, Carr. 10/-

**AERIALS** 11ft. long. 2ft. long when folded, 15/-, P. & P. 2/-.

**AMERICAN WIRE RECORDER/REPRODUCER UNIT.**

Facilities for recording from Dynamic or Carbon microphone and radio. I knob operation for recording, rewinding and erasing. Neon recording level indicator. Internal speaker. Mains 110 v. Supplied with outer transformer, carbon mike and wire magazine for 1 hour's operation and headphones. Price £18.0.0. P. & P. £1. Spare Wire Magazine 50/-, Dynamic mike and stand £4.

**R.209 RECEPTION SET.** A 10-valve high-grade Superhet Receiver with facilities for receiving R/T (A.M. or F.M.) and C.W. frequency 1 Mc/s-20 Mc/s. Hermetically sealed. Built on miniature valves and incorporating its own vibrator power supply unit driven by a 6 v. battery (2 point connector included). The set provides for reception from rod, open-wire or dipole aerial with built-in loudspeaker or phone output. Dimensions: Length 12in., width 8in., depth 9in. Weight 23lb. In as new, tested and guaranteed condition, £23.10.0, including special headphone and supply leads. Carr. £1.

**RECEIVER TYPE R.206.** Frequency 0.55 Mc/s to 30 Mc/s in 6 bands. 100-250 v. A.C. or 12 v. D.C. Loudspeaker in power supply unit. High performance super-heterodyne, eleven valves including a separate local oscillator valve, beat oscillator valve and two valves (Amplifier and Detector) in the A.B.C. system. In very good condition £20.10.0, including power pack. Carriage and Packing 15/-.

**P. C. RADIO LTD.**  
170 GOLDHAWK ROAD, W. 12  
Shepherd's Bush 4946



Here we must remark that in arriving at a figure of  $10 \times R_e$  for  $R_b$  we were faced with several contradictory requirements for this potential divider. To begin with, it should be low in order to keep the base potentials as stable as possible (bleed as large as possible in relation to actual current taken by the base itself). But if it is too low it will take too much from the battery. It will also, being in shunt with the output resistance (as already explained) of the previous stage, effect the effective resistance of that in relation to the base it is driving, and in audio stages would shunt out the lower frequencies as well.

Ten times  $R_e$  is therefore a compromise.

**Calculation of Base Resistance**

Now for the actual values of  $R_1$  and  $R_2$ . The potentials which will exist at the junction, where the base is tapped on, will be determined by the various currents flowing in the chain. We have the base current itself, flowing through  $R_e$ , thence through the internal resistance of the transistor to the base (the base leakage current plus the base current due to the base bias). Thus volts will be dropped over  $R_e$ , and they will be dropped again over the internal resistance between emitter and base. The emitter will be negative to base, therefore, and the base itself slightly negative to emitter. But the drop over  $R_e$  will be considerable because this has the collector current as well as the base current. So, with the emitter dropping 1V the base is going to be at 1V plus (negative).

The potentials developed in the potential divider will be due to the bleed current through the two resistors in series (as seen by the 9V line) plus the base current itself flowing through the two in parallel (as seen by the base).

The respective values of  $R_1$  and  $R_2$  can be worked out from the formula:

$$R_1 = \frac{\text{Supply volts} \times \text{External Base Resistance } (R_b)}{\text{Volts base-to-earth } (V_{bb})}$$

$$R_2 = \frac{\text{Supply volts} \times \text{External Base Resistance } (R_b)}{\text{Supply volts} - \text{volts base-to-earth } (V_{bb})}$$

The supply volts we know. The external base resistance  $R_b$  we have fixed at  $10 \times R_e$ ; namely  $10,000\Omega$  in this case. We have not evaluated  $V_{bb}$ . The potentials on the junction of the potential divider will be the product of the various currents flowing. The formula to evaluate  $V_{bb}$ , therefore, is:

$$V_{bb} = \left( R_e + \frac{R_b}{\alpha'} \right) I_c + V_{be}$$

Where  $R_b$  is the external base resistance;  $I_c$  the collector current; and  $V_{be}$  the required voltage across base-emitter as stated in the published data (Fig. 4).

$R_1$  will be somewhere around  $66,000\Omega$  in the example we have been working on, with  $R_2$  around  $10,000\Omega$ .

It would not be proper to conclude at this stage without remarking that many published circuits may appear to use values which differ considerably from those we have explained above.

We have proceeded hitherto on the assumption that the collector load resistance was going to

drop precisely half the supply volts, therefore producing automatic thermal stability.

We have made no attempt to evaluate exactly what might happen in the circuit if all the values we had assumed for the transistor were in fact way out; if  $\alpha$  for instance which we had taken as a stated value of 40 were in fact in this particular transistor 80; if the leakage current in the collector (which may be defined as the current which would exist through the transistor before any bias was applied at all; i.e. with the base open-circuited) given as a nominal 100mA were in fact nearer 200 (and under some circumstances it could even be milliamperes); and if the stated value of say  $100\mu V$  for  $V_{be}$  (volts base to emitter) were also way out.

Neither has there been any attempt to consider that all these values could change again if the temperature at which the transistor was operating increased—and change disastrously.

We are not going to evaluate them now, either; for the calculations involved would be beyond the scope of this article.

In the main, the effect of adverse changes in any of these factors would manifest itself in the form of an increase in collector current—which would in turn increase the temperature at which the transistor was working, if it increased the dissipation. So that the *maximum* collector current under these conditions could be a good deal more than the 1mA we started with.

What we *can* do, without working it out in detail, is make an automatic allowance for these possibilities—such as a change of transistors for instance—by *assuming* a value to which the collector current might rise owing to these variable

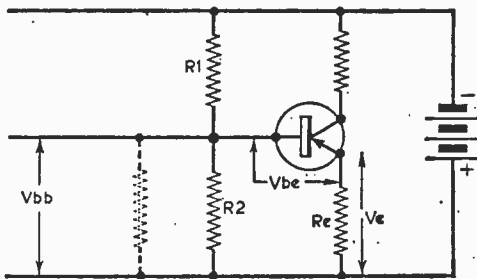

Fig. 4: The method of determining the values for  $R_1$  and  $R_2$  is explained in the text.

factors; and make correcting calculations accordingly.

**Collector Load**

Let us then assume a value for *maximum collector current*, with a nominal current of 1mA. Let us put  $I_{Max}$  at 1.5mA, and re-calculate the value of our collector load resistance on that basis.

But we can make a corrected value for our supply volts, also. In fact, if the actual voltage on the collector is not to drop below the knee-voltage plus a couple of tenths more to keep the peak signal well clear of the knee-voltage, the last volt before zero volts is reached will never be used. In other words, the "minimum voltage" across collector-emitter will never be less than

one volt; it will swing from 1V positive to 8V negative. We are assuming a large value for knee-volts and margin than is necessary; 0.5V would be enough in most cases. But we are dealing with principles rather than actual values, so 1V let it be.

Instead of 9V, therefore, we only have a supply voltage of 8V: that is, supply volts (battery volts) minus knee-volts plus peak-signal allowance.

To evaluate the collector load resistance, then, we now divide *true* supply volts by *maximum* current, i.e. 8V by 1.5mA. This will give us the corrected figure of 5,300Ω for the resistance in the collector circuit ( $R_c + R_e$ ). With 1,000Ω as before for  $R_e$ , that leaves 4,300Ω for the actual collector load.

To evaluate whether the collector loads will drop half supply volts or more at nominal collector current: 5,300Ω at 1mA will drop 5.3V—which is more than half the supply, and we therefore have a good margin of safety.

The other calculation is for temperature. Transistors are rated for a maximum temperature and this must not be exceeded by more than a degree or two.

We need to know whether the actual temperature to which the transistor will rise at *maximum* current will exceed the maker's limits or not. The published data will give a figure for Maximum Ambient Temperature. We have already evaluated maximum current. Related to watts, the maker will also give us a diagram relating maximum permissible watts to ambient temperature.

The actual junction temperature to which the transistor will rise at maximum current is given

by the following formula:

$$T_j = \text{Max. Amb. Temp.} + \theta (\text{max. current})$$

(minimum voltage).

As an example: maximum ambient temperature may be given as 45° C (per mW).  $\theta$  is a constant which is also stated in the published data for the transistor in question and we may take it as 0.4° C. Maximum current we have taken as 1.5mA, and minimum voltage as 1V.

Substituting:

$$45 + 0.4(1.5) (1) = 45.60$$

which is inside a couple of degrees above 45, so we have a good margin of safety.

This is of necessity an imperfect analysis and we have taken liberties with the mathematics in the interests of simplicity. It far from exhausts the subject, referring as it does exclusively to transistors in the grounded-emitter mode, and in small-signal conditions, with r.c. couplings. Also, we have not considered the radio frequency aspects at all or those of large signal audio stages.

But if we have managed to add a little to anyone's understanding of these fascinating modern forms of the old Hertzite and Galeium crystals, and encouraged some who may have been hesitating, to tackle this new field of experiment, then go ahead! There are so many artifices one can produce—from automatic parking lights for your car which come on when darkness falls and go out again when day breaks, to transistorised burglar alarms around your strawberry beds! The whole subject of transistors is continually developing and is wide open to the experimenter and rich in excitement and reward.

## MAINS SUPERHET RECEIVER

(Continued from page 1015)

surfaces come together in exactly the right position at the first attempt—they are extremely difficult to separate once contact is made.

Allow an hour or so for the adhesive to harden and then trim the ends of the laminate accurately with a file. The sides can then be cut, fixed and trimmed in similar fashion, again cutting very slightly longer than the height and  $\frac{1}{16}$ in. wider than the depth.

### Finishing

The next operation is to fit the loudspeaker and cover the whole of the cabinet front with loudspeaker fabric secured with adhesive; make sure that good positive attachment is obtained round the edges of the apertures. When the adhesive is dry, holes should be made for the control spindles and the fabric over the tuning scale aperture should be cut diagonally, folded back through the aperture and stuck to the rear of the hardboard.

If the perspex window is now cut accurately to size, it will be a tight push fit into the aperture. The front must now be treated with some kind of trim to hide the edges of the speaker fabric and hardboard.

### Fitting the Receiver

Reduce the length of the wave change spindle to  $\frac{1}{16}$ in. and cut the other controls to the required length. Place the receiver in position and drill upwards through the bottom of the cabinet and through the chassis end flanges, two holes about  $\frac{1}{16}$ in. diameter at the mains transformer end and one at the other.

The chassis can then be secured by bolts or, if the holes in the wood are enlarged, by wood screws inserted from below, of such diameter that they will have a self tapping action as they enter the aluminium. ■

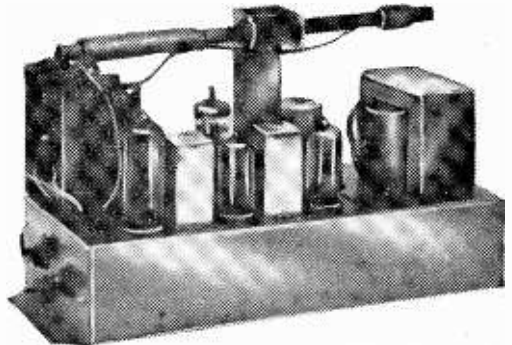

The prototype receiver ready for installation into its cabinet.



**MULLARD 3-3 HI-FI AMPLIFIER**

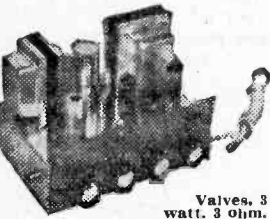

Valves, 3 watt, 3 ohm, and 15 ohm. Output.

A really first-class Amplifier giving Hi-Fi quality at a reasonable cost. Mullard's latest circuit. Valve line up: EF86, EL84, EZ81. Extra HT and LT available for Tuner Unit addition. This is the ideal companion Amplifier for FM tuner units.

**TECHNICAL SPECIFICATION—** Freq. Response:  $\pm$  1dB, 40 c/s.-25 Kc/s. Tone controls: Max. Treble Cut 12 dB, at 10 Kc/s. Max. Bass Boost 14 dB, at 60 c/s. Sensitivity: 100 Mv. for 3 w. output. Output Power (at 400 c/s): 3 w. at 1% total harmonic distortion. Hum and Noise Level: At least 70 dB. below 3 w.

**COMPLETE KIT** (inc. Valves, all components, wiring diagram and special quality sectional Output Trans.). **ONLY £6.19.6.** Carr. 5/-.

Complete wired and tested. 8 gns. Bronze Escutcheon Panel, Printed Vol., Treble, Bass, On-Off, supplied with each Kit. Wired O/P socket power and additional smoothing for Tuner Unit, 10/6 extra.

Recommended Speakers—WB HP1012 85/-, Goodmans AXIOM 110 £5, etc.

**SPECIAL BARGAIN OFFER**

A self-contained Portable Unit incorporating latest BSR 4 speed Auto Changer Record Player and famous High Fidelity "Full-Fi" Xtal Pick Up with Turnover Cartridge, fitted with LP and 78 Sapphire Styl. Internal 2 valve Amplifier of modern design, with variable Tone and Volume Controls. This, together with a quality P.M. Speaker ensures a high standard of reproduction. The whole is housed in a robust wooden Cabinet attractively styled in 2 Tone contemporary leather cloth with contrasting polka dot relief.

Kit consists of 3 sub assemblies already wired. Grub screw connections between Units only necessary—absolutely no soldering.

Originally built to be sold at 17 gns.

Recommended Buy!



**£12.10.0**

Carr. & Ins. 7/6  
Autochanger Unit—BSR Model UA20. Amplifier—valves UCL82, UY85 and 7 x 4in. Elliptical Speaker. Cabinet size 17 x 14 x 8 1/2 in.

**RECORDING TAPE—Reduced Prices**

Famous American Columbia (CBS) Premier Quality Tape at NEW REDUCED PRICES. A genuine recommended Quality Tape—TRY IT! Brand new, boxed and fully guaranteed. Fitted with leader and stop folls.

5in.	Standard	Long Play	Double Play
5in.	900ft. 13/-	900ft. 17/8	1,200ft. 31/8
5 1/2in.	900ft. 18/-	1,200ft. 19/8	1,800ft. 37/8
7in.	1,200ft. 21/-	1,800ft. 29/8	2,400ft. 47/8

P. & P. per reel 1/-; 6d. on each additional reel.

**SPECIAL BARGAIN.** 3in. Message Tape, 150ft. 3/6. P. & P. 6d. 3in. L.P. 255ft. 4/8. 3in. D.P. 30 ft. 8/6.

Plastic Tape Reels 3in. 1/3, 5in. 2/-, 5 1/2in. 2/-, 7in. 2/3

Plastic Spool Containers 5in. 1/8, 5 1/2in. 2/-, 7in. 2/3

**COAX 90 OHM CABLE**—High grade low loss Cellular air spaced Polythene—1/4 in. diameter. Stranded cond. Famous mfrs. Now only 6d. per yard. Bargain Prices—Special Lengths—

- 20 yd. 9/-, P. & P. 1/6,
- 40 yd. 17/8, P. & P. 2/-,
- 60 yd. 25/-, P. & P. 3/-,
- Coax Plug 1/-, Screets 1/-,
- Couplers 1/3, Outlet Boxes 4/6.



**COLLARO STUDIO TAPE RECORDER KIT**

**SPECIAL BARGAIN OFFER. Comp. Kit only Carr. 12/6. £25.0.0**

Famous mfrs. surplus offer—Listed 42 gns. A quality Tape Recorder Kit based on Mullard famous design—EF86, EC683, EL84, EM84 and Rectifier. Specially designed Kit for Collaro latest Studio Deck. Freq. response  $\pm$  3 dB, 60 c/s.—10 Kc/s. Amp. and Power Pack already wired, inter unit wiring only required. Cabinets size: 18 x 16 1/2 x 6 1/2 in. finished in contemp. 2 tone blue Rexine with gilt Speaker Escutcheon. Magic Eye Indicator Circuit and Tech. H/Book. Supplied free with kit. Send 2/6 now for full details of today's outstanding Tape Recorder Bargain.

Cabinet £3.15.0. P. & P. 6/8.  
Amplifier Kit £9.18.8. P. & P. 5/-.  
Speaker 7 x 4 1/8 P. & P. 2/-.  
If above items are purchased together.

**£12.19.6** P. & P. 10/-

**BARGAIN RECORD 4-SPEED PLAYER UNITS**

Single Players Carr. 3/6  
Garrard 4 S.P. £6.19.6  
Garrard T.A. Mk.2 £7.19.6  
Collaro "Junior" 75/-  
B.S.R. Latest TU12 78/6  
E.M.I. Junior "985" 89/6  
Auto-Changers Carr. 5/-  
Collaro "C 60" £7.15.0  
B.S.R. (UA14) £6.19.6  
Garrard "Auto-slim" £7.10.0  
Garrard Model RC209 £9.19.6

**Volume Controls—** 5K-2 Meg-ohms, 3in. Spindles Morganite Midget Type lin. diam. Guar. 1 year. LOG or LIN ratios less Sw. 3/-.  
D.F. Sw. 4/6. Twin Stereo less Sw. 6/6. D.F. Sw. 8/-

**RECORD PLAYER CABINETS**

Cabinet Price **£33.0**  
Carr. & Ins. 5/-



Contemporary style, rexine covered cabinet in two-tone maroon and cream. Size 18 x 13 1/2 x ht. 8 1/2 in., fitted with all accessories including baffle board and anodised metal fret. Space available for all modern amplifiers and autochangers, etc. Uncut record player mounting board 14 x 13 in. supplied.

**2-VALVE 2-WATT AMPLIFIER** Twin stage ECL82 with vol. and nek. feedback Tone control. A.C. 200/250 v. with knobs. etc., ready wired P. & P. 1/6.

6in. Spkr. & Trans. 22/-, P. & P. 2/-.  
Complete Kit, including UA14 Unit as illustrated, £12.19.6, carr. 7/6.

**JACK PLUGS.** Standard 2 1/2" Igranite Type, 2/6. Screened Ditto, 3/2. Miniature 1 1/2", 2/3. Screened Ditto, 2/6.

**ENAMELLED COPPER WIRE**—1lb. reels, 14S-20S, 2/6; 22S-28S, 3/-; 30S-40S, 3/8. Other gauges quoted for.

**Ervin Multicoe Solder 60/40 3d.** per yard. 1lb. 2/6, etc.

**Condensers—Silver Mica.** All values. 2Pf to 1,000Pf. 6d. each Ditto. Ceramics. 9d. Tub. 450V T.C.C., etc., 0.001 mfd to 0.01 and 0.1/350V., 9d. 0.02-0.1/500V., 1/-, 0.25 Hunts 1/6. 0.5 T.C.C. 1/8, etc., etc. Close Tol. 8/Micas—10/- 5Pf 500Pf 8d. 600-5,000Pf 1/-, 12/- 2Pf 100Pf 9d. 100Pf-500Pf 11d. 575Pf-5,000Pf 1/6. **Resistors—** Full Range 10 ohms-10 meg-ohms 20%  $\pm$  and 1W 3d., 1W 5d., (Midget type modern rating) 1W 6d., 2W 9d. Hi-Stab 10d., 1W 5d., 1W 7d. 5c. 1W 9d., 1W 1 1/4 1/6.

New Boxed	VALVES	All Guaranteed
174	6/-	EC683 8/-
185	7/6	ECL82 10/6
186	7/6	ECL80 10/6
384	7/6	EF86 8/-
8V4	7/6	EF86 12/6
DAF96	9/-	EL84 8/6
DF96	9/-	EM81 9/6
DK96	9/-	EY51 9/6
DL96	9/-	EY98 10/-
EC81	9/6	EY83 7/6
EC682	8/-	GZ32 12/6

**JASON FM TUNER UNITS** Designer-approved kits of parts:  
FMT1, 5 gns. 4 valves, 20/-  
FMT2, 27. 5 valves, 37/6  
JTV MERCURY 10 gns.  
FVT £13.19.6 4 valves, 32/6  
NEW JASON FM H/AND-BOOK, 2/6. 48 hr. Alignment Service 7/8. P. & P. 3/6.

**TYGAN FRET** (contemp. pat.)  
12 x 12in. 2/-, 12 x 18in. 3/-,  
12 x 24in. 4/-, 19 x 24in. 6/- etc.

**Speaker Fret**—Expanded bronze anodised metal tin. x 1/4 in. diamond mesh, now 4/6 sq. ft., Multiples of 6in. out max. width 4 ft.

**Electrolytics All Types New Stock**

TUBULAR	CAN TYPES
25/25V 1/8	8+8/450V 4/6
50/12V 1/8	8+16/450V 5/-
50/50V 2/4	32+32/275V 4/6
100/25V 2/-	50+50/300V 8/6
8/450V 2/3	60+250/ 275V
18+18/450V 3/6	100+200/ 275V
32+32/450V 6/8	275V 12/6

**Transistor Components**

Midget I.F. 5-465 Kc/s. 9/16in. dia. 5/6  
Osc. Coil—M/W 9/16in. dia. 5/3  
Osc. Coil—M. & L.W. 5/8  
Midget Driver Trans. 3.5-1 6/8  
Midget O/Put Trans. P.P. to 3 ohms, 6/8.  
Ferrite Aerial M. & L.W. Car aerial coil, 9/3.  
1 Met. Condenser—Midget Type Imfd-50mfd ea. 1/8. 100mfd, 2/-, 12V wkg.  
Condensers—0.1mfd to .04mfd 9d.; .05mfd to .1mfd 1/-; .25mfd 1/3.  
Tuning Condensers—JB"OO" 208 pF. + 178 Pf 8/6, with Trimmers 9/6. Single 365pF 7/8. Sub min. tin. J.B. Dille min. .0001. 0.003 or .0005 7/- each.  
**Midget Vol. Control**—with edge control knob. 5K ohms with switch, 4/9. less switch 3/8.  
**Speakers**—P.M.—2in. Plessey 7c ohms 15/6. 2in. Conventional 8 ohms 13/6. 2in. E.M.I. 3 ohms 17/6. 7 x 4in. Plessey 35 ohms 23/6.  
**Ear Plug Phones**—Min. Conventional lead, 3ft. lead, jack plug and socket. High Imp. 8/-, Low Imp. 7/6.

**TRANSISTOR BARGAINS**

Brand New	BVA	1st Grade
OC44	8/6	GET114 6/6
OC45	8/-	OC72 7/6
OC41	8/6	OC70 7/6
2OC81	15/6	OC71 7/6
XA102	10/6	OC78 5/8
XA101	9/6	GEX34 2/9
XB103	7/6	OA70 2/9
XC101	8/6	OA81 2/9

Special offer: One OC44, two OC45, 21/6. One OC81, two OC81s (matched pair) 19/6

Send for detailed bargain lists, 3d. stamp. We manufacture all types Radio Mains Transf. Choices, Quality O/P Trans. etc. Equities invited for Specials, Prototypes for small production runs. **Questions by return.**

**RADIO COMPONENT SPECIALISTS**

70 Brickstock Rd., Thornton Heath, Surrey. Hours: 9 a.m.-6 p.m., 1 p.m. Wed. THO 2188. Terms C.W.O. or C.O.D. Post and Packing up to 1/6. 9d., 1lb, 1/8; 3lb, 2/8; 5lb, 2/9; 8lb, 3/6.

## A SIMPLE EXPLANATION OF TRANSISTOR RADIOS FOR THE APPRENTICE ENGINEER



Starting with a description of the basic properties of semiconductors, the action of a transistor is explained in detail and without recourse to complex mathematics. The circuits used in transistor radios are described, and the techniques for servicing these sets are considered.

### CONTENTS INCLUDE:

Semiconductor materials; Transistor action; Transistor circuits; Servicing, etc. In all, seven chapters with the emphasis always on practical considerations.

### U.K. PRICE 5/-

Published by Mullard Ltd. Get your copy from your radio dealer or send remittance with direct order (Postage and packing 6d. extra).

**MULLARD LIMITED • MULLARD HOUSE  
TORRINGTON PLACE • LONDON WC1**

MVM1021

TOP QUALITY—LOW COST



AMATEUR RADIO EQUIPMENT

### THE MINI-CLIPPER

The ORIGINAL and finest one valve all band receiver. Outstanding performance. New first-grade components ensure top efficiency. Low loss air spaced tuners, high gain polystyrene plug in coils. Satin Silver metal panel with engraved dials, grey pointer knobs. Provision for adding 2 transistor amplifier stage. Chassis ready punched. Total building cost, all parts, one coil 20-60 metres, wire solder full plans, 36/6. P. & P. 2/6. Other coils 10-2000 metres and electrical bandspread available. Parts sold separately. Plans and parts list, 2/-.

NEW LOW  
PRICE

36/6

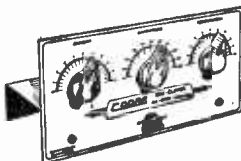

### THE SUPER CLIPPER 88/6

This world-famous hybrid receiver has achieved remarkable success. Tremendous performance with Hi-gain valve detector PLUS two Ediswan transistor amplifiers which are supplied assembled, only 3 wires to connect. Large precision dial, 7 x 4in., with 2 pointers, bandset and bandspread, dual slow-motion drives, air spaced variables. Punched chassis 8 x 5 1/2in. Batteries last months. Covers 10-2000 metres (5 coils). Total building cost including chassis, valve, 2 transistor stages, 2 coils 20-60 and 55-190 metres. Step-by-step pictorial plans, nuts, bolts, wire 88/6. P. & P. 2/6. Plans only, 2/6. THE CLIPPER. As above but one transistor stage, 79/6. P. & P. 2/6. Optional Front Panel, Silver Hammer finish, all holes, 6/9.



### THE NEW CR45 ★ NEW STYLING TOP PERFORMANCE

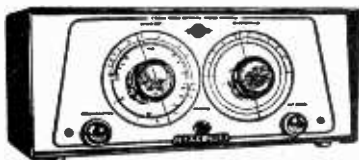

Previously produced exclusively for Export, the de-luxe version of this famous ALL BAND receiver is now also available for the home market. Superb new styling, satin silver front panel, frequency calibrated scales, grey and silver trim knobs, perspex disc cursors. High gain circuit with ECC81 duotride, EL84 output, EZ80 full wave rectifier. Power output 3 1/2 watts for 2/3 ohm speaker. 3 Planetary vernier slow motion drives, separate electrical bandspread. Covers 10-2000 metres (5 Coils). World wide reception. For A.C. supply 200-250 volts (Export version 105-120 volts). Total building cost all parts, valves, front panel, ready punched chassis 2 coils, 20-60 and 55-190 metres, wire, solder, instruction manual. P. & P. 3/6. Optional extra. CR45 Cabinet 12 x 5 x 7in., slide flap for easy coil changing, Silver grey finish, 27/6.

£6.19.6

No technical knowledge required to build these fine receivers. Send 3d. stamp for illustrated leaflets, testimonials, etc.  
★ Now available the NEW 1962 CR 66 A.C. SUPERHET COMMUNICATION RECEIVER.

**CODAR RADIO COMPANY, 24 CHAPEL ROAD, FISHERGATE, PORTSLADE, SUSSEX**

CSRS

Canadian Distributors: JAYCO ELECTRONICS, TWEED, ONTARIO.

G31 PA

# DISTORTION

## HOW IT IS CAUSED AND HOW IT IS CURED

by Gordon J. King

**R**ADIO receivers and amplifiers are subject to two basic types of distortion. One is called "amplitude distortion" and the other "non-linearity distortion".

### Amplitude Distortion

An amplifier is suffering from amplitude distortion when it fails to give equal amplification to all signals within its working frequency range. This is illustrated in Fig. 1, where the input signal is shown by the broken line and the output signal by the continuous line. In spite of the input signal amplitude being constant from about 20c/s to 10,000c/s, the output signal amplitude varies widely over the same range of frequencies, and is flat only from about 100c/s to 1,000c/s.

This shows that the amplifier is frequency selective in that it gives greater amplification to signals between 100 and 1,000c/s than it does to signals below 100c/s and above 1,000c/s.

Ideally, the a.f. stages in a radio receiver should amplify signals from about 30c/s to 15,000c/s evenly (Fig. 2). Good quality hi-fi amplifiers do far better than this and amplify evenly from about 15c/s to 50,000c/s. Although we can only hear frequencies up to about 15,000c/s—the exact frequency depending upon age—there are various acoustical reasons why an amplifier should respond

well above this frequency—but that is another story!

In domestic radio practice, reproduction sounds quite good provided there is no marked fall-off in amplification below about 8,000c/s and above 100c/s (Fig. 2). However, in reality, this is often far from the case. Loudspeakers and baffles on most popular receivers are usually incapable of giving an output at 100c/s, while adjacent station interference on the L.W. and M.W. bands makes it

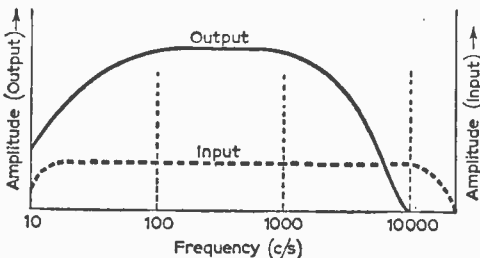

Fig. 1: Although the amplitude of an input signal (broken line) is constant over the a.f. spectrum, the amplitude of an output signal (continuous line) varies widely over the spectrum.

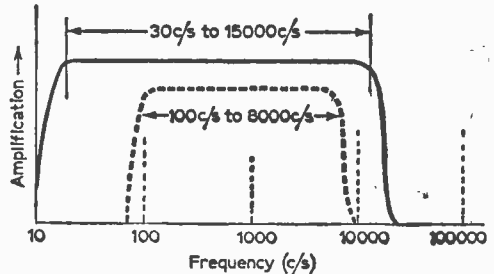

Fig. 2: An ideal amplifier provides even amplification from 30 to 15,000c/s (continuous line), while a practical amplifier may have a response as shown by the broken line.

impossible to keep a sufficiently wide i.f. passband to carry the sidebands of the higher audio modulation frequencies.

Thus, there is little incentive for the designer of a popular receiver to optimise the a.f. response. This does not apply, of course, to radiograms, where an extended amplitude frequency response is necessary for good quality reproduction of records.

### Sideband Attenuation

When a carrier signal is modulated, two sideband signals are produced. These are called the upper and lower sidebands, and they are equal to the carrier frequency plus or minus the modulation frequency respectively. With a carrier frequency of, say, 470kc/s—which is the standard broadcast i.f.—modulated with a 10kc/s (10,000c/s) signal, the lower sideband is 460kc/s and the upper side-

band 480kc/s. For these sidebands to be conveyed through the i.f. stages of the receiver without attenuation, the i.f. response must be sufficiently wide to accommodate them, as shown in Fig. 3.

Unfortunately, at medium broadcast frequencies such a response is entirely out of the question since adjacent stations are present within 10kc/s of the wanted station on certain parts of the band. The desirably wide i.f. response would thus accept not only the wanted station and all of its sidebands but also some of the sidebands of the unwanted adjacent station (Fig. 4). This would cause very bad interference—far more disconcerting than a restricted high frequency a.f. response.

It is necessary, therefore, to limit the i.f. response so that near adjacent stations and their sidebands are greatly attenuated (Fig. 5), but this practice, of course, attenuates the higher frequency side-

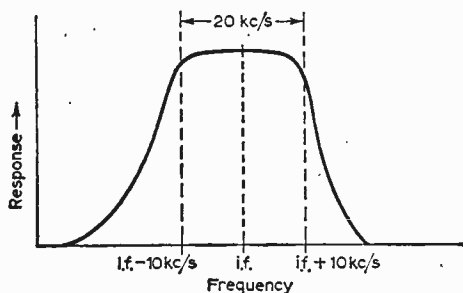

Fig. 3: To cater for modulation sidebands up to 10kc/s without attenuation, the i.f. response should be as shown.

bands of the wanted station.

The foregoing reveals, therefore, that considerable amplitude distortion just cannot be avoided on the L.W. and M.W. bands, even though the detected signals may be applied to a hi-fi audio amplifier.

### Frequency Modulation

This is one of the reasons why frequency modulation on the v.h.f. bands was introduced by the BBC. Careful grouping of the v.h.f. stations makes it impossible for an adjacent station to fall within the i.f. passband of the required station, and as much more room is available in the v.h.f. regions, each f.m. channel can have approximately 200kc/s all to itself. This is adequate to handle the very highest f.m. sideband, which means that responses up to 15,000c/s are possible at f.m., provided they are present at the transmitter.

The majority of small a.m.-only sets do not give much output at audio frequencies above about 4,000 to 5,000c/s, but good quality f.m. sets may go as high as 10,000 to 15,000c/s. The falling high frequency a.f. response due to i.f. passband limiting on a.m. sets does not occur suddenly, but it tails off gradually. One can easily widen the i.f. passband, of course, by carefully realigning the i.f. transformers, preferably with an oscilloscope and wobulator, but if this is done, the set will be useless on all but the very local station for reasons of adjacent channel interference described above.

Nevertheless, a top response up to about 4,000c/s is quite reasonable, and quite a few listeners feel

that even this is too high, and cut it more by turning on the tone control! The tone control on the majority of popular sets is nothing more than a "top cut" control which attenuates the higher audio frequencies in the a.f. circuits. With maximum top cut, the response may not extend to more than about 3,000c/s. This is even practised by the "non-musical" on f.m. receivers, which are usually truly capable of giving a good top without adjacent channel interference and other distortions.

### Non-Linear Distortion

This type of distortion can be much more disconcerting than frequency distortion, and it results due to some non-linearity in the amplifier valves, transformers and associated circuits. With an amplifier which is perfectly linear, any increase or decrease of input signal produces a corresponding increase or decrease of output signal over the voltage or power working limits of the equipment. This can be represented as a perfectly straight line on the transfer characteristic, as shown by the unbroken line in Fig. 6.

Unfortunately, however, no amplifier has such an ideal transfer characteristic, for due to the action of the valves and other components, the characteristic curves slightly, as shown rather exaggerated by the broken line in Fig. 6. This means, then, that the output signal does not follow perfectly faithfully any variation in the input

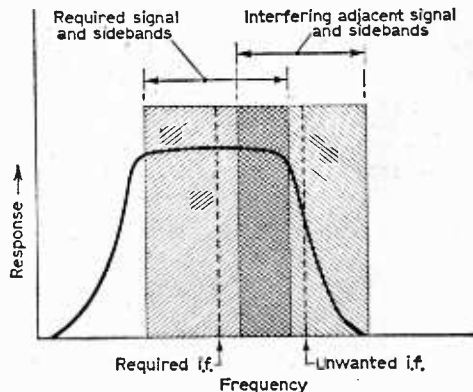

Fig. 4: A wide i.f. response cannot be used on medium broadcast frequencies owing to the breakthrough of an adjacent programme and its sidebands.

signal. In practice, particularly in hi-fi amplifiers, the transfer characteristic is almost linear up to the overload point of the equipment and then it really starts to curve. This is one of the reasons why hi-fi amplifiers are relatively highly powered for within the normal domestic working power range of the equipment the linearity is very good indeed. With a lower powered amplifier, full domestic output may cause the signal to traverse the non-linear top part of the characteristic with consequent bad non-linearity distortion.

Non-linearity destroys the quality of reproduction mainly because it creates harmonics of the original signal. It thus introduces spurious tones

# CLYNE RADIO LTD



18 TOTTENHAM COURT ROAD, W.1  
162 HOLLOWAY ROAD, LONDON N.7  
9 CAMBERWELL CHURCH STREET, S.E.5  
10 WIThey GROVE, MANCHESTER, 4

All post orders, etc. to 162 HOLLOWAY ROAD, LONDON, N.7

## THE COMPONENT SPECIALISTS

MUSEum 5929/0095  
NORth 6295/6/7  
RODney 2875  
Blackfriars 5379

## TAPE RECORDER CONSTRUCTORS

**LATEST COLLARO STUDIO TAPE TRANSCRIBER.** Latest type incorporating Record, Interlock, Lever, Button, 3 motors 3 speeds, 14, 31, 7 1/2 i.p.s., takes 7in. SPOOLS. Push-button controls. **NEW LOW PRICE OF £10.10.0 ONLY!** plus 7/6 P. & P. Usual H.P. facilities.

**NEW! TAPE RECORDER AMPLIFIER TYPE 8311-V.** Sub-assembled—anyone can build! Printed Circuit, all components mounted and dip soldered. Already tested. Each

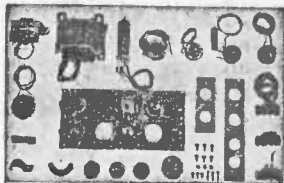

lead cut to length. All that is required to complete the tape recorder is for a few components to be mounted in the cabinet and the free ends of the leads soldered to terminals which are clearly marked, everything supplied, all you need is solder iron, pliers and screwdriver. Valve line-up; EF86, ECC83, 2 x EL84, E2a1 and 2M64 magic eye. Monitoring facilities, output socket for feeding to high quality amplifier, can be used as "straight" amplifier for record reproduction. **EQUALISING ON TWO SPEEDS. OUTSTANDING VALUE AT £11.11.0 plus 2/6 P. & P.** including all necessary instructions.

**ATTRACTIVE TWO-TONE PORTABLE CARRYING CASE.** Suitable for above amplifier and Collaro Studio deck. Fitted with 9in. x 5in. High Flux P.M. speaker for high quality reproduction. Inclusive price £25.5.0 plus 5/- P. & P. Full list of competitively priced mics and stands on request. The above 3 items purchased at one time, SUPPLIED CARR. PAID.

**NOW AVAILABLE! FOUR TRACK STUDIO DECK AS ABOVE, FITTED WITH HIGH-FI FOUR-TRACK HEADS. PRICE £13.19.6 plus 7/6 P. & P.** Four track heads supplied separately, complete with mounting bracket for Studio Deck at 92/6 pair, plus 2/6 P. & P.

**TAPE RECORDER AMPLIFIER 8311-V.** Exactly as 8311-V but four track—suitable for high-fidelity four-track heads. Price £12.12.0 plus 2/6 P. & P.

**PRE-AMPLIFIER KIT TYPE 8312-CP.** Complete high quality pre-amplifier kit for use with Collaro Studio Deck. Price £8.8.0 plus 2/6 P. & P.

**N.B.** Four-track deck and amplifier fit the above case, without any modification whatsoever.

## TAPE! TAPE!

For the first time in this country! Canada's Hi Fi Magnetic Recording Tape. Made by "Bel-Clear" of Canada.

Following sizes available, others to follow. Brand New, NOT sub-standard. High grade Acetate base, attractively boxed, fitted leaders, fully guaranteed.

5in. 600 ft., 12/6; 5in. 900 ft., 15/-; 7in. 1,200 ft., 18/6; 7in. 1,800 ft., 25/-; P. & P. 6d. per spool. 3 or more post free. (Bona fide trade inquiries invited).

**SPECIAL AMERICAN MYLAR DUPONT.** 5in. 1,200 ft. D.P. Top quality Brand New 25/-, post free. Limited quantity only!

**PLASTIC TAPE SPOOLS.** Best quality. 3in., 1/3, 4in., 2/-, 5in., 2/-, 5 1/2in., 2/3, 7in., 2/6, P. & P. 6d. per spool. Orders over £1 post free.

**TELEPHONE PICK-UP COIL.** Designed to feed into the microphone input of either a tape recorder or any high gain amplifier. Easily attached to telephone by rubber section attachment. The coil is electrostatically shielded to minimise hum pick-up. When positioned on telephone this model is more than adequate for a fully modulated tape recording. Brand new complete with 5 ft. shielded cable. **ONLY 14/-.** Post free.

## THE NEW "CLYMAX" !!

NEW LOW PRICE MADE POSSIBLE Through Further BULK PURCHASES !!

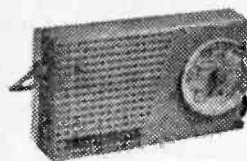

Our 6-transistor pocket size superbet for Medium and Long Wave. All required components. **NOW ONLY 99/6**

Nothing more to buy! Plus 3/6 P. & P.  
★ Completely self contained. No external aerial or earth required. ★ Full medium wave coverage, plus switched Light programme on Long Wave. ★ Push-pull output—250 milliwatts. ★ Matched set of latest type Mullard transistors. ★ Genuine 2 1/2in. P.M. Speaker. ★ New high-Q Coils. ★ Ferrite rod aerial with high selectivity. ★ Size: 5 1/2 x 3 1/2 x 1 1/2in. Two-tone cabinet. ★ Precision etched printed circuit with components references clearly marked. Alignment service available. All parts available separately. Full assembly instructions and individually priced parts list. 2/- post free.

## MODEL TK.20A



Size 3 1/2" x 2 1/2" x 1 1/2". Meter size 2 1/2" x 1 1/2". Sensitivity 1000 o.p.v. on both A.C. and D.C. volts. 0/15. 0/150. 0/1000 volts. D.C. Current. 0/150 mA. Resistance. 0/100 K. Complete with test prods, battery and full instructions. **OUTSTANDING VALUE AT 42/-** Plus 1/6 P. & P.

## The "COURTESAN"

Our 3 transistor plus 2 diode pocket receiver with full Medium and Long Wave Coverage.

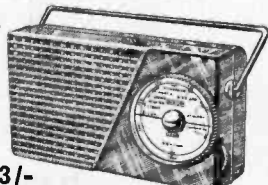

**ONLY 63/-**

Plus 2/6 P. & P.  
★ No external aerial and earth required. ★ Latest 2 1/2in.—75 ohm speaker. ★ First grade Mullard transistors. ★ Condenser tuning. ★ Volume control with on/off switch. ★ Easy assembly on pre-tagged circuit board. ★ Attractive red polystyrene cabinet measures 5 1/2 x 3 1/2 x 1 1/2in. chrome handle, attractive gold and black dial. ★ Luxembourg, Hilversum, etc. guaranteed in reception areas. All parts available separately. Itemised parts list and full assembly instructions 1/6, post free.

## LAST CHANCE TO BUY

The well-known BRAYHEAD TRANSTRONIC "SUPER 60" RADIO KIT.

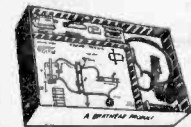

A complete kit to make your own transistorised Transmitter and Receiver. No soldering required. 7 different circuits to build. In original manufacturers coloured box with instructions. Ideal gift for the electronically minded youngster. (As Nationally advertised at £5.4.8)

**FEW ONLY AT 49/6** P. & P. 4/-

## The "AIR KING"

Our new highly successful Six transistor luxury portable with the "SLIM LINE" look. To build yourself with printed circuit chassis for reliability and simplicity in construction. May be used as Car Radio, with full MEDIUM wave and LONG wave coverage. **Look at these features!**

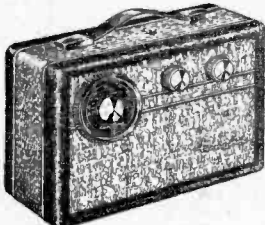

★ 600 milliwatt output to high flux 7 x 3 1/2in. high fidelity loudspeaker. ★ Six selected Mullard Transistors in latest super sensitive circuit, plus germanium diode. ★ Compact size—only 9 1/2 x 3 1/2 x 6 1/2in. (high). ★ Attractive three-tone cabinet. Black, Dark Grey, and Silver Grey, with gilt control knobs and all gilt fittings. ★ Coax socket for car aerial. ★ Brand new guaranteed components. ★ Push pull output. ★ Automatic volume control. ★ Long life battery. ★ Super sensitive internal ferrite rod aerial. ★ Nothing more to buy. Cabinet included. Special inclusive price for **£7.19.6**

Plus P. & P. 4/- Alignment service available. Full assembly details and individually priced parts list, all of which are available separately, price 1/6, post free.

## The "HIGHWAYMAN"

At last a quality Car Radio to build yourself, at an economical price. Look at these features:—

★ Attractive stylism. ★ Push-pull output. ★ 3 latest Mullard transistors plus valves type EF83 and ECH83. ★ No Buzz. High Output and sensitivity. ★ Printed circuit (newest type). 7 x 4" High flux p.m. speaker. ★ Buttons for fingertip control. ★ Extremely low Battery consumption (less than 1 amp.). ★ Easy to fit any make car (Positive earth only). ★ 12 volt operation. ★ Compact size measures only 7 x 7 x 2 1/2" deep. ★ Easy assembly. Supplied with dial and drive already mounted.

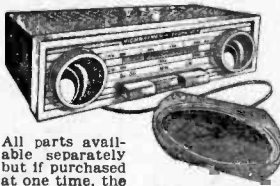

All parts available separately but if purchased at one time, the whole will be supplied at a special inclusive price of only **£10.19.6**

Plus 4/- P. & P. Parts list and comprehensive instruction booklet 2/6, post free. (Deducted from cost if complete parcel purchased later).

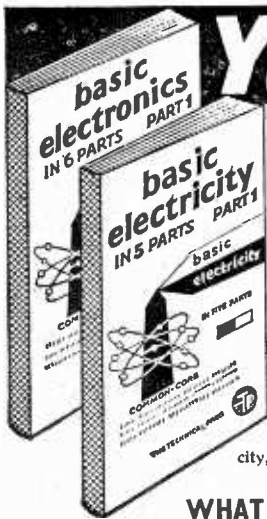

# YOURS FREE FOR 7 DAYS

## The New 'Picture-Book' way of learning **BASIC ELECTRICITY (5 VOLS.)** **BASIC ELECTRONICS (6 VOLS.)**

You'll find it easy to learn with this outstandingly successful new pictorial method—the essential facts are explained in the simplest language, one at a time; and each is illustrated by an accurate, cartoon-type drawing.

The books are based on the latest research into simplified learning techniques. This has proved that the Pictorial Approach to learning is the quickest and soundest way of gaining mastery over these subjects.

The series will be of exceptional value in training mechanics and technicians in Electricity, Radio and Electronics.

### WHAT READERS SAY

"... I have found the manuals to be excellent publications..." D.L.D. "... I wish to congratulate you on these 'Best ever' series..." B.P. "... I consider the manuals are truly the best I have ever studied..." S.A.S.

A TECHNICAL PRESS PUBLICATION

To Selray Book Co.,  
60 Hayes Hill, Hayes, Bromley, Kent

Please send me Without Obligation to Purchase, Basic Electricity/Basic Electronics on 7 Days Free Trial. I will either return set, carriage paid, in good condition within 8 days or send down payment of 10/- (Basic Electricity) followed by 6 monthly payments of 10/-. Down payment of 12/- (Basic Electronics) followed by 6 monthly payments of 12/-. Alternatively, I will send 63/- (Basic Electricity—5 parts), 75/- (Basic Electronics—6 parts) post free.

Tick against set required (only one set allowed on free trial).  
BASIC ELECTRICITY  BASIC ELECTRONICS

Signature \_\_\_\_\_  
(If under 21, signature of parent or guardian)

Block Letters Below  
Name \_\_\_\_\_  
Full Postal Address \_\_\_\_\_

**POST NOW FOR THIS OFFER!!**

## The new NOMBREX

TRANSISTORISED WIDE-RANGE  
SIGNAL GENERATOR 27  
220 kc/s to 220 Mc/s



- CHECK THESE FEATURES**
- COMPACT  
Only 8 1/2" x 4 1/2"
  - PORTABLE  
Weight 2 lbs.
  - ACCURACY!  
Under 2%
  - ECONOMY!  
9v. Battery
  - DIRECT  
Calibration

**RETAIL £7.10.0** Post and Ins. 3/6  
Battery 2/3

36" Screened Test Lead 6/3 extra  
CASH WITH ORDER, REGRET NO C.O.D.

**IMMEDIATE DELIVERY**

Trade and Export Enquiries Invited

S.A.E. for full technical leaflet.

H.P. Terms:  
Send £2 deposit on balance  
£1/- per month

### NOMBREX LTD. (Instruments Division 48)

Estuary House, Camperdown Terrace, Exmouth, Devon, England. Tel. 3515.

## IT'S A JOY TO BUILD A MARTIN 'RECORDAKIT' VALUE AND PERFORMANCE BEYOND COMPARE

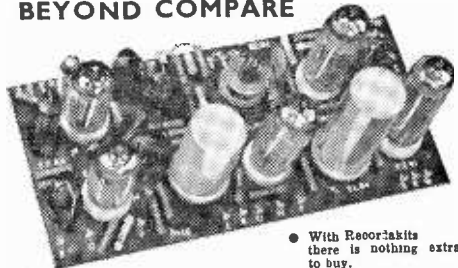

- With Recordakits there is nothing extra to buy.
- Speed compensated.
- Designed to genuine luxury recorder standards.
- Other Martin 'Recordakits' available for P.S.R. and 4-track Studio Decks.
- Case and Speaker assemblies available with and without decks.

With a Martin Recordakit 'D', designed for use with the Coliaro 4-track Studio Deck you can build an instrument of outstanding quality. As with all Martin Recordakits, it is on a printed circuit base and complete with valves, controls, transformers, leads, etc., down to the last screw. Even the wire supplied is cut to length.

Amplifier 'D' as above, 12 gns. Speaker and Case assembly, 5 gns. With Deck Case, Speaker and Amplifier 34 gns.

From radio and audio stockists. In case of difficulty send direct. For free leaflet, cut out this ad. and send it with your name and address.

### MARTIN ELECTRONICS LTD

155 High Street,  
Brentford, Middlesex.  
IS Leworik 5885

which are not present in the original. Harmonic distortion is measured in terms of a percentage relative to the fundamental signal. This means that an amplifier which has, say, 10% harmonic distortion at 10W output creates 1W of spurious harmonic signal!

Total harmonic distortion is the square-root of the sum of all the various harmonics produced. A pentode output valve, for example, gives most third harmonic distortion (with other harmonics at smaller amplitude), while a triode valve gives most second harmonic distortion. With push-pull amplifiers, the second and even harmonics are largely precluded by cancellation in the balanced load of the output transformer, and the third and higher-order odd harmonics are most troublesome. These, however, can be very much reduced in amplitude by the careful application of negative feedback and by running the valves well within their power handling limits.

In the early days, triode valves were popular in the output stages of high quality amplifiers, because as these produce mainly second harmonic distortion, running them in push-pull gives almost complete second harmonic cancellation and good quality output without too much negative feedback.

The amount of non-linearity may not be constant over the entire frequency range of the amplifier. Indeed, towards the low frequency end it may rise considerably due to the speaker transformer being insufficiently large to act as an effective load. This is the direct result of small

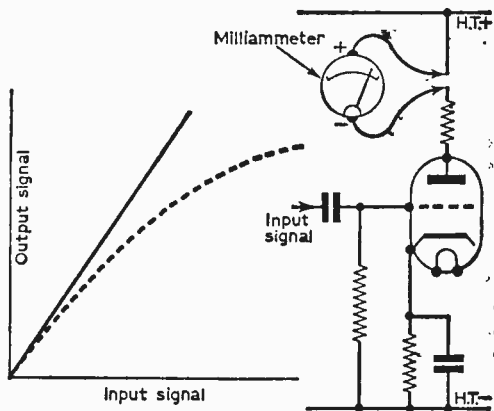

Fig. 6 (left): Transfer characteristic which shows perfect linearity (continuous line) and poor linearity (broken line).

Fig. 7 (right): In stages with a high resistance in the grid circuit, non-linearity distortion can be gleened by connecting a milliammeter in the anode circuit and observing the kicks on the needle with the stage carrying a signal.

A twin-beam oscilloscope is a useful device for investigating a.f. distortion in conjunction with an a.f. signal generator. One beam can be connected to the signal applied to the amplifier stage from the generator, while the other beam can be connected to the output of the amplifier. By adjusting the two Y-gain controls two traces of equal amplitude can be obtained on the screen representing the applied waveform and the output waveform. By careful use of the shift controls it is then possible to get one waveform to fall on top of the other, thereby giving visual indication of any difference between the two in terms of distortion on the output waveform.

The signal from the generator can then be increased, when the point of bad distortion will be evident by the output waveform differing considerably from that of the input signal. Another method of checking for distortion in Class A amplifiers is to introduce a milliammeter in the anode circuit of the valve (Fig. 7) and observe the needle with the stage carrying signal. Under true Class A conditions and zero distortion there will be no movement at all of the needle. Distortion, however, will show up as the needle kicking on loud signals.

A downward kick (reducing current) usually means that the valve is passing grid current on the positive peaks of the signal. This could result from insufficient grid bias, low emission valve and incorrect grid components.

An upward kick, on the other hand, is symptomatic of anode-bend rectification on signal peaks, and is often caused by too much bias voltage (check the cathode resistor), a low emission valve, incorrect anode load resistance and low h.t. voltage.

Note that a disturbance to the biasing is frequently caused by a leak in the coupling capacitor at the grid from the anode of the previous stage.

Pentode valves may not give exactly the same effects, for here the screen grid conditions may also be rather critical.

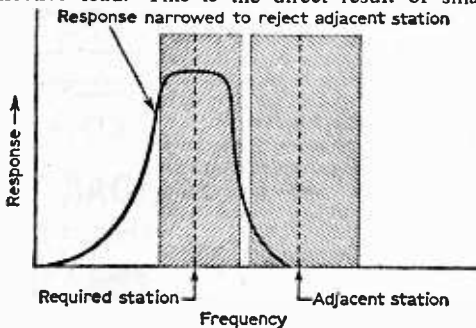

Fig. 5: To avoid adjacent station breakthrough the i.f. response is narrowed, but this also results in the attenuation of the higher sidebands of the wanted station.

primary inductance (and why output transformers in hi-fi amplifiers are remarkably large affairs), and if a set with a small output transformer is enhanced in bass response, very high order harmonics are produced.

Peaks in the response of loudspeakers, chokes and output transformers can also greatly aggravate harmonic distortion by causing the output to peak in the frequency range where the harmonics occur. This is rather like inadvertently tuning the amplifier so that the greatest output is obtained on the harmonics!

**Other causes of Non-linearity Distortion**

The main cause of this distortion is overload in a valve. This can happen due to the application of too great an input signal, low emission valve, incorrect biasing, incorrect anode, screen and heater voltages and poor design.

# THE AUDITRON

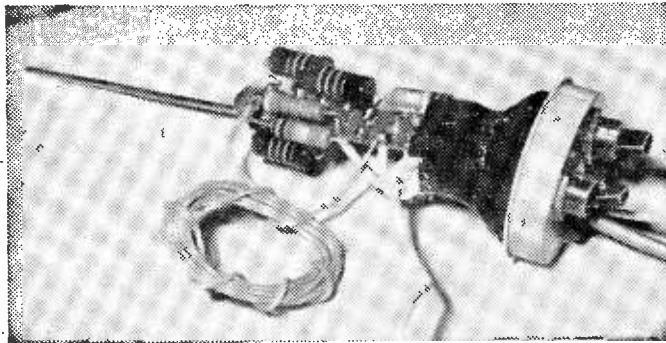

The Auditron probe

By M. L. Michaelis, M.A.,

(Continued from page 942 of the  
February issue)

stray capacity across  $R_b$ , and  $C_e$ , the direct stray capacity from the prod to earth.  $C_e$  is, of course, a direct loading which will be imposed on the signal-source, yet it can be kept very small by using a short straight wire for the prod, mounting  $R_b$  very close to it, and keeping the prod-wire adequately distant from the earthed casing of

FOR the probe unit, a coaxial cable with a capacity not exceeding 1 or 2pF per inch, should be used for the Auditron signal input. With such a cable  $C_c + C_i$  ( $C_m$ )—see Fig. 13, last month—equals approximately 150pF.

If no probe were used, this full 150pF would load the signal source. Apart from serious waveform distortion gross detuning can result in many circuits as soon as the oscilloscope is connected in this way, and when testing oscillators, this capacitive load may even silence the oscillator completely. It is even possible to damage certain equipment if an oscilloscope is connected in this direct way.

Furthermore, the resistive loading, 135k $\Omega$  for the Auditron, is also rather low to impose directly in parallel with many test circuits. This could also silence oscillators due to damping, or grossly change the frequency of multivibrators or saw-tooth-oscillators under test.

It is necessary to reduce capacitive and resistive loading imposed on the signal source, in the face of the inevitable high value of  $C_m$ . This is done by placing a compensating circuit right at the head of the cable, immediately at the signal-source, and this constitutes the probe. Stray inductances and cable transit times have not been considered in the Auditron where about 300yd of cable would be tolerable before this consideration would come into play.

A simple compensated resistance capacitance bleeder is incorporated; this incurs only moderate loss of voltage which can be compensated by extra amplifier gain.

If we constructed such a resistive bleeder quite naively, it would take the form of a large series resistor  $R_b$  in series with the "prod" forming an extension of the core of the coaxial cable. Fig. 14 shows the effective equivalent circuit thereby developed out of Fig. 13. Two new inevitable stray capacities have also thereby appeared,  $C_b$ , the

probe. Thus, with a proper geometric design for the probe,  $C_e$  may be neglected.

$C_b$ , however, is appreciable, and this cannot be avoided, in the Auditron probe in particular, because of the embodied switches and leads (see Fig. 16). We thus have, effectively, two bleeders in parallel, one a capacitive bleeder formed by  $C_b$  and  $C_m$ , and the other a resistive bleeder formed by the intended  $R_b$  and  $R_i$ .

These two bleeders form an a.c. bridge. If this bridge is not balanced, out-of-balance currents will flow in the diagonal  $CD$ , giving phase-shifts and amplitude variation with frequency for the signal reaching the amplifier.

The final step in construction of the probe is therefore to measure the magnitudes of the stray capacities concerned, and thus calculate the size of the capacitor required to be added to one or other of the strays, to bring the bridge to balance. The balance condition is, of course, that  $C_b$  times  $R_b$  should equal  $C_m$  times  $R_i$ .

The ratio of  $R_b$  to  $R_i$  is still free for choice, forming the final bleeder ratio. It should be given the smallest tolerable value (for maximum possible voltage-preservation) consistent with adequate reduction of loading (capacitive and resistive) on the signal source.

Yet in the Auditron the ratio is already fixed by virtue of the necessity for making the pre-calibrated valve voltmeter scale hold true. Certainly, the design there used, and details given in the section dealing with the signal amplifier, already dimensioned these matters such that the ratio of  $R_b$  and  $R_i$  will come out at the optimum, lying between 10 and 15, so the constructor need not be bothered with this consideration any more.

However, slight variations in the meter specified, or making the damping-shunt  $R_{48}$ , will finally lead to slight differences in the final value to be selected



# Just a few of our BARGAINS

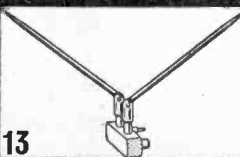
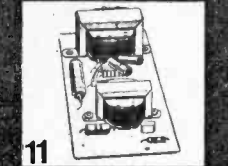
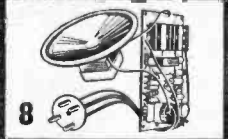
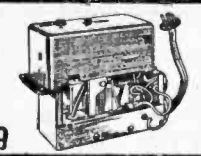
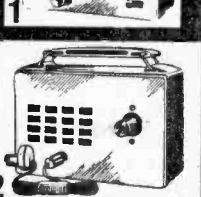

1. **SUPER 5 TRANSISTOR POCKET RADIO INCORPORATING PRINTED CIRCUIT & MINI-EARPIECE.** No Aerial or Earth required. 4 1/2 x 3 1/2 x 1 1/2 in. Output 200 m.w., 5 first quality transistors. High flux moving coil speaker. M/L Internal high gain ferric aerial. £2.19.8. P. & P. 3/6. Circuit diagram 1/6, free with parts. All parts available separately.
2. **TRANSISTORISED POCKET RADIO** with printed circuit, mini-earpiece, high gain ferric slab aerial. No aerial or earth required. To build yourself for completely personal listening. 4 1/2 x 3 1/2 x 1 1/2 in. Luxembourg in favourable areas. Only 21/-, P. & P. 2/6. All parts available separately.
3. **A.C./D.C. POCKET MULTI-METER KIT.** 2in. moving coil meter scale, calibrated in A.C./D.C. volts, ohms and milliamperes. Voltage range A.C./D.C. 0-50, 0-100, 0-250, 0-500. Milliamperes 0-10, 0-100. Ohms ranges 0-10,000, 0-100,000, 24/8. P. & P. 2/-. Wiring diagrams 1/-, free with parts.
4. **SIGNAL GENERATORS.** Cash £7.5.0, or 30/- deposit and 6 monthly payments of 21/8. P. & P. 5/6. Coverage 100 kc/s to 100 Mc/s on fundamentals and 100 Mc/s to 200 Mc/s on harmonics. Case 10 x 6 1/2 x 5 1/2 in. Three miniature valves and Metal Rectifier. A.C. mains 200/250 v. Internal modulation of 400 c.p.s. to a depth of 50 per cent. Modulated or unmodulated R.F. output continuously variable 100 millivolts. C.W. and mod. switch, variable A.F. output. Magic eye as output indicator. Accuracy 2 per cent.
5. **SIGNAL GENERATORS.** Cash £5.5.0. P. & P. 5/6. Coverage 120 kc/s to 84 Mc/s. Case 10 x 6 1/2 x 4 1/2 in. Size of scale 6 1/2 x 3 1/2 in. 2 valves and rectifier. A.C. mains 230-250 v. Internal modulation of 400 c.p.s. to a depth of 50 per cent, modulated or unmodulated R.F. output continuously variable 100 millivolts. C.W. and mod. switch variable A.F. output and moving coil output meter. Accuracy ± 2 per cent.
6. **STAAR 45. 9 v. BATTERY RECORD PLAYER** complete with pick-up and deck. A completely portable player. Head protected by plastic dome with a brush which cleans the stylus as it rises into playing position. 45 r.p.m. Auto on/off switch governed motor, attractive two tone grey finish, £2.14.6. P. & P. 2/-.  
7. **CARRYING CASE** for STAAR 45 or **COMPLETE KIT** beautifully styled in two tone with record compartment. Specially designed to take player and amplifier. Just screw in and connect up. All parts available separately. Case only £2/8. P. & P. 4/-. Complete kit £5.10.0. P. & P. 5/-.
8. **TRANSISTORISED AMPLIFIER**, suitable STAAR 45. Output 1 watt. Size 4 1/2 x 2 1/2 in. Printed circuit, tone/volume controls plus 4 transistors Push-pull output complete with 3in. moving coil speaker. Built and tested, 4/9/8. P. & P. 2/-.  
9. **CHANNEL TUNER I.F.** 16-19 Mc/s. Continuously tunable from 174-216 Mc/s. Valves required—PCF80 and PCB84 (in series). Cover BBC and ITA ranges. Also Police, Fire and Taxis, etc. Brand new by famous maker, 10/-, P. & P. 3/-.  
10. **B.S.R. MONARCH UAS WITH FUL-FI HEAD.** 4-speed, plays 16 records, 12in., 10in. or 7in. at 16, 33, 45 or 78 r.p.m. Internals 7in., 10in. and 12in. records of the same speed. Has manual play position: colour brown. Dimensions: 12 1/2 x 10 1/2 in. Space required above baseboard 4 1/2 in. below baseboard 2 1/2 in. Fitted with Ful-Fi turnover crystal head, £6.19.8. P. & P. 5/6.  
11. **PUSH-PULL OUTPUT STAGE** inclusive of transistors with input and output transformers to match 3 ohms speech coil, suitable for use with the **POCKET RADIO**. Kit of parts, including transistors, 19/8. P. & P. 2/-. Wiring diagram 1/6, free with parts.  
12. **8-watt PUSH-PULL 4 VALVE AMPLIFIER** plus **METAL RECTIFIER**. A.C. mains 200-250 v. Size 10 1/2 x 6 1/2 x 2 1/2 in. 5 valves. For use with all makes and types of pick-up and mike. Negative feed back. Two input, mike and gram, and controls for same. Separate controls for Bass and Treble lift. Response flat from 40 cycles to 15 kc/s. 2 db down to 20 kc/s. Output 8 watts at 5 per cent total distortion. Noise level 40 db down all hum. Output transformer tapped for 3 and 15 ohms speech coils. For use with Std. or L.P. records, musical instruments such as guitars, etc. Suitable for small halls, £3.18.6. P. & P. 6/-. Crystal mike to suit 15/-, P. & P. 2/-. 8in. P.M. Speaker to suit, 12/8. P. & P. 2/-.  
13. **INDOOR AERIAL** for TV/BBC/FM. Complete with standard co-axial plug. Extending fully chrome telescopic mast fully extended. Plugs straight into T.V. or VHF Tuner. Fully directional, 10/6. P. & P. 1/8.  
14. **NO MORE FLAT BATTERIES.** Charge your own battery overnight with this wonderful little charger. Output 6 and 12 volts, 2 amps. Input 200-250 v. A.C. mains. Mains fuse incorporated. Attractive silver hammer finished case, 6 x 3 x 3 1/2 in. Complete with leads and battery clips only 21/-, P. & P. 3/6.

**RADIO & T.V. COMPONENTS**  
[ACTON]  
**LIMITED**

**21b HIGH STREET**  
**ACTON, LONDON, W.3.**  
ALL ENQUIRIES 'S.A.E.  
GOODS NOT DESPATCHED OUTSIDE U.K.

**EXPLORE**  
the  
**WORLD!!**

on  
**SHORT WAVE**

with our exciting new  
**"VENTURE-1" KIT**

Covers both 20M and 40M bands (switched). Band spread tuning. Aluminium chassis. Three ceramic air spaced tuning condensers, valve, plugs and sockets, hardware, etc. Full building plans provided.  
**COMPLETE FOR 47/6**

P.P. 2/6

High Imp. Phones 14/6 extra

**The 'NORPAK'**  
**MAINS POWER PACK KIT**  
**FOR TRANSISTOR RADIOS**

Operates your radio direct from mains. Miniature Size—4 x 2 x 1½ in. In attractive two-tone plastic case. Assembled in an hour. Normal output 9 v, 100 mA. (Adjustable) Full Mains Transformer. Full wave germanium diodes. Cartridge fuse.

Complete Kit with Plans

**35/-** Plus 1/6 P.P.

(Ready assembled 45/-).

**WE PROUDLY ANNOUNCE**

★ THE NEW

**P.W. MERCURY - 6 MK. II!!!**

6 TRANSISTOR LONG AND MEDIUM WAVE SUPERHET



**£10.7.6.** plus 3/6 P. & P.  
All parts required.

This exciting new cabinet has been acclaimed by everyone who has seen it. Existing Mercury owners may purchase it for 48/-. All components supplied to the last washer, together with full building plans (2/6) Free with parts.

**ALIGNMENT SERVICE** available for both the **MERCURY** and **P.W. POCKET SUPERHET** at reasonable charges. (Write for details).

- ★ New, brilliantly styled, timber cabinet giving elegant appearance.
- ★ New 8in. ferrite rod.
- ★ Printed circuit.
- ★ 500 mW into 7 x 4in. speaker.
- ★ Fine performance on both L.W. and M.W. bands including Luxembourg.
- ★ All parts available separately.

**MAINS OPERATION BUILT IN!!**

30/- EXTRA. Also

**CHARGEABLE BATTERY**

Write for details S.A.E.

**NORCOL LTD** 147 LONDON RD., YORKTOWN,  
CAMBERLEY, SURREY Phone: CAMBERLEY 3743

**THE  
PEMBRIDGE  
COLLEGE  
OF ELECTRONICS  
OFFERS TRAINING  
IN RADIO  
TELEVISION  
AND ELECTRONICS**

**ATTENDING COURSE**

- (A) Full-time One Year Course in Radio and Television. College course in basic principles for prospective servicing engineers. Next course commences 25th April, 1963. This course is recognised by the Radio Trades Examination Board (R.T.E.B.) for the Radio and Television Servicing Certificate examinations. Provides excellent practical experience on valve and transistor radio receivers and all well-known makes of television receivers.

**HOME-STUDY COURSES**

- (B) Courses in Radio, Telecommunications and Mathematics for the City and Guilds Telecommunication Technicians' Certificates.

To: The Pembridge College of Electronics.  
(Dept. P11), 34a Hereford Road, London, W.2  
Please send, without obligation, details of  
A— B— (Please tick.)

Name \_\_\_\_\_

Address \_\_\_\_\_

for  $R_b$ , and this is automatically taken care of if the following procedure is observed.

Take an insulated lead from the signal-amplifier input plug, P1, of the finished and operating Audition, and connect this, in series with a  $1M\Omega$  fixed resistor and a  $1M\Omega$  linear variable resistor, to an h.t. voltage of known value.

Adjust the variable resistor (see Fig. 15) until the built-in meter reads the known correct value. Measure the resistance of the variable resistor after disconnection, for the setting thus arrived at. This gives the required resistance value which, increased by  $1M\Omega$ , gives the correct value for  $R_b$ . In the prototype, three  $560\Omega \pm 5\%$  resistors in series

serves the purpose of narrow-bandwidth high-gain/high-bandwidth low-gain changeover. With V closed, the a.c. sensitivity is about  $50mV$  r.m.s. for full-screen deflection on the c.r.t.

The switch C is the one already mentioned in the text on the Bridge Circuits, used when measuring large capacities by the charge-time method. The value should be selected for giving correct readings with the there-described method, using a large capacitor of known value, and will be found to lie somewhere between 2 and  $3M\Omega$ . The exact value should be made up of two resistors as nearly equal as possible, to distribute the voltage strain. This was not required for  $R_v$ , because this is for

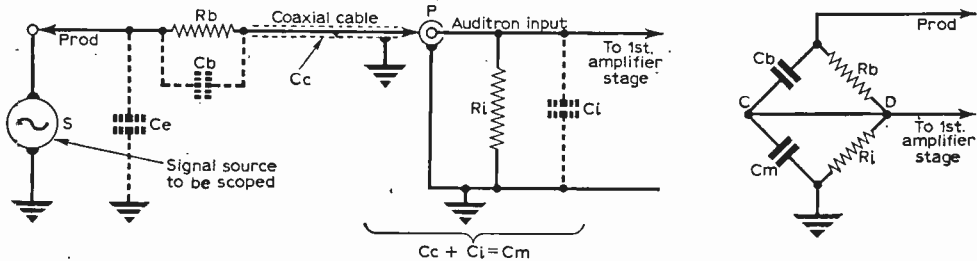

Fig. 14: An equivalent circuit showing the stray capacities operative in the design of a bridge-bleeder probe.

gave the correct value for  $R_b$ ; individual Audition's may well give slightly different values, but if departure is too severe, R53, R48 and the meter sensitivity should be checked in the signal amplifier, as well as the voltage across D10 and D11.

It is advisable to split the determined value for  $R_b$  into three equal, or nearly equal, resistors in series, to give better stability in the face of the high input voltages to the probe acceptable (about  $1kV$  p.p. maximum). Take great care to insulate everything in the probe.

Figs. 16 and 17 give all the necessary information for construction of the probe. It is, of course, necessary to determine the required values for  $R_t$  and  $R_v$ , and instal these components as well as finalising everything except  $C_t$  before making stray-capacity measurements for determining  $C_t$ .

The choice of  $R_v$  is best made, after installation of the determined value for  $R_b$  by wiring a  $100k$  potentiometer in place of  $R_v$ . This is then adjusted when applying the probe to a test voltage of about  $50V$  d.c., until one-tenth of the v.t.v.m. reading is equal to the test voltage as observed on the multimeter (V closed). A value of about  $47k\Omega$  will be found satisfactory; the actual value to be used is the measured potentiometer resistance for the correct setting found.

Switch V is intended to give a tenfold increase of sensitivity compared to "normal" use of the probe. This facility is primarily intended for use with the v.t.v.m. function.

The Audition may also be used for "scope" purposes with V closed, with the same tenfold sensitivity, provided excessive signal amplitudes are not applied. About  $100V$  peak-to-peak will overload the Audition in this setting. Because the probe is not balanced in this state, and signal source loading is high, care must be exercised, and reasonably accurate reproduction of waveforms can only be expected if no frequencies in excess of about  $10kc/s$  are contained. Thus switch V also

a low-voltage range.

Do not otherwise use more resistors in series, or parallel, to obtain the required values but try and obtain or select single resistors with the desired values. This is in the interests of minimising stray capacities, which are seen to play a vital role in probe-design. Normal  $1W$  types should be used throughout.

**Demodulating R.F. Signals**

To enable r.f. signals to be detected, a small sub-

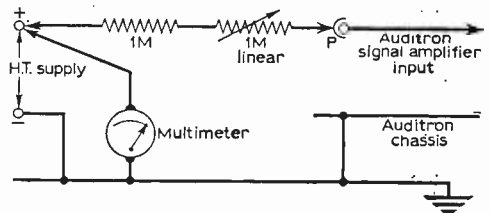

Fig. 15: Determining the correct value of  $R_b$ .

probe can be constructed for fitting as a thimble over the prod of the main probe. This small unit contains a  $1,000pF$  capacitor in series with a  $4.7\Omega$  resistor; across the resistor is a semiconductor diode. This circuit is connected between the main probe input and earth.

The Audition probe may be used with this additional probe for tracing signals through the r.f. and i.f. stages of a receiver. The peak carrier amplitude will be shown on the Audition v.t.v.m., whether or not modulation is present, and the latter, if present, can be scoped and listened to on the "tracer" facilities.

**Excellent Linearity of Audition**

The Audition amplifier itself will not demodulate. In contrast to many other amplifiers of poor quality. This is because of its extreme linearity,

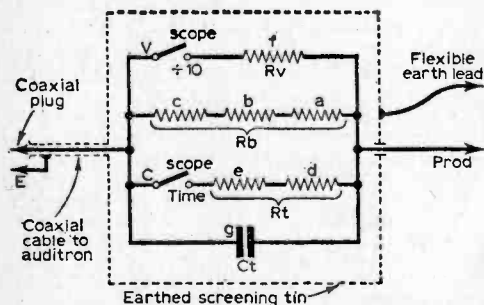

Fig. 16: The circuit of the probe. No list of components is given, as they must all be selected critically according to the details given in the text. Switches V and C are normally set at "scope", i.e. "off", and the probe is balanced for this condition.

especially at the critical input stage, on account of the high quality cathode follower input stage.

Only those r.f. signals of sufficient amplitude to overload the input stage (about 20V r.m.s. at the first grid) will be rectified, unless the frequency is so high that the cathode follower cannot function properly, when somewhat lower amplitudes will commence to be rectified.

To prove the excellent linearity of the Auditorion signal amplifier, a job of work recently done with it may be described briefly. Two signal generators had been built, with nominal ranges 40 to 60kc/s, to a customer specification for a specialised purpose. These were required to operate with a standard tuned circuit (supplied) of 50kc/s resonant frequency as external load.

It was required to calibrate the tuning dials of these signal generators. A simple method was devised, operating both generators simultaneously, and joining the outputs via two equal resistors in series, from the junction of which the Auditorion amplifier was fed. One generator having been brought to resonance with the standard tuned circuit, the other was brought to zero-beat, i.e. constant-amplitude on the c.r.t display on the Auditorion.

It was then progressively detuned, the amount of detuning being given by the audio frequency of the observed amplitude-variation envelope. This frequency could be measured on the Auditorion in the normal way, and progressed from zero to about 10kc/s as the signal generators were respectively tuned through either way. Now, although this amplitude fluctuation at audio-frequency was observed at full-scale deflection, *nothing was heard* in the tracer-loudspeaker, proving that no true beat frequency as such was being produced.

As will be familiar from the basic theory of frequency-changers, rectification or multiplication of two frequencies is needed to produce the beat-frequency as such, i.e., non-linearity in some circuit element dealing with a mixture of two initial frequencies. This test is *extremely sensitive*

for testing for non-linearity, and the Auditorion signal amplifier in the prototype passed it well.

The mixture of two nearly equal supersonic frequencies from the signal generators corresponded to the sidebands of a (suppressed-carrier) signal modulated at an audio frequency equal to half the separation. But this audio frequency is not present as such until it is demodulated out, i.e. rectified, and the Auditorion amplifier is too distortion-free to perform this function, even though the waves and modulation envelope were being observed at full-screen amplitude on the c.r.t. This is as good a credential as any for the quality of the Auditorion within the limits of operation for which it is intended.

### Testing Frequency-response

Many specialised uses are possible for the Auditorion, apart from the more obvious normal uses. A number of these make use of the timebase-waveform output provided, which is most useful, quite apart from wobulator-use.

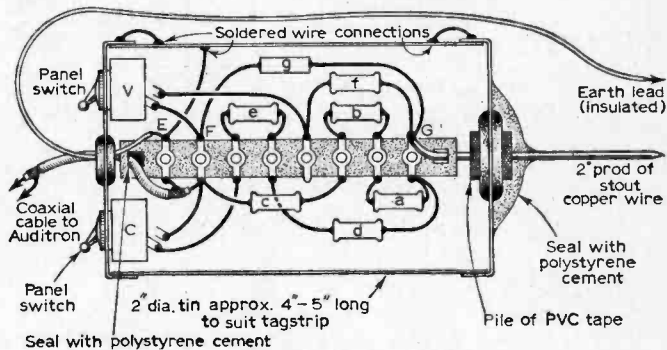

Fig. 17: The wiring of the Auditorion probe.

This timebase-waveform is, first of all, a very useful general-purpose audio test signal, to provide an input of adjustable frequency for simple tests. For such, largely audible, tests, the waveform is not important, the sawtooth being as good as a sine wave—in fact probably better, on account of its better audibility, especially at low frequencies, compared to the sine wave.

Furthermore, it is an ideal signal for feeding into a circuit, and tracing with an oscilloscope through the stages of the circuit, particularly when it is, as here, simultaneously the timebase of the display-scope. Working at high signal-level in the circuit, and at a frequency where all important harmonics of the sawtooth lie within the linear frequency-range of the test circuit, the display on the c.r.t. is necessarily a direct picture of the characteristic curve of the test circuit, in the conventional form of drawing this in the form of an input/output graph. Non-linearity, blocking, over-drive, bottoming, etc. can thus be observed directly and visually. Remembering that the v.t.v.m. shows the d.c. level represented by the timebase zero-line set with the Y-shift, and that the Y-deflection can be quantitatively set with the Zener-calibrator, the display of the characteristic curves is also quantitative, i.e. it can be immediately read off, at what dynamic voltage any effects noticed take place. ■

# SENSATIONAL NEW 1963 DESIGNS — BY CONCORD

## LOW PRICES ★ PICTORIAL STEP-BY-STEP PLANS ★ EASY AS A.B.C.

### THE NEW "VOLKSRADIO" ONLY 14/11

TAKE-OVER BID MAKES THIS FANTASTIC OFFER POSSIBLE—the beautifully compact "5-STAR VOLKSRADIO" measuring 4½ x 2½ x 1½ in. Perfect personal carphone reception—in the Bedroom, Office, Garden—over all medium waves (incl. Luxembourg). Under 1d. hour running cost. ANYONE can assemble it in one or two hours using our simple A.B.C. plan. Complete set of parts ONLY 14/11, plus 2/6 P. & P. C.O.D. extra. (Parts can be bought separately.) Money Back Guarantee.

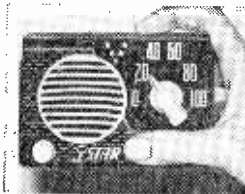

NO EARTH OR AERIAL REQUIRED



Revolutionary INTERNAL FERRITE AERIAL Makes this sensational pocket-size radio the best money-saving bargain of all time. Powerful, superb tone and clarity, ensures perfect reception for all your favourite programmes

Completely portable, only 5½ x 3 x 1½ in. Two-tone case. Anyone can assemble with our simple PRINTED CIRCUIT PLAN. Send 37/6, plus 2/6 P. & P. (C.O.D. 2/- extra. Satisfaction guaranteed. (All parts available separately).

### "OUR NEW 4-STAGE MINUETTE"

Build this newly-designed "MINUETTE" 4-STAGE transistor set in very strong ready drilled ULTRA-MODERN CASE, size only 6 x 3½ x 1½ in. Uses three transistors and diode and SELF-CONTAINED LOUDSPEAKER. Very sensitive. Ideal for office, bedroom, holidays, etc. Months and months of listening off a 1/2d. battery. Can be built FOR ONLY 39/6, including PROPER CASE, miniature speaker, etc. SIMPLE AS A.B.C. PICTORIAL STEP-BY-STEP PLANS etc., plus post and packing 1/6 (C.O.D. 2/- extra). Parts sold separately, priced parts list 1/-.



FREE HIGH SENSITIVITY HIDE-AWAY EAR-PIECE GIVEN WITH EACH SET.

THE MINUTE TRANSISTOR RADIO

M I A M I ONLY 32/6



Unbelievably small—Outrageously cheap. You will be amazed at the fine quality of tone and volume of this great little radio. Only a fantastic 3½ x 2½ x 1½ in. The MIAMI will bring you great entertainment for months on an 1/2d. battery. Simple assembly plan with each set. ONLY 32/6. YES 32/6!

Plus 2/6 P. & P. (C.O.D. 2/- extra). Satisfaction Guaranteed. Demonstrations given daily. Parts available separately if required.

### THE NEW "COSTA BRAVA" 49/6



NO EARTH or AERIAL REQUIRED ALL TRANSISTOR RADIO

Revolutionary INTERNAL FERRITE AERIAL and moving coil speaker makes this sensational pocket-size radio the best money-saving bargain of all time. Powerful, superb tone and clarity, ensures perfect reception for all your favourite programmes. Completely portable, only 5½ x 3 x 1½ in. Two-tone case. Anyone can assemble with our simple PRINTED CIRCUIT PLAN. Send 49/6, plus 2/6 P. & P. (C.O.D. 2/- extra). Satisfaction Guaranteed. (All parts available separately).

FREE HIGH SENSITIVITY HIDE-AWAY EAR-PIECE GIVEN WITH EACH SET.

### THE NEW "LISBON" TRANSISTOR SET

This is a pocket 2-stage transistor set not much larger than a matchbox. Excellent clear reception covering all medium waves, works for months off a tiny 1½ or 3 volt battery costing only 1d. Easy to build and an excellent introduction to transistor circuitry. Everything can be supplied down to the last nut and bolt incl. SIMPLE PICTORIAL STEP-BY-STEP PLANS FOR ONLY 19/6, plus post and packing 1/6 (C.O.D. 2/- extra). Parts sold separately, priced parts list 1/-.

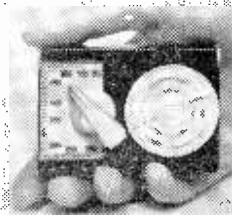

### THE RINGO BURGLAR ALARM CLEARANCE SALE!



BIG PROFITS FOR YOU IF YOU BUY NOW! Made to retail at 7 gu. you can now buy this famous Twin-Ring Alarm for only 37/6—but only if you act now... stocks are strictly limited. Easily installed and operated. Switches on or off at any time Fantastic FINAL reduction to clear 37/6 (minimum order of 3) Carr. Free. Free literature sent with each alarm.

### SELL SAFELY TO THE MOTORIST



Bulk purchase of bankrupt stock ensures this fabulous money-making offer.

AUTOMATIC CIGARETTE LIGHTER instantly provides ready lit cigarette without the driver taking his eyes from the road. Heavily chromium plated case holds 10. Easily and simply fitted to any car's dashboard. Works off 6 or 12 volts. Retail Price 44/8. Special Clearance offer only 12/6 each. sold in minimum lots of 6. Carriage free.

### THE NEW "SAN REMO" 6 STAR 32/6

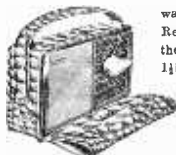

This All Transistor Speaker Radio—The "San Remo" 6 Star covers all medium waves including "Home," "Light," etc. Reliable and lightweight—Slips easily into the Pocket or Handbag—size only 4½ x 2½ x 1½ in. Works for Months on 1/2d. Battery! Ideal for holidays, Camping, Bedroom, etc. Anyone can assemble it in an hour or two with our simple-as-ABC PLAN! Complete set of parts including miniature speaker—everything—only 32/6, plus 2/6 P. & P. (C.O.D. 2/- extra.) Parts can be bought separately.

Cheques accepted. Cash on delivery 2/- extra. Please print name and address in block letters. Suppliers to Schools, Universities, Government and Research Establishments. Complete range of components and values stocked. Regret no C.O.D. abroad. DEMONSTRATIONS DAILY AT WORKS.

# CONCORD ELECTRONICS

## (DEPT. 14/12) 210 CHURCH ROAD, HOVE, SUSSEX

**FREE** THIS BOOK WILL INTEREST YOU!  
 LEARNING the PRACTICAL WAY  
**Radiostructor**  
 EQUIPMENT COURSES

FOR ..Your Career  
 ..Your Own Business  
 ..An Absorbing Hobby

**A NEW-PRACTICAL WAY of UNDERSTANDING**

**Radio : Television Electronics**

including: Transistors; VHF/FM; Hi-Fi equipment; Computers; Servo-mechs; Test instruments; Photo-electrics; Nuclonics, etc.

Radiostructor—an organisation specialising in electronic training systems—offers a new self-instructional method using specially designed equipment on a "do-it-yourself" basis. You learn by building actual equipment with the big kits of components which we send you. You advance by simple steps, performing a whole series of interesting and instructive experiments—with no complicated mathematics! Instructional manuals employ the latest technique for showing the full story of electronics in a practical and interesting way—in fact, you really have fun whilst learning! Fill in the coupon below for full particulars.

**POST NOW**

TO RADIOSTRUCTOR (DEPT. G.40)  
 READING, BERKS.

Please send brochure, without obligation to:

★Name \_\_\_\_\_  
 Address \_\_\_\_\_

★BLOCK  
 CAPS  
 PLEASE

(We do not employ representatives)

3/63

**RADIOSTRUCTOR**  
 LEADS THE WORLD  
 IN ELECTRONICS TRAINING

**Lyons Radio Ltd.**  
 3 Goldhawk Road, London W.12

**DESK TELEPHONES.** Normal Post Office pattern, two make a first rate intercom set requiring only a 4½ v. torch or box battery plus twin connecting flex. Comprise hand set on usual black stand fitted 10 digit dial (not used for intercom) with cord. Ringing facility not provided. In good condition and tested. **PRICE ONLY 19/6 each, post (1 or more) 3/6.** Suitable connecting flex 2/6 per doz. yds. or 16/- per 100 yds. Batteries, torch 1/3, box 3/-.

**CHARGER COMPONENTS**  
**RECTIFIERS,** full wave bridge type for outputs up to 12 v. D.C. 1 amp 5/3, 2 amp 8/9, 4 amp 12/6, 6 amp 14/6. P.P. see below.

**TRANSFORMERS,** Pri. 200/250 v. A.C. mains. Sec. tapped at 9, 9, 17 v. for producing 2, 6 or 12 v. D.C. respectively when used with above rectifiers. 1 amp 10/-, 2 amp 14/6, 4 amp 16/6, 6 amp (Tapped 9 and 17v.) 25/9. Postage 2/6 up to 10/-, over 3/6.

**"PROGRESSIVE" SHORT WAVE RECEIVER.** Specially designed kit employing plug-in coils with exceptionally clear wiring diagrams and instructions to enable even the very beginner to construct a short wave receiver with every confidence of success. A second, and then a third valve stage can be added if desired, the chassis supplied already being punched to take all three stages. Can be operated from dry batteries or from a simply constructed mains power unit, price 32/6. Cost of all parts to build a One Valve S/W Radio including one coil 40/100 metres, **ONLY 35/-.** 1½ Valve Conversion Stage **ONLY 7/6.** 2½ Valve Conversion Stage **ONLY 10/-.** Extra plug-in coils to cover 10/20, 20/40, 100/200, 200/450 metres 4/- each. Plans supplied separately 1/6, credited if kit ordered.

**INDICATOR UNITS TYPE 62A.** Contain 21 valves (12-VR91, 4-VR65, 2-VR54, 3-VR92), C.R. Tube VCR97 and stacks of other useful components, in good condition. **PRICE ONLY 39/8, carriage 9/8.** Oscilloscope Equipment, data on scope construction utilising VCR97 tube, **PRICE 5/- or 5/6** sent separately.

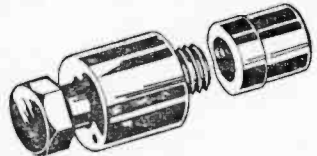

*The PUNCH you need!*

**HOLE PUNCHES**

<b>Instant Type</b>	...	...	...	6/10 ea.
3/8" diameter	...	...	...	
<b>Screw-up Type</b>	...	...	...	
1/2" diameter	...	...	...	
3/8" " B7G	...	...	...	8/6 "
3/8" " B8A, B9A	...	...	...	9/- "
1/2" " " " " "	...	...	...	9/6 "
1/2" " " " " "	...	...	...	10/2 "
1/2" " " " " "	...	...	...	10/8 "
1/2" " " " " "	...	...	...	11/8 "
1/2" diameter Int. Octal	...	...	...	13/4 ea.
1/2" " " " " "	...	...	...	16/2 "
1/2" " " " " "	...	...	...	18/10 "
1/2" " " " " "	...	...	...	21/8 "
1/2" " " " " "	...	...	...	24/4 "
2 3/32" " Meter	...	...	...	33/2 "

Complete Set £8.15.0.

All the above prices include postage and packing.

**Oliver & Randall Ltd**

Dept. 7  
 40 PERRY HILL, LONDON, S.E.6  
 Tel.: Forest Hill 3415

**FIELD'S RADIOCENTRE**

67 LONDON ROAD CROYDON, Surrey CRO 1512  
 94 HURST ST. BIRMINGHAM 5 MID 7072

CALLERS WELCOME

All mail orders to CROYDON address, Dept. P.W.

**SHORT WAVE CONDENSERS.** Ex. R.F. Unit No. 26 and 27. Brand new, 75 plus, 75pFd. silver plated. 2/6, plus 1/- P.P.

**CARBON HAND MIKES.** New with Press switch as used with No. 18 set. 5/- each. P.P. 2/-.

**SMOOTHING CHOKES.** New. Ex-Govt. 10 Henry, 100 mA. Fully shrouded. 5/- each. P.P. 2/-.

**PRINTED CIRCUIT KIT.** With Plastic Bath 100 sq. ins. board and all chemicals, with full instructions. 17/6 inc. postage.

**F.M. LOFT AERIALS.** Single dipole type. 12/6. P.P. 2/6.

**COAXIAL CABLE.** Low loss type, 10 yds. 5/- P.P. 2/-, 15 yds. 7/6, P.P. 2/6.

**THROAT MICS.** New, boxed as used on W.S.38. 3/6, P.P. 1/6.

**TUNING CONDENSERS, AIR SPACED.** With slow motion drive 0.0003 plus 0.0005 on one gang. Can be used separately. 3/6, P.P. 1/6.

**MICROPHONE STANDS.** Two section telescopic, extend to 6 ft. Chrome-plated stem, heavy base. As used with BM3, DX29, MC70, DM176. MICS. £2.5.0. P.P. 4/-.

**PRINTED CIRCUIT BOARD.** 12 x 6in. 4/-, inc. Postage.

**ALUMINIUM SHEET,** 16 x 16in.. 18 gauge, 6/-, P.P. 1/6.

# T rade N ews

## NEW MULTIMETER

A RECENT addition to Avo Limited's range of electrical test equipment is the AVO Multimimor mark 4. This instrument supersedes all previous models in this series, and incorporates as standard, accuracy to B.S.89/54 and a new design of scale plate.

Each range of the instrument is selected by a single switch and the same two sockets are used for all tests.

The 19 ranges cover d.c. voltage from 100mV to 1,000V, with the sensitivity on these ranges being 10,000Ω/V; a.c. voltage from 10V to 1,000V, the sensitivity at 1,000Ω/V; d.c. current from 100μA to 1A and resistance from 0 to 20,000Ω and from 0 to 2MΩ using the internal battery.

These ranges can be extended by external accessories if required—a 2,500 d.c. multiplier and

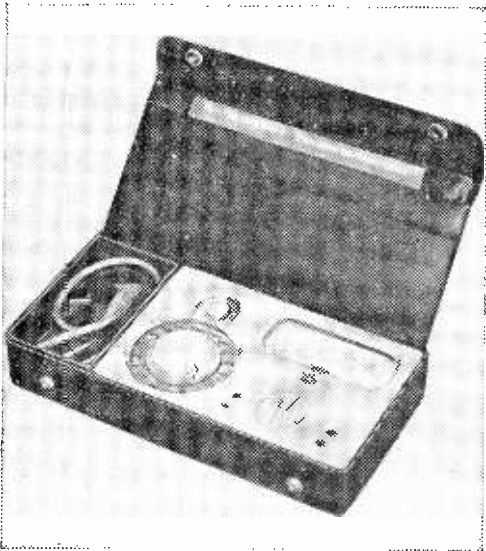

The latest multimeter from Avo's.

5, 10 and 25A d.c. shunts are available. The instrument is supplied complete in a carrying case with leads, prods and clips.

The Multimimor mark 4 is made by Avo Limited, Avocet House, 92/96 Vauxhall Bridge Road, London S.W.1.

## REDUCED VALVE PRICES

THE recent cuts in Purchase Tax on radio and television sets is also applied to radio valves, and Mullard Limited have recently announced reductions in the retail prices of their valves. For example, the EF86 now costs 15s. 9d. which before the cuts in Tax cost 17s. 6d., and the PY80, which previously cost 9s. 9d., now costs 8s. 9d.

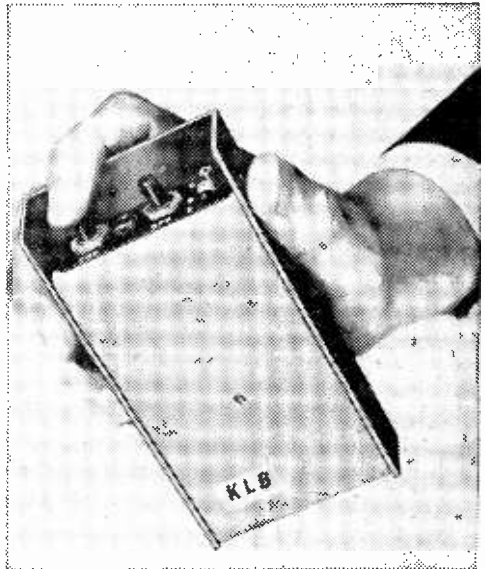

A transistor check instrument made by K.L.B. Electric Ltd.

## TRANSISTOR CHECK

AN inexpensive transistor tester, known as the "Transistor Check", has recently been introduced by K.L.B. Electric Limited. This simple instrument is not a comprehensive analyser but has been designed for use by service engineers and maintenance technicians to locate a transistor failure in equipment that has developed a fault.

The instrument is pocket sized and the controls are protected against accidental battery drain by being recessed into the case.

A.C. gain is measured, and indication of a good transistor is shown on a miniature cold-cathode tube. Both p-n-p and n-p-n transistors can be accommodated; wire ended types can be inserted directly into the sockets whilst special plugs are provided with the instrument to allow extension leads to be used for in-circuit checks in some cases.

The price of this new piece of equipment is £4 12s. 6d. and manufacturers are K.L.B. Electric Limited, Holloway Engineering Works, Parkhurst Road, London N.7.

# Club News

## REPORTS OF CURRENT ACTIVITIES

### COVENTRY AMATEUR RADIO SOCIETY

Hon. Sec.: Alan J. Wilkes, G3PQQ, 141 Overslade Crescent, Coundon, Coventry, Warwickshire.

The aim of the Society in 1963 is to be even more active than last year, and much of this activity should materialise in the use of the newly acquired 150V transmitter for the Club station.

January 7th was devoted to a committee meeting. At the film show given on January 21st, the three films shown were "The Manufacture of Radio Valves", "Mirror in the Sky" and "The Principles of Transistors". On the 28th of the same month a lecture was given on 70 cm.

### EXETER AMATEUR RADIO SOCIETY

Hon. Sec.: Stuart Line, 46 Roseland Crescent, Heavitree, Exeter, Devonshire.

This Society meets on the first Tuesday of each month, and in January the Annual General Meeting was held.

### LICHFIELD AMATEUR RADIO SOCIETY

Hon. Sec.: V. Hickman, G3LXR, 143 Main Street, Stonnall, near Walsall, Staffordshire.

The Society's Annual Dinner and Dance which was held on January 11th, provided members with an enjoyable start to the New Year.

### MITCHAM AND DISTRICT RADIO SOCIETY

Hon. Sec.: B. Blandford, 1 Biggin Avenue, Mitcham, Surrey.

At the first meeting in January—Friday the 4th—Robin Sykes (G3NFV) gave a talk on the "Ham Hop Club".

On January 18th members gathered to discuss arrangements for National Field Day. This was the second N.F.D. meeting, and

topics on the agenda included reports on an alternative site and also the possibility of the Society operating only one station this year.

Future Event:

February 15th—Annual General Meeting.

### NORTHERN HEIGHTS AMATEUR RADIO SOCIETY

Hon. Sec.: A. Robinson, G3MDW, Candy Cabin, Ogden, Halifax, Yorks.

On January 30th, Mrs. Shaw (G30MM) gave a very interesting talk and exhibition on the subject of "Radio on Stamps".

Future Event:

February 13th—Ragchew.

### PURLEY AND DISTRICT RADIO CLUB

Hon. Sec.: E. R. Honeywood, G3GKF, 105 Whytecliffe Road, Purley, Surrey.

At the meeting on January 4th, members had the chance to have their queries and problems solved at a lecture on constructional hints.

### RODING BOYS' SOCIETY (RADIO SECTION)

R. Marchant, 154 Essex Road, Leyton, London, E.10

This Society was formerly the Junior Section of the Wanstead and Woodford Radio Society, but now exists as an independent group. Regular activities include films, constructional projects and lectures on various topics. Work for the R.A.E. and Morse proceeds as the demand arises.

Recently six members passed the R.A.E. out of the eight who sat it. Enquiries from any young people in the Roding Valley area who are interested will be welcomed.

## "GO NORTH, YOUNG HAM"

THE population drift from North to South continues, following industry and work in the unarrested influx into and around the metropolis, ever increasing the hold London has not only on the country's economy, but also on its arts and sciences, its fashions and habits. No one can remain free from the influence of the big city, where all forms of entertainments and pastimes centre. The music and drama lover homes on to the West End like a pigeon to its pigeonry; the soccer fan must inevitably find that Wembley is his goal; and *no one* seems exempt from the grip of London.

Yet it is our experience that at least the North of England remains the active nucleus of the world of amateur radio, when all other interests centre on the South-East.

It is difficult to imagine the reason for this situation, but the Club reports that we receive show clearly that as far as amateur radio enthusiasts are concerned, England is top-heavy. These reports also suggest that the Northern club member is far more conscientious when it comes to attending club-nights, as quite a few of the Southern clubs' newsletters seem to make a regular feature of scolding members for not turning out for the last meeting and pleading with them to come to the next. This, of course, is a generalisation, there being many South of England clubs with regular support from all their members, but this overall impression is one gained by reading the hundreds of reports, from clubs all over the country, which yearly reach the PRACTICAL WIRELESS offices, and is therefore one very hard to dispute.

Yorkshire seems particularly well represented, with clubs in most of the major towns. Societies in Scotland also seem to be flourishing, and in the Midlands, Derby sets a very good example of efficiency in club organisation.

And so "go North, young ham" seems the best advice we can give to any frustrated radio enthusiast who is finding insufficient vitality in his Southern club; and, who knows, he might one day be regarded as a pioneer of a general reversion to the North.



# MAILPLAN

**Immediate Despatch Service! Best Value for Money!**

Dept. PW 138 Lewisham Way, New Cross,  
London, S.E.14. TIDeway 6667

Terms of business—Cash with order or C.O.D.

## TWO SENSATIONAL TRANSISTORISED INTERCOMS

### HANDY INTERPHONE

For Home, Workshop, Office, two-way calling. Consumes current only when talking or calling. Housed in attractive plastic cabinets with chrome stands. Completely portable. Master and sub-station. Replacement battery only 2/6.

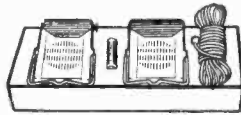

**MAILPLAN PRICE**  
89/6 Incl. PP3 battery, and 25 yds. lead with plugs. P. & P. 1/-.  
(Today's value 8 gns.)

### 7 Station De Luxe Transistorised Intercom

The very latest in Office and Factory communication. Calling is audio and visual. Battery operated but consumes current only when calling or talking. Neat compact attractive units, up to 6 extensions supplied separately. Battery life 300 hours.

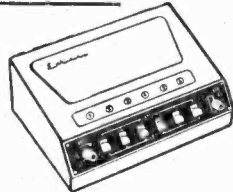

Master 14 GNS. Post free.  
Extension 2 gns. Post free.

HALF THE PRICE OF OTHER MAKES

Construct your own Record Player, Intercom, Tape Recorder, etc., with the **PK.53 SUBMINIATURE 4-TRANSISTOR PUSH-PULL AUDIO AMPLIFIER 52/6**

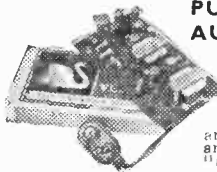

An assembled and wired miniature amplifier incorporating output transformer, and 4 transistors, class B, 200 m. watts. All connections for battery, speaker and volume control. The quality is amazing. Complete with instructions and circuit P217A. Size 3 x 1 1/16 x 1 1/16 in.

8 ohm speaker to suit above, 21". Flux density, 7,800 gauss. Power, 200 mW. 16/6 P. & P. 1/-

### MI78 CRYSTAL LAPEL MIKE 17/6

100-9,000 cps. 1 1/2 in. diam., 5ft. lead. P. & P. 1/-.

### SLIM CRYSTAL 3-way MICROPHONE

- ★ Hand held.
- ★ Stand mounted.
- or
- ★ Suspended by lavalier cord.



**MODEL 100C 39/6** Post Free

Check the spec. and judge for yourself. Response 60-10,000 cps. Built-in ON-OFF Switch. Output Level -52 dB. Omni-directional. Termination above 500 K ohms. Satin Chrome Finish. Accessory Table Top Stand, 8/6.

### PORTABLE SOLDERING IRON Model SPI 30 Watt 230 Volts

(Size 10 1/2 in. 6 1/2 in. when not in use.) Designed on an entirely new principle for light-weight applications. Highly stable heat characteristics ensure ions life. Removable handle permits iron to be carried safely even while hot. Supplied complete with Vinyl bag, lead and plug. Spares available. Element 4/6. P. & P. 6d.



18/9 P. & P. 1/-

All items advertised have been approved by our technical team of qualified engineers.

## A HIGH QUALITY PROFESSIONAL MIKE

**DM.II MICROPHONE with Base.** A flexible, newly designed, dynamic microphone integrated with a matching desk stand. Professional quality, ideal for tape recording, public address, broadcasting and communications. Ruggedly constructed, removable base for desk or hand use. 360° swivel ball joint allows tilting in any direction. 9" high, body dia. 2" tapering to 1". Base 5" dia. Magnificently finished in mist blue with chrome trimming. Complete with shielded cable stand. Fully guaranteed.



AT LOW COST  
**5 GNS.**

## SERVICE ENGINEERS!

The most useful tool that money can buy . . .

### the D900

### TRANSISTOR TESTER/ POWER SUPPLY

LABOUR SAVING SPEEDY SIMPLE

ONLY Ask for full technical specification. £10

Checks Alpha gain (Current gain—AC)  
Checks Beta gain (Current gain under DC conditions).

Measures Leakage currents between Collector/Base and Collector/Emitter at any voltage between zero and 25 V. Specially designed for all receivers using PNP Transistors. Size 5 1/2 x 3 x 2 1/2 in.

NOW you can carry out fast testing of transistors and miniature transistor receivers without removing transistors from circuit. Self-contained signal tracing oscillator, self-contained variable power supply.

## Miniature Clear Plastic Panel Meters FOR YOUR HOME BUILT TEST EQUIPMENT

**DC MICROAMMETERS** Model MR.25 0 to 50  $\mu$ A .. 39/6  
Model MR.250 0 to 500  $\mu$ A .. 32/6  
**DC MILLIAMMETER** Model MR.21 0 to 1 mA .. 27/6  
All models Individually Boxed and Fully Guaranteed. P. & P. 2/6 each.

**"S" METER MODEL SR.3P.** Standard "Ham" Signal strength indicator. Calibrated in "S" units from 0-9 with scale terminating in +10 to +30 dB calibrations. Additional full scale calibrations of 0-5-0-10 in linear scale divisions, 35-.

**VU METER MODEL VR. 1P.** Calibrated and damped in accordance with standard VU Meter Practice. Upper scale reads -20 to +3VU. Lower scale 0-100% modulation. Uses precision carbon film multiplier resistor and full wave rectifiers. 42/6.

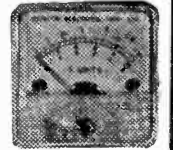

## SKANTEST—THE LOWEST PRICED L.O.P.T. TESTER

Tests TV Windings for shorting turns by unique pulse method. This compact instrument can save you pounds. It detects a single shorting turn in a line output transformer, deflector coil or other Windings. The pulses provided by the instrument detect intermittent faults. In position one, the continuity of the Windings is checked; in position two, high impedance coils, and in position three, low impedance coils. Once you have used the Skantest you will regard it as a must in TV Servicing.

Exclusive Mailplan Offer 99/6 P. & P. 2/9

## MULLARD TAPE RECORDER AMPLIFIER

Printed circuit board and set of 27 capacitors ranging from 50 + 50  $\mu$ F at 350 v. to 47 pF. 28/- plus 1/6 P.F.



### MODEL V-7A/F VALVE VOLTMETER

Equal to many higher priced instruments. Gold-plated printed-circuit. High input impedance (11 meg-ohms). The V-7A measures A.C. volts (0-1.5, 5, 15, 50, 150, 500, 1,500 R.M.S. and A.C. volts (0-4, 14, 40, 140, 400, 1,400 and 4,000 pk-to-pk. D.C. volts (0-1.5, 5, 15, 50, 150, 500, 1,500 Ohms (with 10 ohms centre) X1, X10, X100, X100K, X10K, X100K, and X1 megohm. £19.18.6 Complete with 32-page handbook.

MODEL V-7A (in kit form). £13.18.6

# ACKNOWLEDGED TO BE THE BEST COMPONENT CATALOGUE

A  
MUST  
for every  
radio  
enthusiast

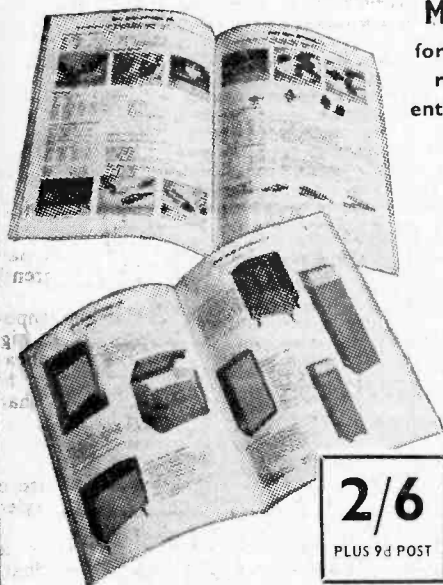

NOW  
172 pages  
Over 600  
illustrations  
Over 5,000  
components listed

This is today's most up-to-date, most comprehensive component catalogue for the radio constructor, experimenter, engineer and Hi-Fi enthusiast.

2/6

PLUS 9d POST

POST  
COUPON  
TODAY  
Write  
CATALOGUE  
on top left  
of envelope

Name .....

Address .....

Enclose  
P.O. 3/3

Home Radio Ltd. (PW) 187 London Rd., Mitcham, Surrey

## Crystals & Components Ltd

2-4 EARLHAM STREET, LONDON W.C.2

Tel: TEMple Bar 1189

Near CAMBRIDGE CIRCUS. A few minutes' walk from Leicester Square or Tottenham Court Road  
Underground Stations.

Hours of business 9 to 6. Saturdays 1 p.m. OPEN ALL DAY THURSDAY until 6.30 p.m.

**TYPE 46 WALKIE-TALKIES.** Best buy in TX/RX units in years. Complete with all accessories at give-away price. 3-channel crystal controlled TX and RX. Supplied complete with one pair of crystals, coil box, rod aerials, leads and plugs, valves, balanced armature head set with throat-mike. Coverage: 3.6 to 4.3 Mc/s or 6.7 to 7.6 Mc/s by means of plus-in coil pack. (State which frequency preferred when ordering.) Requires only 150 v., 15 v., and 3 v. dry batteries. Range over 10 miles under good conditions. Full instructions supplied. As new. We offer this fine unit as listed above with all accessories, at 42/6 per unit or 34 for two. Postage and packing 6/6. Set of batteries 24/- per set.

### SPECIAL OFFER TYPE 46 WALKIE-TALKIES

As described above with valves, crystals and coil box but having had the original send/receive switch removed. Without other accessories. This set is supplied with a substitute switch and full wiring details at 13/6 each or 35/- per pair. P. & F. 5/6.

**BRAND NEW TAPE RECORDING HEADS.** For single, centre track recording. With leads and 4-pin plug, 12/6. Postage 1/6.

**DIODES.** OA81, 2/9 ea., OC71, OC72 substitutes, 3/6 ea.

### TEST INSTRUMENT BARGAINS

Sangamo Weston, brand new (not boxed), 0-750 micro amps flush, round, 3 1/2 in. dia. 49/6  
Sangamo Weston, brand new (not boxed), 0-1 micro amps flush, round 3 1/2 in. dia. 47/6  
0-5 micro amps M.C. projecting 6 in. dia. steel case 39/6 each  
0-15 micro amps M.C. projecting 6 in. dia. steel case 39/6 each  
0-50 micro amps M.C. projecting 6 in. dia. steel case 27/8 each  
0-100 micro amps M.C. projecting 6 in. dia. steel case 27/8 each  
P. & F. 2/- per instrument.

### LATEST MODEL BRAND NEW 'GUNFIRE' TIME SWITCHES

Self starting, non reversing synchronous motor operating on 200/250 v. A.C. continuous rating 20 amps. at 250 v. Special insulated switching device switching on and off in 24-hour cycle automatically, also incorporates manual switching should normal sequence need to be interrupted. Takes extra pair switch arms to give 2 "ons" and 2 "offs". Perspex cover. Ideal for all domestic and electronic circuits. Price 79/6. Extra arms 2/6 per pair.

**SILICON RECTIFIERS.** Miniature power diodes at the right price. Leading makes. 400 P.I.V. at 650 mA, 6/- each. 500 P.I.V. at 200 mA, 3/6 each. 800 P.I.V. at 550 mA, 7/6 each. 1,000 P.I.V. at 500 mA, 8/6 each.

### CRYSTALS !!!

LARGE RANGE OF 10X, 10XJ, FT243, FT241 CRYSTALS ALWAYS IN STOCK.

Send stamped and addressed envelope for our free, comprehensive list.

### BC610 TUNING UNITS

Choice of 5-8.35 or 6.35-8 Mc/s. These compact units (9 x 4 x 2 1/2 in.) were used as plus-in tuning boxes with the BC610 TX. Containing miniature variable condensers of 140 pFd, 100 pFd and a standard size 50 pFd. A 0-100 graduated knob dial 1 1/2 in. dia. D.P.D.T. toggle switch and several others components. Price 6/6 ea. P.P. 3/-.

**HELIPOTS.** Brand new and boxed, 2,000 ohms, 10 turns,  $\pm 0.1\%$  linearity. 18/6 ea. P. & F. 1/6.

**50 VOLT 10 AMPS OUTPUT TRANSFORMERS.** 230 v. primary. Conservatively rated. Brand new in maker's cartons. 55/- each. Carriage 7/6.

### TERMS OF BUSINESS

CASH WITH ORDER. Handling charge of 1/6 on all orders under 20/- where P.P. is not otherwise stated.

# Letters to the Editor

The Editor does not necessarily agree with the opinions expressed by his correspondents

Whilst we are always pleased to assist readers with their technical difficulties, we regret that we are unable to supply diagrams or provide instructions for modifying commercial or surplus equipment. We cannot supply alternative details for receivers described in these pages. **WE CANNOT UNDERTAKE TO ANSWER QUERIES OVER THE TELEPHONE.** If a postal reply is required a stamped and addressed envelope must be enclosed with the coupon from page iii of the cover.

## THE CHANGING WORLD OF WIRELESS

**SIR**,—When I look at the original *Newnes Wireless Constructors' Encyclopaedia*, a copy of which I still have, I can't help but wonder at the great steps which have been made in wireless since those early days. I can remember the first radio valve, the first bright emitter and the first screen grid valve.

What marvels have now become commonplace things, which not so long ago were mere pipe dreams! We indeed should be thankful to all those "backroom boys" who did so much to make our lives the more enjoyable. And who knows what is to come in the future with satellite communications and colour television already here?

My regards to the staff of P.W. who have given many of us radio amateurs such interesting articles, blueprints, etc., and thank you for making my life, at least, more enjoyable.—**H. T. ROLLER** (London S.W.6.) (Member of the Radio Amateur Invalid and Bedford Club).

## LOCAL COMMERCIAL RADIO

**SIR**,—Having read with interest recent letters in P.W. concerning local radio stations, I find myself agreeing with the sympathies expressed by your correspondent, Mr. P. Robinson, in the November 1962 issue.

Commercial stations, running at low power, and situated in the major towns, would, I feel, make a welcome change to the programmes put out by the BBC.

The opinion of Mr. Dent (January issue) that these stations would be cluttering up the wavebands is nonsense, as two or three low power stations, if displaced widely apart and equipped with beam antenna, could easily operate on the same channel.—**W. B. MOON** (Hull, Yorkshire).

## HI-FI FANATICS

**SIR**,—Mr. D. R. Davenport's criticism of his friend's hi-fi system (December issue) surprised me. Fingermarks on record grooves attract dust, and if a record is played without first having such

dust removed, a great deal of surface noise will be apparent. Extra wear and tear on both the stylus and the record will also result.

As to fiddling about with the controls for about twenty minutes, I find this difficult to believe. However, Mr. Davenport's friend may purposely have taken his time, solely to impress him, apparently without success.

As a closing word, I suggest that Mr. Davenport listens to one of his own records over a high quality system. The surface noise will be unbearable, and it will, I hope, make him reconsider his "cheap record player".—**E. W. SKEEN** (Johannesburg, South Africa).

**SIR**,—If Mr. Davenport and Mr. Nicholls are of the opinion that hi-fi enthusiasts are self-styled, then I am afraid they are sadly mistaken.

Mr. Nicholls considers that such terms as "frequency response" and "negative feedback tone circuits" are merely tagged on to articles to impress the buyer, and so it seems to me that he cannot read P.W. very carefully.

Also if Mr. Davenport has never heard the terrible effects caused by fingers carelessly rubbed across the groove of a record, then I suggest that his friend had better demonstrate this to him (with one of Mr. Davenport's own records!).—**A. FERGUSON** (Eastbourne, Sussex).

**SIR**,—May I be allowed to support Mr. D. R. Davenport in his criticism of hi-fi enthusiasts? I agree that it is a bore and a trial to be victimised by the enthusiasm of others.

With regard to the letters of Messrs. J. D. Maitland and D. L. Miller, surely, if one has to have the skill of a jeweller or of a dental technician to handle modern gramophone records correctly, it is high time to find and apply a better system of sound recording?—**W. F. FANSHAWE** (Chesham, Buckinghamshire).

## LANGUAGE BARRIER

**SIR**,—As a newcomer to short wave listening, I find it very annoying when I tune into a foreign amateur station only to find that I cannot understand the language of the operator. This language barrier problem could very easily be solved by the use of Esperanto. So why not make it the accepted language for radio amateurs the world over? If any help is needed, there is an Esperanto Society of Great Britain to assist those interested, as I am sure many amateurs would be.—**A. JAMESON** (Wigan, Lancashire).

## COMPONENTS WANTED

SIR,—I wonder if any of your readers could assist me in getting hold of an item of equipment not obtainable in this locality.

It is the coil pack and switch assembly of the R208 reception set (10-60Mc/s). The existing component in my set has been damaged beyond repair, and therefore if any reader knows of a source of supply for this part, I would be very much obliged if they would get in touch with me.—W. C. STEPHENSON (10 Plungington Road, Preston, Lancashire).

## SERVICE SHEET WANTED

SIR,—Apart from constructing radios in my spare time, I am also the Troop Leader of our local Boy Scout troop. We obtain most of our funds from hiring out our hall for dances, etc. and in connection with this we have a rather elderly m.w. receiver/p.a. amplifier, the Ambassador type PA.145.

For a long time, we have had trouble with microphony and intermittent distortion, but this has become so bad lately that the equipment is almost unusable. I have tried without success to obtain a service sheet and I would therefore be very grateful if one of your readers could give me the valve line-up or preferably loan or sell me the circuit diagram or service sheet.—J. B. MCGINN (13 Hunters Chase, South Godstone, Surrey).

## PARALLEL TRACKING UNIT

(Continued from page 1018)

the run-out groove, and then out again to the 7, 10 or 12in. mark before placing the pick-up on the run-in groove. The unit is pushed with the first finger behind the cartridge, during this time the pick-up sliding on the lowering arm back portion, and by depressing the lowering arm the needle will be brought down on to the record. At the completion of the record the arm is raised and the pick-up pushed away from the centre, allowing the record to be removed.

If on certain passages the unit resonates, either a slightly greater tracking weight is needed or the cartridge housing needs stiffening up by adding extra struts of balsa wood. An error of only  $\frac{1}{4}$ in. in the needle run each side of the centre spindle will increase the distortion considerably. Further distortion will arise if the needle does not run exactly upright in the groove and a careful sight along the record at right-angles to the needle path will show any error. The table and V-bed must be horizontal when the unit is working, a small spirit level being useful for this purpose. The V-bed may be adjusted by means of the elongated hole in the left-hand bracket.

These adjustments may take several hours, but the time will be well spent in ensuring optimum results from the equipment.

# FREE Inside NEXT MONTH'S PRACTICAL WIRELESS

At-a-glance

## PARALLEL RESISTOR and SERIES CAPACITOR CALCULATOR

Plus — Colour Code Guide

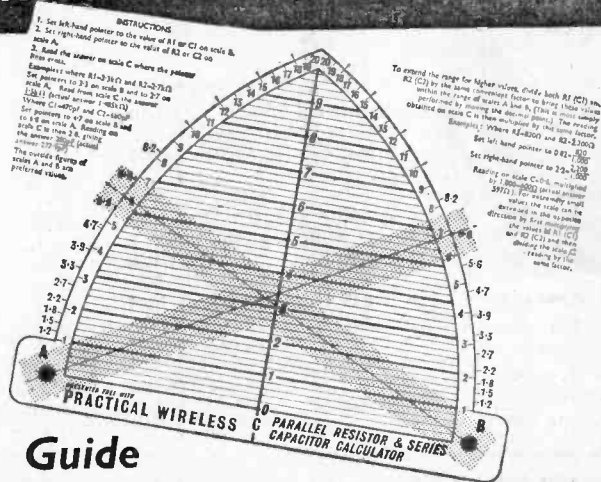

DON'T MISS IT! — ORDER YOUR COPY TODAY!

## Advertiser's Announcement

# Questions and answers for budding engineers

**Q. What age should I be for this advertisement to concern me?**

**A.** Around 16 to 19 if you want to join Electricity Supply from school. If you're an engineering graduate, or diploma-holder, you'll probably be in your early twenties. (Older, if you're a parent or teacher!)

**Q. Where can I find an engineering career offering me plenty of scope?**

**A.** Electricity Supply offers *dozens* of good jobs. Few individual firms can hope to match the variety you'll find in the Electricity Supply industry.

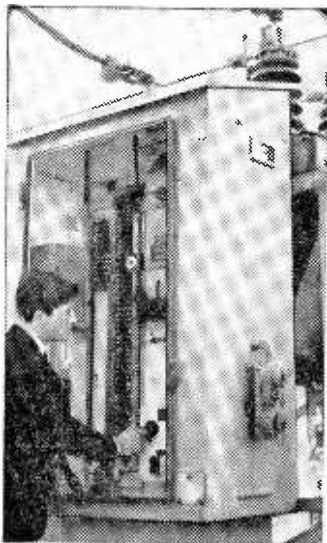

**Q. What is Electricity Supply?**

**A.** It's the national industry responsible for generating electricity, transmitting it, distributing it throughout the country and advising how it can be used.

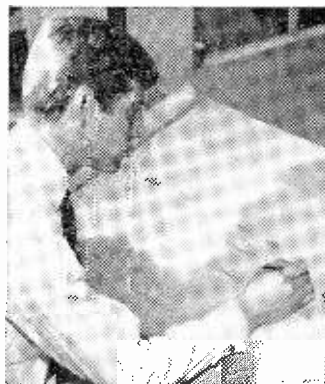

**Q. What qualifications must I have?**

**A.** School-leavers need either a good Ordinary level G.C.E. including Maths, English, and a Science subject; or two Advanced level passes in Maths and Physics. Graduates need a British degree in electrical or mechanical engineering. Or you need an engineering diploma. You can apply in your last year at school or college — preferably in the January-March period before you take your final exams.

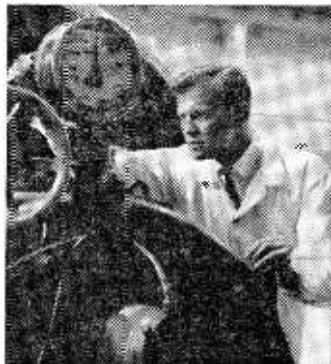

**Q. What sort of training do I get?**

**A.** For school-leavers, there's a 5-year apprenticeship. It consists of planned practical experience in the various departments, accompanied, for 'O' level entrants, by day release to a technical college and, for 'A' level recruits, by a 'sandwich' course, both leading to engineering qualifications.

Graduate trainees have a 2-year practical training in one of the main sections of the industry. The training of diploma-holders is planned to take into account past practical experience.



**Q. Where do I go from here?**

**A.** It's impossible to tell you here all about an industry that has to *double* its output every ten years. But jobs include everything from running a Power Station to bringing power to a new estate. For full details, write (giving age and exams you've passed) to: The Education and Training Officer, The Electricity Council, 155 Winsley Street, London, W.1.

---

## THE DEMAND FOR ELECTRICITY DOUBLES EVERY TEN YEARS

---

## RECEIVERS &amp; COMPONENTS

**PARTS** for OCTS in this issue. IFT's 3/- and all the latest Service Sheets. Stamp for lists. **AJAX ELECTRONICS**, 572 Fulham Road, London SW6.

**NEW VALVES**, 12 months' guarantee  
ECC81/2/3, EF80, EB91 ..... 4/11  
EZ80/1, EL84, EM84, ECL86, ECL80 .... 7/6  
ECL82, FCL82, PL81, U25, PCF80 .... 9/11

**P. BEARMAN (Tubes)**

**3 PANK AVENUE, NEW BARNET HERTS.**  
Tel: BA Rnet 1934/3185

**EXCEPTIONAL VALUE:** Picture Tubes, brand new, Mazda 19in., CME1901, Mullard 19in., AW47-90/91, £4/10/-; Mullard 23in., AW59/90, £5/10/-; carriage (insured) paid. 12 months' guarantee. Note, all brand new. We also supply most other sizes completely regunned at £4/17/6, guaranteed 12 months. **TOMLINS**, 156 Lewisham Way, New Cross SE14. TID 3867.

**ALL TYPES LINE OUTPUT TRANSFORMERS SUPPLIED (RETAIL AND TRADE).** Finest service in the country. Send S.A.E. for return of post service. Terms C.W.O. or C.O.D. Trade enquiries invited. **D. AND B. TELEVISION (WIMBLEDON) LTD.**, 131 Kingston Road, Wimbeldon, SW19. CHERRY ROAD 3955.

**NEW VALVES**, guaranteed: EY86, 7/9; EZ40, 6/6; FCC84, 7/-; PCP82, 7/-; FCL84, 7/3; PL81, 8/6; PY81, 7/-; 6K4, 5/- plus 6d. p. and p. each. S.A.E. for lists. **LEWIS**, 46 Woodford Avenue, Ilford, Essex. Telephone CRE 5685.

**DATA TRANSISTOR POCKET KITS**

**NO SOLDERING OR DRILLING, COMPLETELY SELF CONTAINED**

**NO AERIAL REQUIRED - MEDIUM & LONG WAVE - ASSEMBLY TOOL PROVIDED - CAN BE BUILT BY ANYONE**



5 1/2 x 3 x 1 1/2 in.

**DATA 49T, 4 TRANSISTORS, 2 DIODES, 7 STAGES, MOVING COIL SPEAKER** **70/-**  
Battery 2/8 extra. P.P. 2/9 extra.

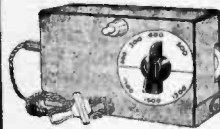

4 1/2 x 2 1/2 x 1 1/2 in.

**DATA 38 3 TRANSISTORS, 2 DIODES, 6 STAGES, PERSONAL EARPHONE** **45/-**  
P.P. 2/- ex. Batt. 1/- ex.

All Parts Supplied Separately  
**DATA ELECTRONICS LTD.**  
6 HILLSIDE GDNS., EDGWARE, Middlesex

**RATES:** 7/3 per line or part thereof, average five words to line, minimum 2 lines. Box No. 1/- extra. Advertisements must be prepaid and addressed to Advertisement Manager, "Practical Wireless", Tower House, Southampton St., London W.C.2.

RECEIVERS & COMPONENTS  
(continued)

**A1 POST-FREE BARGAINS.** First grade TRANSISTORS: OC44 8/9, OC45 7/3, OC70 OC71 5/3, OC72 OC74 OC78 OC81 7/-, OC170 8/9, OC171 9/3. All other Mullard types included. **VALVES** set tested: EB91 EF91 EF50 EF80 9d., 6F1 10F1 1/ L63 20D1 ECL80 3/-, PY81 PZ30 B36 4/-, PCF80 PL32 PL63 PY80 PY82 KT33C 4/3. PL38 N37 KT36 4/9, PCL83 6/-, PY32 6K25 5/9, 185BT 27SU U25 9/6. 10% discount on six, 25% on 12, any combination. Ready-made Transistor Set 32/-. **A1 RADIO COMPONENTS**, 14 The Borough, Canterbury, Kent.

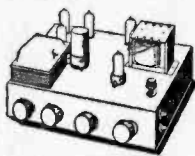
**ULTRA LINEAR AMPLIFIERS**

High Fidelity. 15 watts. Valves ECC83, ECC83, EL84, EL84, EZ81. Two inputs. Sensitivity 10 millivolts. Bass & Treble controls. 3 & 15 ohms output. Kit. £6-10-0, plus 5/- carr. Factory built, £9, plus 5/- carr. Same day despatch.

**STROUD AUDIO**  
Bath Road, Stroud, Glos.  
Tel. Stroud 783.

**HALF PRICE Transistors.** Mullard OC44, OC45, OC81, OC81D, OC170, all 4/6; Min 1 doz. lots: OC28 12/6 each. Post 8d. C.W.O. **RADIOMEX** 184 Kingston Road, Portsmouth.

"HEATHKITS" can now be seen in London and purchased on easy terms. Free brochure. **DIRECT TV REPLACEMENTS LTD.**, Dept. P.W. 7/9, 138 Lewisham Way, SE14. Tideway 6666.

**SPEAKER REPAIRS.** Cones/Fields fitted. Clock coils wound. L. S. REPAIRS, Pluckley, Ashford, Kent.

**TRANSISTORS.** Marked and tested, packets of 10; unmarked but tested, packets of 16; unmarked and untested packets of 40. Duds suitable as Diodes, packets of 80. All packets 20/- each. Any two packets 37/6. C.W.O. **K. R. WHISTON**, Dept. TPW, New Mills, Stockport.

**CANADIAN MARCONI 52 RECEIVERS**

An excellent Communications Receiver covering 1.75 to 16 mc/s in 3 bands. 1 R.F., 2 I.F. stages, 10 valves plus 3 valve crystal calibrator, 10, 100 and 1,000 kc/s. Crash Limiter, Broad/Sharp Selectivity, 500 Mc/amp. valve check/Signal Level meter. 3 in. speaker phone jacks, power required 150 v. H.T. 12 v. a.c. or d.c. L.T. **PRICES** Receiver only £5.10, carriage £1. Receiver in steel cabinet with installation kit comprising power unit ZE12 for a.c. mains 230 or 115 v. or 12 v. D.C., all connecting cables and spares, two pairs padded Headphones and aerial wire. £9.10, carriage £1. Send S.A.E. for detailed leaflet.

**G.W.M. RADIO LIMITED**  
40/42 Portland Road, Worthing, Sussex.

## METAL WORK

**METALWORK.** All types cabinets, chassis, racks, etc., to your specifications. **PHILPOTT'S METALWORKS LTD.**, Chapman St., Loughborough.

## FOR SALE

**EXCEPTIONAL** Transistor Portable Tape Recorder, value £6/19/6, complete with crystal microphone, earphone, spools, tape, batteries, instructions, presentation box (extra tapes 100 4/6). Ideal gift, £6/19/6. Satisfaction guaranteed. Postage, packing 2/6. **TOMLINS**, 156 Lewisham Way, New Cross, SE14.

**ASK** your dealer for American Ferrodynamics. "Brand Five" Recording Tapes—the best tape value!

**GRUNDIG MA1** Transistor Tape Pre-amplifiers suitable for use as microphone transformer, pick-up and tape head booster. Listed at 4 1/2 gns., offered at £2/17/6. Send for full details and free lists. **LEE ELECTRONICS**, 400 Edgware Road, W2. (Paddington 5521.)

**AMATEUR LICENCE** Morse Course. The new Rhythm Method of teaching takes the drudgery out of learning Morse and is the quickest known! For full explanatory booklet: **S.A.E. GSOHS**, 45 Green Lane, Purley, Surrey.

**SUPERHET RADIO CHASSIS**

These well-made sets were made for the Government for Forces' entertainment, using 6K8, 6K7, 6Q7, 6V6. Slow motion tuning, Choke smoothing, 200-550 meters, size 1 1/2 x 5 x 2 1/2 in., printed scale. **BRAND NEW** only 57/6, post 5/-. Case, with 8in. speaker to fit, 27/6.

**12 Volt Vibrator Unit** (P.C.R. series), 100 mA output to 250 volts, double choke smoothed, bridge rectified, spare vibrator, indicator bulbs, battery clips, fusewire. **BRAND NEW** in makers' cartons, case size 6 x 8 x 10in., 22/6, carr. 5/6.

**Clearance Offer, R107 Sets**, 9 valves 1.2-17.5 Mc/s, internal speaker and power unit for 12 volts, 100-250 A.C. £9.15.0. Air tested, realigned, £2.10.0 extra. Carr. 30/-. R107 in maker's crates, Brand New £17.10.0.

**CR.200**, 15-560 Kc/s. Brand New, £12.10.0, carr. 30/-.

**R109(A)**, 2-12 Mc/s, 5 spare valves, 2 pairs headphones, HT-LT voltmeter, manual, circuit, Brand New in maker's boxes, £6.15.0, carr. 10/-.

**1466 Receivers**, 30-40 Mc/s, 6 valves, 27/6, carr. 5/6.

**19 Mk2 TX-RX**. With 12-volt power unit. New, £4.10.0, carr. 10/-.

**J. T. SUPPLY (Dept. N)**,  
309 MEANWOOD ROAD : LEEDS 7

**VALVE** and Semiconductor Handbooks Mazda/AEI (2V); G.E.C. (8V); Ferranti (2V); Mullard 1, 2, 4, £4. R. HUTCHESON, Kershill, Dalderse Avenue, Falkirk, Stirlingshire.

**BARGAIN**, EIGHT 45 rev/min Brand New Pop singles (value over 50/-) for £1. S.A.E. for details to: **R. FLETCHER (P.W.)** 24 Old Hall St., Burnley, Lancs.

**FOR SALE**

(continued)

**E. R. NICHOLLS**  
47 Middle Hillgate  
BUMPER PARCEL

- 100 Assorted Resistors.
- 150 Assorted Condensers.
- 1 5in. 3 ohm Elac Speaker.
- 1 Isolating Transformer.
- 4 Terminal Blocks.
- 2 Rotary Toggle Switches.
- 1 Small Chassis containing 60 components.
- 2 Westectors.
- 2 Thermistors.
- 100 Cartridge Fuses.
- All for 20/- Post Free in U.K.
- 20ft. Steel Telescopic Mast, 50/-.
- High Stub Resistors 8d. each.
- List now ready for Paper Block Condensers, Valves, Oscillators, Test Sets, S.A.E. Please.

Mail Order To:  
33/35 Carrington Field Street,  
Stockport, Cheshire.

**BUILDING YOUR OWN ORGAN.**

We have for disposal a few obsolete hire organs. Wealth of parts, including keyboards, consoles, pedal boards, transformers, condensers, and other valuable electronic components. Write for details and prices. Box No. 41.

**YOUR CASH** can mean a discount of 10-33% on leading brands Tapes, Tape Recorders, Transistor Radios, Valves (12 months' makers' guarantee), Test Gear, etc. S.A.E. for list or quote for your needs. BOYLAN, Duke Street, Warrenpoint, Co. Down.

**TRANSISTORS 100% TESTED**

Red Spot Audio, 1/6 each, 14/- doz.  
A.E.I. Branded Audio XB103 and R.F. XA102, 2/3 each, 25/- doz.  
XC141 (11 watt) Audio, 6/6 each, 12/- pair.

**TRANSISTOR ELECTROLYTICS**

8µF, 25µF, 50µF, 1/3 each, 12/- doz.  
Insulated wiring-up wire,

100 yds., 10/-  
300 mixed small resistors ... 20/-  
150 mixed small PµFF Cons. 20/-

**B. W. CURSONS**

78 BROAD STREET  
CANTERBURY, KENT

**SOUND RECORDINGS**

**TAPE BARGAINS** in all sizes. Example: Top brand 5 1/2in. 1,200ft 19/6 p. and p. 1/3. S.A.E. for list. Large choice of New and Used Recorders. E. C. KINGSLEY AND CO. 132 Tottenham Court Road, London W1. EUS 6500.

**WANTED**

**A PROMPT CASH OFFER** for your surplus Brand new Valves and Transistors. R.H.S., Beverley House, Mannville Terrace, Bradford 7.

**WANTED:** New Valves and Transistors, any quantity. S. N. WILLETS, 43 Spon Lane, West Bromwich, Staffs. Tel: WES 2392.

**VALVES WANTED IMMEDIATE CASH SETTLEMENT**

Loose or boxed but must be new

Phone, write or coll—

**RADIO FACILITIES, LTD.**  
38 Chalcot Road, London, NW1

PRImrose 9090

THE VALVE SPECIALISTS

**WANTED: TEST GEAR.** Meters, Valves, Components, Communication Sets, Amplifiers. HUGGETS LTD., 2-4 Pawson's Road, West Croydon, Surrey.

**ABSOLUTE TOP PRICES** paid for Valves, Transistors, Components, etc. in quantity. Try us first. Cash by return. WOLVERHAMPTON RADIO AND TV SUPPLIES, 42 Darlington Street, Wolverhampton. Tel.: 20315.

**WANTED VALVES & TRANSISTORS**

Must be new and boxed.  
Payment by return.

**WILLIAM CARVIS LTD.**

103 North Street, Leeds 7

**WANTED**

(continued)

**NEW VALVES WANTED**

Any type, any quantity

**CASH PAID**

**R.S.T. Valve Mail Order Co.,**  
211A Streatham Road,  
Mitcham, Surrey  
Telephone: MITCHAM 6202

**SERVICE SHEETS**

**SERVICE SHEETS** for all makes of Radio and TV 1930-1963. Prices from 1/-, with free fault-finding guide. Catalogue of 6,000 models 1/6. 195 Radio/TV sheets covering many popular models 20/-. S.A.E. inquiries: HAMILTON RADIO, Western Road, St. Leonards, Sussex.

**WHY TOLERATE DELAY** when we can supply your Radio or TV Service Sheet by return of post at 4/- each, plus postage. List 1/-. Also Manuals for sale and hire. List 1/-. S.A.E. with inquiries please. Mail orders only to S.P. DISTRIBUTORS, 44 Old Bond Street, London W1.

**FAULTFINDER FILES.** showing common faults that each receiver is prone to and other useful servicing information, 2/- each. List 9d., plus postage. Mail orders only. S.P. DISTRIBUTORS, 44 Old Bond Street, London W1.

**SERVICE SHEETS:** Radio, TV, 5,000 models. List 1/-. S.A.E. inquiries: TELRAY, 11 Maudland Bk., Preston.

**SERVICE SHEETS,** Radio and TV, 4/- each. List 1/-. All orders dispatched on day received. Also manuals for sale and hire. List 1/-. S.A.E. Please. SULTAN RADIO, Pantiles Chambers, Tunbridge Wells, Kent.

**RADIO SERVICE SHEETS** 1936-1962 1/- each. Postage extra. Enclose stamp with enquiries: 85 Charminster Avenue, Bournemouth.

**SERVICE SHEETS;** also Current and Obsolete Valves for sale. JOHN GILBERT TELEVISION, 1b Shepherd's Bush Road, London W12. Phone: SHE 8441.

**MISCELLANEOUS**

**ELECTRONIC MUSIC?**

Then how about making yourself an electric organ? Constructional data available—full circuits, drawings and notes! It has 6 octaves, 2 manuals and pedals with 24 stops—uses 41 valves. With its variable attack you can play Classics and Swing.

Write NOW for free leaflet and further details to C. & S., 20 Maude Street, Darlington, Durham, Send 2d. stamp

**EXPERIENCED CONSTRUCTOR** seeks postal assembly work of Transistor Radios, etc. Box 44.



**GP90—FOR STEREO OR MONAURAL**  
48in. wide, record storage.  
Control Panel and Deck 17 1/2 x 16in.  
Tygan grille. Cash Price £19.19.0.

**SPECIAL OFFER**

**LIMITED QUANTITIES** in OAK, WALNUT AND MAHOGANY (£23.10.0. LIST PRICE)

**SPECIAL PRICE £19.19.0** plus 15/- delivery  
Ferrules and adjustable glides  
15/- Extra

or Special **NO INTEREST** Terms  
39/- deposit plus 15/- delivery and 10/- weekly for 36 weeks.

Full length motor board with record storage omitted at same price.

**A. L. STAMFORD LTD.** Dept. D 29  
98 Weymouth Terrace  
HACKNEY RD., LONDON, E.2.

# Fly as an Air Electronics Officer in the R.A.F.

The domain of the Air Electronics Officer is the whole range of electrical and electronics equipments in an operational aircraft. This covers high frequency long range communication equipment (both voice and wireless telegraphy), VHF communications (short range radio telephone), ASV (air to surface vessel) radar, and the 'black boxes' for the electronic defence of the aircraft.

Having completed your highly-specialised training courses—during which you do about 123 hours flying, including two flights abroad—you fly in the V-bombers of Bomber Command or on Coastal Command reconnaissance.

You are a key man doing a key job—where success depends entirely on your own skill, training and flexibility. There is nothing run-of-the-mill about it. You have a career you can be proud of—and there lies satisfaction.

You are well paid from the very beginning—you earn £976 as a Flying Officer of 21. At 25 as a Flight Lieutenant, drawing full allowances, you could earn over £1,800. You travel the world, meeting old friends on almost every airfield, making new friends wherever you go. You live well in the Officers Mess, and have the opportunity of taking part in almost any sport you can name.

If you are under 26, fit, and hold or expect to gain G.C.E. at 'O' level (or equivalent) in 5 acceptable subjects including mathematics and English language, you are eligible for a Direct Entry commission. Write for further details, giving date of birth and educational qualifications to Group Captain J. A. Crockett, R.A.F., Air Ministry (PW906B) Adastral House, London, W.C.1.

THE FUTURE IS WITH THE R.A.F.



## The Royal Air Force

### SITUATIONS VACANT

**A.M.I.Mech.E., A.M.Brit.I.R.E., City and Guilds, G.C.E., etc.** brings high pay and security. "No pass—no pay" terms. Over 95% successes. For details of exams and courses in all branches of Engineering, Building, Electronics, etc. write for 148-page handbook, free. B.I.E.T. (Dept. 242B), London W8.

**TV AND RADIO, A.M.Brit.I.R.E., City and Guilds, R.T.E.B. Cert., etc.** on "No pass—no fee" terms. Over 95% successes. For details of exams and courses (including practical apparatus) in all branches of Radio, TV and Electronics, write for 148-page handbook free. B.I.E.T. (Dept. 242G), 29 Wright's Lane, London W8.

**CITY AND GUILDS (Electrical, etc.)** on "No pass—no fee" terms. Over 95% success. For details of Electrical Engineering, Applied Electronics, Automation, etc., send for our 148-page handbook, free and post free. B.I.E.T. (Dept. 242A), 29 Wright's Lane, London W8.

### PUBLIC APPOINTMENTS

**RADIO TECHNICIANS** required for Ocean Weather Ships with a sound knowledge of at least three of the following types of equipment: Single Side-band Transmitter, Radar Navigational, Radar Height-finding Echo Sounders and Radio Receivers, Automatic d.f., v.h.f. and m.f. Low voltage Servo Recorders, Digital Telemetering Equipment. Salary scale £617—£1,007 per annum plus £120 per annum overtime allowance. Free food and accommodation provided on board ship. Applicants must be natural born British subjects. Full details from: Shore Captain, Ocean Weather Ship Base, Great Harbour, Greenock.

### EDUCATIONAL

**THE Incorporated Practitioners in Radio and Electronics (I.P.R.E.) Ltd.** Membership Conditions booklet 1/-, Sample copy of I.P.R.E. Official Journal 2/- post free. Secretary, 20 Fairfield Road, London N8.

**BECOME "TECHNICALLY QUALIFIED"** in your spare time. Guaranteed Diploma and Exam—Home-study Courses in Radio, TV, Servicing and Maintenance. R.T.E.B., City and Guilds, etc. Highly informative 120 page Guide—FREE! N.I.E. (Dept. 363), 148 Holborn, London EC1.

$$X = \frac{-b \pm \sqrt{b^2 - 4ac}}{2a}$$

DON'T FUMBLE with Formulae. Master Mathematics quickly and easily the Understandable Way.



The Dryden School of UNDERSTANDABLE MATHEMATICS

11F3 Dryden Chambers, Oxford St., London, W.1.

Name \_\_\_\_\_  
Address \_\_\_\_\_  
\_\_\_\_\_



**EDUCATIONAL**

(continued)

**RADIO OFFICERS** see the world. Immediate sea-going appointments. Our many recent successes provide additional trainee vacancies during 1963. Day and Boarding students. Grants and Scholarships available. Stamp for prospectus. **WIRELESS COLLEGE, Colwyn Bay.**

**It's MADE**



By repairing Radio and TV Sets as a job or as a spare time business. Our practical course will show you the way. No previous experience is required.

**SEND FOR FREE BOOK TODAY!**

**RADIOSTRUCTOR**

Dept. G77      **READING, BERKS**

**LEARN RADIO AND ELECTRONICS** the new and practical way. Hosts of absorbing experiments carried out at home under expert guidance to teach you Radio in a new, enjoyable and interesting way. Construction, servicing and fault-finding on equipment made easy for the first time! No previous experience needed. No mathematics used. Free brochure from: Dept. 11, P.W., **RADIOSTRUCTOR, Reading.**

**Radio Television & Electronics**

Learn at home with the world's largest home study organisation, Brit.I.R.E.; City & Guilds; P.M.G.'s certs., etc. Also Practical Courses with equipment. No books to buy.

Write for **FREE** prospectus stating subjects to

**I.C.S.**

(Dept. 541), Intertext House, Parkgate Road, London, S.W.11.

"**HOW AND WHY**" of Radio and Electronics made easy by a new, non-maths practical way. Postal instruction based on hosts of experiments and equipment building carried out at home. New courses bring enjoyment as well as knowledge of this fascinating subject. Free brochure from: Dept. P.W., 12, **RADIOSTRUCTOR, Reading.**

**BOOKS & PUBLICATIONS**

**THOUSANDS OF BARGAINS** can be found weekly in the Radio, TV, Mechanics and Scientific Sections of **EXCHANGE AND MART, 5d.** every Thursday. (Classified Advt. cont. on page 1063)

**THE NEW "CONTESSA"**

Mk. III

**The Best is Now Even Better!** A brilliant conception of the finest 2-band 6-transistor radio available.

★ **Ultra-modern styling** with a magnificent two-tone cabinet fitted with fully expanded metal front and a slide-rule type waveband dial. **GREATER OUTPUT** using the latest high efficiency Mullard Transistors and Diodes, incorporating an improved design, featuring different circuit constants.

**MORE punch—MORE gain—MORE stations—SUPERB appearance—the NEW "Contessa" scores again!!** SEE it—HEAR it—your will BUY it!

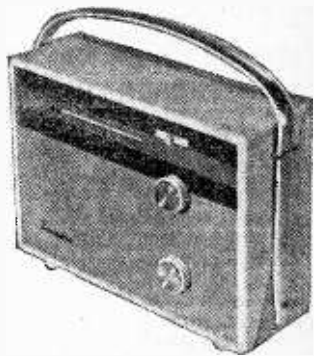

- ★ Waveband coverage of 530 kc/s to 1,630 kc/s and 160 kc/s to 270 kc/s.
- ★ Assured reception of at least half a dozen stations in daylight!
- ★ Large clearly-calibrated station-named dial.
- ★ Internal high-gain Ferrite aerial.
- ★ 5:1 ratio slow motion tuning.
- ★ Fitted with the latest 12,000-line high-flux loudspeaker.
- ★ Power of 600 milliwatts from the single-ended push-pull final stage.
- ★ Specially designed aerial matching coil for use in a CAR.
- ★ Only first-grade Mullard fully-guaranteed matched transistors and diodes are used.
- ★ Tape recorder socket provided.
- ★ Double-tuned IF transformers for maximum gain and knife-edged selectivity.
- ★ Fully drilled printed circuit panel marked with component numbers.
- ★ The two-tone case outer measurements are 10 1/2" x 7 1/2" x 3 1/2", and weighs approx. 4 lbs. when assembled.
- ★ Battery lasts 4 months with normal usage.
- ★ Book supplied with detailed assembly instructions, diagrams and circuitry.
- ★ Anyone can build this set—everything supplied, just a soldering iron required.
- ★ Cabinets available in two tone beige and two tone blue.
- ★ Adjustable carrying handle.

Inclusive price for all associated components, cabinet and battery, complete in every detail: Or our **BUY AS YOU BUILD** scheme, any parts sold separately. Send for comprehensive descriptive Manual and parts List, 2/10 post free.

**£10.19.6**  
(Plus 3/6 P. & Pkg.)

**You can hold Europe in the palm of your hand with—**

**THE "CAPRI"**

A miniature pocket transistor Radio that **REALLY** works, retaining the most attractive features of the famous "Contessa." Six first-grade Mullard transistors plus diode are employed in a highly sensitive superhet MW and pre-set LW circuit embodying the most modern design practices. A special 2 1/2in. high gauss loudspeaker provides surprising volume and a personal earpiece socket is also available. An attractive two-tone plastic case is supplied in two colours—ivory/red or ivory/blue, the full constructional details being furnished with each set of parts. The total measurements of the "Capri" are 4 1/2" x 2 1/2" x 1 1/2in.



**SEE AND HEAR A WORKING MODEL TODAY**

Inclusive price for all associated components, case and constructional data, complete in every detail. **HUGE NEW PURCHASES HAVE ENABLED US TO REDUCE THE PRICE TO ONLY** (9 volt battery 2/6 extra.) Or our **BUY AS YOU BUILD** scheme. Any parts sold separately.

**£5.19.6**  
(Plus 2/- P. & Pkg.)

**STAMPED AND ADDRESSED ENVELOPE** with any enquiry please. But regret lists or catalogues—our stocks move too quickly! PLEASE ALLOW **FULL POSTAGE AND PACKING CHARGES** Terms of Business: **CASH WITH ORDER OR C.O.D. ON ORDERS OVER 10/-.**

**RADIO CLEARANCE LTD.**

**27 TOTTENHAM COURT RD., LONDON W.1**

*The oldest Component Specialists in the Trade*

TRADE ENQUIRIES INVITED Telephone: MUSEUM 9188

EST. 30 YRS.

## New!—For you to build THE COCOVER '6'



This superhet receiver uses the very latest circuitry, 6 transistors and two diodes and is fully tunable over both medium and long wavebands. First stage uses three Mullard AF.117 alloy diffused transistors with OA.79 and OA.91 diodes, output OC.81D and two OC.81's in push-pull. I.F. frequency 470 Kc/s. Large internal ferrite rod aerial gives excellent reception over all ranges. 3 inch high flux speaker has a maximum output of 330mW. Operates on four 1.5 v. pen torch batteries. All components are mounted on a single printed circuit board. Attractive plastic case with carrying handle—fitted sockets for personal earpieces, tape recorder and car aerial. Size 6 1/2 x 4 1/2 in.

**MAY BE BUILT FOR £5.19.6** All parts sold separately. P. & P. 4/- extra. (Data and Instructions 2/6, free if all parts bought.)

## THE 'SPRITE'



A six transistor superhet Miniature Pocket Radio of Commercial Quality. Fully tunable over Long and Medium wavebands. Uses printed circuit and High sensitivity internal ferrite rod aerial. I.F. frequency 470 Kc/s. Transistors: 3-Philco 2067's. 2-Mullard OC81M, OC81DM and OA90 diode. 3 inch speaker. Works on single PPS battery. Supplied with the complete RF ready built and mounted on the printed circuit; for final assembly you only have to

fit the wave-change switch, tuning condenser and drive, volume control, earphone socket and aerial rod. In very attractive plastic case, size 4 x 2 1/2 in.

**COMPLETE AS ABOVE 89/6** All parts sold separately.

Real Calf Leather Case, wrist strap and Personal Earphone with case, 10/- extra. P. & P. 3/6 extra. (Data and Instructions 2/6, free if all parts bought.)

Wirecomp's Finest Ever Value Offer—

## THE 'REALISTIC 7'

FULLY  
TRANSISTOR-  
ISED PORTABLE  
RECEIVER

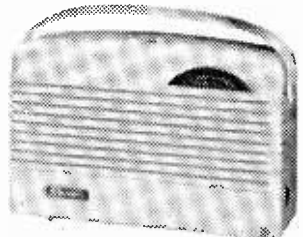

This super set—made to the highest professional standards—is now available to the home constructor. Comprises 7 Mullard Trans. OC44, 2 OC45's, OC71, OC81D, and 2 OC81's, plus OA70 Crystal Diode. Delivers 350 milliwatt output to 4in. high flux speaker—I.F. frequency 470 Kc/s.—fully tunable over medium and long wavebands. All components mounted on single printed circuit board, size 5 1/2 x 5 1/2 in. Attractive two-tone plastic cabinet with carrying handle—size 7 x 10 x 3 1/2 in. with easy to read dial and socket for car aerial, choice of Red/Grey, Blue/Grey or all Grey. Complete with full instructions. All parts sold separately.

**WIRECOMP'S £6.19.6** including Free P.P.9 PRICE Battery — Value 3/9 P. & P. 4/6 extra. (Circuit diagram 2/6, free if all parts bought.)

## WIRECOMP ELECTRONICS

378 HARROW ROAD, LONDON, W9.

TEL: CUNNINGHAM 9530

Hours of business: 9 a.m. to 6 p.m. Open all day Saturday, Opposite Paddington General Hospital Buses 18B and 36 pass the door.

## NEW VALVES!

Guaranteed Set Tested  
24-HOUR SERVICE

1R5, 1S5, 1T4, 3S4, 3V4, DAF91, DF91, DL92, DL94, SET of 4, 18/6	DAF96, DF96, DK96, DL96, SET of 4, 25/6	
1D5 7/-	DL82 5/11	PCL82 8/3
1R5 5/6	DL92 5/11	PCL83 10/0
1S5 4/6	DL96 6/9	PCL84 7/-
1T4 3/3	EB91 3/-	PENDD4020
3S4 5/11	EB41 7/6	17/8
4V4 6/9	EBF80 7/9	PL36 3/6
5U4G 4/6	EBL21 15/-	PL81 8/6
5Y3G 5/3	ECC40 13/-	PL82 6/6
5Z4G 8/6	ECC81 4/6	PL83 6/6
6AM6 2/9	ECC82 4/6	PL84 8/6
6KT7 1/9	ECC83 6/3	PY31 6/6
6K9G 4/9	ECC84 7/6	PY32 11/-
6Q7G 5/6	ECC85 7/6	PY80 7/6
6V6G 4/-	ECC86 6/9	PY81 6/6
6X5GT 6/6	ECC87 8/3	PY82 6/6
12K7GT 4/3	ECH42 7/8	PY83 7/9
12K8GT 9/6	ECF80 6/9	U25 11/-
12K9GT 4/6	EF40 11/-	U26 8/9
12SN7GT 7/3	EF41 7/6	UABC80 6/-
35L6GT 8/-	EF80 4/3	UAF42 8/6
3Z24GT 5/-	EB85 5/8	UBC41 7/6
AZ31 8/9	EF86 8/6	UBF80 8/-
CL33 9/6	EF89 6/9	UCH85 7/-
DAC32 8/9	EF91 2/9	UCH21 11/6
DAF91 4/6	EL41 9/-	UCH42 7/6
DAF96 6/9	EL84 6/3	UCH81 8/9
DF33 8/8	EL81 6/3	UCL82 9/3
DF91 3/3	EY96 6/9	UCL83 13/-
DF96 6/9	EZ40 6/-	UF41 6/9
DB77 6/-	EZ80 5/9	UF89 6/9
DK32 10/6	EZ81 6/-	UL41 8/-
DK91 5/6	MU14 5/6	UL84 6/6
DK92 7/8	PC284 6/9	UY21 10/8
DK96 7/3	PCC89 9/-	UY41 5/6
DL33 7/6	PCF80 7/6	UY83 6/3
DL35 9/6	PCF82 7/8	Z77 2/9

Postage 6d. per valve extra. Any Parcel Insured Against Damage in Transit 6d. extra. Any C.O.D. Parcel 3/- extra. Office address, no callers.

### GERALD BERNARD

(Note new address—formerly of Leeds)  
83 OSBALDESTON ROAD,  
STOKE NEWINGTON, LONDON, N.16

## H.A.C. SHORT-WAVE EQUIPMENT

AND

## SHORT-WAVE KITS

Famous for over 25 years for Quality. S.W. Receivers and Kits of Quality.

H.A.C. were the original suppliers of SHORT-WAVE RECEIVER KITS for the amateur constructor. Over 10,000 satisfied customers—including Technical Colleges, Hospitals, Public Schools, Hams, etc.

Improved designs with Denco coils: One-valve Kit, Model "C", Price 25/-, Two-valve Kit, Model "E", Price 50/-. New Addition: Model "K", Super sensitive "All Dry" Receiver. Special inc. price. Complete Kit, 77/-.

All kits complete with all components, accessories and full instructions. Before ordering call and inspect a demonstration receiver, or send for descriptive catalogue and order form.

### POST THIS COUPON NOW!

"H.A.C." SHORT-WAVE PRODUCTS  
(Dept. TH), 44 Old Bond Street,  
London W.1

Please send me FREE and without obligation your 1963 literature.

NAME.....

ADDRESS.....

## RADIO BOOKS

### BASIC ELECTRICITY ELECTRONICS

In Simple straight-forward words and Clear Explanatory Pictures, The Reader is taken Step by Step from picture to picture.

LEARN WHILE YOU PAY

FOR ONLY 2/6 PER WEEK.

Officially used by the ARMY, NAVY and AIR FORCE, used by Trainees in the Radio and Electronic Industry.

Write for FREE Illustrated Prospectus giving details of instalment plan!

OSCILLOSCOPE Book	5/8
Using an Oscilloscope	7/-
OSCILLOSCOPE Equipment	5/8
MULLARD Transistor Radios	5/8
MULLARD Ref. Transistor Circuits	13/8
EXTRA Equipment Tape Recorder	6/8
G.O.I. Design and Construction	5/8
TRANSISTOR Superhet	8/-
TRANSISTOR Audio Amplifiers	6/8
TRANSISTOR Circuits for Radio	8/-
Control of Models	5/8
RADIO Servicing Instruments	5/8
HIGH Fidelity L/Speaker Enclosures	5/8
BOYS' Book of Crystal Sets	3/-
SERVICING Transistor Receivers	8/6
ELECTRONIC Novelties	5/8
ELECTRONIC Gadgets	5/8
RADIO Valve Data "Wireless World"	7/-
BEGINNERS' Guide to Radio	8/6
MODERN Transistor Circuits for	8/-
Beginners	4/-
TRANSISTOR Test Equipment	4/-
MAGNETIC Recording	5/-
Wire and Tape	5/-
COLOUR Television, 40 Colour plates	17/-
RADIO Engineers' Pocket Book	11/6
RADIO Test Equipment	3/-
40 CIRCUITS using Germanium Diodes	3/6
HI-FI Tape Recorder	3/-
TRANSISTOR Circuits for the Constructor (Bradley) Nos. 1, 2, 3 and 4	4/- each

All above books include postage.

SEND STAMP FOR LISTS

## SELRAY BOOK CO.

60 HAYES HILL, HAYES, BROMLEY  
KENT. Tel. HURSTWAY 1818

# SOLDERING EQUIPMENT



by



## PRECISION SOLDERING for the ELECTRONICS INDUSTRY

Comprehensive range—Robust & reliable  
- Light weight - Rapid heating - Bit sizes 3/32in. to 3/8in. - 'Permatbit' or Copper bits - All voltage ranges 6/7v. to 230/250v. - Prices from 21/-.

Also

- Plastic Cable Strippers
- Miniature Solder Pots
- Heat Guards
- Long Life Bits

Illustrated is the 25w. 3/16in. replaceable bit model with safety shield.

ADAMIN— new range of precision micro-soldering instruments—  
Have you had details?

Brochure No. S10 sent free on request.  
Sole proprietors and manufacturers:

**LIGHT SOLDERING DEVELOPMENTS LTD.**  
28 Sydenham Road, Croydon, Surrey  
Phone: CROYdon 8589 Grams: Litesold Croydon

# FEATURED IN

## THE Radio Constructor

FEBRUARY

20-50 Metre S.W. Mains 2 by R. Morgan. A two valve A.C. mains operated short-wave receiver specifically designed for the beginner.



FEBRUARY

Crystal-Controlled F.M. Tuner. The "Crystella" by Sir John Holder, Bt. A 5-Valve F.M. Tuner for the more advanced constructor.

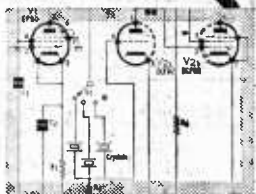

MARCH

208 Booster by A. S. Carpenter. Especially for the home constructor who wishes to improve reception of Radio Luxembourg.

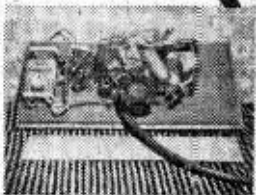

## THE Radio Constructor

PUBLISHED ON THE 1st OF EACH MONTH, PRICE TWO SHILLINGS, BY DATA PUBLICATIONS LTD., 57 MAIDA VALE, LONDON W.9.

## RECONDITIONED TV SETS

ALL MAKES ★ ALL FULLY SERVICED ★ ALL GUARANTEED ★ NOT EARLY CONVERTED MODELS

14" from £6.0.0 to £9.0.0  
3-month Guarantee on Tube and Valves

17" from £11.10.0 to £20.0.0  
12-month Guarantee on Tube, 3-month on Valves

WE ALSO STOCK SLIM-LINES  
from £23.0.0 to £33.0.0

These sets are as new

PERSONAL COLLECTION ONLY TO ENSURE SATISFACTION

## REBUILT TV TUBES

All our TV Tubes are reprocessed to a high standard and are covered by a 12 MONTHS' GUARANTEE. Each tube is fitted with a new, top-grade electron gun, which is identical with the original, ensuring exact plug-in replacement.

21", £6. 17", £5.10.0. 12", 14" and 15", £4.10.0

★ Personal collection advised, carriage by arrangement only. £1 refunded from the above price if you return your old tube.

**PARK LANE RADIO LTD.**  
548 ROMFORD ROAD, MANOR PARK, E.12  
Phone: ILF 6044

**MAXI-Q**  
REGD.

# BLANK CHASSIS

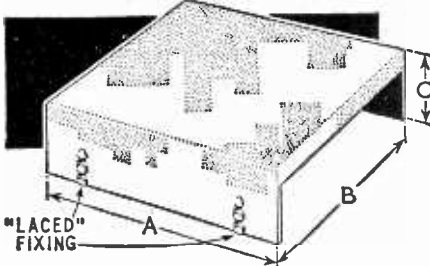

REF. CH.	A	B	C	PRICE
8	7in.	4in.	2in.	6/-
9	9in.	5in.	2½in.	7/3
10	10in.	6in.	2½in.	8/-
11	10in.	8in.	2½in.	8/9
12	12in.	9in.	2½in.	10/-
13	14in.	9in.	2½in.	10/6
14	16in.	8in.	2½in.	11/-
15	16in.	8in.	3½in.	12/6
16	20in.	9in.	2½in.	13/-
17	17in.	9in.	2½in.	12/-
18	17in.	10in.	2in.	12/-

These Robust chassis are manufactured with new material in 16 s.w.g. bright aluminium.

A notable feature is the addition of four lattice fixing holes which enables the mounting of the chassis to the cabinet with

self-tapping or wood screws only, thus saving the constructor a lot of time making brackets and holes, etc., and presenting a much firmer method of fixing.

## HOME CONSTRUCTOR CHASSIS

**CHASSIS made to your requirements with a scale of charges which enables you to work out the cost of your prototype**

Material is in 16 s.w.g. bright aluminium at 1d. per square inch—plus 6d. per bend—plus 3d. per round hole—plus 2/6 per shaped hole—plus welding at 6d. per inch—plus 2/- postage.  
16 s.w.g. aluminium panels—4/- per sq. ft.

GENERAL CATALOGUE covering full range of components, send 1/6 in stamps or P.O. PLEASE SEND S.A.E. WITH ALL OTHER ENQUIRIES.

**DENCO (CLACTON) LTD. (Dept. P.W.) 357/9 Old Road, Clacton-on-Sea, Essex**

Stop Press: S.B. DECODER TRANSFORMERS — 26/- each.

New 1963 Edition

## WORLD RADIO TELEVISION HANDBOOK

1963—17th Edition

22/- Postage 1/-

**RADIO CONTROL FOR MODELS** by F. C. Judd (new edition), 15/-, Postage 1/-.

**ELECTRONIC MUSICAL INSTRUMENT HANDBOOK**, by N. H. Crowhurst, 20/-, Postage 1/-.

**THE AMATEUR RADIO HANDBOOK**, an R.S.G.B. Pub., 34/-, Postage 2/-.

**SERVICING TRANSISTOR RADIOS AND PRINTED CIRCUITS**, by L. Lane, 42/-, Postage 1/-.

**RADIO ENGINEER'S POCKET BOOK**, Newnes, 10/6. Postage 6d.

**SOUND AND CINE FOR BEGINNERS**, by R. Golding, 7/6. Postage 6d.

**TRANSISTOR RADIOS CIRCUITRY AND SERVICING**, Mul-lard, 5/-, Postage 6d.

**RADIO AND TELEVISION TEST INSTRUMENTS**, by G. J. King, 25/-, Postage 1/3.

**COMPLETE CATALOGUE** 1/-.

## THE MODERN BOOK CO.

BRITAIN'S LARGEST STOCKISTS of British and American Technical Books

19-21, PRAED STREET LONDON, W.2

Phone: PADdington 4185  
Open 6 days, 9-6 p.m.

## RECEIVE LOUD & CLEAR INDOOR AERIAL



ONLY 16/6 P.P. 2/-

Scientifically designed and made by craftsmen. Telescopic rods of brass for easy pick-up, chromium plated for beauty. Each rod extends to 3ft. 6in. and can be swivelled, making your aerial tully directional. Perfect for ITV, BBC, AFM and FM reception. Attractive base.

Money refund guarantee

**MARLBOROUGH CABLES & ENGINEERING LTD.**

Eleot Lane, Marlborough, Wiltshire

## 2 METRES!

The thrills of 144 Mc/s can now be yours for only 39/8, complete kit! Tunable range 150-100 Mc/s, simplified construction, etc., write today for descriptive literature, also if a newcomer—beginner to Amateur Radio ask for free copy of the world-famous "Globe-King" kits and receivers—stamp to cover postage costs appreciated. Write now to makers:

**JOHNSONS (Radio)**

St. Martins' Gate, Worcester

## NEW YEAR LOW PRICES

### TRANSISTORS

**GREEN SPOT A.F. 3 v.** Down to 1/3.  
**YELLOW SPOT A.F. 6 v.** Now 1/6.  
**RED SPOTS.** Now only 1/9.  
**WHITE SPOTS 2/6 each.**  
The **LATEST MICRO-ALLOY TYPE** MAT100 7/9, MAT101 8/6, MAT120 7/9, MAT121 8/6.

### MULLARD TRANSISTORS

OC70 6/6, OC71 6/6, OC72 8/-, OC81 8/-, Matched Pairs OC72 or OC81 16/-, OC78 8/-, OC44 or OC44M 9/3, OC45 or OC45M 9/-, OC170 9/6, OC171 10/6, AF102 27/6, AF114 11/-, AF115 10/6, AF116 10/-, AF117 9/6.

**TRANSISTOR HOLDERS** 3- or 5-pin 1/-.  
**MINIATURE SURPLUS DIODES 3** for 2/- or 7/- doz. BTH Diodes CG12E 1/6 each.

**MULLARD** OA70, OA79, OA81, or OA90 all 3/- each.

**REPANCO TRANSISTOR TRANSFORMERS.** TT49 Interstage, TT45 Driver, TT46 Output or TT47 Driver, all 5/- each. FR2 Ferrite Rod Aerial 12/6.

**DRX1** Crystal Set Coil M & L with Circuit, 3/-.  
**EARPIECES,** Crystal or Low Imp Type 6/- each. Magnetic 250 ohm Type, 8/6.

**TRANSISTOR Driver and Output Trans-formers,** Type LT44 & LT700, 8/- pr.

ALL SENT POST FREE IN U.K. by

## PETHERICK'S RADIO SUPPLIES

22 High Street, Bideford, N. Devon  
Tel.: Bideford 1217

**REGUNNED T.V. TUBES**

21 in. 99/6 17 in. 90/-

15, 14 and 12in.—70/-  
TERMS AVAILABLE

**GUARANTEED ONE YEAR**

Ins. and Carr. 12/6

Add 10/- refundable on OLD TUBE  
110° Tubes in Stock

35/- 36/24, 14K/4, 141. Carr. 5/-  
15/- 121, 31/74 and others.  
Ex-Rental Stock.

**TELEPHONE HANDSETS**  
15/6 Pair

G.P.O. standard pattern. House to  
Workshop, garage, inter-office, etc.  
Works off any battery. P. & P. 4/6.

ILFord 6001/3

**DUKE & CO. (LONDON) Ltd.**

621/2 ROMFORD RD.  
MANOR PARK EI2

Liverpool Stn., Manor Park, 10 mins.

**7/9**  
each  
**SPEAKERS**



6in., 8in., 7in. x 4in.  
Money back guaranteed.  
Enquire for other sizes.  
Ex. mfd. salvage. P.P. 2/3.

**EXTENSION 1919**  
**SPEAKERS**

In cabinet complete with  
flex. P. & P. 3/9. Also  
Slim-line De Luxe, 29/9.  
P. & P. 3/3.

**VALVES 9d. EACH**

4/-£1  
Thousands of Valves  
available. P. & P. on  
1-4 6d., 12 1/6.  
Stamp for List

**COMPLETE TELEVISIONS**

14 INCH 17 INCH

**£7.10.0 £11.10.0**

★ Guaranteed 12 months. Tubes,  
Valves, Components.

★ Ex Rental and repossessed tele-  
visions.

★ Two channels word, 7/6 extra.

★ All channels available.

★ Demonstrations daily.

★ Legs—39/6 per set.

★ Part exchange allowance on  
Radios, TV's, etc.

Personal collection advised, or In-  
sured Carr., 14in., 20/-; 17in., 30/-.



**EXPRESS ELECTRONICS**  
**ROSEDENE LABORATORIES**  
**KINGSWOOD WAY, SELSDON, SURREY**

**VALVES NEW TESTED AND GUARANTEED**  
**FOR THREE MONTHS**

IC1	7/6	6BHG	5/9	12AX7	6/9	DH77	8/-	EP91	4/6	PL82	7/6
IC3	8/-	6BJ6	6/9	12BE6	8/6	DH142	8/6	EP92	8/6	PL83	8/6
1F1	8/-	6BR7	8/9	12BH17	10/6	DH150	10/-	EL41	8/6	PY81	6/9
1F3	7/6	6BW0	6/6	12K0T11	-	DK91	7/6	EL84	7/6	PY82	7/6
1FD1	8/-	6BW7	7/-	12K0T7	7/6	DK96	7/6	EL84	10/-	PY83	7/6
1FDJ	7/6	6D2	4/-	12SN7	6/-	DL82	5/6	EM85	10/-	R19	10/6
1F1	8/-	6F12	4/-	18A5	9/-	DL94	6/6	EY81	7/6	86A1	9/6
1F10	7/6	6HGGT	2/-	19AQ5	9/6	DL96	8/-	EY81	10/-	U52	7/6
1P11	7/6	6J7GT	7/6	25A93	7/6	EB91	4/-	EZ40	7/6	U76	7/6
1R5	6/-	6K7G	5/6	25L9GT	7/6	EB41	10/-	EZ80	8/-	U78	8/-
1R5	6/-	6K8G	8/-	26Z4G	9/-	EBF90	8/6	EZ81	8/9	U42	7/6
1T4	2/9	6Q7G	5/6	30C1	7/6	ECC81	6/-	HTV82	9/6	UB41	8/6
1U5	5/6	68L7GT	6/-	30L1	7/6	ECC82	6/6	KT30C	6/-	UCH42	9/6
3Q4	8/-	68N7GT	8/-	35L9GT	7/6	ECC83	8/6	KT86	11/6	UF41	8/6
384	5/9	6V6G	7/6	35W4	8/6	ECC84	7/6	N18	8/-	UY41	7/6
3V4	8/6	6X4	8/-	35Z4GT	8/-	ECC80	8/6	N18	8/-	UY41	7/6
3V4	8/6	6X4	8/-	35Z4GT	8/-	ECC80	8/6	N18	8/-	UY41	7/6
5Y3GT	5/-	6X3G	5/9	5743	7/6	ECC82	8/-	N19	7/6	W17	7/6
5Z4G	7/6	787	4/6	80	6/-	ECH42	9/-	N709	7/-	W78	4/6
6AK6	6/6	8D3	4/-	DAF91	7/6	ECH81	10/-	PCC84	7/6	W142	8/6
6AL5	4/-	917	9/6	DAF96	8/-	ECL80	8/6	PCF80	7/6	X17	7/6
6AM6	6/-	12AD6	11/6	DCX30	12/6	ECL82	9/-	PCF92	7/6	X142	9/-
6AT8	6/-	12AH8	10/-	DF91	8/-	EP41	8/-	PCL82	8/-	X160	9/-
6BA6	5/-	12AT7	8/-	DF96	8/-	EP80	8/-	PCL84	9/-	Z77	4/-
6BE6	7/-	12A07	8/6	DH76	7/6	EP86	8/-	PL81	12/6	ZD17	7/6

High Stability Resistors 1W 5% 50 Ω to 1M, 9d. Midget Ceramics 500 v. 9d. Coax. Super quality 1in., 6d. yd. Plugs 9d. Sockets 9d. Silicon H.T. Resist. 250v. 300 MA 1in. x 1in. 9/6. Contact Cooled 250v. 50 MA 6/6. 85 MA 8/6.

**NEW TRANSISTORS by MULLARD, OC19, OC26, OC68, 25/-; OC44, OC45, 9/-; OC70, OC71, 8/-; OC72, 7/6; OC72 matched in prs. 10/-; OC74, OC75, OC78, OC81, 7/6; OC82 OC170 9/6.**

**VALVES MATCHED IN PAIRS**

EL24 27/6, EL84 15/-, N709 15/-, 6V6G 15/-, 6BW6 14/- per pair. Push Pull O.P. Transformer for above 9 15 Ω 14/6, P. & P. 1/6, 12in. P.M. Speakers 3 Ω 24/6, Baker's "Solhurst" 12in. 15 Ω 15W, 30/-, 12in. Stereo Model, 27.7.0.

**SETS OF VALVES**

DK91, DF91, DAF91, DL92 or DL94, 19/6 ECH42, RF41, EBC41,  
DK96, DF96, DAF96, DL96.....27/6 EL41: EZ40.....37/6  
1R5, 1F1, 1FD1, 1P1.....27/6 UCH42, UF41, URC41,  
1R5, 1T4, 185, 384, or 3V4.....19/6 UL41, UY41.....35/-  
Postage and packing 9d. Over £1 post free. C.O.D. 2/6.

*Make Your Ability*  
**PAY**

**UNLIMITED OPPORTUNITIES** exist today for "getting on" . . . but only for the fully trained man. Let I.C.S. tuition develop your talents and help you to success.

**STUDY IS EASY** with I.C.S. guidance. The courses are thorough. Printed manuals, fully illustrated, make study simple and progress sure.

**YOUR ROAD TO SUCCESS** can start from here—today. Complete this coupon and post it to us, for full particulars of the course which interests you. MODERATE FEES INCLUDE ALL BOOKS.

**Take the right course now . . .**

- ADVERTISING**  
Gen. Advertising, Retail & Dept. Store Copywriting.
- ART**  
Oil & Water Colour  
Commercial Illustrating
- BUILDING**  
Architecture, Clerk of Wks., Buildg. Constr. & Allied Trades, Quantity Surveyg.
- CIVIL ENGINEERING**  
Highway Eng., Struct. Engrg., Concrete Engineering
- COMMERCE**  
Bookkeeping, Accountancy, Office Training, Costing, Secretaryship, Storekeeping, Shorthand & Typewriting
- DRAUGHTSMANSHIP**  
Architectural, Mechanical, Maths. & Machine Drawing  
Drawing Office Practice  
Structural Drawing
- ELECTRONICS**  
Industrial Electronics  
Computers & Maintenance
- FARMING**  
Arable & Livestock  
Farm Machinery Maint.  
Pig & Poultry Keeping  
Market Gardening
- FIRE ENGINEERING**  
I.F.E. Examinations  
Fire Service Promotion
- GENERAL EDUCATION**  
Good Eng., Foreign Langs.  
G.C.E. subjects at ordinary or advanced level
- HORTICULTURE**  
Complete Gardening  
Flower & Veg. Growing
- MANAGEMENT**  
Business Management  
Hotel Management  
Office Management  
Industrial Management  
Personnel Management  
Work Study, Foremanship
- MECHANICAL & MOTOR EN-GINEERING**  
Engineering Maths, Weldg., Diesel Engines and Locom., Inspection Workshop Pract., Refrigeration, Motor Mech., Running and Maintenance (many other subjects)
- PHOTOGRAPHY**  
Practical Photography  
P.D.A. Examination
- POLICE**  
Police Entrance Exam.
- RADIO, T.V. & ELECTL.**  
Radio Servicing & Engrg., Radio Constrn. (with kits)
- SELLING**  
Commercial Travellers  
Sales Mangnt, Ret. Selling
- WRITING FOR PROFIT**  
Short Story Writing  
Free-Lance Journalism

**INTENSIVE COACHING** for all principal examinations including C.I.S., A.C.C.A., I.C.W.A., B.I.M., A.M.I. Mech.E., Brit.I.R.E., I.Q.S., City & Guilds of London Institute, R.H.S., P.M.G. Certificates in Radiotelegraphy, etc.

*Start today the I.C.S. way!*

**INTERNATIONAL CORRESPONDENCE SCHOOLS**  
(Dept. 172)  
Intertext House, Parkgate Rd., London, S.W.11

Send FREE book on \_\_\_\_\_

Name \_\_\_\_\_

Address \_\_\_\_\_

Occupation \_\_\_\_\_

**INTERNATIONAL CORRESPONDENCE SCHOOLS**

# MINISETS LTD Hatherley Mews London E17

## THE IMPERIA

An easy-to-build 6-Transistor Portable Superhet which can be built by the constructor. Pre-assembled circuitboard for easy construction. All components are new, 5in. speaker giving good tone and output. Attractive case of exclusive design 8½ x 5½ x 2½in. with gold-plated grille. Specially designed matching coil for use in car. Only first grade fully guaranteed matched transistors and diodes are used. Anyone can build this set for

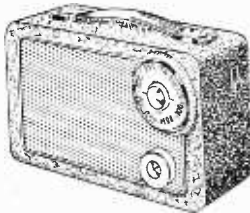

**£7.17.0**

Everything supplied except soldering iron. P. & P. 3/-. Full instructions 1/6 (free with order).

## 3-Transistor Radio (plus 2 diodes)

Total building **70/-** P.P. 2/6

- ★ Pre-assembled circuit board, ensuring easy construction.
- ★ Full medium-wave coverage.
- ★ Attractive case 5½ x 3 x 1½in.
- ★ All components including transistors are brand new and direct from manufacturers.
- ★ Ferrite Rod aerial coil, no external aerial or earth required.
- ★ 2½in. high flux speaker direct from manufacturer.
- ★ After-sales service.

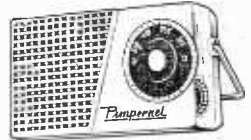

Send 1/6 for instructions, circuit and price list.

## 6-Stage Transistor Pocket Portable

Can be built for **£4.19.6** P.P. 2/6

- ★ Completely self contained, no aerial or earth required.
- ★ Push-pull output, 250 milliwatts.
- ★ 3in. high flux speaker.
- ★ Pre-assembled circuit board with simple instructions ensuring easy construction.
- ★ High Q Ferrite Rod Aerial.
- ★ After-sales service.



Can be supplied with long-wave 8/- extra. Full instructions, price list 1/6 (free with order).

## THE RIETI

6-Stage super sensitive Transistor Portable. Easy to build. All components first grade. A real portable transistor radio, covering Medium wave reception. 5in. speaker, high Q ferrite aerial especially designed. Pre-assembled circuit board enables the complete set to be assembled and tested before placing in case. Attractive case 8½ x 5½ x 2½in. with gold-plated grille. Total

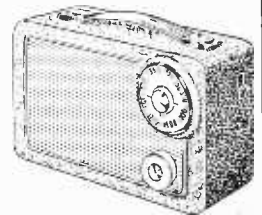

build costs **£5.2.6** P. & P. 3/-

Medium and Long wave 8/- extra. Full instructions 1/6 (free with order).

- Microwaves
- Circuit Design
- Motors and Generators
- Electrical Engineering
- Transformers and Chokes
- Valves and Transistors
- Sound Reproduction
- Cathode Ray Oscillograph
- Transmission and Modulation
- Electromedicine
- Transmitters and Aerials
- Electronics in Industry
- Radio Receivers
- Navigational Equipment
- Television
- Interference and Suppression
- Radar

# RADIO and ELECTRONICS

Edited by J. H. Reyner, B.Sc., D.I.C., M.I.E.E.

Student and specialist alike need a book which will give them the fundamental applications of radio and electronics in an easily digestible form, and this book has been produced with that need in mind. In these two well-illustrated volumes a team of electronics experts show you the theories and techniques, the methods and materials of this exacting science, from Acoustics to X-rays. You cannot hope to keep all of radio and electronics in your head, but you can keep *Radio and Electronics* on your bookshelf as a constant source of information and advice.

*This most important book can be yours for a few small monthly payments under the New Era scheme. If you are interested in it, why not send us this application form? We shall then send you a brochure giving further details and explaining our free inspection offer, which lets you look through the book in your own time before you decide whether you want it. It's easy—and there's no obligation to buy.*

### APPLICATION FORM

To New Era Publishing Co. (Dept. N.3),  
45 New Oxford Street, London, W.C.1.  
Please send me further details of 'Radio and Electronics'

Name \_\_\_\_\_  
(BLOCK LETTERS PLEASE)

Address \_\_\_\_\_

\_\_\_\_\_

Date.....Age (if under 21).....

# LASKY'S RADIO

## "BUILD-YOURSELF" TRANSISTOR RADIOS

The finest receiver at present available for home construction. Fully tunable long and medium wavebands. Uses 7 Mullard Transistors: OC44, 2 OC45's, OC71, OC81D and 2 OC81's, plus Crystal Diode OA70.

### The "REALISTIC" Seven

#### STAR FEATURES

★★★★

- ★ 7 Transistor Superhet. 350 Milliwatt output into 4-inch high flux speaker.
- ★ All components mounted on a single printed circuit board, size 5 1/2 x 5 1/2 in. In one complete assembly.
- ★ Plastic cabinet, with carrying handle size 7 x 10 x 3 1/2 in. In choice of colours:
- ★ Red/Grey, Blue/Grey, all Grey.
- ★ Easy to read Dial.
- ★ External Socket for car aerial.
- ★ I.F. frequency 470 Kc/s.
- ★ Ferrite Rod internal aerial.
- ★ Operates from PP9 or similar battery.
- ★ Full comprehensive data supplied with each Receiver.
- ★ All coils and I.F.'s, etc., fully wound ready for immediate assembly.

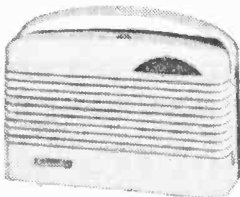

An Outstanding Receiver. Lasky's Prices for the complete parcel including Transistors, Cabinet, Speaker, etc., and Full Construction Data: **£6.19.6** Postage and Packing 3/6 Battery 3/9 (included free with complete parcel). Data and instructions separately 2/6, refunded if you purchase the parcel.

### TELEFUNKEN STEREO HI-FI AMPLIFIERS

Further Great Purchase Enables us to Offer this Excellent Unit at £5.19.6. Post 7/6.

A complete stereo amplifier of unsurpassed quality, with inputs for radio, tape recorder, F.M. tuner or any other hi-fi source, either monaural or stereo. Output power 5 watts total (2 1/2 watts each channel). New and unused, listed at 16 gns.



**LASKY'S PRICE £5.19.6**



### THE SPRITE

- ★ Six-Transistor Superhet Miniature Personal Pocket Radio. ★ Tuneable over Long and Medium wavebands. ★ Used PP3 battery. ★ Ferrite Rod aerial. ★ I.F. Frequency 470 Kc/s. Transistors: 3 x Philco 2067's 2 x Mullard OC81 M, OC81 DM and OA70 diode. ★ 3 inch speaker. ★ Printed circuit 2 1/2 x 2 1/2 in. ★ Slow Motion Drive. ★ In Plastic Case, size 4 x 2 1/2 x 1 1/2 in.

Inclusive price of

**89/6**

P.P. 3/6 extra.

In order to ensure perfect results, the SPRITE is supplied to you with R.F. and I.F. stages, Driver and Output stages, ready built with all components ready mounted on the printed circuit. To complete assembly you only have to fit the wavechange switch, tuning condenser and drive, volume control, earphone socket and aerial rod, the remaining components all having been pre-fitted at the factory for you. The SPRITE is offered as above, pre-assembled, plus cabinet, speaker and all components for final construction, at the inclusive price of 89/6. Postage and packing 3/6 extra. Data and instructions separately. 2/6. Refunded if parcel is purchased. Real calf leather case, wriststrap, personal earphone and case for earphone 10/- the lot extra. Make no mistake this is SUPERHET receiver of genuine commercial quality. It is not a regenerative circuit.

### THE COCOVER '6'

- ★ A 6-transistor plus 2-diode superhet receiver using the latest circuitry. ★ Three Mullard AF117 alloy diffused transistors are used with OA79 and OA91 diodes, followed by OC81D and two OC81's in push-pull. ★ I.F. frequency 470 Kc/s. ★ Covers the full medium and long wavebands. ★ Sockets provided for personal earpiece or tape recorder, and car radio aerial. ★ Large internal ferrite rod aerial gives high sensitivity.
- ★ Uses four 1.5 v. pen torch batteries. ★ All components mounted on a single printed circuit. Simple stage by stage instructions. ★ Cabinet size 6 1/2 x 4 x 1 1/2 in. With carrying handle.
- ★ All coils add I.F.'s ready wound.

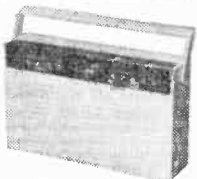

CAN BE BUILT FOR **£5.19.6** Post and packing 4/- extra.

### THE BETA TWO

A 2-transistor plus 2-diode personal receiver for home construction. Uses printed circuit and ferrite rod aerial. Personal earphone gives clear reception for private listening. Tunes over full medium waveband. Size 5 1/2 x 3 1/2 x 1 1/2 in. overall. All components available separately. CAN BE BUILT FOR 21/- Postage 2/6 ex.

Including personal earphone, cabinet, etc. Circuit diagram and step by step instructions 1/6. (Free with parcel.)

### ELECTRIC MOTORS

Brand new single phase motors suitable for tape recorders, radiograms, workshops etc. Has many uses. Reversible 200-250 v. 5in. oz. torque. 1,400 r.p.m. Capacitor start. Weight 4 1/2 lb., length overall 5 1/2 in. spindle both ends 1/2 in. x 1/2 in.; 1/2 in. x 1/2 in. Price including capacitor Postage and Packing 3/6 extra. **19/11**

### KAPURA Model U1 Multi-Test Meters

- ★ Complete with test leads.
- ★ Brand new, fully guaranteed.

Sensitivity: 1,000 ohms per volt A.C. and D.C. Ranges: (A.C. and D.C.) 0-15-50-250-500-1,000 v. D.C. current 0-100-500 mA. 0-1 mA (used at 0-10 v. range). Resistance: 1-2,000 ohms (centre 24 ohms), 100-20,000 ohms (centre 2k).

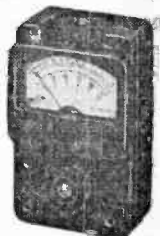

Size: 5 1/2 in. x 3 1/2 in. x 2 1/2 in. **LASKY'S PRICE 39/6** Carriage and Packing 5/-

### CRYSTAL PICK UP CARTRIDGES

Lowest Prices Ever!

All complete with Stylus, L.P. and Standard (and Stereo where shown). Fully guaranteed, standard fitting, will fit most P.U. arms and heads.

Postage 1/- each extra.

#### MONO

TYPE C.T.1. By well known manufacturer. With two sapphire styli

Garrard G.C.E.4	12/6
Ronette Studio 0	15/-
Acos GP.65/3	15/-
Acos GP.65/1	17/-
Acos GP.67/1	17/-
Acos GP.61/1	18/-

#### STEREO

Acostereo 73/1 with two sapphires	25/-
Acostereo 73/2 with Diamond L.P./Stereo and sapphire Std.	28/6
Collaro type C Turnover, with 2 sapphires	25/6
Collie S.C.1 Turnover with 2 sapphires	24/6
Collie S.C.1 Turnover with Diamond L.P./Stereo and sapphire Std.	29/6
Ronette Stereo O.V. Turnover, with 2 sapphires	29/6
Ronette Stereo type 105, with 2 sapphires	35/6
Ronette Stereo type 105, with Diamond L.P./Stereo and sapphire Std.	39/6

### TV TURRET TUNERS

By famous manufacturer, I.F. 33-39 Mc/s., PC84 and PF80 valves fitted, also 12 sets of coils. Lasky's Price Complete with Valves and Coils 29/6. Postage 2/6.

### Distler Miniature Motors

6 volt battery operated 7/11. P. & P. 2/6.

207 EDGWARE ROAD, LONDON, W.2. | 33 TOTTENHAM COURT ROAD, W.1. | Near Praed St. PADDINGTON, 3271/2 | Nearest Stn., Gooidge St. MUSEUM 2605 | BOTH OPEN ALL DAY SAT: Early Closing Thurs. Mail Orders to Dept. P.W., Edgware Rd.

152/3 FLEET STREET, LONDON E.C.4 | Telephone: Fleet Street 2833. | Open all day Thursday. Early closing Sat.

# NOW ANYONE CAN AFFORD TO TRAIN TO BE AN EXPERT IN RADIO AND ELECTRONICS

## EVEN QUALIFY FOR A CERTIFICATE

It's the most exciting news of the year! Just imagine. You can get 35 large, fact-packed lessons for little more than 1/- per lesson! The lessons are crystal clear, practical, easy to master and use. Early lessons make fundamentals clear even to the beginner, while other lessons will give you the practical "know-how" of an expert.

Compares favourably with some courses costing ten times as much. You save because you receive all the lessons at one time and are not required to purchase equipment you do not need.

This is a real home-study course that has been bound into one giant 5 x 11in. 216 page manual. Each page is divided into two columns. A wide column features the text, while a narrow column at the side has the instructor's comments, helpful suggestions and additional pictures to simplify the difficult parts.

Everyone can benefit from this practical course. No old fashioned (or pseudo modern) methods used here, just straight forward, easy to understand explanations to help you make more money in electronics.

As an optional extra, you may pay a further fee if you wish to take the Sim-Tech radio and electronics examination. Students who attain a minimum of 60% correct answers can qualify for a certificate of proficiency in basic radio and electronics. Details sent with each course order.

You must be convinced that this is the best value you have ever seen in electronic training, otherwise you can return the manual (or have your money refunded if sent with order) after you have examined it in your own home for a period of seven days.

The price? Only 36/-, plus postage.

# FREE TRIAL OFFER!

To SIM-TECH TECHNICAL BOOKS, Dept. WA9, Gater's Mill, West End, Southampton, Hants.

RUSH Radio and Electronics Course for seven days examination. If I keep the course I can either pay 37/6d. cash or 12/6d. deposit after seven days and two payments of 12/6d. monthly. Otherwise I will return the course post-paid and owe nothing.

SAVE! Send only 36/- if paying cash with order. We pay postage. Same 7-day money-back guarantee.

Name

Address

City  County

## PADGETTS RADIO STORES

OLD TOWN HALL, KNOWLER HILL, LIVERSEDGE, YORKS.  
Phone: Cleckheaton 2886

Type 46. RX-TX. Complete with two ARP12, one AR8, one ARTP2, one APT4, one APP37, less crystals, coils and send-receive switch, but otherwise complete. These sets are in new condition, 8/6. Post 3/9. Grade two store soiled, 4/6. Post 3/9.

Bomb Computers in new condition. Full of gears, motors, etc. 30/-, Carr. B.R.S. 10/-.

P.M. Speakers, all 3 ohms. Removed from TV sets, perfect condition. Rola 6 x 4in., 5/-. Goodmans 7 x 4in., 6/-. Phillips 5in. round, 5/-. Rola B and A round, 3/6. 6in. dish, 5/-. 8in. round, 6/-. Post extra on any speaker 2/-. Up to six can be sent for 3/6.

Germanium Diodes. 4/6 per doz. Post free.

Grade 1 Transistor Type X.A. 101, 3/6. post free. 30/- per doz.

New Boxed Valves. Post free. ARP12, 1/6. 6 for 5/6. Box of 50, 20/-, 6P6, 2/9, 6K7, 2/-, 6L6 Metal 7/-, 6V6GT 5/-, VR150/30 3/6, 8C4 2/-, 901 9d., 5/- doz., 6V5 3/-, EL91 1/9. Also new valves ex-units, EF91 1/9, EB91 1/9, 5Z4 5/6, MS.PEN 2/6, 12A6 Metal 2/6, 5U4 2/6, 6U6 2/6, 807USA 5/-, 6V3 3/6, 6V6GT 4/-, AC2 per 4/-, 1S5 2/6, 6F50 6/- per doz. 1/9 each, 1T4 2/-.

Valves removed from TV sets, all post free, all tested on a Mullard valve tester and are 100% as new. They carry a three months Guarantee. We also have a large stock of old type radio valves and other TV valves not listed.

ECL80 4/-, ECC82 5/-, EL38 4/-, EL51 2/6, EBF80 4/6, EB91 9d., EF91 9d., 6F1 1/-, 6F13 2/-, 6F14 5/-, 6L20 5/-, 6C6NT 2/6, 6V6 2/6, 6C6 2/6, 6SS7 2/-, 10C2 5/-, 10F1 1/-, 10P13 5/-, 10P14 5/-, 20D1 3/-, 20P1 5/-, 20L1 5/-, 18BT 9/6, U261 5/-, U282 5/-, U329 5/-, KT96 5/-, PL81 5/-, PL82 5/-, PY81 4/-, FY82 5/-, PY80 5/-, PZ30 4/-, PCF80 4/6, PC84 4/6, PL83 5/-, PL33 4/-, B36 4/-, N37 5/-, L63 3/-, 6J5 3/-, 27SU 5/-, U12 4/-, EF80 1/6, 10P/ per doz. Reamed 26d., 4/- per doz.

Perfect Reclaimed Tubes. 6 months guarantee. 12in., 17/-, 14in., 30/-, Carr. and Ins. 7/6.

TV Tubes Completely Rebuilt and refaced. 12 months guarantee. Old glass not required. 12, 14, 15, 16, 17 in., any make. All the special trade price of £3.15.0. Carr. and Ins. 7/6.

H.P. Motors 1400 R.M.P. 230-250 volts. Removed from washing machines, 25/-, carr. 7/-

## BBC · ITV · F.M. AERIALS



B.B.C. (BAND 1). Telescope loft, 19/6. External, S/D, 26/3.  
I.T.V. (BAND 3). 3 Element loft array, 24/-, 5 Element, 32/6. Wall mounting, 3 Element, 33/9. 5 Element, 41/3.  
COMBINED B.B.C. + I.T.V. Loft 1+3 Element, 41/3. 1+5 Element, 48/9. Wall mounting, 1+3 Element, 56/3. 1+5 Element, 63/9. Chimney and mast mounting units also available.

F.M. (BAND 2). Loft "H", 28/-, 3 Element loft, 52/6. S/D loft, 12/9. External S/D, 26/3. State channel when ordering. C.W.O. or C.O.D. P.P. 2/6. Coaxial cable, 8d. yd. Coaxial plugs, 1/3. Send 6d. stamps for illustrated lists.

K.V.A. ELECTRONICS (Dept.P.W.)  
3B, Godstone Road, Kenley, Surrey.

## RES/CAP. BRIDGE 39/6

p. & p. 2/6  
Checks all types of resistors, condensers  
6 RANGES  
Built in 1 hour. Direct reading.  
READY CALIBRATED  
Stamp for details of this and other kits.  
RADIO MAIL (Dept. P.J)  
Raleigh Mews, Raleigh Street, Nottingham

# Lewis have the Cabinet for you

We can supply any cabinet to your own specification. This is only one example of—  
THE LARGEST RANGE OF CABINETS IN THE COUNTRY  
Equipment is also our speciality.

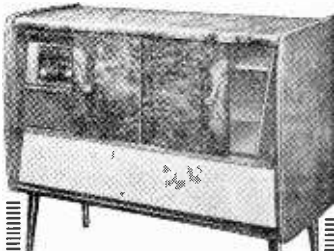

The Grosvenor  
Price 15 gns.



The Lowboy  
Price 24 gns.

## LEWIS radio

100(P33) Chase Side, Southgate, London, N.14. Tel 3733/9666

Send today for the two new Lewis Catalogues

Designed to assist your choice of cabinet and equipment.  
THE New Lewis Radio Cabinet Catalogue—the most comprehensive ever prepared. THE unique 64 page equipment catalogues.  
Please send your two new catalogues enclosed in P.O. for 3/6 which will be credited against any purchase I make.

Name

Address



**D. & B. TELEVISION**

(Wimbledon) LIMITED  
131 & 131a, Kingston Road,  
South Wimbledon, London, S.W.19  
PHONE: CHERRYWOOD 3955  
Open MONDAY to SATURDAY, 10 a.m. to 7 p.m.  
(Except Wednesday, 1 p.m.)  
Nearest Tube: South Wimbledon (North Line)  
COMPARE OUR PRICES  
For the Finest in the Country  
YOUR PROBLEMS ARE OUR BUSINESS  
MOST LINE-OUTPUT TRANSFORMERS

**T.V. TUBES. ALL TUBES ARE REGUNDED WITH FULL 12 MONTHS GUARANTEE**

12in. MULLARD TYPE	.....	£3 15 0
14in. MULLARD TYPE	.....	£4 5 0
15in. MAZDA TYPE	.....	£4 5 0
16in. MULLARD TYPE	.....	£3 15 0
17in. MAZDA TYPE	.....	£4 5 0
12in. MAZDA TYPE	.....	£3 15 0
14in. MAZDA TYPE	.....	£3 15 0
16in. G.E.C. TYPE	.....	£4 5 0
17in. MULLARD TYPE	.....	£4 15 0
17in. G.E.C. TYPE	.....	£4 15 0
17in. BRIMLEY TYPE	.....	£4 15 0

90° and 110° TUBES ON EXCHANGE BASIS ONLY  
Add 4/- for Electrostatic Tubes. Add 10/- for 90° and 110° Tubes.  
Carr. and Ins. 12/6 C.W.O. or C.O.D.

**VALVE LIST**

CY31	14/8	E240	6/3	384	7/-
DF96	5/6	E241	6/3	3V4	7/-
DF96	8/-	E280	6/-	5U4G	7/-
5A F91	5/6	E281	6/-	5Y3	8/-
DAF77	8/-	G232	6/6	5Z4G	6/-
DB177	4/8	G234	12/6	6AT6	6/-
DK91	7/-	KT33C	6/-	6F1	8/-
DK92	7/-	PC084	8/8	6F13	8/6
DL96	8/-	PC085	8/8	6F15	11/8
DL92	7/-	PC089	8/8	6L1	10/0
DL84	7/3	PCF90	8/8	6L18	9/6
DL96	8/-	PCF82	6/8	6X1	4/3
EABCB80	7/3	PCF86	10/6	6X5	5/6
EAF42	9/6	PC182	8/3	6V6	6/6
EB91	8/6	PC183	10/6	6N87	5/6
EEBC38	4/6	PC184	6/-	6Q7G	6/6
EEB041	9/-	PCL35	14/3	6B17	6/6
EBF90	8/-	PL36	12/-	7B7	8/6
EBF89	8/-	PL38	18/6	7C5	8/6
EC081	8/6	PL39	18/6	7C6	8/6
EC082	7/6	PL82	7/6	7H7	7/3
EC083	7/6	PL83	8/-	10C2	15/-
EC084	7/6	PL84	8/-	10F1	5/6
EC085	7/6	PL85	12/6	10P13	8/6
ECF80	9/-	PY32	10/6	10P14	12/6
ECF82	9/-	PY39	8/6	12A7	5/6
ECI442	9/-	PY81	7/3	12AT7	5/6
ECI40	7/6	PY82	6/-	12AX7	5/6
ECI82	8/3	PY83	8/-	12K70T	5/6
ECL90	9/-	U24	11/6	20D1	6/3
EF36	4/-	U26	11/6	20F2	8/6
EF39	4/-	U26	8/-	20L1	19/6
EF80	5/3	U31	7/-	20P1	12/6
EF85	7/6	U37	12/6	20P3	19/6
EF91	8/3	U91	12/-	20P4	22/-
EF91	3/9	U301	19/6	20P5	19/6
EF92	4/-	U801	25/-	30FL1	10/-
EL32	4/3	UAF32	8/-	30P4	9/6
EL33	8/-	UBC41	8/-	30P12	19/6
EL34	7/6	UCB90	10/6	32Z5GGT	8/3
EM34	6/3	UL41	8/-	35Z5	6/6
EM80	6/9	UL40	8/-	185BT	2/2
EV61	8/6	U08	17/8	807	7/6
EV86	8/6	UY41	8/6		

**LISTEN TO YOUR FAVOURITE PROGRAMME "2008" ETC. YOURSELF ON THE V.E.I. PERSONAL TRANSISTOR RADIO**



**45/6** Inc. P.T. P. & P. 1/6  
Battery 2/3 extra. Not a Toy, but a ready built radio for personal listening, to give you hours of delight. No aerial or earth required, tunable over the Medium Wave Band, complete with Earpiece. Self contained battery, plastic case with gold dial. The ideal gift. (For those who wish to build, we can supply the components separately for 26/6 plus 1/6 P. & P.)

**SUPER CRYSTAL DIODE RECEIVER**

**12/6** Inc. P.T. P. & P. 1/-



Headphones 12/6 pr. This crystal receiver will delight many a boy, and even a grown-up. Completely built ready to go (or for those who wish to build themselves, we can supply all the parts separately for a total cost of 9/6, plus P. & P. 1/-). Parts for either receiver are obtainable from us separately.

"SUSPICIOUS ASSURED BY SUPER AFTER SALES SERVICE"  
Send S.A.E. for Free layout plans.  
**REDISERVICE LTD. (P.W.)**  
44 BROADWAY MARKET, LONDON, E.3  
PERSONAL CALLERS WELCOME

**TRANSISTORS**

TSI 376; OC44 6/-; OC45 7/-; OC70 6/-; OC71 6/-; OC72 7/- (14/6 pr.); OC76 8/-; OC81D; OC81 6/- (13/- pr.); OCP71 25/-; all other MULLARD VALVES, TRANSISTORS, DIODES, CRT'S, etc. at list price.  
CRYSTAL DIODES STILL ONLY 1/- ea.  
**ELECTROLYTICS - Guaranteed.**  
450v. w.k.g. wire ended. 32mf. 3/-; 16mf. 2/6; 8mf. 1/9; 1mf. 2/5; 8+8 mf. 2/11; 8+16mf. 3/-; 16+16mf. 3/4; 24+24mf. 350v. 4/-; 50mf. 12v. 1/6; 100mf. 6v. 1/5; SUB MIN. 2, 8, 16 mf. 2/2 each.  
**PW Simple Transistor Two.** Complete Kit 57/6. Case to suit 7/6. S.A.E. for parts list.  
-all prices post paid-  
**oakfield RADIO**  
121 MACCLESFIELD ROAD, HAZEL GROVE, STOCKPORT, CHESHIRE  
MAIL ORDER ONLY

**WORLD RADIO & T.V. HANDBOOK 1963 22/-**

By JOHANSEN. Postage 1/-.  
Radio Data Reference Book by R.S.G.B., 12/8, postage 1/-.  
The Amateur Handbook by R.S.G.B., 34/-, postage 2/6.  
The Amateur Radio Call Book 1963 by R.S.G.B., 4/6, postage 6d.  
Beginners' Guide to Radio by Camm. 7/6, postage 8d.  
The Oscilloscope Book by Bradley, 5/-, postage 6d.  
Mullard Transistor Radios, circuitry and servicing, 5/-, postage 6d.  
Modern Transistor Circuits for Beginners by Sinclair, 7/6, postage 6d.  
Radio Valve Data by W.W., 8/-, postage 9d.

**UNIVERSAL BOOK CO.**  
12 Little Newport Street, London, W.C.2 (adj. Newington Lisle Street)

**SOUTHERN RADIO SUPPLY LTD.**  
11 LITTLE NEWPORT STREET LONDON W.C.2. GER 6653  
All goods still available as previously advertised

**ULTRA VIOLET BULBS**

Easy to use source of UV for dozens of practical and experimental uses. 12 volt 36 watt AC/DC SBC 8/8. P. & P. 1/-.  
12 volt 60 watt AC/DC SBC 8/6. P. & P. 1/-.  
Transformer to suit the above: Input 200-240 A.C. Output 12 volt A.C. 36 watt, 16/6. P. & P. 2/6. Input 200-240 A.C. 12 volt A.C. 60 watt, 22/6. P. & P. 3/6.  
Set of 4 colours FLUORESCENT Paint. Red, Yellow, Green and Blue in 1 oz. tins. Ideal for use with the above Ultra Violet Bulbs, 9/8. P. & P. 1/6.

**BUILD AN EFFICIENT STROBE UNIT FOR ONLY 37/6.**

The ideal instrument for workshop, lab, or factory. This wonderful device enables you to "freeze" motion and examine moving parts stationery. We supply a simple circuit diagram and all electrical parts including the NS2P Strobe tube which will enable you to easily and quickly construct a unit for infinite variety of speeds, from 1 flash in several seconds to several thousands per minute. New modified circuit brings price down to 37/6 plus 3/- P. & P.

**NS2P CV2296 STROBOTRON FLASH-TUBE MADE by Ferranti, brand new, I.O. base. Price 15/- P. & P. 1/-.**

**MAGNETIC COUNTERS 10 IMPULSES PER SECOND**

Very latest High Speed type exc. P.O. guaranteed perfect. type No. 100B, coil 2,300 ohms type No. 100C, operation (will work on 36 volt), overall size 4 x 1 x 1 in. Also available, type 101A which can be used as an interesting accessory, with our Strobe unit. Either type price 15/- P. & P. 1/6.



**Variable Voltage Transformer**

Input 230 v. A.C. Output 0-260 at 25 amp. Fully shrouded. New £15.95 inc. carriage. Also available from stock, 5, 8, 10 and 20 amp. Write for details.



**ORP 60 MULLARD CADMIUM SULPHIDE PHOTOCELLS**

With mounting and leads including circuit for making light sensitive switches, 7/6. Post paid.

**SIEMENS I.L.S. RELAY.** Very latest type, sealed. H96E. 1,700 ohms plus 1,700 ohms, single C/O contacts. Price 16/6 each, plus 1/- P. & P.

**Miniature LEDEX Switch.** 24 volt D.C. operation. Two bank 11 position plus Homing Contact. A miniature and compact form of uniselector. Ex brand new equipment. 32/6. P. & P. 2/-.

**7 R.P.M. Geared Motor.** 12 volt D.C. Double Gearbox. Combination 1 amp. size 3 1/2 x 2 1/2 in. Weight 15 oz. Small and extremely powerful. 32/6. P. & P. 2/6.

**230 VOLT A.C. GEARED MOTORS**  
Type B16G 80 r.p.m., 26 lb. inch, £11.9.6. P.P. 2/-.  
Type D16G 5 r.p.m., 1.7 lb. inch, £2.9.6. P.P. 2/6.  
Type D16G, 13 r.p.m., 1.45 lb. inch, £2.12.6. P.P. 2/6.

**12 v. D.C. Reversible Motor** with tremendous power for weight. 3 position switch. Weight 2 1/2 ounces. Size 1 1/2 x 1 1/2 in. dia. Speed 7,000 R.P.M. Self lubricating. 15/-, plus 1/- P. & P.

**AVO METER MODEL 7.** Individually tested on all ranges and guaranteed. Inclusive of Test Leads. £11.0.0 each, P. & P. 5/-. Case 20/-.

**SPEAKER**  
A beautifully made Speaker and Control Unit for the famous Collins TCS communication equipment. Can be used with any top-grade communication setup. Comprising a super 500 3 to 5 ohm speaker, 600 ohm matching transformer, constant impedance type volume control, 3 control switches. Fitted in robust crackle finished case. 29/6. P. & P. 4/-.

**SERVICE TRADING CO.**

All Mail Orders also callers.  
47-49 High Street, Kingston on Thames  
Tel.: KINGSTON 9450  
Personal callers only  
9 Little Newport Street, London W.C.2 (off Leicester Square)  
Tel.: GERRARD 0576

We pride ourselves that we can obtain and supply any T.V. spare. Please ask us for ANY components you may require we are almost certain to have them.  
TERMS: S.A.E. all inquiries. C.O.D. 3/- extra. C.W.O. Postage on Valves 6d. each. O.R.T.'s 12/6 inc. insurance.  
SATISFACTION ASSURED. Return Post Service.

**PIN-POINT TV TROUBLES IN TEN MINUTES.** The title can be imitated, but the contents never! The book that really tells you how to fix televisions. Over 340 Cross indexed pages. MUST be able to earn you more than its cost within two weeks or your money refunded. Price 63/- incl. postage. Write for free trial to SIM-TECH BOOKS, West End, Southampton, Hants.

**AUDIO.** America's foremost journal. Year's subscription 35/-; specimen copy 4/-. All American radio journals supplied - list free. WILLEN (Dept. 40), 61a Broadway, London E15.

**FIND TV SET TROUBLES IN MINUTES** from that great book "The Principles of TV Receiver Servicing". 10/6 all book houses and radio wholesalers. If not in stock from Secretary, I.P.R.E., 20 Fairfield Rd., London N8.



£8.19.6

30,000 ohms per Volt  
Model 500  
8 Ranges D.C. volts to 1 kV.  
7 Ranges A.C. volts to 1 kV.  
5 Ranges D.C. current to 12 amps.  
3 Range resistance to 60 meg.  
Short circuit buzz test.  
Output meter dB, etc., etc.  
Size 6½ x 4½ x 2½in. With Leads, Batteries and Instructions.



and Instructions. Size 5½ x 3½ x 1½in.

● MODEL ITI-2 as previously advertised £5.5.0.

● CABY MI 54/-.

Full details of all types in our New Catalogue 1/-.

**MODEL TP55**

A.C./D.C. voltage up to 1,000 in 5 ranges, D.C. current 4 ranges up to 500mA. 4 range resistance to 10 megs. Capacity dB scales, etc. 20,000 ohms/volt Fully Guaranteed

£5.19.6

With Test Leads, Battery



49/6

1,000 ohms per volt  
Model PT34

0/10/50/250/500/1,000 volts A.C./D.C. 0/1/100/500 mA D.C. Resistance 0/100k ohm.

Ideal pocket sized multi-tester for all radio and domestic work.

Size 3½ x 2½ x 1½in. with battery, leads and instructions.

All Meters Fully Guaranteed for 6 months. Full Service Facilities.



75/-

2,000 ohms per Volt  
Model THL33

0/10/50/250/500/1,000 volts D.C.

0/10/50/250/500/1,000 volts A.C. 0/500µA/10/250mA., D.C.

Resistance 0/10K/100K/1 Meg Capacity and dB ranges, etc. Size 5 x 3½ x 1½in. with batteries, test leads and instructions.

**A SELECTION FROM OUR STOCKS**

- 1. 2,000 ohm Head Phones ... 12/6
- 4,000 ohm Head Phones ... 14/-
- 1,000 ohm "Amplivox" ... 45/-
- Stereo Phones 2 x 8 ohm ... 29/6
- 2. Make your own printed circuits. Full details with boards, etc.... ... 19/6
- 3. Crystal Microphones (P.P. 1/6).
- Acos 39-1 Stick Microphone ... 32/6
- Acos 40 Desk Microphone ... 15/-
- Acos 45 Hand Microphone ... 25/-
- Lapel/Hand Microphone ... 15/-
- MC 24 Stick Microphone ... 25/-
- 100C Stick with Stand ... 39/6
- BM3 Stick with Stand ... 52/6
- 4. Transistor Megaphone £12.10.0.
- 5. 250 mW 4-Transistor Amplifier, built ready to use ... 52/6 P.P. 1/6
- 6. Complete Test Lead Kits ... 8/6
- 7. Miniature Vernier Dial 8 : 1, reduction marked 0/100 ... 14/-
- 8. 931A Photomultiplier. Brand new with base ... 60/-

**DEAC RECHARGEABLE BATTERIES**

- (a) 18 volt 100 mA 4 x 1in. diameter. Brand new sleeved, 30/-.
- (b) As above but 150 mA, 35/-.
- Both types easily split into any multiple of 1.2 volt. Brand new.

- 9. CV2886 (MRH) Liquid Sampling Geiger Tube, 370 volts. 22/6. P.P. 1/-.
- 10. Antex Miniature Mains Soldering Iron, ¾in. bit. 29/6. P.P. 1/-.
- Pocket Iron with Pouch, 30 watt, 220/250 volt. 18/6. P.P. 1/-.
- 11. Pocket Radio Booster Unit, for any radio. Improves output and quality. 30/-, P.P. 1/-.
- 12. 125 mW 9 volt Sub-min. 3-Transistor Amplifier. 2 x 1 x 1in. 45/-.

**TRANSISTOR PORTABLE SIGNAL GENERATOR**

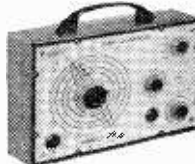

PRICE  
£7.10.0  
P.P. 2/6

A 1st class Signal Generator covering 220 Kc/s to 200 Mc/s in 9 ranges. Radio broadcasts and I.F., Amateur, VHF, Shipping, TV, etc. R.F., I.F., A.F., modulated R.F. outputs. Easy to read and use with full details. Within 2% accuracy. Size 6½ x 4½ x 2in.

**12 MONTHS' GUARANTEE**  
Leaflet on Request.

**RUN YOUR RADIO OR AMPLIFIER FROM MAINS BATTERY ELIMINATORS AND CHARGERS**

- 1. For PP3 or equivalent 9 volt Pocket Radio Battery. 18/6. P.P. 1/-.
- 2. For PP4, PP7, PP9, PP10, 9 volt Portable Radio and Equipment Supplies up to 300 mA. 49/6. P.P. 2/-.
- 3. De Luxe version of No. 1, also charges PP3 type batteries. 29/6. P.P. 1/-.
- 4. Rechargeable PP3 battery. Runs as long as 100 batteries. Complete with charger unit, 25/-, P.P. 1/-.

**METER BARGAINS**

- 50 Microamp 2in. square MC, 35/-.
- 1 mA 2in. square MC, 25/-.
- 1 mA 2½in. Flush Round, 30/-.
- 2½in. Moving Coil double range Voltmeter centre zero. 30-0-30 and 3-0-3 volts. Ideal for transistor tester or voltage measurements. 12/6. Post free.
- 0/500 microamp, 2½in., flush-mounting. D.C. ... 20/-
- 2½-0-2½mA, 2½in. flush. D.C. ... 12/6

**TRANSISTORS, VALVES, QUARTZ CRYSTALS**

We stock the largest range of transistors, valves and quartz crystals and components for the home constructor. Fully detailed and illustrated Catalogue 1/- plus 6d. post.

- 13. Telephone Coil for any amplifier or Recorder, 12/6.
- 14. Crystal Contact Microphone for guitars, etc., 12/6.
- 15. Personal Earphones: 600 ohm 10/6, 1,000 ohm 12/6, Crystal 8/6, 8/10 ohm 9/6. Fitted leads, jack plugs and sockets.
- 16. 2 pole 2 way Miniature Honeywell Micro Switches, 7/6.
- 17. Transistor Baby Alarm, as previously advertised, £5.10.0. P.P. 2/-.
- Also Telephone Amplifier £5.12.0. P.P. 2/-.
- 18. Intercomm., 2-way, 89/6. P.P. 1/6. De Luxe 4-Transistor Version with more power, £7.10.0.
- 19. Miniature Multi-section Telescopic Aerials: 14in. 3/6; 38in. 6/6; 42in. 10/6; 64in. 17/6.
- 20. Miniature 3-Press Button Switches, 6 pole 2-way and on/off, 5/-, P.P. 9d.
- 21. Transistor Signal Injector, 42/6.

**MINIATURE LEDEX SWITCHES**

24 volt D.C. rotating switches, fitted switch at each end of bank of contacts. Uses standard switch wafers.  
● 5 Bank 45/- ● 8 Bank 50/-

- 22. Bin. 15 ohm double cone Hi-Fi Speaker, 92/6.
- Complete range of Speakers stocked.
- 23. 12-way Selector Tube, GS12C (CV1740), 25/- each.
- 24. Tape Deck or Record Player Motor, 9 volt, latest type, 12/6.
- 25. Quartz Fibre Pocket Dosimeters 0/150R and 0/500R, 12/6 each.

**Henry's Radio Ltd**

PADddington 1008/9  
5 HARROW ROAD, LONDON W.2  
Open Monday to Sat: 9-6, Thurs. 1 o'clock

PLEASE TURN TO BACK PAGE

# Practical Wireless

# BLUEPRINT SERVICE

ALL of these blueprints are drawn full-size and although the issues containing descriptions of these sets are now out of print, constructional details are available free with each blueprint except for those marked thus (\*).

Send (preferably) a postal order to cover the cost of the Blueprint (stamps over 6d. unacceptable) to PRACTICAL WIRELESS, Blueprint Dept., George Newnes, Ltd., Tower House, Southampton Street, London W.C.2.

## DOUBLE-SIDED BLUEPRINTS

Each blueprint in this series contains details of two separate instruments or items of equipment.

The Strand Amplifier ... ..	}	*	5/-
The PW Signal Generator ... ..			
The Savoy VHF Tuner ... ..	}	*	5/-
The Mayfair Pre-amplifier ... ..			
The Berkeley Loudspeaker Enclosure ... ..	}	*	5/-
The Luxembourg Tuner ... ..			
The PW Troubadour ... ..	}		7/6
The PW Everest Tuner ... ..			
The PW Britannic Two ... ..	}	*	6/-
The PW Mercury Six ... ..			
The PW Regency ... ..	}	*	5/-
The PW International Short Wave Two ... ..			

## RECEIVERS

The Tutor * ... ..	3/-
The Citizen * ... ..	5/-
Junior Crystal Set ... ..	PW94 2/-
Dual-wave Crystal Diode ... ..	PW95 2/6
Modern One-valver ... ..	PW96 2/6
All-dry Three ... ..	PW97 3/6
Modern Two-valver ... ..	PW98 3/6
A.C. Band-pass Three ... ..	PW99 4/-
A.C. Coronet-4 ... ..	PW100 4/-
A.C./D.C. Coronet ... ..	PW101 4/-
The PW Pocket Superhet ... ..	5/-

## MISCELLANEOUS

The PW 3-speed Autogram ... ..	8/-
The PW Monophonic Electric Organ ... ..	8/-
The PW Roadfarer * ... ..	5/-
The PT Band III TV converter ... ..	1/6
The Mini-amp *... ..	5/-

## SOME EARLIER DESIGNS

THE following blueprints include some pre-war designs and are kept in circulation for those constructors who wish to make use of old components which they may have in their spares box. The majority of the components for these receivers are no longer stocked by retailers.

Experimenter's Short Wave ... ..	PW30a 2/6
Midget Short Wave Two ... ..	PW38a 2/6
Simple S.W. One-valver ... ..	PW88 2/6
Pyramid One-valver ... ..	PW93 2/6
BBC Special One-valver ... ..	AW387 2/6
A One-valver for America ... ..	AW429 2/6
Short-Wave World Beater ... ..	AW436 3/6
Standard Four Valve S.W. ... ..	WM383 3/6
Enthusiast's Power Amplifier ... ..	WM387 3/6
Standard Four Valve ... ..	WM391 3/6
Listener's 5-Watt Amplifier ... ..	WM392 3/6

## QUERY COUPON

This coupon is available until 7th March, 1963, and must accompany all queries in accordance with the notice on our "Letters to the Editor" page.

PRACTICAL WIRELESS, MARCH, 1963

Published on the 7th of each month by GEORGE NEWNES, LIMITED, Tower House, Southampton Street, London, W.C.2. and printed in England by WATMOUGHS LIMITED, Idle, Bradford; and London. Sole Agents for Australia and New Zealand: GORDON & GOTCH (A/asia), Ltd., South Africa and Rhodesia; CENTRAL NEWS AGENCY, LTD. East Africa; EAST AFRICAN STANDARD LTD. Subscription rate including postage for one year: Inland £1.9.0. Abroad £1.7.6 (Canada £1.5.0.). Registered at the General Post Office for the Canadian Magazine Post.

## TO BUILD YOURSELF

★ PRINTED CIRCUIT RADIO DESIGNS ★ ALL PARTS SOLD SEPARATELY ★ FULL AFTER SALES SERVICE AND GUARANTEE ★ FULL DETAILS AND PRICES OF ANY MODEL FREE ON REQUEST

### "CAPRI" POCKET-6 6-TRANSISTOR SUPERHET



Size only  
 $4\frac{1}{2} \times 2\frac{1}{2} \times 1\frac{1}{2}$  in.

**REALLY  
POCKET  
SIZE!**

The most compact 6-transistor and diode radio with speaker available to the home constructor. Features the latest in miniature components and circuitry. Supplied with Mullard transistors and two-tone moulded cabinets in red/white or blue/white with gold fittings. All components are supplied in packets and clearly identified. A printed circuit is used with fully illustrated building instructions. Push-pull output coupled with a sensitive and selective circuit make the "CAPRI" hard to beat. Fitted Earphone/Record Socket. Full tuning on medium waves with long wave Light.

TOTAL COST **£5.19.6** P.P. 2/-

Slip it into your Pocket

### $\frac{3}{4}$ WATT 4 TRANSISTOR AMPLIFIER



- Improved Version
- $1\frac{1}{2}$  watt peak output.
- $\pm 3$ dB 70cs to 12 kc.s.

Output to 3 ohm speaker  
9 volt operated.

Details on request.

Built and Tested	Kit of Parts
<b>59/6</b> OR <b>52/6</b>	
P.P. 1/6	P.P. 1/6

### BATTERY RECORD PLAYERS



- 6- $\frac{1}{2}$  volt Garrard turntable with crystal pick-up. Plays 45 r.p.m. Ideal for above amplifier. 55/- P.P. 1/6.

- Suitable cabinet for amplifier and player, 17/6. P.P. 2/-.

- B.S.R. 9 Volt 4-Speed "Hi-Grade" Turntable with turn-over Crystal Pick-up. £6.5.0. P.P. 2/6.

**44 PAGE  $10\frac{3}{4} \times 7\frac{1}{2}$  in.  
FULLY ILLUSTRATED AND  
DETAILED CATALOGUE  
NOW READY  
SEND 1/- for Your Copy**

**Henry's Radio Ltd.**  
5 HARROW ROAD, LONDON W2

PADDINGTON 1008/9

Open Monday to Sat. 9-6. Thurs. 1 o'clock

← PLEASE TURN PAGE

★ COMPONENT SPECIALISTS

### "CONTESSA" III

#### ★ COMBINED PORTABLE AND CAR RADIO ★

AMAZING SENSITIVITY AND SELECTIVITY ON MEDIUM AND LONG WAVEBANDS

★ The easiest Superhet Radio to build on the market. Features clearly marked printed circuit and packaged components with full illustrated building instructions. Full tuning of medium and long wave bands with unbeatable sensitivity and selectivity. Excellent tone and volume with over 600MV push-pull output.

★ Clearly marked horizontal station dial with slow motion tuning. Two colour Blue or Beige cabinets with Gold handles, grilles and fittings. Size  $10\frac{1}{2} \times 7\frac{1}{2} \times 3\frac{3}{4}$  in.. include car aerial socket, recording sockets.

★ 6-Mullard Transistors and 2-Diodes.  
**Guaranteed the Best Obtainable**

● Attractive Appearance—Reliable Design—Quality Performance ●  
NEW TOTAL COST **£9.19.6** P.P. 3/6

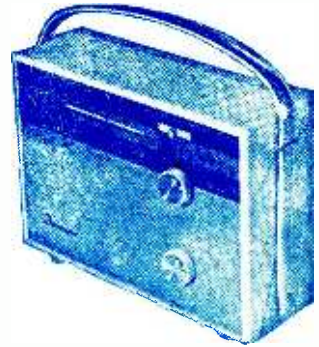

### "MINI-RANGER"

#### PERSONAL POCKET RADIO 3-TRANSISTORS 2-DIODES

Size only  $3 \times 2 \times \frac{3}{4}$  in.

A new printed circuit 5-stage personal pocket radio fully tunable on medium waves and top band, including Radio Luxembourg. A tiny but powerful radio designed to fit into your jacket top pocket. No external aerial or earth. Full station separation with amazing sensitivity and volume. Fully illustrated instructions free on request with clearly marked pre-tinned printed circuit and 1st grade components make this radio Easy to Build and use. Fitted volume control and calibrated dial. All parts sold separately. After sales service and guarantee.

TOTAL COST **59/6** P.P. 1/6



### "QUINTET" Mk. II

#### POCKET RADIO

- Improved 5-transistor with diode 7-stage medium and long wave pocket radio. Now features more output, greater sensitivity and quality. Printed circuit clearly marked with component positions, carded components and matched transistors. Features full volume control, marked dial, airspaced tuning, push-pull speaker output, car aerial socket, phone record socket.
- Guaranteed results, with no station overlap, including Radio Luxembourg. Simple to build with carded components and fully detailed illustrated instructions (free on request).

TOTAL COST OF ALL PARTS **99/6** P.P. 2/-  
Amazing Performance



### 'TRANSFIVE' PORTABLE RADIO

Total Cost of all Parts  
**£5.19.6**  
P.P. 2/6

A 7-stage push-pull output printed circuit portable radio of attractive appearance. Features 5in. speaker, clearly marked printed circuit panel, ferrite aerial, carded components and fully detailed and illustrated building instructions. Size  $8\frac{1}{2} \times 6\frac{1}{2} \times 3\frac{3}{4}$  in.

★ Plans Free on Request ★

### "RANGER 3"

Size  $4\frac{1}{2} \times 3 \times 1\frac{1}{2}$  in.



**59/6** P.P. 1/6

A Three-Transistor Two-Diode Personal Radio for Medium Waves and Amateur top band and shipping. Quality output on personal phone. Fitted air spaced tuner, vol. control. No aerial or earth. Luxembourg guaranteed.

P.W.-6 SUPERHET **£7.19.6** P.P. 2/-  
P.W. "MERCURY" **£9.10.0** P.P. 2/6.  
And all other P.W. Designs.