

R.S.T. VALVE MAIL ORDER CO.

Tel: MITcham 6202
Open Daily to Callers

211a STREATHAM ROAD, MITCHAM, SURREY.

All Valves Brand New and Fully Guaranteed — Obsolete valves a speciality.

Quotations given on any type not listed. Send S.A.E.

Special 24 Hour Express Mail Order Service

AC2/PEN 21/-	ECC85 7/6	EY83 12/6	PCC84 8/6	TDD13C 17/6	UU9 7/6	6AK8 7/6	6P28 12/6	12S17 8/-
AC2/PEN 21/-	ECC88 12/6	EY96 7/6	PCC85 9/6	TH41 27/6	UY1N 12/6	6AL5 4/-	6Q7 9/6	12SK7 6/-
DD 21/-	ECC91 3/-	EZ35 6/-	PCC88 12/6	TY86F 12/6	UY21 15/6	6AM5 5/-	6Q7G 6/6	12SL7 8/-
AC/TP 32/-	ECF82 8/6	EZ40 6/-	PCF80 9/6	UI0 9/6	UY41 7/6	6AM6 4/-	6QGT 8/6	12SN7 10/-
AC/VPI-5-7	ECH3 21/6	EZ41 7/6	PCF82 7/6	UI2 9/6	VM54B 12/6	6AQ5 6/6	6SA7 7/6	12SQ7 8/6
AZ1 15/-	ECH21 21/6	EZ80 6/6	PCF84 12/6	UI4 9/6	VP4 15/-	6AQ8 9/6	6SC7 8/6	14H7 10/-
AZ31 10/-	ECH35 10/6	EZ81 6/6	PCF86 12/6	U22 8/6	VP4A 15/-	6AT6 6/6	6SE 10/6	14S7 10/6
B36 9/6	ECH42 9/6	EZ90 7/6	PCR82 9/6	U24 21/-	VP4B 15/-	6AT6 9/6	6SH7 7/6	14T7 16/6
CIC 10/6	ECH81 8/6	EI148 2/-	PCR83 11/6	U25 12/6	VR105/30 7/6	6BBG 3/-	6SK7 6/6	19AQ5 8/-
CBL31 21/6	ECH83 8/6	FC2 15/-	PCR84 10/6	U26 12/6	VR150/30 7/6	6BE6 6/6	6SK7 5/6	19BGG6 15/-
CCH35 21/-	ECL80 8/6	FC2A 17/6	PCR85 10/6	U31 9/6	W61 11/-	6BG6G 15/-	6SL7GT 6/6	20D2 21/6
CL33 15/-	ECL81 10/6	FC4 15/-	PCR86 12/6	U35 17/6	W76 5/6	6BH6 5/6	6SN7GT 5/6	20F2 17/6
CY1 15/-	ECL83 10/6	FC13 15/-	PEN4A 17/6	U37 17/6	W77 4/6	6B16 6/6	6SUQ 8/6	20L1 24/-
CY31 15/-	ECL86 10/6	FC13C 17/6	PENB4 17/6	U43 8/6	W81 6/6	6BQ7A 12/6	6U4GT 10/6	20P1 15/-
D77 4/-	EF6 21/6	FW4/500 9/6	PEN4DD 24/-	U47 12/6	W81M 6/6	6BR7 10/6	6U5G 7/6	20P3 24/-
DAC32 9/6	EF9 21/6	FW4/800 9/6	PEN4VA 24/-	U50 7/6	X41 15/-	6BS7 12/6	6VG6 4/6	20P4 24/-
DAF91 6/6	EF22 14/6	GZ30 10/6	PEN4VA 17/6	U52 4/6	X61M 10/6	6BW6 8/6	6V6GT 8/6	20P5 24/-
DAF96 8/6	EF36 4/6	GZ32 10/6	PEN36C 20/-	U78 4/6	X65 12/6	6BW7 5/6	6X4 4/6	25A6 8/6
DDC90 12/6	EF37 8/6	GZ33 19/3	PEN45 10/-	U145 10/6	X76 12/6	6C4 3/6	6X5G 6/6	25L6 8/6
DF33 10/-	EF37A 8/6	GZ34 13/6	PEN45DD 25/-	U191 15/6	X76M 12/6	6CSGT 8/6	6XS6GT 8/6	25Y5 8/6
DF91 4/-	EF39 4/6	GZ37 19/3	PEN46 5/-	U251 15/6	X78 24/6	6C6 6/6	6Y30L2 10/6	25Y5G 8/6
DF92 7/2	EF40 15/-	HABCB8610/-	PEN46 5/-	U281 15/6	X79 42/6	6C9 12/6	7B5 12/6	25Z4 7/6
DF96 8/6	EF41 8/6	HL1 8/6	PEN45DD 25/-	U282 19/6	X81 10/6	6CD6G 27/6	7B6 10/6	25Z5 8/6
DF97 11/6	EF42 10/6	HL14DD 8/6	PEN45DD 25/-	U301 22/6	Y61 10/6	6CH6 10/6	7B7 8/6	25Z6 8/6
DH63 6/6	EF50A 3/6	HL92 8/6	PENDD4020 20/-	U301 22/6	Y63 10/6	6D2 4/6	7C5 8/6	27SU 19/6
DH77 7/6	EF50E 3/6	HL133DD 9/6	PENDD4020 20/-	U329 12/6	Z63 7/6	6D6 5/6	7C6 8/6	30C1 9/6
DK32 11/6	EF80 5/6	HN309 26/6	PL33 15/-	U403 10/6	Z66 10/6	6E5 10/6	7D5 15/6	30C15 12/6
DK91 7/3	EF85 5/6	IW4/350 10/6	PL36 12/6	U404 10/6	Z77 4/6	6F1 10/6	7D6 15/6	30F5 10/6
DK92 8/6	EF86 9/6	IW4/500 10/6	PL38 21/6	U801 19/9	Z152 5/6	6F6 6/9	7D8 15/6	30FL1 10/6
DK96 8/6	EF89 9/6	KT33C 8/6	PL81 11/6	UABC80 7/6	OZ4 5/6	6F12 4/6	7H7 7/6	30L1 8/6
DL33 8/6	EF91 4/6	KT36 17/6	PL82 8/6	UAF42 8/6	IC5 10/6	6F14 10/6	7S7 10/6	30L15 11/6
DL35 10/6	EF92 4/6	KT55 17/6	PL83 10/6	UB41 7/6	ID5 8/6	6F15 12/6	7Y4 7/6	30P12 10/6
DL91 8/0	EF95 5/6	KT61 9/6	PL84 8/6	UBC41 8/6	ID6 10/6	6F19 12/6	8D3 4/6	30P16 9/6
DL92 6/6	EF93 10/6	KT66 15/6	PL88 10/6	UBC81 10/6	IHS 9/6	6F23 10/6	9BW6 12/6	30P19 21/-
DL93 7/0	EF183 10/6	KT76 10/6	PL820 18/6	UBF80 8/6	IL4 5/6	6F25 16/6	10C1 12/6	30PL1 - 15/-
DL94 7/6	EF184 10/6	KT81 15/6	PNM24M 13/6	UBF89 7/6	ILN5 4/6	6F26 13/6	10C2 17/6	30PL13 12/6
DL96 8/0	EK32 8/6	LKW61 8/6	PX4 15/-	UBL21 20/-	IN5 9/6	6F33 5/6	10F1 10/6	30PL14 16/6
EA50 2/-	EL2 25/-	L63 5/6	PX25 25/-	UCC84 10/6	IR5 7/3	6H6 2/6	10F3 12/6	35A5 17/6
EABC80 5/-	EL3 21/6	LN152 8/6	PY31 15/-	UCC85 7/6	IS4 8/6	6J5 5/6	10F9 12/6	35L6GT 8/6
EAC91 4/-	EL6 21/6	LN309 11/6	PY32 12/6	UCF80 13/6	IS5 6/6	6J5G 4/6	10DD11 15/-	35W4 7/6
EAF42 9/6	EL32 4/6	LZ319 12/6	PY80 7/6	UCH21 20/-	IT4 4/6	6J5GT 5/6	10P13 15/-	35Z3 16/6
EB34 2/6	EL33 10/6	MKT4 17/6	PY81 7/6	UCH42 9/6	IU5 5/9	6J7 7/6	10P14 19/-	35Z4 7/6
EB41 5/-	EL34 15/-	MS4B 17/6	PY82 7/6	UCH81 8/6	2P 24/9	6J7G 5/6	11D5 23/6	35Z5 8/6
EB91 4/-	EL35 10/6	MVS/PEN 17/6	PY83 8/6	UCL82 10/6	3A4 5/6	6J7GT 7/6	12A6 6/6	40SUA 15/6
EB93 21/-	EL37 17/6	MVS/PEN 17/6	PY88 10/6	UCL83 13/6	3A5 10/6	6K7 7/6	12A8H 9/6	41STH 21/-
EBCC33 4/6	EL33 19/6	MV3/PENB 17/6	PY800 10/6	UF41 7/6	3Q4 8/6	6K7G 2/6	12AT6 7/6	42 12/6
EBCC41 8/6	EL41 10/6	MU14 9/6	PZ30 15/-	UF42 7/6	3Q5 9/6	6K7GT 7/6	12AT7 5/6	50C5 10/6
EBCC81 10/6	EL42 10/6	MX40 15/6	QS95/10 15/-	UF33 7/6	3S4 7/6	6K8 9/6	12AU6 17/6	50CD6G27/6
EBF30 8/6	EL81 12/6	N13 8/6	QS150/15 15/-	UF85 7/6	3V4 7/6	6K8G 5/6	12AU7 5/6	50L6 8/6
EBF83 8/6	EL34 6/9	N37 14/6	R2 10/6	UF86 12/6	3V4 7/6	6K8GT 9/6	12AX7 5/6	53KU 12/6
EBF89 8/6	EL85 10/6	N78 17/6	R3 10/6	UF89 6/6	3V4G 7/6	6K25 18/6	12BA6 7/6	75 8/6
EBL1 21/-	EL90 8/6	N108 15/6	R19 16/6	UL41 8/6	5Y3G 7/6	6L1 10/6	12BE6 7/6	80 7/6
EBL21 21/-	EL91 4/6	N309 20/6	R17 17/6	UL44 20/6	5Y3GT 8/6	6L6 7/6	12CB 8/6	85 9/6
EBL31 21/6	EL95 10/6	N339 30/6	R16 16/6	UL46 14/6	5Z4G 9/6	6L7 10/6	12CGT 8/6	85 17/6
ECC35 8/6	EM80 8/6	N369 10/6	R19 17/6	UL84 7/6	5Z4GT 12/6	6L8 10/6	12S5GT 4/6	85A2 12/6
ECC40 15/-	EM81 8/6	OD3 5/6	R20 16/6	UL85 7/6	6A7 9/6	6L19 15/6	12J7GT 8/6	185BT 30/6
ECC81 5/-	EM84 9/6	OZ4 5/6	SP41 3/6	UM30 10/6	6A3G 8/6	6L34 9/6	12K7GT 5/6	305 13/6
ECC82 5/-	EM85 10/6	P2 10/6	SP61 3/6	URIC 15/-	6AC3GT 13/6	6L7GT 9/6	12K8GT 10/6	80B7 5/6
ECC83 7/6	EY51 8/6	PABC80 13/-	T41 15/6	UU6 17/6	6AC7 6/6	6N7GT 9/6	12Q7GT 6/6	807A 6/6
ECC84 8/6	EY61 8/6		TDD4 12/6	UU8 15/6	6A65 5/6	6P25 10/6	12SA7 8/6	

METAL RECTIFIERS

RM1 5/3	14A86 17/6	16RD-2-2-8-1 12/-
RM2 7/6	14A97 25/-	16RE 2-1-8-1 8/6
RM3 7/9	14A100 27/-	18RA 1-1-8-1 4/6
RM4 14/-	14RA 1-2-8-2 17/6 (FC301)	18RA 1-1-16-1 6/6 (FC116)
RM5 19/6	14RA 1-2-8-3 19/- (FC31)	18RA 1-2-8-1 11/-
	16RC 1-1-16-1 8/6	18RD 2-2-8-1 15/- (FC124)

TRANSISTOR BARGAINS

OC44 6/-	OC75 6/-	OC82 8/-
OC45 7/-	OC77 6/-	OC82D 8/-
OC71 5/-	OC81 6/-	
OC74 6/-	OC81D 6/-	

SILICON RECTIFIERS

400 volts 350 mA ... 12/6 each

SETS OF VALVES

IR5, IS5, IT4, 3S4, 3V4 ...	Set of 4, 19/6
DAF91, DF91, DK91, DL92, DL94 ...	Set of 4, 19/6
DAF96, DF96, DK96, DL96 ...	Set of 4, 27/6

TERMS OF BUSINESS C.W.O. OR C.O.D.

3/2 PACKING CHARGE ON ALL C.O.D.

ORDERS. POSTAGE 6d. per VALVE

Sterns

MULLARD DESIGNS COMPLETE KITS OF PARTS

MULLARD "5-10" MAIN AMPLIFIER

For use with MULLARD 2-stage pre-amplifier with which an undistorted power output of up to 10 watts is obtained. SPECIFIED COMPONENTS AND MULLARD VALVES including PARMEKO MAINS TRANSFORMER and choice of PARMEKO or PARTRIDGE Output Transformer.

COMPLETE KIT (Parmeko Output Trans.) **£10.00**
ASSEMBLED AND TESTED **£11.10**

ABOVE incorporating PARTRIDGE OUTPUT TRANS. £1.6.0 extra.

THE MULLARD 510/RG AMPLIFIER

The popular complete "5-10" incorporating Control Unit providing up to 10 watts high quality reproduction. Specified components and new MULLARD VALVES. Includes PARMEKO MAINS TRANSFORMERS and choice of PARMEKO or PARTRIDGE Output Transformers.

COMPLETE KIT Dep. £2.6.0 **£11.10.0** 12 mths. 17/-
ASSEMBLED AND TESTED **£13.10.0** with PARTRIDGE OUTPUT TRANS. £1.6.0 ex.

THE MULLARD 33/RG

A HIGH QUALITY AMPLIFIER DEVELOPED FROM THE VERY POPULAR 3-WATT MULLARD "3-3" DESIGN.

KIT OF PARTS **£7.10.0**
ASSEMBLED AND TESTED **£8.19.6**

Complete to the MULLARD specification including PARMEKO OUTPUT TRANSFORMER. Switched inputs for 75 and 150V. records plus a Radio position. Extra power to drive a Radio Tuning Unit is also available.

THE "MONO-GRAM"

A small Amplifier of genuine high quality performance. Incorporates new MULLARD ECL86 Valve. separate BASS and TREBLE controls and produces up to 3 watts undistorted output.

KIT OF PARTS **£4.5.0** Assembled and Tested **£4.19.6**

Perfectly suited for Portable Installations for which purpose we offer PORTABLE CASE (£3.10.0), the AMPLIFIER (KIT) and 8" x 5" SPEAKER (£1.0.0).

Alternatively with ASSEMBLED AMPLIFIER **£9.0.0**

The Case quoted above will accommodate some 4-speed Single Record Units. A larger model is available for extra 10/-. With this Equipment a COMPLETE PORTABLE RECORD PLAYER can be built for **£13.10.0**

MULLARD FOUR CHANNEL MIXING UNIT

Self powered Cathode follower output. Incorporates two inputs for CRYSTAL MICROPHONES, one for CRYSTAL PICK-UPS and a fourth for Radio or Tape.

KIT OF PARTS **£8.8.0** ASSEMBLED AND TESTED **£10.0.0**
Alternative Model I/L provides for one input matched for moving coil or ribbon mike **£11.7.0** extra.

!! SENSATIONAL BARGAINS !!

A BULK PURCHASE ENABLES US TO OFFER THESE TWO GRUNDIG MODELS AT APPROX. HALF PRICE. Each are Fully Guaranteed.

THE GRUNDIG "MINI-BOY"

THE "LITTLE" SET with "BIG" PERFORMANCE
LIST PRICE IS **£26.5.0**

OUR PRICE ONLY **£10.10.0**

INCLUDING SPEAKER ENCLOSURE
A six Transistor (plus two Diodes) Portable covering the Medium Waveband. Small enough to slip into Handbag or Pocket (4" x 2" x 1") but when at home "big set" performance is obtained simply by slipping the set into the companion Speaker Enclosure (size 9" x 9" x 11").

GRUNDIG T.M.60 TAPE UNIT

For Stereophonic or Monophonic Operation. Beautifully Styled with Finger Tip Controls. Consisting of Tape Deck incorporating High Quality Pre-amplifier. List Price is **£94.10.0**

PRICE ONLY **£49.10.0**
Deposit **£9.18.8** and 12 months at **£3.15.10**

A completely self contained, self powered Unit designed to add full TAPE RECORDING facilities to existing sound reproducing equipment. Will operate with the majority of high quality audio installations and ideally suited for our MULLARD AMPLIFIERS. When ordering please state the make and type of Amplifier or Radiogram to be used with the Unit.

MULLARD'S 2-VALVE PRE-AMPLIFIER TONE CONTROL UNIT

Employing two EF88 valves and designed to operate with the Mullard MAIN AMPLIFIER but also perfectly suitable for other makes.

* Equalisation for the latest R.I.A.A. characteristics.
* Input for Crystal Pick-ups and variable reluctance magnetic types.

* Input (a) Direct from High Imp. Tape Head, (b) From a Tape Amplifier or Pre-Amp.
* Sensitive Microphone Channel. * Wide range BASS and TREBLE Controls.

KIT OF PARTS **£6.6.0** ASSEMBLED AND TESTED **£8.0.0**

PRICE REDUCTIONS

(a) THE KIT OF PARTS to build both the "5-10" Main Amplifier and the 3-Stage Pre-Amplifier Deposit **£3.7.0** and 12 months at **£1.2.9**

(b) The "5-10" and the 3-Stage Pre-Amplifier both Assembled and Tested **£18.18.0**
Deposit **£3.16.0** and 12 months at **£1.7.8**.
With PARTRIDGE OUTPUT TRANSFORMER **£1.6.0** extra.

HIGH FIDELITY LOUDSPEAKERS

WE STOCK THE COMPLETE RANGE by GOODMANS, WHARFEDALE and W.B. STENTORIAN. A few recommended examples

8 INCH TYPES	
GOODMANS "AXIETTE"	£5.17.7
W.B. HF 816	£8.13.9
WHARFEDALE "SUPER 8/RS/DD"	£7.9.5
10 INCH TYPES	
GOODMANS "AXIOM 10"	£7.0.0
W.B. MODEL HF 1016	£7.18.0
WHARFEDALE "GOLDEN 10/RS/DD"	£8.15.5
12 INCH TYPES	
GOODMANS "AXIOM 20" 15 watts	£10.7.0
GOODMANS "AXIOM 30" 20 watts	£14.10.0
W.B. MODEL HF 1214 15 watts	£10.5.8
WHARFEDALE "W12/RS"	£10.10.0
WHARFEDALE "Super 12/RS/DD"	£17.10.0

LEAK AND QUAD AMPLIFIERS ARE IN STOCK

LEAK "TL/12 PLUS" POWER AMPLIFIER with the "POINT ONE PLUS" PRE-AMPLIFIER, 14 watts rated output. **£31.10.0**

LEAK "TL/25 PLUS" with the "POINT ONE PLUS" PREAMPLIFIER, 28 watts rated output. **£37.16.0**

LEAK "STEREO 20" POWER AMPLIFIER with the "VARISLOPESTEREO" PREAMPLIFIER, 22 watts (11 watts per channel) **£55.9.0**

QUAD II POWER AMPLIFIER with QUAD II CONTROL UNIT, 15 watts output. **£42.0.0**

RECORD PLAYERS

THE COLLARO "JUNIOR" 4-speed single player with separate crystal pick-up. **£3.15.0**

THE NEW GARRARD "AUTOSLIM" 4-speed Autochanger with crystal pick-up. **£8.10.0**

GARRARD "AUTOSLIM DE LUXE" 4-speed Autochanger, incorporates transcription Pick-up Arm. **£12.14.6**

THE COLLARO "C60" 4-speed autochanger unit with Studio "O" pick-up. **£7.19.6**

R.S.R. Model UA14, a 4-speed Mixer Autochanger with crystal pick-up. **£7.19.6**

The new GARRARD Model SHF High Quality Single Record Player fitted with the latest T.P.A. 12 pick-up arm and G.C.S. crystal Cart-ridge. **£18.19.0**

GARRARD Model S.R.P. 10 Single Record Player fitted with high output crystal pick-up. **£6.6.0**

PHILIPS Model AG1016, a 4-speed Player which can be operated both manually and automatically. Suitable for Mono or Stereo operation. Carr. and Ins. on each above 5/- extra. **£13.13.0**

!! HOME CONSTRUCTORS !!

A Range of "Easy to Assemble" Prefabricated Cabinets

Designed by the W.B. "STENTORIAN" COMPANY for "Hi-Fi" Loudspeaker systems or to accommodate high quality equipment. FULL RANGE IN STOCK, please enclose S.A.E. for descriptive leaflets.

IF YOU ARE PLANNING TO INSTALL "HI-FI" AND UNCERTAIN OF THE TYPE OF EQUIPMENT TO USE—OUR WIDELY EXPERIENCED TECHNICAL STAFF WILL WITH PLEASURE PUT FORWARD RECOMMENDATIONS—STATE TYPE OF INSTALLATION CONTEMPLATED AND APPROX. PRICE LEVEL.

HIRE PURCHASE TERMS are available on all Equipment over £10.0.0.

FULLY DESCRIPTIVE LEAFLETS are readily available—please enclose S.A.E.

Stern's

SPECIALISTS IN SOUND EQUIPMENT FOR OVER 25 YEARS

TAPE RECORDING EQUIPMENT

STEREO TAPE PRE-AMPLIFIER

MODEL STP-1. For use with current TRUVOX, BRENNELL, or COLLARO "STUDIO" 1 and 1 track Stereo Decks Incorporates Ferroxcube Oscillator, 4 speed Equalisation Signal Level Meter and separate Gain Controls. Includes separate Power Unit.
KIT OF PARTS **£22.00**



ASSEMBLED **£28.00**

MULLARD'S TYPE "C" TAPE PRE-AMPLIFIER

Suitable for most 1 track Mono Tape Decks. Incorporates Ferroxcube Push Pull Oscillator and 3 Speed Treble Inductor. Includes separate Power Unit.
KIT OF PARTS **£14.00**



ASSEMBLED **£17.00**

MULLARD'S TAPE AMPLIFIER

MODEL HF/TR3 Based on Mullard's Type "A" design and suitable for most 1 track Mono Tape Decks. Incorporates Ferroxcube 3 speed Treble Inductor and Gilson Output Transformer. Includes separate Power Unit.
KIT OF PARTS **£13.10**



ASSEMBLED **£17.00**

STERN'S "ADD-A-DECK"

A self contained Unit consisting of Garrard Deck and matched Preamplifier on one chassis. Provides full tape recording facilities and replays through Pick Up Sockets or standard Radio receiver or Amplifier.
PRICE includes Spool of Tape **£18.80**

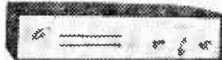

TUDOR AM/FM TUNING UNIT

A SELF-POWERED HIGH FIDELITY TUNER OF OUTSTANDING DESIGN. PROVIDES FULL COVERAGE OF THE VHF/FM TRANSMISSION AND ALSO THE LONG AND MEDIUM WAVEBANDS PRICE ONLY **£19.10** Deposit £4 and 12 months £19.4

Operates perfectly with the STERN-MULLARD AMPLIFIERS and contains matching FRONT PANEL in Black/Gold or White/Black. Also operates equally well with any Amplifier requiring input of 100 to 350 mV/olts.

Mk. II "Fidelity" FM TUNING UNIT An attractively Presented Unit incorporating MULLARD PERMEABILITY TUNING HEART and corresponding Mullard valve line-up. Very suitable to operate with our Mullard Amplifiers.

KIT OF PARTS **£10.10**
ASSEMBLED AND TESTED **£14.50**

ARMSTRONG RADIOGRAM CHASSIS

We have the full range in stock . . . Prices range from **£22.80**
Full details are readily available



THE "TUDOR" STEREO AMPLIFIER

PRICE **£18.80**

A self contained Amplifier designed to provide high quality stereophonic and monophonic reproduction. Each channel provides a rated output of 6 watts and for monophonic operation approx. 12 watts is produced. Separate BASS and TREBLE CONTROLS.

POSTAL ENQUIRIES and MAIL ORDERS TO
STERN RADIO LTD.
6-12, TUDOR PLACE, TOTTENHAM COURT RD.
LONDON, W1. TEL. MUSEUM 6128/9

DEMONSTRATION and SHOWROOMS AT
STERN RADIO LTD.
109, FLEET ST. LONDON, EC4
TEL. FLEET ST. 5812/3
OPEN...9 a.m. to 6 p.m. SAT. close 1 p.m.

DEMONSTRATION and SHOWROOMS AT
PREMIER RADIO
23, TOTTENHAM COURT RD.
LONDON, W1. TEL. MUSEUM 6128/9
OPEN...9 a.m. to 6 p.m. THURS. close 1 p.m.

COMBINED PRICE OFFERS

- STP-1 (Kit) and "STUDIO" Deck **£35.00**
- STP-1 (Assembled "STUDIO" Deck)..... **£45.00**
- STP-1 (Kit) and Brenell Deck..... **£61.00**
- STP-1 (Assembled) and Brenell Deck **£67.00**
- STP-1 (Kit) and Truvox Deck **£48.00**
- STP-1 (Assembled) and Truvox Deck **£54.00**

COMBINED PRICE OFFERS

- TYPE "C" (Kit) and "STUDIO" Deck **£26.10.0** Assembled **£29.10.0**
- TYPE "C" (Kit) and BRENNELL Deck **£43.0.0** Assembled **£46.0.0**
- TYPE "C" (Kit) and TRUVOX D82 Deck **£39.10.0** Assembled **£43.0.0**
- TYPE "C" Assembled and Wearite Deck **£60.10.0** Inc. Head Lift Trans.

COMBINED PRICE OFFERS

- HF/TR3 (Kit) and "STUDIO" Deck **£26.0.0** Assembled **£29.10.0**
 - HF/TR3 (Kit) and BRENNELL Deck **£42.0.0** Assembled **£45.10.0**
 - HF/TR3 Assembled and Wearite Deck **£60.10.0** Inc. Head Lift Trans.
- To build a complete TAPE RECORDER we offer HF/TR3 AMPLIFIER, STUDIO DECK, PORTABLE CASE, ROLA 10 x 6in. SPEAKER, MICROPHONE and 1,200ft. TAPE ALL FOR **£35.0.0**.

Stereo Amplifiers

MULLARD'S "10+10" STEREO AMPLIFIER

A high fidelity design providing up to 10 watts per channel. Superior reproduction frequency response flat to within 3db from 3 c/s to 60 Kc/s at 50 mW Total Harmonic Distortion at 10 watts 0.1%
Price (a) ASSEMBLED AMPLIFIER (as illustrated) **£21.00**
£18.10.0



- (b) KIT OF PARTS..... **£26.0.0**
- Built to the highest technical standards and presented strictly to MULLARD'S specification. Two specially designed GILSON OUTPUT TRANSFORMERS with 20% taps are used. We can also supply the ASSEMBLED MAIN AMPLIFIER only for operation with our DUAL CHANNEL PRE-AMPLIFIER; this provides a more versatile installation and is essential if a low output Magnetic Pick-up is to be used. When ordering specify loudspeaker impedance.
- (a) THE ASSEMBLED MAIN AMPLIFIER and ASSEMBLED DUAL CHANNEL PRE-AMP..... **£30.0.0**
 - (b) KIT OF PARTS for both Units..... **£26.0.0**

THE "TWIN THREE" STEREO AMPLIFIER

ASSEMBLED AND TESTED **£7.15.0**
(Carriage and Insurance 7/6 extra)



Based on a recent design by MULLARD LTD., is ideally suited for use in PORTABLE RECORD PLAYERS for which purpose we offer a specially designed Case. Incorporates MULLARD ECL 86 Valves, separate BASS and TREBLE CONTROLS and produces up to 3 watts per channel. Frequency response is 40 c/s to 30 Kc/s, size is only 11 1/2 in. x 3 in. x 5 in. To construct a STEREO PORTABLE RECORD PLAYER we offer: ASSEMBLED AMPLIFIER with two ROLA 8 in. x 5 in. LOUD-SPEAKERS and PORTABLE CASE for **£16.0.0**

MULLARD DUAL-CHANNEL PRE-AMPLIFIER

A four Valve design for both STEREO-PHONIC and MONOPHONIC operation. Operates equally well with any make of Amplifier requiring an input of up to 250 mV.
KIT OF PARTS **£12.10.0**



ASSEMBLED AND TESTED **£15.0.0**

H.P. ON ALL EQUIPMENT OVER £10

RETURN-OF-POST SERVICE

We offer a really efficient Mail Order Service on all items stocked. All cash orders are dealt with on the day of receipt.

★ Hire purchase orders are subject to slight delay but this is kept to the absolute minimum.

TRANSISTORISE YOUR CRYSTAL SET

We have two new designs for Transistor amplifiers which can be used to greatly improve the signal from any crystal set. RLD4 Kit, one stage 12/-; RLD5 Kit, two stage 21/-; both post free. The kits are easy to build and very detailed instructions are supplied. Leaflet available.

NEW MULLARD CONDENSERS

We now stock the following range of the new Mullard Miniature Foil and Polyester condensers as used in the latest TV and Transistor sets. Fully detailed list available giving full technical information and dimensions.

Miniature Foil. 30 volt working for Transistor sets. .01mf 74d.; .022mf, 94d.; .047mf, 9d.; .1mf, 13d.
Polyester Tubular Capacitors. Moulded outer case designed to withstand accidental contact with the soldering iron. Tolerance 10%. 125v. range: .01mf, .022mf, .047mf, all 9d. each. .1mf, 1/2; .22mf, 1/3; .47mf, 1/6; 1mf, 3/-
 400v. range: .01mf, .022mf, .047mf, .1mf, .22mf, all 9d. each. .47mf, 1/2; .1mf, 1/3; .22mf, 1/6; .47mf, 2/5; Postage extra.

TAPE RECORDING EQUIPMENT

ALL CARRIAGE FREE	Cash Price	Deposit	Hire Purchase Mthly/Pmnts.
B.S.R. TD	£8.18.6	£1.16.6	12 of 13/7
Latest COLLARO Studio	£10.6	£2.3.8	12 of 16/4

TAPE AMPLIFIERS
 We now stock the Martin Recorder Kits. These are partly assembled kits for complete tape recorders. The Amplifier Printed Circuit panels are completely wired, but the assembly of this and external components is left to the constructor. Very complete instructions are supplied. Send for leaflet.

MODEL C for Collaro Studio Deck, £11.11.0.
MODEL B for BSR TD2 Deck, £8.8.0.
CARRYING CASES. Smart carrying cases are available to take the above amplifiers and decks. Fitted with speaker. For Model C Amplifier and Collaro Deck, £5.5.0. For Model B Amplifier and BSR Deck, £4.4.0. H.P. Terms available for amplifiers, cases and decks.

TAPE PRE-AMPLIFIERS
 MULLARD TAPE C PRE-AMPLIFIER. We stock complete kits and all components. Send for list.
MARTIN. Pre-amp kit for Collaro Studio Deck, £8.8.0.

"BRAND FIVE" RECORDING TAPE

Long Play: 900ft. (5"). 18/6; 1200ft. (5 1/2"), 23/6; 1800ft. (7"). 35/-.

JASON F.M. TUNER KITS

Kits supplied complete with every item needed including instruction manuals. Fully detailed list available. Separate items supplied, ask for price list. H.P. Terms available on any kit.
FMT1, £6.12.6; FMT2 (less power), £7.15.0.
FMT2 (with power), £9.12.6; FMT3 (less power), £9.9.0.
FMT3 (with power), £11.7.6; Mercury 2, £10.14.6.
 JTV2: £14.12.6.

ILLUSTRATED LISTS

Illustrated lists are available on LOUDSPEAKERS, TAPE DECKS, TEST GEAR, GRAMOPHONE EQUIPMENT, AMPLIFIERS. Any will be sent free upon request.

STEREO COMPONENTS

Morganite ganged potentiometers as specified for the Mullard circuits. ● Low/Anti-Log, 500k, 1 meg., 2 meg. ● Log/Log, 50k, 250k, 1 meg., 2 meg. ● Lin/Lin 250k, 500k, 1 meg. All 10/6 each.

TRANSISTORS

MULLARD. Reduced prices. Current production types, not rejects. All in "movers" boxes. Postage 3d. on each.
 OC44, 8/3; OC45, 9/-; OC70 and OC71, 6/6; OC72, 8/-; OC72 Matched Pairs 18/-; OC78, 8/-; OC81, 8/-; OC170, 9/6; OC171, 10/6.

AMPLIFIER KITS

We have full stocks of all components for the Mullard 510, Mullard 3-3, Mullard 2 and 3 Valve Pre-amp, Mullard Stereo, Mullard Mixer, GEC 912 Plus. Fully detailed list on any of these sent upon request.
 Instructional Manuals: All Mullard Audio Circuits in "Circuits for Audio Amplifiers", 9/5. GEC912, 4/6. All post free.

TERMS OF BUSINESS

Cash with order or C.O.D. We charge C.O.D. orders as follows: Up to £3, minimum of 3/2. Over £3 and under £5, 1/6. Over £5 and under £10, 1/8. Over £10, no charge. Postage extra on CASH orders under £3 except where stated. Postage extra on overseas orders irrespective of price.

MARTIN STEREO AMPLIFIER KITS

Printed circuit, already wired and tested. Only requires wiring to mains and output transformers. Complete kit with plastic cabinet, escutcheon and full instructions. £6.6.0.

GRAMOPHONE EQUIPMENT

ALL LATEST MODELS	Cash Price	Deposit	Hire Purchase Mthly/Pmnts.
ALL POST FREE			
RECORD CHANGERS			
GARRARD AUTOSLIM	£7.19.6	£1.12.8	12 of 12/3
GARRARD AUTOSLIM			
De-luxe (Mono PU)	£12.14.8	£2.11.8	12 of 18/8
GARRARD AUTOSLIM			
De-luxe (Stereo/MONO PU)	£13.12.9	£2.14.9	12 of 20/-
B.S.R. UA4 (TC8 Mono PU)		£1.12.6	12 of 12/1
B.S.R. UA4 Monarca (TC8 Stereo/LP78)	£8.17.8	£1.16.6	12 of 13/5
SINGLE RECORD PLAYERS			
B.S.R. TU2 (TC8 Mono PU)	£4.5.0	£1.5.0	3 of £1.3.4
B.S.R. GU7 (TC8 Mono PU)	£5.11.8	£1.13.8	3 of £1.10.4
TRANSCRIPTION UNITS			
GARRARD 4HF (GC8 PU)	£17.19.6	£3.11.6	12 of £1.6.5
PHILIPS AG104	£13.13.0	£2.15.0	12 of £1.0.0

Many of the above can be supplied for stereo working. See our Gramophone Equipment List for details.

LOUDSPEAKERS

GOODMAN Acoustic 3in. £5.17.7; Acium 10in. £7.0.0; 12in. £10.20.1; £10.7.0; 12in. Acium £11.4.0; 12in. Audium 51 Bass, £8.14.0; 12in. Audium 61 Bass, £13.14.0; Trebax Tweeter, £6.4.0; X65000 Crossover unit, £1.19.0.
WHITELEY: HF1016 10in., £7.16.0; HF1012 10in., £4.17.6; HF816 8in., £6.13.9; TS16 8in., £6.6.9; T10 Tweeter, £4.8.3; T35 Tweeter, £1.4.0; CX3000 Crossover unit, £1.11.6; CX1500 Crossover unit, £2.0.0. H.P. Terms available on all speakers.

P.W. STRAND, MAYFAIR & SAVOY UNITS

We stock parts for the P.W. Strand Amplifier, Mayfair Pre-amplifier and Savoy FM Tuner. Detailed price lists are available.

"P.W. MERCURY"

P.W. Mercury. (Osmor printed circuit version), including Mullard first grade transistors and instructions manual. Complete set of parts £9.19.6. Instruction manual available separately at 2/6 post free. Separate components supplied. Send for list.

LATEST TEST METERS

	Cash Price	Deposit	Hire Purchase Mthly/Pmnts.
AVO Model 8 Mark II	£24. 0.0	£4.16.0	12 of £1.15. 2
AVO Model 8 with leather carrying case	£27.18.0	£5.12.0	12 of £2. 0.11
AVO Model 7 Mark II	£21. 0.0	£4. 4.0	12 of £1.10.10
AVO Multimeter	£9.10.0	£1.19.0	12 of 14/4
AVO Multimeter with leather carrying case	£11. 9.0	£2. 5.0	12 of 17/-
TALEOR MODEL 157A	£15.10.0	£2. 2.0	12 of 15/8
CARY A-10	£4.17.8	£1. 7.6	3 of £1. 6.8
CARY B-20	£6.10.0	£2. 0.0	3 of £1.13.4
CARY M-1	£2.14.0		

Full details of any of the above supplied free on request. The AVO Models 7 and 8 are both latest models from current production—not to be confused with Government Surplus.

OUTPUT TRANSFORMERS

GILSON: W0696A, W0696B, 50/6, post 2/6. W0710, 55/6, post 2/6. W0832, 62/3, post free; W0767, 27/-; post 1/8. W01796A, 57/6, post 2/6. W01932, 94/-, post free.
PARTRIDGE: P3667, 75/-; P4131, 65/-; P5202, P5203, £5.18.6. All post free.
PARMEKO: P2629, 45/6; P2642, 43/3; P2643, 45/6. All plus post 2/9. P2611, 28/3, post 2/-; P2628, 15/3, post 2/-; P2632, 39/3, post 2/6.
ELSTONE: OT/ML, 45/-, post 2/9; OT/3, 25/-, post 2/6.

MAINS TRANSFORMERS

GILSON: W0741AB, 63/-, post free; W0839, 48/6, post 2/9; W01328, 58/6, post 3/6; W01288, 55/-, post 3/6; W01566, 80/-, post free; W01341, Choke, 36/-, post 2/6.
PARTRIDGE: P2631, 33/9, post 2/9; P2630, 52/6, post 3/3; P2644, 73/8, post free; P2930, 39/3, post 3/-; P2631, 54/6, post 3/3.
ELSTONE: MT/MU, 45/-, post 3/3; MT/3M, 35/-, post 3/-; MT/610, 42/-, post 3/3.

WATTS RADIO

(MAIL ORDER) LTD.

54 CHURCH ST., WEYBRIDGE, SURREY

Telephone: Weybridge 47556

Please note: Postal business only from this address

HIRE PURCHASE TERMS

are available on any item. Repayments may be spread over 3, 6 or 12 months. Details as follows: Three months: Deposit 6/- in the £. Service charge 5 per cent, but minimum charge of 10/-; Six and Twelve months: Deposit 4/- in the £. Service charge 10 per cent, but minimum charge 20/-.

INCREASE YOUR KNOWLEDGE

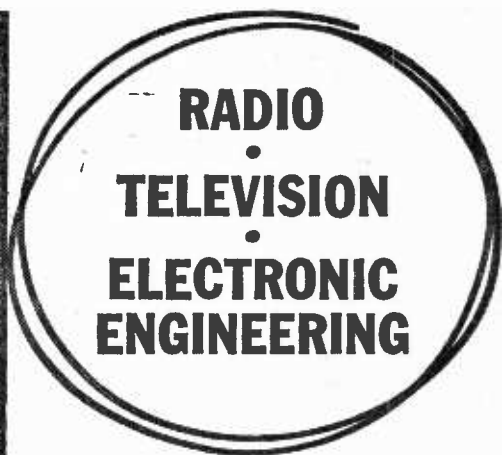

MEMBER OF THE ASSOCIATION
OF BRITISH CORRESPONDENCE COLLEGES

CHOOSE THE RIGHT COURSE FROM:

RADIO AND TELEVISION ENGINEERING, INDUSTRIAL TELEVISION, RADIO AND TELEVISION SERVICING, RADIO SERVICE AND SALES, VHF/FM ENGINEERING, ELECTRONICS, COMPUTERS AND PROGRAMMING, ELECTRONIC TECHNICIANS, SERVOMECHANISMS, TELEMETRY, COLOUR TV, INSTRUMENTATION, AND PRINCIPLES OF AUTOMATION.

ALSO EXAMINATION COURSES FOR:

A.M.Brit.I.R.E.; City and Guilds Telecom. Technicians, C. & G. Radio and T.V. Servicing (R.T.E.B.), and P.M.G.'s Certificates. C. & G. Radio Amateurs' Certificates.

LEARN AS YOU BUILD

Practical Radio Courses: Gain a sound knowledge of Radio as you build YOUR OWN 5-valve superhet radio receiver, Signal Generator and High-quality Multitester. At the end of the course you have three pieces of permanent and practical equipment and a fund of personal knowledge and skill. ICS Practical Radio Course opens a new world to the keen Radio amateur.

THERE IS AN ICS COURSE FOR YOU

Whether you need a basic grounding, tuition to complete your technical qualifications, or further specialised knowledge, ICS help you with a course individually adapted to your requirements.

There is a place for you among the fully-trained men. They are the highly paid men—the men of the future. If you want to get to the top, or to succeed in your own business, put your technical training in our experienced hands.

ICS Courses are written in clear, simple and direct language, fully illustrated and specially edited to facilitate individual home study. You will learn in the comfort of your own home—at your own speed. The unique ICS teaching method embodies the teacher in the text; it combines expert practical experience with clearly explained theoretical training. Let ICS help you to develop your ambitions and ensure a successful future. Invest in your own capabilities.

FILL IN AND POST THIS COUPON TODAY

You will receive the FREE ICS Prospectus listing the examinations and ICS technical course in radio, television and electronics, PLUS details of over 150 specialised subjects.

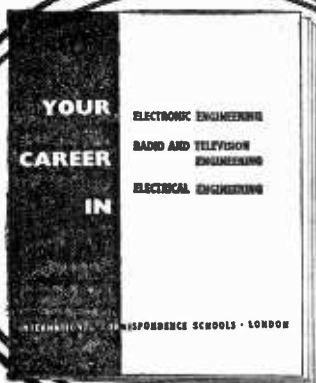

PLEASE SEND FREE BOOK ON _____

NAME _____

ADDRESS _____

OCCUPATION _____ AGE _____

INTERNATIONAL CORRESPONDENCE SCHOOLS
Dept. 170, INTERTEXT HOUSE, PARKGATE RD, London SW11
2.63

Luxembourg is guaranteed also A.F.N., plus dozens of other Continental programmes. The Complete novice will build this set in 3 hours and it will work and its volume will astound you. This kit was specially flown to Europe by Boeing 707 jet for testing and it never failed to pick up programmes anywhere.



ROPE IN LUXEMBOURG! LIKE THE LIGHT PROGRAMME WITH THE FANTASTIC TWIN WAVE BAND **PARISIENNE!!**

A SUPERB POCKET TRANSISTOR

Note:—These star items, starred because they are above any other kit available.

- ★ Elegant dial graduated long and M waves.
- ★ Built in wave change switch not preset.
- ★ Printed circuit for easy assembly.
- ★ "S" ferrite rod aerial.
- ★ Earphone if required, 5/- extra.
- ★ Choice of colour red blue or cream.
- ★ Chrome carrying handle.
- ★ British 3" moving coil speaker.
- ★ Brand new components.
- ★ Best Mullard and Newmarket transistors.

A fully illustrated 30 page booklet, complete with step-by-step assembly instructions and all other data, comes to you for only 2/9 extra; PP4 press-stud type battery 2/3; post and packing on the lot 2/6.

This amazing little set for home or car
HAS TO BE HEARD TO BE BELIEVED
We will supply **ALL** components at a
total cost of only
YOU CAN'T GO WRONG !

£3.19.6 !!!

SO GET WITH IT !!
and build yourself this superb little set NOW
**PUT THE WORLD IN
YOUR POCKET**

Second-to-none after sales service and all your components factory new, plainly marked and fully guaranteed.

SHORT WAVE SECTION

Transmitter Receiver No. 22 as 19 set but 2-12 Megs. Complete with power pack, but used condition, 75/-. Carr. 10/-.

RI09 Receivers, Latest Gov't. Release. Brand new, in original crates, 2-12 meg. Cost £60 to manufacture, our price £5.19.6. Built in phones, speaker and sockets, etc., 6V D.C. input, ready to use, Carr. 10/-.

Mine Detectors—all types of metal, magnetic or non magnetic using modern B7G valves, complete, with search coils, haversack, phones, all in original government packing, £2.5.0., Battery 8/6. Carriage 10/-.

Aluminium Field Tripods, brand new, fully adjustable, suit telescopes, etc. Money back if not satisfied. 29/6. P.P. 6/-.

Moving Coil Mikes (Dynamic) ex Gov't. New, guaranteed 25/-. P.P. 2/6. Hand or stick type.

High Resis. Phones, new, 13/6, P.P. 2/-.

ALL COMPONENTS SUPPLIED
SEPARATELY IF REQUIRED

THIS IS THE FINEST BARGAIN
EVER OFFERED ON MAIL
ORDER

A Seven Transistor. Long, Med. wave superhet, by well known manufacturer. Size only 4 x 3 x 1in. Absolutely complete and tested, less makers case but with leather cloth cover. The most compact set you have seen made like a watch. Money back guarantee. Price £5.12.6. P.P. 2/6. Personal earphones, 7/- extra.

TRADE ENQUIRIES WELCOMED
USUAL DISCOUNT ON ANY LINES

Transistor Soldering Irons, 9/6, 17/6, 22/6, 29/6. P.P. on each 1/6.

Dynamic Mike Inserts. 1/2 x 1/2 x 1/4 in., 7/6. P.P. 6d.

Ferrite Rods 4 x 1/4 in., 2/-, 5 x 3/8 in., 2/6., 6 x 3/8 in., 2/6. P.P. on all rods, 1/-.

Transistors. New and guaranteed, OC71 5/-, OC72 5/-, XC141 power output as OC16 10/-, OC28 10/-, OC35 15/-, OA47 Diodes 2/6, OA90 2/6. Diodes sets of twelve, including CG84E, OA90, AO47, OA10, CG12E 18/- set. P.P. 6d. any type.

Co-ax Cable, orders 10yds. or above, 6d. per yd. P.P. free.

Send for our coloured leaflets on our other products (send large S.A.E.)

WOLVERHAMPTON RADIO & TV SUPPLIES, 42 Darlington St., Wolverhampton

Terms:—C.W.O. to avoid delay. All orders mailed by return, subject to stocks surviving the onslaught! And see us if you can. Fuller details and/or prices by request, write (S.A.E.) or call. Tel.: Wolverhampton 20315.

UNIVERSAL AVOMETERS



Guaranteed perfect working order. Supplied complete with leads, batteries and instructions. Model "D" 34 range £8.19.6 Model "7" 50 range £11.0.0 Registered Post 5/- extra.

COSSOR 1035 DOUBLE BEAM OSCILLOSCOPES
Guaranteed perfect working order. £45 each. Carriage 1/-.

7.5 K.V.A. AUTO TRANSFORMERS
0-115-230 volts. Brand new boxed. £15. Carriage 10/-.

230/250 VOLT A.C. MOTORS
44 x 3in. dia., 90 watts, 5,000 r.p.m. in. spindle. 22/6. P.P. 1/6.

1 K.V.A. ISOLATION TRANSFORMERS
230 v. PRI 230 v. Sec. Boxed. £5 each. Carriage 10/-.

VARIAC TRANSFORMERS
24 amp., 230 volt primary, 185 to 250 volt output, £12-10.0. Carriage 10/-.

TELEPHONES TYPE "L"
Generator Bell Ringing, 2 line connection. With batteries, fully tested. 69/6 per pair. Carriage 5/-.

100 AMP A.C. METERS
Nalder Thompson 6in. scale. Brand new, boxed. 65/-, P.P. 3/6.

3000 WATT AUTO TRANSFORMERS
0-115-230 volts, step-up or step-down. Brand new, boxed ex-U.S.A. £7-10.0 each. Carr. 10/-.

PANEL METERS

100µA	2 1/2"	F.M.	D.C.	42/6
100µA	3 1/2"	F.M.	D.C.	62/6
1 mA	2 1/2"	F.M.	D.C.	25/6
300/30 mA	2 1/2"	F.M.	D.C.	8/6
350 mA	2 1/2"	F.M.	D.C.	10/6
2 v.	2 1/2"	F.M.	A.C.	17/6
10 v.	2"	Proj.	A.C.	15/6
300 v.	2 1/2"	Proj.	A.C.	19/6
300 v.	2 1/2"	F.M.	A.C.	25/-
500 v.	2 1/2"	F.M.	A.C.	25/-
120 v.	3 1/2"	F.M.	D.C.	32/6
1500 v.	2 1/2"	Electrostatic	25/-	

FIELD TELEPHONES TYPE "F"
Suitable for many applications. Generator bell ringing, 2 line connection. With batteries and wooden carrying case, fully tested. £4.19.6 per pair. Carr. 5/-.

WANTED. ALL GOOD QUALITY COMMUNICATION RECEIVERS AND TEST EQUIPMENT.

P.C.R. COMMUNICATION RECEIVERS

6 valves. Frequency coverage on 3 bands: 850-2,000 metres, 190-550 metres and 8-18 Mc/s. Super slow motion drive. AE trimmer, tone control, built in speaker. AS NEW £6.19.6 each. Carr. 7/6.

P.C.M.J. RECEIVERS

850-2,000 metres, 190-550 metres 6-22 Mc/s. output for phones or 3 Ω speaker. As new £5.19.6. Carr. 7/6. PCR3 as PCR2 but covers 190/550 metres, 2-7 Mc/s. 7-22 Mc/s. including top band. As new. £8.8.0. carr. 7/6. All above models can be supplied with internal power unit to operate on 200/250 v. A.C. at 39/6 extra or alternatively plug-in external power units are 35/-.



NATIONAL H.R.O. RECEIVERS

BRAND NEW! Senior model, table mounting. Complete with a full set of 9 coils covering 50 kc/s to 30 Mc/s. Supplied complete in original transit cases. £25. Carr. 20/- . Power units to operate direct from 200/250 volt. A.C. 58/6 extra.

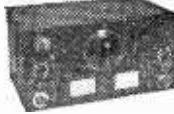

PRECISION COMBINATION VOLT/AMMETER FOR A.C. AND D.C.

Two separate instruments housed in polished wood case, 6in. scales with knife edge pointers.

Ranges: Volts A.C. and D.C. 160-300-600 v. Amps. A.C. and D.C. 25-50-150-200 A. Supplied complete with all current shunts, leads and leather carrying case. Manufactured by Elliott Bros. Supplied brand new. £9.19.6 each. Carriage 7/6.



MINE DETECTOR No. 4A

Will detect all types of metal. Fully portable. Complete equipment supplied tested with instructions, 39/6. Carriage, 10/6. Battery 8/6 extra.

COLLARO STUDIO TAPE TRANSCRIBOR

Brand new 1962 model. 3 speeds, 3 motors, digital counter, etc. With latest bradmatic heads and interlock button. Supplied with spare spool, instructions, fixings. 10 gns. each. Carr. paid.

FABULOUS TAPE OFFER

Famous American Brand Tapes. Brand new, fully guaranteed. 5in.—600ft., 10/6. 5in.—900ft., 13/6. 5in.—1200ft., 17/-, 7in.—1200ft., 15/-, 7in.—1800ft., 20/-, 7in.—2400ft., 30/- . P. & P. extra. S.A.E. for full tape list.

CT-53 SIGNAL GENERATORS

Precision instruments covering 8.9 to 15.5 Mc/s. and 20 to 300 Mc/s. on 6 bands. Variable attenuator from 1 microvolt to 100 millivolts. Operation 110/230/250 volts A.C. Supplied in perfect working order. Complete with calibration charts. 19 gns. each. Carriage 10/6.



PRECISION A.C. AND D.C. VOLTMETERS

Two ranges, 160 and 320 volts, 8 inch mirror scale with knife edge pointer. Housed in polished wooden case. Ideal for schools, labs., etc. Supplied brand new, £5.19.6 each. P.P. 3/6.

R.C.A. AR.88 LF RECEIVERS

These world-famous 14-valve receivers are offered in excellent condition. Fully tested and checked before dispatch. Frequency coverage on six bands is 75 to 550 Kc/s and 1.5 to 30 Mc/s. Completely self-contained except phones or speaker. Operation for 100-200-250 volt A.C. £32-10.0 each, carriage 30/- ex.



JEMCO 4,000 OHM/VOLT TESTMETER

1% Precision Resistors throughout. Single control system for all ranges. Highly accurate. Sensitivity 4,000 Ω/volt A.C. and D.C.



Ranges:
D.C. volts: 0-10-50-250-500-1,000v.
A.C. volts: 0-10-50-250-500-1,000v.
D.C. current: 0-250 vA 0-25-500mA
Resistance: 03-0kΩ 0-30kΩ 0-3MΩ
Decibels: -20 to +36 db (2 ranges).

Meter sensitivity: 100 microamp.

JEMCO 20,000 OHM/VOLT TESTMETER

As above but with increased sensitivity and extended resistance range (0-5M Ω). 97/6 P.P. 2/6. Either type brand new. Guaranteed with leads, prods, batteries, instructions.

L.T. METAL RECTIFIERS

All full wave, bridge connected. Brand new guaranteed.
12/18v. 1.5A. 3/9 24/36v. 4A. 15/6
12/18v. 2.5A. 6/3 24/36v. 15A. 45/-
12/18v. 4A. 8/6 36/48v. 2A. 19/6
12/18v. 6A. 12/3 36/48v. 4A. 29/6
12/18v. 10A. 22/6 36/48v. 6A. 32/6
12/18v. 15A. 37/6 48/60v. 2A. 21/-
24/36v. 1A. 7/3 48/60v. 10A. 82/6
Please add postage.

L.T. TRANSFORMERS

All primaries tapped 200/250 volts.
1 Battery Charging. 3.5, 9 or 17 volt. 6 amp., 28/-
14/3. Ditto 4 amp., 18/6. 9 or 17 volt. 6 amp., 28/-
2 Model Type 3, 4, 5, 6, 8, 10, 12, 15, 18, 20, 24 or 30 volt. 2 amp., 18/6. Ditto 4 amp., 27/6. Ditto 5 amp., 37/6. Add Postage.

AUTO TRANSFORMERS

Step-up, step-down, tapped 0-115-200-230-250 volts. 15w. 9/-; 60w. 12/6; 150w. 18/6; 200w. 27/6; 300w. 42/6; 42/6. 37/6. 1,100w. 99/6; 1,500w. £6.19.6. P.P. extra.

R.C.A. PLATE TRANSFORMERS

Pri. 200/250 v. sec. 2,000-0-2,000 v. 500 mA. tapped 1,500 v. New, boxed. £8.10.0. Carriage 15/-.

DUMONT KIOSKI DOUBLE BEAM C.R.T.

Twin Gun. Brand new, boxed, 59/6. P.P. 3/6.

I.2 Ohm I2 Amp RHEOSTAT

Gearm slider type, new boxed, 15/6 each. P.P. 3/6.

PAINTON 100KΩ 1/2 DIA. INSTRUMENT POTS

Fully screened, precision wirewound. 10/6 each. P.P. 1/3.

CADMIUM SULPHIDE PHOTOCELL

Very sensitive, full data supplied, 12/6 each. P.P. 6d.

MINIATURE PANEL METERS

For 1 1/2in. dia. panel hole.
0-50 uA 39/6 0-300 v. D.C. 97/6
0-500uA 32/6 "S" meter 35/-
0-1 mA 27/6 "VU" meter 49/6
0-5 mA 27/6

Hours of Business: 3 LISLE STREET, 9 a.m.—6 p.m. Half Day Saturday
34 LISLE STREET, 9 a.m.—6 p.m. Half Day Thursday

Send S.A.E. For Bargain Lists

CW. SMITH & CO (RADIO) LIMITED
Phone: GERRARD 8204/9155
Cables: SMITHEX LESQUARE
3-34 LISLE STREET, LONDON, W.C.2

EASY TO BUILD



AMATEUR RADIO EQUIPMENT

CR 66 COMMUNICATIONS RECEIVER ★ A CODAR KIT TRIUMPH

NOW ... THE FINEST KIT
EVER OFFERED !

This completely new Communications Receiver with its many design features and handsome styling offers more in performance and quality than many higher priced units.

Frequency Range 540 Kc/s to 30 Mc/s in four Band-switched ranges. Separate Main Tuning and Electrical Bandspread. Entirely new design High "Q" ferrite cored Coils. Oscillator Coils fitted temperature compensated trimmers for stability. Coil Unit is wired and assembled, and with the I.F. Transformers is supplied factory aligned and tested. Low loss Trollex glass alkylid switch wafers. Controlled regenerative

I.F. amp. for maximum gain and B.F.O. Panel Ant. Trimmer. Delayed A.V.C. Cathode follower output for tape recorder, etc. 3 watts output for external 2/3 ohm speaker. For panel slider switches, On-Off/Standby-Receiver/A.V.C. On-Off/Speaker On-Off. Front Panel Silver and Black, control knobs Grey with Silver trim. Provision for EM 84 Signal strength indicator. Panel phone jack. Heavy gauge steel chassis, cadmium plated. Valve line-up: ECH81/EBF89/ECC81/EL84/EZ80. Instruction Manual, 17 pages. Cabinet size 16 x 6½ x 8½ ins. Silver Grey. For AC 200-250 volts. (Export and Marine Model 115 volts).

Total cost of complete Kit, less Cabinet and Indicator

£16.10.0

carr. 6/-

CR 66 Cabinet £1.15.0

Signal strength indicator with EM 84

17/6

H.P. Terms available

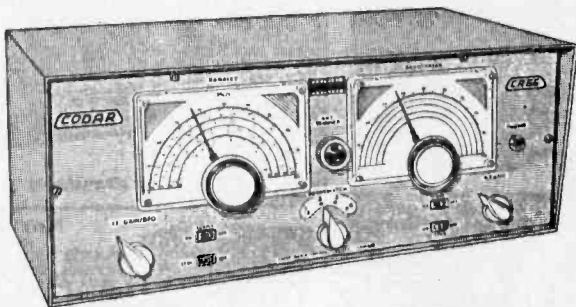

THE NEW CR45 ★ NEW STYLING TOP PERFORMANCE

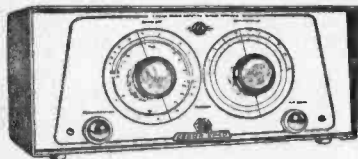

- ★ Tunes 10-2000 metres (5 Coils).
- ★ Separate electrical bandspread.
- ★ Three slow motion vernier drives.
- ★ Low loss polystyrene plug-in coils, factory aligned.
- ★ Dials calibrated in frequencies and degrees.
- ★ Power output 3 watts for 2/3 ohm speaker.
- ★ Valve line-up: ECC81/EL84/EZ80.
- ★ Front Panel Silver and Black, control knobs Grey.
- ★ Provision for panel phone jack.

Superb styling. World-wide reception. Total building cost, with 2 Coils, 25-75 and 60-175 metres.

£6.19.6

carr. 3/6.

Instruction Manual 11 pages, less Cabinet

CR 45 Cabinet Silver Grey, 12 x 5½ x 7in. sliding door for easy coil changing 27/6

Extra coils, all ranges 4/9 each.

ALL PARTS AVAILABLE SEPARATELY

THE MINI-CLIPPER ★

- ★ Tunes 10-2000 metres (5 coils). 36/6
- ★ Miniature 1 valve, all band receiver.
- ★ Low loss polystyrene plug-in coils, factory aligned.
- ★ Air spaced ball bearing condensers.
- ★ Provision to add two-transistor amplifier.
- ★ Battery lasts months.



Can be built in an evening, will receive Amateur and Broadcast stations from all parts of the world. Total building cost with one coil 25-75 metres, Instruction Manual 4 pages, 36/6, carr. 2/6. Extra coils, all ranges, 4/9 each. Electrical bandspread available. All parts available separately.

THE SUPER CLIPPER ★

- ★ Tunes 10-2000 metres (5 coils). 88/6
- ★ Large precision dial, dual slow motion drives.
- ★ Bandspread on all Bands
- ★ High gain valve/transistor hybrid circuit.
- ★ 2 Mullard transistor amplifiers, pre-assembled and tested.
- ★ Low loss polystyrene plug-in coils, factory aligned.
- ★ Batteries last months.



Easy to assemble, this top performing All Band Receiver brings a new world of listening pleasure to your finger-tips at low cost. Total building cost with 2 Coils, 20-60 and 55-190 metres, Instruction Manual 7 pages, 88/6, carr. 2/6. Extra Coils, all ranges, 4/9 each. Front Panel, Silver Grey, 10 x 7½in., 6/9.

CODAR Equipment is famous for Top Quality, Peak Performance and Easy-to-Follow Instructions—no guesswork. All chassis are heavy gauge, pre-punched—all parts fit perfectly into place. All small parts, nuts, bolts, tags, wire, solder, etc., are included. No technical knowledge or equipment is required and Full After Sales Service is available. Hundreds of genuine testimonials from enthusiastic constructors can be inspected at our offices, or ask for copy. CODAR Receivers are supplied to Govt. Depts., Royal Air Force, Royal Navy and Educational Authorities. 6d. in stamps brings full details, illustrated leaflets.

CODAR RADIO COMPANY

24 CHAPEL ROAD, FISHERSGATE, PORTSLADE, SUSSEX
G31RE. Canadian Distributors: JAYCO ELECTRONICS, TWEED, ONT.

G31PA

REDA METER SENSATION!

10,000 O.P.V. multi-tester in semi-assembled kit form. only 69/6
Ranges: D.C. voltage: 0-6-30-120-600-1,000 v. (10,000 o.p.v.).



A.C. voltage: 0-8-30-120-600-1,200 v. (10,000 o.p.v.).
D.C. current: 0-120µA, 0-12-300 mA.
Resistance: 0-20K, 0-2 Meg. (150 ohm, 15K at centre scale).
Capacitance: 0.005 to 0.15µF (at A.C. 5v.).
Decibels: -20 to ±63db (600 ohms 1 mW., o.dbm = 0.775v.).
Accuracy: D.C. voltage and current ±2% f.s. A.C. voltage ±4% f.s. Resistance ±3% of total scale length.
Size: 4 1/2 in. x 3 1/2 in. x 1 in. Complete with test leads, battery and instructions.
Few only available, rush your order now whilst stocks last.

MINIATURE EARPHONE

A really sensitive dynamic earphone of exceptionally fine quality. Provides clear reproduction of music as well as speech. Fully Guaranteed and complete with transparent ear insert, 3 feet cord, sub-miniature plug and socket.



MR-60 New magnetic earpiece with earloop 250 ohms.
CR-5 High imp. crystal 6/- Each
MR-4 Low imp. magnetic Post 1/-

SUB-MINIATURE TRANSFORMERS

Here is outstanding value in transistor transformers consisting of one Driver 3K/14" Nickel finish 3/6. And one Output Transformer. Ideal pair for miniature transistor portables, etc.
Driver Model LT44: Primary: 20k. Secondary: 1k. Centre Tapped. Ratio: 5:1.
Output Model LT700: Primary: 1.2k. Centre Tapped. Output: 3.2 ohms. Ratio: 2:1. Complete with detailed instructions. Only 9/6 per pair. P. & P. 1/6.



MINIATURE COMPONENTS

- As previously advertised
 - P.31 Standard jack plug 2/6 ea.
 - PS.35 Sub-miniature plug and socket 2/6 pr.
 - CB.25 "Tiny" plug and socket 2/6 pr.
 - CH.305 Chrome miniature plug and socket 3/6 pr.
 - CR.5 Crystal earpiece 6/- ea.
 - MR.4 Magnetic earpiece 6/- ea.
 - L.M.176 Crystal inset microphone 14/- ea.
 - SS.219 Standard slide switch, D.P. D.T. 2/6 ea.
 - T.104 S.P. S.T. Toggle switch 2/6 ea.
 - SS.371 Miniature slide switch 2/6 ea.
 - SF.20 High resistance headphones 14/6 ea.
 - L.A.6P 3 v. battery eliminator 29/6 ea.
 - 8A7 8in. double cone hi-fi speaker 92/6 ea.
 - T.655 Tape splicer and cutter 18/9 ea.
 - SF.5000 Stereo headphones 27/6 ea.
 - A.H.13 Test lead kit 9/6 ea.
 - F.501 Vernier dial 14/- ea.
 - P.V.C.105 250 pf tuning condenser 5/- ea.
- Please add P. & P. on above items.

TELESCOPIC AERIAL SNIPS!

Exclusive purchase of entire range. Finest finish—sturdy construction. Three sizes and types available. Limited supply. Ideal for all types of Transistor Radios and Kits. Crystal Sets, Transmitter Receivers, Remote Control Units. Signal injectors and probes. T.A.1. Size 3 1/4" Nickel finish 3/6. T.A.1. Size 5 1/8" Nickel finish 6/6. T.A.3. Size 5 1/2" Chrome finish 9/- Plus P. & P. 9d. each.



A MINIATURE TAPE RECORDER IN KIT FORM

Consisting of three transistor amplifiers, record play volume control, miniature speaker, forward-stop-rewind-switch, reel of tape and spare reel, motor, attractive coloured case, Mic. and earphone sockets, pick-up coil, mike, earphone and carrying handle supplied. Standard battery operated. Simple to put together in less than one hour. Brand new and guaranteed.

ONLY £6.19.6

A guaranteed saving of at least 24! Results comparable with similar built-up recorders selling at around 12 gns.

FULL RANGE HIGH FIDELITY!

12in. Mechanical Two-way Loudspeaker Model CR.12A

This speaker smoothes two reproducing cones mounted coaxially with power coming from the same voice coil. The larger cone reproduces the lower frequencies and the small cone gives you efficient high frequency reproduction. Due to the double cone construction, velvet smooth cross-over is possible and brings you the finest in high fidelity music reproduction. Specification: Freq. response: 30 to 16,000 cps. Resonant freq.: 45-10 cps. Capacity: 10-20 watts. Sensitivity: 102 db/w. Voice coil impedance: 16 ohms. Mechanical crossover freq.: 1300 cps. Diameter: 12in. Depth: 3 1/2 in. Voice Coil diameter: 2 1/2 in. Baffle opening diameter: 11 in.

ONLY £8.8.0 P. & P. 4/-

FINAL OFFER!!! WIRELESS SET No. 19

This most famous Army Trans/Receiver covers 2-8 Mc/s. (150-37 metres in two bands and 230-240 Mc/s V.H.F.). Has an intercom, amplifier. Designed for 12 and 24 volt operation. Uses a 6 valve superhet receiver, 1 P. being 465 Kcs, and a 6 valve transmitter designed for voice and C.W. operation. Incorporates test, aerial loading and current tests. Panel Controls: Frequency tuning, P.A. tuning, Gain control. MCW, CW, R/T switch. Het-tone netting, Off-on, Quench, aerial AVC LT-HT—Drive tests. Supplied complete with valves and instruction book.

FEW ONLY LEFT ONLY 65/-
Don't be disappointed—Order Now Carriage 10/-

Model DM-11

Dynamic Microphone Modern, tastefully integrated design, mike and stand. Wide range flat response from 60 to 12,000 cps. Omnidirectional pick-up sensitivity—54 db, 50K ohms impedance. Stands vertically or tilts in any direction from wide base desk stand. Removes from desk stand and can be attached to floor stand. Finished in blue mist metallic lacquer with chrome trim. Supplied with shielded plastic covered cable. An elegant yet practical instrument. AT ONLY 5 gns.



A 5 STAGE TRANSISTOR RADIO

which can be built in one hour and will give you endless amount of pleasure. Completely portable as the appearance of sets costing considerably more and works equally well. Attractive case 5 1/2" x 9 1/2" x 1 1/2" genuine 2 1/2 in. speaker and G.E.C. transistors, tuning condenser, volume control with switch, etc. All parts sold separately.

SIMPLE TO BUILD FUN TO OWN!!!



ONLY 37/6 P. & P. 2/6.

NOW! HI-FI SOUND FROM YOUR TRANSISTOR RADIO

With the Model TS.30

BOOSTER TRANSISTOR RADIO SPEAKER Designed for use with transistor radios, valve radios, car radios, amplifiers, where quality reproduction of sound is required. Plugs into earpiece output socket of nearly all miniature sets. The cabinet is finished in beige leather with contemporary gold baffles at each end. Complete with 12ft. extension cord fitted with miniature plugs, individually cartoned and guaranteed. Size: 9 1/2 in. x 3 1/2 in. diameter.

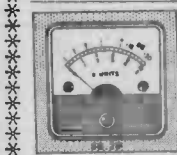

"KEW" PANEL METERS

"S" Meter Model SR.2P. 35/-; VU, Meter Model VR.1P. 42/8; DC Microammeters, Model MR.5, 5 ma. 27/8; Model MR.3, 300 v. 27/8; Model MR.250, 0-800µA. 32/8; DC Milliammeter Model MR.2L, 0-1mA., 27/6. All models individually boxed and fully guaranteed. P. & P. 2/6 each.

MAIL ORDERS TO
(DEPT. P.), 32a COPTIC STREET,
LONDON, W.C.1



CALLERS WELCOME AT
87 TOTTENHAM COURT ROAD,
LONDON, W.1. MUS 9606

INTRODUCING THE R.S.C. BASS-MAJOR 30 WATT GUITAR AMPLIFIER

A MULTI-PURPOSE HIGH FIDELITY, HIGH OUTPUT UNIT FOR VOCAL AND INSTRUMENTALIST GROUPS

Eminently suitable for bass guitar and all other musical instruments.

- * Incorporating two 12in. heavy duty 25-watt high flux (17,000 lines) loudspeakers with 2in. diameter speech coils. Designed for efficiently handling full output of amplifier at frequencies down to 25 c.p.s.
- * Sensitive tweeter unit reproduces frequencies from 3,000 c.p.s. up to 18,000 c.p.s
- * Heavily made cabinet of convenient size 24 x 21 x 14in. has an exceptionally attractive covering in two contrasting tones of Vynalr.
- * For 200-250 v. to 50 c.p.s. A.C. mains operation.
- * Four Jack socket inputs and two independent vol. controls for simultaneous connection of up to four instrument pick-ups or microphones.
- * Separate bass and treble controls providing more than adequate "Boost" or "Cut".
- * LEVEL frequency response throughout the audible range.
- * SUPERIOR TO UNITS AT TWICE THE COST.

39½ Gns. OR DEPOSIT of £4.3.0 and 12 monthly payments of £3.9.11. Carr. 17/6.

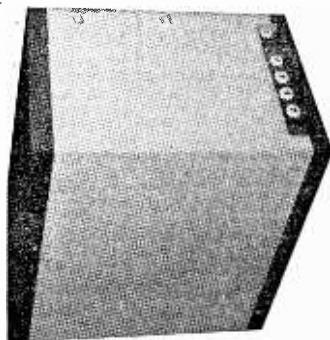

R.S.C. JUNIOR GUITAR AMPLIFIER
5-watt high quality output. Separate bass and treble "cut" and "boost" controls. Sensitivity 15 m.v. Two high impedance inputs. 10in. loudspeaker. Handsome, strongly made cabinet (size 14 x 14 x 7in. approx.) finished in attractive and durable polychrome. 200-250 A.C. mains operation. **£8.19.6** OR DEPOSIT £1 and 9 monthly payments of £1. Carr. 7/6.

LINEAR TREMOLO/PREAMP. UNIT
Designed for introducing the Tremolo effect to any amplifier which is fitted with a reserve power supply point for smoothed H.T. and 6.3 v. A.C. L.T. This applies to practically all amplifiers of our manufacture and to those of several other manufacturers. The unit plugs into power supply point and any input socket of amplifier. Controls are Speed (frequency of interruptions). Depth (for heavy or light effect). Volume and Switch. Three sockets are for two inputs and Foot Switch. **ONLY 4 Gns.**

R.S.C. SENIOR 10-watt GUITAR AMPLIFIER

High-fidelity push-pull output. Separate base and treble "cut" and "boost" controls. Twin separately controlled inputs so that two instruments or "mike" and pick-up can be used at the same time. Two loudspeakers are incorporated, a 12in. high flux 14 watt bass unit, and a 6 x 4in. elliptical for treble. Cabinet is well made and finishes as Junior Model. Size approx. 18 x 18 x 8in. Only

15 Gns. Carr. 10/- OR DEPOSIT 34/9 and nine monthly payments of 34/8.

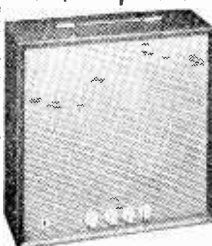

R.S.C. SUPER HI-FI 15-watt

An exceptionally efficient high fidelity Guitar Amplifier incorporating a heavy 20-watt speaker with excellent frequency response. Individual bass and treble controls give ample "boost" and "cut". Two high impedance Jack Socket inputs are separately controlled. If required one or two additional inputs can be provided at a cost of 7/6 per extra socket.

Cabinet is of substantial construction and attractively finished in two tones of polychrome. Size approx. 20 x 18 x 10in. Operation from 200-250 v. 50 c.p.s. A.C. mains. Please do not compare this Unit with others of similar rating until you have heard the difference.

22 Gns. Or Deposit 51/6 and nine monthly payments of 51/6. Carr. 12/6.

TRANSISTOR SALE. Mullard OC71 3/9, OC45 4/11, OC44 4/11, OC72 4/9, OC81 4/11, OC171 8/9, Ediswan XA101 3/9, XB102 3/9, XA112 3/9, XB113 3/9, XB104 3/9, XC101A 3/9. Postage 6d. for up to 3 Transistors.

D.C. SUPPLY KIT. 12 v. 1 a. consisting of a partially drilled metal case, mains trans. F.W. Bridge Rectifier, 2 fuseholders and fuses, Change Direction switch, variable Speed regulator and circuit. For 200-250 v. A.C. mains. Suitable for Electric Trains. Limited number available at 29/11

SELENIUM RECTIFIERS	
F.W. BRIDGE	24 v. 2 amp. .. 14/9
6/12 v. 1 a. .. 3/11	24 v. 20 amp. .. 89/9
6/12 v. 2 a. .. 6/11	H.T. TYPES H.W.
6/12 v. 3 a. .. 9/9	150 v. 40 mA .. 3/9
6/12 v. 4 a. .. 12/3	250 v. 50 mA .. 3/11
6/12 v. 6 a. .. 15/3	250 v. 60 mA .. 4/11
6/12 v. 10 a. .. 25/9	250 v. 80 mA .. 5/11
6/12 v. 15 a. .. 35/9	250 v. 250 mA .. 11/9
CONTACT COILS (D), 250 v. 75 mA. F.W. (Bridge), 10/11. 250 v. 50 mA. F.W. (Bridge), 8/11. H.W. 250 v. 60 mA. 5/11	

LINEAR TAPE PRE-AMPLIFIER
Type LP/1, Switched Negative feedback equalisation Positions for Record 11in. 3In. 7In. and Playback. FM84 Recording Level Indicator. Designed primarily as the link between a 'cassette' Tape Transcriber and a high fidelity amplifier, but suitable for almost any Tape Deck. Only 9 gns. S.A.E. for leaflet.

NEW BRANCH OPENING
32 HIGH SREET, LEICESTER
LATE FEBRUARY

EX. GOVT. SELENIUM RECTIFIERS 12v 15 AMP (BRIDGE) F.W. ONLY 19/9

HUGE PURCHASE OF BRAND NEW 24 v. 20 Amp. F.W. (BRIDGE) SELENIUM RECTIFIERS. each 59/9

R.S.C. GRAM. AMPLIFIER KIT. 3 watts output. Negative feedback. Controls Vol. Tone and Switch. Mains operation 200-250 v. A.C. Fully isolated chassis. Circuit etc., supplied. Only 39/9. Carr. 3/9.

HI-FI 10 WATT AMPLIFIERS
Brand new. Manufacturer's discontinued line. Fitted latest Mullard valves. Dual inputs for "mike" and gram., etc. Bass and Treble Controls. High sensitivity and quality. Output for 3 ohm or 15 ohm speaker. For 230-250 v. A.C. **£7.19.9** Carriage 4/6. Only

THE SKYFOUR T.R.F. RECEIVER
A design of a 3 valve long and medium wave 200-250 v. A.C. Mains receiver with selenium rectifier. High gain H.F. stage and low distortion detector. Valve line-up 6K7, SP61, 6V6G. Selectivity and quality excellent. Simple to construct. Point-to-Point wiring diagrams, instructions and parts list. 1/8. maximum building costs £4.19.6. Inc. attractive Walnut veneered wood cabinet 12 x 61 x 51in.

MULTI-METERS. CABY MI. Sensitivity 2000 ohms per volt. A.C. and D.C. 54/- . A.10. Basic Meter sensitivity 155 micro-amps. A.C. and D.C. ranges £4.17.6. B.20. Sensitivity up to 10,000 ohms per volt A.C. and D.C. £6.10.0.

EX. GOVERNMENT ACCUMULATORS. Size 71 x 4 x 2in. 2v. 16 A.H. brand new. 6/9 each. 3 for 15/6.

EX. GOVT. SMOOTHING CHOKES. 200 mA. 3-5 H. 50 ohms. Parmeco 8/9; 100 mA. 5 H. 100 ohms 3/11; 150 mA. 10 H. 50 ohms 9/9; 80 mA. 20 H. 900 ohms 5/9; 120 mA. 12 H. 100 ohms 8/9; 50 mA. 50 H. 1,000 ohms 6/9; 100 mA. 10 H. 100 ohms 6/9; 60 mA. 5-10 H. 250 ohms 2/11.

COMPLETE POWER PACK KIT, 19/11
Consisting of Mains Trans. Metal Rectifier. Double electrolytic, smoothing choke chassis and circuit. For 200-250v. A.C. mains. Outputs 250v. 60mA. 6.3v. 2a.

R.S.C. POWER PACK, 39/9. Louvred metal case only 8 x 51 x 21ins. Stove enamelled. For 200-250v. A.C. mains Output at 4 pin plug and socket 250 v. 60 mA. fully smoothed and 6.3v. 2a. Suitable for power requirements of almost any Pre-amp or Radio Tuner.

R.S.C. BABY ALARM or INTER-COMM. KIT. Complete set of parts with diagrams, etc. Housed in two polished walnut finished cabinets of pleasing design. High sensitivity. For 200-250v. A.C. mains. Fully isolated. Controllable at both units. An intercomm. of this class would normally cost £20-£30. Only 79/6. carr. 5/- or assembled ready for use £5.15.0

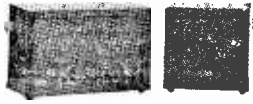

R.S.C. (Manchester) Ltd. MAIL ORDERS to 5 County Arcade, Leeds 1. Terms: C.W.O. or C.O.D. No C.O.D. under £1. Postage 2/9 extra under £2. 4/6 extra under £5. Trade Supplied. S.A.E. with all enquiries please.

BIRMINGHAM:	SHEFFIELD:	HULL:	LIVERPOOL:	BRADFORD:	MANCHESTER:	LEEDS:
6 Gt. Western Arcade Birmingham	13 Exchange St, Castle Market Bldgs. Sheffield	51 Savile St. Hull	73 Dale St. Liverpool 2	56 Marley St. (above Alhambra Theatre) Bradford	8-10 Brown St. (Market St.) Manchester 2	5-7 County (Mecca) Arcade Briggate, Leeds
No half-day	Half-day Thursday		Half-day Wednesday		No half-day	Half-day Wed.

R.S.C. (Manchester) Ltd. MAIL ORDERS to 5 County Arcade, Leeds 1. Terms: C.W.O. or C.O.D. No C.O.D. under £1 Postage 2/9 extra under £2. 4/6 extra under £5. Trade Supplied. S.A.E. with all enquiries please.

BIRMINGHAM: 6 Gt. Western Arcade (Opp Snow Hill Stn) Half-day Wed.

SHEFFIELD: 13 Exchange St. Castle Market Bldgs. Half-day Thurs.

HULL: 51 Savile St. 1/3 Dale St. (8 mins. from Lime St. or Exchange Stations) Half-day Wednesday

LIVERPOOL: 56 Morley St. (above Alhambra Theatre) Half-day Wednesday

BRADFORD: 5-7 County (Mecca) Arcade, Briggate

LEEDS: 8-10 Brown St. (Market St.) No half-day

SENSATIONAL STEREO OFFER

A complete set of parts to construct a good quality Stereo amplifier with an undistorted output total 6 watts. For A.C. mains input of 200-250 v. Including pair matched 6in. speakers. Sensitivity 130 m.v. Ganged Vol. and Tone Controls. Preset balance control. Full instructions and wiring diagrams supplied. Stereo Pick-up Head 19/9 extra with above only.

R.S.C. 30-WATT ULTRA LINEAR HIGH FIDELITY AMPLIFIER A10

A highly sensitive Push-Pull high output unit with self-contained Pre-amp, Tone Control Stages. Certified performance figures compare equally with most expensive amplifiers available. Hum level 70 db down. Frequency response +3 db. 30-30,000 c/s. A specially designed sectionally wound ultra linear output transformer is used with 807 output valves. All components are chosen for reliability. Six valves are used EF86, EF88, ECC83, 607, 607, G234. Separate Bass and Treble Controls are provided. Minimum input required for full output is only 12 millivolts so that ANY KIND OF MICROPHONE OR PICK-UP IS SUITABLE. The unit is designed for CLUBS, SCHOOLS, THEATRES, DANCE HALLS or OUTDOOR FUNCTIONS, etc. For use with Electronic ORGAN, GUITAR, STRING BASS, etc. For standard or long-playing records, OUTPUT SOCKET PROVIDES L.T. and H.T. for a RADIO FEEDER UNIT. An extra input with associated volume control is provided so that two separate inputs such as Gram, and "Mike" can be mixed. Amplifier operates on 200-250 v. 50 c/s. A.C. Mains and has output for 3 and 15 ohm speakers. Complete Kit of parts with fully punched chassis and point-to-point wiring diagrams and instructions. If required perforated cover with carrying handles can be supplied for 18/9. The amplifier can be supplied, factory built with EL34 output valves and 12 months guarantee, for 14 Gns.

11 Gns. Carr. 10/-

TERMS: DEPOSIT 33/9 and 9 monthly payments of 33/9. Suitable microphones and speakers available at competitive prices.

WE STOCK ARMSTRONG, DULCI AND JASON EQUIPMENT GOODMANS AND W.B. SPEAKERS GARRARD AND GOLDRING T/TABLES

SUPERHET FEEDER UNIT. Design of a high quality Radio Tuner (specially suitable for use with our Amplifiers). Delayed A.V.C. Controls are Tuning, W/Och and Vol. Only 250 v. 15 mA. H.T. and L.T. of 6.3 v. 1 amp. required from amplifier. Size approx. 9 x 6 x 7in. High. Simple alignment procedure. Point-to-Point wiring diagrams, instructions and priced parts list with illustrations, 2/6. Total building cost £4.15.0. S.A.E. for leaflet.

R.S.C. BATTERY TO MAINS CONVERSION UNITS

Type BM1. An all-dry battery eliminator. Size 5 1/2 x 4 1/2 x 2in. approx. Completely replaces battery supplying 1.4 v. and 90 v. where A.C. mains 200-250 v. 50 c/s is available. Suitable for all battery portable receivers requiring 1.4 and 90 v. This includes low consumption types. Complete kit with diagrams, 39/9, or ready to use, 46/6.



kit of parts with diagrams and instructions 49/8, or ready to use, 59/8.

P.M. SPEAKERS. 10in. W.B. "Stentorian" 3 or 15 ohms type HF 1012 30 watts, hi-fidelity type. Recommended for use with our All Amplifier 24.12.9. 12in. R.A. 3 ohms 10 watts (12,000 lines). 59/8.

TWEETERS. Plessey 30 19/9, 150 25/9.

JASON FMT1 V.H.F./F.M. Radio Tuner design. Total costs parts including valves Tuning dial, Escutcheon, etc. £8.19.9. Other Jason equipment in stock.

LINEAR L46 MINIATURE 4/5 WATT QUALITY AMPLIFIER. Suitable for any record playing unit, and for microphones. Negative feedback 12 db. Separate Bass and Treble Controls. For mains 200-250 v. 50 c/s. Output for 2-3 ohm speaker. Mullard valves E280, ECC83, EL34. Size only 7-5-5in. High. Guaranteed 12 months. Only £5.19.6. Send S.A.E. for leaflet. Terms: Deposit 22/6 and 5 monthly payments of 22/6.

12in. 10 WATT HIGH QUALITY LOUDSPEAKER

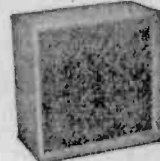

In walnut veneered cabinet. Gauss 12,000 lines. Speech coil 3 ohms or 15 ohms. Only £4.19.6 Carr. 5/- Terms: Deposit 11/3 and 8 monthly payments of 11/3.

12in. 20 WATT HI-FI LOUDSPEAKERS IN CABINETS. Size 18 x 18 x 10in. Finish as above. Terms: Deposit 17/9 and 9 monthly payments of 17/9. Only £27.10.6. Carr. 8/6.

BASS GUITAR LOUDSPEAKER IN CABINET. 15in. 50 watt. highly sensitive unit in rexine covered acoustically lined cabinet. Deposit £37.6. 29 Gns. and 12 monthly payments of £37.6. Carr. 15/-

R.S.C. 4-5 WATT AS HIGH-GAIN AMPLIFIER



A highly-sensitive 4-valve quality amplifier for the home, small club, etc. Only 50 millivolts input is required for full output so that it is suitable for use with the latest high fidelity pick-up heads, in addition to all other types of pick-ups and practically all "mikes". Separate Bass and Treble Controls are provided. These give long-playing record equalisation. Hum level is negligible being 71 db. down in db. of negative feedback is used. H.T. or 300 v. 25 mA. and L.T. or 6.3 v. 1.5 a. is available for the supply of a Radio Feeder Unit, or Tape-Deck pre-amplifier. For A.C. mains input of 200-250 v. 50 c/s. Output for 2-3 ohm speaker. Chassis is not alive. Kit is complete with detailed and fully punched chassis with base plate, hammer finish and point-to-point wiring diagrams and instructions. Exceptional value at only £24.15.0, or assembled ready for use 25/- extra. Plus 3/6 carr., or deposit 22/6 and 5 monthly payments of 22/6 for assembled unit.

R.S.C. PORTABLE GUITAR AMPLIFIERS NOW ON PAGE 883.

AUDIOTRINE HIGH FIDELITY REPRODUCERS

THE DUO/10. Consisting of a 12in. 12,000 line Speaker with heavy four layer voice coil, the Audiotrine cross-over unit, and a 4in. Diameter Tweeter Unit incorporated in the extremely attractive Audiotrine Senior Corner Console Cabinet as described below. Matching Impedance 15 ohms. Power handling 10 watts nominal. 14 watts peak. Frequency range 40-18,000 c.p.s. Deposit 27/9 and nine monthly payments of 27/9. **12 Gns.**

THE DUO/20. Incorporating a 12in. High Flux 20 watt Speaker with 2in. Diameter Speech Coil. (Total Flux 160,000 lines), the Audiotrine Cross-over unit, and a highly sensitive Tweeter unit, in the Audiotrine Senior Corner Console Cabinet. Matching impedance 15 ohms. Peak Power Output 22 watts. Frequency range 30- ONLY 18,000 c.p.s. Deposit 35/9 and nine monthly payments 35/9. **14 Gns.**

R.S.C. JUNIOR HI-FI REPRODUCER. The very latest Goodmans Axieta 3 High Fidelity loudspeaker (retailing at £5.15.7) fitted in a specially designed Bass, Reflex cabinet size 12in. x 18in. x 10in. Acoustically lined and ported and finished in polished walnut veneer. Matching impedance 15 ohms. Frequency range 40-15,000 c.p.s. Power handling 6 watts nominal, Ideal for Stereo. **£8.19.9** Limited number. Carr. 4/6

R.S.C. BASS REFLEX CABINETS, JUNIOR MODEL. Specially designed for W.B. HF1012 Speaker, but suitable for any good quality 10in. speaker. Acoustically lined and ported. Polished walnut veneer finish. Size 18 x 12 x 10in. Handsome appearance. Ensure superb reproduction for only £3.19.6.

STANDARD MODEL. As above but for 12in. speakers. Size 20 x 15 x 18in. Especially recommended for Audiotrine Loudspeaker systems. For vertical or horizontal use. Size 18 x 25 x 19.6. Suitable less with brass ferrules. 19/6 per set of 4.

R.S.C. CORNER CONSOLE CABINETS

Polished walnut veneer finish. Floor design **JUNIOR MODEL.** Size 20 x 11 x 8in. for 8 x 5in. or 10 x 8in. speakers. £2.9.9

STANDARD MODEL. Size 27 x 18 x 12in. for 8 or 10in. speakers, £4.11.9

SENIOR MODEL. Size 30 x 25 x 15in. for 12in. Speaker. Suitable Speaker systems below Only 7 gns.



AUDIOTRINE HI-FI SPEAKER SYSTEMS. Consisting of matched 12in. 12,000 line, 15 ohm high quality speaker; cross-over unit (consisting of choke, condenser, etc.) and Tweeter. The smooth response and extended frequency range ensure surprisingly realistic reproduction. Standard 10 watt rating £4.19.9. Carr. 6/- Or Senior 15 watt. 7 gns. Carr. 7/6.

AUDIOTRINE EQUIPMENT CABINETS. Size 36 x 15 x 18in. Beautiful walnut veneer finish. Electrically contemporary design. Robust construction. Uncut removable baseboard. Depth above baseboard 5 1/2". Only 12 gns. Carr. 15/-



AUDIOTRON HI-FI TAPE RECORDER KIT 25¹/₂ GNS. Carr. 17/8

REALISM AT INCREDIBLY LOW COST, CAN BE ASSEMBLED IN AN HOUR

Incorporating the latest Collaro Studio Tape Transcriber. The Audiophone High Quality Tape Amplifier with negative feedback equalization for each of 3 speeds. High Flux P.M. Speaker, empty Tape Spool, a Reel of Best quality Tape and a Handsome Portable carrying Cabinet with latest attractive two-tone polychrome finish, size 14 1/2 x 15 1/2 inch. high, and circuit. Total cost if purchased individually approximately \$40. Performance equal to units in the \$60-\$80 class. S.A.E. for leaflets. **TERMS.** Deposit \$2.13.8 and 12 monthly payments of 44/-. Cash price if settled in 3 months.



ONLY 3 PAIRS OF SOLDERED JOINTS PLUS MAINS

SPECIAL NOTE. The Tape Decks we supply are latest models. Where customers already have a Deck or wish to use one of those being offered cheaply we can supply Kit less Deck at 13 gns. carr. 10/-. Or deposit 2 gns. and 12 monthly payments 23/9. Also if required we can supply in lieu of portable cabinet and 7" x 4 1/2" speaker, the Equipment Cabinet illustrated at foot of opp. page and a high flux 8 1/2 x 5 1/2 inch. speaker for 81 gns. extra.

HIGH FIDELITY 12-14 WATT AMPLIFIER TYPE A11

PUSH-PULL ULTRA LINEAR OUTPUT "BUILT-IN" TONE CONTROL PRE-AMP STAGES

Two input sockets with associated controls allow mixing of "mike" and gram., as in A10. High sensitivity. Includes 5 valves, ECC83, ECC83, EL84, EL84, EZ81. High Quality sectionally wound output transformer specially designed for Ultra Linear operation and reliable small condensers of current manufacture. **INDIVIDUAL CONTROLS FOR BASS AND TREBLE** "Lift" and "Cut". Frequency response \pm 3 D.B. 30-30,000 c/s. Six negative feedback loops. Hum level 60 D.B. down. **ONLY 23 millivolts INPUT required for FULL OUTPUT.** Suitable for use with all makes and types of pick-ups and microphones. Comparable with the very best designs. For **STANDARD or LONG PLAYING RECORDS.** For **MUSICAL INSTRUMENTS** such as **STRING BASS, GUITARS,** etc.



OUTPUT SOCKET with plug provides 300 v. 30 mA. and 6.3 v. 1.5 a. For supply of a **RADIO FEEDER UNIT.** Size approx. 12.9-7in. For A.C. mains 200-250 v. 50 c.p.s. Output 100/3 and 15 ohms speakers. Kit is complete to last nut. Chassis is fully punched. Full instructions and point-to-point wiring diagrams supplied. **Only 8 Gns. Carr.** (Or factory built 51/- extra.) If required louvred metal cover with 2 carrying handles can be supplied for 18/9. **TERMS ON ASSEMBLED UNITS. DEPOSIT 24/9 and 9 monthly payments of 24/9.** Send S.A.E. for illustrated leaflet detailing Ready-to-assemble Cabinets, Speaker, Microphones, etc., with cash and credit terms.

B.S.R. MONARDECK TAPEDECKS. Speed 3 1/2 in. per sec. with high quality recording heads. **£6.19.6.** Carr. 5/-. Cabineets, to take Deck and amplifier 59/8.

R.S.C. TRANSISTORISED GRAM AMPLIFIER. Output 1 watt, for 3 ohm speaker. Transistors Mullard OC71, OC81D, OC81, OC81. Fitted Vol. Control with switch. Assembled and tested. Suitable for any normal crystal pick-up. **Only 59/9.**

R.S.C. STEREO/TEN HIGH QUALITY AMPLIFIER

A complete set of parts for the construction of a stereophonic amplifier giving 5 watts high quality output on each channel (total 10 watts). Sensitivity is 50 millivolts, suitable for all crystal stereo heads. Ganged Bass and Treble Control give equal variation of "lift" and "cut". Provision is made for use as straight (monaural) 10-watt amplifier. Valve line-up ECC83, ECC83, EL84, EL84. Outputs for 3ohm speakers. Point-to-point wiring diagrams and instructions supplied. Send S.A.E. for leaflet. **8 Gns.** Full constructional details and price list 2/6. Carr. 10/-. Kit can be assembled, ready to use, 59/6 extra.

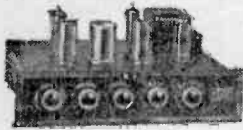

Kit can be assembled, ready to use, 59/6 extra.

HI-FI CRYSTAL PICK-UP HEADS.

(Cartridge) Acos Standard replacement for Garrard B.S.R. and Collaro. 18/9. Acos Stereo-Monaural 49/9. Ronette Stereo-Monaural 59/8. B.S.R. Stereo 39/9. **BRADMATIC RECORDING HEADS.** High Impedance Record/Playback 22/- Low Impedance Erase. 12/6.

PICK-UP ARMS. Complete and with latest Acos/hi-Turnover Cartridge 29/11. **CRYSTAL MICROPHONES.** Hand type NP110 14/9, R.T.C. 19/8, Acos Mic 40 25/9, Acos Mic 45 29/9, Stick type and heavy table stand 59/9. Lapel type 35/9.

COLLARO JUNIOR 4-SPEED Player Unit and Crystal Pick-up with hi-fi Turnover head. **Only £3.19.6.**

COLLARO CONQUEST 4-SPEED AUTO-CHANGER, with high fidelity Studio pick-up. Latest model. For 200-250 v. A.C. mains. **£9.19.8.** Carr. 5/6.

COLLARO RC 457 4-SPEED MIXER AUTO-CHANGERS. Turnover Studio head, for 200-250 v. A.C. £7.19.6. Carr. 4/6.

B.S.R. UA14 4-sp'd AUTO-CHANGERS with hi-fi turnover head. **£6.19.8.** Carr. 4/6.

GLA MINIATURE 2-3 WATT GRAM AMPLIFIER. 12 v. 1.5 a. with any size or auto-change unit. Output for 2-3 ohm speaker. For 200-250 v. A.C. mains. Size 1 1/2 x 2 1/2 inch. Controls: Vol. and Tone with switch. **Only 59/6.**

R.S.C. BATTERY CHARGING EQUIPMENT

HEAVY DUTY CHARGER KIT 8/12 v. 6 amps. variable output. Consisting of Mains Transformer 0-200-230-250 v. F.W. (Bridge) Selenium Rectifier; Ammeter; Variable Charge Rate Selector Panels, Fuses, Fuseholder and circuit. 59/9. Carr. 4/6.

CHARGER KIT, 12v. 14 AMP or 24v. 7 amp. Consisting of mains trans. 200-230-250 v. F.W. (Bridge) selenium Rectifier, F. Ammeter, Fuses, Variable Resistor and Circuit. **Only 4 gns. Carr. 12/-** Please state if 12v. or 24v. Kit required.

SOLDERING IRONS. 230-250 v. 30 watts. First quality. For Radio work, 18/9. Spare elements and bits available.

Assembled 4-5 amps. 6/12 v.

Fitted Ammeter and variable charge rate selector. Also selector plug for 6 v. or 12 v. charging. Louvred steel case in stoved blue, hammer finished. Fused and ready for use. **69/9** with mains and output leads. Carr. 5/-. **TERMS:** Deposit 13/3 and 5 monthly payments 13/3. 6/12 v. 3a., all facilities as above. **Only 59/9, carr. 3/9.**

ASSEMBLED 12V. 10 AMP with variable charge rate adjustment, ammeter and strong louvred, stove enamelled case. Ready for use. **Only 7 gns. Carr. 10/-** or in Kit Form 6 gns.

Assembled 4-5 amps. 6/12 v. 2 amps.

Fitted Ammeter and selector plug for 6 v. or 12 v. Louvred metal case finished attractive hammer blue. Fused, ready for use with mains and output leads. **49/9 Carr. 3/9** 6/12 v. 1amp. 27/9 Less meter.

BATTERY CHARGER KITS

Consisting of Mains Transformer, F.W. Bridge, Metal Rectifier, well ventilated steel case, Fuses, Fuse-holders, Grommets, panels, Heavy Duty Clips, circuit. Carr. 3/6 extra. 6v. or 12v. 1 amp. 22/9 As above, with Ammeter 25/9 6 v. 2 amps. 19/9 6v. or 12v. 2 amps. 25/9 6 v. or 12 v. 2 amps, inclusive of Ammeter. 35/9 6 v. or 12 v. 4 amps. 39/9 6 v. or 12 v. 4 amps. with Ammeter and variable charge rate selector 52/9

CHARGER AMMETERS 0-1.5 a. 0-3 a. 0-4 a. 0-7 a. 0-2.5 a. 0-6.0 a. 8/9.

R.S.C. MAINS TRANSFORMERS (FULLY GUARANTEED)

Interleaved and Impregnated. Primaries 200-230-250 v. 50 c/s. Screened **TOP SHROUDED DROP THROUGH** 250-0-250v. 70mA. 6.3v. 2a. 0.5-6.3v. 3a 17/9 300-0-300v. 80mA. 6.3v. 2a. 0.5-6.3v. 3a 18/9 250-0-250v. 100mA. 6.3v. 2a. 6.3v. 1a .. 21/9 250-0-250v. 100mA. 6.3v. 3.5a. C.T. .. 19/9 250-0-250v. 100mA. 6.3v. 4a. 0.5-6.3v. 3a 25/9 300-0-300v. 130mA. 6.3v. 4a. 6.3v. 1a. for Mullard 510 Amplifier. .. 29/9 300-0-300v. 100mA. 6.3v. 4a. 0.5-6.3v. 3a 28/9 350-0-350v. 100mA. 6.3v. 4a. 0.5-6.3v. 3a 29/9 350-0-350v. 150mA. 6.3v. 4a. 0.5-6.3v. 3a 29/9 425-0-425v. 200mA. 6.3v. 4a. 5v. 3a .. 49/9 **FULLY SHROUDED UPRIGHT** 250-0-250v. 60mA. 6.3v. 2a. 0.5-6.3v. 2a. Midget type 24-3-3in. 17/11 250-0-250v. 100mA. 6.3v. 4a. 0.5-6.3v. 3a 27/9 300-0-300v. 100mA. 6.3v. 4a. 0.5-6.3v. 3a 27/11 300-0-300v. 130mA. 6.3v. 4a. C.T. 6.3v. 1a. for Mullard Amplifier. 33/9 350-0-350v. 100mA. 6.3v. 4a. 5v. 3a .. 27/11 350-0-350v. 150mA. 6.3v. 4a. 5v. 3a .. 35/9

FULLY SHROUDED (continued)- 425-0-425v. 200mA. 6.3v. 4a. C.T. 5v. 3a 55/- 425-0-425v. 200mA. 6.3v. 4a. C.T. 6.3v. 4a. C.T. 5v. 3a .. 59/9 450-0-450v. 250MA. 6.3v. 4a. C.T. 5v. 3a 69/9 **OUTPUT TRANSFORMERS** Midget Battery Pentode 66 : 1 for 3S4, etc. 4/6 Small Pentode, 5000 Ω to 3 Ω .. 4/6 Small Pentode 79,000 Ω to 3 Ω .. 4/6 Standard Pentode 5,000 Ω to 3 Ω .. 5/9 Standard Pentode 7,000 Ω to 3 Ω .. 5/9 10,000 Ω to 3 Ω .. 5/9 Push-Pull 8 watts, EL84, or 6V6 to 3 Ω or matched to 15 Ω .. 9/9 Push-Pull 10-12 watts to match 6V6 or EL84 to 3-5-8 or 15 Ω .. 19/9 Following types for 3 and 15 Ω speakers: Push-Pull 10-12 watts 6V6 or EL84 .. 19/9 Push-Pull 15-18 watts 6V6, KT66 .. 25/9 Push-Pull Mullard 510 Ultra Linear .. 29/9 Push-Pull 20 watts, sectionally wound, EL6, KT66, EL34, etc. .. 49/9

MIDGET MAINS Primaries 200-250 v.

50 c/s. 250 v. 80 mA. 6.3 v. 2a .. 11/9 200-0-250 v. 80 mA. 6.3 v. 2a .. 12/11 Both above size 2 1/2 x 2 1/2 x 2 1/2 in.

FILAMENT TRANSFORMERS

All with 200-250 v. 50 c/s. primaries 6.3 v. 1.5a. 5/9; 6.3 v. 2a. 7/9; 0-4-6.3 v. 2a. 7/9; 12 v. 1 a. 7/11; 6.3 v. 0.5 a. 5/11; 6.3 v. 6.3 v. 17/6; 12 v. 1.5 a. twice. 17/6.

SMOOTHING CHOKES 150 mA. 7-10 H H 250 OHMS .. 11/9 150 mA. 10 H 200 OHMS 4/6 80 mA. 10 H 350 OHMS 4/6 60 mA. 10 H 400 OHMS 4/11

CHARGER TRANSFORMERS

All with 200-230-250 v. 50 c/s Primaries: 0-1.5 v. 11 a. 12/9; 0-1.5 v. 2a. 14/9; 0-1.5 v. 3 a. 16/9; 0-1.5 v. 5 a. 19/9; 0-1.5 v. 6 a. 23/9; 0-1.5 v. 8 a. 28/9.

AUTO (Step up/Step down) TRANS. 0-110/220/320 v. 50-80 watts. 13/9. 250 watts. 39/9. 150 watts. 27/9.

MICROPHONE TRANSFORMERS 120 : 1 high grade, clamped. 6/9; 120 : 1 Potted. Mu-metal screened. 9/9.

Easy-to-build kit-sets of



highest quality at lowest cost



DX-40U

AMATEUR TRANSMITTER. Model DX-40U. Self-contained. 80-10 m. Power input 75 w. CW., 60 w. peak, C.C. phone. Output 40 w. to aerial. Provision for V.F.O.

£33.19.0

AMATEUR TRANSMITTER. Model DX-100U. Covers all amateur bands, 160-10 m. 150 w. D.C. input, self contained with power supply. Modulator, V.F.O.

£74.19.0



DX-100U

AUDIO SIGNAL GENERATOR. Model AG-9U. 10 c/s-100 kc/s, switch selected. Distortion less than 0.1%. 10 v. sine wave output metered in volts and dB's £21.9.6

VALVE VOLTMETER. Model V-7A. Measures volts to 1,500 (D.C. and R.M.S.) and 4,000 pk to pk. Res. 0.1Ω-1,000 MΩ. D.C. input impedance. 11 MΩ. With test prods, leads and standardising battery £13.18.6

R.F. SIGNAL GENERATOR. Model RF-1U. Gives accurate source of R.F. up to 100 Mc/s on fundamentals and 200 Mc/s on harmonics. Up to 100 mV output on all bands. £12.15.6

SINGLE SIDEBAND ADAPTOR. Model SB-10U.

May be used with most A.M. transmitters. Less than 3W R.F. input power required for 10W output. Operation on 80, 40, 20, 15 and 10m bands on USB, LSB or DSB £39.5.0



SB-10U

Printed circuit construction £27.19.6

HI-FI AM/FM TUNER. Tuning range: FM: 88-108 Mc/s. AM: 16-50, 200-550, 900-2,000 m. Tuning heart (£5.5.6 incl. P.T.) and I.F. amplifier (£20.13.0) sold separately. Printed circuit board Total £25.18.6

SHORTWAVE TRANSISTOR PORTABLE. Model RSW-1. Two short bands, trawler and medium £22.8.0

TRANSISTOR PORTABLE. Model UXR-1. Prealigned I.F. transformers, printed circuit, 7 x 4in., high flux speaker. Real hide case £14.3.0

TAPE RECORDING/PLAYBACK AMPLIFIER. Stereo (TA-1S) ... £24.10.0 Monaural (TA-1M) £19.2.6



S-99



AM/FM Tuner



TA-1S

HI-FI 18W STEREO AMPLIFIER. Model S-99. Ganged controls. Stereo/mono gram, radio and tape recorder inputs. Push-button selection. Printed circuit construction £27.19.6

5in. OSCILLOSCOPE. Model O-12U. Wideband amplifiers essential for TV servicing. F.M. alignment, etc. Vertical freq. response 3 c/s-5 Mc/s without extra switching. T/B covers 10 c/s-500 kc/s in 5 ranges £38.10.0

PORTABLE SERVICE OSCILLOSCOPE. Model OS-1. Compact portable scope ideal for servicing and general work. Y amplifier sensitivity 10 mV/cm; response. ± 3 dB 10 c/s-2.0 Mc/s. Time base 15 c/s-150 kc/s. Printed circuits. Case 7½ x 4½ x 12½in. long. Wt. only 10½lb. £19.19.0

"THE MOHICAN" GENERAL COVERAGE RECEIVER. Model GC-1U. Fully Transistorised.

Including 4 piezo-electric transfilters. Excellent portable or general purpose receiver for the amateur and short-wave listener. £39.17.6



GC-1U

NEW DELUXE AMPLIFIER. Model S-33H. A stereo/mono amplifier, 3-5 watt chan. Ideal for use with Decca Deram pick-up. Printed circuit. Attractive two-tone Grey perspex panel £15.17.6

6-W STEREO AMPLIFIER. Model S-33. 3 w/chl. inputs for radio-tape and gram., Stereo or Mono ganged controls. Sensitivity 200 mV. £13.7.6

HI-FI F.M. TUNER. Tuning range 88-108 Mc/s. Tuning Unit (FMT-4U) with 10.7 Mc/s I.F. output (£3.2.0 inc. P.T.) I.F. Amplifier (FMA-4U) complete with cabinet and valves (£12.6.0) Total £15.8.0

SINGLE CHANNEL AMPLIFIER. Model MA-12. 10-12 watt Hi-Fi amplifier. Extremely low distortion and wide frequency range £11.9.6

STEREO CONTROL UNIT USC-1. Luxury model with press-button inputs to suit any pick-up or tuner and most tapeheads. Output 1.3 v. R.M.S. per channel. Printed circuit construction

£19.10.0

Money Saving "PACKAGED DEALS" of Complete Stereo Equipment from £46.6.0

HI-FI SPEAKER SYSTEM. Model SSU-1. Ducted-port bass reflex cabinet "in white". Twin speakers. Pedestal model £11.19.6. Bookcase model

£11.5.0



MALVERN

HI-FI EQUIPMENT CABINETS. Range available to meet various needs. Details on request. (MALVERN equipment cabinet illustrated on the left) from £11.12.6 to £18.10.0.

"COTSWOLD" MFS SYSTEM. For the smaller room. Measures 36in. high x 16½in. x 14in. deep. Almost identical performance with standard Cotswold £23.4.0

"COTSWOLD" HI-FI SPEAKER SYSTEM. Acoustically designed enclosure "in the white" 24 x 23 x 15½in. 12in. bass speaker with 2in. speech coil, elliptical middle speaker. Pressure unit covers the full freq. range of 30-20,000 c/s, complete with cross-over unit, level control, etc. £23.4.0

AUDIO & DO-IT-YOURSELF accessories also available



COTSWOLD

Assembled models also available—prices on request. Deferred terms available over £10. Free Delivery U.K.

Please send me **FREE CATALOGUE** (Yes/No) _____
 Full details of model(s) _____

 NAME _____
 ADDRESS _____
 _____ PW2_____

DAYSTROM LTD.

Dept. P.W.2, GLOUCESTER, ENGLAND

A member of the Daystrom Group, manufacturers of the
WORLD'S LARGEST-SELLING ELECTRONIC KITS

HARVERSON'S F.M. TUNER Mk.I

● F.M. tuning head by famous maker. ● Guaranteed non-drift. ● Permeability tuning. ● Frequency coverage 88-100 Mc/s. ● OA81 balanced diode output. ● Two I.F. stages and discriminator. ● Attractive maroon and gold dial (7 x 3in. glass). ● Self powered, using a good quality mains transformer and valve rectifier. ● Valves used ECC85, two EF80s, and EZ80 (rectifier). ● Fully drilled chassis. ● Size of completed tuner 8 x 6 x 5 1/2 in. ● All parts sold separately. £5.19.6, plus 8/6 P.P. and Ins. Circuit diagram and illustrations 1/8 Post free. **Mark II Version** as above but complete with metric eye, front panel and brackets. £8.12.6. P. & P. 5/6. **Mark III Version** as Mark I but with output stage (ECL92) and tone control. £7.7.0. P. & P. 8/6. Handsome Metal Cabinets. Choice of Grey, Black or Green. To fit Mark I, £5.1. P. & P. 2/6. To fit Mark II, 12/8. P. & P. 2/6.

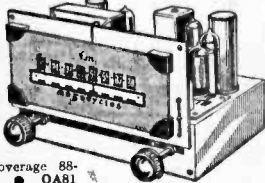

6 TRANSISTOR AND DIODE SUPERHET

A first-class 2 waveband transistor superhet in kit form. ● Printed circuit panel (size 8 1/2 x 2 1/2 in.) ● 3 pre-aligned I.F. transformers. ● High-grade Ferrite rod aerial. ● First-grade G.E.C. transistors. ● Car aerial winding. ● Push-pull output. ● All parts supplied with simple instructions. All parts sold separately.

ONLY £4.5.0 P. & P. 2/6

2 1/2in. 35 ohms speaker, 10/8; 3 1/2in. 35 ohms speaker, 16/8; 3 1/2in. 5in. F.M., 16/8; 7 x 4in. 35 ohms speaker, 21/-; P. & P. 1/6 per speaker.

Portable CABINET

Size approx. 9 1/2 x 6 1/2 x 3 1/2 in. Suitable for above using 3 1/2 in. speaker. 25/-; P. & P. 2/6.

COIL AND TRANSFORMER SET FOR TRANSISTOR SUPERHET

3 I.F. transformers, one oscillator coil, one driver transformer and wound Ferrite aerial (med., long and aerial coupling), 28/6 complete, post 1/6. 6 transistor printed circuit, board to match, 8/6, post 3d. Circuit diagram 1/8 extra.

QUALITY RECORD PLAYER AMPLIFIER

A top-quality record player amplifier. This amplifier (which is used in a 29 gm. record player) employs ECC85, EL84, EZ80 valves. Bass, treble and volume. On/off controls.

PRICE 69/6 P. & P. 3/6

DITTO. Mounted on board with output transformer and 8 1/2 in. speaker. Complete at 89/6, P. & P. 4/6

TRANSISTORS

GET15 (Matched Pair) 15/-
OC71 .. 5/- .. PXA101 .. 6/6
OC72 .. 6/- .. XA103 .. 6/6
OC76 .. 8/- .. V1510p .. 12/6
Set of Mullard 6 transistors 25/-; Set of G.E.C. 1,574; 2873, 3, S1 or GET14, 20/-; All Post Free.

BARGAIN OFFER!

TELEFUNKEN HI-FI STEREO AMPLIFIER. 110/P250 V. A.C. input. 5 watt undistorted output (10 watts nominal). Size 12 x 9 x 2 1/2 in. Weight 9 lb. Complete with spec. and instructions. £5.19.6 Carr. 3/6.

Also Model S82. Similar specification but with balance control. £8.19.6. Carr. 3/6.

10/14 WATT HI-FI AMPLIFIER KIT

A stylishly finished monaural amplifier with an output of 14 watts from 2 EL84s in push-pull. Super reproduction of both music and speech, with negligible hum. Separate inputs for mike and gram allow records and announcements to follow each other. Fully shrouded ultra output transformer to match 3-15 speaker) and 2 independent volume controls, and separate bass and treble controls are provided giving good lift and cut. Valve line-up 3 EL84s, ECC83, EF86 and EZ80 rectifier. Simple instruction booklet 1/6. (Price with parts.) All parts sold separately.

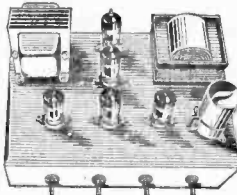

ONLY £6.19.6 P. & P. 6/6.

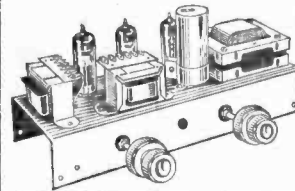

STEREO AMPLIFIER Bargain Offer

- ★ 4 watts per channel.
- ★ Full tone and volume controls.
- ★ Complete with sockets, etc.

89/6 P. & P. 2/6.

AMPLIFIER ON PRINTED CIRCUIT BOARD

Two valve. UY83, UL84 O.P. trans., use with 80 volt tap of motor. 38/6. P.P. 2/6 on above. Dropper res. for filaments if required. 2/6.

B.S.R. AUTO UNITS 180 v. Suitable for use with above. (Slightly soiled.) £5.5.0. P. & P. 5/6.

LARGE CABINET Suitable for above two items. Complete with 3 ohm speaker. £39.6 Carr. 5/6.
Superior CABINET Similar to above to take 8 x 5 in. speaker, with motor board, will accommodate B8R UA14 or UA16. £39.6. Carr. 5/6. Speaker 15/- extra. P. & P. 1/6 extra.

BRAND NEW 3 OHM LOUSPEAKERS

2 1/2in. 12/8; 5in. 12/8; 6 1/2in. 15/-; 10in. 21/-
12in. 27/6. Goodmans 5in. tweeter 10/6
E.M.I. 2 1/2in. tweeter .. 10/6
Goodmans 5in. x 5in. middle register speaker .. 10/8
Goodmans 10in. x 8in. .. 22/6
E.M.I. 13 1/2in. x 8 1/2in. high flux .. 32/6
Rola Celestion approx. 9in. x 6in. middle register speaker .. 10/6
Also 16 ohm 12in., 30/-; P. & P. 1/6 per Speaker.

4-SPEED PLAYER UNIT BARGAINS

SINGLE PLAYERS
TU/12, £3.16.0. Carriage 3/6.
AUTO CHANGERS
B.B.R. UA14, £6.19.6. Latest B.S.R. UA16, £7.19.6. Latest Garrard 'Auto-81mu' £7.15.0. Carr. 6/- on each.

SPECIAL OFFERS!

GORLER F.M. TUNER HEADS. 10.7 Mc/s I.F., 16/-; plus 1/9 P. & P. (ECC85 valve 8/6 extra).
ELECTROSTATIC H.F. TWEETERS. Type L.S.H. 75. Size 3 x 3 in., 2/8 each, plus 9d. P. & P.
MIDGET 2 GANG CONDENSERS. Capacity 195 and 100 pF. Polystyrene case with built in trimmers. Size 1 x 1 1/2 in. Not used but removed from P/C Boards. Two for 9/-; Plus 1/- P. & P.
ACOS CRYSTAL MIKES. Hi-imp., 18/6. P. & P. 1/6.
TRANSISTOR DRIVER and O/P TRANSFORMERS. (Tapped 3 ohms and 15 ohms output), plus 4 suitable Transistors giving approx. 1 watt output. 30/-; P. & P. 2/6.
MAINS TRANSFORMERS. Tapped Primary, 1 wave or Bridge Rectifier. Secondary 250 v. at 75 mA 6.3 volts at 2 amps. 7/8 each. P. & P. 3/6.
3 PUSH-BUTTON TRANSISTOR SWITCH. D.P.—D.T. Each Switch 3/6 and 1/- P. & P.

SPECIAL PURCHASE! TURRET TUNERS

Brand new and unused. Complete with PCC84 and PCF80 valves. 34-38 Mc/s I.F. Biscuits for Channels 1 to 5 and 8 and 9. Circuit diagram supplied. **ONLY 25/- each. P.P. 2/6.**

F.M. TUNER HEAD

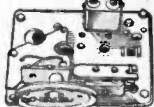

A permeability tuned tuner head by a famous maker, supplied without valve (ECC85) and drum and spindle, 18/6; plus 1/9 P. & P. Valve 8/6 extra. Drum and spindle 3/6 extra.

E.M.I. 4-speed Player and P.U.

FURTHER HUGE PURCHASE enables us to offer these at 60/8, P. & P. 4/6.

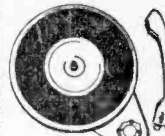

Heavy 8 1/2 in. metal turntable. Low flutter performance 200/250V shaded motor with tap at 45V for amplifier valve filament if required. Turnover LP/78 head.

GOOD COMPANION RECEIVERS

SPECIAL OFFER FOR ONE MONTH ONLY!

Easy to build, using 6 super transistors and 2 diodes 750 M/W output, full medium and long wave coverage, printed circuit, 6in. speaker, prealigned IPT's & OSC. Very fine tuning, ferrite aerial with car aerial socket, attractive 2-colour cabinet. Simple to follow instructions with circuit, everything complete (less P.P.9 battery). Standard version £8.19.6 (P. & P. 3/6 extra other type).

LOUDSPEAKER SILKS

5 1/2 in. wide. Heavily woven in Ivory and gold. Originally 35/- per yard length. **OUR SPECIAL PRICE** 13/8 per yard length. P. & P. 1/6. Also Red Regime, Dark Grey and Oatmeal (fabrics for cabinet covering, 5 1/2 in. wide, 13/8 per yard length. P. & P. 1/6.

HARVERSON SURPLUS CO. LTD.

170 HIGH ST., MERTON, S.W.19. Cherrywood 3985/6

Open all day Saturday. Early closing Wed., 1 p.m.

A few minutes from South Wimbledon Tube Station. Please Note: P. & P. charges quoted apply to U.K. only. P. & P. on overseas orders charged extra.



Complete FM (V.H.F.) AM RADIO FOR £12.10.0

(carr. paid)
Brand new set, in superb walnut cabinet (size 19 x 8 1/2 x 14 1/2 in. high). Covering 80-100 Mc/s. 16-49 M. and 200-500 M. Mains trans. 200-250 v. with 2 tapplings. Ferrite rod aerial for A.M. Controls: volume on/off, tone tuning, w/change. Gram and ext. speaker position provided. Valves 12AT7, 12A8S, 6BJ6, EABC80, 6BW6 and metal rectifier. Fully guaranteed. Today's Value, £20.

TAPE TOP QUALITY BOXED. 5tin.—850ft., 15/-; 1,200ft., 17/6; 7in.—1,200ft., 17/6; 1,800ft., 26/6 (all plus 1/6 post. 2/- for 2).

THE "MILAN" 6-TRANSISTOR AND DIODE PORTABLE COMPLETE KIT FOR ONLY £6.12.6

(post 3/6)



500mW push-pull output. Ferrite rod aerial. Car aerial socket and coil, M.W. and L.W. full coverage. Operates on two 4.5v. cells. Printed circuit board 8 1/2 x 2 1/2 in. All holes drilled and component positions marked. Instructions 2/6 for 16 p. (refunded on purchase of kit). Size 9 x 3 1/2 x 7 in. 8 x 2 1/2 in. P.M. high quality speaker. Attractive Vynair covered cabinet, two tone. Two batteries 5/6 the pair (Ever Ready 126). Mullard transistors OC44, 2 x OC45, OC81D, and 2 x OC71. Top grade. Westmonth Radio cells and transformers. Abundant service if required 17/6 (inc. post). Write for list of prices. All parts supplied separately. Built in two hours.

BUILD YOUR OWN RECORD PLAYER

Price £12 carr. paid
Fully built 2-valve amplifier

R.S.R. 4-sp. autochanger, case 17 x 15 x 8 1/2 in. Assembled in 15 mins. Similar cabinet for tape recorder with plain board only £3, carr. paid. Attractive colours
or with 3-valve amplifier 15/- extra

AUTOMATIC RECORD CHANGERS—LATEST MODELS. 4 SPEED CRYSTAL CARTRIDGE. All 5/- extra carr. B.S.R. UA14, £7.10.0. Garrard Slimline, Mono £3. Stereo, £8.5.0. Motor Board for UAS, UA20. UA14, Slimline, 5/- (post 1/6) or 3/6 post paid when purchased with Autochanger.

TELEPHONE STEREO AMPLIFIERS. 2 ECL82—2 x 24 watts, 12 x 9 x 2 1/2 in. piano keys, 27/- post paid. Complete, with power.

SELF-POWERED VHF TUNER CHASSIS

Covering 55-95 Mc/s. Mullard permeability Tuner. Dims. 10 1/2 x 4 1/2 x 5 1/2 in. ECC85 and 3—EPP91 and 2 diodes. Metal Rectifier. Mains transformer. Fully wired and tested. Only £8.0.0. (carr. p.l.). Some tarnished chassis otherwise O.K. £5.10.0
Vynair Cabinet included. Room dipole 12/6. Feeder, 6d. yd.

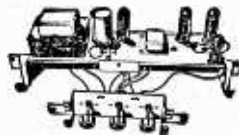
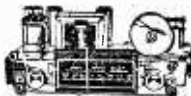

PUSH-PULL AMPLIFIER £5.5.0

(5/- Carr.)

Brand new 200-240 A.C. mains. Bass, treble and vol. controls. With valves E280, EUC83 and 2-EL84 giving full 8 w. Chassis 12 x 3 1/2 x 3 1/2 in. With o.p. trans. for 2-3 ohm speaker. Front panel (normally screwed to chassis) may be removed and used as "dying panel." Stereo version 2 x 4 w, same price.

TAPE RECORDER AMPLIFIER

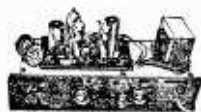

Type TR3. Fully built, high gain, low noise, printed circuit. Attractive grey and gold trim panel 13 x 1 1/2 in. Height 3 1/2 in. overall. Front to back 5 1/2 in. Vol. and on/off tone. Micro. radio, monitor and ext. speaker lacks. Valves EUC83, ECL82, E280. Mains trans. Ready to bolt to B.S.R. Deck, (complete with switch water, wired. Our Price ONLY £8.5.6 (6/- Packing and Carr.). Similar model without magic eye. Type T.R.1, 5in. Instead of 1 1/2 in. £5.15.0. (6/- Carr.). Also available for Collaro Deck at 5/- extra each model.

Transistor Set Battery Eliminator. Converts your 6 transistor receiver to mains operation. With hex lead and battery charging attachment. For Miniature Sets, size 1 1/2 x 1 x 1 1/2 in. Price 18/3. For Larger Sets, 3 x 1 1/2 x 1 1/2 in. Price 24/6.

NEW LOUDSPEAKER BARGAINS. Good Makes.

2-3 ohms 13 x 9 1/2 in. 35/- (4/-); 7 x 4 in. 14/6 (2/-); 6 1/2 x 4 1/2 in. 12/6 (2/-); 10 x 6 in. 25/- (2/-); 5 in. 12/- (2/-); 4 in. tweeter 7/6 (2/-); 7 x 5 in. 17/6 (2/-); 9 x 6 in. 22/- (2/-); 8 in. circ. 18/6 (2/6). Postal charges bracketed.

BRAND NEW AM/FM (V.H.F.) RADIOGRAM CHASSIS AT £14.0.0 (Carriage Paid)

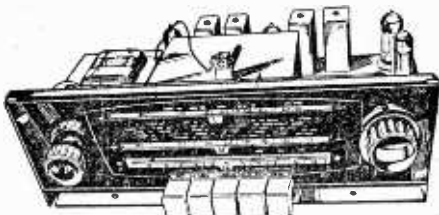

A.C. ONLY. Chassis size 15 x 8 1/2 x 9 1/2 in. high. New manufacture. Dial 14 1/2 x 4 in. in 2 colours, predominantly gold. Pick-up, Ext. Speaker. Ae., E. and Dipole Sockets. Five push buttons—OFF L.W., M.W., P.M. and Gram. Aligned and tested. O.P. Transformer. Tone Control. 1000-1000 M.; 200-300 M.; 88-98 Mc/s. Valves E280 rect.; ECH81, EF89, EABC80, K154, ECC85.

Speaker and Cabinet to fit chassis (table model). 4/6 (post 4/-). 9 x 6 in. ELLIPTICAL SPEAKER, 20/-, in purchasers of this chassis. TERMS: (Chassis) £. down and 5 monthly payments of £2. Cheap Room Dipole for V.H.F. 12/6. Feeder 6d. yd. Circuit diagram 2/6.

"SCALA" 6-TRANSISTOR AND DIODE KIT FANTASTIC VALUE

£6.5.0 (Post 3/-)

uses P.P.6 Battery



All Brand New Parts—attractive cabinet—choice of 6 colours: 8 1/2 x 2 x 5 1/2 in. high. Ferrite aerial, printed circuit, good styling. 3 1/2 in. speaker, fully tunable L.W. and M.W., 400 M.W. push-pull output. All parts supplied separately. Write for Price List. Construction Book and Circuit 2/6 (refunded when kit purchased) or fully built at £9.17.6 including battery.

THIS SUPERB SET FOR £10

6-transistor radio covered in sponge clean Duracour fabric, in latest two-tone shades, M.W. and L.W. ferrite rod, provision for car aerial, 2-colour scale. With PP9 battery giving 300 hours use. Weighs under 4 lbs. With carrying handle. 12 x 7 1/2 in. high x 4 1/2 in. at base tapering to 2 in. at top. Brand new, fully guaranteed, £10. Carr. paid. Worth £16.

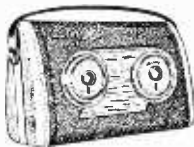

SUPERIOR GRAMPHONE AMPLIFIER

Valves UY85, UF80 and UL84. Mains trans. 200-240 a.c. Covered baffle 13 1/2 x 7 1/2 in. (9 1/2 in. speaker) or 11 x 7 1/2 in. (8 x 5 1/2 in. speaker). 3 front controls, bass, treble, on-off/vol. 74/- (post 4/-) either type. Rexine cabinet to fit, with carrying handle, and lid (detachable) 1 1/2 in. or 12 x 8 1/2 x 5 1/2 in. 16/- extra.

GRAMPHONE AMPLIFIER. With 6in. SPEAKER Baffle 12 1/2 x 6in. ECL82 and Rectifier, Tone and Volume. On/off switch. Useful for Stereo. 57/- (post 4/-).

SPECIAL OFFER

Brand new tape recorder, two-tone beige case, "gold" trimmings. Magic eye, monitor, ext. speaker sockets. With 5 1/2 in. tape and mike. Fully guaranteed. Price usually 147 gns. Very high gain with low noise. Price £15, carr. paid.

COLLARO STUDIO TAPE TRANSCRIBOR, 3 MOTORS, 3 SPEED. 1 1/2, 3 1/2 and 7 1/2 I.P.S. Push buttons, £10.17.6 (10/- carr.) inc. spool.

BATTERY ELIMINATOR

For 4 Low Consumption Valves (96 range). 90v. 15mA and 1.4v. 125mA, 45/- (2/6 post). 200-250v. A.C. Also for 250mA. 1.4v. and 90v. 15mA a same price. Two separate units to replace existing batteries.

BATTERY RADIO

Valves DK96, DF96, DAF96, DL96. Two short Wavebands 16 to 49 M and 25 to 75 M. Size 10 1/2 x 4 1/2 x 5 in. £4.18.0, carr. paid. M.W. and S.W., £5, carr. paid.

ALL ITEMS ARE NEW AND FULLY BUILT UNLESS OTHERWISE STATED. TESTED BEFORE DESPATCH. Terms Available on Items over £5. Send 6d. (stamps will do) for 20-page illustrated catalogue. Delivered by return. C.O.D. 2/- extra.

ALL ITEMS GUARANTEED 12 MONTHS VALVES 3 MONTHS

GLADSTONE RADIO

"SCALA", CAMP RD., FARNBOROUGH, Hants.

(Farnborough 3371) and at 247 New Road, Copnor, Portsmouth. FARNBOROUGH CLOSED SATS.—PORTSMOUTH WEDS.

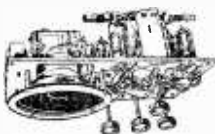

**TABLE MODEL
TRANSISTOR SET**
£9.10.0 (carr. paid)

6 transistors and diode. 5in. circular speaker, superhet circuit. Cabinet 13 x 7½ x 4½in., battery included. Fully tunable L.W. and M.W. Polished walnut front.

**MAINS OPERATED RADIO CHASSIS AND
AMPLIFIER OF FAMOUS MANUFACTURE**

Chassis 10 x 5½ x 4in. front to back. Valves: UBC41, UCH41, UF89, UL84 with metal rectifier. 5in. speaker. Ferrite rod aerial. Tone, vol. and gram. position. Covers L. and M. waves. Limited quantity at only 86 (5/- carr.) complete with small dial. Unused and in working order.



TELEFUNKEN

German made F.M. front end, 22/6 (post 2/6), with EOC85 valve. Permeability tuned, 88-89 Mc/s. 4 x 1½ x 2½in. high plus valve 2in. Circuit 2/-.

MULLARD

Permeability tuned F.M. front end 22/6 (post 2/6), with EOC85. 4 x 3 x 3½in. 88-96 Mc/s.



**4 TRANSISTOR
MINIATURE PUSH-PULL
AUDIO AMPLIFIER**

For 3 ohm speaker. 200mW output suitable for intercoms. Portable radios, etc., with free instruction sheet and diagram. For mike or radio input 4 x 1½ x 1. Printed circuit 47/6, post paid.

TRANSISTORS POST FREE

Set of 6 Mullard transistors OC44, 2-OC45, OC81D, 2-OC81 (matched) and OA70 diode 30/-; set of G.C.E. transistors 874, 2-873, 2-82 or 83, 17/6.

PANEL OF 7 POTS
10 x 1½in.—4 x 1M and
3 x 2M. 4/- (post 1/-).



PERSPEX

12½ x 9½ x ½in. clear, 5/-. Postage on one sheet 2/-, on two or more 3/-

TRANSISTOR COMPONENTS

M.W. and L.W. ferrite rod aerial, with car coupling coil. For 208pF condenser, 8/-; Osc. coil; 1st, 2nd and 3rd I.F.'s, all 5/6 ea.; Driver trans., 7/6; min. 64mF 10v; 10mF 16v; 30mF 6v; all 1/8 ea.; Tuning cond. 208mF + 176pF 8/6; post 9d. on all orders.

5 WATT AMPLIFIER

Our price ONLY 56/- (post 4/-); a few hundred only; valves EF91 and EL84 with metal rectifier; 6 x 4 x 1½in. high (5in. over EL84). Mains trans. and o.p. with vol. and tone controls; on-off; co-ax input.

**SPECIAL OFFER OF
RECORDER CABINET**

Plain boards, polished walnut finish, 38 x 15½ x 23in. high plus 5in. legs. Part delivery charge of £1, as offered elsewhere at over £22, brand new. Fitted with 3 sliding doors.



PRICE **£13**

**COMPONENTS FOR "P.W." AMPLIFIER,
GENERATOR, ETC.**

Tubular condensers 350v 0.01, 0.02, 0.05mF/d, 6d. ea; 0.25 and 0.5mF/d, 9d. ea; Resistors ¼w 10%, 500v, 3/6; 20%, 500v, 3/6; D.P.S.T. toggle switch, 3/-; 50mA, 5/6; 16-16mF/d Elect. 500v, 3/6; D.P.S.T. toggle switch, 3/-; High stab resistors 1/- ea; Valve holders B71 and B9a with skirt and screen, 1/- ea; Co-ax socket 1/-; 1M and 25k pots with spindle 2/6 ea; SK2, SK4, and SK5 sockets 3/- ea; ditto plugs 3/- ea; add postage. Also many other items specified. S.A.E. enquiries.

● **TECHNICAL**
● **TRAINING**
● **in radio**
● **television and**
● **electronics**

Whether you plan to have your own business, to become an electronics engineer, to take up a career in industry, or to brush-up your knowledge and study new developments, transistors, etc., an I.C.S. Course will help you to success. You learn at home in your own time, under expert tuition. Moderate fees include all books.

EXAMINATION COURSES FOR:—

**C. & G. Radio
and
TV Servicing Certificate**
(R.T.E.B.)

**C. & G. Radio
Amateurs' Exam.**
(Amateurs' Transmitting
Licence)
P.M.G. Certificates in
Radiotelegraphy

**British Institution of Radio Engineers, etc.
C. & G. Telecom. Technician's Cert.**

LEARN AS YOU BUILD

**Practical Radio
Servicing Course**

A basic course in radio electronic and electrical theory backed by thorough practical training. You build radio receivers, signal generator and multi-tester.



Post this Coupon TODAY! for FREE book on careers in Radio, and full details of other I.C.S. Courses

**INTERNATIONAL CORRESPONDENCE
SCHOOLS**

(Dept. 171), Intertext House, Parkgate Road, London, S.W.11.

Please send book on _____

Name _____ Age _____
(Block Letters Please)

Address _____

Occupation _____ 2.63

INTERNATIONAL CORRESPONDENCE SCHOOLS

ARMSTRONG AF208AM/FM RADIOGRAM CHASSIS

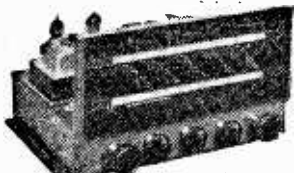

★ Full VHF Band (87-108 Mc/s and Medium Band, 187-370M) ★ 7 Valves ★ 5Watts Output ★ 15dB Negative Feedback ★ Separate wide range Bass and Treble Controls ★ 2 Compensated Pick-up Inputs ★ Frequency Response 30-22,000 c.p.s. to 20B ★ Tape Record and Playback Facilities ★ Continental Reception of Good Programme Value ★ For 3, 7 $\frac{1}{2}$ and 15 ohm speakers. Send S.A.E. for leaflet.

PRICE. **£22.18.0** Carr. Free

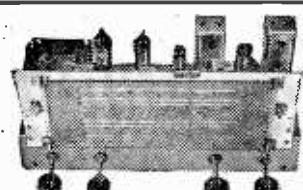

1963 RADIOGRAM CHASSIS

THREE WAVEBANDS FIVE VALVES
R.W. 16 m. - 50m. LATEST MULLARD
M.W. 200 m. - 550 m. ECH81, EF89, EBCH1,
L.W. 800 m. - 2,000 m. EL84, EZ80,
12-month guarantee.
A.C. 200/250 v. 4-way Switch; Short-Medium,
Long-Gram. A.V.C. and Negative feedback,
3 ohm output, 5 watts, Chassis 13 $\frac{1}{2}$ x 5 $\frac{1}{2}$ x 2 $\frac{1}{2}$ in.
Glass dial, horizontal or vertical wording, size
10in. x 4 $\frac{1}{2}$ in. Aligned and calibrated. Isolated
Chassis.

£9.10.0 Carr. & Ins. 4/6

COMPLETE RADIO

CHASSIS £5.19.6. post free

4 Mullard valves, 5in. speaker.
Superhet Circuit. BRAND NEW.
Size 9 x 6 x 5 $\frac{1}{2}$ in. high. Tested by us ready
for use. 200/250 v. A.C.-D.C. Mains.

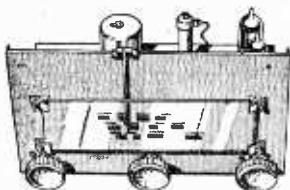

DE LUXE MODEL, as illustrated with
illuminated dial. Fully variable over
Medium and Long Wave. 12-month Guar-
antee. Only **£5.19.6** post free.

MAINS TRANSFORMERS 200/250 v. A.C.

Postage 2/- each transformer.

- STANDARD. 250-0-250, 80 mA, 6.3 v. 3.5 a. Tapped 4 v. 4 a. Rectifier, 6.3 v. 1 a. 5 v. 2 a. or 4 v. 2 a. 22/8, ditto, 350-0-350 .. 29/8
- MINIATURE 200 v. 20 mA, 6.3 v. 1 a. 10/8
- MIDGET, 220 v. 45 mA, 6.3 v. 2 a. .. 15/6
- SMALL, 220-0-220, 50 mA, 6.3 v. 2 a. .. 17/8
- STD. 250-0-250, 65 mA, 6.3 v. 3.5 a. .. 17/8
- HEATER TRANS. 6.3 v. 1 $\frac{1}{2}$ amp. .. 7/6
- Ditto, tapped 1.4, 2, 3, 4, 5, 6.3V .. 8/8
- Ditto, sec. 6.3 v. 4 amp. .. 10/8
- GENERAL PURPOSE LOW VOLTAGE, 2 amp. 3, 4, 5, 6, 8, 9, 10, 12, 15, 18, 24, 30 v. .. 22/8
- AUTO TRANSFORMER, 150 v. .. 22/8
- 0, 115, 200, 230, 250 v., 500 v. .. 22/8
- MULLARD "510" Mains transformer .. 30/-
- PARMECO MAINS TRANSFORMER. Made for special contract, the ratings are safely be doubled. Guaranteed 2 years. Primary 0-110-210-230-250 v. H.T. 300-0-300 v. 50 mA. L.T. 6.3 v. 1.8 amp. Size 4 x 3 $\frac{1}{2}$ x 3 $\frac{1}{2}$ in. Weight 8lb Post 2/6
- MAINS POWER PACK. Size 3 $\frac{1}{2}$ x 4 $\frac{1}{2}$ x 4 $\frac{1}{2}$ in. with mains transformer, metal rectifier and condensers to provide smoothed H.T. output 220 v. 45 mA. D.C., L.T. 6.3 v. 2 a. Centre tapped. Already built on a strong metal chassis. Brand New. Bargain. Post 2/6 .. 22/8

INTERVAL TRANSFORMERS 3:1 or 5:1, 9/-

- O.P. TRANSFORMERS. Heavy Duty 50 mA, 4/6. Multitap, 7/6. Multi-ratio heavy duty push pull, 10 v., 15/6. Miniature, 384, etc., 5/9.
- L.F. CHOKES 15/10H, 60/65 mA, 5/-; 10 H., 85 mA. 10/6; 10 H., 150 mA, 14/-
- FULL WAVE BRIDGE SELENIUM RECTIFIER: 2, 6 or 12 v. 1 $\frac{1}{2}$ amp., 8/6; 2 a., 11/3; 4 a., 17/8
- CHARGER TRANSFORMERS. Tapped input 200/250 v. for charging at 2, 6 or 12 v., 1 $\frac{1}{2}$ amps., 15/6. 2 amp., 17/8; 4 amps., 22/8. Circuit included.
- 4 AMP. CAR BATTERY CHARGER with ammeter Leads, Fuse Case, etc., for 6 v. or 12 v., 69/9.
- AMMETER. 0 to 5 amp. 9/8.

BOOKS list S.A.E.

- 40 Circuits for Germanium Diodes 3/-
- "H.W." Radio Valve Data, 6/-
- High Fidelity Speaker Enclosure, 5/-
- Valve and TV Tube Equivalents, 9/6
- TV Fault Finding, 5/-
- Quality Amplifiers, 4/6
- Radio Valve Guide. Books 1, 2, 3 or 4, 5/- each.
- Transistor Superhet Receivers, 7/6
- Practical Radio Inside Out, 3/6
- Master Colour Code Chart, 1/6
- Transistor Controlled Models, 7/6.

4 TRANSISTOR PUSH-PULL AUDIO

Size 3 x 1 $\frac{1}{2}$ x 1. AMPLIFIER

A ready built miniature push-pull amplifier with input and output transformers, 4 transistors. Ideal for use with record players, intercoms, BABY ALARMS, etc. Complete with full instructions and circuit.
Price **52/6** 9v. Batt. 2/3, 2 $\frac{1}{2}$ in. Speaker 15/-

C.R.T. BOOSTER TRANSFORMERS

for heater cathode short circuit, or tubes with falling emission. Full instructions supplied. mains input. Type A optional 35% and 50% boost. 2v. or 4v. or 6.3v. or 10.8v. or 12.6v. State voltage required. PRICE 10/6.

LOUDSPEAKERS P.M. 3 OHM. 2 $\frac{1}{2}$, 3, 4in., 19/8,

5in. Rola, 17/8; 8in. Plessey, 19/8; 7in. x 10in. Rola 18/-; 6in. Rola, 18/6; 10 x 6in. 27/8; 4in. Rola, 30/-; 4in. Tweeter, 25/-; 12in. R.A. 30/-; 13 $\frac{1}{2}$ x 8in., Double Cone E.M.I. 45/-
STENTORIAN HF1012, 10in. 3to 15 ohms, 10 v. 95/-; 35 ohm. 7 x 4in., 25/-; 5in., 22/8; 3 $\frac{1}{2}$ in., 19/8.

BAKER SELHURST LOUDSPEAKERS

Details S.A.E.

12in. Baker 15w. Stalwart or 15 ohms, 45-13,000 c.p.s. .. 90/-
12in. Stereo, Foam Suspension, 12w., 35-16,000 c.p.s. .. 28.17.8
12in. Baker Ultra Twelve, 20 c.p.s. to 25 kc/s. £17.10.0
15in. Auditorium, 35 w., Bass, 20 c.p.s. to 12 kc/s. £18
Details and Enclosure plans S.A.E.



TWIN GANG TUNING CONDENSERS. 385 pF,

miniature 1in. x 1 $\frac{1}{2}$ in. x 1 $\frac{1}{2}$ in., 10/-, 500pF Standard with trimmers, 9/-; midget, 7/8; with trimmers, 9/-; 500pF slow motion tuning, standard or midjet, 9/-
SMALL 3 gang 500 pF, 17/-, SINGLE 365 pF, 7/8.
SINGLE 25 pF, 50 pF, 75 pF, 100 pF, 160 pF, 6/8. Solid dielectric 100, 300, 500 pF, 3/8.
CONDENSERS. New stock. 0.001 mfd. 7 kV. T.C.C. 5/8; Ditto, 20 kV, 9/8; 0.1 mfd., 7 kV, 9/8. Tubular 500 v. 0.001 to 0.05 mfd., 8d. 0.1, 1/-; 0.25, 6/-; 0.5/300 v., 1/9; 0.1/650 v., 9d.; 0.1/2,000 v. 0.1/1,000 v., 1/9; 0.1 mfd., 2,000 volts, 3/8.
KERAMIC COND. 500 v. 0.3 pF to 0.01 mfd., 9d.
SILVER MICA CONDENSERS, 10% 5 pF to 500 pF 8d.; 600 pF to 3,000 pF, 1/-. Close tolerance (± 1 pF) 2.2 pF to 47 pF, 1/-. Ditto 1% 50 pF to 815 pF, 1/-; 1,000 pF to 5,000 pF, 1/8.

465 Kc/s SIGNAL GENERATOR

Price 15/-. Uses B.F.O. Unit ZA 30038 ready made with valve IS5. POCKET SIZE 2 $\frac{1}{2}$ x 4 $\frac{1}{2}$ x 1in. One resistor to change. Full instructions supplied. Battery 8/6 extra. 69V 11V. Details S.A.E.

WAVECHANGE SWITCHES

3 p. 2-way or 2 p. 6-way long spindle .. 8/8
4 p. 2-way or 4 p. 3-way long spindle .. 3/6
3 p. 4-way, or 1 p. 12-way long spindle .. 8/8
Wavechange "MAKITS". Wafers available: 1 p. 12 way, 2 p. 6 way, 3 p. 4 way, 4 p. 3 way, 6 p. 2 way, 1 way switch, 8/6; 2 wafer switch, 12/8; wafer switch, 1/6; additional wafers up to 12. 3/6 d.p. extra. Toggle Switches, s.d., 2/-; d.c., 3/8; d.p.d.c., 4/-; Rotary s.d., 3/6; d.p., 4/6.

CRYSTAL MIKE INSERT, 8/6

Size 1 x 1 $\frac{1}{2}$ in. or 1 $\frac{1}{2}$ in. dia. 8/6
ACOS MIC. 60, insert 1 $\frac{1}{2}$ in. dia. 8/6
ACOS 39-1 DE LUXE STICK MIKE 35/-
TSL QUALITY STICK MIKE 25/-

Valveholders. Pax. Int. oct., 4d. EA50, 8d. B2A, CRT 1/3. Enrl. and Amer. 4, 5 and 7 pin, 1/-; MOULDED Mazda and int. oct., 6d.; BTG, B2A, BBG, B9A, 9d. BTG with can, 1/6. B9A with can, 1/9. Ceramic EF50, BTG, B9A, int. oct., 1/-; BTG, B9A cans, 1/- each.

Quality 3-Stage HI-FI AMPLIFIER

A.C. only. 200-250 v. Valves ECL86 and EZ90. 3 watt quality output. Mullard tone circuits, bass boost, treble and volume controls. Separate engraved front panel with de-luxe finish. Heavy duty output transformer 3 ohm. Quality mains transformer. Stove enamelled chassis size 6in. x 5in. x 3in. Bargain Price £4.10.0. Circuit supplied.

BARGAIN SALE PRICES

New Boxed Valves 90-day Guarantee

024	5/-	6K7G	5/-	EABC80	9/-	PCL282	10/-
1R5	6/-	6K9G	5/-	EB91	4/-	PCL94	10/-
185	6/-	6L6G	8/-	EBRC41	8/-	PL81	10/-
1T4	3/-	6N7M	5/-	EB81	8/-	PL83	8/-
2X3	2/-	6Q7G	5/-	EBF90	9/-	PV80	7/-
384	7/-	6SN7	5/-	ECH42	9/-	PY81	8/-
3V4	7/-	6V8G	5/-	ECH81	9/-	PY82	8/-
3C5	7/-	6X4	5/-	EF85	6/-	PY83	8/-
5U4	6/-	6X5	5/-	EF89	8/-	PQ25	7/-
5Y3	6/-	12AT7	6/-	EL32	5/-	RP41	3/-
5Z4	9/-	12AU7	6/-	EL84	7/-	RP81	8/-
6AC7	4/-	12AX7	7/-	EY51	9/-	UC2	7/-
6AM6	4/-	12BH7	7/-	EY86	9/-	UBC41	8/-
6AT5	6/-	12K7	5/-	EZ40	7/-	UBC81	9/-
6RA6	7/-	12X5	14/-	EZ80	7/-	UBF89	9/-
6RE6	5/-	12Y7	5/-	EZ81	7/-	UCB81	9/-
6BW6	7/-	25Y3G	9/-	EI148	11/-	UCL82	10/-
6C4	5/-	35L5	9/-	HABC8010	10/-	UCL83	12/-
6D8	5/-	35Z4	5/-	HVR2A	8/-	UPL89	9/-
6G6	4/-	807	5/-	KT33C	8/-	UT41	8/-
6H6	3/-	6B8	2/-	KT76	8/-	UT41	8/-
6J5	5/-	DAF96	8/-	MU14	7/-	UV35	8/-
6J6	5/-	DF96	8/-	PCU8A	8/-	UV19	7/-
6G7G	6/-	DK96	8/-	PCF80	8/-	VR150	7/-
6K6	5/-	DL96	8/-	PCF82	8/-	WR1	6/-

I.F. TRANSFORMERS 7/6 pair

465 K/s Slur Tuning Miniature Can. 2 x 1 x 1 $\frac{1}{2}$ in. High Q and good bandwidth. Data sheets.

NEW ELECTROLYTICS FAMOUS MAKES

TUBULAR	TUBULAR	CAN TYPES	MAKES
1/350V	2/-	50/350V	5/8; 16/450V
2/350V	2/8	100/25V	3/-
4/450V	2/8	32/350V	5/-
8/450V	2/8	47/350V	5/8
16/450V	2/8	500/12V	3/-
30/450V	3/8	100/270V	5/8
50/450V	3/8	5,000/6V	5/-
25/25V	1/8	32/32/350V	6/-
25/50V	1/8	32/32/450V	6/-
25/100V	1/8	32+32+32/350V	7/-
50/25V	2/-	30+50/350V	7/-
50/50V	2/-	64+120/350V	11/8
50/60V	2/-	100+200/275V	11/8

THE ORIGINAL

RADIO COMPONENT

Our written guarantee with every purchase. Bus 133 or 68 pass door
NEW COMPONENT LIST 1/- S.R. Station Selhurst

Volume Controls 80 ohm COAX
 Linear of Log Tracks. Semi-cd spaced 4in.
 Long spindles. Midget 6d. yd.
 5 K ohms to 2 Meg. 40 yds. 17/8
 L/R, 3/-; D.P., 4/6;
 Stereo L/S 10/6; D.P. 14/6

TELESCOPIC CHROME AERIALS. 13in. extending to 43in., 8/6 es. Coax Adaptor Plug, 1/8 extra.
TRIFLEXERS Bands I, II, III. 19/6
COAX PLUG 1/- **LEAD SOCKET** 2/-
PANEL SOCKETS 1/- **OUTLET BOXES** 4/-
BALANCED TWIN FEEDER yd. 8d. 80 or 300 ohms.
DITTO SCREENED per yd. 1/8. 80 ohms only.
Wirewound Ext. Speaker Control, 10Ω 3/-, 25Ω 5/6.
WIRE-WOUND POT'S, 5 WATT. Pre-set Min. TV Types. All values to 10 ohms to 25 K. 3/- es. 30 K, 50 K, 4/-; (Carbon 80 K., to 2meg., 3/-).
WIRE-WOUND 4 WATT Pots. Long spindle. Value: 50 ohms to 50 K.; 6/6; 100 K., 7/6.
PHILIPS TRIMMERS, 0-10 pF, 3-30 pF, 1/-.
TRIMMERS, Ceramic, 30, 50, 70 pF, 100 pF, 150 pF, 1/8; 250 pF, 1/6; 500 pF, 7/6 pF, 1/8. TV etc. **TRIMMER**, 1000 pF, with knobs, 2/-.
RESISTORS, Preferred values, 10 ohms to 10 meg., w., 4d.; 1 w., 4d.; 1 w., 8d.; 1 w., 8d.; 2 w., 1/-; High Stability, 1/-; 2/-; Preferred values 10Ω to 10 meg. Ditto 5%, 10Ω to 22 meg., 9/6 5 watt { **WIRE-WOUND RESISTORS** } 1/3
 10 watt { 10 ohms-10,000 ohms } 2/-
 15 watt { } 2/-
 12.5K to 47K 10 w. 3/-

AMERICAN "BRAND FIVE" PLASTIC RECORDING TAPE
 Double Play 7in. reel, 2,400ft. 87/6 Spare Plastic Reels
 5in. reel, 1,200ft. 87/6
 Long Play 7in. reel, 1,800ft. 25/6 3in. 1/4
 5in. reel, 1,200ft. 23/6 4in. 2/-
 5in. reel, 900ft. 18/6 5in. 2/-
 Standard 7in. reel, 1,200ft. 25/6 6in. 2/-
 5in. reel, 600ft. 18/6 7in. 2/6
 "Instant" Bulk Tape Eraser and Head Defluxer, 200/250 v. A.C., 27/6. Leaflet with full details. S.A.E.

CRYSTAL SET BOOKLET, 1/-.
CRYSTAL DIODE G.E.C., 2/-; GEX34, 4/-; OA81, 3/-.
HIGH RESISTANCE PHONES, 4,000 ohms, 15/-; per SWITCH CLEANER. Fluid squirt spout, 4/6 tin.

HIGH GAIN TV PRE-AMPLIFIERS BAND I B.B.C.
 Tunable channels 1 to 5. Gain 18dB. ECC84 valve. Kit price 29/6 or 49/6 with power pack. Details 6d. (PC84 valves if preferred).
BAND III I.T.A.—Same prices. Tunable channels 8 to 13. Gain 17dB. Circuit and Coils only, 9/6.

1/16in. Paxolin Panels, 10 x 8in., 2/-.
 Miniature Contact Cooled Rectifiers, 250V 50mA, 7/6; 250V 60mA, 8/6; 350V 85mA, 9/6; 300mA 21/-; 300mA 27/6.
 TV etc., Silicon Sub-Min. Rectifier, 125V, 300mA, 6/6; 250V, 300mA, 14/6.
 Selenium Rect., 300V-85mA, 5/-.
 Osmor Wearing "P" type, 3/- each.
 Osmor Midget "Q" type, adj. dust core, from 4/- each. All ranges. List S.A.E.
 Teltron D.W.R. L and Med. T.R.F. with reaction, 4/-; Med. wave D.R., 3/6.
 Ferrite Aerials, M., 8/6; M. and L., 12/6.
 Osmor Ferrite Rod Aerials, L. and M. for transistor circuits, 10/- each.
 Ferrite Rods, 8 x 1in., 3/-.
 H.F. Chokes, 2/6. Osmor QCI, 6/6.
 T.R.F. Coils, A/HF, 7X1, pair; HAX, 3/-; Repanco DR22, 4/-; DRX1, 2/6.
 Radio Screwdriver, 5in., 6d.
 Neon Mains Tester Screwdriver, 5/-.
 Solder Radiogrease, 4d. yd., lib. 5/-.
 Black Crackle Paint, Air drying, 3/- tin.

Aluminium Chassis, 18 s.w.g. Plain undrilled, 4 sides, riveted corners, lattice fixing holes, 2 1/2in. sides, 7 x 4in. 4/6; 3 x 7in., 5/6; 1 1/2 x 7in., 6/6; 1 1/2 x 9in., 8/6; 1 1/2 x 11in., 10/6; 1 1/2 x 14in., 12/6;
 Aluminium Panels, 18 s.w.g., 12 x 12in. 4/6; 14 x 9in., 4/-; 12 x 8in., 3/-; 10 x 7in., 2/6; 8 x 6in., 2/-.

"6 + 1" TRANSISTOR RADIO MEDIUM AND LONG WAVE KIT
 First class components to make a 6 transistor 2 wave band superhet chassis. Ideal for portable or table radio. All parts including BVA transistors, ferrite aerial, with car aerial coil, printed circuit, 8in. x 2 1/2in., but EXCLUDING speaker and cabinet. Simple instructions 1/6 (Free with kit).
 Speakers, 35 ohm. 7 x 4in. 25/-; 5in. 22/6, 3in. 19/6. **£4.50**

BULGIN PLUGS AND SOCKETS. Non-reversible P74, 2-pin, 4/8; P73, 3-pin, 4/6; P194, 6-pin, 5/8.
JACKS. English open circuit, 2/6. Closed circuit, 4/8. Grundig type, 3 pin, 1/8. Grundig lead jack, 3/8.
JACK PLUGS. English, 3/-; Screened, 4/-; Grundig, 3 pin, 3/6.
ALADDIN FORMERS and cores, 4in., 8d.; 2in. 10d.
 0.3in. FORMERS 5937 or 8 cans TV1 or 2, 2in. sq. x 2 1/2in. or 1in. sq. x 1 1/2in., 2/- with cores.
50 WATT MOTION DRIVES. 0, 1, 2/3.
SOLE IRON, 26W, 200V or 230V, 24/-.
ANTEX SUB-MIN IRON 15w. 200 or 240 v., 29/6.
BENCH STAND for above, 12/6.

JASON FM TUNER COIL SET 29/-.
 H.F. coil, aerial coil, oscillator coil, two i.f. transformers 10.7 Mc/s detector transformer and heater choke. Circuit and component book using four 6AN5, 2/6. Complete Jason FMT1 kit, Jason chassis with calibrated dial, components and 4 valves, 28.5.0.
 Model FMT2 with new shelf cabinet. **£8.5.0**

MAINS DROPPERS. Midget adjustable sliders, 0.8A, 1,000 ohms, 5/-; 0.2A, 1,200 ohms, 5/-; 0.16A, 1,500 ohms, 5/-; 0.1A, 2,000 ohms, 5/-.
MIXE TRANSFORMER. 50-1, 3/9.
 P.V.C. Covered Wire, single or stranded, 9d. yd. Sleeving, 1 or 2 mm., 2d.; 4 mm., 3d.; 6 mm., 5d. yd.
SPEAKER FRET. Gold cloth, 17 x 26in., 5/-; 25 x 35in., 10/-; Tygan, various colours, 62in. wide from 10/- ft.; 26in. wide, from 8/- ft. Samples, S.A.E. Expanded Metal, Gold, 12 x 12in., 6/-.

TELEVISION REPLACEMENTS
Line Output Transformers from 45/- each, NEW Stock and other timebase components. Most makes available. S.A.E. with all enquiries

WEYRAD
COILS AND TRANSFORMERS FOR 2-WAVE TRANSISTOR SUPERHETS WITH PRINTED CIRCUIT AND FERRITE ROD AERIAL
 Long and Medium Wave Aerial—BA2V On sin. rod, 208pF tuning, with car aerial coupling coil 12/6
 Osc. Coil P50/1AC, 176pF tuning, 5/4
 1st and 2nd I.F. Trans.—P50/2CC, 470kc/s 11/16in. dia. by Hn 5/7 each
 3rd I.F. Trans.—P50/3CC. 6/-
 Spare Cores 6d. each
 Driver Transformer—LFDT4. 9/6
 Wavechange Slide Switch. 3/6
 Printed Circuit—PAL. Size 2 1/2 x 8 1/2in. 9/6
 Ready drilled and printed. 9/6
 Volume Control, 5KDP. 4/6
 35 ohm Speakers, 3in., 19/6; 6in., 22/6; 7 x 4in., 25/-; 24 Wired Resistors. 10/6
 16 Fixed Condensers. 20/-
 Tuning Gang with trimmers. 10/6
 6 Mullard Transistors and diode. 42/6
 Constructor's Booklet. 2/-
500MW 3 OHM MODIFICATION KIT 12/-

NEW MULLARD TRANSISTORS
 OC71 6/-, OC72 7/6, OC81D 7/6, OC81 7/6, OC44 8/9, OC45 8/9, OC171 10/6, AF117 9/6
 Sub Miniature Condensers, 0.1 mfd. 30v. 1/3, 1.2, 4.5, 8, 16, 25, 30, 50, 100 mfd. 1V. 15 volt 2/6 ea. Transistor Holders 1/3-
 B.B.C. Pocket 2 Transistor, M.W. and L.W. Radio Kit, 22/6.
 Miniature earpiece, 7/6. Batt. 2/3.
 Circuit details, etc. S.A.E.

MONARCH RECORD PLAYER
 Kit with ready built amplifier, speaker and cabinet. **£12.10.0**
 carr. and ins. 5/-

Garrard deluxe auto-player kit
£12.19.6 Carr. and ins. 5/- details S.A.E.
GARRARD QUALITY AUTO-CHANGER, 4-speed, with plug-in xtal head. Ready built 2-valve amplifier, Loudspeaker and contemporary styled Portable Player Case.
 All items guaranteed to fit together perfectly, can be assembled in thirty minutes, full instructions supplied.
MAGNAVOX-COLLARO 4 speed Stereo/Monaural Autochanger, Diamond Stylus and Record Cleaning attachment **£8.10.0**
4 Speed Autochanger, B.S.R., U.A.14 **£7.10.0**
B.S.R. U.A.12 Stereo/Mono **£8.5.0**
 Garrard Autoslim Changer **£7.19.6**
4 SPEED SINGLE PLAYERS:
 E.M.I. with auto stop **£6.5.0**
 E.M.I. with separate pick-up **£5.9.6**
 Amplifier player cabinets **70/-**
 2-valve amplifier and 6 1/2in. speaker **95/-**
 Wired and tested ready for use with above.
 Replacement sapphire styli available from 6/-.
 Replacement Xtals from 21/-; Stereo from 25/-.

SINGLE PLAYER KITS
£8.15.0 post 4/6.
 With ready-built, 2 stage, 3 watts output pre-amplifier. High flux 5in. speaker. Handsome portable case 13 x 10 1/2 x 7 1/2in. Collaro 4-speed junior motor, LP/Std. xtal pick-up for 7, 10, and 12in. records.
 FEW ONLY KITS AS ABOVE but with 3-speed B.S.R. Motor **£7.15.0** complete (Post 4/6)

GABY MULTIMETER
 Moving-coil Model M.I. 54/-
 Measures D.C. or A.C. 6 v., 30 v., 120 v., 600 v., 1200 v. D.C. 30 ma, 300 ma. Ohms 0-100K. Leaflet S.A.E.

ARDENTE Transistor Transformers
 Type D3035, 7.3 CT: Push-Pull to 3 ohms for OC72, etc., 1 x 1 x 1 in. 9/6
 Type D3034, 1.75 : 1 CT. Push-Pull Driver for OC72, etc., 1 x 1 x 1 in. 9/6
 Type D3068, 11.5 : 1 Output to 3 ohms for OC72, etc., 1 x 1 x 1 in. 9/6
 Type D167, 18.2 : 1 Output to 3 ohms for OC72, etc., 1 x 1 x 1 in. 12/-
 Type D239, 4.5 : 1 Driver Transformer, 10/-
 Type D240, 8.5 : 1 Driver Transformer, 10/-

ARDENTE TRANSISTOR CONTROLS
 5K or 1MΩ switched, dia. 0.9in., 5/3
 Type VC176, 6K with switch, dia. 0.7in., 10/6
 Deaf aid earpiece xtal or magnetic, 7/6

COMPONENT SHOP SPECIALISTS

337 WHITEHORSE ROAD WEST CROYDON

Telephone: THO 1665
 (Export welcome. Send reference and extra postage).

Post 1/-, unless otherwise stated. C.O.D. 2/-

FREE THIS BOOK WILL INTEREST YOU!

LEARNING the PRACTICAL WAY

Radiostructor
EQUIPMENT-COURSES

A NEW-PRACTICAL WAY of UNDERSTANDING

Radio - Television - Electronics

Including: Transistors; VHF/FM; Hi-Fi equipment; Computers; Servo-mechs; Test Instruments; Photo-electrics; Nucleonics, etc.

FOR ...Your Career...Your Own Business...An Absorbing Hobby

Radiostructor—an organisation specialising in electronic training systems offers a new self-instructional method using specially designed equipment on a "do-it-yourself" basis.

You learn by building actual equipment with the big kits of components which we send you. You advance by simple steps, performing a whole series of interesting and instructive experiments—with no complicated mathematics! Instructional manuals employ the latest techniques for showing the full story of electronics in a practical and interesting way—in fact—you really have fun whilst learning! Post the coupon below, now, for full details.—

RADIOSTRUCTOR
LEADS THE WORLD
IN ELECTRONICS TRAINING

POST NOW

To RADIOSTRUCTOR (Dept. G82)
READING, BERKS.

Please send brochure, without obligation, to:

★ Name _____

Address _____

2/63

★ **BLOCK CAPITALS PLEASE**
(We do not employ representatives)

Practical Wireless

Vol. XXXVIII No. 672 FEBRUARY, 1963

Editorial and Advertisement
Offices:

PRACTICAL WIRELESS

George Newnes Ltd., Tower House,
Southampton Street, W.C.2.

© George Newnes Ltd., 1963

Phone: Temple Bar 4363

Telegrams: Newnes, Rand, London,
Registered at the G.P.O. for trans-
mission by Canadian Magazine Post.

SUBSCRIPTION RATES

including postage for one year

Inland - - - - £1.9.0 per annum
Abroad - - - - £1.7.6 per annum
Canada - - - - £1.5.0 per annum

Contents

	Page
Editorial	893
Round the World of Wireless	894
Electronic Metronome ...	896
Test Gear Techniques ...	898
Simple Transistor Two ...	902
Quality Amplifier and Pre-amp	907
Echo Chamber	912
On Your Wavelength	919
Home-movie Amplifier ...	920
General Purpose Communi- cations Receiver	923
Semiconductors	929
The Auditron	937
Trade News	945
Club News	946
Letters to the Editor	949

The Editor will be pleased to consider articles of a practical nature. Such articles should be written on one side of the paper only and should contain the name and address of the sender. Whilst the Editor does not hold himself responsible for manuscripts, every effort will be made to return them if a stamped and addressed envelope is enclosed. All correspondence intended for the Editor should be addressed: The Editor, PRACTICAL WIRELESS, George Newnes Ltd., Tower House, Southampton Street, London, W.C.2. Owing to the rapid progress in the designs of wireless apparatus and to our efforts to keep readers in touch with the latest developments, we give no warranty that apparatus described in our columns is not the subject of letters patent.

Copyright in all drawings, photographs and articles published in PRACTICAL WIRELESS is specifically reserved throughout the countries signatory to the Berne Convention and the U.S.A. Reproductions or imitations of any of these are therefore expressly forbidden. PRACTICAL WIRELESS incorporates "Amateur Wireless."

Off Beat

SOME readers might feel that this month's cover subject is a little unusual. Without wishing to be facetious, we agree that it strikes a somewhat unusual note and can, in fact, be described as slightly off beat!

There must be many enterprising readers who have built up similar unconventional pieces of equipment, for there is obviously a limit (physically, at least!) to the number of radio sets one can, or wishes to, build.

While the description of radio sets is one of the main features of PRACTICAL WIRELESS constructional articles, we are fully aware that the advanced constructor may well be satiated with radio sets or has become capable of designing his own.

There is, of course, the associated audio field and it is our policy to provide plenty of material of this kind. But although there is a considerable range of designs to draw upon in radio sets (from the transistor pocket receiver to the multi-stage communications receiver) and a number of new circuit features (such as reverberation—one system is described in this issue and others will follow), it is, perhaps, on the "electronics" side that there is potentially the greatest scope.

So far as the home constructor is concerned, this potential is still largely untapped, but can range from geiger heads to gimmickry. Some of these gadgets, admittedly, may be of more value as construction and design exercises, but many could have very practical applications.

One of these is the metronome shown on the front cover and described in this issue. Most people build or buy radio sets, amplifiers and tape recorders largely for the reproduction of music. And, due partly to the upsurge of interest in hi-fi, there is a growing cult of musical appreciation.

This is reflected in the returning to favour of the erstwhile irreplaceable piano and other instruments. And since many readers of PRACTICAL WIRELESS are no doubt amateur musicians, an electronic metronome is one useful way of combining interests.

If you have constructed any practical "off beat" items you feel would interest other readers, we would like to hear about them.

Last Chance

Just a final reminder that this is your last chance to obtain tickets for the PRACTICAL WIRELESS Film Show which has been arranged in collaboration with Mullard Ltd. and will be held at Caxton Hall, Westminster, London, on *February 1st*, starting at 7.30 p.m.

Tickets for this show are free and may be obtained simply by writing to us and enclosing a S.A.E.

Our next issue dated March will be published on February 7th.



NEWS AT HOME AND ABROAD

Broadcast Receiving Licences

THE following statement shows the approximate number of Broadcast Receiving Licences in force at the end of October, 1962, in respect of wireless receiving stations situated within the various Postal Regions of England, Wales, Scotland and Northern Ireland. The numbers include Licences issued to blind persons without payment.

	Total
London	631,591
Home Counties	583,634
Midland	424,344
North Eastern	446,308
North Western	382,114
South Western	344,362
Wales and Border Counties	193,463
Total England and Wales	3,005,019
Scotland	317,318
Northern Ireland	107,928
Grand Total	3,431,265

First UK Subsidiary of French Firm

THE largest group of electronics companies in France, C.S.F., has recently opened its only British subsidiary. C.S.F. United Kingdom Ltd is designed to extend C.S.F.'s trading interests here on a long term basis. Initially it will be buying everything C.S.F. needs in the United Kingdom and selling everything the group makes.

Electrical Engineers Exhibition 1964

THE 1964 Electrical Engineers Exhibition will be held at Earl's Court from 18th—25th March, 1964. The opening times

will be 10 a.m. to 7 p.m. daily except Thursday March 19th when it will be extended to 9 p.m.

For the first time overseas manufacturers will be invited to exhibit, and although a certain amount of additional space has been made available it is anticipated that it will all be taken before the end of 1963.

Acoustic Fault-finding Apparatus

A NEW acoustic fault-finding apparatus which incorporates an AEI-type BK24 ignitron is now being used by the North Western Electricity Board.

Previously a mechanical contactor was used to discharge two 2.25 μ F capacitors, connected in parallel and charged to 25kV, into the faulty cable. This method proved quite successful, but the high-voltage contactor, being very noisy, made detection difficult when the fault was close

to the equipment. Furthermore, approximately half of the stored energy was dissipated at the contacts and did not reach the fault.

By using an ignitron instead of the contactor, both these disadvantages have been overcome. The ignitron is an inherently noiseless device and its characteristics are such that the arc voltage drop, and consequent energy loss, is very small.

New Organisation Headquarters in London

THE wholly owned British subsidiary of US General Electric, International General Electric Company of New York Ltd., has announced the formation of an Industrial Electronics Division to market many General Electric industrial electronics products in Europe.

International General Electric Company of New York, Ltd. has

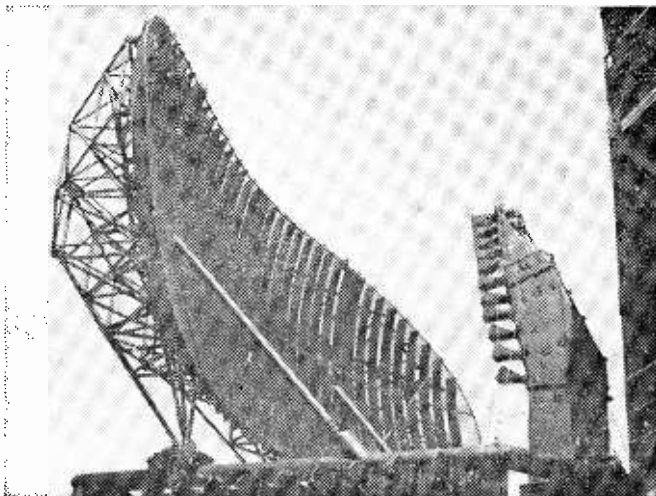

This photograph shows a high-power three-dimensional radar made by C.S.F. of France, who have recently opened their first London office.

been marketing the products of US General Electric in the United Kingdom for many years. The complexity of modern industrial electronics equipment, however, has led to the establishment of this new organisation of much broader scope and capability.

This new organisation will have have headquarters in London at 31 John Street, WCI, and will establish additional facilities in the United Kingdom and on the Continent to meet market requirements.

British Equipment at Milan Exhibition

FOLLOWING demonstrations of electric equipment during past months in Germany and Switzerland, EMI Electronics Ltd. exhibited equipment in Italy, at the Automation and Instrumentation Exhibition held in Milan.

Chief among the exhibits was a Robotug driverless truck, fitted with electronic guidance equipment, which follows a magnetic field surrounding a wire buried just below the surface of the ground.

Also on show was EMI's oscilloscope type WM16 with a range of plug-in pre-amplifiers. Other exhibits included nuclear health monitoring equipment, the EMIac II analogue computer, and a wide range of special electronic valves and tubes.

I.E.E. Membership reaches 50,000

AT a recent meeting the I.E.E.'s Council admitted to membership of the Institution the man who brings the total to 50,000.

Starting in 1871 with about 70 founder members of the then Society of Telegraph Engineers, numbers grew rapidly to 3,660 in 1900. By the beginning of the second World War, the figure was approaching 20,000, and the striking advance in technological developments in the last 20 years has contributed largely to the fact that the membership since then has more than doubled.

The "50,000th member" is William R. Matthews, admitted as a student.

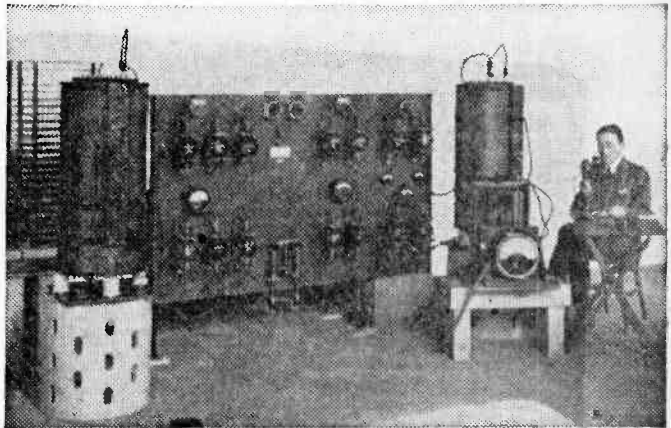

At the microphone of this 6kW transmitter, which was installed at the Marconi works at Chelmsford in 1920, is W. T. Ditcham, whose voice was the first to span the Atlantic from Europe to Nova Scotia.

Transport Minister Opens Medway Scheme

THE Right Hon. Ernest Marples, M.P. recently opened a new radar and radio control centre for the Medway Conservancy Board. The ceremony was carried out in the new control room and was seen by visitors in the reception centre on a closed-circuit television chain.

A well planned operation room, built on top of Garrison Point Fort at Sheerness, houses the control consoles for the three viewing units of the Decca Harbour Surveillance Radar and the Pye v.h.f. radiotelephone equipment. The Pye radio transmitters, which are sited on the Southdown Hills two miles from the operations room, give the best possible coverage to shipping in the Medway.

The Medway Port and Information Service has now been extended to include harbour surveillance radar and the radiotelephone system has been improved and enlarged.

International radiotelephone channels recommended by the Hague Convention are used and two-way v.h.f. radio communication between the Port Authorities and Ships' Masters help in the safe and fast movement of shipping in the Medway.

New British Railways Testing Station

BRITISH Railways Eastern Region has placed a contract with Associated Electrical Industries Ltd. covering electrical loading equipment and a communication system for the new diesel-electric locomotive testing station now being built at Doncaster. When completed this station will be capable of testing a range of twenty-one different locomotives, from small shunters to 3,300 h.p. "Deltics".

Testing will be carried out from two control desks mounted in a control room overlooking the interior of the station. The desks will control the contactors on the fan-cooled loading resistance banks and will also carry test instrumentation.

An AEI type RP loading resistor, in which the resistance strip is edgewise wound and ceramic insulated from the central steel mounting strips, will be mounted on two banks, each with a dissipating capacity of 2,000 h.p. Tappings can be varied on-load by means of contactors mounted on the resistor banks which, in conjunction with the changeover switches and links in the termination cubicles, will enable either one Deltic locomotive to be tested alone, or two locomotives of 2,000 h.p. maximum, by using both resistor banks separately.

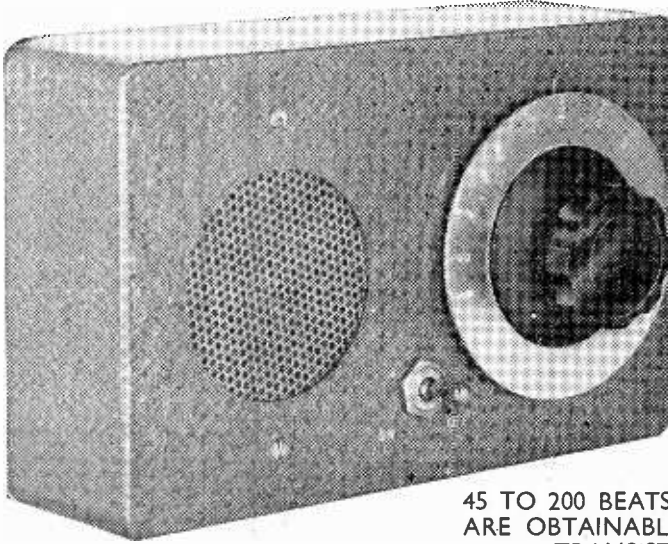

45 TO 200 BEATS PER MINUTE
ARE OBTAINABLE WITH THIS
TRANSISTORISED UNIT

Electronic METRONOME

By K. Berry

ESSENTIAL to someone learning to play the piano and useful to anyone (hi-fi enthusiast or not!) with a keen interest in music is the metronome. This article describes a cheap, easy-to-build electronic metronome. The beat note is continuously variable over the range 45-200 beats per minute. Should this range seem rather large it must be pointed out that this is approximately the range found in a proprietary clockwork metronome.

Circuit

The circuit of the unit is shown in Fig. 1. It will be seen that it is basically a transistor version of the well-known multivibrator circuit.

The rate of operation is altered by varying the time constant $C1$, $VR1$, $R2$. When $VR1$ is set for zero resistance $C1$, $VR1$ is equal to $R3$ and the circuit operates at its fastest rate with $Tr1$ and $Tr2$ "bottomed" for equal periods of time (i.e., with a 1:1 mark-space ratio). When $VR1$ is set for maximum resistance, $C1$, $VR1$, $R2$ is about eight times as large as $C2$, $R3$ and the circuit operates at a lower rate with $Tr1$ and $Tr2$ being bottomed for unequal periods of time (the approximate mark-space ratio in this case is 6.5:1).

The audio output is obtained by connecting a loudspeaker from the collector of $Tr2$ to ground via a capacitor.

Components

The components required for this metronome are given in the component list. The timing capacitors $C1$ and $C2$ are ordinary $50\mu F$ 12V etched aluminium foil electrolytic capacitors. Now since the capacity marked on these is subject to a tolerance of some +100% or -50% one can obviously get into difficulties here. The capacitors used in the prototype equipment were $47\mu F$ and $48.5\mu F$ respectively and measurements made of other electrolytic capacitors would suggest that although electrolytics *can* vary by +100% or -50% they do not often do so. The best solution is to check the capacitors on an impedance bridge if one is available. Failing that, go ahead with

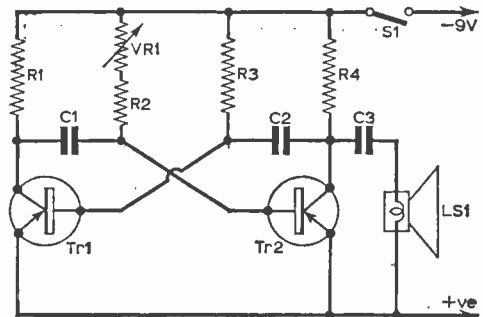

Fig. 1—The circuit of the unit.

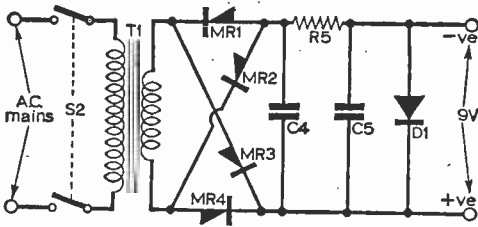

Fig. 2—A suitable power-pack.

standard electrolytics and, if the correct speed cannot be obtained from the metronome at first, substitute fresh 50 μ F capacitors first for C1, then for C2. If this dodge fails the "50 μ F" capacitors can be shunted with some small value electrolytics (if the metronome runs too fast) or replaced with a parallel configuration of small values, say two 20 μ F capacitors plus a 5 μ F capacitor. This may sound rather formidable and in fact one probably won't be faced with having to do this but, since the possibility exists, it is best to bring it out rather than conveniently forget about it!

The transistors used in the prototype unit were Mullard, type OC41. This type is a p-n-p germanium junction switching transistor, but most types of audio p-n-p transistors should serve just as well and a list of possible alternatives has been included in the component list.

The loudspeaker which was incorporated in this unit was marked as having an impedance of 10 Ω . Also tried was a loudspeaker with a speech coil impedance of 2-3 Ω and this was

equally satisfactory. In view of this the impedance quoted in the component list for the loudspeaker has been given as 2-15 Ω . If a small loudspeaker is not readily available, or if it is required to make the unit as small as possible, then a single ear-piece from a pair of low-impedance headphones could be used.

Construction

The photograph shows the interior of the metronome, which is housed in a proprietary die-cast equipment box of size 7 $\frac{1}{2}$ in. x 4 $\frac{1}{2}$ in. x 2 $\frac{1}{2}$ in. The underside of the unit has four small rubber feet attached to it to prevent its scratching polished surfaces. In view of the simplicity of the metronome no further details of construction have been given.

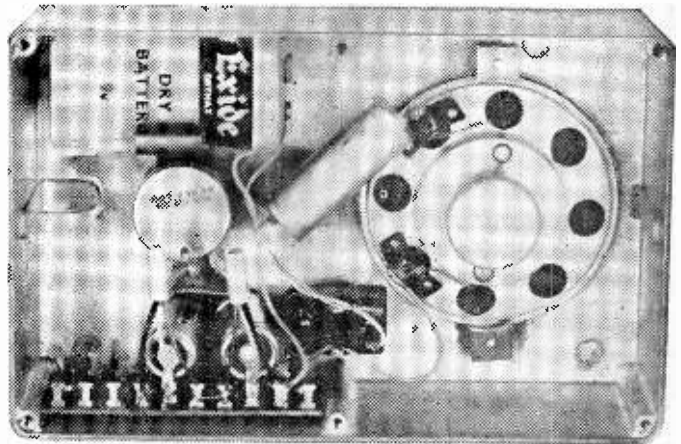

This photograph shows clearly the wiring of the unit.

COMPONENTS LIST

Resistors:

- R1 1k Ω
- R2 3.3k Ω
- R3 3.3k Ω
- R4 1k Ω
- All $\frac{1}{4}$ W carbon
- VRI 25k Ω carbon potentiometer, log

Capacitors:

- C1 50 μ F electrolytic 12V
- C2 50 μ F electrolytic 12V
- C3 8 μ F electrolytic 150V
- C4 250 μ F electrolytic 25V
- C5 250 μ F electrolytic 25V

Semiconductors:

- Tr1, Tr2 Transistors Mullard OC41 (alternatively OC71, OC72)
- MR1-4 Rectifiers S.T.C. RS20
- D1 Zener diode Mullard OAZ207

Miscellaneous:

- LS1 Loudspeaker, 2-15 Ω impedance
- S1 Single-pole switch
- S2 Double-pole switch
- T1 Mains transformer: input 240V 50 c/s; output 12V 30 mA

Power Supplies

The prototype was self-powered by means of a dry (primary) battery. This was a layer-type battery intended for use with transistorised equipments of size 1 $\frac{1}{2}$ in. x 1 $\frac{1}{2}$ in. x 2in., but any type of 9V battery may be used. The normal current consumption of the metronome is 12-15mA at 9V.

There is no reason why the unit should not be run off the d.c. mains supply if portability is not important. A suitable power unit is shown in Fig. 2. The use of a Zener diode to regulate the output voltage is necessary because of the fluctuating nature of the current drawn by the metronome

Calibration and Use

When the unit has been wired all that remains is to calibrate it. This can most easily be accomplished by using an electronic or electro-mechanical counter, but since these are not readily available the practical method is to count the number of beats whilst observing a watch or clock with a sweep second hand. This is quite easy up to about 150 beats per minute and with a little practice one can count up to 240 beats per minute.

TEST GEAR techniques

PART I - THE BASIC METER

H. W. Hellyer

THE story of the radio enthusiast who progressed from the crystal set to a high-powered transmitter with nothing but a keen, wet finger is probably apocryphal. But during the short and crowded history of radio a surprising amount of good work has been done with the minimum of test equipment.

Partly this may have been due to high capital costs, partly because of a lack of information on the capabilities—and, indeed, the limitations—of individual items of test gear. Today we find a very wide range of equipment at our disposal, both surplus and commercial, in kit form and brand, spanking new. The advertisement columns of PRACTICAL WIRELESS abound in tantalising offers.

The problem is to know what to buy or make.

This series of articles aims to reduce the problem by outlining the scope and purpose of test equipment and presenting some of the applications. It does not set out to be a catalogue and specific items of equipment will not be described except where they illustrate a particular test sequence.

Circuits and methods are the result of practical experience at the bench and in the field. Many articles on the modification and adaptation of test gear have appeared in these pages and it is not intended to tread the same ground: additions to commercial test equipment will be mentioned only where such circuits extend the scope and versatility of the basic instrument.

However, queries are welcomed; novel ideas that readers may suggest will be laboratory tested and passed on. In this way it is hoped that these articles may prove a useful source of reference to those who study the advertisements and wonder whether particular instruments are suitable or will fulfil the desired purpose.

Information on test gear is singularly scarce. Of the few books available on the subject perhaps the best, and certainly the most up to date, is "Radio and Television Test Instruments", by Gordon J. King, published by Odhams Press, 25s. Mr. King is no stranger to readers of PRACTICAL WIRELESS; his help and guidance in the preparation of this series is gratefully acknowledged.

The Basic Meter

The fundamental item of equipment in any workshop, amateur or professional, is the test

meter. Without it other, more complicated, instruments are just so much expensive decoration. A good deal of testing can be done with a trustworthy meter and plenty of time and ingenuity.

Unfortunately modern receivers and other electronic circuitry are much more complex than those of previous "wet-finger" days. Closer tolerances demand a higher standard of testing and more precise instruments.

This does not mean that the most expensive meter is necessarily the best for any particular purpose. There are multimeters ambitious enough to knock a hole in any wage packet with many ranges and functions that the owner never uses—even if he has found out how.

But if the only measurements required are voltages and currents met during receiver repair, plus the general purpose resistors of no closer than 5 per cent tolerance, a good "standard" meter should be sufficient. Such factors as robustness, ease of scale reading, foolproof overload and

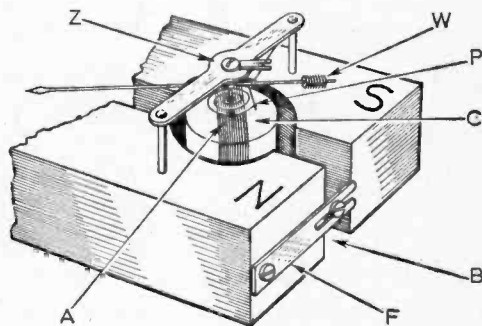

Fig. 1—A typical meter movement.

simple connection may be as important as the movement sensitivity.

Sensitivity

Nevertheless it is the sensitivity of the basic movement that ultimately determines how good or bad a meter can be. Remembering that a meter connected to a circuit for measurement becomes part of the circuit under test, it is obvious that the less effect the meter has upon the circuit the

greater the accuracy of readings.

The sensitivity of a meter depends upon the current needed for FULL-SCALE DEFLECTION and the fundamental resistance of the meter. The latter important factor is stated as the OHMS PER VOLT rating. General purpose meters for measuring voltage and current and, by the addition of a voltage source, indicating resistance, are usually MOVING COIL instruments. There are other types, having special purposes, which we shall discuss later.

A typical basic moving coil assembly is illustrated in Fig. 1. In this the coil A is wound on a rectangular former and mounted on jewelled bearings in a magnetic field provided by polepieces N and S. The field is carefully determined and there are wide variations in the polepiece conformation between different manufacturers.

In our example a brass section is seen, B, between the poles with an iron flux adjuster, F, which should not be altered. Indeed when servicing or cleaning meters take care not to disturb the mechanical assembly: clamps and brackets may, in fact, be acting as magnetic shunts.

Note the flux compensator, C, the cylinder on which the coil is mounted. This serves to maintain a radial field and to reduce the reluctance effect between the moving arms of the coil assembly and the inner surface of the polepieces. On some types advantage is taken of this effect for additional damping.

Even Movement

Others have an aluminium plate fixed to the pointer arranged to operate in a magnetic field. The flux opposes the actuating current and, by Faraday's Law, increases with the acceleration of the pointer movement. This tends to produce an even movement of the pointer across the scale.

On the model shown in Fig. 1 additional balance to the movement is afforded by the weights, W, near the lower end of the pointer. These should not be confused with the gravity balance weights fitted on some of the cheaper models.

Current is fed to the coil by a pair of springs, P, wound in opposing spirals, also assisting in movement balance, particularly in return action of the pointer when the actuating current is removed. An important function of these springs, generally made of a non-magnetic material, phosphor bronze, which has the added advantage of a lower coefficient of linear expansion than spring steel, is the temperature compensation they afford.

Refinements

Other refinements may be found: a transverse bar for extra balancing, a light piston or vane in a virtually closed air chamber for braking action, a mirror backing to part of the scale to assist visual alignment—an anti-parallax device. And the zeroing set screw, Z, which adjusts an eccentric thread to move a fine wire in an inverted U-piece at the lower end of the pointer.

From the foregoing it can be seen that the lighter and more perfectly balanced the meter movement is the less current needed to operate the pointer. Other things being equal, the more sensitive the instrument. By winding the coil with a high number of turns of very fine wire a meter

can be constructed having a high resistance and needing a very small current for full-scale deflection.

Nowadays meters of 20,000 ohms per volt having an f.s.d. of 50 microamps (0.00005 of an ampere) are quite common and at least one well-known meter available to radio engineers has a sensitivity of 100,000 ohms/volt. This means that on the 100-volt range of such an instrument the load presented to the circuit is in the region of 10 Megohms, comparable with the standards of many an electronic meter, about which more later.

The importance of this factor of high Ω/V can be seen by reference to Fig. 2. Here we have an identical pair of 100,000 Ω resistors connected across a 100-volt d.c. supply. We know by simple

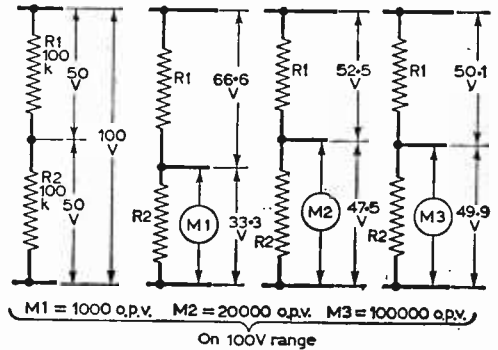

Fig. 2—These diagrams illustrate the importance of high Ω/V factor in meters.

calculation that 50 volts is dropped across each and would be indicated by an ideal voltmeter.

But if we put a meter with a sensitivity of 1,000 ohms/volt across R2 the actual reading is as low as 33.3 volts. This is because a 1,000 ohms/volt meter on its 100-volt range has a resistance of 100,000 ohms. In parallel with the resistance of R2 this reduces the total resistance across the section BC to 50,000 ohms, giving a 2:1 ratio of AB to BC and a voltage drop of 66.6+33.3 instead of the 50+50 in the former instance.

Similarly a 20,000 ohms/volt instrument would read 47.5 volts across R2, which is better, while a 100,000 ohms/volt instrument would indicate the near-accurate voltage of 49.9 across the same point.

This serves to illustrate one practical point. Greater accuracy is obtained by using the voltmeter on its higher ranges. However, from the point of view of mechanical accuracy, anti-parallax reading and an aid to interpolation (the assessment of readings between the divisions of the scale) it is often better to adjust the range so that the pointer lies in the middle third segment of the scale.

A further practical point to note is that most of scale of 110 deg. or more, while there are less useful models with an 80 deg. scale.

Linear Scale

Moving coil meters have the advantage that the torsion, and thus the arc of travel, is proportional to the actuating current so that the scale is linear. They can be made accurate to 1 per cent for

Keep this for reference
FACTS, FIGURES & FORMULAE

During this series, various references will be made to electrical and magnetic properties. Before we can employ test gear efficiently, we must know what the quantities are that we are measuring. The following notes contain definitions that may be familiar to many readers—but their collection and statement at the outset will save time and space in digressing explanations later.

Valve Characteristics

Amplification factor (μ) = Anode impedance (r_a) \times Mutual Conductance (g_m)
 where r_a is in thousands of ohms and g_m in mA/volt.

$$\text{Stage Gain, } A = \frac{\mu \times R_a}{R_a + r_a}$$

(where R_a is the anode load, in the same unit as r_a).

Equivalences

$$R \text{ (ohms)} = \frac{E \text{ (volts)}}{I \text{ (amps)}}$$

$$W \text{ (watts)} = I^2 R = \frac{E^2}{R} = EI$$

$$F \text{ (in Mc/s)} = \frac{3 \times 10^8}{\lambda \text{ in metres}} = \frac{300}{\lambda}$$

(Where λ is wavelength).

$$X_C \text{ (ohms)} = \frac{10^6}{2\pi f C}$$

(Capacitor reactance, where f is frequency in cycles/second and C is capacitance in microfarads).

$$X_L \text{ (ohms)} = 2\pi f L$$

(Inductor reactance, where L is inductance in henries.)

(N.B. $2\pi f$ often designated ω (omega).)

$$\text{At resonance, } X_C = X_L \text{ and } f_r = \frac{1}{2\pi\sqrt{LC}}$$

(Where f_r is resonant frequency in kilocycles, L in microhenries, C in microfarads).

$$\text{Magnification factor of tuned circuit: } Q = \frac{2\pi f L}{R}$$

Decibels

The Bel is the common logarithm of the ratio of two powers.

One-tenth of a Bel, the decibel (dB) is used for convenience.

$$\text{Thus dB} = 10 \times \log \frac{W_1}{W_2}$$

(where W_1 and W_2 are the two power levels).

$$\text{and dB} = 20 \times \log \frac{V_1}{V_2}$$

(where V_1 and V_2 are the two voltage levels) (this supposes equal impedances to be employed).

Typical dB ratios are:

$$\text{Power ratio of } 2 = 3\text{dB, of } 10 = 10\text{dB}$$

$$\text{of } 100 = 20\text{dB.}$$

$$\text{Voltage ratio of } 2 = 6\text{dB, of } 10 = 20\text{dB,}$$

$$\text{of } 100 = 40\text{dB, of } 1000 = 60\text{dB.}$$

Meter Calculations

$$\text{Shunt } R_s = \frac{R_m}{n - 1}$$

(where R_m is internal resistance of meter, and n is the factor of multiplication)

$$\text{Multiplier } R_v = \frac{(E \times 1,000)}{I} - R_m$$

(where E is the required full-scale voltage, R_m the internal resistance of the meter, and I the full-scale current of the meter (mA)).

A unit of reciprocals is given on the following page.

Other factors, figures and formulae will be defined where applicable in the articles.

ABBREVIATIONS AND PREFIXES

Abbr.	denotes	meaning
M	Mega, or Meg	"millions of", as in Megohm = 10^6 ohms.
k	Kilo	"thousands of", as in kilohm or kilocycles, = 10^3 ohms or cycles per second.
d	Deci	"tenths of", as in decibel (dB) = 10^{-1} Bel.
m	Milli	"thousands of", as in milliampere (mA) = 10^{-3} amperes.
μ	Micro	"millionths of" as in microfarad = 10^{-6} Farad.
$\mu\mu$ or p	Pico	"million-millionths of", as in picofarad (pF) = 10^{-12} Farad.
v.l.f.	Very low frequency	0-30 kilocycles per second (kc/s), or above 10,000 metres wavelength.
l.f.	Low frequency	30-300 kc/s, or 10,000-1,000 metres.
m.f.	Medium frequency	300-3,000 kc/s, or 1,000-100 metres.
h.f.	High frequency	3,000-30,000 kc/s (3-30 Mc/s), or 100-10 metres.
v.h.f.	Very high frequency	30-300 Mc/s, or 10-1 metre.
u.h.f.	Ultra high frequency	300-3,000 Mc/s, or 100-10 cm.
s.h.f.	Super high frequency	3,000-30,000 Mc/s, or 10-1 cm.

Reciprocals

Conductance (G) is the reciprocal of resistance, $= \frac{1}{R}$

Susceptance (B) is the reciprocal of reactance, $= \frac{1}{X}$

Admittance is the reciprocal of impedance, $= \frac{1}{Z}$

general work (sub-standard models are accurate to 0.2 per cent) and are not liable to interference from external fields.

Their principal disadvantage is that a reversal of energising current results in a reversal of torque and thus they are basically suitable for d.c. only and polarity must be observed. A.C. ranges are obtained by rectification of the applied current, usually by small metal rectifiers.

These have a non-linear characteristic in the conductive direction and therefore the sensitivity and accuracy of a.c. ranges is less than of d.c. ranges. Calibration is in r.m.s. values and the readings should be multiplied by 1.414 to obtain peak values, but this applies only when a sinu-

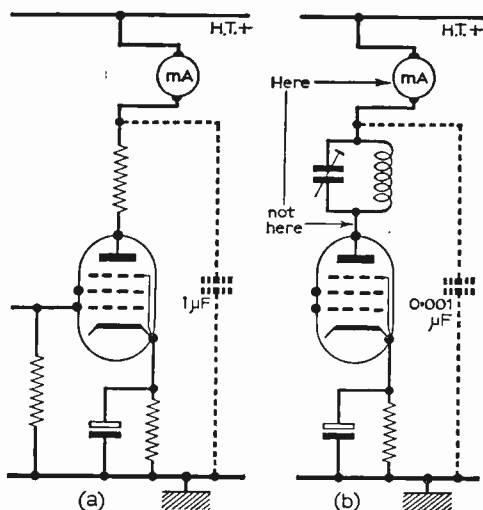

Fig. 3—Methods of decoupling moving coil instruments

soidal waveform is applied. Other waveforms will give misleading indications.

This makes it necessary to provide decoupling for a standard moving coil instrument when it is used to take readings where, for example, signal voltages may be present. Fig. 3 indicates such a method and also shows that the correct place at which a meter should be applied is where the signal voltages have the least effect or, alternatively, are least affected by the presence of the meter.

Thus in Fig. 3a a reading of anode current of an audio amplifier stage is made by inserting the meter on the h.t. side of the load resistor and decoupling the meter for signal voltage by a suitable capacitor. And in Fig. 3b the meter is

inserted in the anode lead of an i.f. amplifier at a point of low signal potential and similarly decoupled. Do not insert the meter between the anode of the valve and the load.

Current Testing

Current testing is done by the insertion of the meter in series with the circuit. From our former statement we can see that a meter with a small f.s.d. current needs a smaller value of shunt resistance for a greater total measured current. Thus the meter plus shunt presents less disturbance to the circuit.

It is not intended to give details of shunt calculation and construction at this point, nor the details of multipliers for extending voltage ranges—this has been done many times before in these pages. We shall assume that we are using the meter within its designed limits.

Practically, however, there are several points to note. Before inserting a meter for current testing switch off the apparatus. In addition to safeguarding the circuit under test this also protects the meter from unnecessary transients which can upset a delicate movement.

Polarity

Observe polarity—a meter which has the reverse connection at high loading can suffer mechanical damage because of the attempt of the pointer to force against the lower stop.

If the current to be tested is not known, always try first on the highest range. Actually it may be better to make some alternative test first to ensure that the current does not exceed the range of the meter. This can sometimes be done by making a voltage reading across part of the circuit and doing a quick calculation.

In a similar way always test at the highest voltage range first and do not switch ranges with the meter in circuit. Overload protection is generally provided; some instruments have a mechanical trip that is operated by the pointer over-riding the upper stop, some use a shunting rectifier which bypasses harmful currents from the moving coil. But there are limits and meters are expensive items to repair or replace.

Maintenance

When attempting meter maintenance, care must be taken not to employ magnetic tools or, indeed, ferrous tools of any kind. Metallic particles can be transmitted to the polepieces and movement very easily and are extremely difficult to eradicate. Getting magnetic particles from the gap in a movement is best done by removing the coil assembly altogether and cleaning the pole faces with a soft cloth. Take great care not to damage the flat spiral springs or pointer. Pivots can be cleaned with jeweller's rouge applied with a sharpened matchstick.

A good deal of space has been used in this introductory article for the purpose of laying the ground. In the next part we shall take a look at other kinds of meter and capacitance resistance testing.

(To be continued)

SIMPLE TRANSISTOR TWO

By F. G. Rayer

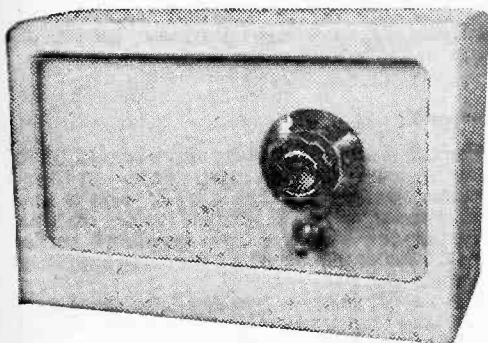

THIS receiver is of extremely simple construction, and is thus particularly suitable for beginners who may be looking for an easy, straightforward circuit. There are three stages—a crystal diode detector, followed by an audio amplifier, and a Class A output stage. The set is intended to run from a L5048 or similar $7\frac{1}{2}$ V battery, though a 9V battery may be used.

The circuit is shown in Fig. 1. A receiver of this kind is not intended for reception of distant or overseas stations, and it requires some kind of aerial and earth. For local station reception, for which it is intended, an indoor aerial should usually be sufficient. The aerial may be taken to tappings B and D, or to the beginning of the coil (A) according to conditions.

Holders are used for the transistors. This avoids possible damage due to overheating, and allows any audio frequency transistors which are to hand to be tried. The transistor in the Tr1 position can best be an OC71 or similar type, while the Tr2 transistor is an OC72 or similar output type. Results obtained with spare transistors can easily be compared by inserting them in the holders.

For optimum amplification, resistor values are quite important. It is easy to check the working of each stage, with phones and a meter, as described later.

Capacitor values are not particularly critical. VC1 is a midget air-spaced capacitor of about 380pF, but the value is not important, and a 500pF solid-dielectric tuning capacitor could be used instead. Alternatively, a 500pF air-spaced capacitor, or similar component. C1 may be 0.1 μ F to 0.5 μ F. C2 may be 32-100 μ F, while C3 may be 4-8 μ F.

The output transformer T1 is a non-miniature transistor type component, such as would be used with a pair of transistors in push-pull. The speaker unit shown is a highly sensitive one, but there is no actual need to use this particular size. Many speakers have a 2 to 3 Ω speech coil, and these require a 2 to 3 Ω secondary on the transformer T1. Speakers of other impedance may be used, with their particular matching transformers. A 75 Ω

loudspeaker may be connected directly, with no transformer.

Paxolin Panel

The receiver is built and wired on a paxolin panel 4in. x 8in. Material $\frac{1}{8}$ in. thick is sufficiently strong, though $\frac{3}{16}$ or $\frac{1}{4}$ in. paxolin could be used. All the holes are drilled as indicated in Fig. 2. Holes for leads can be made with a $\frac{1}{8}$ in. or similar small drill. Holes for the speaker bolts, and L1 mounting, should be about $\frac{1}{4}$ in. diameter, while VC1 is secured with three short 4B.A. bolts.

If any changes are made, such as to the speaker or VC1, these holes should be modified to suit. T1 had lugs, which are passed through slots,

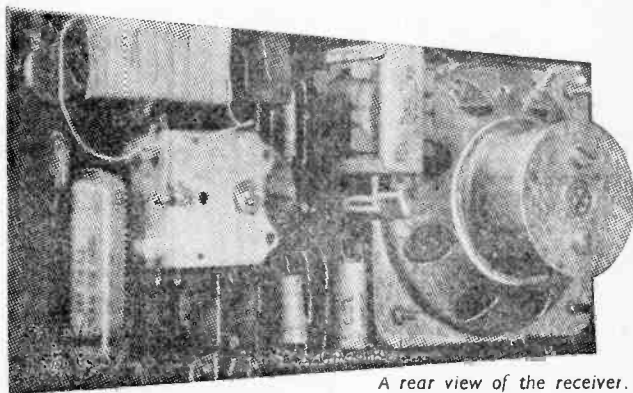

A rear view of the receiver.

then twisted. These slots can be made by drilling two or three small holes close together.

There is no reason why a ready-made coil should not be used. If so, the ferrite slab, with winding, is not required. The coil should be wired to agree with its maker's data. The receiver will also be found to work well on long waves, in those areas where the Light Programme on 1500m is available, so a small rotary switch can replace the on/off switch, for dual-wave tuning. In this case coil wiring should be taken from the coil maker's instructions leaflet.

All holes are drilled before mounting any parts. The transistor holders are a tight push fit in their holes, and are held with a touch of cement. The speaker can be left off until wiring is otherwise finished.

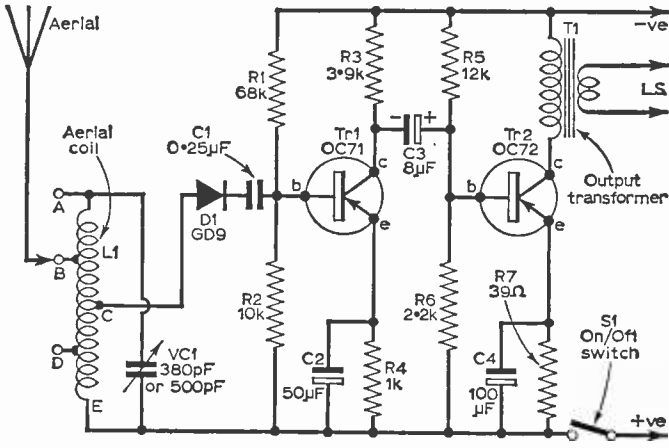

Fig. 1—The circuit.

Rear of Panel

All the components are fitted to the panel, at the back, as in Fig. 3. C2, C3 and C4 have positive and negative ends, so their leads are inserted through the holes as indicated. There should be no possibility of wiring or component value errors, if care is taken to insert the resistors and capacitors as shown.

The tuning coil is wound with 28s.w.g. d.c.c. wire, on a ferrite slab about 1/4 in. x 1/4 in. x 3 in. Referring to Figs. 1 and 3, there are 20 turns from A to B, six turns from B to C, six turns from C to D, and 20 turns from D to E, making a total of 52 turns. All turns are wound in the same direction, closely side by side, and some modification to the number of turns, or gauge of wire, or the size of the slab or ferrite rod, will not be very important.

The tapping points B, C and D can be made by twisting small loops, during winding, and a dab of cement will hold the ends A and E, which are long enough to reach VC1. A is taken to the fixed plates tag, and E goes to the battery positive line, on the other side of the panel.

Two small blocks of hardwood or other insulating material are secured to the paxolin by means of small screws. The ferrite slab rests on top of these blocks, and is held with elastic bands passed through holes, and tied.

All wiring is on the front of the panel, and is very simple. Leads can be of any thin, insulated wire, and all connections are kept flat against the paxolin. Wiring is shown in Fig. 4. Point +ve joins a tag held by one of the bolts securing the variable capacitor. These bolts must be short, or have washers, so that they do

not touch the fixed plates of the capacitor. With the solid dielectric type of capacitor, take the lead through to the moving plates tag.

Clips, or a non-reversible 2-pin plug, may be obtained for the battery, and are convenient, while assuring the battery is not wrongly connected. If a meter is to hand, this may be connected in series with one battery lead, when first testing the receiver. More than 9V should not be used, and the battery must never be connected in the wrong polarity.

Testing

An earth was not found to be essential in some cases, but is preferable, as much better volume is then obtained. A simple indoor aerial can be arranged by having a few yards

of thin, insulated wire round the room, near the ceiling. An outdoor aerial will usually give better volume, but is not essential.

The aerial lead is taken to the tapping which gives best results. Point A gives best volume, especially with a poor aerial. Points B and D allow rather more selective tuning, especially with a fairly long aerial. Tuning with this kind of circuit is quite flat.

With no transistors or battery, headphones may be wired across R2. Reasonable headphone volume should be obtained. If not, the diode may be suspected, or wiring, etc., in this stage, or the aerial and earth system may be too inefficient.

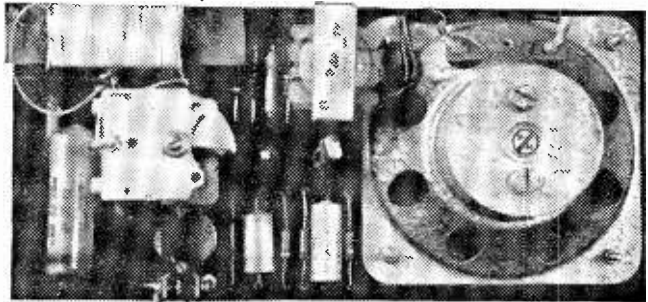

The receiver complete except for its cabinet.

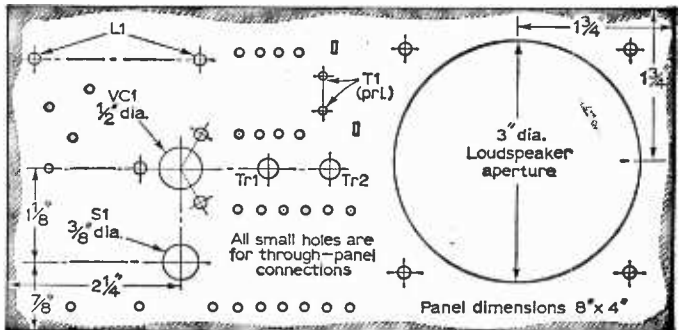

Fig. 2—Drilling details of the panel.

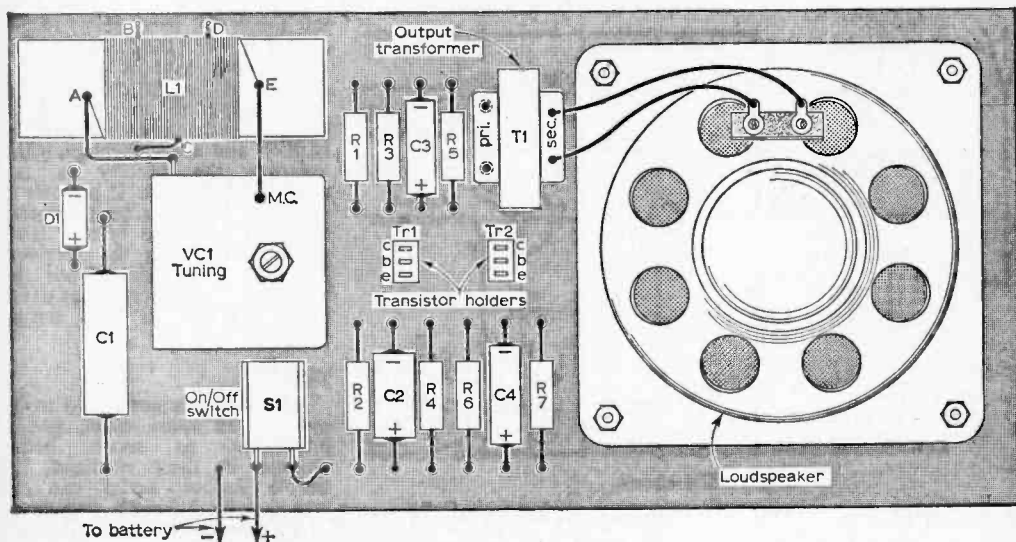

Fig. 3—Component layout on the rear of the panel.

With any reasonably effective aerial, and an average earth, quite good, phone volume should be obtained, from local stations.

The 'phones may then be wired in parallel with R6, and Tr1 may be inserted. There is no need to cut the transistor leads, but thin sleeving should be placed over them, to avoid shorts. It is essential that the collector, base and emitter leads are inserted in the correct sockets, as in Figs. 3 and 4.

Volume should be very much increased. Current consumption of Tr1 will depend on the transistor, but can be expected to be around 1mA. If the stage does not amplify, or if results are distorted, suspect the transistor, or wiring, etc. If Tr1 is of a type much different from that mentioned, the values of R1 and R4 may need changing.

The 'phones can then be removed, and Tr2 inserted. Consumption should be around 18mA to

25mA, with average loudspeaker volume. If current is over about 25mA, with the values shown and a particular transistor of different type, R5 may be increased in value, until the set draws about 20mA or so. If current is low, with lack of volume, R5 may be reduced in value, until the set draws about 20mA. An L5048 or similar battery will have a long life, with this current drain.

Cabinet

The receiver is not intended for portable use, so the smallest possible cabinet is not required.

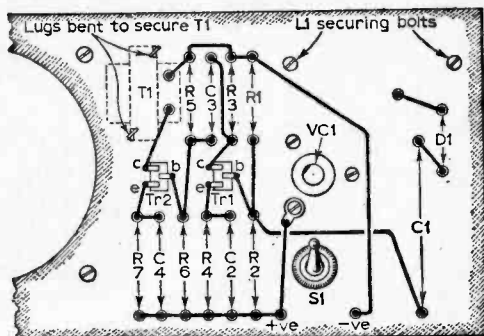

Fig. 4—The wiring diagram.

If no cabinet is to hand, one can be constructed from thin wood.

The receiver front consists of a piece of paxolin or any other thin material, with holes to agree with VC1, switch, and the speaker aperture. Silk or other fabric is stretched over the front, and cemented round the edges. Holes are cut in the fabric to clear the switch, and the spindle of VC1.

The securing nut of the switch is removed, and washers are placed on the switch, so that the front panel will just clear the receiver wiring. The two panels are then locked together with the switch nut, and a control knob is placed on the tuning capacitor spindle.

COMPONENT LIST

Resistors:

- R1 65kΩ
- R2 10kΩ
- R3 3.9kΩ
- R4 1kΩ
- R5 12kΩ
- R6 2.2kΩ
- R7 39Ω

Capacitors:

- VC1 Approx. 380 or 500pF variable capacitor
- C1 0.25μF paper
- C2 50μF 3-6V or similar
- C3 8μF 6-9V or similar
- C4 100μF 3-6V or similar

Semiconductors:

- Two transistor holders
- TR1 OC71 or similar
- TR2 OC72 or similar
- GD9 Crystal diode

Miscellaneous:

- On/off switch. Control knob. Ferrite slab and wire as described, or transistor set coil.
- W/B HF.3.57 3½in. 3 ohm speaker, or similar unit.
- Non-midget type transistor output transformer, ratio about 8 : 1. Paxolin panel approx. 8 x 4in., etc.



SUB-MINIATURE ELECTROLYTICS FOR TRANSISTOR CIRCUITS

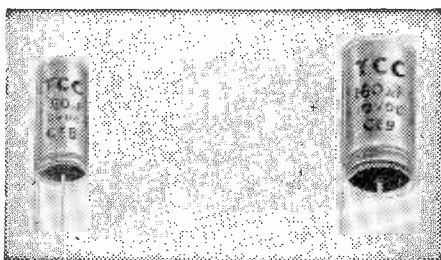

These capacitors are ideal for miniaturised transistor circuits such as in pocket radios. Each is available with wires at opposite ends for horizontal mounting ("H"), or at one end for vertical mounting ("V").

Connection wires are welded for low resistance contact and solder coated for ease of assembly. The standard length is 1½" for the horizontal range, cropped to ¾" for the vertical range.

The capacitors are in insulated seamless aluminium cases and sealed with a synthetic rubber bung.

Capacitance and Tolerance Standard tolerance is -20%+100% of the rated capacitance. Operating Temperature Range: -20°C to +60°C.

T.C.C. TYPE	CASE SIZE IN INCHES			MAXIMUM D.C. WKG. VOLTAGES AND CAPACITANCE (μF)					
	D	L	C	3V.	6V.	10V.	15V.	25V.	50V.
CE.8 ..	¼	¾	0.14	100	80	60	40	25	8
CE.9 ..	⅜	¾	0.2	250	200	160	100	60	20

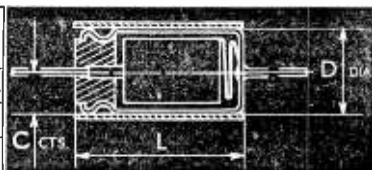

THE TELEGRAPH CONDENSER CO. LTD.

RADIO DIVISION • NORTH ACTON • LONDON • W.3 • Tel: ACO rn 0061

Easy-to-make cabinets to house your hi-fi

- 1 Tape deck/record storage
- 2 & 5 Loudspeaker
- 3 Record storage
- 4 Radio/record player

These easy-to-make sectional units are part of an outstanding new range of designer-styled cabinets for high fidelity sound equipment. They are the direct result of a close collaboration between well-known industrial designer Frank Guille Des RCA FSIA and Percy Wilson MA, technical editor of "The Gramophone" and prominent authority on acoustical engineering.

The cabinets which will house almost any combination of Hi-Fi equipment have been especially designed for making in Vipboard. Vipboard

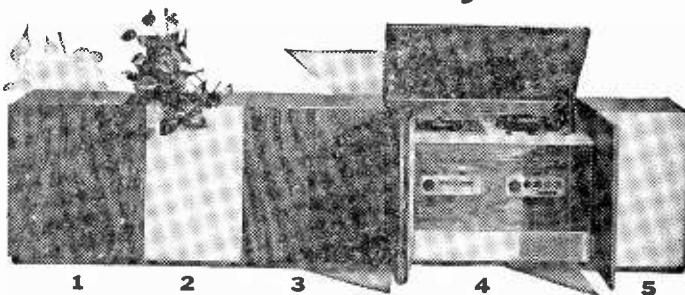

is a fine quality board with superior screw-holding qualities; specifically made for easy and economical furniture-making within the home. It comes in 20 standard sizes, fully veneered on all surfaces and ready

to polish. No special skills are required, and you need only basic household tools. Total cost of Vipboard for the cabinets shown above is £24.4.3. The individual cabinets cost from £3.1.9 (units 2 and 5).

Vipboard fully veneered chipboard with the natural wood finish

Find out how you can choose and build the units best suited to your Hi-Fi requirements—at a fraction of their "shop price". Ask for Free Instruction Leaflets and the Vipboard Furniture Brochure at your local Vipboard stockist, or write to: Vipboard Division, G.W.E. Boards Limited, 6 John Street, London WC1. Holborn 8421

EXPLORE
the
WORLD!!

on
SHORT WAVE

with our exciting new
"VENTURE-1" KIT
Covers both 20M and 40M
bands (switched). Band
spread tuning. Aluminium
chassis. Three ceramic air
spaced tuning condensers,
valve, plugs and sockets,
hardware, etc. Full building
plans provided.
COMPLETE FOR 47/6
ONLY P.P. 2/6

High Imp. Phones 14/6 extra.

The 'NORPAK'
MAINS POWER PACK
KIT
FOR TRANSISTOR
RADIOS

Operates your radio direct
from mains. Miniature Size—
4 x 2 x 1 1/2 in. In attractive
two-tone plastic case. Assem-
bled in an hour. Normal out-
put 9 v., 100 mA. (Adjustable)
Full Mains Transformer. Full
wave germanium diodes.
Cartridge fuse.

Complete Kit with Plans
35/- Plus 1/6 P.P.
(Ready assembled 45/-).

WE PROUDLY ANNOUNCE

★ THE NEW

P.W. MERCURY - 6 MK. II!!!

6 TRANSISTOR LONG AND MEDIUM WAVE SUPERHET



£10.7.6. plus 3/6 P. & P.
All parts required

This exciting new cabinet has been acclaimed by
everyone who has seen it. Existing Mercury
owners may purchase it for 48/- . All components
supplied to the last washer, together with
full building plans (2/6) Free with parts.

ALIGNMENT SERVICE available for both the **MERCURY** and
P.W.6 POCKET SUPERHET at reasonable charges. (Write for details).

- ★ New, brilliantly styled, timber cabinet giving elegant appearance.
- ★ New 8in. ferrite rod.
- ★ Printed circuit.
- ★ 500 mW into 7 x 4in. speaker.
- ★ Fine performance on both L.W. and M.W. bands including Luxembourg.
- ★ All parts available separately.

MAINS OPERATION
BUILT IN!!

30/- EXTRA. Also
CHARGEABLE BATTERY

Write for details S.A.E.

NORCOL LTD 147 LONDON RD., YORKTOWN,
CAMBERLEY, SURREY Phone:
CAMBERLEY 3743

ACKNOWLEDGED TO BE THE BEST
COMPONENT CATALOGUE

A
MUST
for every
radio
enthusiast



NOW
172 pages
Over 600
illustrations
Over 5,000
components listed

This is to-day's most up-to-date, most comprehensive component catalogue
for the radio constructor, experimenter, engineer and Hi-Fi enthusiast.

POST COUPON TODAY
Write CATALOGUE on top left of envelope
Enclose P.O. 3/3

Name

Address

Home Radio Ltd.(PW) 187 London Rd, Mitcham, Surrey

2/6
PLUS 9d POST

Quality Amplifier and pre-amp

(Continued from page 823
of the January issue)

THIS MONTH THE DESCRIPTION OF THE
MAIN AMPLIFIER IS CONCLUDED

By A. Cole

THE author ended last month by mentioning a method of tone control by connecting a 10-50k Ω potentiometer and 0.1 μ F capacitor in series from the anode of the output valve to chassis. This cuts treble by shunting actually produced power to earth instead of through the loudspeaker, and introduces effectively lower impedance at high frequencies to mismatch the output valve, leading to distortion and cross modulation. The "bass" in the "top-cut" setting of such a tone control is muffled and woolly, and the application of a shrill-toned signal can lead to severe overloading even though the actual volume finally present in the loudspeaker may be quite small.

The ideal position for a "top cut" control is right at the grid of the input stage; since then the above named disadvantages do not apply. Accordingly, VR2 and C6 constitute a treble-cut tone control of this kind, at the input grid of V1. This is ahead of the negative-feedback loop, and does not in any way limit the available output power, as there is linear treble response within the amplifier proper.

A treble cut control is more useful than a balanced treble lift/cut. In the same way, a bass-boost is more useful than a balanced bass boost/cut. VR3 and C9 vary the amount of bass negative feedback, so that the gain at bass frequencies may be raised above that at other frequencies, when VR3 is at high resistance setting.

Naturally, the degree of bass-boost available cannot exceed the degree of negative feedback employed, and is thus adjustable by means of VR4. If the completed amplifier howls or squeaks, reverse connections to the secondary of the output transformer.

Amplifiers overload much more easily on bass than on treble, because the human ear is less sensitive to bass sounds and considerably more power is required. Thus many arrangements which simply pump the necessary bass voltage into an amplifier, without further considerations, give a very rough bass response, because of overloading before the necessary sound-intensity is reached.

The arrangement here adopted is much purer, because any would-be distortion consists of higher harmonics for which the negative feedback reduction is much less, so they are still strongly cancelled by the negative feedback, in spite of its

bass reduction for bass-boost tone control.

This form of tone control is an interesting exception to the otherwise normal rule saying "tone and volume controls should not be placed within a negative feedback loop".

Finally, as far as tone is concerned, one of the most effective methods of getting very clean distortion-free reproduction is to use an output stage with a generous power reserve, so that one does not need to drive it to the end if its tether for normal usage.

Checking for Balance

On completion, an oscilloscope check can be made. First of all, after checking the wiring, ensure that in the absence of a signal there is 10V drop across R25 and equal voltages at V2 and V3 anodes.

Connect the oscilloscope Y-amplifier to the loudspeaker terminals (with a resistor of correct value and power rating as load). There should be no extraneous audio or supersonic signals present at any combination of settings of the controls, apart from slight residual hum.

Feed in a sine wave signal from an oscillator to the input and turn up the volume gradually. If the Y-amplifier is voltage calibrated, the r.m.s. voltage across the load resistor when visible distortion just starts can be read off and by dividing its square by the load resistance in ohms, the maximum power output under prevailing conditions obtained.

Turning the volume up still more, distortion should commence symmetrically on both half cycles. This is a sensitive criterion for balance throughout the amplifier and if serious asymmetry on onset of distortion is experienced this must be cured. Possible reasons could be wrong value of R8, R16/R18 unmatched, wrong value of R17, V2/V3 emission grossly different, and parasitic oscillation.

The oscilloscope method of testing can be used to determine the power output at various frequencies throughout the entire audio range, and to determine the necessary input voltage for full output by transferring the oscilloscope probe to the input, after adjusting the input signal for full output as observed when the probe is connected to the output load. The effect of the tone controls can also be studied this way (Table 2).

Power Supply

Separate rectifier bridges are used for the ampli-

fer and the tuner supply. There is no great objection to using a single bridge (300V a.c., 200mA rating) if available. C2 will then appear in parallel with the first section of C1, which should then be about 64-100 μ F. However, the design of Fig. 1 gives good decoupling and better smoothing.

The arrangement of R3, R4, R5, C3, C4, C5, gives three well decoupled separate supplies for the different sections of the tuner.

R3, R4, R5, C3, C4, C5 are located on the power-pack chassis instead of the tuner chassis, otherwise the return paths for a.c. through C3, C4, C5 would run between the two chassis and the interconnecting cables would carry a.c. components at high mains harmonics, resulting in increased stray hum injection into the circuits.

direct galvanic injection through stray "earth-loops". If one makes haphazard earth-connections between the various items and the screenings of signal cables, a chassis inter-connection lead or a signal-cable screening may share some of the a.c. components of power flowing between the two units.

By virtue of the always-present pure resistance of the cable or screening concerned, there will be a resulting a.c. voltage drop along the connection concerned, so that all parts of it are no longer at the same a.c. potential. The result is that proper earthing or screening cannot then be present, because the a.c. voltage drops along the supposed earthing or screening are injected directly in series with the signal proper, such effects being called

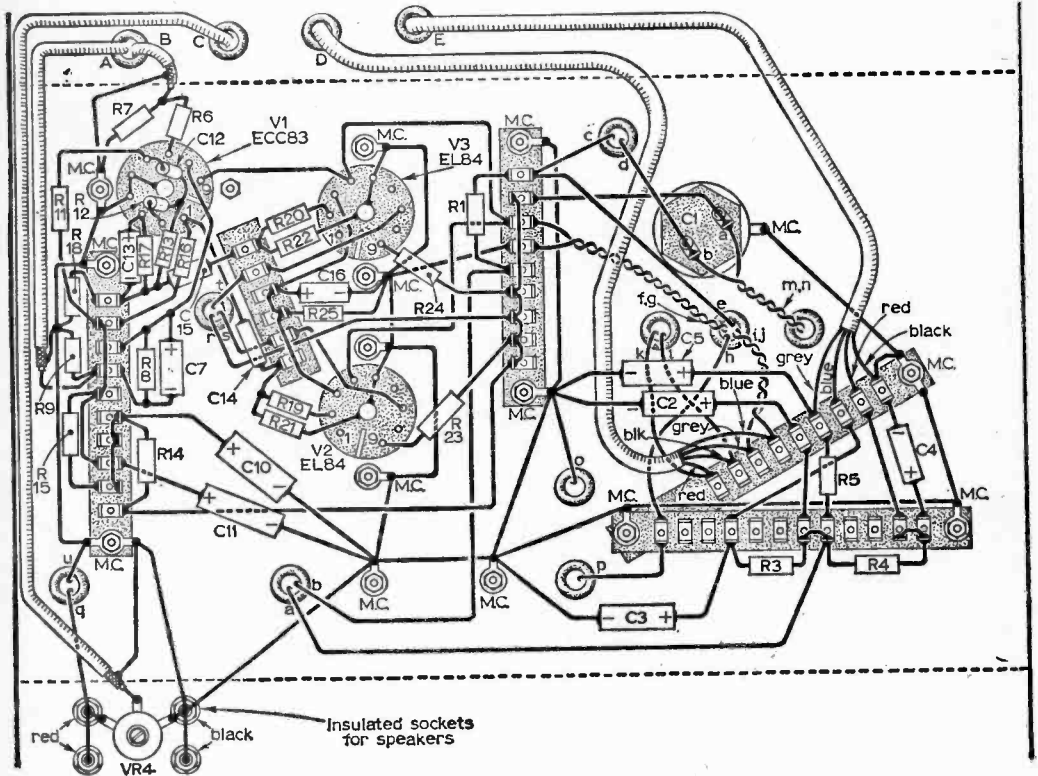

Fig. 2: The under-chassis wiring diagram.

Double Smoothing

Note the arrangement of R14, R15, C10, C11. The ripple from a fullwave bridge rectifier from the 50c/s mains is at 100c/s. A capacitor of 32 μ F has an impedance of roughly 50 Ω at 100c/s; 8 μ F roughly 200 Ω . R14 and C10 thus reduce ripple in the ratio 300:1 and R15, C11 reduce the remainder in the ratio 75:1. The total reduction is thus in the ratio 22.5 thousand to one.

Earth Connections

Hum induced by capacitive coupling of grid circuits to a.c. potentials is less of a danger than

"hum-injection on earth-loops".

Such effects also take place to a slight extent over stray capacities, which also present a finite impedance to a.c., and thus can never be avoided absolutely, yet one can do a great deal to reduce stray hum by a properly-conceived arrangement of earthing connections.

Earthing of Signal-cable Screens

The purpose of a signal cable screen is to prevent the amplifier at the output end of the cable seeing anything else but what is fed in at the input end of the cable. Therefore the cable

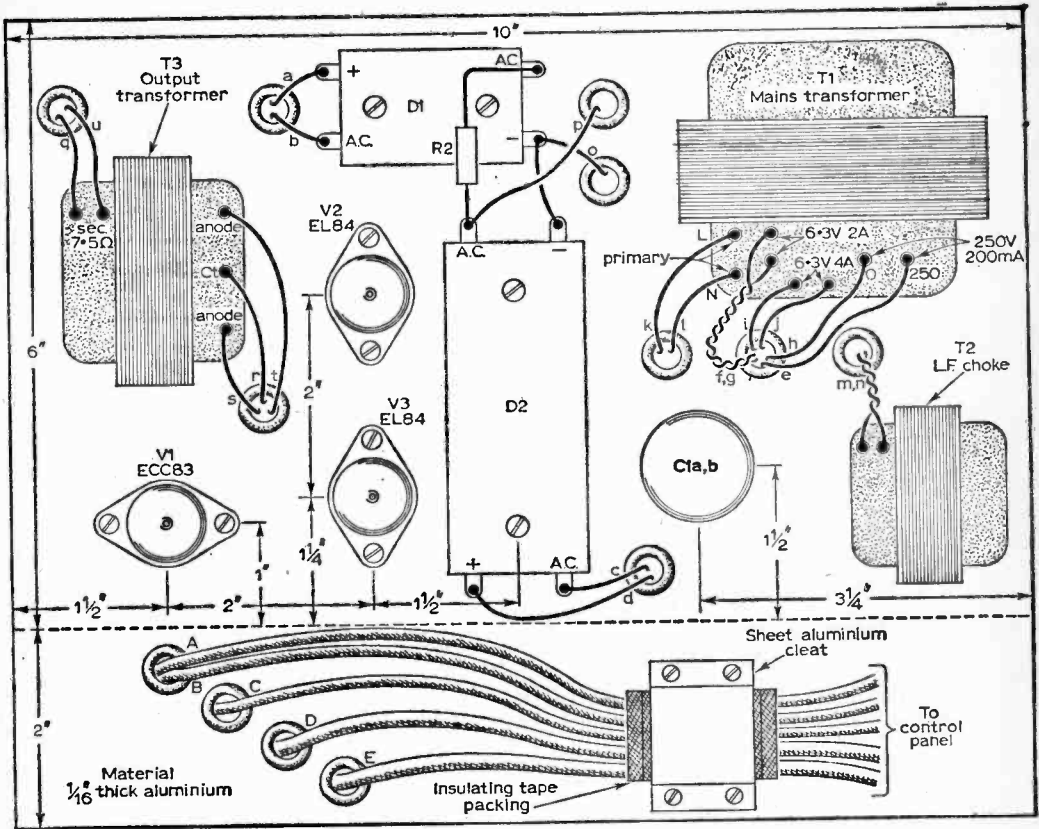

Fig. 3: The above-chassis layout of components.

screening must be at the potential of the "prevailing earth" for the following amplifier stage.

The proper place for earthing the screen of the signal cable is thus at the following amplifier which it feeds, and nowhere else. If the signal input to the cable is from another chassis, it is better to use a separate earth-wire connecting the two chassis, and earth the cable screen only at the following amplifier end, rather than use the screen itself as only, or additional, earth connection between the two chassis.

Furthermore the separate earth connection between the two chassis concerned must be such that no a.c. power components flow along it.

Avoiding A.C. Power Currents

There is only one solution to this problem. If one has to send a.c. power between two chassis of equipment (heater supplies, mains), then one should provide separate outward and return wires for the a.c. from the chassis supplying this power. In other words, earth connections for the a.c. supply concerned must be made on the consumer chassis ONLY. (See Fig. 5.)

The Present Amplifier

In Figs. 2 and 4 cables A, B, C are screened

signal cables. Cables A and B may be combined as a single screened cable with two insulated "inners" not individually screened from each other, but it is essential that C remains separate—otherwise serious interference with the negative-feedback characteristics can result.

Cable E is a substantial four-core 15A mains power type cable, carrying the three h.t. supplies for the tuner and the negative/inter-chassis connection. This cable is entirely for d.c., and the "d.c. loops" thereby resulting, giving slight d.c. differences of potential between the two chassis, are unimportant. They certainly cannot introduce hum! Cable D is another four-core power cable, for all a.c. connections. Note that none of its wires have any direct earth connection to the amplifier chassis nor to the control-panel chassis.

The grey wire, which will be the subsequent earth side of the tuner heaters, will receive an earth (chassis) connection *only on the tuner-chassis*, where the heater power is consumed.

Note that the black lead of the d.c. cable E, used as a.c.-free inter-chassis earth connection, also picks up mains earth on the control panel, yet is not connected to the chassis plate of the control panel. The control panel is earthed via the signal cable screenings, and is thus merely a part of the main amplifier/power-pack chassis.

Hum Injection via Valve-heaters

With modern valves there is only a very small hum-contribution from this source, which can be compensated by connecting a centre-tapped potentiometer across the heater supply.

Such measures were not found necessary in the

prototype, the residual hum at zero-setting of VR1 being such that one can just hear that the amplifier is operating in a quiet room. Also as far as r.f. and i.f. stages are concerned—particularly at v.h.f.—it is definitely of advantage, for stability, if one side of the heater supply can be earthed directly.

Sheet aluminium panel
8" x 2 1/4" x 1/16" thick

Plywood panel
9 1/2" x 3 3/4" x 3/16" thick

From amplifier—power pack chassis

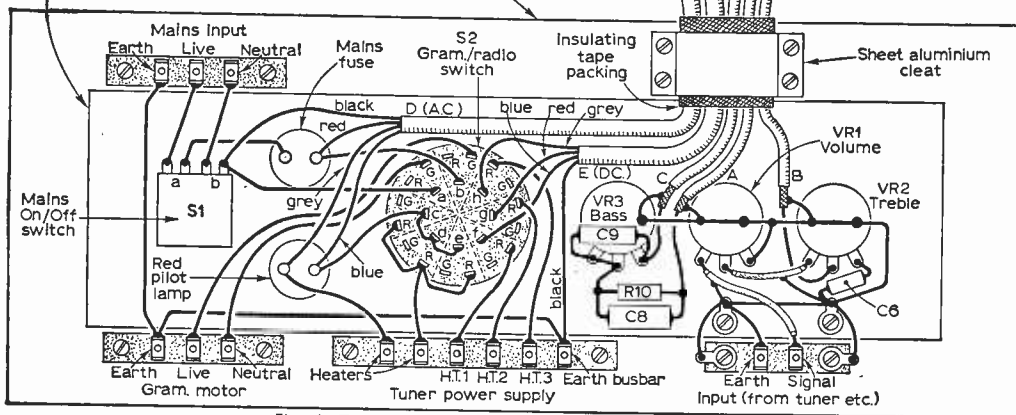

Fig. 4: The wiring diagram of the flying control panel.

COMPONENTS LIST

Resistors:

- R1 100Ω
 - R2 100Ω
 - R3 } 5kΩ 10W w.w.
 - R4 }
 - R5 }
 - R6 22kΩ
 - R7 4.7MΩ
 - R8 1.8kΩ ± 5%
 - R9 100Ω
 - R10 5.6kΩ
 - R11 68kΩ
 - R12 22kΩ
 - R13 1MΩ
 - R14 } 15kΩ
 - R15 }
 - R16 47kΩ matched with R18
 - R17 1.5kΩ ± 5% matched pair
 - R18 47kΩ
 - R19 10kΩ
 - R20 10kΩ
 - R21 560kΩ
 - R22 560kΩ } matched pair
 - R23 100Ω
 - R24 100Ω
 - R25 90Ω 2W w.w. ± 2%
- All resistors ± 20% 1W carbon, unless otherwise stated.

Variable Resistors:

- VR1 500kΩ log
- VR2 500kΩ lin.
- VR3 50k log.
- VR4 500Ω l.n. w.w. preset

Capacitors:

- C1 Electrolytic Can, 50 + 50μF 450V, high ripple rating
- C2 32μF
- C3 16μF
- C4 16μF
- C5 16μF
- C6 200pF Paper, 500V
- C7 50μF 15V electrolytic
- C8 1000pF Paper, 500V
- C9 0.1μF Paper, 500V
- C10 32μF Tubular Electrolytics 350/385V

- C11 8μF Tubular Electrolytics 350 385V
 - C12 0.056μF Paper, 500V
 - C13 50μF 15V electrolytic
 - C14 0.056μF
 - C15 0.056μF } Paper, 500V, matched pair
 - C16 50μF 25V electrolytic
- Valves, Transformers, etc.:**
- V1 ECC83
 - V2 EL84
 - V3 EL84 } matched pair
 - D1 Selenium Bridge Rectifier B250C80
 - D2 Selenium Bridge Rectifier B300C150
 - T1 Mains Transformer, 250V 200mA, 6.3V 2A, 6.3V 4A
 - T2 Smoothing Choke 10H/125mA
 - T3 Hi-Fi Output Transformers for 2 x EL84 in Class A Secondary for 7 1/2 ohms, push-pull
- Switches:**
- S1 2 pole On/Off Toggle Switch, Mains 2A rating
 - S2 Ceramic 2-way rotary switch, 8 pole 2A, 500V

Loudspeakers:

WB "Stentorian" HF1016

Miscellaneous:

Panel Pilot Lamp, Red. Insulated Panel Fuse (Mains). Four knobs. Three Noval Valveholders, Ceramic, 1 with screening-hood (steel). Thirteen Rubber Grommets, 1/2 to 1/4 in. diameter. Two pairs insulated Wanderplug Sockets (Red/Black), Approx. 3 yards 4-core Power Cable, 15A. Approx. 4 1/2 yards flexible thin coaxial screened cable, PVC outer coating (quality microphone cable). Tagstrip, bolts, connecting wire, solder, etc. Aluminium sheet, 1/4 in., for Chassis, Panel Plate and Cleats. (Approx. 16 x 10 in. piece, total needed.) 3/8 in. plywood, approx. 4 x 10 in. raw, for Control Panel. Insulating tape.

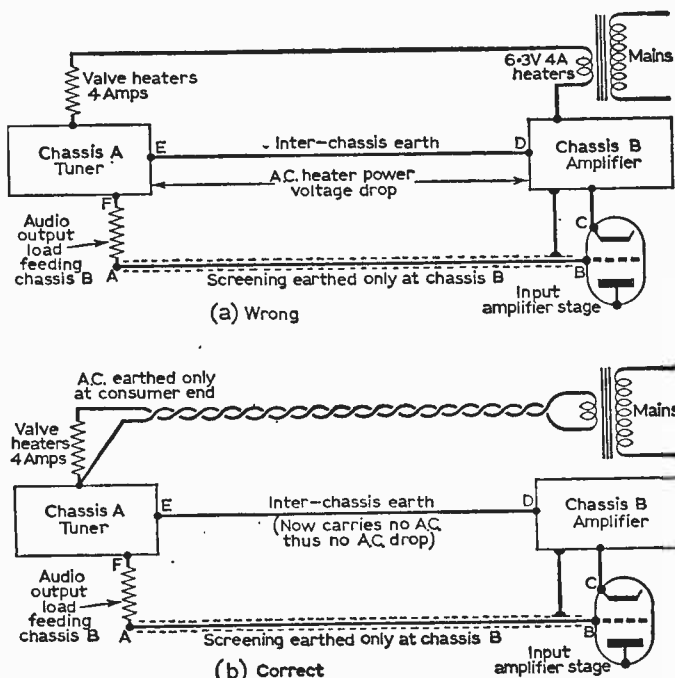

Fig. 5: The correct and incorrect methods of connecting chassis earths.

In general, the author is of the opinion that one need not be hypercritical in striving to get the hum-level in an amplifier so low that it is inaudible even under the most exacting circumstances, for as soon as any ordinary programme is playing at normal volume, slight residual hum is normally quite unnoticeable.

Final Remarks on Wiring

Note the spaced arrangement of R3, R4 and R5 in Fig. 2. This is important, as these resistors will generate considerable heat. Note also the "grid" of bare earth wires strung between chassis-con-

necting tags (marked MC) under component fixing bolts. This is a very effective and convenient component earthing system, giving very high contact reliability.

In Fig. 3 and Fig. 4 can be seen the method of anchoring the cables, to prevent destruction of connections by pulling.

Note carefully the layout of components on the chassis, as shown in Figs. 2 and 3.

The mains transformer and the output transformer are mounted as far apart as possible, and with the cores at right angles to each other. The amplifier components are mounted huddled-up in the opposite corner of the chassis to the mains transformer. The major heat-producers, V2, V3 and the mains transformer, are not placed in the immediate vicinity of each other. The input valve V1 is situated furthest of all from the power supply components.

It is advisable to operate the input valve V1 in a screening can, but this is very inadvisable for V2 and V3, as ventilation of these valves is thereby impaired, leading to overheating of the electrodes and early failure.

The radio/gram switch, S2, should preferably be a ceramic type with good contacts rated at 2A each. It is 8-pole, 2-way, normally on two wafers; the depiction in Fig. 4 is as one wafer only for clarity. Those sections remote from VR3 should be used for the five a.c. switching functions. Three sections are wired in parallel for switching the heaters, to give ample surge rating when switching on the cold heaters of the tuner.

The four tagstrips on the panel are mounted on brass stand-off bolts on the plywood overlap, countersunk from the front. Those of the signal input tagstrip are earthed to the chassis plate, to prevent hand-capacity hum effects from the front. Others may be treated the same way, but this is an unnecessary complication. Note the positioning of tags for higher voltages towards the centre of the strips, for safety.

The amplifier/power-pack chassis and flying panel form an inseparable unit. The panel is intended for mounting with four bolts through the corners to the back of the cabinet top-panel, so that the controls appear through a suitable (smaller) cut-out in the latter.

The gram motor, tuner power supplies and signal from the tuner are connected with soldered joints on the flying panel tagstrips, removable for servicing. Mains input is also wired to the appropriate tagstrip on the flying panel. The pick-up output goes to a socket on the tuner chassis. If the final stage of the tuner requires to be used as audio pre-amplifier, this valve must take h.t. and heaters ahead of S2.

TABLE 2

r.m.s.—DRIVE AT INPUT for full power output as in Table 1.				
(oscilloscopically measured on prototype)				
LEVEL SETTING: approx. 200mV.				
VR2: Treble-Cut (level when full up)				
VR3: Bass-Boost (level when full down)				
VR2	2kc/s	5kc/s	10kc/s	15kc/s
Max. Treble	200mV	200mV	200mV	200mV
Min. Treble	600mV	1½V	2½V	2V
VR3	50c/s	100c/s	} for VR4 in setting with negative-feed-back over ⅔ of output transformer secondary voltage (approx. optimum setting)	
Min. Bass	200mV	200mV		
Max. Bass	50mV	100mV		

NEXT MONTH THE PRE-AMP WILL BE DESCRIBED

LASKY'S RADIO

"BUILD-YOURSELF" TRANSISTOR RADIOS

The finest receiver at present available for home construction. Fully tunable long and medium wavebands. Uses 7 Mullard Transistors: OC44, 2 OC45's, OC71, OC10D and 2 OC81's, plus Crystal Diode OA70.

The "REALISTIC" Seven

STAR FEATURES ★★★★★

- ★ 7 Transistor Superhet. 350 Milliwatt output into 4-inch high flux speaker.
- ★ All components mounted on a single printed circuit board, size 8 1/2 x 5 1/2 in. In one complete assembly.
- ★ Plastic cabinet, with carrying handle size 7 x 10 x 3 1/2 in. In choice of colours:
- ★ Red/Grey, Blue/Grey, all Grey.
- ★ Easy to read Dial.
- ★ External Socket for car aerial.
- ★ I.F. frequency 470 Kc/s.
- ★ Ferrite Rod internal aerial.
- ★ Operates from PP9 or similar battery.
- ★ Full comprehensive data supplied with each Receiver.
- ★ All coils and I.F.'s, etc., fully wound ready for immediate assembly.

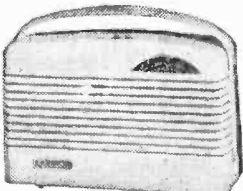

An Outstanding Receiver. Lasky's Price for the complete parcel including Transistors, Cabinet, Speaker, etc., and Full Construction Data: **£6.19.6** Postage and Packing 4/6 Battery 3/9 (included free with complete parcel). Data and instructions separately 2/6, refunded if you purchase the parcel.

THE BETA TWO

A 2-transistor plus 2-diode personal receiver for home construction. Uses printed circuit and ferrite rod aerial. Personal earphone gives clear reception for private listening.



Tunes over full medium waveband. Size 5 1/2 x 3 1/2 x 1 1/2 in. overall. All components available separately. **CAN BE BUILT FOR 21/-**

Postage 2/8 ex. Including personal earphone, cabinet, etc. Circuit diagram and step by step instructions 1/6. (Free with parcel).

KAPURA Model U1 Multi-Test Meters

- ★ Complete with test leads.
- ★ Brand new, fully guaranteed.

Sensitivity: 1,000 ohms per volt A.C. and D.C.
 Ranges: (A.C. and D.C.) 0-15-50-250-500-1,000 v. D.C. current 0-100-500 mA. 0-1 mA (used at 0-10 v. range). Resistance: 1-2,000 ohms (centre 24 ohms), 100-200,000 ohms (centre 2k.)
 Size: 5 1/2 x 8 1/2 x 2 1/2 in.



LASKY'S PRICE 39/6
 Carriage and Packing 6/-

TELEFUNKEN STEREO HI-FI AMPLIFIERS

Further Great Purchase Enables us to offer this Excellent Unit at £5.19.6. Post 7/6.

A complete stereo amplifier of unsurpassed quality, with inputs for radio, tape recorder, F.M. tuner or any other hi-fi source, either monaural or stereo. Output power 5 watts total (2 watts each channel). New and unused. Listed at 16 gns.



LASKY'S PRICE £5.19.6

THE SPRITE



- ★ Six-Transistor Superhet Miniature Personal Pocket Radio. ★ Tuneable over Long and Medium wavebands. ★ Used PP3 battery. ★ Ferrite Rod aerial. ★ I.F. Frequency 470 Kc/s. Transistors: 3 x Philco 2087's 2 x Mullard OC81 M, OC81 DM and OA90 diode. ★ 3 inch speaker. ★ Printed circuit 2 1/2 x 2 1/2 in. ★ Slow Motion Dial. ★ In plastic case, size 4 x 2 1/2 in.

Inclusive price of **89/6**
 P.P. 3/6 extra.

In order to ensure perfect results, the SPRITE is supplied to you with R.F. and I.F. stages. Driver and Output stages, ready built with all components ready mounted on the printed circuit. To complete assembly you only have to fit the wavechange switch, tuning condenser and drive, volume control, earphone socket and aerial rod, the remaining components all having been pre-fitted at the factory for you. The SPRITE is offered as above, pre-assembled, plus cabinet, speaker and all components for final construction, at the inclusive price of 89/6. Postage and packing 3/6 extra. Data and Instructions separately, 2/6. Refunded if parcel is purchased. Real calf leather case, wriststrap, personal earphone and case for earphone 10/- the lot extra. Make no mistake this is SUPERHET receiver of genuine commercial quality. It is not a regenerative circuit.

THE COROVER '6'

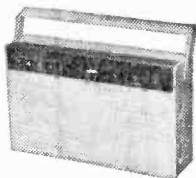

- ★ A 6-transistor plus 2-diode superhet receiver using the latest circuitry. ★ Three Mullard AF117 alloy diffused transistors are used with OA79 and OA81 diodes, followed by OC51D and two OC81's in push-pull. ★ I.F. frequency 470 Kc/s. ★ Covers the full medium and long wavebands. ★ Sockets provided for personal earpiece or tape recorder, and car radio aerial. ★ Large internal ferrite rod aerial gives high sensitivity. ★ Uses four 1.5 v. pen torch batteries. ★ All components mounted on a single printed circuit. Simple stage by stage instructions. ★ Cabinet size 6 1/2 x 4 x 1 1/2 in. With carrying handle.
- ★ All coils add I.F.'s ready wound.

ALL COMPONENTS AVAILABLE SEPARATELY. Data and instructions separately 2/6. Refunded if you purchase the parcel.

CAN BE BUILT FOR
 Post and packing 4/- extra. **£5.19.6**

207 EDGWARE ROAD, LONDON, W.2. 33 TOTTENHAM COURT ROAD, W.1.
 Near Praed St. PADDINGTON 3271/2 | Nearest Stn, Goudge St. MUSEUM 2605
 BOTH OPEN ALL DAY SAT: Early Closing Thurs. Mail Orders to Dept. P.W., Edgware Rd.

CRYSTAL PICK UP CARTRIDGES

Lowest Prices Ever!
 All complete with Stylus, L.P. and Standard (and Stereo where shown) Fully guaranteed, standard fittings will fit most P.U. arms and heads.
 Postage 1/- each extra.

MONO	
TYPE C.T.1. By well known manufacturer. With two sapphire stylus	12/6
Garrard GCE.4	15/-
Ronette Studio O	15/-
Acos GP 65/3	15/-
Acos GP 65/1	17/-
Acos GP 61/1	18/-
STEREO	
Acostereo 73/1 with two sapphires	25/-
Acostereo 73/2 with Diamond L.P./Stereo and sapphire Std.	28/6
Collaro type C. Turnover, with 2 sapphires	25/6
Coller S.C.1. Turnover with 2 sapphires	24/6
Coller S.C.1. Turnover with Diamond L.P./Stereo and sapphire Std.	29/6
Ronette Stereo O.V. Turnover, with 2 sapphires	29/6
Ronette Stereo type 105, with 2 sapphires	35/6
Ronette Stereo type 105, with Diamond L.P./Stereo and sapphire Std.	39/6

TV TURRET TUNERS

By famous manufacturer, I.F. 33-38 Mc/s., PCC84 and PFC80 valves fitted, also 12 sets of coils.
 Lasky's Price Complete with Valves and Coils 29/6. Postage 2/6.

Distler Miniature Motors

6 volt battery operated 7/11. P. & P. 2/6.

152 3 FLEET STREET, LONDON E.C.4
 Telephone: Fleet Street 2833.
 Open all day Thursday. Early closing Sat.

an *Armstrong* chassis is more than just a radiogram chassis

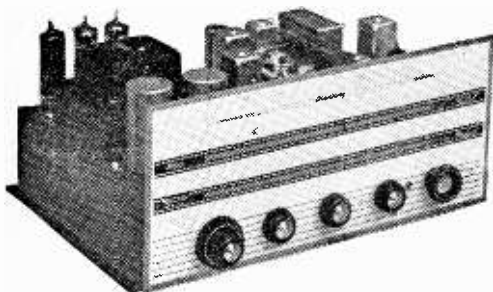

It is a carefully designed combination of tuner, control unit and amplifier in one compact unit which can be used as the basis of a complete high fidelity system. A system which can include tape recording and playback as well as radio and record reproduction.

STEREO 12 MK.2 £43.10.0

8 watts push-pull output from each channel, 16 watts total. VHF, with automatic frequency control, medium and long bands. A hi-fi system on one compact chassis.

STEREO 55 (Illustrated) £32.15.0

A junior version of the Stereo 12 Mk. 2. 5 watts per channel. 10 watts total. VHF and medium bands. Inputs for tape, pick-ups and possible future stereo radio.

JUBILEE MK.2 £30.12.0

A mono chassis of 8 watts push-pull output and covering VHF, medium and long bands. Separate tone controls. A.F.C. Pick-up and tape inputs.

AF208 £22.18.0

An AM/FM mono chassis of 5 watts output covering VHF and medium bands. An inexpensive version of the Jubilee Mk. 2.

Post this coupon or write for catalogue or call at our showroom for full demonstration and professional advice on your installation. Open 9-5 including Saturdays.

NAME _____ PFC

ADDRESS _____

ARMSTRONG WALTERS ROAD, HOLLOWAY LONDON N.7

TRANSISTOR AMPLIFIERS

1/2 WATT 3 TRANSISTOR AMPLIFIER READY BUILT



45/- Plus 1/6 P. & P.

- 1/2 w. Peak output.
- Output to 3ohm speaker.

- Push-pull output stage.
- 9 volt operation.

A printed circuit high gain amplifier. Size 5" x 2" x 1". Three Newmarket Transistors (two NKT 251 and NKT 252). Ideal for intercom or as record player amplifier.

2 WATT 4 TRANSISTOR AMPLIFIER READY BUILT

A 2 watt 4 transistor amplifier with 2 driver and push-pull stage. Size 5" x 2" x 1 1/4". Plus 1/6 P. & P.

62/6

THE NEW TRANSISTOR 6 PANDORA

Designed by

Mel Electronic

USING NEW HIGH GRADE PARTS

TOTAL BUILDING COST

ONLY £6.19.6

FULL AFTER SALES SERVICE



Obtainable from your local stockist or in case of difficulty DIRECT FROM MEL ELECTRONIC

- ★ MEDIUM WAVE & LIGHT ON LONG WAVE
- ★ 6 TRANSISTORS + DIODE
- ★ SUPERHET CIRCUIT
- ★ AUTOMATIC WAVECHANGE
- ★ 500mW PUSH-PULL OUTPUT
- ★ PRE-TINNED PRINTED BOARD
- ★ EXCELLENT RESULTS

Please send S.A.E. for full details of these and other transistor designs

MEL ELECTRONIC CO.

REAR OF 240 HIGH STREET
BECKENHAM, KENT

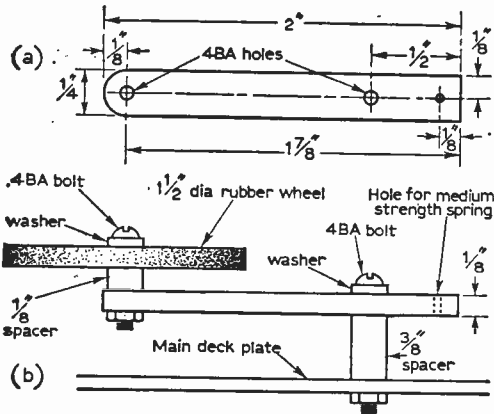
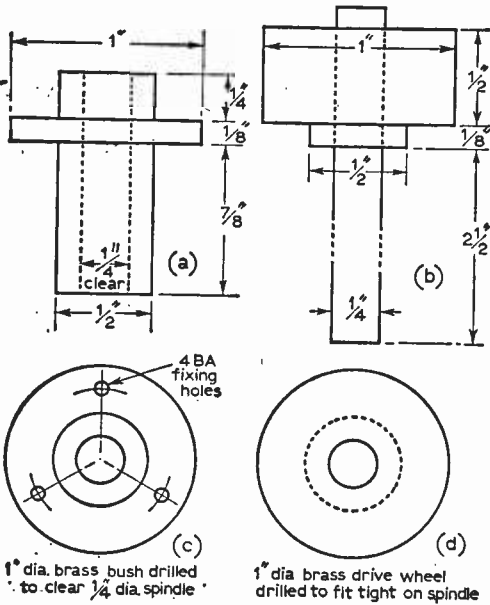

Fig. 8 (above): Motor drive wheel assembly.

Fig. 9 (below): Drive wheel and bush assemblies.



Tension Pulley Assembly

This is made from $\frac{1}{8}$ in. thick steel, drilled and assembled according to details given in Fig. 7. A second pulley wheel is used here, the size being the same as the tape guide pulley. A medium strength string is attached to one end and provides the tension necessary to keep the tape tight. All holes are drilled to take 4B.A. bolts.

Motor Drive Wheel Assembly

This piece is made from $\frac{1}{8}$ in. thick steel cut and drilled as shown in Fig. 8(a). The rubber used is $\frac{1}{2}$ in. diameter. Another medium spring is used to keep the rubber drive wheel in contact with the motor and flywheel. Fig. 8(b) shows the completed assembly.

Drive Wheel and Bush Assembly

This bush is made from a piece of brass rod cut and drilled as in Fig. 9(a). The bush used in the prototype was obtained ready made from a light engineering firm. Fig. 9(b) and Fig. 9(d) show the construction of the drive wheel with the main spindle fitted. The drive wheel is made from a piece of lin. diameter rod. The wheel is made to fit tight on to the main spindle. A small screw can be fitted through the wheel to keep it tight, but this screw must be set well into the brass wheel to avoid scratching the tape. Fig. 9(c) shows the plane view of the brass bush. The holes marked "A" are drilled to take 4B.A. bolts which secure the bush to the main deck plate. The main spindle is cut from $\frac{1}{2}$ in. steel rod as in Fig. 11(a).

The Pressure Wheel Assembly

This is made from $\frac{1}{8}$ in. thick steel, cut and drilled as Fig. 10(b). All holes are drilled to take

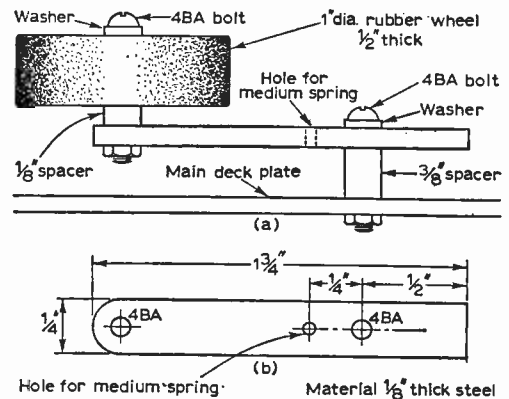
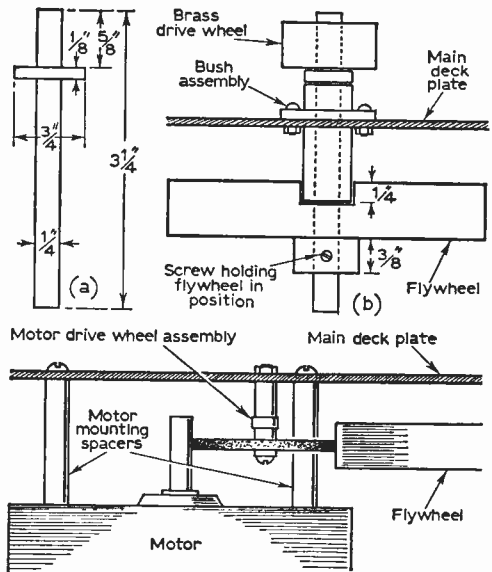

Fig. 10 (above): Pressure wheel assembly.

Fig. 11 (below): Drive wheel and flywheel assemblies.



4B.A. bolts. A standard rubber pressure wheel size 1in. diameter by $\frac{1}{4}$ in. thick is used. This is mounted as in Fig. 10(a). A medium spring at one end of the metal provides the tension against the drive wheel for the tape motion through the heads. At this stage the whole drive assembly and motor are mounted to the main deck plate. The completed assembly is shown in Fig. 11(b). Next the pressure wheel is mounted. Fig. 11(c) shows the flywheel, motor and drive pulley in position.

Completing the Deck

The tension pulley wheel is now added to the deck together with the spring. Then the leads from the heads are connected to a small piece of tag panel mounted on the underside of the deck. The holes marked "D" in Fig. 12 are for the mounting feet which support the deck when it is in the cabinet. Three supporting feet are required and are made from $\frac{1}{4}$ in. steel rod, 4in. long. The hole marked "E" is used for mounting a twin connector or a piece of tag panel for the mains supply to the motor. Fig. 12 shows the completed deck with the tape in position. The tape used is the standard $\frac{1}{4}$ in. type, and is joined by a piece of splicing tape to make a continuous loop.

Adjustments

The adjustments for the bias level are carried out in the normal way. Other adjustments to the completed echo chamber can be made as required. The bias current through the record head should be 1mA constant.

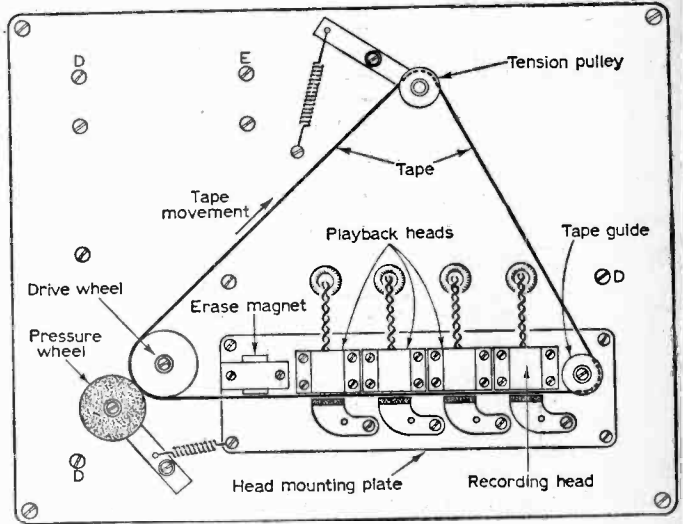

Fig. 12: The completed deck.

The Amplifier

This amplifier is built in the normal way. Care should be taken when wiring the valve grids and heater chain, and these should be kept well away from each other to prevent hum pick-up. Three valves are used: EF86, ECC83 and EL84 (see Fig. 13). The EF86 low noise pentode is used for amplifying the input signals. The first section of the ECC83 double triode valve is used in the equalising stage, and the second section is used as the output stage when recording. The EL84 output pentode is used as the oscillator. An E280 full wave rectifier is employed in the power pack

Input Stage

The EF86 acts as a voltage amplifier. It is possible to record from either microphone or

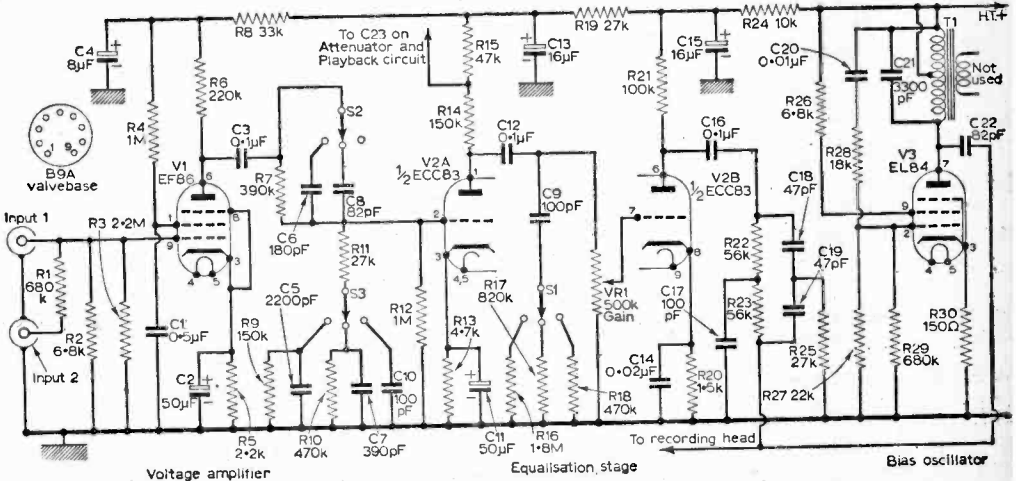

Fig. 13: The main amplifier circuit.

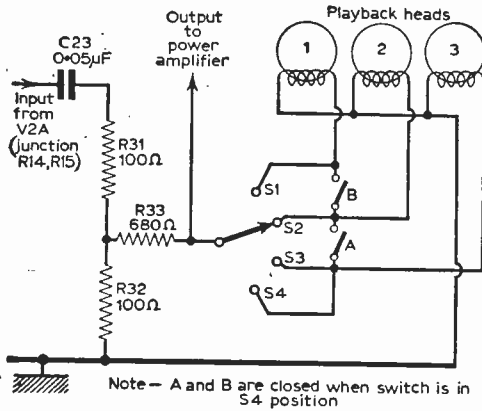

Fig. 14 (above): Attenuator and playback circuits.

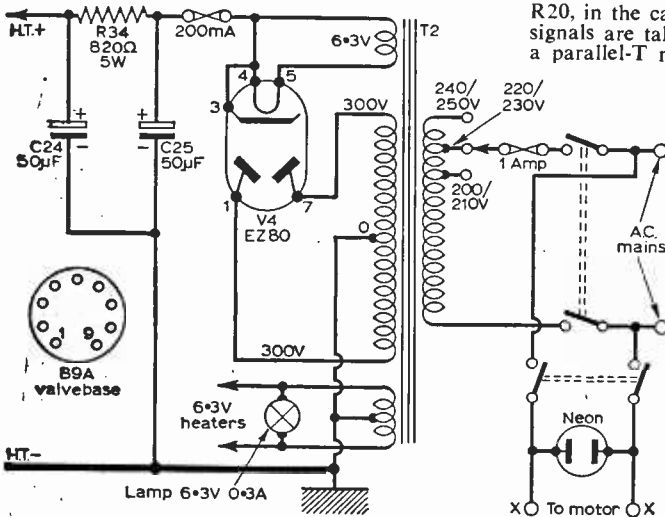
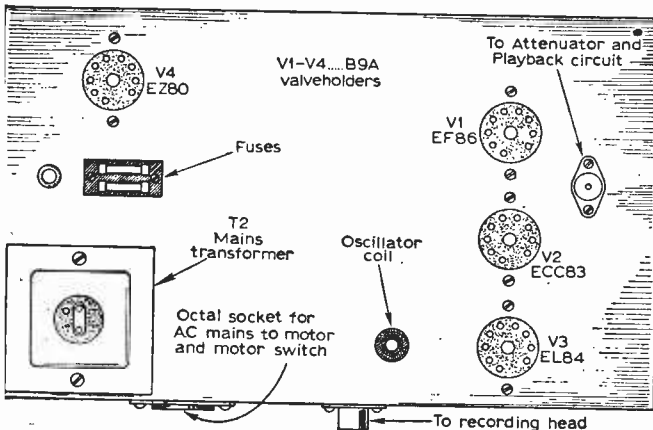

Fig. 15 (above): Power pack circuit.

Fig. 16 (below): Above-chassis layout.



guitar input sources. Both input are fed to the grid of the valve. Input two being attenuated by R1. The two inputs can be used at the same time if required.

Equalising Stage

The first section of the ECC83 (V2A) is used only for equalisation purposes. The component values used in this part of the circuit may need to be varied to give the correct bass and treble response, according to the type of head used. Switches S1, S2 and S3 select the desired equalisation circuit. A low level output is taken from the anode load of this stage and is taken to the attenuator circuit (Fig. 14).

Recording Stage

The output from the anode of the equaliser stage is taken to the grid of the section of the ECC83 via the gain control VR1. Further high frequency boost is added to the recording signal by C14 and R20, in the cathode circuit of V2B. The recording signals are taken from the anode of this stage via a parallel-T network to the recording head. Bias is fed to the recording head immediately after the T network.

H.F. Oscillator

The bias signal is fed to the recording head via the 82pF capacitor C22. The valve of this capacitor determines the bias current flowing in the head. The bias voltage is obtained from the anode of the EL84. The oscillator coil and oscillator component values will depend on the type of recording head used. The record head used in the author's model had an impedance of 300Ω.

Attenuator and Playback Circuit

The attenuator is a straightforward circuit using three resistors and a capacitor (Fig. 14). The input to this circuit is taken from the anode of V2A (junction of R16, R17). The original signal is thus attenuated and then combined with the output from the playback heads to form the echo required. Switches S1-S4 allow the playback heads to be switched simultaneously as required. Switches A and B are closed with the switch in S4 position. The playback signals and the original signals are fed to the main power amplifier.

Power Pack

This is an ordinary power-pack and is wired as shown in Fig. 15. The transformer used is a standard type with a 300-0-300V 250mA h.t. winding and two 6.3V heater windings.

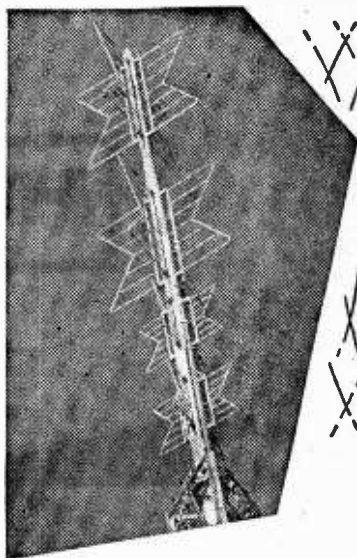

On Your Wavelength

By THERMION

WE have had considerable correspondence in the past regarding the "wonderful tone" of many old sets, and although we are sure many of these claims are due to prejudice, we agree that there is a subtle something about some of them which cannot be denied.

An acquaintance of mine recently asked if I thought that it would be worth while fitting a tweeter and crossover to his vintage set—one which I knew was a really beautifully made early 20's model, with a single-ended output stage. The cabinet was a classy piece of work in mahogany with the lower section housing a 9in. or 10in. loudspeaker behind a mass of fretwork and silk.

I told him not to worry about tweeters etc., and told him that I did not think there was any "top" in his set which was suitable for tweeting anyway, and that what was there would be adequately covered, in my opinion, by the 10in. loudspeaker. He seemed rather disheartened, and although I twitted him on wanting to improve such a remarkable set (I had constantly heard about its wonderful tone), I could see that he had rather set his mind on trying out this improvement.

So after a little thought I made a suggestion which has turned out wonderfully well, and may, therefore, interest others with similar types of apparatus. I said that instead of spending money on the tweeter and crossover he should buy four 8in. loudspeakers of modern design. Then I said he should remove the existing loudspeaker and its baffle, and obtain a new piece of wood for a baffle. He should cut four holes equally disposed in the new baffle to house the four speakers—centre top and bottom, and one on each side.

Next I suggested he cut four small squares to take these speakers and from them make mounts so that when the speakers were screwed to the main baffle they would be tilted slightly, the upper one towards the ceiling, the lower one slightly downwards, and the other two towards right and left. The original loudspeaker and output was 3Ω,

so I suggested four 15Ω new models, and suggested that the slight mismatch would not be noticeable, and I pointed out that I thought that the removal of a single point source of sound, and the new distribution of sound might give him an improved performance.

I have not yet ceased to hear what a miracle this has performed in the set. It certainly has improved reproduction, giving a much rounder tone without the "hole in the wall" effect, and the top definitely sounds much brighter. Probably ideas on this line might be tried in other vintage models with advantage, but I certainly did not expect it to have worked such an improvement in reproduction on an old set.

A Future Trend

I recently read a news item (from America!) that a new infra-red camera had been developed which could photograph the immediate past—during a test some cars were driven from a car park, the camera was set up, and took pictures of the cars which had vacated the site!

Some years ago a technician, also from America, decided (and I believe proved—or was it in a radio play?) that when a transmission is sent out it goes round and round the earth gradually attenuating, but never completely dying out. Will we next hear that a radio or circuit has been demonstrated which can pick up yesterday's signals from the jumble which must be whirling round our earth?

Probably if the transmitter closed down immediately the signal had ceased, a very sensitive set could pick up a weak signal, say after two or three circuits of the earth, but surely next time round it would mix with the outgoing signal on the wavelength.

Come to think of it, perhaps this is the cause of some of our distortion—some of yesterday's signals modulating those of today. Who would like to bet how long it will be before a set is announced which receives old signals?

Modern Music

It is a long time since I mentioned anything about modern music, as I fully realise that the modern generation have much different ideas on this subject than us "old 'uns", but I have become increasingly appalled at the incessant repetitiousness of modern music—not only the melody (if you can call it that), but the words.

In addition to constant repetition of notes or short themes, the words, too, seem to go on and on line after line. Have the writers taken an easy way out, or is this some modern trend? I will not deal with the splitting-up of a single-syllable word into many syllables ("You who who who" etc.)

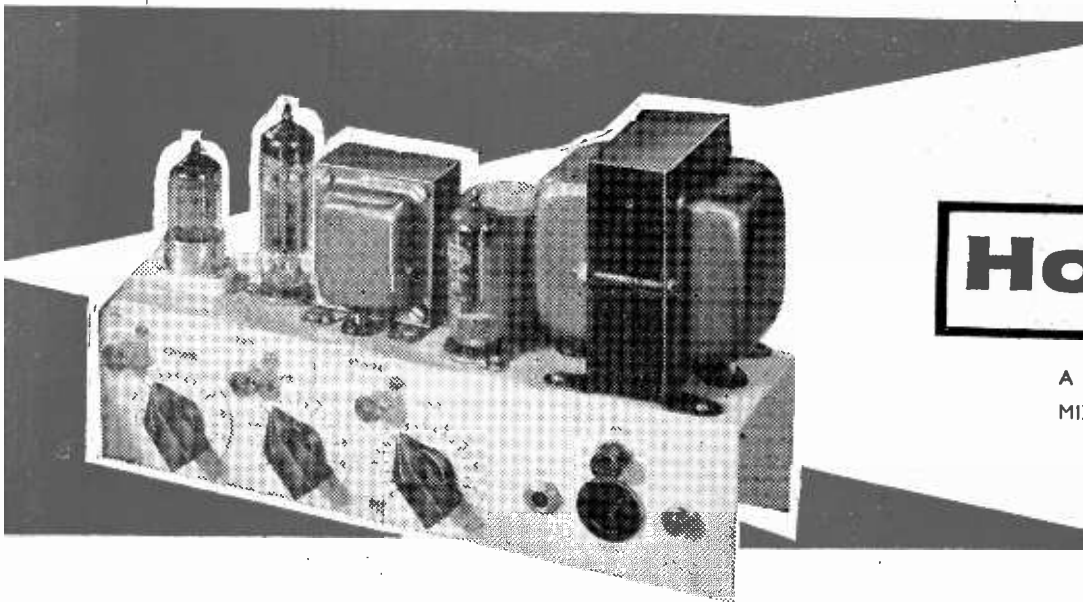

Ho

A
MI

HAVING become interested in 8mm cine photography last summer I found that there was no commercial amplifier available on the market which provided the facilities that were needed for adding sound commentaries at a reasonable cost.

The amplifier to be described was therefore designed and built primarily for this purpose, but it has many other uses as a compact, good quality audio amplifier and mixer. The main requirements that were needed are as follows:

1. Good quality output of 3 to 4W suitable for use at home or occasionally in a small hall.
2. Microphone input with its own independent volume control.
3. Music input (from gram or tape-recorder) with its own independent volume control.

4. Ability to "mix" these two inputs as required. This enables a background of music to be fed into the amplifier while at the same time a spoken commentary can be super-imposed.

5. A simple but effective tone control to cater for different room conditions.

6. The final design had to be sturdy and compact for transporting, have a smart appearance, and be readily accessible for any maintenance that might be required.

One additional feature was added during the actual building and this provides a bonus item. A tape outlet socket was fitted so that music from records or other source, together with a super-imposed spoken commentary, could be recorded.

Considerable care has been taken in designing the layout of the amplifier and the wiring to give the best results together with a clean, neat, work-

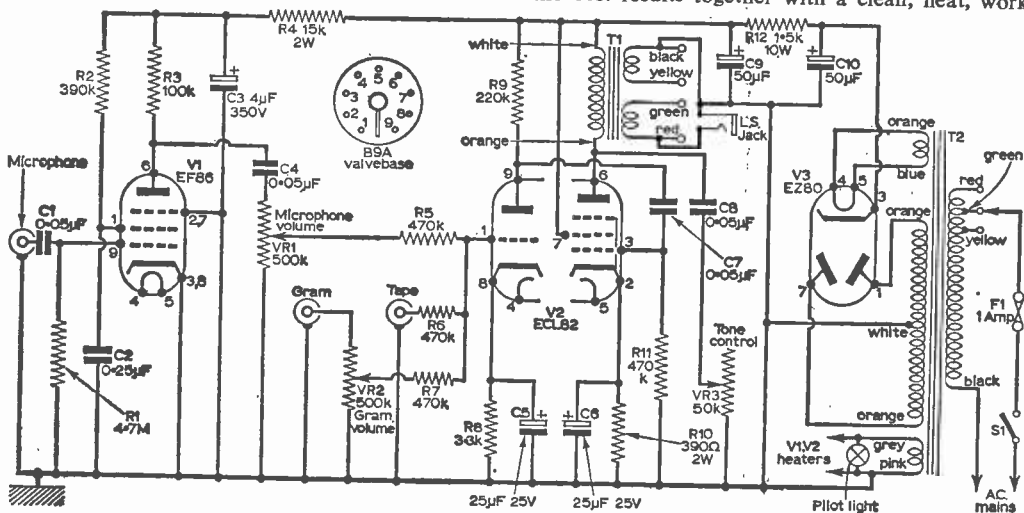

Fig. 1: The circuit.

ne-movie amplifier

By S. COLLINS

GENERAL PURPOSE 4W AMPLIFIER WITH
AND OTHER SPECIAL FACILITIES

manlike appearance. This has also made for an easy straightforward sequence of assembly and wiring up:

The chassis is constructed from 18s.w.g. aluminium, which was found to be quite rigid enough when formed into the two-sided channel section as shown. The dimensions and drilling details are given in Fig. 6 and these should be closely adhered to.

The next step is to mount the main components

on to the chassis, starting with the three valve-holders, noting that the special anti-microphonic holder is fitted in position V1 and a solder tag is fitted under the fixing nut nearest to the edge of the chassis. These holders are mounted from above the chassis and careful reference should be made to the wiring diagram to ensure that the gap between pins 1 and 9 on each one corresponds exactly with the drawing.

Next fit the mains transformer, making sure by the coloured wires that it is the correct way round, and at the same time secure a seven-way tag strip under the two inner nuts. Before these fixing nuts and bolts are fully tightened it may be advisable to fit the clip for the 50+50μF electrolytic as the fixing screw for this comes quite close to the lower edge of the transformer. The flying leads from the transformer should be passed through their respective holes in the chassis and, to protect them, a rubber grommet should be slipped over them and fitted into the chassis.

Place the 50+50μF electrolytic capacitor into

COMPONENTS LIST

Resistors:

R1	4.7MΩ	1W	5%	high stability
R2	390kΩ	1W	5%	high stability
R3	100kΩ	1W	5%	high stability
R4	15kΩ	2W	10%	
R5	470kΩ	1W	10%	
R6	470kΩ	1W	10%	
R7	470kΩ	1W	10%	
R8	3.3kΩ	1W	10%	
R9	220kΩ	1W	10%	
R10	390Ω	2W	10%	
R11	470kΩ	1W	10%	
R12	1.5kΩ	10W	5%	wire wound

Capacitors:

C1	0.05μF	500V
C2	0.25μF	500V
C3	4μF	350V electrolytic
C4	0.05μF	500V
C5	25μF	25V electrolytic
C6	25μF	25V electrolytic
C7	0.05μF	500V
C8	0.05μF	350V
C9	50μF x 50μF	350V electrolytic
C10		

Controls:

VR1	500kΩ log.	(microphone volume)
VR2	500kΩ log.	(gramophone volume)
VR3	50 kΩ lin.	with D.P. switch (tone control)

Miscellaneous:

Three coaxial sockets. One Bulgin D180 signal lampholder. One Bulgin J2 open jack socket.

One Belling Lee L575 miniature fuse-holder.
One Belling Lee L562 1A mini-fuse. One Bulgin P360 mains plug and socket. Three Eddystone 841 knobs and dials. One 12-way Radiospares group board. (std.). One backing plate for above. Two 1/2 in. grommets. Two 3/8 in. grommets. One 1 3/8 in. condenser clip (vertical mtg). One tag strip, 2 insulated, earth, 2 insulated. One tag strip, earth, 3 insulated, earth, 1 insulated. One tag strip, earth, 5 insulated, earth. Twelve 6BA nuts, 10 6BA 1/2 in. screws, 2 6BA 1/2 in. screws. Twelve 4BA nuts, 11 4BA 1/2 in. screws, 1 4BA 1/2 in. screw. Two 6BA solder tags. One 6.3V 0.3A mes pilot lamp.

Valves:

V1 EF86 V2 ECL82 V3 EZ80

Chassis:

18 swg aluminium, size 10 x 3 x 2 1/2 in.

Valve-holders:

One B9A anti-microphonic
Two B9A plain moulded

Mains Transformer:

Electro Voice No. 104F
H.T. 250-0-250 volts at 65mA
L.T.1 6.3V 1A
L.T.2 6.3V 1A

Output Transformer:

Electro Voice No. 117E
Primary 5000Ω
Secondary 3 and 15Ω

Additional items:

Solder, wire, sleeving, 3-core mains leads, etc.

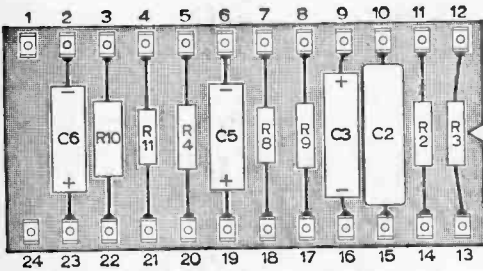

Fig. 2: The front of the group board wiring.

the clip and press well down on to the chassis. Before tightening check that the position of the tags corresponds with the diagram and if necessary slightly bend them to give good clearance from the edge of the hole.

The output transformer can now be mounted by means of four 4B.A. nuts and bolts, and here also care should be taken to see that this is the correct way round according to the coloured leads. A six-way tag strip is secured under two of the fixing nuts as shown in the wiring diagram and this will accommodate the transformer secondary connections, allowing an easy adjustment from 3 to 15Ω output impedance.

Turning now to the front panel of the chassis, these components can be fitted. First the three coaxial sockets (not forgetting the 6B.A. solder tag

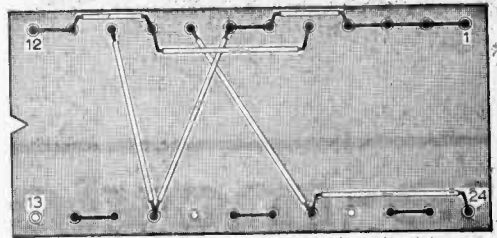

Fig. 3 (above): Rear of group board wiring.

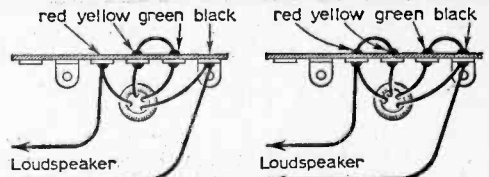

Fig. 4 (left): Loudspeaker/output transformer connections for 15Ω speaker.

Fig. 5 (right): Loudspeaker/output transformer connections for a 3Ω speaker.

under one nut of the first one which is for the microphone). Next fit the pilot light, fuseholder, output jack socket and the mains input connector as shown in the diagram.

(To be continued)

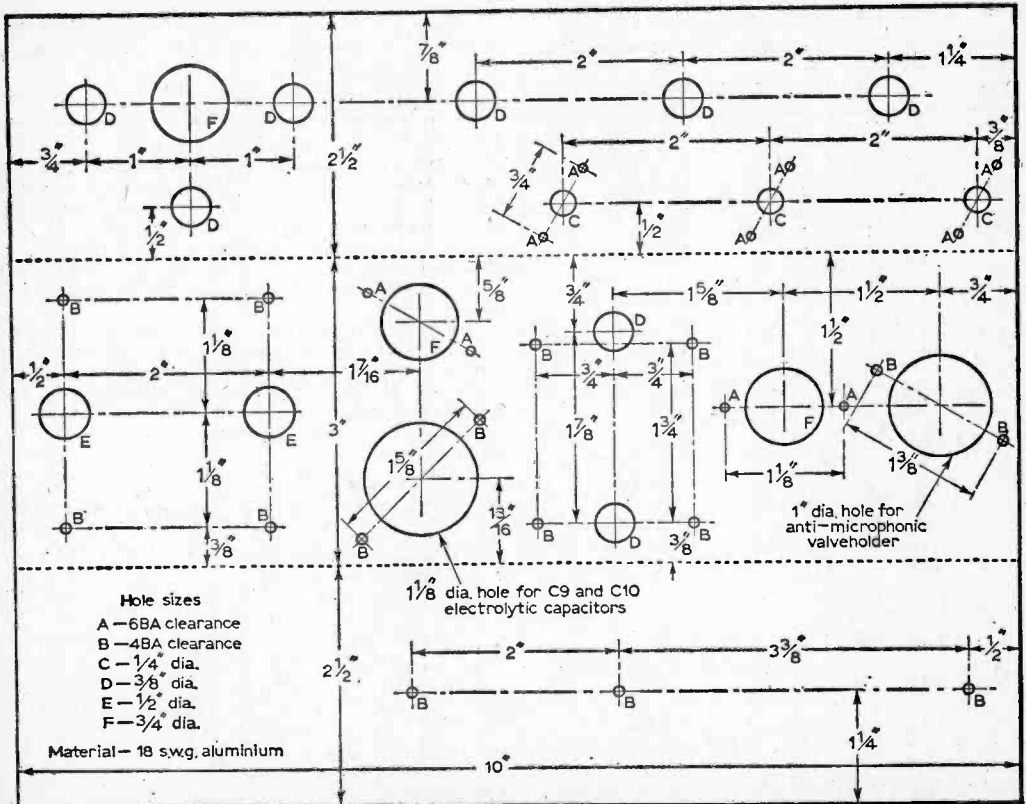
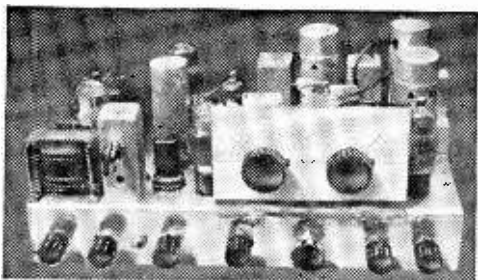

Fig. 6: Chassis drilling details.



(Continued from page 800 of the January issue)

THE m.w. coil for the r.f. stage is L4, and the aerial trimmer is mounted directly on the front runner. Other components are located as in Fig. 3. The anode lead of V1, from tag 3, passes directly through the screen, to wafer 4.

C1 is connected to a tag near the screen and L4, and a tag is fitted to this bolt above the chassis, and is wired to the rotor contacts adjoining VC1A. C1 is positioned as in Fig. 3, to give a short lead to the smallest coil, L1.

The aerial lead from the coaxial socket SK1 on the chassis is screened, and brought to wafer 1.

Other Wavebands

The other coils may now be added. Four bands are provided:

- Band 1, 19-8.5Mc/s, or approx. 16-35m.
- Band 2, 9-3.5Mc/s, or approx. 33-85m.
- Band 3, 4-1.4Mc/s, or approx. 75-210m.
- Band 4, 1-55Mc/s-550kc/s, or approx. 200-550m.

The coils are so positioned as to obtain short wiring for the smaller coils, and particularly for Band 1 coils. Referring to Fig. 3, the coils are:

	Aerial Frequency changer Oscillator			
Band 1	L1	L5	L9	
Band 2	L2	L6	L10	
Band 3	L3	L7	L11	
Band 4	L4	L8	L12	

If the coils are positioned with their flat sides as in Fig. 3, much of the wiring to one coil will be a duplicate of that to the others. Leads to L1, L5 and L9 must be short and direct. C5 is wired directly to L5, L6 and L7, and is taken to a tag bolted to the chassis. A lead passes from this point to the rotor contact adjoining VC2A.

Short leads pass from the coils, to chassis. If referred, coils for one band may be inserted at time, and the receiver may be tested. This will void any possible confusion in wiring.

Second I.F. Amplifier

This is V4, and can be wired up complete. A tuning meter can be used with the receiver, or the two sockets provided for this item can be shorted with a length of wire.

The automatic volume control circuit leads are run close to the chassis. The h.t. positive line wires are also kept near the chassis. It is helpful to use sleeving of suitable colours, such as red for the h.t. positive line, and brown or some

General Purpose COMMUNICATIONS RECEIVER

by R. F. GRAHAM

other colour for the a.v.c. line. Circuits can then be identified more easily.

The IFT's are appropriately wired. Those used had coloured leads, but some have tags or pins. The maker's data will show anode, h.t. a.v.c. and grid connections, which should be followed.

I.F. Filter

This is formed by IFT1 and IFT2, these two transformers being mounted on a small chassis made from aluminium, as in Fig. 1. C11 is of very low capacity, and can be made by twisting together insulated wires, if preferred.

The primary of IFT1 is taken to V2 anode and h.t. line (R7) as shown for an ordinary circuit. The secondary of IFT2 goes to a.v.c. line and V3 between the "grid" tag of IFT1 and the "anode" tag of IFT2. The a.v.c. tag of IFT1 and h.t. tag of IFT2 are joined, and taken to chassis.

C16 is wired from IFT2 to chassis, and R10 is also included in the i.f. filter. A lead from R10 passes through the receiver chassis to the a.v.c. line.

The filter assembly is bolted to the chassis, and holes are required so that the lower cores of the IFT's may be reached by means of a long insulated blade. A plastic knitting needle, suitably shaped, will do for this purpose.

Screening

Adequate screening is required, or the receiver will oscillate when VR1 is adjusted to maximum sensitivity. All valve cap leads are screened, as in Fig. 1. The braiding is taken to the chassis, or other direct earthing point.

When clear glass valves are used, it will be found necessary to fit valve cans round V2, V3 and V4. Valves of many types can be used in the receiver, and they may be of dissimilar size, shape, or may differ in the screening arrangements. The suffix "G" and "GT" indicates glass, and glass-tubular valves, while the omission of this indicates a metal valve. For example, 6K7G valves are of the usual glass shape, while 6K7GT valves are the shorter tubular type. These valves, and a metal type 6K7, are otherwise the same.

Underneath the chassis, anode and grid leads

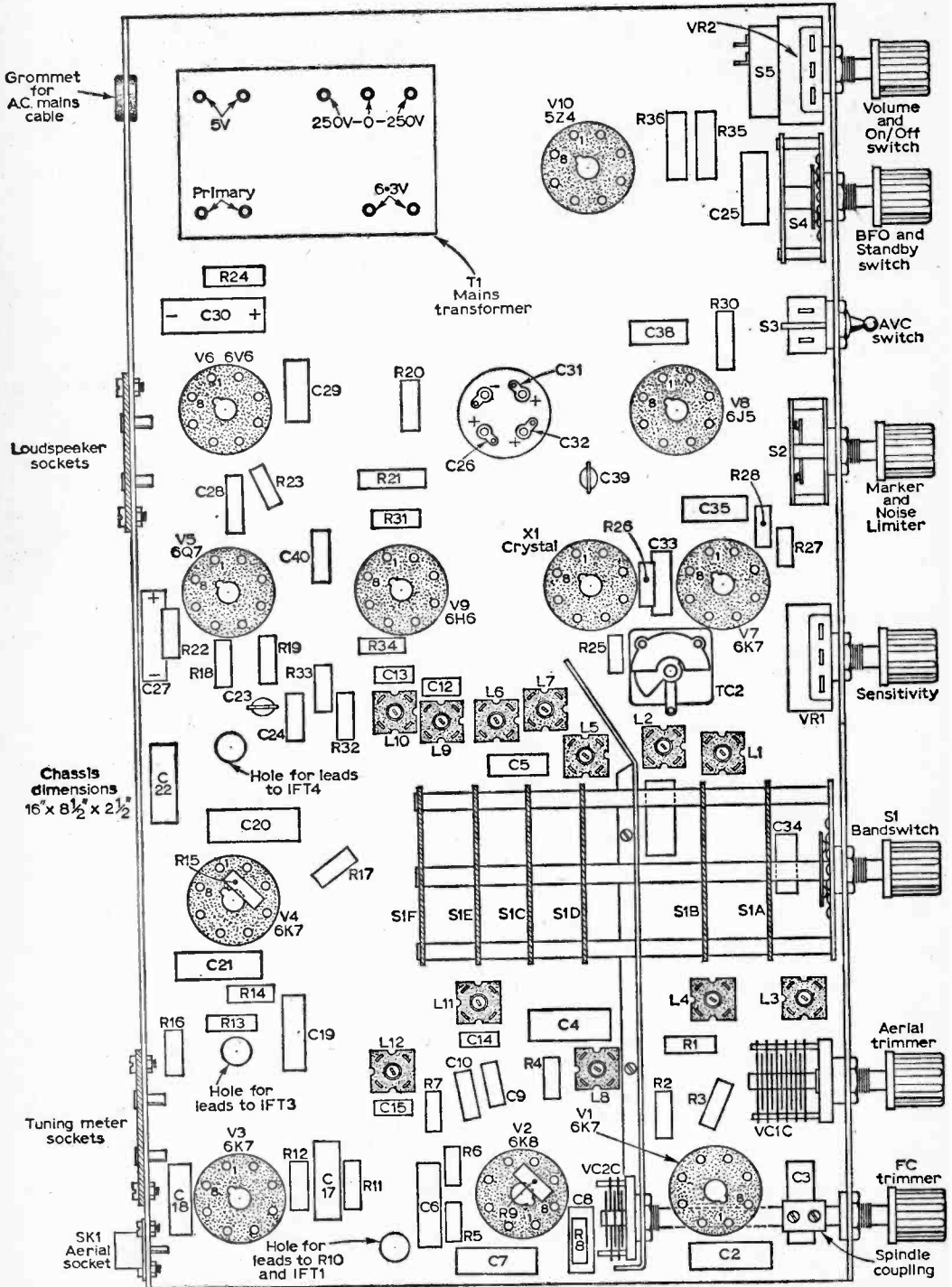
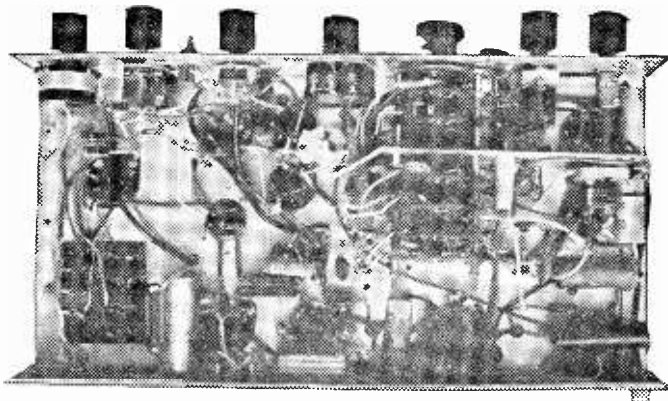

Fig. 3.—The layout of components on the underside of the chassis



An underchassis view of the receiver

should be short and direct, and clear of each other, to avoid back coupling. If oscillation tends to begin when the IFT's are aligned, this shows that screening in these stages is inadequate, or that wiring is too long.

In the audio circuits, the grid lead (cap) of V5 must be screened and also the lead from V9 to the noise limiter switch, and C25. If this screening is omitted, some hum may be heard on signals.

B.F.O.

The beat frequency oscillation is required only for the reception of c.w. morse, and it is built in a screening can, as in Fig. 5. An unused can, as obtained from a fairly large surplus i.f. transformer, is satisfactory. A piece of aluminium forms a bracket, to hold the coil to the variable capacitor VC4, as in Fig. 5. The unit should be tested before fitting it in the screening can, as it is secured by the nut holding the variable capacitor. Leads pass down through the chassis, to V8.

As the IFT's are aligned to 470kc/s, the b.f.o. can best tune from about 467kc/s to 473kc/s, to give an audio beat note of up to 3kc/s (3,000 cycles) with the b.f.o. placed either side of the intermediate frequency.

The b.f.o. coil can be a surplus 470ks/c IFT winding, in which case C36 will generally be present, and a suitable range should be achieved by adjusting the coil core. The variable capacitor VC4 only needs to be of small value, and 15pF should suffice. Exact results depend on the value of C36. Provided the b.f.o. can be tuned to produce a good audio note, the exact value of the variable capacitor is not important.

To obtain oscillation, a cathode tap is used, marked B. With some coils, a turn can be prised up, bared, and a thin lead can be soldered to it. If this is impossible, extra turns can be added, wound in the same direction. The tap is then the junction between the existing winding and the new turns, while A is the beginning of the existing winding, and C is the end of the new winding. Only a few turns are required. This, again, depends on the coil, but ten turns should be adequate.

To test the b.f.o, an ordinary broadcast station can be tuned in. The b.f.o. is then switched on, and VC4 and the coil core can be adjusted until an audible beat note is heard.

Any other coil tunable to 470kc/s (about 640m) is also suitable. If the coil does not have an adjustable core, C36 should be a preset trimmer, alternatively the total capacity needed can be made up by means of preset and fixed capacitors in parallel.

The coupling capacitor C39 is of very small value, and can be made from twisted insulated wires. If so, tune in a fairly weak c.w. signal, and adjust the coupling or twist, until a good audio note is obtained. The value is in no way critical.

D.D.T. and Output

Wiring to the double-diode-triode V5, and output stage V6, will be quite straightforward.

As a loudspeaker with suitable output transformer fitted to it was used, no output transformer was included in the receiver. Two sockets, as shown in Fig. 3 allow the loudspeaker to be connected. The receiver should not be switched on with V6 inserted, unless the loudspeaker with transformer is connected. If a loudspeaker without transformer is to be used, the transformer can be incorporated in the receiver, near the mains transformer. In this case, the transformer primary is wired to tags 3 and 4 of V6, and the secondary is taken to the loudspeaker sockets on the rear chassis runner. The transformer ratio for a 2-3Ω loudspeaker is approximately 45:1.

Noise Limiter

This is V9, and the switch shorts pins 3 and 4 when the limiter is not in use. The marker/limiter

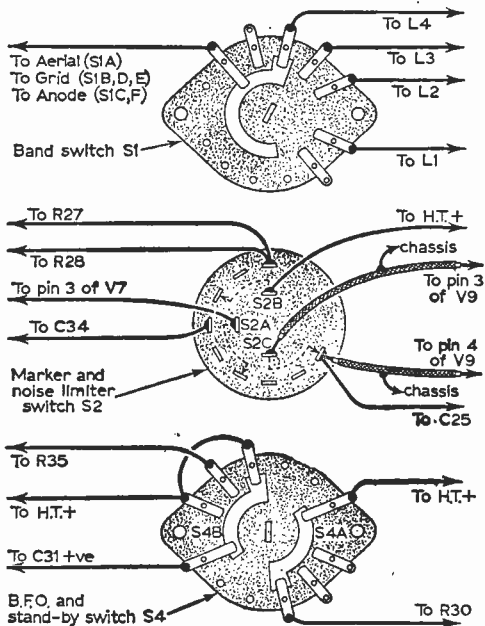

Fig. 4—Details of the switch wiring.

switch is shown in Fig. 4 and one section of the switch is connected as indicated. Leads to the associated resistors should be short and direct, and all wiring here should be clear of the heater circuit. When the limiter is out of action, results should be normal. This setting of the switch is employed for general reception.

Noise of a static nature will often be encountered, especially on some short-wave bands, and the limiter switch may then be turned to the central position. There should then be a considerable reduction in noise level.

Tuning Meter

The tuning meter can be plugged into the sockets provided, which must be shorted when no meter is used. A satisfactory meter of simple type can be arranged by taking the leads to a 1mA instrument, with a shunt which will allow the meter to read full-scale, with VR1 at maximum sensitivity, and no signal tuned in. The shunt can be made from a length of resistance wire, or a preset wire-wound resistor or potentiometer may be employed. The actual type of meter is of no importance, provided its full-scale reading is less than the anode current of V4, so a 5mA instrument is also suitable.

When a signal is tuned in, the meter reading will fall. Correct tuning is therefore that giving the lowest reading. When trimming and aligning, adjustments can be directed towards obtaining the lowest meter reading, as this gives a more accurate indication than can be achieved by ear.

Any modification which changes signal strength will alter the meter reading, so it is easy to compare the results obtained with different aeri- als, and so on.

A test meter set to its 10mA or a similar range, may be employed as a temporary tuning meter. Readings will depend on the aerial and other factors, but a change in current of some 5mA should be expected, with a strong signal.

A bridge circuit meter can also be used. This is rather more complicated, and by no means essential. A typical circuit is shown in Fig. 6. Here, the meter reads zero, with no signal, and the reading rises in proportion to signal strength.

Crystal Marker

The crystal used was a 100kc/s type, with octal base, to fit an octal valveholder. If crystals with a different pin arrangement are used, the holder should be chosen to suit.

V7 is the marker valve, and Fig. 4 shows the marker switch wiring. TC2 is an air-spaced 100pF trimmer, totally insulated from the chassis. An air trimmer can be held with 6B.A. bolts. A small air-spaced variable capacitor of ordinary type can be mounted on a strip of paxolin, which is in turn held to the chassis by long bolts having extra nuts, or spacers. The spindle should be slotted, so that it can be adjusted with an insulated blade.

If the receiver has a long-wave band, obtained by wiring in three l.w. coils, to spare switch contacts, the BBC Light Programme on 200kc/s (1,500m) may be used to check the crystal frequency. If there is no l.w. band, the standard frequency transmissions radiated on 2.5Mc/s (120m) may be used for this purpose. For most easy checking, the signal obtained from the

marker should be of somewhat similar strength to the signal of the station used as a frequency standard. It may thus be necessary to disconnect C34, and probably use a short, temporary aerial, if receiving the Light Programme. This depends on the signal strength, and is not critical, except that adjustment is difficult if signals are not of somewhat similar power.

With a 100kc/s crystal, the marker signal will appear at 100kc/s intervals throughout the tuning ranges, growing weaker as higher harmonics are used. To check crystal frequency, tune in the station chosen, and switch the marker on. Any difference between the marker harmonic and station frequency will be heard as a low audio

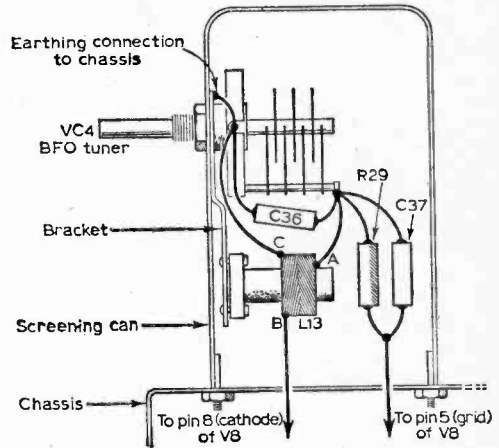
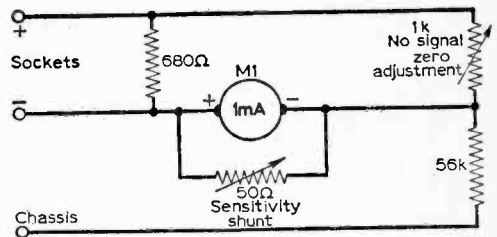

Fig. 5 (above)—The beat frequency oscillator.

Fig. 6 (below)—The bridge tuning meter.



tone, and it may be only a few c/s. TC2 is adjusted to bring the marker crystal to zero beat, or nearly so. No further adjustment is required.

In normal use, the marker provides exact calibration points. For example, the 80m amateur band extends from 3.5Mc/s to 3.8Mc/s and marker harmonics will appear on 3.5, 3.6, 3.7 and 3.8Mc/s. A bandspreading scale will show this, smaller divisions being equally spaced.

The bandsetting scales can be marked at 100kc/s intervals, with bandspread capacitor pointer vertical. To calibrate the scales, remove the aerial. On the s.w. bands, markings at 500kc/s points will suffice. High 100kc/s harmonics become very weak, and closely spaced. A 500kc/s or 1Mc/s crystal avoids this, but is not suitable for lower frequency calibration. If required, 500kc/s check

(Continued on page 950)

FOR READERS OF "PRACTICAL WIRELESS" AT REMARKABLY LOW COST!

RADIO, TELEVISION & ELECTRICAL REPAIRS

AMAZING 'KNOW HOW' BOOK Saves You Pounds



Here is just the practical, at-a-glance guidance YOU need, whether you wish to know how to service radio and TV sets, install lighting points, or repair any domestic appliance, from a bell or an iron to a vacuum cleaner or washing machine. Explains basic principles and working of modern radio and TV sets and electrical appliances. Shows how to test for faults, carry out maintenance and repairs by the most modern methods. Special section on the operation and servicing of frequency modulated receivers. 480 pages. Over 400 illustrations. Amazing VALUE—Standard Edition, 21/-; De Luxe, leathercloth, 23/- . Or on easy terms: 5/- down and 3 monthly instalments. (Total credit prices: Standard, 22/-, De Luxe, 24/-.)

ALL THIS—AND MORE IN ONE GREAT VOLUME!

Comprehensive Contents Include:

Current, Voltage and Resistance. Coils, Capacitors and Valves. Basic Radio-receiver Circuits. Preliminary Tests. Instruments for Set Testing. Locating Faults. Dynamic Testing. Tuned Circuit Alignment. Noises, Interference, Distortion and Instability. Components. Loudspeakers. Pick-ups. Gramophone Motors. Frequency Modulation. Television Circuits and Test Gear. Television Faults, Symptoms and Cures. Aerials and Pre-Amplifiers. Maintenance of Domestic Electric Wiring. Small Appliances. Fires and Space Heaters. Vacuum Cleaners and Polishers. Rewinding Small Motors. Cookers and Boiling Plates. Washing Machines. Refrigerators. Electric Water Heaters. Battery Charging. Testing and Repairs, etc.

ESSENTIAL TO EVERY SERVICE ENGINEER, ENTHUSIAST AND HANDYMAN!

Getting the best from RADIO AND TV SETS

Here is expert advice that will enable you to make the necessary adjustments or repairs in order to get the best possible performance from any radio or TV set.

All you need to know about DOMESTIC WIRING

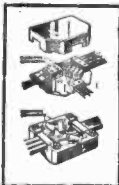

Learn from these helpful pages how to carry out all kinds of installations—and extensions—with efficiency and safety! Complete guidance on conductors, insulation, safety regulations, conduits, cables, earthing, practical work, fuses, flexible cords, etc.

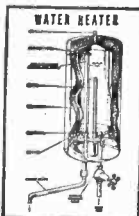

FIRES & SPACE HEATERS

Full, easy-to-follow instructions for servicing small domestic fires—whether of the radiant, reflector or convector type.

WATER HEATING

All you should know about the various types of electric water-heaters and how to install them and keep them in perfect working order. Advice that will save you POUNDS!

TRACKING DOWN TROUBLE

This grand book is invaluable for tracing faults in radio and TV sets. Tells you all you want to know—from how to carry out Preliminary Tests how to align R.F. and I.F. circuits. Shows how to carry out Dynamic Testing. Also shows how to trace the causes of Noises, Distortion and Instability and deal with the trouble. Gives detailed information on Components and Loud-speakers and how to deal with any faults that may develop.

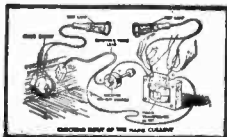

BASIC RADIO CIRCUITS

All you want to know about circuits, so that you can find your way around modern sets without hesitation. How components form various types of set; gives circuits for 1-valve receiver, 3-valve receiver, battery TRF receiver 4-valve superhet, Universal sets, etc.

See how to maintain **Vacuum Cleaners and Floor Polishers, Refrigerators, Cookers and Boiling Plates, Washing Machines, etc.**

Do your own **BATTERY CHARGING**

Here are clear, complete instructions.

DO THIS NOW!

Simply complete form, indicating Edition preferred and post in a 2½d. stamped, unsealed envelope to Dept. E.B.35, Odhams Press Ltd., Basted, Sevenoaks, Kent. Offer applies in the U.K. and Eire only. Hurry! Make sure of your copy.

FULL SATISFACTION GUARANTEE

SEND NO MONEY NOW!

To: Dept. E.B.35, Odhams Press Ltd., Basted, Sevenoaks, Kent.

WITHOUT OBLIGATION reserve me "Radio, Television and Electrical Repairs" and send Special Invoice with "100% Satisfaction or No Charge" Guarantee.

Cross out edition NOT required: STANDARD/DE LUXE
Tick method of payment preferred CASH TERMS
BLOCK LETTERS BELOW

NAME _____

Full Postal ADDRESS _____

E.B.35/Feb. '63

THE LINEAR L1/10

A 10-WATT HIGH FIDELITY ULTRA LINEAR AMPLIFIER WITH INTEGRAL PRE-AMP

Full advantage has been taken of latest component miniaturisation developments to produce a 10-watt Hi-Fi push-pull amplifier incorporating tone control pre-amplifier stages within the measurements of 9 x 7 x 5 ins.

In addition two high impedance input sockets are provided for microphone and gram., etc. With selector switch and vol. control, five B.V.A. valves are employed ECC83, ECC83, EL84, EL84, EZ81, H.T. and L.T. power supply point is included for a radio tuner.

FREQUENCY RESPONSE

± 1 d.b., 30-20,000 c.p.s.

MAXIMUM POWER OUTPUT

in excess of 14 watts.

SENSITIVITY

L.P. 220 m.v. for 10 watts, 78 r.p.m. 220

m.v. for 10 watts. Radio/Microphone 40

m.v. for 10 watts.

TREBLE LIFT CONTROL

+ 10 d.b. to -22 d.b. at 12,000 c.p.s.

BASS CONTROL

+ 14 d.b. to -10 d.b. at 50 c.p.s.

HUM LEVEL

Referred to maximum output and including integral pre-amp.—70 d.b.

NEGATIVE FEEDBACK

21 d.b. in main loop.

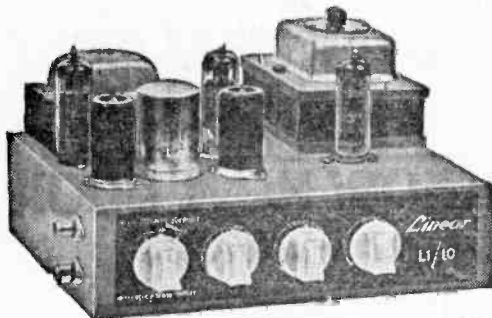

HARMONIC DISTORTION Less than 0.1% measured at 8 watts at 1000 c.p.s. Weight 10 lbs. Power consumption 90 watts. For 200-230-250 v. 50 c.p.s. A.C. mains. Outputs for 3-and 15-ohm speakers. Chassis finish stoved Gold hammer.

HIGHEST QUALITY Retail Price **3**
MAXIMUM RELIABILITY **3**
AT A PRICE YOU CAN AFFORD **GNS.**

Send S.A.E. for descriptive literature

Also Available—THE L45.A compact High Quality 4-5 watt amplifier. Size approx. 7.5-5½ in. high. Sensitivity is 28 millivolts so that the input socket can be used for either microphone or gram., tape, radio tuner etc. B.V.A. valves used are ECC83, EL84, EZ80. Controls are: Vol. Treble and Bass with mains switch. The Tone controls provide full compensation for long playing records. Output matching for 3 ohm loudspeaker. Retail price £5.19.6.

THE LT45 TAPE DECK AMPLIFIER. A complete unit (power pack and oscillator incorporated) ready for connection to A.C. mains. 3 ohm loud-

speaker and practically any make of deck. Negative feedback equalisation adjustment by multi-position switch for 1½, 3½ and 7½ in. per second. Retail price 12 gns.

DIATONIC 10-14 WATT. High Fidelity amplifier with integral pre-amplifier. Retail 12 gns.

CONCHORD 30 WATT. Hi-Fi amplifier with two separately controlled inputs. Retail 16 gns.

L50 50 WATT AMPLIFIER. Size approximately 14 x 10 x 8 in. Sensitivity 25 mV. Output for 3 and 15 Ω speakers. Retail price 22 gns.

L15/5 STEREO AMPLIFIER 5 x 5 watt 12 gns.

TRADE ENQUIRIES to

LINEAR PRODUCTS LTD.

ELECTRON WORKS, ARMLEY LEEDS

R.C.S. CRYSTAL RECEIVER 8/6 P. & P. 1/6.

Covering medium wave band. Ideal for the beginner. All components including case (suitable headphones 8/6). Easily converted to 1-transistor or 2-stage transistor receiver.



THE PERSONAL SET For Private Listening

An amazing little set, with built-in ferrite rod aerial bringing in medium wave at wonderful volume. Sturdy case. Size only 1½ x 3 x 5 ins. Fits into the palm of the hand. Drilled chassis colour coded for easy assembly.

Total Building Costs (including earpiece)

32/6

P. & P. 1/6.

SAME HIGH QUALITY NEW LOW PRICES

BACKED BY FULL AFTER SALES SERVICE

All parts available separately. Send **FREE** Layout plans and parts lists on any of these sets.

R.C.S. TAPE TUNER 25/- P. & P. 1/6.

Record your favourite programmes. Variable Medium wave tuning. Triple wound Super Hi-Q coil. Chassis and components colour coded. Easily constructed. Size 3 x 1½ x 1½ in. All parts, instructions and layout plans.



Total Building Cost

59/6 P. & P. 2/6.

LISTEN TO THE WORLD on "TELSTAR" OUR EASY TO CONSTRUCT 1-VALVE SHORT-WAVE RADIO

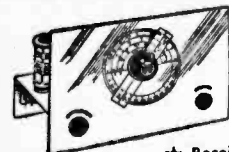

Total Building Costs

35/-

P. & P. 2/6.

★ Receives speech

and music from all over the world. Construction price includes valve and one coil covering 40-100 metres. Can be extended to cover 10-100 metres. Can be converted to 2 or 3 valve. And all mains loudspeaker operation.

The 'REVILO'

5-STAGE POCKET TRANSISTOR PORTABLE

Total Building Costs

90/-

(Including earpiece)

P. & P. 2/6.

In attractive two-tone contemporary case, with gold plated speaker grille and attractive dial. Size only 5½ x 3½ x 2½ ins. No aerial or earth required—completely self contained. Genuine 8 in. high flux PM speaker. Socket for personal listening. First grade transistors. Push-pull output—250 milliwatts. Volume control with on/off switch. Condenser tuning. Easy assembly on eyeletted circuit board.

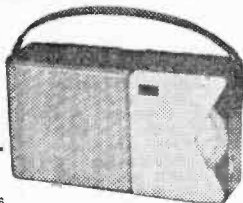

The "BOBETTE" 5-STAGE SUPER SENSITIVE TRANSISTOR PORTABLE

Simple to Build. All First Grade Components. A truly portable transistor radio giving full medium wave reception. Incorporates 8 in. High Flux Speaker, push-pull output, first grade transistors. High-Q ferrite aerial, socket for ear aerial pre-tagged circuit board for easy construction. Attractive two-tone case.

Total Building Costs **95/-** P. & P. 2/6



R.C.S. PRODUCTS (RADIO) LTD. 11 OLIVER RD., LONDON, E17 (Mail Order Only)

by C.M. and E.C.D.

semiconductors

TALKING POINTS ON CIRCUIT PRACTICE

No. 1—D.C. Stabilisation of Transistors

ONE hears a good deal from time to time about the troubles experienced by people experimenting with transistors.

There is no lack of information about the technical aspects, for those whose maths are up to it. But one aspect appears to have been neglected; that is: the precise know-how of how to handle them in practice.

This is not altogether a simple matter. Transistors pose problems which are not quite the same as valves. It can be even less simple if the theory of their operation is incompletely apprehended and, indeed, most of the literature on this subject pre-supposes a technical knowledge at least up to H.N.C. standard.

In consequence, one hears complaints about transistors "ruined in soldering them"; or already defective when bought; or circuits which don't work, or which "run hot".

These problems are not limited to amateurs. As an example we know of at least one commercial firm manufacturing transistorised apparatus which complained that 50% of its diodes were defective when supplied—there was, of course, nothing wrong with the diodes but there was a great deal wrong with the firm's "experts", trained, no doubt, on valve circuitry, who hadn't a clue when it came to transistors and whose own methods of testing them were in fact causing the damage.

Really there is nothing mystifying about transistors once you get used to handling them. But you do have to know your way around and it is probably true that the "way around" is only now beginning really to be understood even by the people making them.

SOLDERING METHODS

For instance, this question of soldering. Transistors will stand up to the iron, properly applied. What they will *not* stand is too *much* heat applied for too long a time. They should be "spotted" on; a quick, clean joint made first time and finished with. (Tin the terminal and sweat the transistor lead to it quickly and cleanly.)

Transistors are made with long leads—leave them long. Sleeve the leads so they won't short to the rim of the capsule. If the joint is made quickly and the iron removed before it has time to damage the transistor there will be no trouble.

Hold the transistor lead close to the iron with a pair of long nosed pliers during the operation, the pliers will draw off the heat and stop it running up the lead to the transistor. But speed is the essence of the job.

In fact far fewer transistors are ruined in soldering than is generally supposed.

But they won't stand up to being put in, taken out again, put in again, on that score however—what will? With all electronic soldering the secret is "once only", and finish!

Diodes are often soldered with a spring in them again a precaution against heat. That is, a loop is made in the lead and this loop is held in the nose of the pliers while soldering.

A final point, transistors can be spoiled by light. too . . . if the capsule is glass it will be painted

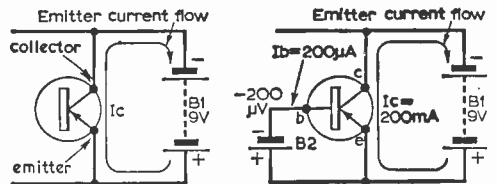

Fig. 1 (left): Here the main flow of current is from positive to negative.

Fig. 2 (right): Here there are two currents flowing

to exclude light. Don't scratch the paint. If the capsule is metal that problem does not arise.

In order to handle transistors properly it is essential to understand how they work.

The transistor is basically a development of the old cat's whisker crystal except that hertzite or galenium crystals would not amplify, whereas the transistor does. Its properties are those of a solid

The basis of the thermionic valve is that current passing through it from anode to cathode can be made a function of the grid, that is, it can be controlled in amplitude by conditions on the grid. In the transistor, current passing through it in one direction can be made a function of current passed through it in another—can be controlled in amplitude by varying the conditions of the second current.

But here the analogy between valve and transistor ends. The valve is a voltage device, controlled and operated by volts. The transistor is a

current device, controlled and operated by current. One finds that it is here that people seem to meet with the greatest difficulty in understanding how a transistor functions. It must be admitted that the majority of technical literature is not very easy to understand on this issue.

BIAS ARRANGEMENTS

A transistor must be biased just as a valve is. But not by volts. A transistor is biased by the amount of *current* put through it. An understanding of this process is an absolute necessity if you are going to do anything with transistors at all. Most of the phenomena which cause so much trouble to the inexperienced spring from this factor; most of the peculiarities of the transistor are rooted in it, so are the difficulties that probably arise when trying to find out what is wrong with a piece of transistorised apparatus which refuses to work properly.

Consider Fig. 1. There is a collector, an emitter and a base. For the nonce these may be regarded as analogous to the anode, the cathode and the grid of a valve provided it is always remembered that in transistors the anode (or collector) is *negative*; that its voltage is likely to be of the order of only some 4.5 instead of the two or three hundred you would find on the anode of a valve and that, whereas varying the voltage on the anode of a valve would have a considerable effect upon the amount of current which would flow in the anode-cathode circuit, in the case of the transistor, once you have exceeded the minimum rated voltage—somewhere around half a volt perhaps—it does not matter how many volts you put on the collector up to the rated maximum, the current flow in the collector-emitter circuit will be substantially the same whatever the collector volts.

In Fig. 1 the main flow of current in the battery circuit will be through the emitter, into the transistor, out of the collector and back to the battery . . . from positive to negative, that is, using the normal terminology. This current will be of an order of milliamperes or even amperes.

It has already been said that this current does not depend upon the voltage on the collector. On what, therefore, does it depend? Returning to the valve analogy again for a moment, it depends upon conditions on the *base*, which functions here as the control grid of a valve.

How does it control? In the valve the control grid would be a few volts negative or positive to the emitter (cathode), thereby causing the collector-emitter (anode-cathode) current to be greater or less as the case might be. Not so with the transistor!

BASE CURRENT

Consider next Fig. 2. Here is included a second battery, B2, sensed so as to make the base, while remaining positive in relation to the collector, slightly negative in relation to the emitter. Current will now flow through the transistor through a second path—namely, from emitter (positive) through the transistor and out of the base (negative). There are now *two* currents flowing through the transistor simultaneously. Rather as there would be in a valve if grid current was allowed to flow.

It is this second current which biases the transistor.

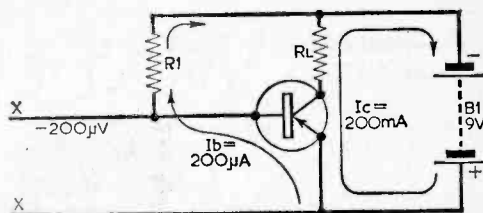

Fig. 3: The battery, B2, of Fig. 2 is replaced here by a resistor.

The value of the current which will flow in the collector-emitter circuit is a function of the value of current flowing in the base-emitter circuit. Varying the current in the base-emitter circuit will cause proportionate but greatly amplified changes in the collector-emitter circuit.

This may still appear to be voltage biasing . . . since there needs to be volts on the base to obtain it, obviously. Avoid thinking that way . . . it is the *current* through the base which operates the transistor; with no current there would be no bias.

So far the picture presents no particular difficulty. In order to obtain the standing quiescent d.c. current in milliamperes or amperes required in the collector circuit then all that needs to be done is to pass a definite value of current through the transistor via the base-emitter circuit. Having stabilised the d.c. or quiescent conditions by selecting the correct base-emitter current to give the quiescent collector current wanted, if now an a.c. signal is fed in between emitter/and base the r.m.s. variations on the base will vary the base potential, thus vary the base current, which will in turn vary the collector-emitter circuit current. Owing to the resistance of the transistor in the collector-emitter sense being greatly more than its resistance in the base-emitter sense the variations in the output will be greater, that is amplified, than those in the input. As the base-emitter current/collector-emitter current transfer characteristic is substantially a straight line over the operating part of the curve the amplification will be substantially linear.

From here the picture complicates somewhat. To begin with, while the current in the collector-circuit will be of the milliampere order, the current required in the base-emitter circuit to procure it is only of the order of microamperes. In order to obtain a current of microamperes, obviously the voltage required on the base to produce it will be microvolts.

This presents one of the difficulties experienced by the trial-and-error experimenters. To obtain a bias of, say, 200 microvolts on the base (in relation to the emitter, which in the diagrams is shown taken direct to earth, which is positive) is not quite the same thing as getting, say, 3V on the grid of a valve!

A further difficulty arises in that this voltage is critical. If the base is a couple of hundred microvolts more negative than it should be the current in the collector circuit rises above the safe limits and the transistor may be ruined; 200 microvolts less than it should be and no current flows at all—the transistor is “cut off”. There are other phenomena, too, which we will leave for the moment. First let us go ahead and see how we get that microvolt bias on the base.

In Fig. 3 the battery B2 is replaced by a

PCR COMMUNICATION RECEIVERS

Manufactured by Pye and Philips. One of the Army's most versatile and sensitive sets. RF stage and 2 of I.F., using 6 British 1.0. type valves. Large 180 degrees illuminating and calibrated Dial. Flywheel Tuning with locking device. Aerial Trimmer. Tone and Vol. Controls. Band Switch from panel jacks for speaker or phones. In black metal case, size 17in. L x 8in. H x 10in. D. Model PCR L covers 6-18 Mc/s. 200-550 metres and 850-2,000 metres and has internal 5-in. speaker. £6.19.6. Model PCR2 has similar L & M waveband coverage. Short wave 6-22 Mc/s, but no speaker. £5.19.6. Model PCR3, as PCR2 but has 3 short wave bands 2-7 and 7-23 Mc/s, and medium wave band 190-550 metres. ONLY 3 Gns. Add 10/6 carr. all models. Designed to operate from bulky EXTERNAL power supply, but any set can be fitted with BRAND NEW COMPONENTS INTERNAL PACK for 200-250 v. A.C. at extra cost of £2. All receivers used but excellent condition and aerial tested before despatch. S.A.E. FOR ILLUSTRATED LEAFLET

TEST METERS FOR EVERY PURPOSE & POCKET



2,000 O.P.V. MODEL TP-10. Reads A.C. & D.C. Volts up to 1,000; D.C. Current to 500mA; Resistance to 1 Meg; Capacitance to 1µF; Decibels from -20 to +36; Output jack for Audio Measurements. Size 3 1/2in. x 5in. x 1 1/2in.

£3.19.6.



20,000 O.P.V. MODEL TP-5S. Reads voltage up to 1,000 D.C. at 20,000 ohms per volt and A.C. at 10,000 o.p.v.; D.C. Current to 500mA; Resistance to 10 Megs.; Capacitance to 0.1µF; Decibels from -20 to +36. Size 3 1/2in. x 5 1/2in. x 1 1/2in.

£5.19.6.



30,000 O.P.V. MODEL 500. Volts to 1,000; D.C. at 30,000 O.P.V. A.C. at 20,000; 12 Ampe D.C. Current; 60 Megs Resistance; -20 to +56 Dbs; Internal buzzer short circuit warning. Size 3 1/2in. x 6 1/2in. x 2 1/2in.

£8.19.6.

All New Stock, with leads, prods, and internal batteries. 6 months' Guarantee backed by full service facilities. Details S.A.E.

FOR CALLERS ONLY

10 VALVE CANADIAN RECEIVER No. 52. Covers 1.75-16 Mc/s (19-170 metres) in 3 bands. Built-in 3-valve Crystal calibrator, and internal speaker. Circuit and instructions supplied. Store soiled and untested, and accordingly will only be sold to callers. ONLY 50/-.

HIRO SENIOR TABLE MODEL RECEIVERS. Complete with 9 coil sets covering 50 Kc/s to 30 Mc/s. Used, very good condition, aerial tested. ONLY £17.10.0 (carriage, etc., 30/-). A few late Model 3T with I.O. valves. £22.10.0., plus carriage.

COMBINED VIBRATOR/MAINS UNIT. The Power Pack of the Army R.107 Receiver. Has vibrator for 12 v. D.C. operation, and mains transformer for 100/250 volts A.C. Output 12.5 volts 3 A. L.T. and 250 v. at 100 mA H.T. Complete with vibrator, 6XSG rectifier, and connecting data. Ideal for driving T.C.S. or Type 52 Receivers, etc., or mobile equipment. BRAND NEW IN MAKERS' CARTONS ONLY 45/- (Carr. 5/6).

R107 RECEIVER R.F. UNIT. Brand new tuning sections of the famous R107 receiver. A 3-stage unit, complete with 4 gang condensers and dial. Calibrated 1.2 to 17.5 Mc/s in 3 bands, coil pack and wave-change switch, aerial trimmer. Less valves. Ideal front end for constructing a superhet receiver. Complete R107 circuit supplied. BRAND NEW IN MAKERS' CARTONS. ONLY 35/- (Carr. 5/6).

AVOMETER MODEL 7 Reconditioned and in perfect order with leads, internal batteries, and instructions. ONLY £11. (res. post 5/-).

AVOMETER MODEL 7 LEATHER CASES, fitted with carrying handle & long strap. BRAND NEW. ONLY 32/6 (Post 2/6). 20/- CONSTRUCTOR'S PARCEL. Assorted colours wiring wire, solder, resistors, condensers, volume controls, tag panel. ALL NEW. (Post 2/6).

RESISTORS, 100 assorted values our choice. NEW 10/-.

CONDENSERS, 100 assorted mica & silvermica. NEW 12/6.

"P.W." 6 TRANSISTOR PERSONAL RECEIVER

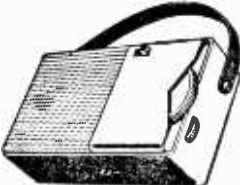

Designed by the technical staff of Practical Wireless, easy to build, using printed circuit and 1st Grade Matched Transistors and Diode. Full Medium and Long Wave coverage to internal speakers. All parts sold separately (new components only) enabling you to buy as required and full detailed price list will be sent on request. Constructional details 1/6.

Newly designed OSMOR Cabinet and reduced price. TOTAL COST INCLUDING BATTERY AND CABINET NOW £7.19.6. "P.W. TROUBADOUR" Parts List, S.A.E.

THE "GOOD COMPANION" Mk. II

USING TRANSFILTERS, THE LATEST MANUFACTURING TECHNIQUE TO SAVE ALIGNMENT DIFFICULTY

THE FINEST COMBINED PORTABLE AND CAR RADIO YET DESIGNED FOR THE HOME CONSTRUCTOR

- 750 mW output.
- 6 transistors and diode.
- Full Medium and Long Wave coverage.
- Quality speaker.
- Brilliantly styled 2-tone cabinet, size 11 x 8 x 3in.
- Very fine tuning with calibrated dial.
- Latest printed circuit. ● Internal high gain aerial with car aerial socket. Easy to follow construction data (available separately 3/6). All parts sold separately and full illustrated details will be sent on request.

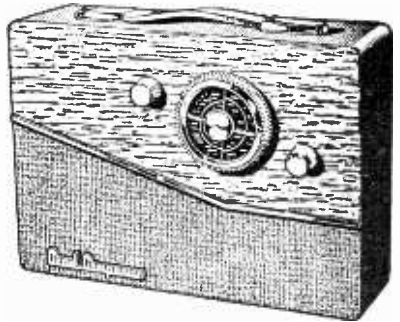

£9.19.6.

Total Cost

With alternative luxury cabinet using 7 x 4in. speaker. £10.19.6. Either type, plus 5/- post and ins. (Battery 3/6 extra).

"POCKET 4" TRANSISTOR RECEIVER

Uses miniature speaker, proper tuning condenser, and volume control. Built-in aerial makes unit efficient and portable. Ideal for the beginner. Full medium wave coverage. All components and case for only 42/6 (p. & p. 2/6). Ten-page constructional book free with parts or separately 1/6. S.A.E. for parts price list.



HARRIS ELECTRONICS (LONDON) LTD

138 Grays Inn Road, London W.C.1
Phone TERminus 7937

Please include carriage costs on all items. (Open until 1 p.m. Saturdays). We are 2 mins. from High Holborn (Chancery Lane Station) and 5 mins. by Bus from King's Cross.

WEYRAD

**6-TRANSISTOR 2-WAVE SUPERHET RECEIVER
MODIFICATIONS NOW AVAILABLE FOR 500mW OUTPUT**

ROD AERIAL—RA2W 6 in long, 3/8 in. diameter, connections to tags on Coils. For 208pF tuning capacity. Complete with Car Aerial Coil	12/6
OSCILLATOR COIL—P50/1AC M.W. covered with 176pF tuning capacity, L.W. by extra padder	5/4
I.F. TRANSFORMERS 1st and 2nd Stage—P50/2CC	5/7 (2 required)
3rd Stage—P50/3CC	6/-
DRIVER TRANSFORMER—LFDT4	9/6
OUTPUT TRANSFORMER—OPT1	10/6
PRINTED CIRCUIT—PCAT	9/6

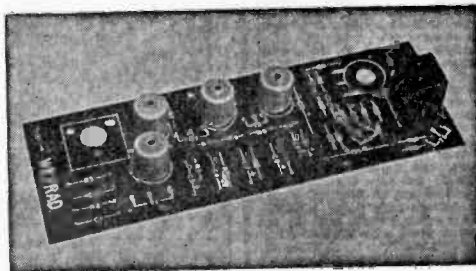

In response to many requests we have redesigned the output stages to give 500mW and to enable a standard 3 ohm Speaker to be used. Full details of the simple changes are given on a separate leaflet available on receipt of stamp.

CONSTRUCTORS BOOKLET WITH FULL DETAILS	2/-
TRANSISTOR A.F. AMPLIFIER TYPE A.F.1—LOW IMPEDANCE INPUT, 3-TRANSISTOR, 500mW OUTPUT, FULLY ASSEMBLED WITH VOLUME CONTROL	63/8

WEYMOUTH RADIO MANUFACTURING CO., LTD.
REGENT FACTORY, SCHOOL STREET,
WEYMOUTH, DORSET

FREE TO AMBITIOUS ENGINEERS

— THE LATEST EDITION OF ENGINEERING OPPORTUNITIES

Have you sent for your copy?

ENGINEERING OPPORTUNITIES is a highly informative 156-page guide to the best paid engineering posts. It tells you how you can quickly prepare at home for a recognised engineering qualification and outlines a wonderful range of modern Home Study Courses in all branches of Engineering. This unique book also gives full details of the Practical Radio & Electronics Courses, administered by our Specialist Electronics Training Division—the B.I.E.T. School of Electronics, explains the benefits of our Employment Dept. and shows you how to qualify for five years promotion in one year.

**We definitely Guarantee
"NO PASS — NO FEE"**

Whatever your age or experience, you cannot afford to miss reading this famous book. If you are earning less than £25 a week, send for your copy of "ENGINEERING OPPORTUNITIES" today—FREE.

**BRITISH INSTITUTE OF ENGINEERING
TECHNOLOGY (Incorporating E.M.I. Institutes)**
(Dept. SE/21), 29 Wright's Lane, London, W.8

**WHICH IS YOUR
PET SUBJECT?**

Mechanical Eng.,
Electrical Eng.,
Civil Engineering,
Radio Engineering,
Automobile Eng.,
Aeronautical Eng.,
Production Eng.,
Building, Plastics,
Draughtsmanship,
Television, etc.

**GET SOME
LETTERS AFTER
YOUR NAME!**

A.M.I. Mech. E.
A.M.I.C.E.
A.M.I. Prod. E.
A.M.I.M.I.
A.I.O.B.
A.F.R. Ae. S.
B.Sc.
A.M. Brit. I.R.E.
City & Guilds
Gen. Cert. of Education
Etc., etc.

**PRACTICAL
EQUIPMENT**

Basic Practical and Theoretical Courses for beginners in Radio, T.V. Electronics, Etc., A.M. Brit. I.R.E. City & Guilds Radio Amateurs' Exam. R.T.E.B. Certificate P.M.G. Certificate Practical Radio Radio & Television Servicing Practical Electronics Electronics Engineering Automation

**INCLUDING
TOOLS!**

The specialist Electronics Division of B.I.E.T. (Incorporating E.M.I. Institutes) NOW offers you a real laboratory training at home with practical equipment. Ask for details.

**B.I.E.T.
SCHOOL OF
ELECTRONICS**



POST COUPON NOW!

Please send me your FREE 156-page "ENGINEERING OPPORTUNITIES"

(Write if you prefer not to cut page)

NAME _____

ADDRESS _____

SUBJECT OR EXAM THAT INTERESTS ME _____

SE/21

THE B.I.E.T. IS THE LEADING ORGANISATION OF ITS KIND IN THE WORLD

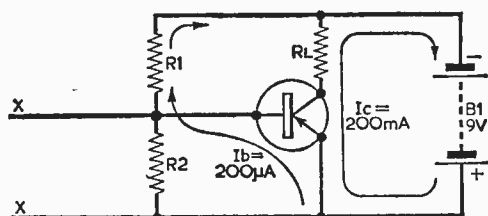

Fig. 4: Here $R1$ is extended, thus making a potential divider.

resistor ($R1$) from the negative line of the supply. Now, on the assumption that we want a current of $200\mu\text{A}$ through the base-emitter path and we have a voltage of -9V on the supply line (with the emitter at 0V positive), and the published data for the transistor in question tells us that in order to get a base current of $200\mu\text{A}$ we need a negative potential on the base of, say, $200\mu\text{V}$, it is a simple matter to calculate what value of resistor, $R1$, will be needed to drop -9V to $-200\mu\text{V}$. That is, to drop the whole nine volts except the odd $200\mu\text{V}$.

Provided the resistor is accurate—and it will have to be accurate within 1%—the correct conditions will be obtained. Also provided the resistor is *high stability* and does not vary under load the conditions will remain stabilised. The correct d.c. base current will flow to produce the correct required collector current—somewhere in the centre of the output curve probably. If we feed an r.m.s. signal in at the points X—X across base and emitter it will swing the base current and an amplified and linear copy of it will result in the collector circuit. Provided, of course, that it does not swing the base so far negative as to cause the collector current to exceed its maximum or too far positive so as to stop collector current flowing altogether — “clipping” and “bottoming”, which will be dealt with later.

DOWN TO MICROVOLTS

For the sake of the experts who may be reading this we will not complicate matters by considering “leakage currents” at this stage.

Sufficient should have been said to make this matter of current bias clear to those who may not completely have understood it and also to point what is one of the first hurdles to the man who wants to experiment with transistors . . . that we are dealing with *microvolts* on the base, not volts, and they *must* be precise! It is not very easy to obtain microvolts within fine limits by a process of trial and error. With transistors, therefore, the thing is to make precise calculations first, then make sure that all one's components, especially resistors, are accurate and will remain so under operating conditions. If calculations are correct there is no reason why apparatus should not work for the first time of asking—which will be a great deal easier than trying to find out why it *doesn't* work, as may be the case if trial-and-error methods are used.

The values given here are, of course, only approximations, nor do they include leakage currents, but all the essential information is in the published data for any actual transistor, although there are many circuits in which the bias is obtained in the manner just explained; this method

is wholly unsatisfactory in practice! If anything goes the slightest degree wrong there will be more transistors burned out—without the aid of the soldering iron.

Which leads to a consideration of certain peculiarities of transistors. These are: impedances, temperature effects, transistor spreads . . . the whole question of d.c. stabilisation.

IMPEDANCE EFFECTS

Consider again the circuit in Fig. 3. The value of volts dropped by the biasing resistor $R1$ must depend upon the amount of current through the base, which will be the sum of the leakage current for that particular transistor and the actual current at the bias volts. The leakage current can be taken as the current which would flow if the collector were open circuited, but at this stage that may be ignored. The amount of current flowing through the base will depend upon the resistance or impedance of the base-emitter internal path through the transistor.

Now a transistor is not resistive—that is, it does not obey Ohm's law. Therefore this impedance is not stable. In fact it varies with frequency (considering d.c., we are at zero frequency, of course), it varies in sympathy with the output impedance, which is also not stable. It varies under load. Also it varies from transistor to transistor due to production spreads, which can be considerable, hard though the manufacturer tries to keep them within close limits.

This means that the input impedance is going to vary during operation and is unlikely to be identical between different transistors. Therefore the base biasing potentials are going to vary during operation and, if a transistor has to be changed, the conditions set up for one may be miles out for the new one. One cannot afford to be miles out with transistors.

A reasonably stable bias is needed on the base, one which will not vary greatly from transistor to transistor and one which is as little dependent upon the varying impedance of the base itself under load as possible. This cannot be obtained by using the series resistance shown. Every variation in base impedance, and therefore in current, is going to cause considerable variation in the voltage dropped across the resistor, which must be large in order to drop the necessary volts at a current of only microamps.

There are a number of recommended ways of obtaining a reasonably stable condition on the base each with its own particular merits or demerits for certain applications . . . but we are going to confine ourselves to the preferred method.

The resistor $R1$ is extended by means of a second leg, $R2$, to earth (emitter), thus making it into a potential divider (see Fig. 4). Consider this condition: if the impedance of the divider is made sufficiently low it will swamp the impedance of the transistor under drive and the voltage at the base tapping will remain reasonably constant regardless of the current taken by the base or, more properly, regardless of variations in it, which will be small in comparison to the current taken through the divider as a whole.

That is, the potential at the tapping point can be made more dependent upon the total current through the divider than it is upon the amount drawn by the base. Changes in transistors will also have much less effect. Thus there is a reason-

able degree of d.c. stabilisation of conditions on the base!

TEMPERATURE EFFECTS

A transistor is not stable against *heat*. Transistors are rated at a temperature of round about 45°C.

There are two ways in which temperature can be considered. One is the room temperature, or ambient temperature, which will determine the lowest temperature these components can operate at. But in actual operation they will heat up according to the value of the current passing through them. Unless steps are taken to limit the rise in temperature within the safety value there will be more destroyed transistors.

Consider what may happen in the circuit of Fig. 3 with the series base resistor and the emitter down to earth. If the transistor is allowed to take too much current, perhaps by fault conditions on the base or because calculations were wrong in the first place, it will heat up. The hotter it gets the more current it takes . . . until by a process analogous to internal combustion and termed "thermal runaway" it exceeds the safety value and destroys itself.

This will not be prevented by using mica washers, heat sinks and so on, which merely increase the amount of current the transistor can take without getting too hot.

Consider, however, the circuit of Fig. 5, in which there is now an emitter resistor, R_e . Under normal operating conditions the volts dropped across this resistor by the emitter current will be, say, 1V at quiescent current value.

The base bias will have been calculated so that the base potential is some 1.2V to earth—that is, 200 μ V to emitter as before.

Now in the event of a rise in quiescent collector current through any cause—temperature or otherwise—the volts dropped by the emitter resistor will also increase; the voltage at the base tap on the potential divider remaining substantially unaffected. Thus the emitter moves more negative to base, which is the same as saying the base

moves positively to the emitter, so tending to reduce the current in the collector circuit to its original value and thus prevent thermal runaway. Remembering, of course, that moving the base negatively *increases* collector current, whereas moving it positively *decreases* it. (If the base becomes positive to the emitter then the collector current will cease entirely, the transistor enters cut-off condition and the flow of base current reverses and now flows *in* to the base and *out* of the emitter. This gives rise to some interesting phenomena.)

This final circuit, which is the preferred circuit for d.c. stabilisation, gives substantial protection against thermal runaway effects as well as compensating for transistor spreads and impedance variations.

Once d.c. stabilised a transistor stage can be used in any sort of a.c. configuration. The emitter or the collector can be grounded to a.c. even though not earthed to d.c.

So the rule is: establish the conditions of d.c. stabilisation before you do anything else. If the hook-up does not work, check the d.c. conditions. The collector current can be read by checking the voltage drop through the collector load; the emitter voltage can be checked by reading the volts dropped across the emitter resistor. As a transistor obeys Kirchoff's Law the base current could be read as the electrical difference of collector and emitter currents were that difference large enough to measure, which normally it will not be. But the *value* of the collector current, in milliamps, will enable the base biasing current to be ascertained by making reference to the published data for the transistor.

The base voltage to earth can be read if there is an emitter resistor; this should be slightly more negative than the emitter itself.

This is by no means the whole story. A glance at the circuit (Fig. 5) will suffice to show that the potential divider R_1, R_2 is not quite what it appears to be on the surface. In practice the biasing potential is almost wholly determined by R_1 because the input impedance of the transistor itself is in effective shunt with R_2 and, as seen, this is of a low order, some 100 Ω perhaps. Thus R_2 is really only a bleeder.

Nevertheless with this circuit for d.c. stabilisation, if calculations have been accurate having regard to the published data on the transistor in use, the stage should work—as far as d.c. is concerned—first go off.

Trouble shooting with transistors has its own problems. The impedances are far lower than those associated with valves, so are the voltages; on the base you are dealing with micro values. If the value of a resistor is taken in situ it will probably only read the impedance of a transistor in shunt with and, as the whole set-up is critical within fine limits, transistors can be wrecked when trying to find out why they won't work.

Once d.c. conditions have been established go ahead to the next stage and consider the a.c. applications.

If the circuit shown in Fig. 6 is used, and in addition arrange that the collector load is of a value which drops at least half the supply voltage (in this case 4.5V, which is half of 9V), it will result in a set-up which should work and remain stable under almost any conditions. ■

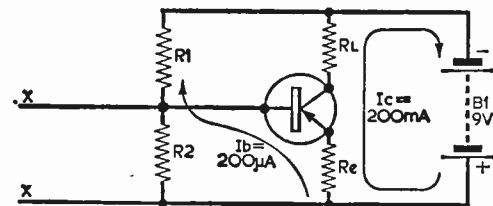
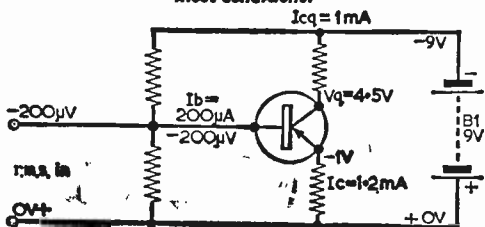

Fig. 5 (above): An emitter resistor, R_e , is included in this circuit.

Fig. 6 (below): This circuit should remain stable under most conditions.



"ROAMER" 7 (5 Wavebands)

PERFORMANCE WILL AMAZE YOU!

★ (7 Transistor plus 2 Diode designs)

★ Med/Long Waves, Trawler Band and 2 S.W. to approx. 17 metres.

- ★ Rich-toned 5in. Speaker.
- ★ Sockets for car radio use.
- ★ Telescopic aerial for S. Waves.
- ★ FERRITE ROD AERIAL FOR M/L.
- ★ Full After Sales Service.
- ★ Air spaced gauged Tuning Condenser.
- ★ Uses latest Mullard Transistors.

Total cost **£7.9.6** P.P. 5/6.
Or Less Case **£6.9.6**

- ★ Push-Pull output for room filling volume.
- ★ Two tone Cabinet with gilt trim.
- ★ Case size 12 x 8½ x 3½in.
- ★ Parts price list and Plans 3/-.



THE SUPER SEVEN

★ ★ (7 Transistors plus 2 Diodes)

- ★ 2 R.F. STAGES.
- ★ Mullard and Surface Barrier Transistors.
- ★ Coverage of Medium, Long Waves, Trawler Band.
- ★ Use as domestic radio, car radio or fit with strap for carry-about.
- ★ No aerial required.
- ★ 3-inch speaker but will drive a larger speaker.
- ★ 400 milliwatts output stage.

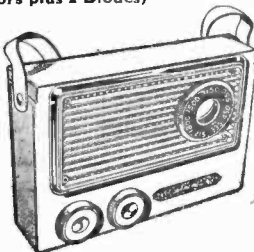

May be built for **£5.19.6** SIZE: 7½ x 5½ x 1½in.
plus 3/6 post, etc.

Or with telescopic aerial for trawler band **£6.5.6**

PARTS PRICE LIST AND EASY BUILD PLANS 2/-

NEW TRANSONA-6

★ (6 Transistors, plus 2 Diodes)
★ M/L & T. BAND

400 Mw Mullard push-pull output Transistors, Powerful magnet 3in. high grade speaker. Push-pull transformers. This is a top performing receiver. Many stations listed in one evening including Luxembourg loud and clear. A pleasure to listen to. **FERRITE ROD AERIAL.** All parts sold separately, including pale blue gleaming polystyrene case with duo-diffusion grilles in red. Uses 9 volt battery. Sockets for car aerial.

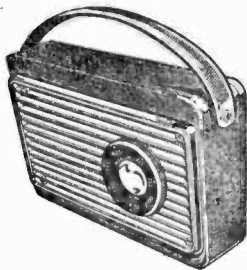

Total building cost **£4.19.6** P.P. 3/-. Size 6½ x 4½ x 1½in.

"Agreeably surprised with Trawler Band reception. Luxembourg as loud as local. Your easy build diagram helped a lot... my first attempt."—H. S., Penzance, Cornwall (poor reception area). **PARTS PRICE LIST AND EASY BUILD PLANS 1/6**

All components used in our receivers may be purchased separately if desired. *Parts Price List only, S.A.E.*

AFTER SALES SERVICE

Radio Exchange Co.

27 HARPUR STREET, BEDFORD

Phone: 2367
Closed 1 p.m. Sat. Opp. Co-op.

BEGINNERS POCKET 5

(MW/LW and TRAWLER BAND) (7 Stages)
(5 Transistors, plus 2 Diodes)

Designed round supersensitive **FERRITE ROD AERIAL** and 3in. moving coil speaker. Attractive case in black with speaker grille in red. On test Home, Light, Radio Luxembourg and many Continental stations were received.



Total cost of all parts **£2.19.6** P.P. 3/-
EASY BUILD PLANS AND PARTS PRICE LIST 1/6

"THE MELODY SIX"

- ★ Ferrite rod aerial.
- ★ 6 new type transistors and top quality components. Attractive case in blue and red and carrying strap with gold trim.
- ★ 3in. Speaker.
- ★ M.W./L.W.
- ★ No aerial required.

£3.19.6

P.P. 3/-
Price list and plans, 2/-.

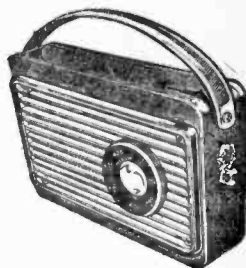

"BEGINNERS" PUSH-PULL FIVE

(5 Transistors, plus Diode)

- ★ 2½" Super-tone Loudspeaker.
- ★ Ferrite rod aerial.
- ★ Tuning condenser.
- ★ Volume control.
- ★ Case with speaker grille in red.
- ★ Fully tunable over med/long waves and T-band.
- ★ Simple assembly diagrams.
- ★ 250 Milliwatts output stage.

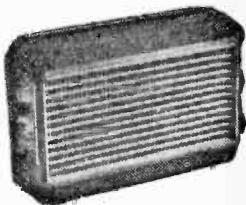

Can be built for **59/6** P.P. 3/-. or with 3in. speaker **68/-**

★ **PARTS PRICE LIST & PLANS** etc. 2/-

"Home, Light, AFN, Lux., all at good volume."—G.P., Durham.

MICRO-AMPLIFIER



ACTUAL SIZE

SMALLEST OF ITS TYPE IN THE WORLD



Out-performs amplifiers 20 times as large.



Overall size! $\frac{2}{2}'' \times \frac{3}{8}'' \times \frac{1}{2}''$
28/6 plus 1/6 p. & p.

- 1) Power gain—60dB (1,000,000 times).
- 2) Frequency response 30 c/s to 50 kc/s \pm 1 dB.
- 3) Works on any voltage from 1.3 to 9 V.
- 4) Drives any earpiece or small loudspeaker.
- 5) Simple to build with ordinary tools.
- 6) Uses **Micro-Alloy** transistors throughout.
- 7) Free applications data gives circuits for using micro-amp. in micro-radios, transmitters, etc.

MICRO-ALLOY TRANSISTORS

MAT100	7/9	MAT101	8/6
MAT120	7/9	MAT121	8/6

- ★ Easily the best for all A.F., R.F. and V.H.F. applications.
- ★ Extremely high gains, typical betas of 150.
- ★ Cut-off frequencies of 120 Mc/s.
- ★ Gold plated for protection and soldering.

SEND FOR COMPLETE BOOK ON MATS

"22 TESTED CIRCUITS USING MICRO-ALLOY TRANSISTORS"

ONLY **5/9** including postage.

This book includes new circuits for amplifiers, transmitters, micro-radios, F.M. tuners, etc.

SINCLAIR RADIONICS LTD. 69, Histon Rd. Cambridge

TELEPHONE CAMBRIDGE 53965

TRADE ENQUIRIES INVITED

JACKSON

the big name in **PRECISION** components

Precision built radio components are an important contribution to the radio and communications industry. Be sure of the best and buy Jackson Precision Built Components.

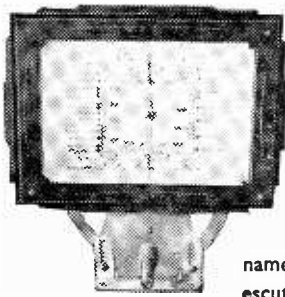

SQUAREPLANE DRIVE

Scale $4\frac{5}{16}'' \times 3\frac{1}{4}''$. Oblong clockface type drive ratio 8:1. Printed two wave-bands and station names. Bronze-finished escutcheon with glass.

Write for literature

JACKSON BROS. (LONDON) LTD.

(Dept. P.W.) KINGSWAY-WADDON, SURREY

Phone: Croydon 2754-5 Grams: Walfico, Souphone, London

NEW MERCURY SIX CASE

The result of a cross section of opinion of amateur constructors. A quiet yet really attractive contemporary design.

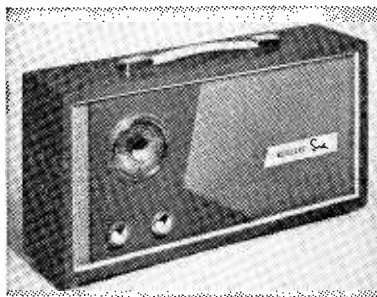

Size $4\frac{1}{2} \times 7\frac{1}{2} \times 4$ in.

Price 48/-.

Suitable for many other transistor receivers currently offered, and plenty of room for 9 x 4 in. speaker for quality.

Coloured illustration on request.

Mercury 6 Booklet 2/6.

Trade and Retail.

OSMOR 418 BRIGHTON ROAD
S. CROYDON CRO 5148

THE AUDITRON

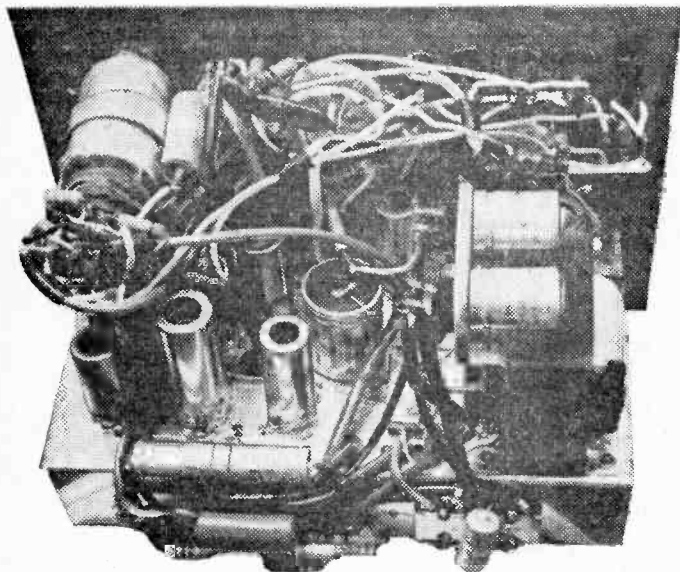

By M. L. Michaelis, M.A.

indicators, because this is normally by far the easiest to achieve. A phase-indicator normally requires a cathode-ray oscilloscope, which would involve costs and complications out of all proportion if one merely desired to build a bridge alone. However, it is well worth while if matters lie the other way, namely that an oscilloscope exists, and we want to modify this to include a bridge function, as here. Phase-Null indication has, namely, some advantages in sharp definition of the Null (Balance), as it involves the closure of an ellipse to a straight line at true balance, opening up again beyond, which is a visually very distinctive action. The human eye is very sensitive to any departures from the straight line!

The actual bridge itself is one of the conventional arrangements for a.c., though novel in detail. R17 and R18 form an a.c. bleeder on the 110V a.c. line, tapping off sufficient amplitude to give about 2cm deflection on the X plates, using the mains sinewave. C13 and R12 form the "standard" arm of the bridge, giving a definite phase shift (in fact, 45°, because the impedances of C13 and R12 have been chosen to be approximately equal at mains frequency) for the bridge X deflection, compared to the incoming mains voltage. It is seen that S1e and S1f, two wafers of the function switch, cut off the a.c. supply to R17 and short R12, in all positions except "three", which is the "bridge" setting.

The other arm of the bridge is given by the unknown capacitor or inductor to be measured, connected between the terminals "LT AC" and "Pot" of the "bridge" connections on the panel. This is fed from the a.c. heater line, which is in phase with the 110V a.c. line feeding the other bridge arm. The completion of the second arm is given by the fixed and variable resistors selected on S3a, a wafer of the bridge range switch S3.

Normal Use of the Auditron Bridge

The normal use of the Auditron Bridge is for checking and measuring capacities larger than 1,000pF. The capacitor is first of all checked for leakage before making a capacity measurement, because leaking capacitors would still give a capa-

(Continued from page 842 of the January issue)

THE shift controls have a time-lag of about one second before the trace fully follows movement of the controls VR3 and VR4. This is due to the charging time of C28 and C38. It could be avoided by returning R15 and R16 to the final anode (pin 8) of the c.r.t., and applying the shift voltages in the same manner to the other two plates. This was found to worsen the hum level on the trace slightly, and to worsen astigmatism slightly, yet should by all means be tried, as conditions could easily be different with individual Auditrons, whether the specified tube is employed or not.

The Bridge Circuit

Fig. 3 (page 514, October issue) shows the arrangements for measuring capacities of from about 1,000pF to 30 μ F, and inductances from about 1 to 20H, by means of the "bridge" arrangements built as an integral part into the Auditron.

It is a fact that, in a.c. bridge arrangements of conventional type, not only are the voltages equal, but also the phases are equal, for the two pints between which the null-indicator is connected, once the point of balance has been reached. Thus, in principle, a null-indicator can be used to react to voltage or to phase differences, though almost always voltage indication is used in normal null-

city reading, apparently, i.e., a phase balance may still be found, but at the wrong point. Thus it is first necessary to make sure that the insulation is reasonable. This is done by first connecting the capacitor with one end to the bridge terminal labelled "h.t.", and the other end to the prod of the signal amplifier probe, having turned the signal amplifier gain to zero beforehand, because only the valve-voltmeter function is needed at this stage of proceedings. If the capacitor insulation is reasonable, the valve-voltmeter in the signal amplifier of the Audiotron should, as soon as the above connections are made, give a sharp kick to about +250V (for all except the smallest capacities), and thereafter return to zero at once, or within a short time, according to the capacity.

Leaks having resistances of 20M Ω or less will have been shown up by this method, and a capacitor passing this test should be suitable for most normal purposes. Note that the applied test voltage in this test was about 250V which should be permissible for most normally used condensers. If the capacitor is of lower voltage rating, then adopt a modified procedure described later in this discussion.

Capacity Measurement

The capacitor undergoing tests is next connected between "LT AC" and "Pots", and the prod of the probe is connected also to "Pots". The signal amplifier gain is turned up until an oblique ellipse of reasonable size is observed on the c.r.t. screen.

S3 is switched to that range including the nominal (or estimated) value of the test capacitor. The corresponding potentiometer then in circuit, VR5, VR6 or VR7 is turned until the ellipse *exactly* closes up to a pure straight line going obliquely across the c.r.t. screen, and the capacity value is then simply read off from the scale attached to the potentiometer. If one has no previous idea of what value the capacity might have, one has to search through the various ranges, yet there is a right and a wrong way of doing this. If, even at full signal amplifier gain, the oblique ellipse is lying very flat, giving little departure from a horizontal trace, it is a sign that the capacity of the test capacitor is much less than the bridge range set at the time. If the ellipse is large and distinct, yet makes no attempt to close to a line over the entire range set, then the capacity of the capacitor is much greater than the range set. Always adjust the signal amplifier gain (VR13) such that the figures are as large as possible, yet still do not fold over at the ends (distortion in the signal amplifier due to overload).

Arrangement of Potentiometers

When making the calibration scales to be attached to the "bridge" section of the Audiotron panel, the five positions of S3 should be marked clearly with the capacity range covered in each case, and an arrow pointing to the potentiometer knob operative for each position. Position 1 operates with VR5, and will cover about 1 to 30 μ F. R19 is here a safety resistor, to avoid short-circuits if the test condenser has a dead-short fault and VR5 is turned to minimum. In such a case, without R19, a total short would be present on the heater line, which would most likely burn out the bottom end of VR5.

Position 2 operates with VR6, and should cover about 0.1 to 1.0 μ F. R28 here serves the double function of safety resistor as above, and limits the high capacity end of the range to reasonable overlap with the next range.

Positions 3, 4, 5 all operate with VR7, which thus carries three scales. In position 3 coverage is about 0.02 to 0.25 μ F. Position 4 merely switches in an additional series resistor, changing the range from about 0.01 to about 0.02 μ F. Finally, in position 5, the same range of 0.01—0.02 μ F is still operative, but a standard capacitor of 0.01 μ F is placed in parallel with the unknown one, so that the actual range, as far as the external capacitor on test is concerned, has become zero to 0.01 μ F. Balance clarity is too weak for anything except very rough indications below 1,000pF, thus this

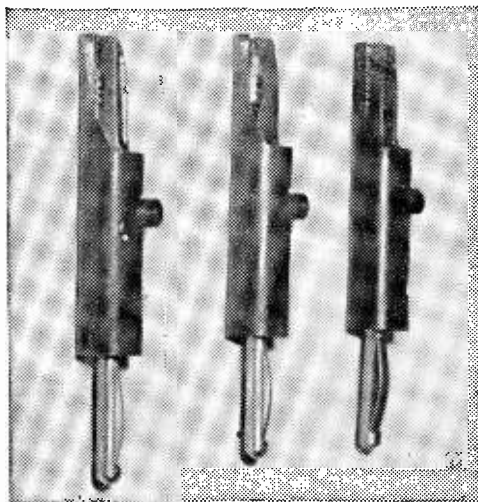

Banana plug/crocodile clips of the type used by the author
(See page 942)

range is calibrated 1,000 to 10,000pF. Capacities smaller than 1,000pF should be measured by resonance methods with a coil, using a grid-dip meter, or by other standard methods. For ranges 3, 4, 5 R21 performs the functions of safety resistor and scale range limiter.

Paper Capacitors rated at less than 250V

To obtain test voltages less than the full h.t. of 250V, the "H.T." and "Pots" terminals should be shorted together. VR6 carries a voltage scale, in addition, from about 12 to 100, giving the indicated voltages at the shorted terminals, for the relevant slider positions. VR5 carries a similar additional scale from about 1 to 12V.

For the initial leakage test, therefore, S3 should be switched to the desired voltage range, and the potentiometer adjusted to the rated voltage of the condenser, after shorting "H.T." and "Pots". One end of the capacitor is then connected to "H.T." as before, and the other end to the prod of the probe, and the same procedure used as before.

R2 is a limiting safety resistor, to prevent excessive currents under all circumstances of faulty

MULLARD 3-3 HI-FI AMPLIFIER

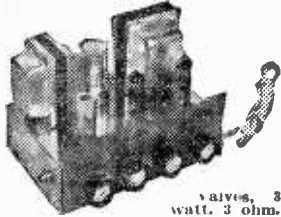

3 valves, 3 watt, 3 ohm. and 15 ohm. Output giving Hi-Fi quality at a reasonable cost. Mullard's latest circuit. Valve line up: EF86, EL84, EZ81. Extra HT and LT available for Tuner Unit addition. This is the ideal companion Amplifier for FM tuner units.

TECHNICAL SPECIFICATION— Freq. Response: ± 1 dB, 40 c/s.-26 Kc/s. Tone controls: Max. Treble Cut 12 dB. at 10 Kc/s. Max. Bass Boost 14 dB. at 80 c/s. Sensitivity: 100 Mv. for 3 w. output. Output Power (at 400 c/s); 3 w. at 1% total harmonic distortion. Hum and Noise Level: At least 70 dB. below 3 w.

COMPLETE KIT (incl. Valves, all components, wiring diagram and special quality sectional output Trans.). **ONLY £6.19.6.** Carr. 5/- Complete wired and tested. 8 pins. Bronze Escutcheon Panel, Grinned Vol., Treble, Bass, On-off, supplied with each kit. Wired O/P socket power and additional smoothing for Tuner Unit, 10/6 extra. Speakers—WB Recommended Goodmans AXIOM H102 95/-, 110 25, etc.



COLLARO STUDIO TAPE RECORDER KIT

SPECIAL BARGAIN OFFER. Comp. Kit only £25.00 Carr. 12/6.

Famous mfrs. surplus offer—Listed 42 gns. A quality Tape Recorder Kit based on Mullard famous design—EF36, ECC63, EL84, EM84 and Rectifier. Specially designed Kit for Collaro latest Studio Deck. Freq. response ± 3 db. 60 c/s.—10 Kc/s. Amp. and Power Pack already wired, inter unit wiring only required. Cabinets size: 18 x 16 x 6 in. finished in contemp. 2 tone blue Rexine with gilt Speaker Escutcheon, Magic Eye Indicator Circuit and Tech. H/Book, supplied free with kit. Send 2/6 now for full details of to-day's outstanding Tape Recorder Bargain.

Cabinet £3.15. P. & P. 6/6. Amplifier Kit £8.19.6. P. & P. 5/-. Speaker 7 x 4 1/2". P. & P. 2/- If above items are purchased together.

£12.19.6 P. & P. 10/-

BARGAIN 4-SPEED PLAYER UNITS

Single Players Carr. 3/6
Garrard 4 S.P. £6.19.6
Garrard TA Mk.2 £7.19.6
Collaro "Junior" 7/5-
E.S.R. Latest TU12 7/9/6
E.M.I. Junior '985' 8/9/6
Auto-Changers Carr. 5/-
Collaro "C60" £7.15.0
R.S.R. (UA14) £7.10.0
Garrard "Auto-slim" £8.12.6
Garrard Model RC206 £9.19.6

Volume Controls— 5K-2 Meg-ohms, 3in. Spindles Morganite Midget Type 1 1/2 in. diam. Guar. 1 year. LOG or LIN ratios less Sw. 3/-. DP. Sw. 4/6. Twin Stereo less Sw. 6/6. DP Sw. 8/-.
Speakers—WB Goodmans AXIOM H102 95/-, 110 25, etc.

RECORD PLAYER CABINETS



Cabinet Price **£3.3.0** Carr. & Ins. 5/-

Contemporary style, rexine covered cabinet in two tone maroon and cream. Size 18 x 13 x 6 in. fitted with all accessories including baffle board and anodised metal fret. Space available for all modern amplifiers and autochangers, etc. Uncut record player mounting board 14 x 13 in. supplied.

2-WATT 2-WATT AMPLIFIER Twin stage ECL2 with vol. and neg. feedback control. A.C. 200/250 v. with knobs, etc., ready wired to fit above cabinet. £2.17.6. P. & P. 1/6.
6in. Spkr. & Trans. 29/- P. & P. 2/- Complete Kit, including UA14 unit as illustrated, £12.19.6, Carr. 7/6.

JACK PLUGS. Standard 2 1/4" Irganic Type, 2/6. Screened Ditto, 3/3. Miniature 1 1/4", 2/3. Screened Ditto, 2/6.

ENAMELLED COPPER WIRE— 1lb. reels, 148-20g, 2/6; 228-28s, 3/-; 30g-40g, 3/6. Other gauges quoted for.

Erskin Multicore Solder 60/40 3d. per yard. 1lb. 2/6, etc.

Condensers—Silver Mica. All values, 2pF to 1,000pF, 6d. each. Dittos—Ceramics 9d. Tub. 450V T.C.C., etc., 0.001 mfd. to 0.01 and 0.1/350V, 9d. 0.02 to 0.1/500V, 1/-, 0.25 Hunts 1/6. 0.5 T. 1/6, etc. etc. Close Tol. S/Micas—10% 5pF-500pF 8d. 600-5,000pF 1/-, 1% 2pF-100pF 9d. 100pF-500pF 11d. 575pF-5,000pF 1/6. Resistors—Full Range 10 ohms-10 meg. Ohms 20% 1 and 1/4 W 9d., 1W 5d. (Midget type modern rating) 1W 6d., 2W 9d. 1/2-Stab 10d., 1W 5d., 1W 7d. 5 W 9d., 1/4 W 1/6.

New Bored	VALUES	All Guaranteed	TRANSISTOR BARGAINS
1T4 6/-	ECC83 8/-	PC84 9/6	OC44 8/6
1R5 7/6	ECL82 10/6	PCF80 9/6	OC45 8/-
1S5 7/6	ECL80 10/6	PCL83 12/6	OC81 7/6
334 7/6	EF80 8/-	PCL84 12/6	2/OC81 15/6
3V4 7/6	EF86 12/6	PL81 12/6	XA102 10/-
DAF06 6/-	EL84 8/6	PL82 9/6	XA101 9/6
DF96 6/-	EN81 9/6	PL83 10/6	XB103 7/6
DK96 9/6	EY51 9/6	PY32 12/6	XC101 8/6
DL96 9/6	EY36 10/-	PY81 9/6	Special offer: One OC14 two
ROC81 8/-	EZ81 7/6	PY82 7/6	OC45; 21/6. One OC12 two
ROC82 8/-	OZ32 12/6	U35 12/6	OC81's (matched pair) 19/6.

SPECIAL BARGAIN OFFER

A self-contained Portable Unit incorporating latest BSR 4 speed Auto Changer Record Player and famous High Fidelity "Full-F" Xtal Pick Up with Turnover Cartridge, fitted with LP and 78 Sapphire Styl. Internal 2 valve Amplifier of modern design with variable Tone and Volume Controls. This, together with a quality P.M. Speaker ensures a high standard of reproduction. The whole is housed in a robust wooden Cabinet attractively styled in 2 Tone contemporary leather cloth with contrasting polka dot relief.



Kit consists of 3 sub assemblies already wired. Grub screw connections between Units only necessary—absolutely no soldering. Originally built to be sold at 17 Gns. Recommended Buy!

Standard Model **£12.10.0** Carr. & Ins. 7/6

Autochanger Unit—BSR Model UA20. Amplifier—valves UCL82, UY85 and 7 4 in. Elliptical Speaker. Cabinet size 17 x 14 x 8 1/2 in.

RECORDING TAPE—Reduced Prices

Famous American Columbia (CBS) Premier Quality Tape at NEW REDUCED PRICES. A genuine recommended Quality Tape—TRY IT! Brand new, boxed and fully guaranteed. Fitted with leader and stop folds.

Standard	Long Play	Double Play
5in. 600ft. 13/-	900ft. 17/6	1,200ft. 31/6
5 1/2 in. 900ft. 16/-	1,200ft. 19/6	1,800ft. 37/6
7in. 1,200ft. 21/-	1,800ft. 29/6	2,400ft. 47/6

P. & P. per reel 1/- 6d. on each additional reel.

SPECIAL BARGAIN. 3in. Message Tape, 150ft. 3/9. P. & P. 6d.
3in. L.P. 225ft 4/0, 3in. D.P. 30 f 6/6
Plastic Tape Reels ... 3in. 1/3, 5in. 2/-, 5 1/2 in. 2/-, 7in. 2/3
5in. 1/6, 5 1/2 in. 2/-, 7in. 2/3
Plastic Spool Containers ...

COAX 80 OHM CABLE
High grade low loss Cellular air spaced Polythene—1/4 in. diameter. Stranded cond. Famous mfrs. Now only 6d. per yard. Bargain Prices—
Special Lengths—
20 yd. 9/- P. & P. 1/6.
40 yd. 17/6. P. & P. 2/-.
60 yd. 25/6. P. & P. 3/-.
Coax Plugs 1/-, Sockets 1/-, Couplers 1/3, Outlet Boxes 4/6.



Est. 1949

Send for detailed bargain lists, 3d. stamp. We manufacture all types Radio Mains Transf. Chokes, Quality O/P Trans., etc. Enquiries invited for Specials, Prototypes for small production runs. Quotations by return

RADIO COMPONENT SPECIALISTS

70 Brigsteek Rd., Thornton Heath, Surrey. Hours: 9 a.m.-6 p.m., 1 p.m.-Wed. THO 2188. Terms C.W.O. or O.O.D. Post and Packing up to 1lb. 9d., 1lb. 1/3; 3lb., 2/3; 6lb., 2/9; 8lb., 2/6.

D. & B. TELEVISION

(Wimbledon) LIMITED

131 & 131a KINGSTON ROAD
SOUTH WIMBLEDON, LONDON S.W.19
PHONE: CHerrywood 3955

OPEN MONDAY—SATURDAY 10 a.m.—7 p.m.
(Except Wednesday—1 p.m.)

Nearest Tube: South Wimbedon (North Line)

COMPARE OUR PRICES
FOR THE FINEST IN THE COUNTRY
YOUR PROBLEMS ARE OUR BUSINESS

MOST LINE-OUTPUT TRANSFORMERS

COMPLETE NEW RANGE OF TRANSISTOR COMPONENTS IN STOCK

BRAND NEW *STAR* BARGAIN
Designed for quality and outstanding value.

NEW R.T.D. 6 Watt Monaural Amplifier, using heavy duty, double-wound mains Transformer. With separate rectifier winding. Valves: Rectifier, Driver and Output. 5 Controls: Switch, Volume, Base, Treble, Middle. Heavy duty output Transformer. METAL CHASSIS. All components brand new. Ready built.....ONLY £5.5.0. COMPLETE or all parts in kit form. Point to point diagram. ONLY £3.15.0. P. & P. 3/6.



TV TUBES

ALL TUBES ARE REQUIRED WITH FULL 12 MONTHS' GUARANTEE

12in. MULLARD TYPE.....£2.15.0	12in. MAZDA TYPE.....£3.15.0
14in. MULLARD TYPE.....£4. 5.0	14in. MAZDA TYPE.....£4. 5.0
16in. MAZDA TYPE.....£4. 5.0	16in. G.E.C. TYPE.....£4.15.0
16in. MULLARD TYPE.....£4.15.0	17in. MULLARD TYPE.....£4.15.0
17in. MAZDA TYPE.....£4.15.0	17in. G.E.C. TYPE.....£4.15.0

17in. EBIAL TYPE.....£4.15.0.
90° AND 110° TUBES ON EXCHANGE BASIS ONLY
ADD 5/- FOR ELECTROSTATIC TUBES. ADD 10/- FOR 90° AND 110° TUBES.
CARR. AND INS. 12/6. C.W.O. OR C.O.D.

ALL VALVES ARE SOLD SUBJECT TO FULL GUARANTEE

CURRENT VALVE LIST

6Y1	14/6	6CH8	7/6	6CC89	8/9	6U80	19/6	705	8/-
6F91	5/6	6CL80	3/3	6CF80	8/3	6U81	25/6	606	3/6
6F96	8/-	6CL82	9/-	6CF82	9/6	6UAF49	8/-	7H7	7/8
6DAF91	5/6	6F36	4/-	6CF86	10/6	6UBC41	8/-	10C2	15/-
6DAF96	8/-	6F39	4/6	6CL82	8/3	6UCF80	10/6	10F1	5/6
6H77	4/6	6F80	5/3	6CL83	10/6	6U41	8/-	10F13	8/9
6K91	7/-	6F85	7/6	6CL84	9/-	6U46	8/-	10F14	12/9
6K92	7/-	6F86	9/-	6CL85	14/3	6U8	17/6	12AU7	5/8
6K96	8/-	6F89	8/3	6PL36	12/-	6UY41	6/9	12AT7	5/6
6L92	7/-	6F91	3/9	6PL38	18/6	384	7/-	12AX7	5/6
6L94	7/3	6F92	4/-	6PL31	10/6	3V4	7/-	12K7GT	5/-
6L96	8/-	6F92	4/3	6PL32	7/6	6U4G	7/-	12D7GT	6/3
6KBC80	7/3	6L33	3/-	6PL83	7/6	6U4G	8/-	20D1	8/6
6AF42	9/-	6L84	7/6	6PL84	8/-	6Z4G	9/6	20F2	12/3
6B91	3/9	6M34EM806/3	6/3	6PY31	12/-	6at6	6/-	20L1	18/6
6BC33	4/6	6M80	6/9	6PY32	10/6	6P1	8/-	20P1	12/6
6BC41	9/-	6X51	8/6	6PY80	6/-	6P13	8/6	20P3	19/6
6BF80	8/-	6Y80	8/6	6PY81	7/3	6P15	11/6	20P4	22/-
6BF89	8/-	6Z40	6/3	6PY82	6/-	6L1	10/-	20P5	19/6
6CC81	6/-	6Z41	6/3	6PY83	8/-	6L18	9/6	30FL1	10/-
6CC82	7/6	6Z90	6/-	6U24	10/-	6X4	4/3	30P4	19/6
6CC83	7/6	6Z91	6/-	6U25	11/6	6X5	5/6	30P12	9/6
6CC84	7/6	6Z92	9/6	6U26	9/-	6V8	6/-	33L6GT	8/3
6CC85	7/6	6Z94	12/6	6U31	7/-	6SN7	5/6	3Z4	6/6
6CP80	9/-	6KT380	6/-	6U37	12/6	607G	6/6	195B7	22/-
6CP82	9/-	6PC84	8/3	6U50	8/-	68J7	6/6	807	7/8
6CC86	9/-	6PC86	8/3	6U191	12/-	1Y87	8/6		

We pride ourselves that we can obtain and supply any TV spare. Please ask us for ANY components you may require we are almost certain to have them.

TERMS: S.A.E. all enquiries. C.O.D. 3/- extra.

C.W.O. Postage on Valves, 6d. each. C.R.T.'s 12/6 inc. insurance. SATISFACTION ASSURED. RETURN POST SERVICE.

SOLDERING EQUIPMENT

by



PRECISION SOLDERING for the ELECTRONICS INDUSTRY

Comprehensive range—Robust & reliable - Light weight - Rapid heating - Bit sizes 3/32in. to 3/8in. - 'Permagit' or Copper bits - All voltage ranges 6/7v. to 230/250v. - Prices from 21/-.

Also

- Plastic Cable Strippers
- Miniature Solder Pots
- Heat Guards
- Long Life Bits

Illustrated is the 25w. 3/16in. replacable bit model with safety shield.

ADAMIN— new range of precision micro-soldering instruments— Have you had details?

Brochure No. S10 sent free on request.

Sole proprietors and manufacturers:

LIGHT SOLDERING DEVELOPMENTS LTD.

28 Sydenham Road, Croydon, Surrey

Phone: CROYdon 8589 Grams: Litesold Croydon



with a MARTIN RECORDAKIT
make your own

TAPE RECORDER

quickly, easily, cheaply
with no previous experience

Post to:
MARTIN ELECTRONICS LTD.
155 HIGH STREET, BRENTFORD
MIDDLESEX
Please send Free Leaflet on Martin Recordakits.
NAME
ADDRESS
..... PW 263
(BLOCK LETTERS)

With a Martin Recordakit everything you need is supplied, ready to assemble—even down to wire cut to length! The easiest and cheapest way to own a Hi-Fi quality Tape Recorder. Fill in coupon for details.

test components or mistaken connections.

After checking the insulation of a low voltage paper capacitor in this way (or any other non-electrolytic type of capacity within the ranges covered), a capacity measurement may be made in the same way exactly as for higher voltage ratings, because the applied voltage is then only 6.3V a.c. maximum. Naturally, the shorting lead between "H.T." and "Pots" must be removed again prior to the capacity measurement.

Quantitative Insulation Measurement

As will have been made clear in another article which appeared in past months in this magazine, dealing with noisy volume controls, those capacitors used for coupling from the anode circuit of a stage of amplification to the grid of the next stage can sometimes give trouble if the insulation is not better than 500M Ω . The Auditron can be used, in the "bridge" setting, to check whether a capacitor satisfies this condition.

After successfully completing the above described "reasonable" insulation check the capacity measurement, multiply the observed capacity (in μ F's) by 500. This gives the *shortest* tolerable time-constant (in seconds) of the self-discharge rate of the capacitor across its own leakage, for the purposes envisaged, and the Auditron can now be used to check that this time-constant is with certainty exceeded.

For this purpose, proceed exactly as for the "reasonable" insulation test. Now set the signal amplifier gain, by means of the Zener diode calibrator to give a vertical-deflection sensitivity of two-thirds as many volts per centimeter as the test voltage used. Now touch the prod of the signal probe on to the free end of the test capacitor in the normal way, and wait until the initial valve-voltmeter deflection has died away to invisibility. Then remove the prod of the probe, leaving the capacitor hanging with one end free, and wait the calculated "minimum-time-constant" period (e.g. for a typical coupling capacitor of 0.05 μ F, this would be 0.25 seconds). Then immediately touch the prod on to the free end of the capacitor again. If the jerk of the trace on the c.r.t. screen (upwards) is then less than one centimeter, the capacitor has insulation better than 500M Ω , and is thus satisfactory. If the jerk is greater, the capacitor is of doubtful quality for coupling purposes.

Insulation Tests for Electrolytic Capacitors

All tests and measurements on electrolytics must use a polarising voltage of the correct sense, and this is automatically provided in the "reasonable insulation" test here. Thus leakage checks for electrolytics can be performed in the same way exactly as for other types of capacitor. Observe that the test voltage does not exceed the rated voltage (though it may be less, but not less than half of the rated voltage), and observe correct polarity. The positive lead of the electrolytic should go to the "H.T." terminal, and the negative lead to the prod of the probe.

The "reasonable insulation" test, showing leaks of about 20M Ω or less resistance, is normally adequate, and represents all that can be expected in the way of insulation from many large capacity

electrolytics. However, there is nothing against applying the above described time-constant observation method to test for even better insulation. This is desirable in those cases where electrolytics are to be used for coupling purposes, such as in certain types of frame-timebase circuits in television circuits.

Capacity Measurements for Electrolytics

It is not possible to use the normal bridge operation and calibration for capacity measurements on electrolytics, because no d.c. polarisation is then available. A different method is thus to be used, which is particularly possible because of the high capacity of electrolytics.

This method proceeds in the same manner as the "reasonable insulation" test, and may be performed simultaneously with the latter right at the start. Apart from observing that the valve-voltmeter deflection should return fully to zero if the insulation is satisfactory, the *time* it needs to halve its initial deflection should be noted, in seconds, with the switch marked "C" on the probe set to position "time". This time, in seconds, gives the capacity of the electrolytic, in μ F's.

The same procedure is to be used for non-electrolytic types with capacities exceeding 30 μ F, i.e. not covered by the highest bridge range.

The switch "C" should be left at position "scope" for all other uses of the Auditron.

Capacitors found in modern transistorised equipment are often electrolytics of about 6 to 12V rating and have capacities of hundreds or thousands of μ F's. The above described method of capacity measurement (primarily intended for h.t. smoothing capacitors) would thus take too long with these components, apart from insufficient sensitivity on the valve voltmeter at the low working voltages.

These capacitors should thus be charged from a suitable tap on a grid-bias battery, observing polarity and keeping to within the voltage rating. Allow about 15 seconds for charging. Then connect the charged capacitor to a suitable range on a good multimeter, i.e. a voltage range of about 5 or 10V f.s.d., and having at least 4,000 Ω /V.

The time in seconds should be noted, required for the initial meter deflection to decrease to one third of its value. Dividing this by the meter resistance for the used range, expressed in M Ω , gives the capacity of the capacitor in μ F. Thus, for example, if a 6V working capacitor is charged to 6V and 110 seconds are needed for the initial meter deflection of 6V to fall to 2V, using the 10V d.c. range of total resistance 40k Ω (0.04M), the capacity is clearly 2,500 μ F. Insulation should be tested in these cases by first touching the charged capacitor on to the meter terminals, long enough to observe the deflection, then disconnecting the capacitor again, and after a time—long compared to the capacity—measurement time, i.e. at least ten minutes—re-connecting and noting that the reading should not have changed appreciably.

The fact that tests on low-voltage high-capacity electrolytics can be performed in this simple manner with an ordinary multimeter explains why no attempt has been made to cover this function on the Auditron, it being thus superfluous there. All the other numerous capacitor test facilities embodied in the Auditron, as described above, are seen, however, to be far more convenient there

than with other arrangements, justifying their incorporation.

Choke-Coil Inductance Measurements

Inductances cause a phase shift in the opposite sense to capacitors thus, when connected between the "LT AC" and "Pots" terminals on the Audiron bridge, they will increase the phase difference between the two points of the bridge diagonal, instead of compensating it to zero as in the case of capacitors at balance.

The criterion here to be used for "balance" is when the phase difference has thereby been augmented to 90°, manifested by an erect or horizontal positioning of the ellipse on the c.r.t.-screen, according to the Y-amplifier gain set. In other words, the ellipse ceases to be oblique. In this condition, a suitable setting of the Y-amplifier gain enables a perfect circle to be produced on the c.r.t.-screen, which is the final true indication of "balance" with a choke.

The only setting of S3 giving a useful range here is position 1, which was for 1 to 30µF and here covers about 1 to 20H. This range of inductance is useful for checking smoothing chokes, audio-output transformers, etc.

Measuring Small Inductances

The bridge-facilities on the Audiron have been designed to cover those capacity and inductance measurements normally required and not conveniently covered by employment of the grid-dip meter mentioned in an earlier article.

All r.f. coils, for anything from long waves down to v.h.f., r.f. chokes, i.f. transformers, etc. should be measured with a grid-dip meter.

Calibrating the Bridge Controls

The bridge controls should be calibrated against capacitors of accurately known values. As standard inductances, a number of chokes and transformers as different as possible should be selected, their total impedance at mains frequency determined by measuring the current they take when connected to a suitable low voltage a.c. supply, and using Ohm's Law. The inductance is then given by the following formula:—

$$Z = \text{Total impedance at 50c/s mains frequency (ohms).}$$

$$L = \frac{\sqrt{Z^2 - R^2}}{314} \text{ Henry}$$

R = d.c. resistance of windings (ohms) (use ohms-range of multimeter).

The voltage calibrations of VR5 and VR6, for test-voltages for low rating capacitors, should be made as follows. For each scale mark desired, the potentiometer resistance needed to give the corresponding voltage with R2 as bleeder from 250V input should be calculated by direct proportion. The multimeter should then be connected between "Pot" and chassis (Audiron disconnected from the mains), and the knob of VR5 or VR6 turned until the desired resistance is noted on the meter. The voltage mark concerned is then made against the pointer position of the potentiometer knob.

Alternatively a valve-voltmeter can be used for direct calibration of the voltage between "Pot"

and chassis when "H.T." and "Pot" terminals are shortened, and the Audiron switched to "bridge". The built-in valve voltmeter can be used for this purpose for the higher range 12V to 100V, but is not sensitive enough for the lower range.

The three bridge terminals on the panel of the Audiron are coloured wander plug sockets of the insulated type. Three miniature insulated crocodile clips with a banana plug at one end and the jaws at the other, made as small integral units (see photograph) were purchased. These can be plugged into the wander plugs, and the test capacitor held between the respective jaws.

A Probe for the Audiron

As mentioned earlier in this series, the Audiron should normally never be used without its specially constructed probe at the signal amplifier input, i.e. only in exceptional circumstances should a signal be fed direct from its source, via a screened or unscreened cable, into the signal-amplifier input.

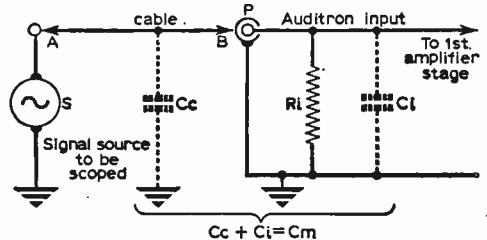

Fig.13: Equivalent circuit showing the stray capacities operative if a signal source is connected directly to the input of an oscilloscope amplifier.

Also no oscilloscope should be operated without its proper test-probe at the signal amplifier input. Probes are generally not exchangeable between various oscilloscopes since these must be carefully balanced to suit the particular signal amplifier with which they are to be used.

Fig. 13 depicts the important aspects of the signal amplifier input circuit if it is attempted to feed in a signal direct, without using a probe. Ri represents the d.c. impedance of the amplifier input, which is 135kΩ in the case of the Audiron. Ci represents the total effective internal stray capacity of the amplifier input, up to and including the coaxial input plug-socket P. The value of Ci is unknown and must be measured in a completed amplifier.

AB represents a length of cable, screened or unscreened, used to connect the signal source to the amplifier input P. Cc represents the stray capacity of the cable to earth. Cc and Ci, acting in parallel, can be lumped together as a single stray capacity, Cm, once it has been decided what length and type of input cable to use.

Two yards of good coaxial cable with a capacity not exceeding about 1 to 2pF per inch can be used for the Audiron signal input. Choose a fairly thin, easily flexible, coaxial cable. With such a cable Cc+Ci (Cm) comes out at around 150pF.

(To be continued)

CLYNE RADIO LTD.



18 TOTTENHAM COURT ROAD, W.1
162 HOLLOWAY ROAD, LONDON, N.7
9 CAMBERWELL CHURCH STREET, S.E.5
10 WITTHY GROVE, MANCHESTER, 4

MUSEum 5929/0095
NORth 6295/67
RODney 2875
Blackfriars 5379

All post orders, etc. to 162 HOLLOWAY ROAD, LONDON, N.7

THE COMPONENT SPECIALISTS

TAPE RECORDER CONSTRUCTORS

LATEST COLLARO STUDIO TAPE TRANSCRIBER. Latest type incorporating Record, Interlock, Lever, Button, 3 motors, 3 speeds, 1, 3, 7 1/2 i.p.s., takes 7in. spools. Push-button controls. **NEW LOW PRICE OF £10.10.0 ONLY!** plus 7/6 P. & P. Usual H.P. facilities.

NEW TAPE RECORDER AMPLIFIER TYPE 8311-V. Sub-assembled—anyone can build! Printed Circuit, all components mounted and dip soldered. Already tested. Each

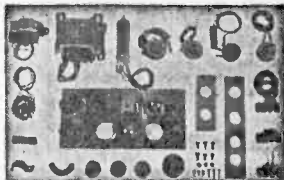

lead cut to length. All that is required to complete the tape recorder for a few components to be mounted in the cabinet and the free ends of the leads soldered to terminals which are clearly marked, everything supplied, all you need is solder iron, pliers and screwdriver. Valve line-up: EF86, ECC83, 2 x EL84, E281 and 6M64 magic eye. Monitoring facilities, output socket for feeding to high quality amplifier, can be used as "straight" amplifier for record reproduction. **EQUALISING ON TWO SPEEDS. OUTSTANDING VALUE AT £11.10.0 plus 2/6 P. & P.** including all necessary instructions.

ATTRACTIVE * TWO-TONE PORTABLE CARRYING CASE. Suitable for above amplifier and Collaro Studio deck. Fitted with 9in. x 5in. High Flux P.M. speaker for high quality reproduction. Inclusive price £5.5.0 plus 5/- P. & P. Full list of competitively priced mics. and stands on request. The above 3 items purchased at one time, SUPPLIED CARR. PAID.

NOW AVAILABLE! FOUR TRACK STUDIO DECK ABOVE, FITTED WITH MARRIOTT HEADS. PRICE £13.19.6 plus 7/6 P. & P. Four track heads supplied separately, complete with mounting bracket for Studio Deck at 84/- pair, plus 2/6 P. & P.

TAPE RECORDER AMPLIFIER 8311-IV. Exactly as 8311-V but four track, suitable for Marriott heads. Price £12.12.0 plus 2/6 P. & P.

N.B. Four-track deck and amplifier fit the above case, without any modification whatsoever.

PRE-AMPLIFIER KIT TYPE 8312-CP. Complete high quality pre-amplifier kit for use with Collaro Studio Deck. Price £8.8.0 plus 2/6 P. & P.

TAPE ! TAPE !

For the first time in this country Canada's Hi Fi Magnetic Recording Tape. Made by "Bel-Clear" of Canada.



Following sizes available, others to follow. Brand New, NOT Sub-standard. High grade Acetate base, attractively boxed, fitted leaders, fully guaranteed.

5in. 600 ft., 12/8; 5in. 900 ft., 15/-; 7in. 1,200 ft., 18/6; 7in. 1,800 ft., 25/-, P. & P. 6d. per spool. 3 or more post free. (Bona fide trade inquiries invited).

SPECIAL AMERICAN MYLAR DUPONT. 5in. 1,200 ft. D.P. Top quality Brand New 25/- post free. Limited quantity only!

PLASTIC TAPE SPOOLS. Best quality, 3in., 1/3, 4in., 2/-, 5in., 2/-, 5in., 2/3, 7in., 2/6, P. & P. 6d. per spool. Orders over £1 post free.

TELEPHONE PICK-UP COIL. Designed to feed into the microphone input of either a tape recorder or any high gain amplifier. Easily attached to telephone by rubber section attachment. The coil is electrostatically shielded to minimise hum pick-up. When positioned on telephone this model is more than adequate for a fully modulated tape recording. Brand new complete with 5 ft. shielded cable. **ONLY 14/- Post free.**

THE NEW "CLYMAX" !!

NEW LOW PRICE MADE POSSIBLE Through Further BULK PURCHASES !!

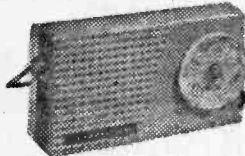

Our 6-transistor pocket size superhet for Medium and Long Wave. All required components. **NOW ONLY 99/6**

Nothing more to buy! Plus 3/6 P. & P.
★ Completely self contained. No external aerial or earth required. ★ Full medium wave coverage, plus switched Light programme on Long Wave. ★ Push-pull output—250 milliwatts. ★ Matched set of latest type Mullard transistors. ★ Genuine 21in. P.M. Speaker. ★ New high-Q Coils. ★ Ferrite rod aerial with high selectivity. ★ Size: 5 1/2 x 3 1/2 x 1 1/2in. Two-tone cabinet. ★ Precision etched printed circuit, with components references clearly marked. Alignment service available. All parts available separately. Full assembly instructions and individually priced parts list. 2/- post free.

The "AIR KING"

Our new highly successful Six transistor luxury portable with the "SLIM LINE" look. To build yourself, with printed circuit chassis for reliability and simplicity in construction. May be used as Car Radio, with full MEDIUM wave and LONG wave coverage. Look at these features!

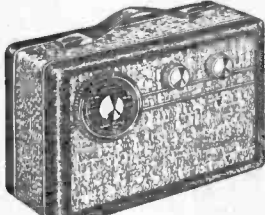

★ 500 milliwatt output to high flux 7 x 3 1/2in. high fidelity loudspeaker. ★ Six selected Mullard Transistors in latest super sensitive circuit, plus germanium diode. ★ Compact size—only 9 1/2 x 3 1/2 x 6 1/2in. (high). ★ Attractive three-tone cabinet. Black, Dark Grey, and Silver Grey, with gilt control knobs and all gilt fittings. ★ Coax socket for car aerial. ★ Brand new guaranteed components. ★ Push pull output. ★ Automatic volume control. ★ Long life battery. ★ Super sensitive internal ferrite rod aerial. ★ Nothing more to buy. Cabinet included. Special inclusive price for **£7.19.6** all required components. Plus P. & P. 4/-

Alignment service available. Full assembly details and individually priced parts list, all of which are available separately, price 1/6, post free.

GENUINE ANNUAL SALE

commences at all branches on January 7th. Callers Only

The "COURTESAN"

Our 3 transistor plus 2 diode pocket receiver with full Medium and Long Wave Coverage.



ONLY 63/- Plus 2/6 P. & P.

★ No external aerial and earth required. ★ Latest 21in.—75 ohm speaker. ★ First grade Mullard transistors. ★ Condenser tuning. ★ Volume control with on/off switch. ★ Easy assembly on pre-tagged circuit board. ★ Attractive red polystyrene cabinet measures 5 1/2 x 3 1/2 x 1 1/2in., chrome handle, attractive gold and black dial. ★ Luxemborg, Hilversum, etc., guaranteed in reception areas. All parts available separately, itemised parts list and full assembly instructions 1/6, post free.

LAST CHANCE TO BUY

The well-known BRAYHEAD TRANS TRONIC "SUPER 60" RADIO KIT.

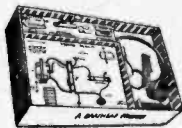

A complete kit to make your own transistorised Transmitter and Receiver. No soldering required. 7 different circuits to build. In original manufacturers coloured box with instructions. Ideal gift for the electronically minded youngster. (As nationally advertised at £5.4.8.)

FEW ONLY AT 49/6 P. & P. 4/-



All parts available separately but if purchased at one time, the whole will be supplied at a special inclusive price of only **£10.19.6** Plus 4/- P. & P.

Parts list and comprehensive instruction booklet 2/6, post free. (Deducted from cost if complete parcel purchased later.)

The "HIGHWAYMAN"

At last a quality Car Radio to build yourself, at an economical price. Look at these features:—

★ Attractive styling. ★ Push-pull output. ★ 3 latest Mullard transistors plus valves type EF86 and ECH83. ★ No Buzz. High Output and sensitivity. ★ Printed circuit (neat type). 7 x 4" High flux p.m. speaker. ★ Medium and Long Waves. ★ Push Buttons for fingertip control. ★ Extremely low Battery consumption (less than 1 amp). ★ Easy to fit any make car (Positive earth only). ★ 12 volt operation. ★ Compact size measures only 7 x 7 x 2" deep. ★ Easy assembly. Supplied with dial and drive already mounted.

MINISETS LTD Hatherley Mews London E17

THE IMPERIA

An easy-to-build 6-Transistor Portable Superhet which can be built by the constructor. Pre-assembled circuit board for easy construction. All components are new. 5in. speaker giving good tone and output. Attractive case of exclusive design 8 1/2 x 5 1/2 x 2 1/2in. with gold-plated grille. Specially designed matching coil for use in car. Only first grade fully guaranteed matched transistors and diodes are used. Anyone can build this set for

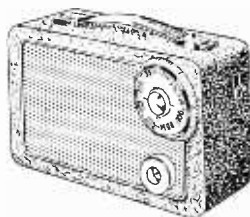

£7.17.0

Everything supplied except soldering iron. P. & P. 3/-. Full instructions 1/6 (free with order).

3-Transistor Radio (plus 2 diodes)

Total building **70/-** P.P. 2/6

- ★ Pre-assembled circuit board, ensuring easy construction.
- ★ Full medium-wave coverage.
- ★ Attractive case 5 1/2 x 3 x 1 1/2in.
- ★ All components including transistors are brand new and direct from manufacturers.
- ★ Ferrite Rod aerial coil, no external aerial or earth required.
- ★ 2 1/2in. high flux speaker direct from manufacturer.
- ★ After-sales service.

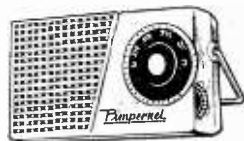

Send 1/6 for instructions, circuit and price list.

6-Stage Transistor Pocket Portable

Can be built for **£4.19.6** P.P. 2/6

- ★ Completely self contained, no aerial or earth required.
- ★ Push-pull output, 250 milliwatts.
- ★ 3in. high flux speaker.
- ★ Pre-assembled circuit board with simple instructions ensuring easy construction.
- ★ High Q Ferrite Rod Aerial.
- ★ After-sales service.



Can be supplied with long-wave 6/- extra. Full instructions, price list 1/6 (Free with order).

THE RIETI

6-Stage super sensitive Transistor Portable. Easy to build. All components first grade. A real portable transistor radio, covering Medium wave reception. 5in. speaker, high Q ferrite aerial especially designed. Pre-assembled circuit board enables the complete set to be assembled and tested before placing in case. Attractive case 8 1/2 x 5 1/2 x 2 1/2in. with gold-plated grille. Total

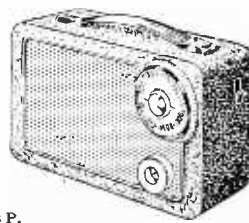

build costs **£5.2.6** P. & P. 3/-.

Medium and Long wave 8/- extra. Full instructions 1/6 (free with order).

The new NOMBREX

TRANSISTORISED WIDE-RANGE SIGNAL GENERATOR 27

220 kc/s to 220 Mc/s



CHECK THESE FEATURES

COMPACT Only 6 1/2" x 4 1/2"

PORTABLE Weight 2 lbs.

ACCURACY Under 2%

ECONOMY 1/2v. Battery

DIRECT Calibration

S.A.E. for full technical leaflet.

H.P. Terms: Send £2 deposit pay balance 2/- per month

RETAIL **£7.10.0** Post and Ins. 3/6 Battery 2/3

36" Screened Test Lead 6/3 extra
CASH WITH ORDER. REGRET NO C.O.D.
IMMEDIATE DELIVERY
Trade and Export Enquiries Invited

NOMBREX LTD. (Instruments Division 45)

Estuary House, Camperdown Terrace, Exmouth, Devon, England. Tel. 3515.

EXPRESS ELECTRONICS ROSEDENE LABORATORIES KINGSWOOD WAY, SELSDON, SURREY

VALVES NEW TESTED AND GUARANTEED FOR THREE MONTHS

1C1	7/6	6BH6	5/8	12AX7	6/9	DH77	6/-	EF91	4/-	PL82	7/-
1C3	8/-	6BJ6	5/9	12BE6	8/6	DH142	8/8	EF92	5/6	PL3	7/6
1P1	8/-	6BK7	8/6	12BH7	10/6	DH130	10/-	FL41	9/6	PY81	6/9
1P3	7/8	6BW3	6/6	12CK11	11/-	DK91	7/6	FL44	7/-	PY82	7/6
1PD1	8/-	6BW7	7/-	12CV7	7/6	DK93	8/-	EM84	10/-	Y35	7/6
1PD9	7/8	6D2	4/-	12SN7	6/-	DL92	5/8	EM55	10/-	R19	10/6
1P1	8/-	6F12	4/-	18A5	9/-	DL94	6/8	EY51	7/6	85A1	9/6
1P10	7/8	6H6GT	2/-	18AQ5	8/8	DL96	8/-	EY81	10/-	U52	7/6
1P11	7/8	6H7GT	7/6	25A6G	7/6	EH91	4/-	EZ40	7/6	U76	7/6
1R5	6/-	6K7J	5/6	25L6GT	7/6	EBC41	10/-	EZ80	8/-	U78	5/-
1S5	6/-	6K8G	8/-	25Z4G	9/-	EF80	8/8	EZ81	8/8	U142	7/6
1T4	2/9	6Q7G	6/6	30C1	7/6	ECC81	6/-	HVR2	9/8	UBC41	8/6
1U5	5/8	6SL7GT	6/-	30L1	7/6	ECC82	6/9	KT38C	6/-	UCH42	9/6
3Q4	8/-	6SN7GT	6/-	35L6GT	7/6	ECC83	6/9	KT66	11/8	UF41	8/6
3S4	8/8	6V6G	7/6	35W4	8/8	ECC84	7/8	N17	5/8	UL41	8/6
3V4	6/8	6X4	5/-	35Z4GT	6/-	ECP80	8/8	N18	8/-	UY41	7/6
5Y3GT	5/-	6X5G	5/8	5763	7/6	ECP82	8/-	N19	7/8	W17	7/6
5Z4G	7/8	787	9/8	80	6/-	ECH42	9/-	N709	7/-	W76	4/6
6AK6	6/8	8D3	4/-	DAP91	7/8	ECH81	10/-	PCC84	7/8	W142	8/6
6AL5	4/-	8D7	9/8	DAP96	8/-	ECL80	8/8	PCF80	7/8	X17	7/6
6AM6	4/-	12AD6	11/8	12C30	12/8	ECL82	9/-	PCF82	7/8	X142	9/-
6AT6	6/-	12AH8	10/-	DF91	8/-	EF41	9/-	PCL82	8/-	X160	9/-
6BA6	5/-	12AT7	6/-	DF96	8/-	EF80	8/-	PCL84	9/-	Z77	4/-
6BE6	7/-	12A7	6/-	DH76	7/8	EF86	9/-	PL81	12/8	ZD17	7/6

High Stability Resistors 1W 5% 50 Ohm to 1M, 9d. Midgat Ceramics 500 v. 9d. Coax. Super quality jin, 6d. yd. Plugs 9d. Sockets 8d. Silicon H.T. Rects. 250v. 800 MA jin. x jin. 8/6. Contact Cooled 250v. 50 MA 6/8. 85 MA 8/6.

NEW TRANSISTORS BY MULLARD, OC19, OC26, OC66, 25/-; OC44, OC45, 8/-; OC70, OC71, 6/-; OC72, 7/6; OC72 matched in pra. 18/-; OC74, OC75, OC78, OC81, 7/6; OC82, OC170, 9/6.

VALVES MATCHED IN PAIRS

EL34 27/6, EL84 18/-, N709 15/-, 6V6G 15/-, 6BW6 14/- per pair. Push-Pull O.P. Transformer for above 3-15 Ohm 14/8, P. & P. 1/6. 12in. P.M. Speakers 3 Ohm 24/6. Baker's "Solihurst" 12in. 15 Ohm 15W, 80/- 12in. Stereo Model, 27/6.

SETS OF VALVES
DK91, DP91, DAF91, DL92 or DL94, 19/6
DK96, DF96, DAF96, DL96, 27/6
1C3, 1P1, 1FD1, 1P1, 27/6
1R5, 1T4, 1S5, 384, or 3V4, 19/6
Postage and packing 6d. Over £1 post free. C.O.D. 2/6.

T N

rade ews

NEW STYLED HI-FI CABINET

A NEW radiogram cabinet has just been brought on to the market by G.K.D. Limited and which has been specifically designed to house Leak hi-fi units.

G.K.D. have called this new cabinet the "Southdown" and have managed to combine good styling and compactness with generous space allowance for any combination of Leak equipment. This has been achieved by incorporating a spring-loaded drawer which, when opened, reveals a panel for mounting tuner or pre-amplifier units.

The manufacturers are *G.K.D. Limited, King Street, Houghton Regis, Bedfordshire.*



(Above) The new radiogram cabinet from G.K.D. Ltd.

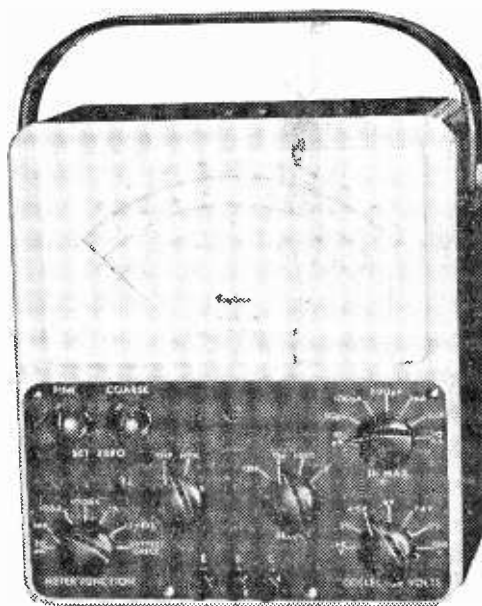

This new transistor tester is made by Taylor Ltd.

TRANSISTOR TESTER

A NEW transistor tester—model 44—is announced by Taylor Electrical Instruments Ltd. This portable tester is capable of measuring accurately the characteristics and performance of modern transistors.

Several new features have been introduced in this model, including facilities for varying the collector voltage, base current and collector current independently.

The tester is made by *Taylor Electrical Instruments Ltd., Montrose Avenue, Slough, Buckinghamshire.*

SWEEP GENERATOR

A NEW sweep generator is now available covering a wide spectrum of r.f. frequencies with a sweep width over its entire range. The new instrument, model SP-1200, manufactured by Telonic Industries Inc. (U.S.A.), has a centre frequency range of 5Mc/s to 1,200Mc/s and a sweep width also 5 to 1,200Mc/s.

The English agents for Telonic equipment are *Livingston Laboratories Ltd., 31 Camden Road, London, N.W.1.*

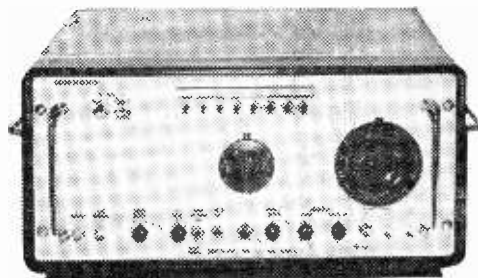

(Right) Telonic's new sweep generator.

Club News

REPORTS OF CURRENT ACTIVITIES

AMATEUR RADIO SOCIETY OF CHESHAM AND DISTRICT

Hon. Sec.: Capt. C. G. Stephenson, G3CLJ/T, 21 Lynton Road, Chesham, Buckinghamshire.

Each Tuesday evening morse, first aid, practical construction and other subjects are taught and on Fridays the Society arranges RAE theory lectures. Sunday meetings are devoted to practical operating.

At the recent Annual General Meeting it was disclosed that the Society's membership had increased 600%.

BRIDLINGTON AMATEUR RADIO SOCIETY

Hon. Sec.: P. Cartwright, G3P0C, 55 Hermitage Road, Bridlington, East Yorkshire.

This Society has recently moved into new premises in the centre of the town in North Street. Any persons interested in becoming a member would be most welcome.

On Wednesday evening the Society runs morse classes for those wishing to gain experience in this subject.

Arrangements are already going ahead for another mobile rally to be held in June.

BURTON-ON-TRENT AND DISTRICT RADIO SOCIETY

Hon. Sec.: H. Harrison, 38 Baker Street, Burton-upon-Trent, Staffordshire.

Lectures have been arranged for members on the first Wednesday of each month, and on December 5th an RAE lecture was given.

The meeting on December 12th was devoted to a film show.

CITY OF BELFAST Y.M.C.A. RADIO CLUB

Hon. Sec.: R. H. Payne, 25 Arundel Street, Belfast 12.

The club meets every Wednesday and Saturday and a varied programme of lectures and visits has been arranged. There are also constructional facilities available to members.

A slide show and Christmas party was enjoyed by all who attended on December 19th.

CLIFTON AMATEUR RADIO SOCIETY

Hon. Sec.: C. E. Godsmark, 211 Manwood Road, London, S.E.4.

The annual Constructional Contest was held on December 14th at the clubrooms.

The 1.9Mc/s net on Christmas morning was controlled by G3GHN, the club station.

COVENTRY AMATEUR RADIO SOCIETY

Hon. Sec.: A. J. Wilkes, G3PQQ, 141 Overslade Crescent, Coundon, Coventry.

This Society is now settled at its new headquarters and the newly purchased 150W transmitter is also installed.

DERBY AND DISTRICT AMATEUR RADIO SOCIETY

Hon. Sec.: F. C. Ward, G2CVV, 5 Uplands Avenue, Littleover, Derby.

Probably the most enjoyable meeting for many members was the Christmas Party held on December 19th. There were no more meetings for December but a club net on 160m was operated on Christmas Eve and New Year's Eve.

The first meeting in the New Year was held on January 2nd, and was a surplus sale.

LOTHIANS RADIO SOCIETY

Hon. Sec.: W. T. Sutherland, GN3JWS, 47 Great King Street, Edinburgh 3.

On December 13th members attended an R.S.G.B. tape recorded lecture on "World Wide Telecommunications".

Later in the month, on the 27th, members enjoyed a "Social evening".

MITCHAM AND DISTRICT RADIO SOCIETY

Hon. Sec.: B. Blandford, 1 Biggin Avenue, Mitcham, Surrey.

A very successful Christmas Meeting was held on December 14th. A Christmas Draw was arranged with many inviting prizes.

During the evening judging for the annual Constructional Contest took place and the Society trophies were presented.

PLYMOUTH RADIO CLUB

Hon. Sec.: R. Hooper, 2 Chestnut Road, Peverell, Plymouth, Devon.

In the recent competition for the "Ernie Hillyard" trophy, the winner was judged to be Colin Jones with his radio teletype converter. Second was John Fallen with a stereo amplifier, and third was Ted Fallen with a grid dip oscillator.

A party of members attended the opening night of the Torbay Radio Club on Saturday, December 9th.

Future Event:

January 19th—Dinner and social evening.

"CORONATION STREET OR CQ.ZL..."

THE radio ham, perhaps more than any other hobbyist, needs to belong to a club to attain full enjoyment of his chosen pastime. To be a lone-wolf will not do, for the very act of listening or transmitting—which, after all, must be considered the fulfilment of whatever else he may decide is intimated in the title of "radio ham"—brings him into immediate contact with his fellow enthusiasts.

Yet in spite of this undeniable fact, the PRACTICAL WIRELESS offices receive many letters from readers who obviously do not belong to a radio club and whose particular problem could be solved simply by joining such a society.

For instance, we receive many queries about ex-government sets and, as most readers will know, information about this equipment is very hard to come by. In fact most information originates with the more ambitious enthusiasts who are prepared to service such equipment "blind". And where do these individuals gather and compare notes?—in the radio clubs of course, and it is in these clubs therefore, that the most comprehensive data on ex-government sets is to be found (except in government records, that is).

The radio clubs also offer unrivalled opportunities for instruction on the practical side of operating as a licensed amateur, and this is very important for any potential ham. Also important are the number of social events that take place from time-to-time, not to mention rallies, d.f. contests, lectures, construction competitions, etc., etc.

This time of the year is the busiest for all amateurs whether on the air or at the workbench, and so the choice is yours, "Coronation Street" or "CQ. ZL . . .", but for those who do not belong to a radio society, we would suggest that you seriously consider joining your local club, if only for the ragchews and film shows! There are many clubs listed on this page and most secretaries will be pleased to give you details of their activities and also extend a welcome to go along to the next meeting to see "just what goes on".

SURBITON PARK RADIO LTD.

FOR POST HASTE—POST FREE SERVICE

MARTIN RECORDAKITS

HALF TRACK

B.S.R. TD2 Monardeck, latest model 5 1/2 in. spool	\$9.90
Deposit \$1.0.0 and 9 monthly	\$11.0
Tape Amplifier for B.S.R. deck, printed circuit ready wired, with ECC83, ECL82, EM85 and EZ81. Complete with all plugs, sockets, panels, knobs, etc. The whole amplifier mounts onto the deck, making a self-contained unit.....	\$8.8.0
Deposit \$1.0.0 and 9 monthly	\$11.0
Case with 7 in. x 4 in. speaker, in two tone grey.....	\$4.4.0
Complete Kit as above.....	\$22.0.0
Deposit \$2.4.0 and 12 monthly	\$11.6.6
The above recorder can be supplied assembled, tested and complete with tape and microphone for.....	\$25.0.0
Deposit \$2.10.0 and 12 monthly	\$2.1.6
Collaro Studio Deck. Very latest model 3 speeds 7 in. spools.....	\$12.10.0
Deposit \$1.5.0 and 12 monthly	\$11.0.8
Tape Amplifier for studio deck, with ready wired printed circuit control and input panels, mains and output transformers. Complete with valves, knobs, plans, screws, etc. EF86, ECC83, EM84, EZ81, OA81 and 2 EL84, 3 watts output. Magic eye, radio and mic. inputs, EX L/8 socket, tone and monitor controls. Can be used as an amplifier.....	\$11.11.0
Deposit \$1.4.0 and 12 monthly	19/-
Case for above including 9 in. x 5 in. speaker.....	\$5.5.0
Total Kit as above.....	\$29.0.0
Deposit \$2.18.0 and 12 monthly	\$2.8.2
We can offer the above recorder, complete with tape and microphone, in a De Luxe two tone grey cabinet, assembled for.....	\$35.0.0
Deposit \$3.10.0 and 12 monthly	\$2.18.2

This Machine is listed at 39 rns. by makers and is a very good buy. Building Instructions available at 2/6 each kit (refunded if kit bought)

QUARTER TRACK

B.S.R. TD2	\$11.11.0
Deposit \$1.4.0 and 12 monthly.....	19/-
Tape Amplifier as over, but quarter track.....	\$9.9.0
Deposit \$1.0.0 and 9 monthly	\$11.0
Case, two tone grey, with speaker.....	\$4.4.0
Complete Kit as above.....	\$25.0.0
Deposit \$2.10.0 and 12 monthly	\$2.1.6
Collaro Studio Deck, 4 track.....	\$17.17.0
Deposit \$1.18.0 and 12 monthly	\$1.9.5
Tape Amplifier, as over, but 4 track.....	\$12.12.0
Deposit \$1.7.0 and 12 monthly	\$1.0.8
Case with 9 in. x 5 in. speaker.....	\$5.5.0
Complete Kit 4 track Collaro.....	\$35.0.0
Deposit \$3.10.0 and 12 monthly	\$2.18.2
Tape Pre-amplifier for Collaro deck, with power supplies, ECC83, ECL82, EZ80 and EM85. Radio and Mic. sockets, gives an equalised output of 400 mV/ohms.....	\$11.0
Half Track	\$8.8.0
Deposit \$1.0.0 and 8 monthly.....	\$1.1.0
Quarter Track	\$9.9.0
Deposit \$1.0.0 and 9 monthly.....	\$11.0
Marriott Tape Heads, 4 track type L/R/PS/7 and L/ES/9 Record/Playback and Erase with mounting bracket for Studio deck.....	\$4.4.0
Pair Complete (Marriott list price is \$2.14.0).....	\$1.7.8
Marriott 2 track type R/R/P/1 Record/Playback only with bracket for Studio deck. Has 3rd head.....	8/6
Pressure pad (Studio deck only).....	\$29.8.0
Brenell Mk. 5 deck, 4 track, 4 speeds	\$2.8.7
Deposit \$3.1.6 and 12 monthly	\$24.0.0
Brenell Mk. 5 Amplifier, with power.....	\$1.19.10
Deposit \$2.8.0 and 12 monthly.....	\$1.19.10

JASON F.M. TUNERS

FMT1, complete with valves	\$6.17.6
Deposit \$1.1.0 and 6 monthly	\$1.2.9
FMT2, complete with valves, Less Power	\$7.17.6
Deposit \$1.0.0 and 7 monthly	\$1.2.5
FMT2, complete with valves, Self powered	\$9.15.0
Deposit \$1.0.0 and 9 monthly	\$1.1.8
FMT3, complete with valves, Less Power	\$9.12.6
Deposit \$1.0.6 and 9 monthly	\$1.1.4
FMT3, complete with valves, Self powered.....	\$12.0.0
Deposit \$1.8.0 and 12 monthly	19/10
Power pack kit ready drilled chassis for FMT1, etc. The instruction books are included in all kits but are otherwise 2/6.	\$2.12.6
JTV/2, switched F.M. and TV. Sound self powered. All valves.....	\$14.15.0
Deposit \$1.9.6 and 12 monthly	\$1.4.5
Mercury 2 as JTV/2 but less power, with all valves.....	\$10.15.0
Deposit \$1.1.6 and 12 monthly	17/10

The instruction book is again included but is otherwise 3/6 each. All the above units are available ready built and signed. Price on request.

RADIO TUNERS

Armstrong T4 C. V.H.F. Tuner, self powered.....	\$19.19.0
Deposit \$2.8.6 and 12 monthly.....	\$1.12.9
Armstrong ST3 Mk. 2, AM/FM Tuner, self powered.....	\$27.16.0
Deposit \$2.16.6 and 12 monthly	\$2.6.1
Armstrong AF208 AM/FM Radio chassis, Beam and Treble controls, P.U. inputs, etc.....	\$22.18.0
Deposit \$2.8.6 and 12 monthly	\$1.17.9
Armstrong Jubilee Mk. 2, AM/FM with Push-pull output.....	\$30.12.0
Deposit \$3.3.0 and 12 monthly	\$2.10.8
Armstrong Stereo 55 AM/FM Radio Chassis, Separate tone and volume controls.....	\$32.15.0
Armstrong Stereo 12, Mk. 2, AM/FM Radio chassis, Push-pull output stage, both channels	\$43.10.0
Deposit \$4.7.0 and 12 monthly	\$3.12.4
Brass dial escutcheon is available for AF208 and Jubilee.....	7/6
Quad, F.M. Tuner.....	\$28.1.9
Deposit \$2.17.9 and 12 monthly.....	\$2.5.6

AMPLIFIERS (MONO)

Linear L45 Three valve amplifier	\$5.19.6
Linear Dionian Five valve. Push-pull	\$12.12.0
Deposit \$1.7.0 and 12 monthly	\$1.0.8
Dulci DPA15 Main amplifier, Five valve, Push-pull.....	\$15.15.0
Deposit \$1.11.6 and 12 monthly	\$1.6.1
Dulci DPA15 Pre-Amplifier, suitable magnetic pickups.....	\$9.9.0
Deposit \$1.0.0 and 9 monthly	\$1.1.0
Leak TL12 Main amplifier only	\$18.18.0
Deposit \$2.0.6 and 12 monthly	\$1.11.1
Leak Variatone Pre-amplifier	\$15.15.0
Deposit \$1.11.6 and 12 monthly	\$1.6.1
Quad Main amplifier	\$22.10.0
Deposit \$2.5.0 and 12 monthly	\$1.17.4

AMPLIFIERS (STEREO)

Dulci AC202, Integrated.....	\$12.12.0
Deposit \$1.7.0 and 12 monthly.....	\$1.0.6
Dulci GA505, Integrated.....	\$18.18.0
Deposit \$2.0.6 and 12 monthly	\$1.11.1
Dulci Stereo Five, Pre amplifier	\$11.11.0
Deposit \$1.4.0 and 12 monthly	19/-
Leak Stereo 20, Main amplifier.....	\$30.9.0
Deposit \$3.4.6 and 12 monthly	\$2.10.8
Leak Variatone Stereo Pre-amplifier.....	\$25.0.0
Deposit \$2.10.0 and 12 monthly	\$2.1.6
Quad 22 Stereo Control Unit.....	\$25.0.0
Deposit \$2.10.0 and 12 monthly.....	\$2.1.6

GRAMOPHONE UNITS

B.S.R. UA 14 TCS/H	\$7.15.0
Deposit \$1.0.0 and 7 monthly	\$1.2.3
Garrard TP A12 arm and shell less cartridge.....	\$4.11.9
Garrard Autolium with mono cartridge.....	\$8.14.6
Deposit \$1.1.0 and 8 monthly	\$1.1.9
Garrard Autolium De Luxe with mono cartridge.....	\$12.14.
Deposit \$1.5.6 and 12 monthly	\$1.1.1
Phillips AG1018 with stereo cartridge	\$12.12.0
Deposit \$1.10.0 and 12 monthly	\$1.2.4
Connoisseur Craftsman	\$18.3.0
Deposit \$1.19.8 and 12 monthly	\$1.9.10
Golding Lenco GL 58, less cartridge	\$17.15.5
Deposit \$1.5.11 and 12 monthly	\$1.9.5
Garrard 4HF with mono cartridge	\$18.19.0
Deposit \$2.1.6 and 12 monthly	\$1.11.1
Garrard Lab., Type "A" with mono cartridge	\$21.18.0
Deposit \$2.7.4 and 12 monthly	\$1.16.1
Garrard 301	\$22.18.3
Deposit \$2.8.9 and 12 monthly	\$1.17.9
Garrard 301 Strobe	\$24.10.3
Deposit \$2.9.0 and 12 monthly	\$2.0.8

LOUDSPEAKERS

Goodmans Ariette 8	\$5.17.0
Axiom 10	\$7.0.0
Axiom 201	\$10.7.0
Deposit \$1.1.0 and 8 monthly	\$1.5.9
5K/20XL	\$7.0.0
Wharfedale Super 8/FS/AL	\$6.9.11
Super 3	\$6.9.11
RS12/DD	\$11.10.0
Deposit \$1.7.6 and 9 monthly	\$1.4.9

48 SURBITON ROAD, KINGSTON-UPON-THAMES, SURREY

Established over 30 Years

Telephone KIN 5549

We pay all postage and insurance. All orders despatched same day. Money refund guarantee.
Hours: 9 a.m.—6 p.m. (1 p.m. Wednesday). We do not close for lunch. Open all day Saturday.

Letters to the Editor

The Editor does not necessarily agree with the opinions expressed by his correspondents

Whilst we are always pleased to assist readers with their technical difficulties, we regret that we are unable to supply diagrams or provide instructions for modifying commercial or surplus equipment. We cannot supply alternative details for receivers described in these pages. **WE CANNOT UNDERTAKE TO ANSWER QUERIES OVER THE TELEPHONE.** If a postal reply is required a stamped and addressed envelope must be enclosed with the coupon from page iii of the cover.

SAVE OUR STYLUS?

SIR,—In reply to Mr. Davenport's letter in the December issue, may I respectfully suggest that if he were to study microphotographs of record grooves, he would soon realise the serious damage caused by the dirt and dust which adheres to fingermarks on a long playing record. This dirt not only causes excessive surface noise on a light-weight pick-up, which has been specially designed to give the highest quality with the lowest record wear, but also damages the stylus. This in turn deforms the grooves of every record which is afterwards played by it, therefore causing over £50 of unnecessary damage to even a modest collection of 30 records.

If Mr. Davenport cannot tell the difference in quality between the average "3W-or-bust" record player with a cheap multi-purpose 5in. loud-speaker, and a 30W hi-fi stereo system whose tweeters and bass reflexes alone can do credit to frequencies ranging from cascading strings down to a deep organ diapason, then I am afraid that he is missing a great deal of enjoyment and pleasure indeed. — J. D. MAITLAND (Preston, Lancashire).

SIR,—In answer to Mr. Davenport's letter in the December issue, I would have thought that, although he is obviously not an hi-fi enthusiast, he would not have condemned his friend's disc and stylus cleaning activities. In addition to the effect of dust on the quality of reproduction obtained, it can also be very damaging to the surfaces of modern microgroove records, and the expense of 30s. or £2 for replacing records carelessly damaged in this way is, in my opinion, considerable.—D. L. MILLER (Plymouth, Devon).

HI-FI FANATICS

SIR,—How right your correspondent D. R. Davenport is to criticise these self-styled hi-fi fanatics.

From such contact as I have had with these people, I am convinced that it is not an appreciation of music that drives them to buy expensive record reproducing equipment, but rather a very juvenile type of pleasure in showing off audio set-ups to friends. Their wariness of people touching their records and equipment I am sure arises from nothing more than a desire to reserve the pleasures and mysteries of hi-fi for selective cliques.

Recording and equipment manufacturers must bless this gullible section of the public who so readily buy their products, just so long as they can impress their friends with "frequency response", "rumble filters", "negative feedback tone circuits" and all the other little non-committal technical terms which clever salesmanship dictates shall be tagged to these products.—N. L. NICHOLLS (Northampton).

THE QUANTUM THEORY

SIR,—With reference to Mr. Robbins' letter in the October issue, I suggest that he, as well as Mr. Craske has misconstrued the Quantum theory entirely.

Mr. Robbins' statement that photon simultaneously exhibits wave and particle properties is entirely erroneous. The term photon, from the Greek meaning "light", came into general use around 1928. It is frequently regarded as synonymous with energy quantum, but is strictly the quantity, or quantum of radiation associated with a single quantum of energy. It may in fact be described as an "atom" or "particle" of radiation. By Max Plank's equation, a photon of radiation of frequency, ν , carries an amount $h\nu$, of energy: h being the Plank constant.

Also, the wave and particle conceptions are not as Mr. Robbins states, analogies used to explain certain phenomena. They are in fact fundamental characteristics of nature. The diffraction and interference properties of radiation necessitate a wave structure, whereas photo-electric phenomena and the Compton Effect imply that radiation consists of particles.

The fact is that everything exhibits wave character or particle character depending on the circumstances. But as such, they do not exhibit simultaneously, as shown by Heisenberg's "Uncertainty Principle".

Electromagnetic radiation is definitely a wave motion, covering the enormous range from about 10^{-10} cm for Gamma rays to 10^6 cm for the longest known radio waves. These radiations are fundamentally the same, all travelling at the speed of light, differing only in their wavelength. Also their energy content is calculated by the Quantum theory: the energy Quantum being proportional to the frequency.

Further by means of Plank's constant and the mass-energy equations of Albert Einstein, DeBroglie showed that a particle of mass M , moving with a velocity V , is associated with a

wavelength λ , given by $\lambda = \frac{h}{MV}$; where h is the

Plank constant. Therefore wave-particle duality of matter, is an inherent concept of nature.

SENSATIONAL NEW 1963 DESIGNS — BY CONCORD

LOW PRICES ★ PICTORIAL STEP-BY-STEP PLANS ★ EASY AS A.B.C.

THE NEW "VOLKS RADIO" ONLY 19/6

TAKE-OVER BID MAKES THIS FANTASTIC OFFER POSSIBLE—the beautifully compact "5-STAR VOLKS RADIO" measuring 4 1/2 x 2 1/2 x 1 1/2 in. receives perfectly—in the Bedroom, Office, Garden—over all medium waves (incl. Luxembourg). Under 1d. hour running cost. ANYONE can assemble it in one or two hours using our simple A.B.C. plan. Complete set of parts ONLY 19/6, plus 2/6 P. & P. (C.O.D. extra. (Parts can be bought separately.) Money Back Guarantee.



NO EARTH OR AERIAL REQUIRED

ALL TRANSISTOR RADIO

ONLY 37/6
THE COSTA BRAVA

Revolutionary INTERNAL FERRITE AERIAL Makes this sensational pocket-size radio the best money-saving bargain of all time. Powerful, superb tone and clarity, ensures perfect reception for all your favourite programmes

Completely portable, only 5 1/2 x 3 x 1 1/2 in. Two-tone case. Anyone can assemble with our simple PRINTED CIRCUIT PLAN. Send 37/6, plus 2/6 P. & P. (C.O.D. 2/- extra). Satisfaction guaranteed. (All parts available separately).

FREE HIGH SENSITIVITY HIDE-AWAY EAR-PIECE GIVEN WITH EACH SET.

"OUR NEW 4-STAGE MINUETTE"

Build this newly-designed "MINUETTE" 4-STAGE transistor set in very strong ready drilled ULTRA-MODERN CASE, size only 6 x 2 1/2 x 1 1/2 in. Uses three transistors and diode and SELF-CONTAINED LOUDSPEAKER. Very sensitive, ideal for office, bedroom, holidays, etc. Months and months of listening off a 1 1/2 battery. Can be built FOR ONLY 39/6, including PROPER CASE, miniature speaker, etc. SIMPLE AS A.B.C. PICTORIAL STEP-BY-STEP PLANS etc., plus post and packing 1/6 (C.O.D. 2/- extra). Parts sold separately, priced parts list 1/-.

39/6

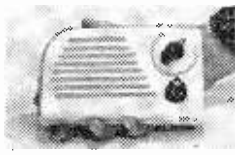

THE MINUTE TRANSISTOR RADIO

MIAMI ONLY 32/6



Unbelievably small—Outrageously cheap! You will be amazed at the fine quality of tone and volume of this great little radio. Only a fantastic 3 1/2 x 2 1/2 x 1 1/2 in. the MIAMI will bring you great entertainment for months on a 1 1/2 battery. Simple assembly plan with each set. ONLY 32/6. YES 32/6.

Plus 2/6 P. & P. (C.O.D. 2/- extra). Satisfaction Guaranteed. Demonstrations given daily. Parts available separately if required.

THE NEW "COSTA BRAVA" 49/6

NO EARTH or AERIAL REQUIRED
ALL TRANSISTOR RADIO



Revolutionary INTERNAL FERRITE AERIAL and moving coil speaker makes this sensational pocket-size radio the best money-saving bargain of all time. Powerful, superb tone and clarity, ensures perfect reception for all your favourite programmes. Completely portable, only 5 1/2 x 3 x 1 1/2 in. Two-tone case. Anyone can assemble with our simple PRINTED CIRCUIT PLAN. Send 49/6, plus 2/6 P. & P. (C.O.D. 2/- extra). Satisfaction Guaranteed. (All parts available separately).

FREE HIGH SENSITIVITY HIDE-AWAY EAR-PIECE GIVEN WITH EACH SET.

THE NEW "LISBON" TRANSISTOR SET 19/6

This is a pocket 2-stage transistor set not much larger than a matchbox. Excellent clear reception covering all medium waves, works for months off a tiny 1 1/2 or 3 volt battery costing only 8d. Easy to build and an excellent introduction to transistor circuitry. Everything can be supplied down to the last nut and bolt incl. SIMPLE PICTORIAL STEP-BY-STEP PLANS FOR ONLY 19/6, plus post and packing 1/6. (C.O.D. 2/- extra). Parts sold separately, priced parts list 1/-.



THE RINGO BURGALAR ALARM CLEARANCE SALE!



BIG PROFITS FOR YOU IF YOU BUY NOW! Made to retail at 7 gns. you can now buy this famous Twin-gong Alarm for only 37/6—but only if you act now... stocks are strictly limited. Easily installed and operated. Switches on or off at any time. Fantastic FINAL reduction to clear 37/6 (minimum order of 3) Carr. Free. Free literature sent with each alarm.

SELL SAFETY TO THE MOTORIST



Bulk purchase of bankrupt stock ensures this fabulous money-making offer.

AUTOMATIC CIGARETTE LIGHTER

Instantly provides ready lit cigarette, without the driver taking his eyes from the road. Heavily chromium plated case holds 10. Easily and simply fitted to any car's dashboard. Works off 6 or 12 volts. Retail Price 44/6. Special Clearance offer only 12/6 each. sold in minimum lots of 6. Carriage free.

THE NEW "SAN REMO" 6 STAR 32/6

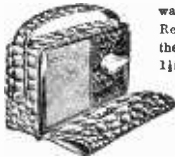

This All Transistor Speaker Radio—the "San Remo" 6 Star covers all medium waves including "Home," "Light," etc. Reliable and lightweight—Slips easily into the Pocket or Handbag—size only 4 1/2 x 2 1/2 x 1 1/2 in. Works for Months off 1 1/2 Battery! Ideal for holidays, Camping, Bedroom, etc. Anyone can assemble it in an hour or two with our simple-as-ABC PLAN! Complete set of parts including miniature speaker—everything—only 32/6, plus 2/6

P. & P. (C.O.D. 2/- extra). Parts can be bought separately.

Cheques accepted. Cash on delivery 2/- extra. Please print name and address in block letters. Suppliers to Schools, Universities, Government and Research Establishments. Complete range of components and values stocked. Regret no C.O.D. abroad. DEMONSTRATIONS DAILY AT WORKS.

CONCORD ELECTRONICS

(DEPT. 14/11) 210 CHURCH ROAD, HOVE, SUSSEX

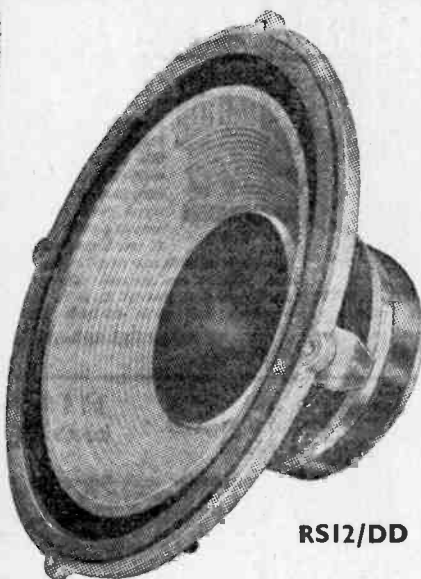

RS12/DD

**A 12" SPEAKER
for the HOME CONSTRUCTOR**

A fine 12" Speaker employing a new type of double diaphragm and magnet assembly, the RS12/DD has been designed with the home constructor in mind—it is one of the few 12" models suitable for use in compact enclosures enabling a really high quality system to be assembled at a modest price.

Some important features of the RS12/DD—

- Very low bass resonance
- Synthetic Centring Device
- Ceramic Magnet
- Die-cast Chassis
- Foam edge Damping
- One-piece HF Flare Dome
- Airtight impregnated Roll Surround

£11.10.0 TAX FREE



Complete the coupon! for technical specification of the RS12/DD including Constructional details of suitable cabinets.

Post to Wharfedale Wireless Works Ltd.,
Idle, Bradford, Yorkshire.

SLIM CRYSTAL 3-way MICROPHONE

- ★ Hand held.
- ★ Stand mounted.
- or
- ★ Suspended by lavalier cord.

MODEL 100C 39/6 Post Free

Check the spec. and judge for yourself. Response 60-10,000 cps. Built-in ON-OFF Switch. Output Level—52 dB. Omni-directional. Termination above 500 K ohms.

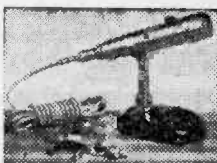

Satin Chrome Finish. Accessory Table Top Stand, 8/6.

HANDY INTERPHONE

For Home, Workshop, Office, two-way calling. Consumes current only when talking or calling. Housed in attractive plastic cabinets with chrome stands. Completely portable. Master and sub-station. Replacement battery only 2/6. Today's value 8 gns.

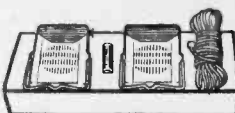

MAILPLAN PRICE

89/6 Inc. PP3 battery, and 25 yds. lead with plugs. P. & P. 3/-.

SKANTEST—THE LOWEST PRICED L.O.P.T. TESTER

Tests TV Windings for shorting turns by unique pulse method. This compact instrument can save you pounds. It detects a single shorting turn in a line output transformer, deflector coil or other Windings. The pulses provided by the instrument detect intermittent faults. In position one, the continuity of the Windings is checked; in position two, high impedance coils, and in position three, low impedance coils. Once you have used the Skantest you will regard it as a must in TV Servicing.

Exclusive Mailplan Offer 99/6 P. & P. 2/9

MAILPLAN Dept. P.W. 138 Lewisham Way, New Cross, London, SE14 (TID 6667)

R-107 POWER UNITS. A complete sub-chassis from the R-107 set. Operates from AC mains 110/200-250 and can also be used from a 12v car battery. Output 250v HT and 12v LT. Ideal for 52 set (Instructions and resistor supplied). Complete with circuit input plugs, 6X5G sect. and vibrator. Unused, tested and in original cartons. 45/- carr. 5/-

R-107 R.F. UNIT. As well as a replacement front end for the R-107 this unit will make a good front end for a home constructed receiver. The RF. mixer and oscillator coils with the associated tuning condenser, dial and dual ratio drive covers 1.2 Mc/s to 17.5 Mc/s in 3 wavebands. IF output is 465 Kc/s. Less valves with circuit. New and unused. Real bargain. 35/- carr. 5/-.

SILICON RECTIFIERS. Type 1EA2 (1 x 1in.) will handle 250 volts at up to 500 mA. Replaces any TV metal rectifier. 7/6.

H.O. RECEIVERS—SENIOR MODEL M.X. Complete with 9 coils from 50 Kc/s—30 Mc/s. A superb communications receiver. Guaranteed in brand new condition, £25, carr. 30/- POWER UNIT 5/6, extra carr. 5/6.

AVO L. C. & R. BRIDGE. Capacity 5 pfd. to 50 mfd. Resistance 5 Ω to 50 Ω. Inductance can be measured against external standard. Balance is indicated on a meter which can be used as a valve voltmeter from 0.1 to 15 v. Leakage test and Power Factor scale. A.C. mains operation. Tested and guaranteed and in superlative condition £9.10.0, plus 5/- P. & P.

PCR COMMUNICATIONS RECEIVER

Type PCR-1. self contained speaker. Covers 850-2000, 200-550 and 19-50 metres. AS NEW CONDITION. £6.19.6

Type PCR-2. Requires external speaker. Covers 850-2000, 200-500 and 19-50 metres. USED (Good condition). £5.19.6

Type PCR-3. Requires external speaker. Covers 200 to 550, 120 to 43 and 49 to 13 metres. Used (Good condition). £8.8.0

Carriage (any type) 10/6. Full details S.A.E. Any model fitted with BRAND NEW INTERNAL POWER SUPPLY, guaranteed ready for use on A.C. mains, £2 extra.

AERIAL KITS. Comprising seven 4ft. aerial rods which will make a 16ft. and a 12ft. aerial. There is also an aerial base with a ground spike. All contained in a steel carrying tube with web strap. 22/6 plus 4/- carr.

WESTON ANALYSER (MODEL 772 TYPE 6 (U.S.A.)), A.C./D.C. VOLTS 0-2.5, 10, 60, 250, & 1000. D.C. CURRENT 0-100μA 1mA, 10mA, 50mA, 250mA, 1A, & 10A. OHMS 0-30M Ω (in 4 ranges). SENSITIVITY 20,000Ω/volt or 1000Ω/volt by selector switch. Provision for use as output meter (dB). In handsome oak carrying case 14 x 8 1/2 x 5 1/2in. Complete with leads, batteries and instructions. FULLY GUARANTEED £7.10.0. P. & P. 5/-.

CHARLES BRITAIN (RADIO) LTD.

11 Upper Saint Martins Lane, London, W.C.2

TEMPLE Bar 0545.

Shop Hours 9-6 p.m. (9-1 p.m. Thursday).
Open all day Saturday.

NAME _____

ADDRESS _____

PW

Questions and answers for budding engineers

Q. What age should I be for this advertisement to concern me?

A. Around 16 to 19 if you want to join Electricity Supply from school. If you're an engineering graduate, or diploma-holder, you'll probably be in your early twenties. (Older, if you're a parent or teacher!)

Q. Where can I find an engineering career offering me plenty of scope?

A. Electricity Supply offers *dozens* of good jobs. Few individual firms can hope to match the variety you'll find in the Electricity Supply industry.

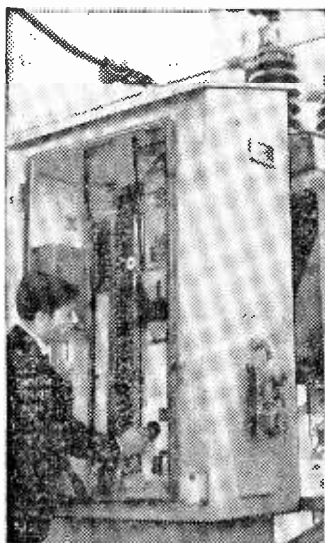

Q. What is Electricity Supply?

A. It's the national industry responsible for generating electricity, transmitting it, distributing it throughout the country and advising how it can be used.



Q. What qualifications must I have?

A. School-leavers need either a good Ordinary level G.C.E. including Maths, English, and a Science subject; or two Advanced level passes in Maths and Physics. Graduates need a British degree in electrical or mechanical engineering. Or you need an engineering diploma. You can apply in your last year at school or college — preferably in the January-March period before you take your final exams.



Q. What sort of training do I get?

A. For school-leavers, there's a 5-year apprenticeship. It consists of planned practical experience in the various departments, accompanied, for 'O' level entrants, by day release to a technical college and, for 'A' level recruits, by a 'sandwich' course, both leading to engineering qualifications.

Graduate trainees have a 2-year practical training in one of the main sections of the industry. The training of diploma-holders is planned to take into account past practical experience.

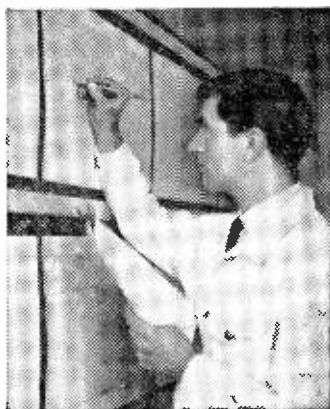

Q. Where do I go from here?

A. It's impossible to tell you here all about an industry that has to *double* its output every ten years. But jobs include everything from running a Power Station to bringing power to a new estate. For full details, write (giving age and exams you've passed) to: The Education and Training Officer, The Electricity Council, 155 Winsley Street, London, W.1.

**THE DEMAND FOR ELECTRICITY
DOUBLES EVERY TEN YEARS**

RECEIVERS & COMPONENTS

"HEATHKITS" can now be seen in London and purchased on easy terms. Free brochure. DIRECT TV REPLACEMENTS LTD., Dept. P.W. 7/9, 138 Lewisham Way, SE14. Tideway 6666.

SPEAKER REPAIRS. Cones/Fields fitted. Clock coils wound. L. S. REPAIRS. Pluckley, Ashford, Kent.

TRANSISTORS. Marked and tested. packets of 10; unmarked but tested, packets of 16; unmarked and untested packets of 40. Duds suitable as Diodes, packets of 80. All packets 20/- each. Any two packets 37/6. C.W.O. K. R. WHISTON, Dept. TPW, New Mills, Stockport.

EXCEPTIONAL VALUE: Picture Tubes, brand new. Mazda 19in., CME1901, Mullard 19in., AW47-90/91, £4/10/-; Mullard 23in., AW59/90, £8/10/-; carriage (insured) paid. 12 months' guarantee. Note, all brand new. We also supply most other sizes completely returned at £4/17/6, guaranteed 12 months. TOMLINS, 156 Lewisham Way, New Cross SE14. TID 3857.

NEW VALVES, 12 months' guarantee
ECC81/2/3, EF80, EB91 4/11
EZ80/1, EL84, EM84, ECL86, ECL80 7/6
ECL82, PCL82, PL81, U.25, PCF80 9/11

P. BEARMAN (Tubes)

3 PANK AVENUE, NEW BARNET
HERTS.
Tel: BARNET 1934/3185

A1 POST-FREE BARGAINS. First-grade TRANSISTORS: OC44 8/9, OC45 7/3, OC70 OC71 5/3, OC72 OC74 OC78 OC81 7/-, OC170 8/9, OC171 9/3. All other Mullard types stocked. VALVES set tested: EB91 EF91 EF50 EF80 9d., 6F1 10F1 1/- 1.63 20D1 ECL80 3/-, PY81 PZ30 B36 4/-, PCF80 PL82 PL83 PY80 PY82 KT33C 4/3, PL38 N37 KT36 4/9, PCL83 6/-, PY32 GK26 5/9, 185BT 27SU U25 9/6. 10% discount on six, 25% on 12, any combination. Ready-made Transistor Set 32/-. A1 RADIO COMPONENTS, 14 The Borough, Canterbury, Kent.

ALL TYPES LINE OUTPUT TRANSFORMERS SUPPLIED (RETAIL AND TRADE). Finest service in the country. Send S.A.E. for return of post service. Terms C.W.O. or C.O.D. Trade enquiries invited. D. & B. TELEVISION (WIMBLEDON) LTD., 131 Kingston Road, Wimbledon, SW19. CHERRYWOOD 3955.

CANADIAN MARCONI 52 RECEIVERS

An excellent Communications Receiver covering 1.75 to 16 mc/s in 3 bands. 1 R.F., 2 I.F. stages. 10 valves plus 3 valve crystal calibrator, 10, 100 and 1,000 kc/s. Crash Limiter, Broad/Sharp Selectivity, 500 MC/amp. valve check/Signal Level meter. 3 in. speaker phone jacks, power required 150 v. H.T. 12 v. a.c. or d.c. L.T. PRICES: Receiver only £5.10., carriage £1. Receiver in steel cabinet with installation kit comprising power unit ZE12 for a.c. mains 230 or 115 v. or 12 v. D.C., all connecting cables and spares, two pairs padded Headphones and aerial wire. £9.10., carriage £1. Send S.A.E. for detailed leaflet.

G.W.M. RADIO LIMITED

40/42 Portland Road, Worthing, Sussex.

RATES: 7/3 per line or part thereof, average five words to line, minimum 2 lines. Box No. 1/- extra. Advertisements must be prepaid and addressed to Advertisement Manager, "Practical Wireless," Tower House, Southampton St., London W.C.2.

RECEIVERS & COMPONENTS (continued)

NEW VALVES, guaranteed: EY86, 7/9; EZ40, 6/6; PCC84, 7/-; PCF82, 7/-; PCL84, 7/3; PL81, 8/6; PY81, 7/-; 6X4, 5/-; plus 6d. p. and p. extra. S.A.E. for lists. LEWIS, 46 Woodford Avenue, Ilford, Essex. Telephone CRE 5685.

TRANSISTORS, A.F. 2/-, R.F. 2/9. Post free. Money back guarantee. D. J. MANSELL, 67 Cartway, Bridgnorth, Shrops.

NEW 10.7Mc/s I.F.T.S., usual square can, 3/- each. S.A.E. for latest lists. AJAX ELECTRONICS, 572 Fulham Road, London SW6.

CONDENSERS. Fantastic Bargain! 500,000 miniature condensers. 1in. long, 1in. diameter. Tested 750V. Capacity .0001 to .04uf 7/6 per 100. Post free. Ideal for transistor sets. MILWARD, 17 Peel Close, Drayton Bassett, Staffordshire.

SONO BUOY TX type 87 with 3 3A4, 1 1L4, 1 B7G crystal approx. 10Mc/s output at 60Mc/s converts to model control TX, only 15/- less valves and xtal 6/-; Sono Buoy Amplifier, type 455 with 3 1T4, 2 1L4 valves, 2 OV488 crystal diodes, only 10/- less valves 5/-; 6V-24V d.c. Miniature Motors with gear box giving approx. 2-8 r.p.m. according to input voltage, 15/- all carriage paid. I will buy surplus American Radio Equipment, Manuals. Write for quotation: CLARKE, 29 Leightinnmohr Avenue, Ballymena, N. Ireland.

FOR SALE

EXCEPTIONAL Transistor Portable Tape Recorder, value £8/19/6. complete with crystal microphone, earphone, spools, tape, batteries, instructions, presentation box (extra tapes 100 4/6. Ideal gift, £8/19/6. Satisfaction guaranteed. Postage, packing 2/6. TOMLINS, 156 Lewisham Way, New Cross, SE14.

ASK your dealer for American Ferro-dynamics. "Brand Five" Recording Tapes—the best tape value!

FOR SALE

(continued)

TRANSISTORS 100% TESTED

Red Spot Audio, 11/6 each, 14/- doz. A.E.I. Branded Audio XB103 and R.F. XA102, 2/3 each, 25/- doz. XC141 (11 watt) Audio, 6/6 each, 12/- pair.

All Guaranteed. Post Free.
Transistor Condensers 1/3 each.
8µF, 25µF, 50µF.

EPIOK Multimeters only £4.10 each.
100 c. Slim Mics, only 32/6 each.
Large Stocks of Ex-Govt. Equipment.

B. W. CURSONS
78 BROAD STREET
CANTERBURY. Phone 5442

GRUNDIG MA1 Transistor Tape Pre-amplifiers suitable for use as microphone transformer, pick-up and tape head booster. Listed at 4½ gns., offered at £2/17/6. Send for full details and free lists. LEE ELECTRONICS, 400 Edgware Road, W2. (Paddington 5521.)

AUTOCHANGERS

Garrard Autoslim ... £8. 5.0
B.S.R. UA16 ... £8.10.0
GU7 latest B.S.R. Single
Player ... £5. 0.0

MICROPHONES

ACOS MIC45 (fist mike
in metal case) ... 22/6
ACOS Stick Mike 39/1 ... 32/6

BROADWAY ELECTRONICS

92 Mitcham Road, Tooting,
S.W.17.

AMATEUR LICENCE Morse Course. The new Rhythm Method of teaching takes the drudgery out of learning Morse and is the quickest known! For full explanatory booklet: S.A.E. G3CHS, 45 Green Lane, Purley, Surrey.

SPECIAL OFFER

LIMITED QUANTITIES in OAK,
WALNUT AND MAHOGANY
CASH PRICE £19.19.0 plus 15/-
PRICE delivery
Ferrules and adjustable glides
15/- Extra

or Special NO INTEREST Terms
39/- deposit plus 15/- delivery and
10/- weekly for 36 weeks.

Full length motor board with record
storage omitted at same price.

A. L. STAMFORD LTD. Dept. C 29
98 Weymouth Terrace
HACKNEY RD., LONDON, E.2



GP90—FOR STEREO
OR MONAURAL
4in. wide, record storage.
Control Panel and Deck 17½ x 16in.
Tygan grille. Cash Price £19.19.0.

TELEVISION TECHNICIANS
LINE OUTPUT TRANSFORMERS
SCAN COILS ETC.

LABORATORY TESTED

- ALBA: T301, T304, T394, T484, T494, etc. 46/6
- BUSH: TV11A, 11B, 12A, 12B, TVG12A, 12B, TVG12A, 12B 44/-
- TVG26, TV32, TV33, TVG34, TVG34A, TV35, TV36, TVG36, TV36C, TVG36C, TV43 88/6
- TV53, TV56, TV57, TV58, TV62, TV63, TV66, TV67, etc. 94/-
- TV80 with EY81 109/-
- COSSOR: 930 and T931, 933-4-5, 937, 938A, and F, 939 and A and F 61/6
- 943T, 940-946, 945, 945B 68/6
- 954F, 947, 949 68/6
- DECCA: D17 and C 88/6
- D11, DM2C, DM3, DM4/C 74/-
- DM5, DM14, DM17, 444, 555 74/-
- DEFIANT: TR1483, TR1753 58/6
- DYNATRON:
- EKO: T893, TC8102, TS105, T8114.
- TRC124, TC138, T818A, T8193 54/-
- TRC139, TC140, T141, TV142 78/6
- T161, TC162, T164, T165, etc. 78/6
- TC208, TV209, T231, T221, T231F, T248, T283, T284, T293, etc. 58/6
- FERGUSON: 103T, 105T, 113T, 135T, 145T 65/6
- 941T-953T inclusive 68/6
- 991T-997T inclusive 68/6
- 203T-244T inclusive 68/6
- 306T, 308T 64/-
- FERRANTI: 14T3, 14T3F, 13TA 47/6
- 17K3 and F, 17T3 and F 47/6
- 17K4 and F, 17SK4 and F 47/6
- 17T4 and F 47/6
- 14T5, 17SK5, 17K5 47/6
- G.E.C.: BT1251, BT1252, BT1746, BT1748, BT4743 48/6
- BT4648, BT5147, BT9246-48 88/6
- BT9348-BT9643R inclusive 49/6
- and 88/6
- H.M.V.: 1824 and A to 1831 inclusive 66/6
- 1840, 1841, 1842-1848 66/6
- All models available. 54/-
- INVICTA: T118, T119, T120 54/-
- All other models available.
- K.B.: LPT50, LVT50, LFT50, MV60 106/6
- All models available.
- MARCONI: All models available.
- MASTERADIO: Most models in stock.
- MICHAEL: Most models in stock. 56/6
- MURPHY: V200, V202C 94/6
- V240, V250
- PETO SCOTT, PHILCO: Most models in stock. 54/-
- PAM: 908, 909, 952, 953, 958 106/6
- PHILIPS: 1265B, 2168U 74/-
- 1100V, 1200V 74/-
- 122GU, 1236V, 1238V 74/-
- 114UF, 114UM, 115U 74/-
- 1437U, 1446U 74/-
- Most models in stock.
- PILOT: Most models in stock. 54/-
- PYE: CTM4, FV4C, FV4COL 54/-
- V4, VT4, V7, VT7 54/-
- LV30, FV1, FV1C 68/6
- CR17F, CTM17F, CW17 68/6
- CW17C, CW17CF, CW17K, etc. 68/6
- Most models in stock.
- RAYMOND: Most models in stock.
- REGENTONE: All models available.
- R.G.D.: 6017T, 7017, C54, etc. 58/6
- SOBELL: TS17, T345 64/-
- Most models in stock.
- STELLA: ST5721U 104/-
- ST5617U, ST8621U 104/-
- ST8917U 104/-
- ST6414U, ST6417U 74/-
- ST8314U 74/-
- ULTRA: 86 series, 185 series, with U25, etc., complete 78/6
- Most models in stock.
- VIDOR: CN217-CN4231 inclusive 64/-
- Post and Packing 3/6 C.W.O. Only

Also: Used O.P. Txs., Scan Coils, etc.
ALL GUARANTEED 90 DAYS
(All enquiries S.A.E.)

WYNDSOR TELEVISION
TECHNICAL DIVISION

ST. ALBANS RD., BARNET, HERTS.
BAR 1769

FOR SALE
(continued)

BARGAIN, EIGHT 45 rev/min Brand New Pop singles (value over 50/-) for £1. S.A.E. for details to: R. FLETCHER (P.W.), 24 Old Hall St., Burnley, Lancs.

SUPERHET RADIO CHASSIS

These well-made sets were made for the Government for Forces entertainment, using 6K8, 6K7, 6Q7, 6V6. Slow motion tuning, Choke smoothing, 200-550 meters, size 11 x 5 x 2in., printed scale. BRAND NEW only 57/6, post 5/-. Case, with Bin. speaker to fit, 27/6.

12 Volt Vibrator Unit (P.C.R. series), 100 mA output to 250 volts, double choke smoothed, bridge rectified, spare vibrator; indicator bulbs, battery clips, fusewire. BRAND NEW in makers' cartons, case size 6 x 8 x 10in., 22/6, carr. 5/6.

Clearance Offer, R107 Sets, 9 valves 1.2-17.5 Mc/s, internal speaker and power unit for 12 volts, 100-250 A.C. £9.15.0. Air tested, realigned, £2.10.0 extra. Carr. 30/-. R107, in maker's crates, Brand New £17.10.0.
CR.200, 15-560 Kc/s. Brand New, £12.10.0, carr. 30/-.
R109(A), 2-12 Mc/s, 5 spare valves, 2 pairs headphones, HT-LT voltmeter, manual, circuit, Brand New in maker's boxes, £6.15.0, carr. 10/-.
1466 Receivers, 30-40 Mc/s, 6 valves, 27/6, carr. 5/6.
19 Mk2 TX-RX. With 12-volt power unit. New, £4.10.0, carr. 10/-.
J. T. SUPPLY (Dept.N),
309 MEANWOOD ROAD : LEEDS 7

WANTED

A PROMPT CASH OFFER for your surplus Brand New Valves and Transistors. R.H.S., Beverley House, Mannville Terrace, Bradford 7.

WANTED: NEW Valves and Transistors, any quantity. S. N. WILLETS, 43 Spon Lane, West Bromwich, Staffs. Tel: WES 2392.

VALVES WANTED
IMMEDIATE CASH
SETTLEMENT

Loose or boxed but must be new

Phone, write or call—
RADIO FACILITIES, LTD.
38 Chalcot Road, London, NW1
PR1mrose 9090
THE VALVE SPECIALISTS

WANTED: TEST GEAR, Meters, Valves, Components, Communication Sets, Amplifiers. HUGGETS LTD., 2-4 Pawson's Road, West Croydon, Surrey.

WANTED VALVES
& TRANSISTORS

Must be new and boxed.
Payment by return.

WILLIAM CARVIS LTD.
103 North Street, Leeds 7

WANTED
(continued)

ABSOLUTE TOP PRICES paid for Valves, Transistors, Components, etc. in quantity. Try us first. Cash by return. WOLVERHAMPTON RADIO AND TV SUPPLIES, 42 Darlington Street, Wolverhampton. Tel.: 20315.

NEW VALVES WANTED.
Any type, any quantity
CASH PAID

R.S.T. Valve Mail Order Co.,
211A Streatham Road,
Mitcham, Surrey
Telephone: MITCHAM 6202

EDUCATIONAL

Radio
Television
& Electronics

Learn at home with the world's largest home study organisation, Brit.I.R.E.; City & Guilds; P.M.G.'s Certs., etc. Also Practical Courses coupled with equipment. No books to buy.

Write for FREE prospectus stating subjects to

I.C.S.

(Dept. 541), Intertext House, Parkgate Road, London, S.W.11.

LEARN RADIO AND ELECTRONICS the new and practical way. Hosts of absorbing experiments carried out at home under expert guidance to teach you Radio in a new enjoyable and interesting way. Construction, servicing and fault-finding on equipment made easy for the first time! No previous experience needed. No mathematics used. Free brochure from: Dept. 11, P.W., RADIO-STRUCTOR, Reading.

$$X = \frac{-b \pm \sqrt{b^2 - 4ac}}{2a}$$

DON'T FUMBLE with Formulae. Master Mathematics quickly and easily the Understandable Way.

1st lesson and details FREE

The Dryden School of UNDERSTANDABLE MATHEMATICS.
11F2 Dryden Chambers, Oxford St., London, W.1.
Name _____
Address _____

EDUCATIONAL

(continued)

"HOW AND WHY" of Radio and Electronics made easy by a new, non-maths practical way. Postal instruction based on hosts of experiments and equipment building carried out at home. New courses bring enjoyment as well as knowledge of this fascinating subject. Free brochure from: Dept. P.W. 12, **RADIOSTRUCTOR**, Reading.

The Incorporated Practitioners in Radio and Electronics (I.P.R.E.) Ltd. Membership Conditions booklet 1/-. Sample copy of I.P.R.E. Official Journal 2/- post free. Secretary, 20 Fairfield Road, London N8.



By repairing Radio and TV Sets as a job or as a spare time business. Our practical course will show you the way. No previous experience is required.

SEND FOR FREE BOOK TODAY!

RADIOSTRUCTOR

Dept. G77

READING, BERKS

WIRELESS. See the world as a Radio Officer in the Merchant Navy; short training period, low fees; scholarships, etc. available. Boarding and Day students. Stamp for prospectus. **WIRELESS COLLEGE**, Colwyn Bay.

BECOME "TECHNICALLY QUALIFIED" in your spare time. Guaranteed Diploma and Exam Home-study Courses in Radio, TV, Servicing and Maintenance. R.T.E.B., City and Guilds, etc. Highly informative 120 page Guide—FREE! N.I.E. (Dept. 363), 148 Holborn, London EC1.

SERVICE SHEETS

SERVICE SHEETS for all makes of Radio and TV 1930-1962. Prices from 1/-, with tree fault-finding guide. Catalogue of 6,000 models 1/6. 125 Radio/TV sheets covering many popular models 20/-. S.A.E. inquiries: **HAMILTON RADIO**, Western Road, St. Leonards, Sussex.

WHY TOLERATE DELAY when we can supply your Radio or TV Service Sheet by return of post at 4/- each, plus postage. List 1/-. Also Manuals for sale and hire. List 1/-. S.A.E. with inquiries please. Mail orders only to **S.P. DISTRIBUTORS**, 44 Old Bond Street, London W1.

FAULTFINDER FILES, showing common faults that each receiver is prone to and other useful servicing information. 2/- each. List 9d., plus postage. Mail orders only. **S.P. DISTRIBUTORS**, 44 Old Bond Street, London W1.

SERVICE SHEETS: Radio, TV, 5,000 models. List 1/-. S.A.E. inquiries: **TELRAY**, 11 Maudslayi Bk., Preston.

SERVICE SHEETS

(continued)

SERVICE SHEETS, Radio and TV, 4/- each. List 1/-. All orders dispatched on day received. Also manuals for sale and hire. List 1/-. S.A.E. please. **SULTAN RADIO**, Pantiles Chambers, Tunbridge Wells, Kent.

RADIO SERVICE SHEETS 1936-1962 1/- each. Postage extra. Enclose stamp with enquiries; 85 Charminster Avenue, Bournemouth.

SERVICE SHEETS; also Current and Obsolete Valves for sale. **JOHN GILBERT TELEVISION**, 1b Shepherd's Bush Road, London W12. Phone: SHE 8441.

METAL WORK

METALWORK. All types cabinets, chassis, racks, etc., to your specifications. **PHILLPOT'S METALWORKS LTD.**, Chapman St., Loughborough.

SITUATIONS VACANT

A.M.I.Mech.E., A.M.Brit.I.R.E., City and Guilds, G.C.E., etc. brings high pay and security. "No pass—no pay" terms. Over 95% successes. For details of exams and courses in all branches of Engineering, Building, Electronics, etc. write for 148-page handbook, free. **B.I.E.T. (Dept. 242B)**, London W8.

TV AND RADIO, A.M.Brit.I.R.E., City and Guilds, R.T.E.B. Cert., etc. on "No pass—no fee" terms. Over 95% successes. For details of exams and courses (including practical apparatus) in all branches of Radio, TV and Electronics, write for 148-page handbook, free. **B.I.E.T. (Dept. 242G)**, 29 Wright's Lane, London W8.

CITY AND GUILDS (Electrical, etc.) on "No pass—no fee" terms. Over 95% successes. For details of Electrical Engineering, Applied Electronics, Automation, etc., send for our 148-page handbook, free and post free. **B.I.E.T. (Dept. 242A)**, 29 Wright's Lane, London W8.

BOOKS & PUBLICATIONS

FIND TV SET TROUBLES IN MINUTES from that great book "The Principles of TV Receiver Servicing" 10/6 all book houses and radio wholesalers. If not in stock from Secretary, I.P.R.E., 20 Fairfield Rd., London N8.

THOUSANDS OF BARGAINS can be found weekly in the Radio, TV, Mechanics and Scientific Sections of **EXCHANGE AND MART**, 5d. every Thursday.

PIN-POINT TV TROUBLES IN TEN MINUTES. The title can be limited, but the contents never! The book that really tells you how to fix televisions. Over 340 Cross indexed pages. **MUST** be able to earn you more than it's cost within two weeks or your money refunded! Price 63/- incl. postage. Write for free trial to **SIM-TECH BOOKS**, West End, Southampton, Hants.

SOUND RECORDINGS

TAPE BARGAINS in all sizes. Example: Top brand 5in. 1,200ft 19/6 p. and p. 1/3. S.A.E. for list. Large choice of New and Used Recorders. **E. C. KINGSLEY AND CO.**, 132 Tottenham Court Road, London, W1. EUS 6500.

MISCELLANEOUS**ELECTRONIC MUSIC?**

Then how about making yourself an electric organ? Constructional data available—full circuits, drawings and notes! It has 5 octaves, 2 manuals and pedals with 24 stops—uses 41 valves. With its variable attack you can play Classics and Swing.

Write NOW for free leaflet and further details to **C. & S., 20 Maude Street, Darlington, Durham.** Send 2d. stamp.

The Plessey Company (UK) Limited has vacancies for

TESTER TROUBLE SHOOTERS AND ELECTROMECHANICAL INSPECTORS

with experience of multichannel transmitters and receivers. Alternatively, candidates with a very sound knowledge of radio and TV would be acceptable. Consideration will also be given to applicants with considerable theoretical knowledge but no practical experience.

These vacancies present excellent opportunities and we are prepared to train ex-Servicemen with experience of maintenance and repair of wireless transmitters and receivers, and radar, etc.

Very good working conditions and facilities. First-class rates of pay. Applicants with the requisite experience are invited to write to or call at—

The Employment Bureau
The Plessey Company (UK) Limited
Vicarage Lane, Ilford, Essex.

Fly as an Air Electronics Officer in the R.A.F.

The domain of the Air Electronics Officer is the whole range of electrical and electronics equipments in an operational aircraft. This covers high frequency long range communication equipment (both voice and wireless telegraphy), VHF communications (short range radio telephone), ASV (air to surface vessel) radar, and the 'black boxes' for the electronic defence of the aircraft.

Having completed your highly-specialised training courses—during which you do about 123 hours flying, including two flights abroad—you fly in the V-bombers of Bomber Command or on Coastal Command reconnaissance.

You are a key man doing a key job—where success depends entirely on your own skill, training and flexibility. There is nothing run-of-the-mill about it. You have a career you can be proud of—and there lies satisfaction.

You are well paid from the very beginning—you earn £976 as a Flying Officer of 21. At 25 as a Flight Lieutenant, drawing full allowances, you could earn over £1,800. You travel the world, meeting old friends on almost every airfield, making new friends wherever you go. You live well in the Officers Mess, and have the opportunity of taking part in almost any sport you can name.

If you are under 26, fit, and hold or expect to gain G.C.E. at 'O' level (or equivalent) in 5 acceptable subjects including mathematics and English language, you are eligible for a Direct Entry commission. Write for further details, giving date of birth and educational qualifications to Group Captain J. A. Crockett, R.A.F., Air Ministry (PW906A) Adastral House, London, W. C. 1.

THE FUTURE IS WITH THE R.A.F.



The Royal Air Force

ULTRA VIOLET BULBS

Easy to use source of UV for dozens of practical and experimental uses. 12 volt 36 watt AC/DC SBC 6/6. P. & P. 1/-, 12 volt 60 watt AC/DC SBC 8/6. P. & P. 1/-, Transformer to suit the above: Input 200-240 A.C. Output 12 volt A.C. 36 watt, 16/6. P. & P. 2/6. Input 200-240 A.C. 12 volt A.C. 60 watt, 22/6. P. & P. 3/6.

Set of 4 colours **FLUORESCENT PAINT**, Red, Yellow, Green and Blue in 1 oz. tins ideal for use with the above Ultra Violet Bulbs, 9/6. P. & P. 1/6.

BUILD AN EFFICIENT STROBE UNIT FOR ONLY 37/6.

The ideal instrument for workshop, lab, or factory. This wonderful device enables you to "freeze" motion and examine moving parts of stationary. We supply a simple circuit diagram and all electrical parts including the NSP2 Strobe tube which will enable you to easily and quickly construct a unit for infinite variety of speeds, from 1 flash in several seconds to several thousands per minute. New modified circuits bring price down to 37/6 plus 3/- P. & P.

NSP2 CV2336 STROBOTRON FLASH-TUBE made by Ferranti, brand new, I.O. base. Price 15/-. P. & P. 1/-.

MAGNETIC COUNTERS 10 IMPULSES PER SECOND

Very latest High Speed type ex P.O. guaranteed perfect. type No. 100B, coil 2,300 ohms, for 48 volt D.C. operation (will work on 36 volt), overall size 4 x 1 x 1 in. Also available, type 101A which can be used as an interesting accessory with our Strobeunit. Either type price 15/-. P. & P. 1/6.



Variable Voltage Transformer

Input 230 v. A.C. Output 0-260 v. at 2.5 amp. Fully shrouded. New. £5.19.6. inc. carriage. Also available from stock, 5, 8, 10 and 20 amp. Write for details.

ORP 60 MULLARD CADMIUM SULPHIDE PHOTOCELLS

With mounting and leads including circuit for making light sensitive switches, 7/6. Post paid.

SIEMENS H.S. RELAY. Very latest type sealed. HSE. 1,700 ohms plus 1,700 ohms, single C/O contacts. Price 16/6 each, plus 1/- P. & P.

Miniature LEDEX Switch. 24 volt D.C. operation. Two bank 11 position plus Homing Contact. A miniature and compact form of unselector. Ex brand new equipment, 32/6. P. & P. 2/-.

7 R.P.M. Gearing Motor. 12 volt D.C. Double Gearbox. Consumption 1 amp, size 3 1/2 x 2 1/2 in. Weight 15 oz., small and extremely powerful, 32/6. P. & P. 2/6.

230 VOLT A.C. GEARED MOTORS
Type D18G 80 r.p.m., 28 lb. inch. £1.19.6. P.P. 2/-
Type D18G 5 r.p.m., 1.7 lb. inch. £2.9.6. P.P. 2/6.
Type D18G 13 r.p.m., 1.45 lb. inch. £2.12.6. P.P. 2/6.



12 v.D.C. Reversible Motor with tremendous power weight ratio. 3 position switch. Weight 2 1/2 ounces. Size 1 1/2 x 1 1/2 in. 60 r.p.m. Self lubricating. 15/- plus 1/- P. & P.

AVO METER MODEL 7. Individually tested on all ranges and guaranteed. Inclusive of Test Leads. £11.0.0 each. P.P. 5/- Case 20/-.

SPEAKER

A beautifully made Speaker and Control Unit for the famous Collins TCS communication equipment. Can be used with any top-grade communication setup. Comprising a super 5ln. 3 to 5 ohm speaker, 600 ohm matching transformer, constant impedance type volume control, 3 control switches. Fitted in robust crackle finished case. 20/6. P. & P. 4/-.

SERVICE TRADING CO.

All Mail Orders also callers.
49 High Street, Kingston on Thames
Tel.: KINGSTON 8450
Personal callers only
9 Little Newport Street, London W.C.2
(off Leicester Square)
Tel.: GERRARD 0376

Become a Television expert this easy way

The Bennett College offers you a complete course

THE Bennett College offers you personal tuition in a course that's non-mathematical and particularly easy to follow. It contains clear diagrams which cover everything you want to know from beginning to end (and even includes the basic principles of sound radio if you wish).

The complete home-study course covers everything: Production of the signal, scanning and reproduction of picture from signals. Aerials, types and purposes. The cathode-ray tube. Time-base oscillators, and output circuits. Synchronisation. Video frequency amplifiers. The TV tuner, turret incremental, etc. Television test gear. Television faults.

For more details, please fill in the coupon below. Your studies cost very little and the book you need is included in the cost.

To THE BENNETT COLLEGE (Dept. 104NTV), Sheffield
Please send me details of the new
TELEVISION SERVICING COURSE

NAME _____

ADDRESS _____

AGE _____



COMPLETE TELEVISIONS
14 INCH 17 INCH
£7.10.0 £11.10.0

- ★ 12 Months' free replacement on tube, valves and components.
- ★ Ex Rental and repossessed televisions.
- ★ All channels available.
- ★ Demonstrations daily.
- ★ Legs—39/6 per set.
- ★ Part exchange allowance on Radios, TV's etc.

Personal collection advised, or Insured. Carr. 14in., 20/-, 17in., 30/-.

SPEAKERS
7/9 EACH



6in. Bin. 7in. x 4in.
Money back guaranteed.
Enquire for other sizes.
Ex. mfd. salvage. P.P. 2/3.

VALVES 9d each
Thousands of ex-service stock and ex-government. All good. MOST TYPES AVAILABLE.
Post 3d. FOR FREE LIST.

RENTAL TUBES
14in., 35/-, 36/24, 14KP4, 141, 5/-.
Carr. Ex Rental stock.

Extension speakers, 19/9. 2 tone covered cabinet, 6in. PM speaker, switch and flex. Ideal for kitchen, sick room, etc., P. & P. 3/9.

TAPE RECORDER AMPLIFIER £7.19.6.
5 Valve, 3.5w. output. Size 8 1/2 x 3 x 4 1/2ins. suitable for Cabinet. Ins. Carr. 4/6.
RECORD PLAYER AMPLIFIER 39/6. 3 watts output, A.C. mains isolated, P.P. 3/9.



DUKE & CO (London) Ltd
621/3 ROMFORD RD.
MANOR PARK, E.12
ILFord 6001/3
Liverpool St. Stn. to Manor Park only 10 mins.

TAPE CABINET 49/6.
For Collaro Studio Deck. Carriage 5/-.

VALVES SAME DAY SERVICE NEW! TESTED! GUARANTEED!

SETS 1R5, 1S5, 1T4, 3S4, 3V4, DAF91, DF91, DK91, DL92, DL94 ... Set of 4 for 19/-
DAF96, DF96, DK96, DL96 ... 4 for 26/6

1A7GT 11/-	6LD20 8/-	30P4 12/6	EBC33 5/-	EY51 7/6	U25 12/-
1D5 8/6	6P25 8/-	30PL13 12/3	EBC41 8/-	EY32 7/-	U26 9/3
1H5GT 9/-	6P23 11/6	35A5 15/9	EBF60 8/-	EZ40 6/9	U50 5/6
1NSGT 9/-	6Q7G 6/-	35L6GT 8/3	EBF89 8/9	EZ41 7/-	U52 4/6
1R5 6/-	6Q7GT 8/-	35Z23 15/-	EBL21 13/6	EZ80 6/3	U78 4/6
1S4 8/-	6SL7GT 5/9	35Z4GT 5/6	EBL31 17/-	EZ81 6/8	U191 14/6
1S5 5/3	6SN7GT 4/9	50L6GT 7/9	ECC40 13/6	GZ32 8/6	U281 12/6
1T4 3/6	6U4GT 9/9	185BT 21/6	ECC81 4/9	K761 8/-	U282 15/6
1U5 5/9	6V6G 4/6	AZ1 12/6	ECC82 4/9	KT71 8/-	U291 16/6
2P 22/6	6V6GT 7/3	AZ31 9/6	ECC83 7/-	MU14 6/8	U301 17/-
3A5 9/-	6X4 4/6	B36 7/6	ECC84 7/9	MX40 13/6	U801 21/-
3Q4 7/-	6Z3GT 6/9	CB11 12/-	ECC85 7/9	N18 7/-	UABC30 6/6
3S4 6/-	6/30L2 4/6	COH35 13/6	ECF80 7/-	N37 11/-	UAF42 8/3
3V4 7/-	7B6 8/-	CL33 12/3	ECF82 8/6	PCC84 7/6	UBC41 7/9
5U4G 4/6	7B7 8/-	CY1 12/6	ECF85 7/3	PCC89 9/3	UBF80 8/3
5V4G 8/-	7C5 7/9	CY31 8/6	ECH42 8/9	PCF80 7/9	UBF89 8/3
5Y3GT 8/-	7C6 7/6	DAC32 9/-	ECH81 7/9	PCF82 8/3	UBL21 14/6
5Z4G 9/-	7H7 7/6	DAF91 5/3	ECF80 7/6	PCF86 9/3	UCB4 13/3
6AL5 3/9	7S7 9/-	DAF96 7/6	ECL82 9/-	PCL82 9/-	UCC85 7/6
6AM8 3/6	7Y4 6/-	DCC90 9/-	ECL86 10/-	PCL83 10/6	UCF80 14/6
6AQ5 3/6	10C1 12/-	DF33 9/-	EF9 15/-	PCL84 10/-	UCH21 13/6
6AT8 6/-	10C2 16/6	DF91 3/6	EF37A 8/9	PCL85 10/6	UCH42 9/-
6B48 5/9	12AT8 7/-	DF96 7/6	EF39 4/6	PEN44 11/-	UCH81 8/9
6BE8 5/6	12AT7 18/9	DH78 4/9	EF40 11/6	PEN36C 5/-	UCL82 8/6
6BGGQ 14/6	12AU7 4/9	DH77 6/-	EF41 7/9	PL36 11/6	UCL83 13/3
6BH6 6/3	12AX7 4/9	DH81 9/-	EF42 7/6	PL81 7/6	UF41 7/6
6BJ6 5/9	12K7GT 4/9	DK32 11/-	EF80 4/9	PL82 7/6	UF97 9/-
6BW6 8/-	12Q6T 9/6	DK31 6/-	EF85 5/9	PL83 7/6	UL41 8/6
6CD6G 27/3	12Q7GT 4/9	DK92 7/6	EF98 8/9	PL84 8/6	UL84 6/6
6K8GT 5/-	19B6G 14/6	DK96 7/6	EF99 7/-	PL820 12/6	URIC 8/-
6K8GT 5/-	20F2 17/-	DL33 8/-	EF91 3/6	PX25 9/-	UU7 9/-
6K9T 9/-	20L1 17/6	DL35 9/6	EL33 9/6	PX32 11/6	UY21 11/-
6K7G 11/1	20P3 18/9	DL92 6/-	EL41 9/6	PY32 11/6	UY41 6/6
6KTGT 5/6	20P4 20/-	DL94 7/-	EL42 9/-	PY36 7/6	UY88 6/6
6K8G 5/-	20P5 15/9	DL96 7/6	EL84 6/6	PY81 7/-	VP4B 9/6
6K8GT 9/-	25L8GT 7/-	DM70 6/6	EM34 7/3	PY82 6/6	VP41 5/-
6K25 12/6	25Z4G 7/6	EABC90 4/9	EM80 8/-	PY83 7/9	W76 4/9
6L6G 6/6	27SU 17/6	EAF42 8/6	EM81 8/6	PZ30 12/6	W77 3/9
6L18 10/-	30L15 11/-	EB91 3/9	EM84 9/6	TH21 15/-	Z77 3/6

RADIO BOOKS BASIC ELECTRICITY ELECTRONICS

in Simple straight-forward words and Clear Explanatory Pictures. The Reader is taken Step by Step from Picture to Picture

LEARN WHILE YOU PAY
FOR ONLY 2/6 PER WEEK
Officially used by the ARMY, NAVY and AIRFORCE, used by Trainees in the Radio and Electronic Industry.

- Write for FREE Illustrated Prospectus
and details of instalment plan.
- OSCILLOSCOPE Book 5/6
 - USING an Oscilloscope 7/6
 - OSCILLOSCOPE Equipment 5/6
 - MULLARD Transistor Radios 5/6
 - MULLARD Ref. Transistor Circuits 13/6
 - EXTRA Equipment Tape Recorder 8/6
 - COIL Design and Construction 5/6
 - TRANSISTOR Superhet 8/-
 - TRANSISTOR Audio Amplifiers 6/6
 - TRANSISTOR Circuits for Models 8/6
 - RADIO Servicing Instruments 5/6
 - HIGH Fidelity L/Speaker Enclosures 5/6
 - BOYS' Book of Crystal Sets 3/-
 - SERVICING Transistor Receivers 8/-
 - ELECTRONIC Novelties 5/6
 - ELECTRONIC Gadgets 4/-
 - RADIO Valve Data "Wireless World" 7/-
 - BEGINNERS' Guide to Radio 8/6
 - MODERN Transistor Circuits for Beginners 8/6
 - TRANSISTOR Test Equipment 4/-
 - MAGNETIC Recording. Wire and Tape 5/-
 - COLOUR Television. 40 Colour plates 17/-
 - RADIO Engineers' Pocket Book 11/6
 - RADIO Test Equipment 3/6
 - 40 CIRCUITS using Germanium Diodes 3/6
 - HI-FI Tape Recorder 3/-
 - TRANSISTOR Circuits for the Constructor (Bradley) Nos. 1, 2, 3 and 4 - each

All above books include postage. SEND STAMP FOR LISTS

SELRAY BOOK CO.
60 HAYES HILL, HAYES, BROMLEY KENT. Tel. HURstway 1818

READERS' RADIO
24 COLBERG PLACE, STAMFORD HILL LONDON, N.16 STA. 4587

Post 6d. per valve extra.
Any Parcel Insured Against Damage in Transit 6d. extra.
Any C.O.D. Parcel 3/- extra.



TRANSISTOR SET CASE. 11½ x 8 x 3in. with carrying handle finished in two-tone grey with gold trim, price 22/6. Set of suitable knobs, 5/- extra. **LEATHERCLOTH COVERED RECORD PLAYER CASE,** suitable for single player unit, etc. Size 14½ x 13 x 6½in., supplied with uncut motorboard, carrying handle, gold trim, available in red/grey and two-tone grey. Price 44/-.

LEATHER CLOTH CASE, as above but suitable for automatic record player, size 14½ x 14½ x 8½in., available in blue/grey, red/grey, price 56/-. Uncut motorboard.

Miniature Jack plug and socket 2/6 set. Miniature Slide Switch 2 pole change over 2/6. Transformers LT.44/700 Driver and Output 8/- pair. Top Quality co-axial Cable semi airspaced 6d. yard. All Co-Axial Accessories available from stock.

PERSONAL EARPHONE

A really sensitive dynamic earphone of exceptionally fine quality. Provides clear reproduction of music as well as speech. Fully guaranteed and complete with ear insert, 3 feet cord, sub miniature plug and socket. **Model CR5** Crystal Earpiece high amp, **Model MR-4** Magnetic earpiece low amp., 6/- each.

"PRACTICAL WIRELESS" POCKET TRANSISTOR SUPERHET



COMPLETE KIT £7.19.6

BUILD YOUR OWN PORTABLE RADIO

FUN TO BUILD!
FUN TO OWN!

★ Up to the minute styling, precision-engineered circuitry and extraordinary tonal quality highlight the design of this popular kit. You'll be proud of its "big set" performance—and doubly proud to have built it yourself!

★ Advanced GEC drift-field transistors, high impedance 2½in. speaker, powerful reflex circuit.

★ Built-in ferrite rod aerial, extremely efficient circuit. Uses popular 9V battery (Ever-Ready pp.4) available everywhere.

★ Attractive high impact ivory case is virtually unbreakable. Two controls—off-on/volume and tuning. Ready drilled circuit board.

The perfect kit for beginners interested in transistor circuits. 52/6.

Complete set of parts and step-by-step pictorial instructions.

★ ALL PARTS SOLD SEPARATELY ★

LOUDSPEAKER CABINETS

Baffle type, walnut finish:—
Type suitable for an 8" unit Price 21/-
Type suitable for a 10" unit... Price 25/6
Types suitable for a 7" x 4" unit Price 17/6

AUTOMATIC RECORD CHANGERS

BSR UA14 £6.19.6
COLLARO C60 £7.19.6
GARRARD AUTOSLIM £7.19.6

SINGLE PLAYERS

EMT. 4 Speed with pick-up £3.15.0
BSR GU6 £4.19.6
GARRARD TA MK11 £8.10.0
EMI BATTERY VERSION..... £5.9.6

J.B. DILEMIN CONDENSER

Solid Dielectric available in 300pF or 500pF, 7/6 each.

A NEW EDITION OF THE ALPHA 60-PAGE HI-FI CATALOGUE

A really up-to-date catalogue illustrating and providing Technical Data on all the latest equipment. Price 2/6, post 6d.

Our new 1962/63 48-page catalogue, profusely illustrated, is now available. Please send 1/- in stamps for your copy. Trade Catalogue also available for which please attach your Business Letter Heading.

"MERCURY SIX" Components Price List for the Printed Circuit Version

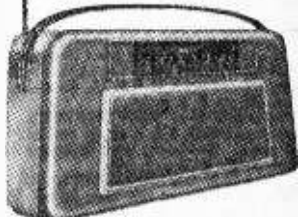

- COIL SET (OSC. and 3 I.F.s) 22/-
- DRIVER TRANSFORMER. 8/3
- Type PW/DT
- OUTPUT TRANSFORMER. 8/-
- Type PW/OT.
- FERRITE ROD AERIAL. 8/6
- Type PW/FR
- 2-GANG CAPACITOR, Type "OO" 12/6
- VOLUME CONTROL, EGEN 10K. 6/6
- S/P SWITCH 3/6
- SWITCH
- TRANSISTOR Type Y.C. (set of 6) 43/-
- XTAL DIODE Type GD9
- SPEAKER 22/5
- CASE complete with handle, front grille, studs 25/-
- CAPACITORS 17/6
- RESISTORS 5/-
- TRIMMERS, Type MT.31/4A, 1/3 ea. 3/9
- PRINTED CIRCUIT BOARD 14/6
- COMPLETE DIAL ASSEMBLY (BOXED) 14/6
- HARDWARE (Screws, Nuts, Washers, Spacers, Battery Clips, Aerial Cradle) 5/9
- Postage and Packing 2/6
- INSTRUCTION HANDBOOK 2/6
- COMPLETE KIT £9.9.0

TRANSISTORS AND DIODES

Transistors	OC75 8/-	OCP71 25/-	OA73 3/-	GECS1
OC35 18/-	OC77 12/-	Matched Prs.	OA79 3/9	Audio 3/6
OC36 21/6	OC78 8/-	2xOC72 16/-	OAB1 2/6	Red 3/6
OC44 6/-	OC81 8/-	2xOC78 16/-	OAB5 3/-	Spot 3/6
OC45 6/-	OC84 8/6	Diodes	OA91 3/3	White 5/-
OC70 6/6	OC170 9/6	OA5 6/-	OA95 3/6	Spot 5/-
OC71 5/-	OC171 10/6	OA5 6/-	Sundry Types	GEX34 3/-
OC72 8/-	OC201 31/-	OA10 8/-	PXA102 4/-	GEX35 3/-
OC73 16/-	OC202 26/-	OA70 3/-		XD201 1/-

A set of Transistors comprising 1 OC44, 2 OC45, 1 OC81D, 2 OC81, 32/6 set. Set of Audio Transistors, 1 x OC81, 2 x OC81, Driver Matched Pair, 15/6 set.



103 LEEDS TERRACE
WINTOUN STREET
LEEDS 7

TERMS: Cash with Order or C.O.D. Postage and Packing Charges extra. Single valves 9d., Minimum Parcel Post charges 2/-. Please include sufficient postage with your order. Minimum C.O.D. fee and postage 3/6. These Postal Rates apply to U.K. only. For full terms of business see inside cover of catalogue. Personal shoppers 9 a.m. to 5 p.m. Mon. to Friday, Saturday 10 a.m. to 1 p.m.

GAZAK: This Month's Bargains

★ SHADED POLE MOTORS ★

230v. or 110v. operation. Ideal for fans, blowers or models.
One only, 12/6, plus 2/- p. & p. Or pair, £1, plus 2/6 p. & p.

AERIAL EQUIPMENT

TWIN FEEDER. 300 ohm twin ribbon feeder, similar K25, 6d. per yard. K35B Telecon (round) 1/6 per yard. Post on above feeder and cable 1/6 any length.

COPPER WIRE, 14 G., H/D 140ft. 17/-; 70ft. 8/6. P. & P. 2/-.

Other lengths pro rata.

RIBBED GLASS. 3in. aerial insulators, 1/9 each. Shell ins 2in. 9d. each. P & P. 1/6. Up to 12.

CERAMIC FEEDER SPREADERS. 6in. type F.S. 10d. each. P. & P. 2/-.

CERAMIC "T" PIECES, Type A.T. for centre of dipoles, 1/6 each. P. & P. 1/-.

2 METRE BEAM 5 ELEMENT W.S. YAGI. Complete in box with 1 - 2 1/2in. mast head bracket. PRICE 49/-.

SUPER AERIAL CABLE. 75 ohms, 300 watts, very low loss, 1/8 per yard. P. & P. 2/-.

ABSORPTION WAVEMETERS. 3.00 to 35.00 Mc/s in 3 switched bands, 3.5, 7, 14, 21 and 28 Mc/s. Ham bands, marked on scale. Complete with indicator bulb. A MUST for any Ham shack, 22/6 post free.

VARIABLE CONDENSERS. All brass with ceramic end plates and ballrace bearings, 50 pF, 5/9. 100 pF, 6/6. 160 pF, 7/6. 240 pF, 8/6, and 300 pF, 9/6. All fitted with rear extension for ganging, P. & P. 1/-.

Also Flexible Couplers, 1/- each. **B.I. 8 MFD.** 1,200 v. D.C. W/kg. Capacitors, 12/6 each. P. & P. 2/-.

CHAS. H. YOUNG LTD.

★ THE COMPONENT SPECIALISTS

Dept. "P", 110 Dale End, Birmingham 4. (CEN 1635)
(No C.O.D. under £1 please). (By return service)

RECONDITIONED TV SETS

ALL MAKES ★ ALL FULLY SERVICED ★ ALL GUARANTEED ★ NOT EARLY CONVERTED MODELS

14" from £6.0.0 to £9.0.0

3-month Guarantee on Tube and Valves

17" from £11.10.0 to £20.0.0

12-month Guarantee on Tube, 3-month on Valves

WE ALSO STOCK SLIM-LINES

from £23.0.0 to £33.0.0

These sets are as new

PERSONAL COLLECTION ONLY TO ENSURE SATISFACTION

REBUILT TV TUBES

All our TV Tubes are reprocessed to a high standard and are covered by a 12 MONTHS' GUARANTEE. Each tube is fitted with a new, top-grade electron gun, which is identical with the original, ensuring exact plug-in replacement.

21", £6. 17", £5.10.0. 12", 14" and 15", £4.10.0

★ Personal collection advised, carriage by arrangement only. £1 refunded from the above price if you return your old tube.

PARK LANE RADIO LTD.

548 ROMFORD ROAD, MANOR PARK, E.12
Phone: ILF 6044

FIELD'S RADIOCENTRE

67 LONDON ROAD 94 HURST ST.
CROYDON, Surrey BIRMINGHAM 5
CRO 1512 MID 7072

CALLERS WELCOME.

All mail orders to CROYDON address, Dept. P.W.

SHORT WAVE CONDENSERS. Ex. R.F. Unit No. 26 and 27. Brand new, 75 plus, 75pF/d, silver plated, 2/6, plus 1/- P.P.

CARBON HAND MIKES. New with Press switch as used with No. 18 set. 5/- each. P.P. 2/-.

SMOOTHING CHOKES. New. Ex-Govt. 10 henry, 100 mA. Fully shrouded, 5/- each, P.P. 2/-.

PRINTED CIRCUIT KIT. With Plastic Bath, 100 sq. ins. board and all chemicals, with full instructions. 17/6 inc. postage.

F.M. LOFT AERIALS. Single dipole type, 12/8. P.P. 2/6.

COAXIAL CABLE. Low loss type, 10 yds. 5/-, P.P. 2/-; 15 yds. 7/6, P.P. 2/6.

THROAT MICS. New, boxed as used on W.S.38. 3/6, P.P. 1/6.

TUNING CONDENSERS, AIR SPACED. With slow motion drive 0.0003 plus 0.0005 on one gang. Can be used separately. 3/6, P.P. 1/-.

MICROPHONE STANDS. Two section telescopic, extend to 6 ft. Chrome-plated stem, heavy base. As used with BM3, DX29, MC70, DM176, MICS. £2.5.0, P.P. 4/-.

PRINTED CIRCUIT BOARD. 12 x 6in. 4/-, inc. postage.

ALUMINIUM SHEET, 16 x 16in., 18 gauge, 6/-, P.P. 1/6.

—TRANSISTORS—

Revitalize your set. Fit the famous TS1 by BRIMAR in place of those red spots. ONLY 3/6 each.

White Spot 2/6, OC44 6/-, OC45 7/-, OC70 6/-, OC71 6/6, OC72 7/- (14/6 pr.), OC76 8/-, OC81D 7/-, OC81 7/-. Crystal Diodes. 10,000 sold and never a complaint, ONLY 1/- EACH. EVERY TYPE OF MULLARD TRANSISTOR DIODE AND OTHER COMPONENTS AT LIST PRICE. By Return. Connecting wire. 6 assorted colours, 1 yard each colour, 1/9, 2 yards 2/9, 10 yards 10/6.

Resistors, all values, 10% 1/2 watt, 6d. ea. Ferrite Rod, 3 x 1/2 in. 1/6.

—all prices post paid—

OAKFIELD RADIO
121 MACCLESFIELD ROAD, HAZEL GROVE,
STOCKPORT, CHESHIRE
SAVE POUNDS BARGAIN LIST 6d.
MAIL ORDER ONLY

RES/CAP. BRIDGE 39/6

p. & p. 2/6
Checks all types of resistors, condensers
6 RANGES

Built in 1 hour. Direct reading

READY CALIBRATED
Stamp for details of this and other kits.

RADIO MAIL (Dept. PH)
Raleigh Mews, Raleigh Street, Nottingham

SOUTHERN RADIO SUPPLY LTD.

11 LITTLE NEWPORT STREET
LONDON W.C.2. GER 6653

All goods still available
as previously advertised

Everyman's guide to
astronomy—a fascinating
book—

FOCUS ON STARS

Julius D. W. Staal, F.R.A.S.

Today, probably more than ever before, astronomy is a vital study. This fascinating book by a distinguished astronomer is an account of the universe which will be a practical inspiration to both the layman and the amateur astronomer. The reader will experience a real pioneering excitement as astronomical calculations are made step by step and the wonderful workings of the heavens are unfolded. Clear and simple diagrams are used to illustrate the cause of the tides, the complex motion of the earth, the seasons of the other solar planets, eclipses, the nature of galaxies. Monthly star charts give a unique all-the-year-round guide. The author was previously at the London Planetarium.

292 pages, 16 plates, numerous figures and 12 star charts.

40s. FROM ALL BOOKSELLERS

...or, in case of difficulty, 41s. 6d. by post from George Newnes Ltd., Tower House, Southampton St., London, W.C.2.

NEWNES

Just a few of our BARGAINS



1. **SUPER 5 TRANSISTOR POCKET RADIO INCORPORATING PRINTED CIRCUIT & MINI-EARPIECE.** No Aerial or Earth required. 4 1/2 x 3 1/2 x 1 1/2 in. Output 200 m.w. 5 first quality transistors. High flux moving coil speaker. M/L Internal high gain ferrox aerial. £2.19.6. P. & P. 3/6. Circuit diagram 1/6, free with parts. All parts available separately.
2. **TRANSISTORISED POCKET RADIO** with printed circuit, mini-earpiece, high gain ferrox slab aerial. No aerial or earth required. To build yourself for completely personal listening. 4 1/2 x 3 1/2 x 1 1/2 in. Luxurious in favourable prices. Only 21/- P. & P. 3/6. All parts available separately.
3. **A.C./D.C. POCKET MULTI-METER KIT.** 2in. moving coil meter scale, calibrated in A.C./D.C. volts, ohms and milliamperes. Voltage range A.C./D.C. 0-50, 0-100, 0-250, 0-500. Milliamps 0-10, 0-100. Ohms ranges 0-10,000, 0-100,000, 24/8. P. & P. 2/-. Wiring diagrams 1/-, free with parts.
4. **SIGNAL GENERATORS.** Cash £75.0, or 30/- deposit and 6 monthly payments of 21/6. P. & P. 5/6. Coverage 100 kc/s to 100 Mc/s on fundamentals and 100 Mc/s to 200 Mc/s on harmonics. Case 10 x 6 1/2 x 3 1/2 in. Three miniature valves and Metal Rectifier. A.C. mains 200/230 v. Internal modulation of 400 c.p.s. to a depth of 30 per cent. Modulated or unmodulated R.F. output continuously variable 100 millivolts. C.W. and mod. switch, variable A.F. output. Magic eye as output indicator. Accuracy 2 per cent.
5. **SIGNAL GENERATORS.** Cash £55.0. P. & P. 5/6. Coverage 120 kc/s to 84 Mc/s. Case 10 x 6 1/2 x 4 1/2 in. Size of scale 6 1/2 x 3 1/2 in. 2 valves and rectifier. A.C. mains 230-250 v. Internal modulation of 400 c.p.s. to a depth of 30 per cent. modulated or unmodulated R.F. output continuously variable 100 millivolts. C.W. and mod. switch variable A.F. output and moving coil output meter. Accuracy ± 2 per cent.
6. **STAA 45.** 9 v. **BATTERY RECORD PLAYER** complete with pick-up and deck. A completely portable player. Head protected by plastic dome with a brush which cleans the stylus as it rises into playing position. 45 r.p.m. Auto on/off switch governed motor, attractive two tone grey finish, £2.14.8. P. & P. 2/-.
7. **CARRYING CASE** for STAA 45 or COMPLETE KIT beautifully styled in two tone with record compartment. Specially designed to take player and amplifier. Just screw in and connect up. All parts available separately. Case only 22/8. P. & P. 4/-. Complete kit £5.10.0. P. & P. 5/-.
8. **TRANSISTORISED AMPLIFIER,** suitable STAA 45. Output 1 watt. Size 4 1/2 x 2 1/2 in. Printed circuit, tone/volume controls plus 4 transistors. Push-pull output complete with 2in. moving coil speaker. Built and tested 45/8. P. & P. 2/-.
9. **CHANNEL TUNER L.F.** 16-18 Mc/s. Continuously tunable from 174-216 Mc/s. Valves required—PCF30 and PC34 (in series). Cover BBC and ITA ranges. Also Police, Fire and Taxia, etc. Brand new by famous maker, 10/-. P. & P. 3/-.
10. **B.S.R. MONARCH UAS WITH FUL-PI HEAD.** 4-speed, plays 10 records, 12in., 10in. or 7in. at 16, 33, 45 or 78 r.p.m. Internals 7in., 10in. and 12in. records of the same speed. Has manual play position: colour brown. Dimensions: 12 1/2 x 10 1/2 in. Space required above baseboard 4 1/2 in. below baseboard 3 1/2 in. Fitted with Ful-Pi turnover crystal head, £6.19.8. P. & P. 5/6.
11. **PUSH-PULL OUTPUT STAGE** inclusive of transistors with input and output transformers to match 3 ohms speech coil, suitable for use with the POCKET RADIO. Kit of parts, including transistors, 19/8. P. & P. 2/-. Wiring diagram 1/6, free with parts.
12. **2-watt PUSH-PULL 4 VALVE AMPLIFIER** plus METAL RECTIFIER. A.C. mains 200-250 v. Size 10 1/2 x 6 1/2 x 2 1/2 in. 5 valves. For use with all makes and types of pick-up and mike. Negative feedback. Two input, mike and gram, and controls for same. Separate controls for Base and Treble lift. Response flat from 40 cycles to 18 kc/s. 2 db down to 20 kc/s. Output 2 watts at 5 per cent total distortion. Noise level 40 db down all hum. Output transformer tapped for 3 and 15 ohms speech coils. For use with 8td. or L.P. records, musical instruments such as guitars, etc. Suitable for small halls. £3.19.6. P. & P. 6/-. Crystal mike to suit 15/-. P. & P. 2/-. 5in. P.M. Speaker to suit. 12/8. P. & P. 2/-.
13. **INDOOR AERIAL** for ITV/BBC/FM. Complete with standard co-aerial plug. Heavy chrome extending dipoles—7ft. fully extended. Plugs straight into TV or VHF Tuner. Fully directional, 10/6. P. & P. 1/6.
14. **NO MORE FLAT BATTERIES.** Charge your own battery overnight with this wonderful little charger. Output 6 and 12 volts, 2 amps. Input 200-250 v. A.C. mains. Mains fuse incorporated. Attractive silver hammer finished case. 6 x 3 x 3 ins. Complete with leads and battery clips only 21/-. P. & P. 3/6.

RADIO & T.V. COMPONENTS
[ACTON]
LIMITED

21b HIGH STREET
ACTON, LONDON, W.3.
ALL ENQUIRIES S.A.E.
GOODS NOT DESPATCHED OUTSIDE U.K.

Lewis have the Cabinet for you

We can supply any cabinet to your own specification. This is only one example of—

THE LARGEST RANGE OF CABINETS IN THE COUNTRY

Equipment is also our speciality.



The Grosvenor
Price 15 gns.



The Lowboy
Price 24 gns.

LEWIS radio

100(P23) Chase Side, Southgate, London, N.14. Tel 3733/9666

Send today for the two new Lewis Catalogues

Designed to assist your choice of cabinet and equipment.

THE New Lewis Radio Cabinet Catalogue—the most comprehensive ever prepared. THE unique 64 page equipment catalogues.

Please send your two new catalogues enclosed in P.O. for 3/6 which will be credited against any purchase I make.

Name _____

Address _____

NEW YEAR LOW PRICES

TRANSISTORS

GREEN SPOT A.F. 3 v. Down to 1/3.
YELLOW SPOT A.F. 6 v. Now 1/6.
RED SPOTS. Now only 1/9.
WHITE SPOTS 2/6 each.

The LATEST MICRO-ALLOY TYPE
MAT100 7/9, MAT101 8/6, MAT120 7/9,
MAT121 8/6.

MULLARD TRANSISTORS

OC70 6/6, OC71 6/6, OC72 8/-, OC81 8/-,
Matched Pairs OC72 or OC81 16/-, OC78
8/-, OC44 or OC44M 9/3, OC45 or OC45M
9/-, OC170 9/6, OC171 10/6, AF102 27/6,
AF114 11/-, AF115 10/6, AF116 10/-,
AF117 9/6.

TRANSISTOR HOLDERS 3- or 5-pin 1/4.
MINIATURE SURPLUS DIODES 3
for 2/- or 7/- doz. BTH Diodes CG12E
1/6 each.

MULLARD OA70, OA79, OA81, or
OA90 all 3/- each.

REANCO TRANSISTOR TRANS-
FORMERS. TT49 Interstage, TT45 Driver,
TT46 Output or TT47 Driver, all 5/- each.
FR2 Ferrite Rod Aerial 12/6.

DRX1 Crystal Set Coil M & L with Circuit,
2/6. EARPIECES, Crystal or Low Imp
Type 6/- each. Magnetic 250 ohm Type, 8/6.
TRANSISTOR Driver and Output Trans-
formers, Type LT44 & LT700, 8/- pr.

ALL SENT POST FREE IN U.K. by

PETHERICK'S RADIO SUPPLIES

22 High Street, Bideford, N. Devon
Tel.: Bideford 1217



The PUNCH you need!

HOLE PUNCHES

Instant Type	6/10 ea.
3/8" diameter	8/6
3/8" diameter	B7G	9/-
3/8" diameter	B8A, B9A	9/6
1/2" diameter	10/2
1/2" diameter	10/8
1/2" diameter	11/8
1/2" diameter Int.	13/4 ea.
1/2" diameter	16/2
1/2" diameter	18/10
1/2" diameter	B9G	21/8
1/2" diameter	24/4
2 1/2" diameter	Meter	33/2

Complete Set £8.15.0.

All the above prices include postage and packing.

Oliver & Randall Ltd

Dept. 7
40 PERRY HILL, LONDON, S.E.6
Tel.: Forest Hill 3415

NEW VALVES!

Guaranteed Set Tested
24-HOUR SERVICE

1R5, 1S5, 1T4, 3S4, 3V4, DAF91, DF91, DK91, DL92, DL94, SET of 4, 18/-.				
DAF96, DF96, DK96, DL96, SET of 4, 25/6.				
1D5	7/-	DL92	5/11	PCL82 8/3
1R5	5/6	DL94	6/9	PCL83 10/-
1S5	4/8	EB36	6/9	PCL84 9/9
1T4	3/3	EB91	3/-	PENDD4020
3S4	5/11	EBC41	7/6	
3V4	6/9	EBF80	7/9	PL36 9/6
5U4G	4/6	ECL21	12/-	PL81 8/6
5Y3GT	5/3	ECC40	13/-	PL82 6/6
5Z4G	8/6	ECC81	4/6	PL83 6/6
6AM6	2/9	ECC82	4/6	PL84 8/-
6K7G	1/9	ECC83	6/3	PY31 8/8
6X8G	4/9	ECC84	7/6	PY32 11/-
6Q7G	5/6	ECC85	7/6	PY80 7/-
6V6G	4/-	ECC86	6/9	PY81 6/6
6X5GT	6/6	ECC82	8/3	PY82 6/-
12K7GT	4/3	ECH42	7/9	PY83 7/3
12K8GT	9/-	ECL90	6/9	U25 11/-
12Q7GT	4/6	EF40	11/-	U26 8/9
12SN7GT	7/3	EF41	7/6	UABC80 6/-
35L6GT	8/-	EF90	4/3	UAF42 8/6
35Z4GT	5/-	EF85	5/9	UBC41 7/-
AZ31	8/9	EF86	8/6	UBP80 8/-
CL33	9/6	EF89	6/9	UCC85 7/-
DAC32	8/9	EF91	2/9	UCH21 11/6
DAF91	4/6	EL41	9/6	UCH42 7/8
DAF96	6/9	EL84	6/3	UCH81 8/9
DF91	3/3	EY81	7/3	UCL82 9/3
DF96	6/9	EY86	6/9	UCL83 13/-
DH77	6/-	EZ40	6/-	UF41 6/9
DH82	10/6	EZ80	5/9	UF89 6/9
DK91	5/6	EL14	5/6	UL41 8/6
DK92	6/9	PCC84	6/9	UY21 10/6
DK96	7/3	PCC89	9/-	UY41 5/6
DL33	7/6	PCF80	7/6	UY85 6/3
DL35	9/6	PCF82	7/6	Z77 2/9

Postage 6d. per valve extra. Any Parcel Insured Against Damage in Transit 6d. extra. Any C.O.D. Parcel 3/- extra. Office address, no callers.

GERALD BERNARD

(Note new address—formerly of Leeds)
83 OSBALDESTON ROAD,
STOKE NEWINGTON, LONDON, N.16

H.A.C. SHORT-WAVE EQUIPMENT

AND

SHORT-WAVE KITS

Famous for over 25 years for S.W. Receivers and Kits of Quality.

H.A.C. were the original suppliers of SHORT-WAVE RECEIVER KITS for the amateur constructor. Over 10,000 satisfied customers—including Technical Colleges, Hospitals, Public Schools, Hams, etc.

Improved designs with Denco coils: One-valve Kit, Model "C", Price 25/-. Two-valve Kit, Model "E", Price 50/-. New Addition: Model "K", Super sensitive "All Dry" Receiver. Special inc. price. Complete Kit, 77/-.

All kits complete with all components, accessories and full instructions. Before ordering call and inspect a demonstration receiver or send for descriptive catalogue and order form.

POST THIS COUPON NOW!

"H.A.C." SHORT-WAVE PRODUCTS
(Dept. TH), 44 Old Bond Street,
London, W.1

Please send me FREE and without obligation your 1963 literature.

NAME

ADDRESS

NOW ANYONE CAN AFFORD TO TRAIN TO BE AN EXPERT IN RADIO and ELECTRONICS

EVEN QUALIFY FOR A
CERTIFICATE

It's the most exciting news of the year! Just imagine. You can get 35 large, fact-packed lessons for little more than 1/- per lesson! The lessons are crystal clear, practical easy to master and use. Early lessons make fundamentals clear even to the beginner, while other lessons will give you the practical "know-how" of an expert.

Compare favourably with some courses costing ten times as much. You save because you receive all the lessons at one time and are not required to purchase equipment you do not need.

This is a real home-study course that has been bound into one giant 8 x 11in. 216 page manual. Each page is divided into two columns. A wide column features the text, while a narrow column at the side has the instructor's comments, helpful suggestions and additional pictures to simplify the difficult parts.

Everyone can benefit from this practical course. No old fashioned (or pseudo modern) methods used here, just straight forward, easy to understand explanations to help you make more money in electronics.

As an optional extra, you may pay a further fee if you wish to take the Sim-Tech radio and electronics examination. Students who attain a minimum of 60% correct answers can qualify for a certificate of proficiency in basic radio and electronics. Details sent with each course ordered.

You must be convinced that this is the best value you have ever seen in electronic training, otherwise you can return the manual (or have your money refunded if sent with order) after you have examined it in your own home for a period of seven days.

The price? Only 36/-, plus postage.

FREE TRIAL OFFER!

To SIM-TECH TECHNICAL BOOKS, Dept. WA2, Gater's Mill, West End, Southampton, Hants.

RUSH Radio and Electronics Course for seven days, examination. If I keep the course I can either pay 37/6d. cash or 12/6d. deposit after seven days and two payments of 12/6d. monthly. Otherwise I will return the course post-paid and owe nothing.

SAVE! Send only 36/- if paying cash with order. (We pay postage.) Same 7-day money-back guarantee.

Name _____
Address _____
City _____ County _____

THE NEW "CONTESSA"

Mk. III

The Best is Now Even Better!
A brilliant conception of the finest 2-band 6-transistor radio available.

★ Ultra-modern styling with a magnificent two-tone cabinet fitted with fully expanded metal front and a slide-rule type waveband dial. GREATER OUTPUT using the latest high efficiency Mullard Transistors and Diodes, incorporating an improved design, featuring different circuit constants.

MORE punch—MORE gain—MORE stations—SUPERB appearance—the NEW "Contessa" scores again!!
SEE it—HEAR it—you will BUY it!

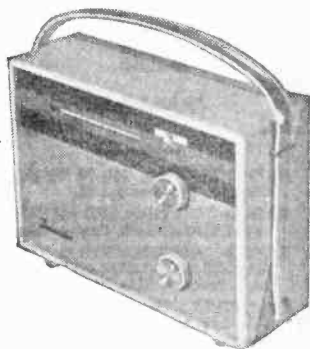

- ★ Waveband coverage of 530 kc/s to 1,620 kc/s and 160 kc/s to 270 kc/s.
- ★ Assured reception of at least half a dozen stations in daylight!
- ★ Large clearly-etched station-named dial.
- ★ Internal high-gain Ferrite aerial.
- ★ 5 : 1 ratio slow motion tuning.
- ★ Fitted with the latest 12,000-line high-flux loudspeaker.
- ★ Power of 600 milliwatts from the single-ended push-pull final stage.
- ★ Special designed aerial matching coil for use in a CAIT.
- ★ Only first-grade Mullard fully-guaranteed matched transistors and diodes are used.
- ★ Tape recorder socket provided.
- ★ Double-tuned IF transformers for maximum gain and knife-edged selectivity.
- ★ Fully drilled printed circuit panel marked with component numbers.
- ★ The two-tone case outer measurements are 10 1/2 x 7 1/2 x 3 1/2 in. and weighs approx. 4 lbs. when assembled.
- ★ Battery lasts 4 months with normal usage.
- ★ Book supplied with detailed assembly instructions, diagrams and circuitry.
- ★ Anyone can build this set—everything supplied, just a soldering iron required.
- ★ Cabinets available in two tone beige and two tone blue.
- ★ Adjustable carrying handle.

Inclusive price for all associated components, cabinet and battery, complete in every detail: Or our BUY AS YOU BUILD SCHEME, any parts sold separately. Send for comprehensive descriptive Manual and parts List, 2/10 post free.

£10.19.6

(Plus 3/6 P. & Pkg.)

You can hold Europe in the palm
of your hand with—

THE "CAPRI"



A miniature pocket transistor Radio that REALLY works, retaining the most attractive features of the famous "Contessa." Six first-grade Mullard transistors plus diode are employed in a highly sensitive superhet MW and pre-set LW circuit embodying the most modern design practices. A special 2 1/2 in. high gauss loudspeaker provides surprising volume and a personal earpiece socket is also available. An attractive two-tone plastic case is supplied in two colours—Ivory/red or Ivory/blue, the full constructional details being furnished with each set of parts. The total measurements of the "Capri" are 4 1/2 x 2 1/2 x 1 1/2 in.

SEE AND HEAR A WORKING MODEL TODAY

Inclusive price for all associated components, case and constructional data, complete in every detail. HUGE NEW PURCHASES HAVE ENABLED US TO REDUCE THE PRICE TO ONLY (9 volt battery 2/6 extra.) Or our BUY AS YOU BUILD Scheme. Any parts sold separately.

£5.19.6

(Plus 2/- P. & Pkg.)

STAMPED and ADDRESSED ENVELOPE with any enquiry please. But regret no lists or catalogues—our stocks move too quickly!
PLEASE ALLOW FULL POSTAGE AND PACKING CHARGES
Terms of Business:
CASH WITH ORDER OR C.O.D. ON ORDERS OVER 10/-.

RADIO CLEARANCE LTD.

27 TOTTENHAM COURT RD., LONDON W.1

The oldest Component Specialists in the Trade

TRADE ENQUIRIES INVITED Telephone: MUSEUM 9188

EST. 30 YRS.

RADIO DATA REFERENCE BOOK

An R.S.G.B. Pub:

12/6 Postage 1/-

INTRODUCING HI FI by A. H. Rasheed. 6/-. Postage 6d.

RADIO-CONTROLLED MODELS, by F. J. Camm. 12/6. Postage 6d.

RADIO ENGINEERING FORMULAE & CALCULATIONS, by W. E. Pannett. 21/-. Postage 6d.

PRINCIPLES OF COLOUR TELEVISION, by G. N. Patchett. 16/-. Postage 6d.

GEC TRANSISTOR MANUAL. 16/-. Postage 1/2.

AMATEUR RADIO CALL BOOK, 1963 ed., by R.S.G.B. 4/6. Postage 6d.

RADIO VALVE DATA, 7th Ed. Compiled "WV". 6/-. Postage 10d.

CIRCUITS FOR AUDIO AMPLIFIERS, by Mullard. 8/6. Postage 1/-.

COMPLETE CATALOGUE 1/-.

THE MODERN BOOK CO.

BRITAIN'S LARGEST STOCKISTS of British and American Technical Books

19-21 PRAD STREET LONDON, W.2

Phone: PADdington 4185
Open 6 days 9-6 p.m.

FIRST-CLASS RADIO AND T/V COURSES... GET A CERTIFICATE!

After brief, intensely interesting study—undertaken at home in your spare time—YOU can secure a recognised qualification or extend your knowledge of Radio and TV. Let us show you how.

"FREE GUIDE"

The New Free Guide contains 120 pages of information of the greatest importance to both the amateur and the man employed in the Radio industry. N.I.E. provides first-rate postal courses for Radio Amateur, Exam., R.T.E.B. Servicing Cert., C. & G. Telecoms, Grad. Brit. I.R.E. Guide also gives details of range of diploma courses in Radio/TV Servicing, Electronics and other branches of engineering, together with particulars of our remarkable Guarantee of

SUCCESS OR NO FEE
Write now for your copy of this invaluable publication. It may well prove to be the turning point in your career.
FOUNDED 1885—OVER 150,000 SUCCESSES

NATIONAL INSTITUTE OF ENGINEERING
(Dept. 461), 148 HOLBORN LONDON, E.C.1

S. Africa: P.O. Box 8417, Jo'burg.
Australia: P.O. Box 4570, Melbourne.

PADGETTS RADIO STORES

OLD TOWN HALL, KNOWLER HILL, LIVERSEDEGE, YORKS.
Phone: Cleckheaton 2866

Type 46. HX-TX. Complete with two ARP12, one AR8, one ARTP2, one APT4, one AFP37, less crystals, coils and send-receive switch, but otherwise complete. These sets are in new condition, 8/6. Post 3/8. Grade two store soiled, 4/6. Post 3/9.

Bomb Computers in new condition. Full of gears, motors, etc. 30/-. Carr. B.R.S. 10/-.

P.M. Speakers, all 3 ohms. Removed from TV sets, perfect condition. Rola 6 x 4in. 5/-. Goodmans 7 x 4in. 6/-. Phillips 5in. round. 5/-. Rola 4in. A round. 3/6. 8in. dish. 5/-. 8in. round. 8/-. Post extra on any speaker 2/-. Up to six can be sent for 3/6.

Germanium Diodes, 4/6 per doz. Post free.

Grade 1 Transistor Type X.A. 101, 3/6; post free, 30/- per doz.

New Boxed Valves, Post free. ARP12, 1/6, 6 for 5/6. Box of 50, 20/- X41, 4/- 6K7, 2/- 6L6 Metal 7/-, 6V6GT 5/-, VR150/30 3/6, 6C4 2/-, 9001 9d., 5/- doz., 6V5 3/-, EL91 1/8. Also new valves ex-units, EF91 1/8, EB91 1/9, 5Z4 5/6, 6X5 4/6, 12A6 Metal 2/6, 5U4 2/6, 6U6 2/6, 807USA 5/-, 6V6 3/-, 6V6GT 4/-, AC/2 pen 4/-, 12AT7 2/6, EF50 6/- per doz., 1/8 each, 6P6 2/8.

Valves removed from TV sets, all post free, all tested on a Mullard valve tester and are 100% as new. They carry a three months Guarantee. We also have a large stock of old type radio valves and other TV valves not listed.

EC180 4/-, ECC82 5/-, EL38 4/-, EY51 2/6, EBFR0 4/6, EB91 9d., EF91 9d., 6P1 1/-, 6P13 2/-, 6P14 5/-, 6LD20 5/-, 6SN7 2/8, 6V6 2/6, 806 2/6, 6SS7 2/-, 10C2 5/-, 10F1 1/-, 10P13 5/-, 10P14 5/-, 20D1 3/-, 20P1 5/-, 20L1 5/-, 18BT 8/6, U281 5/-, U282 5/-, U329 5/-, KT36 5/-, PL81 5/-, PL82 5/-, PY81 4/-, PY82 5/-, PY80 5/-, PZ30 4/-, PCF80 4/6, PCC84 4/6, PL83 5/-, PL33 4/-, B36 4/-, N31 5/-, L83 3/-, 6J5 3/-, 2SU 5/-, U12 4/-, EP80 1/6, 10/- per doz. Grade 2 6d., 4/- per doz.

Perfect Reclaimed Tubes, 6 months guarantee. 12in., 17/-, 14in., 30/-, Carr. and Ins., 7/6.

TV Tubes Completely Rebuilt and refaced. 12 months guarantee. Old glass not required. 12, 14, 15, 16, 17 in., any make. All the special trade price of £3.15.0. Carr. and Ins., 7/6.

½ H.P. Motors 1400 R.M.P. 230-250 volts. Removed from washing machines. 25/- carr. 7/-.

THE HIKER

A new Transistor Portable design from **REPANCO**

- ★ 4 Transistors.
- ★ Long and Medium wave
- ★ Super Regenerative T.R.F.
- ★ Printed Circuit.
- ★ Easy to Build.
- ★ Chassis size 8½ x 2½in.
- ★ 3 ohm output.
- ★ Ferrite Rod Aerial.

Envelope of easy Wiring Plans and Instructions 1/6 (Post 3d.).

RADIO EXPERIMENTAL PRODUCTS LTD.
33, Much Park Street, Coventry.

2 METRES!

The thrills of 144 Mc/s can now be yours for only 39/6, complete kit! Tunable range 150-100 Mc/s, simplified construction, etc., write today for descriptive literature, also if a newcomer-beginner to Amateur Radio ask for free copy of the world-famous "Globe-King" kits and receivers—stamp to cover postage costs appreciated. Write now to makers:

JOHNSONS (Radio)
St. Martins Gate, Worcester

BBC · ITV · F.M. AERIALS



B.B.C. (BAND 1). Telescope loft, 19/6. External, 39/6.
ITV. (BAND 3). 3 Element loft array. 24/-, 5 Element, 32/6. Wall mounting, 3 Element, 33/6. 5 Element, 41/3.
COMBINED B.B.C. + ITV. Loft 1+3 Element 41/3. 1+5 Element, 49/6. Wall mounting, 1+3 Element, 56/3. 1+5 Element, 63/8. Chimney and mast mounting units also available.

F.M. (BAND 2). Loft "H", 28/-, 3 Element loft, 52/6. S/D loft, 12/6. External S/D, 26/3. State channel when ordering. C.W.O. or C.O.D. P.P. 2/6. Coaxial cable, 8d. yd. Coaxial plugs, 1/3. Send 6d. stamps for illustrated lists.

K.V.A. ELECTRONICS (Dept.P.W.)
3B, Godstone Road, Kenley, Surrey

WORLD RADIO & T.V. HANDBOOK 1963 22/-

By JOHANSEN. Postage 1/-

Amateur Radio Handbook, by R.S.G.B., 34/-, postage 2/6.
Principles of Colour Television, by Patchett, 16/-, postage 9d.
Introducing HI-FI, by Rasheed, 6/-, postage 6d.
Sound and Cine for Beginners, by Golding 7/6, postage 8d.
Radio Servicing Pocket Book, by Hawker, 12/6, postage 9d.
Servic Valve Equivalents, new ed., by R.S.G.B., 3/-, postage 6d.
Mullard, Transistor Radios, circuitry and Servicing, 5/-, postage 6d.
R.S.G.B. Call Book, 1963 ed., 4/6, postage 6d.

UNIVERSAL BOOK CO. 12 Little Newport Street, London, W.C.2 (adjoining Lisle Street)

18,000 O.P.V. MULTIMETER KIT

Ranges 0-0.25 and 2.5 V DC; 10, 25, 100, 250, 500, 1000 V A.C. DC, and output volts: Ohms 100 ohms to 10 Meg. (two ranges); 0.25, 2.5, 25, 250 mA DC (2.5A range 4/- extra). Kit comprises new 3 x 2½in. Weston 0-50 microamps m.c. meter, all 1% multipliers, 1% ready adjusted shunts, padding resistor adjusted for each meter, 3 other resistors, 1 condenser, meter rec. knobs, switches, sockets, pots, circuit, instructions, wiring diagram (ohms, dB, uF, mA & V, 10V AC scales) i.e. everything except case and battery. Details of 200 pF—0.5uF range. Price 69/-, post free. Circuit, scale, etc. 9d. Free with Kit. Scale fitted to meter 2/6 extra. 1% High Stability Resistors. Complete range 2/-. Special 0.5%, 100, 10K, 100K, 1/6 each.

PLANET INSTRUMENT CO.
25 DOMINION AV. LEEDS, 7

Brand new, individually checked and guaranteed

VALVES

AL60	6/-	EABC80	7/3	EP72	5/-
AR8	5/-	EAC91	3/6	ESU208	6/-
ARDD5	2/-	EAC91W	7/6	EY51	8/-
ARP3	3/-	EB34	1/6	EY86	8/-
ARP4	3/6	EB91	3/9	EY91	3/-
ARP12	3/-	EB33	7/1	EZ40	7/-
ARP21	5/6	EB41	7/9	EZ41	6/9
ARP24	3/6	EB90	5/-	EZ80	6/9
ARP34	4/-	EC52	8/-	EZ81	6/9
ARTH2	7/-	EC70	10/-	FW4/500	6/6
ATP4	2/9	EC90	20/-	G1/236G	9/-
ATP7	5/6	EC91	3/-	G120/1B	9/-
AU1	5/-	ECC81	5/6	GL450	10/-
AU4	5/-	ECC82	6/6	GL464A	10/-
AW3	4/-	ECC83	7/-	GZ20/2140/-	9/-
AZ31	7/-	ECC84	7/-	GU32	2140/-
BS4A	5/6	ECC85	8/-	H63	7/-
BT45	15/-	ECC91	4/-	HK54	5/-
BT9B	20/-	ECF80	10/6	HL23	6/-
BT83	22/6	ECF82	8/6	HL23DD	6/-
CV54	5/-	ECH81	7/6	HVR2	12/6
CV71	3/-	ECL80	7/6	KRN2A	19/-
CV102	1/-	ECL82	8/6	KT32	8/-
CV264	20/-	EF36	3/6	K78	22/6
CV4014	8/-	EF37A	7/-	KT33C	4/-
CV4015	7/-	EF39	4/-	KT44	6/3
CV4025	10/-	EF50	1/6	KT63	5/-
CV4046	40/-	EF54	3/3	KT76	10/-
CV731	6/-	EF55	5/-	KTW61	6/-
D1	1/6	EF70	4/-	KTW62	6/-
D41	3/3	EF73	6/-	KTW63	6/6
D77	4/3	EF80	5/6	KTZ41	6/-
DA30	12/6	EF85	6/6	KTZ63	8/-
DAF70	35/-	EF86	7/-	MH4	3/6
DAF91	6/-	EF89	7/-	MH41	5/-
DAF96	7/6	EF91	3/6	ML4	4/-
DD41	4/-	EF92	3/-	ML6	6/-
DET5	15/-	EF95	5/-	MS/PEN	6/-
DET19	3/6	EL32	3/9	OB3	7/-
DET20	2/-	EL33	7/-	OC3	5/6
DF39	4/-	EL35	6/-	OD3	6/-
DF72	7/6	EL41	8/-	OZ4	4/-
DF91	4/-	EL42	8/-	PCC84	7/-
DF96	7/6	EL84	7/-	PCC85	7/-
DK96	7/3	EL91	4/6	PCF80	8/-
DL92	6/-	EM80	8/-	PCF82	8/-
DL94	6/-	EM84	9/-	PCL82	8/6
DL96	7/6	EN31	10/-	PCL83	10/-
EA50	1/6	EP71	6/6	PCL84	9/-

PEN45	4/6	VP23	3/-	6AK7	6/-
PEN46	5/-	VP41	5/6	6AM5	5/-
PEN65	6/6	VR99	8/-	6AM6	4/-
PEN220A	3/-	VR105/305/6	6/-	6AQ5	7/-
PL36	10/6	VR150/30	6/-	6AT6	5/-
PL81	9/-	VT4C	25/-	6B7	5/-
PL82	8/-	VU39	6/-	6B8G	2/6
PL83	8/-	WX31	7/-	6BA6	5/6
PT15	10/-	X66	8/-	6C4	2/6
PT25H	7/6	Y63	5/-	6C5	6/-
PX4	19/-	Y65	4/-	6CFG	4/-
PX25	9/-	Y66	8/-	6CG6	3/-
PY32	12/-	Z31	6/-	6C8G	5/-
PY80	6/9	IA3	3/-	6D6	3/-
PY81	7/-	IA5GT	5/-	6F5G	5/3
PY82	7/-	IC5GT	7/6	6F6G	4/-
PY83	7/3	ID8GT	6/-	6F7	5/-
PZ1-35	9/-	IE7G	7/6	6F5GT	5/9
QP21	6/-	IG6GT	6/-	6F8G	5/-
QP25	5/-	IL4	3/-	6F12	4/6
Q595/10	6/9	ILD5	5/-	6F13	5/-
QV04/7	7/-	IR5	6/-	6F33	3/6
R3	8/-	IS4	5/-	6G6G	2/6
RX/10	4/-	IS5	5/6	6H6M	1/6
REL21	25/-	IT4	4/-	6J5	3/6
RK34	2/6	IW4	6/-	6J5G	3/-
RX235	10/-	2A3	5/-	6J6	3/6
SP2	3/6	2A5	6/-	6J7G	5/-
SP13C	4/6	2A6	7/-	6K6GT	6/-
SP41	2/6	2C34	2/6	6K7G	2/-
SP61	2/-	2C42	25/-	6K7GT	4/9
STV280/40	12/6	2C46	30/-	6K8G	5/9
STZ280/80	50/-	3A4	5/-	6K8GT	8/3
STZ150A/9	3/24	3B7	5/-	6K8M	8/6
T41	7/-	3E29	5/-	6L5G	6/-
TP25	15/-	(829B)	60/-	6L6	9/-
TT11	3/-	3C4	6/-	6L6G	9/-
TT15	25/-	354	6/-	6L7C	4/6
TT20	16/-	3V4	5/-	6L34	4/6
UI2/14	8/-	5R4GY	9/-	6N7G	5/9
UI7	5/-	5T4	9/-	6N7GT	6/-
UI8	6/6	5U4G	5/-	6Q7G	6/-
UI27	8/-	5V4G	8/-	6R7	6/-
U52	5/-	5Y3G	3/-	6S7C	5/6
UCH42	7/6	5Y3GT	6/-	6S7GT	5/-
UBF80	8/6	5Z4	8/6	6SH7	3/-
UL11	5/-	5Z4G	7/-	6S1GT	4/9
UL12	5/-	6A87	4/-	6SK7	5/-
UL41	7/-	6AC7	3/-	6SL7GT	6/6
UL84	7/6	6AG5	3/-	6SN7GT	4/6
UO9	5/6	6AG7	6/-	6S7	5/-
UY41	6/-	6AJ7	3/-	6S7G	3/-
UY85	6/6	6AK5	5/-	6V6G	4/-

6V6GT	6/-	77	6/-	9001	3/-
6X4	5/-	78	7/6	9002	5/6
6X5GT	4/6	80	5/6	9303	6/-
6Y6G	6/-	81	9/-	9004	2/6
6Z4	5/-	82	8/-	9006	2/6
7B7	7/6	84	8/-		
7C6	7/-	85A3	15/-		
7C7	5/-	89	2/6		
7H7	7/3	210VPT	2/6		
7Y7	7/-	7 pin	7/-		
7Y4	5/-	220TH	4/-		
7Z4	4/-	250TH	4/-		
8D2	2/6	368A	5/-		
9D2	3/-	391A	15/-		
12A6	2/6	705A	15/-		
12AH7	5/-	715B	60/-		
12AT7	5/6	717A	8/6		
12AU6	9/-	801	6/-		
12AU7	6/6	803	22/6		
12AX7	7/-	805	30/-		
12C8	3/-	807 (selected)	5/6		
12E1	20/-	829A	30/-		
12H6	2/6	807BR	5/6		
12J5GT	3/6	808	8/-		
12J7GT	8/-	810	80/-		
12K7GT	4/6	813	60/-		
12K8M	7/6	815	40/-		
12Q7GT	4/4	816	30/-		
12S2A7	7/-	829A	30/-		
12S7	3/-	832A	15/-		
12SH7	3/-	843	7/4		
12S17	5/-	866A	14/-		
12S7	3/6	930	8/-		
12S17	5/9	954	4/-		
12N17	5/9	955	2/6		
12S7	5/-	956	2/-		
12Y4	2/-	957	5/-		
14L7	7/-	958A	4/-		
15D2	6/-	1616	3/-		
20A2	17/6	1619	5/-		
21B6	9/-	1625	6/-		
25L6GT	7/9	1626	4/6		
30	5/-	1629	4/6		
35L6GT	8/-	4043C	13/6		
35T	17/6	4063	8/-		
35Z4GT	7/-	6064	10/-		
37	4/-	6065	8/-		
46	5/-	6120	4/-		
47	5/-	6516	8/-		
48	6/-	7193	1/9		
51	6/-	7475	3/-		
57	5/6	8013A	25/-		
76	5/-	8020	10/-		

Cathode Ray Tubes
 ACR1 15/-
 ACR11 15/-
 CV995 15/-
 CV1596 4/-
 (091) 55/-
 E4103/B4 5/-
 3FP7 25/-
 5BP1 35/-
 5CP1 42/6
 5FP7 45/-
 5FP7A 25/-
 7BD7 40/-
 12DP7 60/-
 VCRX259 (with scanning coil) 45/-
 VCR138 30/-
 VCR139A 35/-

Photo Tubes
 CMGB 9/-
 GS16 12/6

Special Valves
 2J31 45/-
 3A/1481 45/2
 3J170E £38
 3J192E £37.10
 4J31 £35
 4J50 £35
 5D21 £3
 723A/B 50/-
 725A 30/-
 726A 27/6
 ACT6 160/-
 CV193 30/-
 CV238 70/-
 CV980 3/-
 KR/3 £4
 L57B 30/-
 WL47A 15/-

AND MANY OTHERS IN STOCK, INCLUDING CATHODE RAY TUBES AND SPECIAL VALVES. All U.K. Orders below 10/-, 1/- P. & P. 2/6 over 10/-, Orders over £3, P. & P. free. C.O.D. 2/6 extra. Overseas Postage extra at costs.

BRAND NEW ORIGINAL SPARE PARTS FOR AR88 RECEIVERS.
 Please write your requirements.
MARCONI RECEIVER TYPE CR 100/2 tested and aligned £32.10.0 Carr. £1.
TELEPHONE HANDESET. Standard G.P.O. type. New 12/- P. & P. 2/-.
CONNECTORS FOR TCS RECEIVER, TRANSMITTER AND REMOTE CONTROL, with original plugs on both ends. New £1.17.6 each. P. & P. 2/6.
SPECIALLY BUILT POWER PACK for TCS receivers, 230 volts A.C. mains, including 6X5GT valve, £31.0.0. Carr. 5/-.
R.109 RECEIVER. Covering 2-8 Mc/s. 5 v. D.C. with set of spare valves and carrier. Brand new in original packing case. £6.18.0 including delivery in U.K.
R.109A RECEIVER. Covering 2-12 Mc/s., £7.18.0.
"CONNECT AND FORGET—CANNOT OVERCHARGE" "ESSTRON" MARK I AUTOMATIC BATTERY CHARGER. Initial charging rate 6-7 amps. The charging rate automatically adjusts itself to the charge in the battery. Automatic current and voltage control. Patented application of magnetic amplification to battery charging. Indicator lights show battery fully charged, receiving charge, incorrectly connected or faulty cells. Mains voltage 200/250 v. Built for 6 or 12 v. batteries. Measurements 7 x 5 x 5 1/2 in. Weight 8 1/2 lb. Price £7.19.6. P. & P. 3/6.

53 TRANSMITTER SPARES. Full range. Price list on application.
H.R.O. Senior. Table Model. In excellent, fully checked, and tested condition (without coils and power pack), £15.10.0. As above but rack mounted model, £14.10.0.
Individual frequency coils for above £1 each or set of 9 £8. Either model carriage £1.10.0.
Power pack for above. British made, A.C. 110/200/250 v., 59/6. Postage 4/-.
COMPLETE V.F.O. UNIT from TX53. Freq. range in 4 switched bands from 1.2-17.5 Mc/s. Two V.T. 501s as oscillator and buffer, 807 as driver, two 130s as voltage stabilizers. Output sufficient to drive two 813s in parallel. Slow motion drive directly calibrated in Mc/s. Provision for crystal control, metering of buffer and driver stage. Power requirements 400 v. and 6.3 v. D.C. Can also be used as low power transmitter. In excellent condition with valves and circuit diagram. £5. P. & P. 15/-.
RE-ENTRANT LOUD HAILERS. 500 ohms, approx. 20w. £6.10.0. Carr. 10/-
AERIALS 1ft. long. 2ft. long when folded, 15/- P. & P. 2/-.

P. C. RADIO LTD.
 170 GOLDHAWK ROAD, W. 12
 Shepherd's Bush 4946

AMERICAN WIRE RECORDER/REPRODUCER UNIT. Facilities for recording from Dynamic or Carbon microphone and radio. 1 knob operation for recording, rewinding and erasing. Neon recording lever indicator. Internal speaker. Mains 110 v. Supplied with outer transformer, carbon mike and wire magazine for 1 hour's operation and headphones. Price £18.0.0. P. & P. £1.
Spire Wire Magazine 50/-. Dynamic mike and stand £4.
R.209 RECEPTION SET. A 10-valve high-grade Superhet Receiver with facilities for receiving R/T (A.M. or F.M.) and C.W. frequency 1 Mc-20 Mc/s. Hermetically sealed. Built on miniature valves and incorporating its own vibrator power supply unit driven by a 6 v. battery (2 point connector included). The set provides for reception from rod, open-wire or dipole aerial with built-in loudspeaker or phone output. Dimensions: Length 12in., width 8in., depth 9in. Weight 23lb. In as new, tested and guaranteed condition, £23.10.0, including special headphone and supply leads. Carr. £1.
RECEIVER TYPE R.206. Frequency 0.55 Mc to 30 Mc/s in 6 bands. 100-250 v. A.C. or 12 v. D.C. Loudspeaker in power supply unit. High performance super heterodyne, eleven valves including a separate local oscillator valve, beat oscillator valve and two valves (Amplifier and Detector) in the A.B.C. system. In very good condition £20.10.0, including power pack. Carriage and packing 15/-.

BRAND NEW TEST METERS - BEST VALUE - FOR ALL PURPOSES



£8.19.6

30,000 ohms per Volt Model 500
 8 Ranges D.C. volts to 1 kV.
 7 Ranges A.C. volts to 1 kV.
 5 Ranges D.C. current to 12 amps.
 3 Range resistance to 60 meg. Short circuit buzz test. Output meter dB, etc., etc. Size 6½ x 4½ x 2½ in. With Leads, Batteries and Instructions.



5 GNS.

20,000 ohms per Volt Model ITI-2
 6 Ranges D.C. voltage to 2½ kV.
 5 Ranges A.C. voltage to 1 kV.
 3 Ranges D.C. current to 250 mA.
 Resistance to 6 meg. Capacity and dB ranges.
 Size 4½ x 3½ x 1½ in. with leads, batteries and instructions.



75/-

2,000 ohms per Volt Model THL33
 0/10/50/250/500/1,000 volts D.C.
 0/10/50/250/500/1,000 volts A.C.
 0/500µA/10/250mA., D.C.
 Resistance 0/10K/100K/1 Meg. Capacity and dB ranges, etc. Size 5 x 3½ x 1½ in. with batteries, test leads and instructions.

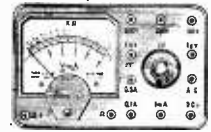

49/6

1,000 ohms per volt Model PT34
 0/10/50/250/500/1,000 volts A.C./D.C. 0/1/100/500 mA D.C. Resistance 0/100k ohm.
 Ideal pocket sized multi-tester for all radio and domestic work. Size 3½ x 2½ x 1½ in. with battery, leads and instructions.

All Meters Fully Guaranteed for 6 months. Full Service Facilities.



MODEL TP55

A.C./D.C. voltage up to 1,000 in 5 ranges. D.C. current 4 ranges up to 500mA. 4 range resistance to 10 meg. Capacity dB scales, etc. 20,000 ohms/volt Fully Guaranteed

£5.19.6

With Test Leads, Battery and Instructions. Size 5½ x 3½ x 1½ in.

TRANSISTORS
 100% 1st Grade Fully Guaranteed
 A selection from our complete list.

XAI01 5/-	XB102 4/-	XC121 Pairs 10/-
XAI11 5/-	XB112 4/-	XC131 Pairs 10/-
XAI12 6/-	XB121 8/6	
XAI13 6/-	XB103 4/6	Pairs 10/-
XAI03 4/-	XB113 4/6	XC171 Pairs 10/-
XAI04 4/-	XB133 5/6	
XAI25 7/6	XC101 6/-	XA701 9/-
XAI41 9/6	XC101A 6/-	XA702 17/6
XAI42 9/6	XC121 6/-	XA703 25/-
XAI43 10/6	XC161 6/-	XC141 10/-
XAI51 5/-	XC163 7/-	XC142 15/-
XAI52 5/-	XC181 7/-	XC155 20/-
XAI61 9/6	XC101A	XC156 22/6
XAI62 10/6	Pairs 10/-	
XC141 Pairs 22/6.	XC142 Pairs 32/6	
XC155 Pairs 42/6.	XC156 Pairs 50/-	

New Transistor Catalogue with Connection Diagrams, Equivalents and Details included in New 44 Page Catalogue, 1/-.

AFI02 27/6	OC23 20/-	OC78D 7/-
AFI14 11/-	OC29 20/-	OC82 10/-
AFI15 10/6	OC35 18/-	OC83 6/-
AFI16 10/-	OC41 9/-	OC84 8/6
AFI17 9/6	OC42 9/6	OC170 9/6
AC107 14/6	OC44 7/6	OC171 10/6
AC121 6/-	OC45 6/6	OCP71 29/-
AFZ12 35/-	OC71 5/-	ORP12 12/6
OC16 20/-	OC72 7/-	MAT100 7/9
OC22 23/-	OC75 7/-	MAT101 8/6
OC23 33/6	OC76 7/-	MAT120 7/9
OC24 29/-	OC78 7/-	MAT121 8/6
OC25 12/-	OC81 7/-	SB305 8/6
OC26 25/-	OC81D 7/-	SB231 12/6

Special Very Low Price for Matched Sets—Let us Quote.

SILICON RECTIFIERS 500mA
 XU611 3/- XU614 5/-
 XU612 3/6 XU604 5/-
 XU613 4/6 5E10 10/-

REMEMBER—All our transistors and devices are 100% 1st Grade and Fully Guaranteed. We can advise as to the correct type to use.

SOLDERING IRON

Antex miniature 15 watt 220/250 volt Iron. Easily removed ½ in. bit. Ideal for all miniature work, 29/6.

DEKATRON ERICSSON GS12C (CV-1740) Bi-directional 12-way Selector Tube. 25/-.

PHOTO MULTIPLIER 931A (CV2696). Brand new, 60/- each. Base 2/-. Special purpose version 931A-CV337, 80/- each. Base 2/-.

TYPE 38, TRANSMITTER RECEIVER Complete with 5 valves. In new condition. These sets are sold without guarantee but are service-able. 7.4 to 9 Mc/s. 22/6 P.P. 2/6
 Headphones 7/6 pair. Junction Box 2/6. Throat Mike 4/6. Aerial Rod 2/6.

MARCONI 19 SET CRYSTAL CONTROLLED CALIBRATOR Crystal controlled oscillators giving either 10 kc/s, 100 kc/s or 1 Mc/s pips. Features neon modulator, supplied with spare valves and full handbook. 79/6 P.P. 2/-

deal standard frequency chain.
CV2886 (M2H) LIQUID SAMPLING GEIGER TUBE. 370 volts. 22/6. P.P. 1/-.

AMPLIVOX Medium Impedance Lightweight HEADPHONES—Special Offer. 45/- P.P. 1/6.

TAPE RECORDER MOTOR Miniature Motor designed for Battery Recorders, 4½ to 9 volts. Built in governor, 12/6. P.P. 1/-.

STEREO AMPLIFIER 4-Valve Amplifier with 2 watts output per channel to 3 ohms. Ready built, complete with Dials, Sockets and Knobs. Full tone, volume and balance controls. Crystal input. 220/250 volt mains input. Fully Guaranteed 79/6 P.P. 2/-
 Suitable 8 x 5 inch Speakers 49/6 Pair.

VALVES AND CRYSTALS New Catalogue Now Ready More Types—Lower Prices

Henry's Radio Ltd.
 PADdington 100B/9
 5 HARROW ROAD, LONDON W.2
 Open Monday to Sat. 9-6, Thurs. 1 o'clock
PLEASE TURN TO BACK PAGE

CRYSTAL MIC. INSERTS
 ACOS 2in. ... 10/6
 ACOS 1½in. ... 7/6
 ½in. sq. ... 3/6
 ACOS 39-1 Insert 15/-

METER BARGAINS
 2½ in. Moving Coil double range Voltmeter centre zero. 30-0-30 and 3-0-3 volts. Ideal for transistor tester or voltage measurements. 12/6. Post free.
 0/500 microamp, 2½ in., flush-mounting. D.C. ... 20/-
 2½-0-2½ mA, 2½ in. flush. D.C. ... 12/6

TRANSISTOR PORTABLE SIGNAL GENERATOR



PRICE **£7.10.0**
 P.P. 2/6

A 1st class Signal Generator covering 220 Kc/s to 200 Mc/s in 8 ranges. Radio broadcasts and I.F., Amateur, VHF, Shipping, TV, etc. R.F., I.F., A.F., modulated R.F. outputs. Easy to read and use with full details. Within 2% accuracy. Size 6½ x 4½ x 2 in.
12 MONTHS' GUARANTEE
 Leaflet on request.



ALL TRANSISTOR BABY OR INVALID ALARM

HOUSED IN ATTRACTIVE GOLD HAMMER FINISH PORTABLE CABINET. Battery operated, push-pull, 400mW output. Low impedance microphone enables unit to be used up to 200 yards. Output on quality speaker.

- ★ GUARANTEED FOR 12 MONTHS and 100% SAFE.
- ★ MICROPHONE is placed within 10ft. of baby; twin flex is taken to amplifier unit and placed in any room required. COMPLETELY BUILT & TESTED. P.P. 2/6. **£5.10.0**
- ★ Used All Night, Every Night. Battery Life 3 to 4 months.

3/4 WATT 4 TRANSISTOR AMPLIFIER

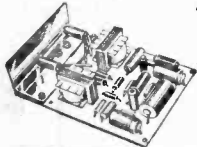

- Improved Version
- 1 1/2 watt peak output.
- ± 3dB 70c/s to 12 kc/s.
- Output to 3 ohm speaker
- 2-way operated.
- Details on request.

Built and Tested Kit of Parts
59/6 or 52/6
P.P. 1/6 P.P. 1/6

A printed circuit high gain amplifier size 4 x 2 1/2 x 3/4 in. using Ediswan XB112, XB113 and 2-XC171 Transistors. Ideal for Intercomm., Record Player, Tuner Amplifier or any application requiring a quality and reliable amplifier. Suitable large magnet 5-inch speaker, 15/-.

TRANSISTOR SIGNAL INJECTOR
A new design pocket size tested for fault finding on valve or transistor radios, TV amplifiers, etc. Built-in indicator and batteries with detachable probe. 42/6.

TRANSISTOR MEGAPHONE
A new design lightweight megaphone. Ideal for all indoor or outdoor uses. Built-in batteries. Complete with shoulder strap. £12.10.0. Leaflet on request.

NEW MINIATURE TELESCOPIC AERIALS

- 3 1/2 in. closed 14 in. extended. Complete with screw in sockets. 3/6. P.P. 6d.
 - 8 1/2 in. closed 38 in. extended, with 4BA threaded end. 6/6. P.P. 6d.
 - 9 in. closed 64 in. extended. 17/6. P.P. 1/-.
- All types heavily plated.

ALL-TRANSISTOR TIMESAVER

OFFICE OR HOME TELEPHONE PICK-UP AMPLIFIER

★ No more "holding on" wasting time waiting for your call to come through. When it does the amplifier can be switched off if required. No connections, just press the pick-up coil to back of phone as below. Fully guaranteed. Housed in attractive Gold Finish Cabinet.

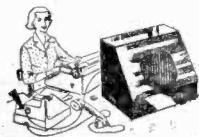

BUILT, TESTED, READY TO USE

£5.10.0
P.P. 2/6

NEW 44-PAGE CATALOGUE, 1/-

3-TRANSISTOR SUB-MINIATURE AMPLIFIER

New 3-transistor amplifier. 125 mWV push-pull output to 35 ohm speaker. PP3 9-volt operated.

- Size only 1.9 x 1 x 1 inches!
- Complete with circuit
- Suitable 2 1/2 in. Speakers, 15/-
- 45/-** P.P. 1/-

RUN YOUR RADIO OR AMPLIFIER FROM MAINS BATTERY ELIMINATORS AND CHARGERS

1. For PP3 or equivalent 9 volt Pocket Radio Battery. 18/6. P.P. 1/-.
2. For PP4, PP7, PP9, PP10, 9 volt Portable Radio and Equipment Supplies up to 300 mA. 49/6. P.P. 2/-.
3. De Luxe version of No. 1, also charges PP3 type batteries. 29/6. P.P. 1/-.
4. Rechargeable PP3 battery. Runs as long as 100 batteries. Complete with charger unit, 35/-, P.P. 1/-.

OFFICE, WORKS OR HOME USE COMPLETE INTERCOM. SYSTEMS

★ 2-transistor transformer coupled, two speakers in moulded cabinets. Features 2-way Buzzer system and talking. Supplied complete with cable **89/6** P.P. 1/6 and batteries.

★ 4-transistor de luxe version, with 2-way calling and talking. Moulded cabinets, long battery life—very sensitive. With cable and **£7.10.0** P.P. 2/- batteries.

MAKE YOUR OWN PRINTED CIRCUITS

Complete kits supplied with all necessary chemicals, brush, dishes etc. Fully detailed instructions. 3-boards 5 1/2 x 3 1/2 in., 19/6, P.P. 1/6.

GUITAR CONTACT MICROPHONE. High Impedance Guitar Contact Microphone with screened lead. Plugs into any valve amplifier. Very sensitive. 12/6. P.P. 9d.

TEST LEAD KIT

Complete set of test leads, clips and prods, etc. Suitable for most instruments. Complete with pouch, 8/6. P.P. 1/-.

POCKET RADIO BOOSTER

Tubular unit, 8 1/2 x 2 1/2 in. diam., which plugs into earphone socket of any transistor radio. Performance increase is fantastic. Ideal for home or car. NOW ONLY 30/-. P.P. 1/6.

PERSONAL EARPHONE

- ★ 600 ohm 10/6
 - ★ Crystal 6/-
 - ★ 1,000 ohm 12/6
 - ★ 8/10 ohm 9/6
- Fitted leads, Jack Plug and Socket.

"GARVETER"

MOBILE TRANSISTOR SHORTWAVE CONVERTER

As featured in May edition of "Radio Constructor." Just plugs into the aerial socket of any medium wave car radio. Crystal controlled, covers broadcast bands from 5 to 16 Mc/s. Total cost with sprayed metal cabinet, booklet and 39/40 metre band crystal, 69/6. P.P. 2/-.

No modifications to your existing car radio at all! Full booklet 1/-.

TELEPHONE ADAPTOR

★ Ideal for recording or amplifying telephone conversations. Supplied with screened cable. Fitted rubber sucker, 12/6. Have fun recording.

VERNIER DIAL

New Miniature Slow Motion Vernier Dial, 8 to 1 reduction. Marked 0/100. Ideal for all test equipment, 14/-.

4 TRANSISTOR PUSH-PULL AUDIO MODEL PK-5 3 AMPLIFIER

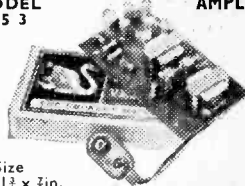

Size 3 x 1 1/2 x 3/4 in.

A ready built miniature 250mW push-pull amplifier incorporating input and output transformers, 4 transistors, 9 volt battery snap cord, speaker and column connection leads. Ideal for use with record players, intercoms, hearing aids, tape recorders, etc. Complete with full instructions and circuit diagram.

PRICE **52/6** P.P. 1/6
SUITABLE 2 1/2 in. SPEAKER 16/6

BATTERY RECORD PLAYER



- 6-7 1/2 volt Garrard turntable with crystal pick-up. Plays 45 r.p.m. Ideal for above amplifier. 55/- P.P. 1/6.

- Suitable cabinet for amplifier and player, 17/6. P.P. 2/-.

STEREO PHONES

New stethoscope type stereo earphones with adjustable tubes. Fitted miniature jack plugs and leads. 2 x 8 ohms impedance, 27/6.



LIGHTWEIGHT HEADPHONES

- ★ 2000 OHMS 12/6
- ★ 4000 OHMS 14/6

HIGH EFFICIENCY.

MINIATURE CLEAR FACED Brand New PANEL METERS

0-50 microamp	DC	39/6
0-500	DC	32/6
0-1 milliamp	DC	27/6
0-5	DC	27/6
0-300 volts	DC	27/6
"S" meter 1mA		35/-
"VU" meter		42/6

CRYSTAL MICROPHONES

ACOS 39-1. Stick Microphone with screened cable and stand (list 5 gns.), 32/6. P.P. 1/6.

ACOS 40. Desk Microphone with screened cable and built-in stand (list 50/-), 15/-, P.P. 1/6.

ACOS 45. Hand Microphone with screened lead, very sensitive, 25/-, P.P. 1/6.

100 C. Stick Microphone with muting switch and screened cable, detachable desk stand and neck cord, 39/6. P.P. 1/6.

MC 24. Stick Microphone with muting switch and cable, 25/-, P.P. 1/6.

LAPEL. Miniature Mic. With clip. Ideal for recording, 15/-, P.P. 1/-.

BM 3. De Luxe Stick Mic., with muting switch cable, neckcord and detachable stand. Complete 52/6. P.P. 2/-.

(Illustrations of all types in our New Catalogue. 1/- post free).

Henry's Radio Ltd

PADDINGTON 1008/9
5 HARROW ROAD, LONDON W.2
Open Monday to Sat. 9-6. Thurs. 1 o'clock

