

NOVEMBER
1962

Practical **2/-** **WIRELESS**

FREE inside!

**DOUBLE-SIDED
BLUEPRINT**

**4-VALVE
PRE-AMPLIFIER
VHF
RADIO TUNER**

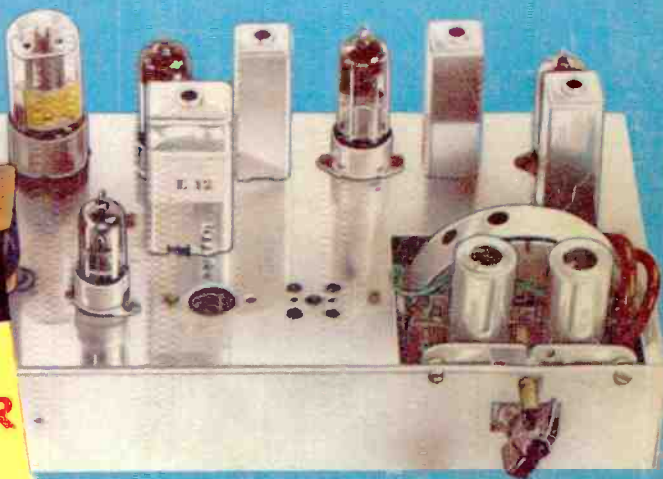

**The SAVOY VHF
Tuner**

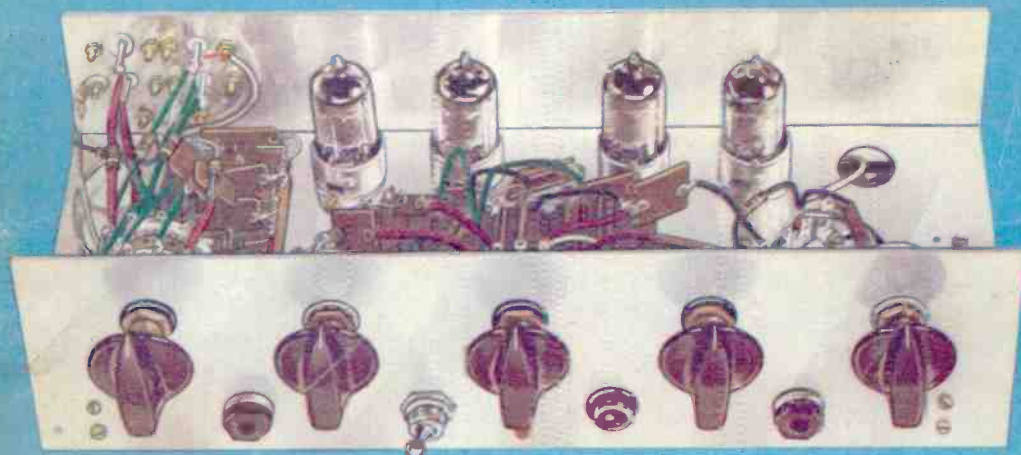

The MAYFAIR Pre-amplifier



**SOLDERING
INSTRUMENTS
AND
EQUIPMENT**

**DESIGNED FOR
THE AMATEURS
RADIO STATION**

ILLUSTRATED

List No. 70. $\frac{1}{8}$ " BIT
IN
PROTECTIVE
SHIELD
List No. 68



APPLY DIRECT
FOR
CATALOGUE
TO

Sales and
Service Dept.

**ADCOLA
PRODUCTS
LTD**

**ADCOLA HOUSE
GAUDEN ROAD,**

Telephones
MACaulay 4272 & 3101

LONDON, S.W.4

Telegrams
SOLJOINT LONDON SW4



the big name in **PRECISION** components

Precision built radio components are an important contribution to the radio and communications industry. Be sure of the best and buy Jackson Precision Built Components.



**"DILEMIN"
CONDENSERS**

These miniature solid dielectric condensers are only $\frac{7}{8}$ " square. The $\frac{1}{4}$ " dia. spindle projects $\frac{1}{2}$ " from the Front Plate. Low loss construction provides Power Factor better than .001.

Write for literature

JACKSON BROS. (LONDON) LTD.

(Dept. P.W.) KINGSWAY-WADDON, SURREY
Phone: Croydon 2754-5 Grams: Walfico, Souphone, London

P.W. BEST

TRANSISTORISED

**SETS
A-Z
INSTRUCTIONS**

- PRINTED CIRCUIT VERSIONS
- "P.W. POCKET S'HET"
- "MERCURY SIX"
- "TROUBADOUR"
- "FAULT-FINDER"

COMPONENT LIST ON REQUEST



Driver
&
Output



31Fs
&
Osc.

**THESE COMPONENTS
MAKE YOUR SET**



2/6
EACH

OSMOR

418 BRIGHTON ROAD
S. CROYDON

★ VALVES ★

by return of post

10% DISCOUNT
SPECIAL OFFER TO PURCHASERS of any SIX VALVES marked in black type (15% in dozen). Post: 1 valve, 6d., 2-11, 1/-.

NEW LOW PRICES GUARANTEED 3 MONTHS

FREE TRANSIT INSURANCE. All valves are new or of fully guaranteed ex-Government origin. Satisfaction or Money Back Guarantee on Goods if returned unused within 14 days.

| | | | | | | | | | | | |
|-------|------|-------|------|--------|------|--------|------|--------|------|--------|------|
| 024 | 5/- | 6AG7 | 7/8 | 6J3GT | 4/- | 7A7 | 8/6 | 12K84T | 9/6 | 3525GT | 8/- |
| 1A3GT | 5/- | 6AK5 | 5/- | 6J6 | 4/- | 7B7 | 9/- | 12Q7GT | 5/- | 41 | 7/3 |
| 1A7GT | 11/- | 6AL5 | 3/- | 6J7 | 8/6 | 7B7 | 7/9 | 12SA7 | 7/- | 42 | 7/6 |
| 1C3GT | 9/- | 6AM8 | 3/- | 6J9 | 7/6 | 7C5 | 7/3 | 12S47 | 5/- | 50-5 | 12/- |
| 1D3 | 8/- | 6AQ5 | 6/- | 6J7GT | 7/6 | 7E6 | 7/6 | 12S17 | 8/9 | 50C1D6 | 19/- |
| 1D8 | 9/9 | 6AT6 | 5/9 | 6J8 | 8/6 | 7H7 | 7/3 | 12S47 | 5/6 | 50L6GT | 8/6 |
| 1H3GT | 9/9 | 6AU6 | 7/6 | 6K6GT | 6/6 | 7K7 | 9/6 | 12K87 | 4/9 | 52K U | 10/6 |
| 1L4 | 3/3 | 6B7 | 8/6 | 6K7 | 5/9 | 707 | 8/6 | 12S7GT | 7/9 | 53K U | 10/6 |
| 1L3 | 3/6 | 6B8G | 5/- | 6K7G | 2/3 | 767 | 10/6 | 13D3 | 9/- | 613GT | 11/- |
| 1L5 | 4/9 | 6IA6 | 5/9 | 6K7GT | 4/6 | 787 | 9/- | 14K5 | 14/9 | 62BT | 13/6 |
| 1N3GT | 9/9 | 6IB8 | 5/9 | 6K8GT | 8/9 | 7V7 | 7/9 | 15AQ5 | 7/6 | 75 | 13/6 |
| 1R5 | 5/6 | 6B06G | 15/- | 6K25 | 7/6 | 7Y4 | 8/6 | 16B6 | 19/6 | 16GT | 19/6 |
| 184 | 8/6 | 6B16 | 6/- | 6L1 | 12/6 | 774 | 7/- | 2011 | 9/6 | 80 | 5/9 |
| 185 | 4/6 | 6B6 | 6/- | 6L6G | 6/6 | 8D3 | 3/- | 2012 | 9/6 | 83 | 5/6 |
| 1T4 | 3/6 | 6BR7 | 7/6 | 6L18 | 8/- | 1001 | 11/6 | 2021 | 18/6 | 18GT | 19/6 |
| 2A3 | 6/6 | 6BW6 | 7/6 | 6L19 | 11/- | 1002 | 14/6 | 2011 | 8/9 | 803 | 19/- |
| 2A7 | 9/9 | 6BW7 | 5/6 | 6L13 | 8/- | 10014 | 8/- | 2014 | 12/6 | 807(A) | 5/6 |
| 3A4 | 4/9 | 6BX6 | 4/9 | 6L12 | 6/9 | 10P1 | 5/9 | 2014 | 18/6 | 808 | 7/6 |
| 3D5 | 9/6 | 6C5 | 5/6 | 6L20 | 7/6 | 10P2 | 10/6 | 2015 | 15/6 | 813 | 55/- |
| 3Q4 | 7/- | 6C6 | 3/9 | 6L7 | 7/6 | 10P18 | 10/6 | 25AG | 6/9 | 842 | 14/6 |
| 3Q5GT | 8/- | 6C9 | 11/- | 6P25 | 8/6 | 10L13 | 7/6 | 25L6GT | 7/9 | 854 | 2/- |
| 384 | 8/- | 6C10G | 19/6 | 6P26 | 12/6 | 10L14 | 6/6 | 25V5G | 8/- | 956 | 2/6 |
| 3L4 | 6/9 | 6C16 | 7/6 | 6P27 | 6/- | 10L12 | 8/- | 25ZAG | 7/- | 1205 | 5/9 |
| 6R4CY | 12/6 | 6D2 | 3/6 | 6P7GT | 8/6 | 10P13 | 11/6 | 26P1 | 10/6 | 866 | 7/6 |
| 5T4 | 8/- | 6D3 | 9/6 | 6R7G | 6/6 | 10P14 | 9/- | 22AG | 8/- | 9002 | 4/9 |
| 5U4G | 4/9 | 6D6 | 4/3 | 6SA7 | 5/6 | 10P18 | 7/- | 30C1 | 7/- | ATP4 | 2/9 |
| 5V45 | 7/9 | 6E1 | 4/9 | 6S67 | 4/9 | 12A6 | 1/9 | 30C15 | 11/6 | AZ31 | 8/- |
| 6V3G | 5/9 | 6E3 | 5/9 | 6S7 | 3/- | 12A18 | 9/- | 30F5 | 6/- | AZ41 | 11/- |
| 6Y3GT | 9/9 | 6E18 | 6/6 | 6S87 | 4/9 | 12A19 | 7/6 | 30P1 | 9/6 | 901 | 7/6 |
| 5Y4G | 11/- | 6F13 | 6/9 | 6S17GT | 5/9 | 12A27 | 5/6 | 30L1 | 6/9 | 910 | 9/6 |
| 5Z4 | 11/- | 6F14 | 9/6 | 6S7GT | 4/6 | 12A7 | 9/6 | 30L15 | 9/6 | CB11 | 26/6 |
| 5Z4G | 7/6 | 6F15 | 9/6 | 6S67 | 5/9 | 12A7 | 8/- | 30P4 | 9/6 | CB12 | 21/- |
| 5Z4GT | 11/- | 6F16 | 8/- | 6S87 | 7/6 | 12A5 | 6/6 | 30P12 | 7/6 | CB15 | 14/6 |
| 6B12 | 6/6 | 6F23 | 6/6 | 6S87 | 7/6 | 12A6 | 7/6 | 30P16 | 9/6 | CB16 | 14/6 |
| 6A7 | 10/- | 6F24 | 12/- | 6V6GT | 6/- | 12B17 | 5/6 | 30P11 | 9/6 | D77 | 3/6 |
| 6A8G | 8/6 | 6F25 | 13/- | 6X2 | 7/9 | 12B8 | 6/6 | 30P13 | 13/- | D152 | 5/6 |
| 6ASGT | 13/6 | 6F26 | 6/6 | 6X4 | 5/- | 12B1 | 17/6 | 33L6GT | 8/6 | DA30 | 12/6 |
| 6A8 | 7/- | 6F33 | 6/6 | 6X3G | 5/6 | 12GT | 9/- | 35T | 25/- | DA32 | 9/6 |
| 6A7 | 3/3 | 6J5 | 4/3 | 6X5GT | 6/6 | 12K7GT | 4/9 | 35W1 | 6/9 | DAF91 | 6/6 |
| 6AU5 | 3/- | 6J5G | 3/- | 6Y9G | 7/6 | 12K8 | 11/- | 3ZAGT | 5/6 | DAF96 | 7/3 |

Tubes

HIGHEST QUALITY—COMPARE OUR PRICES

GUARANTEED 6 Months 12 Months

NEW TYPES

CO-AX, standard and low loss, 25 yds., 12/6, 50 yds., 22/6; 100 yds., 42/6. Co-ax Plugs 1/3. Wall outlet boxes 3/6.

4-SPEED RECORD PLAYERS. Latest Turntable, together with lightweight Star Galaxy dual sulphur crystal turnover pick-up head. Amazing value (pick-up only 19/-). £3.10.0. Carr. 3/-.

P.M. SPEAKERS. 3 ohm, top makes, Performance guaranteed. 6j1n, 8in, 8/-, 5in, 7 4 in., 11/-.

13 CHANNEL T.V.s. Table Models, Famous Makes. Absolutely Complete. These sets are unequaled in value due to huge purchase direct from source. They are untested, and not guaranteed to be in working order. Carr. etc., 15/-.

12in. £2.19.0 14in. £4.19.0

TRANSISTOR PORTABLES. Med. and Long. 6 + diode light weight approx. 1lb., slightly larger than pocket set, but much greater volume, better quality, complete battery, amazing sensitivity worth £11. Our price only £8.10.0.

F.M. TUNER KITS. Well-known make, comprising P.M. Tuning Head, guaranteed no drift. Frequency coverage 50-150 Mc/s. OAS1 balanced diode output, Magic Eye Tuning, Two I.F. stages and discriminator, £6.9.6.

P.V.C. CONNECTING WIRE. 100 yds. 30 mil; Special Price 7/6, 200 yds. 30 mil; special price 12/6, 25ft. 50il, 1/-, 3 Cables different colours, 4/-, Connecting 6/-.

TRANSISTORS. Red spot 3/6 ea. White Spot 4/6 ea. Yellow Spot 2/9 ea. Germanium diodes 9d. ea, 8/- doz.

TRADE SUPPLIED. Civil and Industrial valves, receiver valves and components. Quantity quotations for all items advertised plus 100% more. Government departments and manufacturers supplied.

FRUSTRATED EXPORT ORDER

Amazing Value, Top quality, Factory Fresh Standard Superhet, plus Magic Eye Sets of Valves.—

ECB1 ECB11 ECZ1 All for 35/- Post Free

ECF88 ECN4 EML4 ONLY

Satisfaction Guaranteed. This works out at only 5/10 per valve FM Valve Kits as above plus EC65 42/- post free.

| | | | | | | | | | | | |
|--------|------|---------|------|--------|-------|--------|------|---------|------|-------|------|
| DET19 | 2/9 | EC63 | 6/6 | E191 | 4/- | N78 | 13/- | R19 | 11/- | UCH81 | 8/- |
| DF33 | 9/9 | EC64 | 8/- | E180 | 7/9 | N108 | 16/- | SP41 | 2/8 | UC182 | 9/9 |
| DF91 | 3/6 | EC65 | 7/6 | E181 | 8/6 | N152 | 8/6 | SP61 | 2/6 | UC183 | 13/6 |
| DF96 | 7/3 | EC69 | 16/- | E184 | 9/- | P11 | 4/6 | ST25 | 16/- | UC184 | 7/6 |
| DF97 | 8/6 | EC691 | 4/- | E185 | 10/6 | P61 | 2/9 | STU2150 | 4/6 | UC185 | 5/6 |
| DF98 | 6/- | ECF80 | 8/6 | E181 | 16/- | PABC80 | T41 | 7/6 | UF80 | 7/- | |
| DB73 | 5/- | ECF82 | 8/6 | EY1 | 7/9 | 11/6 | TD44 | 7/6 | UF85 | 7/6 | |
| DK32 | 11/- | ECU21 | 12/6 | EY96 | 7/6 | PC84 | 6/9 | U14 | 8/- | UF86 | 14/6 |
| DK91 | 5/6 | ECU33 | 7/6 | EZ25 | 6/6 | PC85 | 8/9 | U18 | 8/- | UF89 | 7/- |
| DK92 | 7/- | ECU42 | 8/6 | EZ96 | 6/6 | PC88 | 14/- | U22 | 8/9 | U141 | 7/- |
| DK96 | 7/3 | ECU81 | 7/9 | EZ40 | 6/6 | PC89 | 9/- | U24 | 16/- | U44 | 11/- |
| LD33 | 8/- | ECU83 | 8/3 | EZ41 | 7/- | PC189 | 13/6 | U25 | 11/6 | U46 | 9/9 |
| LD35 | 9/- | ECU20 | 8/- | EZ80 | 6/- | PCF80 | 7/- | U26 | 9/9 | U84 | 7/6 |
| LD36 | 8/- | ECU82 | 6/6 | EZ96 | 12/6 | PC82 | 7/6 | U1 | 17/6 | U80 | 9/6 |
| LD75 | 6/- | ECU83 | 11/7 | FW4500 | 8/9 | PCF84 | 11/- | U33 | 14/- | UR10 | 8/- |
| LD82 | 9/- | ECU86 | 10/6 | FW4800 | 8/9 | PCF86 | 12/6 | U35 | 12/6 | U16 | 12/6 |
| LD91 | 8/- | ECF22 | 7/- | GTIC | 7/- | PCU82 | 13/6 | U37 | 26/- | U17 | 9/6 |
| LD92 | 6/- | ECF36 | 3/3 | GT32 | 8/9 | PCU83 | 10/6 | U39 | 5/9 | U20 | 17/- |
| LD94 | 6/9 | ECF39 | 4/6 | GT34 | 12/6 | PCU84 | 7/6 | U38 | 10/6 | U21 | 11/- |
| LD96 | 7/8 | ECF40 | 12/- | HLADD | PCU85 | 11/6 | U75 | 6/9 | U21 | 11/- | |
| EABC80 | 6/9 | EF41 | 8/- | 8/3 | PCU86 | 12/6 | U78 | 5/- | UY41 | 6/6 | |
| EAC91 | 4/9 | EF42 | 7/8 | HN309 | 19/7 | PEN45 | 8/6 | U191 | 12/6 | UY85 | 6/6 |
| EF42 | 8/- | EF50-BR | 2/- | HW32 | 10/6 | PE46 | 5/- | U281 | 15/6 | VP44 | 5/6 |
| EF41 | 7/- | EF51 | 14/6 | HW4350 | 7/6 | PE86 | 6/6 | U282 | 7/- | VR105 | 5/6 |
| EB91 | 3/- | EF54 | 3/4 | IW4500 | 7/6 | PL36 | 9/6 | U301 | 15/- | VR150 | 6/9 |
| EB33 | 4/9 | EF80 | 4/9 | KL132 | 8/6 | PL38 | 16/6 | U309 | 6/9 | W41M | 11/- |
| EB41 | 8/- | EF85 | 6/9 | KT32 | 6/9 | PL81 | 8/6 | U329 | 6/9 | W76 | 4/9 |
| EB81 | 7/9 | EF86 | 8/- | KT33C | 4/6 | PL82 | 6/6 | U339 | 11/- | W81 | 7/3 |
| EBF80 | 7/9 | EF87 | 6/6 | KT36 | 12/6 | PL89 | 6/6 | U382 | 7/6 | W81 | 11/- |
| EBF83 | 9/6 | EF91 | 9/- | KT44 | 7/6 | PL84 | 8/6 | U400 | 8/- | W83 | 9/6 |
| EBF89 | 3/6 | EF92 | 4/6 | KT45 | 8/6 | PL820 | 8/6 | U442 | 7/9 | X65 | 11/- |
| E121 | 12/6 | EF96 | 3/- | KT61 | 8/6 | PX4 | 12/6 | U441 | 7/9 | X66 | 11/- |
| E131 | 17/6 | EF183 | 14/6 | KT63 | 5/9 | PX25 | 9/6 | U441 | 7/9 | X76M | 11/- |
| E191 | 4/4 | EL12 | 8/6 | KT67 | 9/6 | PX31 | 6/6 | U481 | 9/6 | X77 | 21/- |
| EC31 | 7/6 | EL32 | 4/6 | KTW61 | 5/9 | PY32 | 10/6 | U480 | 8/- | X79 | 10/6 |
| EC32 | 4/- | EL33 | 7/9 | K'W62 | 5/9 | PX80 | 6/9 | UBF89 | 7/6 | X81M | 9/- |
| EC33 | 4/6 | EL35 | 7/- | KTW63 | 5/9 | PX81 | 6/6 | UB121 | 14/6 | X63 | 6/3 |
| EC34 | 9/- | EL41 | 8/- | KTZ63 | 5/6 | PY82 | 6/6 | UB434 | 14/6 | X83 | 4/9 |
| EC35 | 6/- | EL42 | 8/6 | KTZ68 | 2/9 | PX83 | 7/6 | UC95 | 7/- | Z36 | 9/6 |
| EC40 | 14/- | EL81 | 11/- | LN152 | 7/- | PX88 | 9/6 | UCF80 | 12/- | Z152 | 4/9 |
| EC81 | 5/6 | EL83 | 11/- | M14 | 7/6 | PZ30 | 9/6 | UC121 | 12/- | Z119 | 4/9 |
| EC82 | 6/- | EL84 | 7/- | N37 | 11/- | R18 | 11/6 | UCH42 | 7/3 | ZD152 | 7/9 |

TUBE SNIPS

Due to huge Bulk Special Purchase factory direct MW 3175 Tubes (the unreplaceable price of 29/-, MW 3624 ditto, 39/-, P.P. 12/6. The above are guaranteed for 6 months.

CO-AX, standard and low loss, 25 yds., 12/6, 50 yds., 22/6; 100 yds., 42/6. Co-ax Plugs 1/3. Wall outlet boxes 3/6.

4-SPEED RECORD PLAYERS. Latest Turntable, together with lightweight Star Galaxy dual sulphur crystal turnover pick-up head. Amazing value (pick-up only 19/-). £3.10.0. Carr. 3/-.

P.M. SPEAKERS. 3 ohm, top makes, Performance guaranteed. 6j1n, 8in, 8/-, 5in, 7 4 in., 11/-.

13 CHANNEL T.V.s. Table Models, Famous Makes. Absolutely Complete. These sets are unequaled in value due to huge purchase direct from source. They are untested, and not guaranteed to be in working order. Carr. etc., 15/-.

12in. £2.19.0 14in. £4.19.0

TRANSISTOR PORTABLES. Med. and Long. 6 + diode light weight approx. 1lb., slightly larger than pocket set, but much greater volume, better quality, complete battery, amazing sensitivity worth £11. Our price only £8.10.0.

F.M. TUNER KITS. Well-known make, comprising P.M. Tuning Head, guaranteed no drift. Frequency coverage 50-150 Mc/s. OAS1 balanced diode output, Magic Eye Tuning, Two I.F. stages and discriminator, £6.9.6.

P.V.C. CONNECTING WIRE. 100 yds. 30 mil; Special Price 7/6, 200 yds. 30 mil; special price 12/6, 25ft. 50il, 1/-, 3 Cables different colours, 4/-, Connecting 6/-.

TRANSISTORS. Red spot 3/6 ea. White Spot 4/6 ea. Yellow Spot 2/9 ea. Germanium diodes 9d. ea, 8/- doz.

TRADE SUPPLIED. Civil and Industrial valves, receiver valves and components. Quantity quotations for all items advertised plus 100% more. Government departments and manufacturers supplied.

CONDENSERS. 25 Mixed, Electrolytic

Many popular sizes, List Value £5, Our Price 10/-.

B.B.C./I.T.A. TUNERS

Famous makes complete with P.C.M.S, PCC4 valves, 35 M/c I.F. Fantastic value 19/-

GET 15. G.E.C. High Power, Contact cooled, miniature matched pre Transistor with Push-Pull Input & Output Transformers, with complete 1 watt ampl. circuit. Knock out price 29/-.

NEW SPEAKER CABINETS, covered in attractive Relexine, Gold Metal front 11 1/2" x 11 1/2" x 11 1/2" Complete with 7 x 4 Speaker, 19/-, P.P. 1/6.

UA20 Autochangers. Latest B.S.R. 10 mixed records, Brand New. Unreplaceable, £8.19.0. Also UA14. A Proven Choice £7.19.0, P.P. 4/-.

"GARRARD" Stimuline. Very latest Compact Autochanger. Just released, Amazing value, £8.19.0. Also available, Garrard Model 209, £9.17.6, P.P. 4/-.

100 RESISTORS 6/6

100 CONDENSERS 10/-

Miniature Ceramic and Silver mica Condensers 3 pF to 5,000 pF. LIST VALUE OVER £5.

IVORY/GOLD KNOBS 1" Diameter, half price 1/2, 5 for 4/6; 1 1/2" 5 for 5/-

Post: 2 lbs. 2/-, 4 lbs. 2/6, 7 lbs. 3/6, 15 lbs. 4/-, etc. No C.O.D. ALL ITEMS LESS 5% AND POST FREE IN DOZENS. LIST OF 1000 SNIP3, 6d.

TECHNICAL TRADING CO.

RETAIL SHOP 350-352 FRATTON ROAD, PORTSMOUTH

MAIL ORDER ONLY DEVONIAN ROAD, PARK CRESCENT PLACE, BRIGHTON 7, SUSSEX



COMPLETE V.H.F./A.M. RADIO FOR £12.10.0

(carr. paid)
Brand new set, in superb walnut cabinet (size 19 x 8 1/2 x 14 1/2 in. high). Covering 80-100 Mc/s. 16-49 M. and 200-300 M. Mains trans. 200-250 v. with 2 tapplings. Ferrite rod aerial for A.M. Controls: volume on/off, tone tuning, w/change. Gram and ext. speaker position provided. Valves 12A7, 12AH5, 6B/6, 6ABC80, 6BW6 and metal rectifier. Fully guaranteed. Today's Value, £20.

THE "CANTATA" 6-TRANSISTOR AND DIODE PORTABLE

COMPLETE KIT FOR ONLY

£7.19.6 (post 3/6)

500mW push-pull output. Ferrite rod aerial. Car aerial socket and coil. M.W. and L.W. full coverage. Operates on two 4.5v. cells. Printed circuit board 8 1/2 x 2 1/2 in. All holes drilled and component positions marked. Instructions 2/6 for 10p. (retfunded on purchase of kit). Size 9 x 3 1/4 x 7 in. 8 x 2 1/2 in. P.M. high quality speaker. Attractive Vynair covered cabinet two tone. Two batteries 5/6 the pair (Ever Ready 126). Mullard transistors OC44, 2 x OC45, OC81D, and 2 x OC81. Top grade Weymouth Radio coils and transformers. Alignment service if required 17/6 (inc. post). Write for list of prices. All parts supplied separately. Built in two hours.



BUILD YOUR OWN RECORD PLAYER
Price £12 carr. paid

Fully built 2-valve amplifier

B.S.R. 4-sp. autochanger, case 17 x 13 x 9 1/2 in. Assembled in 15 mins. Similar cabinet for tape recorder with plain board only £8, carr. paid. Attractive colours.

or with 3-valve amplifier 15/- extra

AUTOMATIC RECORD CHANGERS—LATEST MODELS. 4 SPEED CRYSTAL CARTRIDGE. All 6/- extra. B.S.R. UA14, £7.10.3. Garrard Slimline, Mono £8. Stereo, £8.5.0. Motor Board for UAS, UA20 UA14, Slimline, 5/-, (post 1/6) and 2 x OC81. post paid when purchased with Autochanger. Motor Board for Collaro C60, 4/-, post paid.

TELEFUNKEN STEREO AMPLIFIERS. 2 EC182—2 x 2 1/2 watts, 12 x 9 x 2 in. piano keys, £7, post paid. Complete with power.

SELF-POWERED VHF TUNER CHASSIS. Covering 88-95 Mc/s. Mullard permeability Tuner, Dims. 10 1/2 x 4 1/2 x 5 in. high EC045, EP91, EP91 and 2 diodes. Metal Rectifier. Mains transformer. Fully wired and tested. Only £7.10. (carr. pd.) Attractive Vynair Cabinet 20/-, Room dipole 12/6, Feeder, 6d. yd.

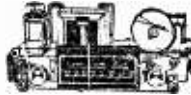

PUSH-PULL AMPLIFIER £5.50

(6/- Carr.)

Brand new 200-240 A.C. mains. Bass, treble and vol. controls. With valves E230, EC083 and 2-EL84 giving full 8 w. Chassis 12 x 3 1/2 x 3 1/2 in. With o.p. trausa for 2-3 ohm speaker. Front panel (normally screws to chassis) may be removed and used as "flying panel." Stereo version 2 x 4 w. same price.

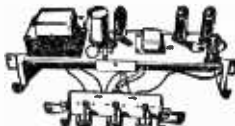

TAPE RECORDER AMPLIFIER

Type TR3. Fully built, high gain, low noise, printed circuit. Attractive grey and gold front panel 13 x 1 1/2 in. Height 5 1/2 in. overall. Front to back 3 1/2 in. Vol. and on/off tone. Mike, radio, monitor and ext. speaker jacks. Valves EC083, EC182, E230, Mains trans. Ready to bolt to B.S.R. Deck. Complete with switch waffer wired. Our Price ONLY £6.2.6. (6/- Packing and Carr.) Similar model without magic eye, Type T.H.L. 3" instead of 1 1/2", £5.15.0. (6/- Carr.) Also suitable for Collaro Deck.

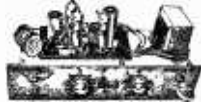

Transistor set Battery Eliminator. Converts your 6 transistor receiver to mains operation. Size 1 1/2 x 1 x 1 in. With rtx lead and battery charging attachment, 18/6.

Star "Galaxy" or Garrard 9v. battery operated single 45 r.p.m. record player deck, with pick-up arm, and stylus etc. Only 60/-, P. & P. 4/-.

NEW LOUDSPEAKER BARGAINS. Good Makes.

2-3 ohms, 13 x 8 1/2 in. 35/- (4/-); 7 x 4 in. 14/6 (2/-); 8 1/2 x 4 1/2 in. 12/6 (2/-); 10 x 6 in. 25/- (3/-); 5 in. 12/- (2/-); 4 in. tweeter 7/6 (2/-); 7 x 5 in. 17/6 (2/-); 9 x 6 in. 22/- (2/6); 5 in. circ. 18/6 (2/6); 10 in. circ. 25/- (3/-). Postal charges bracketed.

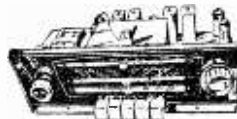

BRAND NEW AM/FM (V.H.F.) RADIOGRAM CHASSIS AT £14.0.0 (Carriage Paid)

A.C. U.L.Y. Chassis size 1 1/2 x 8 1/2. 3 1/2 in. high. New manufacture. Dia 1 1/2 x 4 in. in 2 colours predominantly gold. Pick-up. Ext. speaker. A6, B, and Dipole sockets. Five push buttons—OFF L.W., M.W., P. 31. and Gram. Aligned and tested. O.P. Transformer. Tone Control, 1,000-1900 M.; 200-300 M.; 88-98 Mc/s. Valves EZ80 rect. ECH81, EP91, EAC80, EL84, EC083. Speaker and Cabinet to fit chassis (Cable model). 47/6 (post 1/-). 9 x 6 in. ELLIPTICAL SPEAKER, 20/-, to purchasers of this chassis. T.E.L.S. (Chassis) £5 down and 5 monthly payments of £1. Cheap Boom Dipole for V.H.F., 12/6. Feeder: 6d. yd. Circuit diagram 2/6.

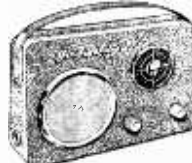

6-TRANSISTOR PORTABLE—Fully Built

The "SCALA" for only £12.17.6, carr. paid. 8 1/2 x 2 x 5 1/2 in. high. Choice of colours. Resin. M.W. and L.W. Ferrite aerial. Battery included. Printed circuit. Nicely styled. A professional job. 3 1/2 in. speaker. Fully Tunable M.W. and L.W.

THIS SUPERB SET FOR £10

6-transistor radio with 3 push button controls, covered in sponge clean Duracor fabric, in latest two tone shades, M.W. and L.W. ferrite rod, provision for car aerial. 2-colour scale. With 177 battery giving 300 hours use. Weighs under 4 lbs. With carrying handle. 12 x 7 1/2 in. high x 4 1/2 in. at base tapering to 2 in. at top. Brand new, fully guaranteed. £10, Carr. paid. Worth £16.

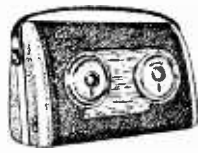

SUPERIOR GRAMOPHONE AMPLIFIER

Valves UY85, UY80 and UL4. Mains trans. 200-240 a.c. Covered baffle 13 x 7 1/2 in. (9 1/2 in. speaker) or 11 x 7 1/2 in. (8 x 5 in. speaker). 3 front controls: bass, treble, on-off/rol. 74/- (post 4/-) either type. Resin cabinet to fit, with carrying handle, and lid (detachable) 14 in. or 12 x 8 1/2 x 5 in. 16/- extra.

GRAMOPHONE AMPLIFIER. With 5 in. SPEAKER Baffle 12 1/2 x 6 in. EC182 and Rectifier, Tone and Volume. On/off switch. Two knobs. Useful for Stereo, 57/- (post 4/-).

TAPE JOE QUALITY BOXED. 5 1/2 in.—850ft., 15/-; 1,200ft., 17/6; 1 in.—1,200ft., 17/6; 1,800ft., 26/6 (all plus 1/6 post. 2/- for 2).

SPECIAL OFFER

Brand new tape recorder, two tone beige case, "gold" trimmings. Magic eye, monitor, ext. speaker sockets. With 5 1/2 in. tape and mike. Fully guaranteed. Price usually 191 kns. Very high gain with low noise. Price £18 carr. paid.

COLLARO STUDIO TAPE TRANSCRIPTION. 3 MOTORS, 3 SPEED. 1 1/2, 3 1/2 and 7 1/2 P.S. Push buttons. £10.17.8 (10/- incl. stool).

3-VALVE AMPLIFIER (inc. RECT.)

2 1/2 watts. EC083, EC182 and EZ80. Controls, volume, bass and treble. On/off switch. Mains and O.P. trans. Size as for Push-Pull Amp. Suitable for microphone input and for Guitar. 95/- P. & P. 6/-

Also acts as telephone amplifier using pick-up coil price 14/-, Chassis 12 x 8 1/2 x 3 1/2 in. Fixed front panel. Price includes handsome walnut finish polished cabinet, 13 x 7 1/2 in. fascia containing high quality 8 ohm P.M. speaker 5 1/2 x 4 1/2 in. (20/- less without cab. and speaker).

BATTERY ELIMINATOR

For 4 Low Consumption Valves (9v range), 90v. 15mA and 1.4v. 125mA, 45/- (2/6 post). 200-250v. A.C. Also for 250mA, 1.4v. and 90v. 15mA at same price.

CHASSIS BATTERY RADIO

Valves DK06 DP96, DAF96, DL36. Two short W. windings 16 to 49 M. and 25 to 75 M. Size 10 1/2 x 4 1/2 x 3 in. £4.2.3, carr. paid. MW and SW, £5, carr. paid. Or see kit 75/-.

ALL ITEMS ARE NEW AND FULLY BUILT UNLESS OTHERWISE STATED. TESTED BEFORE DESPATCH.

Terms Available on Items over £5. Send 6d. (stamps will do) for 20 page illustrated catalogue. Delivered by return. C.O.D. 2/- extra.

ALL ITEMS GUARANTEED 12 MONTHS VALVES 3 MONTHS

GLADSTONE RADIO "SCALA", CAMP RD., FARNBOROUGH, Hants.

(Farnborough 3371) and at 247 New Road, Copnor, Portsmouth. FARNBOROUGH CLOSED SATS.—PORTSMOUTH WEDS.

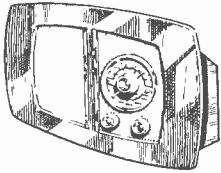

**TABLE MODEL
TRANSISTOR SET
£9.10.0 (carr. paid)**

6 transistors and diode. 5in. circular speaker, superhet circuit. Cabinet 13 x 7½ x 4½in. battery included. Fully tuneable LW and MW. Polished walnut front.

MAINS OPERATED RADIO CHASSIS AND AMPLIFIER OF FAMOUS MANUFACTURE

Chassis 10 x 5½ x 4in. front to back. Valves: 6UB41, 6CH41, 6F99, 6L64 with metal rectifier. 5in. speaker. Ferrite rod aerial. Tone, vol. and gram. position. Covers L. and M. waves. Limited quantity at only £6 (5/- carr.) complete with small dial. Unused and in working order.



TELEFUNKEN

German made F.M. front end. 22/6 (post 2/6), with ECC85 valve. Permeability tuned, 88-99 mc/s. 4 x 1½ x 2in. high plus valve 2in. Circuit 2/-

MULLARD

Permeability tuned F.M. front end 22/6 (post 2/6), with ECC85. 4 x 3 x 3½in 88-95 mc/s.

TRANSISTOR BABY ALARM

Two attractive moulded units with connecting lead. Just plug the units together. FULLY BUILT not a kit. Battery included, lasts months. Is excellent intercomm. ONLY £5, carr. paid.

BRAYHEAD "TRANSTRONIC" TRANSISTOR CONSTRUCTION KIT

Two Mullard transistors and diode. Seven circuits can be built inc. transmitter and receiver. 13-page instruction book. Includes all necessary components. Just the gift for a beginner. Originally over £5. Our price 42/6 (post 2/6).

MINIATURE EARPHONES FOR TRANSISTOR RADIOS

3 foot cord. Miniature Jack and Socket. Crystal 8/-, magnetic 7/6.



**4 TRANSISTOR
MINIATURE PUSH-PULL
AUDIO AMPLIFIER**

For three ohm speaker. 200mW output suitable for intercoms. Portable radios, etc., with free instruction sheet and diagram. For tube or radio input 4 x 1½ x ¾in. Printed circuit 47/6, post paid.

TRANSISTORS POST FREE

Set of 6 Mullard transistors OC34, 2-OC45, OC111, 2-OC81 (matched) and OA70 diode 30/- set of G.E.C. transistors 874, 2-873, 3-82 or 83, 17/6.

TEST LEAD KIT

Leads, prods, terminals, clips, in case, 10/-, post paid.

PANEL OF 7 POTS.

10 x 1½in.—4 x 1M and 3 x 2M. 4/- (post 1/-).



THREE-VALVE AMPLIFIER and RECTIFIER



4 watts. Valves 6X5S, 6L6 and 6Z80. Controls, volume, bass and treble. On/off switch. (Chassis size 6½ x 3 x 2½in.) 6½in. round or 7 x 4in. elliptical speaker. Not suitable for microphone input. A.C. only. 67/-, P. & P. 3/-.

PERSPEX

12½ x 9½ by ½in. clear, 5/-, 16 x 14 x ¾in. clear, 7/6. Postage on one sheet 2/-, on two or more 3/-.



UNLIMITED OPPORTUNITIES exist today for "getting on" . . . but only for the fully trained man. Let I.C.S. tuition develop your talents and help you to success.

STUDY IS EASY with I.C.S. guidance. The courses are thorough. Printed manuals, fully illustrated, make study simple and progress sure.

YOUR ROAD TO SUCCESS can start from here—today. Complete this coupon and post it to us, for full particulars of the course which interests you. MODERATE FEES INCLUDE ALL BOOKS.

Take the right course now . . .

- | | |
|--|---|
| ADVERTISING Gen. Advertising, Retail & Dept. Store Copywriting. | HORTICULTURE Complete Gardening Flower & Veg. Growing |
| ART Oil & Water Colour Commercial Illustrating | MANAGEMENT Business Management Hotel Management Office Management Industrial Management Personnel Management Work study, Foremanship |
| BUILDING Architecture, Clerk of Wks, Buildg. Constr. & Allied Trades, Quantity Surveying. | MECHANICAL & MOTOR ENGINEERING Engineering Maths. Weldg. Diesel Engines and Locom. Inspection, Workshop Pract. Refrigeration, Motor Mech. Running and Maintenance (many other subjects) |
| CIVIL ENGINEERING Highway Eng., struct. Eggrg., Concrete Engineering | PHOTOGRAPHY Practical Photography P.D.A. Examination |
| COMMERCE Bookkeeping, Accountancy, Office Training, Costing, Secretaryship, Storekeeping Shorthand & Typewriting | POLICE Police Entrance Exam. |
| DRAUGHTSMANSHIP Architectural, Mechanical, Maths. & Machine Drawing Drawing Office Practice Structural Drawing | RADIO, T.V. & ELECTCL Radio Servicing & Engrg. Radio Constrn. (with kits) |
| ELECTRONICS Industrial Electronics Computers & Maintenance | SELLING Commercial Travellers Sales Mgmtnt, Ret. Selling |
| FARMING Arable & Livestock Farm Machinery Maint. Pig & Poultry Keeping Market Gardening | WRITING FOR PROFIT Short Story Writing Free-Lance Journalism |
| FIRE ENGINEERING I.P.E. Examinations Fire Service Promotion | And many other subjects |
| GENERAL EDUCATION Good Eng., Foreign Langs. G.C.E. subjects at ordinary or advanced level | |

INTENSIVE COACHING for all principal examinations including C.I.S., A.C.C.A., I.C.W.A., B.I.M., A.M.I.Mech.E. Brit.I.R.E., I.Q.S., City & Guilds of London Institute, R.H.S., P.M.G. Certificates in Radiotelegraphy, etc.

Start today the I.C.S. way!

INTERNATIONAL CORRESPONDENCE SCHOOLS
(Dept. 172)

Intertext House, Parkgate Rd., London, S.W.11

Send FREE book on.....

Name.....

Address.....

Occupation.....

11.62

INTERNATIONAL CORRESPONDENCE SCHOOLS

BENTLEY ACQUICOR CORPORATION LTD.

THE VALVE SPECIALISTS 38 CHALCOT ROAD, LONDON, N.W.1

Telephone: PRIMROSE 9093

EXPRESS POSTAL SERVICE! ALL ORDERS DESPATCHED SAME DAY AS RECEIVED. FOR ONLY 2/6 EXTRA TELEPHONE FOR THAT URGENT ORDER TO BE DESPATCHED IMMEDIATELY BY OUR SPECIAL C.O.D. SERVICE

ANY ORDER INSURED AGAINST DAMAGE IN TRANSIT FOR ONLY 6d. EXTRA.

| | | | | | | | | | | | | | | | | | | | | | | |
|-------|-------|-------|-------|--------|-------|-------------|-----------|------------|-------|-------|-------|--------|--------|----------|-------|--------|-------|-----------------------|-------|-------------|------------|-----|
| 0A2 | 17/8 | 6B95 | 7/8 | 6855 | 7/- | 2509GT111/6 | AC/PCN(7) | EAC01 | 4/6 | EK32 | 8/8 | K791 | 12/3 | PY83 | 13/- | 110 | 48/8 | Transistors and Tubes | | | | |
| 0B2 | 17/8 | 6BQ7A | 15/- | 6740T | 18/8 | 2509GT112/6 | AC/PCN(7) | EAC01 | 4/6 | EK32 | 8/8 | K791 | 12/3 | PY83 | 13/- | 110 | 48/8 | Transistors and Tubes | | | | |
| 0B4 | 9/- | 6B37 | 12/8 | 6B34 | 9/6 | 2509GT113/6 | AC/PCN(7) | EAC01 | 4/6 | EK32 | 8/8 | K791 | 12/3 | PY83 | 13/- | 110 | 48/8 | Transistors and Tubes | | | | |
| 1A3 | 3/- | 6B18 | 13/2 | 6U7G | 8/6 | 2509GT114/6 | AC/PCN(7) | EAC01 | 4/6 | EK32 | 8/8 | K791 | 12/3 | PY83 | 13/- | 110 | 48/8 | Transistors and Tubes | | | | |
| 1A3 | 6/- | 6B47 | 8/6 | 6V6G | 7/- | 2509GT115/6 | AC/PCN(7) | EAC01 | 4/6 | EK32 | 8/8 | K791 | 12/3 | PY83 | 13/- | 110 | 48/8 | Transistors and Tubes | | | | |
| 1A7 | 12/8 | 6B8V | 10/8 | 6V6GT | 8/6 | 2509GT116/6 | AC/PCN(7) | EAC01 | 4/6 | EK32 | 8/8 | K791 | 12/3 | PY83 | 13/- | 110 | 48/8 | Transistors and Tubes | | | | |
| 1C1 | 6/8 | 6B8V7 | 9/- | 6X4 | 5/- | 2509GT117/6 | AC/PCN(7) | EAC01 | 4/6 | EK32 | 8/8 | K791 | 12/3 | PY83 | 13/- | 110 | 48/8 | Transistors and Tubes | | | | |
| 1C2 | 9/- | 6B126 | 8/- | 6X3 | 8/- | 2509GT118/6 | AC/PCN(7) | EAC01 | 4/6 | EK32 | 8/8 | K791 | 12/3 | PY83 | 13/- | 110 | 48/8 | Transistors and Tubes | | | | |
| 1C3 | 9/8 | 6C4 | 8/- | 736 | 20/9 | 2507 | 7/- | AC/PT224/3 | 2B08A | 3/- | EL41 | 9/- | EL7441 | 8/- | R10 | 18/- | U3 | 25/11 | GD9 | 4/- | | |
| 1C4 | 12/6 | 6C5 | 8/6 | 787 | 8/6 | 3001 | 9/- | AP4 | 7/8 | EB09 | 7/- | EL42 | 10/3 | L08 | 9/- | R12 | 7/8 | U7 | 25/11 | GD9 | 4/- | |
| 1C4 | 13/8 | 6C6 | 8/6 | 787 | 8/- | 3001.15 | 16/2 | AP4 | 7/8 | EB09 | 7/8 | EL41 | 10/2 | L08 | 9/8 | R13 | 25/11 | C41 | 19/8 | OD10 | 4/- | |
| 1C5 | 13/2 | 6C7 | 12/6 | 706 | 8/6 | AC/PT 2/3 | 15/8 | EB09 | 7/8 | EL41 | 10/2 | EL43 | 10/8 | ME41 | 12/6 | R14 | 17/6 | C42 | 19/8 | OD10 | 4/- | |
| 1D6 | 10/8 | 6C9 | 13/8 | 747 | 8/- | 300FL1 | 13/- | AZ31 | 10/- | EBF33 | 14/7 | EL44 | 7/6 | ME91 | 12/8 | R15 | 14/6 | U45 | 13/8 | OD15 | 10/- | |
| 1F1 | 8/6 | 6C10 | 9/6 | 747 | 9/6 | 300FL12 | 18/2 | AZ41 | 13/7 | EBF59 | 9/8 | EL45 | 13/7 | 414 | 7/- | R19 | 12/3 | C47 | 17/8 | GD16 | 4/- | |
| 1F2 | 3/6 | 6C12 | 13/7 | 71 | 7/3 | 300L1 | 8/- | 300L1 | 13/- | EB11 | 8/2/8 | EL46 | 10/10 | HDH4 | 12/8 | R52 | 12/3 | C50 | 9/8 | GET10617/8 | 4/- | |
| 1F3 | 3/8 | 6C16D | 23/8 | 102 | 3/8 | 300L15 | 9/- | EL08 | 7/3 | EB12 | 22/8 | EL47 | 7/6 | HO1/240A | 10/8 | R53 | 12/3 | C52 | 9/8 | GET1118/7 | 4/- | |
| 1F4 | 12/8 | 6C18 | 12/6 | 747 | 7/8 | 300L17 | 8/6 | EL11 | 12/8 | EB13 | 22/8 | EL48 | 10/8 | MILD01/3 | 10/8 | R54 | 12/3 | C53 | 9/8 | GET114 | 4/6 | |
| 1FD3 | 6/- | 6B84 | 24/- | 91W6 | 14/11 | 300L22 | 7/8 | C1 | 12/8 | EB21 | 1/7 | EL360 | 27/- | 111 | 8/8 | RK36 | 27/8 | U76 | 9/8 | GET1876/10 | 4/- | |
| 1G6 | 17/8 | 6D1 | 2/- | 312 | 4/- | 300P4 | 7/8 | EL11 | 27/2 | EL22 | 5/8 | EL220 | 14/- | 416 | 6/3 | R130 | 29/8 | U78 | 8/8 | GET18746/11 | 4/- | |
| 1H5 | 10/8 | 6D3 | 12/6 | 917 | 13/7 | 300P1 | 19/8 | EL31 | 22/3 | EL23 | 12/8 | EL221 | 25/11 | 534B | 29/8 | SP48 | 29/8 | C107 | 18/8 | GET13 | 4/6 | |
| 1L4 | 3/6 | 6D6 | 9/6 | 10C1 | 13/- | 300P1 | 10/8 | UCH33 | 22/3 | EC34 | 8/- | EL22 | 19/8 | MSF4 | 20/- | SP44 | 19/8 | C101 | 18/8 | GET135 | 4/6 | |
| 1L4S | 16/10 | 6D8 | 15/8 | 10C1 | 13/- | 300P12 | 12/8 | CK308 | 8/6 | EA70 | 12/8 | EL44 | 17/8 | AP12/11 | 3/- | SP41 | 19/8 | C101 | 18/8 | GET136 | 10/8 | |
| 1LD5 | 5/6 | 6E5 | 12/6 | 101 | 7/8 | 300A | 20/8 | LA | 23/13 | EC51 | 27/8 | EL44 | 19/8 | EX40 | 15/8 | SP43 | 19/8 | U85 | 14/8 | GET1854/16 | 4/- | |
| 1LX5 | 5/- | 6F1 | 25/11 | 10D2 | 11/2 | 3141GT | 10/8 | CL33 | 18/8 | EC90 | 7/8 | EM35 | 18/8 | 87 | 22/8 | SP41 | 20/8 | U81 | 19/8 | GET1851/17 | 4/- | |
| 1N3 | 10/8 | 6F5 | 12/6 | 10F1 | 25/11 | 33W4 | 7/8 | CV6 | 8/6 | EC91 | 10/5 | EM35 | 18/8 | N74 | 22/8 | SP45 | 27/8 | U89 | 25/8 | GET1852/18 | 4/- | |
| 1P1 | 8/8 | 6F8 | 7/- | 10F9 | 11/3 | 33Z6 | 15/2 | CV63 | 10/8 | EC91 | 12/8 | EM35 | 18/8 | N08 | 22/8 | SP41 | 20/8 | U91 | 11/8 | GET1853/19 | 4/- | |
| 1P10 | 7/8 | 6F9 | 12/6 | 10F9 | 11/3 | 33Z6GT | 9/- | CV71 | 13/2 | EC92 | 5/6 | EM35 | 18/8 | N14 | 22/8 | SP210A | 4/8 | U91 | 11/8 | GET1854/20 | 4/- | |
| 1P11 | 7/8 | 6F8 | 12/6 | 10L3 | 9/6 | 33Z6GT | 8/- | CV1 | 13/2 | EC92 | 5/6 | EM35 | 18/8 | N15 | 13/7 | 7/- | U92 | 12/8 | U92 | 12/8 | GET1855/21 | 4/- |
| 1P8 | 6/6 | 6F11 | 17/8 | 10L3 | 9/6 | 408UA | 13/2 | CV10 | 13/2 | EC92 | 3/6 | EM35 | 18/8 | N30 | 50/1 | F41 | 9/- | U93 | 19/8 | GET1856/22 | 4/- | |
| 1S4 | 9/- | 6F12 | 4/6 | 10P13 | 15/- | 4131HT | 11/8 | Y81 | 11/- | EC93 | 3/6 | EM35 | 18/8 | N39 | 15/8 | FD12 | 12/8 | U93 | 19/8 | GET1857/23 | 4/- | |
| 1S5 | 6/- | 6F13 | 11/6 | 10P14 | 13/8 | 42 | 22/8 | 8/- | EC95 | 8/6 | EM35 | 18/8 | N40 | 18/10 | FD13 | 12/8 | U94 | 19/8 | U94 | 19/8 | GET1858/24 | 4/- |
| 1T2 | 25/11 | 6F2 | 13/8 | 10P15 | 13/8 | D13 | 17/8 | D13 | 17/8 | EC95 | 18/8 | EM35 | 18/8 | N41 | 18/8 | FD12C | 9/8 | U91 | 19/8 | GET1859/25 | 4/- | |
| 1T4 | 3/6 | 6F15 | 14/11 | 11E3 | 15/- | 90A5 | 21/10 | D42 | 10/6 | EC95 | 8/- | EM35 | 18/8 | N42 | 18/8 | FD15 | 15/11 | U95 | 14/8 | GET1860/26 | 4/- | |
| 1Y4 | 12/6 | 6F19 | 9/6 | 12A6 | 5/- | 90C3 | 10/7 | D93 | 5/- | EC95 | 8/6 | EM35 | 18/8 | N43 | 18/7 | FD133 | 8/6 | U95 | 14/8 | GET1861/27 | 4/- | |
| 1U5 | 6/- | 6F17 | 12/6 | 12A8 | 16/8 | 90D6G | 36/7 | D77 | 4/- | EC95 | 7/8 | EM35 | 18/8 | N44 | 18/7 | FD22 | 13/8 | U96 | 14/8 | GET1862/28 | 4/- | |
| 2A7 | 10/8 | 6F18 | 14/11 | 12A8 | 16/8 | 90G11 | 13/8 | DA32 | 10/8 | EC95 | 9/- | EM35 | 18/8 | N45 | 18/7 | FD25 | 13/8 | U97 | 14/8 | GET1863/29 | 4/- | |
| 2C98 | 4/- | 6F20 | 12/6 | 12A6 | 13/8 | 90K1 | 14/8 | DA32 | 10/8 | EC95 | 9/- | EM35 | 18/8 | N46 | 18/7 | FD25 | 13/8 | U97 | 14/8 | GET1864/30 | 4/- | |
| 2D10C | 7/8 | 6F23 | 10/8 | 12A6G | 13/7 | 90L10 | 13/8 | EP36 | 8/6 | EC95 | 18/8 | EM35 | 18/8 | N47 | 18/7 | FD26 | 13/8 | U98 | 14/8 | GET1865/31 | 4/- | |
| 2D21 | 15/- | 6F24 | 12/6 | 12AHT | 7/- | 72 | 4/6 | D90 | 10/6 | EC95 | 10/6 | EM35 | 18/8 | N48 | 18/7 | FD26 | 13/8 | U98 | 14/8 | GET1866/32 | 4/- | |
| 2P | 25/11 | 6F32 | 19/8 | 12A1H | 12/8 | 77 | 8/- | DD1 | 12/6 | EC95 | 10/6 | EM35 | 18/8 | N49 | 18/7 | FD26 | 13/8 | U98 | 14/8 | GET1867/33 | 4/- | |
| 2X2 | 25/11 | 6F33 | 7/8 | 12A10 | 7/8 | 74 | 9/6 | DD4 | 18/7 | EC95 | 10/6 | EM35 | 18/8 | N50 | 18/7 | FD26 | 13/8 | U98 | 14/8 | GET1868/34 | 4/- | |
| 3A1 | 8/- | 6F34 | 8/6 | 12A11 | 7/8 | 81 | 15/8 | D72 | 12/8 | EC95 | 10/6 | EM35 | 18/8 | N51 | 18/7 | FD26 | 13/8 | U98 | 14/8 | GET1869/35 | 4/- | |
| 3A3 | 10/8 | 6F34 | 3/- | 12A16 | 22/8 | 88 | 15/8 | D72 | 12/8 | EC95 | 10/6 | EM35 | 18/8 | N52 | 18/7 | FD26 | 13/8 | U98 | 14/8 | GET1870/36 | 4/- | |
| 3B7 | 12/8 | 6A5G | 5/- | 12A17 | 9/8 | 83V | 19/8 | DF33 | 10/6 | EC95 | 10/6 | EM35 | 18/8 | N53 | 18/7 | FD26 | 13/8 | U98 | 14/8 | GET1871/37 | 4/- | |
| 3D9 | 5/- | 6A5G | 5/- | 12A16 | 12/4 | 82A1 | 4/2 | DF65 | 15/8 | EC95 | 10/6 | EM35 | 18/8 | N54 | 18/7 | FD26 | 13/8 | U98 | 14/8 | GET1872/38 | 4/- | |
| 3Q4 | 7/8 | 6A6 | 5/6 | 12A17 | 7/8 | 83A | 18/8 | DF72 | 9/8 | EC95 | 10/6 | EM35 | 18/8 | N55 | 18/7 | FD26 | 13/8 | U98 | 14/8 | GET1873/39 | 4/- | |
| 3Q9 | 9/8 | 6A7 | 9/8 | 12A18 | 7/8 | 80A3 | 18/8 | DF91 | 8/6 | EC95 | 10/6 | EM35 | 18/8 | N56 | 18/7 | FD26 | 13/8 | U98 | 14/8 | GET1874/40 | 4/- | |
| 3A4 | 7/- | 6A7GT | 10/8 | 12B10 | 5/8 | 80AV | 6/7/8 | DF91 | 8/6 | EC95 | 10/6 | EM35 | 18/8 | N57 | 18/7 | FD26 | 13/8 | U98 | 14/8 | GET1875/41 | 4/- | |
| 3V4 | 7/3 | 6A8 | 12/6 | 12B17 | 20/8 | 80C3 | 3/7/8 | DF97 | 9/- | EC95 | 10/6 | EM35 | 18/8 | N58 | 18/7 | FD26 | 13/8 | U98 | 14/8 | GET1876/42 | 4/- | |
| 4D1 | 7/8 | 6A6 | 8/- | 12E1 | 30/8 | 90B5 | 3/7/8 | DI30 | 15/8 | EC95 | 10/6 | EM35 | 18/8 | N59 | 18/7 | FD26 | 13/8 | U98 | 14/8 | GET1877/43 | 4/- | |
| 5R10V | 17/8 | 6A7 | 8/6 | 12E2 | 30/8 | 90B5 | 3/7/8 | DI30 | 15/8 | EC95 | 10/6 | EM35 | 18/8 | N60 | 18/7 | FD26 | 13/8 | U98 | 14/8 | GET1878/44 | 4/- | |
| 5R10V | 17/8 | 6A7GT | 6/- | 12E3GT | 9/8 | 90C2 | 10/8 | DI30 | 15/8 | EC95 | 10/6 | EM35 | 18/8 | N61 | 18/7 | FD26 | 13/8 | U98 | 14/8 | GET1879/45 | 4/- | |
| 5A40 | 10/8 | 6K8G | 6/- | 12F1GT | 9/8 | 109C2 | 12/3 | DI77 | 7/- | EL42 | 10/6 | GZ33 | 19/5 | 34/- | UCL2 | 12/8 | W21 | 12/8 | OC44 | 8/8 | | |
| 5V3 | 6/8 | 6K8GT | 10/8 | 12K5 | 17/8 | 101 | 10/8 | DH41 | 45/8 | EL43 | 18/8 | GZ34 | 14/6 | PNK45 | 18/8 | UCL3 | 18/8 | W42 | 22/8 | OC45 | 9/- | |
| 5Y4 | 12/6 | 6K25 | 19/8 | 12K7GT | 5/6 | 158RT | 32/4 | DI10127/11 | EL46 | 18/2 | GZ37 | 16/5 | PNK45 | 18/8 | UCL4 | 18/8 | W42 | 22/8 | OC45 | 9/- | | |
| 5Z3 | 19/5 | 6L1 | 22/8 | 12K8G | 13/8 | 158RT | 32/4 | DI107 | 13/7 | EP8 | 22/8 | L30 | 5/- | PNK45 | 18/8 | UCL5 | 18/8 | W42 | 22/8 | OC45 | 9/- | |
| 6A1 | 9/- | 6L1G | 9/8 | 12Q1GT | 5/6 | 301 | 10/6 | DK32 | 12/8 | EP8 | 22/8 | H08 | 18/8 | PNK46 | 18/8 | UCL6 | 18/8 | W42 | 22/8 | OC45 | 9/- | |
| 6A102 | 10/8 | 6L6M | 10/8 | 12S4T | 8/6 | 302 | 12/3 | DK40 | 21/10 | EP22 | 14/- | IABCS0 | 18/8 | PNK352/3 | U95 | 9/- | W77 | 4/8 | OC70 | 6/8 | | |
| 6A7 | 10/6 | 6L7GT | 7/8 | 12S4T | 8/6 | 313 | 10/3 | DK91 | 8/8 | EP33 | 4/- | 13/8 | PNK43D | U96 | 13/8 | W81M | 8/8 | OC71 | 6/8 | | | |
| 6A8 | 9/- | 6L18 | 13/8 | 12S6 | 7/8 | 304 | 10/3 | DK92 | 10/8 | EP37A | 8/- | HL2 | 7/8 | PNK48 | 9/8 | W101 | 25/11 | OC72 | 6/8 | | | |
| 6A37 | 3/- | 6L19 | 22/8 | 12S17 | 9/6 | 317 | 13/8 | DK93 | 8/6 | EP39 | 5/5 | HL13C | 7/8 | PNK43 | 22/3 | U141 | 10/8 | OC73 | 16/8 | | | |
| 6A7 | 4/- | 6D10 | 8/8 | 12S17 | 9/6 | 317 | 13/8 | DK93 | 8/6 | EP40 | 15/- | HL23 | 14/11 | PNK44 | 25/11 | U146 | 14/8 | OC74 | 7/8 | | | |
| 6A15 | 5/6 | 6L1D3 | 11/8 | 12S8K7 | 6/8 | 307 | 7/8 | DK | | | | | | | | | | | | | | |

New 10th Edition Newnes Great Profit Maker!

COMPLETE IN
6 VOLUMES



Radio & TV Servicing

MODELS FROM 1962 BACK TO 1956

This NEW EDITION provides all the technical information you need for quicker repair work now and for years ahead! It gives you full servicing data and specialist repair hints for the popular models marketed by 70 principal makers during the past seven years. It is essential to the shrewd repair man because people are keeping their sets longer. If you have never before examined this famous reference work now is your opportunity. See the new edition for a week on free examination without obligation to buy.

TELEVISION · RADIO · RADIOGRAMS · CAR RADIOS
TAPE RECORDERS · RECORD REPRODUCERS

DATA FOR ALL THESE MAKES—Alba, Ambassador, Argosy, Armstrong, Baird, Beethoven, Berec, Brayhead, B.R.C., B.S.R., Bush, Capitol, Champion, Channel, Collaro, Cossor, Cyldon, Dansette, Decca, Defiant, Dynatron, E.A.R., Eddystone, Ekco, Elizabethan, Emerson, E.M.I., Emisonic, English Electric, Ever Ready, Ferguson, Ferranti, Fidelity, Ford Motor Co., Garrard, G.E.C., Gramdeck, Grundig, H.M.V., Invicta, K-B, McCarthy, McMichael, Marconiphone, Masteradio, Motorola, Murphy, Pageant, Pam, Perdio, Peto Scott, Philco, Phillips, Pilot, Portadyne, Portogram, Pye, Radiomobile, Raymond, Regentone, R.G.D., Roberts' Radio, Sobell, Sony, Sound, Spencer-West, Stella, Stereosound, Strad, Ultra, Vidor, Walter, Webcor. Includes special 50-page supplementary section of older models.

PLUS 2 YEARS' FREE POSTAL ADVISORY SERVICE

More than 4,000 Circuits and Component Layout Diagrams · 2,250 Popular Models

Use it **FREE** for 7 days
to prove its value



Every purchaser receives a Free copy of
TV ENGINEERS POCKET BOOK
(Value 12/6)

**272 PAGES : OVER 200
PRACTICAL ILLUSTRATIONS**
An invaluable companion to
your set for on-the-spot repairs
Concise information on installing,
fault-tracing and repairing, servicing
equipment and alignment, etc.

Hurry - Post Coupon To-day

George Newnes Ltd., 15-17 Long Acre, London, W.C.2.
Send me Newnes RADIO AND TELEVISION SERVICING (in 6 Volumes) and TV ENGINEERS POCKET BOOK without obligation to purchase. I will return them in 8 days or send 15/- deposit 8 days after delivery, then twenty monthly subscriptions of 15/-, paying £15. 15s. in all. Cash price in 8 days is £15.

Name and Address in block letters please

Mr., Mrs., Miss

Address

Occupation

Signature

(Parent signs if you are under 21).

Coupon is invalid if not signed and questions answered.

Tick ✓ where applicable

The address on left is—

- My Property
- Rented unfurnished
- Parents' Home
- Furnished Accom.
- Temporary Address

(RV) 533/32

R.S.C. (Manchester) MAIL ORDERS to 29 Moorfield Rd., Leeds 12. Terms: C.W.O. or C.O.D. No C.O.D. under £1 Lcd. Postage 2/9 extra under £2. 4/6 extra under £5 Trade Supplied. S.A.E. with all enquiries please.

| | | | | | | |
|---|--|------------------------------|---|--|--|--|
| BIRMINGHAM: 4 Gs Western Arcade (Opp. Snow Hill Stn) (Half-day Wed.) | SHEFFIELD: 13 Exchange St. Castle Market Bldgs. (Half-day Thurs.) | HULL: 51 Savile St | LIVERPOOL: 73 Dale St. (8 mins. from Lime St. or Exchange Stations) | BRADFORD: 56 Morley St. (above Alhambra Theatre) (Half-day Wednesday) | LEEDS: 5-7 County (Mecca) Arcade, Briggate | MANCHESTER: 18-10 Brown St. (Market St.) (No half day) |
|---|--|------------------------------|---|--|--|--|

SENSATIONAL STEREO OFFER

A complete set of parts to construct a good quality Stereo amplifier with an undistorted output total 8 watts. For A.C. mains input of 200-250 v. Including pair matched 61n. speakers. Sensitivity 130 m.v. Ganged Vol. and Tone Controls. Preset balance control. Full instructions and wiring diagrams supplied. Stereo Pick-up Head 19/9 extra with above only.

R.S.C. 30-WATT ULTRA LINEAR HIGH FIDELITY AMPLIFIER A10

A highly sensitive Push-Pull high output unit with self-contained Pre-amp. Tone Control Stages. Certified performance figures compare well with most expensive amplifiers available. Hum level 70 db down. Frequency response +3 db. 30-33,000 c/s. A specially designed sectionally wound ultra linear output transformer is used with 807 output valves. All components are chosen for reliability. Six valves are used EP86, EP88, ECC83, 837, 807, GZ34. Separate Bass and Treble Controls are provided. Minimum input required for full output is only 12 millivolts so that ANY KIND OF MICROPHONE OR PICK-UP IS SUITABLE. The unit is designed for CLUBS, SCHOOLS, THEATRES, DANCE HALLS or OUTDOOR FUNCTIONS, etc. For use with Electronic ORGAN, GUITAR, STRING BASS etc. For standard or long-playing records, OUTPUT SOCKET PROVIDES L.T. and H.T. for a RADIO FEEDER UNIT. An extra input with associated vol. control is provided so that two separate inputs such as Gram. and 'Mics' can be mixed. Amplifier operates on 200-250 v. 50 c/s. A.C. Mains and has output for 3 and 15 ohm speakers. Complete Kit of parts with fully punched chassis and point-to-point wiring diagrams and instructions. If required 10/- perforated cover with carrying handles can be supplied for 19/9. The amplifier can be supplied, factory built with EL34 output valves and 12 months guarantee, for 49/9s.

11 Gns. Carrying handles can be supplied for 19/9. The amplifier can be supplied, factory built with EL34 output valves and 12 months guarantee, for 49/9s.

TERMS: DEPOSIT 33/9 and 9 monthly payments of 33/9. Suitable microphones and speakers available at competitive prices.

WE STOCK ARMSTRONG AND JASON EQUIPMENT GOODMAN'S AND W.B. SPEAKERS

SUPERB FEEDER UNIT. Design of a high quality Radio Tuner (specially suitable for use with our Amplifiers). Delayed A.V.C. Controls are Tuning, Wch. and Vol. Only 200 v. 15 mA. H.T. and L.T. of 6.3 v. 1 amp. required from amplifier. Size approx. 9 x 6 x 7 in. high. Simple alignment procedure. Point-to-Point wiring diagrams, instructions and priced parts list with illustrations, 2/6. Total building cost £4.15.0. S.A.E. for leaflet.

R.S.C. BATTERY TO MAINS CONVERSION UNITS

Type BM1. An all-dry battery eliminator. Size 5 1/2 x 4 1/2 x 2 1/2 in. approx. Completely replaces battery supplying 1.4 v. and 90 v. where A.C. mains 200-250 v. 50 c/s is available. Suitable for all battery portable receivers requiring 1.4 and 90 v. This includes low consumption types. Complete kit with diagrams, 30/6, or ready to use, 49/6.



Type BM2. Size 8 x 5 1/2 x 2 1/2 in. Supplies 120 v. 90 v. and 90 v. 40 mA. and 2 x 0.1 A. to 1 amp. fully smoothed. Thereby completely replacing both H.T. batteries and L.T. accumulators when connected to A.C. mains supply 200-250 v. 50 c/s. **SUITABLE FOR ALL BATTERY RECEIVERS** normally using 2 v. accumulator. Complete kit of parts with diagrams and instructions, 49/9, or ready for use, 59/6.

TRANSISTOR RADIO CHARGER/ELIMINATOR UNITS. Ready for use, fitted "Snap On" clips. When connected to 200-250v. A.C. mains will charge 9 v. battery or replace same. PP3 Size 19/9. Larger size 29/9.

P.M. SPEAKERS. 10in. W.B. "Stentorian" 3 or 15 ohms type HF1012 10 watts, hi-fidelity type. Recommended for use with our A11 Amplifier, £4.12.9. 12in. R.A. 3ohms 10 watts (12,000 lines), 59/6. **TWEETERS.** Plessey 3 1/2 19/9. 15 1/2 95/0. **R.S.C. EQUIPMENT CABINET.** Size and appearance as Standard Bass Reflex Cabinet. Top hinged. Base board adjustable 8 gns.

Jason FMTI V.H.F./P.M. Radio Tuner design. Total costs of parts including valves Tuning dial, Escutcheon, etc., 26.19.0. Other Jason equipment in stock.

LINEAR L65 MINIATURE 4/5 WATT QUALITY AMPLIFIER. Suitable for any record playing unit, and most microphones. Negative feedback 12db. Separate Bass and Treble Controls. For mains 200-250 v. 50 c/s. Output for 2-3 ohm speaker. Mullard valves E280, LCC83, EL84. Size only 7-5-5 1/2 in. high. Guaranteed 12 months. Only 25.19.6. Send S.A.E. for leaflet. Terms: Deposit 22/9 and 5 monthly payments of 12/6.

R.S.C. 4-5 WATT AS HIGH-GAIN AMPLIFIER



A highly-sensitive 4-valve quality amplifier for the home, small club, etc. Only 50 millivolts input is required for full output so that it is suitable for use with the latest high fidelity pick-up heads. In addition to all other types of pick-ups and practically all 'mikes'. Separate Bass and Treble Controls are provided. These give full long-playing record equalisation. Hum level is negligible being 71 db. down 15 db. of Negative feedback is used. H.T. of 300 v. 25 mA. and L.T. of 6.3 v. 1.5 A. is available for the supply of a Radio Feeder Unit, or Tape-Deck pre-amplifier. For A.C. mains input of 200-250 v. 50 c/s. Output for 2-3ohm speaker. Chassis is not alive. Kit is complete in every detail and includes fully punched chassis (with baseplate) with Blue hammer finish and point-to-point wiring diagrams and instructions. Exceptional value at only £4.15.0. or assembled ready for use 25/- extra. Plus 2/6 carr. or Deposit 22/6 and 5 monthly payments of 12/6 for assembled unit.

R.S.C. PORTABLE GUITAR AMPLIFIERS. (For 200-250 v. A.C. Mains) Junior 3 watts High Quality output. Separate Bass and Treble "Cut" and "Boost" controls. Sensitivity 75 m.v. Twin inputs. High Flux 8in. Loudspeaker "built-in". Handsome, strongly made Cabinet (size approx. 14 x 14 x 7 in.) finished in attractive and durable nollacrome, and fitted with carrying handle. Terms: Deposit 21 and 9 monthly payments of 21. Send S.A.E. for leaflet. Carr. 10/-

£8.19.6 Separate Bass and Treble "Cut" and "Boost" controls. Twin separately controlled high gain inputs so that two instruments such as Guitar and String Bass can be used at the same time. Two loudspeakers are incorporated, a high Flux 12in. for Bass notes and a 7 x 4 in. elliptical for Treble. Cabinet is well made and finished as Junior model. Size approx. 18 x 18 x 9 in. **H.P. Terms. Deposit 34/9 and 15 Gns.** 9 monthly payments of 34/9. Carr. 10/- Send S.A.E. for leaflet of this or 15 watt. **Super III-PI 15 Watt.** All facilities as 10 watt Cabinet, size 20 x 16 x 13 in. Terms: Deposit 22.11.6. and nine monthly payments of 51/6. Cash 22 Gns. Carr. 12/6. Tremolo units on half page ad.

12in. 10 WATT HIGH QUALITY LOUD-SPEAKER

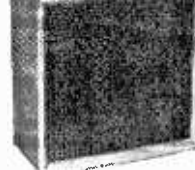

In walnut veneered cabinet. Gauss 12,000 lines. Speech coil 3 ohms or 15 ohms. Only £4.19.6 Carr. 6/- Terms: Deposit 11/3 and 8 monthly payments of 11/3.

12in. 30 WATT HI-FI LOUD-SPEAKERS IN CABINETS. Size 18 x 18 x 10 in. Finish as above. Terms: Deposit 17/9 and 9 monthly payments of 17/9. Only £7.19.6. Carr. 8/6.

R.S.C. JUNIOR BASS REFLEX CABINETS

Specially designed for W.B. HF1012 Speaker, but suitable for any good quality 10in. speaker. Accountably lined and ported. Polished walnut veneer finish. Size 18 x 12 x 10 in. Handsome appearance. Ensure superb reproduction for only 23.19.6. **STANDARD MODEL.** As above but for 12in. speakers. Size 20 x 15 x 13 in. Specially recommended for Audiotone Loud-speaker systems. £5.19.6. Suitable legs with brass ferrules, 19/6 per set of 4. **R.S.C. CORNER CABINETS**

Polished walnut veneer finish. Pleasing design. **JUNIOR MODEL.** Size 20 x 11 x 8 in. for 8 x 6 in. or 10 x 6 in. speakers. £2.19.6. **STANDARD MODEL.** Size 27 x 19 x 12 in. for 8 or 10 in. speakers. £4.11.9. **SENIOR MODEL.** Size 30 x 20 x 15 in. for 12in. Speaker. Suitable Speaker systems below. Only 7 gns. **AUDIOTONE HI-FI SPEAKER SYS-**

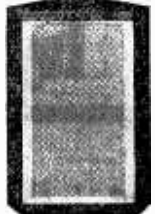

tems. Consisting of matched 12in. 12,000 line, 15 ohm high quality speaker; cross-over unit (consisting of choke, condenser, etc.) and Tweeter. The smooth response and extended frequency range ensure a surprisingly realistic reproduction Standard 10 watt rating £4.19.9. Carr. 5/- Or Senior 15 watt 7 gns. Carr. 7/6.

AUDIOTONE EQUIPMENT CABINETS. Size 36 x 15 x 18 in. Beautiful walnut veneered finish. Elegant contemporary design. Robust construction. Uncut removable baseboard. Depth above baseboard 5 1/2". **12 1/2 gns.**



AUDIOTRON HI-FI TAPE RECORDER KIT 25¹/₂

REALISM AT INCREDIBLY LOW COST. CAN BE ASSEMBLED IN AN HOUR
 Incorporating the latest Collaro Studio Tape Transcriber, The Audiotrone High Quality Tape Amplifier with negative feedback equalization for each of 3 speeds. High Flux P.M. Speaker, empty Tape Spool, a Reel of Best quality Tape and a Handsome Portable carrying Cabinet with latest attractive two-tone polychrome finish. Size 14 1/2 x 15 x 8 1/2 in. high, and circuit. Total cost if purchased individually approximately \$40. Performance equal to units in the £60-£80 class. S.A.E. for leaflets. **TERMS:** Deposit \$2.13.9 and 12 monthly payments of 44/-. Cash price if settled in 3 months.

GNS. Carr. 17/6

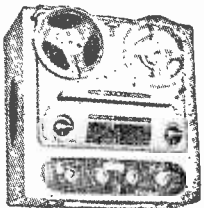

HIGH FIDELITY 12-14 WATT AMPLIFIER TYPE A11

PUSH-PULL ULTRA LINEAR OUTPUT "BUILT-IN" TONE CONTROL PRE-AMP STAGES

Two input sockets with associated controls allow mixing of "mike" and gram, as in A10. High sensitivity. Includes 5 valves, ECC83, ECC83, EL84, EL84, EZ81. High Quality sectionally wound output transformer specially designed for Ultra Linear operation and reliable small condensers of current manufacture. INDIVIDUAL CONTROLS FOR BASS AND TREBLE "Lift" and "Cut". Frequency response ± 3 D.B. 30-30,000 c/s. Six negative feedback loops. Hum level 60 D.B. down. ONLY 23 millivolts INPUT required for FULL OUTPUT. Suitable for use with all makes and types of pick-ups and microphones. Comparable with the very best designs. For STANDARD or LONG PLAYING RECORDS. For MUSIC HALL USEMENTS such as STRING BASS, GUITARS, etc. **OUTPUT SOCKET with plug provides 300 v. 30 mA. and 6.3 v. 1.5 a.** For supply of a **RADIO FEEDER UNIT.** Size approx. 12.9-7in. For A.C. mains 200-250 v. 50 c.p.s. Output for 3 and 15 ohm speakers. Kit is complete to last nut. Chassis is fully punched. Full instructions and point-to-point wiring diagrams supplied. Only **8 Gns. Carr. 10/-** (or factory built 51/- extra). If required louvered metal cover with 2 carrying handles can be supplied for 18/9. **TERMS ON ASSEMBLED UNITS, DEPOSIT 24/9, and 9 monthly payments of 24/9.** Send S.A.E. for illustrated leaflet detailing Ready-to-assemble Cabinets. Speaker, Microphones, etc., with cash and credit terms.

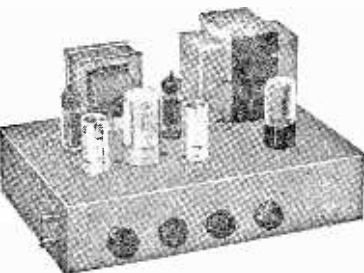

ONLY 3 PAIRS OF SOLDERED JOINTS PLUS MAINS

SPECIAL NOTE. The Tape Decks we supply are latest models. Where customers already have a Deck or wish to use one of those being offered cheaply we can supply Kit less Deck at 13 gns. carr. 10/-. Or deposit 2 gns. and 12 monthly payments 29/9. Also if required we can supply in lieu of portable cabinet and 7 x 4in. speaker, the Equipment Cabinet illustrated at foot of opp. page and a high flux 8 1/2 x 5 1/2 in. speaker for 8 gns. extra.

R.S.C. STEREO/TEN HIGH QUALITY AMPLIFIER



A complete set of parts for the construction of a stereo-amplifier giving 5 watts high quality output on each channel (total 10 watts). Sensitivity is 50 millivolts, suitable for all crystal stereo heads. Ganged Bass and Treble Control give equal variation of "lift" and "cut". Provision is made for use as straight (monaural) 10-watt amplifier. Valve line-up ECC83, ECC83, EL84, EL84, EZ81. Outputs for 2-3ohm speakers. Point-to-point wiring diagrams and instructions supplied. Send S.A.E. for leaflet. **8 Gns. Carr. 10/-** Full constructional details and price list 2/6. Carr. 10/-.

Kit can be assembled, ready to use, 59/6 extra.

HI-FI CRYSTAL PICK-UP HEADS. (Cartridges.) Acos. Standard replacement for Garrard, B.S.R. and Collaro. 16/9. Acos Stereo-Monaural 49/9. Ronette Stereo-Monaural 59/6. **MECHANICAL RECORDING HEADS.** High Impedance Record/Playback 22/-, Low Impedance Erase, 12/6. **PICK-UP ARMS.** Complete and with latest Acos/hi-fi Turnover Cartridge 29/11. **CRYSTAL MICROPHONES.** Hand type NP110 14/9, R.T.C. 19/9, Acos Mic 40 25/9, Acos Mic 45 29/9. Stick type Acos 39-1 39/9, BM3 with neck band and heavy table stand 59/9, Lapel type 35/9. **COLLARO JUNIOR** 4-speed Single Player Unit and Crystal Pick-up with hi-fi Turnover head. Only £3.19.6. **COLLARO CONQUEST 4-SPEED AUTO-CHANGER,** with high fidelity Studio pick-up. Latest model. For 200-250 v. A.C. mains. £6.19.6. Carr. 3/6. **COLLARO R 457 4-SPEED MIXER AUTO-CHANGERS.** Turnover Studio head, for 200-250 v. A.C. £7.19.6. Carr. 4/6. **U.S.A. 4-SPEED AUTO-CHANGERS** with hi-fi turnover head. £6.19.6. Carr. 4/6. **GLENA MINIATURE 2-3 WATT GRAM AMPLIFIER.** For use with any single or auto-change unit. Output for 2-3 ohm speaker. For 200-250 v. A.C. mains. Size 1 1/2 x 2 1/2 x 2 1/2 in. Controls: Vol. and Tone with switch. Only 59/6.

R.S.C. BATTERY CHARGING EQUIPMENT

HEAVY DUTY CHARGER KIT 6/12 v. 6 amps. variable output. Consisting of Mains Transformer 0-200-230-250 v. F.W. (Bridge) Selenium Rectifier, Ammeter. Variable Charge Rate Selector Panels, Plugs, Fuses, Fuseholder and circuit. 59/9. Carr. 4/6.

CHARGER KIT, 12V. 14 AMP or 24v. 7 amp. Consisting of mains trans. 200-230-250 v. F.W. (Bridge) selenium Rectifier, F Ammeter, Fuses, Variable Resistor and Circuit. Only 6 gns. Carr. 15/-. Please state if 12v. or 24v. kit required.

SOLDERING IRON. 240 W. 30 watts. First quality. For Radio work, 19/9. Spare elements and bits available.

Assembled
 6/12v. 4.5 amps. Fitted Ammeter and variable charge rate selector. Also selector plug for 6 v. or 12 v. or charging. Louvred steel case with stoveed blue hammer finished. Fused and ready for use **69/9** output leads. Carr. 5/- Terms: Deposit 13/9 and 5 monthly payments 13/9. 6/12 v. 3a., all facilities as above. Only 59/9. carr. 3/9.

ASSEMBLED 12V. 10 AMP with variable charge rate adjustment, ammeter and strong louvred, stove enamelled case. Ready for use. Only 7 gns. Carr. 10/- or in Kit Form 5 gns.

All for A.C. Mains 200-250v., 50c/s Guaranteed 12 months.

BATTERY CHARGER KITS Consisting of Mains Transformer, F.W. Bridge, Metal Rectifier, well ventilated steel case. Fuses. Fuse-holders, Grommets, panels, Heavy Duty Clips, circuit. Carr. 3/6 extra. 6v. or 12v. 1amp. 22/9 As above, with Ammeters 29/9 6 v. 2 amps. 21/9 6 v. or 12v. 2 amps. 27/9 6 v. or 12 v. 2 amps. including Ammeter 35/9 6 v. or 12 v. 4 amps. 45/9 6 v. or 12 v. 4 amps. with Ammeter and variable charge rate selector 55/-

CHARGER AMMETERS. 0-1.5 a., 0-3 a., 0-4 a., 0-7 a., 0-25 a., 0-60 a., 8/9.

R.S.C. MAINS TRANSFORMERS (FULLY GUARANTEED)

Interleaved and Impregnated. Primaries 200-230-250 v. 50 c/s. Screened TOP SHROUDED DROP THROUGH
 250-0-250v. 70mA. 6.3v. 2a. 0.5-6.3v. 2a 17/9
 350-0-350v. 80mA. 6.3v. 2a. 5v. 2a ... 18/9
 250-0-250v. 100mA. 6.3v. 2a. 6.3v. 1a ... 21/9
 250-0-250v. 100mA. 6.3v. 3.5a. C.T. 3p. ... 19/9
 350-0-350v. 150mA. 6.3v. 4a. 0.5-6.3v. 3a 25/9
 300-0-300v. 130mA. 6.3v. 4a. 6.3v. 1a. for Mullard 510 Amplifier ... 20/9
 300-0-300v. 100mA. 6.3v. 4a. 0.5-6.3v. 3a 26/9
 350-0-350v. 100mA. 6.3v. 4a. 5v. 3a ... 26/9
 350-0-350v. 150mA. 6.3v. 4a. 0.5-6.3v. 3a 29/9

FULLY SHROUDED UPRIGHT
 250-0-250v. 60mA. 6.3v. 2a. 0.5-6.3v. 2a. Mid-geat type 21-3-3in. 17/11
 250-0-250v. 100mA. 6.3v. 4a. 0.5-6.3v. 3a. 27/9
 300-0-300v. 130mA. 6.3v. 4a. 5v. 3a ... 27/11
 300-0-300v. 130mA. 6.3v. 4a. C.T. 6.3v. 1a. for Mullard Amplifier ... 33/9
 350-0-350v. 100mA. 6.3v. 4a. 5v. 3a ... 27/11
 350-0-350v. 150mA. 6.3v. 4a. 5v. 3a ... 35/9
 425-0-425v. 200mA. 6.3v. 4a. C.T. 5v. 3a 55/-

FULLY SHROUDED (continued)
 425-0-425v. 200mA. 6.3v. 4a. C.T. 6.3v. 4a C.T. 5v. 3a ... 59/9
 450-0-450v. 250mA. 6.3v. 4a C.T. 5v. 3a 69/9

OUTPUT TRANSFORMERS
 Midget Battery Pentode 66 : 1 for 354, etc. 4/6
 Small Pentode, 5000Ω to 3Ω ... 4/6
 Small Pentode 7/8,000Ω to 3Ω ... 4/6
 Standard Pentode 5,000 to 3Ω ... 5/9
 Standard Pentode 7,000 to 3Ω ... 5/9
 10,000 to 3Ω ... 5/9
 Push-Pull 8 watts. EL84, or 6V6 to 3Ω or matched to 15Ω ... 9/9
 Push-Pull 10-12 watts to match 6V6 or EL84 to 3-5-8 or 15Ω ... 19/9
 Following types for 3 and 15Ω speakers:
 Push-Pull 10-12 watts 6V6 or EL84 ... 18/9
 Push-Pull 15-18 watts. 6L6, KT66 ... 22/9
 Push-Pull for Mullard 510 Ultra Linear ... 29/9
 Push-Pull 20 watts, sectionally wound. 6L6, KT66, EL34, etc. ... 49/9

MIDGET MAINS Primaries 200-250 v.
 50 c/s. 250 v. 60 mA. 6.3 v. 2a. ... 11/9
 250-0-250 v. 60 mA. 6.3 v. 2a. ... 12/11
 Both above size 2 1/2 x 2 1/2 in.

FLUORESCENT TRANSFORMERS
 All with 200-250 v. 50 c/s. primaries 6.3 v. 2a. 1.5a. 5/9; 6.3 v. 2 a. 7/6; 0-4-6.3 v. 2a. 7/9; 12 v. 1 a., 7.11; 6.3 v. 3 a. 8/11; 6.3 v. 6 a. 17/8; 12 v. 1.5 a. twice, 17/6.

SHOULDER CHOKES
 150 mA. 7-10 H H 250 ohms ... 11/9
 100 mA. 10 H 200 ohms ... 8/9
 80 mA. 10 H 350 ohms ... 5/9
 60 mA. 10 H 400 ohms ... 4/11

TRANSFORMERS
 All with 200-230-250 v. 50 c/s Primaries:
 0-9-15 v. 11 a. 12/9; 0-9-15 v. 2 a. 14/9; 0-9-15 v. 3 a. 16/9; 0-9-15 v. 5 a. 19/9; 0-9-15 v. 6 a. 23/9; 0-9-15 v. 8 a. 28/9.
AT 110 (STEP UP/ST. DOWN) TRANS.
 0-110-120-230/250 v. 50-80 watts, 13/9;
 250 watts, 39/9; 150 watts, 27/9.

MICROPHONE TRANSFORMERS
 120 : 1 high grade, clamped, 6/9; 120 : 1 Potted, Mu-metal screened, 9/9.

Brand new, individually checked and guaranteed VALVES

| | | | | | |
|----------|------|--------|---------|---------|------|
| AL60 | 6/- | EB34 | 1/6 | EY00 | 5/- |
| AR8 | 5/- | EB91 | 3/9 | EY91 | 3/6 |
| ARD5 | 2/- | EBC33 | 7/1 | EZ40 | 7/1 |
| AR3 | 3/- | EBC41 | 7/9 | EZ41 | 6/9 |
| ARP4 | 3/6 | EBC90 | 5/- | EZ80 | 6/- |
| ARP12 | 3/- | EC52 | 8/- | EZ81 | 6/9 |
| ARP21 | 5/6 | EC70 | 10/- | FW4/500 | |
| ARP24 | 3/6 | EC90 | 20/- | | |
| ARP34 | 4/- | EC91 | 3/- | | |
| ARTH2 | 7/1 | ECC81 | 5/6 | GI20/1B | 9/- |
| ATP4 | 2/9 | ECC82 | 6/6 | GL450 | 10/- |
| ATP7 | 5/6 | ECC83 | 7/1 | GL464A | 10/- |
| AUI | 5/- | ECC84 | 7/1 | GU20/21 | |
| AU4 | 5/- | ECC85 | 8/- | | |
| AV3 | 4/- | ECC91 | 4/- | GZ32 | 9/- |
| AZ31 | 8/- | ECCF80 | 10/6 | H63 | 7/1 |
| BS4A | 5/6 | ECCF82 | 8/6 | HL23 | 6/- |
| BT45 | 15/- | ECH81 | 7/9 | HL23DD | 8/- |
| BT9B | 20/- | ECL80 | 8/6 | HVR2 | 12/6 |
| BT83 | 22/6 | ECL82 | 9/- | KRNZA | 19/- |
| CV54 | 5/- | EF36 | 3/6 | KT32 | 8/- |
| CV264 | 20/- | EF37A | 7/- | KT8 | 22/6 |
| CV4014 | 8/- | EF39 | 4/- | KT33C | 4/- |
| CV4015 | 7/1 | EF50 | 2/6 | KT44 | 6/3 |
| CV4025 | 10/- | EF54 | 3/6 | KT63 | 5/- |
| CV4046 | 40/- | EF55 | 5/- | KT76 | 10/- |
| CY31 | 7/6 | EF70 | 4/- | KTW62 | 7/6 |
| D41 | 3/3 | EF73 | 6/- | KTW63 | 6/6 |
| D77 | 4/3 | EF80 | 5/6 | KTZ41 | 6/- |
| DA30 | 12/6 | EF85 | 6/6 | MH4 | 3/6 |
| DAF70 | 35/- | EF86 | 6/6 | MH41 | 5/- |
| DAF91 | 6/- | EF89 | 7/1 | ML4 | 4/- |
| DAF96 | 7/6 | EF91 | 3/6 | ML6 | 6/- |
| DD41 | 4/- | EF92 | 3/- | MS/PEN | 6/- |
| DE75 | 15/- | EF95 | 5/- | OB3 | 7/1 |
| DET19 | 3/6 | EL32 | 3/9 | OC3 | 5/6 |
| DET20 | 2/- | EL33 | 8/- | OD3 | 6/6 |
| DF39 | 4/- | EL35 | 6/- | OZ4 | 5/- |
| DF72 | 7/6 | EL41 | 8/- | PCC84 | 7/1 |
| DF91 | 4/- | EL42 | 8/- | PCC85 | 8/- |
| DF96 | 8/- | EL84 | 7/- | PCF80 | 7/1 |
| DK96 | 7/3 | EL91 | 4/6 | PCF82 | 8/- |
| DL92 | 6/- | EM80 | 8/- | PCL82 | 8/6 |
| DL94 | 6/- | EM84 | 9/- | PCL83 | 11/- |
| DL96 | 8/- | EN31 | 15/- | PCL84 | 9/- |
| EAS0 | 1/6 | EP71 | 6/6 | PEN45 | 4/6 |
| EABC80 | 7/3 | EP72 | 5/- | PEN46 | 6/6 |
| EAC91 | 3/6 | ESU208 | 6/- | PEN45 | 4/6 |
| EAC91W76 | EYS1 | 6/- | PEN220A | 3/- | |
| | | | PL36 | 10/6 | |

| | | | | | | | | | | | |
|-------------|------|---------|-------|--------|-----|--------|-------|----------|------|------|-----|
| PLB1 | 9/- | VT4C | 25/- | 6AM6 | 4/- | 6X4 | 5/- | 80 | 5/6 | 9001 | 3/- |
| PLR2 | 8/- | VU3Y | 6/- | 6AQ5 | 7/- | 6X5GT | 5/- | 81 | 9/- | 9002 | 5/6 |
| PLR3 | 10/- | W3J | 6/- | 6AT6 | 5/- | 6Y6 | 5/- | 82 | 8/- | 9003 | 6/- |
| PT15 | 10/- | X66 | 8/- | 6B7 | 5/6 | 6Z4 | 5/6 | 83V | 9/- | 9004 | 2/6 |
| PT25H | 7/6 | Y63 | 5/- | 6BBG | 2/6 | 6B7 | 7/6 | 84 | 8/- | 9006 | 2/6 |
| PX4 | 19/- | Y65 | 4/- | 6BA6 | 5/6 | 6C6 | 7/1 | 85A3 | 13/- | | |
| PX25 | 9/- | Y66 | 8/- | 6CA | 2/6 | 6C7 | 6/6 | 89 | 6/9 | | |
| PY32 | 12/- | Z31 | 6/- | 6C5 | 6/- | 7H7 | 7/1 | 210VPT | | | |
| PY80 | 6/9 | I A3 | 3/- | 6CFG | 4/- | 7Q7 | 7/1 | 7-pin | 2/6 | | |
| PY8 | 7/1 | 1A5GT | 5/- | 6C6G | 3/1 | 7V1 | 5/- | 250TH | 4/9 | | |
| PY82 | 8/- | 1CSGT | 7/6 | 6C8G | 5/- | 7Y1 | 6/- | 350B | 8/- | | |
| PY83 | 7/3 | 1DSGT | 6/- | 6D6 | 4/- | 7Z4 | 4/6 | 393A | 15/- | | |
| PZ1-35 | 9/- | 1E7G | 7/6 | 6F5 | 5/3 | 8D2 | 2/6 | 705A | 15/- | | |
| QP21 | 6/- | 1G6GT | 6/- | 6F6G | 4/1 | 9D2 | 3/- | 715B | 6/9 | | |
| QP25 | 5/3 | 1L4 | 3/6 | 6F7 | 5/- | 12A6 | 2/6 | 717A | 8/6 | | |
| QS75/20 | 6/9 | 1LD5 | 5/- | 6F8GT | 5/9 | 12AH7 | 5/- | 801 | 6/- | | |
| QS95/10 | 6/9 | 1R5 | 5/- | 6F8G | 5/- | 12AT7 | 5/6 | 803 | 22/6 | | |
| QV04/7 | 7/6 | 1S4 | 5/- | 6F12 | 4/6 | 12A06 | 6/6 | 804 | 5/6 | | |
| R3 | 8/- | 1S5 | 5/9 | 6F13 | 5/- | 12A07 | 6/- | 805 | 30/- | | |
| R3/10 | 4/1 | 1T4 | 4/1 | 6F15 | 5/- | 12AX7 | 7/1 | 807 AMER | | | |
| R10 | 7/6 | 1W4 | 4/1 | 6G6G | 2/6 | 12C8 | 6/- | | | | |
| REL21 | 25/- | 2A3 | 5/- | 6H6M | 1/6 | 12E1 | 22/6 | 807BR | 6/- | | |
| RK34 | 2/6 | 2A5 | 6/- | 6J5 | 3/6 | 12H6 | 2/1 | 808 | 8/- | | |
| RX235 | 10/- | 2A6 | 7/- | 6J5G | 3/1 | 12K7GT | 4/6 | 810 | 80/- | | |
| SP2 | 4/- | 2C34 | 2/6 | 6J6 | 3/6 | 12K8M | 7/6 | 813 | 60/- | | |
| SP13C | 4/6 | 2C42 | 25/- | 6J7G | 5/- | 12K9T | 3/6 | 815 | 40/- | | |
| SP41 | 2/6 | 2C46 | 30/- | 6K6GT | 6/- | 12Q7GT | 4/4 | 816 | 30/- | | |
| SP61 | 2/- | 2X2 | 4/1 | 6K7G | 2/3 | 12SA7 | 7/6 | 829A | 30/- | | |
| SU2150A | 3A4 | 4A5 | 5/- | 6K7GT | 4/9 | 12SC7 | 4/- | 832 | 15/- | | |
| T41 | 4/9 | 3B7 | 5/- | 6K8G | 5/9 | 12SG7 | 4/- | 832A | 35/- | | |
| TP25 | 17/- | 3B24 | 5/- | 6K8GT | 8/3 | 12SH7 | 3/- | 843 | 7/4 | | |
| TP25 | 7/6 | 3E29 | 6/- | 6K8M | 8/6 | 12S17 | 3/- | 866 | 10/- | | |
| TT11 | 3/- | (829B) | 60/- | 6L5G | 6/- | 12SK7 | 3/6 | 872 | 20/- | | |
| TT15 | 25/- | 3Q4 | 6/- | 6L6 | 9/- | 12SL7 | 5/9 | 930 | 8/6 | | |
| TT20 | 16/- | 3S4 | 5/- | 6L6G | 6/- | 12SN7 | 5/9 | 954 | 4/6 | | |
| U12/14 | 8/- | 3V4 | 6/- | 6L7G | 4/6 | 12SR7 | 6/- | 955 | 2/6 | | |
| U17 | 5/- | 4E27 | 60/- | 6L8A | 4/6 | 12Y4 | 2/- | 956 | 2/1 | | |
| U18 | 6/6 | 5B/254M | | 6N7G | 5/9 | 14L7 | 7/- | 957 | 5/- | | |
| U27 | 8/- | | 30/- | 6N7GT | 6/- | 15D2 | 6/- | 958A | 5/- | | |
| U52 | 5/- | 5R4GY | 9/- | 6O7G | 6/- | 20A2 | 17/6 | 1616 | 3/- | | |
| UCH42 | 7/6 | 5T4 | 9/- | 6R7 | 6/- | 21B6 | 9/- | 1619 | 5/- | | |
| UBF80 | 8/6 | 5U4G | 5/- | 6S5C | 5/6 | 25L6GT | 7/9 | 1625 | 6/6 | | |
| UL11 | 5/- | 5V4G | 8/- | 6S7GT | 5/1 | 30 | 5/- | 1626 | 4/6 | | |
| UL12 | 5/- | 5Y3GT | 6/- | 6S7G | 5/- | 35L6GT | 8/- | 1629 | 4/6 | | |
| UL41 | 7/- | 5Z4 | 8/6 | 6SH7 | 3/- | 35T | 17/6 | 4043C | 13/6 | | |
| UL84 | 7/6 | 5Z4G | 8/- | 6S17GT | 5/9 | 35Z4GT | 7/- | 4063 | 8/- | | |
| UO9 | 5/6 | 6A87 | 4/1 | 6S17Y | 6/6 | 37 | 4/- | 6064 | 10/- | | |
| UY41 | 6/- | 6AC7 | 3/- | 6S7K | 5/3 | 38 | 4/- | 6065 | 8/- | | |
| UY85 | 6/6 | 6AG5 | 3/- | 6SL7GT | 6/6 | 58 | 6/- | 6120 | 4/- | | |
| VP23 | 3/- | 6AG7 | 3/- | 6SN7GT | 4/6 | 59 | 6/- | 6516 | 8/- | | |
| VP41 | 5/6 | 6A17 | 6/- | 6S07 | 6/- | 75 | 5/6 | 7193 | 1/9 | | |
| VR99 | 8/- | 6AK5 | 5/- | 6S57 | 6/- | 76 | 5/- | 7475 | 3/- | | |
| VR105/305/6 | 6AK7 | 6/- | 6V6G | 4/6 | 77 | 6/- | 8013A | 28/- | | | |
| VR150/306 | 6AM5 | 5/- | 6V6GT | 5/- | 78 | 7/- | 8020 | 10/- | | | |

Cathode Ray Tubes

| | |
|----------------------|------|
| ACR1 | 15/- |
| ACR11 | 15/- |
| CV995 | 15/- |
| CV1596 | |
| (091) | 58/- |
| E4103/B4 | |
| 3FP7 | 28/- |
| 5BP1 | 38/- |
| 5CP1 | 42/6 |
| 5FP7 | 48/- |
| 5FP7A | 25/- |
| 7B2P | 40/- |
| 12DP7 | 60/- |
| VCRX25B | |
| (with sck-wgng coil) | 48/- |
| VCR138 | 30/- |
| VCR139A | |
| | 38/- |

Photo Tubes

| | |
|------|------|
| CMG8 | 9/- |
| CS16 | 12/6 |

Special Valves

| | |
|---------|--------|
| 2131 | 48/- |
| 3A11481 | 48/- |
| 3A1170E | 435 |
| 3A192E | |
| | 437.10 |
| 4131 | 435 |
| 4150 | 435 |
| 5D21 | 43 |
| 723A/B | 50/- |
| 725A | 30/- |
| 726A | 27/6 |
| ACT6 | 160/- |
| CV193 | 30/- |
| CV238 | 70/- |
| CV980 | 3/- |
| KR6/3 | 44 |
| LS7B | 30/- |
| WL417A | 15/- |

AND MANY OTHERS IN STOCK, INCLUDING CATHODE RAY TUBES AND SPECIAL VALVES. All U.K. Orders below 10/-, 1/- P. & P. 2/6 over 10/-. Orders over £3, P. & P. free. C.O.D. 2/6 extra. Overseas Postage extra at costs.

BRAND NEW ORIGINAL SPARE PARTS FOR AR88 RECEIVERS.

Please write your requirements.
MARCONI RECEIVER TYPE CR 100/2 tested and aligned £32.10.0. Carr. £1.
TELEPHONE HANDSET. Standard G.P.O. type. New 12/-, P. & P. 2/-.
CONNECTORS FOR TCS RECEIVER, TRANSMITTER AND REMOTE CONTROL, with original plugs on both ends. New £1.17.6. P. & P. 2/6.

SPECIALLY BUILT POWER PACK for TCS receivers, 230 volts A.C. mains, including 6X5GT valve, £3.10.0. Carr. 5/-.
R.109 RECEIVER. Covering 2-8 Mc/s. 6 v. D.C. with set of spare valves and carrier. Brand new in original packing case. £6.18.0 including delivery in U.K.
R.109A RECEIVER. Covering 2-12 Mc/s, £7.18.0.

"CONNECT AND FORGET—CANNOT OVERCHARGE" "ESS-TRON" AUTOMATIC BATTERY CHARGER. Charging rate 4 amps. The charging rate automatically adjusts itself to the charge in the battery. Automatic current and voltage control. Patented application of magnetic amplification to battery charging. Indicator lights show battery fully charged, receiving charge, incorrectly connected or faulty cells. Mains voltage 200/250 v. Built for 6 or 12 v. batteries. Measurements 7 x 5 x 5 1/2 in. Weight 8 1/2 lbs. Price £6.19.6. P. & P. 3/6.

53 TRANSMITTER SPARES. Full range. Price list on application.

H.R.O. Senior. Table Model, in excellent, fully checked, and tested condition (without coils and power pack), £15.10.0. Carriage 30/-. As above but rack mounted model, £14.10.0. Carriage 30/-.

Set of 9 coils for above £8 post paid, or individual frequency coils £1 each Post 2/6.

Power pack for above. British made, A.C. 110/200/250 v., 59/6. Postage 4/-.
TANNOY LOUDSPEAKERS, 7.5(1) imp., in wooden case. New 19/-. Carr. 5/-.

LOW RESISTANCE HEAD- PHONES (D.L.R.) 8/-, P. & P. 2/-.

COMPLETE V.F.O. UNIT from TX53. Freq. range in 4 switched bands from 1.2-17.5 Mc/s. Two V.T. 501s. as oscillator and buffer, 807 as driver, two S130s as voltage stabilizers. Output sufficient to drive two 813s in parallel. Slow motion drive directly calibrated in Mc/s. Provision for crystal control, metering of buffer and driver stage. Power requirements 400 v. and 6.3 v. D.C. Can also be used as low power transmitter. In excellent condition with valves and circuit diagram. £5, P. & P. 15/-.

P. C. RADIO LTD.
 170, GOSHAWK RD., W.12
 Shepherds Bush 4946

CRYSTAL CALIBRATORS No. 10.

Frequency range 1.5 to 10 Mc/s. Together with working instructions, lead and spare valves. £4.10.0. P. & P. 3/-.

AMERICAN WIRE RECORDER/REPRODUCER UNIT.

Facilities for recording from Dynamic or Carbon microphone and radio. 1 knob operation for recording, rewinding and erasing. Neon recording lever indicator. Internal speaker. Mains 110 v. Supplied with outer transformer, carbon mike and wire magazine for 1 hour's operation and headphones. Price £18.0.0. P. & P. £1. Spare Wire Magazine 50/-. Dynamic mike and stand £4.

R.209 RECEPTION SET. A 10-valve high-grade Superhet Receiver with facilities for receiving R/T (A.M. or F.M.) and C.W. frequency 1 Mc/s-20 Mc/s. Hermetically sealed. Built on miniature valves and incorporating its own vibrator power supply unit driven by a 6 v. battery (2 point connector included). The set provides for reception from rod. open-wire or dipole aerial with built-in loudspeaker or phone output. Dimensions: Length 12in., width 8in., depth 9in. Weight 23lb. In as new, tested and guaranteed condition. £23.10.0, including special headphone and supply leads. Carr. £1.
CARBON INSET MICROPHONE, G.P.O. type, 2/6. P. & P. 1/6.

STERN'S MULLARD DESIGNS

Designed by MULLARD—presented by STERN'S strictly to specification

MULLARD "5-10" MAIN AMPLIFIER

For use with the MULLARD 1-valve pre-amplifier with which undistorted power output of up to 10 watts is obtained. We supply SPECIFIED COMPONENTS AND NEW MULLARD VALVES, including PARMKO MAINS TRANSFORMER and choice of the latest Ultra-Linear PARMKO or the PARTRIDGE Output Transformer. COMPLETE KIT OF PARTS **£10.00** (PARMEKO Output Trans.).

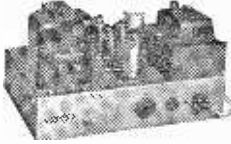

Alternatively we supply **£11.10.0** INCORPORATING PARTRIDGE OUTPUT ASSEMBLED and TESTED. **£11.10.0** TRANSFORMER, **£16.0** EXTRA.

MULLARD'S PREAMPLIFIER TONE CONTROL UNIT

Employing two 5F86 valves, and designed to operate with the MULLARD MAIN AMPLIFIERS, but also perfectly suitable for other makes. PRICE COMPLETE **£6.6.0** KIT OF PARTS **£8.0.0** ASSEMBLED AND TESTED



- Equalisation for the latest R.I.A.A. characteristics.
- Input for Crystal Pick-ups, and variable reluctance magnetic types.
- Input (a) Direct from High Imp. Tape Head, (b) From a Tape Amplifier or Pre-Amplifier.
- Sensitive Microphone Channel. ● Wide range BASS and TREBLE Controls.

THE MULLARD "510/RC" AMPLIFIER

The popular and very successful complete "5-10" incorporating Control Unit providing up to 10 watts high quality reproduction. Only Specified Components and new MULLARD VALVES are supplied including PARMKO MAINS TRANSFORMERS and choice of the latest PARMKO or PARTRIDGE ULTRA-Linear Output Transformer.

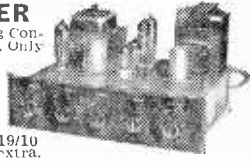

KIT OF PARTS **£11.10.0** OR ASSEMBLED AND TESTED **£13.10.0** H.P. Dep. **£2.6.0**, 12 months at 17/0, Dep. **£2.14.0** 12 months at 19/10 ABOVE incorporating PARTRIDGE OUTPUT TRANS. **£1.6.0** extra.

THE MULLARD "33/RC" AMPLIFIER

THE IDEAL AMPLIFIER FOR A SMALL HIGH QUALITY INSTALLATION PROVIDING EXCELLENT REPRODUCTION OF UP TO 3 WATTS OUTPUT. COMPLETE KIT **£7.10.0** OR ASSEMBLED **£8.19.6** (Plus 5/6 carriage and insurance) H.P. Terms: Deposit **£2.0.0** MULLARD'S SPECIFICATION including Mullard valves and a PARMKO OUTPUT TRANSFORMER.

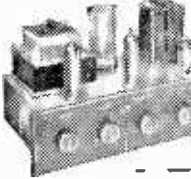

A SPECIAL PURCHASE ENABLES US TO OFFER "The TUDOR" AM/FM TUNING UNIT

A SELF POWERED HIGH FIDELITY TUNER OF OUTSTANDING DESIGN. PRICE ONLY **£19.19.0** Deposit **£4.0.0** and 12 months at **£1.9.4**.

Provides full coverage of the VHF/FM band (87-108 Mc/s) and also the LONG and MEDIUM wavebands. Incorporates Multiplex outlet socket for stereophonic purposes (when adopted), and separate controls for tuning the FM and AM bands. Operates perfectly with the STERN-MULLARD AMPLIFIERS and contains matching FRONT PANEL in Black/Gold or White/Black. Also operates equally well with any Amplifier requiring input of 100 to 500 mVolts.

THE "TUDOR" STEREO AMPLIFIER

For Only **£18.18.0** Deposit **£3.16.0**, 12 months **£1.7.5**. A self powered Amplifier designed to provide high quality stereophonic and monophonic reproduction. Each channel provides a rated output of 6 watts and for monophonic operation approx. 12 watts is produced. Separate BASS and TREBLE CONTROLS. DESCRIPTIVE LEAFLET IS AVAILABLE.

ALL EQUIPMENT IS AVAILABLE FROM

STERN RADIO 109, FLEET ST., PREMIER RADIO 23, TOTTENHAM COURT RD., LONDON W.1.
 TELEPHONE FLEET ST., 81223 LONDON, E.C.4. TELEPHONE MUSEUM 351
 MAIL ORDERS and all POSTAL ENQUIRIES to 7-9 TUDOR PLAGE, TOTTENHAM COURT RD., LONDON, W.1. MUSEUM 41511

PRICE REDUCTIONS

- (a) The KIT OF PARTS to build both the "5-10" Main Amplifier and the 2-valve PRE-AMP CONTROL UNIT H.P. Dep. **£3.7.0** and 12 months at **£12.15.0**
- (b) The "5-10" and the 2-stage PRE-AMP both ASSEMBLED and TESTED H.P. Dep. **£3.6.0** and 12 months at **£18.18.0** With Partridge Output Transformer **£1.6.0** extra.

RECORD PLAYERS

- Each Unit is available with Stereo Cartridge fitted.
- THE NEW GARRARD "AUTO-SLIM" 4-speed Autochanger with Crystal Pick-up... **£8.10.0**
- PHILIPS MODEL AG1016... A 4-speed Player which can be operated both manually and automatically. Suitable for Mono or Stereo operation... **£13.13.0**
- GARRARD "AUTO-SLIM DELUXE" 4-speed Auto changer Incorporates transcription Pick Up Arm... **£12.14.6**
- COLLARO "AUTO-SLIM" 4 SPEED SINGLE RECORD PLAYER with separate Crystal Pick-up Carriage and Insurance 5/- Above Pick-up separately for **£16.6**.
- THE NEW COLLARO C60 4-speed Autochanger unit with Studio "O" Pick-up... **£7.19.6**
- B.S.R. MODEL U414 4-speed Mixer Autochanger with Crystal Pick-up... **£7.10.0**
- GARRARD MODEL TAMK.11 4-speed Player fitted high output Crystal Pick-up... **£8.10.0** Carriage and Insurance on each above 5/- extra.

SPECIAL CASH OFFER

This very attractive PORTABLE AMPLIFIER CASE



- together with a good quality GRAM AMPLIFIER and a matched P.M. SPEAKER ALL FOR ONLY **£8.7.6** (Plus 7/6 Cart. & Ins.)
- The Amplifier consists of a 2-stage design incorporating 3 modern B.V.A. valves and has separate BASS and TREBLE CONTROLS.
- The Portable Case will also accommodate almost any make of Autochanger and is attractively finished in Mushroom Grey Rexine.
- WE ALSO SUPPLY SEPARATELY— **£4.2.6**
- (a) The 2-stage (plus Rectifier) AMPLIFIER **£3.17.6**
- (b) The PORTABLE CARTRIDGE CASE
- (c) 6IN. P.M. SPEAKER 13/8, Carriage and Insurance 4/- extra.

MULLARD FOUR CHANNEL MIXER UNIT

Self powered with Cathode follower output. Incorporates Two inputs for MICROPHONES One for CRYSTAL PICK UP and a fourth for RADIO or TAPE Complete Kit of Parts **£8.8.0** Assembled and Tested **£10.0.0** TERMS: Deposit **£2** and 2 months at 15/- Alternatively MODEL 1.L. provides for one microphone Input matched for moving coil or Ribbon Mike. **£1.17.0** extra.

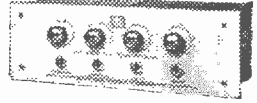

STERN'S INTER-COMM BABY ALARM

A small versatile Unit employing the new MULLARD ECL86 valve and designed to provide two (or three) way conversation up to extreme distances. Operates from A.C. mains 200 to 250 Volts. PRICES... MASTER UNIT and ONE EXTENSION KIT OF PARTS **£6.17.6** ASSEMBLED AND TESTED **£8.8.0** Consists of a MASTER UNIT, size only 8 1/2 x 5 1/2 x 6 in. and ONE EXTENSION (a second extension may be added to any time). The Master Unit incorporates switching and power supply and with the chassis completely isolated from the mains is operated in absolute safety. Cases covered in quality leatherette.

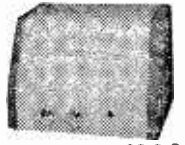

Stereophonic Sound by Stern's

THE "STP-1" STEREO TAPE PRE-AMPLIFIER DESIGNED TO OPERATE WITH

- BREWELL Mk. V TAPE DECK incorporating 1-TRACK MINIFLUX TAPE HEADS.
- PUSH-PULL OSCILLATOR CIRCUIT
- 4-SPEED EQUALISATION
- FERROXUBE OSCILLATOR TRANSFORMER
- SENSITIVE METER FOR SIGNAL LEVEL
- SEPARATE GAIN CONTROLS IN EACH CHANNEL
- MULLARD VALVES INCORPORATED

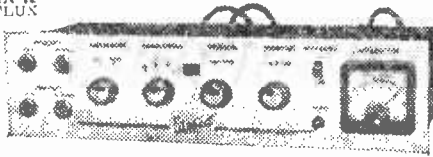

COLLARO "STUDIO" TAPE DECK incorporating the latest 1-TRACK TAPE HEADS.

OVERALL SIZE CASE 19 1/2 x 3 1/2, FRONT PANEL (choice of Black or White) 14 x 9 1/2 in.

PRICES INCLUDES SEPARATE POWER SUPPLY UNITS

Kit of **£22.0.0** Deposit **£4.0.0**, 12 months of **£1.12.8**
 Assembled **£28.0.0** Deposit **£5.16.0**, 12 months of **£2.1.1**

COMBINED PRICE SCHEDULE

- (a) The BREWELL Mk. V 1-TRACK DECK with the complete KIT to build the STP-1..... **£61.0.0**
 Deposit **£18.4.0**, 12 months of **£4.4.0**
- (b) The COLLARO "STUDIO" 1-TRACK DECK with the complete KIT to build the STP-1..... **£39.0.0**
 Deposit **£7.16.9**, 12 months of **£2.17.3**

- (a) The BREWELL Mk. V 1-TRACK DECK with the Assembled STP-1 and matched to the Deck..... **£67.0.0**
 Deposit **£18.9.0**, 12 months of **£4.18.3**
- (b) The COLLARO "STUDIO" 1-TRACK DECK with the STP-1 Assembled and matched to the Deck..... **£45.0.0**
 Deposit **£9.0.0**, 12 months of **£3.2.0**

STEREOPHONIC RECORD PLAYER UNITS ARE AVAILABLE FROM STOCK

MULLARD'S "10 PLUS 10"

STEREO AMPLIFIER

A high fidelity design based on the famous Mullard "8-10". Provides up to 10 watts (per channel) superb reproduction. Frequency response flat to within 1 db from c/s. to 20,000 at 10 Mw. Total Harmonic Distortion at 10 watts: 0.1%.

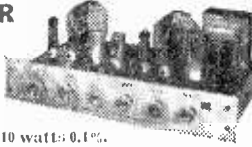

- (a) ASSEMBLED COMPLETE AMPLIFIER, including CONTROL UNIT (as Illustrated)..... **£21.0.0**
 Deposit **£4.4.0**, 12 months at **£1.10.10**
- (b) A complete KIT OF PARTS..... **£18.10.0**
 Deposit **£3.14.0**, 12 months at **£1.7.9**
- We also supply the assembled MAIN AMPLIFIER only (excludes control unit) for operation with our DUAL CHANNEL PRE-AMPLIFIER. This provides for a more versatile or elaborate installation and would be essential if a low output Magnetic Pick-Up, such as the Decca, is to be used.
- (a) THE ASSEMBLED MAIN AMPLIFIER with the ASSEMBLED DUAL CHANNEL PRE-AMPLIFIER..... **£30.0.0**
 Deposit **£6.0.0**, 12 months at **£2.4.0**
- (b) A complete KIT OF PARTS for both Unit..... **£26.0.0**
 Deposit **£5.4.0**, 12 months at **£1.18.2**

ARMSTRONG RADIOGRAM CHASSIS

FULL RANGE IN STYVIC, please enclose S.A.E. for leaflets.
STEREO 12 Mk. 2 £43.10.0

(ILLUSTRATED)

Deposit **£6.11.0**, 12 months at **£2.9.10**

The most complete chassis ever produced, combines AM and FM, a Stereo Control Unit and two High Fidelity Amplifiers in one compact unit, provides a total of 16 watts for both mono and stereo. Other features include: inputs for tape recording, play back, pick-ups and stereo radio (should this come about); separate wide range bass and treble control and balance control.



STEREO 55 £32.15.0 Deposit **£6.15.0**, 12 months at **£2.7.8**
 A junior version of the Stereo 12 Mk. 2 providing ten watts output, five watts from each amplifier and covering the VHF and Medium wavebands.

JUBILEE Mk.2 £30.12.0 Deposit **£6.4.0**, 12 months at **£2.4.9**
 A Hi-Fi mono chassis giving eight watts push-pull output and covering VHF, medium and long bands. Tape recording and play back inputs.

AF208 £22.18.0 Deposit **£4.16.0**, 12 months at **£1.13.0**
 An AM/FM chassis providing 5 watts output and covering the full VHF and medium wavebands. Tape recording and playback inputs.

TV8 VHF TUNER £21.18.0 Deposit **£4.14.0**, 12 months at **£1.11.7**
 A self-powered high-fidelity tuner of outstanding design, incorporating features which are normally found only in the most expensive tuners. The full VHF band (87-103 Mc/s) is covered and a matching output control enables the output to be varied between 0 and 500 mV.

"HI-FI" LOUDSPEAKERS WE HAVE IN STOCK A COMPLETE RANGE BY GOODMAN'S WILKINSONS. ILLUSTRATED AND PRICE LEAFLETS ON REQUEST.

THE MULLARD "10 + 10" AMPLIFIER (described below) with the "STP-1" PRE-AMPLIFIER and one of the TAPE DECKS provide a complete STEREOPHONIC INSTALLATION. Details are readily available.

DUAL CHANNEL PREAMPLIFIER

Incorporates two Mullard 2-valve Pre-amplifiers combined into a single unit enabling it to be used for both STEREOPHONIC or MONOPHONIC operation. It is designed primarily to operate with our range of MULLARD MAIN AMPLIFIERS but will also operate equally well with any make of Amplifiers requiring an input of up to 250 mV.

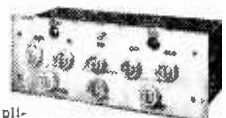

COMPLETE KIT **£12.10.0** ASSEMBLED AND TESTED **£15.0.0**
 OF PARTS
 H.P. **£9.10.0** & 12 mths. at **18/4**. H.P. **£3.0.0** & 12 mths. at **£1.2.0**

STEREO "TWIN THREE" AMPLIFIER

OFFERED ASSEMBLED and TESTED for (Carr. & Ins., 7/6 extra).



Based on a recent design by MULLARD LTD., the "TWIN THREE" is ideally suited for use in PORTABLE RECORD PLAYERS for which purpose we offer a specially designed Portable Case. It incorporates MULLARD ECL86 valves, separate BASS and TREBLE CONTROLS, and produces excellent reproduction of up to 3 watts per channel. Frequency response is 40 c/s to 30 K/s. Size is only 11 1/2 x 3 1/2 in.

To construct a STEREO PORTABLE RECORD PLAYER WE OFFER: The assembled AMPLIFIER with two ROLA 8 1/2 in. LOUD-SPEAKERS and the PORTABLE CASE for **£14.0.0** (Carr. & Ins., 10/- extra). Deposit **£2.16.0**, 12 months of **£1.6.6**.

SUITABLE RECORD PLAYERS are AVAILABLE FROM **£8.14.0**

An alternative "TWIN THREE" can be supplied for DUAL CHANNEL MONOPHONIC operation producing output of 6 watts. PRICE AS ABOVE.

THE "MONO GRAM" AMPLIFIER



A small Amplifier capable of genuine high quality performance. It incorporates the new Mullard ECL86 Valve, separate BASS and TREBLE CONTROLS and when driven by the standard Crystal Pick-up a power output of 3 watts is achieved without distortion. PRICE - READY FOR USE **£4.19.6** Carr. & Ins. 5/- extra.

The MONO-GRAM is ideal for portable applications, an attractive case finished in two tone Roxins is available to accommodate the amplifier-speaker and a variety of record changers. Price **£4.0.0**. The 8" x 5" matching speaker **£1.0.0**. Constructors Can Build a Really First-Class Record Player, Complete in all respects, for approx. **£14**. This will compare with known Record Players currently offered at much higher prices.

STERN RADIO PREMIER RADIO
 MAIL ORDERS and all POSTAL ENQUIRIES to



BUILD A HIGH QUALITY TAPE RECORDER LIKE THIS FOR

£35.0.0

FOR THIS WE SUPPLY

- ★ Complete Kit of Parts to Build the HF/TR3 Tape Amplifier.
- ★ The Latest Collaro "Studio" Tape Deck.
- ★ Portable Carrying Case (as illustrated).
- ★ 100Ω Celestion 10 x 6in. p.m. Loudspeaker.
- ★ ACOS Crystal Microphone and 1200Ω. Spool E.M.I. Tape.

Deposit £7.0.0 and 12 months of £2.11.4.

ALTERNATIVELY WE SUPPLY THE COMPLETELY ASSEMBLED and GUARANTEED TAPE RECORDER FOR **£39.10.0**

H.P. Terms: Deposit £7.18.0 and 12 months of £2.17.11

HF/TR3MKII TAPE AMPLIFIER (Mullard Type "A" design)

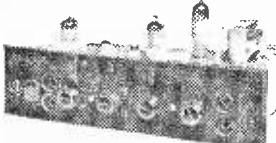

A very high quality Amplifier incorporating 3-speed treble equalisation, by the latest FEROCUBE POT CORE INDUCTOR, FOR COLLARO TRUVOX - BRENELL WEARITE Tape Decks, has GILSEN Output Transformer. Includes separate Power Supply Unit. KIT OF PARTS **£13.13.0**
Deposit £2.15.0
12 months at £1.0.0.

ASSEMBLED and TESTED **£17.0.0**
Deposit £3.8.0
12 months at £1.4.11.

SPECIAL "COMBINED ORDER" PRICES

- For Constructors with their own cabinet—WE OFFER—
- (a) COMPLETE KIT to build the HF/TR3 Amplifier together with the COLLARO "STUDIO" DECK **£26.0.0**
Deposit £5.4.0. 12 monthly payments of £1.18.2
 - (b) As above but with the HF/TR3 supplied ASSEMBLED and TESTED **£29.10.0**
Deposit £5.18.0. 12 monthly payments of £2.3.4
 - (c) COMPLETE KIT to build the HF/TR3 AMPLIFIER with the BRENELL MK. V TAPE DECK **£42.0.0**
Deposit £8.8.0. 12 monthly payments of £3.1.7.
 - (d) As above but with HF/TR3 supplied ASSEMBLED and TESTED **£45.10.0**
Deposit £9.2.0. 12 monthly payments of £3.6.9
 - (e) THE ASSEMBLED AND TESTED HF/TR3 AMPLIFIER with the WEARITE MODEL 4A DECK, incorporates Wearite Head Lift Transformer etc. **£60.10.0**
Deposit £12.12.0. 12 monthly payments of £4.8.0.

(Carriage and Insurance on each above is 10/- extra.)

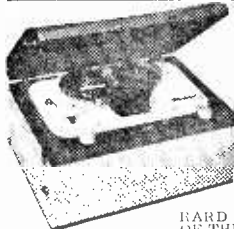

The MODEL HFG/2R PORTABLE TAPE RECORDER (Original Price £33.0.0) FOR ONLY 22 gns.

Deposit £4.14.0. 12 months £1.13.9
Crystal Microphone £1.0.0 extra. (Carr. and Ins. 10/- extra). Incorporates THE LATEST GARRARD "MAGAZINE" TAPE DECK and a HIGH QUALITY AMPLIFIER which is entirely based on the very successful MULLARD TYPE "A" DESIGN and specifically developed to operate the GARRARD DECK. Price INCLUDES SUPPLY OF THE GARRARD TAPE MAGAZINE and

4in. SPOOL OF DOUBLE PLAY TAPE. Comprises a Twin Track Recorder operating at 3 1/2in/sec. speed and providing up to 1 hour 10 mins. playing time. Truly "Portable", weighs only 22 lbs. Outstanding features are excellent performance and simplicity of operation.

The TROVOX "TOUCH"

With the New "SERIES 60" Recorders
Two Models are available
R62. A Twin Track Recorder with speeds of 1 1/2 and 3 1/2 i.p.s.
R64. A Four Track Recorder with speeds of 3 1/2 and 7 1/2 i.p.s.
PRICE FOR EACH MODEL **£40.19.0**
Deposit £8.4.0, 12 months of £3.0.1.

They offer full MIXING, MONITORING and SUPER-IMPOSING facilities. There is an AUTOMATIC STOP, a REV. COUNTER and a storage compartment for 7 inch spools tape. DESCRIPTIVE LEAFLETS READILY AVAILABLE

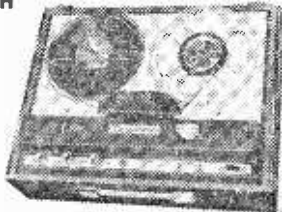

ADD "HI-FI" TAPE RECORDING TO YOUR EXISTING AUDIO INSTALLATION WITH

MULLARD TYPE "C" TAPE PRE-AMPLIFIER—ERASE UNIT



The "Hi-Fi" link to add full tape recording facilities to High Fidelity home installations. Incorporates FEROCUBE POT CORE PUSH-PULL OSCILLATOR and 3-speed treble equalisation by FEROCUBE POT CORE INDUCTOR FOR WEARITE-COLLARO-TRUVOX OR BRENELL TAPE DECKS. Includes separate power Supply Unit. KIT OF PARTS

OR ASSEMBLED
£14.0.0 Deposit **£2.16.0** 12 mths. at **£1.0.6** **£17.0.0** Deposit **£3.8.0** 12 months at **£1.4.11**
(Excluding power unit **£11.15.0** and **£14.10.0** respectively.)

- (a) The COLLARO "Studio" Deck with the Model "C" Preamplifier and POWER SUPPLY UNIT ASSEMBLED AND TESTED. **£29.10.0**
Deposit £5.18.0. 12 monthly payments of £2.3.3
- (b) As above but the TYPE "C" UNIT and POWER UNIT supplied as COMPLETE KIT OF PARTS. Deposit £5.6.0. 12 monthly payments of £1.18.10 **£26.10.0**
- (c) The BRENELL Mk. V Deck with the Model "C" PREAMPLIFIER and POWER UNIT. ASSEMBLED and TESTED. **£46.0.0**
Deposit £9.4.0 and 12 monthly payments of £3.7.6
- (d) As above but the Model "C" PREAMPLIFIER and POWER UNIT supplied as a COMPLETE KIT OF PARTS. **£43.0.0**
Deposit £8.12.0. 12 monthly payments of £3.3.1
- (e) The WEARITE MODEL "A" DECK with ASSEMBLED and TESTED Model "C" PREAMPLIFIER and POWER UNIT incorporating WEARITE HEAD LIFT TRANSFORMER, Etc. **£60.10.0**
Deposit £12.2.0 and 12 months at £4.8.9
(Carriage and Insurance on above is 10/- extra.)

THE 'ADD-A-DECK'

Incorporating GARRARD TAPE DECK and MODEL HFG/2P PRE-AMPLIFIER
Supplied on ONE CHASSIS (as illustrated) READY FOR USE **18 Gns.**
(Carr. & Ins. 10/- extra.)
Price includes Garrard Magazine and a 4 in. Spool Double Play Tape



H.P. Deposit **£3.16.0**, and 12 months of **£1.7.8**. Provides complete tape recording facilities and designed to operate through the pick-up sockets of the standard type of RADIO RECEIVER, or an AMPLIFIER, from which really first class reproduction is obtained. It consists of a Twin Track Deck connected to the Pre-amplifier and operates at 3 1/2in/sec. speed providing up to 1 hr. 10 mins. playing time.

The JEMCO MODEL MT-955 MULTIMETER



50,000 ohms per volt — D.C.
5,000 ohms " " A.C.
A truly efficient Meter for the amateur or professional user, having features found normally in more expensive Meters. Ranges:
D.C. volts 2.5-10-50-250-1K
A.C. " 2.5-10-50-250-1K
D.C. Current 100µA-10mA-100mA-500mA 10 amps
Resistance 4 Ranges up to 20 meg.
Add D.B. 0-46 Size 7 x 5 1/2 x 3 1/2 in.
PRICE, including Full Test Kit **£12.19.6** 4/- p. & p.

STEREO-MONO CRYSTAL CARTRIDGES AT GREATLY REDUCED PRICES

- RONETTE Model "OV" Output 110mVolts **29/6**
- RONETTE Model "105" Output 250mVolts **35/-**
- RONETTE Model "105" with DIAMOND STYLUS..... **39/6**
- RONETTE Model "106" Output 500mVolts **32/-**
- COLLARO "CERAMIC" Output 50mVolts **25/6**

All above are "TURNOVER" type Cartridges.

109, FLEET ST., LONDON, E.C.4.
TELEPHONE FLEET ST. 5812-3
23, TOTTENHAM COURT RD., LONDON W.1.
TELEPHONE MUSEUM 3451
7.9 TUDOR PLACE, TOTTENHAM COURT RD., LONDON, W.1. TELEPHONE MUSEUM 4178/9.

R S T

211a STREATHAM ROAD
MITCHAM · SURREY
Tel: Mitcham 6202

METAL RECTIFIERS

| | | | | | |
|------|----------|-------|------|--------|---------|
| RM1 | 5/3 | RM4 | 14/- | 14A97 | 25/- |
| RM2 | 7/6 | RM5 | 19/6 | 14A100 | 27/- |
| RM3 | 7/9 | 14A86 | 17/6 | | |
| 14RA | 1-2-8-2 | ... | ... | 17/6 | (FC31) |
| 16RC | 1-1-16-1 | ... | ... | 8/6 | |
| 14RA | ... | ... | ... | 19/- | (FC31) |
| 16RD | 2-2-8-1 | ... | ... | 12/- | |
| 16RE | 2-1-8-1 | ... | ... | 8/6 | |
| 18RA | 1-1-8-1 | ... | ... | 4/6 | |
| 18RA | 1-1-16-1 | ... | ... | 6/6 | (FC116) |
| 18RA | 1-2-8-1 | ... | ... | 11/- | |
| 18RD | 2-2-8-1 | ... | ... | 15/- | (FC124) |

TERMS OF BUSINESS

C.W.O., C.O.D.; C.O.D. 3/2
extra. Postage 6d. per Valve.
Open to Callers: 9 a.m. to 6-30 p.m.
Phone: Mit 6202



VALVE

ALL VALVES ETC. BRAND EXPRESS 24 HOUR

TRANSISTOR BARGAINS

| | | | | | |
|------|-----|-----|-------|-----|-----|
| OC44 | ... | 6/- | OC77 | ... | 6/- |
| OC45 | ... | 7/- | OC81 | ... | 6/- |
| OC71 | ... | 5/- | OC81D | ... | 6/- |
| OC72 | ... | 6/- | OC82 | ... | 8/- |
| OC74 | ... | 6/- | OC82D | ... | 8/- |
| OC75 | ... | 6/- | | | |

| | | | | | | |
|--------------|------------|------------|--------------|--------------|---------------|------------|
| AC2/PEN 21/- | EAC91 4/- | EF36 4/- | EM85 10/- | LN309 11/6 | PEN453DD | U10 9/- |
| AC2/PEN 21/- | EAF42 9/6 | EF37 8/- | EY51 8/6 | LZ319 12/6 | PENDD4020 | U12 9/- |
| AC/THI 34/- | EB34 2/6 | EF37A 8/- | EY81 8/6 | MHD4 15/- | PL33 15/- | U14 9/- |
| AC/TP 32/- | EB41 5/- | EF39 4/- | EY83 12/6 | MKT4 17/6 | PL36 12/6 | U16 9/- |
| AC/VPI-5-7 | EB91 4/- | EF40 15/- | EY86 7/- | MS48 17/6 | PL38 21/- | U22 8/- |
| | EBC3 21/- | EF41 8/- | EY91 3/- | MVS/PEN 17/6 | PL81 11/6 | U24 21/- |
| | EBC33 4/6 | EF42 10/- | EZ35 6/- | MVS/PENB | PL82 0/- | U25 12/6 |
| AZI 15/- | EBC41 8/6 | EF50A 3/6 | EZ40 7/- | MU14 9/- | PL83 10/6 | U26 10/- |
| AZ31 10/- | EBF81 10/- | EF50 3/- | EZ41 7/- | MX40 15/- | PL84 8/3 | U31 9/- |
| B36 9/- | EBF80 8/6 | EF80 5/- | EZ80 6/6 | N18 8/- | PL820 18/- | U33 17/6 |
| CIC 10/- | EBF83 8/6 | EF85 5/- | EZ81 6/6 | N18 8/- | PM24M 13/6 | U35 17/6 |
| CBL1 12/6 | EBF89 8/- | EF86 9/- | EZ90 7/- | N37 14/- | PX4 15/- | U37 17/6 |
| CBL31 21/6 | EBL1 21/- | EF89 9/- | E1143 2/- | N78 17/6 | PX25 25/- | U43 8/6 |
| CCH35 21/- | EBL21 21/- | EF91 4/- | FC2 15/- | NI08 15/- | PY31 15/- | U47 12/6 |
| CL33 15/- | EBL31 21/6 | EF92 4/- | FC2A 17/6 | N303 20/- | PY32 12/6 | U50 7/- |
| CY1 15/- | ECC31 10/- | EF95 5/- | FC4 15/- | N339 30/- | PY33 12/6 | U52 4/- |
| CY31 15/- | ECC32 6/- | EF98 10/- | FC13 15/- | N369 10/6 | PY80 7/6 | U76 7/6 |
| D77 4/- | ECC33 8/6 | EF183 10/6 | FC13C 17/6 | OB2 11/- | PY81 7/6 | U78 4/6 |
| DAC32 9/6 | ECC34 10/- | EF184 10/6 | FW4/500 9/- | OD3 5/- | PY82 7/- | U107 16/6 |
| DAF91 6/6 | ECC35 8/- | EK2 21/- | FW4/800 9/- | OZ4 5/6 | PY83 8/- | U145 10/6 |
| DAF96 8/- | ECC40 15/- | EK3 21/- | GZ30 10/6 | P2 10/- | PY88 10/- | U191 15/6 |
| DCC90 12/6 | ECC81 5/- | EK32 8/6 | GZ32 10/6 | PABC80 13/- | PY800 10/- | U251 12/6 |
| DF33 10/- | ECC82 5/- | EL2 25/- | GZ33 19/3 | PCC84 0/6 | PY801 10/- | U281 15/- |
| DF91 4/- | ECC83 7/6 | EL3 21/6 | GZ34 13/6 | PCC85 9/6 | PY810 10/- | U282 19/6 |
| DF92 7/2 | ECC84 8/6 | EL6 21/- | GZ37 19/3 | PCC88 12/6 | PY810 10/- | U301 22/6 |
| DF96 8/- | ECC85 7/6 | EL32 4/6 | HABC86 10/- | PCC89 8/6 | PZ30 15/- | U329 12/6 |
| DF97 11/6 | ECC88 12/6 | EL33 10/- | HL41 8/- | PCCF80 9/- | QS95/10 10/- | U339 15/- |
| DH63 6/- | ECC91 3/- | EL34 15/- | HL41DD 8/6 | PCF82 7/- | QS150/15 10/- | U403 10/- |
| DH77 7/- | ECF80 7/6 | EL35 10/- | HL92 8/6 | PCF84 12/6 | R2 10/- | U404 10/- |
| DK32 11/6 | ECF82 8/6 | EL37 17/6 | HL133DD 9/6 | PCF86 12/6 | R3 10/- | U801 19/3 |
| DK91 7/3 | ECH3 21/6 | EL38 19/2 | HN309 26/6 | PCL82 9/- | R16 17/6 | UABC80 7/- |
| DK72 8/6 | ECH21 21/- | EL41 10/- | HVR2 13/- | PCL83 11/6 | R19 16/- | UJAF42 8/6 |
| DK96 8/6 | ECH35 10/- | EL42 10/- | IW4/350 10/- | PCL84 10/6 | R20 16/- | UB41 7/6 |
| DL33 8/6 | ECH42 9/6 | EL81 12/6 | IW4/500 10/- | PCL85 10/6 | S130 7/6 | UBC41 8/6 |
| DL35 10/6 | ECH81 8/- | EL84 6/9 | KT33C 8/- | PCL86 12/6 | SP4 10/- | UBC81 10/- |
| DL91 8/0 | ECH83 8/6 | EL85 10/- | KT36 17/6 | PEN4A 17/6 | SP41 3/6 | UBF80 8/6 |
| DL92 6/6 | ECL80 8/- | EL86 10/- | KT55 17/6 | PEN44 17/6 | SP61 3/6 | UBF89 7/6 |
| DL93 7/0 | ECL81 10/- | EL90 8/6 | KT61 9/6 | PEN4DD 24/- | SU2150 15/- | UBL21 20/- |
| DL94 7/6 | ECL82 9/6 | EL91 4/- | KT66 15/- | PEN4VA 17/6 | SU2150A 17/6 | UCC84 10/6 |
| DL96 8/0 | ECL83 10/6 | EL95 10/6 | KT76 10/- | PEN36C 20/- | T41 15/- | UCC85 7/6 |
| DM70 7/6 | ECL86 10/6 | EM34 9/6 | KT81 15/- | PEN45 10/- | TDD4 12/6 | UCF80 13/6 |
| DY86 12/6 | EF6 21/- | EM80 8/6 | KTW61 8/- | PEN45DD 25/- | TDD13C 17/6 | UCH21 20/- |
| EAS50 2/- | EF9 21/6 | EM81 8/6 | L63 5/- | PEN46 5/- | TH41 27/6 | UCH42 9/6 |
| EABC80 5/- | EF22 14/- | EM84 9/6 | LN152 8/- | | TY86F 12/6 | UCH81 8/- |

ALL VALVES ETC. BRAND

SALE! ★

NEW & FULLY GUARANTEED MAIL ORDER SERVICE

SETS OF VALVES

IR5, IS5, IT4, 3S4, 3V4 ... Sets of 4, 19/6
 DAF91, DF91, DK91, DL92, DL94 Set of 4, 19/6
 DAF96, DF96, DK96, DL96 ... Set of 4, 27/6

SILICON RECTIFIERS

400 volts 350 mA 15/- each

R S T

211a STREATHAM ROAD
 MITCHAM · SURREY
 Tel: Mitcham 6202

SPECIAL OFFER

| | | | | | |
|--------|-----|--------|-----|-------|------|
| DF91 | 4/- | PCC84 | 8/6 | 6D2 | 4/- |
| EABC80 | 5/- | PCC89 | 8/6 | 6K7 | 7/6 |
| EAC91 | 4/- | PCF80 | 9/- | 6K8 | 9/6 |
| EB91 | 4/- | PCL82 | 9/- | 6L6 | 10/- |
| EBC33 | 4/6 | PL84 | 8/6 | 6Q7 | 9/6 |
| EBF89 | 8/- | UABC80 | 7/- | 6SL7 | 5/6 |
| ECC81 | 5/- | UBF89 | 7/6 | 6SN7 | 6/6 |
| ECC85 | 7/6 | UF41 | 7/6 | 6V6 | 8/6 |
| ECC91 | 3/- | UF89 | 6/6 | 6X5 | 6/6 |
| ECH81 | 8/- | UL11 | 8/- | 8D3 | 3/- |
| EF32 | 4/- | UL94 | 7/- | 12AT7 | 4/6 |
| EF50 | 3/- | UY85 | 7/- | 12AH8 | 9/6 |
| EF80 | 5/- | W81 | 6/- | 12BA6 | 7/6 |
| E-85 | 5/- | 5U4 | 4/- | 12BE6 | 7/6 |
| EP91 | 4/- | 6AQ5 | 6/6 | 12K7 | 5/6 |
| EL84 | 6/9 | 6BA6 | 6/- | 12Q7 | 6/6 |
| EY86 | 7/- | 6BE6 | 6/- | 807 | 6/- |
| OZ4 | 5/6 | | | | |

Obsolete Valves a

Speciality — Quotations
 by Return

| | | | | | | | | | | | | | |
|----------|------|-------|------|-------|------|--------|------|--------|------|--------|------|---------|------|
| UCL82 | 10/- | X76M | 12/6 | 6A7 | 9/- | 6F13 | 10/- | 6SR7 | 10/- | 12AH8 | 7/6 | 25Y5 | 8/- |
| UCL83 | 13/6 | X78 | 28/6 | 6ABG | 8/6 | 6F14 | 10/- | 6SS7 | 10/- | 12AT6 | 9/6 | 25Y5G | 8/- |
| UF41 | 7/6 | X79 | 28/6 | 6ABGT | 13/6 | 6F15 | 12/6 | 6U4GT | 10/- | 12AT7 | 5/- | 25Z4 | 7/6 |
| UF42 | 7/6 | X81 | 13/- | 6AC7 | 6/- | 6F19 | 12/6 | 6U5G | 7/6 | 12AU6 | 17/6 | 25Z5 | 8/- |
| UF80 | 7/- | X109 | 26/6 | 6AJ8 | 9/6 | 6F23 | 10/6 | 6V6 | 8/6 | 12AU7 | 5/- | 25Z6 | 8/6 |
| UF85 | 7/6 | Y61 | 10/- | 6AK5 | 5/- | 6F25 | 16/6 | 6V6G | 4/6 | 12AX7 | 5/- | 27SV | 19/6 |
| UF86 | 12/6 | Y63 | 10/- | 6AK8 | 7/6 | 6F26 | 13/6 | 6V6GT | 8/- | 12BA6 | 7/6 | 30C1 | 9/- |
| UF89 | 6/6 | Z63 | 7/6 | 6ALS | 4/- | 6F33 | 5/6 | 6X4 | 4/6 | 12BE6 | 7/6 | 30C15 | 12/6 |
| UL41 | 8/- | Z66 | 10/- | 6AM5 | 5/- | 6H6 | 2/- | 6X5G | 6/- | 12BH7 | 8/6 | 30F5 | 10/- |
| UL44 | 20/- | Z77 | 4/- | 6AM6 | 4/- | 6J5 | 5/6 | 6X5GT | 8/6 | 12C8 | 10/6 | 30FL1 | 10/6 |
| UL46 | 14/6 | Z152 | 5/- | 6AQ5 | 6/6 | 6J5G | 4/6 | 6/30L2 | 10/- | 12J5GT | 4/- | 30L1 | 8/6 |
| UL84 | 7/- | ZDI52 | 8/6 | 6AQ8 | 9/3 | 6J5GT | 5/- | 7B5 | 12/6 | 12J7GT | 8/6 | 30L15 | 11/6 |
| UL85 | 7/6 | OZ4 | 5/- | 6AT6 | 6/- | 6J7 | 7/6 | 7B6 | 10/- | 12K7GT | 5/- | (30P4) | 20/- |
| UM80 | 10/6 | IA7 | 11/6 | 6AU6 | 9/- | 6J7G | 5/6 | 7B7 | 8/6 | 12K8GT | 10/- | (30P19) | 21/- |
| UR1C | 15/- | ICS | 10/6 | 6B7 | 8/6 | 6J7GT | 7/6 | 7C5 | 3/6 | 12Q7GT | 6/6 | 30P12 | 10/- |
| UU5 | 10/- | ID5 | 8/6 | 6B86 | 3/- | 6K7 | 7/6 | 7C7 | 8/- | 12H6 | 5/- | 30P16 | 9/- |
| UU6 | 19/- | ID6 | 10/- | 6BA6 | 6/- | 6K7G | 2/- | 7D3 | 15/- | 12SA7 | 8/6 | 30P19 | 21/- |
| UU8 | 15/- | IHS | 9/6 | 6BE6 | 6/- | 6K7GT | 7/6 | 7D5 | 15/- | 12SC7 | 7/6 | 30PL1 | 15/- |
| UU9 | 7/6 | IL4 | 5/- | 6BG6G | 15/- | 6K8 | 9/6 | 7D6 | 15/- | 12SG7 | 7/6 | 30PL13 | 12/6 |
| UY1N | 12/6 | ILNS | 4/6 | 6BH6 | 8/- | 6K8G | 5/6 | 7D8 | 15/- | 12SH7 | 8/- | 30PL14 | 16/6 |
| UY21 | 15/6 | INS | 9/6 | 6BJ6 | 6/- | 6K8GT | 9/6 | 7H7 | 7/6 | 12SJ7 | 8/- | 35A5 | 17/6 |
| UY41 | 7/6 | IR5 | 7/3 | 6BQ7A | 12/6 | 6K25 | 18/- | 7K7 | 8/6 | 12SK7 | 6/- | 35L6GT | 8/6 |
| UY85 | 7/- | 134 | 8/- | 6BR7 | 10/6 | 6L1 | 10/- | 7K7 | 7/6 | 12SL7 | 8/- | 35W4 | 7/6 |
| VMS4B | 7/6 | 155 | 6/6 | 6BS7 | 12/6 | 6L6 | 7/6 | 7Q7 | 10/- | 12SQ7 | 8/6 | 35Z3 | 16/- |
| VP2 | 12/6 | 1T4 | 4/- | 6BVV5 | 7/- | 6L7 | 10/- | 7R7 | 10/- | 12SN7 | 10/- | 35Z4 | 7/6 |
| VP4 | 15/- | 1T5 | 5/9 | 6BVV7 | 5/- | 6L18 | 10/- | 7S7 | 10/- | 12SR7 | 10/- | 35Z5 | 8/6 |
| VP4A | 15/- | 2P | 24/9 | 6BX6 | 5/- | 6L19 | 15/- | 7Y4 | 7/6 | 12T2 | 10/- | 40SUA | 15/6 |
| VP4B | 7/6 | 2A3 | 10/- | 6C4 | 3/6 | 6L34 | 9/6 | 8D3 | 4/- | 13D3 | 12/6 | 41STH | 21/- |
| VF41 | 7/6 | 3A4 | 5/- | 6CSG | 6/6 | 6N7GT | 9/6 | 9BVV6 | 12/6 | 14H7 | 10/- | 42 | 12/6 |
| VR105/30 | 7/- | 3A5 | 10/6 | 6CSGT | 8/- | 6P25 | 10/6 | 10C1 | 12/6 | 14R7 | 10/- | 50C5 | 10/- |
| VR150/30 | 7/- | 3D6 | 10/6 | 6C6 | 6/6 | 6P28 | 12/6 | 10C2 | 17/6 | 14S7 | 16/- | 50CD6G | 27/6 |
| VU39 | 9/- | 3Q4 | 8/- | 6C9 | 12/6 | 6Q7 | 7/6 | 10C14 | 13/6 | 18AQ5 | 8/- | 50L6 | 8/6 |
| VU111 | 2/6 | 3Q5 | 9/- | 6CD6G | 27/6 | 6Q7G | 6/6 | 10F1 | 10/- | 19BG6G | 15/- | 53KU | 12/6 |
| VU120 | 2/6 | 3S4 | 7/- | 6CH6 | 10/- | 6Q7GT | 8/6 | 10F3 | 12/6 | 20D1 | 10/- | 75 | 8/- |
| W61 | 11/- | 3V4 | 7/6 | 6CW4 | 14/6 | 6SA7 | 7/- | 10F9 | 14/6 | 20D2 | 21/6 | 78 | 7/6 |
| W76 | 5/- | 5U4 | 4/- | 6D2 | 4/- | 6SC7 | 8/6 | 10F18 | 15/- | 20F2 | 17/6 | 80 | 9/- |
| W77 | 4/- | 5V4G | 7/9 | 6D6 | 5/6 | 6SF5 | 10/- | 10LD11 | 15/- | 20L1 | 24/- | 85 | 17/6 |
| W81 | 6/- | 5Y3 | 8/6 | 6E5 | 10/- | 6SG7 | 7/- | 10LD12 | 15/- | 20P1 | 15/- | 85A2 | 12/6 |
| W81M | 6/- | 5Y3G | 7/- | 6F1 | 10/6 | 6SH7 | 6/- | 10P13 | 15/- | 20P3 | 24/- | 185BT | 30/- |
| W107 | 11/- | 5Y3GT | 8/6 | 6F6 | 6/9 | 6S17 | 6/6 | 10P14 | 19/- | 20P4 | 23/6 | 305 | 13/- |
| X41 | 15/- | 5Z3 | 10/6 | 6F7 | 10/- | 6SK7 | 5/6 | 10P18 | 15/- | 20P5 | 24/- | 807B | 5/- |
| X61M | 10/- | 5Z4 | 10/- | 6F11 | 10/- | 6SL7GT | 5/6 | 11D3 | 23/6 | 25A6 | 8/- | 807A | 6/- |
| X65 | 12/6 | 5Z4G | 9/6 | 6F12 | 4/- | 6SQ7 | 8/6 | 11D5 | 23/6 | 25L6 | 8/- | 7475 | 5/- |
| X76 | 12/6 | 5Z4GT | 12/6 | | | | | 12A6 | 6/6 | | | | |

NEW & FULLY GUARANTEED

More for less...



19 Ranges

| | |
|---------------------|---------------------|
| D.C. Voltage | A.C. Voltage |
| 0—100mV. | 0—10 V. |
| 0—2.5 V. | 0—25 V. |
| 0—10 V. | 0—100 V. |
| 0—25 V. | 0—250 V. |
| 0—100 V. | 0—1000 V. |
| 0—250 V. | |
| 0—1000 V. | |
| D.C. Current | |
| 0—100µA | |
| 0—1mA | |
| 0—10mA | |
| 0—100mA | |
| 0—1A | |
| Resistance | |
| 0—20,000 Ω | |
| 0—2M Ω | |

Size: 5½ x 3½ x 1¼ in.
Weight: 1 lb. approx.

Designed to offer the widest possible range of accurate and reliable measurements at the lowest possible price, the versatility and usefulness of the Multiminor are further extended by specially designed leads. These new leads, available at no extra cost, will accept crocodile clips or PRODCLIPS.

The Multiminor takes full advantage of the possibilities of printed circuit techniques to achieve outstanding compactness and economy of weight. The scale is clear and open. The fine red colour pointer and effectively damped movement facilitate easy and rapid reading.

For use in Radio, TV, Electronics, Motor Vehicles, domestic appliances, workshop equipment, you'll find the Multiminor a great little meter!

Use PRODCLIPS with the MULTIMINOR (Pat No. 748811)

These cleverly designed spring-loaded insulated prods are the complete answer to a long-standing problem. Press the trigger to open, release to grip. Keep your hands free no matter how difficult of access your test points may be.

...with the **MULTIMINOR**

Write for illustrated literature to:—

AVO LTD

AVOCET HOUSE - 92-96 VAUXHALL BRIDGE ROAD
LONDON - S.W.1
VICtoria 3404 (12 lines)



FREE TO AMBITIOUS ENGINEERS
— THE LATEST EDITION OF ENGINEERING OPPORTUNITIES

Have you sent for your copy?

ENGINEERING OPPORTUNITIES is a highly informative 156-page guide to the best paid engineering posts. It tells you how you can quickly prepare at home for a recognised engineering qualification and outlines a wonderful range of modern Home Study Courses in all branches of Engineering. This unique book also gives full details of the Practical Radio & Electronics Courses, administered by our Specialist Electronics Training Division—the B.I.E.T. School of Electronics, explains the benefits of our Employment Dept. and shows you how to qualify for five years promotion in one year.

We definitely Guarantee
“NO PASS—NO FEE”

Whatever your age or experience, you cannot afford to miss reading this famous book. If you are earning less than £25 a week, send for your copy of “ENGINEERING OPPORTUNITIES” today—FREE.

BRITISH INSTITUTE OF ENGINEERING TECHNOLOGY (Incorporating E.M.I. Institutes)
(Dept. SE/21), 29 Wright's Lane, London, W.8

WHICH IS YOUR PET SUBJECT?

- Mechanical Eng..
- Electrical Eng..
- Civil Engineering,
- Radio Engineering,
- Automobile Eng..
- Aeronautical Eng..
- Production Eng..
- Building, Plastics,
- Draughtsmanship,
- Television, etc.

GET SOME LETTERS AFTER YOUR NAME!

- A.M.I. Mech. E.
- A.M.I.C.E.
- A.M.I. Prod. E.
- A.M.I.M.I.
- A.I.O.B.
- A.F.R. Ae.S.
- B.Sc.
- A.M. Brit. I.R.E.
- City & Guilds
- Gen. Cert. of Education
- Etc., etc.

PRACTICAL EQUIPMENT

Basic Practical and Theoretic Courses for beginners in Radio, T.V., Electronics, Etc., A.M. Brit. I.R.E. City & Guilds Radio Amateurs' Exam. R.T.E.B. Certificate P.M.G. Certificate Practical Radio Radio & Television Servicing Practical Electronics Electronics Engineering Automation

INCLUDING TOOLS!

The specialist Electronics Division of B.I.E.T. (Incorporating E.M.I. Institutes) NOW offers you a real laboratory training at home with practical equipment. Ask for details.

B.I.E.T. SCHOOL OF ELECTRONICS

POST COUPON NOW!

Please send me your FREE 156-page “ENGINEERING OPPORTUNITIES” (Write if you prefer not to cut page)

NAME.....
ADDRESS.....

SUBJECT OR EXAM THAT INTERESTS ME.....

SE/12



THE B.I.E.T. IS THE LEADING ORGANISATION OF ITS KIND IN THE WORLD



TRANSISTOR SET CASE, 11½ x 8 x 3in. with carrying handle finished in two-tone grey with gold trim, price 22/6. Set of suitable knobs, 5/- extra. **LEATHERCLOTH COVERED RECORD PLAYER CASE**, suitable for single player unit, etc. Size 14½ x 13 x 6½in., supplied with uncut motorboard, carrying handle, gold trim, available in red/grey and two-tone grey. Price 44/-.

LEATHER CLOTH CASE, as above but suitable for automatic record player, size 14½ x 14½ x 8½in., available in blue/grey, red/grey, price 56/-.

Uncut motorboard. Case as above, base size 15½ x 15 x 8½in. tapered front, motorboard cut out for UA14, available lemon/black, price 63/-.

Miniature Jack plug and socket 2/6 set. Miniature Slide Switch 2 pole change over 2/6. Transformers LT.44/700 Driver and Output 8/- pair. Top Quality Co-axial Cable semi airtaced 6d. yard. All Co-Axial Accessories available from stock.

PERSONAL EARPHONE

A really sensitive dynamic earphone of exceptionally fine quality. Provides clear reproduction of music as well as speech. Fully guaranteed and complete with ear insert, 3 test cord, sub miniature plug and socket. Model CR5 Crystal Earpiece high amp. Model MR-4. Magnatic earpiece low amp., 6/- each.

"PRACTICAL WIRELESS" POCKET TRANSISTOR SUPERHET



The new version in a redesigned cabinet with carrying strap.

COMPONENTS PRICE LIST

| | |
|---|-------|
| Coil Set, (Osc. and 3 I.F.s) | 22/- |
| Driver Transformer, Type PW/DT | 8/3 |
| Output Transformer, Type PW/OT | 8/- |
| Ferrite Rod Aerial, Type PW/FR | 8/6 |
| Printed Circuit Board | 7/6 |
| 2 Gang Capacitor, Type "OO" | 12/6 |
| Volume Control, Type V.C.1545 | 0/- |
| Switch | 3/6 |
| Hardware (Screws, nuts, washers, spacers, battery clips, cable cradles, cable studs, cable strapping) | 4/- |
| Transistors, Type YC (Set of 6) | 43/- |
| Xtal Diode, Type GD9 | 17/10 |
| Speaker | 12/6 |
| Case | 15/- |
| Capacitors | 5/- |
| Resistors | 3/9 |
| Trimmers, Type MT31/4A (3 required) | |

CONSTRUCTION LEAFLET AND "BLOW-UP" CIRCUIT DIAGRAM. PRICE FOR THE COMPLETE KIT £7.19.6.

LOUDSPEAKER CABINETS

Baffle type (as per illustration), walnut finish:—

| | |
|---------------------------------------|------------|
| Type suitable for an 8" unit | Price 21/- |
| Type suitable for a 10" unit | Price 25/6 |
| Type suitable for a 7 x 4" unit | Price 17/6 |

AUTOMATIC RECORD CHANGERS

| | |
|------------------------|---------|
| BSR UA14 | £6.19.6 |
| COLLARO C60 | £7.12.6 |
| GARRARD AUTOSLIM | £7.19.6 |

SINGLE PLAYERS

| | |
|---------------------------------|---------|
| EMT. 4 Speed with pick-up | £3.15.0 |
| BSR EU6 | £4.19.6 |
| GARRARD TA MK11 | £8.10.0 |
| EMI BATTERY VERSION | £5.9.6 |

J.B. SD/2 GANG CONDENSER

Sub Min. Solid Dielectric Size 2" square x 7/16" deep. Cap 192pF Aerial 78pF osc. TRIMMERS FITTED 17/6 each.

J.B. DILEMIN CONDENSER

Solid Dielectric available in 300pF or 500pF, 7/6 each. Send for our Price Lists on Mini Amp Tutor, etc. etc.

Our new 1962/63 48-page catalogue, profusely illustrated, is now available. Please send 1/- in stamps for your copy. Trade Catalogue also available for which please attach your Business Letter Heading.

"MERCURY SIX" Components Price List for the Printed Circuit Version

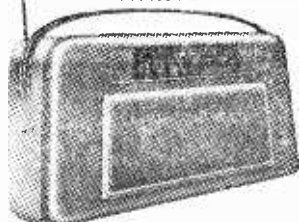

| | |
|---|-------|
| COIL SET (OSC. and 3 I.F.s) | 22/- |
| DRIVER TRANSFORMER, Type PW/DT | 8/3 |
| OUTPUT TRANSFORMER, Type PW/OT | 8/- |
| FERRITE ROD AERIAL, Type PW/FR | 8/6 |
| 2-GANG CAPACITOR, Type "OO" | 12/6 |
| VOLUME CONTROL, EGEN 10K. S/P SWITCH | 6/6 |
| SWITCH | 3/6 |
| TRANSISTOR Type Y.C. (set of 6) | 43/- |
| Xtal Diode Type GD9 | 17/10 |
| SPEAKER | 22/5 |
| CASE complete with handle, front grille, studs | 25/- |
| CAPACITORS | 17/6 |
| RESISTORS | 5/- |
| TRIMMERS, Type MT.31/4A, 1/3 ea. | 3/9 |
| PRINTED CIRCUIT BOARD | 14/6 |
| COMPLETE DIAL ASSEMBLY (BOXED) | 14/6 |
| HARDWARE (Screws, Nuts, Washers, Spacers, Battery Clips, Aerial Cradle) | 5/9 |
| Postage and Packing | 2/6 |
| INSTRUCTION HANDBOOK | 2/6 |

TRANSISTORS AND DIODES

| | | | | |
|-------------|------------|-------------|--------------|-----------|
| Transistors | OC75 8/- | OCP71 25/- | OA73 3/- | GECS1 3/6 |
| OC35 18/- | OC77 12/- | Matched Prs | OA79 3/3 | Audio 3/6 |
| OC36 21/6 | OC78 8/- | 2xOC72 15/- | OA81 2/6 | Red 3/6 |
| OC44 6/- | OC81 8/- | 2xOC7B 16/- | OA85 3/- | Spot 3/6 |
| OC45 6/- | OC84 8/5 | | OA91 3/- | White 5/- |
| OC70 6/6 | OC170 9/6 | Diodes | OA95 3/6 | Spot 5/- |
| OC71 5/- | OC171 10/6 | OA5 6/- | | GEX34 3/- |
| OC72 8/- | OC201 31/- | OA10 8/- | | GEX35 3/- |
| OC73 16/- | OC202 26/- | OA70 3/- | Sundry Types | XD201 1/- |
| | | | PXA102 4/- | |

A set of Transistors comprising 1 OC44, 2 OC45, 1 OC81D, 2 OC81, 32/6 set. Set of Audio Transistors, 1 x OC81, 2 x OC81, Driver Matched Pair, 15/6 set.

TERMS: Cash with Order or C.O.D. Postage and Packing Charges extra. Single valves 9d., Minimum Parcel Post charges 2/-. Please include sufficient postage with your order. Minimum C.O.D. fees and postage 3/6. These Postal Rates apply to U.K. only. For full terms of business see inside cover of catalogue. Personal shoppers 9 a.m. to 5 p.m. Mon. to Friday, Saturday 10 a.m. to 1 p.m.



103 LEEDS TERRACE
WINTOUN STREET
LEEDS 7

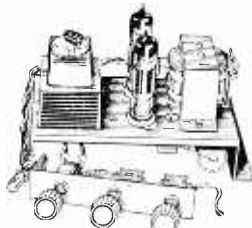

SPECIAL OFFER!

6 Watt Push-Pull Amplifier

2 ECL82 metal rec., separate bass and treble cont. on aux. panel. Made for one of the largest manufacturers of record players. Used in 30 gn. unit. Size 7 x 4 in. panel, 6 x 1 1/4 in. 3 ohm output, trans. included.

Our Price **£4.9.6** Post 4/-

6 TRANSISTOR AND DIODE SUPERHET

A first class 2 waveband transistor superhet in kit form. ● Printed circuit panel (size 8 1/2 x 2 1/2 in.) ● 3 pre-aligned. I.F. transformers. ● High-gain Ferrite rod aerial. ● First-grade G.E.C. transistors. ● Car aerial winding. ● Push-pull output. ● All parts down to the minutest item with simple instructions.

ONLY **£4.5.0** P. & P. 2/6

2 1/2 in. 35 ohm speaker, 10/6; 3 1/2 in. 35 ohm speaker 16/6; 35 ohm 5 in. P.M. 18/6; 7 x 4 in. 35 ohms speaker 21/-, P. & P. 1/6 per speaker.

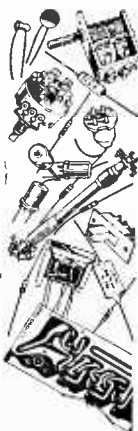

PORTABLE CABINET

Size approx. 9 1/2 x 6 1/2 x 3 1/2 in. Suitable for above using 3 1/2 in. speaker. 25/-, P. & P. 2/-.

COIL AND TRANSFORMER SET FOR TRANSISTOR SUPERHET

3 I.F. transformers, one oscillator coil, one driver transformer and wound Ferrite aerial (med., long and aerial coupling), 28/6 complete, post 1/-. 6 transistor printed circuit, board to match, 8/6, post 9d. Circuit diagram 1/6 extra.

HARVERSON'S F.M. TUNER MARK I

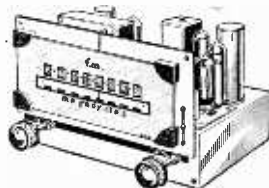

● F.M. tuning head by famous maker. ● Guaranteed non-drift. ● Permeability tuning. ● Frequency coverage 88-100 mc/s. ● OA81 balanced diode output. ● Two I.F. stages and discriminator. ● Attractive maroon and gold dial (7 x 3 in. glass). ● Self powered, using a good quality mains transformer and valve rectifier. ● Valves used ECC85, two EF80s, and EZ80 (rectifier). ● Fully drilled chassis. ● Size of completed tuner 8 x 6 x 5 1/2 in. ● All parts sold separately. **£5.19.6**, plus 8/6 P.P. and ins. Circuit diagram and illustrations 1/6 P. free.

MARK II version as above but complete with magic eye, front panel and brackets. **£6.12.6**, P. & P. 8/6.

MARK III version as Mark I but with output stage (FCL82) and tone control. **£7.7.0**, P. & P. 8/6.

Handsome Metal Cabinet in choice of Grey, Black or Green. To fit Mark I, 25/-, P. & P. 2/6. To fit Mark II, 17/6, P. & P. 2/6.

TAPE DECKS

B.S.R. Monardeck

(Single speed) 3 1/2 in. per sec., simple control, uses 5 1/2 in. spools, **£6.15.0**, plus 5/6 carr. and ins. (Tapes extra.)

COLLARO STUDIO DECK

£10.10.0, plus 5/6 carr. and ins. (Tapes extra.)

10/14 WATT HI-FI AMPLIFIER KIT

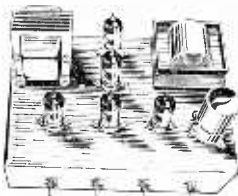

A stylishly finished monaural amplifier with an output of 14 watts from 2 EL84s in push-pull. Super reproduction of both music and speech, with negligible hum. Separate inputs for mike and gram allow records and announcements to follow each other. Fully shrouded ultra output transformer (to match 3-15 speaker) and 2 independent volume controls, and separate bass and treble controls are provided giving good life and cut. Valve line-up 2 EL84s, ECC83, EF86 and EZ80 rectifier.

(Simple instruction booklet 1/6, free with kit).

ONLY **£6.19.6** P. & P. 1/6.

LOUDSPEAKERS

All 3 ohm impedance.

| | |
|--|------|
| 2 1/2 in. | 12/6 |
| 5 in. | 12/6 |
| 6 1/2 in. | 15/- |
| 12 in. | 27/6 |
| Goodmans 5 in. tweeter | 10/6 |
| E.M.I. 2 1/2 in. tweeter | 10/6 |
| Goodmans 8 in. x 5 in. middle register speaker | 10/6 |
| E.M.I. 13 1/2 in. x 8 1/2 in. high flux | 32/6 |
| Rola Celestion, approx. 9 in. x 6 in., middle register speaker | 10/6 |

P. & P. 1/6 per Speaker.

AMPLIFIER ON PRINTED CIRCUIT BOARD

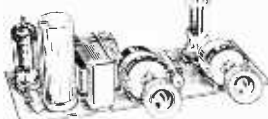

Two valve. UY85, UL84 with O.P. trans., use with 80 volt tap off motor. 39/6.

Two valve. UY85, UCL82, 3 watts output. O.P. trans., use as above, 49/6. P.P. 2/6 on above. Dropper res. for filaments if required, 2/6.

B.S.R. AUTO UNITS

160 v. Suitable for use with above. (Slightly soiled.) **£5.5.0**. P. & P. 5/-.

LARGE CABINET

Suitable for above

two items.

Complete with

3 ohm speaker.

£3.9.6 Carr. 5/-.

Superior Cabinet. Similar to above

to take 8 x 5 in. speaker, with motor

board, will accommodate BSR UA14 or

UA16. **£3.9.6** Carr. 5/6. Speaker

15/- extra. P. & P. 1/6 extra.

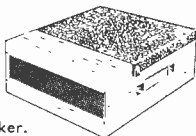

WODEN TRANSFORMERS

(Ex equip.). 200-240 v. input. Output 12 v. 1 amp., tapped 1, 8 and 10 v. Ideal for model railways and chargers. 8/6, P. & P. 2/-.

Colvern Wire Wound Potentiometers. 3 in. 10 ohm 1 amp. Suitable for above. 5/-, P. & P. 1/6.

LARGE WODEN MAINS TRANSFORMER

220/240 v. input. Output 40 v. at 3 amps. tapped 30 and 35 v. H.T. voltages 300 v. 100 mA. tapped 10 v. 150 v., 230 v., 260 v., also 90 v. 100 mA., 350 v., tapped at 200 v. 100 mA. Size 4 1/2 x 5 x 5 in. Weight approx. 12 lb. 20/- each. P. & P. 5/-.

TRANSISTORS

| | | | | | |
|--|------|-------|-----|---------|------|
| GET15 (Matched Pair), 15/-, All Post Free. | OC71 | 5/- | | | |
| OC72 | 6/- | OC76 | 6/- | OC34 | 9/- |
| PXA101 | 6/6 | XA103 | 6/6 | V15/10p | 12/6 |

Set of Mullard 6 transistors 25/-, Set of G.E.C. 1,874; 2,873; 3, S1 or GET14 20/-.

HARVERSON SURPLUS CO. LTD.

RECORD PLAYER AMPLIFIER

- ★ 2 watt output.
 - ★ Ready built with valves and 6 $\frac{1}{2}$ in. speaker, tone and volume controls. Mounted on panel 13 x 7 $\frac{1}{2}$.
- 75/- P. & P. 2/-.

STEREO AMPLIFIER Bargain Offer

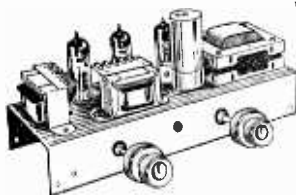

- ★ 4 watts per channel.
 - ★ Full tone and volume controls.
 - ★ Complete with sockets, etc.
- 89/6 P. & P. 2/6.

QUALITY RECORD PLAYER AMPLIFIER

A top-quality record player amplifier. This amplifier (which is used in a 29in. record player) employs ECC83, EL84, EZ80 valves. Bass, treble and volume. On/off controls.

PRICE 69/6 P. & P. 3/6.

DITTO. Mounted on board with output transformer and 6 $\frac{1}{2}$ in. speaker. Complete at 89/6 P. & P. 4/6.

4-SPEED PLAYER UNIT BARGAINS

SINGLE PLAYERS

Garrard TA Mk. 2, £7.15.0. B.S.R. TU/12, £3.15.0. Carr. 3/6 on each.

AUTO CHANGERS

B.S.R. UA14, £6.19.6. Latest B.S.R. UA16, £7.19.6. Latest Garrard "Auto-Slim," £7.15.0. Latest Garrard "Auto-Slim" de luxe, £11.9.6.

Carr. 5/- on each.

SEND STAMP FOR OUR SURPLUS VALVE LIST.

RADIOGRAM CHASSIS

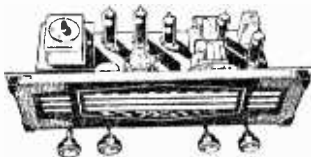

A chassis of distinction, by a famous maker. Covering Long, Med. and Short Waves, plus gram position. (Size 15 $\frac{1}{2}$ x 7 $\frac{1}{2}$ x 6 $\frac{1}{2}$ in. high). Incorporates the latest circuitry, using fully delayed A.V.C., and negative feedback. Controls: Tone, Vol. On/Off, W/Change (L.M.S. and Gram), Tuning. Tapped input 200-250 v. A.C. only. An attractive brown and gold illuminated dial with matching knobs, make this one of the most handsome, in addition to being one of the best performing chassis yet offered. Complete with valves (ECH81, EF89, EBC81, EL84, EZ81), knobs, output transformer, leads, etc. OUR PRICE ONLY **£9.19.6** Plus 8/6 post and packing.

ALSO AVAILABLE: 6 valve, 3 waveband, F.M. M.W., L.W. ECC85, ECH81, EF89, EABC80, EL84, EZ80, £11.11.0. P. & P. 8/6. Deluxe version of above with F.M., S.W., M.W., L.W. and piano-key wavechange, same line up, £13.13.0. P. & P. 8/6.

6 TRANSISTOR AND TWO DIODES RECEIVER

Easy to build, using 6 super transistors and 2 diodes 750 M/W output, full medium and long wave coverage, printed circuit, 5in. speaker, prealigned IFTS & OSC. Very fine tuning, ferrite aerial with car aerial socket, attractive 2-colour cabinet. Simple to follow instructions with circuit, everything complete.

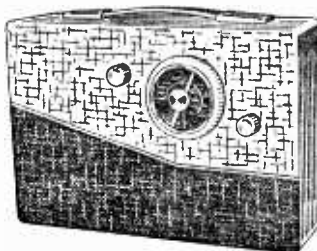

£8.19.6 P. & P. 3/6. Battery 3/6.

THIS MONTH'S BARGAIN!

TELEFUNKEN HI-FI STEREO AMPLIFIER LATEST MODEL S82. 110/250 v. A.C. input. 5 watt undistorted output (10 watts nominal). Size 12 x 9 x 2in. Weight 9 lb. Complete with spec. and instructions. **£6.19.6** Carr. 5/-.



SPECIAL OFFERS!

GAULER F.M. TUNER HEADS. 10.7 Mc/s. I.F., 15/-, plus 1/9 P. & P. (ECC85 valve 8/6 extra).

ELECTROSTATIC H.F. TWEETERS. Type L.S.H. 75. Size 3 x 3in., 2/6 each, plus 9d. P. & P.

MIDGET 2 GANG CONDENSERS. Capacity 195 and 100 PF. Polystyrene case with built in trimmers. Size $\frac{1}{2}$ x $\frac{1}{2}$ x $\frac{1}{2}$ in. Not used but removed from P/C Boards. 2 for 9/-. Plus 1/- P. & P.

ACOS CRYSTAL MIKES. Hi-imp., 18/6. P. & P. 1/6.

4 MFD MANSBRIDGE PAPER CONDENSERS. Ideal for Crossover Units. 4/6 each. P. & P. 1/-.

TRANSISTOR DRIVER and O/P TRANSFORMERS. (Tapped 3 ohms and 15 ohm o/p), plus 4 suitable Transistors giving approx. 1 watt o.p. 30/- P. & P. 2/-.

MAINS TRANSFORMERS Tapped Primary. $\frac{1}{2}$ wave or Bridge Rectifier. Secondary 250 v. at 75 m/a 6.3 volts at 2 amps. 7/6 each. P. & P. 3/-.

3 PUSH-BUTTON TRANSISTOR SWITCH. D.P.—D.T. Each Switch 5/6 and 1/- P. & P.

FOR PERSONAL CALLERS ONLY. SELECTION OF RADIO-GRAM CABINETS From £3.3.0 each.

F.M. TUNER HEAD

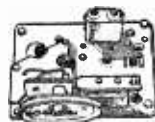

A permeability tuned tuner head by a famous maker, supplied without valve (ECC85) and drum and spindle, 18/6, plus 1/9 P. & P. Valve 8/6 extra. Drum and spindle 3/6 extra.

E.M.I. 4-speed Player and P.U.



Heavy 8 $\frac{1}{2}$ in. metal turntable. Low flutter performance 200/250V shaded motor with tap at 80V for amplifier valve filament if required. Turnover LP/78 head.

PRICE 79/6 Plus 4/6 P. & P.

SPECIAL PURCHASE!

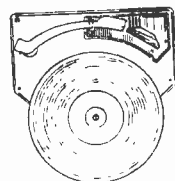

E.M.I. 4-speed. 9 v. battery operated Record Player Unit. Mounted on unit plate. Complete with turn-over head and sapphire stylii.

69/6 P. & P. 3/6.

WE STOCK GOOD COMPANION AND MARTIN RECORDER KITS.

170, HIGH STREET, MERTON, S.W.19

CHE 3985/6

Open all day Saturday.

Early Closing Wed., 1 p.m.

A few minutes from South Wimbledon Tube Station.

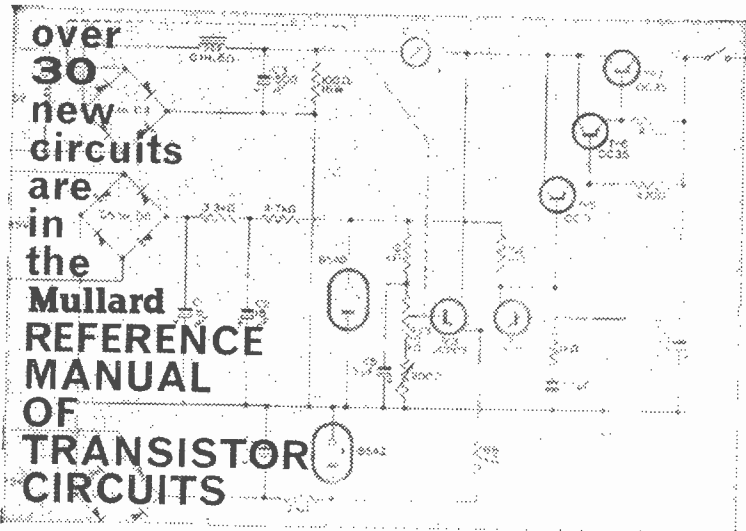

This manual of transistor circuitry has been prepared by Mullard engineers, as an up-to-date and readable volume which will be of use and interest to technicians, service engineers, junior designers and electronics students. It has a page size of 8 1/2" x 5 1/2" and describes more than 60 circuits—over 30 are made generally available for the first time—including both domestic and industrial applications.

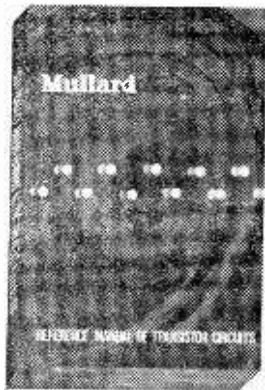

over 30 new circuits are in the Mullard REFERENCE MANUAL OF TRANSISTOR CIRCUITS

308 PAGES • 241 DIAGRAMS • U.K. PRICE 12s. 6d.

PUBLISHED BY MULLARD LTD.

Get your copy of the Mullard "Reference Manual of Transistor Circuits" today from your radio dealer, or order direct from Mullard Ltd. (postage and packing 1s. 0d. extra in U.K.).

MULLARD LTD · MULLARD HOUSE · TORRINGTON PLACE · LONDON W.C.1
OVERSEAS READERS SHOULD ENQUIRE OF THEIR LOCAL MULLARD AGENTS

MVM4008

DUKE & COMPANY (London) LTD.

CABINETS - AMPLIFIERS - TAPE DECK PLAYERS - SPEAKERS - MICROPHONES, ETC.



COMPLETE TELEVISIONS
14 INCH 17 INCH
£7.10.0 £11.10.0

- ★ Guaranteed 12 months. Tubes, Valves, Components.
- ★ Ex Rental and repossessed televisions.
- ★ Two channels more, 7/6 extra.
- ★ H.P. Terms—London area. Demonstrations daily.
- ★ Legs—39/6 per set.
- ★ Part exchange allowance on Radios, TV's, etc.

Personal collection advised, or Insured Carr., 14", 20"; 17", 30/-.

SEE LIST FOR - VALVES - TUBES - T.V. SETS - AERIALS - CHASSIS - TRANSISTORS

TUBES RE-GUN

ONE YEAR GUARANTEE

Terms available

21in. ... 99/6

17in. ... 90/-

15, 14, 12in. ... 70/-

Add £1, refundable on receipt of your OLD Tube. Ins., Carr., 7/6.

TAPE RECORDER AMPLIFIER

£7.19.6

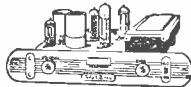

Well designed 5 valve amplifier. Output 3.5 w. Input for Microphone. Radio and Gram. Size 8 1/2 x 3 x 4 1/2 in. Ins., Carr., 4/6

SPEAKERS 8/9

6 and 8in. round and 7 x 4in.

Ex manufacturers salvage. Post 1/3.

621/3 ROMFORD ROAD MANOR PARK ILF 6001/3

EXPRESS ELECTRONICS

ROSEDEEN LABORATORIES

KINGSWOOD WAY, SELSDON, SURREY

VALVES NEW TESTED AND GUARANTEED FOR THREE MONTHS

| | | | | | | | | | | | |
|-------|-----|--------|------|--------|------|-------|------|-------|------|-------|-----|
| 1C1 | 7/6 | 6RA6 | 6/- | 12AU7 | 8/9 | 11H77 | 8/- | EF91 | 4/- | PL82 | 7/- |
| 1C3 | 8/- | 6BE6 | 7/- | 12AX7 | 6/9 | DH142 | 8/6 | EF92 | 5/8 | PL83 | 7/6 |
| 1F1 | 8/- | 6BD6 | 5/9 | 12BE6 | 8/6 | DH150 | 10/- | EL41 | 9/6 | PY81 | 6/9 |
| 1F3 | 7/6 | 6BD6 | 5/9 | 12BH7 | 10/6 | DK91 | 7/6 | EL84 | 7/- | PY82 | 7/6 |
| 1FD1 | 6/- | 6BR7 | 8/9 | 12CG7 | 7/6 | DK96 | 8/- | EM84 | 10/- | PY83 | 7/6 |
| 1FD9 | 7/6 | 6BW6 | 7/6 | 12GT7 | 7/6 | DL92 | 7/6 | EM85 | 10/- | 55A1 | 9/6 |
| 1L4 | 6/9 | 6BW7 | 7/- | 12N8T | 6/- | DL94 | 6/6 | EY31 | 7/6 | 1552 | 7/6 |
| 1P1 | 8/- | 6D2 | 4/- | 16A5 | 9/- | DL96 | 8/- | EY81 | 10/- | 1552 | 7/6 |
| 1P10 | 7/6 | 6F12 | 4/- | 35A6G | 8/6 | ER91 | 4/- | EZ40 | 7/6 | 176 | 7/6 |
| 1P11 | 7/6 | 6H6GT | 2/- | 35L6GT | 7/6 | ER94 | 10/- | EZ50 | 8/- | 178 | 5/- |
| 1R5 | 6/- | 6I74T | 7/6 | 35Z4G | 9/- | EPF90 | 8/6 | EZ81 | 6/6 | U142 | 7/6 |
| 1R5 | 6/- | 6K7G | 5/6 | 30C1 | 7/6 | EV81 | 6/- | HV22 | 9/6 | UR341 | 8/6 |
| 1T4 | 7/6 | 6K8G | 6/- | 30L1 | 7/6 | EV82 | 6/9 | KT36C | 6/- | U142 | 7/6 |
| 1U5 | 5/6 | 6Q7G | 5/6 | 35L6GT | 9/- | EV83 | 6/9 | KT36C | 11/6 | UF41 | 8/6 |
| 3Z4G | 8/- | 68L7GT | 8/- | 35W4 | 8/6 | EV84 | 7/6 | N17 | 7/6 | U141 | 8/6 |
| 384 | 7/6 | 68N7GT | 6/- | 35Z4GT | 8/- | EV86 | 8/6 | N18 | 8/- | UY41 | 7/6 |
| 3V4 | 6/6 | 6V6G | 7/6 | 5763 | 7/6 | EV82 | 8/- | N19 | 7/6 | W17 | 7/6 |
| 5U4G | 7/6 | 6X4 | 5/- | 80 | 6/- | EVH42 | 9/- | N709 | 7/- | W76 | 4/6 |
| 5Y3GT | 5/- | 6X5G | 5/- | DAP91 | 7/6 | EVH41 | 10/- | PCN4 | 7/6 | W142 | 8/6 |
| 6AK6 | 6/6 | 6D3 | 4/- | DAP95 | 8/6 | ECL50 | 8/6 | PCP50 | 7/6 | X142 | 7/6 |
| 6AL5 | 4/- | 12AD6 | 11/6 | DF91 | 7/6 | EF41 | 9/- | PCP82 | 8/- | X150 | 9/- |
| 6AM6 | 4/- | 12AH8 | 10/- | DF96 | 8/- | EPF80 | 8/- | PCL84 | 9/- | Z77 | 4/- |
| 6AT6 | 8/- | 12AT7 | 6/- | DH176 | 7/6 | EPF8 | 9/- | PLS1 | 12/6 | ZD17 | 9/6 |

High Stability Resistors 1W 5% 50 Ω to 1M, 9d. Midget Ceramics 500 v. 9d. Coax. Super quality 1in., 8d. v. Plug 9d. Sockets 5d. Silicon H.T. Rects. 250v. 500 MA 1in. x 1in. 8/6. Contact Cooled 250v. 50 MA 6/6, 85 MA 8/6.

NEW TRANSISTORS BY MULLARD

OC19, OC26, OC66 25/-; OC44, OC45, 9/-; OC70, OC71, 8/-; OC72, 7/6; OC72 matched in prs. 12/-; OC74, OC75, OC78, OC81, 7/6; OC82, OC176 9/6.

VALVES MATCHED IN PAIRS

EL84 17/-, N709 17/-, 6V6G 17/-, 6BW6 18/- per pair. Push Pull O.P.F. Transformers for above 3-15 Ω 14/6, P. & P. 1/6. 12in. P.M. Speakers 3 Ω 24/6. Baker's "Selhurst" 12in. 15 Ω 15W. 90/-, 12in. Stereo Model, £7.7.0.

SETS OF VALVES

| | |
|---------------------------------------|---------------------|
| DK91, DF91, DAF91, DL92 or DL94, 19/6 | EVH42, EF41, EBC41, |
| DK96, DF96, DAF96, DL95, 22/6 | EL41, EZ40, 37/6 |
| 1C3, 1F1, 1FD1, 1P1, 27/6 | U142, U141, UBC41, |
| 1R5, 1T4, 1R5, 384, or 3V4, 19/6 | U141, UY41, 33/- |

Postage and packing 6d. Over £1 post free. C.O.D. 2/6.

CLYNE RADIO LTD



18 TOTTENHAM COURT ROAD, W.1
162 HOLLOWAY ROAD, LONDON N.7
9 CAMBERWELL CHURCH STREET, S.E.3
10 WITBY GROVE, MANCHESTER, 4

All post orders, etc. to 162 HOLLOWAY ROAD, LONDON, N.7

THE COMPONENT SPECIALISTS

MUSEum 5929/0095
NORth 6295/677
RODney 2875
Blackfrisks 5379

The "AIR KING"

Our new highly successful Six transistor luxury portable with the "GLIM LINE" look. To build yourself, with printed circuit chassis for reliability and simplicity in construction. May be used as Car Radio, with full MEDIUM wave and LONG wave coverage.

Look at these features!

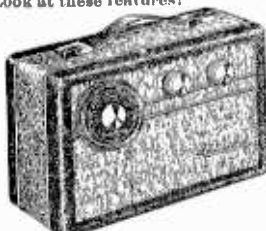

- ★ 500 milliwatt output to high flux 7 x 3 1/2 in. high fidelity loudspeaker.
- ★ Six selected Mullard Transistors in latest super sensitive circuit, plus germanium diode. ★ Compact size—only 8 1/2 x 3 1/2 x 3 1/2 in. high.
- ★ Attractive three tone cabinet, Black, Dark Grey, and Silver Grey, with black control knobs and all gilt fittings.
- ★ Coax socket for car aerial. ★ Brand New guaranteed components. ★ Push pull output. ★ Automatic volume control. ★ Long life battery. ★ Super sensitive internal ferrite rod aerial. ★ Nothing more to buy. Cabinet included.

Special inclusive price for **£7.19.6** Plus P. & P. 4/- assembly details and individually priced parts list, all of which are available separately, price 1/6, post free.

The "HIGHWAYMAN"

At last a quality Car Radio to build yourself, at an economical price. Look at these features:—

- ★ Attractive styling. ★ Push-pull output. ★ Latest Mullard transistors plus valves type EBF 83 and ECH 83.
- ★ No Buzz. High Output and sensitivity. ★ Printed circuit (newest type). 7 x 4" High flux p.m. speaker.
- ★ Medium and Long Waves. ★ Push Buttons for fingertip control. ★ Extremely low Battery consumption (less than 1 amp). ★ Easy to fit any make car (Positive earth only). ★ 12 volt operation. ★ Compact size measures only 7 x 2" deep. ★ Easy assembly. Supplied with dial and drive already mounted.



All parts available separately, but if purchased at one time, the whole will be supplied at a special inclusive price of only

£10.19.6 Plus 4/- P. & P.

Parts list and comprehensive instruction booklet 2/6, post free. (Deducted from cost if complete parcel purchased later.)



3 NEW BATTERY CHARGER KITS

All complete with ammeter! For 6 and 12 volt operation. Laminated metal case, fuses, metal rectifier, transformer, absolutely complete including heavy duty crocodile clips.

2 1/2 amp., 4/2/6. 4 amp., 50/- each plus 2/6 P. & P. Also available 2 amp charger kit complete, no ammeter fully shrouded, main transformer. Full instructions 30/-, plus 2/6 P. & P.

NEW BRANCH now open in MANCHESTER

at 10 WITBY GROVE
OPEN ALL DAY SATURDAY

MODEL 1500

30,000 ohms per volt Multimeter! 9 ranges D.C. voltage to 1 KV. 7 ranges A.C. voltage to 1 KV. 6 ranges D.C. current to 12 amp. 3 ranges resistance to 60 meg. Incorporates internal buzzer (or audible warning of direct shorts and blocking condenser for A.F. Output capacity —20 +55. Size 3.5/16 x 8.5/16 x 2 1/2 in. Outstanding Value at £8.19.6. H.P. available.



NEW IMPORT! Large quantity shipments enable us to offer keenest meter value yet!

20,000 ohms per volt
MODEL ITI-2, Volt-ohm-Milliammeter (Similar to Model 200H originally advertised)



A fully guaranteed pocket size meter (actual size 4 1/2 x 3 1/2 x 1 1/2) knife edge pointer, top quality supplied complete with test prods and full operating instructions ONLY **£5.5.0** FREE

ALSO AVAILABLE: MODEL TF10. Identical in appearance and size with rotary type switch but 0.000 Ohm. Ranges: D.C. Voltage: 0-6-30-120-600-1200 volts (10,000 ohms per volt). A.C. voltage: 0-6-30-120-600-1200 volts (10,000 ohms per volt). D.C. Current: 0-120 microamp. 0-3-300 mA. Resistance: 0-30k, 0-3 Meg. (150 ohm and 15k at centre scale). Capacitance: 50 pF to 0.01 mfd., 0.001 mfd., to 0.15 mfd. Decibels: —20 to +63 dB in 5 ranges.

ONLY **89/6** POST FREE

Optional Extra. Attractive carrying case suitable for either meter. 13/6 only. (Bonafide trade enquiries invited.) Leaflet available.

INEXPENSIVE TEST GEAR

Three Ideal Pocket Instruments for Amateur or Student

MODEL TH
Size only 3 1/2" x 2 1/2" x 1 1/2"
Meter Size 1 1/2" x 1 1/2"
Sensitivity 285 microamps —1000 ohms per volt AC/DC
DC Current 1.25, 250 mA
DC and AC volts 10, 50, 250, 1,000 v.

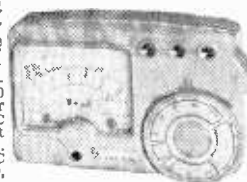

50 ohms—100 K Battery 1.5 v-U12. Complete with test prods, battery and full instructions.

Outstanding Value at **57/6** Plus 2/6 P. & P.

MODEL TK.50

Size 5" x 3 1/2" x 1 1/2" 1000 ohms per volt AC/DC. DC Current 1-250 mA DC and AC volts. 10, 250-500 and 1000 v. Resistance 0-10K, 0-100K. Complete with test prods, battery and full instructions. Outstanding buy at



63/- Plus 2/6 P. & P.

MODEL TK.20A

Size 3 1/2" x 2 1/2" x 1 1/2". Meter size 2 1/2" x 1 1/2". Sensitivity 1000 o.p.v. on both A.C. and D.C. volts. 0/15, 0/150, 0/1000 volts. D.C. Current, 0/150 mA. Resistance, 0/100K. Complete with test prods, battery and full instructions. OUTSTANDING VALUE at **42/-** Plus 1/6 P. & P.



The "COURTESAN"

Our New 3 transistor plus 2 diode pocket receiver with full Medium and Long Wave Coverage.



- ★ No external aerial and earth required.
- ★ Latest 21—75 ohm speaker.
- ★ First grade Mullard transistors.
- ★ Condenser tuning.
- ★ Volume control with on/off switch.
- ★ Easy assembly on pre-tagged circuit board.
- ★ Attractive red polystyrene cabinet measures 5 1/2 x 3 1/2 x 1 1/2, chrome handle, attractive gold and black dial.
- ★ Luxambourx, Bilversum, etc., guaranteed in reception areas.

ONLY **63/-** Plus 2/6 P. & P.

All parts available separately, itemised parts list and full assembly instructions 1/6, post free.

"FAMILY FOUR"

Our super-sensitive T.R.F. Receiver for home construction. Covers Long and Medium Wavebands, is housed in very smart plastic table cabinet in Brown or Black, 5 valve plus controlled rectifier. For A.C. mains 200/250 v. Comprehensive assembly instructions provided, including practical and theoretical diagrams, which are easy to follow and will enable you to complete this receiver which will be the envy of your friends. ALL NECESSARY COMPONENTS ARE BEING OFFERED FOR LIMITED PERIOD ONLY at the REMARKABLE PRICE of ONLY **79/6**, plus 2/6 P. & P. Instruction book available separately if you wish to study before purchase at 1/6 post free.



TECHNICAL TRAINING in radio television and electronics

Whether you plan to have your own business, to become an electronics engineer, to take up a career in industry, or to brush-up your knowledge and study new developments, transistors, etc., an I.C.S. Course will help you to success. You learn at home in your own time, under expert tuition. Moderate fees include all books.

EXAMINATION COURSES FOR:—

C. & G. Radio and TV Servicing Certificate
(R.T.E.B.)

C. & G. Radio Amateurs' Exam.
(Amateurs' Transmitting Licence)
P.M.G. Certificates in Radiotelegraphy

British Institution of Radio Engineers, etc. C. & G. Telecom. Technician's Cert.

LEARN AS YOU BUILD

Practical Radio Servicing Course

A basic course in radio electronic and electrical theory backed by thorough practical training. You build radio receivers, signal generator and multimeter.



Post this Coupon TODAY! for FREE book on careers in Radio, and full details of other I.C.S. Courses

INTERNATIONAL CORRESPONDENCE SCHOOLS

(Dept. 171), Intertext House, Parkgate Road, London, S.W.11.

Please send book on.....

Name..... Age.....
(Block Letters Please)

Address.....

Occupation..... 11.62

INTERNATIONAL CORRESPONDENCE SCHOOLS

TOOL KITS!

5 Piece Screw Driver Set, Model 3369. Consisting of mechanics, electricians, Phillips, ridget and stubby types Magnetized blades of tempered, hardened tool steel. Unbreakable, flameproof and shock-proof plastic handles. Display bagged. **PRICE 8/-.**



Multi Purpose Tool Set, Model 7900.

Consisting of insulated plastic handle, 5 interchangeable screw driver bits, including Phillips type, one hammer, 5 hexagon sockets (1/4"-7/16") and extension bar. Complete in Vinyl roll case. **Price 12/6.**

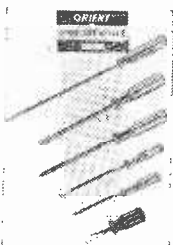

TWO NEW DYNAMIC MICROPHONES

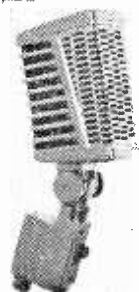

Model DM-16 III. Single direction pick-up, dual impedance. (50,000 ohms high, 50 ohms low). Excellent for PA recording both voice and music. Handsome new styling with terrific performance. Will stop or greatly reduce feed-back howl on PA systems and allow greater working distance from mike. Quickly changed from high to low impedance, allowing long mike lines without frequency loss. Has detachable cable. Flat response 60-12,000 cps. Output—62db. Swivel mounting for 1" stands. **PRICE 7 gns. COMPLETE.**

Model DM-II Dynamic Microphone.

Modern.

tastefully integrated design mike and stand. Wide range flat response from 60 to 12,000 cps. Omni-directional pick-up-sensitivity-54 db, 50K ohms impedance. Stands vertically or tilts in any direction from wide base desk stand. Removes from desk stand and can be attached to floor stand. Finished in blue mist metallic lacquer with chrome trim. Supplied with shielded plastic covered cable. An elegant yet practical instrument. **AT ONLY 5 gns.**

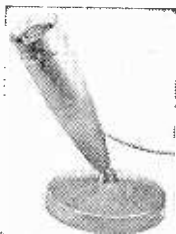

8" DOUBLE CONE HI-FI SPEAKER



Model 8A7. Frequency range 50-16,000 c/s. Lowest resonance 60 ± 15 c/s. Sensitivity 98db. Programme source input 8 watts. Voice coil impedance 16 ohms. Net weight 970 grammes. **BRAND NEW AND GUARANTEED, 92/6.**

BOOSTER TRANSISTOR RADIO SPEAKER

MODEL TS.3
Designed for use with transistor radios, valve radios, car radios, amplifiers where quality reproduction of sound is required. Plugs into car piece output socket of nearby all miniature sets. The cabinet finished in beige leather with contemporary gold baffles at each end. Complete with 12ft. extension cord fitted with miniature plugs, individually cartoned and guaranteed. Size: 9 1/2 in. x 3 1/2 in. diameter. **54/2 P. & P.**

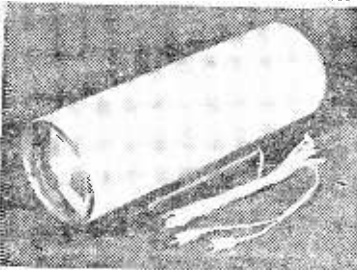

54/2 P. & P.



See opposite page for addresses



A MINIATURE TRANSISTOR TAPE RECORDER IN SEMI ASSEMBLED KIT FORM

Consisting of three transistor amplifiers, record/play, volume control, miniature speaker, forward-stop-rewind-switch, reel of tape and spare reel, motor, attractive coloured case, Mic. and carbonho sockets, pick-up coil, mike, car-phon and carrying handle supplied. Standard battery operated. Simple to put together in less than one hour. Brand new and guaranteed.

ONLY £6.19.6

A guaranteed saving of at least £4! Results comparable with similar built-up recorders selling at around 12 gns. S.A.E. for further details. Order early.

S.L.I.M. RADIO
111.68
1 wo-wky. single bakelite
socket terminal P.L.U.C. Panel
mounting. neat finish. Stand-
ard size 2/6 each. (Plus only).

NEW "STEREO-SYNETHO" HEADPHONES

Freq. response 40-16000 cps. Impedance 1-ohms. Equipped with individual transducers and cord sets for true stereo reproduction. Extremely sensitive, the sound is carried through plastic tubes lined with removable earpieces. Ingenious hinge device permits adjustment to any desired spacing. Weighs less than 2 ozs. May also be used for monaural listening. 27/6.

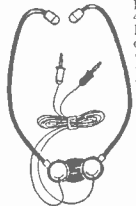

MINIATURE EARPHONE

A really sensitive dynamic earphone of exceptionally fine quality. Provides clear reproduction of music as well as speech. Fully Guaranteed and complete with transparent ear insert, 3 foot cord, sub-miniature plug and socket.

CR-3 High imp. crystal 6/- Each
MR-4 Low imp. magnetic 1/6 Post 1/-



CALLERS ONLY BARGAIN!

LEAD ACID ACCUMULATORS (unspillable), 2 volts 16 A.H. Ideal for 6 volts and 12 volts supply. Brand new original cartons. Size each 4in. x 6in. x 2in. Minimum lots of six will be sent by post for 20/-, post paid.



BUDGET UNIVERSAL TEST LEAD KIT IN PLASTIC CASE



Consists of 4 1/2 in. long x 1/2 in. dia. red and black plastic handle pin prods with heavy duty 37in. rubber leads with 5000v. breakdown insulation terminating 2in. long x 1/2 in. dia. plastic grip banana plugs. 3 sets of interchangeable terminals are included (spade lugs, phone tips, alligator clips), all slip directly on to banana plugs. 9/6, Post Paid.

VERNIER DIAL Model T.311



A precision vernier dial with approx. 8 to 1 ratio. Surface mounting. Accurately centred metal insert for 1in. shaft. Reads counter clockwise 0-100 in 100's, 1 1/2in. diameter dial, 1 3/16in. front to back 14/-. Post Paid.

Signal Injection Probe Model IT-1



Injects a signal into the circuit at any given point. Produces a signal rich in harmonics from a built-in miniature transistor oscillator. Push button operation, and neon battery strength indicator. Ideal for making rapid checks on radioes amplifiers, T.V. Tuners etc. A must for the amateur, hobbyist and service man. PRICE 42/6. Complete with batteries.

COME AND SEE US AT THE RADIO COMMUNICATIONS EXHIBITION, Seymour Hall, Oct. 31-Nov. 8

WIRELESS SET No. 19

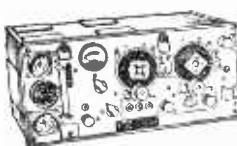

This most famous Army Trans Receiver covers 24 Mc/s. 150-75 metre- in two bands and 30-240 Mc/s. V.H.F. Has an intercom. amplifier. Designed for 12 and 24 volt operation. Uses a 6 valve superhet receiver, I.F. being 455 Kc/s, and a 6 valve transmitter designed for voice and C.W. operation. Incorporates test and tuning meter for voltages, aerial loading and current test. Panel Controls: Frequency tuning, P.A. tuning, Gain control, S.C.V. C.W. R/T switch, Het-tone netting, Off-on, On-off, aerial A.V.C. I.T.H.T.—Drive tests. Supplied complete with valves and instruction book.

ONLY 65/- FEW ONLY LEFT
Carriage 10/- Don't be disappointed—Order Now

F.M. TRANSMITTERS BC620

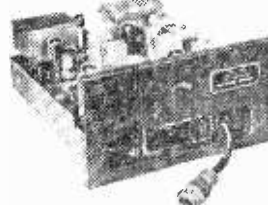

Frequency range 20-77.9 Mc/s. Crystal controlled, operating on any two of 80 different channels in 100 Kc/s. steps. Average range 10 miles. Contains 14 valves filament plus. Automatic meter, volume control, mike and phone inputs, 6 and 12 volt supply unit and cry battery enc.

Complete Station offered for only **£5** Carr. 20/-

GREATEST TRANSISTOR SET VALUE YET KNOWN— FUN TO BUILD— FUN TO OWN!

A 5 stage medium waveband radio which can be built in one hour. No aerial or earth required. Built-in ferrite rod aerial brings you top notch reception both indoors and out, extremely efficient circuit greatly reduces battery drain—provides longer playing time. Uses popular 9v. battery. This set has the appearance of sets worth 7 to 9 gns. and works as well as sets 4 times the price, remember the saving is not in the parts used but by you making it yourself. Complete in case, size 3 1/2 x 3 1/2 x 1 1/2 in. advance G.E.C. drift-field transistors, genuine 2 1/2 in. speaker, tuning condenser, volume control with switch, etc. All parts sold separately.



37/6
P. & P. 2/6

MAIL ORDERS TO (DEPT. P.) 32a COPTIC STREET, LONDON, W.C.1



CALLERS WELCOME AT 57 TOTTENHAM COURT ROAD, LONDON, W.1. MUS 9806

P.W. TRANSISTORISED BEST SETS

"MERCURY 6"

uses

7 x 4 in. speaker
for quality



Parts lists on
request

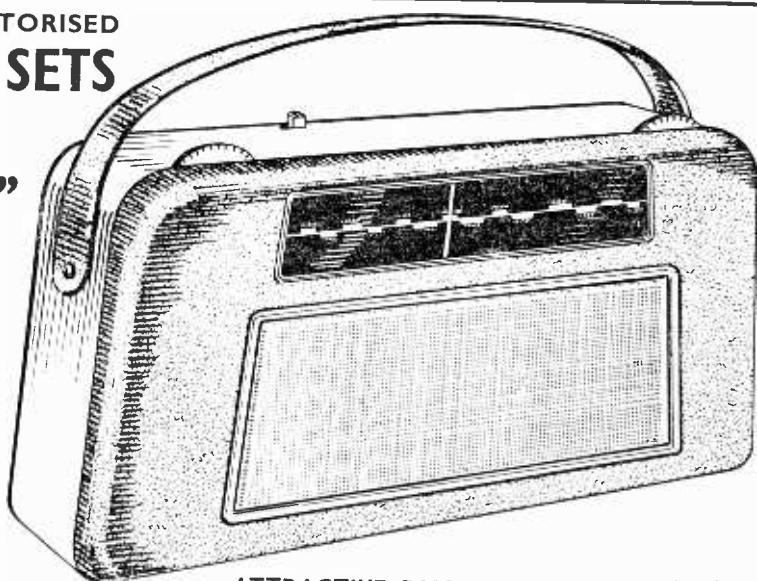

A-1 CONSTRUCTION
BOOKLET **2/6**

ATTRACTIVE DUO COLOUR CASE **25/-**

OSMOR 418 BRIGHTON ROAD
SOUTH CROYDON, SURREY.

VALVES SAME DAY SERVICE

NEW! TESTED! GUARANTEED!

SETS

1R5, 1S5, 1T4, 3S4, 3V4, DAF91, DF91, DK91, DL92, DL94 .. Set of 4 for 19/6
DAF96, DF96, DK96, DL96 4 for 27/6

| | | | | |
|------------|-------------|-------------|------------|-------------|
| 0A2 11/6 | 6LD20 8/- | 30L15 11/- | E241 7/6 | U26 9/3 |
| 1A7GT 11/- | 6P1 7/- | 30P19 14/6 | E280 6/3 | U47 12/- |
| 1D3 7/6 | 6P25 8/- | 30PL13 12/3 | E281 6/6 | U50 6/- |
| 1H5GT 9/- | 6P28 12/- | 33A3 15/9 | GZ32 8/6 | U52 4/6 |
| 1N5GT 9/- | 6Q7G 6/- | 35L8GT 8/3 | ECC83 7/- | U78 4/6 |
| 1R7 6/- | 6Q7GT 8/- | 35Z4GT 5/6 | ECC84 8/3 | U191 14/6 |
| 1S4 8/- | 6SL7GT 5/9 | 50L8GT 9/- | ECC85 7/9 | U281 17/- |
| 1S5 5/3 | 6SN7GT 4/9 | 85A2 8/6 | ECC87 8/9 | U291 16/6 |
| 1T4 3/6 | 6U4GT 4/9 | AZ91 9/6 | ECH42 8/6 | U301 17/- |
| 1U5 5/9 | 6V6G 4/6 | B36 7/6 | ECH35 7/3 | U801 21/- |
| 3A5 9/- | 6V6GT 8/- | CL33 12/3 | ECH41 7/9 | UABC80 6/6 |
| 3D7 7/- | 6X4 4/6 | CY31 10/- | ECH81 7/9 | UAF12 8/3 |
| 3S4 6/- | 6X5GT 7/6 | DAC32 9/- | ECH83 8/6 | UB41 8/6 |
| 3V4 7/- | 7B6 9/- | DAF91 5/3 | ECL80 7/6 | UBC41 7/9 |
| 5U4G 4/6 | 7B7 7/6 | DAF96 7/6 | ECL82 9/- | UBF80 8/3 |
| 5V4G 8/- | 7C5 7/6 | DC93 9/- | ECL86 15/6 | UBF89 8/- |
| 5Y3GT 8/- | 7C6 7/6 | DF33 9/- | EF39 4/6 | UCC84 13/3 |
| 5Z4G 9/- | 7Y4 6/- | DF91 3/6 | EF40 11/6 | UCC85 7/6 |
| 6AL5 3/9 | 7H7 7/6 | DF96 7/6 | EF41 7/9 | UCF80 14/6 |
| 6AM6 3/6 | 7S7 7/6 | DH7 6/- | EF42 8/9 | UCH21 13/6 |
| 6AQ5 6/- | 7S7 7/6 | DH76 4/9 | EF80 4/9 | UCH42 8/- |
| 6BA6 5/9 | 10C2 16/6 | DH81 6/- | EF83 6/6 | UCH81 8/9 |
| 6BE6 5/9 | 12A7 5/- | DK32 11/- | EF86 9/- | UCL82 9/9 |
| 6BH6 7/6 | 12A7 6/3 | DK91 6/- | EF89 7/- | UCL83 13/3 |
| 6BJ6 5/9 | 12A7 7/- | DK96 7/6 | EF91 3/6 | UF41 7/6 |
| 6BR7 5/9 | 12K7GT 4/9 | DL33 8/- | EF92 3/9 | UF89 7/- |
| 6BW6 8/- | 12K8GT 9/6 | DL35 9/6 | EL33 9/6 | UL41 8/- |
| 6CD6G 27/3 | 12Q7GT 4/9 | DL92 6/- | EL42 9/- | UL84 6/6 |
| 6F1 10/- | 12SN7GT 7/6 | DL94 7/- | EL81 12/- | URIC 11/- |
| 6F6G 6/6 | 12Z3 10/6 | DI96 7/6 | EL84 6/6 | UY21 11/- |
| 6F13 10/- | 20P2 10/6 | EABC80 5/6 | EM34 7/3 | UY41 6/6 |
| 6F14 10/- | 20L1 16/- | EAF42 8/6 | EM80 8/- | UY85 6/6 |
| 6F23 10/- | 20P3 18/9 | EB91 3/9 | EM81 8/6 | VP4B 9/6 |
| 6K7G 1/11 | 20P4 20/- | EBC33 5/- | EM84 9/6 | VP41 5/- |
| 6K7GT 5/- | 20P5 15/9 | EBC41 8/- | EY51 7/6 | VP1321 16/6 |
| 6K8G 5/- | 25A6G 8/- | EBF80 8/- | EY86 7/9 | W76 4/9 |
| 6K8GT 9/- | 25GCT 7/- | EBF89 8/9 | EZ40 6/9 | W77 3/9 |
| 6L8 10/- | 25ZAG 8/6 | | | Z77 3/6 |

READERS RADIO
24 COLBERG PLACE, STAMFORD HILL
LONDON N.16 STA. 4587

1962 EDITION RADIO AMATEUR'S HANDBOOK

by The A.R.R.L. Post 2/6

FUN WITH RADIO-CONTROLLED MODELS, by E. L. Safford Jr., 25/-, Postage 1/-.

BASIC RADIO COURSE, by J. T. Frye, 32/-, Postage 1/-.

ELECTRONIC ORGAN HANDBOOK, by H. Emerson Anderson, 40/-, Postage 1/-.

A BEGINNERS GUIDE TO RADIO, by F. J. Camm, 7/6, Postage 6d.

ROMPING THROUGH MATHEMATICS, by R. W. Anderson, 5/-, Postage 6d.

TRANSISTOR MANUAL, by Inter-GEC New Ed., 16/-, Postage 1/2.

RADIO VALVE DATA, 7th Ed. Compiled by "WW", 6/-, Postage 10d.

COMPLETE CATALOGUE 1/-.

THE MODERN BOOK CO.

BRITAIN'S LARGEST STOCKISTS
of British and American Technical Books

19-21 PRAED STREET
LONDON, W.2

Phone: PADDington 4185
Open 6 days 9-6 p.m.

Post 6d. per valve
extra.
Any Parcel Insured
Against Damage in
Transit 6d. extra.
Any C.O.D. Parcel 3/-
extra.

Hi Fi SPEAKERS

E.M.I. Ceramic magnet 12,000 lines, size 13 x 8 in. (roughly equivalent to 12 in. round speaker). Handles up to 10 watts. Price 33/6, plus 3/- carriage and insurance. State whether 13 ohm or 3 ohm. Similar model but specially designed and hand made for very low frequencies (4 to 55 cycles). Price £7.10.0.

Hi-Fi Snip Infinite Wall Baffle



Nicely Veneered and polished. Corner fitting. (attaches to picture rail). Takes up no floor space. Gives really fantastic results with only low-priced 8 in speaker fitted for tweeter. Only 45/- each, carriage and insurance 3/-.

The J.B. Tangential Air Conditioner



The displacement caused by the new Tangential fan is quite amazing, but what is more amazing is the almost complete absence of noise.

In addition to a fan for moving the air, the unit also contains a heater and control switch, wired such that 500, 1,000 or 2,000 watts of heating may be used.

The total building cost of this air-conditioner is £7.10.0, plus 5/- carriage and insurance. The case is very nicely finished in hammered enamel, and when assembled, the unit is indistinguishable from those selling at £12 and more.

Last of these Brayhead Turret Tuners

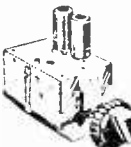

Complete with Band 1 and Band 3 coils. New but removed from unused equipment. Less valves 15/- each or with valves 25/- each. Post 2/6 (Knobs 3/6 extra).



Fishing Rod from Dinghy Mast

Tubular aluminium not separate sections, extends like telescope from 15 in., to 9 ft., 6/6 each.

Transfitters

These ceramic devices save alignment problems and improve performance. Use instead of I.F. transformer. Complete with circuit, 8/6 each.

The 'Good Companion' Mk.II using Transfitters



In the 'de-luxe' cabinet as illustrated it costs £10.10.0 to build—but what a set!

Scan these pages: you will find nothing to compare with its specification. It uses transfitters instead of I.F. transformers, has variable feedback as well as all the usual features. A.V.C., Push-pull output, Ferrite Aerial, Slow Motion Tuning, etc. etc. and is a very powerful Medium & Long Wave set, conservatively rated at 750mW. Every component used is by a famous maker, such as American Philco MADT R.F. transistors—Mullard A.F. transistors—Jackson Brothers tuning condensers—Rola-Celestion loudspeaker—Dubbler—T.C.C.—Morganite resistors and controls. Also built alter sales service available.

You will definitely be doing the right thing if you buy a 'Good Companion'.

"A jolly fine set but deserving a better case"



This is a comment which many constructors have voiced and therefore we now offer a De Luxe version of the Pocket Companion. This uses a solid hide case of very pleasant red with gold lettering and our Pocket Companion now has the 15 guinea look.

The most up-to-date Superbet portable of its type, it uses a transfitter in conjunction with Philco R.F. transistors and Mullard output transistors. Complete building costs with plastic case £6.15/-, or with solid hide case, £7.15/-.

If you have already built and want to change your case, then return the plastic case with a postal order for £1 or if you wish to retain the plastic case then send 2/-, plus 1/6 Post and Ins. for the hide case only. AGENTS WANTED TO BUILD OUR COMPANION PC-R-TABLES. SEND S.A.E. FOR FULL DETAILS.

ROMANTICA 7



Cheaper than you might make it, we offer a completely made up transistor Pocket Superbet. Uses all first made miniature parts and is complete with leather case, carbones and battery, 555-1065 Kof's, sensitivity 300 micro volts/M, output 150 mW, ferrite slab aerial. Size approximately 4 1/2 x 2 1/4 in. Price £6.19.6. Post and Ins. 3/-.



Transistor Set Cabinets

Very modern cream cabinet, size 5 1/2 x 3 1/4 in. with chrome handle, tuning knob and scale. Price 7/6, plus 1/6 postage and packing. Special quotations for quantities.

Be the Best Dad in the World



What a thrill for your boy to receive a present like this. Completely transistorised tape recorder with full range of accessories, suitable for work or play—study or relaxation—office or home—outdoors or indoors. Weight 2 1/2 lb. and only 9 x 8 x 3 in. (approx.). Supplied as completely wired sub-assemblies; just link these together only 10 connections to make. Three transistor amplifier with centre microphone input switch-forward stop-rewind with microphone input modern carrying case in two-tone and with microphone reel of tape and spare reel. Nothing else to buy. Order this bargain now as it won't be available for Xmas. Only £6.19.6, plus Post and Ins. 5/-, or secure with a small deposit.

Miniature Circuit Breaker

(Or repairman's use) You will have experienced the annoyance of having to repair a fuse especially in the middle of an experiment or repair job. Save yourself this bother by installing a simple miniature circuit breaker. All you have to do then (if you touch the wrong wires together) is to re-set (push in) the circuit breaker. Offered with instructions at 15/- each. (Will save its cost in time and temper in no time).

Triple Purpose Auto Transformer

Ministry reference 10K/143. This will convert 230 v. to 110 v. or 230 v. to 460 v. Use it also as a filament transformer 230 v. to 6.3 v. 5 amps or 230 v. to 2.5 v. 3 amps. Price 12/6. Post and Packing 2/6.

Ice-Stat

This is a small thermostat which cuts on and off at around freezing point. Has many uses, one of which could be an early warning device to be fitted under your motor car. Price 7/6. Post 1/-.

Gramophone Motor

E.M.I. 4 speed with turntable and pick-up on control board 4.5.50, plus 5/- post & ins. Plinth for mounting same in cupboard or drawer 12/6. Post free if ordered with motor.

Mains Motor

Intended for vertical mounting so suitable for gramophone or tape recorder. Can also be mounted horizontally when it can be used as a fan for ventilating, the fan blades being fitted directly on to the shaft. Snip price only 15/-, plus 2/6 post and insurance.

Flood Lamp Control

Our dim and full switch is ideal for controlling photo flood lamps: it gives two lamps in series, two lamps full brilliance and lamps off. Similar control of other appliances can be arranged where used in pair or where circuit can be split exactly in half. Technically the switch is known as a double-pole change over with off. Our price 3/6, plus post and insurance 1/-.



Limited Quantity Only!

Waterproof heater wire, 16 yds. length, 70 watts. Self regulating temperature control. 10/-. Post Free.

15 amp. Thermostat

(Sunvic) Adjustable over a fairly wide range of temperatures but set for 70°F. suitable for wall mounting to control room heaters. Exceptional bargain at 9/6, plus 1/- post and insurance. Crackle finished and calibrated case, suitable for mounting; this (only minor adjustment) 5/- extra.

Fluorescent Lighting

Complete Kit, Comprises: Hi-Craft choke unit starter lamps 2 lamp holders, white enamel metal work and 40 watt tube. Special summer price 30/- complete, plus carriage and insurance 6/-. Lots of 12 or more carriage free.

Zener Diodes

Latest invention for voltage control and stabilisation. Complete with circuit diagram 7/6.

Yaxley Switches

All new and unused and in first class condition.

- 1 pole, 2 way 1/8; 1 pole, 3 way 1/6
- 1 pole, 4 way 1/9; 1 pole, 5 way 2/6
- 1 pole, 7 way 5/-; 1 pole, 9 way 3/-
- 1 pole, 11 way 3/-; 1 pole, 12 way 3/3
- 2 pole, 2 way 2/-; 2 pole, 4 way 1/6
- 2 pole, 5 way 3/6; 2 pole, 6 way 2/6
- 2 pole, 12 way 5/6; 3 pole, 3 way 3/6
- 3 pole, 6 way 3/6; 3 pole, 12 way 8/6
- 4 pole, 2 way 2/-; 4 pole, 3 way 3/-
- 4 pole, 4 way 3/6; 4 pole, 5 way 4/6
- 4 pole, 6 way 5/6; 4 pole, 11 way 10/6
- 4 pole, 12 way 11/6; 5 pole, 3 way 3/6
- 5 pole, 6 way 7/-; 5 pole, 12 way 14/6
- 6 pole, 2 way 2/6; 6 pole, 3 way 3/6
- 6 pole, 6 way 8/6; 6 pole, 11 way 16/6
- 6 pole, 12 way 17/6; 8 pole, 2 way 3/6
- 8 pole, 4 way 4/6; 8 pole, 6 way 11/6
- 8 pole, 12 way 23/6; 12 pole, 2 way 3/6
- 12 pole, 5 way 16/6; 12 way fader 3/6
- 6 pole, 6 way, shorting 3/6

Big stocks of most types. Special prices for quantities.

Battery Charger Bargain

Eliminate the trouble Car Battery Charger—ready-made high output battery charger in stove enamelled sheet steel louvered case. New, complete and ready to work. Rated at 12 v. 5 amps, and variable rate selector for trickle charging, also a meter to show charging rate. Suitable for 230/250, A.C. mains. Special snip price of 65/-, plus 3/6 post and ins.

Infra-red Heaters

Make up one of these latest type heaters ideal for bathroom, kitchen, bedroom, etc. They are simple to make from our easy to follow instructions—use silica enclosed elements designed for the correct infra-red wavelength (3 microns). Price for 750 watt element and instructions 15/6, plus 2/6 post and insurance.

Convactor Heater

Just screw it together. Uses 1250 watt copper clad element which gives off black heat. Will last a lifetime. Ideal for bedroom. It's so safe Complete in crackle finished case. £3.19.6, easily worth double. Carriage and insurance, 6/6.

"Starlux 20B"

Solderless '3' TRANSISTOR. Ideal for home and holidays as no Aerial or Earth required. Enjoy assembling and performance. Our solderless Terminals ensure perfect connections Using first grade Transistors and all parts incl. Earpiece for private listening. Will receive Luxemburg (the station of the stars) and other stations on both Medium and Long waves. Penlight Battery operated, 37/6. Post and insurance, 2/6.

Suppressor Condenser

Stop your drill or other appliances interfering with your TV, neighbour's, radio or television. Simple instructions given. 1/6 each. 12/- dozen.

Bargain For Service Engineers

You often come up against the old set that won't be fixed with. For these we can offer bargain parcel of rectifiers MU12 replacement and 1D5 replacement. Ex-government of course, six of each for £1, post paid.



THIS MONTH'S SNIP!
Cabinet & Pick-up

Cabinet for battery record player. Size approx. 9 x 11 x 5in. allows for 7 x 4in. speaker and amplifier. Nicely covered two tone. Must have cost at least £2 to make. New and perfect. Offered whilst stocks last.

ONLY 19/6

Plus 4/6 post and insurance.

DO YOU EVER FORGET?



...us Pocket Secretary could eliminate the trouble (often embarrassment) your forgetfulness causes you—she will stay in your jacket pocket and as fast as you can think she will capture and store—ideas notes—formulas—appointments—anything you can say or sing! then at your demand she will play them all back to you.

Undoubtedly one of the smallest precision tape recorders made. Entirely controlled by push buttons, you can record and play back with the instrument in your pocket. It is a full function machine using standard 4" tape and easy to replace batteries. Speaking and playing back is from the same (crystal) microphone.

Specifications: Dimensions: 6 1/2 x 2 1/2 x 1 1/2, weight: 14 oz. recording time: 12 mins. rewinding time 4 mins. recording system: D.C. Bias. erasing system: Magnetic erasing, wow and flutter: within 2% and frequency response: 500-1,200 c/s (within—6db).

Price £14.14.0. Complete ready to work.

PARCEL OF MICA CONDENSORS

50 all very useful values. Total list price over £5. Yours for 6/-, plus 1/6.

MINIATURE MICROPHONE

American made. Dynamic type, real bargain at 2/6, plus 6d. postage.

SIMMERSTAT HEATER REGULATOR

A device for controlling the quantity of heat delivered from an element, boiling ring, heater, soldering iron (anything up to 2,500 watts) Completely adjustable from zero to max. Normally these are 55/- each. Special snip price 15/- each. Plus 1/6 post and insurance.

MULTI-METER BARGAINS!

MODEL 200H (illus. on right). 20,000 ohms per volt, 20 ranges comprising A.C. volts, 5 ranges up to 1,000V D.C. volts, 6 ranges up to 2.5KV, C.C. current, 3 ranges up to 26 ohms, resistance, 2 ranges up to 6 meg. capacity 2 ranges up to 0.1, decibels —20 to +22. Scale cornerwise to the equivalent of 4 in. movement is a pocket size instrument measuring 4 1/2 x 3 1/2 x 1 in. Complete with test prods, battery and operating instructions, price £6.19.6, post free.

MODEL EPI0K. Similar in size and appearance to 200H except that this is 10,000 ohms per volt and maximum D.C. volts 1,200 instead of 2.5K, also no capacity range. Price £5.19.6. Post free.

ALL METERS BRAND NEW AND FULLY GUARANTEED



MODEL TP55. (illus. on left). 20,000 ohms per volt, D.C. volts, 5 ranges up to 1,000 A.C. volts, 5 ranges up to 1,000 resistance, 2 ranges up to 10 meg., capacity 2 ranges up to 0.1 decibels —20 to +26. One switch control really beautifully made precision instrument, size only 3 1/2 x 5 1/2 x 1 1/2 in., price only £5.19.6. Post free.

MODEL TP10K. Similar in size and appearance to TP55, but sensitivity 2,000 ohms per volt, price £3.19.6. Post free.

MODEL U1. A robust instrument of 1,000 ohms per volt sensitivity. A.C./D.C. volts up to 1,000 D.C. current up to 500, resistance up to 200K, size 5 1/2 x 3 1/2 x 2 1/2 in., complete with test prods, single switch control, large easily read scale, price only £2.19.6. Post free.

ELECTRONIC PRECISION EQUIPMENT LTD.

post orders are dealt with from Eastbourne, so for prompt attention please post your orders to 66 Grove Road, Eastbourne, marked Department 7. Callers may use any one of the Companies below.

286 London Road, Croydon. Phone: CR0 6558 Half day Wednesday

29 Strand Green Rd., Finsbury Park, N.4. Phone: ARChway 1049 Half day Thursday

520 High Street North Manor Park, E.12. Phone: ILFord 1011 Half day Thursday

42-46 Windmill Hill, Ruislip, Middx. Phone: RUISlip 5780 Half day Wednesday

246 High Street, Harlesden, N.W.10. Phone: ELGor 4444 Half day Thursday

ARMSTRONG AF208AM/FM RADIOGRAM CHASSIS

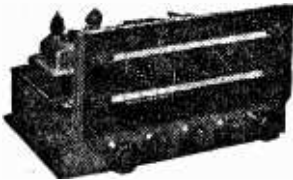

★ Full VHF Band (87-108 Mc/s) and Medium Band, 157-570M) ★ 7 Valves ★ 5 Watts Output ★ 15db Negative Feedback ★ Separate wide range Bass and Treble Controls ★ 2 Compensated Pick-up Inputs ★ Frequency Response 30-22,000 c.p.s. ±2db ★ Tape Record and Playback Facilities ★ Continental Reception of Good Programme Value ★ For 3, 7 and 15 ohm speakers. Send S.A.E. for leaflet.

PRICE £22.18.0 Carr. Free

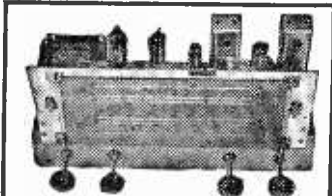

1962 RADIOGRAM CHASSIS
THREE WAVEBANDS FIVE VALVES
S.W. 16 m.—60. LATEST MULLARD
M.W.200 m.—850 m. ECH81, EF89, EBC81,
L.W. 800 m.—2,000 m. EL84, E280,
12-month guarantee.
A.C. 200/250 v. 4-way Switch: Short-Medium-
Long-Gram. A.V.C. and Negative Feedback.
Class dial, horizontal or vertical wording, size
10m. x 4 1/2m. Aligned and calibrated. Isolated
Chassis.

£9.10.0 Carr. & Ins. 4/6.

COMPLETE RADIO £5.19.6. post free

4 Mullard valves, 5in. speaker. Superhet Circuit. BRAND NEW. Size 9 x 6 x 5 1/2 in. High. Tested by us ready for use. 200/250 v. A.C.-D.C. Mains.

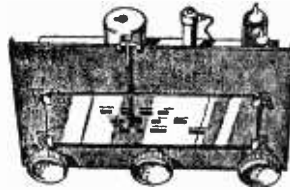

DE LUXE MODEL as illustrated with illuminated dial. Fully tunable over Medium and Long Wave. 12-month Guarantee.

MAINS TRANSFORMERS 200/250 v. A.C.

Postage 2/- each transformer.
STANDARD, 250-0-250, 90 mA, 6.3 v. 3.5 a. tapped 4 v. 4 a. Rectifier 6.3 v. 1 a. 5 v. 2 a. or 4 v. 2 a. 22/8, ditto, 360-0-350 ... 22/6
MINIATURE 200 v. 20 mA, 6.3 v. 1 a. ... 10/6
MIDGET, 220 v. 45 mA, 6.3 v. 2 a. ... 15/8
SMALL, 250-0-250, 90 mA, 6.3 v. 3 a. ... 17/8
STD. 250-0-250, 65 mA, 6.3 v. 3.5 a. ... 17/8
HEATER TRANS. 6.3 v. 1 1/2 amp. ... 7/6
Ditto, tapped sec. 2, 4, 6.3 v., 1 1/2 amp. ... 8/8
Ditto, sec. 6.3 v. 3 amp. ... 10/8
GENERAL PURPOSE LOW VOLTAGE, 2 amp. 3, 4, 5, 6, 8, 9, 10, 12, 15, 18, 24, 30 v. ... 22/6
AUTO TRANSFORMERS, 150 w. ... 22/6
0, 120, 200, 220, 250 v., 500 w. ... 22/6
MULLARD "610" Mains transformer ... 30/-
GENERAL PURPOSE MAINS TRANSFORMER. Made for special contract, the ratings can safely be doubled. Guaranteed 2 years. Primary 0-110-210-230-250 v. H.T. 300-0-300 v. 50 mA. L.T. 6.3 v. 1.5 amp. Size 4 1/2 x 3 1/2 x 3 1/2 in. Weight 6 lb. Post 2/6 ... 17/6
MAINS POWER PACK. Size 3 1/2 x 4 1/2 x 4 1/2 in. with mains transformer, metal rectifier and condensers to provide smoothed H.T. output 220 v. 45 mA. D.C. L.T. 6.3 v. 2 a. Centre tapped. Fully built on a strong metal chassis. Brand New. Bargain. Post 2/6 ... 22/6

C.R.T. BOOSTER TRANSFORMERS

for heater cathode short circuit, or tubes with falling emission. Full instructions supplied, mains input. Type A optional 25% and 50% boost. 2v. or 4v. or 6.3v. or 10v. or 12.6v. State voltage reqd. PRICE 10/6.

LOUDSPEAKER P.M. 3 OHM, 2 1/2, 3, 4in., 19/6
5in. Rola, 17/6; 8in. Plessey, 19/6; 7in. x 4in. Rola 18/-; 6in. Rola, 18/6; 10 x 6in. 27/6; 10in. Rola, 30/-; 4in. Tweeter, 25/-; 12in. R.A. 30/-; 1 1/2 x 6in. Double cone R.M.I. 45/-
STENTORIAN HF1012, 10in. 3 to 15 ohms, 10 v. 24/-
35 ohm, 7 x 4in., 25/-; 3 1/2in., 19/6

BAKER SELHURST LOUDSPEAKERS



Details S.A.E.
12in. Baker 15w. Stalwart 2 or 15 ohms, 45-13,000 c.p.s. ... 90/-
12in. Stereo, Foam Suspension, 12w., 35-16,000 c.p.s. ... £6.17.6
12in. Baker Ultra Twelve, 20 c.p.s. to 25 kc/s. £17.10
15in. Auditorium, 35 w., Bass, 30 c.p.s. to 12kc/s, £18
Details and Enclosures please S.A.E.

TWIN GANG TUNING CONDENSERS, 365 pF miniature lin. x 1 1/2 in. x 1 1/2 in., 10/-, 500pF standard with trimmers, 9/-; midget, 7/8; with trimmer, 9/-; 500pF slow motion tuning, standard or midget, 9/-
SMALL 3 gang 500 pF, 17/-
SINGLE 25 pF, 60 pF, 75 pF, 100 pF, 180 pF, 8/6.
Solid dielectric 100, 300, 500 pF, 3/6.
CONDENSERS. New stock. 0.001 mfd. 7 kV. T.C.C. 5/8; Ditto, 20 x 1 1/2 in., 7 kV, 9/6.
Tubular 500 v. 0.001 to 0.05 mfd. mfd., 8d. 0.1, 1/-; 0.25, 1/8; 0.5/500 v. 1/9; 0.1/350 v., 9d.; 0.1/2,000 v. 0.1/1,000 v. 1/9; 0.1 mfd., 2,000 volts, 3/6.
CERAMIC COND. 500 v. 0.3 pF to 0.01 mfd., 9d.
SILVER MICA CONDENSERS, 10% 5 pF to 500 pF 9d.; 600 pF to 3,000 pF, 1/-, Close tolerance (±1 pF) 2.2 pF to 47 pF, 1/-; Ditto 1 m. 50 pF to 815 pF, 1/-; 1,000 pF to 5,000 pF, 1/8.

465 kc/s SIGNAL GENERATOR Price 15/-. Uses E.F.O. Unit, ZA 30038 ready made with valve ISS. POCKET SIZE 2 1/2 x 4 1/2 x 1 1/2 in. One resistor to change, full instructions. Price 10/-. Battery 8/6 extra 69V 11V. Details S.A.E.

WAVECHANGE SWITCHES
8 p. 4-way 2 wafer long spindle. ... 6/6
2 p. 2-way, or 2 p. 6-way long spindle or 4 p. 2 p. 2-way or 4 p. 3-way long spindle. ... 3/6
3 p. 4-way, or 1 p. 12-way long spindle ... 8/6
Wavechange "MAKITS". Wafers available: 1 p. 12 way, 2 p. 6 way, 3 p. 4 way, 4 p. 3 way, 6 p. 2 way, 7 wafer switch, 8/6; 2 wafer switch, 12/6; 3 wafer switch, 18/6; additional wafers up to 12, 3/6 each extra.
Toggle Switches, s.p., 2/-; d.p., 2/6; d.p.t.d., 4/-. Ex. Govt. s.p.d.t., 1/-.

CRYSTAL MIKE INSERT, 6/6 Precision engineered. Midget size

ACOS 39-1 DE LUXE STICK MIKE 35/- TSL QUALITY STICK MIKE..... 25/-

Valveholders. Pax. int. oct., 4d. EA56, 6d. B12A, CRT, 1/3. Eng. and Am. 4, 5 and 7 pin, 1/-. MOULDED Mazda and int. oct., 6d.; B7G, B8A, B8G, B9A, 9d. B7G with can, 1/6. B9A with can, 1/6. Ceramic EF50, B7G, B9A, int. oct., 1/6. B7G, B9A cans, 1/- each.

Quality 2-Stage Hi-Fi AMPLIFIER A.C. only, 200-250 v. Valve, ECL86 and E280. 3 watt quality output. Mutual tone circuits, bass boost, treble and volume controls. Separate engraved front-panel with de-luxe finish. Heavy duty output transformer 3 ohm. Shrouded mains transformer. 30w. enamelled chassis size 8in. x 6in. x 3in. Barkain Price £4.10.0. Circuit supplied.

SUMMER SALE PRICES

New Boxed VALVES 90-day Guarantee

| | | | | | | | |
|------|-----|-------|------|----------|-------|-------|------|
| 024 | 6/- | 6K7G | 5/- | EBC80 | 8/- | POL82 | 10/- |
| 1R5 | 6/- | 6K9G | 5/- | EB91 | 4/- | POL84 | 10/- |
| 189 | 6/- | 6L6G | 8/- | EBC41 | 8/- | PL81 | 10/- |
| 174 | 6/- | 6N7M | 5/- | EBC81 | 8/- | PL83 | 8/- |
| 2X3 | 8/- | 6Q7G | 6/- | EBF90 | 9/- | PY80 | 7/- |
| 384 | 7/- | 68N7 | 5/- | ECH49 | 9/- | PY81 | 8/- |
| 3V4 | 7/- | 6V8G | 5/- | ECH81 | 8/- | PY82 | 7/- |
| 3Q5 | 7/- | 6X4 | 5/- | EF85 | 8/- | PY83 | 8/- |
| 5U4 | 6/- | 6X5 | 5/- | EF89 | 8/- | QPY25 | 7/- |
| 5U4 | 6/- | 12AT7 | 6/- | EL32 | 5/- | SP41 | 8/- |
| 5Z4 | 6/- | 12AU7 | 6/- | EL54 | 7/- | SP61 | 8/- |
| 6AC7 | 4/- | 12AX7 | 7/- | EY61 | 9/- | U92 | 7/- |
| 6AM6 | 4/- | 12BH7 | 7/- | EY86 | 9/- | UBC41 | 8/- |
| 6AT5 | 9/- | 12K7 | 6/- | EZ40 | 7/- | UBC81 | 9/- |
| 6BR6 | 7/- | 12X3 | 14/- | EZ80 | 7/- | UBF89 | 9/- |
| 6BR6 | 5/- | 12Q7 | 5/- | EZ81 | 7/- | UCH81 | 9/- |
| 6BW6 | 7/- | 25Y5G | 9/- | E1148 | 1/- | UCL83 | 10/- |
| 6C4 | 5/- | 32L6 | 9/- | HAB80101 | UCL83 | 12/- | |
| 6D6 | 6/- | 35Z4 | 8/- | HVR2A | 8/- | UP89 | 9/- |
| 6E8 | 4/- | 307 | 5/- | K789G | 8/- | UL41 | 9/- |
| 6H6 | 8/- | 354 | 2/- | K776 | 8/- | UY1 | 6/- |
| 6V6 | 5/- | DAF96 | 8/- | MU14 | 7/- | UY85 | 7/- |
| 6S7 | 6/- | DFP96 | 8/- | PC8A | 8/- | UY9 | 7/- |
| 6V7G | 6/- | DK98 | 8/- | PCF80 | 8/- | VR150 | 7/- |
| 6K6 | 5/- | DL86 | 8/- | PCF82 | 8/- | WR1 | 6/- |

L.F. TRANSFORMERS 7/6 pair 400 K/s Ring Tuning Miniature Can, 2 x 1 x 1 1/2 in. High Q and good bandwidth. Data sheet.

NEW FAMILIAR ELECTROLYTICS TUBULAR CAN TYPES

| | | | | | |
|--------|-----|------------|-----|---------------|------|
| 1350V | 5/- | 50/350V | 5/8 | 18/450V | 6/- |
| 2350V | 8/6 | 100/23V | 3/- | 32/350V | 5/8 |
| 4500V | 2/6 | 250/25V | 3/- | 100/270V | 5/8 |
| 8500V | 2/6 | 500/12V | 3/- | 2,000/6V | 4/- |
| 16500V | 2/6 | 1,000/12V | 3/- | 5,000/6V | 5/- |
| 32500V | 2/6 | 8+8/450V | 3/6 | 32+32/350V | 5/- |
| 32500V | 1/6 | 8+16/450V | 3/6 | 32+32+32/350V | 5/- |
| 50500V | 2/6 | 16+16/450V | 4/6 | 50+50/350V | 7/- |
| 50500V | 2/6 | 32+32/350V | 4/6 | 64+120/350V | 11/6 |
| 50500V | 2/6 | 32+32/350V | 4/6 | 100+200/275V | 12/6 |

O.P. TRANSFORMERS. Heavy Duty 50 mA, 4/6. Multitap, push-pull, 7/6. Ditto, 10 w., 15/6. Miniature, 354m etc., 5/8. L.F. CHOKE 1510H. 60/65 mA, 5/-; 10 H., 85 mA, 10/6; 10 H., 150 mA, 14/-.
FULL WAVE BRIDGE SELENIUM RECTIFIER: 2, 6 or 12 v. 1 1/2 amp. 8/6; 2 a., 11/8; 4 a., 17/6.
CLEARER TRANSFORMERS. Tapped input 200/250 v. for charging at 2, 6 or 12 v. 1 1/2 amp., 15/6. 250 v. for charging at 2, 6 or 12 v. 1 1/2 amp., 22/6. 2 amps., 17/8; 4 amps., 22/6. Circuit included.
4 AMP CAR BATTERY CHARGER with amp. meter Leads, Fuse Case, etc., for 6 v. or 12 v., 69/6

BOOKS list S.A.E.
40 Circuits for Germanium Diodes 3/-
"W.W." Radio Valve Data, 6/-
High Fidelity Speaker Enclosure, 5/-
Valve and TV Tube Equivalents, 9/6
TV Fault Finding, 5/-
Quality Amplifiers, 4/6.
Radio Valve Guide. Books 1, 2, 3 or 4, 5/- each.
Transistor Superhet Receivers, 7/6.
Practical Radio Inside Out, 3/6.
Master Colour Code Chart, 1/6.
Transistor Controlled Models, 7/6.

4 TRANSISTOR PUSH-PULL AUDIO AMPLIFIER
Size 3 x 1 1/2 x 1.
A ready built miniature push-pull amplifier with input and output transformers, 4 transistors. Ideal for use with record players, intercoms, etc. Complete with full instructions and circuit.
Price 52/6 9v Batt. 2/3. 2 1/2 in. Speaker 15/-

THE ORIGINAL RADIO COMPONENT

Our written guarantee with every purchase. Bus 133 or 88 pass door NEW COMPONENT LIST 1/- S.R. Station Selhurst

Volume Controls 80 ohm COAX

Linear of Log Tracks. Sem-air spaced fin. Long spindles. Midget. 5 K ohms to 2 Meg. L/S, 3/-; D.P., 4/6; Stereo L/S 10/8; DP 14/8

TELESCOPIC CHROME AERIALS. 13in. extending to 43in. 3/8 ea. Coax Adaptor Plug, 1/6 extra. TRIPLEXERS Bands I, II, III 12/6
COAX PLUG 1/- LEAD SOCKET 2/-
PANEL SOCKETS 1/- OUTLET BOXES 4/6
BALANCED TWIN FEEDER yd. 6d. 80 or 300 ohms. DITTO SCREENED per yd. 1/8. 30 ohms only.
WIRE-WOUND POT, 3 WATT. Pre-set. Min. TV Types. All values 10 ohms to 25 K. 3/- ea. 30 K, 50 K, 4/-; (Carbon 30 K., to 2 meg., 3/-).
WIRE-WOUND 4 WATT POT. Long spindle. Value. 50 ohms to 250 K. 6/6; 100 K, 7/6.
PHILIPS TRIMMERS 0-10 pF. 3-30 pF. 1/-
TRIMMERS, Ceramic. 30, 50, 70 pF. 9d.; 100 pF, 150 pF, 1/8; 250 pF, 1/6; 500 pF, 7/50 pF, 1/8. TV etc. TRIMMER, 1000 pF. with knob, 2/-.
RESISTORS. Preferred values. 10 ohms to 10 meg.; 1 w., 4d.; 1 w., 4d.; 1 w., 6d.; 1 1/2 w., 8d.; 2 w., 1/-
HIGH STABILITY. 1/2 w., 1/6. 2/- Preferred values. 10 Ω to 10 meg. Ditto 5%, 10 Ω to 22 meg., 9d. 5 watt { WIRE-WOUND RESISTORS } 1/8
 10 watt { 10 ohms—10,000 ohms } 2/-
 15 watt { } 2/-
 12.5K to 50K 10 w. 3/-

AMERICAN "BRAND FIVE" PLASTIC RECORDING TAPE

| | |
|---|---------------------|
| Double Play 7in. reel, 2,400ft. 60/- | Spare Plastic Reels |
| 5in. reel, 1,200ft. 37/8 | |
| Long Play 7in. reel, 1,800ft. 35/- | 3in. 1/6 |
| 5in. reel, 1,200ft. 23/8 | 4in. 2/- |
| 1 w. 4d.; 1 w., 6d.; 1 1/2 w., 8d.; 2 w., 1/- | 5in. 2/- |
| Standard 7in. reel, 1,200ft. 25/- | 5in. 2/- |
| 5in. reel, 600ft. 15/- | 7in. 2/6 |

"Instant" Bulk Tape Eraser and Head Defuser, 200/250 v. A.C. 27/6. Lead with full details.S.A.E.

CRYSTAL SET BOOKLET, 1/-
CRYSTAL DIODE G.E.C. 2/-, GEX34, 4/-, OA81, 3/-
HIGH RESISTANCE PHONES, 400 ohms, 15/- pr.
SWITCH CLEANER. Fluid squirt spout, 4/8 tin.

HIGH GAIN TV PRE-AMPLIFIERS BAND I B.B.C.

Tunable channels 1 to 5. Gain 18dB. ECC84 valve. Kit price 29/6 or 49/6 with power pack. Details 6d. (ECC84 valves 1/- preferred.)

BAND III I.T.A.—Same prices.
 Tunable channels 8 to 13. Gain 17 dB

1/16in. Paxolin Panels, 10 x 8in., 2/-
 Miniature Contact Cooled Rectifiers, 250V 50mA, 7/6; 250V 60mA, 8/6; 250V 85mA, 9/6; 300mA, 21/-; 300mA, 27/6.
 TV etc., Silicon Sub-Min. Rectifier, 125V, 300mA, 6/6; 250V, 300mA, 14/6.
 Selenium Rect., 300V 85mA, 5/-
 Coils Wearite "P" type, 3/- each
 Osrom Midget "Q" type, ad. dust core, from 4/- each. All ranges. List S.A.E.
 Teletron D.W.R. L. and Med. T.R.F. with reactions, 4/- Med. wave D.R., 3/6.
 Ferrite Aerials, M., 8/6; M. and L., 12/6.
 Osrom Ferrite Rod Aerials, L. and M. for transistor circuits, 10/- each.
 Ferrite Rods, 8 x 1in., 3/-; 8 x 5/16in., 3/-
 H.F. Chokes, 2/6. Osrom QCL, 6/6.
 T.R.F. Coils, A/H.F. 7/- pair; HAX, 3/-
 Repanco DR12, 4/-; DRX1, 2/6.
 Radio Screwdriver, 5in., 6d.
 Neon Mains Tester Screwdriver, 5/-
 Solder Radiograde, 4d. yd., 1lb, 5/-
 Black Crackle Paint. Air drying, 3/- tin.

Aluminum Chassis, 18 s.w.g. Plain undrilled, 4 sides, riveted corners, lattice fixing holes, 2 1/2in. sides, 7 x 4in. 4/6; 9 x 7in., 5/8; 11 x 7in., 6/8; 13 x 9 1/2in. 8/6; 14 x 1 1/2in., 10/6; 15 x 14in., 12/6; 18 x 16 x 3in., 15/6.
Aluminum Panels, 18 s.w.g., 12 x 12in. 4/6; 14 x 9in., 4/-; 12 x 8in., 3/-; 10 x 7in., 2/3; 8 x 6in., 2/-.

"6 + 1" TRANSISTOR RADIO MEDIUM AND LONG WAVE KIT
 First class components to make a 6 transistor 2 wave band superhet chassis Ideal for portable or table radio. All parts including BVA transistors, ferrite aerial, printed circuit, 8 1/2in. x 2 1/2in., with EXCLUDING speaker and cabinet. Simple instructions 1/6 (Free with kit)
 Speakers, 35 ohm, 7 x 4in. 25/- 5in. 22/6, 3 1/2in. 19/6. **£4.50**

"V" Aerial 16/6
TV Plug-in JACKS. English open circuit, 2/6. Closed circuit, 4/3. Grundig type, 3 pin, 1/3.
JACK PLUGS, English, 3/-; Screened, 4/-; Grundig, 3 pin, 3/6.
 Wirewound Ext. Speaker Control, 10Q 3/-
ALADDIN FORMERS and cores, 1in., 8d.; 1 1/2in., 10d. 0.3in. FORMERS 5937 or 8 and cans T.V.1 or 2, 4in. sq. x 2 1/2in. or 1in. sq. x 1 1/2in., 2/- each
SLOW MOTION DRIVES. 6in., 2/3.
SIRON IRON, 25W, 200V or 230V, 24/-
ANTEX SUB-MIN IRON 15w. 200 or 240 v. 29/6.

JASON FM TUNER COIL SET 29/-
 H.F. coil, aerial coil, oscillator coil, two i.f. transformers 10.7 Mc/s detector transformer and heater choke. Circuit and component book using four 6AM6, 2/6. Complete Jason FMT.1 Kit. Jason chassis with calibrated dial, components and 4 valves, £6.50.

MAINS DROPPERS. Midget adjustable sliders, 0.3A, 1,000 ohms, 5/-; 0.2A, 1,200 ohms, 6/-; 0.15A, 1,500 ohms, 5/-; 0.1A, 2,000 ohms, 5/-.
P.V.C. TRANSFORMER. 60-1, 3/6.
 M.K.V. Conn. Wire, single or stranded, 2d. yd. Sleeving, 10 1/2in., 2d.; 4in., 3d.; 6mm, 6d. yd.
SPEAKER FRET. Gold cloth, 17 x 25in., 5/-; 25 x 35in., 10/-; Tygan, various colours, 52in. wide from 10/- ft.; 26in. wide, from 5/- ft. Samples, S.A.E. Expanded Metal, Gold, 12 x 12in., 6/-.

TELEVISION REPLACEMENTS Line Output Transformers
 from 45/- each, NEW Stock and other timebase components. Most makes available. S.A.E. with all enquiries

"REGENT" 4 VALVE "96"

RANGE VALVES KIT PRICE £6. 6. 0.
 carr. 4/-



PRINTED CIRCUIT BATTERY PORTABLE KIT

Medium and long wave. Powerful 7 x 4in. high Flux Speaker. T.C.C. Printed Circuit and condensers. Components of finest quality clearly identified with assembly instructions. Osrom Ferrite Aerial Coils. Reszine covered atache case cabinet. Size 12in. x 8in. x 4in. Batteries used B126 (L5512) and AD35 (L5040). 10/9 extra. Instructions 9d. (free with kit).

MONARCH RECORD PLAYER

Kit with ready built amplifier, speaker and cabinet. **£12.10.0**
 carr. and ins. 5/-



Garrard deluxe auto-player kit £14.10.0

Carr. and ins. 5/- details S.A.E.
 With finest quality AUTOCHANGER RC121 (plug-in xtal head). Ready built 2-valve amplifier, Loudspeaker and contemporary styled Portable Player Case.
 All items guaranteed to fit together perfectly, can be assembled in thirty minutes, full instructions supplied.
 4 Speed Autochanger, B.S.R., U.A.14 27.10.0
 B.S.R., U.A.12 Stereo/Mono .. 25.5.0
 Garrard Model Automin .. 27.13.6
 4 Speed Single Flatters, EMI .. 26.5.0
 Garrard 7A Mk.II, G8 Head .. 28.0.0
 Garrard Model 48P GUC8 .. 28.17.6
 Garrard 4HF Transcription .. 27.19.6
 Amplifier player cabinets (except 4 H.F.) 70/-
 2-valve amplifier and 6in. speaker .. 95/-
 3-valve amplifier and 6in. speaker .. 106/-
 Wired and tested ready for use with above.
 All sample styles available from 6/-.

ARDENTE Transistor Transformers
 Type D3035, 7.3 CT: Push-Pull to 3 ohms for OC72, etc., 1 x 1 x 1 in. 9/6
 Type D3034, 1.75 : 1 CT: Push-Pull Driver for OC27, etc., 1 1/2 x 1 in. 9/6
 Type D3058, 11.5 : 1 Output to 3 ohms for OC72, etc., 1 x 1 x 1 in. 9/6
 Type D167, 16.2 : 1 Output to 3 ohms for OC72, etc., 1 x 1 x 1 in. 12/-
 Type D239, 4.5 : 1 Driver Transformer, 10/-
 Type D240 8.5 : 1 Driver Transformer, 10/-

ARDENTE VOLUME CONTROLS
 Type VC1545, 5K with switch, dia. 0.9in., 5/3.
 Type VC1760, 5K with switch, dia. 0.7in., 10/6
 Deal air ear piece xtal or magnetic, 7/6.

WEYRAD COILS AND TRANSFORMERS FOR 2-WAVE TRANSISTOR SUPERHETS WITH PRINTED CIRCUIT AND FERRITE ROD AERIAL

Long and Medium Wave Aerial—RA2W. On 6in. rod, 208P tuning. 12/6
 Car Aerial Coil. 1/-
 Osc. Coil P50/1AC, 176P tuning. 5/4
 1st and 2nd I.F. Trans.—P50/2CC, 470kc/s 11/16in. dia. by 1in. 5/7 each.
 3rd I.F. Trans.—P50/3CC. 6/-
 Spare Cores. 6d. each.
 Driver Transformer—LFD4. 9/6
 Wavechange Switch. 3/6
 Printed Circuit—PCA1, Size 2 1/2 x 8 1/2in. Ready drilled and printed. 9/6
 Volume Control, 5K-DP. 4/6
 7 x 4in., 35 ohm Speaker. 25/-
 3 1/2in. round 35 ohm speaker. 19/6
 24 Fixed Resistors. 10/8
 16 Fixed Condensers. 21/-
 Tuning Gang with trimmers. 10/8
 6 Mullard Transistors and diode. 42/6
 Constructor's Booklet. 2/-

NEW MULLARD TRANSISTORS
 OC71 6/-, OC72 7/6, OC81D, 7/6, OC81, 7/6, OC4 8/9, OC45 8/9, OC711 10/6, AF117 9/6
 Sub Miniature Condensers. 0.1 mfd. 30 v. 1/3. 1. 2. 4. 5. 8. 16. 25. 30. 50, 100 mfd. 15 volt, 2/6 each.

B.B.C. Pocket 2 Transistor. M.W. and L.W. Radio Kit, 22/6.
 Miniature earpiece, 7/6. Batt. 2/6.

COMPONENT SHOP SPECIALISTS

337 WHITEHORSE ROAD WEST CROYDON

Telephone: THO 1665
 (Export welcome. Send remittance and extra postage.)

Post 1/-, unless otherwise stated. C.O.D. 2/-

Easy-to-build kit-sets of



highest quality at lowest cost



DX-40U

AMATEUR TRANSMITTER. Model DX-40U. Self-contained. 80-10 m. Power input 75 w. C.W., 60 w. peak, C.C. phone. Output 40 w. to aerial. Provision for V.F.O.

£33.19.0

AMATEUR TRANSMITTER. Model DX-100U Covers all amateur bands, 160-10 m. 150 w. D.C. input. self contained with power supply. Modulator, V.F.O.

£74.19.0



DX-100U

AUDIO SIGNAL GENERATOR. Model AG-9U. 10 c/s-100 kc/s, switch selected. Distortion less than 0.1%. 10 v. sine wave output metered in volts and dB's £21.9.6

VALVE VOLTMETER. Model V-7A. Measures volts to 1,500 (D.C. and R.M.S.) and 4,000 pk to pk. Res. 0.1 Ω-1,000 MΩ. D.C. input impeded. 11 MΩ. With test prods, leads and standardising battery £13.18.6

R.F. SIGNAL GENERATOR. Model RF-1U. Gives accurate source of R.F. up to 100 Mc/s on fundamentals and 200 Mc/s on harmonics. Up to 100 mV output on all bands. £12.15.6

SINGLE SIDEBAND ADAPTOR, Model SB-10U May be used with most A.M. transmitters. Less than 3W R.F. input power required for 10W output. Operation on 80, 40, 20, 15 and 10m bands on USB, LSB or DSB £39.5.0



SB-10U

Mon. Printed circuit construction £27.19.6

HI-FI AM/FM TUNER. Tuning range: FM: 88-108 Mc/s. AM: 16-50, 200-550, 900-2,000 m. Tuning heart (£5.5.6 incl. P.T.) and I.F. amplifier (£20.13.0) sold separately. Printed circuit board Total £25.18.6

SHORTWAVE TRANSISTOR PORTABLE. Model RSW-1. Two short bands, trawler and medium £22.8.0

6-TRANSISTOR PORTABLE. Model UXR-1. Prealigned I.F. transformers, printed circuit, 7 x 4in., high flux speaker. Real hide case £14.3.0

TAPE RECORDING/PLAYBACK AMPLIFIER Stereo (TA-1S) ... £24.10.0 Monaural (TA-1M) £19.2.6

STEREO CONTROL UNIT USC-1. Luxury model with press-button inputs to suit any pick-up or tuner and most tapeheads. Output 1.3 v. R.M.S. per channel. Printed circuit construction. £19.10.0

Money Saving "PACKAGED DEALS" of Complete Stereo Equipment from £46.6.0



S-99



AM/FM Tuner



TA-1S

VAR. FREQ. OSCILLATOR. Model VF-1U Calibrated 160-10 m. fundamentals 160 and 40 m. Ideal DX-40U and similar transmitters. £11.17.6

HI-FI F.M.T. TUNER. Tuning range 88-108 Mc/s. Tuning Unit (FMT-4U) with 10.7 Mc/s I.F. output (£3.2.0 inc. P.T.) I.F. Amplifier (FMA-4U) complete with cabinet and valves (£12.6.0) Total £15.8.0

6-W STEREO AMPLIFIER. Model S-33. 3 w/chl. inputs for radio-tape and gram., Stereo or Mono ganged controls. Sensitivity 200 mV. £13.7.6

SINGLE CHANNEL AMPLIFIER. Model MA-12. 10-12 watt Hi-Fi amplifier. Extremely low distortion and wide frequency range £11.9.6



GC-1U

HI-FI SPEAKER SYSTEM. Model SSU-1. Ducted-port bass reflex cabinet "in white." Twin speakers. Pedestal model £11.19.6. Bookcase model. £11.5.0



MALVERN

HI-FI EQUIPMENT CABINETS. Range available to meet various needs. Details on request. (MALVERN equipment cabinet illustrated on the left) from £11.12.6 to £18.10.0.

STEREO HEAD PREAMPLIFIER USP-1. Ideal for boosting tape-head output and low output pick-ups (e.g. Decca ffs) £7.7.6

"COTSWOLD" HI-FI SPEAKER SYSTEM. Acoustically designed enclosure "in the white" 26 x 23 x 15 1/2 in. 12in. bass speaker with 2in. speech coil, elliptical middle speaker. Pressure unit covers the full freq. range of 30-20,000 c/s., complete with cross-over unit, level control, etc. £23.4.0

AUDIO & DO-IT-YOURSELF accessories also available



COTSWOLD

Assembled models also available—prices on request. Deferred terms available over £10. Free Delivery U.K.

Please send me FREE CATALOGUE (Yes/No) _____
 Full details of model(s) _____

 NAME _____
 ADDRESS _____
 _____ PW11

DAYSTROM LTD.
 Dept. P.W.11, GLOUCESTER, ENGLAND
 A member of the Daystrom Group, manufacturers of the
 WORLD'S LARGEST-SELLING ELECTRONIC KITS

Practical Wireless

Vol. XXXVIII No. 669 NOVEMBER, 1962

Editorial and Advertisement
Offices:

PRACTICAL WIRELESS

George Newnes, Ltd., Tower House,
Southampton Street, W.C.2.

© George Newnes Ltd., 1962

Phone: Temple Bar 4363

Telegrams: Newnes, Rand, London,
Registered at the G.P.O. for trans-
mission by Canadian Magazine Post.

SUBSCRIPTION RATES

including postage for one year

Inland - - - - £1.9.0 per annum
Abroad - - - - £1.7.6 per annum
Canada - - - - £1.5.0 per annum

Contents

| | Page |
|--|------|
| Editorial | 581 |
| Round the World of Wireless | 582 |
| The Savoy VHF Tuner... | 584 |
| Hi-fi Output Transformer ... | 587 |
| Vintage-model or F.M. Tuner | 590 |
| Increasing Ohmmeter Ranges | 595 |
| The Auditor | 596 |
| The Finishing Touch | 600 |
| Radio Components and their Functions | 603 |
| Universal Test Oscillator ... | 606 |
| The Mayfair Pre-amplifier ... | 608 |
| Wideband Masthead Amplifier | 613 |
| Transportable A.C. Superhet | 617 |
| Reflexing the P.W. Minuette ... | 625 |
| Central Control Amplifier ... | 629 |
| Servicing Tape Recorders ... | 633 |
| Anodising Aluminium... .. | 638 |
| Trade News | 641 |
| Short Wave Listeners' Log ... | 645 |
| Club News | 646 |
| Letters to the Editor | 649 |

The Editor will be pleased to consider articles of a practical nature. Such articles should be written on one side of the paper only, and should contain the name and address of the sender. Whilst the Editor does not hold himself responsible for manuscripts, every effort will be made to return them if a stamped and addressed envelope is enclosed. All correspondence intended for the Editor should be addressed: The Editor, PRACTICAL WIRELESS, George Newnes, Ltd., Tower House, Southampton Street, London, W.C.2. Owing to the rapid progress in the designs of wireless apparatus and to our efforts to keep readers in touch with the latest developments, we give no warranty that apparatus described in our columns is not the subject of letters patent.

Copyright in all drawings, photographs and articles published in PRACTICAL WIRELESS is specifically reserved throughout the countries signatory to the Berne Convention and the U.S.A. Reproductions or imitations of any of these are therefore expressly forbidden. PRACTICAL WIRELESS incorporates "Amateur Wireless."

TWO NEW BLUEPRINTS

INCLUDED in this issue of P.W. is the second in our current series of free blueprints, dealing with a pre-amplifier and a VHF tuner.

The *Mayfair* pre-amplifier has been specially designed to feed the *Strand* amplifier (which was the subject of the October blueprint) but it can be used equally well with any other high quality amplifier requiring an input of up to 250mV.

The *Mayfair* has all the features one expects from a versatile control unit, including a choice of five separate input circuits, treble and rumble filters, treble and bass cut-and-lift controls and two outputs—normal output for feeding the power amplifier and an auxiliary output for feeding a tape recorder.

The other side of the blueprint features the *Savoy* VHF tuner. This incorporates a turret tuner which can be switched to the three BBC Band II F.M. programmes plus two positions for Band I and Band III Television sound (A.M.) The turret is supplied ready trimmed and fitted with the appropriate coils. In the interests of quality, the discriminator is of the Foster-Seeley type, which permits the use of A.F.C.

The December issue of P.W. will also contain a free double-sided blueprint to complete the present series.

A P.W. FILM SHOW

ON February 1st, 1963, beginning at 7.30 p.m., a film show is to be held at Caxton Hall, Westminster, London. As in previous years this show has been arranged in collaboration with Mullard Ltd. and will include the showing of the two films "Fuel for the Future" and "The Electroners".

Readers are invited to apply to these offices for free tickets which are now available. When applying for tickets, please enclose a S.A.E. (which must measure at least 3½ × 6in.).

RADIO SHOW INTEREST

ALTHOUGH the Radio Show has come and gone, many interesting facts continue to emerge from those hectic two weeks.

A research team acting on behalf of Bush Radio Limited took a 12½% test sample and found that of the 350,620 visitors in ten days, no fewer than 138,277 spent a considerable time in their clients' demonstration room. In addition 72,739 visitors passed through the main stand and the information desk dealt with a total of 12,062 firm enquiries.

Yet, despite this obvious interest by the public (and by the dealers) many firms considered it not worth while exhibiting. We wonder exactly why?

Our next issue dated December, will be published on November 7th.

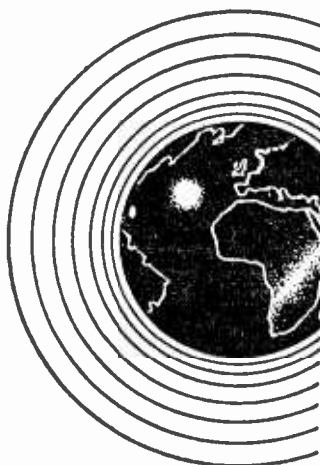

of WIRELESS

NEWS AT HOME AND ABROAD

Broadcast Receiving Licences

THE following statement shows the approximate number of Broadcast Receiving Licences in force at the end of July, 1962, in respect of wireless receiving stations situated within the various Postal Regions of England, Wales, Scotland and Northern Ireland. The numbers include Licences issued to blind persons without payment.

| Region | Total |
|--|------------------|
| London Postal | 641,529 |
| Home Counties | 594,562 |
| Midland | 430,216 |
| North Eastern | 455,066 |
| North Western | 391,406 |
| South Western | 349,789 |
| Wales and Border Counties | 199,294 |
| Total England and Wales | 3,061,852 |
| Scotland | 327,135 |
| Northern Ireland | 109,340 |
| Grand Total | 3,498,327 |

Extension to A.A. Radio Network

OVER 1,200 square miles of North-East England were recently added to the area covered by the Automobile Association's radio - controlled breakdown services with the official opening of a new A.A. area headquarters at York.

The new Fanum House serves the North and East Ridings of Yorkshire and is the third A.A. office to be established in Britain's largest county, the others being at Leeds and Sheffield.

Radio emergency services are available from the new office from 8 a.m. until 11 pm., calls to the office outside those hours

being switched automatically to the A.A. office in Leeds, from which help is forthcoming at any hour of the day or night.

New Experimental Dish Reflector

A 30ft diameter experimental dish reflector has recently been produced at Marconi's mechanical engineering works at Felling, Co. Durham. It has been designed to operate at wavelengths down to 3cm and an intensive programme of load and deflection tests has been arranged for it.

Several new production techniques had to be devised in order to ensure a sufficiently high degree of precision and this large dish has been manufactured with a measured surface accuracy of better than 20 thousandths of an inch standard deviation. Reflectors of this type working at

these high frequencies are likely to find increasing use in the field of satellite tracking.

Transistors Replace Valves in U.K.-Belgium Cable

TRANSISTORS will take the place of valves in the U.K.-Belgium submarine cable when new repeaters are inserted in the cable in mid-1964. This will be the first British cable using transistors and will provide a big increase in circuit capacity.

An order for transistorised repeaters has been placed by the Post Office, working in partnership with the Belgian Regie des Telegraphes et des Telephones.

The cable, laid in 1948 between St. Margaret's Bay, Kent, and La Panne, at present carries 216 telephone circuits and by inserting two transistorised repeaters the capacity will be

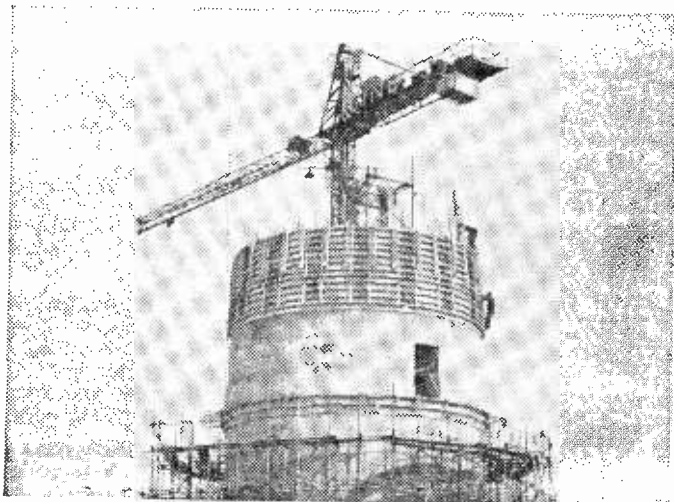

A start has already been made on the new radio tower which will house the Museum Telephone Exchange, in London, and will also be used for radio and television broadcasting.

raised to 420 circuits of standard CCITT quality for 4kc/s spacing. The cable, which is 47.5 nautical miles long, is a single coaxial cable of 1.7in. diameter in which the polythene core incorporates a partial air space.

It is the largest type of submarine coaxial telephone cable in service, but, since it was laid, the rapid development of submerged repeaters has made the use of such large and expensive cables less attractive.

An essential feature of the submerged repeater is the emphasis on reliability and, as one of the factors to achieve this, only components of proven reliability are incorporated. The transistor offers obvious advantages for a submerged repeater because its power requirement is substantially less than that of a thermionic valve of similar capacity; this should give an advantageous reduction in power feed voltages for a long system using many repeaters in tandem. However, until it has been established that transistors will meet the exceptional reliability requirements they will not be incorporated in submerged repeaters for use on long routes.

The present system uses frequency bands of 60-956kc/s and 1152-2048kc/s for the 216 circuits now in service; the new system will use bands of 312-2044kc/s and 2544-4276kc/s and the transistorised amplifier in each repeater will therefore be operating in the band from about 0.3 to 4.3Mc/s.

It is expected to have the repeaters ready for insertion in the cable by about the middle of 1964.

Experimental Transmissions of Stereophonic System

SINCE 1958 the BBC has been making experimental stereophonic transmissions on alternate Saturday mornings, using the sound transmitters of television stations for the right-hand channel and the Third Programme transmitters (medium wave and VHF) for the left-hand channel. The use of two transmission channels in this way makes it necessary for listeners to have two receivers and would not be practicable for regular stereophonic broadcasting. Although no decision has been made to introduce a stereophonic service the BBC is now

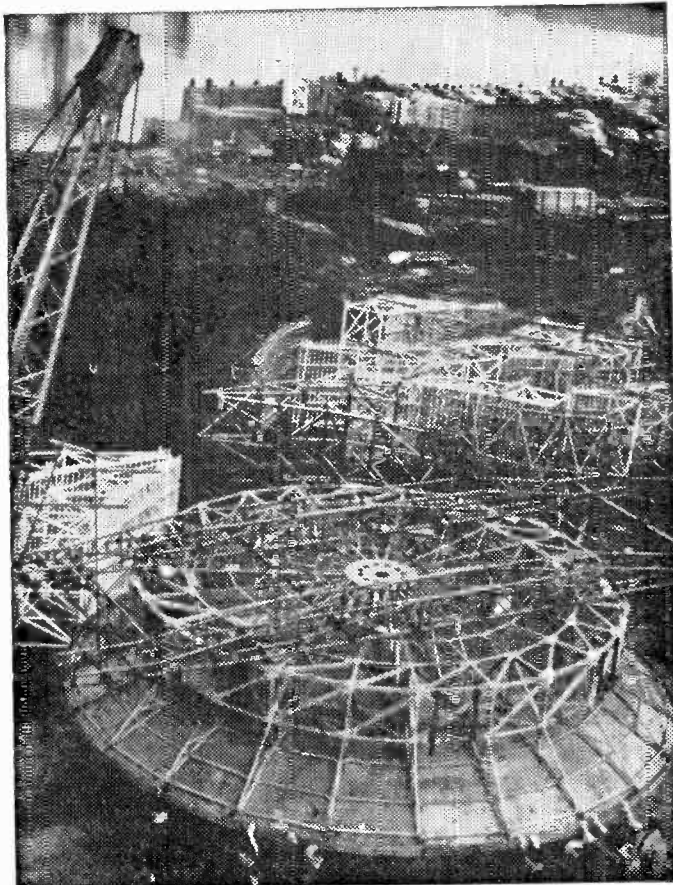

The 30ft diameter experimental dish reflector, recently produced by Marconi's.

making some experiments with a system in which a single VHF transmitter is used for both channels in such a way that listeners with ordinary VHF receivers can obtain satisfactory monophonic reception of the stereophonic transmissions.

On 28th August the BBC started a series of experimental transmissions from the Wrotham VHF sound station, using the Zenith-GE stereophonic system developed in the USA. This system is compatible—i.e., the stereophonic signals can be reproduced monophonically by a conventional VHF receiver. The main purpose of these transmissions, which will continue for about ten weeks, is to enable an engineering assessment of the Zenith-GE system to be made under service conditions, in particular to allow a check to be

carried out of the service area for stereophonic reception. The Wrotham Third Programme transmitter (91.3Mc/s) is being used for the experiments with an effective radiated power of 120kw.

There are four regular transmissions each week and each transmission consists of a setting-up period lasting about five minutes, followed by the playing of stereophonic recordings. The setting-up period consists of four speech items from different positions in the following order: centre, left, right, centre.

The service area of the stereophonic transmissions is somewhat less than that for the normal transmissions from Wrotham and in the fringe of the service area the stereophonic effect may not be realised without an efficient receiving aerial.

The _____ *Savoy* _____ VHF TUNER

THIS EQUIPMENT IS THE SUBJECT OF ONE SIDE OF THIS MONTH'S FREE BLUEPRINT.

By W. J. Delaney

THE Savoy tuner, which forms the subject of one side of this month's Free Gift Blueprint has been designed on novel lines, as may be seen from the circuit. Firstly, it utilises a commercial type of tuner of the switched type, being pre-set to five stations. Two of these are for the local TV transmissions (A.M.), and the remaining three the standard BBC F.M. transmissions. Accordingly, the turret requires critical adjustment and this is carried out by the manufacturers, so that part of the main alignment troubles of an F.M. tuner are already overcome.

Outputs

Secondly, the I.F. stages are based on normal lines, but after the detector, which is of the Foster Seeley type, the output may be taken direct to an amplifier or pre-amp, or fed to either of these via a cathode follower, and it will be seen on the blueprint that there is a broken line between these two points (A) indicating the fact that the circuit may be terminated on either side of it, as well as after the cathode-follower (B).

This divides off the power supply, and indicates that if desired, the mains section may be dispensed with and the tuner fed from a power amplifier. There are thus two alternative schemes available, and when building the tuner the chassis may be cut down in size to suit the actual unit which is to be used.

I.F. and Detector

The tuner is fed direct to the I.F. section which consists of two stages—the first an EF89, the gain

of which is controlled by the AGC line, and the second an EF80.

The next stage is the limiter, which also employs an EF80, and the output from the previous stage is tapped off between these two and the signal

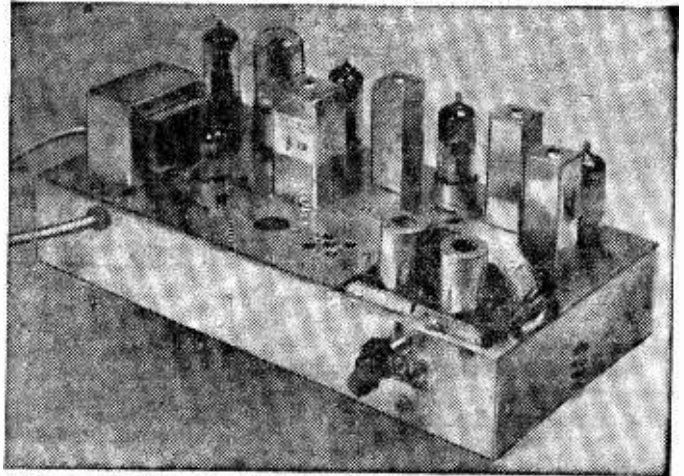

The finished tuner.

rectified by a simple diode with I.F. filter and taken to one side of a simple change-over switch. The output from the limiter is taken through a special discriminator transformer to a simple double-diode valve from which it is fed to the other side of the change-over switch previously referred to.

It will be noted in the circuit that the arm of this switch is on the line "A", and the signal at this point may be either the F.M. or A.M.—

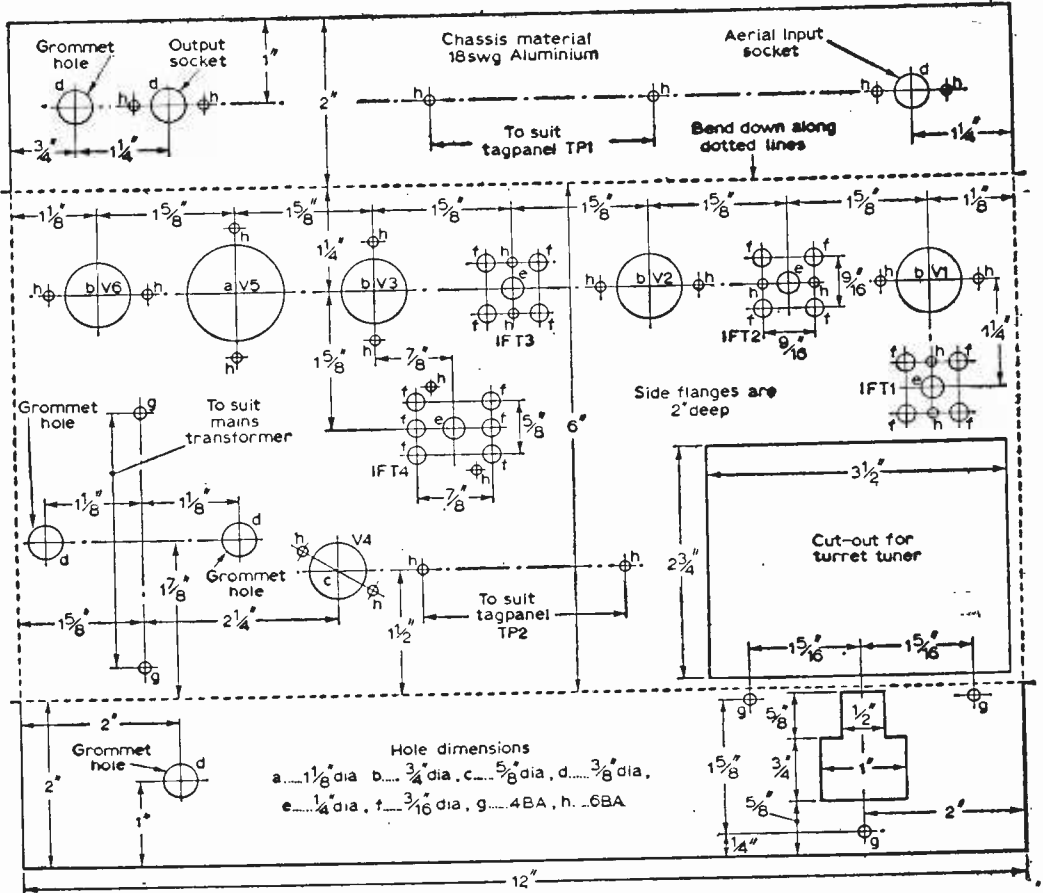

Fig. 5—The drilling details of the chassis.

according to the position of the switch—and is taken either to the pre-amp or the cathode-follower.

Construction

Having decided on the type of tuner which is required the chassis should be drilled as shown in Fig. 5, noting particularly the cut-out for the turret. Some care is necessary here, as if the cut-out is too large, the chassis will be weakened, whilst if too small, difficulty will be experienced in fitting the turret without distorting it. When the chassis has been drilled grommets should be fitted as required, and then the actual work of wiring commenced.

For this, it is preferable to make up the two tag-boards first. These should be fully wired, and the appropriate extension leads attached. Note particularly here that if the A.M. section is not required (owing to the use of an alternative turret of the all-F.M. type) the tag-panel 2 may be suitably shortened, and one of the output coupling condensers omitted.

Capacitor C17 is shown at two points, (a) and

(b). If the cathode follower is dispensed with, then the output is taken direct from C17(a). The capacitor marked C* in Fig. 4 is important from the point of view of stability, and may give more stable working on F.M. if transferred to a position over C16, R19 etc.

Wiring and Turret

Proceed with all the wiring as shown in Fig. 4, and only when this has been completed and checked should the turret be mounted and wired. Fig. 6 shows the position and colour coding of the leads of this, and in conjunction with Fig. 4 there should be no difficulty.

Just one word of caution when connecting up the leads on the turret. The AGC lead (coloured green) is attached on the turret to a resistor, and care should be taken when taking out the green lead to the short tag-strip not to pull the lead so that the resistor comes into contact with the valve screen and thereby introduces a short-circuit.

Switch S2 may be of any preferred type, either a simple toggle, or a rotary with long spindle—depending upon how you intend to mount the

chassis on completion. By using screened leads for the three points on the switch it is possible to mount the switch on a control panel remote from the chassis, and this was the idea behind the prototype.

The switch was then mounted close to the main control on the turret, but if desired an ordinary toggle may be mounted in place of the grommet in Fig. 4 and the three leads terminated there.

Alignment

When wiring is complete, the tuner is ready for alignment and the first task is to check carefully for any short-circuits or left-out connections. Go over the circuit carefully, and check with a meter for any H.T. shorts. When satisfied that everything is in order, alignment may commence and it

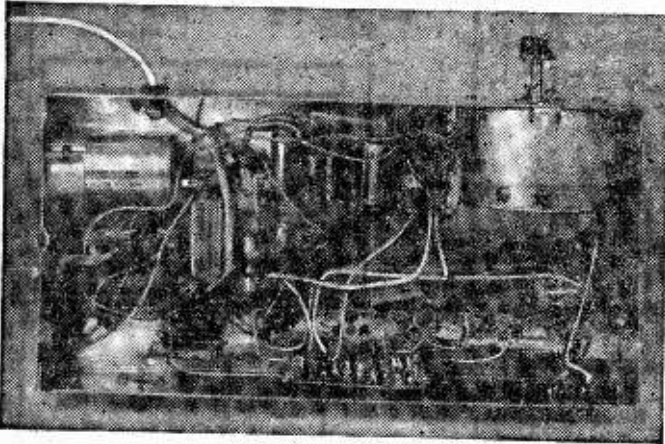

An underside view of the tuner.

should be stressed here that the turret and the I.F. transformers (with the exception of the discriminator transformer) are pre-aligned by the makers and should not be adjusted in any way at first.

Insert the various valves as shown in Fig. 4 and switch on. As soon as the valves have reached normal temperature some sound should be heard at all the five settings of the turret. Note carefully that this has twelve positions, and therefore a number of these will not be productive of signals.

Ideally, alignment should be carried out using a wobulator and oscilloscope. If this equipment is not available, an ordinary A.M. signal generator and high resistance (10,000Ω/V or more) testmeter can be used.

Clip the negative lead of the meter to the chassis, and join the other lead to TP1 via a 100k resistor, the ends of the resistor being clipped off to about ½ in. to avoid detuning effects.

Then loosen the screening can on V2 and slip a small roll of paper under it so that it encompasses the valve, and replace the can just short of the skirt. In other words remove the can slightly so that it is still over the valve but is not earthed.

Clip the signal generator lead to the can through the hole in the top and this will provide ideal input coupling without upsetting the tuning. Tune the signal generator to 10.7Mc/s. The I.F. transformers should now be adjusted to provide a fairly wide response centred round the intermediate frequency—say a width of 150kc/s.

As these transformers are over-coupled a staggered response will not be possible—that is, it will not be possible to tune one primary to say, 10.64 and its secondary to 10.74 and so on. However, with patience a nicely squared response may be obtained—but use a long thin plastic trimming tool, not a screwdriver.

The Discriminator

We now come to the most tricky part of the trimming, namely the discriminator transformer.

The meter should be transferred to T/P2. The trimmer at the lower end of the transformer (secondary) should now be adjusted down to zero and a careful note made when the meter pointer arrives at the end.

The two leads must now be changed on the meter and the trimmer again adjusted until it starts to increase. (A centre-reading meter would indicate the passage of current from negative through zero to positive.) Make quite certain that you have the zero point accurately defined and then adjust the trimmer so that there is a very small residual positive voltage—not exceeding ½ V.

Now adjust the trimmer on top of the transformer (this is the primary) to show a maximum reading, and return to the secondary trimmer and adjust this for absolute zero. Return again to the top trimmer and make certain there is no improvement possible and the tuner is then set up.

On no account should the trimmers on the turret be adjusted until station reception has been

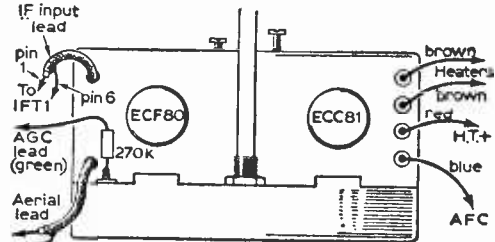

Fig. 6—Connections from the turret tuner unit

obtained at all five positions. If there is any distortion present on one station only, then the trimmer for that may be adjusted through the hole in the turret screen, but it should only need the slightest movement, and if this is ineffective, attention should be paid to the adjustment of the L.F.'s.

See page 589 for Components List

A HOME-MADE HI-FI OUTPUT TRANSFORMER

BY W. GROOME

THE USE OF A TERTIARY FEEDBACK WINDING ARRANGEMENT SIMPLIFIES THE CONSTRUCTION OF THIS TRANSFORMER AND REDUCES THE COST.

(Continued from page 502 of the October issue)

THE section diagram of one of the author's tertiary-wound transformers is shown in Fig. 12, which may seem, at first glance, to be as complex as the conventional high quality product, but it is really quite a simple job for the enthusiastic home constructor. Sections 1 and 7 are only of 20 turns each spaced to form single layers and the secondary (4) is a simple winding of about a hundred turns. The primary is so arranged that sections 2 and 5, serving one valve,

any audibly detectable loss of quality occurs. Because of this, a departure has been made from the usual rigid specification that limits the amateur's choice of material (and reduces expenses because core material is far from cheap) and constructional details will be given which can be adapted to material that is available or easily obtainable.

Stripping down an old component is one way of obtaining laminations, and wire too. It can bring a slight simplification in the job of re-winding, because, as stripping proceeds, the turns per layer, and the number of layers can be counted and so the number of primary turns to put on for power-handling at least equal to, and probably better than, the original component can be discovered. It will be a useful guide, but not quite all of the wire will go back on because two single-layer tertiary windings, some extra insulation and a possible loss of compactness owing to hand-winding, will use up some space. The sacrifice need not be too great, and the turns-ratio (if it must be the same) can be maintained.

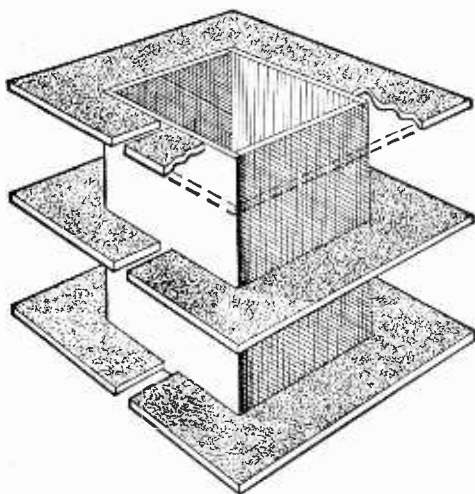

Fig. 10—The construction of the bobbin.

match 3 and 6 for the other much more accurately than the more usual arrangement in which only the number or turns—and nothing else—can be matched.

Laminations

The amateur's main difficulty is obtaining core material, for very few dealers carry laminations in stock and the delivery for small orders of one or two stacks seems somewhat lengthy. Fortunately, the tertiary-wound transformer is so stable, so free of trouble in the use of heavy negative feedback, that quite generous tolerance is permissible in the choice of laminations before

Former

The constructor who does not resort to using old components will have to make decisions on wire gauge and number of turns, but some guidance will be given. The transformer needs a special cheeked and partitioned bobbin in place of the simple former most often used, and this, shown in Fig. 10, can be made at home from paxolin, Perspex or even cardboard. Cardboard bobbins look rather the worse for wear on completion of the winding but can be made to serve the purpose.

Set the dimensions by measurement of the stack of laminations. The end cheeks and the central partition are identical, and can be slotted to enable the leads to be brought out if rigid material is used. Alternatively, with cardboard, they can be brought out through holes pierced with a needle as winding proceeds. A bobbin made for a core of square section will wind more smoothly than one made for a rectangular stack. A geared hand-brace makes a useful winder when clamped in a vice. Check the gear ratio by counting the chuck revolutions for one turn of the handle. Fig. 11 shows one simple way of fitting the bobbin to the chuck. It comprises a woodscrew driven into a piece of wood of the same size and section as the core; the head is then removed.

The gadget must be made accurately, otherwise it will revolve with a wobble that will cause overlapping turns and snapped wires. Try cutting the wood oversize and paring it to exact size after fitting the screw.

Ratio

Almost the only simple aspect of transformer design is the turns ratio, which is given by (Z_p/Z_s) where Z_p and Z_s are respectively the valve output impedance and the nominal loudspeaker impedance. All others are so complex that no single specification can be offered when the object is to enable the constructor to use available materials. Nor would it be helpful to present a page of formulae with an invitation to the constructor to sort it out himself. Because of these difficulties, and because the tertiary-wound transformer is tolerant to a reasonable range of variation, a procedure that seems rough and ready is given but which will prove satisfactory. A general description of the method will be given first, followed by step-to-step winding instructions.

Refer to Fig. 12, which gives a cross-section of the windings with the core on the left and the partition seen horizontally. The cheeks, which would be horizontal at top and bottom, have been omitted to avoid confusing the leads in the diagram. All sections are balanced equally each side of the secondary winding (section 4), and therefore this section must be positioned accurately half-way through the depth of the winding space. Allowing for four layers (at the most) of 20 or 22 s.w.g. enamelled wire plus paper interleaving and Empire cloth insulation, the secondary will occupy 0.20in. of winding space, of which 0.10in. will lie either side of the true mid-point.

Mark these boundaries on the outsides of the cheeks near the slots, or on the insides if they are not slotted. The inner marks indicate the limits of sections 1, 2 and 3. There, with all insulation layers, they must stop, regardless of the number of turns wound on because an equal space is needed for sections 5, 6 and 7. As all four primary sections are equal, the number of turns on section 2 can be multiplied by 4 and the product divided by the required turns ratio to give the number of turns that must be wound on for the secondary (section 4).

Turns

Reference to standard wire tables will give advance guidance as to the likely number of primary turns that can be accommodated. The width between one cheek and the partition divided by the wire diameter gives the number of close-wound turns per layer. The section depth less 0.05in. for insulation gives the actual winding space. Add 0.003in. to the wire diameter for interleaving paper and the layer thickness is obtained. The total number of turns is then given by

$$\frac{\text{Winding space} \times \text{turns-per-layer}}{\text{Layer thickness}}$$

From 3000 to 3500 turns is a fair total for a primary winding and the gauge can be chosen from the range 32 to 38s.w.g. to suit the available space. If the original gauge of wire is used with an old component, it will be found that the

number of turns is less than the number removed.

Use laminations of reasonably good quality and aim for a core section of about 1/2in. square for 5W and up to 1 1/2in. thickness for 10W. Make the bobbin to suit and mark the secondary boundaries on the cheeks. Wind section 1 (Fig. 12) straight on to the bobbin, 20 turns only, spaced to occupy the full width, passing the partition so that 10 turns lie each side of it, Gauge (25 to 30s.w.g.)

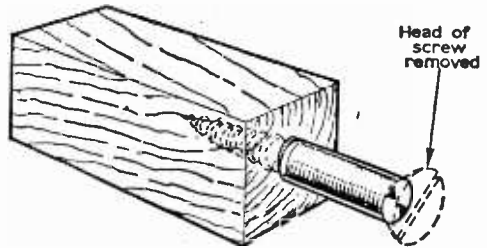

Fig. 11—A suitable bobbin holder for use with a geared brace for winding.

is not very important because the feedback network draws virtually zero current and only a few milliamps of V1 cathode current passes through the winding.

Insulation

Fasten the wire ends to the cheeks with adhesive tape to prevent them becoming tangled as winding proceeds. This section will operate near to earth potential, but the next will have a wide A.C. swing; therefore, three layers of 0.005in. Empire cloth should be wound on for insulation. It also provides an even surface on which to commence the next winding.

The first primary layer for section 2 should be close-wound to fill the width between one cheek and the partition. Note the number of turns, add a layer of 0.003in. paper and continue to add similar paper-interleaved layers until it is obvious that the addition of three layers of Empire cloth will fill the allotted space up to the boundary mark. Calculate the total number of turns.

Section 3 is identical to section 2 but, as it serves the other valve of a push-pull pair, it must be wound in the reverse direction. Simply take the bobbin off its temporary wood core and put it on the other way round; then, rotation of the winder need not be reversed. This section, complete with insulation, should

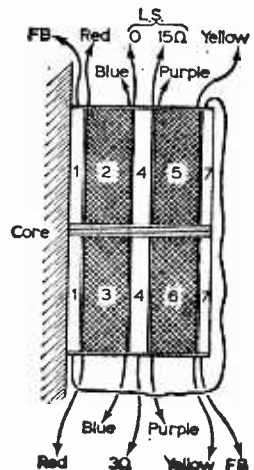

Fig. 12 (right)—The arrangement of the sections.

end up level with section 2 on the other side of the partition.

Calculation

Next is the secondary, section 4, and the number of turns has to be calculated. The number of turns in section 2, multiplied by 4, gives the total primary turns and this figure divided by the turns ratio, gives the number of secondary turns. For example, if section 2 has 750 turns and the ratio required is 30:1 the calculation is

$$\frac{750 \times 4}{30} = 100$$

The secondary must be wound evenly right across the bobbin, passing the partition as it extends from cheek to cheek. If the last layer

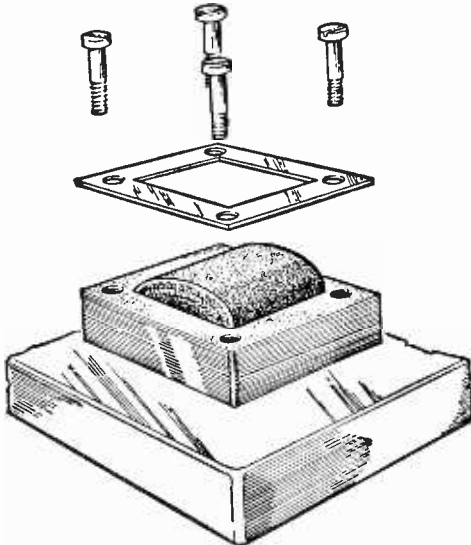

Fig. 13—A method of clamping the finished transformer to the amplifier chassis.

has insufficient turns to fill its full width the turns must be spaced evenly to distribute them equally each side of the partition. A 3Ω tap can be made at 50% of a 15Ω secondary provided it can be arranged near a cheek. This is impossible with a three-layer secondary and easy with a two-layer one when the wire gauge is chosen to fill the width exactly. In a four-layer winding, the second and fourth can be spaced evenly so that the tap can be at a cheek and the balance maintained.

When the secondary has been insulated with three layers of Empire cloth, the remaining winding space should equal that used for sections 1, 2 and 3. Wind section 5 exactly the same as section 2 and in the same direction. Section 6 must be wound in the same direction as section 3. These sections, with three-layer insulation, should leave just enough space for the outer tertiary winding which is identical with section 1 and wound in the same direction. Three more layers of Empire cloth complete the work of winding.

The end of section 1 and the beginning of section 2 should be soldered together, leaving two leads which should be sleeved. The flimsy

primary wires should be anchored and colour coded immediately, those from each cheek being a separate one-valve set. Sleeve them, using the colours indicated in Fig. 12, and then bind the sleeves firmly to the insulated windings with adhesive tape, or tape coloured leads to the insulation and solder the wires to these. If the securing is delayed until after assembly of the laminations, tag-strips can be fitted to the transformer mounting.

Assembly

Insert the laminations with the E's and I's in alternate directions, and butted together without gaps. Firm clamping is essential to avoid buzz and chatter. Fig. 13 shows a transformer dropped into a rectangular hole in the chassis and clamped into a plate with a rectangular hole bolted through the laminations.

In all circuits to which this versatile transformer can be applied, sections 2 and 5 together form the load for one valve of a push-pull pair and for straight anode loading they are put in series by joining the blue and purple leads together. Yellow is then taken to the anode and red to H.T. Sections 3 and 6 are used in exactly the same way with the other valve. Ultra-linear loading is obtained by taking the screens to the junctions of the blue and purple leads.

THE "SAVOY" COMPONENTS LIST

Resistors: (all $\frac{1}{2}W$ unless otherwise stated)

| | | |
|-----------------|----------|------------------|
| R1 33k | R9 10k | R17 2.2M |
| R2 4.7k | R10 68k | R18 220k |
| R3 100 Ω | R11 1M | R19 100k |
| R4 1M | R12 1.5M | R20 1k 2W |
| R5 22k | R13 1M | R21 680 Ω |
| R6 4.7k | R14 47k | R22 8.2k 1W |
| R7 47k | R15 120k | R23 1M |
| R8 220k | R16 120k | |

Capacitors: (all ceramic unless otherwise stated)

| | |
|----------------------------------|-------------------------|
| C1 0.01 μ F paper | C4 1000pF S.M. |
| C2 0.005 μ F | C5 47pF S.M. |
| C3 0.005 μ F | |
| C6 0.05 μ F paper | |
| C7 0.005 μ F | C9 0.005 μ F |
| C8 0.05 μ F | |
| C10 0.05 μ F paper | |
| C11 270pF | C12 100pF |
| C13 0.05 μ F paper | C14 47pF |
| C15 8 μ F elec. | C16 100pF |
| C17a 0.05 μ F paper | C17b 0.05 μ F paper |
| C18 and C19 32+32 μ F elec. | |
| C20 8 μ F elec. | |
| C21 0.005 μ F | C22 0.005 μ F |
| C* 0.05 μ F paper (see text) | |

Valves:

| | | |
|---------|---------|---------|
| V1 EF89 | V3 EF80 | V5 6J5 |
| V2 EF80 | V4 EB91 | V6 EZ80 |

Transformers:

| |
|---|
| T1 Mains transformer: 250-0-250V, 60mA and 6.3V, 2A |
| IFT1, 2 and 3 I.F. transformers (Jason) |
| IFT4 Discriminator transformer (Jason) |

Switches:

| |
|--------------------|
| S1 On/off switch |
| S2 S.P.D.T. switch |

Miscellaneous:

Valveholders. Two tag boards. Two coaxial sockets. One diode (see text), etc.

Vintage-Model or F.M. Tuner?

By E. Dexter

JHE writer has followed the lively discussion regarding "Vintage Models" in Letters to the Editor in the past months with considerable interest. Having considerable practical and theoretical experience on this subject, it is felt desirable to add a finalising word to this interesting discussion.

What Is Good Tone?

There can be only one real criterion for good tone, and that is to obtain reproduction as close to the original as possible.

The person taking this question at all seriously should therefore first of all visit (a) an opera, (b) a symphony concert, and (c) a jazz concert, and listen very carefully and very critically to the general frequency balances and tonal pictures involved in reality.

He will notice several things then apart from the condition for distortion-free reproduction, which are all too often forgotten in the design of electronic music-reproduction installations. The two most important of these are the reverberation—its time and its frequency—selection, i.e. the "acoustics" of the listening room, and the geometric dimensions of the sound source, which are normally very large in any concert orchestra, etc., and *some attempt* must be made to imitate these dimensions in the home-installation if life-like reproduction is required. Thus at least two loudspeakers are needed, well separated from each other—preferably at least two yards apart. If these are fed with stereo-signals in the conventional way, so much the better, but this is by no means essential, as surprisingly great improvements result from proper use of a normal mono-signal in such an arrangement—and present-day radio programmes are still "mono" anyway!

Acoustic Influences

The dimensions of most domestic rooms being quite small, and the reverberation of these selecting very often the higher frequencies (with average surfaces, furnishings, etc.), the result of operating an amplifier with true balanced bass and treble response, such as is possible only from modern F.M. transmission, easily leads to the accumulation of considerable treble-energy as standing-waves, etc., in the room, leading to "screeching" in the ears of the listener, which is naturally unpleasant. Furthermore, such conditions can even overload the human ear, giving cross-modulation products of bass and treble within the ear, which are felt as real distortion.

SOME INTERESTING NOTES ON THE RESPECTIVE QUALITIES OF A.M. & F.M. RECEIVERS.

On account of these facts, an old vintage set giving ample bass response, and virtually no treble (because such sets are generally fully incapable of real treble response, A.M. transmissions not containing such anyway, for reasons already explained by other writers) naturally sounds far more *pleasant* in such domestic rooms than a poorly-installed and acoustically mismatched, but otherwise superb, $\frac{1}{2}$ HF F.M. hi-fi installation. In this sense, the writer fully agrees with the vintage-model supporters, though he nevertheless feels they are missing something! There is a world of difference between a "pleasant" tone and "good" tone in the sense defined above. "Good" tone is naturally pleasant, but "pleasant" tone need not be "good" in all cases. Those vintage-model owners who do not believe this should make a comparison between a live concert in the concert-hall and the reproduction of the same or a similar transmission on their sets. Both will sound pleasant, but the live-performance will certainly give the better enjoyment, and make the vintage-model owner think and wonder whether his set really is the best possible after all!

Geometric-Dimensional Improvements in Domestic Rooms

If full-frequency range reproduction in a domestic room is to sound natural, i.e. a balanced natural reproduction of all frequencies from about 30c/s to at least 15kc/s, the geometric size of the sound source *must* be increased, to avoid danger of the screeching-effect already mentioned, which invariably sends the owner running to turn down the treble-control, or to condemn the set!

The simplest, cheapest and most effective method discovered and used by the writer is to give his audio amplifier two identical but fully separate output stages. These are fed from a common pre-amplifier stage or stages, with the tone-controls and volume controls, an independent set of controls for each output stage, between this pre-amp and the respective output stages.

The one output stage feeds a good loudspeaker, as large as possible, in the cabinet of the set, and the other output stage feeds a good large extension-loudspeaker at least two yards away in the same room. Positioning the loudspeakers as for stereo, relative to the listener, gives very good results.

Volume controls and tone controls for the two channels are individually adjusted for the best "apparent size" of the sound-source, maximum brilliance, and general best acoustic match to the qualities of the room. Both loudspeakers should

handle all frequencies to some extent, but the one should be a little stronger on bass, and the other a little stronger on treble, which tends to give the impression of separation in space between various types of musical instrument.

Performance is certainly not identical to the concert-hall, and also certainly not equal to true stereo, yet it is a *vast* improvement on a simple one-speaker installation, and is probably essential in that it represents the bare minimum of extra equipment necessary to make proper use of VHF F.M., doing justice to such transmissions.

Reverberation

There are various methods open to the experimenter to increase the reverberation of his listening room, to imitate the concert hall to a small extent. The best is the use of electrodynamic torsional transducer elements within his amplifier, a recent development just coming on to the market. Another method capable of success if carefully dimensioned is to use a microphone situated within the listening room, feeding its output into the same amplifier at a level below that causing self-oscillation over the resulting acoustic loop. The quality of this method is improved if the signal picked up by the microphone is fed to a tape-recorder head situated close to a playback-head, a short closed loop of tape running continuously between the two heads. The signal from the playback-head is then fed at a suitable small level back into the main amplifier. The reverberation time-constant is set by altering the separation of the record and playback heads, the tape-loop speed, or both.

Note that *very small* reverberation effects are fully sufficient. Particular caution is needed not to overdo the matter in time or intensity, as otherwise ringing signals result. A stage further is the addition of another amplifier channel for the delayed signal from the playback head, so that apart from feeding this into the main amplifier it can at the same time be fed *alone* to some additional small loudspeakers *concealed* (psychologically important; Listeners must not be able to see these further loudspeakers) at the rear of the room behind the listeners.

Note that, although this arrangement may sound complicated, it in fact uses very straightforward and inexpensive items, which can all be home-built at a most reasonable cost by the handy experimenter. The many volume and tone controls can in fact be pre-sets within the cabinet of the amplifier, and all amplifier channels included in the one cabinet. As external controls need only appear *combined* volume and tone controls, and possibly a reverberation-intensity control. Even the two-head tape-loop transducer can be built permanently into the cabinet, as it does not normally need further attention.

Psychological Factors

It must be remembered that such an installation will give a tone quality which is already *extremely* lifelike, especially in spacial dimensions. It will overpower the listener, *demanding* his attention. This is, of course, exactly what one desires when listening properly to music, yet can prove irritating if one is not really intending to listen, but just

want a "background-din" for what one is otherwise doing. In that case, the vintage-receiver type of tone again scores and is to be recommended. It is primarily a brilliant natural treble response coupled with adequate bass-balance which psychologically demands our attention. Bass alone does not share this property, and thus strong bass-lift together with strong treble-cut (vintage-model tone) does not force us to listen—one can even carry on a conversation with other listeners at the same time! Maybe some vintage-set owners like

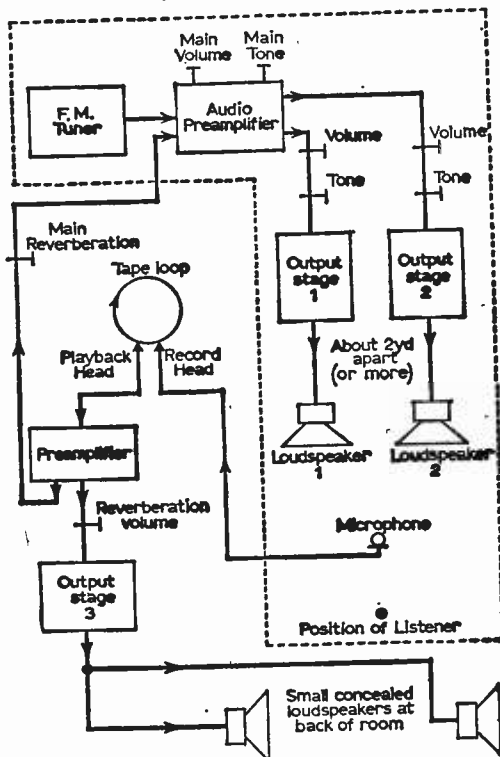

Fig. 1—A block diagram of the system used by the author of this article to obtain high quality audio reproduction.

this facility, preferring such social possibilities to intensive music-enjoyment. That is a matter of personal taste.

A further example bearing out this point is afforded by the jukeboxes appearing at so many public places of entertainment, etc. These invariably boom bass, and cut treble, even though "hi-fi" may be written on them in large letters! This is "vintage-model" tone, not hi-fi, and is of course essential in such places of public entertainment, for true hi-fi would render all other activities impossible, the sounds demanding the full attention of the listener.

Resonances

A final point to be touched on briefly is the question of loudspeaker and cabinet resonances. The cabinet must be properly designed acoustically.

ally, and the loudspeaker resonances should be damped out by using output stages with exceedingly low output impedances reflected across the loudspeaker. Using special transistor-circuits, it is possible to get high power at high power-efficiency into ordinary speakers, yet having output impedances ten times lower than the speaker impedance. This effectively short-circuits the loudspeaker as far as any signals not present in the electrical input are concerned. It should be possible with such output stages, to make the bass strong, yet crisp and clear, free of all 'hooting', 'thumping' and resonances.

Distortion in R.F. and Detector Stages of VHF F.M. Receivers

So much for the audio-amplifier side of a VHF F.M. receiver system; the points which require

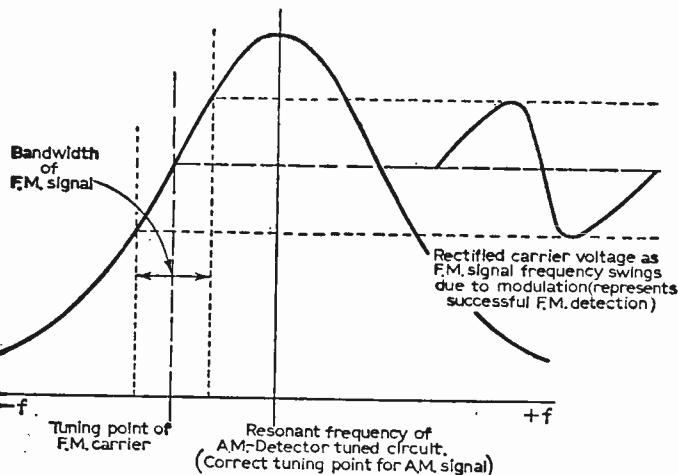

Fig. 2—Flank-detection (slope-detection) of an F.M. signal using ordinary A.M.-detector of sufficient bandwidth.

attention there have now been discussed. It remains to make sure that a proper signal is emerging from the detector.

One point which seems to go right through the readers correspondence is that, if distortion or any trouble is experienced, they blame it immediately onto the F.M. detector. This may not be correct. The detector can certainly cause distortion, but so can improperly aligned I.F. stages. This is one important difference between A.M. and F.M. receivers. Whilst misalignment of I.F. transformers in an ordinary A.M. receiver merely causes lack of sensitivity and possibly incorrect selectivity, but never any harmonic distortion. The same maladjustments in an F.M. receiver can lead to severe harmonic distortion, the same as the effects produced when operating an audio-amplifier valve on a non-linear part of the characteristic.

It is not difficult to see the reason for this. If the I.F. transformers are so far misaligned that the pass-bandwidth is narrower than the F.M. signal bandwidth, non-linear harmonic distortion invariably results. The frequency-deviation is a measure of the amplitude (volume) of the

modulating signal. Thus, with an I.F. chain misaligned as described, all is well until the modulation-depth of the signal at the transmitter represents a frequency deviation which causes the sidebands to be further separated than the bandwidth of the misaligned IFT's but beyond this point, there is firstly a loss of amplitude response, which does not matter because the final limiter in front of the detector takes care of that, and secondly a phase-shift, which most certainly *does* matter. The phase between the input signal and output signal of an amplifier employing tuned circuits as loads is zero, i.e. the signals are fully in phase, as long as their frequencies lie within the pass-band of the tuned circuits. For all other frequencies there are progressive phase shifts, which reach a maximum of 90° far off resonance. Now, if a signal of rapidly-varying frequency is

presented to such an amplifier, the frequency excursions going beyond the pass-band of the tuned circuits, then the rapid swing through the corresponding phase-shifts is identical to corresponding additions to, or subtractions from, the net frequency swing. In other words, the output signal does not have the same frequency-swing as the input signal. The peaks are flattened or elongated, which results in the typical harmonic amplitude distortion, cross-modulation of bass and treble, and general roughness in the detected audio waveform.

Those constructors having trouble with their F.M. tuners, thinking this might be the detector, should first of all check for proper alignment of the I.F. stages and adequate bandwidth. If a wobulator arrangement is not available, the set should be passed on for alignment to some person or shop possessing these facilities.

Naturally any ordinary A.M. detector will also work for F.M. provided one flank of the selectivity-curve of the associated tuned circuit is long enough on its linear portion to accommodate the entire F.M. signal bandwidth. Tuning the carrier of the F.M. signal to the midpoint of one of these flanks will then give the necessary direct correspondence between instantaneous frequency and instantaneous rectified D.C. amplitude to demodulate the signal.

Quality is naturally equally good as good as any other form of special F.M. detector—provided the flank-linearity and flank-bandwidth are adequate. However, the circuit responds excellently to A.M. interference of man-made nature and of any other nature—including valve-hiss noise from a sensitive amplifier.

Summary

An F.M. tuner, if misaligned, leads to severe harmonic distortion. A.M. sets do not possess this difficulty. Thus tone of vintage-receivers is likely to be considerably better, taken as a whole, than an incorrectly-operated VHF/F.M. installation. ■

Just Published!

RADIO AND TELEVISION TEST INSTRUMENTS

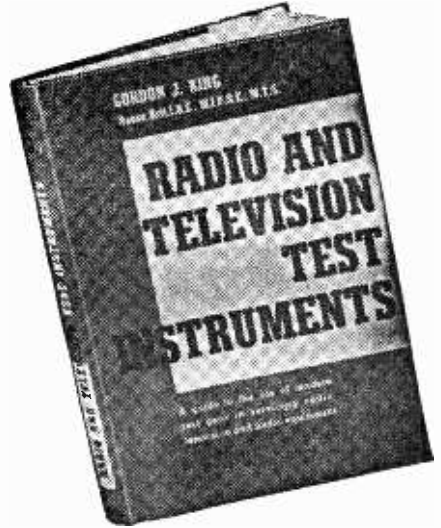

By the same author:—

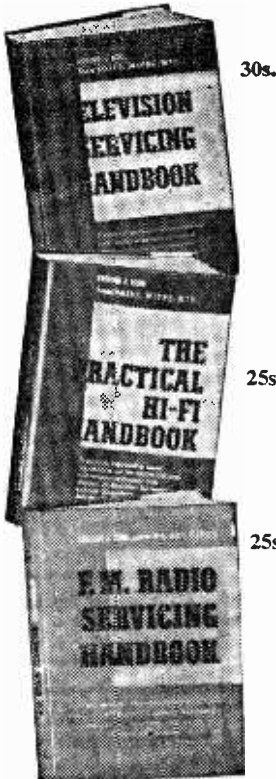

By GORDON J. KING

ASSOC. BRIT. I.R.E., M.I.P.R.E., M.T.S.

Latest in the famous series of Gordon J. King handbooks, here is a thoroughly practical guide to using standard test gear in radio, TV and audio works. Shows clearly how to solve dozens of difficult fault-finding and alignment problems—tells **everything** you want to know about 20 different types of test instruments! Here's how to get the utmost out of all your equipment. For service engineers, constructors, operators, experimenters, repair shop and laboratory workers.

176 pages. 100 circuit diagrams, oscillograms and other illustrations. **25s.**

Published by

ODHAMS



Obtainable from All Booksellers

another FINE instrument
from Salford, the

minitest

POCKET-SIZED MULTIRANGE TEST SET



A new compact instrument suitable for the measurement of D.C. voltages and currents, A.C. voltages and ohms. Its high sensitivity renders it suitable for testing and fault location in all types of electrical and electronic circuits. It is well built to ensure long and satisfactory service. The instrument is economically priced and supplied with test leads with plug connections at one end. (Leather carrying case available as an extra).

- RANGES:** A.C. Volts 2.5, 10, 25, 100, 250, 1000.
D.C. Volts 2.5, 10, 25, 100, 250, 1000.
D.C. Amps. 50 μ A, 1mA, 10mA, 100mA, 1A.
Ohms 2000 200,000 20 M Ω
- ACCURACY:** D.C. Volts & Amps \pm 3% of full scale deflection
A.C. Volts \pm 4% of full scale deflection
Ohms \pm 5% at centre scale.

Send for leaflet MIN16009/PW

neat and compact... with large instrument performance

SALFORD ELECTRICAL INSTRUMENTS LIMITED

Peel Works · Silk Street · Salford 3 · Lancs · Tel: Blackfriars 6688

London Sales Office: Brook Green Hammersmith, W.6. Tel: Riverside 5246.

A Subsidiary of THE GENERAL ELECTRIC CO. LTD. OF ENGLAND



£1 COMMISSION FOR YOU

on every ZEPHYR you Sell ★

The fabulous new contemporary styled ZEPHYR transistor pocket radio is a new concept in precision manufacture.

What a Set! It's packed with latest advancements, gets more stations with more power and what superb tone!

Show your friends... let them hold and try it and they will fall over themselves to order, earning you £1 profit again and again... that's real easy money.

Selling at £6.19.6, the ZEPHYR is a winner—large sales enable us to cut out shop discount and reduce our own profit—FOR YOUR BENEFIT—ACT NOW!

LEATHER CASE—EARPHONE & CASE—BATTERY—PRESENTATION BOX ALL INCLUDED! SECURELY PACKAGED AND SENT BY INSURED POST WITH SIGNED GUARANTEE.



Turn spare time into Cash Time—
Become a prosperous ZEPHYR
selling agent

CUT OUT AND POST TODAY

I enclose £6.3.0. Please despatch a Zephyr demonstration model, also send me details of tape recorders and other bargains which will earn me £££s, before Xmas.

NAME _____

ADDRESS _____

Post to :- ELECTRONICS, (Dept. 7), 66 Grove Road, Eastbourne, Sussex.

**NO COMPLICATED
FORMS TO FILL**

**Just send £5.19.6. Plus 3/6
Post & Ins. AND START
EARNING NOW.**

INCREASING OHMMETER RANGES

By G. A. W. Partridge

THERE are many types of resistance measuring devices, but one of the most useful is the simple ohmmeter. Resistances can be checked very quickly with this instrument, which is sufficiently accurate for most practical purposes. However, its range is limited. Some ohmmeters read from 0 to 20,000Ω. Others go up to a Megohm or more, but on the other hand some meters are scaled to a few hundred ohms only.

How can the ranges of these instruments be increased? Fig. 1 shows a simple ohmmeter circuit which can also be found in some multi-meters when they are switched to Ohms. The test leads are first shorted together and the rheostat is adjusted until the meter reads "0Ω" at full

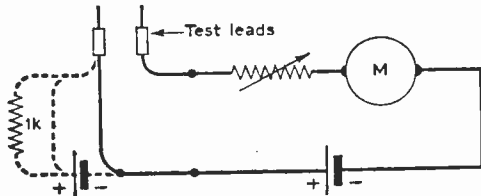

Fig. 1—A series ohmmeter circuit.

scale deflection. The test leads are then connected to the unknown resistance and its value read directly off the scale.

The range in question is from 0 to 13,000Ω and power is supplied from a 1.5V dry cell fitted into the meter. To double the range (0-26,000Ω) it is necessary only to double the voltage. This can be done quite easily by connecting another dry cell in series with one of the leads.

Make sure that the polarity is correct and that all the rheostat resistant is in circuit before shorting the test leads, or the meter might be damaged by the excessive current.

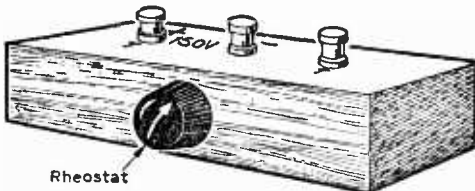

Fig. 2—The multiplier.

If the meter will not zero, add a 1,000Ω resistor to the external battery circuit, short the leads and adjust the rheostat for zero. The scale reading with or without the extra resistor will be doubled (i.e., multiply all readings by 2).

The multiplier in Fig. 2 increases the range of the instrument 100 times. So 0-13,000Ω becomes 0-1,300,000Ω. The value of the rheostat in the multiplier can be found by experiment but for a 0-13,000Ω scale it will be about 150,000Ω. 150V is drawn either from a battery or from a mains operated power pack.

The 1½V cell is taken out of the instrument and the terminal "bridged" as shown in Fig. 3. Full resistance is brought into circuit by adjusting the rheostats. The test prods are shorted and the rheostats adjusted for "zero Ohms". Resistances are now tested in the usual manner but remember in this case to multiply the scale by 100. The battery voltage has been increased by that amount.

Always multiply the scale by the number of times the voltage has been increased. The multiplier rheostat can be mounted in a box with three clearly marked terminals (Fig. 2).

Fig. 4 illustrates the potentiometer type of ohmmeter. Its range can also be doubled by doubling the battery voltage, but a small rheostat R must

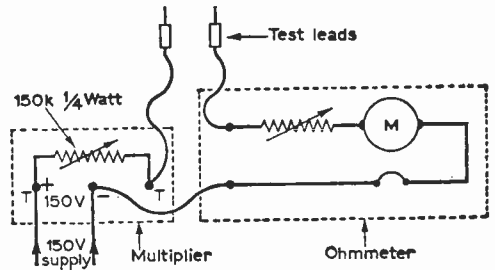
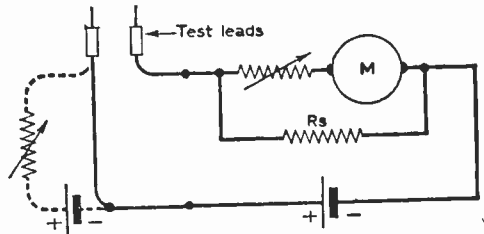

Fig. 3 (above)—Connecting the multiplier and ohmmeter.

Fig. 4 (below)—A potentiometer-type ohmmeter.



be placed in circuit to prevent overloading R_s. The ohmmeter is set to "zero ohms" on the 1.5V cell only.

The extra cell and the rheostat R is now brought into circuit and "zero ohms" again adjusted by using R and not the ohmmeter rheostat. It is now ready for checking resistors in the normal way but the scale reading is double.

The same principle applied when the range is increased to Megohms. The meter as it stands

(Continued on page 626)

THE AUDITRON

(This Instrument was previously known as the MINISCOPE—see footnote)

By M. L. Michaelis, M.A.

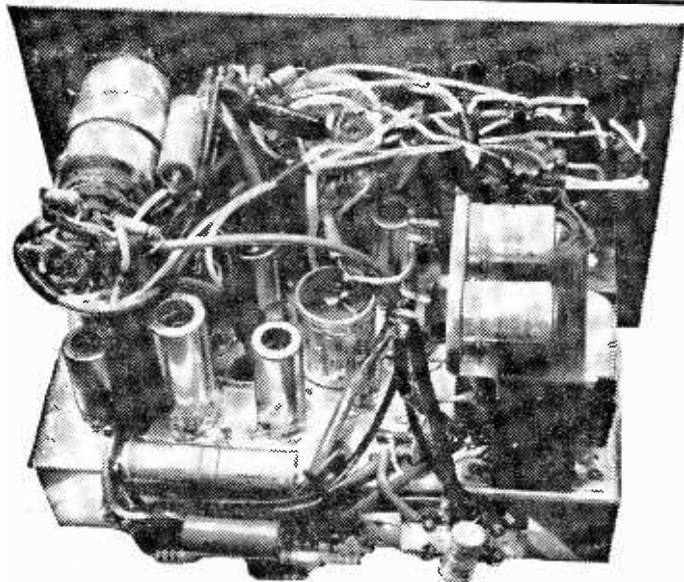

(Continued from page 514 of the October issue)

It is seen that the second stage of V2 (pins 1, 2 and 3) has also, apart from the main anode load R65+R63 feeding the CRT Y-deflection and V3, a tapping on the anode load, R63, and an equal cathode load, R68. This enables the sync-signal to be selected, via S7, with either polarity. The trigger transient needed at the timebase oscillator must be positive to be effective and thus negative at the grid of the sync amplifier. However, a negative transient at the signal amplifier input appears negative across R68 and positive across R63. A positive transient at the signal amplifier input appears positive across R68 and negative across R63. Thus, for a negative transient input, R68 gives the effective sync output and for a positive transient input R63 gives the effective sync output and the positions of S7 are labelled accordingly.

If an input signal contains steep transients of preferentially one polarity, then best sync is obtained by switching S7 to that polarity. On a sine wave either setting of S7 is equally good; the display will start with a positive half-wave if S7 is set "positive" and with a negative half-wave if S7 is set to "negative". But with inputs which are not sine waves, particularly at the upper frequencies within the range of operation of the

Auditron proper polarity on the sync switch can make all the difference between good or bad synchronisation.

Decoupling

Note the small-capacity paper condensers in parallel with the main electrolytics. These are necessary for achieving good decoupling over the entire frequency range of the Auditron as some electrolytics tend to have considerable inductive impedance at frequencies around 100kc/s.

The Signal Tracer Output Stage

R70 and C41 represent a top-cut filter, allowing only frequencies below about 15kc/s to reach V3, the signal tracer output stage, only these frequencies being properly audible, all others being of no interest at this stage. It is in general not sufficient to allow all frequencies to reach V3 and rely on the output transformer T2 to block supersonic ranges. There would then be danger of sufficient supersonic amplitudes reaching external circuits to produce various possible forms of trouble.

T2 is a perfectly ordinary small output transformer which should be designed for impedance matching from about 9k to 5-15Ω, though these values are by no means very critical. Far more important is the need for correct D.C. resistance of the primary, as this sets the operating point of V3. This D.C. resistance should be as close as possible to 500Ω. Under such conditions the linear drive which V3 will accept before onset of distortion is equal to the maximum undistorted output of V2, which just corresponds to full-screen deflection on the specified CRT. The output power from V3 is then about 50mW, which is the usual rating of headphones for full volume without giving pain to the listener and will give moderate volume on a miniature loudspeaker. If the D.C. resistance of the primary of the available transformer differs slightly from 500Ω, suitable series or parallel resistors can be used.

THE "MINISCOPE"

The General Electric Company Ltd. have drawn our attention to the fact that the name "Miniscope" is a registered G.E.C. trade mark. In view of this we have changed the name of our instrument to "The Auditron". We apologise to G.E.C. for the unwitting infringement of their trade mark.

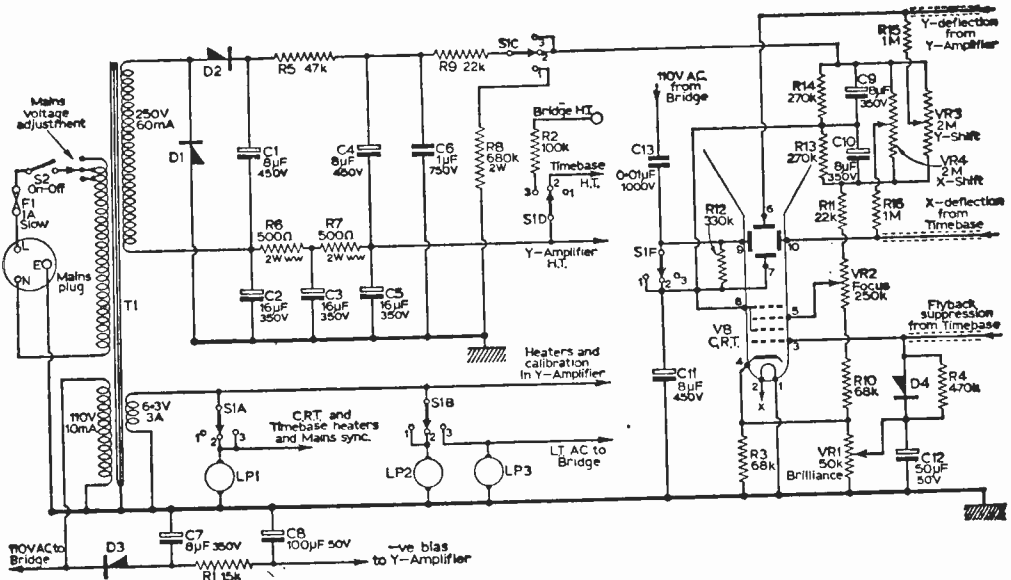

Fig. 4—The circuit of the power supplies and CRT-feed.

The Y-amplifier Voltage Calibrator

Two zener diodes connected back to back, D8 and D9, limit a sample of the heater voltage to 14V peak to peak, and any portion of this stabilised A.C. reference voltage can be fed into the Y-amplifier by means of VR11. The calibration on the scale attached to VR11 is such that it indicates the voltage which, applied to the probe, would give the same amplitude of vertical deflection on the CRT. The range incorporated is from 1V to 125V peak to peak.

The procedure to be adopted for setting any desired sensitivity for quantitative measurements is first of all to set the desired sensitivity (volts per centimetre deflection) on the scale of the calibrator VR11. With the probe point not connected to anything the gain control VR13 is then advanced until the calibrator waveform has a height of exactly 1cm on the CRT screen. The calibrator VR11 is then turned back to zero and the scope is ready for quantitative A.C. voltmeter operation; Setting the timebase trace to lie exactly on the centre line of the engraved centimeter-grid on the CRT window, by means of the Y-shift control, the moving-coil meter indicates the D.C. level represented by this line in the subsequently displayed waveform (which may or may not be zero), and the A.C. deviations through each cycle can

be quantitatively read off on account of the appropriate sensitivity calibration as just described. A word of explanation why a separate calibrator D8, D9 and VR11 is used instead of calibrating the gain control VR13 directly. The signal runs through four amplifier stages before reaching the CRT and thus mains voltage fluctua-

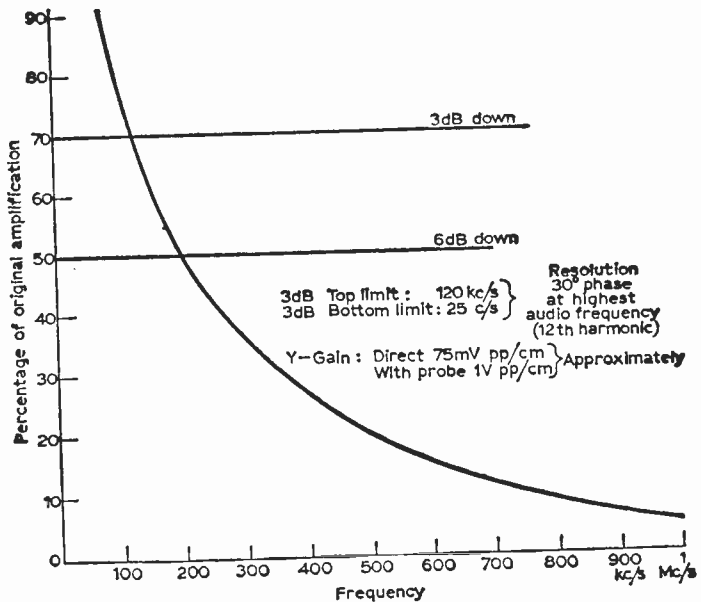

Fig. 5—The graph of the measured Y-amplifier H.F. response.

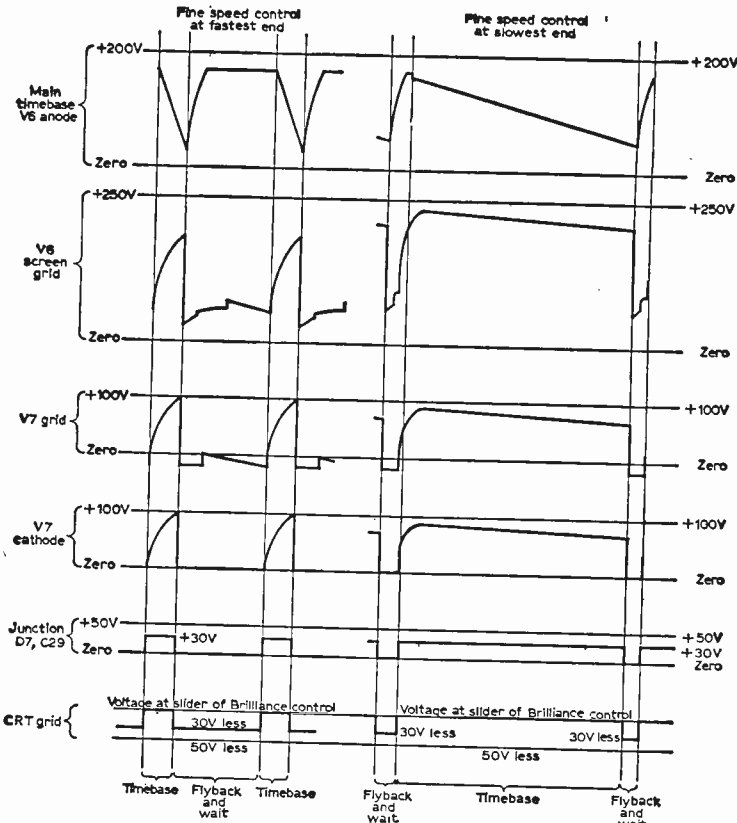

Fig. 6—The timebase waveforms when the flyback switch is set at "Long".

tions react in the fourth power into the gain, as do any ageings or deviations of the valves. The constancy would thus not be up to the accuracy achievable with the simple arrangement of D8, D9 and VR11.

Gain

There is a limit to the usable gain in an amplifier passing very low frequencies, as in the Audiron, if special stabilisation features are not used. Above this limit, which lies between about 500 to 1,000 voltage gain, "rumbling" sets in which consists of random fluttering output signals at average frequencies below 10c/s for no intentional input. Their amplitude can approach full output level in poor designs or even cause overloading. Whilst the signal tracer function would be far less disturbed, as such low frequencies are not audible and thus only possible overloadings and blockings could appear in severe cases or cross-modulation giving a fluctuatingly rough tone, the "scope" function is seriously disturbed by the slightest presence of such rumbling.

The causes of rumbling add together from chiefly two independent sources. Firstly, continuous tiny fluctuations in the local mains voltage reflect as H.T. fluctuations, which are passed on to

the grid of the first amplifier stage coupled from a previous anode circuit and then amplified through the whole amplifier chain. Secondly, electrolytics and even many metalised paper condensers manifest slight voltage fluctuations of a few millivolts (which become as many volts after amplification through a gain of about 1,000) when holding H.T. voltages of normal magnitudes, and this effect is normal and unavoidable. There is only one successful method of obtaining a rumble-free low-frequency amplifier with gain greatly in excess of 1,000 and that is to use an accurately balanced push-pull arrangement throughout. Expensive oscilloscopes thus use this type of amplifier, often augmented with electronically stabilised H.T. supplies. It was not considered to be justified to go to these expenses and complications in the Audiron.

The total gain of the Miniscope amplifier lies between 500 and 1,000 and the low value of R50 was chosen just to bring the gain down to a value where rumble is just no longer noticeable — i.e., visible random fluttering of the

CRT display just ceases. Further to this effect, the values of the coupling condensers and grid leaks throughout the amplifier were judiciously chosen so that the low-frequency response was no more than really necessary for normal audio frequency measurements—i.e., 25c/s lower 3dB down limit. Larger coupling condensers or grid leaks of twice the specified values could easily have been used, enabling superb display of really slow phenomena, but the whole display then dances about continuously unless the gain is considerably reduced. Thus, the specified component values are considered to be an ideal compromise for general purpose usage of the Audiron.

Bandwidth

The signal amplifier in the Audiron has a bandwidth of 25c/s to 120kc/s level within the usual specification of ± 3 dB. Thus, square waves are excellently displayed with fundamental frequencies anywhere in the range from 50c/s to 20kc/s, so that waveforms with fundamentals anywhere within the full hi-fi audio spectrum are accurately displayed whatever their shape may be. The Audiron is thus fully suited for any audio work and moderate frequency pulse work. It will be found useful for much television work, though

the bandwidth is not adequate for accurate display of all pulse features of television video waveforms, etc. However, all wobulator work for equipment at any frequency can naturally be performed with full success.

A signal amplifier bandwidth up to at least 2 to 3Mc/s would be essential for comprehensive TV work. This would require various inductive peaking coils and special valves to raise the Y-amplifier top limit sufficiently. These complications were considered an unnecessary burden for the average wireless experimenter for whom the Audiron is intended. It is seen that a carefully designed conventional RC amplifier, as here used, gives adequate bandwidth for his purposes and has the great merit of simplicity of construction.

The Miller-Transitron Timebase

Fig. 2 shows the complete timebase circuit for the Audiron. This uses a conventional Miller-Transitron oscillator (V6) as its heart, yet taken together with its three ancillary valves and other refinements constitutes a novel type of multi-function timebase circuit which is the outcome of careful experiments conducted specially for the Audiron during preparation of this article.

After having operated for a very long period with a simpler version of the Audiron in the workshop, and having noted all its shortcomings the present circuit may be regarded as "matured", and should be found to be very stable and reliable if the instructions given are followed carefully.

The Miller-Transitron circuit is a one-valve saw-tooth-waveform oscillator with extremely good linearity. The saw-tooth-wave is produced at the anode, and its exact form is shown in graphs 2 and 3. The anode voltage falls relatively slowly at an extremely linear rate, this fall being used to sweep the spot on the CRT across the screen horizontally from left to right, at a constant rate, to form the time axis (time-base).

After the anode voltage has reached its minimum, it returns to its maximum in a short time (the "flyback"), the spot of the CRT returning to the start at the left of the screen, ready for the next linear timebase run.

The graphs show that the flyback is not particularly linear, but that is completely unimportant, as it is not used for the display on the CRT. In fact, the purpose of V7 and associated circuitry is to render the spot invisible on the CRT during flyback, by means of applying a well-refined negative pulse to the grid of the CRT during the flyback time.

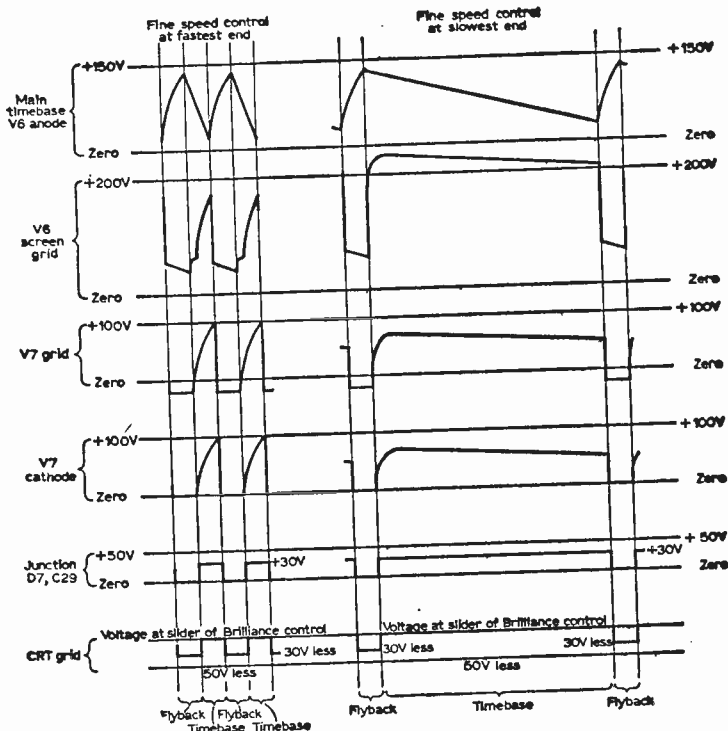

Fig. 7—The timebase waveforms when the flyback switch is set at "Short".

The other parts of graphs 2 and 3 show how the screen-grid waveform of the Miller-Transitron, which is of the rudimentary form needed for this flyback-blanking, is progressively "shaped" to the required form in the circuitry associated with V7. These graphs should be used primarily for checking operation of the Audiron when building, or in case of any necessary future repairs.

For observation, any other good oscilloscope may be used, but though this is helpful it is not essential to successfully construct the Audiron. It was only during design and refinement of the circuit that another oscilloscope was indispensable, and the observations on the finalised circuit given in Fig. 2 are depicted in the Graphs 2 and 3.

D5 serves as "anode-catch", shortening the flyback-time by removing the progressively more non-linear later portions (as the flyback is really a normal exponential charging curve). V5 diode (pins 1 and 7) serves to prevent the suppressor-grid of V6 going positive to chassis, which could otherwise cause the timebase to block and stop oscillating, erratically.

There is no reason against using a semiconductor-diode here, too, of the same type as D6 and D7. The same applies to the other diode-section in V5 (pins 2 and 5), which is used to remove any negative spikes in the synchronisation input, which could irritate V6, leaving only positive spikes which represent the correct polarity for synchronisation at V6 pin 8. (To be continued)

The Finishing Touch

LETTERING RADIO PANELS

By M. O. Sparks

THE circuitry of a unit may be first class and the construction follow the best precepts; it may out-perform its commercial counterpart or fill some need for which the manufacturers have not provided, but nine times out of ten the appearance labels amateur-built equipment as "home made". This applies particularly to home-made test gear where finished panels and dials are not generally available as they are for some designs of amplifiers and tuners. Even where the instrument is housed in a well-made case the finish of the panel, particularly the labelling of the various controls, lacks the crispness and clarity of the factory-built design. To a certain extent this difficulty may be overcome by the use of commercially available decals, but sooner or later the need for a more flexible method of labelling controls will arise.

Type Transfer System

The method of lettering control panels to be described makes use of the "Letraset type lettering system." This consists of a special type sheet from which the individual letters can easily be transferred to any surface and arranged to form any word. A large variety of type faces and sizes are available in black or white letters, figures and punctuation marks. The author's own choice is 10 and 12 pt. (pronounced "ten and twelve point") Gill Sans Bold in white and used on charcoal-grey panels. Sheet No. 3A/B contains the 10 pt. and 12 pt. sizes in both Roman (this is the professional's term for ordinary upright letters and figures) and italic faces, with the numbers of the various letters correctly adjusted so that there are more of the frequently used letters and fewer of the little used letters. The whole sheet contains over 2,000 characters and costs about 3s. 6d.

The method of applying the letters is extremely simple, the only requirements, apart from the actual transfer sheet, being a razor blade, a very fine artist's watercolour brush, a saucer of water, a small piece of blotting paper and a large amount of patience. Arrange the finished instrument with its panel horizontal and draw a fine guide line where the letters are to be placed. Cut round each selected letter on the type sheet with a razor blade and peel off the gummed tissue

bearing the letter from the paper backing. Float it on water for about one minute and then place the letter, still on its tissue backing, face uppermost in its approximate position. Hold down the tissue with the corner of the razor blade and slide the letter off into position with the brush. Final spacing of the letters is done by eye, the letters floating on the drop of water carried over with them from the soaking.

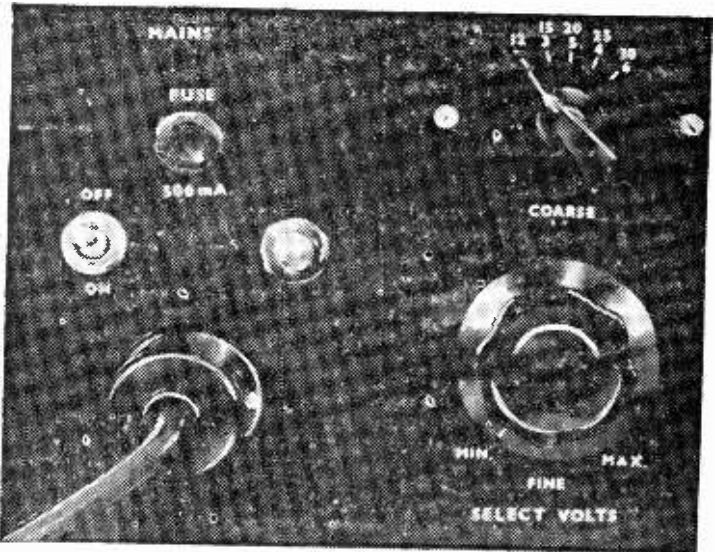

An example of the excellent results achieved with the author's method of finishing his home-constructed equipment.

When correctly positioned the surplus water is removed with the corner of the blotting paper and the lettering allowed to dry naturally. One word of warning: watch out for any odd letters which float out of alignment as they dry and coax them back into position with a wet brush before they dry out completely. The result is a label without any "background" other than the panel itself and in which all the characters are identical in size and shape, forming a perfectly matched whole.

A fully detailed catalogue is available from Letraset Ltd., 21 Webber Street, London, S.E.1., from which address single type transfer sheets may also be obtained.

It is regretted that, owing to indisposition, the usual page by "Thermion" is not available this month, but will be resumed in the next issue.

SUPERB COMMUNICATION RECEIVERS

TEST METERS FOR EVERY PURPOSE & POCKET

AMERICAN ARSSD RECEIVERS. Fresh release of these renowned sets. 14 valves, 6 wavebands, covering 500 Kc/s-32 Mc/s. Incorporate every possible refinement and have internal A.C. mains pack for nominal 5/230 v. Thoroughly reconditioned, immaculate in appearance, and in perfect working order. **ONLY £35** (add carriage 30/- and 50/- deposit on returnable transit case). S.A.E. brings illustrated leaflet.



MARCONI CR. 100/8 COMMUNICATIONS RECEIVER. Covers 60 Kc/s to 30 Mc/s. Complete with all valves, makers instruction manual, and internal A.C. Power unit for 200/250 volts. **BRAND NEW IN ORIGINAL TRANSIT CASES.** Aerial tested before despatch. **ONLY £35** (carr. etc. 40/-). S.A.E. for full details.

2,000 O.P.V. MODEL TP-10. Reads A.C. & D.C. Volts up to 1,000; D.C. Current to 500mA; Resistance to 1 Meg; Capacitance to 1µF; Decibels from -20 to +30; Output Jack for Audio Measurements. Size 3 1/2 in. x 4 1/2 in. **£3-10-6**

20,000 O.P.V. MODEL TP-55. Reads voltage up to 1,300; D.C. at 20,000 ohms per volt and A.C. at 10,000 o.p.v.; D.C. Current to 500mA; Resistance to 10 Megs.; Capacitance to 0.1µF; Decibels from -20 to +36. Size 3 1/2 in. x 5 1/2 in. **£5-10-6**

30,000 O.P.V. MODEL 500. Volts to 1,000; D.C. at 30,000 O.P.V.; A.C. at 20,000; 12 Amps D.C. Current; 60 Megs Resistance; -20 to +56 Dbs; Internal buzzer short circuit warning. Size 3 1/2 in. x 6 1/2 in. x 2 1/2 in. **£8-10-6**

All New Stock, with leads, prods, and internal batteries. 6 months' guarantee backed by full service facilities. Details S.A.E.

AMPLIFIER TYPE A1413. Ex R.A.F. For normal A.C. Mains use. 524 Rectifications with 6V5 output. Input and output jack sockets, gain control, fully fused 600 ohms output transformer easily changed for 3 ohms type. Standard rack mounting size 19" x 7" x 6". Used, good condition. **ONLY 59/6** (carriage etc. 10/6).

POWER UNITS TYPE 234. Primary 200/250 v. 50 cycles. Outputs of 250 v. 100 mA, and 6.3 v. 4 amps. Fitted double smoothing. For normal rack mounting (or bench use) having grey front panel size 19" x 7". Fitted Input and Output Voltmeter, 79/6, or model less meter 59/6. (Carriage either type 10/6.)

AVOMETER MODEL 7 LEATHER CASES, fitted with carrying handle and long strap. **BRAND NEW. ONLY 32/6** (Post 2/6).

20/- CONSTRUCTORS PARCEL. Assorted colours wiring wire, solder, resistors, condensers, volume controls, tag panel, ALL NEW. (Post 2/6).

RESISTORS. 100 assorted values our choice. **NEW 10/-**

CONDENSERS. 100 assorted mica & silvermica. **NEW 12/6.**

PCR COMMUNICATION RECEIVERS

Manufactured by Pye & Philips. One of the Army's most versatile and sensitive sets. RF stage and 2 of L.F., using 6 British L.O. type valves. Large 180 degree illuminating and Calibrated Dial. Flywheel Tuning with locking device. Aerial Trimmer. Tone and Vol. Controls. Band Switch from panel jacks for speaker or phones, in black metal case, size 17 1/2 in. L x 8 in. H x 10 1/2 in. D. Model PCR covers 6-18 Mc/s. 200-550 metres and 850-2,000 metres and has internal 5-in. speaker. **£6-19-6.** Model PCR has similar L & M waveband coverage. Short wave 6-22 Mc/s, but no speaker. Used but excellent condition **£5-19-6.** Every receiver aerial tested before despatch. Add 10/6 carr. all models. Designed to operate from bulky EXTERNAL power supply, but any set can be fitted with **BRAND NEW COMPONENTS INTERNAL PACK** for 200/250 v. A.C. at extra cost of £2.

S.A.E. FOR ILLUSTRATED LEAFLET

"P.W." 6 TRANSISTOR PERSONAL RECEIVER



Designed by the technical staff of Practical Wireless: easy to build, using printed circuit and 1st Grade Matched Transistors and Diode. Full Medium and Long Wave coverage to internal speakers. All parts sold separately (new components only) enabling you to buy as required and full detailed price list will be sent on request. Constructional details 1/6.

Newly designed OSMOR Cabinet and reduced price. **TOTAL COST INCLUDING BATTERY and CABINET NOW £7-10-6.** "P.W. TROUBADOUR 7" Parts List, S.A.E.

THE "GOOD COMPANION" Mk. II

USING TRANSFILTERS, THE LATEST MANUFACTURING TECHNIQUE TO SAVE ALIGNMENT DIFFICULTY THE FINEST COMBINED PORTABLE AND CAR RADIO YET DESIGNED FOR THE HOME CONSTRUCTOR

- 750 mw output.
- 6 transistors and 2 diodes.
- Full Medium and Long Wave coverage.
- Quality speaker.
- Brilliantly styled 2-tone cabinet, size 11 x 8 x 3 in.
- Very fine tuning with calibrated dial.
- Latest printed circuit.

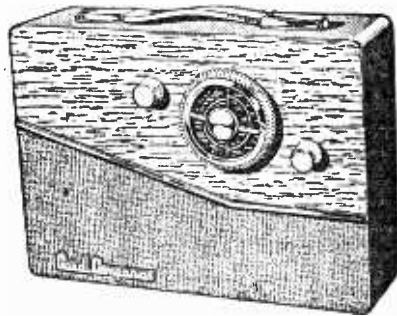

● Internal high gain aerial with car aerial socket. Easy to follow construction data (available separately 3/6). All parts sold separately and full illustrated details will be sent on request.

£9.19.6.

Total Cost
With alternative luxury cabinet using 7 x 4 in. speaker, **£10-19-6.** Either type, plus 5/- post and ins. (Battery 3/6 extra.)

"POCKET 4" TRANSISTOR RECEIVER



Uses miniature speaker, proper tuning condenser, and volume control. Built-in aerial makes unit efficient and portable. Ideal for the beginner. Full medium wave coverage. All components and case for only 42/6 (p. & p. 2/6). Ten-page constructional book free with parts or separately 1/6. S.A.E. for parts price list.

HARRIS ELECTRONICS (LONDON) LTD 138 Gray's Inn Road, London W.C.1
Phone TERminus 7937

Please include carriage costs on all items. (Open until 1 p.m. Saturdays). We are 2 mins. from High Holborn (Chancery Lane Station) and 5 mins. by Bus from King's Cross.

Armstrong QUALITY TUNERS

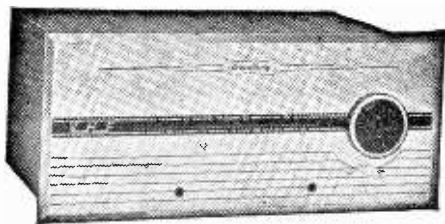

- T4B FM TUNER** (illustrated) £21.18.0
T4C FM TUNER (without case) £19.19.0
ST3 MK.2 AM/FM TUNER £27.16.0

We also make a wide range of high fidelity amplifiers and tuner-amplifiers, both mono and stereo, all of which offer top quality performance at reasonable prices.

Write for descriptive literature (quoting Dep't PNT) to

ARMSTRONG, WARLTERS ROAD, LONDON, N.7.

NORTH 3213

Designed to match
any amplifier or
tape recorder

The T4B model (and uncased version—T4C) is a self-powered high fidelity FM Tuner. Automatic frequency control ensures complete stability and the cathode follower stage, together with the variable output control, enables it to be used with any amplifier or tape recorder. All these features are to be found also in the ST3 Mk.2 AM/FM Tuner together with coverage of the medium and long wavebands. The AM section includes a ferrite aerial and two IF stages ensuring good Continental reception, and there is a miniature bright-line indicator for easy tuning.

The case of the T4B Tuner is covered in maroon vinyl-hide, making an attractive shelf-mounted unit.

Microwaves
Circuit Design
Motors and
Generators
Electrical
Engineering
Transformers and
Chokes
Valves and
Transistors
Sound
Reproduction
Cathode Ray
Oscillograph
Transmission and
Modulation
Electromedicine
Transmitters and
Aerials
Electronics in
Industry
Radio Receivers
Navigational
Equipment
Television
Interference and
Suppression
Radar

RADIO and ELECTRONICS

Edited by J. H. Reyner, B.Sc., D.I.C., M.I.E.E.

Student and specialist alike need a book which will give them the fundamental applications of radio and electronics in an easily digestible form, and this book has been produced with that need in mind. In these two well-illustrated volumes a team of electronics experts show you the theories and techniques, the methods and materials of this exacting science, from Acoustics to X-rays. You cannot hope to keep all of radio and electronics in your head, but you can keep *Radio and Electronics* on your bookshelf.

This most important book can be yours for a few small monthly payments under the New Era scheme. If you are interested in it, why not send us this application form? We shall then send you a brochure giving further details and explaining our free inspection offer, which lets you look through the book in your own time before you decide whether you want it. It's easy—and there's no obligation to buy.

APPLICATION FORM

To New Era Publishing Co., (Dept. N.2),
45 New Oxford Street, London, W.C.1.

Please send me further details of 'Radio and Electronics'

Name _____
(BLOCK LETTERS PLEASE)

Address _____

Date _____ Age (if under 21) _____

Radio Components and their Functions

(Continued from page 485 of the October issue)

LAST month's article gave a component-by-component analysis of a battery-operated TRF receiver. The mains-operated counterpart is akin in principle, but uses mains-type valves and a mains power supply system. Certain components, therefore, may differ slightly in value from those considered in the previous article, but this is solely so that they will suit the mains valves in terms of operating conditions.

How the components differ in value will be almost totally revealed when we consider the mains-operated superhet later in this article, but before going on to that, and for the sake of completeness, the mains power section of a TRF set will first be considered.

Such receivers are invariably designed for operation on A.C. or D.C. mains supplies, and Fig. 3 shows the basic arrangement employed. R1 is the mains dropping resistor, which could be either a large wire-wound component on a ceramic former or a line-cord. When it is a line-cord, the on/off switch S1 would be connected at the set end of the resistor, and not at the mains end as shown. The resistor is required to set the current in the series-connected valve heaters to the correct value for the particular class of valve adopted.

For example, suppose that the valves have an 0.3A heater rating (they must, anyway, have the same current in a series chain, though the voltage is relatively unimportant), that V1 and V2 have a 12V rating and V3 and V4 a 25V rating. This adds up to a total of 74V. Now, if the mains voltage is, say, 230, then R1 would have to drop 230-74V, which is 156V.

It has to do that with a current of 0.3A flowing, so by Ohm's law is it easy to find the value required for R1. In this particular example, R1 would be equal to 156 (the voltage to be dropped) divided by 0.3 (the heater current in amperes), which works out to 520Ω.

The wattage rating of the resistor is also important, and it must be at least equal to 156 (the voltage dropped) times 0.3 (the heater current in amperes), which is almost 47W. This represents quite a large resistor which will dissipate a fair amount of heat. Alternatively, the line-cord, if used, must itself be rated at 0.3A, and it must be trailed out to avoid overheating.

Some mains droppers, and even line-cords, have a tap for connecting to the anode of the rectifier valve V4, as shown in Fig. 3. Section "A" serves the dual functions of surge limiting and voltage dropping for the rectifier. Thus, instead of the rectifier anode being in receipt of the full mains voltage, a smaller value as required is picked up from a lower potential point down the resistor, towards the heaters. This section also limits heavy surge currents in the event of the set being switched off and then on again before the rectifier has had a chance to cool off.

By K. Royal

Three-way Cord

On some models a three-way line cord is used, as shown in Fig. 4. The end of the resistive element connects to the heater chain, via the on/off switch S1, the black lead connects to chassis, via the other pole of S1 and the red lead connects either direct to the anode of the rectifier valve or through a 100Ω surge limiting resistor. At the mains input end of the line-cord, the red and resistive cables are joined as shown.

Included in the series chain may be a thermistor and a pilot lamp. The thermistor has a negative temperature co-efficient. That is, its resistance falls considerably as its temperature rises. This compensates for the heavy rise of heater current which would otherwise occur when first switching on due to the low resistance of the valve heaters, which increase in resistance as they warm up. The thermistor thus ensures that the current progressively rises to the normal value in the chain as the valve heaters warm up.

If a pilot lamp is used, this must have a current rating equal to that of the valves themselves, and the voltage must be taken into consideration when computing the value for R1. It is current practice to shunt the pilot lamp in a series-connected chain with a thermistor.

The idea of this is to prevent the set from failing in the event of the lamp fusing. Owing to the high "cold resistance" of a thermistor, it bypasses very little current from the bulb under ordinary conditions, but if the bulb should fuse all the chain current would be passed by the thermistor. It would thus get hot and reduce in value, and in that way keep the heaters alive.

The remaining items in Fig. 3 are C1, C2 and R2. C1 is the reservoir capacitor, which is an electrolytic usually valued at about 16μF and rated at 275V. C2 is the smoothing capacitor. This is also an electrolytic and may, in fact, partner C1 in a common case. R2 is the H.T. smoothing resistor. This component usually has a value of 1,000Ω, or perhaps a little higher, and is rated between 1 and 3W, depending upon the set's H.T. current.

The Mains Superhet

A typical circuit of this kind of receiver is given in Fig. 5. It is for AM-only, with V1 the frequency changer, V2 the I.F. amplifier, V3 the A.F. amplifier and detector, V4 the output valve and

V5 the H.T. rectifier. The aerial signal is applied to the aerial coupling coils L1 (S.W.) and L2 (L.W. and M.W.) via the isolating capacitor C1. On A.C.-only sets, as this one is, C1 would have a value of around $0.001\mu\text{F}$ and would be rated at 350V.

In the "S.W." position, switch section S1 simply shorts out the aerial coil on the L.W. and M.W. assembly. This avoids a loss in S.W. signal strength, and ensures that all the S.W. signal picked up by the aerial is fully coupled to L1 secondary.

Coil L5 and the trimmer C33 form a wavetrapp circuit adjustable over the set's intermediate-frequency. This avoids I.F. breakthrough (e.g., the pickup of interfering signals at the i.f.), since at the tuned frequency the wavetrapp "looks" like a short-circuit between aerial and earth, this being the normal characteristic of a series tuned-circuit.

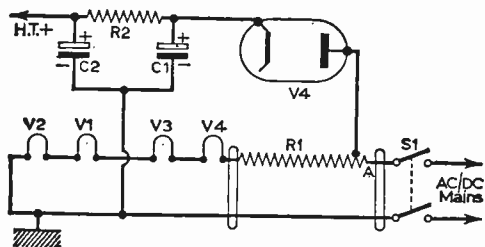

Fig. 3—The power supply circuit of a typical TRF A.C./D.C. model. R1 may be either a wire-wound mains dropper on a ceramic former or the resistive element in a line-cord. The valves are usually connected in the order shown to reduce the effects of hum.

Switch section S2 selects the required L.W., M.W. or S.W. tuned winding and directs the signal as tuned by C7 section of the tuning gang to the signal grid of V1. C2 is the M.W. trimmer and C4 the L.W. trimmer. These are adjusted during realignment for maximum sensitivity at the high-frequency ends of the appropriate bands.

C5 holds the bottom of the L.W. and M.W. coil assembly (L2 secondary) down to chassis from the R.F. point of view, whilst also acting as isolation for AGC. It will be seen that AGC is applied via R5 to the signal grid of V1 via L2 and S2. In the S.W. position, however, AGC is removed, since L1 secondary is terminated direct to chassis.

C5 has a value of the order of $0.002\mu\text{F}$, which gives a sufficiently low impedance at R.F. and acts to a small extent as a fixed padder for enhancing the tracking towards the low-frequency ends of the LW and MW bands. C3 in conjunction with R1 provides a small amount of bottom-end coupling on the M.W. and L.W. bands. R1 is about $1,000\Omega$ and C3 $0.02\mu\text{F}$.

A degree of fixed bias is applied to V1 by the voltage drop across R2, this making the cathode of the valve positive with respect to the signal grid. The triode section of V1 is not biased in that way since the grid is returned direct to the cathode through the grid leak R3.

R2 is in the region of 220Ω , and the capacitor across it (C9) has a value of $0.05\mu\text{F}$. This gives a low impedance path to the R.F. signal across R2,

thereby completely masking the effect of the resistor from the signal point of view.

Local Oscillator

L3 is the S.W. and M.W. oscillator coil, while L4 is the L.W. oscillator coil, these being selected by the ganged switch sections S3 and S4. The coils provide a feedback path between the anode and grid of the triode oscillator section of V1, and the oscillator frequency is tuned by the oscillator section of the tuning gang C17. The trimmer C18 is for tuning the S.W. band during alignment. This is partnered by C7 trimmer also on the gang. Trimmers C14 and C11 are for the L.W. and M.W. oscillator coils respectively, while C13 and C15 are the M.W. and L.W. padders respectively.

The trimmers are adjusted for correct dial calibration at the high-frequency ends of the bands, while the padders are adjusted for correct calibration at the low-frequency ends of the bands. The padders always have a greater value than the trimmers (and are thus larger), an example being 700pF for the M.W. padder and 50pF for the M.W. trimmer.

Coupling is provided to the oscillator coils by C12 in the grid and C16 in the anode, typical values being 60pF and 100pF respectively. C12 forms a time-constant with the grid leak R3 ($47\text{k}\Omega$) to give optimum oscillator activity over the three bands. Poor or intermittent oscillator activity is often attributable to a faulty C12 or C16. Grid current flows in R3 when the triode is oscillating, but since the current is very small a microammeter is required to detect it.

However, the current in the anode is far greater, occurring through the anode resistor R4 ($22\text{k}\Omega$) and can be measured on a normal milliammeter

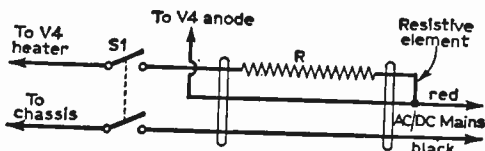

Fig. 4—This diagram shows the use of a three-way line-cord in an A.C./D.C. TRF receiver.

by connecting at the top of R4, as marked by "X" in the circuit. When the oscillator is working correctly, there should be a distinct change in anode current when a short is applied across the oscillator tuning gang (C18). If there is no change in current, then the oscillator is defective.

The anode of the mixer section of V1 is fed with H.T. voltage through the primary of the first I.F. transformer T1. This is tuned to the I.F., currently 470kc/s , being the difference between the incoming signal and the local oscillator. Tuning is accomplished by the trimmers across the windings, though in some transformers a fixed capacitor is used and the associated winding is tuned by a dust-core.

The I.F. signal is applied to the control grid of V2 via the secondary of T1, and there is no fixed bias on that valve since the cathode is connected direct to chassis. The bottom end of the secondary winding is held to chassis signal-wise by the $0.1\mu\text{F}$

C19, which also provides isolation for the AGC bias.

The second I.F. transformer T2 is tuned in a like manner and the secondary winding is connected to the diodes in V3. These rectify the I.F. signal, and extract the modulation across the load resistor R8, which is the volume control valued at $0.5M\Omega$. Residual I.F. signal at that point is by-passed to chassis through the $100pF$ C20. There are two components of the signal across R8; one if the A.F. signal and the other a direct-voltage due to rectification of the I.F. carrier.

The former is coupled to the grid of the A.F. triode in V4 through C21 which also isolates the

electro-chemical characteristics of the valve. The cathode is therefore taken direct to chassis.

R10 is the triode anode load ($270k\Omega$) across which the amplified A.F. signal is developed. This is fed through the coupling capacitor C23 ($0.01\mu F$) to the control grid of the output tetrode. This valve is biased by the voltage developed across its cathode resistor R12. The cathode is made positive by the amount of the voltage drop relative to control grid which is held to the chassis end of R12 via the $1M\Omega$ grid-leak R11.

R12 has a value of 270Ω , but is not by-passed with a capacitor. This means that there occurs a small A.F. signal across the resistor, and this as

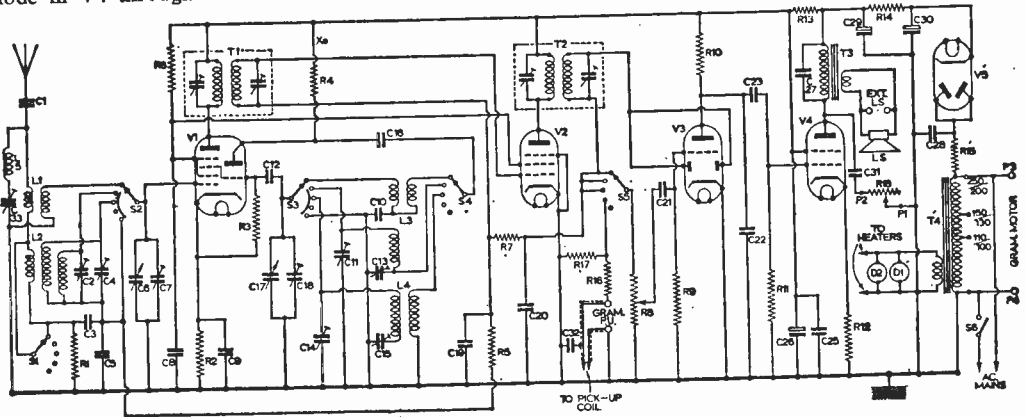

Fig. 5—A complete circuit of a mains-operated superhet receiver.

direct-voltage. The latter, however, is used as AGC bias, and is fed through R7 ($1M\Omega$) to the control grids of V1 and V2. R7 can have a high value since the grid circuits are adequate help to chassis from the signal aspect, as we have already seen. The high value also helps to get rid of any residual I.F. which may be present at the output of the detector.

The AGC bias can be measured with a voltmeter, but owing to the high impedance circuits involved, the meter must have a sensitivity at least as high as $10,000\Omega/V$. A meter of smaller sensitivity would damp the AGC circuits and probably decrease the voltage to a level which is not recordable. The loading would, of course, also upset the operation of the AGC circuit.

It will be found that the voltage rises negatively (with respect to chassis) when a strong signal is tuned in. This negative voltage biases the valves and thus causes their gain to fall, thereby avoiding overloading. On weak signals the bias is negligible and the valves work at full gain.

S5 switches out the detector load in the "gram" position and switches in the pick-up and associated equalising components comprising R16, R17 and C32. The pick-up signal is effectively applied across the volume control, and is thus fed via the slider to the grid of V3 triode, as is the radio A.F. signal.

The triode is biased due to a small difference in potential which is developed across the $10M\Omega$ grid-leak R9. This is often called "contact potential biasing", it being a function of the

well is reflected back into the control grid circuit out of phase with the applied signal from V3. In that way, negative feedback is applied to the output valve and hum and distortion are reduced.

The anode of the output transformer T3, the turns ratio of which is selected as described in Part 1 of this series. C27 ($0.02\mu F$ 450V paper) across the primary of the transformer attenuates the higher order harmonics (e.g., harmonic distortion) produced by the output valve. Variable tone control is given by C31 in series with the tone control R18 ($0.05\mu F$ and $50k\Omega$). This circuit reduces the higher audio frequencies at an amount increasing with decrease in R18 resistance.

The set features a fully isolated mains transformer for the valve heaters, but the H.T. circuit is connected direct across the mains primary of the transformer, between receiver chassis and the parallel-connected anodes of the rectifier V5.

R15 is the surge limiting resistor, the purpose of which is given in the first part of this article. R14 is the smoothing resistor, and is a 2W component valued at $1,000\Omega$. C30 is the $16\mu F$ electrolytic reservoir capacitor, while C29 is the main smoother of like value. Further smoothing is provided by R13 ($1,000\Omega$) and C26 ($8\mu F$ electrolytic). C25 is connected in parallel with C26 to by-pass the inductive effects of the latter.

Although C25 is only an $0.1\mu F$ it effectively offers a low impedance to any R.F. or I.F. which could develop across the electrolytic.

(To be continued)

universal test oscillator

By R. Murray-Shelley

A MINIATURE TRANSISTORISED INSTRUMENT

MOST signal generators which are used for test purposes are designed to produce a note of one specific frequency together with a relatively small number of harmonics of that frequency. In this piece of test equipment, a deliberate attempt has been made to produce an oscillator having as many harmonics of the fundamental frequency as possible in its output. The use of such an instrument is at once apparent—it is invaluable for the testing of almost all types of radio receivers and amplifiers, since a signal from the oscillator can be injected into the circuit under test at any point, whether in a radio frequency or audio frequency stage, and, if the circuit is in order, will produce a response in the output.

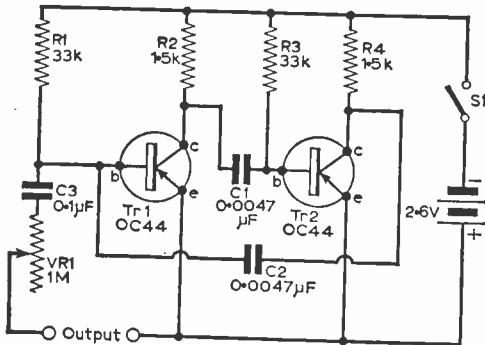
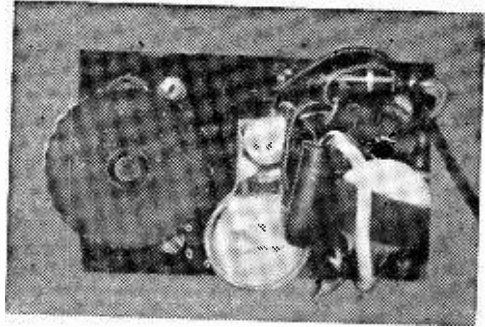

Fig. 1—The circuit.

The circuit employed in this equipment is, in the main, quite conventional. It is the well-known multivibrator arrangement which produces square waves (Fig. 2). If a square wave is analysed, it is found to be composed of a very large number of odd harmonics of the basic frequency. If the fundamental frequency lies in the audio spectrum, then harmonics extending well into the radio frequency bands will be produced. In this design transistors capable of operating up to many megacycles are used, and, as a result, although the fundamental frequency is of the order of four kilocycles, harmonics have been detected at frequencies of several megacycles.

Method of Construction

A fairly novel method of construction is suggested. This makes use of a small piece of



The prototype instrument

paxolin board to form a type of "chassis", the components being mounted on this as shown in the wiring diagram (Fig. 4). It will be seen, from Fig. 3, that the whole oscillator is extremely small.

Components

A study of the circuit diagram, Fig. 1, shows that there are, in fact, relatively few components. Construction is simplified if miniature or even sub-miniature parts are obtained, but the prototype was built, using quite conventional components throughout.

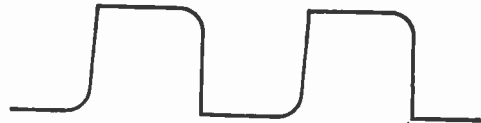

Fig. 2—The output waveform.

The resistors are normal $\frac{1}{4}$ W components of 10% tolerance. The exact values used are not particularly critical, any changes in R2 and R4 merely serving to alter the fundamental frequency of the oscillator. Care should be taken, however, to see that both R2 and R4 have approximately the same value otherwise a reduced output will result.

The condensers C1 and C2 are of the disc ceramic type, though here again their characteristics are not particularly critical. The output of the unit can be adjusted as regards amplitude by the control VR1. This is a miniature volume control of the type which are used in hearing aids etc. If a really small oscillator is required, then this refinement could be omitted, though it is useful for carrying out comparative gain tests on amplifiers in particular.

The transistors call for some mention. It has already been explained that radio frequency types are used in order to accentuate the higher frequency harmonics and make the oscillator suitable for testing the radio frequency and intermediate frequency sections of radio receivers. Almost any types of R.F. transistors will prove to be suitable.

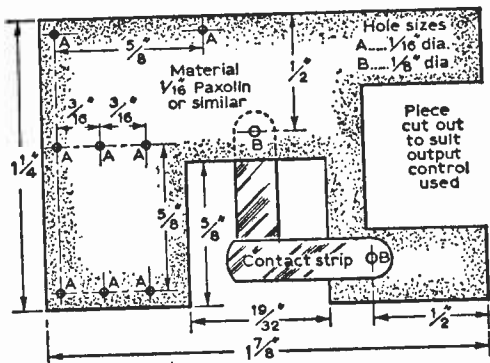

Fig. 3—The drilling details of the paxolin chassis.

The prototype used OC44's, since these were to hand. Whatever types are decided upon, it is important to ensure that both of the transistors have more or less the same characteristics.

Power Supply

The power requirements of the oscillator are very modest, only 2mA at a potential of 2.6V. The smallest and most convenient source of power comes from two mercury cells. These cells are eminently suitable since they will provide a very steady current at a constant potential throughout their working lives which may amount to many hundreds of hours. The case of the cells forms the positive terminal, and the smaller electrode is negative. The specified cells should not be heated in any way. The battery mounting is shown in detail in Fig. 5. Great care should be taken to ensure that the polarity of the supply battery is correct, otherwise damage to the transistors may result.

Construction

The construction of the equipment is quite simple provided elementary precautions are taken

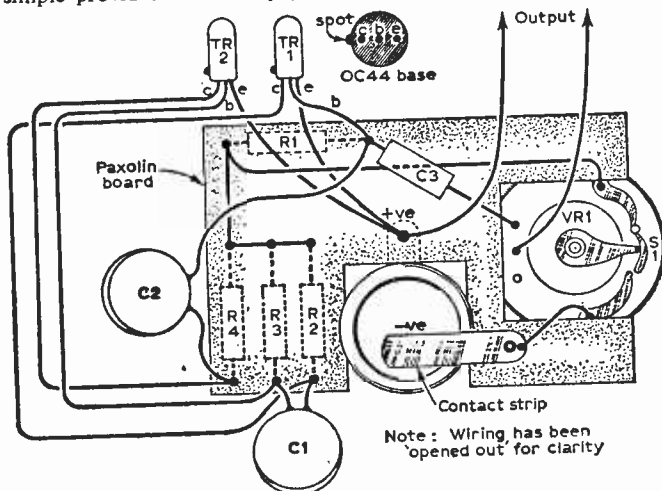

Fig. 4—The complete wiring diagram.

COMPONENTS LIST

- Resistors (All 1/4W components)**
 R1 33k R3 33k
 R2 1.5k R4 1.5k
 VR1 1M miniature potentiometer with switch, S1
- Capacitors**
 C1 0.0047µF ceramic
 C2 0.0047µF ceramic
 C3 0.1µF 150V
- TI, T2 OC44 transistors**
Battery Two Mallory type 625 mercury cells
 Paxolin board, small pieces of spring brass, etc.

to avoid overheating components—particularly the transistors.

The paxolin "chassis" is first prepared. The dimensions of this together with all the necessary drilling instructions are given in Fig. 3. Paxolin is rather a brittle substance and care is needed when working with it. It is most easily cut using a fret-

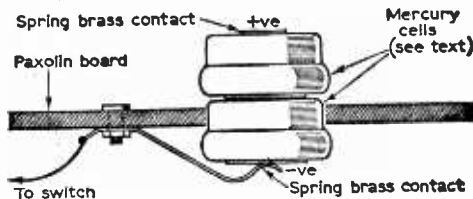

Fig. 5—The method used to mount the mercury cells.

saw or a fine-toothed hacksaw blade. The mounting of the output control depends on the nature of the control itself and thus some improvisation will be required on the part of the individual constructor. The battery clips are made from pieces of springy brass obtained from old 4½V dry cell batteries. These are bent to make contact with the cells, and also to help hold them in position. The brass strips are bolted on to the chassis and connecting wires soldered to them.

The component wires are cut fairly short and they are inserted through holes in the board as shown in Fig. 4. The wiring is very compact and for this reason alone the constructor should be careful to see that there are no shorts between components. The transistor leads should be kept as long as is possible and insulated with sleeving. A thermal shunt in the form of a pair of long nosed pliers must be used when soldering the transistors. Note that the mercury cells should only be inserted after the rest of the wiring is complete.

The output from the unit is taken via two flying leads, though small terminals could be substituted in their place if thought to be necessary.

Using the Oscillator

When the oscillator is used to test an amplifier or radio receiver.
 (Continued on page 614)

The MAYFAIR Pre-amp

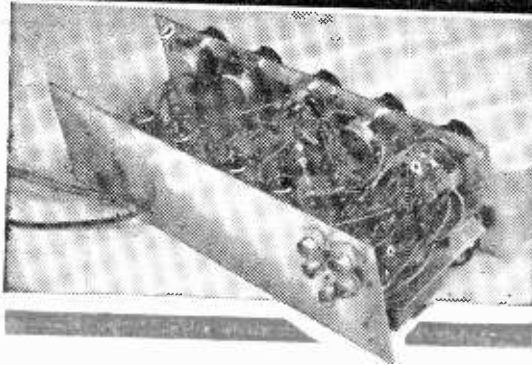

A VERSATILE CONTROLS
A HIGH QUALITY, PERFORMANCE

by F. E. B

THE Mayfair pre-amplifier has been designed for use with the Strand power amplifier and incorporates the kind of features normally expected in a versatile high quality reproduction system. It is, of course, also suitable for use with other power amplifiers requiring an input not in excess of 250mV for full output.

This pre-amplifier will accept inputs from magnetic and crystal pick-ups, radio tuners, tape recorders and microphones. Separate input sockets are provided for these five different categories of programme source and an appropriate equalisation network is brought into operation at each setting of the input selector switch.

A treble filter circuit with a choice of three roll-off frequencies (3, 9 and 20kc/s) is included. This switched filter is particularly useful for reducing

surface noise on certain records, and at its lowest setting it will assist in the elimination of interference and whistles on radio programmes.

The low frequency response of the pre-amplifier is deliberately reduced just below 20c/s in order to eliminate motor rumble and other undesirable L.F. effects. Wide range tone controls allow the bass and the treble response to be either boosted or cut to meet individual preferences and to suit acoustical conditions in the listening area.

With the tone controls in the level position, and the treble filter set to 20kc/s, the overall frequency characteristic of the pre-amplifier is substantially flat from 30c/s to 20kc/s.

A double-pole mains on/off switch is wired to a plug at the rear of the instrument so that connection can be made to the mains terminal block in the Strand power unit, thus allowing the whole amplifying system to be controlled from the pre-

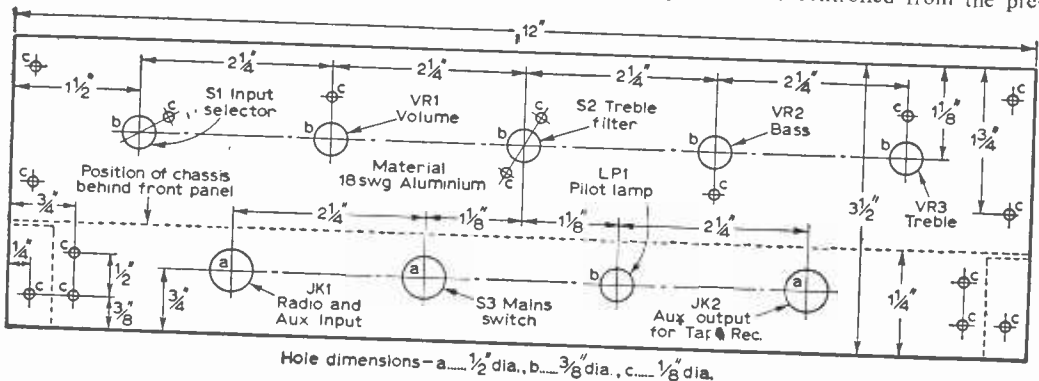
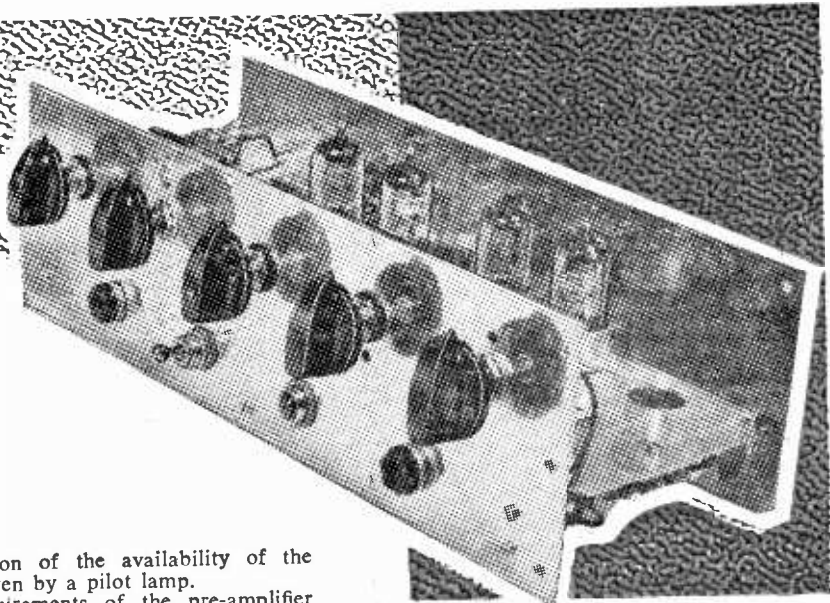

Fig. 6—Front panel drilling details.

ifier

OL UNIT, FOR NER AMPLIFIER

nnett



amplifier. Indication of the availability of the mains supply is given by a pilot lamp.

The power requirements of the pre-amplifier are as follows: H.T. 350V 7mA; L.T. 6.3V 1A. These supplies are usually obtainable from the associated power amplifier unit, and are fed into the pre-amplifier through a four-core cable. The cable plug PL2 as specified in the components list is suitable for mating with the auxiliary power outlet sockets on the Strand power unit.

Details of the five input channels and the kind of programme source for which each is suited are given below. The sensitivity figures quoted are for a 20W output from the power amplifier.

Radio and Auxiliary Input

Connection may be made at JK1 or SK1. Insertion of jack plug into JK1 automatically disconnects the coaxial socket SK1 from circuit. This input is suitable for radio tuner outputs, the sensitivity is 250V, and the impedance 1M Ω . No frequency compensation is applied and therefore the response is linear.

Other alternative uses are: (1) for the connection of a high output crystal pick-up (2) for tape with a replay speed other than 7 $\frac{1}{2}$ in./sec, or having a recording characteristic different to C.C.I.R.

Tape Input

The input at SK2 is for use with pre-recorded tapes, replayed at 7 $\frac{1}{2}$ in./sec with high impedance heads. Bass boost is provided, approximately in accordance with C.C.I.R. curve. The sensitivity at 5kc/s is 3mV and the input impedance 80k Ω .

Microphone Input

High impedance (crystal) microphones may be connected directly to SK3; or moving coil type via a matching transformer. The response characteristic is linear. Sensitivity is 6mV and impedance 1M.

Magnetic Pick-up Input

The sensitivity at SK4 is 6mV for microgroove (L.P.) and 13mV for 78 r.p.m. The impedance is

100k Ω . Separate equalisation arrangements are provided to suit the requirements of current recording standards (R.I.A.A.) for both L.P. and 78 records.

Crystal Pick-up Input

The sensitivity at SK5 is 85mV for microgroove (L.P.) and 250mV for 78 r.p.m. The impedance is 100k Ω . Bass cut is introduced in this input circuit so that the resultant signal has a characteristic similar to that of a magnetic pick-up; this facilitates the equalisation arrangements.

Circuit Description

Four high-gain, low-noise pentodes type EF86 are employed in this circuit. The five coaxial input sockets SK1-SK5 are connected to the input selector switch S1A via series resistors. The value of each resistor has been chosen to adjust the input sensitivity and impedance of the pre-amplifier to suit a particular type of programme source.

The first pentode amplifier stage V1 provides frequency compensation or equalisation for the various inputs by means of a feedback loop between anode and grid, the appropriate feedback components being selected by S1C. The two remaining sections of the input selector switch are used for muting purposes and are wired up in such a manner that the input sockets immediately adjacent to the required input are taken to earth by the rotors S1B and S1D. This arrangement minimises any likelihood of signal break-through when a number of signal sources are permanently connected to the pre-amplifier.

Continued over...

Output from V1 anode is taken via C8 to the volume control VR1, the slider of which feeds the grid of V2. An auxiliary output at a suitable level for applying to the input of a tape recorder is made available at JK2. This auxiliary output is approximately 200mV and will match a tape recorder having an input impedance of not less than 500kΩ.

Treble Filter

The second valve is triode connected, and feedback is applied via low-pass parallel-T filter networks which are brought into circuit between this and the following stage by S2C and S2D (positions 1 and 2). Associated with these filter networks are the phase shift capacitors C12, C13 and C14, C15 which are connected into the grid circuit of V2 by S2A and S2B.

Due to the phase lag introduced by these capacitors, the feedback over this stage is positive at frequencies below the resonant frequency of the filter network, while at frequencies above resonance the feedback becomes negative.

Consequently the response characteristic of this stage has a slight rise just below the filter network frequency and then a steep fall off of more than 20dB per octave. The roll-off frequency, i.e. the point at which the response is 3dB down, is 5kc/s for switch position 1, and 13kc/s for switch position 2. In the third position of S2, a single T-section filter comprising R32, R33 and C25 gives a

Fig. 7—Rear panel drilling details.

fairly sharp cut-off at 20kc/s.

Rumble Filter

The third valve is also triode connected and like its predecessor provides little gain; its main purpose is to reduce the response below 20c/s through the use of a high-pass parallel-T feedback network comprising R34-37, C26-28. The combined effect of this circuit and the comparatively small value inter-stage coupling capacitor C18 results in a 30dB per octave fall-off below 20c/s in the overall frequency response of the pre-amplifier.

Tone Controls

A frequency dependent negative feedback tone control network is connected between the input and output of the final stage. The two variable elements of this network, VR2 and VR3, are the bass and treble tone controls respectively.

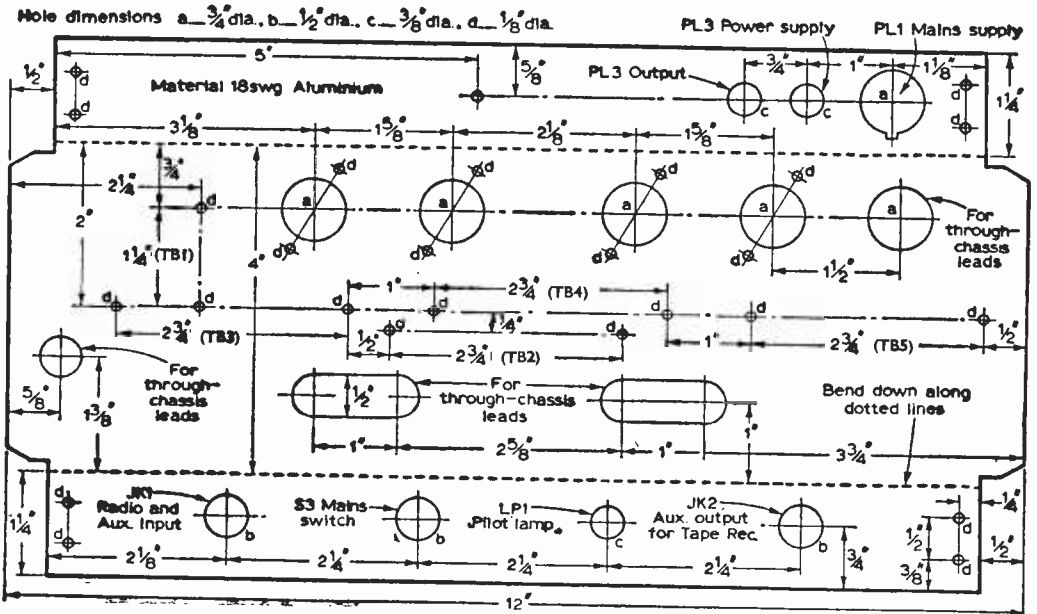
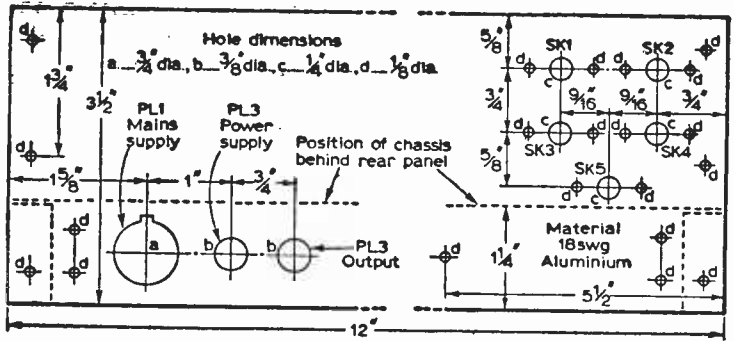

Fig. 8—Chassis drilling dimensions.

COMPONENTS LIST

Resistors (all 10%, $\frac{1}{2}$ W carbon, unless otherwise stated)

| | | | | | |
|-----|---|-----|------|-----|------|
| R1 | 150k | R6 | 220k | R11 | 1M |
| R2 | 560k | R7 | 1M | R12 | 100k |
| R3 | 10M | R8 | 56k | R13 | 100k |
| R4 | 560k | R9 | 1M | | |
| R5 | 5.6M | R10 | 68k | | |
| R14 | 1M 5%, H.S. cracked carbon | | | | |
| R15 | 8.2k 5%, H.S. cracked carbon | | | | |
| R16 | 220k 5%, H.S. cracked carbon | | | | |
| R17 | 2.2k 5%, H.S. cracked carbon | | | | |
| R18 | 3.3k | | | | |
| R19 | 100k | R20 | 100k | R21 | 330k |
| R22 | 220k 5%, H.S. cracked carbon | | | | |
| R23 | 2.2k 5%, H.S. cracked carbon | | | | |
| R24 | 3.3k | | | | |
| R25 | 470k | R30 | 100k | R35 | 2M |
| R26 | 100k | R31 | 47k | R36 | 2M |
| R27 | 100k | R32 | 47k | R37 | 1M |
| R28 | 47k | R33 | 220k | R38 | 470k |
| R29 | 100k | R34 | 10M | R39 | 1M |
| R40 | 220k 5%, H.S. cracked carbon | | | | |
| R41 | 2.2k 5%, H.S. cracked carbon | | | | |
| R42 | 47k | R44 | 470k | R46 | 1k |
| R43 | 180k | R45 | 180k | | |
| R47 | 390k 5%, H.S. cracked carbon | | | | |
| R48 | 3.3k | R50 | 1k | R52 | 2M |
| R49 | 100k | R51 | 20k | | |
| VR1 | 500k carbon potentiometer, logarithmic | | | | |
| VR2 | 1M carbon potentiometer, logarithmic | | | | |
| VR3 | 500k carbon potentiometer centre tapped logarithmic | | | | |

Capacitors:

| | |
|-----|------------------------------|
| C1 | 390pF silver mica 1% |
| C2 | 150pF silver mica 1% |
| C3 | 560pF silver mica 1% |
| C4 | 2,200pF silver mica 1% |
| C5 | 220pF silver mica 1% |
| C6 | 0.1 μ F paper 350V |
| C7 | 25 μ F electrolytic 12V |
| C8 | 0.1 μ F paper 350V |
| C9 | 16 μ F electrolytic 350V |
| C10 | 0.1 μ F paper 350V |
| C11 | 22pF silver mica \pm 1pF |
| C12 | 300pF silver mica 1% |
| C13 | 56pF silver mica 1% |
| C14 | 470pF silver mica 1% |
| C15 | 120pF silver mica 1% |
| C16 | 16 μ F electrolytic 350V |
| C17 | 25 μ F electrolytic 12V |
| C18 | 5,000pF silver mica 1% |
| C19 | 170pF (175pF) silver mica 1% |

| | |
|-----|--------------------------------------|
| C20 | 360pF (2 x 180pF) silver mica 1% |
| C21 | 170pF (175pF) silver mica 1% |
| C22 | 56pF silver mica 1% |
| C23 | 110pF silver mica 1% |
| C24 | 56pF silver mica 1% |
| C25 | 360pF (2 x 180pF) silver mica 1% |
| C26 | 3,900pF silver mica 1% |
| C27 | 7,800pF (2 x 3,900pF) silver mica 1% |
| C28 | 3,900pF silver mica 1% |
| C29 | 25 μ F electrolytic 12V |
| C30 | 0.25 μ F paper 350V |
| C31 | 0.04 μ F paper 500V |
| C32 | 8 μ F electrolytic 350V |
| C33 | 4,700pF ceramic |
| C34 | 4,700pF ceramic |
| C35 | 100pF silver mica 1% |
| C36 | 0.25 μ F paper 350V |
| C37 | 0.1 μ F paper 350V |
| C38 | 25 μ F electrolytic 12V |
| C39 | 0.05 μ F paper 500V |

Plugs:

| | |
|-----|---|
| PL1 | 6-way chassis mounting plug (Bulgin P427); free socket P428 |
| PL2 | 5-way cable plug (T.S.L. A5B) |
| PL3 | Coaxial cable plug (Belling Lee L734/PAC) |

Sockets:

| | |
|----------|---|
| SKI-5 | Coaxial sockets (Belling Lee L604/S(CD)) |
| JK1, JK2 | Closed circuit jack socket (Igranlic P72) |

Switches:

| | |
|----|--|
| S1 | Two wafers, each 2-pole 5-way (Radle-spares "Maka-Switch") |
| S2 | 4-pole 3-way single wafer make before break |
| S3 | D.P.S.T. toggle 1A |

Valves:

VI-4 EF86

Lamp:

LPI 6.5V 0.15A

Miscellaneous:

Four valveholders, B9A nylon-loaded with screening skirt. Four 10-way group boards (Bulgin C125). One 5-way group board (Bulgin C120). One 4-way tag strip. Lampholder with amber lens (Bulgin D180). Five knobs (Bulgin K370). Aluminium for chassis, B.A. bolts and nuts. Lightweight screened cable (about 5ft).

A level response is obtained when both controls are in their mid position, anti-clockwise rotation provides cut and clockwise rotation boost. The extreme settings of VR2 raise or lower the response level by 14dB at 50c/s with respect to the level at 1kc/s; a similar rise or fall at 10kc/s is obtained for the two extreme settings of VR3.

The final pentode stage V4 supplies an output signal of between 2 and 3V; this is fed via C39 and R51 to the output plug PL3.

Construction

The chassis assembly is built up from three

pieces of 18s.w.g. aluminium. The overall dimensions and drilling details of the chassis section and the front and rear panels are given in Figs. 6, 7 and 8. It is essential that the pre-amplifier is thoroughly screened when in operation and complete enclosure can be effected by the addition of a pair of end panels and top and bottom plates. The end panels should not however be fitted until the wiring has been finished.

Having cut out and drilled the three sections of the assembly, take the chassis section and fit the valveholders; then mount three 10-way group-boards to the underside surface, first drilling an

additional hole in TB3 and TB4 as indicated in Fig. 11. A pair of 6B.A. screws are required for securing each group-board.

Mount the five-way group-board TB1 to the top surface of the chassis, passing one of the fixing screws through the additional hole in TB3. Mount the 10-way group-board TB2, passing one screw through the additional hole in TB4; the second screw passes directly through the chassis between the ends of TB3 and TB4. Finally fit the four-way tag-strip as indicated.

Secure the front panel to the front edge of the chassis with 6B.A. screws and nuts. Mount the following components: JK1, JK2, SW3 and the pilot lamp holder assembly. The valveholder heater pins (4 and 5) and the lamp holder should now be wired up using for this purpose a tightly twisted pair of leads, and running the wire close to the chassis throughout.

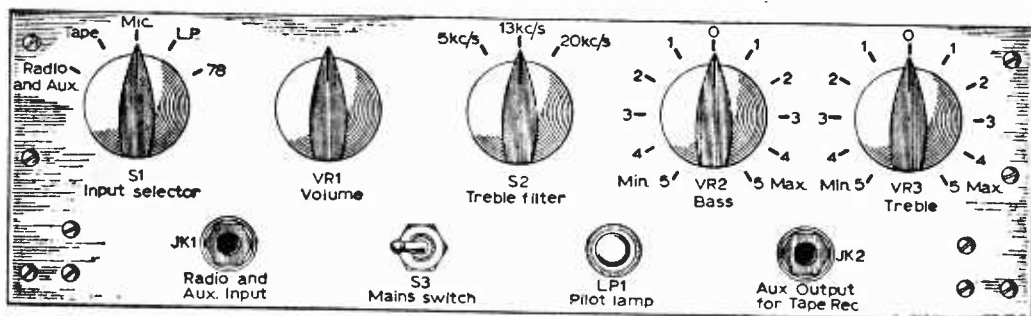

Fig. 9—Front panel layout diagram.

Pass a length of tinned copper wire through the holes in each valveholder spigot and adjust so that sufficient wire is available at either end to reach the tags on TB3 and TB5 as shown in Fig. 5. Solder the wire at each spigot. Fit insulated sleeving over the ends of the wire before soldering to the tags referred to.

Underside Components

Now the major task of mounting the underside components can be commenced. It is advisable to start work from the outer end of TB3 and to proceed methodically from tag to tag towards the other end of the chassis, digressing to complete the wiring of each valveholder, and to fit the few components that are not installed on the group-boards, as these points are reached. All screened leads should be ignored for the present.

Wiring the Controls

The top side of the chassis should now be dealt with. First mount and wire the components on TB1. Prepare the switch S1 for fitting to the front panel. Ensure that this component is properly assembled, with two spacers fitted on each

threaded rod so giving sufficient clearance between wafers to facilitate wiring.

Before fitting the switch in position it is essential to wire up the linking connections between S1B, and S1D (see Fig. 3). With the switch in position complete the wiring between it and TB1, but leave the remainder of the switch wiring (including the input resistors) until the rear panel has been fixed in position.

Proceed now to mount the components and wire up the 10-way group-board TB2; then fit the treble filter switch S2—which must be of the "make-before-break" type—and wire up to TB2. The three potentiometers should be mounted on the front panel and the tone control circuit components wired in position as shown in Fig. 2.

Take the rear panel and fit the five coaxial sockets in position, then secure the panel to the rear edge of the chassis. The input resistors can

Fig. 10—Rear panel layout diagram.

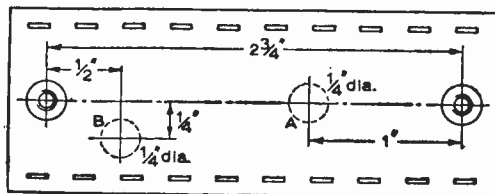
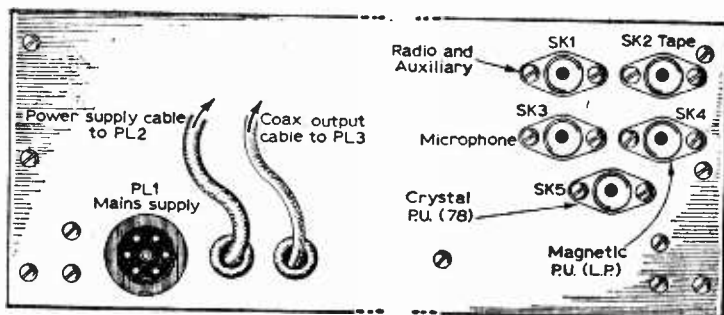

Drill 'A' in TB3 for access to TB1 fixing screw. Drill 'B' in TB4 for access to TB2 fixing screw.

Fig. 11—Group board drilling diagram.

(Continued on page 637)

A WIDEBAND MASTHEAD AMPLIFIER

By K. Berry

IMPROVING SIGNAL-TO-NOISE RATIO ON MEDIUM AND LONG- WAVE BANDS

ALTHOUGH the country is well covered by BBC VHF/F.M. stations, a considerable number of listeners still use the long and medium wavebands for the reception of foreign stations. Reception is, however, only too often spoilt by "man-made" interference. Most of this interference is "mains-borne", and if this interference can be eliminated or greatly reduced, then better entertainment value can be obtained from the medium and long wavebands. It was with this purpose in mind, that this masthead amplifier was designed.

The amplifier is mounted in a small box at the base of a whip aerial, and is connected to the receiver by a coaxial cable. The power supply for the amplifier is obtained from the receiver which it feeds, and this is sent up the coaxial feeder. The signals received by the aerial are amplified by about 30dB, then changed in impedance to 70Ω for transmission by coaxial cable. The cable length used is unimportant—up to 1,000ft could be used if desired.

The overall effect of this system is to increase the signal to "man-made" noise ratio by some 30dB. The amplifier can of course, be equally well used with a long wire aerial, the only essential being that the aerial and amplifier are kept some 10ft away from any building and its resultant noise field.

Circuit Description

The circuit of the amplifier and the method of power feeding is shown in Fig. 1. It will be seen that only two transistors are used in the circuit. The first transistor, Tr1, is a common-emitter amplifier. This is D.C. coupled to the second transistor, Tr2, which is an emitter follower stage. This results in a low output impedance suitable for feeding the co-axial cable.

The transistors used are OC170's. These are R.F. junction transistors with an average f_a of 70Mc/s and their use in this circuit results in an amplifier with a useful gain at over 6Mc/s. The frequency response of the prototype amplifier is shown in Fig. 2. The amplifier requires a supply of 9V (approximately) at 4mA. This is derived from the receiver to which it is connected.

Construction and Operation

The amplifier is mounted on a small S.R.B.P. tag-board, and this board is screwed to a tinplate

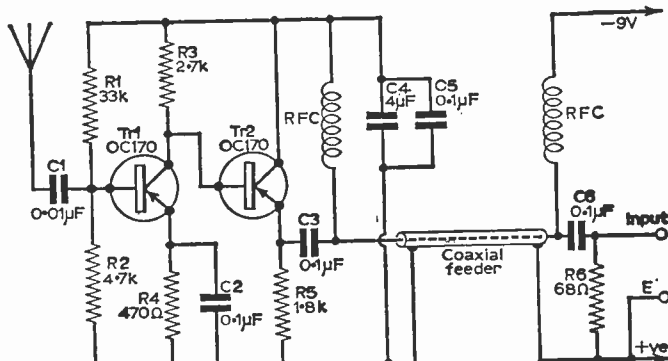

Fig. 1—The Circuit.

bracket. The bracket is soldered to the inside of a lid from a can of the type used for packaging commodities which must be kept dry. The can itself is painted to resist corrosion, rust, etc., and is secured to the aerial mast with insulating tape. This tape is varnished with copal varnish to give it some protection from the weather.

The aerial lead-in and coaxial feeder are led through tightly fitted grommets inserted in holes drilled in the lid of the can. It should be noted that the can is fixed to the aerial mast so that the lid is on the underside; this reduces the chances of rain entering the amplifier housing should the lid be a poor fit. The details given here, are, in fact, those of the author's installation and in no way essential for the successful operation of this unit.

The lead from the amplifier to the receiver should be of normal 70Ω characteristic impedance

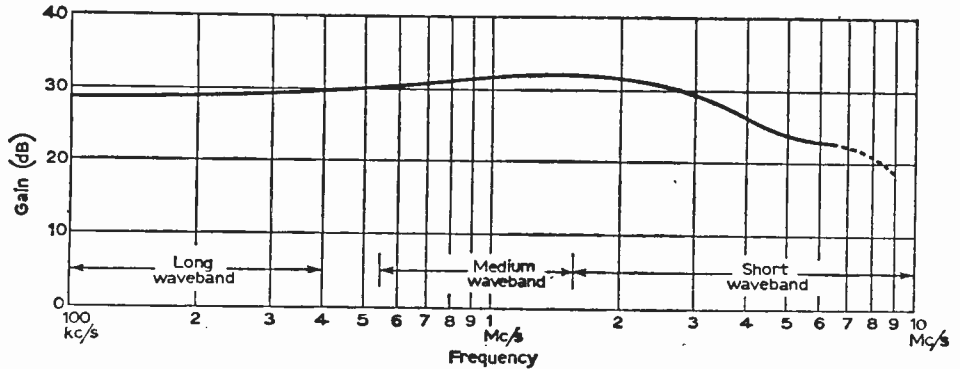

Fig. 2—A graph showing the gain of the amplifier.

coaxial cable of the type sold for television down-leads. The usual "solid" dielectric cable may be used, since at the frequencies concerned, there is no advantage to be gained by using the "air-spaced" low loss feeders which are available.

It should be noted that at the receiver end of the cable, there is a 68Ω terminating resistor (see Fig. 1). This resistor is necessary to ensure that the feeder is correctly terminated and that no "standing waves" occur. This is particularly important if the amplifier is required to work at the highest possible frequency.

Power Supplies

To power the amplifier from the main receiver it is necessary to make a slight modification to the receiver power unit in order to provide the 9V supply required for the amplifier. In Fig. 3 is shown a typical receiver H.T. supply. This is shown again in Fig. 4 with the addition of an extra resistor, R, and a 50μF decoupling capacitor. The value of "R" should be calculated from the

expression $R = \frac{9,000}{I}$, where I = the measured H.T.

consumption of the receiver. Many receivers will have an H.T. consumption of about 60mA, in such cases the value of "R" would be 180Ω.

Reference to Fig. 4 will show that the main smoothing capacitors of the receiver must be isolated from chassis. If this is impossible, then the resistor "R" may be connected between the transformer centre-tap and chassis. In this case, it should be decoupled by connecting a 250 or 500μF

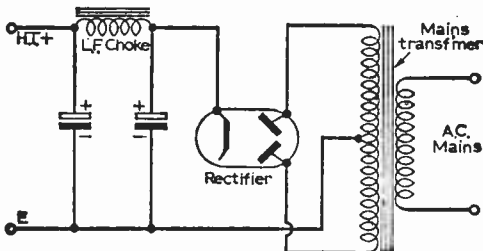
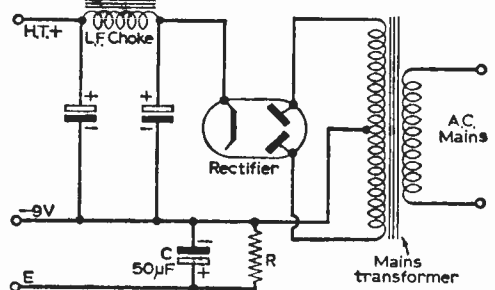

Fig. 3—A suitable H.T. supply.

Fig. 4 (below)—Provision for a transistor supply.



12V electrolytic capacitor in parallel with it. The information in this article on connecting this amplifier to a receiver should only be followed on receivers employing a double-wound mains transformer. It must not be so connected to A.C./D.C. receivers. If it is desired to use it with such receivers a separate power supply must be provided and care taken to ensure that the feeder is isolated from the mains.

universal test oscillator

(Continued from page 607)

the procedure is as follows. One side of the oscillator output is connected to the chassis of the equipment under test. The other side of the output is then applied to the various stages of the equipment, working backwards from the final stage until the faulty section of the apparatus can be determined.

Note that when the oscillator is used to test equipment of the A.C./D.C. variety, which may or may not have a live chassis, isolating condensers (0.1μF 1,000V are suitable), must be used in both of the leads between the generator and that equipment.

This oscillator will be found to be invaluable for the rapid diagnosis of faults in all manner of apparatus, whether it be used primarily as a signal generator, or in conjunction with a pair of high resistance headphones, as a continuity testing device.

LASKY'S RADIO

"BUILD-YOURSELF" TRANSISTOR RADIOS

The "REALISTIC" Seven

STAR FEATURES ★★★★★

- ★ 7 Transistor Superhet. 350 Milliwatt output into 4-inch high flux speaker.
- ★ All components mounted on a single printed circuit board, size 5 1/2 x 5 1/2 in. in one complete assembly.
- ★ Plastic cabinet, with carrying handle, size 7 x 10 x 3 1/2 in. in choice of colours:
- ★ Red/Grey, Blue/Grey, all Grey.
- ★ Easy to read Dial.
- ★ External Socket for car aerial.
- ★ I.F. frequency 470 K/c/s.
- ★ Ferrite Rod internal aerial.
- ★ Operates from PP9 or similar battery.
- ★ Full comprehensive data supplied with each Receiver.
- ★ All coils and I.F.'s, etc., fully wound ready for immediate assembly.



An Outstanding Receiver. Lasky's Price for the complete parcel including Transistors, Cabinet, Speaker, etc., and Full Construction Data. **£6.19.6** Postage and Packing 4/6 Battery 3/6 (included free with complete parcel). Data and instructions separately 2/6, refunded if you purchase the parcel.

The New "ALBERTA 5" Mk. 11 Now using printed circuit and supplied with miniature earphones for personal listening at no extra cost.

Push-pull, 200 milliwatts output. Five transistors and one diode. 2 1/2 in. moving coil speaker, ferrite rod aerial. Med. and long wave. Smart plastic Case, 4 1/2 x 3 1/2 x 1 1/2 in. overall.



CAN BE BUILT FOR **59/6** Post 3/6 All components available separately. Full details, circuit diagram, 1/6 post free.

THE BETA TWO

A 2-transistor plus 2-diode personal receiver for home construction. Uses printed circuit and ferrite rod aerial. Personal earphone gives clear reception for private listening. Tunes over full medium waveband. Uses same cabinet as our Alberta 5 receiver, illustrated above, size 5 1/2 x 3 1/2 x 1 1/2 in. overall. All components available separately. CAN BE BUILT FOR **21/-** Postage 2s. 6d. extra including personal earphone, cabinet, etc. Circuit diagram and step by step instructions 1s. 6d. (Free with parcel).

"KINEMATIX" STEREO BALANCE METER UNIT

AT A FRACTION OF THE LIST PRICE No more guessing! Perfect balance in seconds. Brand new U.S.A. import supplied with full operating instructions. Suitable for use with all hi-fi stereophonic amplifiers. Enables you to recreate the stereo effect in any particular area of the room. Smart polished wood Cabinet 6 1/2 x 3 1/2 x 4 in.

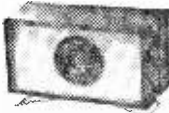

LIST PRICE £7.7.0.

LASKY'S PRICE

29/6 Post 2/6

CRYSTAL PICK-UP CARTRIDGES

Lowest Prices Ever! All complete with Stylus L.P. and Standard (and Stereo where shown). Fully guaranteed, standard fittings, will fit most P.U. arms and heads. Postage 1/- each extra

| MONO | |
|---|------|
| TYPE C.T.1. By well known manufacturer. With 2 sapphire stylus..... | 12/6 |
| Garrard GC.2..... | 15/- |
| Ronette Studio 0..... | 15/- |
| Acos GP.85/3..... | 17/- |
| Acos GP.85/1..... | 17/- |
| Ronette Stereo G.V. Turnover, with 2 sapphires..... | 18/- |
| STEREO | |
| Acostereo 73/1 with 2 sapphires..... | 25/- |
| Acostereo 73/2 with Diamond, L.P./Stereo and sapphire Std..... | 29/6 |
| Collaro type C. Turnover, with 2 sapphires..... | 25/6 |
| Collar S.C.I. Turnover with 2 sapphires..... | 24/6 |
| Collar S.C.I. Turnover with Diamond L.P./Stereo and sapphire Std..... | 29/6 |
| Ronette Stereo G.V. Turnover, with 2 sapphires..... | 29/6 |
| Ronette Stereo type 105, with 2 sapphires..... | 35/6 |
| Ronette Stereo type 105, with Diamond L.P./Stereo and sapphire Std..... | 39/6 |

ELECTRIC MOTORS

Brand New Single-phase motors, suitable for tape recorders, workshops, etc. Many uses. Reversible 200-250v, 5in. OZ torque, 1,400 r.p.m. Capacitor Start. Weight 4 1/2 lb. length 5in. Spindle both ends 1" x 1/4"; 1" x 1/4". Price, including capacitor, 19/11. P. & P. 3/6 extra.

TRANSTRONIC CONSTRUCTION KIT

Make your own transistorised transmitter and receiver. With components supplied, you can build 7 different circuits. Full size wiring diagrams for mounting on pcb board 1 1/2 x 9in. supplied. Two transistors OC44 and OC72, 1 XTAL Diode. No soldering necessary. IDEAL GIFT FOR YOUNGSTERS All components marked for absolute simplicity, attractively packed in multi-coloured gift box. 15-page instruction booklet. Originally intended to retail at £5.4s.

LASKY'S SPECIAL OFFER **49/6** complete P. & P. 4s Money refunded if dissatisfied

THE VERY LATEST "PHONOTRIX" TRANSISTOR BATTERY TAPE RECORDER



Supplied in Real Leather Carrying Case, with Shoulder Strap. Capstan drive, push-button controls. Constant speed 9 1/2 i.p.s., uses 3in. spool. High impact plastic case with transparent high impact plastic case with leather outer case. Size: 9 1/2 x 5 x 3 1/2 in. List 25s 6ds.

LASKY'S PRICE **18 Gns.** with Mike and Tape, Carr. 7/6.

TELEFUNKEN STEREO HI-FI AMPLIFIERS £5.19.6

Further Great Purchase Enables us to offer this Excellent Unit at £5.19.6. Post 7s

A complete stereo amplifier of unsurpassed quality, with inputs for radio, tape recorder, F.M. tuner or any other hi-fi source, either monaural or stereo. Output power 5 watts total (2 1/2 watts each channel). New and unused. Listed at 16 gns

★ REBUILDING CLEARANCE SALE

at 2 Tottenham Court Rd., W.1
LAST SIX WEEKS!
HUNDREDS OF BARGAINS!

KAPURA Model U1

Multi-Test Meters

- ★ Complete with test leads.
 - ★ Brand new, fully guaranteed.
- Sensitivity: 1,000 Ohms per volt A.C. and D.C.
Ranges: (A.C. and D.C.) 0-15-50-250-500-1,000 v. D.C. current 0-100-500 m/a. 0-1 m/a. (used at 0-10 v. range).
Resistance: 1-2,000 ohms (centre 24 ohms), 100-200,000 ohms (centre 2.4k).
Size: 5in. x 3in. x 2 1/2 in.



LASKY'S PRICE **39/6**
Carriage and Packing 5/-

TV TURRET TUNERS

By famous manufacturer. I.F. 33-38 Mc/s., PCC94 and PFC90 valves fitted, also 12 sets of coils.
Lasky's Price Complete with Valves and Coils 29/6. Postage 2/6.

Distler Miniature Motors

6 volt battery operated 7/11. P. & P. 2/6.

207 EDGWARE ROAD, LONDON, W.2.
Near Praed St. PADDINGTON 3271/2

33 TOTTENHAM COURT ROAD, W.1.
Nearest Stn. Goode St. MUSEUM 2605

BOTH OPEN ALL DAY SAT. Early Closing Thurs. Mail Orders to Dept. P.W. Edgware Road.

more o.p.v. * for less £.s.d!

TAYLOR MULTIMETER MODEL 105A

has been produced to meet a demand for an inexpensive bench type Multimeter with a sensitivity of

***20,000 o.p.v.**

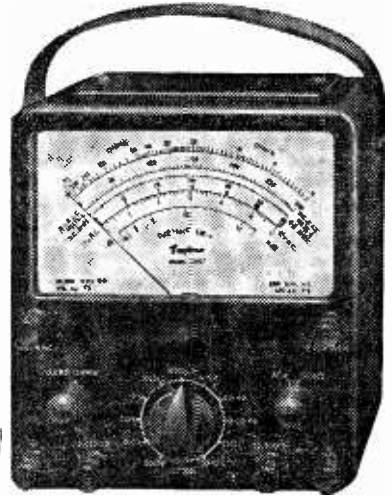

- ★20,000 o.p.v. (5° scale)
 - ★D.C. volts 0.3, 3, 12, 30, 120, 300, and 1,200 (30kV with probe).
 - ★A.C. volts 12, 30, 120, 300, 1,200.
 - ★Current 50μA, 600μA, 6mA, 60mA, 600mA, 12 amps D.C.
 - ★Resistance 0-20 megs., in 3 ranges (self contained).
 - ★Portability.
 - ★40μA Meter 5° Arc.
 - ★Accuracy D.C. 2%, A.C. 3%.
- Price £17.10.0.
High quality leather case available if required. £3.10.0.



Write for full details and catalogue to:
TAYLOR ELECTRICAL INSTRUMENTS LIMITED,
Montrose Avenue, Slough, Bucks.
Cables: TAYLINS, Slough.
Tel: Slough 21381.



WEYRAD

IMPROVED COMPONENTS FOR THE 6-TRANSISTOR 2-WAVE SUPERHET RECEIVER

NEW ROD AERIAL AND DRIVER TRANSFORMER FOR SIMPLER ASSEMBLY AND HIGHER PERFORMANCE

ROD AERIAL—RA2W

6 in. long, 3/8 in. diameter, connections to tags on Coils. For 208pF tuning capacity 12/6
Car Aerial coupling Coil 1/-

OSCILLATOR COIL—P50/1AC

M.W. covered with 176 pF tuning capacity. L.W. by extra padder 5/4

I.F. TRANSFORMERS

1st and 2nd Stage—P50/2CC 5/7
(2 required)
3rd Stage—P50/3CC 6/-

DRIVER TRANSFORMER—LFDT4

redesigned to reduce size and improve performance. Six spills for mounting and connections. 9/6

PRINTED CIRCUIT—PCA1

Size 2 3/4 in. x 8 1/4 in. Ready drilled and printed with component positions CONSTRUCTOR'S BOOKLET WITH FULL DETAILS AND FREE SCALE 2/- ... 9/6

TRANSISTOR A.F. AMPLIFIER TYPE A.F.1—LOW IMPEDANCE INPUT, 500 mW OUTPUT. MATCHING 3 OHM SPEAKER. FULLY ASSEMBLED WITH VOLUME CONTROL 63/6

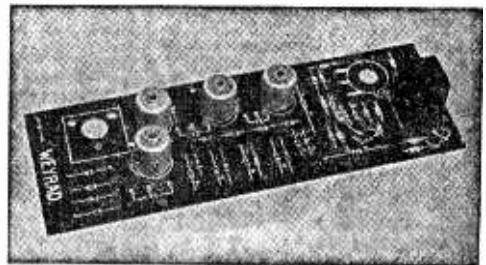

WEYMOUTH RADIO MANUFACTURING CO., LTD.

REGENT FACTORY, SCHOOL STREET,
WEYMOUTH, DORSET

Transportable A.C. Superhet

By F. G. Rayer

A 5-VALVE MAINS RECEIVER

THIS receiver is an A.C. mains 5-valve superhet of quite compact size, tuning long and medium waves, and with an internal ferrite rod aerial. A circuit of this type is very good indeed for general listening purposes, and will give ample volume from a fairly large number of stations. As no external aerial or earth is needed, the receiver can be operated wherever mains are available, and is thus useful for general listening.

The circuit is shown in Fig. 1, and has five miniature valves. The ferrite rod has a medium wave winding L1. L3 is the medium wave oscillator coil, with its padder C7. For long wave reception, the loading coil L2 is in series with L1, and L4 is the long wave oscillator coil, with padder C8. This arrangement proves to be very efficient on both bands. A 6BA6 is used in the intermediate frequency stage, followed by the 6AT6, which provides detection, automatic volume control, and audio amplification. A 6BW6 is used as output

stage, driving a 3½ in. speaker. The receiver is isolated from the mains by T2, and the 6X4 is a full-wave rectifier.

With a standard or general purpose circuit of this type, there is considerable latitude in coils, valves, and other components, but if items to hand are to be used, a few points must be observed, or results may be unsatisfactory. L1 and L2 should be for normal M.W. and L.W. coverage, and L3 and L4 should be oscillator coils to suit, with the specified padders C7 and C8. IFT1 and IFT2 also require to be 465kc/s or 370kc/s transformers; if these points are observed, any set of coils and pair of IFT's should be satisfactory.

If different valves are used, screen grid and cathode bias resistor values may need changing to suit. Some rectifiers also require a separate heater winding. The 6X4 heater is, however, run in parallel with the other heaters.

Above chassis Layout

The layout is shown in Fig. 2. The chassis is about 4 in. x 8 in. x 2 in. deep, and a hardboard panel about 5½ in. x 8½ in. is bolted to the chassis front, to carry the loudspeaker. A tuning scale may also be glued to the hardboard panel. In the receiver illustrated, the scale was upon glass, fitted to the cabinet front, so only a sheet of thin white card was required behind the pointer.

For station identification, the simplest method is to mark the dial when stations are tuned in, then to draw up the scales as neatly as possible. A dial calibrated in wavelengths, from a signal generator, is also useful.

The 2-gang capacitor, VC1 and VC2, has its spindle passing through a clearance hole, and a double ended push-on pointer is fitted. The drum is situated as in Fig. 2, and the cord is taken through holes, to the driving spindle, as in Fig. 3. The cord is given one complete turn

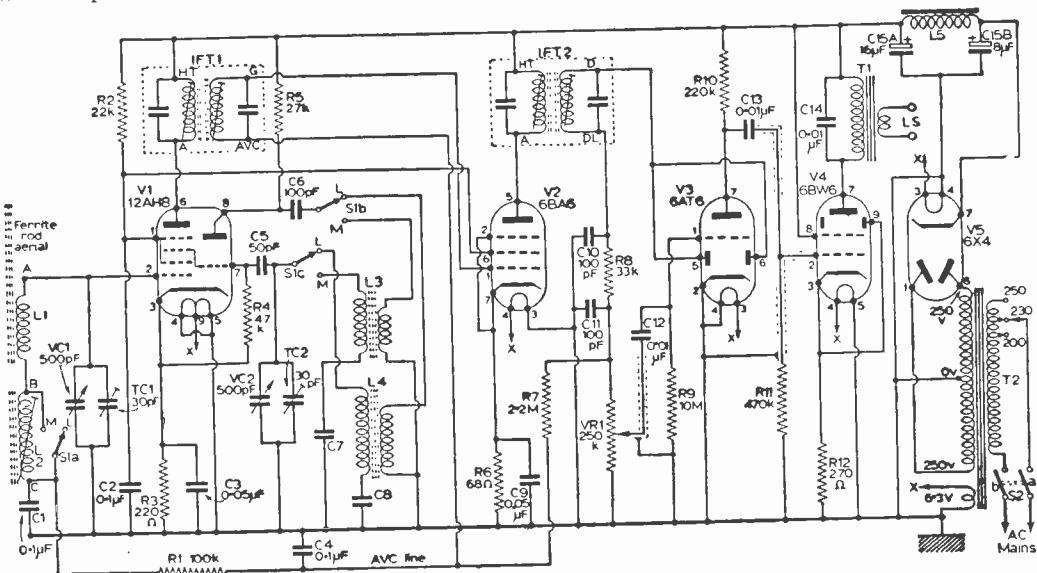
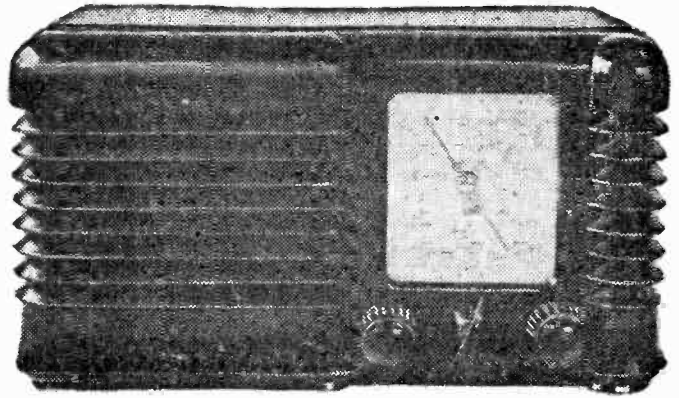

Fig. 1—The circuit.

round the spindle, and its ends are passed through the slot in the drum, and tied so that the spring is under tension.

A piece of aluminium about 2½ in. x 2½ in. is bent to form a bracket about 2½ in. high, shown in Fig. 2. This bracket is bolted to the chassis near the twin-gang condenser. A tag is bolted to the bracket (M.C. in Fig. 2) and the trimmers TC1 and TC2 are soldered to this. A stout, short lead is taken from the second tag of TC1 to the rear fixed plates A. A similar lead goes from TC2 to the front fixed plates of VC2.

A strip of paxolin about 1 in. wide has a slot cut in it to take a grommet, the latter being a



(Above) The cabinet used on the prototype receiver.

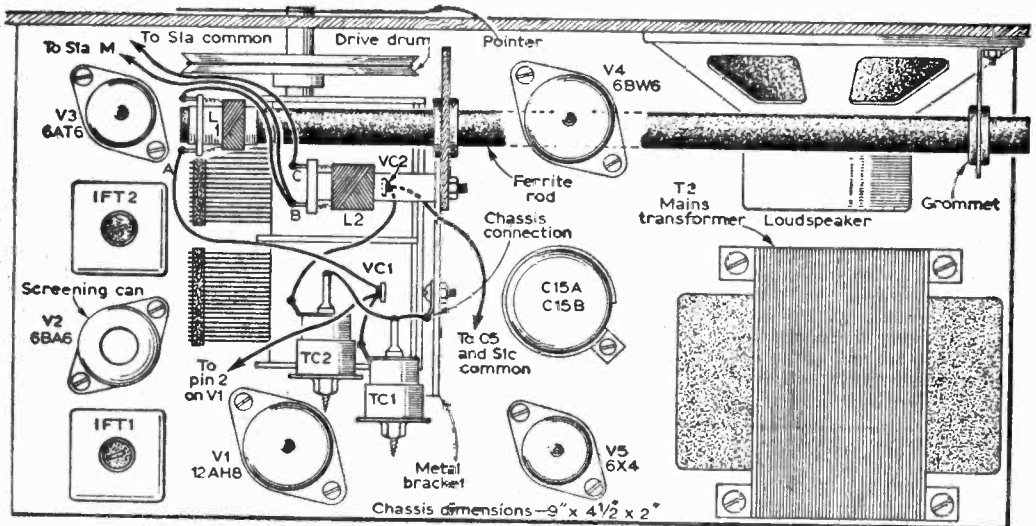

Fig. 2—The above-chassis view.

push fit on the ferrite rod. The paxolin is bolted to the large bracket described. The other end of the ferrite rod is fitted in a similar grommet, which is held by a strong wire hook placed on one of the bolts securing the loudspeaker, as in Fig. 2.

The long wave loading coil L2 is also mounted on the bracket. IFT's and valveholders are positioned as shown. T2 may have leads or tags, and a slot, or two large holes, will allow leads to pass through the chassis.

(Continued on page 621)

(Below)—The underchassis view of the complete receiver.

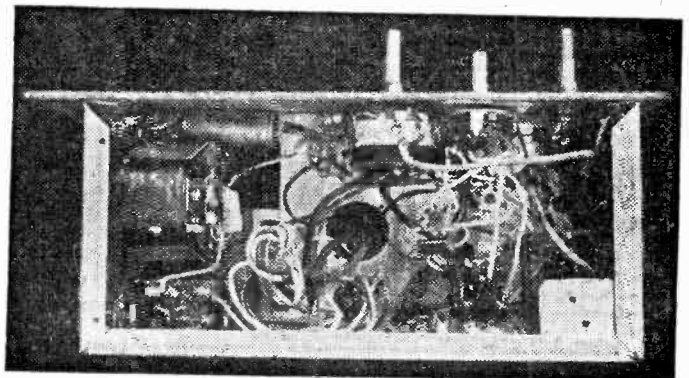

MULLARD 3-3 HI-PI AMPLIFIER

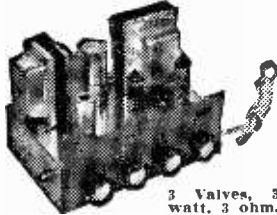

3 Valves, 3 watt, 3 ohm, and 15 ohm. Output. A really first-class Amplifier giving Hi-Fi quality at a reasonable cost. Mullard's latest circuit. Valve line up: 6X5, EL84, E281. Extra HT and LT available for Tuner Unit addition. This is the ideal companion Amplifier for FM tuner units.

TECHNICAL SPECIFICATION—Freq. Response: \pm 1db. 40 c/s-25 Kc/s. Tone controls: Max. Treble Cut 12 db at 10 Kc/s. Max. Bass Boost 14 db at 80 c/s. Sensitivity: 100 mv. for 3 w. output. Output Power (at 400 c/s): 3 w. at 1% total harmonic distortion. Hum and Noise Level: At least 70 db. below 3 w.

COMPLETE KIT (incl. Valves, all components, wiring diagram and special quality sectional Output Trans.). **ONLY £8.19.6.** Carr. 5/- Complete wired and tested. 8 kns. **Bronze Escutcheon Panel, Printed Vol., Treble, Bass, On-Off,** supplied with each kit.

Wired O/P socket power and additional smoothing for Tuner Unit, 10/6 extra. Recommended Speakers—WB HF102 95/- Goodmans AXIOM H1015, etc.

SPECIAL BARGAIN OFFER

"6 plus 1" . . . using 3 latest type surface Barrier Transistors
TRANSISTOR RADIO KIT Now only **£6. 19. 6**
Complete Kit carr. 2/6.

MANUFACTURERS SURPLUS BARGAIN OFFER. PRICE BARRIER SLASHED! A further bulk purchase of this popular Kit enables us to pass on latest price reduction direct to Construct. Kit is a modern, sensitive, quality Receiver with all latest circuit features and is complete with 7 x 3 1/2in. Speaker (3 ohms), and all circuit and assembly instructions. 8 BVA Transistors and Germ. Diode. Printed Cot. Med. and L.W. Ferrite Aerial and Car Radio Coupling. 500 MW Output. Attractive Gilt dial and Slow Motion Drive with "Clear Vu" Tuning Knob, etc. Contemp. two-tone Cabinets 9 x 5 x 3 1/2in., as illustrated. 25/- extra.

RECORDING TAPE—Reduced Prices

Famous American Columbia (CBS) Premier Quality Tape at **NEW REDUCED PRICES.** A genuine recommended Quality Tape—**TRY IT!** Brand new, boxed and fully guaranteed. Fitted with leader and stop foils.

| | Standard | Long Play | Double Play |
|----------|---------------|---------------|---------------|
| 5in. | 600ft. 13/- | 900ft. 17/6 | 1,200ft. 31/6 |
| 5 1/2in. | 800ft. 21/- | 1,200ft. 19/6 | 1,800ft. 37/6 |
| 7in. | 1,200ft. 28/- | 1,800ft. 29/6 | 2,400ft. 47/6 |

P. & P. per reel 1/-, 6d. on each additional reel.
SPECIAL BARGAIN. 3in. mtrs. Tape 225ft. 3/9. P. & P. 6d.
3in. Message Tape, 150ft. . . . 3in. 1/3, 5in. 2/-, 5 1/2in. 2/-, 7in. 2/3
Metric Tape Reels 5in. 1/6, 5 1/2in. 2/-, 7in. 2/3
Plastic Spool Containers

ENAMELLED COPPER WIRE

—lib. reels, 14g.-20g 2/6; 22g-23g 3/-; 20g-40g. 3/9. Other gauges quoted for. Erskin Multicores Solder 60/40 3d. per yard. lib. 2/6, etc.

COAX 50 OHM CABLE

High grade low loss Cellular air spaced Polythene—1in. diameter. Stranded cond. Famous mfrs. Now only 6d. per yard. Bargain Prices—Special Lengths: 20 yd. 8/-, P. & P. 1/6. 40 yds. 17/6, P. & P. 2/-. 80 yds. 25/-, P. & P. 3/-. Coax Plugs 1/-. Sockets 1/-. Couplers 1/3. Outlet Boxes 4/6.



COLLARO STUDIO TAPE RECORDER KIT

SPECIAL BARGAIN OFFER. Comp. Kit only £25.00
Carr. 12/6.

Famous mfrs. surplus offer—Listed 42 kns. A quality Tape Recorder Kit based on Mullard famous design—EF86, ECC83, EL84, EM84 and Rectifier. Specially designed Kit for Collaro latest Studio Deck. Freq. response \pm 3db. 60 c/s—10 kc/s. Amp. and Power Pack 164 x 8in. finished in contemp. 2 tone blue Rexine with gilt Speaker Escutcheon. Magic Eye Indicator Circuit and Tech. H/Book, supplied free with kit. Send 2/6 now for full details of to-day's outstanding Tape Recorder Baratan.

Cabinet £3.15. P. & P. 6/6
Amplifier Kit £8.19.6. P. & P. 5/-
Speaker 7 x 4 1/2in. P. & P. 2/-
If above items are purchased together.

£12.19.6 P. & P. 10/-

BARGAINS 4-SPEED PLAYER UNITS

Single Players Carr. 3/6
Garrard 4 S.P. £8.19.6
Garrard TA Mk.2 £7.19.6
Collaro "Junior" £5.19.6
B.S.R. Latest TU12 7/9.6
E.M.I. Junior '985' 8/9.6

Auto-Changers Carr. 5/-
Collaro "C 60" £7.15.0
B.S.R. (UA19) £7.10.0
Garrard "Auto-slim" £8.12.6
Garrard Model RC209 9/-

SOLDERING IRONS. Mains 200/220V or 230/250V. Solon 25 watt Inst. 22/6. Spare Elements 4/6. Bits. 1/- 65 watt, 27/6, etc.



RECORD PLAYER CABINETS

Cabinet Price
£3.3.0
Carr. & Ins. 5/-



Contemporary style, rexine covered cabinet in two tone maroon and cream. Size 184 x 134 x ht. 8 1/2in., fitted with all accessories including baffle board and anodised metal fret. Space available for all modern amplifiers and autochangers, etc. Uncut record player mounting board 14 x 13in. supplied. 2-YA L.V. 2-WATT AMPLIFIER. Two stage ECL2 with vol. and neg. feedback Tone control. A.C. 200/250 v. with knobs, etc., ready wired to fit above cabinet. £2-17.6. P. & P. 1/6.

6in. Spkr. & Trans. 29/-, P. & P. 2/-
Complete Kit, including UA14 Unit as illustrated. £12.19.6, carr. 7/6.
ALUMIN. CHASSIS. 18g. Plain Undrilled folded 4 sides. 2" deep. 6" x 4 1/2, 8" x 8", 5 1/2" 10" x 7", 6 1/2, 12" x 6", 7 1/2, 12" x 8", 8 1/2, etc.
JACK PLUGS. Standard 2" Igranite Type, 2/6. Screened Ditto 3/3. Miniature 1 1/2, 2/3. Screened Ditto. 2/6.
JACK SOCKETS. Open Igranite Moulded Type, 3/3. Closed Ditto, 3/6. Miniature Closed Type, 1/9. Sub-min (deaf aid) Ditto, 1/3.

Condensers—Silver Mica. All values, 2Pf to 1,000Pf, 6d. each Ditto. Ceramics 9d. Tub. 450V T.C.C., etc., 0.001 mfd. to 0.01 and 0.1/350V. 9d. 0.02-0.1/500V 1/-. 0.25 Hunts 1/6. 0.5 T.C.C. 1/9, etc., etc. Close T. 3/4 Micas—10% 5Pf-500Pf 8d. 600-5,000Pf 1/-, 1% 2Pf-100Pf 9d. 100Pf-500Pf 11d. 575Pf-5,000Pf 1/6. Resistors—Full Range 10 ohms-10 meg-ohms 20% 1 and 1/4 W 3d. 1W 5d. 2W 9d. Hi-Stab 10g. 1W 5d., 1W 7d. 5 d. 1W 9d., 1% 1W 1/6.

JASON FM TUNER UNITS
Designer-approved kits of parts:
FM1, 5 kns. 4 valves, 20/-
FM2, £7. 5 valves, 37/6.
JTV MERCURY 10 kns.
JTV2 £13.19.6. 4 valves, 32/6.

NEW JASON FM HAND BOOK. 2/8. 48 hr. Alignment Service 7/6, P. & P. 2/6.

TYGAN FRET (contemp. pat.)
12 x 12in. 4/-, 12 x 18in. 3/-
12 x 24in. 4/-, 18 x 24in. 6/- etc.

Speaker Fret — Expanded bronze anodised metal lin. x 1in. diamond mesh, now 4/6 sq. ft., multiples of 6in. cut max. width, 4ft.

Electrolytics All Types New Stock
TUBULAR CAN TYPES
25/25V 1/9 8+8/450V 4/8
50/12V 1/9 8+16/450V 5/-
50/50V 2/- 8+32/275V 4/8
100/25V 2/- 50+50/350V 6/6
8/450V 2/6 60+250/ 3/-
16/450V 3/6 275V 12/6
16+16/45V 6/6 100+200/ 275V 12/6
32+32/450V 6/6 275V 12/6

Transistor Components

Midget I.F.'s—465 Kc/a. 9/16in. dia. 5/8
Osc. Coil—M/W, 9/16in. dia. 5/8
Osc. Coil—M. & L.W. 5/9
Midget Driver Trans. 3.5-1 8/9
Midget O/Put Trans. P.P. to 3 ohms, 6/9.
Ferrite Aerial M. & L.W., Car aerial coil, 9/6.
Circuits—Condensers—Midget Type 1 mfd-50mfd eac. 1/6. 100 mfd. 2/-, 12V rms.
Condensers—0.1 mfd. to .04mfd 9d.; .05 mfd. to 1mfd. 1/-; .25mfd 1/3; 5 mfd. 1/6.

Tuning Condensers—"JB" 00"
208 Pf. + 176 Pf. 8/6, with Trimmers 9/6. Single 365Pf 7/6. Sub min. 1in. J.B. Dile min. .0001, .0003 or 0005 7/- each.
Midget Vol. Control—with edge control knob. 5K ohms with switch, 4/9, less switch 3/9.
Speakers P.M.—2in. Plessey 75 ohms 15/6, 24in. Continental 8 ohms 13/6, 24in. E.M.I. 3 ohms 17/6, 7 x 4in. Plessey 35 ohms 23/6.
Ear Plug Phones—Min. Continental type. 3ft. lead, jack plug and socket. High Imp. 8/- Low Imp. 7/6.

TRANSISTOR BARGAINS

Brand New—BVA 1st Grade
OC44 8/6 CET14 6/6
OC45 8/6 OC72 7/6
OC81 7/6 OC70 7/6
2OC21 15/6 OC71 6/6
XA102 10/- OC78 7/6
XA101 9/6 CEY34 2/9
XA103 7/6 CA70 2/9
XC101 8/6 OA81 2/9
Special offer: One OC44, two OC45; 21/6. One OC81, two OC81's (matched pair) 19/6.

Send for detailed bargain list, 3d. stamp. We manufacture all types Radio Main Trans. Chokes, Quality O/P Trans, etc. Enquiries invited for Specials, Prototypes for small production runs. Quotations by return.

RADIO COMPONENT SPECIALISTS

70 Brigstock Rd., Thornton Heath, Surrey. Hours: 9 a.m.-6 p.m., 1 p.m. Wed. THO 2188. Terms C.W.O. or C.O.D. Post and Packing up to 10. 9d.; 1lb., 1/3; 2lb., 2/3; 5lb., 2/9; 8lb., 3/6.



Est. 1949

Home Constructors LOOK!

TRANSISTOR
POCKET
RADIO

'JUNIOR MkII'

OUR IMPROVED
VERSION OF
THE 'JUNIOR A'

NOW SUPPLIED COMPLETE WITH PRINTED CIRCUIT BOARD AND FREE GIFT OF MINIATURE EAR PIECE. An easy "first step" set for the young constructor. This miniature marvel with the BIG performance has an internal Ferrite rod aerial—5 transistors and 1 diode—separate medium and long waveband control—200 milliwatt push-pull output—2 1/2 in. moving coil speaker—unbreakable plastic case with carrying handle. Complete with full instructions. Circuit diagram 1/6. free if all parts bought. All parts sold separately.

£2.19.6

P. & P. 2/-

TRANSISTOR AMPLIFIER

COMPLETE WITH
3in. MOVING
COIL SPEAKER

P. & P. 2/-

1 watt full transistorised amplifier. Incorporates 2 power Transistors and 3 G.E.T. 114 Transistors in push-pull—complete with separate tone and volume controls on 2 1/2 x 4 1/2 in. printed circuit board. Operates from Ever Ready P.P.11 Battery. Suitable for use with the Staar Galaxy Player.

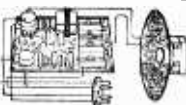

THE 'STAAR GALAXY'

9v. Battery Operated
Single Player

£2.14.6

Complete with P.U. The ideal deck for your transistorised portable Record Player, complete with Cartridge and Stylus. Size 7 1/2 x 6 in., depth below motor 2 1/2 in. Attractive two-tone grey finish. Ideally suited for use with the above Transistor Amplifier. Specially offered together with the above Amplifier for



£4.18.6. P. & P. 3/-.

SPECIAL PURCHASE!!! HUGE SELECTION OF VARIOUS TYPES OF CHASSIS—SUITABLE FOR RADIOS—RADIOGRAMS—AM/FM TUNERS ETC. ALL BRAND NEW—PRICES FROM £6. PERSONAL SHOPPERS ONLY.

Wirecomp's Finest Ever Value Offer—

THE 'REALISTIC 7'

FULLY
TRANSISTOR-
ISED PORTABLE
RECEIVER

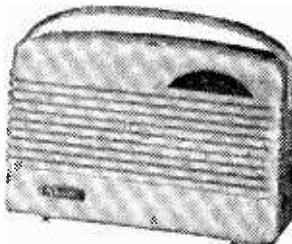

This super set—made to the highest professional standards—is now available to the home constructor. Comprises 7 Mullard Trans. OC44, 2 OC45's, OC71, OC81D, and 2 OC81's, plus OA70 Crystal Diode. Delivers 350 milliwatt output to 4in. high flux speaker—1F frequency 470 Kc/s.—fully tunable over medium and long wave-bands. All components mounted on single printed circuit board, size 5 1/2 x 5 1/2 in. Attractive two-tone plastic cabinet with carrying handle—size 7 x 10 x 3 1/2 in. with easy to read dial and socket for car aerial; choice of Red/Grey, Blue/Grey or all Grey. Complete with full instructions. All parts sold separately.

WIRECOMP'S PRICE £6.19.6 Including Free P.P.3 Battery — Value 8/9

P. & P. 4/6 extra. (Circuit diagram 2/6, free if all parts bought.)

WIRECOMP ELECTRONICS

378 HARROW ROAD, LONDON, W9.

TEL: CUNNINGHAM 9530

Hours of business: 9 a.m. to 6 p.m. Open all day Saturday. Opposite Paddington General Hospital Buses 18B and 36 pass the door.

THE
PEMBRIDGE
COLLEGE
OF ELECTRONICS
OFFERS TRAINING
IN RADIO
TELEVISION
AND ELECTRONICS

ATTENDING COURSE

(A) Full-time One Year Course in Radio and Television. College course in basic principles for prospective servicing engineers. Next course commences 1st January, 1963.

This course is recognised by the Radio Trades Examination Board (R.T.E.B.) for the new Servicing Certificate examinations.

HOME-STUDY COURSES

- (B) Radio and Television Servicing.
1 Introductory course.
2 Basic course covering R.T.E.B. Intermediate Radio and Television Servicing Certificate examination.
- (C) Courses in Radio, Telecommunications and Mathematics up to City and Guilds Telecommunication Technicians' Final Certificate.

To: The Pembridge College of Electronics,
(Dept. P11), 34a Hereford Road, London, W.2.
Please send, without obligation, details of
A. B. C. (Please tick.)

Name _____

Address _____

COMPONENTS LIST

Resistors ($\frac{1}{2}$ W unless otherwise stated):

| | | |
|-----------------|----------------|---------------------|
| R1 100k | R5 27k 1W | R9 10M |
| R2 22k 1W | R6 68 Ω | R10 220k |
| R3 220 Ω | R7 2.2M | R11 470k |
| R4 47k | R8 33k | R12 270 Ω 1W |

VR1 250k potentiometer with single pole switch

Capacitors:

| |
|--------------------------------------|
| C1 0.1 μ F paper 250V |
| C2 0.1 μ F paper 250V |
| C3 0.05 μ F paper 250V |
| C4 0.1 μ F paper 250V |
| C5 50pF mica |
| C6 100pF mica |
| C7 470pF 5% |
| C8 150pF 5% |
| C9 0.05 μ F paper 250V |
| C10 100pF mica |
| C11 100pF mica |
| C12 0.01 μ F paper 250V |
| C13 0.01 μ F mica |
| C14 0.01 μ F paper |
| C15 A and B 81 + 6 μ F elec 350V |

VC1, VC2 500pF twin-gang tuning
TC1 and TC2 30pF trimmers

Transformers:

T1 Output transformer (with 60mA primary) to match loudspeaker to 5k load: 45:1 for 2/3 Ω loudspeaker
T2 Mains transformer: 250-0-250V, 70mA; and 6.3V, 2A secondaries
IFT1, IFT2 Miniature I.F.'s: 465 or 470kc/s

Coils (Osmor):

L1 8in. x $\frac{1}{8}$ in. M.W. ferrite rod aerial, QFR3
L2 QA6 L3 Q08 L4 Q09
L5 5H at 70mA

Valves:

V1 12AH8 V2 6BA6 V3 6AT6
V4 6BW6 V5 6X4

Miscellaneous:

Chassis, 4in. x 8in. Three B7G and two B9A valveholders. One $\frac{3}{2}$ in. 2W loudspeaker. One 3-pole 2-way rotary switch, etc.

(Continued from page 618)

Wiring and Components Underneath the Chassis

Fig. 3 shows the underside of the receiver chassis. The wavechange switch is fitted to the panel between VR1 and the tuning drive, and is removed in Fig. 3 to clarify tag connections.

Point A in Figs. 1 and 2 is the fixed plates tag to VC1, and goes to T1, and the coil L1. A lead

also passes from these fixed plates, through the chassis, to tag 2 of the 12AH8 holder. Point B is the junction of L1 and the loading coil L2, and is wired to the switch tag shown in Fig. 3. Point C is the end of L2 and is connected to R1 and C1, and also to the switch tag indicated.

Wiring for the oscillator coils L3 and L4 is shown in Fig. 3. One switch tag is connected to C5, and a lead also passes from this tag through the chassis to the front fixed plates of the gang capacitor. These fixed plates are also wired to trimmer T2, as mentioned.

The lead from C12 to the centre tag of VR1, is screened, the braiding being taken to a convenient chassis return point. In the same way, the lead from C11 to V4 pin 2 and R11, is also screened.

With the first IFT, Anode. H.T. positive, Grid and AVC circuit tags are wired as indicated. In the case of the second IFT, tags are for H.T. positive, anode, diode, and diode load circuits. A central hole is required under each IFT, so that the lower cores can be reached.

All wiring should be insulated, and no tags or joints should be in such a position that they may touch each other, or the chassis. Heater circuit wires are run against the chassis, and are clear of other connections. The 12AH8 has centretapped heater, so tags 4 and 5 are joined and connected to the chassis.

The mains transformer primary connections are taken to the appropriate tags or leads. To suit the actual mains voltage. If the

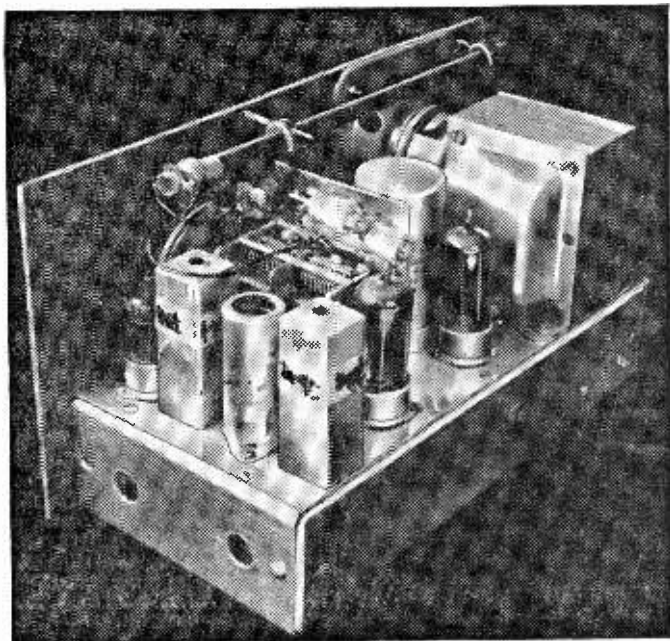

Another view of the receiver.

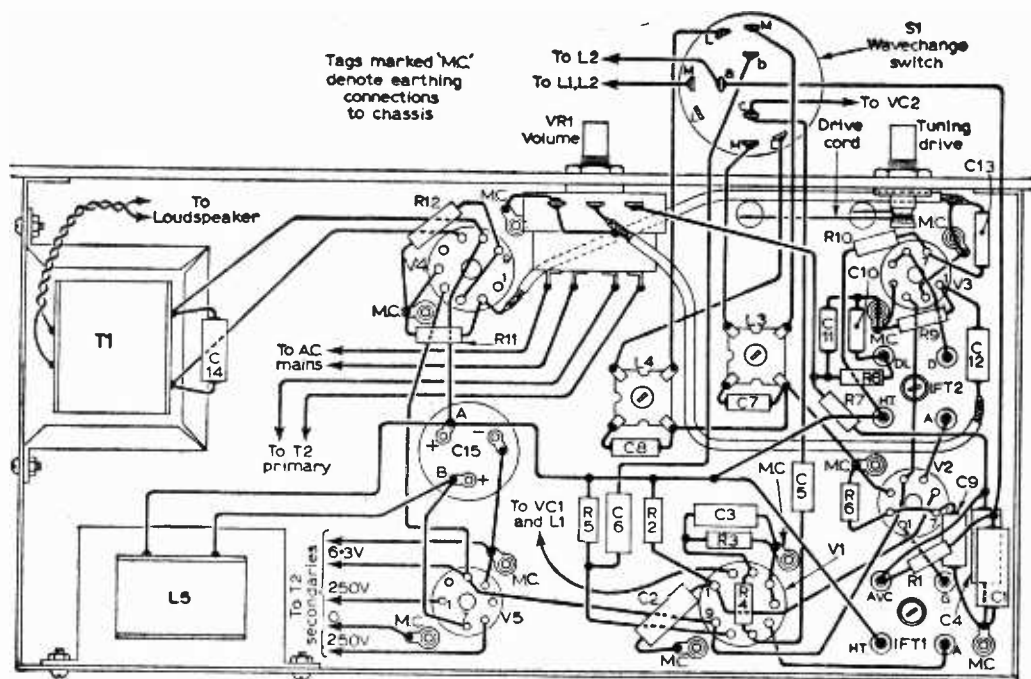

Fig. 3—The underchassis wiring diagram.

transformer has leads, unused leads should be insulated with tape. The H.T. secondary centre-tap, and one side of the 6.3V winding are both connected to the chassis. All control bushes, and the metal case of VR1, are wired to the chassis.

Testing and Alignment

The valves are inserted in the positions shown in Fig. 2. When the receiver is switched on, all heaters should soon reach operating temperature, and a 1,000 Ω /V meter connected from H.T. positive, Fig. 3, to chassis, should show about 250V. Roughly 12.5V bias should be found across R12. Some stations may be heard, if alignment is not too much in error.

To align the receiver, the IFT's are first tuned to 470kc/s. This is done by inserting an insulated blade so that it engages with the cores. Each transformer has two cores, so two are reached from below, by placing the receiver on its side. A high resistance voltmeter may be connected from the AVC line to chassis, and all adjustments can be directed towards obtaining the highest meter reading, either with a signal generator input, or with a station tuned in. The AVC line is negative, and chassis positive, for this purpose. If no signal generator is to hand, the cores are adjusted for best results. Once the IFT's have been aligned to 470kc/s, or fairly near this frequency, they do not need further attention while adjusting oscillator and aerial circuits.

To align for M.W. reception, put the switch (S1) in the M.W. position and set both trimmers to about half capacity. It can then be checked that the receiver tunes to about 550m with the gang

capacitor fully closed. If the receiver tunes to a rather higher wavelength, unscrew the core of L3, to correct this, but if the receiver does not reach 550m the core of L3 is screwed in. L1 can then be slid along the rod, to the positive giving best results. A low-wavelength signal should then be tuned in (with the tuning capacitor nearly open) and the trimmers adjusted for best results. Slight re-adjustment of L1 will then probably be necessary, at a high wavelength.

Adjustments are easy, if it is remembered that TC1 and TC2 are set at a low wavelength, and also modify coverage at the low wavelength end of the M.W. band. The position of L1, and the core of L3 are adjusted at a high wavelength in the M.W. band. When maximum sensitivity has been obtained throughout the M.W. band, leave L1, L3 and both trimmers untouched, and adjust the core of L2 for best L.W. results. This is done by turning the switch to the L.W. position, and tuning in a station of fairly high wavelength, on the L.W. band. The core of L2 is then rotated, and should tune quite sharply, for best reception.

If adjustments are made by ear, instead of with a meter wired as mentioned, very weak signals should be chosen. Strong signals will operate the AVC system, so that adjustments seem to have less effect on sensitivity. For this reason, aligning with the aid of a meter is preferable. If a sensitive voltmeter is not available, a 10mA or similar meter may be wired between the H.T. pin of IFT2 and the H.T. line, with a 0.05 μ F or similar capacitor from the H.T. pin to chassis. Adjustments are then directed towards obtaining the lowest meter reading, which corresponds with the highest AVC voltage, and thus with maximum sensitivity.

MAILPLAN OFFERS

Immediate Despatch Service! Best Value for Money!

Dept. PW 138 Lewisham Way, New Cross,
London, S.E.14. TIDeway 6667

All items advertised have been approved
by our technical team of qualified
engineers.

TWO SENSATIONAL TRANSISTORISED INTERCOMS

HANDY INTERPHONE

For Home, Workshop, Office, two-way calling. Consumes current only when talking or calling. Housed in attractive plastic cabinets with chrome stands. Completely portable. Master and sub-station. Replacement battery only 2/6

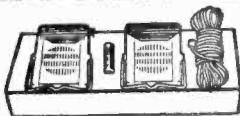

MAILPLAN PRICE
89/6 Incl. PP3 battery, and 25 yds. lead with plugs. P. & P. 3/-
(Today's value 8 gns.)

7 Station De Luxe Transistorised Intercom

The very latest in Office and Factory communication. Calling is audio and visual. Battery operated but consumes current only when calling or talking. Neat compact attractive units, up to 6 extensions supplied separately. Battery life 300 hours.

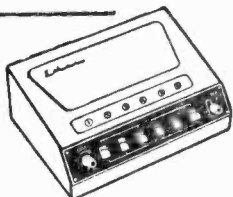

Master 14 GNS. Post free. **HALF THE PRICE**
Extensions 2 gns. Post free. **OF OTHER MAKES**

Construct your own Record Player, Intercom,
Tape Recorder etc. with the

PK.543 SUBMINIATURE 4-TRANSISTOR PUSH-PULL AUDIO AMPLIFIER 52/6

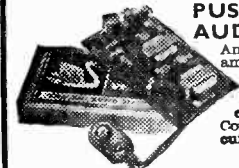

An assembled and wired miniature amplifier incorporating output transformer, and 4 transistors, class B, 200mW. All connections for battery speaker and volume control. The quality is amazing. Complete with instructions and circuit P217A. Size 3x1 1/4 x 1 1/4 in.

8 ohm speaker to suit above, 24" flux density 7,800 Gauss. Power, 200mW. **16/6** P. & P. 1/-

M178 CRYSTAL LAPEL MIKE 17/6

100-9,000 cps. 1 1/2 in. diam., 5ft. lead. P. & P. 1/-

SLIM CRYSTAL MICROPHONE

— 3 WAY —

Hand held, Stand mounted
or suspended by lavalier
cord.
MODEL 100C 39/6



Check the spec. and judge for yourself. Response 60-10,000 cps. Built-in ON-OFF Switch. Output Level -52 dB. Omni-directional. Termination above 500 K ohms. Satin Chrome Finish. Accessory Table Top Stand, 8/6.

PORTABLE SOLDERING IRON Model SPI

30 Watt 230 Volts
(Size 10 1/2 in. 6 1/2 in. when not in use.)
Designed on an entirely new principle for light-weight applications. Highly stable heat characteristics ensure long life. Removable handle permits iron to be carried safely even while hot. Supplied complete with Vinyl bag, lead and plug. Spares available. Element 4/6. P & P 6d.



18/9 P. & P. 1/-

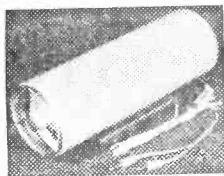

TUBULAR BAFFLE EXTENSION SPEAKER

Most adaptable of all speakers. Mounts vertically, horizontally, or sits on desk.

ANOTHER MAILPLAN

Top Value offer . . . **54/6** P. & P. 2/6.

The T.S. 30. Frequency Response: 65-7,000 cps. Impedance 8 Ohms. Rated at 1.5 watts. Cabinet, beige leather finish with contemporary grid baffles. Size 9 1/2 x 3 in. diam.

SERVICE ENGINEERS!

Here's the most useful tool money can buy . . .

the **D900**

TRANSISTOR TESTER/ POWER SUPPLY

LABOUR SAVING
SPEEDY SIMPLE

**ONLY
£10** Ask for full technical specification

Checks Alpha gain (Current gain—AC)
Checks Beta gain (Current gain under DC conditions)

Measures Leakage currents between Collector/Base and Collector/Emitter, at any voltage between zero and 25 V. Specially designed for all receivers using P.N.P. transistors. Size 5 1/2 x 3 x 2 1/4 in.

NOW you can carry out fast testing of transistors and miniature transistor receivers without removing transistors from circuit. Self-contained signal tracing oscillator, self-contained variable power supply.

Miniature Clear Plastic Panel Meters

FOR YOUR HOME BUILT TEST EQUIPMENT

DC MICROAMMETERS Model MR.25 0 to 50 μ A .. 39/6
Model MR.250 0 to 500 μ A .. 32/6
DC MILLIAMMETER Model MR.21 0 to 1 mA .. 27/6
All models Individually Boxed and Fully Guaranteed. P. & P. 2/6 each

"S" METER MODEL SR. 2P. Standard "Ham" Signal strength indicator. Calibrated in "S" units from 0-9 with scale terminating in +10 to +30 dB calibrations. Additional full scale calibrations of 0-5+0-10 in linear scale divisions. 35/-



VU METER MODEL VR. 1P. Calibrated and damped in accordance with standard VU Meter Practice. Upper scale reads -20 to +30V. Lower scale 0-100% modulation. Uses precision carbon film multiplier resistor and full wave rectifiers. 42/6.

SKANTEST—THE L.O.P.T. TESTER

Tests TV Windings for shorting turns by unique pulse method. This compact instrument can save you pounds. It detects a single shorting turn in a line output transformer, deflector coil or other Windings. The pulses provided by the instrument detect intermittent faults. In position one, the continuity of the Windings is checked; in position two, high impedance coils, and in position three, low impedance coils. Once you have used the Skantest you will regard it as a must in TV Servicing.

Exclusive Mailplan Offer **99/6** P. & P. 2/9

High resistance **TWIN HEADPHONES 13/6**

Standard type 2,000 ohm Model SF20. Complete with headband. P. & P. 1/-.

TRANSISTOR MEGAPHONE

MODEL ER304
The smallest ever! Incorporates printed circuit amplifier with current limiting device to give effective battery life. Range up to 2,000 feet. Size 10 1/2 x 6 in. dia. Complete with batteries and shoulder strap. Post free.



12 GNS.

**AWKWARD SPOT?
MINIATURE COMPONENTS?**

Soldering is easier with the

NEW 15 WATT SOLO

electric soldering iron

- Ideal for transistorised and printed circuitry.
- $\frac{1}{8}$ in. diam. bit in $\frac{1}{4}$ in. diam. stem will reach normally inaccessible connections and components.
- Just the right amount of heat. Melts resin-cored solder within $1\frac{1}{2}$ minutes from cold.
- Spare parts easily replaceable—readily obtainable.
- Designed and made by the team responsible for the highly successful 25-watt Solon.
- 200-220V or 220-240V.

LIST PRICE 23/4d Obtainable from your usual electrical stockist, or electrical counter of your hardware store.

AN **AEI** PRODUCT

For further details, write to the local AEI Stock Depot, or to:

Associated Electrical Industries Limited
Distribution Equipment Sales Dept
145 Charing Cross Rd.
London WC2



D. & B. TELEVISION Phone: Cherrywood 3955
(Wimbledon) LIMITED Dept. A.7
131 & 131A KINGSTON ROAD
SOUTH WIMBLEDON, S.W.19
Open Mon.—Sat. 10 a.m.—7 p.m. (Except Wed. 1 p.m.).
Nearest Tube Station South Wimbledon (Northern Line).
"COMPARE OUR PRICES"

FOR THE FINEST SERVICE IN THE COUNTRY
Your problems are our Business
LOOK! TRANSISTOR PRICES DOWN AGAIN.
MULLARD OC44 6/-, OC45 6/-, OCT1 5/-, *OC72 6/-, *OC76 7/-, *OC77 12/-, *OC81 7/-, OC81D 6/-.
Complete set of 6 Mullard Transistors only 30/-, Comprising OC44, two OC45's, OC81, two OC81's, Matched Pair.
MULLARD DIODES: OA81 2/6, OA90 2/6, OA91 2/6.
G.E.C. Transistors: GET875 11/3, GET874 6/6, GET873 5/6, *GET115 7/8, *GET114 4/8.
Complete Set of 6 G.E.C. Transistors comprising: GET874, two GET873's, GET114 & Matched Pair GET115. Only 25/-.
(*Available in matched pairs, 1/- extra).

COMPLETE NEW RANGE OF TRANSISTOR COMPONENTS IN STOCK

THREE BRAND NEW * STAR * BARGAINS
Designed for quality and outstanding value.
NEW R.T.D. 6 Watt Monaural Amplifier, using heavy duty, double-wound mains Transformer. With separate rectifier, including Valves: Rectifier, Driver and Output, 5 Controls: Switch, Volume, Base, Treble, Middle, Heavy duty output Transformer, METAL CHASSIS. All components brand new. Ready built. **ONLY 25.5.0** COMPLETE or all parts in kit form. Point to point diagram. **ONLY 23.15.0 P. & P. 3/6.**

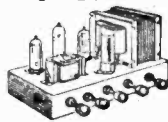

Build your own Portable Radio

Comprising Advance GEC drift-field transistors, high impedance 2in. speaker, powerful reflex circuit and a host of other features rank it as the finest value for the do-it-yourself enthusiast. Built-in Ferrite rod aerial brings you top notch reception both indoors and out, extremely efficient circuit greatly reduces battery drain—provides longer playing time. Uses popular 9V battery available everywhere. Attractive high impact ivory case is virtually unbreakable. Two controls—off/on volume and tuning. Ready drilled circuit board ensures fast, enjoyable assembly and perfect performance. Size 5 1/2 x 3 1/2 in. All Parts Sold Separately. Price complete **50/-** Transistor Radio Ear Pieces, 8/9 P. & P. 3/6.

Two Valve Amplifier Kit PY 22/PCL 22

Metal chassis. Point-to-point diagram. 3 watts output. **58/6**
Tone and volume controls. P. & P. 3/6.

ALL TYPES INTERNATIONAL OCTAL VALVES SUPPLIED
ALL VALVES ARE SOLD SUBJECT TO FULL GUARANTEE

CURRENT VALVE LIST

| | | | | | | | | | | | |
|--------|------|-------|------|-------|------|--------|------|------|------|-------|------|
| AZ31 | 8/6 | ECF80 | 8/- | KT61 | 8/8 | EP61 | 2/8 | UU8 | 14/8 | 7C8 | 7/8 |
| B36 | 6/6 | ECH35 | 9/- | KT63 | 6/3 | U22 | 6/8 | UU9 | 6/3 | 7C6 | 7/8 |
| COH35 | 12/6 | ECH42 | 7/6 | KTW61 | 5/8 | U24 | 10/- | UY41 | 6/- | 787 | 9/8 |
| D77 | 3/- | ECH81 | 7/6 | KTW63 | 5/8 | U25 | 12/- | UY85 | 6/6 | 7Y4 | 4/6 |
| DAF91 | 5/- | ECL80 | 7/8 | L63 | 2/8 | U26 | 9/8 | W77 | 4/- | 10F1 | 4/6 |
| DAF96 | 7/- | ECL82 | 9/8 | PC84 | 7/8 | U31 | 7/- | Z77 | 8/- | 10C1 | 10/- |
| DF91 | 3/6 | ECL83 | 1/3 | PC89 | 8/8 | U37 | 17/- | 5U4 | 4/8 | 10P2 | 13/- |
| DF96 | 7/8 | EF39 | 4/3 | PCF80 | 7/8 | U39 | 6/8 | 5V4 | 8/8 | 10P13 | 8/9 |
| DH63 | 6/- | EF60 | 1/8 | PCF82 | 7/8 | U39 | 6/8 | 5V4 | 8/8 | 10P14 | 8/9 |
| DH77 | 4/6 | EF80 | 4/6 | PCF86 | 14/8 | U191 | 9/8 | 5Z4 | 10/- | 12A7A | 7/8 |
| DK91 | 6/- | EF85 | 6/8 | PCL82 | 7/- | U281 | 9/- | 6AL5 | 3/- | 12A7 | 4/6 |
| DK92 | 7/8 | EF86 | 8/8 | PCL84 | 9/8 | U282 | 14/8 | 6AM6 | 3/- | 12AU7 | 6/6 |
| DK96 | 7/8 | EF89 | 6/8 | PCL84 | 7/8 | U282 | 14/8 | 6AT6 | 6/8 | 12AX7 | 6/8 |
| DL91 | 8/8 | EF91 | 3/- | PCL85 | 15/- | U301 | 17/8 | 6BD6 | 12/- | 198B6 | 14/6 |
| DL92 | 8/8 | EF93 | 4/- | PL33 | 8/- | UABCS0 | 8/8 | 6BW6 | 7/8 | 20D1 | 8/8 |
| DL94 | 7/- | EL33 | 7/8 | PL38 | 9/8 | UAF42 | 8/- | 6CD6 | 26/8 | 20F3 | 8/8 |
| DL96 | 7/- | EL38 | 12/- | PL38 | 14/8 | UAF42 | 8/- | 6CD6 | 26/8 | 20L1 | 12/8 |
| EABC80 | 7/8 | EL41 | 7/8 | PL81 | 9/8 | UB41 | 7/8 | 6D2 | 3/- | 20Y1 | 8/8 |
| EAF42 | 7/8 | EL84 | 6/8 | PL82 | 6/8 | UBC41 | 7/8 | 6F1 | 4/8 | 20P3 | 12/- |
| EB41 | 6/6 | EM80 | 6/8 | PL83 | 6/8 | UBF89 | 7/8 | 6F2 | 3/- | 20P4 | 16/8 |
| EB91 | 3/- | EM81 | 8/8 | PL84 | 8/8 | UC84 | 12/6 | 6F13 | 6/8 | 20V6 | 14/6 |
| EB33 | 4/8 | EM84 | 9/8 | PY31 | 7/- | UC85 | 7/8 | 6P14 | 9/- | 278U | 6/8 |
| EB41 | 7/8 | EY51 | 7/8 | PY32 | 10/- | UCF80 | 14/8 | 6F15 | 9/- | 30C1 | 7/8 |
| EBF80 | 7/8 | EY86 | 7/8 | PY80 | 6/- | UCH42 | 7/- | 6F33 | 8/8 | 30FL1 | 9/3 |
| EBF89 | 8/8 | EZ40 | 6/3 | PY81 | 6/- | UCH81 | 8/3 | 6L1 | 12/- | 30L1 | 7/6 |
| EBJ31 | 20/- | EZ41 | 8/8 | PY82 | 6/- | UCL53 | 12/6 | 6L5 | 9/8 | 30P4 | 11/8 |
| ECC32 | 6/3 | EZ80 | 6/8 | PY83 | 8/- | UF41 | 3/8 | 6L18 | 8/- | 30P12 | 8/8 |
| ECC81 | 4/8 | GZ32 | 8/8 | PY88 | 12/- | UL41 | 7/- | 6L19 | 12/- | 32KU | 10/- |
| ECC82 | 5/8 | GZ34 | 12/6 | PZ30 | 8/- | UL44 | 10/8 | 6AN7 | 4/8 | 52KU | 10/- |
| ECC84 | 7/8 | KT33C | 6/- | R18 | 10/- | UL46 | 7/- | 6V8 | 5/- | 54KU | 8/6 |
| ECC85 | 7/8 | KT36 | 8/8 | 8P41 | 2/3 | UL84 | 7/3 | 6C4 | 10/- | 185BT | 14/6 |

We pride ourselves that we can obtain and supply any TV spare. Please ask us for ANY components you may require we are almost certain to have them.

TERMS: S.A.E. all enquiries. C.O.D. 3/- extra.
C.W.O. Postage on Valves, 6d. each. C.R.T.s, 12/6 inc. insurance.
SATISFACTION ASSURED. RETURN POST SERVICE.
SUBJECT TO STOCK BEING AVAILABLE.

ADDING EXTRA STAGES
TO THIS POPULAR
P.W. DESIGN

Reflexing the P.W. MINUETTE

By F. G. Rayer

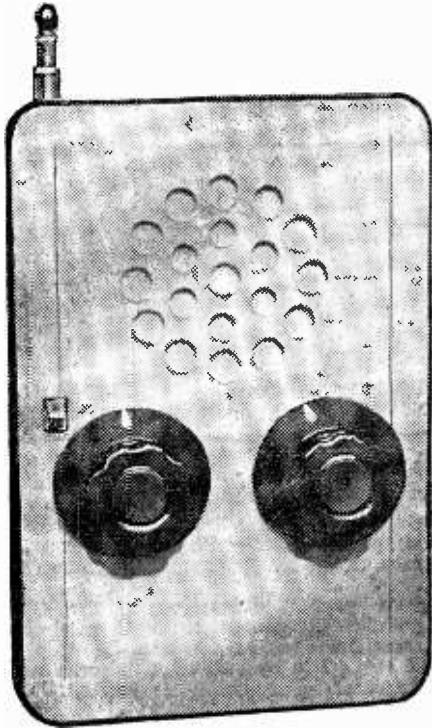

The prototype receiver.

THIS receiver was described in the January and February issues and uses a straightforward 4-transistor circuit, having a detector (with regeneration), driver, and push-pull output stages. The original circuit is shown in Fig. 1, which gives very good speaker results, from local stations.

A simple TRF receiver of this kind lends itself readily to development into a larger set. This will require more components, but there will be plenty of space for these in its original case. If the original receiver works well, these enlargements to the circuit will increase sensitivity, so that more stations can be received.

Regeneration

The first transistor in Fig. 1 operates as a regenerative detector. By adding some further components, this may be changed to a reflex stage,

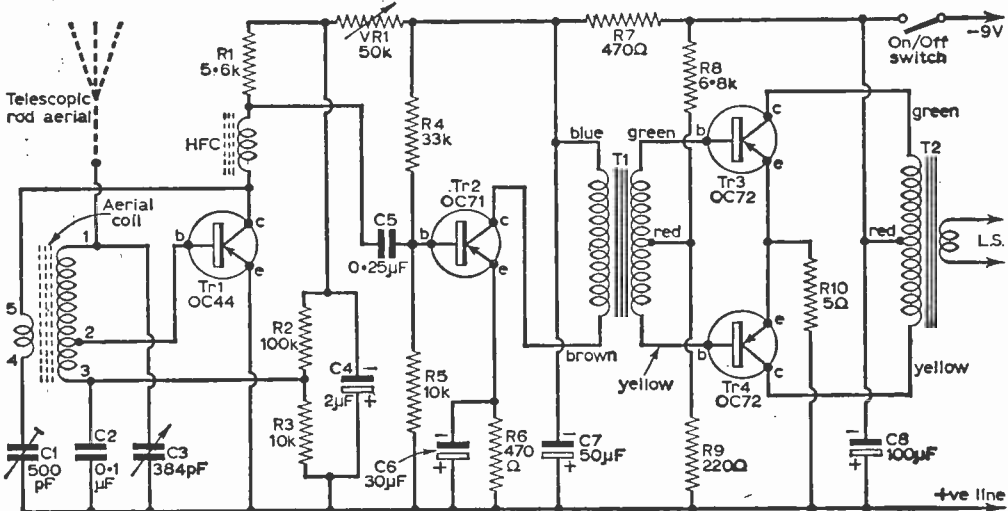

Fig. 1—The original circuit.

providing a regenerative R.F. stage, followed by a diode detector, and with the same transistor also working as A.F. amplifier.

A suitable circuit for this purpose is shown in Fig. 2. Here, values are given for the extra components, other parts remaining unchanged. Regeneration is obtained in the same way as in Fig. 1. The amplifier R.F. signal passes to the diode. After detection by the diode, the signal returns to the transistor base through the ferrite aerial winding, and is amplified at audio frequency. The A.F. signal is taken to C5, in Fig. 1.

In Fig. 1, C2 is 0.1 μ F. This must be reduced to about 0.04 μ F, as in Fig. 2, or there will be a great loss in volume. The crystal diode must be connected in the polarity shown. For maximum possible efficiency, with any individual diode, it may be worth changing the value of the 82k resistor. This is because the diode and 5.6k resistor virtually replace R3 in Fig. 1, and the internal resistance of such diodes varies somewhat. With an OA70 or equivalent diode, 82k or 100k should usually be satisfactory.

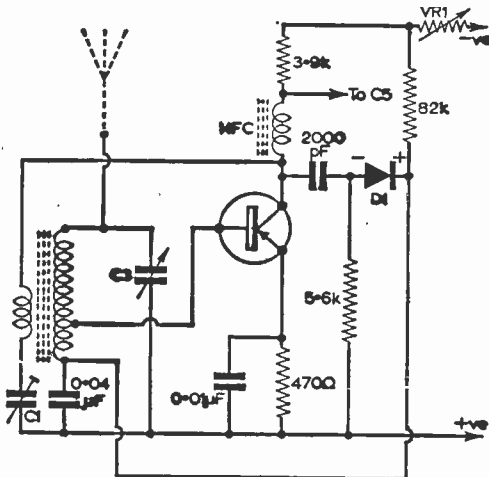

Fig. 2—The reflex R.F. and A.F. amplifier.

Operation of the receiver is exactly as before. The H.F. choke should preferably be a good, dust-coated miniature transistor type, kept well clear of the ferrite rod.

Audio Amplifier

An increase in amplification, at the expense of a very slight increase in current consumption, may be obtained by taking the blue lead in Fig. 1 directly to the 9V negative line, instead of to R7. Other items remain unchanged, and C7 is still wired as in Fig. 1.

The sensitivity of the output stage may also be increased, if desired, by removing R10, taking emitters directly to the battery positive. This has little effect on current drain at moderate volume, but will increase current peaks by some 5mA to 10mA or so, at full volume. With R10 in circuit, the output should generally be adequate, but a resistor is not always included here, so it can be omitted if preferred.

Adding an A.F. Amplifier

When the regeneration circuit is working correctly, the receiver is very sensitive to weak signals. Due to the use of only four transistors, distant stations cannot give very loud speaker results. For such purposes, signal strength may be increased by adding an A.F. amplifier before the driver.

A suitable stage for this purpose is shown in Fig. 3. Because of the large degree of amplification in following stages, this stage must use a good

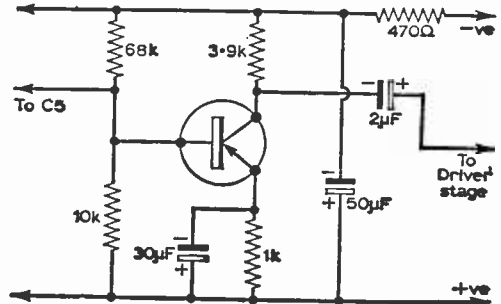

Fig. 3—An extra A.F. amplifier stage.

quality transistor, such as the OC71. If a surplus transistor with a high noise level is fitted, the noise will be amplified, and will be tiresome. With good transistors, the background noise will be very low.

The extra stage is decoupled by the 470 Ω resistor and 50 μ F condenser, to avoid instability. Wiring must be short and direct. A stopper resistor of about 2.7k may be wired in series with the 2 μ F condenser, if instability is apparent.

Increasing Ohmmeter Ranges

(Continued from page 595)

reads up to, say, 5,000 Ω . To increase the range to one Megohm it will be necessary to multiply the scale by 200, which means that the voltage will have to be 1.5 \times 200 = 300V.

If the total resistance of the ohmmeter at "zero ohms" is 500 Ω then a multiplier will have to be used to increase this resistance to 500 \times 300 = 150,000 Ω .

A 200,000 Ω rheostat is chosen and fitted into the multiplier which is constructed in the same way as the one for the series ohmmeter (Figs. 2 and 3).

The ohmmeter is again adjusted to "zero ohms" without the multiplier. The 1.5V cell is then removed and the terminals "bridged" in the same way as the series instrument in Fig. 3. The multiplier is connected to a 300V D.C. supply and to the ohmmeter which is adjusted to "zero ohms" by means of the multiplier rheostat. It is now ready for use. Its scale readings must be multiplied by 200.

For the higher ranges the 1.5V cell is dispensed with so that an exact multiple of the scale is obtained by using 150 or 300V. The 1.5V cell can, however, be left in circuit if 148.5 instead of 150 or 298.5 instead of 300V supplies are used.

—NOT DODGY

YOU WILL BE TOP OF YOUR GIRL'S HIT PARADE WHEN YOU PACK A ...

PARISIENNE!

—SWINGIN' !!!

ROPE IN LUXEMBOURG!

WITH THE FANTASTIC

PARISIENNE!!

A SUPERB POCKET TRANSISTOR

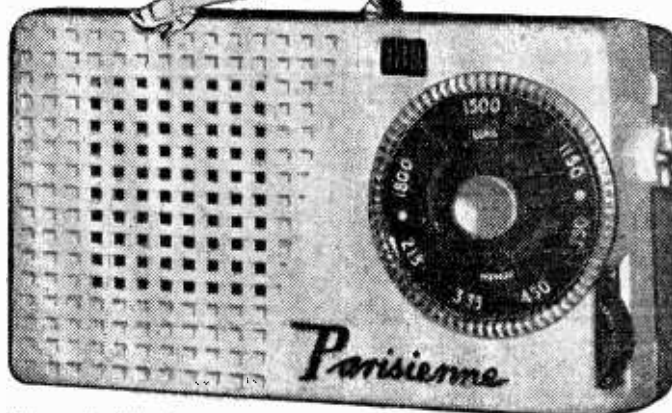

This amazing little set

HAS TO BE HEARD TO BE BELIEVED
We will supply **ALL** components at a total cost of only **YOU CAN'T GO WRONG !**

£3.19.6 !!!

Free advice bureau, second-to-none service and all your components

Transistors: OC76 4/6, OC71 5/-, Japanese Audio 2/6, SB305 7/-, OC170 8/-, OC77 10/6, 2N398 10/-, SB240 7/6, OC42 3/6, XA701 6/-, GET 103 6/-, OA10 6/-, OA2 203 7/6, OA5 diode 5/-, OA2 202 7/6, Latest miniature diode OA90 2/-, XC141 power output as OC16, only 10/-, XA116 6/-, general purpose diodes 1/-, P.P. 4d. on each transistor. All these are new. Special quotes for quantity.

OC28 19/6, OC35 19/6, OCP71 19/6, OC200 12/6, P.P. 6d. OC72 5/-, P.P. 3d. OC44 5/6. OA47 V.H.F. or h/speed switching diode 2/6. OA86 4/-, 2N456 19/6, OC28 and OC29 19/6, CG12E diodes 4/-, SB345 6/6, SB346 7/-.

12-way Tag Board, with resistors and condensers as follows, all 1in. watt transistor type: two 10 meg., two 0.01, one 3.9 M, 5.6 M, 3.3 M, 1.2 M, 2.2 M, 470 Ω , 470K. All for 2/-, P.P. 3d.

6000 Ω P.O. Relays. Platinum contacts, 3 way normal open, few only at 9/-, P.P. 9d.

Car Aerials. By well-known maker. Adjustable angle telescopic. 12in. closed, 36in. extended with Co-ax plug, 17/6. Post paid. **MONEY BACK GUARANTEE.**

FOR THE ENTHUSIAST

A Seven Transistor. Long, Med. wave superhet, made by famous manfr. Size only 4 x 3 x 1in. Absolutely complete and tested, less makers case but with leather cloth cover. The most compact set you have seen made like a watch. Money back guarantee. Price £5.19.6. P.P. 2/6. **Xmas offer, TWO for £11.**

WANTED

Valves, transistors, miniature components, all types of radio equipment, any quantity, but must be new. cash paid by return.

WHOLESALE AND TRADE ENQUIRIES WELCOMED ON ANY LINES

Dozens of continentals come rolling in! **LUXEMBOURG ROMPS IN LIKE THE LIGHT!!** Fully tunable over long and medium waves; the complete novice and experienced constructor alike will delight in building it. Already excellent reports have reached us from all over Europe and the U.K.! You will be **ASTOUNDED** by its tremendous volume and truly remarkable performance. Build-up presents **NO PROBLEMS!** **EVEN to the COMPLETE NOVICE!**

Components include a built-in ferrite rod aerial, high quality 3in. moving coil speaker, printed circuit, elegant style cabinet, etc.

A fully illustrated booklet, complete with step-by-step assembly instructions and all other data, comes to you for only 2/9 extra; PP4 press-stud type battery 2/3; post and packing on the lot 2/6.

SO GET WITH IT!!
and build yourself this superb little set **NOW!**
PUT THE WORLD IN YOUR POCKET!

Xmas offer:- **TWO kits complete, £7.16.0 p.p.**
top quality and fully guaranteed

F.T.R. 11. Tape Recorder Kit. Sub-assembled, finished in one hour. Size: 6 x 8½ x 2½in. Fully portable. 20 min. play. Send for illustrated leaflet. S.A.E. Kit cost £6.19.6. P.P. 3/6.



WOLVERHAMPTON RADIO & TV SUPPLIES, 42 Darlington St., Wolverhampton

Terms:—C.W.O. to avoid delay. All orders mailed by return, subject to stocks surviving the onslaught! All components can, of course, be supplied individually. Fuller details and/or prices by request, write (S.A.E.) or call

Tel.: Wolverhampton 20315

"CODAR CLIPPER" ALL BAND RECEIVERS 10-2000 METERS

LISTEN TO AMATEURS, AIRCRAFT, SHIPPING, SHORT, MEDIUM, LONG WAVE BROADCAST STATIONS THROUGHOUT THE WORLD.

THE MINI-CLIPPER

The ORIGINAL and finest one valve all band receiver. Outstanding performance. New first grade components ensure top efficiency. Low loss air spaced tuners, high gain polystyrene plug in coils. Satin Silver metal panel with engraved dials, grey pointer knobs. Provision for adding 2 transistor amplifier stage. Chassis ready punched. Total building cost, all parts, one coil 20-60 meters, wire solder full plans, 36/6. P. & P. 2/6. Other coils 10-2000 meters and electrical breadspread available. Parts sold separately. Plans and parts list, 2/-.

NEW LOW PRICE **36/6**



THE SUPER CLIPPER 88/6

This world-famous hybrid receiver has achieved remarkable success. Tremendous performance with Hi-gain valve detector PLUS two Ediswan transistor amplifiers which are supplied assembled, only 3 wires to connect. Large precision dial, 7 x 4in., with 2 pointers, bandset and breadspread, dual slow-motion drives, air spaced variables. Punched chassis 8 x 5 1/2in. Batteries last months. Covers 10-2000 metres (5 coils). Total building cost including chassis, valve, 2 transistor stages, 2 coils 20-60 and 55-190 metres. Step-by-step pictorial plans, nuts, bolts, wire 88/6. P. & P. 2/6. Plans only, 2/6. THE CLIPPER. As above but one transistor stage, 79/6. P. & P. 2/6. Optional Front Panel, Silver Hammer finish, all holes, 6/9.



THE NEW CR45 ★ NEW STYLING TOP PERFORMANCE

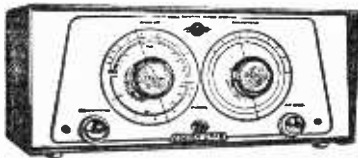

Previously produced exclusively for Export, the de-luxe version of this famous ALL BAND receiver is now also available for the home market. Superb new styling, satin silver front panel, frequency calibrated scales, grey and silver trim knobs, perspex disc cursors. High gain circuit with ECC81 duotriode, EL84 output, EZ80 full wave rectifier. Power output 3 1/2 watts for 2/3 ohm speaker. 3 Planetary vernier slow motion drives, separate electrical breadspread. Covers 10-2000 meters (5 Coils). World wide reception. For A.C. supply 200-250 volts (Export version 105-120 volts). Total building cost all parts, valves, front panel, ready punched chassis, 2 coils, 20-60 and 55-190 meters, wire, solder, instruction manual. P. & P. 3/6. Optional extra. CR45 Cabinet 12 x 5 x 7in., slide flap for easy coil changing, Silver grey finish, 27/6.

£6.19.6

No technical knowledge required to build these fine receivers. Send 3d. stamp for illustrated leaflets, testimonials, etc. Now available the NEW 1962 CR 66 A.C. SUPERHET COMMUNICATION RECEIVER.

CODAR RADIO COMPANY, 24 CHAPEL ROAD, FISHERSGATE, PORTSLADE, SUSSEX G31RM

Canadian Distributors: JAYCO ELECTRONICS, TWEED, ONTARIO.

G31PA

APPROX £1 A WEEK FOR 8 WEEKS YOU CAN

Build the Practical Wireless 6-Transistor Pkt. Superhet on our **BUY AS YOU BUILD PLAN.**

New style two-tone case, printed circuit, all new components, matched transistors and diode. This is the latest boosted version by Osmor, with simpler step-by-step instructions, circuit photo and plans, 1/6. **WHY NOT BUY A SECTION A WEEK?**

| | | | |
|----------|--|-----------------------------------|---|
| SECTIONS | A 20' Cabinet & Printed Circuit | B 22' Osc. and -8 IP's | C 16/3 Matched P. Transformers |
| | D 43' 6 Transistors & Diode | E 16/11 High Flux. Speaker | F 21' Tuning Condensers & Ferr. Rd. Aerial |
| | G 20' Resistors Condensers | It's Easy to Build the STUART Way | H 19/3 L&M Switch Vol. Control & Trimmers |

The complete kit costs only **£7.19.6** Why pay more?

WHY NOT SEND STAMP FOR NEW COMPONENTS LIST?

TRANSISTOR BOOKS

TRANSISTOR CIRCUITS MANUALS NO. 2 AND 4, 2/6 EACH.
MANUAL OF TRANSISTOR AUDIO AMPLIFIERS, 6/-
TRANSISTORISED TEST EQUIPMENT AND SERVICING MANUAL, 3/6.

STUART SPARES DI

34 Essex Road, Rushden, Northants.

Become a Television expert this easy way

The Bennett College offers you a complete course

THE Bennett College offers you personal tuition in a course that's non-mathematical and particularly easy to follow. It contains clear diagrams which cover everything you want to know from beginning to end (and even includes the basic principles of sound radio if you wish).

The complete home-study course covers everything: Production of the signal, scanning and reproduction of picture from signals. Aerials, types and purposes. The cathode-ray tube. Time-base oscillators, and output circuits. Synchronisation. Video frequency amplifiers. The TV tuner, turret incremental, etc. Television test gear. Television faults.

For more details, please fill in the coupon below. Your studies cost very little and the book you need is included in the cost.

To THE BENNETT COLLEGE (Dept. 104NTV), Sheffield
Please send me details of the new
TELEVISION SERVICING COURSE

NAME _____

ADDRESS _____

AGE _____

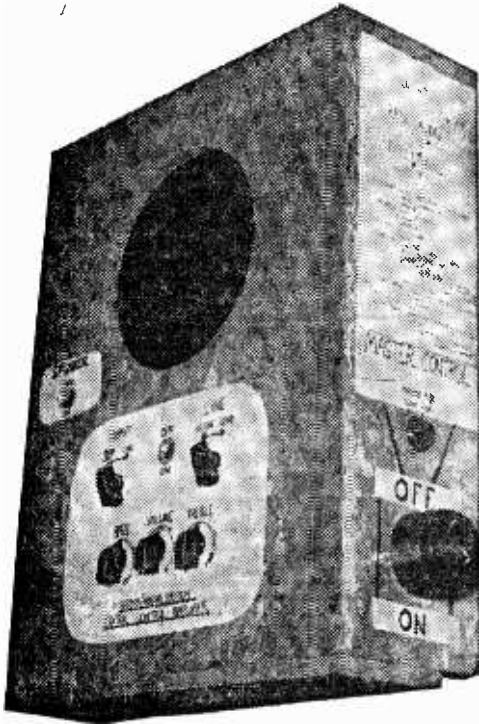

Central Control Amplifier

By E. McLoughlin

A MASTER-CONTROL UNIT FOR AN AUDIO INSTALLATION

AN Audio distribution system" (August, 1962, issue page 297) sketched, in a quite general way, the possibilities open for designing a multi-way radio/audio installation in a small house or flat, using inexpensive and neat three-core unscreened mains power cable for all transmission lines. A single such cable carries mains distribution, audio power, aerial and earth. The introductory article discussed the advantages and the limitations of such a system and showed how, with at the most a few and simple modifications, almost any available radio, amplifier and loudspeaker equipment could be used in an installation of the envisaged

type. Thus, whilst the constructor may use any other equipment he may have already built from other designs published in this magazine, or which has been otherwise procured, the specific continuation articles of this series will deal with special units which have been designed to be *particularly* suitable for the installation. These units will also be of such a form that they each preserve, in addition, the widest possible characteristics of "independent usability", so that those constructors not wishing to follow through the whole series can build and use almost any of the units isolated and alone (with suitable simple omissions and slight modifications for such cases, which will usually be obvious).

The unit described in the present article, the first of the "specific" articles, is the only one which is probably of no use isolated and alone. This for the excellent reason that it is to form the heart of the whole installation. For this reason, too, it is taken first of all. It is to provide master-control for the whole installation and embodies a very special amplifier particularly suited to the requirements of this form of audio-distribution. Thus, whilst it is perfectly true that, provided not too many loudspeakers are switched in parallel on to the line, matching is in practice uncritical and ample volume is obtained simply by switching ordinary output-transformer secondaries on to the line (as discussed in the initial article). The special type of drive-amplifier introduced in this article gives performance of superior quality and power and has the interesting advantage that it will largely suppress other signals on the line from simpler sub-units, replacing them with its own output signals (without the need for further override switching) when it is switched on to the line. This is because of its exceedingly low internal output impedance, which largely short-circuits other signals present and not because of any "shouting-down" on account of excessive power. The new amplifier here to be introduced has high power certainly, but this is only developed when sufficient loudspeakers are switched on to the line and is *not* blasted into a single loudspeaker if all others are switched off. Thus a very smooth "master-control" action, justifying this name, results.

Functional Summary

The unit is designed for the "principal" station of the installation, which will be the workshop, laboratory or "den" of the experimenter. Here it forms a permanent wall unit containing, first of all, the mains-input, main fuse and master-switch for the whole installation. If power is switched off here everything else in all rooms wired to the system is necessarily dead—whatever the switch-positions on subsidiary apparatus in the other rooms. This master-control is essential as otherwise it is too awkward to run round all rooms each evening to see that all is switched off.

The unit contains two amplifiers, integrated as one functional whole. A two-valve high-fidelity amplifier, using an only very slightly modified form of a design for an EF86 driving an EL84 output pentode, provides audio-gain. This has separate bass and treble controls, as well as volume control, and very heavy negative feedback, giving some three watts output into a built-in 8in.

loudspeaker at very low inherent distortion, low cross-modulation and wide frequency-range. Either the internal 4Ω loudspeaker (or a dummy 4Ω resistor-load in the off position) match this output correctly at all times.

Three watts into 4Ω represents some 3.5V r.m.s. Were another loudspeaker connected in parallel this voltage would collapse to a considerably smaller value, so that each loudspeaker would receive *less than half* of the power (because of the resulting mismatch to the EL84). Matters are progressively worse as more loudspeakers are hypothetically switched in. Nevertheless, ample volume would normally still be obtained from

is a push-pull emitter-follower, using a matched pair of 2N257 power-transistors. This feeds the audio-signal on to the line at a source-impedance of something under a quarter of an ohm and a voltage some 10 to 15% higher than that impressed on the internal speaker or its dummy load. The slight excess is to compensate, roughly, losses in the line to the other rooms so that the distant loudspeakers finally receive each precisely the same power as the internal loudspeaker running direct from the EL84. The voltage does not collapse much as more loudspeakers are switched in; each comes on almost independently with full power and volume of about 3W maximum.

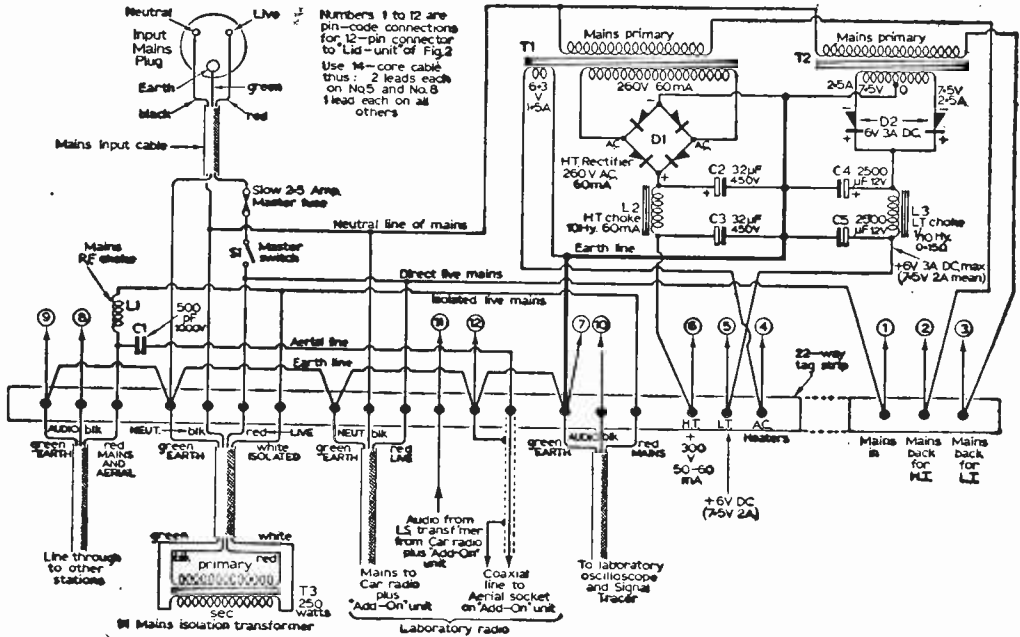

Fig. 1 The power-pack circuit and cabinet-body distribution wiring plan.

many loudspeakers but there would be a progressive lack of available "punch" on difficult music, etc. All this is because the EL84, in common with any other output valve, is very exacting regarding its precise load and impedance conditions are relatively high, so that the voltage rapidly collapses with decrease of load-resistance.

It would thus be highly desirable, whilst still keeping to the same voltage developing some 3W in a 4Ω loudspeaker, to transform the effective source-impedance down to a much lower value before feeding the signal on to the main line. A simple transformer would be useless for this purpose as it would simultaneously reduce the voltage to a negligible value. Some form of cathode-follower is the correct solution to the problem and, because of the high powers and extremely low impedances to be involved, a transistorised version is ideal. A valve-version would be unnecessarily awkward, though—in principle—possible.

Accordingly, the second incorporated amplifier

Number of Loudspeakers

Design is for any arbitrary number of loudspeakers between one and five on the line in the unit here detailed. Operating points have been chosen carefully such that the transistors just receive maximum acceptable drive under the given conditions when the EL84 is also just receiving maximum acceptable drive, and distortion then just does not start on the line when all five loudspeakers are on the line, or an additional partial short is present, distortion will start on the line before the EL84 reaches full undistorted output. In spite of the very low source impedance, excessive power is not driven into a full short-circuit fault condition on the line because the L.T. D.C. power-pack has been designed such that its output voltage then collapses sufficiently at the resulting increased current. The transistors are rated at 12W collector dissipation each and 4A peak collector current each.

(To be continued)

RADIO CLEARANCE LIMITED

27 TOTTENHAM COURT ROAD, LONDON, W.1.

THE OLDEST COMPONENT SPECIALISTS IN THE TRADE

TRADE ENQUIRIES INVITED

Telephone: MUSEUM 9188

EST. 30 YRS.

YOU CAN
HOLD EUROPE
IN THE PALM
OF YOUR HAND
WITH THE



"CAPRI"

A miniature pocket transistor Radio that **REALLY** works, retaining the most attractive features of the famous "Contessa." Six first-grade Mullard transistors plus diode are employed in a highly sensitive superhet MW and pre-set LW circuit embodying the most modern design practices. A special $2\frac{1}{2}$ in. high gauss loudspeaker provides surprising volume and a personal earpiece socket is also available. An attractive two-tone plastic case is supplied in two colours—ivory/red or ivory/blue, the full constructional details being furnished with each set of parts. The total measurements of the "Capri" are $4\frac{1}{2} \times 2\frac{1}{4} \times 1\frac{1}{4}$ in.

SEE AND HEAR A WORKING MODEL TODAY

Inclusive price for all associated components, case and constructional data, complete in every detail, or our BUY AS YOU BUILD Scheme, any parts sold separately. (9 volt battery 2/6 extra.)

£6.19.6

(Plus 2/- P. & Pkg.)

INTRODUCING THE NEW "CONTESSA"

Mk III

The Best is Now Even Better!
A brilliant conception of the finest 2-band 6-transistor radio available.

★ Ultra-modern styling with a magnificent twin-tone cabinet fitted with fully expanded metal front and a slide-rule type waveband dial. **GREATER OUTPUT** using the latest high-efficiency Mullard Transistors and Diodes, incorporating an improved design, featuring different circuit constants.

MORE punch—MORE gain—MORE stations—SUPERB appearance—the NEW "Contessa" scores again!!
SEE it—HEAR it—you will BUY it!

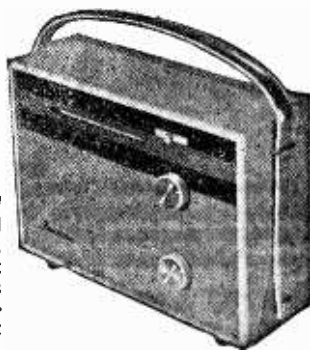

- Waveband coverage of 530 kc/s to 1,620 kc/s and 160 kc/s to 270 kc/s.
- Assured reception of at least half a dozen stations in daylight!
- Large clearly-calibrated station-named dial.
- Internal high-gain Ferrite aerial.
- 5:1 ratio slow motion tuning.
- Fitted with the latest 12,000-line high-flux loudspeaker.
- Power of 600 milliwatts from the single-ended push-pull final stage.
- Specially designed aerial matching coil for use in a CAR.
- Only first-grade Mullard fully-guaranteed matched transistors and diodes are used.
- Tape recorder socket provided.
- Double-tuned IF transformers for maximum gain and knife-edged selectivity.
- Fully drilled printed circuit panel marked with component numbers.
- The two-tone case outer measurements are $10\frac{1}{2} \times 7\frac{1}{2} \times 3\frac{1}{2}$ in. and weighs approx. 4 lbs. when assembled.
- Battery lasts 4 months with normal usage.
- Book supplied with detailed assembly instructions, diagrams and circuitry.
- Anyone can build this set—everything supplied, just a soldering iron required.
- Cabinets available in two tone beige and two tone blue.
- Adjustable carrying handle.

Inclusive price for all associated components, cabinet and battery, complete in every detail: Or our BUY AS YOU BUILD SCHEME, any part sold separately. Send for comprehensive descriptive Manual and Parts List, 2/10 post free.

£10.19.6

(Plus 3/6 P. & Pkg.)

STILL AVAILABLE to callers only

SUPERB MAGNAVOX PRINTED CIRCUIT 4-WATT TAPE RECORDER AMPLIFIER

Record, playback and erase facilities. Bass and Treble Tone Controls—40 cys to 12,000 cys. With valves, plugs, leads and full circuit details.

DIRECT FROM THE MANUFACTURERS @ **£3.10.0**

OR LESS VALVES @ **£2.0.0**

ALL the Components for the matching **POWER SUPPLY** including Transformer, Rectifier, Sub-chassis, smoothing, plugs and sockets. **£1.3.6**

SPECIAL OFFER! Above amplifier less valves, with suitable power transformer, **£2.19.6**

Regret Transistors **SOLD OUT.**

STAMPED and ADDRESSED ENVELOPE with any enquiry please. But regret no lists or catalogues—our stocks move too quickly!
PLEASE ALLOW FULL POSTAGE AND PACKING CHARGES

Terms of Business: CASH WITH ORDER OR C.O.D. ON ORDERS OVER 10/-

TRANSISTOR AMPLIFIERS

1/2 WATT 3 TRANSISTOR AMPLIFIER READY BUILT

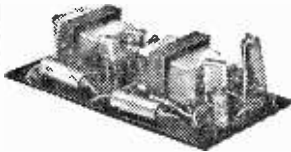

45/- Plus 1/6 P. & P.

- 1/2 w. Peak output.
- Output to 3ohm speaker.
- Push-pull output stage.
- 9 volt operation.

A printed circuit high gain amplifier. Size 3 1/4" x 2" x 1/2". Three Newmarket Transistors (two NKT 251 and NKT252). Ideal for intercom or as record player amplifier.

2 WATT 4 TRANSISTOR AMPLIFIER READY BUILT

A 2 watt 4 transistor amplifier with 2 driver and push-pull stage. Size 4 x 2 1/2 x 1/2 in. Plus 1/6 P. & P.

62/6

THE NEW TRANSISTOR 6 PANDORA

Designed By
Mel Electronic

USING NEW HIGH GRADE PARTS
TOTAL BUILDING COST
ONLY £6.19.6



FULL AFTER SALES SERVICE

Obtainable from your local stockist or in case of difficulty DIRECT FROM MEL ELECTRONIC

- MEDIUM WAVE & LIGHT ON LONG WAVE
- 6 TRANSISTORS + DIODE
- SUPERHET CIRCUIT
- AUTOMATIC WAVECHANGE
- 500mW PUSH-PULL OUTPUT
- PRE-TINNED PRINTED BOARD
- EXCELLENT RESULTS

Please send S.A.E. for full details of these and other transistor designs:

MEL ELECTRONIC CO.

REAR OF: 240 HIGH STREET
BECKENHAM, KENT

NEW! DO-IT-YOURSELF TRAINING TECHNIQUE in RADIO & ELECTRONICS

You LEARN while you BUILD...

SIMPLE...PRACTICAL...FASCINATING... 1st stage receiver

ANNOUNCING—after many years of highly successful operation in the U.S.A. and in Europe—the latest system in home training in electronics is now introduced by an entirely new British training organisation. **AT LAST**—a comprehensive and simple way of learning —by practical means—the basic principles of radio and electronics, with a minimum of theory. **YOU LEARN BY BUILDING** actual equipment with the components and parts which we send you. You advance by simple steps using high quality equipment and performing a whole series of interesting and instructive experiments. No mathematics! **INSTRUCTION MANUALS** and our teaching staff employ the latest techniques for showing clearly how radio works in a practical and interesting manner. You really have fun whilst learning! And you end by possessing a first rate piece of home equipment with the full knowledge of how it operates and—very important—how to service and maintain it afterwards. A full library of magnificent illustrated textbooks are included with the Courses. **IN FACT** for the "Do-it-Yourself" enthusiast, the hobbyist, or those wanting help with their radio career training, or to set up their own full or part-time servicing business—then this new and exciting instructional system is exactly what is needed and it can all be provided at very moderate cost. Easy payments available. Post the coupon now, for full details. There is no obligation.

BUILD YOUR OWN • RADIO EQUIPMENT • TEST GEAR • HI-FI INSTALLATION—AND LEARN AS YOU DO IT

RADIOSTRUCTOR

BRITAIN'S LEADING RADIO TRAINING ORGANISATION

FREE-POST TODAY

To: RADIOSTRUCTOR (Dept. G107),
Reading, Berks.

Name

Address

.....

(821) We do not employ representatives 11-62

BLOCK CARS PLEASE

SERVICING TAPE RECORDERS

TYPICAL FAULT
SYMPTOMS AND
THEIR CURES

By T. S. Smith

(Continued from page 525 of the October issue)

IN past articles of this series, we have investigated the principles of tape recording, examined circuit sections in some detail and discovered the best ways of recording a radio programme. In this final article of the present series we will examine a typical recorder circuit, find out exactly what the components do and finally discuss the various fault symptoms which are characteristic of tape recorders.

The circuit to be discussed is given in Fig. 32. Here V1 is a high-gain low-noise pentode which serves as a preamplifier for both the microphone on "record" and the tape head on "replay". Failure of this valve or associated component would thus result in lack of both record and replay. This is typical of most recorders, and well worth bearing in mind.

With switch S1A in the "record" position, the microphone signal is coupled direct to the control grid of V1, across the grid leak R2 and the equalising capacitor C3.

High Gain Amplifier

V1 is arranged as an ordinary A.F. amplifier to provide a high gain, this being necessary to boost the very weak signals from the microphone and replay head. Since it is running at high gain, the valve may be prone to microphony (e.g., it may produce a ringing noise in the loudspeaker when mechanically disturbed), and for that reason its holder is often mounted on rubber buffers on the chassis.

After some time in service, the valve may become "noisy"; that is, frying and crackles may be superimposed on replay or on the recording, but this can usually be checked by switching to replay, turning the volume control to maximum and gently tapping the valve with the handle of a screwdriver. If this action results in loud noises from the loudspeaker, then the valve should be checked by substitution. Note, however, that even a new valve will give some noise when mechanically disturbed owing to the very high circuit gain.

If the valve is reasonable, yet a disconcerting background noise remains, but only with the volume control turned up, the cause must lie in V1 stage. Typical troubles are bad connections between the pins of the valve and the sockets on the holder, a "noisy" grid leak (R2), a "noisy" anode load resistor (R3) and poor soldered connections on the valveholder. If the trouble persists

even with the volume control turned right down, the trouble must then lie after V1 stage, since V1 is always operating at full gain and the volume is controlled prior to V2A.

V1 is biased by the voltage dropped across the cathode resistor R4—this making the cathode more positive than the control grid, which is the same as the control grid being more negative than the cathode. Heavy cathode decoupling is provided by C5 to avoid degenerative feedback. Should C5 go open-circuit, then the gain on both record and replay would be well below standard, and there would be a definite lack of bass response. A short-circuit would cause bad distortion and excessive microphony.

The stage would fail completely, of course, in the event of either the screen feed resistor or the anode load (R1 and R3) going open-circuit. The same would happen should the screen decoupler C2 or the main decoupler C1 short-circuit, but in the latter case R7 would overheat.

The amplified signal at the anode of V1 is coupled to the volume control VR1 through the coupling capacitor C4. The required level of signal is taken from the volume control and fed direct to the control grid of V2A. This valve is also arranged as a voltage amplifier and, in conjunction with the following stage V2B, gives suitable equalisation via the negative feedback loop coupled through C7.

It will be seen that the feedback signal is injected at the cathode of V2A, and to facilitate that, the cathode is not decoupled. R6 is the anode load, and from here the signal is fed to V2B grid through the coupler C6. Because the overall gain provided by V2B need not be very great, degenerative feedback (e.g., current negative feedback) is introduced by leaving the cathode resistor R10 unby-passed.

The H.T. supply for both V1 and V2A is decoupled by R7 and C1, these components also giving extra H.T. smoothing, which is essential in high-gain stages to eliminate all traces of mains hum.

Radio and Pick-up Input

On the majority of domestic recorders, there is provision for the injection of a radio or pick-up signal for recording purposes (see Parts 7 and 8). This does not require to be a low-level input since the signal from a radio or pick-up is usually far stronger than that from a microphone or replay

head, so the signal is fed in after the preamplifier V1.

In the circuit of Fig. 32, it is applied across the volume control. This, then, gives another way of checking stage V1, for if the microphone input is dead and yet normal operation is possible by injecting the signal at the radio and pick-up input socket, we can be absolutely sure that the trouble is in stage V1. The signal at this socket can also be monitored, if required, on a pair of high resistance headphones.

The amplified signal at the anode of V2B is fed to the negative feedback loop, via R11, R12 and R13, with frequency correction being given by C9. The signal is also fed to the wiper of switch S1B through R14. Moreover, the signal is also directed to the "extension amplifier" socket. The signal at that point is at a fairly high level, so it can be used to drive a separate hi-fi amplifier, for example.

as a bias oscillator. Feedback takes place between the screen grid and control grid circuits via C15. Erase on this model is by permanent magnet but on models where an erase head is used instead the oscillator also feeds that head in the "record" position.

Record Level

V3 is a "magic eye" valve which is arranged as a record level indicator. This comes into operation only on record, the anode being switched to the H.T. line by S1C.

The grid of the valve is fed by a D.C. voltage the level of which is proportional to the peaks of the signal at the anode of V2B. The signal is rectified by M3 and smoothed by C12, which also endows the circuit with a time-constant. R15 and C11 form an A.F. filter circuit and contribute towards giving a clear-cut shadow on the eye.

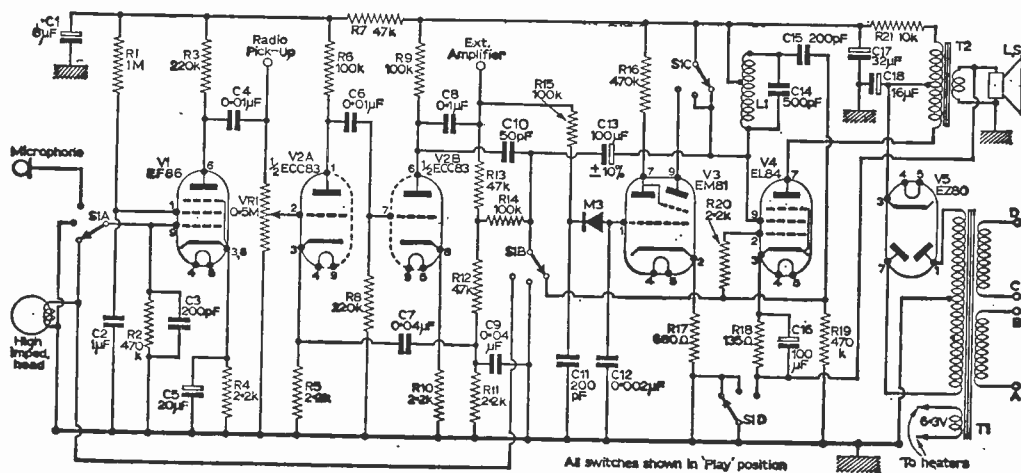

Fig. 32—The circuit diagram of a typical domestic tape recorder.

With switch S1B in the "record" position the signal is taken back to the head and a "constant current" record characteristic is secured by the signal being passed through the high resistance of R14. With the switch in the "replay" position, however, the signal is directed to the control grid of V4 through R20, with R19 being the grid-leak.

On "replay" V4 is the normal output valve, it being loaded in its anode by the speaker and speaker transformer T2. Under that condition S1D disconnects the bottom of the cathode resistor R18 from chassis, the return circuit then being provided through the secondary of the speaker transformer. This is done to facilitate switching the speaker out of circuit on "record".

Also the screen grid of V4 is connected direct to the H.T. positive line, since S1C shorts out the oscillator coil L1. Thus V4 works as a conventional output stage.

On "record" several things happen. S1D changes over and puts the bottom of R18 to chassis, thereby shorting out the speaker. S1C changes over and puts L1 into the screen grid circuit of V4, in that way causing the valve to act

The recorder is powered from the mains supply via a fully-isolated mains transformer T1. The two primary windings give 200-250V operation when points B and C are connected and 110-115V operation when points B and C are disconnected, A connected to C and B connected to D.

The H.T. primary winding feeds a full-wave rectifier V5, while a separate 6.3V winding energises all the parallel-connected valves. The reservoir capacitor is C18, with C17 as the main smoother. The tapped primary of the speaker transformer gives hum cancellation, since the hum voltage in the top section is opposite in phase to that in the bottom section, and lower current smoothing is provided by R21.

Replay Normal—No Record

On the type of instrument detailed in the foregoing this symptom would almost certainly mean that a faulty connection exists between the switch section S1B and the record/replay head. The best thing to do would be to switch to "record", inject

(Continued on page 637)

WHAT READERS SAY ABOUT

THE

Common

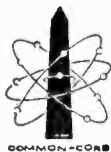

Core

SERIES

ILLUSTRATED COURSES OF ELEMENTARY TECHNICIAN TRAINING

" . . . Wish to congratulate you for publishing one of the best-ever series dealing with this complex subject . . . "

" . . . Your books seem to explain things much more easily. I wish they were on sale when I had to learn radio . . . "

" . . . Having obtained the two volumes of 'Basic Synchros & Servomechanisms' I find them very interesting and a novel way of learning . . . "

" . . . As a lecturer I am finding these of great assistance and congratulate you on publishing such excellent books . . . "

" . . . I am writing to tell you how much I enjoyed reading your 'Basic Electricity' and 'Basic Electronics' . . . "

" . . . I have all the previous sets, namely: 'Basic Electricity', 'Basic Electronics' and 'Basic Synchros & Servomechanisms' and will mention that it's truly one of the best I've studied . . . "

" . . . I have found 'Basic Electricity' and 'Basic Electronics' excellent publications . . . "

" . . . I have been supplied with some of the above publications, and needless to say I am delighted with them . . . "

BASIC ELECTRICITY (5 PARTS)

BASIC ELECTRONICS (6 PARTS)

BASIC SYNCHROS & SERVOMECHANISMS (2 PARTS)

ALL THE ABOVE ARE ON SALE NOW

BASIC RADAR (3 PARTS)

PART 1 ON SALE NOW. PARTS 2 and 3 IN PREPARATION

BASIC ELECTRONIC CIRCUITS (3 PARTS)

PART 1 ON SALE NOW. PARTS 2 and 3 IN PREPARATION

COUPON - SEND NOW!

OR ASK YOUR BOOKSELLER

To THE TECHNICAL PRESS LTD.

112 Westbourne Grove, London, W.2.

Please send me your FREE prospectus describing:—

BASIC ELECTRICITY/ELECTRONICS/
SYNCHROS

BASIC RADAR/ELECTRONIC
CIRCUITS

(Please put a X against your requirements).

NAME _____

ADDRESS _____

PW

Electronics Ltd

152-153 Fleet St., London, E.C.4. Tel. Fle 2833

Business Hours: Weekdays, 9-6, Saturdays 9-1

Stockists for
**AMPLIFIERS, V.H.F. TUNERS, HI-FI SPEAKERS BY
ALL THE LEADING MANUFACTURERS**

SOMETHING TO SHOUT ABOUT THE SET YOU HAVE BEEN WAITING FOR THE REALISTIC SEVEN

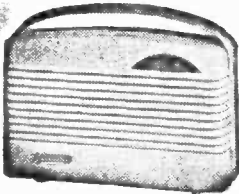

The finest receiver at present available for home construction, a set that will give results. Fully tunable long and medium wavebands, using 7 Mullard transistors, OC44, 2-OC469, OC71, OC81D and 2-OC815, plus OA70 crystal diode, 350 milliwatt output, 4in. high flux speaker, printed circuit board size 5 $\frac{1}{2}$ x 5 $\frac{1}{2}$ in. Neat plastic cabinet with carrying handle, size 7 x 10 x 3 $\frac{1}{2}$ in.. In choice of colours: red/grey, blue/grey, all

grey. Easy to read dial! External sockets, for car aerial; all coils, I.F.T.s and aerial fully wound ready for immediate assembly. Full comprehensive data and circuit supplied with each receiver. Operates from PP9 or equivalent battery. Price for the complete parcel including transistors, cabinet, speaker, etc. Post and packing 4/6. Battery 3/9. Supplied free with complete parcel. Easy to follow data and instructions 2/6, refunded if parcel is purchased. Parcel supplied on approval. Your money refunded by return post **PROVIDING COMPONENTS ARE COMPLETE AND NOT SOLDERED. All parts supplied separately.**

£6.19.6



MULTI TEST METER MODEL U1

- Complete with test leads.
- Brand new, fully guaranteed. Sensitivity: 1,000 ohms per volt A.C. and D.C.
- Ranges (A.C. and D.C.): 0-15-50-200-500-1,000 v. D.C. current 0-100-500 mA.

(tuned at 0-10 v. range).

Resistance: 1-2,000 ohms (centre 24 ohms). 100-200,000 ohms (centre 2.4 k.). Size: 5in. x 3in. x 2 $\frac{1}{2}$ in.

OUR PRICE 39/6

Carriage and Packing 5/-.

HUGE PURCHASE

CRYSTAL PICK-UP CARTRIDGES. LOWEST PRICES EVER. Some are less than half list price.

ALL COMPLETE WITH STYLI L.P. & STANDARD (AND/OR STEREO WHERE SHOWN). FULLY GUARANTEED STANDARD FITTING.

WILL FIT MOST P.U. ARMS AND HEADS. Postage 1/- each extra.

TYPE C.T.1. By well known manufacturer. With 2 sapphire styli. 12/6

| | | | |
|--|------|--------------|------|
| Gerrard GC2 | 15/- | Acos GP.65/1 | 17/- |
| Ronette Studio O | 15/- | Acos GP.67/1 | 17/- |
| Acos GP.65/3 | 15/- | Acos GP.61/1 | 18/- |
| STEREO | | | |
| Acostereo 73/1. With 2 sapphires 25/-. | | | |
| Acostereo 73/2. With Diamond L.P./Stereo and sapphire 84d. 29/6. | | | |
| Collaro type C. Turnover with 2 sapphires 25/6. | | | |
| Collie S.C.1 Turnover, with 2 sapphires 24/6. | | | |
| Collie S.C.1 Turnover, with Diamond L.P./Stereo and sapphire Std. 29/6 | | | |
| Ronette Stereo O.V. Turnover 29/6. | | | |
| Ronette Stereo type 105 35/6. | | | |
| Ronette Stereo type 105, with Diamond L.P./Stereo and sapphire Std. 39/6 | | | |
| Ronette Stereo type 106 | | | 32/- |
| Ronette Stereo type 106 with Diamond L.P./Stereo and sapphire Std. 37/6 | | | |

HIGH QUALITY TAPE RECORDER MOTOR

Fully shrouded heavy duty, suitable for capacitor or take-up 200/250 v A.C. only, 50 cycles 1,400 r.p.m., 4 pole singular phase.

Complete only **19/11** P. & P. 3/6.

SPECIAL OFFER T.V. REMOTE CONTROL UNIT.

By well known manufacturer, on/off, brightness and volume controls. In smart grey plastic box with 15 feet of multi 7 way screened cable (grey). Listed at £2/2/-. **SPECIAL PRICE 14/11** Post 1/6.

SOLDERING EQUIPMENT

by



PRECISION SOLDERING for the ELECTRONICS INDUSTRY

Comprehensive range-Robust & Reliable - Light weight - Rapid heating - Bit sizes 3/32in. to 3/8in. - 'Permagit' or Copper bits - All voltage ranges 6/7v. to 230/250v. - Prices from 21/-.

Also

- Plastic Cable Strippers
- Miniature Solder Pots
- Heat Guards
- Long Life Bits

Illustrated is the 25w. 3/16in. replaceable bit model with safety shield.

ADAMIN— new range of precision micro-soldering instruments— Have you had details?

Brochure No. S10 sent free on request.

SOLE PROPRIETORS and manufacturers:
LIGHT SOLDERING DEVELOPMENTS LTD.

28 Sydenham Road, Croydon, Surrey
Phone: CROYdon 8589 Grams: Litesold Croydon

The new NOMBREX

TRANSISTORISED WIDE-RANGE SIGNAL GENERATOR 27

220 kc/s to 220 Mc/s



RETAIL £7.10.0 Post and Ins. 3/6 Battery 2/3

Screened Lead and Probe 6/3 extra

CASH WITH ORDER. REGRET NO C.O.D. NOW IN QUANTITY PRODUCTION ALL ORDERS IN STRICT ROTATION

Trade and Export Enquiries Invited

CHECK THESE FEATURES

COMPACT! Only 6 $\frac{1}{2}$ " x 4 $\frac{1}{2}$ "

PORTABLE Weight 2 lbs.

ACCURACY Under 2%

ECONOMY 9v. Battery

DIRECT Calibration

S.A.E. for full technical details.

H.P. Terms: Send £2 deposit

pay per month 21/- per month

NOMBREX LTD. (Instruments Division 39)

Estuary House, Camperdown Terrace, Exmouth, Devon, England. Tel. 3515.

(Continued from page 634)

a signal and endeavour to monitor it either on a high resistance A.C. voltmeter or pair of headphones first at S1B and then at the head.

Since "replay" is normal R14 must be working correctly and there would be a good connection at the wiper of the switch, since the signal is conveyed correctly to the control grid circuit of V4.

Replay Normal—Distorted Recording

This symptom is typical of bias oscillator failure. One check for oscillation is by metering the screen current at the H.T. tap of L1. The tap should be disconnected from the H.T. line and a milliammeter (25mA full scale) connected between the tap and H.T. positive (positive of meter to H.T. positive). If the stage is oscillating a distinct change in screen current will occur when L1 is short-circuited.

If the stage is not oscillating C15 would probably be open-circuit or there may be shorting turns in L1. If the stage is proved to be oscillating, lack of bias at the record head could be caused by C13 being open-circuit.

Record Normal—No Replay

Again, as all the valves themselves must be working reasonably well to give normal record facilities the trouble would most likely be in the head switching or in the speaker circuit. A pair of headphones could be used to trace a tape signal through the preamplifier and triode voltage amplifiers right up to the control grid circuit of the output valve.

Indeed, a pair of headphones can be extremely useful to trace the signal through any audio section whether it be on record or replay. The bias signal, of course, will not be heard since this is at a frequency just outside the audible range.

Low Record/Replay Gain

If this is accompanied by the record level indicator not closing fully on signal peaks, even with the record level control (gain) turned to maximum, attention should first be directed to the preamplifier, and voltage amplifier valves themselves. Low emission of one or more of the valves is a frequent cause of the trouble.

If the valves are in order it would pay to check

Mayfair pre-amplifier

(Continued from page 612)

now be wired in position and the remainder of the wiring to S1 completed.

Screened Leads

It now remains to make the connections between top and underside of the chassis. Lightweight plastic covered screened cable should be used for this purpose. Each screened lead is clearly shown in the wiring diagrams Figs. 2 and 5, and is marked with a code letter to distinguish it from the other leads that pass through the same opening in the chassis, thus simplifying cross-references from one diagram to the other.

Final Wiring

The mains input circuit should be wired next. This requires four conductors—two lengths of twin-core mains lead will be satisfactory—and these should be routed from the input plug PL1 across the end of the chassis then along the front edge of the chassis close in the angle of the metal-

work, and terminated at the mains switch S3. Because of the close proximity of PL1 to other components and wiring, the protruding pins must be covered with insulated sleeving.

With the mains wiring in position the earth busbar can be completed. This involves running a length of 18s.w.g. tinned copper wire between the two jack sockets JK1 and JK2 with further connections to TB3, TB4 and TB5. As this wire runs very close to the mains switch and the lamp holder, suitable lengths of insulated sleeving should be threaded on to the straight portion of busbar so that, except for the points where a branch connection is made, the whole of the wire running from JK1 to JK2 is covered.

Connect wire "D" to TB3 and feed this wire through to the top of the chassis and secure it by means of a solder tag to a fixing screw of one of the input sockets.

This completes all the internal wiring. The four-core power cable and the coaxial output cable should be brought in through grommet holes and connected up according to Figs. 1 and 5.

Hum Troubles

If hum is present with the volume control turned right down it is usually caused by low value or open-circuit of one of the electrolytic smoothing capacitors.

If hum occurs only when the volume control is advanced it is probably getting in at the preamplifier. Check the valve by substitution and ensure that the screening (if fitted) on the head is properly bonded to chassis and also that the braid of the wire connected to the head winding is earthed to chassis. Check the preamplifier decoupling capacitor and screen by-pass capacitor (such as C1 and C2 in Fig. 32).

Displaced heater leads to the preamplifier valve is another cause of hum injection.

work, and terminated at the mains switch S3.

Because of the close proximity of PL1 to other components and wiring, the protruding pins must be covered with insulated sleeving.

With the mains wiring in position the earth busbar can be completed. This involves running a length of 18s.w.g. tinned copper wire between the two jack sockets JK1 and JK2 with further connections to TB3, TB4 and TB5. As this wire runs very close to the mains switch and the lamp holder, suitable lengths of insulated sleeving should be threaded on to the straight portion of busbar so that, except for the points where a branch connection is made, the whole of the wire running from JK1 to JK2 is covered.

Connect wire "D" to TB3 and feed this wire through to the top of the chassis and secure it by means of a solder tag to a fixing screw of one of the input sockets.

This completes all the internal wiring. The four-core power cable and the coaxial output cable should be brought in through grommet holes and connected up according to Figs. 1 and 5.

A Simple Method of ANODISING ALUMINIUM

By K. D. Rendall

ANODISING is a process that can be carried out by the average home constructor for an initial outlay of about 15s. and, as the chemicals can be used again and again, the cost is even cheaper than painting and there is the advantage that one can carry on work as soon as it is finished and not have to wait for paint to dry.

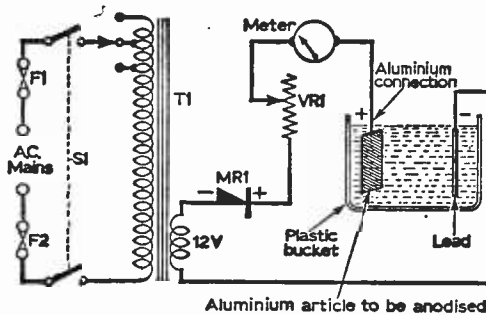

Fig. 1—The apparatus needed in the operation.

Chemicals

The only equipment needed is a couple of containers for the chemicals and plenty of clean water. The author used a plastic bucket for all processing and put the chemicals in bottles as soon as he had finished each stage of the process.

The first and most important rule to observe is absolute cleanliness, or the final product will be smeary and the colour uneven, so at all times keep the article to be anodised as clean as possible. First clean the article by brushing it all over with steel wool so that there is an even matt finish all over the surface. Care spent in ensuring that all parts of the surface are clean will be repaid in the appearance of the finished product.

The cleaned article is next placed in a strong solution of ordinary caustic soda; this is not a critical operation and as long as the mixture is strong enough to etch the metal then it is strong enough. The article is left in this solution for about a quarter of an hour and then it is removed, thoroughly rinsed and placed to one side. It is not advisable to touch it after this operation as greasy finger marks can be caused. Great care must be taken that the caustic soda does not

COMPONENTS LIST

| | |
|--------|--|
| T1 | Transformer—tapped mains primary, 12V 8A secondary (or lower current rating if desired—see text) |
| SI | Double pole mains on/off switch |
| F1, F2 | Mains fuses—2A |
| MR1 | Rectifier—12V A.C. input to give 8A D.C. (or to suit transformer current rating) |
| VR1 | about 2Ω 10W—may be several W.W. resistors in series, tapped where required. |

splash into the eyes or on to the skin. If this does happen, then rinse it off with plenty of cold water as soon as possible. A preparation of dilute sulphuric acid diluted in the following proportions will then be needed: to one part of acid add seven parts by volume of water. Always add the acid to the water, not the water to the acid or the liquid will become very hot and may splash violently. This dilute acid is then placed on one side and allowed to cool.

A D.C. supply of 12V is needed in order to form the layer of oxide that will accept the dye to give the anodised finish. This layer is formed by electrolysis and the theory of this will not be given as public libraries have many books on the chemical theory. The D.C. supply must be capable of providing 8A or thereabouts. If this is not possible, then the times given by the author must be extended to suit the individual needs of the constructor. The circuit of a suitable supply is given in Fig. 1.

The acid is placed in a plastic bucket and the aluminium article to be anodised placed in it with a connection made with a piece of aluminium. The reason that this metal is specified for the connection is that a piece of copper or steel will be attacked and cause the aluminium article to take on a colour that is not wanted. A small piece of lead is used for the negative connection and the article is connected to the positive lead and the current adjusted to between 6 and 7A. Current is passed for about 15 minutes or longer if a current lower than 6 to 7A is used.

Dyeing

The next stage is the actual dyeing of the metal in the colour that you prefer. The dye used is a domestic dye that is known as "Drummer" the contents of which are dissolved in half a gallon of water that is just below the boiling point to which a spoonful of acetic acid (vinegar) has been added. This assists in the fixing of the dye and helps to render it stable and stop it being bleached out by sunlight. Into this mixture the article is placed and left to soak for about half an hour. It is then taken out and washed. Then it is left in a solution of copper sulphate. The strength of this solution is 2% of copper sulphate in water (by weight). The anodised article is left in this solution for about ten minutes and then washed.

The chemicals can be used again and again until they become discoloured and the dye begins to lose its strength and does not dye to the same strength as before. The anodised article may be bent and drilled, but this is best left to the final operation so that it does not become scratched. Note that the oxide layer must be scratched away before an electrical connection can be obtained to the metal underneath.

RETURN-OF-POST SERVICE

We offer a really efficient Mail Order Service on all items stocked. All cash orders are dealt with on the day of receipt.
 * Hire purchase orders are subject to slight delay but this is kept to the absolute minimum.

● P.W. HI-FI SYSTEM

We stock parts for the P.W. Amplifier and Pre-amplifier. Detailed price lists are available.

● "P.W. BLUEPRINTS"

Full stocks of all items for the Mercury, Troubadour, Regency, Citizen, Mini-amp and Tutor. Printed circuit for Mercury now in stock. Instruction manuals: Mercury (printed circuit version), 2/6; Mini-amp, 1/6; Citizen, 2/3. Fully detailed price list for any circuit available free.

● NEW ILLUSTRATED LISTS

Illustrated lists are available on LOUDSPEAKERS, TAPE DECKS, TEST GEAR, GRAMOPHONE EQUIPMENT, AMPLIFIERS. Any will be sent free upon request.

● STEREO COMPONENTS

Morganite ranged potentiometers as specified for the Mullard circuits. ● Log/Anti-Log, 500k, 1 meg., 2 meg. ● Log/Log, 50k, 250k, 1 meg., 2 meg. ● Lin/Lin 250k, 500k, 1 meg. All 10/8 each.

● TRANSISTORS

MULLARD. Reduced prices. Current production types, not rejects. All in makers' boxes. Postage 3d. on each. OC44, 9/3; OC45, 9/-; OC70 and OC71, 6/6; OC72, 8/-; OC72 Matched Pairs 16/-; OC78, 8/-; OC81, 8/-; OC170, 10/6.

● OUTPUT TRANSFORMERS

GILSON: W0696A, W0698B, 50/6, post 2/6. W0710, 55/6, post 2/6. W0892, 62/3, post free; W0767, 27/-, post 1/6. W01796A, 57/6, post 2/6. PARTRIDGE: P366Y, 75/-; P4131, 65/-; P5202, P5203, £5.18.6. All post free.

FARMEK(O): P2629, 45/6; P2642, 43/3; P2643, 45/6. All plus post 2/9. P2641, 28/3, post 2/-; P2628, 15/3, post 2/-; P2632, 39/3, post 2/6.

ELSTONE: OT/ML, 45/-, post 2/9; OT/3, 25/-, post 2/6.

● MAINS TRANSFORMERS

GILSON: W0741AB, 63/-, post free; W0839, 40/9, post 2/9; W0123B, 59/6, post 3/6; W0123B, 59/-, post 3/6. FARMEK(O): P2631, 33/9, post 2/9; P2630, 52/6, post 3/3; P2644, 73/6, post free; P2930, 39/3, post 3/-; P2931, 54/6, post 3/3. ELSTONE: MT/MU, 45/-, post 3/3; MT/W/M, 35/-, post 3/-; MT/610, 42/-, post 3/3.

● LOUDSPEAKERS

GOODMANS: Axiette 8in., £5.5.1; Axiom 10in., £5.16.8; 12in., Axiom 201, £9.15.0; 12in., Axiom 301, £14.0.0; 12in., Audiom 51 Bass, £8.4.0; 12in., Audiom 61 Bass, £13.2.0; Trebax Tweeter, £6.4.0; X50900 Crossover unit, £1.19.0. WHITELEY: HF1016 10in., £7.16.0; HF1012 10in., £4.17.6; HF1816 8in., £6.13.9; 7816 8in., £6.6.9; T10 Tweeter, £4.8.3; T359 Tweeter, £1.14.0; CX3000 Crossover unit, £1.11.6; CX1500 Crossover unit, £2.0.0. H.P. Terms available on all speakers.

● AMPLIFIER KITS

We have full stocks of all components for the Mullard 510, Mullard 3-3, Mullard 2 and 3 Valve Pre-amp, Mullard Stereo, Mullard Mixer, GEC 912 Plus. Fully detailed list on any of these sent upon request. Instructional Manuals: All Mullard Audio Circuits in "Circuits for Audio Amplifiers", 9/5. GEC912, 4/6. All post free.

● LATEST TEST METERS

| | Cash Price | Deposit | Hire Purchase Mthly/Pmts. |
|---|------------|---------|---------------------------|
| AVO Model 8 Mark II | £24. 0.0 | £4.16.0 | 12 of £1.15. 2 |
| AVO Model 8 with leather carrying case | £27.18.0 | £5.12.0 | 12 of £2. 0.11 |
| AVO Model 7 Mark II | £21. 0.0 | £4. 4.0 | 12 of £2.10.10 |
| AVO Multiminor | £9.10.0 | £1.19.0 | 12 of 14/4 |
| AVO Multiminor with leather carrying case | £11. 9.0 | £2. 5.0 | 12 of 17/- |
| TAYLOR MODEL 127A | £10.10.0 | £2. 2.0 | 12 of 15/8 |
| CABY A-10 | £4.17.6 | £1. 7.6 | 3 of £1. 6.8 |
| CABY B-20 | £6.10.0 | £2. 0.0 | 3 of £1.13.4 |
| CABY M-1 | £2.14.0 | — | — |

Full details on any of the above supplied free on request. The AVO Models 7 and 8 are both latest models from current production—not to be confused with Government Surplus.

● TERMS OF BUSINESS

Cash with order or C.O.D. We charge C.O.D. orders as follows: Up to £3, minimum of 3/2. Over £3 and under £5, 1/6. Over £5 and under £10, 1/8. Over £10, no charge. Postage extra on CASH orders under £3 except where stated. Postage extra on overseas orders irrespective of price.

● TRANSISTORISE YOUR CRYSTAL SET

We have two new designs for Transistor amplifiers which can be used to greatly improve the signal from any crystal set. RLD4 Kit, one stage 12/-; RLD5 Kit, two stage 21/-; both post free. The kits are easy to build and very detailed instructions are supplied. Leaflet available.

● NEW MULLARD CONDENSERS

We now stock the following range of the new Mullard Miniature Foil and Polyester condensers as used in the latest TV and Transistor sets. Fully detailed list available free giving technical information and dimensions.
 Miniature Foil, 30 volt working for Transistor sets. .01mfd, 71d.; .022mfd, 9d.; .047mfd, 9d.; .1mfd, 11d.
 Polyester Tubular Capacitors. Moulded outer case designed to withstand accidental contact with the soldering iron. Tolerance 10%. 125v. range: .01mfd, .022mfd, .047mfd, all 9d. each. .1mfd, 1/2; .22mfd, 1/3; .47mfd, 1/6; 1mfd, 3/-.
 400v. range: .01mfd, .022mfd, .047mfd, .01mfd, .022mfd, all 9d. .047mfd, 1/2; .1mfd, 1/3; .22mfd, 1/6; .47mfd, 2/5. Postage extra.

● GRAMOPHONE EQUIPMENT

ALL LATEST MODELS ALL POST FREE

| | Cash Price | Deposit | Hire Purchase Mthly/Pmts. |
|--|------------|---------|---------------------------|
|--|------------|---------|---------------------------|

RECORD CHANGERS

| | | | |
|---------------------------------------|----------|---------|------------|
| GARRARD AUTOSLIM (GC8 PU) | £7.19.6 | £1.12.6 | 12 of 12/3 |
| GARRARD AUTOSLIM De-luxe (GC8 PU) | £12.14.8 | £2.11.8 | 12 of 13/8 |
| GARRARD AUTOSLIM De-luxe (V26A PU) | £13.12.9 | £2.14.9 | 12 of 20/- |
| B.S.R. UA14 (TC8 PU) | £7.17.6 | £1.12.6 | 12 of 12/1 |
| B.S.R. UA14 Monarch (TC8 Stereo/LP78) | £8.17.6 | £1.16.6 | 12 of 13/5 |

SINGLE RECORD PLAYERS

| | | | |
|----------------------|--------|---------|-------------|
| GARRARD TA (GC8 PU) | £8.2.6 | £1.12.8 | 12 of 12/6 |
| B.S.R. TUI2 (TC8 PU) | £4.5.0 | £1.5.0 | 3 of £1.3.4 |

TRANSCRIPTION UNITS

| | | | |
|----------------------|----------|---------|--------------|
| GARRARD 4HF (GC8 PU) | £17.19.6 | £3.11.6 | 12 of £1.6.5 |
| PHILIPS AG1016 | £13.13.0 | £2.15.0 | 12 of £1.0.0 |

Many of the above can be supplied for stereo working. See our Gramophone Equipment List for details.

● TAPE RECORDING EQUIPMENT

| | Cash Price | Deposit | Hire Purchase Mthly/Pmts. |
|-----------------------|------------|---------|---------------------------|
| ALL CARRIAGE FREE | | | |
| B.S.R. TD2 | £8.19.6 | £1.16.6 | 12 of 13/7 |
| Latest COLLARO Studio | £12.12.6 | £2.12.6 | 12 of 19/- |

TAPE AMPLIFIERS
 We now stock the Martin Recorder Kits. These are partly assembled kits for complete tape recorders. The Amplifier Printed Circuit panels are completely wired, but the assembly of this and external components is left to the constructor. Very complete instructions are supplied. Send for leaflet.
 MODEL C for Collaro Studio Deck £11.11.0.
 MODEL B for BSR TD Deck £8.8.0.

CARRYING CASES. Smart carrying cases are available to take the above amplifiers and decks. Fitted with speaker. For Model C Amplifier and Collaro Deck, £4.5.0. For Model B Amplifier and BSR Deck, £4.4.0. H.P. Terms available for amplifiers, cases and decks.

TAPE PRE-AMPLIFIERS

ARMSTRONG PA10-3. This is a ready made version of the Mullard Tape C Pre-amplifier. Price £18.16.0. Hire Purchase Deposit £3.5.0, and 12 monthly payments of £1.4.7.

MULLARD TAPE C PRE-AMPLIFIER. We stock complete kits and all components. Send for list.
 MARTIN. Pre-amp kit for Collaro Studio Deck £8.8.0.

● "BRAND FIVE" RECORDING TAPE post free.
 Long Play: 90ft. (5"), 18/6; 120ft. (5 1/2"), 23/6; 180ft. (7"), 35/-

● JASON F.M. TUNER KITS

Kits supplied complete with every item needed including instruction manuals. Fully detailed list available. Separate items supplied, ask for price list. H.P. Terms available on any kit.

| |
|---|
| FMT1 (with power), £9.12.6; FMT2 (less power), £7.15.0. |
| FMT2 (with power), £9.12.6; FMT3 (less power), £7.15.0. |
| FMT3 (with power), £11.7.8; Mercury 2, £10.14.8. |

JTV/2, £14.12.6.

WATTS RADIO

(MAIL ORDER) LTD.

54 CHURCH ST., WEYBRIDGE, SURREY

Telephone: Weybridge 4556

Please note: Postal business only from this address

● HIRE PURCHASE TERMS

are available on any item. Repayments may be spread over 3, 6 or 12 months. Details as follows: Three months: Deposit 6/ in the £. Service charge 5 per cent but minimum charge of 10/-. Six and Twelve months: Deposit 4/- in the £. Service charge 10 per cent, but minimum charge 20/-

EXPLORE THE WORLD ON THIS I-VALVE SHORT-WAVE RADIO

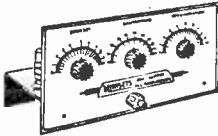

Total Building Costs **35/6**
P. & P. 2/-

★ **Receives speech and music from all over the world.** Construction price includes valve and one coil. Covering 40-100 metres. Can be extended to cover 10-100 metres. Suitable headphones 11/8. Can be converted to 2 valve.

THE IMPERIA

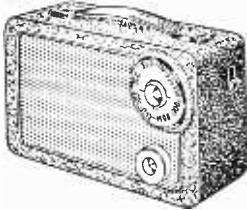

An easy to build 6 Transistor Portable superhet, which can be built by the constructor. Pre-Assembled circuit board for easy construction. All components are new. 5 inch Speaker giving good tone and output. Attractive case of exclusive design 8 1/2 x 5 1/2 x 2 1/2 with gold plated grille. Specially designed matching coil for use in car. Only first grade fully guaranteed matched transistors and diodes are used. Anyone can build this set for £7.17.6. P. & P. 3/- (Long wave 6/- extra). Everything supplied, except soldering iron.

The **AIROLO**
6-STAGE
POCKET
TRANSISTOR
PORTABLE



In attractive two-tone contemporary case, with gold plated speaker grille and attractive dial. Size only 5 1/2 x 3 1/2 x 1 1/2 ins. No serial or earth required—completely self contained. Genuine 3in. high flux PM speaker. First grade transistors. Push pull output—250 milliwatts. Volume control with on/off switch. Condenser tuning. Easy assembly on eyeletted circuit board. Total Building Cost **£4.19.0**
P. & P. 2/6. (Long wave 6/- extra).

The RIETI 6-STAGE SUPER SENSITIVE TRANSISTOR PORTABLE

Simple to Build. All First Grade Components. A truly portable transistor radio giving full medium wave reception. Incorporates 5in. High Flux Speaker, pull-push output, first grade transistors. High-Q ferrite aerial, socket for car aerial, pre-tagged circuit board for easy construction. Attractive case with gold plated grille. Long wave 8/- extra. Total Building Cost **£5.2.0**
P. & P. 2/6.

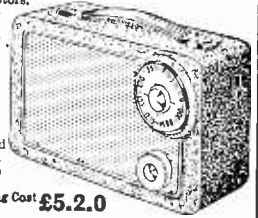

CRYSTAL RECEIVER
Covering medium wave band. Ideal for the beginner! All components including case for **11/6** P. & P. 1/6. Suitable headphones 11/8 extra.

THE "TINYMITE"

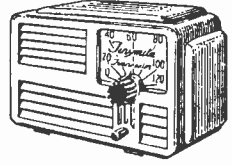

Suitable headphones 11/8

EASY TO BUILD TWO STAGE TRANSISTOR SET

The set that looks like a Radio Set. Attractive Case. Mini .0005 Tuner. High Q Litz Coil. Works for months off No. 8 Battery. Simple to construct in 15 min. Medium & Long Wave coverage. Total Building Cost **25/6** P. & P. 1/6.

MINISETS LTD.

Hatherly Mews London E17

with a **MARTIN RECORDAKIT**



High Quality

YOU CAN BUILD YOUR OWN

TAPE RECORDER QUICKLY, EASILY, CHEAPLY WITH NO PREVIOUS EXPERIENCE

With a Martin Recordakit everything you need is supplied, ready to assemble—even down to wire cut to length. The easiest and cheapest way to own a Hi-Fi quality Tape Recorder. Fill in the coupon for full details.

Post to: **MARTIN ELECTRONICS LTD.**
155 HIGH STREET, BRENTFORD, MIDD.
Please send free leaflet on Martin Recordakits
NAME _____
ADDRESS _____
(In block letters) _____ PW.1

T rade N ews

NEW RECORD PLAYER

A PRODUCT new to their range of audio equipment has recently been released by Ekco Radio and Television Ltd., and is a four-speed record player fitted with a Garrard "Autoslim" four-speed autochanger. The crystal pick-up, which has a sapphire-tipped styli, provides the input to the amplifier which employs printed circuit construction and feeds an 8in. x 5in. moving coil loudspeaker. The record player features a frequency-corrected volume control and independent bass and treble controls.

The lightweight case of the record player measures 14½in. x 7½in. x 17in. and is available in two colour schemes. The price of this new equipment is 24 guineas and it is made by *Ekco Radio and Television Ltd., Southend-on-Sea, Essex.*

7-TRANSISTOR RECEIVER

THE RT.8 is the latest radio to be announced by Roberts' Radio Co. Ltd. It employs a 7-transistor circuit which tunes over the medium and long wavebands. The RT.8 has a 1W output stage feeding an 8in. x 5in. loudspeaker fitted with a high flux ceramic magnet. The receiver is also fitted with car aerial and tape recorder sockets.

The price of this new receiver is 22 guineas and is made by *Roberts' Radio Co. Ltd., Molesey Avenue, West Molesey, Surrey.*

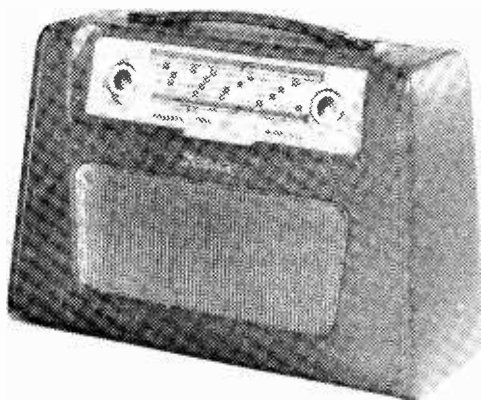

The RT.8 seven-transistor receiver made by the Roberts' Radio Co. Ltd.

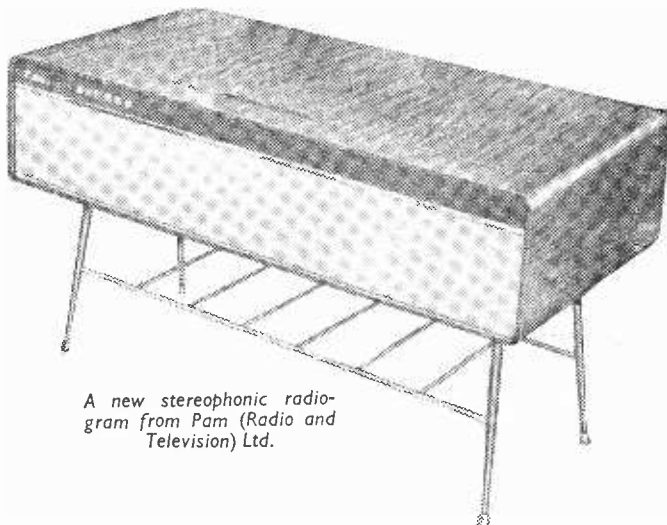

A new stereophonic radiogram from Pam (Radio and Television) Ltd.

STEREOPHONIC RADIOGRAM

A RECENT addition to the range of radio and television equipment made by Pam (Radio and Television) Ltd., is the model 5210 stereophonic radiogram. This model employs a loudspeaker system covering the full range of audio frequencies, and which reproduces both stereophonic and monaural sound.

Incorporated in the 5210 is a radio receiver covering long, medium and VHF transmissions. This receiver features two built-in aerials and the record deck employed in the gram is a four-speed autochanger.

The cabinet of the radiogram is in sapele mahogany veneers with a polyester finish. It is priced at 63 guineas and is made by *Pam (Radio and Television) Ltd., 295 Regent Street, London, W.1.*

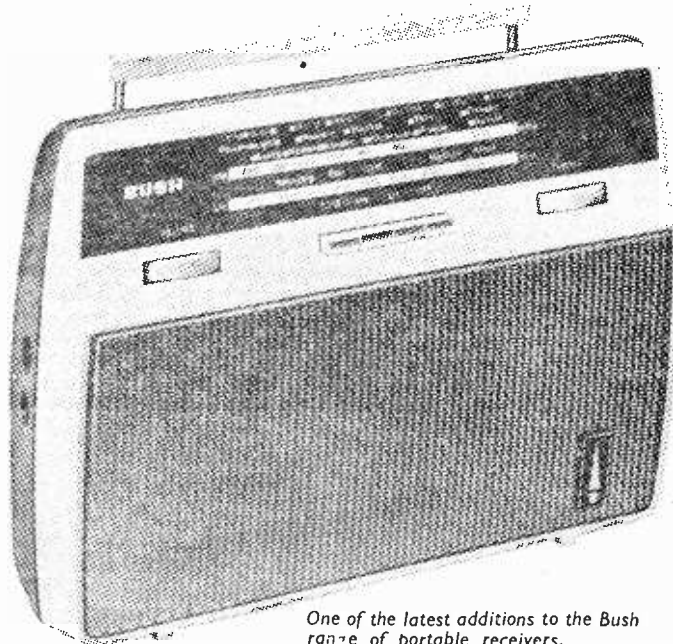

One of the latest additions to the Bush range of portable receivers.

ELECTRICIAN'S KIT

THE amateur electrician will find the Steadfast Electrician Kit No. 4 a useful addition to his supply of tools, as all essential tools needed for normal use in this field have been included in this kit which comes in a handy plastic wallet.

All the tools are made by J. Stead and Co. Ltd., and the complete contents of the wallet are: an electric mains tester, diagonal nippers, insulated combination pliers, electrician's insulated screwdriver and a small screwdriver. This kit costs 25s. 3d. and the manufacturers are *J. Stead and Co. Ltd., Manor Works, Cricket Inn Road, Sheffield 2.*

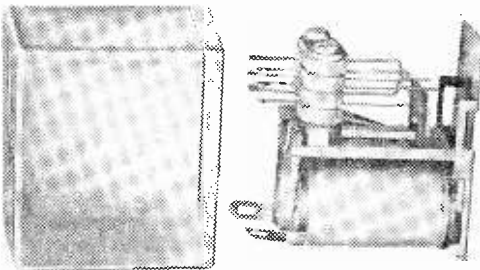

This relay, made by The Plessey Company (UK) Limited, is intended for R.F. switching at frequencies up to 100 Mc/s.

RELAY FOR USE UP TO 1000Mc/s

DETAILS of a new low-capacitance relay have been announced by the Industrial Relays Division of the Plessey Company (U.K.) Limited.

The new relay is intended for R.F. switching at frequencies up to 100Mc/s and has a capacitance between contacts of less than 0.5pF, with contact-to-frame capacitance less than 1pF. Contact rating is 5mA at 200V with a life of more than 10⁹ operations. The self-cleaning silver-palladium wire contacts are arranged to give two-pole change-over switching and can be used at switching rates up to 25c/s.

Designed for D.C. operation, the coil can be supplied in a wide range of operating voltages and resistances to suit individual requirements. The unit is housed in a transparent dust cover and one of its useful features is its short operating time of 6 milliseconds. The makers of this new relay are *The Industrial Relays Division, The Plessey Company (U.K.) Limited, Abbey Works, Titchfield, Fareham, Hampshire.*

TRANSISTOR PORTABLE RADIO

THE model TR.106 is a new portable receiver from Bush Radio Limited. It covers medium

and long waves and waveband selection and tone control is achieved by push-button controls.

The TR.106, which incorporates a fully transistorised circuit, weighs only 4lb and costs 16½ guineas. *Bush Radio Ltd., Power Road, Chiswick, London, W.4.*

INTERESTED IN SCIENCE?

LIKE PRACTICAL HOBBIES?

Then PRACTICAL MECHANICS AND SCIENCE is the magazine for you.

November issue, on sale November 1st, price 2/-, contains practical articles on making:—

A WATER-POWERED MICROSCOPE;
TRANSISTORISED STETHOSCOPE; HIGH-EFFICIENCY CONVECTOR HEATER;
PHOTOGRAPHIC DRY-MOUNTING PRESS;
ELECTRICAL CHILDREN'S TEACHING AID—
and other articles and regular features.

Together with scientific articles about:—

N.S. SAVANNAH, FIRST ATOMIC MERCHANT SHIP; SPACE-AGE METALS; THE MAGNUS EFFECT AND V.T.O. PLANES; INFLATABLE SPACE STATIONS; PICTURE NEWS FROM THE WORLD OF SCIENCE.

ORDER YOUR COPY NOW!

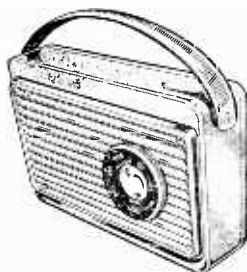

NEW TRANSONA-SIX

(6 Transistors, plus 2 Diodes)
M/I/L & T. BAND

400 Mw Mullard push-pull output Transistors. Powerful magnet 3in. high grade speaker. Push-pull transformers. This is a top performing receiver. Many stations listed in one evening including Luxembourg loud and clear. A pleasure to listen to. **FERRITE ROD AERIAL.** All parts sold separately, including pale blue gleaming polystyrene case with duo-diffusion grilles in red. Uses 9 volt battery. Sockets for car aerial.

Total cost **£4.19.6** P.P. 3/-, Size 6½ x 4½ x 1½in.

"Agreeably surprised with Trawler Band reception. Luxembourg as loud as local. Your easy build diagram helped a lot . . . my first attempt."—H. S., Penzance, Cornwall (poor reception area).

PARTS PRICE LIST AND EASY BUILD PLANS 1/6

BEGINNERS POCKET 5

(M/W/LW and TRAWLER BAND)

(5 Transistors, plus 2 Diodes)

Designed round supersensitive **FERRITE ROD AERIAL** and 3in. moving coil speaker. Attractive case in black with speaker grille in red. On test Home, Light, Radio Luxembourg and many Continental stations were received. No Aerial.

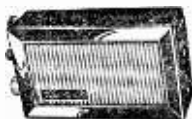

Total cost **£2.19.6** P.P. 3/-

EASY BUILD PLANS AND PARTS PRICE LIST 1/6

THE MELODY SIX

- ★ Ferrite rod aerial.
- ★ 6 new type transistors and top quality components. Attractive case in blue and red and carrying strap with gold trim.
- ★ 3in. Speaker.
- ★ M.W/L.W.

May be built for **£3.19.6**

P.P. 3/-

Components price list and plans, 2/-.

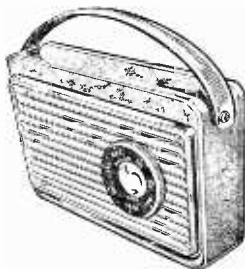

BEGINNERS PUSH-PULL FIVE

(5 Transistors, plus Diode)

- ★ No aerial or earth.
- ★ M/C Speaker, 2½in.
- ★ Ferrite rod aerial.
- ★ Tuning condenser.
- ★ Volume control.
- ★ Case with speaker grille in red.
- ★ Fully tunable over med/long waves.
- ★ Simple assembly diagrams.
- ★ 250 Milliwatts output stage.
- ★ Can be built for **59/6** P.P. 3/-, or with 3in. speaker 68/-

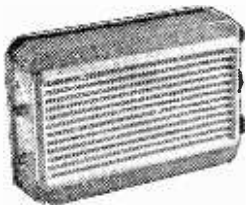

★ PARTS PRICE LIST, etc. 2/-.

"Home, Light, AFN, Lux. All at good volume."—G.P., Durham.

THE SUPER SEVEN

(7 Transistors plus 2 Diodes)

- ★ 2 R.F. STAGES.
- ★ Mullard and Surface Barrier Transistors.
- ★ Coverage of Medium, Long Waves, Trawler Band
- ★ Use as domestic radio, car radio or fit with strap for carry-about.
- ★ No aerial required except for use as car radio.
- ★ 3-inch speaker but will drive a larger speaker.
- ★ 400 milliwatts output stage.

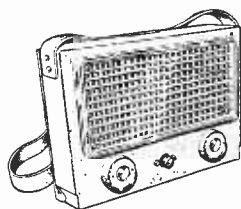

SIZE: 7½ x 5½ x 1½in.

May be built for **£6.9.6** plus 3/6 post, etc.

PARTS PRICE LIST AND EASY BUILD PLANS 2/-

AFTER SALES SERVICE

NAME AND ADDRESS
CAPITAL LETTERS PLEASE

RADIO EXCHANGE COMPANY

27 HARPUR STREET, BEDFORD

PHONE 2367

(Opposite Co-op)

10 a.m. to 1 p.m. SAT.

THE WORD **MAXI-Q** IS THE REGISTERED TRADE MARK

REGD.

OF DENCO (CLACTON) LIMITED
IT IS ALSO A GUARANTEE OF
WORKMANSHIP & TECHNICAL PERFORMANCE

OUR RANGE OF PRODUCTS IS SO GREAT THAT WE NOW HAVE TO REQUEST THE AMOUNT OF 1/6 FOR OUR GENERAL CATALOGUE AND TO SAVE YOU POSTAL ORDER POUNDAGE CHARGE WE REQUEST SEND 1/6 IN STAMPS.

COMPONENTS FOR USE WITH "PRACTICAL WIRELESS"

AN AMATEUR COMMUNICATIONS RECEIVER

PUBLISHED JULY/AUGUST 1961

COIL TURRET—CT7/B

This turret is the basic portion of the CT7. It comprises cadmium plated steel frame (size 5 1/4" deep x 4 1/4" high x 3 1/2" wide), silver plated contacts, polystyrene insulation and a rotary turret movement incorporating Aerial, Mixer and Oscillator coils for the three bands 1.5-4 Mc/s, 4-12 Mc/s and 10-30 Mc/s.

PRICE 75/-

Coil strips for the long and medium wavebands may be purchased separately for incorporation in the turret.

PRICE 10/6 each

The turret requires a 315pF tuning capacitor. A suitable 3-gang component with ceramic insulation is available.

PRICE 19/-

Air spaced concentric trimmers, 3/30pF.

PRICE 3/6 each

SCALE ASSEMBLY—S1

Comprising basic 5 waveband glass scale for use with 315pF tuning condenser, back plate, pulleys, rubber scale mounts, pointer, cord, drum, spring, drive spindle, screws, nuts and spacers.

PRICE 19/-

BEAT FREQUENCY OSCILLATOR COIL—BFO.2/465 kc/s.

A compact coil wound on a bakelite former and enclosed in an aluminium screened can.

PRICE 5/-

I.F. TRANSFORMER—I.F.T.11/465 kc/s (Four required)

A miniature I.F. Transformer for 465 kc/s. Permeability tuned, litz wound coils, enclosed in an aluminium screening can 1 1/8" high x 1 1/8" square.

PRICE 6/6 each

PLEASE SEND S.A.E. WITH ALL ENQUIRIES

DENCO (CLACTON) LTD., (Dept. P.W.) 357/9 Old Road, Clacton-on-Sea, Essex

HOME RADIO OF MITCHAM

(Dept. P), 187 London Road, Mitcham, Surrey.
M/T 3282
Shop hours 9 a.m. to 6 p.m. Wed. 9 a.m. to 1 p.m.

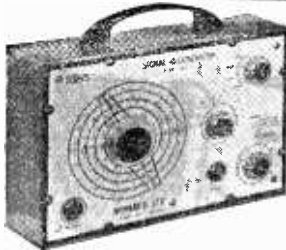

NOMBREX Signal Generator

Transistor unit covering 200 Kc/s to 220 mc/s in 8 ranges at an accuracy of better than 2%. R.F. output modulated or CW. Separate audio output at 1 Kc/s. Weighs under 2 lbs. and size only 6" x 4". An essential test instrument for all engineers and constructors.

PRICE £7.15.0. complete with battery. Post and packing 3/6.

Goodmans Speakers

All the latest Goodmans Hi-Fi speakers and accessories in stock including:—
AXI1117 8. 6 watts 15 ohms 8" die-cast chassis FERODIA 11 high-flux magnet. PRICE £5.5.0, post 1/6.
AXI101 10. 10 watts 15 ohms 10" die-cast chassis FERODIA 11 high-flux magnet. PRICE £5.10.0, post 1/6.
AXI101 201. 15 watts 15 ohms 12" die-cast chassis FERODIA 11 high-flux magnet. Twin diaphragm range 30 to 16,000 cycles, aluminium voice coil. PRICE £9.15.0, post 1/6.
AXI101 301. Similar to the 201 but will handle up to 20 watts. The most advanced twin diaphragm 12" speaker ever produced. PRICE £14.0.0, post 1/6.

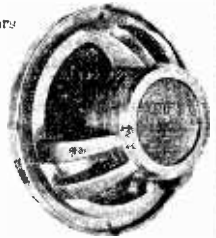

SUPER CATALOGUE
166 PAGES, 5,000 ITEMS
600 Illustrations. 2/6, Post 9d.

WE ARE ACTUAL STOCKISTS FOR HEATHKITS

Mullard 10 watt Amplifier PRINTED CIRCUIT BOARDS FOR New ECL86 Circuit. 12-6,
Post 6d.

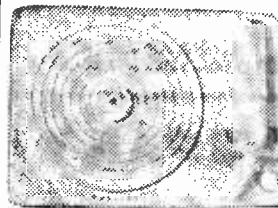

PHILIPS HI-FI Stereo Gram Unit

4 speed playing deck specially designed for the enthusiast building his own radiogram. Superb reproduction of mono and stereo records of all sizes and speeds. Precision engineered, robust construction, arm lifting and lowering device. Compact and easy to install. Leaflet with specification on request. PRICE 13 gns., carriage 3/6.

EDDYSTONE COMMUNICATIONS RECEIVERS AND COMPONENTS

We carry the full range of the famous EDDYSTONE receivers and components including:—
870A 5 valve £32.0 (Overseas £24.0.0. export price).
840C 7 valve £58.0.0 (Overseas shipping quoted on request).
940 11 valve £125.0.0 (Overseas shipping quoted on request).
Full specifications available on request. Priority for overseas orders.



Short-wave Listeners' Log

AN average receiver will not usually cover wavebands required by the S.W.L., but this can be overcome by using a converter. The converter itself tunes the bands needed, and its output is fed into the aerial socket of the main receiver. This arrangement allows short-wave or VHF A.M. transmissions to be heard with the aid of a receiver having no S.W. or VHF bands. Many all-wave receivers begin to lose efficiency towards 15m or 10m (30Mc/s), while few such receivers cover the 5m (60Mc/s) and other VHF bands. For these reasons, a converter is quite often used by S.W. listeners who are interested in the H.F. bands.

In an ordinary superhet with 470kc/s intermediate frequency, all signals received are converted to 470kc/s. With a "double superhet" receiver, signals received are converted to a frequency such as 1.6Mc/s (1,600kc/s), and after amplification, are again converted to a lower frequency, such as 470kc/s, or 110kc/s. This method is very effective in obtaining high selectivity, and avoiding interference on H.F. S.W. bands.

When a converter is used, its output is within the ordinary tuning range of the receiver. The receiver is tuned to the converter output signal, and the receiver R.F. stage or frequency-changer provides some amplification. The receiver then converts the signal to its own intermediate frequency (say 470kc/s). When a converter is used in this way, the whole thus acts as a double superhet, and very good results indeed can be obtained.

The frequency of the output of the converter is

not too important, provided it is fairly high (within the tuning range of the receiver) and not on a frequency where the receiver is liable to pick up a local or other strong signal.

Surplus Units

Various surplus units are often modified for use as converters. For example, the R.F. Unit Type 27 tunes approximately 3.5-5m, while the Type 26 tunes about 5-6m. The output of these units is on about 7-8Mc/s, so the receiver is tuned to the converter signal in this range.

For home construction, the simplest converter is a single valve employed as a frequency changer stage. The tuned circuits in the converter cover the required bands, and this method can be used to obtain S.W. coverage with a long- and medium-wave set, or to extend the coverage of an all-wave receiver. Current for a single valve can often be drawn from the receiver power supplies.

[A two-valve converter for short-waves was described in the August and September issues.—Ed.]

For the VHF bands, low-loss construction is used, with small coils and a low value tuning capacitor. Three valve circuits, having R.F. amplifier, mixer, and separate oscillator, similar to the R.F. Units, are popular, but generally require a separate power pack.

Tuning is carried out on the converter, as the receiver only operates as the intermediate frequency and audio amplifier stages. The lead from converter to the receiver's aerial socket should be short, and may be screened to avoid to pick-up the receiver frequency.

COMING SOON!

Two new **PRACTICAL WIRELESS** Handbooks for the enthusiast

- **25 Selected Circuits for Amateurs**

Contents include:

Portable receivers; audio amplifiers; transmitters; voltmeters; superhet receivers; F.M. equipment; etc.

- **Radio Construction for Amateurs**

Contents include:

Receivers; hints on construction; test equipment; guide to components; amplifiers; elementary theoretical articles; etc.

ON SALE OCTOBER 15th — MAKE SURE OF YOUR COPIES NOW

Hand this form to your bookseller or newsagent:

Please reserve.....copies of "25 Selected Circuits for Amateurs"

.....copies of "Radio Construction for Amateurs"

Name

Address

Club News

REPORTS OF CURRENT ACTIVITIES

AMATEUR RADIO MOBILE SOCIETY

Hon. Sec.: G3FPK, 79 Murchison Road, London, E.10.

September this year was a busy month for mobile amateurs. The first important fixture was the Thames Valley Amateur Radio Society's rally at Polesden Lacy, Surrey. This was followed by the R.S.G.B. mobile rally at Woburn Abbey in Buckinghamshire, which was well attended by A.R.M.S. members and on September 16th the Lincoln Rally was held in North Hykeham.

CRAWLEY AMATEUR RADIO CLUB

Hon. Sec.: R. G. B. Vaughan, G3FRV, 9 Hawkins Road, Tilgate, Crawley, Surrey.

At a recent meeting, G8RW gave a lecture on "23cm operation". Other recent activities have included a visit to Gatwick Airport which was enjoyed by a number of members.

Future Event:

October 24th—Annual film show.

DUDLEY AMATEUR RADIO CLUB

Hon. Sec.: D. H. W. Pratt, G3MHS, 23 Kent Street, Upper Gornal, Dudley, Worcestershire.

On 14th September, G8CK and G6GR gave a talk on "Mobile activities". In the radio quiz, held on 28th September, the S.W.L.'s challenged the Hams, with G2DTQ as quiz-master.

JERSEY AMATEUR RADIO CLUB

Hon. Sec.: D. Watkin, 73 Marett Court, Marett Road, St. Helier, Jersey.

This newly formed club will be holding a meeting at the YMCA, New Street, St. Helier on 15th October, commencing at 8 p.m., when prospective members and visitors are invited to attend.

MIDLAND AMATEUR RADIO SOCIETY

Hon. Sec.: C. J. Haycock, 29A Wellington Road, Handsworth Birmingham, 20.

The society's Annual General Meeting was held on September 18th, but the evening was also the occasion for an exhibition of members' home constructed equipment.

PURLEY AND DISTRICT RADIO CLUB

Hon. Sec.: E. R. Honeywood, G3GKF, 105 Whytecliffe Road, Purley.

A number of members visited the BBC receiving station at Tatsfield in Kent on September 1st, and on September 7th, members enjoyed a 90 minute programme of films presented by Ralph Cathles, G3NDF.

WESSEX AMATEUR RADIO GROUP

Hon. Sec.: G. J. Fowle, 138 Surrey Road, Branksome, Poole, Dorset.

An "Aerial" quiz was the main item of the meeting on September 3rd, but members also took part in a discussion which followed. A "Bring-and-buy" sale of equipment was held on October 1st.

YORK AMATEUR RADIO SOCIETY

Hon. Sec.: N. Spivey, G3GWI, 80 Melton Avenue, Clifton, York.

The September meeting was taken up by a tape recorded lecture called "Receivers".

Future Event:

October 11th—"Tx design and TVI".

FREE!!!

DOUBLE-SIDED

BLUEPRINT

inside

NEXT MONTH'S

Detailed Instructions to build
**THE BERKELEY BASS
REFLEX LOUDSPEAKER
ENCLOSURE**

A corner cabinet incorporating a 12-in. moving coil unit, with provision for additional H.F. tweeter unit if required. 15W power handling capacity.

LUXEMBOURG TUNER

A high-gain selective receiver pre-tuned to 208m. An easily constructed unit of novel design for reception of this popular broadcasting station.

Practical WIRELESS

ORDER FROM YOUR NEWSAGENT TODAY!

SURBITON PARK RADIO LTD.

FOR POST HASTE—POST FREE SERVICE

AMPLIFIERS (MONO)

| | |
|---|----------|
| Linear L45 Three valve amplifier | £51.96 |
| Linear DPA15 Five valve, Push-pull | £12.12.0 |
| Deposit £11.7.0 and 12 monthly | £10.0 |
| Dulci DPA15 Main amplifier, Five valve, Push-pull | £15.15.0 |
| Deposit £11.1.8 and 12 monthly | £1.61 |
| Dulci DPA15 Pre Amplifier, suitable magnetic pickups, | £9.3.0 |
| Deposit £1.3.0, and 9 monthly | £1.1.0 |
| Leak TL12 Main amplifier only | £18.18.0 |
| Deposit £2.0.6 and 12 monthly | £11.11 |
| Leak Varislope Pre amplifier | £15.15.0 |
| Deposit £11.1.8 and 12 monthly | £1.61 |
| Quad Main amplifier | £22.10.0 |
| Deposit £2.5.0 and 12 monthly | £11.7.4 |

AMPLIFIERS (STEREO)

| | |
|-------------------------------------|----------|
| Dulci AC202, Integrated | £12.12.0 |
| Deposit £1.7.0 and 12 monthly | £1.0.8 |
| Dulci GA505, Integrated | £19.18.0 |
| Deposit £2.0.6 and 12 monthly | £11.11 |
| Dulci Stereo Five, Pre amplifier | £11.11.0 |
| Deposit £1.4.0 and 12 monthly | 19/- |
| Leak Stereo 20, Main amplifier | £30.9.0 |
| Deposit £3.4.8 and 12 monthly | £210.5 |
| Leak Varislope Stereo Pre amplifier | £25.0.0 |
| Deposit £2.10.0 and 12 monthly | £21.6 |
| Quad 22 Stereo Control Unit | £25.0.0 |
| Deposit £2.10.0 and 12 monthly | £21.6 |

LOUDSPEAKERS

| | |
|---|----------|
| Goodmans Axietee 3 | £5.5.1 |
| Goodmans Axiom 10 | £5.18.8 |
| Goodmans Axiom 201 | £9.15.0 |
| Deposit £1.0.0 and 9 monthly | £1.1.8 |
| Goodmans 5K/20XL | £7.0.0 |
| Goodmans X0500 | £11.18.0 |
| Goodmans X0950 | £5.5.8 |
| V.B. HF412, £4.5.6; HF1012, £4.17.7; CX3000 31/6 CX1500 | £2.0.0 |
| Wharfedale Super 8/FS/AL £6.9.11 Super 8 tweeter | £6.9.11 |
| Wharfedale RS12/DD 12 inch, full range unit | £11.10.0 |
| Deposit £1.7.8 and 9 monthly | £1.4.9 |

PICK UPS AND CARTRIDGES

| | |
|--|----------|
| Acos Hi Light, with stereo head | £18.10.0 |
| Deposit £1.17.0 and 12 monthly | £110.8 |
| Decca FFS5, with Stereo head | £21.0.0 |
| Deposit £2.2.0 and 12 monthly | £411.9 |
| Decca Deram Arm Only | £5.15.6 |
| Garrard TPA12, Arm Only | £3.17.7 |
| Garrard SPG3 Stylus gauge | 19/9 |
| Tannoy Mono. Single-play diamond | £8.16.0 |
| Deposit £1.0.0 and 8 monthly | £1.2.0 |
| Tannoy Stereo, Vari-twin Mk. 2 | £12.12.8 |
| Deposit £1.9.8 and 12 monthly | £1.2.4 |
| Decca Deram Autochanger cartridge, £4.4.0 Transcription type | £5.5.0 |

MARTIN RECORDAKITS

HALF TRACK

| | |
|--|----------|
| B.S.R. TD2. Latest model | £9.0.0 |
| Deposit 1.0.0 and 9 monthly | £1.1.0 |
| Tape Amplifier for B.S.R. deck, printed circuit ready wired, with EC'83, EC'152, EM85 and EZE1. Complete with all plates, sockets, panels, knobs, etc. The whole amplifier mounts on to the deck, making a self-contained unit | £8.8.0 |
| Deposit £1.0.0 and 8 monthly | £1.1.0 |
| Case with 7 x 4in. speaker, in two-tone grey | £4.4.0 |
| Complete kit as above | £22.0.0 |
| Deposit £2.4.0 and 12 monthly | £116.6 |
| The above recorder can be supplied assembled, tested and complete with tape and microphone for | £25.0.0 |
| Deposit £2.10.0 and 12 monthly | £21.6 |
| Collaro Studio Deck. Very latest model, 3 speeds, 7in. spools | £12.10.0 |
| Deposit £1.5.0 and 12 monthly | £1.0.8 |
| Tape Amplifier for Studio Deck with ready wired printed circuit, control and input panel. Mains and output transformers. Complete with valves, knobs, plans, screws etc.; EC'83, EC'85, EM'84, EZE1, G481 and EZE4. 3 wates output. Mastic etc. Radio and Mic inputs, ex 1/8 socket, tone and inductor controls. Can be used as an amplifier | £11.11.0 |
| Deposit £1.0.0 and 11 monthly | £1.1.0 |
| Case for above, including 9 x 5in. speaker | £5.5.0 |
| Total kit, as above | £29.0.0 |
| Deposit £2.15.0 and 12 monthly | £2.8.2 |
| We can offer the above recorder complete with tape and microphone in a De Luxe two-tone grey cabinet, assembled for | £35.0.0 |
| Deposit £3.10.0 and 12 monthly | £213.2 |
| THIS MACHINE IS LISTED BY MANUFACTURERS AT £40.10.0 AND IS A VERY GOOD BUY. | |

GRAMOPHONE UNITS

| | |
|--------------------------------------|-----------|
| B.S.R. UA 14 TOSH | £7.15.0 |
| Deposit £1.0.0 and 7 monthly | £1.2.3 |
| Garrard TA Mk. 2 G68 | £8.15.0 |
| Deposit £11.0 and 8 monthly | £11.9 |
| Garrard Autoshm GCS | £8.14.6 |
| Deposit £11.0 and 8 monthly | £11.0 |
| Garrard Autoshm De Luxe GCS | £12.14.8 |
| Deposit £1.5.6 and 12 monthly | £11.1 |
| Philips AG1016 with stereo cartridge | £13.13.0 |
| Deposit £1.10.0 and 12 monthly | £12.4 |
| Connoisseur Craftsman | £18.3.9 |
| Deposit £1.9.8 and 12 monthly | £19.10 |
| Goldring Lenco GL 58, less cartridge | £17.5.5 |
| Deposit £1.14.11 and 12 monthly | £1.8.7 |
| Garrard 4HF GCS | £18.19.0 |
| Deposit £2.1.6 and 12 monthly | £11.11 |
| Garrard Lab. Type "A" GCS | £21.18.10 |
| Deposit £2.7.4 and 12 monthly | £1.16.1 |
| Garrard 301 | £22.18.3 |
| Deposit £2.8.9 and 12 monthly | £117.9 |
| Garrard 301 Sirobe | £24.10.3 |
| Deposit £2.8.0 and 12 monthly | £20.8 |

RADIO TUNERS

| | |
|--|----------|
| Armstrong T4 C. V.H.F. Tuner, self powered | £19.19.0 |
| Deposit £2.3.6 and 12 monthly | £112.9 |
| Armstrong STJ Mk. 2, AM/FM Tuner, self powered | £27.16.0 |
| Deposit £2.16.6 and 12 monthly | £2.61 |
| Armstrong AF208 AM/FM Radio chassis, Bass and Treble controls, P.C. inputs, etc. | £22.18.0 |
| Deposit £2.8.6 and 12 monthly | £117.9 |
| Armstrong Jubilee Mk. 2, AM/FM with Push-pull output | £30.12.0 |
| Deposit £3.3.0 and 12 monthly | £210.8 |
| Armstrong Stereo 55 AM/FM Radio Chassis. Separate tone and volume controls | £32.15.0 |
| Armstrong Stereo 12, Mk. 2, AM/FM Radio chassis, Push-pull output stage, both channels | £43.10.0 |
| Deposit £4.7.0 and 12 monthly | £312.4 |
| Brass dial escutcheon is available for AF208 and Jubilee. Price | 7/6 |
| Quad, F.M. Tuner | £28.1.9 |
| Deposit £2.17.8 and 12 monthly | £2.6.6 |

TAPE DECKS, PRE AMPS & HEADS

| | |
|---|---------|
| Brenell Mk. 5 deck, 1 track, 4 speeds | £29.8.0 |
| Deposit £2.3.6 and 12 monthly | £2.8.7 |
| Brenell Mk. 5 Amplifier, with power | £24.0.0 |
| Deposit £2.8.0 and 12 monthly | £119.10 |
| Marriott Tape heads, 4 track type L/R/S/7 and L/S/9 Record/Playback and Erase with mounting bracket for Studio deck | £44.0 |
| Marriott type R/RP/1, 1/2 track Record/Playback only with bracket for Studio deck. Ideal 3rd head | £17.8 |
| Pressure pad (Studio only) | 5/6 |

QUARTER TRACK

| | |
|---|----------------|
| B.S.R. TD2 | £11.11.0 |
| Deposit £1.0.0 and 11 monthly | £1.1.0 |
| TAPE AMPLIFIER as in first column, but Quarter track | £9.9.0 |
| Deposit £1.0.0 and 9 monthly | £1.1.0 |
| Case, two-tone grey, with speaker | £4.4.0 |
| Complete Kit as above | £25.0.0 |
| Deposit £2.10.0 and 12 monthly | £21.6 |
| Collaro Deck, 4 track, Michigan heads | £17.17.0 |
| Deposit £11.5.6 and 12 monthly | £1.9.5 |
| Tape Amplifier, as in first column, but 4 track | £21.5.0 |
| Deposit £1.7.0 and 12 monthly | £1.0.8 |
| Case with 9 x 5in. speaker | £5.5.0 |
| Complete Kit, 4 track Collaro | £34.0.0 |
| Deposit £3.3.0 and 12 monthly | £21.9 |
| Tape Pre Amplifier for Collaro deck with power supplies EC'83, EC'152, EZE0 and EM'85. Radio and Mic. sockets, gives an equalised output of 400m/volts. | £8.8.0 |
| Half Track | £8.8.0 |
| Deposit £1.0.0 and 8 monthly | £1.1.0 |
| Quarter Track | £9.9.0 |
| Deposit £1.0.0 and 9 monthly | £1.1.0 |
| Cabinet, polished to house either Pre amps or Studio deck | £6.6.0 |
| Mounting kit for above, brackets, etc. | £11.1.6 |
| BUILDING INSTRUCTIONS AVAILABLE AT 2/6 each kit. | |
| BRENELL Mk. 5 Recorder, Complete 1/2 track | £67.4.0 |
| Deposit £6.14.6 and 12 monthly | £511.11 |
| FERRGRAPH 5A'N, New Series. | £89.5.0 |
| Deposit £8.18.6 and 12 monthly | £7.8.7 |

48 SURBITON ROAD, KINGSTON-UPON-THAMES, SURREY

Phone: KIN 5549

We pay all postage and insurance. All orders despatched same day. Money refund guarantee.
Hours: 9 a.m.—6 p.m. (1 p.m. Wednesday). We do not close for lunch. Open all day Saturday.

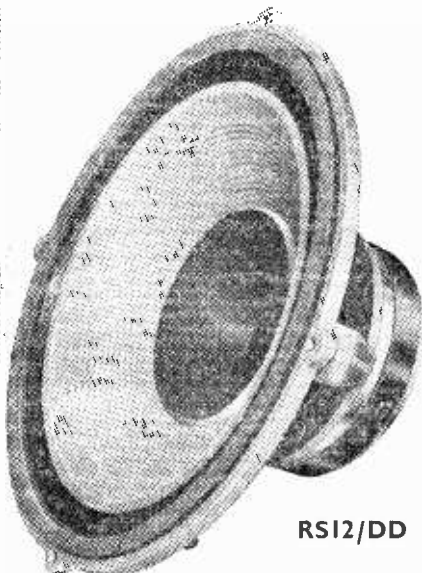

RS12/DD

**A 12" SPEAKER
for the HOME CONSTRUCTOR**

A fine 12" Speaker employing a new type of double diaphragm and magnet assembly, the RS12/DD has been designed with the home constructor in mind—it is one of the few 12" models suitable for use in compact enclosures enabling a really high quality system to be assembled at a modest price.

Some important features of the RS12/DD—

- Very low bass resonance
- Synthetic Centring Device
- Ceramic Magnet
- Die-cast Chassis
- Foam edge Damping
- One-piece HF Flare Dome
- Airtight impregnated Roll Surround

£11.10.0 TAX FREE



Complete the coupon for technical specification of the RS12/DD including Constructional details of suitable cabinets.

Post to Wharfedale Wireless Works Ltd.,
Idle, Bradford, Yorkshire

NAME

ADDRESS

PW

The
**AMATEUR RADIO
HANDBOOK**

Third Edition

Contents include Fundamentals, Valves, Semi-conductors, H.F. Receivers, V.H.F./U.H.F. Receivers, H.F. Transmitters, V.H.F./U.H.F. Transmitters, Keying and Break-in, Modulation, Single Sideband, Frequency Modulation, Propagation, H.F. Aerials, V.H.F. Aerials, Noise, Mobile Equipment, Power Supplies, Interference Measurements, Operating Technique and Station Layout, the R.S.G.B. and General Data.

Bound in maroon linson buckram - - 544 pages
700 diagrams and 100 half-tones

PRICE 34/- (Postage and packing 2/6)
(£5.50 post paid U.S.A. and Canada)

Obtainable from leading booksellers or
(Dept. P.W.1)

**RADIO SOCIETY OF
GREAT BRITAIN**

28 Little Russell Street, London, W.C.1

AMAZING RESULTS

FROM THE
"OLIVER"
5 STAGE TRANSISTOR
RECEIVER



A highly sensitive receiver using top grade transistors and components. Fully tunable over medium and long waves.

- Can be built in 1 hour
- High flux moving coil speaker
- Built-in ferrite rod aerial
- Specially designed coils for maximum signal strength
- Volume on/off control
- Eyeletted circuit board
- Easy to follow building plans

Send S.A.E. for
FREE Layout plans
and parts lists

Total Building Costs
ONLY 65/- Plus P. & P. 2/6

EXPLORE THE WORLD
ON THIS 1-VALVE
SHORT WAVE RADIO



Total Building Costs only
35/-
P. & P. 2/-

- ★ Receives speech and music from all over the world.
 - ★ Construction price includes valve and one coil covering 40-100 metres.
 - ★ Can be extended to cover 10-100 metres.
 - ★ Can be converted to 2 or 3 valve.
- Send 2/- for wiring diagram and components price list.

All parts for the above circuits are available separately.

R.C.S. PRODUCTS (Radio) LTD.
11 Oliver Road, London, E17 (Mail Order Only)
Trade Enquiries Welcomed.

Letters to the Editor

The Editor does not necessarily agree with the opinions expressed by his correspondents

Whilst we are always pleased to assist readers with their technical difficulties, we regret that we are unable to supply diagrams or provide instructions for modifying commercial or surplus equipment. We cannot supply alternative details for receivers described in these pages. **WE CANNOT UNDERTAKE TO ANSWER QUERIES OVER THE TELEPHONE.** If a postal reply is required a stamped and addressed envelope must be enclosed with the coupon from page iii of the cover.

COMMERCIAL RADIO STATIONS

SIR,—With reference to your editorial in the September issue of *Practical Wireless* you rightly ask why the Pilkington Committee outlaws commercial radio. In the States, Australia, Malaya and everywhere in progressive communities, major towns have their own station. In this way the housewife learns which store is promoting a certain product; the sports fan hears the scores in local matches; in fact everyone gets to know all the local news. For serious programme material there is always the national medium or short-wave network.

In my travels as a radio officer for a manufacturer of radio equipment I have studied these systems and I must confess that I become impatient when the idea is dismissed here at home.—P. ROBINSON, G3MGJ (Stratford-on-Avon, Worcestershire).

LOCAL STATION PICK-UP

SIR,—May I put forward a suggestion for Messrs. R. Ferguson and B. J. Claxton and other readers who experience broadcast breakthrough in audio equipment such as tape recorders? It appears that very often it is the mains lead which is to blame; a wire roughly 5ft long is very near the resonant length for a 94Mc/s aerial.

Whether your readers are detecting VHF transmissions I know not, but may I suggest that they try altering the length of the mains lead to their equipment or investigating the possibilities of screening it or, in extreme cases, fitting R.F. filters?—C. STEVENSON (London).

AMERICAN STATION

SIR,—Concerning the transmission referred to by Mr. R. R. Diamond (September issue), I would like to confirm that this is a single sideband transmission for the Overseas Telephone Service in Frankfurt (Main)-Eschborn, Germany. The station has a power of 20kW, a frequency of 7537kc/s with a call of DFG53 and the aerial used is a three-wire rhombic type directed at New York. I obtained this information by sending in a report of these transmissions to the station.—R. HARSANT (Ware, Hertfordshire).

SIR.—The letter written by Mr. R. Patrick in the September issue about the transmissions from the American station of the American Telephone and Telegraph Company is quite correct, but I would like to add that this station is operated as a point-to-point radio/telephone station in the international fixed public service. It is located near White Plains, New York.—R. W. H. PEMBERTON (Bury, Lancashire).

[We have received many replies to Mr. T. Gerrard's letter which appeared in the July issue concerning this transmission and there seem to be one or two discrepancies concerning its exact source. We will be interested to hear from any other readers about this station.—Ed.]

CORRESPONDENTS WANTED

SIR,—I am 16 years of age and have been interested in radio for several years. I hope to take the R.A.E. sometime in the near future and I should like to correspond with any other radio enthusiasts of my age from any country. All letters I receive will be answered.—M. R. KING (32 Langley Crescent, South Yardley, Birmingham 26).

☆ ☆ ☆ ☆ ☆ ☆ ☆ ☆ ☆ ☆

☆ A PRACTICAL GIFT ☆

☆ *Send your technical friends the ideal Christmas gift . . . a year's subscription to PRACTICAL WIRELESS. It's a present you know they'll appreciate. And each new issue will be a renewal of your best wishes . . . month in, month out, right up until Christmas 1963.* ☆

☆ *Simply send your friends' names and addresses, together with your own, and remittance* to cover each subscription, to The Subscription Manager (G.I.), Practical Wireless, Tower House, Southampton Street, London, W.C.2. We will despatch first copies to arrive in time for Christmas and send an attractive Christmas Greetings Card in your name to announce each gift.* ☆

☆ *RATES (INCLUDING POSTAGE) FOR ONE YEAR (12 ISSUES):—U.K. £19.0, OVERSEAS £17.6, CANADA £15.0. ☆

☆ ☆ ☆ ☆ ☆ ☆ ☆ ☆ ☆ ☆



**INTERNATIONAL
RADIO
COMMUNICATIONS
EXHIBITION**

SEYMOUR HALL
SEYMOUR PLACE, MARBLE ARCH, LONDON, W.1.
OCTOBER 31st to NOVEMBER 3rd
10 A.M. TO 9 P.M.
ADMISSION 3/-

**DISPLAYS BY THE ARMY, NAVY and AIR FORCE
and EDUCATIONAL ASSOCIATIONS**

**SATELLITE DISPLAY
BY THE POST OFFICE ENGINEERING DEPT.**

DEMONSTRATION of STEREOPHONIC SOUND & COLOUR by FRED JUDD
TECHNICAL LECTURES AND FILMS

LATEST COMMUNICATIONS RECEIVER to be presented
(Exchange this advertisement for entry form at door)

Further details from:

P. A. Thorogood, M.A.S.E.E., G4KD, 35 Gibbs Green, Edgware, Middlesex



**A NEW-PRACTICAL WAY
of UNDERSTANDING**

Radio • Television • Electronics

Including: Transistors; VHF/FM; Hi-Fi equipment; Computers; Servo-mechs; Test Instruments; Photo-electrics; Nucleonics, etc.

FOR ... Your Career ... Your Own Business ... An Absorbing Hobby

Radiostructor—an organisation specialising in electronic training systems offers a new self-instructional method using specially designed equipment on a "do-it-yourself" basis.

You learn by building actual equipment with the big kits of components which we send you. You advance by simple steps, performing a whole series of interesting and instructive experiments—with no complicated mathematics! Instructional manuals employ the latest techniques for showing the full story of electronics in a practical and interesting way—in fact—you really have fun whilst learning! Post the coupon below, now, for full details.—

RADIOSTRUCTOR
LEADS THE WORLD
IN ELECTRONICS TRAINING

POST NOW

To RADIOSTRUCTOR (Dept. G82)
READING, BERKS.

Please send brochure, without obligation, to:

★ Name _____

Address _____

11/62

★ **BLOCK CAPITALS PLEASE**

(We do not employ representatives)

RECEIVERS & COMPONENTS

ANY KIT BUILT: Nominal fees charged. Apply: A. J. PEARCE, Fernham, Connaught Rd., Ben Rhydding, Ikley, Yorks.

"HEATHKITS" can now be seen in London and purchased on easy terms. Free brochure. DIRECT TV REPLACEMENTS LTD., Dept. P.W. 7/9, 138 Lewisham Way, SE14. Tideway 8666.

Famous R107 Receiver

All Band Amateur, Shipping Broadcast 9 valve 1.2 to 17 mc/s (18 to 250 metres), 100/230V. A.C. or 12V. D.C. operation. Internal Speaker. Absolutely as new. £13.10.0. Carr. 30/-.

Many other bargains. S.A.E. enquiries. A. J. THOMPSON
"Elling Lodge", Coddleote, Hitchin, Herts
Phone: Coddleote 242

SPEAKER REPAIRS. Cones/Fields fitted. Clock coils wound. L. S. REPAIRS, Pluckley, Ashford, Kent.

RADIO KITS BUILT. Ready built Good Campanion from 11 gns.; Conzessa £12; Miniature Tape Recorder £9. Also Pocket Sets, V.H.F. 8.W., etc. List and quotations 3d. M. L. COLTON, 21 Maplewood Drive, Blackpool.

DATA TRANSISTOR POCKET KITS NO SOLDERING OR DRILLING. COMPLETELY SELF CONTAINED

NO AERIAL REQUIRED - MEDIUM & LONG WAVE - ASSEMBLY TOOL PROVIDED - CAN BE BUILT BY ANYONE



DATA 427
5½ x 3 x 1½ in.

75/-

P.P. 2/9 ex.
Battery 2/3 ex.

4 TRANSISTORS - 2 DIODES
7 STAGES - MOVING COIL SPEAKER



DATA 326
4½ x 2½ x 1½ in.

49/6

P.P. 2/- ex.
Battery 1/- ex.

3 TRANSISTORS - 2 DIODES - 6 STAGES - PERSONAL EAR PIECE
ALL PARTS CAN BE BOUGHT SEPARATELY

DATA ELECTRONICS LTD.

6 HILLSIDE GDNS., EDGWARE, Middlesex

RATES: 7/3 per line or part thereof, average five words to line, minimum 2 lines. Box No. 1/4 extra. Advertisements must be prepaid and addressed to Advertisement Manager, "Practical Wireless", Tower House, Southampton St., London W.C.2.

RECEIVERS & COMPONENTS
(continued)

NEW AND SURPLUS Valves. guaranteed, from 3/6. Also reclaimed Valves, perfect, from 1/6. Many bargains. S.A.E. for complete list. LEWIS, 46 Woodford Avenue, Ilford, Essex.

ULTRA LINEAR AMPLIFIERS

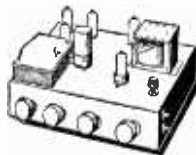

High Fidelity. 15 wats. Valves ECC83, ECC83, EL84, EL84, EZ81. Two inputs. Sensitivity 10 milli-volts. Bass & Treble controls. 5 & 15 ohms. outputs. Kit, £6.10.0, plus 5/- carr.

Factory built, 2g, plus 6/- carr. Similar 30 watt £12, plus 7/6 carr. Leaflet free. Same day despatch.

STROUD AUDIO

11th Road, Stroud, Glos.
Tel. Stroud 783.

TRANSISTOR COMPONENTS. 7 x 4in. 35 ohm speakers, 25/-, 7 x 4in. 3 ohm. 19/6.

EARPIECES. 7 ohm, 150 ohm. 6/6. Xtal with Jack, 7/6, all complete with plugs. 4 pole 2 way switches 1 inch spindle, 2/6 each. Min. Caps. 15 v. wkg.—3, 2, 4, 5, 3, 19, 18, 32, 50 mfd., 64 mfd., 10 v., 100 mfd., 6 v., 100 mfd., 12 v., all at 1/10 each. Resistors mostly 10% small, 10 ohms to 10 meg., 3d. each. Ceramics, most values in stock, 1 pd. to 5,000 pd. Slide switches, DE7D, 3/- each.

TRANSISTORS. OC44, OC45, 7/6 each. A.F. Pack OC81D, 2 OC81, 18/6, set. G.E.C. 874, 4/6, S6, S7, good output transistors. 2/6 each. Red spots. 2/3. White spots, 2/6. OC78, 1/6, OC77, 1/6. OA81 Diodes, 2/6. GEX00, 9d. Terms C.W.O. or C.O.D.

BROADWAY ELECTRONICS

92 Mitcham Road, Tooting, S.W. 17.

POST FREE

Guaranteed Transistors, OC44 6/6, OC45 6/-, OC200 6/-, matched set OC81D, 2 x OC81 16/6, AF114, 115, 116 and 117, all 9/6 each. Red Spot 3/-, White Spot 3/6, 35 ohm 5in. round speakers 24/6, 25 ohm elliptical 7 x 4in., 24/6. 2½ round 3, 8, and 80 ohm 19/6. Introducing "The Pandora" 6 Transistor Pocket Superhet. De-lux case, 250mW P/P, printed circuit, complete kit £6.19.6. Post free.

SOUND VISION of CHELMSFORD

137 MOULSHAM STREET

BRIAN E. HAMPSHER (R & T) LTD.

Dept PWA, 23 NORTH CROSS ROAD, S.E.22.

| | | | | | | |
|------|------|------|------|------|------|--------|
| 6F13 | EF80 | EF91 | 6P25 | 10F1 | Z77 | 25L6GT |
| EB91 | 6P28 | 6F1 | EF50 | L63 | 6F12 | |

SALVAGED. GUARANTEED 100% ALL AT ONE PRICE
£1 for 10, p. & p. FREE

BARGAINS FROM THE

TELEVISION TUBE SHOP

ALL BRAND NEW

Famous BERNAU
Radiogram Chassis

Long, Medium, Short, V.H.F. Full range bass and treble knobs. 6 Push buttons, 7 valves, 2 Loudspeakers, Magic Eye, A.C. mains, 110-240 volts.

25 gns.

Same chassis in superb gold-trimmed cabinet, 12 x 9 x 23in. Few only.

27 gns.

(40 gn. value) Terms—£5 down plus P. & P. 10/-.

TAPE RECORDER KITS

(by well-known maker)

Smart cabinet 13½ x 15 x 8in., with all knobs, switches etc. 5 valves, 4 watt, A.C. with provision for AC/DC use. With B.S.R. deck,

16 gns.

Less credit 9 gns.

AC/DC model complete with B.S.R. deck complete, for 110v. or 240v. A.C. or D.C.

18 gns.

Terms—£4 down, plus P. & P. 10/-.

R.C.A. TAPE

(the finest U.S.A. make)

5in. 600 feet, 14/9

5½in. 1,200 feet, 19/6

7in. 1,800 feet, 27/-

P. & P. 1/6 (1), 2/6 (2 plus)

TELEVISION TUBE SHOP

48 BATTERSEA BRIDGE ROAD
S.W.11. Bat. 6859. Open Sats.

MOTORS**B.S.R. MONARCH
TAPE RECORDER****and
RECORD PLAYER****MOTORS**

Price

**Monarch Tape-Deck
TD2 Complete
Assembly .. 46/-****Motor for Monarch
Record Changer
TU8 .. 44/-****Motor for Monarch
Record Changer
TU9 .. 44/-****Motor for Monarch
Record Changer
UA12 & UA14 44/-****Motor for Monarch
Record Changer UA7,
UA6, UA5,
HF100, GU4A 40/-**

All Motors P. & P. 3/6 extra

ALL SPARES AVAILABLE

Any Motor Supplied

Enquiries S.A.E. P.P. 3/6

WYNDSOR TELEVISION**TECHNICAL DIVISION**St. Albans Rd., Barnet
Herts. BAR 1769**FOR SALE****SLIDE RULES.** Essential to every radio engineer. Send for price list to **KENMAR YOUNG**, 137 Westminster Bridge Road, London SE1.**RED SPOT** Transistors 1/8, six for 8/-; 1mfid to 100mfid Trans. Cons. 2/- each, six for 10/-; Midjet I.F.T. 465kc 6/- pair, 10.7mc 4/- pair; 9V Trans. Eliminators 17/6; EP10K meter £5; Silicon Rects. 250V, 500mA 10/-; 1962 Catalogue 2/-. All post free. **B. W. CURSONS**, 78 Broad Street, Canterbury.**SPECIAL OFFERS
NO INTEREST TERMS
DELIVERED FREE**

| | |
|---|---------------|
| Armstrong AP208 Chassis, | Cash £82.18.0 |
| or 68/- dpt. and 10/- weekly for 35 wks. | |
| Armstrong Jubilee Mk. II, | Cash £30.12.0 |
| or 87/- dpt. and 15/- weekly for 35 wks. | |
| Armstrong Micro 35, | Cash £22.15.0 |
| or 85/- dpt. and 15/- weekly for 38 wks. | |
| Armstrong Stereo 12, Mk. II | Cash £43.10.0 |
| or 130/- dpt. and 20/- weekly for 37 wks. | |
| Armstrong A20/PC125, | Cash £44.2.6 |
| or 132/6 dpt. and 20/- weekly for 38 wks. | |
| Goodmans Aviette S, | Cash £6.5.1 |
| or 15/1 dpt. and 5/- weekly for 18 wks. | |
| Goodmans Axiom 10, | Cash £5.18.8 |
| or 19/8 dpt. and 5/- weekly for 20 wks. | |
| Goodmans Axiom 201, | Cash £9.15.0 |
| or 30/- dpt. and 5/- weekly for 38 wks. | |
| Goodmans Trebax 5K/20XL, | Cash £7.0.0 |
| or 20/- dpt. and 5/- weekly for 24 wks. | |
| Garrard Autoslim G38, | Cash £7.14.11 |
| or 22/11 dpt. and 5/- weekly for 29 wks. | |
| Garrard 4HF/GCS10, | Cash £18.13.0 |
| or 88/- dpt. and 10/- weekly for 38 wks. | |
| Garrard AT9/EV26, | Cash £13.14.9 |
| or 48/8 dpt. and 7/6 weekly for 31 wks. | |

Payment accepted monthly by Banker's Draft
These units and other equipment supplied on
18 months' H.P. terms.

A. L. STAMFORD Ltd. (Dept A29)
98 WEYMOUTH TERRACE, LONDON, E2**GRUNDIG MA1** Transistor Tape Pre-amplifiers suitable for use as microphone transformer, pick-up and tape head booster. Listed at 41 gns., offered at £2 17s. 6d. Send for full details and free lists. **LEE ELECTRONICS** 400 Edgware Road, W2 (PADDINGTON 5521).**E. R. NICHOLLS**

47 MIDDLE HILLGATE, STOCKPORT

RETAIL SHOP

BUMPER PARCEL

100 Resistors, 100 Condensers, 100 Cartridge Fuses, 3 Mains Droppers, 2 Rotary Toggle Switches, 6 Paxolin Panels, 2 B.C. Lampholders, 1 Transmitter, Chassis less Valves, 6 Potentiometers. 20/- Post Free.

No. 2 PARCEL. 1 ex Unit Mains Transformer 250-0-250x4x5x6.3 volts, 1 Sound Output Transformer, 1 Isolation Transformer, 1 5in. Speaker P.M., 3 Jack Sockets, 4 Terminal Blocks, 2 Inert Cells, 1 Telephone Fuse Box, 1 12-volt 4-pin Vibrator, 100 Cartridge Fuses, 1 Helmet Spot Lamp, 1 Nylon Parachute for the youngster, 24 asstd. sizes Polythene Bags for the wife, 12 sheets Carbon Paper for the lodger. 1 Thermistor and if you send a local view (post card) I will send 12 High Stab Resistors. All this for 40/-, Post Free. Don't Miss It.High Stab Resistors 6d. each. S.A.E. List 20 ft. Telescopic Masts 50/-, via BRS Post free
Mail Order to—

33/35 Carrington Field St., Stockport.

FOR SALE

(continued)

BRAND NEW Adjustable Steel Shelving, 73in. high by 34in. wide by 12in. deep. Stove Enamelled dark green. Sent unassembled. Six-shelf buy £3/15/-, Sample delivered free. Quantity discounts. **N. C. BROWN LTD.**, Eagle Steelworks, Heywood, Lancs. Tel.: 69018.**BARGAIN, EIGHT** 45 rev/min Brand New Pop singles (value over 50/-) for £1. S.A.E. for details to: **R. FLETCHER (P.W.)**, 24 Old Hall St., Burnley, Lancs.**PERSONAL EARPHONES**for transistor radios high sensitivity
units 25/- complete.**CUNNINGHAM BEATTIE LTD.**
49 Wigmore Street, W.1.**ASK** your dealer for American Ferro-dynamics. "Brand Five" Recording Tapes—the best tape value!**AMATEUR LICENCE** Morse Course. The new Rhythm Method of teaching takes the drudgery out of learning Morse and is the quickest known! For full explanatory booklet: **S.A.E. G3CHS**, 45 Green Lane, Purley, Surrey.**WANTED****A PROMPT CASH OFFER** for your surplus Brand New Valves and Transistors. **R.H.S.** Beverley House, Mannville Terrace, Bradford 7.**NEW VALVES WANTED**

Any type, any quantity

CASH PAID**R.S.T.** 211 Streatham Road,
Mitcham, Surrey.

Telephone: MITCHAM 6202

WANTED: NEW Valves and Transistors, any quantity. **S. N. WILLETS**, 43 Spon Lane, West Bromwich, Staffs. Tel.: WES 2392**WANTED: TEST GEAR,** Meters Valves, Components, Communication Sets, Amplifiers. **HUGGETS LTD.**, 2-4 Pawson's Road, West Croydon, Surrey.**VALVES WANTED**IMMEDIATE CASH SETTLEMENT
Must be new
Phone, write or call**Radio Facilities Ltd.**38 Chalcot Road, London, N.W.1
PR1mrose 9090

The valve specialists

WANTED

(continued)

WANTED VALVES

All types for prompt cash. Must be new. State quantity.

WILLIAM CARVIS LTD.

103 North Street, Leeds 7

SERVICE SHEETS

SERVICE SHEETS for all makes of Radio and TV, 1930-1962. Prices from 1/- with free fault-finding guide. Catalogue of 8,000 models 1/6. 125 Radio/TV sheets covering many popular models. 20/- S.A.E. inquiries: **HAMILTON RADIO**, Western Road, St Leonards, Sussex.

WHY TOLERATE DELAY when we can supply your Radio or TV Service Sheet by return of post at 4/- each, plus postage. List 1/-. Also Manuals for sale and hire. List 1/-. S.A.E. with inquiries please. Mail orders only to **S.P. DISTRIBUTORS**, 44 Old Bond Street, London W1.

FAULTFINDER FILES, showing common faults that each receiver is prone to and other useful servicing information, 2/- each. List 9d., plus postage. Mail orders only. **S.P. DISTRIBUTORS**, 44 Old Bond Street, London W1.

SERVICE SHEETS, Radio and TV, 4/- each. List 1/-. All orders dispatched on day received. Also manuals for sale and hire. List 1/- S.A.E. please: **SULTAN RADIO**, Pantiles Chambers, Tunbridge Wells, Kent.

SERVICE SHEETS; also Current and Obsolete Valves for sale. **JOHN GILBERT TELEVISION**, 1b Shepherd's Bush Road, London W12. Phone SHE 8441.

SERVICE SHEETS: Radio, TV, 5,000 models. List 1/-. S.A.E. inquiries: **TELRAY**, 11 Maudland Bk., Preston.

EDUCATIONAL

**Radio
Television
& Electronics**

Learn at home with the world's largest home study organisation, Brit.I.R.E.; City & Guilds; P.M.G.'s certs., etc. Also Practical Courses with equipment. No books to buy.

Write for **FREE prospectus** stating subjects to

I.C.S.

(Dept. 541), Intertext House, Parkgate Road, London, S.W.11

EDUCATIONAL (continued)



By repairing Radio and TV Sets as a job or as a spare time hobby. Our practical course will show you the way. No previous experience is required.

**SEND FOR
FREE BOOK
TODAY!**

RADIOSTRUCTOR

Dept. G77 READING, BERKS

THE Incorporated Practitioners in Radio and Electronics (I.P.R.E.) Ltd. Membership Conditions booklet 1/-. Sample copy of I.P.R.E. Official Journal 2/ post free. Secretary, 20 Fairfield Road, London N8.

$$X = \frac{-b \pm \sqrt{b^2 - 4ac}}{2a}$$

DON'T FUMBLE with Formulae. Master Mathematics quickly and easily the Understandable Way.



The Dryden School of **UNDERSTANDABLE MATHEMATICS**
 111F1DrydenChambers, OxfordSt. London, W.1.
 Name.....
 Address.....

"HOW AND WHY" of Radio and Electronics made easy by a new, non-maths practical way. Postal instruction based on hosts of experiments and equipment building carried out at home. New courses bring enjoyment as well as knowledge of this fascinating subject. Free brochure from: Dept. P.W. 12. **RADIOSTRUC-TOR**, Reading.

LEARN RADIO AND ELECTRONICS the new and practical way. Hosts of absorbing experiments carried out at home under expert guidance to teach you Radio in a new, enjoyable and interesting way. Construction, servicing and fault-finding on equipment made easy for the first time! No previous experience needed. No mathematics used. Free brochure from: Dept. 11. P.W. **RADIO-STRUC-TOR** Reading.

WIRELESS. See the world as a Radio Officer in the Merchant Navy; short training period, low fees; scholarships, etc. available. Boarding and Day students. Stamp for Prospectus **WIRELESS COLLEGE**, Colwyn Bay.

MISCELLANEOUS

PRINTED BILLHEADS, 8 x 5, blue ruled, 100 12/6, 250 20/-, cash with order. Print copy clearly. **BROOK-VALE PRESS**, 147 George Road, Birmingham 23.

YOUR OWN Kits built up or assistance given. Bradford/Leeds area. S.A.E.: **TVS**, 19 Aberdeen Terrace, Bradford 7, Yorkshire.

ANY P.W. DESIGN made up professionally. BOX 40.

ELECTRONIC MUSIC?

Then how about making yourself an electric organ? Constructional data available—full circuits, drawings and notes! It has 5 octaves, 2 manuals and pedals with 24 stops—uses 41 valves. With its variable attack you can play Classics and Swing.

Write NOW for free leaflet and further details to C. & S., 20 Maude Street, Darlington, Durham. Send 2hd. stamp.

COURSES

CITY AND COUNTY OF BRISTOL EDUCATION COMMITTEE
BRISTOL TECHNICAL COLLEGE

Principal: E. POOLE, B.Sc.(Eng.), M.I.Mech.E., M.I.Prod.E.

SCHOOL OF MARINE RADIO AND RADAR

Lecturer in Charge: F. E. BARLTROP (ex A.S.T. Hamble)

MARINE RADIO OFFICERS

A full-time Course for prospective Radio Officers in the Merchant Navy, leading to the 2nd and 1st Class P.M.G. Certificates, and the M.O.T. Radar Maintenance Certificate, is provided, and entry may be made in January, May or September of each year.

Fees: **P.M.G. Courses:**
 Over 18 years of age £23.10.0 per College year
 Under 18 years of age £2.0.0 per College year
M.O.T. Radar £5.0.0 per term

A six-week Course of Pre-Sea Training is also held, and entry is normally made on completion of the Radar Course.

For further particulars apply to:

THE REGISTRAR,
 BRISTOL TECHNICAL COLLEGE, ASHLEY DOWN, BRISTOL 7

SITUATIONS VACANT

A.M.I.Mech.E., A.M.Brit.I.R.E., City and Guilds, G.C.E., etc., brings high pay and security. "No pass—no pay" terms. Over 95% successes. For details of exams and courses in all branches of Engineering. Building, Electronics, etc. write for 148-page handbook free. B.I.E.T. (Dept. 242B), London W8.

TV AND RADIO, A.M.Brit.I.R.E., City and Guilds, R.T.E.B. Cert., etc. on "No pass—no fee" terms. Over 95% successes. For details of exams and courses (including practical apparatus) in all branches of Radio, TV and Electronics, write for 148-page handbook free. B.I.E.T. (Dept. 242G), 29 Wright's Lane, London W8.

CITY AND GUILDS (Electrical, etc.) on "No pass—no fee" terms. Over 95% successes. For details of Electrical Engineering, Applied Electronics, Automation, etc., send for our 148-page handbook, free and post free. B.I.E.T. (Dept. 242A), 29 Wright's Lane, London W8.

UNITED KINGDOM ATOMIC ENERGY ESTABLISHMENT, WINFRITH

Electronic Instrument Mechanics

A.E.E. Winfrith require experienced men with knowledge of electronic equipment and/or industrial instrumentation for fault diagnosis, repair and calibration of a wide range of instruments used in nuclear reactors and associated experiments.

Men with Services, Industrial or Commercial backgrounds of radar, radio, television, industrial or aircraft instruments are invited to write for further information. Training in Specialised Techniques is provided for successful applicants having suitable background.

Married men living beyond daily travelling distance may be eligible for housing and this will be determined at time of interview. A lodging allowance is payable whilst waiting for housing. Working conditions are good and include sick pay and pension schemes.

Application forms may be obtained by sending a post card quoting your name, address and the reference EL/INST/NAT to the Labour Department, A.E.E. Winfrith, Dorchester, Dorset.

BOOKS & PUBLICATIONS

FIND TV SET TROUBLES IN MINUTES from that great book The Principles of TV Receiver Servicing. 10/6 all book houses and radio wholesalers. If not in stock from Secretary, I.P.R.E., 20 Fairfield Road, London N8.

AUDIO. America's foremost journal. Year's subscription 35/-; specimen copy 4/-. All American radio journals supplied—list free. WILLEN (Dept. 40), 61a Broadway, London E15.

METAL WORK

METALWORK. All types cabinets, chassis, racks, etc., to your specifications. PHILPOTT'S METALWORKS LTD., Chapman St., Loughborough.

SOUND RECORDINGS

TAPE BARGAINS in all sizes. Example: Top brand 5 1/2 in. 1200ft 10/6 p. and p. 1/3. S.A.E. for list. Large choice of New and Used Recorders. E. C. KINGSLEY AND CO., 132 Tottenham Court Road, London W1. EUS 6500.

RADIO BOOKS

A BRILLIANT NEW Pictorial approach to understanding **BASIC ELECTRICITY BASIC ELECTRONICS** In Simple straight-forward words and Clear Explanatory Pictures. The Reader is taken Step by Step from Picture to Picture **LEARN WHILE YOU PAY FOR ONLY 2/6 PER WEEK** Write for FREE Illustrated Prospectus giving details of instalment plan.

MODERN TRANSISTOR CIRCUITS FOR BEGINNERS, 8/- **ELECTRONIC GAMES, Bradloy 6/6** **SERVICING TRANSISTOR RECEIVERS** New and enlarged edition. Pettit, 8/- All above titles include postage. SEND STAMP FOR LISTS

SELRAY BOOK CO. 60 HAYES HILL, HAYES, BROMLEY KENT. Tel. HURstway 1818

PADGETTS RADIO STORE

OLD TOWN HALL, KNOWLER HILL, LIVERSEDGE, YORKS. Phone: Cleckheaton 2866

Type 46 RXTX Sets. Complete with two ARP12, one AR8 one ARTP2, one AP14 and one AP137 valves, less crystals plug in coil and send/receive switch, but otherwise complete. These sets are in new condition at 8/6. Post 3/6. Grade 2 as above store sold 4/6. Post 3/6.

Home Computers. New condition. Full of gears, motors, etc. 30/-. Carr. 6/6.

P.M. Speakers, all 3 ohms. Removed from TV sets, perfect condition. Rola 6 x 4in. 5/-. Goodmans 7 x 4in. 6/-. Philips 5in. round 5/-. Rola R and A round 3/6, 4in. Dish 5/-. 8in. round 6/-. Post extra on any speaker 2/- up to six can be sent for 3/6.

Germanium Diodes, 4/6 doz. Post free.

New Valves, Ex Units, All Post free. KT66 6/6, USA807 5/-, 6V6 3/6, 6VU6CT 4/6, EC4 2/6, VR150/30 4/6, 12AM6 2/6, EF51 1/6, EF50 1/6 or 6/6 doz., 5Y4 4/6, 5Z4 5/6, DH63 4/6, 9A4 1/6, 900J 9d, or 5/- doz. USA EF50 Red 2/6.

Valves Removed from TV sets. All post free. All tested on a Mullard Valve tester and are 100 per cent as new. They carry a three month guarantee. We also have a large stock of old type radio valves and other TV valves not listed. ECL80 4/6, ECC82 5/6, EL38 4/6, EY81 5/6, EBF80 4/6, EB91 6d., EY81 9d., 6P1 1/6, 6P13 2/6, 6P14 5/6, 6L20 2/6, 6BN7 2/6, 6S1 7/6, 6Y3 2/6, 6C6 3/6, 6SS 2/6, 6C2 2/6, 6P1 1/6, 10P13 5/6, 10P14 3/6, 20D1 3/6, 20F1 5/6, 20L1 5/6, 20P4 1/6, 105B1 8/6, U281 5/6, U282 5/6, U801 8/6, U320 5/6, KT66 5/6, PL81 5/6, PL89 1/6, PL38 5/6, PY80 5/6, PY84 4/6, PY82 6/6, PZ30 4/6, PC20 4/6, ECC84 4/6, PL83 5/6, PL83 4/6, B36 4/6, N37 5/6, L63 3/6, 6V6 3/6, 2T8U 5/6, U12 4/6, EF80 1/6, 10/- per doz. Grades 2 6d., 4/- per doz.

Perfect Reconditioned Tubes, 6 months' guarantee. 12in. 17/-, 14in. 30/-. Carr. and ins. 7/6.

Complete TV set. (Untested), 12in. 20/-. 14in. 30/-. 14in. 13 channel 50/-. 17in. E.B.C. only 60/-. Carr. B.R.S. 10/-. Sent at owner's risk.

TV Tubes Completely Rebuilt and re-tested 12 month guarantee. Old glass not required. 12, 14, 15, 16and 17in., any make. All same price. Special trade price of 23.15. Carr. and ins. 7/6.

Special Offer New Boxed Valves. ARP12 1/6, 6/ for 5/6, MSPEN 2/6, X41 4/- (KTZ836J7) 3/6, AC2PEN 4/-. All post free.

New Transistors, OC72 3/6, OC45 4/-. Post free.

ULTRA VIOLET BULBS

Easy to use source of UV for dozens of practical and experimental uses. 12 volt 30 watt AC/DC BBC 6/6. P. & P. 1/- 12 volt 60 watt AC/DC BBC 8/6. P. & P. 1/- Transformer to suit the above: Input 200-240 A.C. Output 12 volt A.C. 36 watt, 18/6. P. & P. 2/6. Input 200-240 A.C. 12 volt A.C. 60 watt. 22/6. P. & P. 3/6.

BUILD AN EFFICIENT STROBE UNIT FOR ONLY 3/6

The ideal instrument for workshop, lab, or factory. This wonderful device enables you to "frooze" motion and examine moving parts as if stationary. We supply a simple circuit diagram and all electrical parts including the NSP2 strobe tube which will enable you to easily and quickly construct a unit for infinite variety of speeds, from 1 flash in several seconds to several thousand per minute. New modified circuits bring price down to 3/6 plus 3/- P. & P.

NSP2 CV2206 STROBOTRON FLASH-TUBE: made by Ferranti, brand new, L.O. base. Price 15/-. P. & P. 1/-.

MAGNETIC COUNTERS

10 IMPULSES PER SECOND Very latest High Speed type ex P.O., guaranteed perfect, type No. 100B, coil 2300 ohms, for 48 volt D.C. operation (will work on 38 volt), overall size 4 x 1 1/2 in. Also available type 101A which can be used as an interesting accessory with our Strobe unit. Either type price 15/-. P. & P. 1/6.



Variable Voltage Transformer

Input 230 v. A.C. Output 0-260 v. at 2 amp. Fully shrouded. New. £5.19.8, inc. carriage. Also available from stock, 5, 8, 10 and 20 amp. Write for details.

ORP 60 MULLARD CADMIUM SULPHIDE PHOTOCELLS With mounting and leads including circuit for making light sensitive switches. 7/6. Post paid.

SIEMENS H.S. RELAY. Very latest type, sealed. 196E, 1700 ohms plus 1700 ohms, single C/O contacts. Price 16/6 each, plus 1/- P. & P.

SOLENOID OPERATED MAGNETIC RELAY. Type 5CW/3945, 4-pole changeover. 1 A contacts 24 v. operation. Brand new 13/6. P. & P. 2/-.

SLIDER RESISTANCE, geared drive 14 amp. 1.2 ohm, Brand new. 27/6. P. & P. 3/6.

NEW P.O. RELAYS TYPE 3000 2,000 ohms coil, 4 make 4 break. 12/6 each. 500-500 ohms (1,000) ohms 2 changeovers. Price 2/6. 6,500 ohms 1 changeover, 1 break Price 12/6. 10,000 ohms coil, 2 light c/o. 2 heavy duty c/o. Price 22/6. 16,000 ohms 2 make 2 break. Price 15/-. P. & P. 1/- each item.

100 OHM COIL for 6 v. operation, 4 make, 4 break, 9/6.

CROMPTON PARKINSON BRAND NEW 4 hp. MOTORS. 230/250 VOLT A.C. 1440 R.P.M. Fitted with 2 1/2 in. SPINDLE. Price £215/-. Carriage 8/6.

AVO METER MODEL 7. Individually tested on all ranges and guaranteed. Inclusive of Test Leads. £115.0.0 each. P. & P. 5/-. Case 20/-.
SPEAKER

A beautifully made Speaker and Control Unit for the famous Collins TCS communication equipment. Can be used with any top-grade communication setup. Comprising a super 6in. 3 to 5 ohm speaker, 600 ohm matching transformer, constant impedance type volume control, 3 control switches. Fitted in robust crackle finished case. 29/6. P. & P. 4/-.

SERVICE TRADING CO.

All Mail Orders also callers
47-49 High Street, Kingston on Thames:
Tel: KINGston 9450
Personal callers only
9 Little Newport Street, London W.C.2
(off Leicester Square)
Tel: GERRard 0576

LINEAR TREMOLO-PRE-AMP UNIT Type TP/U1, with 3 controls, volume, amplitude and frequency, inputs for guitar and microphone. Requires power supply of 250 v. 10 mA and 6.3 v. 1 a., available from any R.S.C. or LINEAR amplifier. The unit is merely connected to normal input socket of hi-fi amplifier or Guitar amplifier. Only 8 gns.

D.C. SUPPLY KIT, 12 v. 1 a. consisting of a partially drilled metal case, mains trans., F.W. Bridge Rectifier, 2 fuseholders and fuses. Change Direction switch, variable Speed regulator and circuit. For 200-250 v. A.C. mains. Suitable for Electric Trains. Limited number available at 28/11

SELENIUM RECTIFIERS

| | | |
|---------------|------------|-----------------------|
| F.W. BRIDGE | 24 v. 2 a. | .. 14/9 |
| 3/12 v. 1 a. | .. 3/11 | |
| 3/12 v. 2 a. | .. 8/11 | H.T. TYPES H.W. |
| 3/12 v. 3 a. | .. 9/9 | 150 v. 40 mA .. 3/9 |
| 3/12 v. 4 a. | .. 12/3 | 250 v. 50 mA .. 4/11 |
| 3/12 v. 6 a. | .. 15/3 | 250 v. 60 mA .. 4/11 |
| 3/12 v. 10 a. | .. 25/9 | 250 v. 80 mA .. 5/11 |
| 3/12 v. 15 a. | .. 35/9 | 250 v. 250 mA .. 11/9 |

CONTACT COOLED, 250 v. 75 mA, F.W. (Bridge), 8/11. 250 v. 50 mA, F.W. (Bridge), 8/11. 250 v. 60 mA, 5/11

B.S.R. MONARDECK TAPEDECKS Speed 3 1/2 in. per sec. With high quality recording heads. £6.19.6. Carr. 5/-. Cabinets, to take Deck and amplifier 39/6.

LINEAR TAPE PRE-AMPLIFIER Type LPL. Switched Negative feedback equalisation. Positions for Record 12in. 3 1/2 in. and Playback, RMS recording Level Indicator. Designed primarily as the link between a Collaro Tape Transcriber and a high fidelity amplifier, but suitable for almost any Tape Deck. Only 9 gns. S.A.E. for leaflet.

EX GOVT. SELENIUM RECTIFIERS 12v 15 AMP (BRIDGE) F.W. 19/9

R.S.C. GRAM. AMPLIFIER KIT. 3 watts output. Negative feedback. Controls Vol. Tone and Switch. Mains operation 200-250 v. A.C. Fully isolated chassis. Circuit etc., supplied. Only 39/9. Carr. 3/9.

HI-FI 10 WATT AMPLIFIERS Brand new. Manufacturer's discontinued line. Fitted latest Mullard valves. Dual inputs for "mike" and gram., etc. Bass and Treble Controls. High sensitivity and quality. Output for 3 ohm or 15 ohm speaker. For 230-250 v. A.C. **£7.19.9** Carriage 4/6.

THE SKYPOUR T.R.F. RECEIVER A design of a 3 valve long and medium wave 200-250 v. A.C. Mains receiver with selenium rectifier. High gain H.F. stage and low distortion detector. Valve line-up 6K7, 6P61, 6V6G3. Selectivity and quality excellent. Simple to construct. Point-to-Point wiring diagrams, instructions and parts list, 1/9, maximum building costs £4.19.6, inc. attractive Walnut veneered wood cabinet 12 1/2 x 5 1/2 in.

R.S.C. TRANSISTORISED GRAM AMPLIFIER. Output 1 watt, for 3 ohm speaker. Transistors OC71, OC81D, OC81, OC81. Fitted Vol. Control with switch. Assembled and tested. Suitable for any normal crystal pick-up. Only 59/9.

MULTI-METERS. CABY M1. Sensitivity 2000 ohms per volt. A.C. and D.C. 54/- A.10. Basic Meter sensitivity 155 microamps. A.C. and D.C. ranges £4.17.6. B.20. Sensitivity up to 10,000 ohms per volt. A.C. and D.C. £6.10.0.

EX. GOVERNMENT ACCUMULATORS. Size 7 1/4 x 4 x 2 1/2 in. 2v. 16 A.H. brand new. 6/9 ea., 3 for 15/6.

EX. GOVT. SMOOTHING CHOKES. 200 mA, 3-5 H, 100 ohms, Parneko 8/9; 100 mA, 5 H, 100 ohms 3/11; 150 mA, 10 H, 50 ohms 9/9; 80 mA, 20 H, 900 ohms 5/9; 120 mA, 12 H, 100 ohms 8/9; 50 mA, 50 H, 1,000 ohms 6/9; 100 mA, 10 H, 100 ohms 6/9; 60 mA, 5-10 H, 250 ohms 2/11.

EX. GOVT. MAINS TRANSFORMERS Primaries 200-250 v. 50 c.p.s. A.C. 250v. 60mA 6.3v. 2a. .. 11/9
200-0-250v. 60mA 6.3v. 2a. .. 12/9
300-0-300v. 60mA 6.3v. 2a. .. 12/11
3,500v. 5mA 2v. 2a. .. 39/9
0-35-40-45-50v. 300mA 6.3v. 3a. .. 17/9
12v. 20a. (carr. 7/6) .. 58/9

COMPLETE POWER PACK KIT, 19/11. Consisting of Mains Trans., Metal Rectifier. Double electrolytic, smoothing choke chassis and circuit. For 200-250v. A.C. mains. Outputs 250v. 60mA, 6.3 v. 2a.

R.S.C. POWER PACK, 39/9. Loured metal case only 8 x 5 1/2 x 2 1/2 in. Stove enamelled. For 200-250v. A.C. mains Output at 4 pin plug and socket 250 v. 60 mA, fully smoothed and 6.3v. 2a. Suitable for power requirements of almost any Pre-amp or Radio Tuner.

R.S.C. BABY ALARM or INTER-COMM. KIT. Complete set of parts with diagrams, etc. Housed in two of cabinets of pleasing design. High sensitivity. For 200-250v. A.C. mains. Fully isolated. Controllable at both units. An Intercomm of this class would normally cost £20-£30. Only 79/6, carr. 5/- Or assembled ready for use £25.15.0.

R.S.C. (Manchester) MAIL ORDERS to 29 Moorfield Rd., Leeds 12. Terms: C.W.O. or C.O.D. No C.O.D. under £1 Ltd. Postage 2/9 extra under £2. 3/9 extra under £5 Trade Supplied. S.A.E. with all enquiries please.

| | | | | | | |
|--|---|--|--|---|---|---|
| BIRMINGHAM: 6 Gt Western Arcade Birmingham | SHEFFIELD: 13 Exchange St. Castle Market Bldgs. Sheffield | HULL: 51 Savile St. Hull (Half day Thurs.) | LIVERPOOL: 73 Dale St. Liverpool 2 | BRADFORD: 56 Morley St. (above Alhambra Theatre) Bradford | MANCHESTER: 8-10 Brown St. (Market St. Manchester 2 | LEEDS: 5-7 County (Mecca) Arcade Briggate Leeds |
|--|---|--|--|---|---|---|

FIRST-CLASS RADIO AND T/V COURSES... GET A CERTIFICATE!

After brief, intensely interesting study—undertaken at home in your spare time—YOU can secure a recognised qualification or extend your knowledge of Radio and TV. Let us show you how.

—FREE GUIDE—
The New Free Guide contains 120 pages of information of the greatest importance to both the amateur and the man employed in the Radio industry. N.I.E. provides first-rate postal courses for Radio Amateurs' Exam., R.T.E.B. Servicing Cert., C. & G. Telecoms., Grad. Brit. I.R.E. Guide also gives details of range of diploma courses in Radio/TV Servicing, Electronics and other branches of engineering, together with particulars of our remarkable Guarantee of
SUCCESS OR NO FEE
Write now for your copy of this invaluable publication. It may well prove to be the turning point in your career.
FOUNDED 1885—OVER 150,000 SUCCESSSES

NATIONAL INSTITUTE OF ENGINEERING (Dept. 461), 148 HOLBORN LONDON, E.C.1
S. Africa: P.O. Box 8417, Jo'burg.
Australia: P.O. Box 4570, Melbourne.

STAGE! LOOK!

TRANSISTORS FROM 1/6 EACH

GREEN SPOT A.F. 3 volt 1/6 each.
YELLOW SPOT A.F. 6 volt 2/- each.
RED SPOTS now only 2/6 each.
WHITE SPOTS 2/6 each.
YELLOW/GREEN only 3/- each.
RED/YELLOW R.F. type 4/6 each.

MULLARD TRANSISTORS OC70 6/6, OC71 6/6, OC72 8/-. Matched pair OC72 or OC81 16/- pair. OC81 8/- OC78 8/-, OC44 9/3, OC45 9/-, OC170 9/6, OC171 10/6, AF114 11/-, AF115 10/6, AF116 10/-, AF117 9/6, AF102 27/6.
TRANSISTOR HOLDERS 1/- each. Miniature Germanium Diodes 3 for 2/-.
MULLARD DIODES OA70, OA79, OA81, OA90 all 3/- each.
REPANCO TRANSISTOR TRANSFORMERS, TT49 Interstage, TT45 Driver, TT46 Output, TT47 Driver all 5/- each. FR2 Ferrite Rod Aerial, 12/6.
J.B. Dileon Condensers .0001, .0002, .0003, or .0005 all 4/9 each.
REACTION CONDENSERS, .0001, 3/-, .0003, 3/9, .0005, 4/-.
Miniature .0003 or .0005 4/-.
DIFFERENTIAL REACTION CONDENSERS, .0001, 3/6, .0003, 4/-, .0005, 5/-.
DRX1 Crystal Set Coils with circuit 2/6.
Repanco DRR2 Coils, 4/- each.

ALL SENT POST FREE IN U.K. by
PETHERICK'S RADIO SUPPLIES
22 High Street, Bideford, N. Devon
Tel.: Bideford 1217

H.A.C. SHORT-WAVE EQUIPMENT

AND
SHORT-WAVE KITS

Famous for over 25 years for... S.W. Receivers and Kits of Quality.

H.A.C. were the original suppliers of SHORT-WAVE RECEIVER KITS for the amateur constructor. Over 10,000 satisfied customers—including Technical Colleges, Hospitals, Public Schools, Hams, etc.

Improved designs with Denco coils: One-valve Kit, Model "C", Price 25/-. Two-valve Kit, Model "E", Price 50/-. New Addition: Model "K", Super sensitive "All Day" Receiver. Special inc. price. Complete Kit, 77/-.

All kits complete with all components, accessories and full instructions. Before ordering call and inspect a demonstration receiver, or send for descriptive catalogue and order form.

POST THIS COUPON NOW!
"H.A.C." SHORT-WAVE PRODUCTS (Dept. TH), 44 Old Bond Street, London W.1

Please send me FREE and without obligation your 1962 literature.
NAME.....
ADDRESS.....

| TESTED AND GUARANTEED VALVES | | | |
|------------------------------|------|---------|------|
| 0A2 | 6/- | | |
| 0B2 | 6/- | | |
| 0C3 | 5/6 | | |
| 0D3 | 5/- | | |
| 0Z4 | 5/- | | |
| 1G0GT | 7/7 | 6BR7 | 12/6 |
| 1H5GT | 9/- | 6BR8 | 14/6 |
| 1H5GT | 9/- | 6BR9 | 14/6 |
| 1R5 | 6/- | 6BW7 | 7/6 |
| 1R4 | 5/- | 6C4 | 2/6 |
| 1R5 | 5/6 | 6C0D6G | 17/6 |
| 1T4 | 4/- | 6C16 | 6/3 |
| 1U4 | 7/- | 6C16 | 10/3 |
| 1U5 | 7/- | 6C4W4 | 14/3 |
| 2C26 | 3/- | 6E5 | 7/3 |
| 2CW4 | 14/- | 6F5 | 6/3 |
| 2D21 | 6/- | 6F32 | 5/3 |
| 2E22 | 25/- | 6F33 | 4/3 |
| 2E26 | 20/- | 6J4 | 9/3 |
| 3A4 | 4/- | 6J5G | 3/3 |
| 3A5 | 5/- | 6J6 | 3/6 |
| 3E29 | 50/- | 6J7G | 5/- |
| 3V4 | 6/6 | 6K6G | 5/8 |
| 4A3A | 60/- | 6L6G | 6/8 |
| 5R40Y | 9/- | 6L8 | 8/3 |
| 5U4G | 8/- | 6Q4 | 6/- |
| 5Y30 | 4/- | 6R67 | 5/- |
| 5Y30T | 6/- | 6R67 | 5/6 |
| 5Z3 | 8/- | 6S17GT | 6/6 |
| 5Z4 | 8/- | 6S17GT | 4/6 |
| 6A3 | 8/- | 6X4 | 5/- |
| 6ASQM | 7/- | 6X3G | 4/6 |
| 6AB7 | 4/- | 6Y6G | 6/- |
| 6AG5 | 3/- | 6Z4 | 6/- |
| 6AG7 | 7/- | 6F1 | 7/3 |
| 6AK5 | 4/- | 11E2 | 20/- |
| 6AL5 | 4/- | 11E3 | 20/- |
| 6AM5 | 4/- | 12AT7 | 5/- |
| 6AM6 | 4/- | 12AU7 | 5/- |
| 6AQ5 | 6/- | 12AX7 | 6/- |
| 6AS9 | 5/- | 12AY7 | 10/- |
| 6AT6 | 5/- | 12BA6 | 8/- |
| 6AU6 | 7/- | 12BB6 | 5/- |
| 6B8 | 5/- | 12K1 | 20/- |
| 6B8G | 2/6 | 12K7GT | 4/- |
| 6BA6 | 6/- | 12Q7GT | 5/- |
| 6BE6 | 6/- | 12SK7 | 5/- |
| 6BB6 | 8/- | 12SL7GT | 7/6 |
| 6BJ6 | 10/- | 12SN7GT | 7/6 |
| 6BQ7A | 8/- | | |

Z & I AERO SERVICES LTD

Retail Shop: 85 TOTTENHAM COURT ROAD
Tel: LANGHAM 8403

Lead Office and Warehouse: 14 SOUTH WIMBORNE RD., W. 2, Tel. AMB 0151/2, 0677

Please send all correspondence and mail orders to the Head Office.

TRANSISTORS—Mullard Top Quality: OC44 7/6; OC45 6/6; OC78 7/-; OC78D 7/-; OC81 7/-; OC81D 7/-; OC72 8/-; Pair of Matched OC78 or OC81 13/-; Set of two Transistors, perfect to use on reduced voltage, OC44 3/-; OC45 3/-; Standard R.C.A. Transistors: 2N410 (OC45) 5/-; 2N412 (OC44) 5/-; White Spot 2/8; Red Spot 2/8; Yellow Spot 1/15; Green Spot 1/6.

SEMICONDUCTOR DIODES—Silicon: SX641, 60 p.l.v., 200 mA D.C. 3/-; SX642, 120 p.l.v., 270 mA D.C. 3/6; SX643, 180 p.l.v., 200 mA D.C. 3/6; SX 645, 400 p.l.v., 190 mA D.C. 5/6; SX71, 60 p.l.v., 50 mA D.C. max. switching speeds 100 Me/s 7/6; Germanium: CG12E, 25 p.l.v., 30 mA max. 1/6; CV432, 25 p.l.v., 30 mA max. 1/6.

CATHODE RAY TUBES
2AP1 25/-; VCR97 40/-; 09D 30/-; VCR138 60/-; Bases for the above 3/8 each.

SPECIAL OFFER (Strictly limited to Personal Shoppers only)
Cossor type 339 Double Beam Oscilloscopes in full working order for £13.00 only. Demonstrations on request.

UNIVERSAL RELAYS
300Ω Coil; 4 change-over contacts which can be independently adjusted to operate at any voltage from 3.5 to 24V D.C. The relay can therefore be used for sequence switching, energising each contact in turn 15/-; P. & P. 3/-; Increased to max. 15/-; P. & P. 3/-.

CHARGER TRANSFORMERS
MT3AT, input 200/250V, output tapped at 12-13-20-24-30V, 2A... 25/6
MT16AT, input 200/250V, output 24 at 5 Amps... 38/6
MT12AT, input 200/250V, output tapped at 12-15-20-24-30V, 3 Amps... 38/6

POST OFFICE RELAYS TYPE 3000
2 x 0.5, 500mA, 10KΩ Coil, sec. hand... 8/6
4M + 4R, 500mA, 250Ω Coil, sec. hand... 8/6
1M, 1 Amp, 650Ω Coil, brand new... 10/6
3M + 1B, 1 Amp, 880Ω, brand new... 12/6

MINIATURE PANEL MOUNTED METERS
1 1/2in. Round Flush General Electric Meters, available in the following ranges: 1mA 25/-; 25mA 20/-; 75mA 20/-; 100mA 20/-; 150mA 20/-.

Unless stated otherwise, please add 2/6 in the £ to cover postage and packing, subject to a minimum of 1/6.

Amateur or Professional

it pays to have qualifications. Let us tell you what Britain's oldest and most successful radio correspondence school can do for you. We will tell you the facts. No follow-up letters, no high-pressure salesmanship, no callers.

Write for details, today, to:

Mr. J. SYKES

(M.I.E.E., M.Brit.I.R.E., M.I.N.)

Principal:

BRITISH NATIONAL RADIO SCHOOL
Red Lion Court, Stalbridge, Dorset.

Britain's premier Radio Correspondence School specialising in City and Guilds examinations.

RECONDITIONED T.V. SETS

ALL MAKES ★ ALL FULLY SERVICED ★ ALL GUARANTEED ★ NOT EARLY CONVERTED MODELS.

14" from £6.0.0 to £9.0.0
3-month Guarantee on Tube and Valves.

17" from £11.0.0 to £20.0.0
12-month Guarantee on Tube, 3-month on Valves.

WE ALSO STOCK SLIM-LINES
from £23.0.0 to £33.0.0

These sets are as new.

PERSONAL COLLECTION ONLY TO ENSURE SATISFACTION.

REBUILT TV TUBES

All our TV Tubes are reprocessed to a high standard and are covered by a 12 MONTHS' GUARANTEE. Each tube is fitted with a new, top-grade electron gun, which is identical with the original, ensuring exact plug-in replacement.
21", £6. 17", £5.10.0. 12", 14" and 15", £4.10.0
★ Personal collection advised, carriage by arrangement only.
£1 Refunded from the above price if you return your old tube.

PARK LANE RADIO LTD.
548 ROMFORD ROAD, MANOR PARK, E.12
Phone: ILF 6044

SENSATIONAL NEW 1962 DESIGNS — BY CONCORD

LOW PRICES ★ PICTORIAL STEP-BY-STEP PLANS ★ EASY AS A.B.C.

THE NEW "VOLKSRADIO" ONLY 19/6

TAKE-OVER BID MAKES THIS FANTASTIC OFFER POSSIBLE—the beautifully compact "5-STAR VOLKSRADIO" measuring 4 1/2 x 2 1/2 x 1 1/2 in. receives perfectly—in the Bedroom, Office, Garden—over all medium waves (incl. Luxembourg). Under 1d. hour running cost, ANYONE can assemble it in one or two hours using our simple A.B.C. plan. Complete set of parts ONLY 19/6, plus 2/6 P. & P. C.O.D. extra. (Parts can be bought separately). Money Back Guarantee.



NO EARTH OR AERIAL REQUIRED



Revolutionary INTERNAL LARKIE AERIAL Makes this sensational pocket-size radio the best money-saving bargain of all time. Powerful, superb tone and clarity, ensures perfect reception for all your favourite programmes

Completely portable, only 5 1/2 x 3 x 1 1/2 in. Two-tone case. Anyone can assemble with our simple PRINTED CIRCUIT PLAN. Send 37/6, plus 2/6 P. & P. (C.O.D. 2/- extra. Satisfaction guaranteed. (All parts available separately). **FREE HIGH SENSITIVITY HIDE-AWAY EAR-PIECE GIVEN WITH EACH SET.**

"OUR NEW 4-STAGE MINUETTE"

Build this newly-designed "MINUETTE" 4-STAGE transistor set in very strong ready drilled ULTRA-MODERN CASE, size only 6 x 3 1/2 x 1 1/2 in. Uses three transistors and diodes and **CONTAINED LOUDSPEAKER**. Very sensitive, ideal for office, bedroom, holidays, etc. Months and months of listening off an 8d. battery. Can be built FOR ONLY 39/6, including PROPER CASE, miniature speaker, etc. SIMPLE AS A.B.C. PICTORIAL STEP-BY-STEP PLANS etc., plus post and packing 1/8 (C.O.D. 2/- extra). Parts sold separately, priced parts list 1/-.

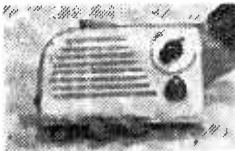

THE MINUTE TRANSISTOR RADIO

MIAMI ONLY 19/6

Unbelievably small—Outrageously cheap. You will be amazed at the fine quality of tone and volume of this great little radio. Only a fantastic 34 x 2 1/2 x 1 1/2 in. the MIAMI will bring you great entertainment for months on an 8d. battery. Simple assembly plan with each set. ONLY 19/6. YES 19/6!

Plus 2/6 P. & P. (C.O.D. 2/- extra). Satisfaction Guaranteed. Demonstrations given daily. Parts available separately if required.

THE NEW "COSTA BRAVA" 49/6



NO EARTH or AERIAL REQUIRED ALL TRANSISTOR RADIO

Revolutionary INTERNAL FERRITE AERIAL and moving coil speaker makes this sensational pocket-size radio the best money-saving bargain of all time. Powerful, superb tone and clarity, ensures perfect reception for all your favourite programmes. Completely portable, only 5 1/2 x 3 x 1 1/2 in. Two-tone case. Anyone can assemble with our simple PRINTED CIRCUIT PLAN. Send 49/6, plus 2/6 P. & P. (C.O.D. 2/- extra). Satisfaction Guaranteed. (All parts available separately). **FREE HIGH SENSITIVITY HIDE-AWAY EAR-PIECE GIVEN WITH EACH SET.**

THE NEW "LISBON" TRANSISTOR SET 19/6

This is a pocket 2-stage transistor set not much larger than a matchbox. Excellent clear reception covering all of a tiny 14 or 3 volt battery costing only 3d. Easy to build and an excellent introduction to transistor circuitry. Everything can be slipped down to the last nut and bolt incl. **PICTORIAL STEP-BY-STEP PLANS FOR ONLY 19/6**, plus post and packing 1/8. (C.O.D. 2/- extra). Parts sold separately, priced parts list 1/-.

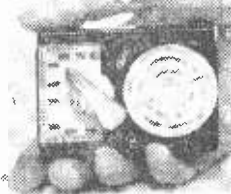

THE RINGO BURGLAR ALARM CLEARANCE SALE!

BIG PROFITS FOR YOU IF YOU BUY NOW! Made to retail at 7 gns, you can now buy this famous Twin-gong Alarm for only 37/6—but only if you act now... stocks are strictly limited. Easily installed and operated. Switches on or off at any time. Fantastic FINAL reduction to clear 37/6 (minimum order of 3) Carr. Free. Free literature sent with each alarm.



SELL SAFELY TO THE MOTORIST

Bulk purchase of bankrupt stock ensures this fabulous money-making offer.

AUTOMATIC CIGARETTE LIGHTER instantly provides ready lit cigarette, without the driver taking his eyes from the road. Heavily chromium plated case holds 10. Easily and simply fitted to any car's dashboard. Works off 6 or 12 volts. Retail Price 44/6. Special Clearance offer only 12/6 each. sold in minimum lots of 6. Carriage free.



THE NEW "SAN REMO" 6 STAR 32/6

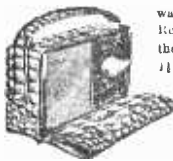

This All Transistor Speaker Radio—The "San Remo" 6 Star covers all medium waves including "Home," "Light," etc. Reliable and lightweight—Slips easily into the Pocket or Handbag—size only 4 1/2 x 2 1/2 x 1 1/2 in. Works for Months of 8d. Battery! Ideal for holidays, Camping, Bedroom, etc. Anyone can assemble it in an hour or two with our simple-as-ABC PLAN! Complete set of parts including miniature speaker—everything—only 32/6, plus 2/6

P. & P. (C.O.D. 2/- extra). Parts can be bought separately.

Cheques accepted. Cash on delivery 2/- extra. Please print name and address in block letters. Suppliers to Schools, Universities, Government and Research Establishments. Complete range of components and values stocked. Regret no C.O.D. abroad. DEMONSTRATIONS DAILY AT WORKS.

CONCORD ELECTRONICS

(DEPT. 14/8) 210 CHURCH ROAD, HOVE, SUSSEX

CABINET HANDBOOK

By G. A. Briggs

Price only **7/6** (8/6 Post free)

112 pages
90 illustrations
Fine art paper
Stiff back



In addition to practical advice on woodworking, veneering, polishing, mesh fittings, etc., this book contains designs for 16 cabinets and baffles, with special attention to compact enclosures, polystyrene diaphragms and also acoustic principles in general.

Other books by G. A. Briggs

AUDIO BIOGRAPHIES

With contributions by 64 collaborators.

344 pages, 112 illustrations, 19/6 (20/9 post free).

A to Z in AUDIO

224 pages, 160 illustrations, 15/6 (16/6 post free).

STEREO HANDBOOK

146 pages, 88 illustrations, 10/6 (11/6 post free).

LOUDSPEAKERS 5th Ed.

336 pages, 230 illustrations, 19/6 (20/9 post free).

SOUND PRODUCTION 3rd Ed.

368 pages, 315 illustrations, 17/6 (18/9 post free).

PIANOS, PIANISTS & SONICS

190 pages, 102 illustrations, 10/6 (11/6 post free).

The above books are sold by many radio dealers and bookshops. In case of difficulty direct from



IDLE, BRADFORD, YORKSHIRE
Tel. Idle 1235/6
Grams 'Wharfedale' Idle, Bradford

Lyons Radio Ltd

3 Goldhawk Road,
Shepherds Bush, London W.12
Telephone: SHEpherds Bush 1729

RECTIFIERS. Full wave bridge type for outputs up to 12v. D.C. 1 amp size, 5/3. 2 Amp. 8/0. 4 Amp. 12/6. 6 Amp. 15/6. P.P. see below.

TRANSFORMERS. Pri. 200/250v. A.C. mains. Sec. tapped 3 $\frac{1}{2}$, 9 and 17v. for producing 2, 6 or 12v. D.C. respectively when used in conjunction with above rectifiers. 1 Amp size, 11/3. 2 Amp. 15/6. 4 Amp. 18/6. 6 Amp (tapped 9 and 17v.), 26/- . Postage (up to 10/6). 2/- over 3/- . Wiring diagram supplied.

"PROGRESSIVE" SHORT WAVE RECEIVER. Specially designed kits employing plug-in coils with exceptionally clear wiring diagrams and instructions which enable even the beginner to construct a one valve short wave radio to which a second and then a third valve can be added. The chassis supplied is already punched to take all three stages. Can be operated from dry batteries or from a simply constructed mains power unit, price 32/6. Cost of all parts to build a one valve radio, including one coil 40/100 metres, only 35/- . Post 2/- . 2 Valve Conversion Kit, only 7/6. 3 valve Conversion Kit, only 10/- . Extra plug-in coils to cover. 10-20, 20-40, 100-200, 200-450 metres, 4/- each. High resistance headphones, 10/6 pair, and if supplied separately, 1/6 postage. Plans supplied separately 1/9. credited if kit ordered.

MORSE PRACTICE KITS. Comprising carbon mike insert, earphone, morse key, battery and wire. When these components are correctly connected together, full details are provided, a loud high pitched realistic note is produced ideal for the learner. Price per kit ONLY 8/6. postage 1/6. "Learning Morse" publication, price 1/6, post free with kit or separately, post 4d.

H.P. MOTORS. 200/250v. A.C. mains, new unused spindle 2 x lin. dia., 1440 r.p.m.. **BARGAIN PRICE ONLY 75/-**, carriage 7/6

NEW VALVES !

Guaranteed Set Tested
24-HOUR SERVICE

1R5, 1S5, 1T4, 3B4, 3V4, DAF91, DF91, DK91, DL32, DL64, SET of 4, 18/6.
DAF96, DF96, DK96, DL36, SET of 4, 26/-

| | | | | | |
|--------|------|-------|------|--------|------|
| 1D5 | 7/- | DL35 | 9/6 | PCP80 | 9/6 |
| 1R5 | 5/6 | DL92 | 5/11 | PCP82 | 7/6 |
| 1S5 | 4/6 | DL91 | 6/9 | PCL82 | 8/3 |
| 1T4 | 3/3 | DL96 | 6/9 | PCL83 | 10/- |
| 3B4 | 5/11 | EB31 | 3/- | PCL84 | 9/6 |
| 3V4 | 6/9 | EBC41 | 7/9 | PL18 | 9/6 |
| 5U4G | 4/6 | EBF80 | 7/9 | PL1 | 8/6 |
| 5Y3GT | 5/9 | EEL21 | 12/- | PL82 | 6/6 |
| 5Z4G | 8/6 | ECC30 | 13/- | PL83 | 6/6 |
| 6AM6 | 2/9 | ECC31 | 4/9 | PL84 | 8/6 |
| 6K7G | 1/9 | ECC82 | 5/9 | PY32 | 11/- |
| 6K8G | 4/9 | ECC83 | 6/3 | PY80 | 7/- |
| 6Q7G | 5/6 | ECC84 | 7/3 | PY81 | 6/6 |
| 6V6G | 4/- | ECC85 | 7/6 | PY82 | 6/- |
| 6V8GT | 7/9 | ECC86 | 7/9 | PY83 | 7/3 |
| 6X5GT | 6/6 | ECP82 | 8/3 | U25 | 11/- |
| 12K7GT | 4/3 | ECH42 | 7/9 | U26 | 8/9 |
| 12K8GT | 9/- | ECL80 | 5/9 | UABC80 | 6/- |
| 12X7GT | 4/6 | EF40 | 11/- | UAF42 | 8/- |
| 12S8GT | 7/3 | EF41 | 7/6 | UBC80 | 7/- |
| 35L8GT | 8/- | EF80 | 4/6 | UBC81 | 7/6 |
| 35Z4GT | 5/- | EF85 | 6/6 | UC85 | 7/- |
| AZ31 | 8/9 | EF86 | 8/6 | UCH21 | 11/6 |
| CL33 | 11/- | EF89 | 6/9 | UCH42 | 7/6 |
| DAC32 | 8/9 | EF91 | 8/9 | UCB81 | 8/9 |
| DAF91 | 4/6 | EL41 | 6/6 | UCL82 | 9/3 |
| DAF96 | 6/9 | EL84 | 6/3 | UCL83 | 13/- |
| DF33 | 8/9 | EY51 | 7/3 | UP41 | 6/9 |
| DF91 | 3/3 | EY86 | 7/6 | UP89 | 6/9 |
| DP96 | 6/9 | EZ40 | 6/- | UL41 | 8/- |
| DH77 | 6/- | EZ41 | 7/6 | UL84 | 6/6 |
| DK32 | 10/6 | EZ80 | 5/9 | UY21 | 10/6 |
| DK91 | 5/6 | EZ81 | 6/- | UY41 | 5/6 |
| DK96 | 7/3 | MU14 | 5/6 | UY85 | 6/3 |
| DL33 | 7/6 | PCC84 | 6/3 | YF4B | 8/6 |
| | | PCC89 | 9/- | Z77 | 2/9 |

Postage 6d. per valve extra. Any Parcel Insured Against Damage in Transit 6d. extra. Any C.O.D. Parcel 3/- extra. Office address, no callers.

GERALD BERNARD
(Note new address—formerly of Leeds)
83 OSBALDESTON ROAD,
STOKE NEWINGTON, LONDON, N.16

NOW ANYONE CAN AFFORD TO TRAIN TO BE AN EXPERT IN RADIO and ELECTRONICS

EVEN QUALIFY FOR A CERTIFICATE

It's the most exciting news of the year! Just imagine! You can get 35 large, fact-packed lessons for little more than 1/- per lesson! The lessons are crystal clear, practical, easy to master and use. Early lessons make fundamentals clear even to the beginner, while other lessons will give you the practical "know-how" of an expert.

Compares favourably with some courses costing ten times as much. You save because you receive all the lessons at one time and are not required to purchase equipment you do not need.

This is a real home-study course that has been bound into one giant 8 x 11 in. 216 page manual. Each page is divided into two columns. A wide column features the text, while a narrow column at the side has the instructor's comments, helpful suggestions and additional pictures to simplify the difficult parts.

Everyone can benefit from this practical course. No old-fashioned (or pseudo-modern) methods used here, just straightforward, easy to understand explanations to help you make more money in electronics.

As an optional extra, you may pay a further fee if you wish to take the Sim-Tech radio and electronics examination. Students who attain a minimum of 80% correct answers can qualify for a certificate of proficiency in basic radio and electronics. Details sent with each course ordered.

You must be convinced that this is the best value you have ever seen in electronic training, otherwise you can return the manual (or have your money refunded if sent with order) after you have examined it in your own home for a period of seven days.

The price? Only 36/-, plus postage.

FREE TRIAL OFFER!

To SIM-TECH TECHNICAL BOOKS, Dept WA5, Gater's Mill, West End, Southampton, Hants.

- RUSH Radio and Electronics Course for seven days examination. If I keep the course I can either pay 37/6 l. cash or 12/6 l. deposit after seven days and two payments of 12/6 l. monthly. Otherwise I will return the course post-paid and owe nothing.
- SAVE! Send only 36/- if paying cash with order. (We pay postage.) Same 7-day-money-back guarantee.

Name _____
Address _____
City _____ County _____

The 'NORPAK'
MAINS POWER PACK
KIT

FOR TRANSISTOR
RADIOS
Boosts and greatly extends life of old batteries. Miniature Size—4 x 2 x 1 1/2 in. In attractive two-tone plastic case. Assembled in an hour. Normal output 9 v. 100 mA. (Adjustable) Full Mains Transformer. Full wave germanium diodes. Cartridge use. Complete Kit with Plans

35/- Plus 1/6 P.P.

(Ready assembled 45/-).

Telescopic Aerials, 5ft. to 30in., 15/6, P.P. 6d. 12in. to 46in., 12/6, P.P. 6d.

Personal Earpieces with Plug and Socket. High Imp., 9/-, Low Imp., 8/-.

Saax Battery Turntable with Crystal P.U., 6v., 54/-.

2 Speed Model, 97/6, P.P. 2/-.

60W Soldering Irons, 15/6, P.P. 1/6.

Carbon Pots, 2/9, P.P. 6d.

2M., 500K., 250K., 200K., 100K., 100Ω.

Speakers and complete range of first grade miniature components for most P.W. designs.

P.W. 'MERCURY' 6
PRINTED CIRCUIT VERSION



£9.17.6

Plus 2/6 P.P.

All parts required

This exciting new Transistor Superhet gives superb performance on a 7 x 4in. speaker housed in attractive two-tone cabinet with ferrite aerial.

For both of these fine kits every item down to the last nut and bolt is supplied together with detailed building plans. All parts sold separately. Send 1/6 (2/6 Mercury) for Building Plans (Free with Kit).

PAY AS YOU BUILD SCHEME

AT NO EXTRA COST the above sets may be bought in 3 complete stages of 53/2 ("P.W." 6) or 65/10 ("Mercury" 6) each plus 1/6 P.P. (stato A, B, or C).

ALIGNMENT SERVICE

WE OFFER a very comprehensive service for both the above versions purchased from us, including Fault Finding, at reasonable charges. (write for details).

TERRIFIC VOLUME !!

WITH THE

P.W. ε-TRANSISTOR

Medium and Long Wave Pocket Superhet

THE CONTINUED POPULARITY OF THIS FAMOUS SET IS PROOF OF ITS VERY HIGH QUALITY AND FINE PERFORMANCE

- 450 mW Push-Pull Output on 2 1/2in. P.M. Speaker.
- Printed Circuit.
- Guaranteed first grade Miniature Components.
- High Q Internal Ferrite Rod Aerial.

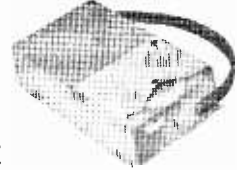

All parts required

£7.19.6

Plus 2/- P.P.

NORCOL LTD

147 LONDON RD., YORKTOWN, CAMBERLEY, SURREY

Phone: CAMBERLEY 22760

AVO METERS

MODEL 7 £11.0.0. MODEL 7 Mark II £12.0.0.

Guaranteed perfect. With leads and batteries. Registered P. & P. 5/- extra. Solid leather carrying case £1 extra.

SPECIAL OFFER! COSSOR DOUBLE BEAM OSCILLOSCOPE TYPE 339A

A.C. mains operation. Screen dia. 4in. Time base range 8 c/s—250 Kc/s. 2 amplifiers with max. sensitivity of 1.3mV/mm. Size 13 1/2 x 8 1/2 x 18 1/2 in. Controls:—Brilliance, Focus, X shift, Y1 shift, Y2 shift, Time base coarse, Time base fine, Amplitude, Trigger A1 gain, A2 gain, and Sync. In very good condition and working order. £8.19.6. Carr. and packing £1.

SPECIAL RECTIFIERS. Type 1E2 (4 x 1in.) will handle 50 volts at up to 50 mA. Replaces any TV metal rectifier. 8/6.

H.F.O. RECEIVERS—SENIOR MODEL M.N. Complete with 9 coils from 50 Kc/s—30 Mc/s. A superb communications receiver. Guaranteed in brand new condition. £25, carr. 30/-.

POWER UNIT 50/6, extra carr. 5/6.

H107 RECEIVERS, 1. Mc/s—17.5 Mc/s continuously. 3 wave bands. Self contained with speaker and power unit for A.C. mains and 12 v. battery operation. Brand new £15, Carr. 90/-.

PCR COMMUNICATIONS RECEIVER
Type PCR-1. Has self-contained speaker. Covers 250-2000, 200-550 and 18-50 metres. AS NEW CONDITION. £8.19.6.
Type PCR-2. Requires external speaker. Covers 850-2000, 200-500 and 13-60 metres. USED (Good condition). £5.19.6
Carriage (any type) 10/6. Full details S.A.E. Any model fitted with BRAND NEW INTERNAL POWER SUPPLY, guaranteed ready for use on A.C. mains. £2 extra.

Moving Coil Phones. Finest quality Canadian, with Chamois ear muffs and leather-covered headbands. With lead and 'ack' 1/c. Noise excluding, supremely comfortable, 10/6, post 1/c.

WESTON ANALYSER MODEL 772 TYPE 6 (U.S.A.). A.C./D.C. VOLTS 0-2.5, 10, 50, 250, & 1000. D.C. CURRENT 0-100μA, 1mA, 10mA, 50mA, 250mA, 1A, & 10A. OHMS 0-30MΩ (in 4 ranges). SENSITIVITY 20,000Ω/volt or 1000Ω/volt by selector switch. Provision for use as output meter (dB). In handsome oak carrying case 14 1/2 x 8 1/2 x 5 1/2 in. Complete with leads, batteries and instructions. FULLY GUARANTEED £ 10.0.0. P. & P. 5/-.

CHARLES BRITAIN (RADIO) LTD.

11 Upper Saint Martins Lane, London, W.C.2
TEmple Bar 0545. Shop Hours 9-8 p.m. (9-1 p.m. Thursday)
Open all day Saturday.

ERSIN MULTICORE SOLDERS

for a first class joint every time

Ersin Multicore contains 5 cores of extra-active, non-corrosive Ersin Flux. Prevents oxidation and cleans surface oxides.

SIZE 1 CARTON
5/-



HANDYMAN'S
CARTON

Suitable for 200 average joints. 6d.

HOME CONSTRUCTORS
2/6 PACK

In addition to the well-known Home Constructors Pack (containing 16ft. of 18 s.w.g. 60/40 alloys) a similar pack is now available containing 35ft. of 22 s.w.g. 60/40 alloy especially suitable for printed circuits.



Wherever precision soldering is essential, manufacturers, engineers and handymen rely on MULTICORE. There's a MULTICORE SOLDER just made for the job you have in hand. Here are some of them.

SAVBIT TYPE 1 ALLOY

A specially formulated alloy to reduce the wear of soldering iron bits. Contains cores of non-corrosive Ersin Flux and is ideal for all soldering purposes.



SIZE 1 CARTON 5/-

Available in three specifications.

BIB WIRE STRIPPER AND CUTTER

Strips insulation without nicking wire. Cuts wire cleanly, splits extruding flex. 3/8 each



MULTICORE SOLDERS LTD.,

MULTICORE WORKS, HEMEL HEMPSTEAD, HERTS. (BOXMOOR 5650)



*The PUNCH
you need!*

HOLE PUNCHES

| | | | |
|--------------------------------|----------|-----|-----------|
| Instant Type 3/8" diameter | ... | ... | 5/6 ea. |
| Screw-up Type 1/2" diameter | ... | ... | 6/8 ea. |
| " | B7G | ... | 7/2 " |
| " | B8A, B9A | ... | 7/8 " |
| " | ... | ... | 8/3 " |
| " | ... | ... | 8/7 " |
| " | ... | ... | 9/6 " |
| Postage and packing 1/4 | | | |
| 1" diameter Int. Octal | ... | ... | 10/11 ea. |
| " | ... | ... | 13/3 " |
| " | ... | ... | 15/6 " |
| " | B9G | ... | 17/11 " |
| " | ... | ... | 20/4 " |
| " | Meter | ... | 27/8 " |
| Postage and packing 2/3 | | | |

Complete set including postage and packing, £7.10.0

We regret all prices will be increased from 1st January 1963

Oliver & Randall Ltd
Dept. 7
40 PERRY HILL, LONDON, S.E.6
Tel.: Forest Hill 3415

CABINETS & HI-FI EQUIPMENT

We can supply any cabinet to your own specification

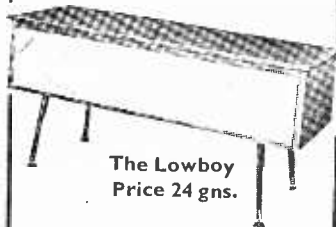

**The Lowboy
Price 24 gns.**

This is only one example of—
**THE LARGEST RANGE OF CABINETS
IN THE COUNTRY**
Equipment is also our speciality.
**SEND TODAY FOR THE TWO
NEW LEWIS CATALOGUES**
Designed to assist your choice of cabinet and equipment.
THE New Lewis Radio Cabinet Catalogue—the most comprehensive ever prepared. THE unique 64 page equipment catalogue.
Please send your two new catalogues enclosed is P.O. for 3/6 which will be credited against any purchase I make.

LEWIS radio

100 (P112) Chase Side, Southgate, London, N.14. Pal 3733/9666

**The SAVOY SUPER-3
3-TRANSISTOR
POCKET RADIO**

with miniature loudspeaker
No SOLDERING No DRILLING



3 transistors and 2 diodes. Full medium wave coverage. Size 4 1/2" x 2 1/2" x 1 1/2". Full instructions provided.

47/- Battery 1/-
P. & P. 2/- extra

All parts sold separately

or SAVOY-4 with 4 transistors

and 2 diodes. in 5 stage reflex circuit. Size 3 1/2" x 3" x 1 1/2". **75/-**

Battery 2/3. P. & P. 2/9 extra.

SAVOY ELECTRONICS LTD

15 Maiden Lane, Strand, London, W.C.2.
(Behind the Adelphi Theatre).

**THE AMATEUR RADIO
HANDBOOK 1962**

by R.S.G.B., new edition, 34/-, postage 2/6

Radio Engineers' Pocket Book, new edition, by Hawker, 10/6, postage 8d.

Elements of Electronic Circuits by Peters, 21/-, postage 1/-.

How To Listen To The World by Johansen 12/6, postage 8d.

The Loudspeaker Guide by Borwick, 7/6, postage 8d.

Modern Transistor Circuits for Beginners by Sinclair, 7/6, postage 6d.

Radio Controlled Models by Warring, 16/-, postage 1/-.

Electronic Music and Musique Concrete by Judd, 16/-, postage 1/-.

The Hi-Fi Year Book 1962, 10/6, postage 1/-.

UNIVERSAL BOOK CO.

12 Little Newport Street, London, W.C.2.
(adjoining Lisie Street)

Portable Transistor Kit, £5.17.6, (post 3/6). M. & L. Waves, no aerial required, no difficult aligning, simple to follow instructions. If you have been disappointed with other Kits, try ours. We were amongst the first to advertise Transistor circuits in P.W. and we can recommend this set with confidence. Pocket Kit with personal earphone, 65/-, (post 2/-).

Red Spot Transistors 2/3, White Spots 2/3, Yell. Green 3/-, Mullard OC71, 6/-; OC72, 7/6; OC44, 7/6; OC45, 7/6. Sets of 6 for superhets Mullard 40/-; our selection 30/-. Newmarket V15/10P, 15/-; Silicon Rectifiers 70 p.v. 1/2 amp., 3/3; 400 p.v. 1/2 amp., 3/9. Sub-min Electrolytics 2, 4, 8, 10, 16, 32, 50µF 2/-; 100µF, 2/9; 250, 500, 1,000µF, 3/3. Transistor Holders 1/-; Super Coax. 75 ohms., 6d, yd. Tannoy Mike, 3/6 (post 2/-); Crystal Inserts new 7/6. Gortler Units—the amazing 1 watt amplifier 92/6; i.F. Amplifier (460 Kc/s pre-aligned), 92/6; 3 waveband converter 90/3; Manual No. 167 describing and circuits, 2/9 post free.

TERMS: C.W.O. Post extra, excess refunded. Send 10d. stamps for Transistor Notes.

MOORE'S EXPERIMENTAL SUPPLIES
(Dept. P)
8 & 10 Granville Street, Sheffield 2

2 METRES!

The thrills of 144 Mc/s can now be yours for only 39/6, complete kit! Tunable range 150-100 Mc/s, simplified construction, etc., write today for descriptive literature, also if a newcomer-beginner to Amateur Radio ask for free copy of the world-famous "Globe-King" kits and receivers—stamp to cover postage costs appreciated. Write now to makers:

JOHNSONS (Radio)
St. Martins Gate, Worcester

18,000 O.P.V. MULTIMETER KIT

Ranges 0-0.25 and 2.5V D.C.; 10, 25, 100, 250, 500, 1000V A.C., D.C. and output volts; 100 ohms to 10 Meg. (2 ranges); 0.25, 2.5, 25, 250 mA D.C. (2.5A range 4/- extra). Kit comprises new 3 x 2 1/2 in. Weston 0-50µA m.c. meter and all parts except case and battery. Shunts ready adjusted to 1%. High stability 1% multipliers (1% stability as stocks permit). Price 89/-, post free. Circuit multimeter scale, instructions 9d, free with kit.

NOUGHTS AND CROSSES MACHINE

This is a fantastic device which will play a game against you, and NEVER LOSE. It is a thinking machine, with a brain, yet is simple, and costs less than 70/- to build. Full circuit, instructions, and details of £50 REWARD to first person to beat the machine, 3/6.

High Stab. 1% Resistors. All popular values 2/-.

1W 1% and 1% Wirewound Resistors. Your value wound to order.

PLANET INSTRUMENT CO.

25 DOMINION AVENUE, LEEDS 7

RES/CAP. BRIDGE 38/-
p. & p. 2/6

Checks all types of resistors, condensers 6 RANGES

Built in 1 hour. Direct reading

READY CALIBRATED
Stamp for details of this and other kits.

RADIO MAIL (Dept. PE)

Raleigh Mews, Raleigh Street, Nottingham

**SOUTHERN RADIO
SUPPLY LTD.**

11 LITTLE NEWPORT STREET
LONDON W.C.2. GER 6653

All goods still available
as previously advertised

BBC - ITV - F.M. AERIALS

B.B.C. (BAND 1). Telescopic loft, 19/6. External. S/D, 26/3.

I.T.V. (BAND 3). 3 Element loft array, 24/-, 5 Element, 32/6. Wall mounting, 3 Element, 33/9. 5 Element, 41/3.

COMBINED B.B.C. + I.T.V. Loft 1+3 Element, 41/3. 1+5 Element, 48/9. Wall mounting, 1+3 Element, 56/3. 1+5 Element, 63/9. Chimney and mast mounting units also available.

F.M. (BAND 2). Loft "H", 28/-, 3 Element loft, 52/6. S/D loft, 12/6. External S/D, 26/3. State channel when ordering. C.W.O. or C.O.D. P.P. 2/6. Coaxial cable, 8d. yd. Coaxial plugs, 1/3. Send 6d. stamps for illustrated lists.

K.V.A. ELECTRONICS (Dept. P.W.)
3B, Godstone Road, Kenley, Surrey.



TRANSISTOR PORTABLE SIGNAL GENERATOR

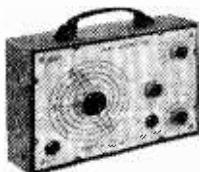

PRICE
£7.10.0
P.P. 2/6

A 1st class Signal Generator covering 200 Kc/s to 200 Mc/s in 8 ranges. Radio broadcasts and I.F., Amateur, V.H.F. Shipping, TV, etc. R.F., I.F., A.F., modulated R.F. outputs. Easy to read and use with full details. Within 2% accuracy. Size 6½ x 4½ x 2in.

12 MONTHS' GUARANTEE

TAPE HEAD

Miniature ½ Track Record/Playback Head with Mouncing Block. 850 ohm.

12/6, P.P. 9d.

TAPE RECORDER MOTOR

Miniature Motor designed for Battery Recorders, 4½ to 9 volts. Built in governor, 12/6, P.P. 1/-.

"TRANSIVE" PORTABLE RADIO



Medium and Long Wave Portable

8½ x 6½ x 3½in.
£5.19.6
P.P. 2/6

A simple to build 5-Transistor and Diode. Printed Circuit, Medium and Long Wave Portable. Features 5in. speaker, Car aerial socket, 1st grade transistors and carded components. Building plans free on request. **THE IDEAL PORTABLE.** Full after sales service and guarantee. (See Back Cover for other types).

TRANSISTOR MEGAPHONE

A new design lightweight megaphone. Ideal for all indoor or outdoor uses. Built-in batteries. Complete with shoulder strap. **£12.10.0** Leaflet on request.

3/4 WATT 4 TRANSISTOR AMPLIFIER



● 1 watt peak output.
± 3dB 70c/s to 12 kc/s.
Output to 3 ohm speaker
9 volt operated.

Built and Tested Kit of Parts
59/6 OR 52/6
P.P. 1/6 P.P. 1/6

Details on request.

A printed circuit high gain amplifier size 4 x 2½ x ¾in. using Mullard OC71/OC81D and 2-OC81 Transistors. Ideal for Intercomm., Record Player, Tuner Amplifier or any application requiring a quality and reliable amplifier.

TRANSISTOR SIGNAL INJECTOR

A new design pocket size tester for fault finding on valve or transistor radios, TV amplifiers, etc. Built-in indicator and batteries with detachable probe. 52/6.

GUITAR CONTACT MICROPHONE. High Impedance Guitar Contact Microphone with screened lead. Plugs into any valve amplifier. Very sensitive. 12/6, P.P. 9d.

TEST LEAD KIT

Complete set of test leads. Suitable for most instruments. Complete with pouch, 8/6, P.P. 1/-.

POCKET RADIO BOOSTER

Tubular unit, size 9½ x 3½in. dia., which plugs into earphone socket of any transistor radio. Performance increase is fantastic. Ideal for home or car. 52/6, P.P. 1/6.

PERSONAL EARPHONES

★ 600 ohm. 10/6 ★ Crystal 9/6
★ 1,000 ohm. 12/6 ★ 8/10 ohm. 9/6
Fitted leads, Jack Plug and Socket.

SOLDERING IRON

Autex miniature 15 watt 220/250 volt Iron. Easily removed ½in. bit. Ideal for all miniature work. 29/6. Spare bits, five sizes to ¼in.. 3/- each.

| | | |
|---------|-----------------|------|
| CRYSTAL | ACOS 2in. | 10/6 |
| MIC. | ACOS 1½in. | 7/6 |
| INSERTS | ¾in. sq. | 3/6 |

TYPE 3B, TRANSMITTER RECEIVER

Complete with 5 valves. In new condition. These sets are sold without guarantee but are service-able. 7.4 to 9 Mc/s. **22/6** P.P. 2/6
Headphones 7/6 pair. Junction Box 2/6. Throat Mike 4/6. Aerial Rod 2/6.

TELEPHONE ADAPTOR

★ Ideal for recording or amplifying telephone conversations. Supplied with screened cable. Fitted rubber sucker, 14/-.

MARCONI 19 SET CRYSTAL CONTROLLED CAL'BRATOR

Crystal controlled oscillators giving either 10 kc/s, 100 kc/s or 1 Mc/s pips. Features neon modulator, supplied with spare valves and full handbook. **79/6** P.P. 2/-.
Ideal standard frequency check.

TRANSISTOR PORTABLE TAPE RECORDER

★ New 4-Transistor Version ★

- Play/record up to 30 min.
- Built-in speaker, volume control batteries and play/record rewind.
- Quality reproduction.
- Sturdy case 6 x 8½ x 2½in.

£10.10.0
P.P. 5/-



Fully Guaranteed
Supplied complete with microphone, tape, batteries and personal phone (for monitoring), and full instructions. New 4-transistor version with push-pull output, better quality, more attractive case, etc.

The Above are FULLY ASSEMBLED TESTED and GUARANTEED.

4 TRANSISTOR PUSH-PULL AUDIO AMPLIFIER

MODEL PK-5 3



Size
3 x 1" x ¾in.

A ready built miniature 250mW push-pull amplifier incorporating input and output transformers, 4 transistors, 9 volt battery snap cord, speaker and volume connection leads. Ideal for use with record players, intercoms, hearing aids, tape recorders, etc. Complete with full instructions and circuit diagram.

PRICE **52/6** P.P. 1/6
SUITABLE 2½in. SPEAKER 16/6.

BATTERY RECORD PLAYER



● 6-7½ volt Garrard turntable with crystal pick-up. Plays 45 r.p.m. Ideal for above amplifier.

55/- P.P. 1/6.

○ Suitable cabinet for amplifier and player, 17/6, P.P. 2/-.

LIGHTWEIGHT HEADPHONES



★ 2000 OHMS
12/6

★ 4000 OHMS
14/6

HIGH EFFICIENCY.

MINIATURE CLEAR FACED Brand New PANEL METERS

| | | |
|----------------|-----------|------|
| 0-50 microamp | DC | 39/6 |
| 0-500 " | DC | 32/6 |
| 0-1 milliamp | DC | 27/6 |
| 0-5 " | DC | 27/6 |
| 0-300 volts | DC | 27/6 |
| "SI" meter 1mA | | 35/- |
| "VU" meter | | 42/6 |

Fully Guaranteed

CRYSTAL MICROPHONES

ACOS 39-1. Stick Microphone with screened cable and stand (list 5 guns), 32/6, P.P. 1/6.
ACOS 40. Desk Microphone with screened cable and built-in stand (list 50/-), 15/-, P.P. 1/6.
ACOS 45. Hand Microphone with screened lead, very sensitive, 25/-, P.P. 1/6.
100 C. Stick Microphone with muting switch and screened cable, detachable desk stand, cord and neck, 39/6, P.P. 1/6.
MC 24. Stick Microphone with muting switch and cable, 25/-, P.P. 1/6.
LAPEL. Miniature Mic. With clip. Ideal for recording, 15/-, P.P. 1/-.

Henry's Radio Ltd

PADdington 1008/9

5 HARROW ROAD, LONDON W2

Open Monday to Sat. 9-6, Thurs. 1 o'clock

TRADE SUPPLIED

PLEASE TURN TO BACK PAGE



ALL TRANSISTOR BABY OR INVALID ALARM

HOUSED IN ATTRACTIVE GOLD HAMMER FINISH PORTABLE CABINET. Battery operated, push-pull, 400MW output. Low impedance microphone enables unit to be used up to 200 yards. Output on quality speaker.

- ★ GUARANTEED for 12 MONTHS and 100% SAFE
- ★ MICROPHONE is placed within 10ft. of baby; twin flex is taken to amplifier unit and placed in any room required. COMPLETELY BUILT & TESTED. P.P. 2/6. **£5.10.0**
- ★ Used All Night, Every Night. Battery Life 3 to 4 months.



MODEL TH-L33

2,000 ohms per volt AC/DC. Size 5 x 3½ x 1½ in.

75/- Fully Guaranteed with test leads, battery and instructions.

0/10/50/250/500/1000 volts D.C., 0/10/50/250/500/1000 volts A.C., 0/500µA/10/250mA, D.C.

3 ranges resistance 0/10K/100K/1 Meg. Capacity and dB ranges.



MODEL 500

30,000 ohms per volt multi-meter

£8.19.6

Fully Guaranteed

- 8 Ranges D.C. volts to 1 kV.
- 7 Ranges A.C. volts to 1 kV.
- 5 Ranges D.C. current to 12 amps.
- 3 Range resistance to 60 meg.
- Short circuit, Buzz test. Output meter dB, etc., etc. Size 6½ x 4½ x 2½ in. With Leads, Batteries and Instructions.



MODEL TP55

A.C./D.C. voltage up to 1,000 in 5 ranges. D.C. current 4 ranges up to 500mA. 4 range resistance to 10 megs. Capacity dB scales, etc. 20,000 ohms/volt Fully Guaranteed

£5.19.6

With Test Leads, Battery and Instructions. Size 5½ x 3½ x 1½ in.

TRANSISTORS

1st GRADE FULLY GUARANTEED

| | | | | |
|-------|-----|-------------|---------|------|
| XAI01 | 5/- | NPN types | XC101 | 6/- |
| XAI02 | 6/- | XA701 9/- | XC121 | 6/- |
| | | XA702 17/6 | | |
| XAI03 | 4/- | XA703 25/- | XC131 | 10/- |
| XAI04 | 4/- | Power types | (Pairs) | |
| | | XC141 12/6 | XC171 | 10/- |
| XB102 | 4/- | Pairs | XC163 | 7/- |
| XB112 | 4/- | 11 w 27/6 | XS104 | 7/6 |
| XB113 | 4/6 | XC156 22/6 | XS101 | 10/- |
| XB121 | 8/6 | 50 w 50/- | XC703 | 35/- |

Complete range of over 400 Transistors and Diodes now available. Latest list on request.

SPECIAL—Very Low Prices for Matched Sets from 29/6 to 32/6.

PRACTICAL TRANSISTOR CIRCUITS 3/6 (Post Free)

Contains easy to follow plan of 40 all transistor units, including light operated switches, amplifiers, transmitters, receivers, test oscillators, signal tracers, hearing aids, radio control, etc. All parts available separately.

STEREO AMPLIFIER

4-Valve Amplifier with 2 watts output per channel to 30 ohms. Ready built, complete with Dials, Sockets and Knobs. Full tone, volume and balance controls. Crystal Input. 220/250 volt mains input. Fully Guaranteed **79/6** PP. 2/-

GEIGER MULLER TUBES

Mullard Type MX115, 400 volts. Gamma sensitive type. 22/6. P.P. 1/6.

BATTERY ELIMINATOR AND CHARGER

Replaces PP3 or T6003 9 volt batteries to run transistor radios from mains. Also charges to give 5 times normal battery life. Fitted neon indicator and supplied with full details. 29/6. P.P. 1/6.

OFFICE, WORKS or HOME USE

COMPLETE INTERCOMM. SYSTEMS

★ 2-transistor transformer coupled, two speakers in moulded cabinets. Features 2-way Buzzer system and talking. Supplied complete with cable **89/6** P.P. 1/6

★ 4-transistor de luxe version, with 2-way calling and talking. Moulded cabinets, long battery life—very sensitive. With cable and **£8.8.0** P.P. 2/- batteries.

STEREO PHONES

New stethoscope type stereo earphones with adjustable tubes. Fitted miniature jack plugs and leads. 2 x 8 ohms impedance, 27/6.

Henry's Radio Ltd

PADddington 1003/9

5 HARROW ROAD, LONDON W2

Open Monday to Sat. 9-6, Thurs. 1 o'clock
Send 1/- Stamp for Latest Catalogue and Lists.

PLEASE TURN PAGE— BOTH WAYS!

ALL-TRANSISTOR

TIME SAVER

OFFICE OR HOME TELEPHONE PICK-UP AMPLIFIER

★ No more "holding on" wasting time waiting for your call to come through. When it does the amplifier can be switched off if required. No connections, just press the pick-up coil to back of phone as below. Fully Guaranteed. Housed in attractive Gold Finish Cabinet.

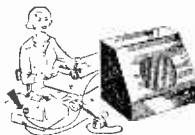

BUILT, TESTED, READY TO USE

£5.10.0

P.P. 2/6

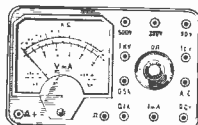

MODEL PT34

SIZE: 3½ x 2½ x 1½ in.

1,000 ohms per volt

49/6 Fully Guaranteed

0/10/50/250/500/1000 volts on A.C. and D.C.

0/1/100 mA. 0/500 mA D.C. 0/100k ohm resistance.

Complete with Leads, Battery and Instructions.

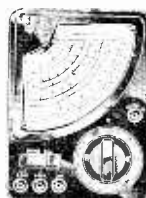

MODEL ITI (200H)

20,000 ohms per volt.

£5.5.0

With Test Leads, Battery and Instructions.

- 6 Ranges D.C. voltage to 2½ kV.
- 5 Ranges A.C. voltage to 1 kV.
- 3 Ranges D.C. current to 250 mA.
- Resistance to 6 meg.
- Capacity and dB ranges.

AVO-7

Famous Multi-meter, reconditioned and fully guaranteed. Full A.C./D.C. voltage and current, resistance, dB, power, etc., etc.



Supplied with Batteries, Leads and Instructions. (Normal price £19.10.0.)

£11.0.0

Regd. Post 5/-

LEATHER CASES for "AVO-7," 25/- extra.

ALL METERS FULLY GUARANTEED for 6 MONTHS

Practical Wireless

BLUEPRINT

SERVICE

ALL OF these blueprints are drawn full-size and although the issues containing descriptions of these sets are now out of print, constructional details are available free with each blueprint except for the PW Monophonic Electronic Organ and the PW Roadfarer.

The Index letters which precede the Blueprint Number indicate the periodical in which the description appeared. Thus PW refers to PRACTICAL WIRELESS; AW to *Amateur Wireless* and WM to *Wireless Magazine*.

Send (preferably) a postal order to cover the cost of the Blueprint (stamps over 6d. unacceptable) to

PRACTICAL WIRELESS, Blueprint Dept., George Newnes, Ltd., Tower House, Southampton Street, London W.C.2.

SPECIAL NOTE

THE following blueprints include some pre-war designs and are kept in circulation for those constructors who wish to make use of old components which they may have in their spares box. The majority of the components for these receivers are no longer stocked by retailers.

| Title | Number | Price | Title | Number | Price |
|---|--------|-------|--|--------|-------|
| CRYSTAL SETS | | | A.C. Fury Four | PW20 | 2/6 |
| Junior Crystal Set | PW94 | 2/- | Experimenter's Short Wave | PW30a | 2/6 |
| Dual-wave Crystal Diode | PW95 | 2/6 | Midget Short Wave Two | PW38a | 2/6 |
| STRAIGHT SETS | | | Band-Spread Three (Battery) | PW68 | 2/6 |
| Battery Operated | | | Crystal Receiver | PW71 | 2/- |
| Modern One-valver | PW96 | 2/6 | Signet Two (Battery) | PW76 | 2/6 |
| All-dry Three | PW97 | 3/6 | Simple S.W. One-valver | PW88 | 2/6 |
| Modern Two-valver | PW98 | 3/6 | Pyramid One-valver | PW93 | 2/6 |
| SUPERHETS | | | BBC Special One-valver | AW387 | 2/6 |
| A.C. Band-pass Three | PW99 | 4/- | A One-Valver for America | AW429 | 2/6 |
| A.C. Coronet-4 | PW100 | 4/- | Short-Wave World Beater | AW436 | 3/6 |
| A.C. D.C. Coronet | PW101 | 4/- | Standard Four Valve S.W. | WM383 | 3/6 |
| The PW Pocket Superhet | — | 5/- | Enthusiast's Power Amplifier | WM387 | 3/6 |
| MISCELLANEOUS | | | Standard Four Valve | WM391 | 3/6 |
| The PW 3-speed Autogram | — | 8/- | Listener's 5-Watt Amplifier | WM392 | 3/6 |
| The PW Monophonic Electronic Organ | — | 8/- | <div style="border: 2px dashed black; padding: 10px;"> <p style="text-align: center;">QUERY COUPON</p> <p>This coupon is available until 7th November, 1962, and must accompany all queries in accordance with the notice on our "Letters to the Editor" page.</p> <p style="text-align: center;">PRACTICAL WIRELESS, NOVEMBER, 1962</p> </div> | | |
| (No constructional details are available with this blueprint) | — | 5/- | | | |
| The PW Roadfarer | — | 5/- | | | |
| (No constructional details are available with this blueprint) | — | — | | | |
| TELEVISION | | | | | |
| The PT Band III converter | — | 1/6 | | | |

Published on the 7th of each month by GEORGE NEWNES, LIMITED, Tower House, Southampton Street, London, W.C.2. and printed in England by WATMOUGHS LIMITED, Idle, Bradford; and London. Sole Agents for Australia and New Zealand; GORDON & GOTCH (A/asia), Ltd., South Africa and Rhodesia; CENTRAL NEWS AGENCY, LTD., East Africa; EAST AFRICAN STANDARD LTD., Subscription rate including postage for one year: Inland £1.9.0., Abroad £1.7.6 (Canada £1.5.0.). Registered at the General Post Office for the Canadian Magazine Post.

PROVE IT YOURSELF! SEE HOW EASY IT IS TO BUILD ONE OF OUR DESIGNS

● FULL DETAILS OF ANY MODEL ON REQUEST—WRITE NOW ●

THE FABULOUS "CONTESSA" Mk. III combined portable and car radio

- WITH 600mW MELLOWTONE OUTPUT ON MEDIUM AND LONG WAVES.
 - FITTED HORIZONTAL TUNING SCALE
 - WITH ALL STATIONS CLEARLY MARKED.
 - SUPPLIED WITH SIX MULLARD TRANSISTORS AND TWO DIODES.
 - FITTED RECORDING SOCKET AND CAR AERIAL SOCKET.
 - SUPPLIED WITH TWO-TONE BEIGE OR TWO-TONE BLUE CABINET WITH GOLD FITTINGS.
- DETAILED LEAFLET ON REQUEST

GUARANTEE THE VERY BEST OBTAINABLE

- All parts sold separately ●

TOTAL COST
£10.19.6 P.P. 3/6



OVERALL SIZE
10½ x 7½ x 3½ in.

The New "CONTESSA" 6-Transistor Portable Superhet Radio features simple printed circuit construction and fully illustrated building instructions, with all parts clearly marked and identified. Fitted with 8 inch Ferrite Aerial, double IFT's and the latest in components and design. Full tuning of both Medium and Long Wave Bands with unbeatable Selectivity and Sensitivity. Clearly marked station dial and room filling "MELLOWTONE" push-pull output are standard features. Performance is guaranteed to be better than any other design available to the home constructor whether used at home, out and about, or in a car.

CALL AFTER SALES SERVICE AND GUARANTEE

"CAPRI" POCKET-6 6-TRANSISTOR SUPERHET



Size only
4½ x 2½ x 1½ in.

**REALLY
POCKET
SIZE!**

The most compact 6-transistor and diode radio with speaker available to the

home constructor. Features the latest in miniature components and circuitry. Supplied with Mullard transistors and two-tone moulded cabinets in red/white or Blue/White with gold fittings. All components are supplied in packets and clearly identified. A printed circuit is used with fully illustrated building instructions. Push-pull output coupled with a sensitive and selective circuit make the "CAPRI" hard to beat. Fitted Earphone/Record socket. Full tuning on medium waves with long wave Light.

TOTAL COST **£6.19.6** P.P. 2/-

- Detailed Leaflet on Request ●
- After Sales Service and Guarantee.

We can supply most of the components specified on circuits published in this and other magazines and books. Let us quote for your circuit. Competitive Prices.

Henry's Radio Ltd

PADDINGTON 1008 9
5 HARROW ROAD, LONDON W2
Open Monday to Sat 9-6. Thurs. 1 o'clock
Send 1/- Stamp for Latest
Illustrated Price Lists.

← ANOTHER 2 PAGES OF ITEMS

"QUINTET" MEDIUM AND LONG WAVE POCKET RADIO PUSH-PULL SPEAKER OUTPUT

Size
5½ x 3 x 1½ in.

Red or Blue
with Gold
trim.

Total Cost
99/6 P.P. 2/-

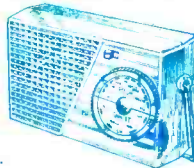

A Five-Transistor and Diode medium and long wave printed circuit loudspeaker radio. Features 1st grade transistors and plainly marked printed circuit with carded components. Excellent results with full station separation guaranteed. Including Radio Luxembourg. Push-pull output up to 200 mW. Fitted 'Phone/Record socket and Car aerial socket. **Full after sales service and guarantee.**

"PW" TROUBADOUR

7-Transistor
Superhet

Medium
and
Long Wave
Radio

Size
5½ x 3½ x 2 in.

£8.10.0 P.P. 2/-

("PW" SIX £7.19.6, P.P. 2/-)
Modified version of previously advertised "PW" Superhet. Now with new style Two-tone Cabinet. 1st grade components and transistors. Printed circuit. Features matched set of 7 Transistors. New 2½ inch quality speaker and new illustrated building instructions.

ALL PARTS IN STOCK

For "PW"-6, Mercury-6, Weyrad MW/LW and MW/SW, "PW" Regency, Alpha-3, etc.

Price List on Request.



NEW! "MINI-RANGER"

PERSONAL POCKET RADIO

Size only
3 x 2 x ¾ in.

**Three
transistors
Two
diodes**



A new printed circuit 5-stage personal pocket radio fully tunable on medium waves and top band, including Radio Luxembourg. A tiny but powerful radio designed to fit your jacket top pocket. No external aerial or earth. Full station separation with amazing sensitivity and volume. Fully illustrated instructions with clearly marked pre-tinned printed circuit and 1st grade components make this radio Easy to Build and use. Fitted volume control and calibrated dial.

TOTAL COST **59/6** P.P. 1/6

- Building Instructions Free on request.

Amazing Results—Guaranteed!

"RANGER 3"

Size 4½ x 3 x 1½ in. A Three-Transistor Six-Diode Personal Radio for Medium Waves and Amateur top band and shipping. Quality output on personal phone. Fitted air spaced tuner, vol. control. No aerial or earth.



59/6 P.P. 1/6

Luxembourg guaranteed.

Diagrams on request.