

JUNE
1962

Practical 2/- WIRELESS

FREE inside!

DOUBLE-SIDED
BLUEPRINT

for

7-TRANSISTOR
M.W./L.W. POCKET
PORTABLE

**HI-FI F.M.
TUNER**



THE P.W. TROUBADOUR



THE P.W. EVEREST TUNER

CLYNE RADIO LTD.



18 TOTTENHAM COURT ROAD, W.1
162 HOLLOWAY ROAD, LONDON N.7
9 CAMBERWELL CHURCH STREET, S.E.5

MUSEum 5929/0095
NORth 6295/67
RODney 2875

All post orders etc. to 162 HOLLOWAY ROAD, LONDON N.7

THE COMPONENT SPECIALISTS

NEW! NEW! The "CRUSADER"

Our new four transistor plus diode portable, with big set quality.

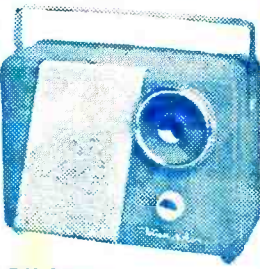

- ★ Full Medium Wave coverage.
- ★ Completely self-contained
- ★ Five Inch P.M. Speaker
- ★ Genuine high grade Mullard or Ediswan Transistors
- ★ New Components throughout
- ★ Attractive two-tone blue/grey Vynide covered cabinet size 8 x 5 1/2 x 3 1/2 in with adjustable carrying handle
- ★ Eveltled chassis simplifies construction
- ★ Longer life with larger size PP7 battery

★ SPECIAL FEATURES! ★
SUPPLIED WITH JACK SOCKET FOR DIRECT CONNECTION TO CRYSTAL MICROPHONE FOR USE AS BATTERY ALARM. WITHOUT ANY MODIFICATION ALSO WITH DIRECT CONNECTION TO CRYSTAL PICK-UP FOR USE AS A GRAMOPHONE AMPLIFIER! SUPPLIED COMPLETE WITH RECESSED SOCKET FOR DIRECT CONNECTION TO CAR AERIAL!

All required components including full instructions, solder battery etc at special inclusive price of **ONLY 95/-** Plus 3/- All parts available separately **1/6** P & P
Itemised parts list and full assembly instructions 1/6 post free

THE NEW SIGNAL INJECTION PROBE MODEL ITI-1

Ideal companion for the service-man and hobbyist, making rapid checks on radios, amplifiers, tuners, TV, etc. The ITI-1 injects a signal into the circuit at any given point. Produces a signal rich in harmonics from a miniature transistor oscillator, built into the probe. Powered by four standard pen-lite cells. Push-button operation and neon battery strength indicator. Price complete with batteries 52/6 only, plus 1/6 P. & P.

THE "BABYCALL"

At last! A Baby Alarm without untidy connecting wires. Can be used anywhere and transferred from room to room at will.

Consisting of two completely separate units—Just plug the "receiver unit" into any mains socket in the house (or next door) and you will immediately receive "loud and clear" sounds that the remote microphone unit is picking up, (from wherever it is plugged into). Operates by using the "house mains wiring" as the connecting link. Completely safe. Each unit is contained in an attractive modern "Slim line" type moulded cabinet. Handsome appearance, with Vynair front panel.

TCC Printed circuit board. TCC Capacitors. No "live" chassis. High flux loudspeaker. Easy to assemble. Dimensions 10" x 4" x 4 1/2" (deep) Each Unit.

Complete Kit of Parts, including instruction booklet at special inclusive price of **£5.19.6**, plus 3/6 postage and packing. Itemised parts list and full assembly details 1/6, post free

N.B. This is a non-repeatable offer. Limited quantity only. Purchased complete from manufacturer. Worth Double!!

The "HIGHWAYMAN"

At last a quality Car Radio to build yourself, at an economical price. Look at these features:—

- ★ Attractive styling. ★ Push-pull output. ★ 3 latest Mullard transistors plus valves type EBF 83 and ECH 83.
- ★ No Buzz. High Output and sensitivity. ★ Printed circuit (newest type). 7" x 4" High flux p.m. speaker
- ★ Medium and Long Waves. ★ Push Buttons for fingertip control. ★ Extremely low Battery consumption (less than 1 amp). ★ Easy to fit any make car (Positive earth only) ★ 12 volt operation. ★ Compact size measures only 7" x 7" x 2" deep. ★ Easy assembly, supplied with dial and drive already mounted.

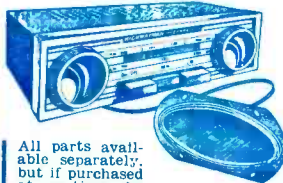

All parts available separately, but if purchased at one time, the whole will be supplied at a special inclusive price of only

£10.19.6 Plus 4/- P & P

Parts list and comprehensive instruction booklet 2/6, post free. (Deducted from cost if complete parcel purchased later)

The "CLYMAX"



At last a 6-transistor pocket size superhet for Medium and Long Wave at a price you can afford. All required components

ONLY £6.16.6

Nothing more to buy! Plus 3/6 P & P
★ Completely self contained. No external aerial or earth required ★ Full medium wave coverage, plus switched Light programme on Long Wave. ★ Push-pull output—250 milliwatts ★ Matched set of latest type Mullard transistors ★ Genuine 3in. P.M. Speaker ★ High-Q Coils ★ Ferrite rod aerial with high selectivity. ★ Size: 5 1/2 x 3 1/2 x 1 1/2 in Two-tone cabinet ★ Precision etched printed circuit with components references clearly marked Alignment service available. All parts available separately. Full assembly instructions and individually priced parts list 2/- post free

SPECIAL OFFER !! EXPORT CHASSIS

by famous manufacturer

Medium and Two Short Waves



M.W. 200-550 metres
S.W. 1 13.30 metres
S.W. 2 31-90 metres

(Calibrated also in k/cfs and M/cfs)
A five valve superhet chassis—ECH81, EBF89, EBC81, EL84 and EZ80 for A.C. mains. 90/110/200/230/250 v Four watts output, negative feedback. Push-button selection of gram, and wavechange. Volume on/off. Tone and Tuning controls. Tropicalised high grade mains and output transformers, separate from main chassis, reduce hum and heat to a minimum. Attractive dial printed in Black, Gold and Red. Chassis dimensions 15in. long x 6in. deep x 7in. high (This includes mounting brackets which can be removed and reduces the depth to 5 1/2in.) Dial aperture 1 3/4 x 3in. Supplied complete with rotatable separate ferrite rod aerial.
Quantity strictly limited. **£12.12.0**
AT BARGAIN PRICE OF (P.T. Paid) Carriage and packing in U.K. only 7/6 H.P. available

THE R.C. 3/4 WATT AMPLIFIER

Compare the advantages Treble, bass AND middle controls For crystal or magnetic pick-up A.C. Mains 200/250 v. Valve line-up: 5V6GT, 6X07 metal 6X50T. Negative feedback. Built on stove enamelled steel chassis, measuring only 8 x 4 x 1 1/2 in. Four engraved cream knobs are included in the price of the complete kit with all necessary practical and theoretical diagrams at **£4.5.0** only, plus 2/6 p. & p. or Instruction Book fully illustrated for 1/- post free. This amplifier can be supplied, tested, and ready for use at **£5.5.0** plus p & p



A QUALITY F.M. TUNER UNIT TO BUILD YOURSELF!



Combines quality with simplicity of construction (only specially selected top-grade components are used). The refinements achieved are equal to many commercial models at twice the price. ★ Guaranteed non-drift ★ Permeability tuning. ★ Freq. coverage 88-100 Mc/s. ★ Self powered using a good quality mains transformer and valve rectifier. ★ Fully drilled chassis. ★ F.M. Tuning Head by famous maker. ★ OA81 Balanced Diode output. ★ Magic-eye tuning indicator. ★ Two I.F. Stages and Discriminator. ★ Attractive maroon and gold glass dial. ★ Valves used: ECC85, two EBF80s, EZ80 (rectifier) and magic-eye. ★ Attractive metal front panel as illus. finished in a choice of black crackle, glossy hammer green or grey enamel. ★ Everything supplied down to the last nut and bolt. All parts sold separately.

Special inclusive price for all components, full assembly instructions, circuit diagram, etc. **£6.12.6**

Plus 5/- P. & P. Full assembly instructions, etc., available separately if required at 1/6 post free.

Tel: Mitcham 6201

Open Daily to Callers

R S T

All Valves Brand New
and Fully Guaranteed

211 STREATHAM ROAD, MITCHAM, SURREY

Special 24 Hour Express Mail Order Service

| | | | | | | | | | | | | | | | | |
|--------|-------|------|-------------|------|------------|------|---------|------|---------|------|-------|------|--------|------|--------|------|
| AC2PEN | ECC88 | 17/6 | EY86 | 8/6 | PCC89 | 9/6 | UY10 | 9/. | UY41 | 7/6 | SZ4 | 9/6 | 6L18 | 10/. | 12C8 | 8/6 |
| DD | ECC91 | 4/. | EZ35 | 6/. | PCF80 | 9/6 | UY12 | 9/. | UY85 | 7/. | SZ4GT | 12/6 | 6L19 | 17/6 | 12J5GT | 4/. |
| ACTP | ECC82 | 8/6 | EZ40 | 7/. | PCF82 | 7/. | UY14 | 9/. | YMS4B | 12/6 | 6A7 | 9/. | 6LD20 | 14/. | 12J7GT | 8/6 |
| ACVPI | ECH21 | 22/. | EZ41 | 7/. | PCF84 | 16/. | UY22 | 8/. | VP4 | 15/. | 6A8G | 8/6 | 6P25 | 10/6 | 12K7GT | 5/. |
| AZ1 | ECH42 | 9/6 | EZ80 | 7/. | PCF86 | 15/. | UY24 | 21/. | VP4A | 17/6 | 6A8GT | 13/6 | 6P28 | 17/6 | 12K8GT | 10/. |
| AZ31 | ECH35 | 10/. | EZ81 | 7/. | PCL82 | 9/6 | UY25 | 12/6 | VP4B | 17/6 | 6A8B | 9/. | 6Q7 | 6/6 | 12Q7GT | 6/6 |
| B36 | ECH81 | 8/. | EZ90 | 7/. | PCL83 | 12/6 | UY26 | 10/. | VR10530 | 7/. | 6A8J | 9/6 | 6Q7GT | 8/6 | 12S7A | 8/6 |
| C1C | ECH83 | 8/6 | E1148 | 2/. | PCL84 | 10/6 | UY27 | 8/. | VR15030 | 7/. | 6AK5 | 5/. | 6SA7 | 7/. | 12SK7 | 6/. |
| CLB31 | ECL80 | 9/. | FC2 | 21/. | PCL85 | 16/. | UY31 | 9/. | VU39 | 9/. | 6AK8 | 7/6 | 6SG7 | 7/. | 12SQ7 | 8/6 |
| CCH35 | ECL81 | 10/. | FC2A | 21/. | PENA4 | 17/6 | UY35 | 17/6 | VU111 | 2/6 | 6AL5 | 6/. | 6SH7 | 6/. | 12SL7 | 8/. |
| CL33 | ECL82 | 9/6 | FC4 | 15/. | PENB4 | 17/6 | UY37 | 17/6 | VU120 | 2/6 | 6AM5 | 5/. | 6S17 | 6/6 | 12SN7 | 10/. |
| CY1 | ECL83 | 12/. | FC13 | 21/. | PEN4DD | | UY43 | 8/6 | W61 | 11/. | 6AM6 | 4/. | 6SK7 | 5/6 | 13D3 | 12/6 |
| CY31 | EF6 | 21/. | FW4/500 | 9/. | | 25/. | UY45 | 10/. | W76 | 5/. | 6AN5 | 7/6 | 6SL7GT | 6/. | 14H7 | 10/. |
| D77 | EF9 | 21/. | GZ30 | 10/6 | PEN4VA | | UY47 | 12/6 | W77 | 4/. | 6AQ5 | 6/6 | 6SN7GT | 5/6 | 14R7 | 10/. |
| DAK32 | EF22 | 14/. | GZ32 | 10/6 | PEN36C21/. | 17/6 | UY52 | 4/. | W81 | 6/. | 6AQ8 | 9/3 | 6S7 | 8/6 | 14S7 | 15/. |
| DAF91 | EF36 | 4/. | GZ33 | 19/3 | PEN45 | 10/. | UY54 | 7/6 | W81M | 6/. | 6AT6 | 6/. | 6U4GT | 10/. | 19AQ5 | 8/. |
| DAF96 | EF37 | 8/. | GZ34 | 13/6 | PEN45DD | | UY78 | 4/6 | X17 | 8/6 | 6AU6 | 9/. | 6U5G | 7/6 | 19B6G | 21/. |
| DC90 | EF37A | 4/. | GZ37 | 19/3 | PEN46 | 5/. | UY91 | 15/. | X18 | 9/. | 6BBG | 3/. | 6V6 | 4/6 | 20D1 | 10/. |
| DF33 | EF39 | 4/. | GABC80 | 10/. | PEN453DD | | UY281 | 18/. | X41 | 15/. | 6BA6 | 6/. | 6V6GT | 8/. | 20F2 | 17/6 |
| DF91 | EF40 | 15/. | HL1ADD | 8/6 | | 27/6 | UY282 | 19/6 | X61 | 12/6 | 6BE6 | 6/. | 6X4 | 4/6 | 20L1 | 17/6 |
| DF92 | EF41 | 8/. | HL92 | 8/6 | PENDD4020 | | UY301 | 22/6 | X61M | 22/6 | 6BG6G | 17/6 | 6X5 | 7/6 | 20P1 | 25/. |
| DF96 | EF42 | 10/. | HL133DD | | | 25/. | UY329 | 12/6 | X65 | 12/6 | 6BH6 | 8/. | 6X5GT | 8/6 | 20P3 | 25/. |
| DF97 | EF50A | 4/. | | 10/. | PL33 | 15/. | UY339 | 15/. | X76M | 12/6 | 6B16 | 6/. | 6X6 | 15/. | 20P4 | 22/. |
| DH63 | EF50E | 3/6 | HN309 | 20/. | PL36 | 15/. | UY403 | 10/. | X78 | 21/. | 6BQ7A | 12/6 | 630L2 | 10/. | 20P5 | 25/. |
| DH77 | EF80 | 5/. | IW4/35010/. | | PL38 | 21/. | UY404 | 10/. | X79 | 21/. | 6BR7 | 12/6 | 785 | 12/6 | 21B6 | 12/. |
| DK32 | EF85 | 5/. | IW4/50010/. | | PL81 | 12/. | UY801 | 29/. | Y66 | 9/6 | 6B57 | 12/6 | 786 | 10/. | 25A6 | 8/. |
| DK91 | EF86 | 10/6 | KT33C | 8/. | PL82 | 8/. | UYABC80 | 7/. | Z63 | 7/6 | 6BW6 | 7/. | 787 | 8/6 | 25L6 | 8/. |
| DK92 | EF89 | 9/. | KT36 | 17/6 | PL83 | 10/6 | UYAF42 | 8/6 | Z66 | 10/. | 6BW7 | 5/. | 788 | 8/. | 25Y5 | 8/. |
| DK96 | EF91 | 4/. | KT55 | 17/6 | PL84 | 9/. | UYB41 | 7/6 | Z77 | 4/. | 6BX6 | 5/. | 7CS | 8/. | 25Z4 | 7/6 |
| DL33 | EF92 | 4/. | KT61 | 9/6 | PL820 | 18/. | UYBC41 | 8/6 | Z152 | 5/. | 6C4 | 3/6 | 7C7 | 8/. | 25Z5 | 8/. |
| DL35 | EF95 | 7/6 | KT66 | 15/. | PM24M | 13/6 | UYBC81 | 10/. | ZD17 | 8/. | 6C5GT | 8/. | 7D3 | 15/. | 25Z6 | 8/. |
| DL92 | EF97 | 12/6 | KT76 | 10/. | PX4 | 15/. | UYBF80 | 8/6 | ZD152 | 8/6 | 6C6 | 6/6 | 7D5 | 15/. | 27S0 | 17/6 |
| DL93 | EF98 | 10/. | KT81 | 15/. | PX25 | 25/. | UYBF89 | 7/6 | Q74 | 5/. | 6C9 | 12/6 | 7D6 | 15/. | 30C1 | 9/6 |
| DL94 | EF183 | 18/. | KT88 | 21/. | PY31 | 15/. | UYBL21 | 21/. | IA7 | 11/6 | 6CD6G | 32/. | 7D8 | 15/. | 30F5 | 10/. |
| DL96 | EF184 | 14/. | L63 | 5/. | PY32 | 12/6 | UYCC84 | 10/6 | IC1 | 8/6 | 6CH6 | 10/. | 7H7 | 7/6 | 30FL1 | 10/6 |
| EA50 | EK32 | 8/6 | LN152 | 9/. | PY80 | 7/6 | UYCC85 | 7/6 | IC2 | 9/6 | 6D2 | 4/. | 7K7 | 8/6 | 30L15 | 11/6 |
| EABC80 | EL2 | 21/. | LN309 | 12/6 | PY81 | 7/6 | UYCF80 | 13/6 | IC3 | 9/6 | 6D6 | 5/6 | 7Q7 | 10/. | 30P4 | 21/. |
| EAC91 | EL3 | 21/. | LZ319 | 12/6 | PY82 | 7/6 | UYCH21 | 21/. | IC5 | 10/6 | 6E5 | 10/. | 7Y4 | 7/6 | 30P4 | 21/. |
| EAF42 | EL6 | 21/. | MKT4 | 17/6 | PY83 | 8/6 | UYCH42 | 9/6 | ID5 | 8/6 | 6E6 | 6/9 | 8D3 | 4/. | 30P12 | 9/. |
| EB34 | EL32 | 4/6 | MS48 | 17/6 | PZ30 | 18/6 | UYCH81 | 8/. | ID6 | 10/6 | 6F1 | 10/6 | 8BVW6 | 12/6 | 30P16 | 10/. |
| EB41 | EL33 | 10/. | MVSPEN | | Q59S10 | 10/. | UYCL82 | 10/. | IHS | 9/6 | 6F6 | 6/9 | IOC1 | 12/6 | 30PL1 | 15/. |
| EB91 | EL34 | 15/. | | 17/6 | QS15015 | 10/. | UYCL83 | 13/6 | IL4 | 5/6 | 6F11 | 10/. | IOC2 | 17/6 | 30PL13 | 12/6 |
| EB33 | EL35 | 10/. | MVSPENB | | R2 | 10/. | UYF41 | 7/6 | ILNS | 4/6 | 6F12 | 4/. | IOF1 | 15/. | 35L6GT | 8/6 |
| EB41 | EL37 | 17/6 | | 17/6 | R3 | 10/. | UYF42 | 7/6 | INS | 9/6 | 6F13 | 10/. | IOF3 | 15/. | 35W4 | 7/6 |
| EB41 | EL38 | 21/. | MU14 | 9/. | R12 | 8/6 | UYF80 | 7/. | IR5 | 7/6 | 6F14 | 10/. | IOF9 | 12/6 | 35Z3 | 16/. |
| EB81 | EL41 | 10/. | MX40 | 15/. | R16 | 17/6 | UYF85 | 7/6 | IS4 | 8/. | 6F15 | 12/6 | IOD11 | 15/. | 35Z4 | 7/6 |
| EBF80 | EL42 | 10/. | N18 | 8/. | R19 | 19/. | UYF86 | 12/6 | ISS | 7/6 | 6F19 | 12/6 | IOD12 | 10/. | 35Z5 | 8/6 |
| EBF83 | EL81 | 12/6 | N37 | 14/. | R20 | 19/. | UYF89 | 6/6 | IT4 | 4/. | 6F23 | 10/6 | IOPI3 | 15/. | 40SUA | 15/. |
| EBF89 | EL84 | 6/9 | N78 | 17/6 | S130 | 7/6 | UYL41 | 8/6 | IU5 | 5/9 | 6F33 | 5/6 | IOPI4 | 19/. | 41STH | 21/. |
| EBL1 | EL85 | 10/. | N108 | 18/. | SP41 | 3/6 | UYL44 | 21/. | 2P | 24/9 | 6H6 | 2/. | IOPI8 | 15/. | 42 | 12/6 |
| EBL21 | EL90 | 8/6 | N308 | 20/. | SP61 | 3/6 | UYL46 | 14/6 | 3A4 | 5/. | 6J5 | 4/6 | IID3 | 23/6 | 50CS | 10/. |
| EBL31 | EL91 | 4/. | N339 | 30/. | SU2150 | 25/. | UYL84 | 7/. | 3A5 | 10/6 | 6J7 | 5/. | IID5 | 23/6 | 50L6 | 8/6 |
| ECC34 | EL95 | 10/6 | N369 | 10/6 | SU2150A | | UYL85 | 7/6 | 3Q4 | 8/. | 6J7GT | 7/6 | IZA6 | 6/6 | 50CD6G | |
| ECC35 | EM80 | 8/6 | OD3 | 5/. | | 25/. | UYM80 | 10/6 | 3Q5 | 9/. | 6K7 | 2/. | IZAH8 | 9/. | 53KU | 12/6 |
| ECC40 | EM81 | 8/6 | OZ4 | 5/6 | T41 | 15/. | UYR1C | 15/. | 3S4 | 7/. | 6K7GT | 8/6 | IZAT6 | 7/6 | 78 | 7/6 |
| ECC81 | EM84 | 9/6 | P2 | 10/. | U06 | 19/. | UYU16 | 19/. | 3V4 | 8/. | 6K8 | 5/. | IZAX7 | 7/6 | 80 | 9/. |
| ECC82 | EM85 | 10/. | PABC80 | 13/. | U08 | 21/. | UYU8 | 21/. | SU4 | 4/. | 6K8GT | 9/6 | IZAU6 | 17/6 | 85A2 | 12/6 |
| ECC83 | EY1 | 8/6 | PCC84 | 9/. | UY9 | 7/6 | UYU9 | 7/6 | SV4 | 7/9 | 6K25 | 18/. | IZBA6 | 7/6 | 18SBT | 30/. |
| ECC84 | EY81 | 8/6 | PCC85 | 9/6 | TH41 | 24/. | UY1N | 12/6 | SY3 | 8/6 | 6L1 | 13/. | IZB6E | 7/6 | 305 | 9/6 |
| ECC85 | EY83 | 15/. | PCC88 | 15/. | TY86F | 12/6 | UY21 | 15/6 | SY3GT | 8/6 | 6L6 | 7/6 | IZBH7 | 10/. | 807BR | 9/6 |

METAL RECTIFIERS

| | | | | | | |
|-------|------|------|----------|-------------|--------------|------|
| RM1 | 5/3 | 14RA | 1-2-8-2 | 17/6 (FC31) | 14A97 | 25/. |
| RM2 | 7/6 | 16RC | 1-1-16-1 | 8/6 | 14A100 | 27/. |
| RM3 | 7/9 | 14RA | 1-2-8-3 | 19/. | 16RD 2-2-8-1 | 12/. |
| RM4 | 14/. | 1BRA | 1-1-16-1 | 6/6 (FC116) | 16RE 2-1-8-1 | 8/6 |
| RMS | 19/6 | 1BRA | 1-2-8-1 | 11/. | 1BRA 1-1-8-1 | 4/6 |
| 14A86 | 17/6 | 1BRD | 2-2-8-1 | 15/. | (FC124) | |

SPECIAL OFFER

EABC80 6/., EAC91 4/., EB91 4/., EBF89 8/6, ECC81 5/9
 ECC85 8/., ECC91 4/., ECH81 8/., EBC33 4/6, EF39 4/.,
 EF50 3/6, EF80 5/., EF85 5/., EF91 4/., DF91 4/., EL84 6/9,
 PCC89 9/6, PL84 9/., UABC80 7/., UBF89 7/6, UF41 7/6,
 UL41 8/6, UF89 6/6, UL84 7/., UY85 7/., W81 6/.,
 OZ4 5/., SU4 4/., 6AQ5 6/6, 6BA6 6/., 6BE6 6/.,
 6D2 4/., 6K7 2/., 6K8 5/., 6L6 7/6, 6Q7 6/6, 6SL7 6/6,
 6SN7 5/6, 6V6 4/6, 8D3 4/., 807 5/., 12AT7 5/., 12AH8 9/.,
 12BA6 7/6, 12BE6 7/6, 12K7 5/., 12Q7 6/6.

TERMS OF BUSINESS C.W.O. OR C.O.D.
 3/2 PACKING CHARGE ON ALL C.O.D.
 ORDERS. POSTAGE 6d. PER VALVE

OBsolete VALVES A SPECIALITY.
 QUOTATIONS GIVEN ON ANY TYPE
 NOT LISTED

STERN'S MULLARD DESIGNS

Designed by MULLARD—presented by STERN'S strictly to specification
COMPLETE KIT OF PARTS

MULLARD "5-10" MAIN AMPLIFIER

For use with the MULLARD 2-valve pre-amplifier with which undistorted power output of up to 10 watts is obtained. We supply SPECIFIED COMPONENTS AND NEW MULLARD VALVES, including PARMEKO MAINS TRANSFORMER and choice of the latest Ultra-Linear PARMEKO or the PARTRIDGE Output Transformer. COMPLETE KIT OF PARTS (PARMEKO Output Trans.) **£10.00**
 Alternatively we supply **ASSEMBLED AND TESTED, £11.10.0** INCORPORATING PARTRIDGE OUTPUT TRANSFORMER, £1.0.0 EXTRA.

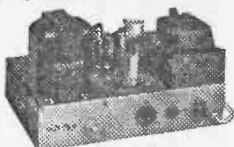

MULLARD'S PREAMPLIFIER TONE CONTROL UNIT

Employing two EF86 valves, and designed to operate with the MULLARD MAIN AMPLIFIERS, but also perfectly suitable for other makes. PRICE COMPLETE **£6.6.0** ASSEMBLED AND TESTED



£8.0.0

Supplied strictly to MULLARD'S SPECIFICATION and incorporating:

- Equalisation for the latest R.I.A.A. characteristics.
- Input for Crystal Pick-ups, and variable reluctance magnetic types.
- Input (a) Direct from High Imp. Tape Head. (b) From a Tape Amplifier or Pre-Amplifier.
- Sensitive Microphone Channel. • Wide range BASS and TREBLE Controls.

COMPLETE MULLARD "5-10" AMPLIFIER

The popular and very successful complete "5-10" incorporating Control Unit providing up to 10 watts high quality reproduction. Only Specified Components and new MULLARD VALVES are supplied including PARMEKO MAINS TRANSFORMERS and choice of the latest PARMEKO or PARTRIDGE ULTRA-Linear Output Transformers.

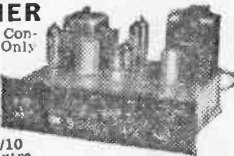

Kit of Parts **£11.10.0** OR ASSEMBLED AND TESTED **£13.10.0**
 H.P. Dep. £2.6.0. 12 months at 17/0. Dep. £2.14.0 12 months at 19/10.
 ABOVE incorporating PARTRIDGE OUTPUT TRANS. £1.8.0 extra.

COMPLETE MULLARD "3-3"

THE IDEAL AMPLIFIER FOR A SMALL HIGH QUALITY INSTALLATION PROVIDING EXCELLENT REPRODUCTION OF UP TO 3 WATTS OUTPUT. COMPLETE KIT OF PARTS **£7.10.0** OR ASSEMBLED AND TESTED **£8.19.6** (plus 6/6 carriage and insurance) H.P. Terms: Deposit £2.0.0 and 8 months at £1.0.0. Complete to MULLARD'S SPECIFICATION including Mullard valves and a PARMEKO OUTPUT TRANSFORMER.



MULLARD'S "10 PLUS 10"

STEREO AMPLIFIER

A high fidelity design based on the famous Mullard "5-10". Provides up to 10 watts (per channel) Superb reproduction. Frequency response flat to within 3 db from c/s. to 60 Kc/s at 50 Mw. Total Harmonic Distortion at 10 watts 0.1%.



(a) ASSEMBLED COMPLETE AMPLIFIER, including CONTROL UNIT (as illustrated), **£21.0.0**
 Deposit £4.4.0. 12 months at £1.10.10.

(b) A complete KIT OF PARTS, **£18.10.0**
 Deposit £2.14.0. 12 months at £1.7.2.

We also supply the assembled MAIN AMPLIFIER only (excludes control unit) for operation with our DUAL CHANNEL PREAMPLIFIER, this provides for a more versatile or elaborate installation and would be essential if a low output Magnetic Pick-Up, such as the Decca, is to be used.

(a) THE ASSEMBLED MAIN AMPLIFIER with the ASSEMBLED DUAL CHANNEL PREAMPLIFIER **£30.0.0**
 Deposit £6.0.0. 12 months at £2.4.0.

(b) A complete KIT OF PARTS for both Units, **£26.0.0**
 Deposit £5.4.0. 12 months at £1.18.2.

Illustrated and Descriptive Brochure available. Please enclose S.A.E.

STERN'S INTER-COMM BABY ALARM

A small versatile Unit employing the new MULLARD ECL86 valve and designed to provide two (or three) way conversation up to extreme distances Operates from A.C. mains 230 to 250 Volts.

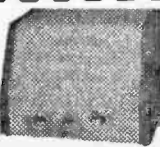

PRICES . . . MASTER UNIT AND ONE EXTENSION **£6.17.6** ASSEMBLED AND TESTED **£8.0.0**

Consists of a MASTER UNIT, size only 8 1/2 x 5 1/2 x 6 1/2 in. and ONE EXTENSION (a second extension may be added to any time). The Master Unit incorporates switching and power supply and with the chassis completely isolated from the mains is operated in absolute safety. Cases covered in quality leatherette.

PRICE REDUCTIONS

(a) The KIT OF PARTS to build both the "5-10" Main Amplifier and the 2-valve PRE-AMP CONTROL UNIT H.P. Dep. £3.7.0 and 12 months at **£15.15.0**
 (b) The "5-10" and the 2-stage PRE-AMP both ASSEMBLED and TESTED H.P. Dep. £3.16.0 and 12 months at **£18.18.0**
 With Partridge Output Transformer £1.0.0 extra.

RECORD PLAYERS

The Latest Models are in stock, many at reduced prices.

Send S.A.E. For Illustrated Leaflet.

THE NEW GARRARD "AUTOSLIM" 4-speed Autochanger with Crystal Pick-up **£8.10.0**

COLLARO "JUNIOR" 4 SPEED SINGLE RECORD PLAYER with separate Crystal Pick-up Carriage and Insurance 5/- Above Pick-up separately for £1.6.8

THE NEW COLLARO C60 4-speed Autochanger unit with Studio "O" Pick-up **£7.19.6**

THE F.M.I. 4-speed Single Record Player with Crystal Pick-up **£6.9.6**

B.S.R. MODEL UA14. A 4-speed mixer Autochanger with Crystal Pick-up Available incorporating the B.S.R.

STEREO Pick-up, plays L.P. and 78 Records **£8.13.10**

GARRARD MODEL TA/MKH 4-speed Player fitted with high output Crystal Pick-up **£8.10.0**

GARRARD MODEL RC210. Autochanger 4-speeds. High output Crystal Pick-up Carriage and Insurance on each above 5/- extra. **£9.19.6**

SPECIAL CASH OFFER

This very attractive PORTABLE AMPLIFIER CASE together with a good quality GRAM AMPLIFIER and a matched P.M. SPEAKER ALL for ONLY **£8.7.6** (Plus 7/6 Carr. & Ins.)



The Amplifier consists of a 2-stage design incorporating 3 modern B.V.A. valves and has separate BASS and TREBLE CONTROLS.

The Portable Case will also accommodate almost any make of Autochanger and is attractively finished in Mushroom Grey Rexine. WE ALSO SUPPLY SEPARATELY—

- (a) The 2-stage (plus Rectifier) AMPLIFIER **£4.2.6**
- (b) THE PORTABLE CARRYING CASE **£3.17.6**

(c) 6 1/2 in. P.M. SPEAKER 18/0. Carriage and Insurance 4/- extra.

MULLARD FOUR CHANNEL MIXER UNIT

Self powered with Cathode follower output. Incorporates Two inputs for MICROPHONES and One for CRYSTAL PICK UP and a fourth for RADIO or TAPE Complete Kit of Part **£8.8.0**
 Assembled and Tested **£10.0.0**

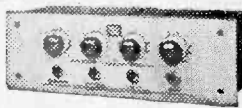

TERMS: Deposit £2 and 12 months at 15/-
 MODEL I.L. one microphone input matched for moving coil or Ribbon Mike. £1.17.0 extra.

DUAL CHANNEL PREAMPLIFIER

Incorporates two Mullard 2-valve Pre-amplifiers combined into a Single unit enabling it to be used for both STEREOPHONIC or MONAURAL operation. It is designed primarily to operate with our range of MULLARD MAIN AMPLIFIERS but will also operate equally well with any make of Amplifiers requiring an input of 250 mv/volts. COMPLETE KIT **£12.10.0**
 H.P. £2.10.0 & 12 mths. at 18/4



ASSEMBLED AND TESTED **£15.0.0**
 H.P. £3.0.0 & 12 mths. at £1.2.0

STERN RADIO LTD.

BUILD A THREE SPEED HIGH QUALITY TAPE RECORDER LIKE THIS FOR £35.0.0

FOR THIS WE SUPPLY

Deposit £7.0.0 12 months at £2.11.4

- ★ Complete Kit of Parts to Build
- ★ The HF/TR3 Tape Amplifier.
- ★ The New Collaro "Studio" Tape Deck.
- ★ Portable Carrying Case (as illustrated).
- ★ Rola/Celestion 10 x 1in. p.m. Loudspeaker.
- ★ ACOS Crystal Microphone and 1,200ft. Spool E.M.I. Tape.

ALTERNATIVELY WE SUPPLY THE COMPLETELY ASSEMBLED AND GUARANTEED TAPE RECORDER FOR £39.10.0

H.P. Terms: Deposit £7.18.0 and 12 months of £2.17.11.



(Mullard Type "A" design)

A very high quality Amplifier incorporating 3-speed treble equalisation by the latest FEROCUBE POT CORE INDUCTOR. FOR COLLAROTRUVOX - BRENE LL WEARITE Tape Decks, has GILSEN Output Transformer. Includes separate Power Supply Unit.

KIT OF PARTS £13.13.0

Deposit £2.15.0
12 months at £1.0.0.

ASSEMBLED and TESTED £17.0.0

Deposit £3.8.0
12 months at £1.4.11.

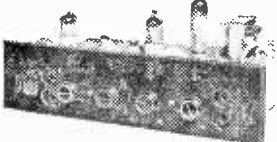

ADD "HI-FI" TAPE RECORDING TO YOUR EXISTING AUDIO INSTALLATION WITH MULLARD TYPE "C" TAPE PRE-AMPLIFIER - PHASE UNIT

The "Hi-Fi" link to add full tape recording facilities to High Fidelity home installations. Incorporates FEROCUBE POT CORE PUSH PULL OSCILLATOR and 3-speed treble equalisation by FEROCUBE POT CORE INDUCTOR FOR WEARITE-COLLAROTRUVOX OR BRENE LL TAPE DECKS. Includes separate power Supply Unit.



KIT OF PARTS

£14.0.0

Deposit £2.16.0
12 mths. at £1.0.6

OR ASSEMBLED £17.0.0

Deposit £3.8.0
12 months at £1.4.11

(Excluding power unit £1.15.0 and £14.10.0 respectively.)

SPECIAL "COMBINED ORDER" PRICES

- For Constructors with their own cabinet—WE OFFER—
- (a) COMPLETE KIT to build the HF/TR3 Amplifier together with the COLLARO "STUDIO" DECK **£26.0.0**
 - (b) As above but with the HF/TR3 supplied ASSEMBLED and TESTED **£29.10.0**
 - (c) COMPLETE KIT to build the HF/TR3 AMPLIFIER with the BRENE LL Mk. V TAPE DECK. **£42.0.0**
 - (d) As above but with HF/TR3 supplied ASSEMBLED and TESTED **£45.10.0**
 - (e) THE ASSEMBLED and TESTED HF/TR3 AMPLIFIER with the WEARITE MODEL 4A DECK. Incorporates Wearite Head Lift Transformer etc. Deposit £12.12.0. 12 monthly payments of £3.6.9. **£60.10.0**
- (Carriage and Insurance on each above is 10/- extra.)

- (a) The COLLARO "Studio" Deck with the Model "C" Pre-amplifier and POWER SUPPLY UNIT ASSEMBLED and TESTED **£29.10.0**
 - (b) As above but the TYPE "C" Unit and POWER UNIT supplied as COMPLETE KIT OF PARTS. Deposit £5.18.0. 12 monthly payments of £2.3.3 **£26.10.0**
 - (c) The BRENE LL Mk. V Deck with the Model "C" PREAMPLIFIER and POWER UNIT ASSEMBLED and TESTED **£46.0.0**
 - (d) As above but the Model "C" PREAMPLIFIER and POWER UNIT supplied as a COMPLETE KIT OF PARTS. Deposit £9.4.0 and 12 months at £3.7.6 **£43.0.0**
 - (e) THE WEARITE MODEL "4" DECK with ASSEMBLED and TESTED Model "C" PREAMPLIFIER AND POWER UNIT incorporating WEARITE HEAD LIFT TRANSFORMER. Etc. Deposit £12.2.0 and 12 months at £4.8.9 **£60.10.0**
- (Carriage and Insurance on above is 10/- extra.)



The MODEL HFG/2R PORTABLE TAPE RECORDER (Original Price £33.0.0) FOR ONLY 22 gns.

H.P. Dep. £4.14.0. 12 months £1.13.9 (Curr. and Ins. 10/- extra). Incorporates THE LATEST GARRARD "MAGAZINE" TAPE DECK and a HIGH QUALITY AMPLIFIER which is entirely based on the very successful MULLARD TYPE "A" DESIGN and specifically developed to operate the GARRARD DECK. Price INCLUDES SUPPLY OF THE GARRARD TAPE MAGAZINE and 4in. SPOOL OF DOUBLE PLAY TAPE. Comprises a Twin Track Recorder operating at 3 1/2 in./sec. speed and providing up to 1 hour 10 mins. playing time. Truly "Portable", weighs only 22 lbs. Outstanding features are excellent performance and simplicity of operation

STEREO "TWIN THREE" AMPLIFIER with specially designed PORTABLE CASE

A most compact portable design consisting of TWIN CHANNEL AMPLIFIER based on the latest design by MULLARD LTD. incorporating top grade Output Transformers, and the new audio Triode-Pentode Valves Mullard E.C.L.86 Separate Bass and Treble controls. Suitable for use with Crystal Pick Ups, and capable of genuine high quality reproduction up to 3 Watts per channel. A versatile stereo arrangement tested and guaranteed which can be assembled in the minimum of time.



PRICE for the ASSEMBLED AMPLIFIER. Two 8 x 5in. ROLA SPEAKERS and PORTABLE CASE **£14.0.0**
Deposit £2.16.0, 12 months at £1.0.6 **£7.15.0**
ASSEMBLED AMPLIFIER supplied for.....

THE 'ADD-A-DECK'

Incorporating GARRARD TAPE DECK and MODEL 4A DECK PRE-AMPLIFIER Supplied on ONE CHASSIS (as illustrated) READY FOR USE **18 Gns.** (Curr. & Ins. 10/- extra.)



Price includes Garrard Magazine and a 4 in? x 100? Double Play Tape H.P. Deposit £3.16.0, and 12 months of £1.7.8. Provides complete tape recording facilities and designed to operate through the pick-up sockets of the standard type of RADIO RECEIVER, or an AMPLIFIER, from which really first class reproduction is obtained. It consists of a Twin Track Deck connected to the Pre-amplifier and operates at 3 1/2 in./sec. speed providing up to 1 hr. 10 mins. playing time.

THE "STP-1" STEREO TAPE PRE-AMPLIFIER DESIGNED TO OPERATE WITH

- BRENE LL Mk. V TAPE DECK, incorporating similar 1-TRACK MINIFLUX TAPE HEADS.
 - COLLARO "STUDIO" TAPE DECK, incorporating the latest 1-TRACK COLLARO TAPE HEADS.
 - PUSH PULL OSCILLATOR CIRCUIT.
 - 4-SPEED EQUALISATION.
 - FEROCUBE OSCILLATOR TRANSFORMER.
 - SENSITIVE METER FOR SIGNAL LEVEL.
 - SEPARATE GAIN CONTROLS in Each Channel.
 - MULLARD VALVES INCORPORATED.
- PRICE **£28.0.0** (Including separate Power Supply Unit. Dep. £5.12.0 12 months £2.1.1.)

COMBINED PRICE SCHEDULE

- The "STP-1" PRE-AMPLIFIER IS OFFERED WITH TAPE DECKS as follows:
- BRENE LL Mk. V 4-TRACK MODEL. DEPOSIT £13.8.0, 12 months £4.18.3. **£67.0.0**
 - COLLARO "STUDIO" 4-TRACK MODEL. DEPOSIT £9. 12 months £3.0.0. **£45.0.0**
 - THE MULLARD "10" 10" STEREO AMPLIFIER (described opposite) with the "STP-1" PRE-AMPLIFIER and one of the TAPE DECKS provides a COMPLETE Stereophonic Installation. WE OFFER "10 + 10" AMPLIFIER, "STP-1" PRE-AMPLIFIER and the TRUVOX. As above with BRENE LL Mk. V DECK. Deposit £17.8.0, 12 months £6.7.5. **£87.0.0**
 - As above with COLLARO "STUDIO" DECK. Deposit £12.12.0, 12 months £4.16.0. **£65.0.0**

Dept. P.W. **109 FLEET ST. LONDON, E.C.4**
Telephone: **FLEET STREET 5812/3/4**

DESCRIPTIVE LEAFLET AVAILABLE, PLEASE SEND S.A.R.

CHECK with these

BARGAINS

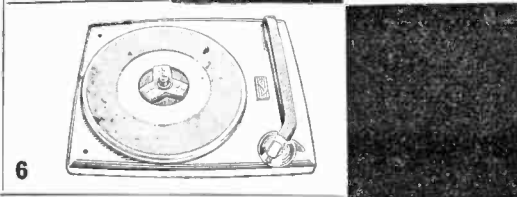
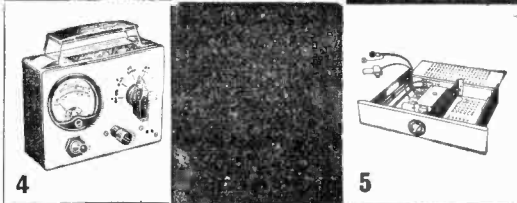
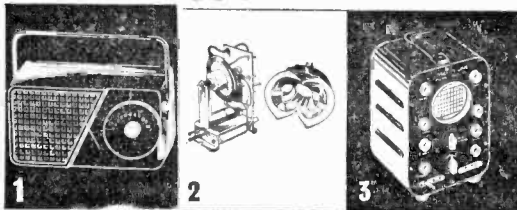

10. **SIGNAL GENERATORS.** Cash £5.5.0. P. & P. 5/6. Coverage 120 kc/s to 84 Mc/s. Case 10 x 6 1/2 x 4 1/2 in. Size of Scale 6 1/2 x 3 1/2 in. 2 valves and rectifier. A.C. mains 230-250 v. Internal modulation of 400 c.p.s. to a depth of 30 per cent, modulated or unmodulated R.F. output continuously variable 100 millivolts. C.W. and mod. switch variable A.F. output and moving coil output meter. Accuracy ± 2 per cent.
- CHANNEL TUNER I.F.** 16-19 Mc/s. Continuously tunable from 174-216 Mc/s. Valves required—PCF80 and PCC84 (in series). Covers BBC and ITA ranges. Also Police Fire and Taxis etc. Brand new by famous maker, 10/-. P. & P. 3/-.
12. **8-watt PUSH-PULL 5 VALVE AMPLIFIER.** A.C. mains 200-250 v. Size 10 1/2 x 6 1/2 x 2 1/2 in. 5 valves. For use with all makes and types of pick-up and mike. Negative feed back. Two inputs, mike and gram, and controls for same. Separate controls for Bass and Treble. Response flat from 40 cycles to 15 kc/s. ± 2 db down to 20 kc/s. Output 8 watts at 5 per cent total distortion. Noise level 40 db down all hum. Output transformer tapped for 3 and 15 ohms speech coils. For use with 8 Ω , or I.P. records musical instruments such as guitars, etc. Suitable for small halls, £3.19.6. P. & P. 6/-. Crystal mike to suit 15/-, P. & F. 2/-. 8in. P.M. Speaker to suit 12/6, P. & P. 2/-.
13. **B.S.R. MONARCH UAS WITH FUL-FI HEAD.** 4-speed, plays 10 records, 12in., 10in., or 7in. at 16, 33, 45 or 78 r.p.m. Intermixes 7in., 10in., and 12in. records of the same speed. Has manual play position, colour brown. Dimensions: 12 1/2 x 10 1/2 in. Space required above baseboard 4 1/2 in. below baseboard 2 1/2 in. Fitted with Ful-Fi turnover crystal head. £6.19.6, P. & P. 5/6 With Stereo Head £7.19.6, P. & P. 5/6.
14. **TRANSISTOR TESTER.** For both P.N.P. and N.P.N. transistors incorporating moving coil meter. In metal case, size 4 1/2 x 3 1/2 x 1 1/2 in. Scale marked in gain and leakage. 19/6. P. & P. 3/-.
15. **PUSH-PULL OUTPUT STAGE** inclusive of transistors with input and output transformers to match 3 ohms speech coil, suitable for use with the **POCKET RADIO.** Kit of parts, including transistors. 19/6. P. & P. 2/-. Wiring diagram 1/6, free with parts.
16. **PORTABLE AMPLIFIER.** On printed circuit for A.C. Mains 200/250 v. Size 4 x 3 in. with tone and volume control. Complete with Valves: ECL82 and 6Z80. Output 2 watts, 39/6, P. & P. 3/-.

1. **3-TRANSISTOR POCKET RADIO** with MINIATURE SPEAKER, FERRITE ROD and 2 GERMANIUM DIODES. The only 3-transistor radio available at the price. Build it in 1 evening! Tunable over M/L waves. Complete with easy-to-follow instructions and all components (less batteries obtainable anywhere 1/3). 27/6. P. & P. 2/6. (All parts available separately).
2. **LINE E.H.T. TRANSFORMERS.** Built-in line width control. 14kV. Scan coil 500 μ , deflection on ferrite yokes. Frame O.P. Transformer pl. 18kV smoothing condenser, suitable for 14in., 17in., or 21in. tubes. With circuit diagram, 28/6 plus 4/6 P. & P. Suitable Focus Magnet (state tube), 10/- plus 3/- P. & P.
3. **OSCILLOSCOPE** for D.C. and A.C. APPLICATIONS. Push-pull X amplifier; Fly-back suppression; Internal Time-base Scan Wave form available for external use; pulse output available for checking TV line O/P Transformers, etc. Provision for external-I/P and C.R.T. Brightness Modulation. A.C. mains 200/250 v. £19.18.0, P. & P. 8/- of £4.13.0 deposit, plus P. & P. 5/- and 12 monthly payments of 25/6. FULL 12 MONTHS' GUARANTEE INCLUDING VALVES and TUBE.
4. **A.C./D.C. POCKET MULTI-METER KIT.** 2in. moving coil meter, scale, calibrated in A.C./D.C. volts, ohms and milliamps. Voltage range A.C./D.C. 0-50, 0-100, 0-250, 0-500. Milliamps 0-10, 0-100. Ohms ranges 0-10,000, 0-100,000 24/6, P. & P. 2/-. Wiring diagram 1/-, free with parts.
5. **CHANNEL TUNER.** Will tune to all Band I and Band III stations. Complete with P.C.C.84 and P.C.F.80 valves (in series) I.F. 16-19 or 33-38. Can be modified as an aerial converter (instructions supplied), 32/6, plus 4/- P. & P. **HEATER TRANSFORMER** to suit above, 200-250 v., 6/-, plus 2/- P. & P.
6. **STAAR 45, 9 VOLT BATTERY RECORD PLAYER** Complete with pick-up and deck. A completely portable record player. Head is protected by a plastic dome, with a brush which cleans the stylus as it rises into playing position. 45 r.p.m. Automatic on-off switch, governed by a motor, attractive 2 tone grey finish. £2.14.6. P. & P. 2/6. **TRANSISTORISED AMPLIFIER** can be used with the STAAR 45, output 1 watt. Size 4 1/2 x 2 1/2 in., printed circuit, tone and volume controls, 4 transistors. By altering 2 resistors, 2 watt output can be obtained. Push-pull output, complete with 3in. moving coil speaker. Built and tested, 49/6, P. & P. 2/-.
9. **SIGNAL GENERATORS.** Cash £7.5.0 or 30/- deposit and 6 monthly payments of 21/6. P. & P. 5/6. Coverage 100 kc/s to 100 Mc/s on fundamentals and 100 Mc/s to 200 Mc/s on harmonics. Case 10 x 6 1/2 x 5 1/2 in. Three miniature valves and Metal Rectifier. A.C. mains 200/250 v. Internal modulation of 400 c.p.s. to a depth of 30 per cent. Modulated or unmodulated R.F. output continuously variable 100 millivolts. C.W. and mod. switch, variable A.F. output. Magic eye as output indicator. Accuracy ± 2 per cent.

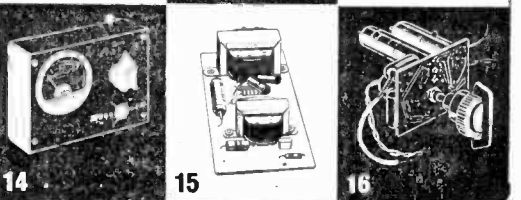
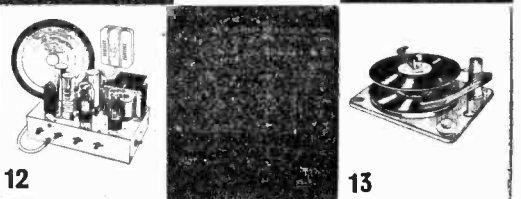
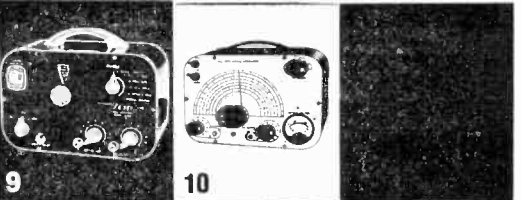

RADIO & T.V. COMPONENTS
(Acton) LTD.

23B HIGH STREET, ACTON LONDON, W.3.

ALL ENQUIRIES S.A.E. GOODS NOT DISPATCHED OUTSIDE U.K.

AUDIOTRON HI-FI TAPE RECORDER KIT

REALISM AT INCREDIBLY LOW COST. CAN BE ASSEMBLED IN AN HOUR.
The Recorder incorporates the latest Collaro Studio Tape Transcriber. The Auditor High Quality Tape Amplifier listed E12.12.0 High Flux P.M. Speaker listed 30s. empty. Tape Spool, a Reel of Best quality Tape listed 22.6, and a Handsome Portable carrying Cabinet with latest attractive-two tone polychrome finish, size 14 1/2 x 16 x 8 1/2 in. h.f.h. listed £4.10.0. and circuit. Total cost if purchased individually approximately £40. Performance equal to units in the £60-£80 class. S.A.E. for leaflet.

HIGH FIDELITY 12-14 WATT AMPLIFIER TYPE A11

PUSH-PULL ULTRA LINEAR OUTPUT "BUILT-IN" TONE CONTROL PRE-AMP STAGES

Two input sockets with associated controls allow mixing of "mike" and gram, as in A10. High sensitivity. Includes 5 valves, ECC83, ECC83, EL34, EL84, 5Y3. High Quality sectionally wound output transformer specially designed for Ultra Linear operation and reliable small condensers of current manufacture. **INDIVIDUAL CONTROLS FOR BASS AND TREBLE** "Lift" and "Cut". Frequency response +3 D.B. 30-30,000 c/s. Six negative feedback loops. Hum level 50 D.B. down. ONL 103 millivolts INPUT required for FULL OUTPUT. Suitable for use with all makes and types of pick-ups and microphones. Comparable with the very best designs. For **STANDARD or LONG PLAYING RECORDS.** For **MUSICAL INSTRUMENTS** such as **STRING BASS, GUITARS, etc.** **OUTPUT SOCKET** with plug provides 300 v. 30 mA. and 6.3 v. 1.5 a. For supply of a **RADIO FEEDER UNIT.** Size approx. 12-8-7in. For A.C. mains 200-250 v. 50 c.p.s. Output for 3 and 15 ohm speakers. Kit is complete to last nut. Chassis is fully punched. Full instructions and point-to-point wiring diagrams supplied. Only **8 Gns.** Carr. 10/- (Or factory built £11- extra).
If required louvred metal cover with 2 carrying handles can be supplied for 18/9. **TERMINAL ON ASSEMBLED UNITS. DEPOSIT 24/0.** and 9 monthly payments of 24/8. Send S.A.E. for illustrated leaflet detailing Ready-to-assemble Cabinets. Speakers. Microphones, etc., with cash and credit terms.

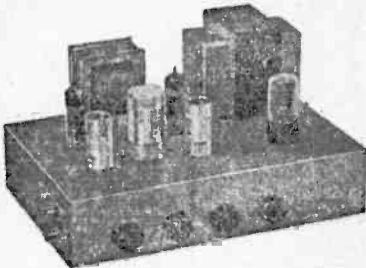

25 1/2 GNS.
Carr. 17/6

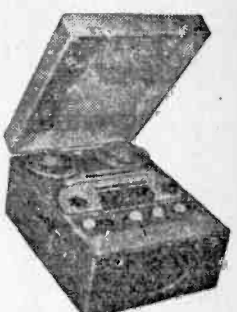

H.P. TERMS. Deposit £5.7.6 and 12 monthly payments of 2 gns. Cash Price if settled in 3 months.

BRADMATH RECORDING HEADS. High Impedance Record/Playback 22-1/2. Low Impedance Erase 12/6.
COLLARO AUDIOPHON 4-SPEED Single Player Unit and Crystal Pick-up with hi-fi Turnover head. Only £3.19.6.
PICK-UP ARMS. Complete with latest Acos/h-f Turnover head and rest. Only 29/11.
CRYSTAL MICROPHONES. Hand type NP110 14/9. R.T.C. 19/9. Acos Mic 40 25/9. Acos Mic 45 29/9. Stick type Acos 35-1 39/9. BMS with neck band and heavy table stand 59/9. Lapel type 55/9.

R.S.C. STEREO TEN HIGH QUALITY AMPLIFIER

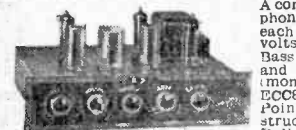

A complete set of parts for the construction of a stereophonic amplifier giving 5 watts high quality output on each channel (total 10 watts). Sensitivity is 50 millivolts, suitable for all crystal stereo heads. Ganged Bass and Treble Control give equal variation of "Lift" and "cut". Provision is made for use as straight (monaural) 10 watt amplifier. Valve line-up ECC83, ECC83, EL84, EL34, EZ81. Outputs for 2-3 ohm speakers. Point-to-point wiring diagrams and instructions supplied. Send S.A.E. for leaflet. Full constructional details and price list 2/6. Carr. 10/- use. 59/6 extra.

COLLARO CONQUEST 4-SPEED AUTO-CHANGER, with high fidelity Studio pick-up. Latest model. For 200-250 v. 50 c.p.s. A.C. mains. Our price £8.19.6. Carr. 5/6.
COLLARO RC 457 4-SPEED MIXER AUTO-CHANGERS. Turnover Studio Pick-up head, for 200-250 v. A.C. £7.19.6. Carr. 4/6.
B.S.R. UAR 4-speed AUTO-CHANGERS with hi-fi turnover head. £6.19.9. Carr. 4/8.
GLS MINIATURE 2-3 WATT GRAM AMPLIFIER. For use with any single or auto-change unit. Output for 2-3 ohm speaker. For 200-250 v. A.C. mains. Size 1 1/2 x 2 1/2 in. Controls: Vol. and Tone with switch. Only 59/6.

Kit can be assembled, ready for use, 59/6 extra.

R.S.C. BATTERY CHARGING EQUIPMENT

HEAVY DUTY CHARGER KIT 6/12 v. 8 amps. variable output. Consisting of Mains Transformer 0-200-230-250 v. F.W. (Bridge) Selenium Rectifier. Ammeter. Variable Charge Rate Selector. Panels, Plugs, Fuses, Fuseholder and circuit. 59/6. Carr. 4/6.



Assembled 6/12v. 4-5 amps. Fitted Ammeter and variable charge rate selector. Also selector plug for 6 v. or 12 v. charging. Louvred steel case with stoved base hammer finished. Fused and ready for 69/9 use with Carr. 5/- mains and output leads. Terms: Deposit 13/8 and 5 monthly payments 13/8, 6/12 v. 3a., all facilities as above. Only 59/9. carr. 3/9.

All for AC. Mains 200-250v., 50cps Guaranteed 12 months.

BATTERY CHARGER KITS Consisting of Mains Transformer, F.W. Bridge, Metal Rectifier, well ventilated steel case. Fuses. Fuse-holders. Grommets, panels and circuit. Carr. 3/6 extra.
6v. or 12v. 1 amp. 24/9
As above, with Ammeters 32/9
6 v. 2 amps. 25/9
6v. or 12v. 2 amps. 31/6
6v. or 12v. 2 amps. Inclusive of Ammeter. 42/9
6v. or 12v. 4 amps. 49/9
6 v. or 12 v. 4 amps. with Ammeter and variable charge rate selector. 59/9
CHARGER AMMETERS. 0-1.5 a., 0-3 a., 0-4 a., 0-7 a., 0-25 a., 0-60 a. 8/8.

PARMEKO POTTED CHOKES

200 mA. 12 H 100 ohms 16/9
120 mA. 30 H 200 ohms 18/9
120 mA. 8 H 10 ohms 13/9

SOLDERING IRONS. 230-250 v. 30 watts. First quality. For Radio work. 19/9. Spare elements and bits available.

R.S.C. MAINS TRANSFORMERS (FULLY GUARANTEED)

Interleaved and Impregnated. Primaries 200-230-250 v. 50 c/s. Screened TOP SHROUDED DROP THROUGH
250-0-250V. 70mA. 6.3v. 2a. 0-5-6.3v. 5a. 17/9
350-0-350V. 80mA. 6.3v. 2a. 5v. 2a. 18/9
250-0-250V. 100mA. 6.3v. 2a. 6.3v. 1a. 21/9
250-0-250V. 100mA. 6.3v. 3.5a. C.T. 19/9
250-0-250V. 100mA. 6.3v. 4a. 5v. 3a. 25/9
300-0-300V. 130mA. 6.3v. 4a. 6.3v. 1a. (or Mullard 510 Amplifier) .. 20/9
300-0-300V. 100mA. 6.3v. 4a. 5v. 3a. 26/9
250-0-250V. 100mA. 6.3v. 4a. 5v. 3a. 28/9
350-0-350V. 150mA. 6.3v. 4a. 0-5-6.3v. 3a. 20/9
FULLY SHROUDED UPRIGHT
250-250V. 30mA. 6.3v. 2a. 0-5-6.3v. 2a. 17/1
Midget type 2i-3-3in. 27/1
250-0-250V. 100mA. 6.3v. 4a. 5v. 3a. 27/0
300-0-300V. 100mA. 6.3v. 4a. 5v. 3a. 27/11
300-0-300V. 130mA. 6.3v. 4a. C.T. 6.3v. 1a. for Mullard Amplifier .. 33/9
350-0-350V. 100mA. 6.3v. 4a. 5v. 3a. 27/11
350-0-350V. 150mA. 6.3v. 4a. 5v. 3a. 35/9
425-0-425V. 200mA. 6.3v. 4a. C.T. 5v. 3a. 55/-

FULLY SHROUDED (continued)-
425-0-425V. 200mA. 6.3v. 4a. C.T. 6.3v. 4a C.T. 5v. 3a. 59/9
450-0-450V. 250mA. 6.3v. 4a C.T. 5v. 3a. 69/9
Standard Pentode 7.5,000 to 3n
10,000 to 3n
Push-Pull 0 watts, EL84, or 6V6 to 3n or matched to 15n 9/9
Push-Pull 10-12 watts to match 6V6 or EL84 to 3-7-8 or 15n 19/0
Following types for 3 and 15 ohm speakers:
Push-Pull 10-12 watts 6V6 or EL84 .. 18/9
Push-Pull 15-18 watts 6L6, KT66 .. 22/9
Push-Pull for Mullard 510 Ultra Linear .. 29/9
Push-Pull 20 watts, sectionally wound. 6L6, KT66, etc. 49/9

MIDGET MAINS Primaries 200-250 v. 50 c/s. 250 v. 60 mA. 6.3 v. 2a. 11/9
250-0-250 v. 60 mA. 6.3 v. 2a. 12/9
Both above size 2 1/2 x 2 1/2 in.
FILAMENT TRANSFORMERS All with 200-250 v. 50 c/s. primaries 6.3 v. 0-1.5 v. 11 a. 12/9; 0-9-15 v. 2 a. 14/8; 0-9-15 v. 1.2 a. 17/1; 6.3 v. 3 a. 8/11; 6.3 v. 6 a. 17/6; 1.2 v. 1.5 a. twice. 17/6.
SMOOTHING CHOKES
150 mA. 7-10 H 250 ohms. 11/9
100 mA. 10 H 200 ohms 8/9
80 mA. 10 H 350 ohms 5/9
60 mA. 10 H 400 ohms 4/11
CHARGER TRANSFORMERS All with 200-230-250 v. 50 c/s. Primaries: 0-9-15 v. 11 a. 12/9; 0-9-15 v. 2 a. 14/8; 0-9-15 v. 1.2 a. 16/9; 0-9-15 v. 5 a. 19/9; 0-9-15 v. 3 a. 23/9; 0-9-15 v. 8 a. 25/8.
AUTO (Step up/Step down) TRANS. 0-110/120-230/250 v. 30-90 watt. 13/8; 2-5 watts. 50/9; 150 watts. 27/0.
MICROPHONE TRANSFORMERS 120:1 high grade, clamped. 6/9; 120:1 Potted. Mu-metal screened. 9/9.

R.S.C. (M.C.) SHEFFIELD, HULL, LIVERPOOL, LEEDS, BRADFORD, MANCHESTER

SENSATIONAL STEREO OFFER

A complete set of parts to construct a good quality Stereo amplifier with an undistorted output total 6 watts. For A.C. mains input of 200-250 v. Including pair matched 61n. speakers. Sensitivity 130 m.v. Ganged Vol. and Tone Controls. Preset balance control. Full instructions and point-to-point wiring diagrams supplied. Stereo Pick-up Head 19/9 extra with above only.

**ALWAYS IN STOCK
FULL RANGE OF LINEAR HI-FI
AMPLIFIERS WITH OUTPUTS OF
UP TO 100 WATTS. Cash or CREDIT
TERMS. Carriage Free.**

**R.S.C. 30 WATT ULTRA LINEAR
HIGH FIDELITY AMPLIFIER A10**

A highly sensitive Push-Pull high output unit with self-contained Pre-amp. Tone Control Stages. Certified performance figures compare equally with most expensive amplifiers available. Hum level 10 db. down. Frequency response ±3 db. 30-30,000 c/s. A specially designed sectionally wound ultra linear output transformer is used with 807 output valves. All components are chosen for reliability. Six valves are used E96, EF86, ECC83, 807, 807, GZ33. Separate Bass and Treble Controls are provided. Minimum input required for full output is only 12 millivolts so that **ANY KIND OF MICROPHONE OR PICK-UP IS SUITABLE.** The unit is designed for CLUBS, SCHOOLS, THEATRES, DANCE HALLS or OUTDOOR FUNCTIONS, etc. For use with Electronic ORGAN, GUITAR, STRING BASIS etc. For standard or long-playing records. **OUTPUT SOCKET PROVIDES L.T. and H.T. for a RADIO FEEDER UNIT.** An extra input with associated vol. control is provided so that two separate inputs such as Gram and 'Mike' can be mixed. Amplifier operates on 200-250 v. 50 c/s. A.C. Mains and has output for 3 and 15 ohm speakers. Complete Kit of parts with fully punched chassis and point-to-point wiring diagrams and instructions. If required perforated cover with carrying handles can be supplied for 19/9. The amplifier can be supplied, factory built with EL34 output valves and 12 months guarantee, for 14 Gns.

TERMS: DEPOSIT 33/9 and 9 monthly payments of 33/9. Suitable microphones and speakers available at competitive prices.

WE STOCK ARMSTRONG RADIO-GRAM CHASSIS, GOODMAN'S and WHARFEDALE SPEAKERS. H.P. or Credit Terms available. No carriage charges on Mail Orders for above.

R.S.C. BATTERY TO MAINS CONVERSION UNITS

Type BM1. An all-dry battery eliminator. Size 5 1/2 x 4 1/2 x 2 1/2 in. approx. Completely replaces battery supplying 1.4 v. and 90 v. where A.C. mains 200-250 v. 50 c/s is available. Suitable for all battery portable receivers requiring 1.4 v. and 90 v. This includes latest low consumption types.



Complete kit with diagrams, 39/9, or ready to use, 46/6.

LINEAR TAPE PRE-AMPLIFIER Type LP1. Switched Negative feedback equalisation. Positions for Record 1 1/2 in. 3 1/2 in. 7 1/2 in. and Playback, EM84 Recording Level Indicator. Designed primarily as the link between a Colloredo Tape Transcriber and a high fidelity amplifier, but suitable for almost any Tape Deck. Only 9 gns. S.A.E. for leaflet.

JASON FMTI V.H.F.F.M. Radio Tuner design. Total costs of parts including valves, Tuning dial, Escutcheon, etc. £6.19.9.

LINEAR L45 MINIATURE 4 1/2 WATT QUALITY AMPLIFIER. Suitable for use with any record playing unit, and most microphones. Negative feedback 12db. Separate Bass and Treble Controls. For A.C. mains input of 200-250 v. 50 c/s. Output for 2-3 ohm speaker. Three miniature Mullard valves used. Size of unit only 7-5-5 1/2 in. high. Guaranteed for 12 months. Only £5.19.6. Send S.A.E. for illustrated leaflet. Terms: Deposit 22/6 and 5 monthly payments of 22/6.

R.S.C. 4.5 WATT A5 HIGH-GAIN AMPLIFIER



A highly-sensitive 4-valve quality amplifier for the home, small club, etc. Only 50 millivolts input is required for full output so that it is suitable for use with the latest high fidelity pick-up heads, in addition to all other types of pick-ups and practically all 'mikes'. Separate Bass and Treble Controls are provided. These give full long-playing record equalisation. Hum level is negligible being 71 db. down 15 db. of Negative feedback is used. H.T. or 300 v. 25 ma. and L.T. or 6.3 v. 1.5 a. is available for the supply of a Radio Feeder Unit, or Tape-Deck pre-amplifier. For A.C. mains input of 200-250 v. 50 c/s. Output for 2-3 ohm speaker. Chassis is not alive. Kit is complete in every detail and includes fully punched chassis (with baseplate) with Blue Hammer finish and point-to-point wiring diagrams and instructions. Exceptional value at only £4.15.0, or assembled ready for use £5/- extra. Plus 3/6 carr.; or Deposit 22/6 and 5 monthly payments of 22/6 for assembled unit.

R.S.C. PORTABLE GUITAR AMPLIFIERS (FOR 200-250 v. A.C. Mains) Junior 5 watts High Quality output. Separate Bass and Treble "Cut" and "Boost" controls. Sensitivity 15 m.v. Twin inputs. High Flux 8in. Loudspeaker "built-in". Handsome, strongly made Cabinet (size approx. 14 x 14 x 7 1/2 in.) finished in attractive and durable polichrome, and fitted carrying handle. Terms. Deposit £1 and 9 monthly payments of £1. Carr. 10/-

£8.19.6

Senior 10 watts High Fidelity output Separate Bass and Treble "Cut" and "Boost" controls. Twin separately controlled high gain inputs so that two instruments such as Guitar and String Bass can be used at the same time. Two loudspeakers are incorporated, a high Flux 12in. for Bass notes and a 7 x 4 m. elliptical for Treble. Cabinet is well made and finished as Junior model. Size approx. 18 x 18 x 9 1/2 in. H.P. Terms. Deposit 34/9 and 9 monthly payments of 34/9. Carr. 10/-

15 Gns.

Super Hi-Fi 15 Watt. All facilities as 10 watt. Cabinet size 20 x 15 x 13ins. Terms: Deposit £2.11.6, and nine monthly payments of 51/6. 22 gns. Carr. 12/6.

12in. 10 WATT HIGH QUALITY LOUD-SPEAKER IN POLISHED WALNUT FINISHED CABINET



Gauss 12,000 lines. Speech coil 3 ohms or 15 ohms. Only £4.19.6 Carr. 5/- Terms: Deposit 11/3 and 8 monthly payments of 11/3.

12in. 20 WATT HI-FI LOUD-SPEAKERS IN CABINETS. Size 18 x 18 x 10in. Finish as above. Terms: Deposit 17/9 and 9 monthly payments of 17/9. Only £7.19.6. Carr. 8/6.

R.S.C. BASS REFLEX CABINETS, JUNIOR MODEL. Specially designed for W.B. HF1012 Speaker, but suitable for any good quality 10in. speaker. Acoustically lined and ported. Polished walnut veneer finish. Size 18 x 12 x 10in. Handsome appearance. Ensure superb reproduction for only £3.19.6.

STANDARD MODEL. As above but for 12in. speakers. Size 20 x 15 x 13in. Especially recommended for Plessey Dual Concentric Speaker, £5.19.6. Suitable legs with brass ferrules, 25/- per set of 4.

AUDIOTRON CORNER CONSOLE CABINETS. Polished walnut veneer finish. Pleasing design. Size 27x18x8 1/2 in. for 8 or 10in. speaker. 4 Gns.

P.M. SPEAKERS. 10in. W.B. "Stentorian" 3 or 15 ohms type HF1012 10 watts. hi-fidelity type. Recommended for use with our A11 or similar amplifier. Rated 10 watts. Price only £5.19.6.

TWEETERS. Plessey 30 19/9, 15 0 25/9. HI-FI CRYSTAL PICK-UP HEADS. (Turnover type with sapphire stylus. Acos. Standard replacement for Garrard, B.S.R. and Collaro, 19/9. Acos Stereo-Monaural 49/9. Ronette Stereo/Monaural 59/6.

R.S.C. EQUIPMENT CABINET. Dimensions and outer appearance identical with Standard Bass Reflex Cabinet. Top hinged Bass board adjustable. Will take Tape Deck or Player Unit, and Amplifier plus F.M. or A.M./P.M. Unit. Only 6 gns. **SEPERATE PICK-UP UNIT.** Design of a high quality Radio Tuner Unit (specially suitable for use with any of our Amplifiers). Delayed A.V.C. Controls are Tuning, W/Ch. and Vol. Only 250 v. 15 ma. H.T. and L.T. of 6.3 v. 1 amp. required from amplifier. Size of unit approx. 9-6-7 1/2 in. high. Simple alignment procedure. Point-to-Point wiring diagrams, instructions and priced parts list with illustration 2/6. Total building cost £4.15.0. For leaflet send S.A.E.

TERMS: C.W.O. or C.O.D. No C.O.D. under £1. Post 19/9 extra under £2. 3/3 extra under £5. Open 9 to 6. Weds. until 1 p.m., except Manchester open all week. Trade supplied. S.A.E. with all enquiries

R.S.C. (M.C.) Mail Orders to 29-31 Moorfield Road, Leeds 12. 13 Exchange St. Sheffield

Personal Shoppers to any of branches below—
51 Savile St. Hull (Half day Thurs.) 73 Dale Street, Liverpool 2 5-7 County (Mecca) Arcade, Briggate Leeds 1 8-10 Brown St. (Market St.), Manchester 2 56 Morley Street, (Above Alhambra Theatre), Bradford

TECHNICAL TRAINING in radio television and electronics

Whether you plan to have your own business, to become an electronics engineer, to take up a career in industry, or to brush-up your knowledge and study new developments, transistors, etc., an I.C.S. Course will help you to success. You learn at home in your own time, under expert tuition. Moderate fees include all books.

EXAMINATION COURSES FOR:—

C. & G. Radio and TV Servicing Certificate
(R.T.E.B.)

C. & G. Radio Amateurs' Exam.
(Amateurs' Transmitting Licence)

**British Institution of Radio Engineers, etc.
C. & G. Telecom. Technicians' Cert.**

LEARN AS YOU BUILD

Practical Radio Servicing Course

A basic course in radio electronic and electrical theory backed by thorough practical training. You build radio receivers signal generator and multimeter.



Post this Coupon TODAY! for FREE book on careers in Radio, and full details of other I.C.S. Courses

INTERNATIONAL CORRESPONDENCE SCHOOLS
(Dept. 171), Intertext House, Parkgate Road, London, S.W.11.

Please send book on.....
Name..... Age.....
(Block Letters Please)
Address.....
Occupation..... 6.62

INTERNATIONAL CORRESPONDENCE SCHOOLS

REDA METER SENSATION !!



10,000 o.p.v. MULTI TESTER IN SEMI-ASSEMBLED KIT FORM only 69/6

Ranges: D.C. Voltage: 0-6-30-120-600-1,200 v. (10,000 o.p.v.).
A.C. Voltage: 0-6-30-120-600-1,200 v. (10,000 o.p.v.).
D.C. Current: 0-120μA, 0-12-300 mA.
Resistance: 0-20K, 0-2 Meg. (150 ohm. 15K at centre scale.)
Capacitance: 0.005 to 15μF (at A.C. 6 v.).
Decibels: -20 to +63db (600 ohms 1 mW, odm—0.775 v.).
Accuracy: D.C. voltage and current ±2%, I.S. A.C. Voltage ±4% I.S.
Resistance ±3% of total scale length.
Size: 4 1/2 in. x 3 1/2 in. x 1 in. Complete with test leads, battery and instructions.

Only 100 available—rush your order now whilst stocks last!

'KEW' PANEL METERS

Precision built clear plastic miniature type. Featuring d'Arsonval movements, jewelled bearings, silvered dials with black numerals and pointers. 1.21/32 squarefronts. 1 1/2" overall depth. Owing to colossal sales of these meters our range has now been increased to include the following:
5 mA 27/6; 300v. D.C. 27/6
all other types as previously advertised are still available.



THE MOST USEFUL AMPLIFIER EVER PRODUCED!

4 TRANSISTOR PUSH-PULL AMPLIFIER

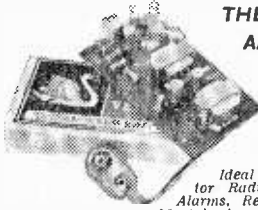

Ideal for making powerful Transistor Radios, Tape Recorders, Baby Alarms, Record Player, Intercom., etc. Must be heard to be appreciated.

NOT A KIT—READY BUILT UNIT ONLY 52/6 P. & P. 1/6

WILL MATCH OUR 8 ohm Speaker at 16/6: Lapel Mike at 17/6: Telephone Pick-up Coil at 14/-. Can be run off PP3 at 2/6 or off A.C. Mains with our 1 A6P Battery Eliminator at 2/6.

TELEPHONE PICK-UP COIL

Suction type. Feeds into m.i.c. input of all amplifiers, tape Recorders, etc. Ideal for recording telephone conversations. **ONLY 14/- P. & P. 1/-**

HOW WOULD YOU LIKE TO OWN A TRANSISTORISED RECORD PLAYER — RADIO BABY ALARM — INTERCOM & PARTY AMPLIFIER ALL FOR ONLY

£6.19.6 P. & P. 5/-.

The following equipment, offered for the first time in this country, can be used to make any or all of the above units. Attractive carrying case, 45 r.p.m. motor unit with arm and Hi-Fi head, 3 1/2 in. super quality speaker, 4 transistor multi-purpose power amplifier, Crystal lapel microphone, M.W. coil, tuning condenser, crystal diode, volume control, plugs and sockets, all necessary components, wire solder, nuts and bolts, etc., and full easy to follow assembly instructions. (Batteries 5/- extra).

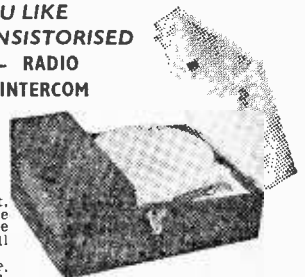

Send S.A.E. for leaflet

MINIATURE COMPONENTS

As previously advertised

- PS.35 Sub-miniature plug and socket .. 3/6 pr.
- CB.25 "Tiny" plug and socket .. 2/8 pr.
- Telescopic 7"-30" Aerial K2.16 5k Edgewise volume control with switch .. 4/6 ea.
- CR.5 Crystal earpiece .. 8/- ea.
- MR.4 Magnetic earpiece .. 8/- ea.
- P.217A 2 1/2 in. sq. 8 ohm miniature speaker .. 16/6 ea.
- TP.22K 2 1/2 in. round 75 ohm miniature speaker .. 17/6 ea.
- L.T.44/700 Miniature driver and output transformer 200mW .. 9/6 pr.
- SS.3271 Miniature slide switch .. 3/- ea.
- PVC.200 208pF miniature two gang tuning condenser .. 12/6 ea.

Please add P. & P. on above items

SF-20 RADIO EARPHONES

Hi-impedance-2,000 ohms-general use headset. Black and Ivory Plastic cased electro-magnetic units with adjustable head-band for comfortable fit. Individual listening for all types of applications. Individually packed, with flexible cord attached. 14/6. post paid.



PORTABLE MAINS SOLDERING IRON MODEL SPI



30 watts. For lightweight applications. Highly stable heat characteristics ensure long life and safety in use. Features a removable handle that may be used to cover the tip and barrel to permit the iron to be carried safely even while hot. Complete with Vinyl bag, mains lead and plug. All for only 18/9.

TELEGRAPH TRANSMITTER and MORSE PRACTICE OSCILLATOR

Can be set up with others for network practice in classrooms, groups, house to house, etc. Adjustable spring tension and contact clearance. Complete with buzzer, 50ft. wire on reel, ground spike and wire, crystal earphone, Morse sheet. Only 6 ounces. Uses 1.5 v. battery.



19/6 P.&P. TWO 40/- Post 2/6. FOR Free

3-WAY SLIM CRYSTAL MICROPHONE

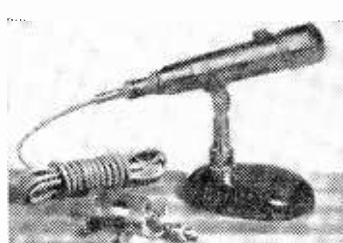

MODEL 100C

May be hand-held, stand mounted (either floor stand or desk stand) or suspended by lavalier cord. Responder 60-10,000 Cps. Built in on/off switch. Output level -52db. Omni-directional head. Clips on or off standard stand adaptor perceptor.

mitting tilting for multi-angle use. Satin chrome finish.

ONLY 48/-

Supplied complete with 7ft. of shielded cable, lavalier cord and desk stand. Brand new Floor Stand and Base, suitable for above, 65/-, Carriage Paid.

TRUTEST 5 watt STEREO AMPLIFIER

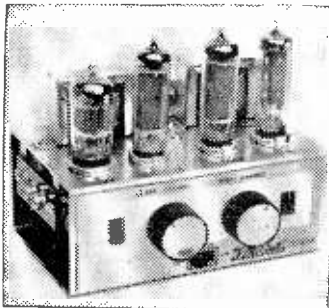

- Individual Stereo Volume Balance Controls
- For both Stereo and Monaural
- Fully wired, ready for Stereo

Controls include stereo/mono switch, tone control switch and on/off switch. Inputs for crystal or ceramic cartridge. Speaker output terminals. A.C. mains. 200 v. Size 4 1/4 x 5 1/2 x 4 1/4 in.

£6.19.6

Never before such value!

PORTABLE TRANS/RECEIVER SETS

Consisting of trans/receiver covering 7.4-9 Mc/s range up to 10 miles, complete with 5 valves, headphones, microphone, junction box and 6ft. telescopic aerial. Only requires 120 v. and 3 v. dry battery.

TWO FOR £6. Post Free. BATTERIES 20/- per set.



ONLY 60/- Per Set P. & P. 4/-.



TRANSISTORISED 1000 C/S SPOT AUDIO GENERATOR

Battery operated simplest operation. Ideal for all types of alignment of amplifiers, receivers, transmitters. Used for measurement of gain, fault finding, distortion. Test all a udi requirements. 39/

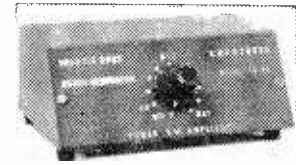

BOOSTER TRANSISTOR RADIO SPEAKER

MODEL TS.30 Designed for use with transistor radios, valve radios, car radios, amplifiers, where quality reproduction of sound is required. Plugs into ear-piece output socket of nearly all miniature sets. The cabinet is finished in beige leather with contemporary gold baffles at each end. Complete with 12ft. extension cord fitted with miniature plugs, individually cartoned and guaranteed. Size: 9 1/4 in. x 3 1/4 in. diameter. 57/6 P. & P. 2/6.



BRAND NEW PYE COMMUNICATION RECEIVERS

World coverage on these famous Communication Receivers. They are the simplest type to use yet bring in stations that will amaze you. The ideal domestic receiver for medium wave during the day with Amateur stations at night. All have been converted to 230 v. A.C. mains and are guaranteed to work immediately. Incorporate Wave Switch. Audio gain aerial trimmer, high and low tone control, station locking device, aerial and earth inputs, speaker output sockets, etc. Size 17 x 8 x 9 1/2 in. Black crackle finish front panel. On demonstration at 87 Tottenham Court Road. P.C.H. Medium and long waves and 6-18 Mc/s. With speaker. **ONLY £8.19.6** Carr. 10/6 each.

9V BATTERY CHARGER AND A.C. ELIMINATOR MODEL LA.6P 29/6 P.P. 1/6



Save those batteries by running your transistor set direct from A.C. Mains. Reactivate all your old 9V batteries. Unit contains neon indicator and standard battery connections with nearly 2 yards of mains lead and plug. Also snap cord for connection to set.

Our goods must be seen to be appreciated—a visit to 87 Tottenham Court Road will be most rewarding.

MAIL ORDERS TO (DEPT. P.), 32a COPTIC STREET, LONDON, W.C.1



CALLERS WELCOME AT 87 TOTTENHAM COURT ROAD, LONDON, W.1 MUS 9606

CLEARING DEPOT!

Unused, good quality equipment being offered at very keen prices.

Variable Rheostats. 4 or 80 heavy duty slider resistor rated at 25 amps. Ideal for dimmer circuits, etc. Sale price 7/6. plus 1/6 postage.

Rectifier Bargain. Selenium rectifier 95 v. 25 amp., easily rebuilt into a full-wave charger rectifier, each suitable 6 or 12 v. battery at 3 amps. Sale price 15/- plus 3/6 postage.

80 ohm Coax. low loss expanded polythene, normally 9d. per yard. Sale price 6d. vd. Superbet 7 v. 5 Waveband Chassis. Unused, less valves and power pack, 75/-. Coil pack worth twice as much. Carriage and insurance 7/6.

Geiger Counter Tube. 20th Century. No. G25 with circuit of geiger counter. Sale price 27/6. Transistor A.F. Equivalent to red spot. Sale price 2/6. 24/- doz.

Bakelite Wall Switch, household type, 6/- doz., one way 8/- doz., two way.

Wall Switch by Crabtree, two way and off. Sale price 1/- each.

Double pole, double throw toggle switch, heavy duty, 10 amp., 250 volts. Suitable for controlling photolood lamps, sale price 1/9 each, 18/- doz.

Multi-speed Motor with gearbox, works on A.C. or D.C. mains, gives any speed from 3 r.p.m. Sale price 17/6, plus 2/6 postage.

Chest Microphone. excellent American make with adjustable mouthpiece, 6/6, plus 1/6. Snipenser. "Cat's Eye" for seeing in the dark. Will work burglar alarms, circuits, etc. Sale price 4/-, plus 2/- post.

R.F. 25 Tuner Unit, complete, new condition, sale price 8/6, plus 2/6 post.

Stud Switch, heavy duty, 30 amp. contacts, for dimmer, charger, regulator, etc. Sale price 5/6, plus 2/- post.

Canadian Telephone Sets, although originally intended for use with transmitters, these make excellent telephones for calling over long distances in noisy situations. Distances up to 3 or 4 miles (using our versatile wire, 6/8 for 1/2 mile) can be covered using these sets, which contain hand generator, telephone bell, hand microphone, Morse key, indicator lamp, buzzer, relay, etc. Sets complete 27/6, with full instructions, complete in carrying case.

Packard Bell Pre-Amp. complete with 68L7 and 28D7 valves, relay, leads, jacks, input and output transformers, etc. 7/6. Plus 2/- post less case.

VCR517 Cathode Ray Tube is a plug in replacement for the VCR57, 8/6, carriage and insurance 4/6.

10 Valve 1/2 metre Superbet contains 9 valves, 6 I.F. Transformers and hundreds of useful spares. Brand New 29/6. Carriage and insurance 10/-.

R.F. Tuning Unit. No. 24 in solid condition, but contains valves and many useful components, 3/6, carriage 3/6.

Rotary Switch by Arrow carry 15 amp. A.C. 4 position hot, oil, cold, off. Suitable hair drier, air-conditioning plant etc. 3/6, post 1/-.

Sapphire Gramophone Needles, miniature or standard 78 r.p.m. type. 12/- doz. 1/6 each. Push-Pull Transformers, 4 in. and output, midget potted. Sale price 5/- pair, plus 1/6.

Metal Rectifiers. 250 v. 60-80 mA, ideal for mains set or instrument, or to replace that expensive valve. Sale price 3/6.

Dimthy Mast. Tubular aluminium extends from 15m. to 9ft. Sale price 4/6 plus 1/6 post.

Magneto Generator (battery), as used in telephones. Sale price 7/6, plus 1/6 post.

P.O. Type 3000 Relays. 2,000 ohm coil, 6 contacts 7/6. 4 contacts 6/6, 2 contacts 6/6, plus postage 1/-.

Versatile Wire. single strand 18 gauge with p.v.c. covering. New 1/2 mile on drum. Sale price 6/6, plus 3/6 carriage.

Wire Joints (welder for 25 gauge or thinner), in bakelite case with trigger switch, works off step-down transformer. Sale price 2/6, plus 9d. postage.

Centre Zero Meter 3 1/2 in. movement. Flush mounting, 500-500 micro Amp. Sale price 30/-, plus 1/6 post.

Unbreakable mains leads, as fitted to electric razors, etc. Makes ideal lead for test meters. Twin 6in. ions 6d. per lead, 5/- doz.

MOST POPULAR PORTABLES or CAR RADIOS

"Works better than my 25 gn. '———'!"

We hear this remark so many times and feel this is why our Companion portables are growing more and more popular.

The "Good Companion" Mk. II

In the "de-luxe" cabinet as illustrated it costs £10.19.6 to build—but what a set!

Scan these pages you will find nothing to compare with its specification. It uses transistors instead of I.F. transformers, has variable feedback as well as all the usual features, A.V.C., Push-pull output, Ferrite Aerial, Slow Motion Tuning, etc. etc. and is a very powerful Medium & Long Wave set, conservatively rated at 750 mW. Every component used is by a famous maker, such as American Philco MADT R.F. transistors—Mullard A.F. transistors—Jackson Brother's tuning condensers—Rola-Celestion loudspeaker—Dubilier—T.C.C.—Morganite resistors and controls. Also full after sales service available.

You will definitely be doing the right thing if you buy a Good Companion.

The "Tremendo Companion"

If you don't mind the battery consumption being a little higher and you want really big output then order The "Tremendo". This has an undistorted output of almost 1watts and is probably the most powerful home constructor set available today. Complete building cost of this is £11.5.0, which includes the transmitter (Mk.11 circuit) batteries, cost 3/6 (two required).

The "Pocket Companion"

This is without doubt the most modern and best pocket set available. It uses the very latest I.F. transistors, Philco R.F. transistors, inspected tuning condenser in Superhet circuit covering M.W. and L.W. Complete building cost £8.15.0. Battery 2/- Post & ins. 2/6. Data free with parts or separately 2/6.

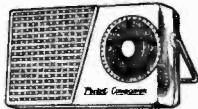

T.R.F. POCKET PORTABLES

Still available as previously advertised, all are complete and with cabinet similar to "Pocket Companion".

THE "PIMPERNEL"

Five transistors, 3in. Moving Coil Speaker. 79/6, plus 2/6 postage and insurance.

THE POCKET "4"

Undoubtedly the easiest to build set available, three transistors and one diode. 42/6, plus 2/6 postage and insurance.

THE SOLDERLESS "3"

Two transistors, miniature earphone. Assembled like a Mecano set, ideal for juveniles and beginners. 37/6, plus 2/6 postage and insurance.

CABINET AND PICK-UP



Cabinet for battery record player. Size approx. 9 x 11 x 5in. allows for 7 x 4in. speaker and amplifier. Nicely covered two tone. Must have cost at least £2 to make. New and perfect. Offered whilst stocks last 27/6, plus 4/6 post and insurance.

Cosmocord Pick-up

As illustrated with cartridge and headrest. Ready, new and perfect. Suitable for 45 or 33 records. Price

12/6, plus 2/6 post and insurance.

Extra Special Offer

The above two items if ordered together will be supplied for 37/6, plus 4/6 postage and insurance.

CLEARING DEPOT!

MORE unused, good quality equipment is being offered at very keen prices.

Mains Transformer, drop through chassis type, 250-0-250 v., at 80 mA, 6.3 v., at 2 amps, 12/6, plus 2/6 post.

Mains Transformer, drop through chassis type, 250-0-250, 80 mA, 6.3 v., 2 amp. 5 v. 10 amp., 15/-, plus post 2/6.

Filament Transformer, Upright mains type, 6.3 v., 1 amp, 6/6 post 1/6.

Filament Transformer, upright Mtg. 6.3 v. 3 amp., unused, but tag panels 8/6 each, post 1/-.

Close Tolerance Mica Condensers. 50 assorted values up to 1,000 pF, 12/6.

Double Fuse Holder Panel. Mounted for standard fuses, 2/-.

Spindle Couplers for joining or extending 1/2 in. spindles, 6d each 5/- per dozen.

Octopus Clip adjustable, up to 4in. diameter, for joining hoses to poles etc., 6d each.

Torch or Radio Bulbs. 3.5 v. .3 amp or 2.5 v. .3 amp., 3/6 per box of 25.

Precision Stud Switch. Made by Muirhead, 4 banks, 24 positions each, 17/6, plus 1/6 post.

Wiring Cleats, suitable for temporary lighting, 2 groove 1/8, dozen pairs, 3 groove 2/- dozen pairs, post 2/6.

Charging Cut-out Bakelite Case, suitable 6, 12 or 24 volts, 9/6, plus 1/- post.

12 v. 5 amp. Selenium Charging Rectifier. 9/6, plus 2/- carriage.

Beginners Superbet. All components including metal chassis, valves, metal rectifier, coils, tuning condenser etc., with instructions, 42/- post 5/-.

Don't stumble in the Dark. Two way switch outfit, comprises 30 yards multicore cable. Two 2 way switches, 2 wood blocks and full instructions. Price 9/6, plus post and insurance 2/6.

Microphone miniature type, American made dynamic, size only 1 1/2 in. diameter, 2/6.

Push Switch. Spring return on porcelain block, ideal basis of foot switch for sewing machine etc., price 4/6, 1/- post.

Rotary Converter, doubles or halves car battery voltages. Thus you can have 12 v. from 6 v. battery, or v. from 12 v. battery. 24 from 12, etc. price 45/-, plus 3/6 post.

Set of I.F. Transformers for communications receiver, first class American make, 19/6 a set of 7, post 1/-.

Power Resistor, 1,000 ohm tapped at 600, 300, 75 and 75. Conservatively rated 75 watts. 4/6, post etc. 1/-.

Battery Charger or Power Pack, output variable 100-200 v., at 1/2 amp., in metal case, 27/6, post etc. 5/-.

Dashpot Delayed Contactor. American make (type No. R011), adjustment to delay opening or closing. Heavy duty contacts and secondary microswitch. Operating coil voltage 110 at 50 cycles, but can be used off 230 v. mains through step-down transformer, choke etc. Price 37/6, post etc. 2/-.

Toggle Switch, standard type, metal body. Borgis or similar good maker, 1/3 each, or 12/- dozen.

Silicon Diodes, these are okay for h.f. or i.f., and have a very high backward/forward ratio: 2/6 each, or 6 for 12/-.

Trigger Valve-gas filled type No. G240/2D on octal base. Price 9/6, post and insurance 1/6 (5).

Voltage Stabilizer type No. N82 striking volts 140, operating volt 87, regulation 5 v. at 30-180 mA. Mounted on 4 in. base. Price 6/6, plus 1/6 post and insurance.

Suppressor Condenser. Stop your drill or other appliance interfering with yours or your neighbours radio or T.V. Simple instructions 1/6 each.

Mesdrex Hearing Aid as supplied by National Health. New and in good working order. Complete with case, plugs and earphone, but not batteries. Price £3.15.0, plus 1/6 postage and insurance.

Please include enough for postage and request "Clearing Depot List", for details of many other items.

Introducing the J.B. Range of Transistors

- Try these, you will be very pleased—*
- JB1. All wave mixer (replaces OC45 etc.) .. 6/6
 - JB3. I.F. Amplifier (replaces OC44 etc.) .. 4/6
 - JB4. A.F. Driver (replaces OC81D etc.) .. 5/-
 - JB6. Output matched pair (replaces OC61 etc.) .. 13/-
- Special offer set of six matched for superhet .. 25/-
 Special offer set of four matched for Amplifier (1 watt) .. 17/-

A.C./D.C. Multimeter Kit

Ranges: D.C. volts 0-5, 0-50, 0-100, 0-50, 0-1,000 A.C. volts 0-5, 0-50, 0-100, 0-500, 0-1,000 D.C. millamps 0-5, 0-100, 0-500. Ohms 0-50,000 with internal batteries. 0-500,000 with external batteries Measures A.C./D.C. volts, D.C. current and ohms. All the essential parts including metal case, 2in. moving coil meter, selected resistors, wire for shunts, range selector, switches, calibrated scale and full instructions. Price £2/6, plus 2/6 post and insurance.



Blueprint Receiver

The Rekeney (April). All parts available for this receiver 75/-. A suitable cabinet, 25/- extra.

The Taylor Meter Model 127A

A pocket size meter but with a big scale and a sensitivity of 20,000 ohms per volt D.C., therefore an ideal unit for television servicing—robustly made and complete with leads and prods—20 ranges as follows: D.C. current 50 microamps. to 1 amp. D.C. voltages—0-1,000 volt in seven ranges (25 kV) with external probe, optional extra. Volts A.C.—0-2,500 in six ranges. Ohms—0-20 meg. ohm in three ranges (self-controlled). Self-contained, 3in. movement. Price £10 or 10/- deposit and 23 fortnightly payments of 10/-. Non-callers add 2/- carriage and insurance.

Transistor Set Cabinets



Very modern cream cabinet, size 5 1/2 x 3 x 1 1/2 in. with chrome handle, tuning knob and scale. Price 7/6, plus 1/6 postage and packing. Special quotations for quantities.

P.W. BLUEPRINT SERVICE

We try to hold stocks of parts for all the P.W. Blueprint sets, and we will be glad to help you. When ordering please mention the month of issue and the of the Blueprint set in question. Mark your order P.W. Blueprint Service.

"DIPYT" Automatic Headlamp Dimmer



A transistorised device for automatically dipping headlamps so leaving driver's hands and feet free for emergency, could easily avoid an accident. We now offer such a device ready made and tested. The unit measures 5 x 2 x 5 in. and fits under the dash, it is very easy to wire into the circuit and can also be used to control side lamps for parking. Price of unit is £10.19.6, carr. paid, diagram and instructions free with unit or separate 2/6. (Agents Wanted).

THIS MONTH'S SNIP



BREAKDOWN UNIT. Contains a mass of components, and must have cost the Government at least £20.

Contents: Over 50 paper tubular and mica condensers values up to .05 mfd. Over 50 carbon resistors, various wattages and values—6 Yaxley switches—6 I.F. transformers, dust covered suitable for TV or rewinding—7 octal valve holders. Many useful sundries—chokes, valve top clips, tag boards, plugs switch, springs, etc., weighs 6lb. Secure one of these whilst stocks last, price only 9/8, plus 3/6, postage and packing.

TRANSFILTERS

These ceramic devices save alignment problems and improve performance. Use instead of I.F. transformer. Complete with circuit, 8/6 each.

PHILCO RECORD PLAYER CABINET



Two tone, covered with high grade rexine, fitted with rubber feet. The front is particularly nice being made of tygan with a horizontal gold bar. Size approximately 14 1/2 in. wide, 8 1/2 in. deep, 16 1/2 in. long. Will take BSR or similar record player or tape deck and amplifier. Must have cost at least £3 each, our special

snip price 35/- each, carriage and insurance 6/6.

11" WALLCLOCK

Ex G.P.O. impulse operated, in good working order.

Bargain at 15/- plus 4/6. post and insurance.



Component Storage Drawers

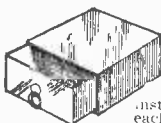

Stout board construction, these drawers are ideal for small parts. Supplied complete with simple erection instructions—1/6 each or 12 drawers each 6 x 2 1/2 x 6 1/2 in., 13/6, post 2/-.

Yaxley Switches

All new and unused and in first class condition

- | | |
|-----------------------------|---------------------|
| 1 pole, 2 way 1/8; | 1 pole, 3 way 1/6 |
| 1 pole, 4 way 1/8; | 1 pole, 5 way 2/6 |
| 1 pole, 7 way 3/-; | 1 pole, 9 way 3/- |
| 1 pole, 11 way 3/-; | 1 pole, 12 way 3/3 |
| 2 pole, 2 way 2/-; | 2 pole, 4 way 2/6 |
| 2 pole, 5 way 3/6; | 2 pole, 6 way 3/6 |
| 2 pole, 12 way 3/6; | 3 pole, 3 way 2/- |
| 3 pole, 6 way 3/6; | 3 pole, 12 way 8/6 |
| 4 pole, 2 way 2/-; | 4 pole, 3 way 3/6 |
| 4 pole, 4 way 3/6; | 4 pole, 5 way 4/6 |
| 4 pole, 6 way 5/6; | 4 pole, 11 way 10/6 |
| 4 pole, 12 way 11/6; | 5 pole, 3 way 3/6 |
| 5 pole, 6 way 7/-; | 5 pole, 12 way 14/6 |
| 6 pole, 2 way 2/6; | 6 pole, 3 way 3/6 |
| 6 pole, 6 way 8/6; | 6 pole, 11 way 16/6 |
| 6 pole, 12 way 17/6; | 8 pole, 2 way 3/6 |
| 8 pole, 4 way 4/6; | 8 pole, 6 way 11/6 |
| 8 pole, 12 way 22/6; | 12 pole, 2 way 8/6 |
| 12 pole, 5 way 18/6; | 12 way fader 3/6 |
| 6 pole, 6 way, shorting 3/6 | |

Big stocks of most types
 Special prices for quantities.

Blueprint Receiver

The International SW2

All components to make up this receiver as described in the April issue are available. Price 39/6, plus 2/6 postage and insurance. Note this price does not include cabinet, baking tin or headphone.

Motor with blower attached

24 volts D.C., but will work on 12 volts. For cooling equipment or can be adapted as car heater. 15/- plus 1/6.

Rotary Converter

24 volts D.C. to 230 volts, 50 cycle A.C. with automatic regulator, this is complete in a grey steel case for silent running and it is rated 100 watts though this is a Navy rating, which usually can be considerably exceeded. Ideal to operate TV set on boat, etc. These are big units and can only be viewed by prior arrangement. Price £27.10.0 each, carriage at cost.

Morganite Potentiometers

Single and 2-gang types available. standard size with good length spindle. All new and boxed. Single types, 1/- each, values available: 5K, 10K, 25K, 50K, 100K, 250K, 1 meg., 2 meg. Gang type 3/- each—values available: 5K+5K, 10K+10K 1/2 meg. + 1/2 meg. 2 meg. + 2 meg.

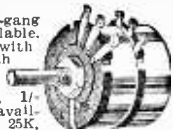

Infra Red Monocular Equipment

This is portable equipment, made originally for military use. It is a complete viewing device, having an infra red cell with optical lens system and Zambini pin to provide the E.H.T. Complete with leather case for easy carrying, these devices are sold in their sealed packages as collected from the Ministry, and they must not be opened during the daylight. Sold as received, believed to be in good working order, but without guarantee. Price £4.10.0, plus 5/- carriage and insurance.

Transistor Components

Send S.A.E. for our new price list, just printed.

ELECTRONIC PRECISION EQUIPMENT LTD.

post orders are dealt with from Eastbourne, so for prompt attention please post your orders to 66 Grove Road, Eastbourne, marked Department 7. Callers may use any one of the Companies below.

| | | | | |
|---|---|---|--|--|
| 266 London Road, Croydon. Phone: CRO 6558. Hall day Wednesday | 29 Strand Green Rd., Finsbury Park, N.4. Phone: ARChway 1049. Half day Thursday | 520 High Street North Manor Park, E.12. Phone: LLFord 1011. Half day Thursday | 42-48 Windmill Hill, Ruislip, Middx. Phone: RUISlip 5780. Half day Wednesday | 246 High Street, Harlesden, N.W.10. Phone: ELGar 4444. Half day Thursday |
|---|---|---|--|--|

BENTLEY ACOUSTIC CORP. LTD.

38 CHALCOT ROAD, CHALK FARM, LONDON, N.W.1
Telephone PR11970-3090.

Express postal service. All orders despatched same day as received. Immediate despatch of C.O.D. orders if telephoned before 3.30 p.m.

| | | | | | | | | | |
|------------|-------|------------|-------|------------|-------|--------|-------|--------|-------|
| OZ4GT | 5/- | 20L1 | 27/2 | ECC35 | 8/6 | EV51 | 9/- | U18/20 | 8/6 |
| IL4 | 3/8 | 20P1 | 27/2 | ECC40 | 23/10 | EV83 | 17/- | U19 | 48/6 |
| IR5 | 6/8 | 20P2 | 28/10 | ECC41 | 6/- | EV96 | 9/- | U22 | 57/- |
| IR1 | 9/- | 20P4 | 27/2 | ECC42 | 8/6 | EY40 | 8/- | U24 | 30/7 |
| IR5 | 6/- | 20P5 | 23/10 | ECC43 | 7/6 | EZ41 | 7/- | U25 | 18/5 |
| IT4 | 3/8 | 25L6G/11/6 | | ECC44 | 9/- | EZ90 | 7/- | U26 | 10/- |
| 2D21 | 15/- | 35Z4G | 9/6 | DCC85 | 8/6 | EZ81 | 7/- | U31 | 9/6 |
| 3A5 | 10/6 | 2750 | 20/5 | ECC88 | 13/- | GU50 | 41/6 | U33 | 27/2 |
| 344 | 7/6 | 30C15 | 17/- | EVP90 | 10/6 | GZ33 | 20/5 | U35 | 27/2 |
| 384 | 7/6 | 30F5 | 6/- | EVP92 | 10/6 | GZ34 | 14/- | U37 | 27/2 |
| 3V4 | 7/6 | 30F11 | 10/- | ECP96 | 20/5 | HN309 | 25/3 | U43 | 13/6 |
| 5R4GY | 17/6 | 30L15 | 11/6 | ECP90427/2 | | HVR2 | 20/- | U76 | 6/- |
| 5U4G | 6/6 | 30P4 | 15/- | EVH42 | 9/6 | HVR2A | 6/- | U107 | 17/- |
| 5V3G | 10/- | 30P12 | 12/6 | EVH41 | 9/- | KT353 | 10/- | U191 | 17/- |
| 5Z3 | 20/5 | 30P11 | 10/6 | EVH93 | 14/3 | KT39 | 30/7 | U201 | 17/- |
| 6Z4 | 9/- | 30P13 | 12/6 | EVLS9 | 9/- | KT65 | 15/- | U281 | 20/5 |
| 6AT1 | 7/- | 35Z3 | 19/1 | EVLS2 | 10/6 | KT88 | 43/- | U282 | 23/2 |
| 6BA5 | 7/6 | 35Z4GT | 6/- | ECL83 | 19/9 | KT101 | 34/- | U301 | 23/10 |
| 6B25 | 6/- | 35Z5GT | 9/- | ECL86 | 17/- | M114 | 8/- | U329 | 14/- |
| 6B48 | 9/- | 88Z2 | 18/- | EP39 | 4/- | N77 | 23/10 | U359 | 9/6 |
| 6B16 | 6/- | 90AG | 67/6 | EP38 | 5/6 | N108 | 23/10 | U403 | 17/- |
| 6BQ7A | 15/- | 90AV | 67/6 | EF39 | 5/6 | N308 | 23/2 | U404 | 8/6 |
| 6BR7 | 12/6 | 90C1 | 18/- | EF40 | 15/- | N308 | 21/10 | U401 | 30/7 |
| 6BR8 | 19/1 | 90C2 | 37/6 | EF41 | 9/- | N339 | 15/- | U4BC90 | 9/- |
| 6BW4 | 8/6 | 150R2 | 13/- | EP42 | 10/6 | PC55 | 13/7 | U4C2 | 9/6 |
| 6BW7 | 6/- | 150E2 | 17/6 | EP50(A) | 7/- | PC84 | 8/- | UB41 | 12/- |
| 6C115 | 9/- | 185BT | 34/- | EP50(B) | 5/- | PC85 | 9/6 | UB41 | 8/6 |
| 6C1V4 | 24/- | 807 | 7/6 | EP54 | 5/- | PC88 | 13/- | UB41 | 11/5 |
| 6F1 | 27/2 | 3763 | 12/6 | EP73 | 10/6 | PC89 | 11/6 | UB80 | 9/- |
| 6F6G | 7/6 | A06PEN | 7/6 | EP85 | 6/- | PC92 | 10/6 | UC90 | 9/6 |
| 6F13 | 11/10 | AZ31 | 10/- | EP85 | 6/- | PC92 | 10/6 | UC94 | 15/- |
| 6F24 | 12/6 | AZ41 | 14/4 | EP86 | 10/6 | PC94 | 17/- | UC85 | 9/- |
| 6K25 | 20/5 | B36 | 15/- | EP89 | 9/- | PC96 | 15/- | UC90 | 17/- |
| 6L1 | 23/10 | CL33 | 19/9 | EP97 | 4/6 | PC182 | 10/- | UH42 | 9/6 |
| 6L6G | 3/- | CV31 | 11/- | EP92 | 4/6 | PC183 | 10/6 | UH61 | 9/6 |
| 6L18 | 13/10 | DAF96 | 8/6 | EP93 | 13/7 | PC184 | 9/6 | UH82 | 11/5 |
| 6P28 | 27/2 | DF66 | 15/- | EP98 | 13/7 | PC185 | 12/6 | UC83 | 19/9 |
| 6Q74 | 6/6 | DF96 | 8/6 | EP183 | 19/1 | PC186 | 17/- | UF41 | 9/- |
| 6RLGT | 8/6 | DF97 | 9/- | EP184 | 23/6 | PEN46 | 7/6 | UF42 | 12/6 |
| 6R87GT | 5/6 | DF92 | 9/- | EP804 | 23/10 | PL189 | 19/10 | UF80 | 10/6 |
| 6U34 | 7/6 | DK96 | 8/6 | EL33 | 12/6 | PL135 | 15/- | UF85 | 9/6 |
| 6V6G | 7/- | D166 | 17/6 | EL34 | 15/- | PL138 | 27/2 | UF86 | 18/5 |
| 6V6GTG | 8/- | D168 | 15/- | EL37 | 25/2 | PL1 | 10/6 | UF89 | 9/- |
| 6X1 | 5/- | D196 | 8/6 | EL38 | 27/2 | PL2 | 7/6 | UF41 | 10/6 |
| 6X5GT | 9/- | H479 | 7/6 | EL41 | 9/- | PL3 | 9/- | UL44 | 27/2 |
| 6Y301Z | 10/- | EN6P | 30/- | E42 | 10/6 | PL4 | 13/- | UL46 | 14/6 |
| 10C1 | 13/- | EB3F | 30/- | EL81 | 17/- | PL820 | 19/1 | UL4 | 8/6 |
| 10C2 | 27/2 | E180F | 34/6 | EL83 | 20/5 | PMB4 | 17/9 | UM4 | 17/9 |
| 10F1 | 27/2 | EACH80 | 9/- | EL84 | 7/6 | PX4 | 10/6 | UM34 | 17/9 |
| 10F13 | 15/- | EAF42 | 9/- | EL85 | 14/4 | PV11 | 17/- | UM80 | 15/8 |
| 10F14 | 18/6 | EB91 | 4/- | EL86 | 17/9 | PV32 | 12/6 | UR1C | 9/1 |
| 12A0C | 15/8 | EB33 | 5/- | EL95 | 10/6 | PY80 | 7/6 | UC9 | 20/5 |
| 12AD6 | 17/9 | EB34 | 8/6 | EL360 | 26/- | PY81 | 8/6 | UJ8 | 27/2 |
| 12AE8 | 14/4 | EB31 | 8/- | EL820 | 19/1 | PY82 | 7/6 | UY19 | 7/6 |
| 12AH5 | 12/6 | EBF80 | 9/- | EL821 | 27/2 | PY83 | 8/6 | UY19 | 19/1 |
| 12AT9 | 7/6 | EBF83 | 14/4 | EL822 | 19/6 | PY88 | 17/7 | Y21 | 17/7 |
| 12BA8 | 8/- | EBF89 | 9/6 | EM4 | 17/8 | PZ30 | 20/5 | UY41 | 7/6 |
| 12BE9 | 9/- | EEL3123 | 10 | EM34 | 9/6 | SP41 | 3/6 | UY85 | 7/6 |
| 12BH721/10 | | EV79 | 12/6 | EM71 | 23/10 | SP61 | 3/6 | VR105 | 9/- |
| 12K3 | 18/5 | EV81 | 27/6 | EM80 | 9/- | SP25 | 27/2 | VR150 | 7/6 |
| 12KA5 | 10/6 | EV92 | 13/7 | EM81 | 9/- | T41 | 9/- | X61 | 12/6 |
| 19H1 | 10/- | EV92 | 5/6 | EM84 | 10/6 | TK86F | 13/7 | X66 | 12/6 |
| 20D1 | 15/8 | EV33 | 8/6 | EM85 | 17/9 | U12/14 | 8/6 | X78 | 23/10 |
| 20F2 | 27/2 | EV34 | 25/3 | EN31 | 53/- | U16 | 10/- | X79 | 23/10 |

Price bid. We do not sell secondhand goods nor manufacturers' rejects.

METAL RECTIFIERS. DRM19 13/-, DRM26 and DRM33 15/6, LW7 21/-, RMO 7/11, RMI 5/8, RM2 7/6, RM3 7/6, RM4 13/-, RMS 19/6, 14A86 17/6, 14A97 25/-, 14A100 27/-, 14A124 28/-, 14A168 38/-, 14R130 35/-, 14R261 11/8, FC101 17/6, 16RC.1.1.16.1 3/6, P131 21/-, 16R.122.2.1 12/-, 16RE.2.1.1.8.1 8/6, 18RA.1.1.8.1 4/6, 18RA.1.2.1.1 11/-, FC116 6/6, PC124 15/-, LW15 25/-.

ELECTROLYTIC CONDENSERS. Can types: 32 x 32/450v. 5/2, 56 x 56/350v. 7/-, 84 x 120/350v. 8/6, 88 x 250/275v. 9/6, 100 x 400/275v. 12/6, 100/275v. 3/-, 200/275v. 4/-, 100 x 200/275v. 9/6. Tubular types: 8/450v. 1/6, 16/450v. 2/9, 32/450v. 3/8, 5 x 450v. 3/-, 16 x 16/450v. 4/-, 32 x 32/350v. 4/-, 8 x 16/450v. 3/9, P.M. SPEAKERS. 8 ohm types: 2 1/2" 17/-, 3" 15/6, 6 1/2" 17/-, 7 x 4" 15/-, 10" 27/-, 12" 29/6, 2 1/2" 80 ohms 17/6, 12" Auditorium with latest foam plastic suspension, Aluminium resistant frame - 15 ohms £2.8.0, 12" Quality type. Hand Assembled. Very sensitive. Handles 15 watts, 15 ohms, £5.5.0. Post 2/- each.

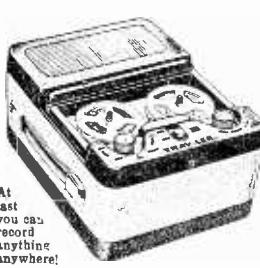

At last you can record anything anywhere!

SENSATIONAL OFFER!
Brand new, fully portable transistor tape recorders. Size 10 x 8 x 5 in. Weight 9 lbs. Playing time 44 mins. Battery life 50 hours. Rewind time 2 1/2 mins., 7 x 4 in. high-flux speaker. Recorder switch. Pause control. All the features of a full size machine. Complete with tape and dynamic microphone. Reduced from £30 to only 16/- gns. Batteries 10/6 extra.

Post/packing charges 6d. per item except where stated. Orders over £3 post free. C.O.D. 2/6 extra. Shop hours 8.30-5.30. Sats. 1 p.m. Any parcel insured against damage in transit for only 6d. extra.

COMPLETE TELEVISIONS

17 in. £11.10.0 14 in. £7.10.0

- ★ Ex Rental and repossessed Televisions.
- ★ Tube guaranteed 12 months.
- ★ Valves, Components and chassis guaranteed 3 months.
- ★ ITA/BBC. Any two selected Channels.
- ★ Maintained to Rental standards.
- ★ Demonstrations daily—10 a.m. to 6 p.m. (Thursdays 10 a.m. to 1 p.m.)



Personal Collection advised, special delivery by arrangement, B.R.S. (Ins., Carr. on quotation).



TV TUBES

12 months' Guarantee

21 in. 99/6
17 in. 90/-
15, 14, 12 in. 70/-

£1 extra without old bowl, refundable if same received within 14 days. Insurance and Carriage 15/6

14 in. 36-24 and 14KP4 **35/-**
Salvage purchase of Rental replacement stocks. Carriage 5/-

DUKE & CO. (London) Ltd. 621/3 ROMFORD RD. MANOR PARK, E12
Stamp for Free List ILFord 6001/3

"There is no Virtue without Courage— No Reward without Labour"

Not simply a school motto but at B.N.R.S. a creed and a way of life. We owe to it all we have and are. If you are prepared to make it your motto and live up to it, we can help you get to the top. It will take time, it will take effort, it will take courage, and as if this were not enough, YOU WILL ACTUALLY BE CHARGED FEES!

If we haven't succeeded in putting you off, write for details, 'oday, to:

Mr. J. SYKES
(M.I.E.E., M. Brit. I.R.E., M.J.N.)

Principal:
BRITISH NATIONAL RADIO SCHOOL
Red Lion Court, Stalbridge, Dorset.

Britain's premier Radio Correspondence School
specialising in City and Guild's examinations.

UNIVERSAL AVOMETERS

Guaranteed perfect working order. Supplied complete with Leads, Batteries and Instructions.
 Model "D", 34 range... £8.19.6
 Model "7", 50 range... £11.10.0
 Model "8", 20,000 Ω/volt model... 15 Gns.
 Registered Post 5/- extra.

SET OF S.T.C. TRANSISTORS
 1 R.F., 2 x I.F., 1 driver, 2 x output plus GD17 diode. Brand New, 19/6. P & P 9/-

MINE DETECTORS No. 4A
 Will detect all types of metal. Complete equipment with instructions. 39/6. Carr. 10/6. Batteries 5/- extra.

AUTO TRANSFORMER
 Step Up, Step Down, 115-200, 250 volts. 15 w. 9/-; 60 w. 12/6; 150 w. 18/6; 500 w. 67/6; 1000 w. 99/6. Postage extra. 1500 w. £8.19.6.

Class D. WAVEMETERS No. 2
 Frequency coverage 1.2-19.2 Mc/s. Operation 12 volt D.C. or 230 volt A.C. Complete with valves, crystal and calib. charts (Like BC221). Complete with valves, crystal £8.19.6. Carriage 10/-.

230/250 volt A.C. MOTORS
 Size 4 1/2 in. x 3 in. dia. 90 watt rating, 5,000 r.p.m. 1/2 in. drive shaft. Brand New. 22/8 each. P & P 1/6.

SELENIUM L.T. RECTIFIERS
 Full wave bridge connected.
 12/18v. 11A. 3/9 24/36v. 2A. 9/9
 12/18v. 21A. 6/3 24/36v. 4A. 15/9
 12/18v. 4A. 8/6 24/36v. 10A. 45/-
 12/18v. 5A. 11/9 24/36v. 15A. 47/6
 12/18v. 6A. 12/3 48/60v. 2A. 18/6
 12/18v. 10A. 22/6 48/60v. 10A. 82/6
 12/18v. 15A. 37/6 PLEASE ADD
 24/36v. 1A. 7/3 POSTAGE.

L.T. TRANSFORMERS
 All Primaries tapped 200/250 volts. 3.5, 9 or 17 volts. 1 amp... 9/9
 Ditto 2 amp, 12/3. Ditto 3 amp, 18/6
 9 or 17 volt, 6 amp... 26/-
 3, 4, 5, 6, 8, 10, 12, 18, 20, 24 or 30 volt, 2 amp... 18/6
 Ditto 1 amp... 27/6
 Please add postage.

PARMEKO TABLE TOP TRANSFORMER
 230v. Primary. 0-20-0-500v. 250 mA. tapped 550 and 375v. 2 x 5v. 3 amp. 45/- each. P & P 5/-.

PAINTON MINIATURE JONES PLUGS/SOCKETS
 2 pin. 2/6 pr.; 4-pin. 3/6 pr.; 6-pin. 4/- pr.; 8-pin. 4/6 pr.; 12-pin. 5/6 pr.; 33-pin. 10/6 pr. Postage extra.

G.E.C. SELECTEST MULTI-RANGE TESTMETERS



1,000 ohms per volt. 37 ranges. A.C./D.C. Fitted with automatic cut out. Supplied in perfect condition. Complete with batteries and leads. £9.19.6 each. Reg. Post 5/- extra.

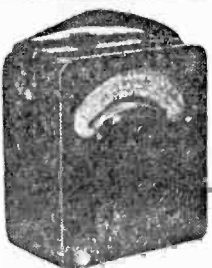

R.C.A. AR88 L.F. RECEIVERS
 World famous 14 valve receiver. Frequency coverage on six bands 75-550 kc/s and 1.5-30 Mc/s. Variable selectivity, crystal, B.F.O., mechanical bandspread, noise limiter, etc. operation 110/200/250V A.C. output for phone or 3Ω speaker. Supplied in perfect working order. £32.10.0 ea. Carr. 30/-.

NATIONAL H.R.O. RECEIVERS
 Sentor Model, table or rack mounting. Supplied with a full set of 9 coils covering 50kc/s-30Mc/s. Special features include: S meter, crystal phasing, B.F.O. etc. Output for phones or speaker. Supplied fully tested, superb condition throughout. 21 Gns. Carr. 10/- . Power units available 59/6 extra.

R.206 MARK II RECEIVERS
 Superb Receivers covering 550 kc/s-90 Mc/s on 6 bands. B.F.O. variable bandwidth, noise limiter, etc. Output for speaker or phones. Power requirements 250v. H.T., 12v. L.T. Supplied brand new and fully tested. £15 each. Carriage £2 extra.

CLASS "D" WAVEMETERS MK. II
 Frequency coverage, 1,900-4,000 kc/s and 4,000-8,000 kc/s. 6 volt D.C. input. Supplied complete with crystal and spare 6 volt vibrator. Brand New with instructions. 59/6 each. P & P 3/6.

COLLARO STUDIO TAPE TRANSCRIPTORS
 Very latest model with interlock button and fitted with Bradmatic heads, 3 speeds, 14", 3 1/2", 7 1/2" per sec., 3 motors, digital counter, press button switching. Complete with instructions and spare 7-inch spool. Supplied Brand New and Guaranteed. 10 Gns., each. P & P 3/6.

FIELD TELEPHONES TYPE F
 Ideal for all Intercom. systems, house, garage, office building sites, etc. Generator bell ringing, 2 line connection. Supplied complete with batteries and wooden carrying case, fully tested. £4.19.6 per pair. P & P 3/-.

COMBINATION PRECISION VOLTMETER/AMMETER
 A.C. and D.C. 2 separate precision instruments housed in polished wood case. Manufactured by Elliott Bros. 8in. scales, knife edge pointers, Ranges: Volts A.C. and D.C. 160, 300 and 600 volts. Amps A.C. and D.C. 25, 50, 150 and 200 amp. Supplied with all current shunts, leads and leather carrying case. Ideal for labs, schools, etc. Brand New, fully checked. £9.19.6 each. Carriage 7/6.

TRANSISTOR BARGAINS
 XA103 3/6 XA123 7/6 OC45 6/6 White Spot 3/-
 XA104 4/6 XA124 7/6 OC44 6/6 Yellow Spot 2/6
 XB112 3/- XA125 7/6 OC75 6/6 Yellow Green 3/-
 XC141 10/- XA126 7/6 OC74 pr.12/6 Yellow/Red 4/6
 Please add postage.

R.C.A. AR88D RECEIVERS
 14 valves. Frequency coverage on 6 bands 550 kc/s-32 Mc/s. Variable selectivity, crystal, B.F.O., mechanical bandspread, noise limiter, etc. Operation 110/200/250 volt A.C. Output for phone or speaker. £35 each. Carriage 30/-.

C.B.S. AMERICAN RECORDING TAPE
 Finest quality by the most famous American Co. All fitted with Leader Tape and Stop Roll.
 5in. std. play. 600ft. . 13/- 5in. dbie. play. 1800ft. . 37/-
 5in. long play. 300ft. . 18/6 7in. std. play. 1200ft. . 21/-
 5in. dbie play 1200ft. . 32/- 7in. long play. 1800ft. . 28/6
 5in. long play. 1200ft 19/6 7in. dbie play. 2400ft. . 47/-
 Spare Spools: 3in. 1/-, 4in. 1/9, 5in. 2/-, 5in. 2/3, 7in. 3/6.
 Plastic Spool Containers: 5in. 1/6, 5in. 2/-, 7in. 2/3.
 SEND FOR FULL LISTS. Please add postage.

COLLINS T.C.S. RECEIVERS
 Superb 7 valve short wave receivers. Frequency coverage on 3 bands 1.5-12 Mc/s. Circuit incorporates B.F.O., R.F. and A.F. gain controls, etc. Power requirements 225 v. H.T., 4 v. L.T. Supplied brand new with circuit. £8.19.6 ea. Carr. 7/6.

P.C.R. COMMUNICATION RECEIVERS

6 valves. Frequency coverage on three bands: 850-2,000 metres, 180-550 metres, 6-18 Mc/s. Super slow motion drive, A.E. trimmer, tone control, built-in speaker. AS NEW £8.19.6. Carriage 7/6.

P.C.R.3 Communications Receiver. 190-550 metres, 2-7 Mc/s. 7-23 Mc/s. Output for phone or 3Ω speaker AS NEW 8 Gns. Carr. 7/6. Both above models are available with internal power unit to operate on 200/250 volt A.C. at 39/6 extra or alternatively plug-in external power units are 35/-.

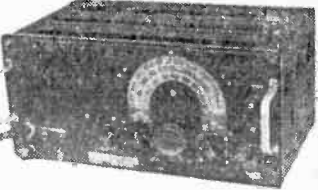

Circuit and details supplied.

SET OF MULLARD TRANSISTORS
 1xOC4, 2xOC45, 1xOC81D, 2xOC81. Brand New, 30/- . P & P 9/-.

CADMIUM SULPHIDE PHOTOCELLS
 Type PX1/1. Sub-miniature, wire ended. Extremely sensitive. 12/6 each. P & P 6d. Data supplied.

PERSONAL EARPHONES
 Complete with Lead, Jack and Plug. Available High (crystal) or Low (mag.) Imp. 5/- each. P & P 6d.

CR.100 SPARES KITS
 Contain 15 valves, condenser and resistor packs, pots, output transformer, etc. Brand New, 59/6 each. P & P 3/6.

24 D.C. volt PUMPS
 100 G.P.H. Impeller type. 15/6 each. P & P 2/6.

B.T.H. 18-inch SPEAKERS
 Heavy Duty type, 15 ohm speech coil. £9.19.6 each. Carriage 10/-.

PRECISION A.C./D.C. VOLTMETERS
 0-160v. and 0-320v. 8in. mirror scale with knife edge pointer. Housed in polished wooden cases, ideal for schools, labs., etc. Supplied brand new. £5.19.6 each. P & P 3/6.

AR88D SPARES
 Complete Wavechance Switch Assembly with Screens, New, Boxed 17/6 each. P & P 2/6. 1st I.F. Transformer, Boxed, 3/6. P & P 9d.

1,000 watt ISOLATION TRANSFORMERS
 230 volt Primary, 230 volt Secondary, Ex-Admiralty. Boxed, £5 each. Carriage 10/-.

7.5 kVA AUTO TRANSFORMER
 Step Up, Step Down, 115-230 volts. Brand New. Boxed. £15 each. Carriage 10/-.

20,000 O.P.V. TESTMETERS
 A.C. and D.C. voltage up to 1000 v. D.C. Current up to 500 mA.



Resistance up to 5 megohm. Capacitance up to 0.1 mFd. Decibels -20 to +30. Brand New. Guaranteed. Supplied with Leads, Battery and instructions. 5 Gns. each. P & P 2/6.

GW SMITH & CO (RADIO) LIMITED
 Phone GERRARD 8204/9135
 Cables: SMITHEX LESQUARE
 3-34 LISLE STREET, LONDON, W.C.2

ARMSTRONG AF208 AM/FM RADIOGRAM CHASSIS

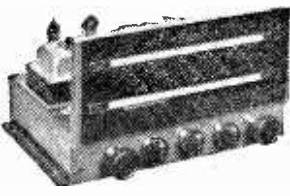

★ Full VHF Band (87-108 Mc/s and Medium Band, 187-570M) ★ 7 Valves ★ 5 Watts Output ★ 15db Negative Feedback ★ Separate wide range Bass and Treble Controls ★ 2 Compensated Pick-up Inputs ★ Frequency Response 30-22,000 c.p.s. ±2db ★ Tape Record and Playback Facilities ★ Continental Reception of Good Programme Value ★ For 3, 7 and 15 ohm speakers. Send S.A.E. for leaflet.

PRICE 22 GUINEAS Carr. Free

LATEST "EMI" 4 SPEED SINGLE RECORD PLAYER

Acos Hi-Fi Pick-up for L.P. and/or 7 1/2, 10 and 12in. records. Silent motor, heavy turntable, auto stop. Complete on Baseplate.

Special offer **£6.5.0** post free.

or with Stereo/Monaural pick-up **£8.10.6.**

SINGLE-PLAYER BARGAIN

Ready-built, complete with BSR TU9 4-speed gram pick-up unit. Handsome portable case. 3-watt amplifier with 2 valves and speaker. List price **£12.12.0.** OUR PRICE **£8.19.6.** Fully guaranteed in manufacturer's sealed cartons.

New Boxed VALVES 90-day Guarantee

| | | | | | | | |
|-------|-----|-------|------|--------|------|--------|------|
| 1R5 | 7/6 | 6AK9 | 7/6 | EA50 | 1/8 | EZ90 | 7/8 |
| 1R5 | 7/6 | 6AL6 | 10/6 | EACB80 | 5/8 | E1148 | 1/8 |
| IT4 | 6/- | 6N7M | 6/8 | EB91 | 6/- | HBAC80 | |
| 2X2 | 3/6 | 6Q7G | 8/8 | ECB33 | 9/8 | | 12/8 |
| 3S4 | 7/6 | 6SA7 | 6/8 | EBC41 | 9/6 | HV124 | 9/6 |
| 3V4 | 7/6 | 6BS7M | 6/8 | EBF80 | 10/- | MU14 | 8/- |
| 5U4 | 7/6 | 6N8T | 6/8 | EEC84 | 9/6 | PCC84 | 9/6 |
| 5Y3 | 7/6 | 6V6G | 6/8 | EECF80 | 9/6 | PCF80 | 9/6 |
| 5Z4 | 9/8 | 8X4 | 7/8 | ECH92 | 10/8 | PCL82 | 11/8 |
| 6A3M6 | 5/- | 6X5 | 6/8 | ECL80 | 10/8 | PEN28 | 8/8 |
| 6R8 | 5/- | 12A6 | 7/6 | ECL82 | 10/8 | PL82 | 12/8 |
| 6BE6 | 7/6 | 12AT7 | 8/- | EF39 | 5/8 | PL82 | 10/8 |
| 6BE6 | 7/6 | 12AU7 | 8/- | EF41 | 9/6 | PL80 | 7/8 |
| 6BW6 | 9/8 | 12AX7 | 8/- | EF50 | 5/8 | PV81 | 9/8 |
| 6D8 | 8/- | 12BE6 | 8/6 | EP80 | 8/- | PY82 | 7/8 |
| 6P8 | 7/6 | 12K7 | 6/8 | EP86 | 12/8 | SP61 | 8/8 |
| 6H6 | 3/6 | 12Q7 | 6/8 | EP92 | 5/8 | UBC41 | 9/8 |
| 6J5 | 5/6 | 35L6 | 9/8 | EL32 | 5/8 | UCH42 | 9/8 |
| 6K6 | 5/6 | 35Z4 | 7/8 | EL41 | 9/8 | UF41 | 9/8 |
| 6W7G | 8/6 | 80 | 9/8 | EL84 | 8/8 | UL41 | 9/8 |
| 6K6GT | 6/8 | 80T | 5/8 | EY51 | 9/8 | UY41 | 8/8 |
| 6K7G | 5/- | 954 | 1/8 | EZ40 | 7/8 | UZ2 | 8/- |

SETS OF VALVES

| | | | | |
|---------------------------------|---------|------|---------|------|
| DK96, DF96, DAF96, DL96 | 8/6 | each | or 27/8 | set. |
| 1R5, 1T4, 1R5, 3S4 | or 3V4 | | | 18/8 |
| 6KA, 6K7, 6Q7, 6V6, 5Z4 | or 6X5. | | | 27/8 |
| ECH42, EF41, EBC41, EL41, EZ40. | | | | 37/8 |
| ECH81, EF80, EBC81, EL4, EZ80. | | | | 39/8 |
| 12K3, 12K7, 12Q7, 35L6, 35Z4. | | | | 35/- |

NEW ELECTROLYTICS

FAMOUS MAKES

| TUBULAR | TUBULAR | CAN TYPES | TYPES |
|---------|---------|------------|-------|
| 1/350V | 2/- | 50/350V | 5/8 |
| 2/350V | 2/3 | 100/25V | 5/8 |
| 4/450V | 2/3 | 250/25V | 5/8 |
| 8/450V | 2/3 | 500/12V | 5/8 |
| 16/450V | 3/- | 8+8/450V | 5/8 |
| 32/450V | 3/6 | 8+16/450V | 5/8 |
| 25/25V | 1/8 | 8+16/450V | 5/8 |
| 50/25V | 2/- | 16+16/450V | 4/8 |
| 50/50V | 2/- | 32+32/350V | 4/8 |
| | | 4/8 | 11/8 |
| | | 4/8 | 12/8 |

COMPLETE RADIO £4.19.6 post free



4 Mullard valves, 5in. speaker, frame aerial. 4 pre-set stations. 1 long, 3 med. wave. Superhet circuit. H.R. AND L.W. Size 9 x 6 x 5 1/2 in. high. Tested by us ready for use. 200/250 v. A.C.-D.C. Mains.

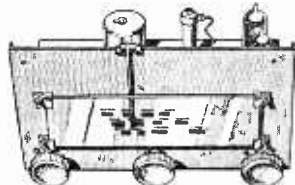

DE LUXE MODEL as above but with illuminated dial. Fully tunable over Medium and Long Wave. 5 inch speaker. Bargain £5.19.6, post free. Tested by us before despatch.

MAINS TRANSFORMERS 200/250 v. A C

| | |
|--|------|
| Postage 2/- each transformer. | |
| STANDARD, 250.0-250, 80 mA, 6.3 v. 3.5 a. | |
| tapped 4 v. 4 a. Rectifier 6.3 v. 1 a. 5 v. 2 a. or 4 v. 2 a. 22/8, ditto, 350.0-350 ... | 29/8 |
| MINIATURE 200 v. 20 mA, 6.3 v. 1 a. ... | 10/8 |
| MIDGET, 220 v. 45 mA, 6.3 v. 2 a. ... | 15/8 |
| SMALL, 220.0-220, 50 mA, 6.3 v. 2 a. ... | 17/8 |
| STD., 250.0-250, 65 mA, 6.3 v. 3.5 a. ... | 17/8 |
| HEATER TRANS. 6.3 v. 1j amp. ... | 7/8 |
| Ditto, tapped sec. 2, 4, 6.3 v., 1j amp. ... | 8/8 |
| Ditto, sec. 6.3 v. 3 amp. ... | 10/8 |
| GENERAL PURPOSE LOW VOLTAGE, 2 amp 3, 4, 5, 6, 8, 9, 10, 12, 15, 18, 24, 30 v. ... | 22/8 |
| AUTO TRANSFORMERS, 150 v. ... | 22/8 |
| 9, 12, 200, 230, 250 v. 500 mA. ... | 22/8 |
| MULLARD "510" Mains transformer ... | 30/- |

O.P. TRANSFORMERS. Heavy Duty 50 mA. 4/6. Multitap, push-pull, 7/6. Ditto, 10 w. 15/6. Miniature, 394m etc, 5/8. L.F. CHOKES 15/10H. 60/65 mA, 5/- 10 H. 85 mA, 10/6; 10 H., 130 mA, 14/-

TELEVISION REPLACEMENT

Line Output Transformers from 45/- each, New Stock and other timebase components. Most makes available. S.A.E. with all enquiries.

FULL WAVE BRIDGE SELENIUM RECTIFIER: 2, 6 or 12 v. 11 amp., 9/8; 2 a., 11/3; 4 a., 17/8. CHARGER TRANSFORMERS. Tapped input 200/250 v. for charging at 2, 6 or 12 v., 11 amps., 15/6. 2 amps., 17/8; 4 amps., 22/8. Circuit included. 4 AMP CAR BATTERY CHARGER with amp meter Leads, Fuse Case, etc., for 6 v. or 12 v., 69/8.

BOOKS list S.A.E.

40 Circuits for Germanium Diodes 3/- "W.W." Radio Valve Data, 6/- High Fidelity Speaker Enclosure, 5/- Valve and TV Tube Equivalents, 9/6 TV Fault Findin', 5/- Quality Amplifiers, 4/6 Radio Valve Guide, Books 1, 2, 3 or 4, 5/- each. Transistor Superhet Receivers, 7/6. Practical Radio Inside Out, 3/6. Master Colour Code Chart, 1/6. Transistor Controlled Models, 7/6.

C.R.T. BOOSTER TRANSFORMERS

For Cathode Ray Tubes having heater cathode short circuit, and for C.R. Tubes with failing emission. Full instructions supplied. Type A. Optional 25% and 50% Boost. 1V or 4V or 6.3V or 10.8V or 13.5V. Mains input. 12/6

LOUDSPEAKER P.M. 3 OHM. 2 1/2, 3, 4in. 19/6. 5in. Rola, 17/8; 5in. Plesey, 19/6; 7in. x 4in. Rola, 18/-; 4 1/2in. Rola, 18/6; 10 x 6in. 27/8; 10 in. Rola, 30/-; 4in. Tweeter, 25/-; 12in. R.A. 30/-; 13 1/4 8in., 45/- STENTORIAN HF1012. 10in. 3-15 ohms, 10 w., 95/-

BAKER SELHURST LOUDSPEAKERS

Details S.A.E.

12in. Baker 15 W. Stalwart 3 or 15 ohms, 45-13,000 c.p.s. ... 90/-
12in. Baker Stalwart, foam suspension, 15 ohms, 40-13,500 c.p.s. ... 26
12in. Stereo, Foam Suspension 12w., 35-16,000 c.p.s. ... £6.17.8
12in. Baker Ultra Twelve, 20 c.p.s. to 25 kc/s. £12.10
15in. Auditorium, 35 w., Bass. 20 c.p.s. to 12 kc/s. £15



TWIN GANG TUNING CONDENSERS.

365 pF miniature lin. x 1 1/2 in. x 1 1/2 in., 10^-, 500pF Standard with trimmers, 9/-; midget, 7/6; with trimmers, 9/- SMALL 3 gang 500 pF, 17/- SINGLE 25 pF, 100 pF, 160 pF, 5/6. Solid dielectric 100, 300, 500 pF, 3/6. CONDENSERS. New stock. 0.001 mfd., 7 kV; T.U.C.C. 5/8; Ditto, 20 kV, 9/8; 0.1 mfd., 7 kV, 9/8. Tubular 500 v. 0.001 to 0.05 mfd., 8d., 0.1, 1/-; 0.25, 1/8 0.3/500 v., 1/8 0.1/330 v., 8d. 0.1/2,000 v. 0.1/1,000 v., 1/8 0.1 mfd., 2,000 volts, 3/6. CER. MIC CONDENSERS. 500 v. 0.3 pF to 0.01 mfd., 9d. SILVER MICA CONDENSERS. 10% 5 pF to 500 pF, 1/-; 600 pF to 3,000 pF, 1/8. Close tolerance (± 1 pF) 1.5 pF to 47 pF, 1/8. Ditto 1% 50 pF to 815 pF, 1/8; 1,000 pF to 5,000 pF, 2/-.

465 kc/s SIGNAL GENERATOR

Total cost 15/- Uses B.F.O. Unit. ZA 30038 ready made. POCKET SIZE 2 1/2 x 4 1/2 in. Slight modifications required, full instructions supplied. Battery 7/6 extra 69V 1 1/2V. Details S.A.E.

Wavechange Switches. 2 p. 2-way, 3 p. 2-way, short spindle, 2/8; 2 p. 4-way, 2 wafers, long spindle, 6/8; 2 p. 6-way, 4 p. 2-way, 4 p. 3-way, long spindle, 3/6; 6 p. 4-way, 1 p. 2-way, long spindle, 3/6.

Wavechange "MAKITS". Wafers available: 1 p. 12 wafers, 3 p. 6 wafers, 3 p. 4 wafers, 4 p. 3 wafers, 6 p. 2 wafers, 1 wafers, 8/6; 2 wafers, 12/8; 3 wafers, 16/-; additional wafers up to 14, 3/6 each extra.

TORGE Switches, s.p., 2/-; d.p., 3/6; d.p.t.d., 4/-; Ex. Govt. s.p.d.t., 1/-.

CRYSTAL MIKE INSERT

Precision engineered. Size only 1 1/2 in. dia. x 1 in. ACOS CRYSTAL MIKE 40 .. 25/- DE LUXE STICK MIKE .. 35/-

Valveholders. Pax. int. oct., 4d. EA50, 6d. B12A, CRT, 1/3, Engl. and Amer. 4, 5, 6 and 7 pin, 1/-, MOULDED Mazda and int. oct., 6d.; B7C, B8A, B8C, B9A, cd. B7C with can, 1/6; B9A with can, 1/9. Ceramic EP30, B7C, B9A, int. oct., 1/-; B7C, B9A cans, 1/- each.

THE ORIGINAL RADIO COMPONENT

Our written guarantee with every purchase. Bus 133 or 68 pass door S.R. Station Selhurst

Volume Controls 80 ohm CABLE 6d.yd.
 5 K ohms to 2 Meg. 40 v.s. 17/6
 No. sw. D.P.S. 10 v.s. 2/6
 3/4 4/6 Fringe quality 1/- yd.
 Linear or Log Tracks. Air spaced.

TELESCOPIIC CHORIE AERIALS. 13in. extending to 43in. 8/6 ea. Coax Aiator Plug, 1/6 extra.
TRIPLEKERS Bands I, II, III 12/6
COAX PLUGS LEAD SOCKET... 2/6
PANEL SOCKETS 1/- **OUTLET BOXES** 4/6
BALANCED TWIN FEEDER yd. 6d. 80 or 300 ohms.
DITTO SCREENED par yd. 1/6. 80 ohms only.
WIRE-WOUND POTS, 5 WATT. Pre-set 3in. TV Types. All values 10 ohms to 25 K. 3/- ea. 30 K. 50 K. 4/-. (4000 30 K. to 2 meg., 8/-).
WIRE-WOUND 4 VALVE POTS. Lon. spindle. Values, 30 ohms to 50 K., 6/8. 100 K. 7/6.
PHILIPS TRIMMERS, 0-10 pF. 3-30 pF. 1/-
TRIMMERS, Ceramic, 30, 50, 70 pF. 9d., 100 pF. 150 pF. 1/3; 250 pF. 1/6; 500 pF. 750 pF. 1/9.
TRIMMER, 1000 pF. with knob. 2/-.
RESISTORS, Preferred values. 10 ohms to 10 meg., 1 w., 4d.; 1 w., 4d.; 1 w., 6d.; 1 w., 8d.; 2 w., 1/-; 5 w., 1/6.
PRECISELY STABLE 10 to 10 meg. Ditto 5%, 100 to 5 meg., 9/-
5 watt { **WIRE-WOUND RESISTORS** } 1/3
10 watt { 25 ohms—10,000 ohms } 1/6
15 watt { } 2/-
12.5K to 50K 10 w 3/-

AMERICAN "BRAND FIVE" PLASTIC RECORDING TAPE

| | |
|--------------------------------------|--------------------------------|
| Double Play 7in. reel, 2,400ft. 89/- | Spare 7in. reel, 1,200ft. 37/6 |
| Long Play 7in. reel, 1,800ft. 33/6 | Reels 5in. reel, 1,200ft. 23/6 |
| 5in. reel, 900ft. 18/6 | 3in. 1/6 |
| Standard 7in. reel, 1,200ft. 25/- | 5in. 2/- |
| 5in. reel, 600ft. 16/- | 7in. 2/6 |

"Instant" Bulk Tape Eraser and Head Deluxer, 200/250 v. A.C. 27/6.

CRYSTAL SET BOOZLEY, 1/-
CRYSTAL DIODE 4/6, GEN 34, 4/-, OA81, 3/-
HIGH RESISTANCE PHONES, 4,000 ohms, 15/- pr.
SWITCH CLEANER, 1 fluid squirt spout, 4/6 tin.

HIGH GAIN TV PRE-AMPLIFIERS BAND 1 B.B.C.
 Tunable channels 1 to 5. Gain 18db. ECC84 valve. Kit price 29/6 or 49/6 with power pack. Details 6d. (PCC84 valves if preferred).
BAND III I.T.A.—Same prices.
 Tunable channels 6 to 13. Gain 17db.

Paxolin Panels, 10" x 6", 2/-
Miniature Contact Coated Rectifiers, 250V 50mA, 7/6; 250V 60mA, 8/6; 250V 85mA, 9/6; 200mA, 21/-; 300mA, 27/6.
TV etc. Silicon Sub-Min. Rectifier, 125V, 300mA, 6/6; 250V, 300mA, 14/6.
Scintium Rect., 300V 85mA, 5/-
Coils Weaire "P" type, 3/- each.
Osmor Midget "Q" type, adj. dust core. from 4/- each. All ranges.
Teletron D.W.A., L. and Med. T.R.F. with reactions, 4/-, Med. wave D.R. 3/6.
Ferrite Aerials, M., 8/9; M. and L., 12/6.
Osmor Ferrite Rod Aerials, L. and M. for transistor circuits, 10/- each.
Ferrite Rods, 8 x 1in., 3/-; 4 x 1/8in., 3/-.
H.F. Chokes, 2/6. Osmor QC1, 6/9.
T.R.F. Coils, A/HF, 7/- pair; HAX, 3/-; Repanco DR2, 4/-; DRX1, 2/6.
Radio screwdriver, 5in., 6d.
Neon Mains Tester screwdriver, 5/-
Solder Radiograde, 4d. 3d. 1lb. 5/-
Black Crackle Paint. Air drying, 3/- 1lb.

Aluminium Chassis, 18 s.w.g. Plain undrilled, 4 sides, riveted corners. Lattice fixing holes, 2 1/2in. sides, 7 x 4in. 4/6; 8 x 1in.; 5/11 x 7in.; 6/5; 13 x 9in.; 8/8; 14 x 11in.; 10/6; 15 x 14in.; 12/6; 18 x 16 x 3in., 16/6.
Aluminium Panels, 18 s.w.g., 12 x 12in. 4/6; 14 x 9in., 4/-; 12 x 8in., 3/-; 10 x 7in., 2/3; 8 x 6in., 2/-.

6 TRANSISTOR RADIO MED. & LONG WAVE KIT
 First class components to make a 6 transistor 2 wave band superhet chassis. Ideal for portable or table radio. All parts including BVA transistors, 100 pF. aerial, printed circuit, 8 1/2in. x 4 1/2in., but EXCLUDING speaker and cabinet. P. & P. 2/6. Simple instructions 1/6 (Free with kit). 35 ohm 7 x 4in. Speaker 25/- extra. **£4.50**

TV Plug-in "V" Aerial 16/6
JA.KS. English open circuit, 2/6. Closed circuit, 4/8. Grundig type, 3 pin, 1/6.
JACK PLUGS. English, 3/-; Screened 4/-, Grundig, 3 pin, 3/6.
Wirewound Ext. Speaker Control, 10 1/2 3/-.
ALADDIN FORMERS and cores, 1in. 8d.; 1in., 10d. 0.5in. FORMERS 5937 or 8 and cans TVJ or 2, 1in. 8d.; 2 1/2in. or 3in. 5d.; 4 1/2in., 2/- with cores.
SLOW MOTION DRIVES, 6d., 2/3.
SOLON IRON, 25W, 200V or 230V, 24/-.

JASON FM TUNER COIL SET. 29/-
 H.F. coil, aerial coil, oscillator coil, two i.f. transformers 10.7 Mc/s. detector transformer and heater choke. Circuit and component book using four 6AM6, 2/6. Complete Jason FMT-1 kit. Jason chassis with calibrated dial, components and 4 valves, £6.50.

MAINS DROPPER, 3 x 1 1/2in. With adjustable sliders. 0.3A, 1,000 ohms, 4/3; 0.2A, 1,000 ohms, 4/3.
LINE CORD. 0.3A 60 ohms per foot, 0.2A 100 ohms per foot, 2-way, 1/- per foot 3-way 1/- per foot.
MIKE TRANS. 50-1, 3/8; 601, potted, 10/8.
P.V.C. Conn. Wire, 8 colours, single or stranded, 2d. v.d. Slewing, 1.2mm, 2d.; 4mm, 3d.; 6 mm, 5d. 5d.
SPEAKER FRET. Gold cloth, 17 x 25in., 5/-; 25 x 35in., 10/-; Tycor, 3in. wide, 10/-; 20in. wide, 5/-; samples, s.A.E. Expanded Metal, Gold, 12 x 12 in., 6/-.

I.F. TRANSFORMERS 7/6 pair
 465 kc/s tuning miniature can 1 1/2 x 1 1/2 in. High Q and good band width. Data sheet supplied.

"REGENT" 4 VALVE "96" RANGE VALVES KIT PRICE £6. 6. 0. carr. 4/-



PRINTED CIRCUIT BATTERY PORTABLE KIT
 Medium and long wave. Powerful 7 x 4in. high flux speaker. T.C.T. Printed circuit and components. Components of finest quality clearly identified with assembly instructions. Osmor Ferrite Aerial Coils. Revco covered attache case cabinet. Size 1 1/2in. x 3in. x 4in. Batteries used 1125 (4.5/12) and A235 (1.5/40). 1/- extra. Instructions 9d. (free with kit). Osmor Mains Unit suitable for above, 39/6. Sold separately. Details free.

MONARCH RECORD PLAYER



World's Best Record Autochanger
BUILD IT YOURSELF USING 4-3-LEAD BSR MONARCH AUTOCHANGER
READY BUILT SW. AMPLIFIER. HANDSOME PORTABLE CASE. HIGH FLUX LOUD-SPEAKER. FULL INSTRUCTIONS SUPPLIED.
 Total Price **£12.10.0**
 Carr. and Ins. 3/-.

RECORD PLAYER BARGAINS Post 2/- each
 4 Speed Autochangers:
 BSR, U.A.8 £6.18.0
 BSR, U.A.14 £7.10.0
 BSR, U.A.12, Stereo/Mono £8.5.0
 Garrard "Autoslim" £8.17.8
 4 Speed Single Players:
 Garrard Mk. II £8.0.0
 Model ASP £6.17.8
 Garrard 4 HF Transcription £17.18.6
 Garrard Stereo Heads £2 extra.
 All Sapphire Stylus available from 6/-.

ARDENTE TRANSISTOR TRANSFORMERS
 Type D3035, 7.5 CT: Push Pull to 3 ohms for OC72, etc., 1 x 4 x 1in., 2/6.
 Type D3034, 1.75 : ICT, Push Pull Driver for OC72, etc., 1 x 1 x 1in., 9/6.
 Type D 958, 11.5 : 1 Output to 3 ohms for OC72, etc., 1 x 1 x 1in., 9/6.
 Type D167, 18.2 : 1 Output to 3 ohms for OC72, etc., 1 x 1 x 1in., 12/-
 Type D230, 4.5 : 1 Driver Transformer, 1 x 4 x 1in., 10/-.
 Type D 40 6.5 : 1 Driver Transformer, 1 x 1 x 1in., 10/-.

ARDENTE TRANSISTOR VOLUME CONTROLS
 Type VC1545, 5K with switch, dia. 0.9in., 8/-
 Type VC1760, 5K with switch, dia. 0.7in., 10/6
 Decal aid ear piece xtal or magnetic, 7/6.

WEYRAD COILS AND TRANSFORMERS FOR A 2-WAVE TRANSISTOR SUPERHET WITH PRINTED CIRCUIT AND FERRITE ROD AERIAL
 Long and Medium Wave Aerial—RA2W. On 8in. rod, 7/16in. diameter, 205pF tuning, 12/6.
 Oscillator Coil P50/1AC. Medium wave. For 176pF tuning, 5/4.
 1st and 2nd i.f. transformers—P50/2CC. 470 kc/s, 11/16in. diameter by 1in. high, 5/7.
 3rd i.f. transformers—P50/3CC. to feed diode detector, 8/-
 Driver Transformer—LFD2T. 1 5/16 x 4 x 1 1/2in., 9/6.
 Printed Circuit—PCAL. Size 2 1/2 x 8 1/2in. Ready drilled and printed with component positions, 1/6.
 1 x 4in., 25 ohm Speaker, 25/-.
 These components are approved by transistor makers and performance is guaranteed.
 Constructor's Booklet 2/-.

NEW MULLARD TRANSISTORS
 Audio OC71 6/-; R.F. OC44 10/8; OC7 7/6; OC45 4/6
Sub-miniature Electrolytics (15V). 10uF, 4uF, 4uF, 5uF, 8uF, 16 uid., 25uF, 50uF, 100uF, 2/6. Diodes OA70, OA81, 3/-; GEN 34, 4/-.

B.I.C. Pocket 2 Transistor, M.W. and L.W. Radio Kit, 22/8. Phones 7/6 or deal aid earpiece, 7/6. Batt. 2/-.

"P.W." POCKET 8 TRANSISTOR KIT MK.II WITH LATEST OSMOR MODIFICATIONS, ALL PARTS, PRINTED CIRCUIT AND NEW CABINET. OSMOR DESIGNED KIT, £8.15.0.

COMPONENT SHOP SPECIALISTS
 P. and P. charge 1/-, over £3 post free. C.O.D. 2/-.

337 WHITEHORSE ROAD WEST CROYDON
 Telephone: THO 1665
 (Export welcome. Send remittance and extra postage).

NOW
YOU can MASTER ELECTRONICS!

BRITAIN'S MOST COMPREHENSIVE PRACTICAL COURSE IN RADIO · ELECTRONICS TELEVISION!

THESE SPECIAL TRAINING KITS — YOURS TO KEEP

Multi-Range TEST METER

CATHODE RAY OSCILLOSCOPE

AM and VHF/FM LUXURY RECEIVER

SIGNAL GENERATOR

Complete set of Picture Way books and Experimental Manuals

LEARN BY BUILDING NOW for your **CAREER · HOBBY OWN BUSINESS**

YOU RECEIVE

- ★ Complete kits of equipment as illustrated.
- ★ Complete set of experimental manuals.
- ★ Complete set of "picture-way" theory books.
- ★ Modern test-yourself examination sheets.
- ★ Study programme.
- ★ Unlimited consultation with Tutors.

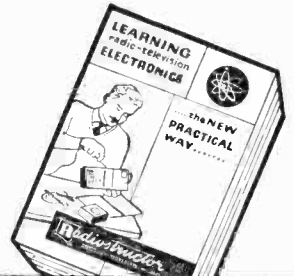

FREE BROCHURE NOW

RADIOSTRUCTOR

TO RADIOSTRUCTOR (DEPT. M82) READING, BERKS.

Name _____ **BLOCK**

Address _____ **CAPS**

_____ **PLEASE**

(We do not employ representatives) 6/62

Practical Wireless

Vol. XXXVIII No. 664 JUNE, 1962

Editorial and Advertisement
Offices:

PRACTICAL WIRELESS

George Newnes, Ltd., Tower House,
Southampton Street, W.C.2.

© George Newnes Ltd., 1962

Phone: Temple Bar 4363

Telegrams: Newnes, Rand, London,
Registered at the G.P.O. for trans-
mission by Canadian Magazine Post.

SUBSCRIPTION RATES

including postage for one year

Inland - - - - £1.90 per annum

Abroad - - - - £1.76 per annum

Canada - - - - £1.50 per annum

Contents

| | Page |
|---|------|
| Editorial | 113 |
| Round the World of Wireless ... | 114 |
| The P.W. Everest Tuner ... | 116 |
| How to Make A.C. Ammeters ... | 120 |
| Servicing Tape Recorders ... | 122 |
| On Your Wavelength ... | 127 |
| Power Rectifier Circuits ... | 128 |
| Books Reviewed... .. | 132 |
| A 4-valve Signal Tracer ... | 135 |
| How Transistors Work ... | 138 |
| The P.W. Troubadour ... | 140 |
| Using Your Multimeter ... | 143 |
| Short Wave Listeners' Log ... | 146 |
| Faults in VHF/F.M. Receivers ... | 149 |
| Club News | 154 |
| Trade News | 157 |
| Versatile Low-Current H.T. Supply | 161 |
| Letters to the Editor | 166 |
| News in the Experimenter's Power-pack | 169 |

The Editor will be pleased to consider articles of a practical nature. Such articles should be written on one side of the paper only, and should contain the name and address of the sender. Whilst the Editor does not hold himself responsible for manuscripts, every effort will be made to return them if a stamped and addressed envelope is enclosed. All correspondence intended for the Editor should be addressed: The Editor, PRACTICAL WIRELESS, George Newnes, Ltd., Tower House, Southampton Street, London, W.C.2. Owing to the rapid progress in the designs of wireless apparatus and to our efforts to keep readers in touch with the latest developments, we give no warranty that apparatus described in our columns is not the subject of letters patent.

Copyright in all drawings, photographs and articles published in PRACTICAL WIRELESS is specifically reserved throughout the countries signatory to the Berne Convention and the U.S.A. Reproductions or imitations of any of these are therefore expressly forbidden. PRACTICAL WIRELESS incorporates "Amateur Wireless."

ANOTHER BLUEPRINT

ANOTHER double-sided blueprint is presented free with every copy of this issue; the two sides cover Designs Nos. 3 and 6 in our series of six graded constructional articles. Design No. 3 (The Troubadour) is a seven-transistor pocket portable receiver which has been designed to fit into a readily available plastic cabinet. Blueprint 3 gives complete details of the circuit employed in the receiver and also clear diagrams of the wiring on both sides of the paxolin panel which forms the "chassis" of the set. The diagrams are in fact considerably larger than the actual receiver and with their aid, no difficulty should be experienced in making the set. The Troubadour covers both medium and long waves and will give good reception of BBC programmes and a large number of Continental programmes (especially in the evening).

The Everest Tuner—Design No. 6—is a six-valve unit for reception of the Home, Light, and Third (or Network Three) programmes on the BBC's VHF/F.M. service. As is well known, reception of medium and long wave broadcasts, anywhere except close to the transmitter, is marred, particularly at night, by interference between stations operating on adjacent wavelengths. The broadcasts on VHF provide a means of obtaining interference-free reception over a wide area and the Everest Tuner has been designed to take account of this fact. Broadcasts on VHF are also of greater fidelity both as regards frequency response and dynamic range and the Everest will provide a high quality signal suitable for feeding to a hi-fi amplifier.

The use of switch-tuning for the three programmes simplifies the tuning of the receiver for the non-technical user and is made possible by crystal control of the local oscillator circuit in each of the three switched positions. Thus, tuning drift is eliminated and construction made easier.

COMMERCIAL RADIO

Although the report of the Pilkington Committee has not yet been received, and it is not known whether it will recommend the introduction of commercial radio stations in Great Britain, there have been several demonstrations of the form which commercial broadcasts would take if eventually permitted. One such was recently given in Bristol on closed-circuit—permission for a public broadcast had been refused. Two hours listening was provided to demonstrate the possible coverage of a day's programmes and the advertisements in the broadcasts included good support by both national firms and local traders, no charge being made for the programme time. Publicity was given in the local Press and attendance at the demonstration included representatives of more than 50 of the independent radio companies in other parts of the country.

Demonstrations of this sort seem to us to be of great value in enabling the possibilities of commercial radio to be explored without actually transmitting programmes. Certainly, it is more constructive than operating "pirate" transmitters which can only cause more overcrowding of the medium wave broadcast band.

Our next issue dated July, will be published on June 7th.

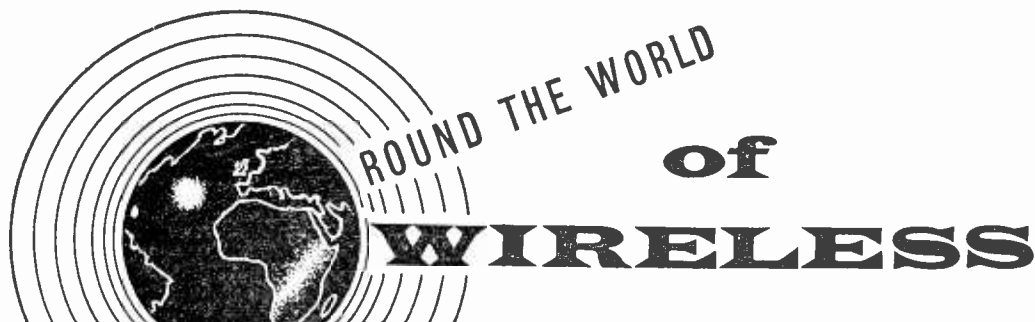

ROUND THE WORLD of WIRELESS

NEWS AT HOME AND ABROAD

Broadcast Receiving Licences

THE following statement shows the approximate number of Broadcast Receiving Licences in force at the end of February, 1962, in respect of wireless receiving stations situated within the various Postal Regions of England, Wales, Scotland and Northern Ireland. The numbers include Licences issued to blind persons without payment.

| Region | Total |
|--|------------------|
| London | 648,410 |
| Home Counties | 539,572 |
| Midland | 434,334 |
| North Eastern | 465,049 |
| North Western | 401,655 |
| South Western | 355,385 |
| Wales and Border Counties | 206,133 |
| Total England and Wales | 3,110,538 |
| Scotland | 335,896 |
| Northern Ireland | 107,365 |
| Grand Total | 3,553,809 |

Embassy Send-off for Demonstration Unit

AN attaché of the Belgian Embassy in London, M. Jean Coene, inspected a mobile demonstration unit belonging to the Westminster firm of Avo Limited before it left London for Belgium recently on an extended tour of the Continent.

The unit carries a complete range of Avo's electrical, electronic and nucleonic measuring instruments for demonstrations at Government departments, technical colleges and industrial concerns in Belgium as well as in Holland, Denmark, Sweden and Norway.

Equipment Exhibition in Milan

TO promote sales in the rapidly expanding market for electronic equipment in Italy, EMI Electronics Ltd. held a special exhibition of latest equipment in the Museo Nazionale della Scienza e della Technica in Milan during March.

Senior members of Italian industrial and scientific organisations visited the exhibition and saw films featuring the EMIDEC range of fully-transistorised electronic computers and EMI machine tool control system.

Among the exhibits were EMI closed-circuit television, nuclear health monitoring equipment, professional tape recorders, oscilloscopes, stroboscopes and special electronic tubes and valves. The EMIAAC II analogue computer was also shown.

A working model of the EMI Robotug driverless truck and a scale model of an EMIDEC 1100 electronic digital computer were also displayed.

Equipment for New Ships

THREE new ships which have just been completed are fitted with radio, radar, inter-communication, navigational and other equipment supplied by the Telecommunications Division of Associated Electrical Industries Ltd. They are the "Ocean Transport", built for the Houlder Line Ltd.; the "Teakwood", for John I. Jacobs and Co. Ltd.; and the "Clan Graham", built for the Clan Line Steamers Ltd.

Equipment supplied for the "Ocean Transport" includes main W.T. R.T. transmitter,

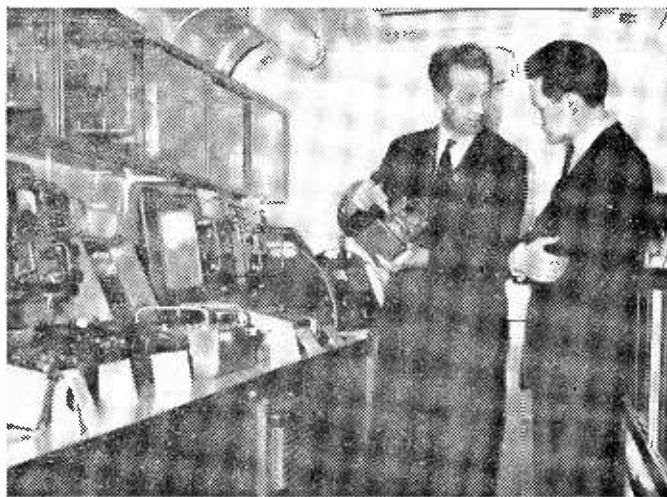

M. Jean Coene (right), an attaché at the Belgian Embassy in London, is seen here inspecting one of the instruments in the Avo mobile demonstration unit before it left London today for Belgium on an extended tour of the Continent.

H.F. W.T. transmitter, main receiver, portable lifeboat equipment, "escort" radar, broadcast receiver with seven loudspeakers and an emergency assembly.

For the "Teakwood" the main W.T. R.T. transmitter, H.F. W.T. transmitter, main receiver, emergency assembly, portable lifeboat equipment, communal aerial system with 45 outlet boxes, escort chart plan with reflection plotter, Bergen Nautik log, echo sounder 28-channel VHF transmitter/receiver and direction finders have been supplied.

The "Clan Graham" has been fitted with a main W.T. transmitter, H.F. W.T. transmitter, main receiver, emergency assembly, 28-channel transmitter/receiver reflection plotter and broadcast receiver.

Public Address Equipment for Theatre

PUBLIC address equipment for the theatre-assembly hall at the Harrow (Middlesex) factory of Kodak Ltd, has been supplied and installed by Associated Electrical Industries Ltd. The equipment is used for dances, theatrical productions and other social functions.

The apparatus includes a main control console housing 60W amplifiers, turntable and control panels, a portable transistorised mixer unit and loudspeakers on both sides of the hall consisting of two 5ft. line source loudspeaker units, two 18in. bass speakers and two pressure horn speakers.

EEV Klystron for Marconi Traffic Radar

A NEW application for English Electric Klystrons has been found in the Marconi "Peta" Traffic Radar equipment. More than 60 sets of this equipment are now in use with police forces at home and overseas.

The klystron used in this equipment is the K357, a low voltage reflex type operating in the range 10660—10720Mc/s and giving a typical output power of 12mW.

It was specially developed by English Electric Valve Co. Ltd. for this application with its requirements for low power consumption, portability and a long and reliable life.



The Marconi Sea-EVA (Electronic Velocity Analyser), was experimentally demonstrated recently to a technical representative of the Dunlop Sports Co. Ltd. as being suitable for gathering data on golf balls.

Testing Golf Balls

TO the manufacturer of golf balls it is important to have precise and continuous information of the speed of the ball in flight, but this has hitherto been impossible.

Recently the Marconi Sea-EVA (electronic velocity analyser), the normal function of which is to provide an extremely accurate assessment of aircraft landing speeds on carriers, was experimentally demonstrated to a technical representative of the Dunlop Sports Co. Ltd. as being suitable for gathering data on golf balls. The data (velocity/time) is displayed in graphical form on a teledeltos paper recorder for subsequent analysis and storage.

Motorists Radio Service

THE Automobile Association announced today that it has asked the Pilkington Committee on Broadcasting to recommend that approval be given for the A.A. to operate an on-the-spot local road and traffic information service to motorists, obtainable through their car radios.

The A.A. has asked for a frequency on the medium wavelength on which broadcasts can be made over a radius of 10 to 12 miles, and for permission to operate a mobile broadcasting unit which would "cover"

big outdoor events attracting thousands of motorists such as race meetings, agricultural shows and public displays.

An A.A. spokesman said: "As long ago as 1956 the A.A. was exploring the possibility of providing a broadcast service of information for motorists listening on car radios.

Hi-Fi in U.S. Trade Centre

HI-FI sound amplifying equipment has been installed by Associated Electrical Industries Ltd. in the United States Trade Centre in London. This is an exhibition centre where ranges of American-made goods are displayed by the manufacturers themselves or by their accredited U.K. importers to the trade in Britain. The system, ordered by the U.S. Embassy from the Sound Equipment Group of AEI Electronic Apparatus Division, is used for making announcements but later it is intended to relay music.

The large size and awkward shape of the centre presented problems which made it difficult to obtain good sound coverage. Furthermore, the difficulties were increased when exhibition stands were erected. These were overcome by siting selected loudspeakers on baffle boards which were substituted for the existing acoustic tiles of the ceiling at certain points.

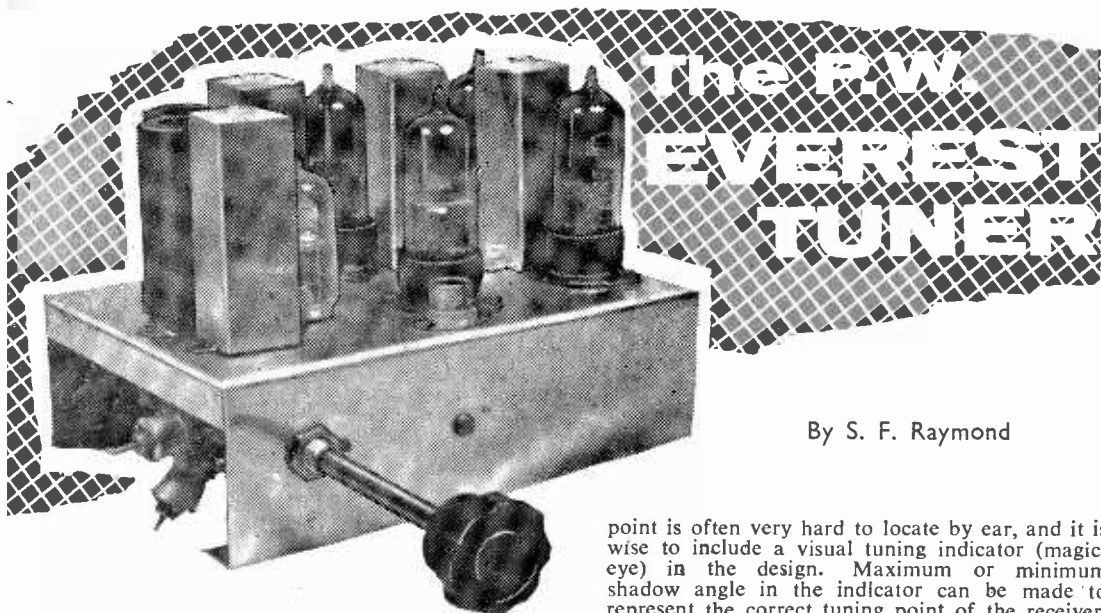

By S. F. Raymond

A SWITCH-TUNED, VHF/F.M. TUNER.

THIS receiver is a tuner unit for the BBC's VHF/F.M. service and is intended for use with a hi-fi amplifier (if the best results are to be obtained from it). It is a superhet which uses the standard intermediate frequency of 10.7Mc/s. Six valves are used, two of which are "double" types—a double triode and a double diode. The six valves perform the following functions: R.F. amplifier; local oscillator; mixer; I.F. amplifier; limiter and discriminator.

R.F. and Oscillator Circuits

The R.F. stage uses an EF80 in a conventional circuit (see Fig. 1 on the Blueprint), the purpose of this stage is two-fold; firstly, it amplifies the signal from the aerial and, secondly, it isolates the oscillator circuit from the aerial, thus preventing radiation from the receiver which might otherwise interfere with reception on neighbouring receivers.

The oscillator circuit is not conventional and is designed to eliminate the criticism that F.M. receivers are difficult to tune (at least so far as non-technical users are concerned). One of the difficulties in most home-built F.M. receivers is the drift of tuning with time as the set warms up; of course, this can be eliminated by the use of combinations of capacitors having negative and positive temperature coefficients, but for most amateurs, this would complicate the construction of the receiver too much. Another difficulty is that of tuning the receiver accurately; F.M. receivers differ from A.M. receivers in that, off tune, they generally give a distorted output rather than a diminished output. The correct tuning

point is often very hard to locate by ear, and it is wise to include a visual tuning indicator (magic-eye) in the design. Maximum or minimum shadow angle in the indicator can be made to represent the correct tuning point of the receiver. However, the inclusion of such an indicator increases the expense of the set and does not sufficiently simplify the tuning of the receiver for the lay user.

The difficulties mentioned above can be eliminated by the use of a switch-tuned oscillator circuit in which a three-position switch is used to select the three available programmes — Home, Light, and Third (or Network Three). In order to do this, of course, the oscillator circuit must be inherently stable both with time and temperature

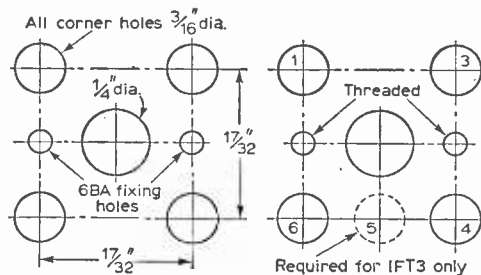

Fig. 7—The chassis drilling dimensions for the coil-former bases.

so that no appreciable drift occurs. The usual method of doing this is to use some form of automatic frequency control (AFC). A voltage is derived from the output of the receiver which is proportional to the error in tuning. This voltage is used to operate a device connected in the oscillator circuit which is in effect a voltage-dependent capacitor. The sense of the voltage is arranged so that if the tuning of the set varies, the oscillator tuning is altered to correct the error. In the oscillator circuit of this receiver, tuning drift is eliminated rather than corrected. This is

made possible by the use of crystal control of each of the three frequencies required for reception of programmes.

Crystal Unit

The three crystals used are enclosed in a glass envelope rather like a valve and in fact the unit fits a B7G valveholder. Of course, the crystal unit must be purchased bearing in mind the area in which it is to be used since the required frequencies will differ from area to area. The units are made by Standard Telephones and Cables Ltd., and a table giving the type numbers for various areas is given on page 118. The type required must be specified when ordering.

The oscillator circuit uses an ECC81 double triode (V2), the crystal unit being connected between the two cathodes, and the tuning trimmers between chassis and one of the anodes. The switching can be seen in Fig. 1 on the Blueprint.

The R.F. and oscillator valves are connected via C5 and C8 respectively to the mixer valve (V3). The oscillator circuit operates on the fifth overtone of the crystal in use at 10.7Mc/s below the signal frequency; the difference frequency (10.7Mc/s) is picked out in the anode circuit of V3 by the primary of IFT1.

The I.F. signals are passed to the grid of V4, the I.F. amplifier, via the secondary of IFT1. After amplification, the signals reach the grid of V5, the limiter, via IFT2.

The Limiter

Here, it is necessary to explain the function and operation of the limiter stage. As is well known, with frequency modulation, the amplitude of the carrier radiated from the transmitter is kept at a constant level and only the frequency is varied. The detector circuit in an F.M. receiver is therefore not required to respond to an A.M. signal. Also, the effects of external interference on the broadcasts received should be minimised as much as possible in order to ensure reception of high quality and high entertainment value. Most interference is mainly amplitude modulated and if

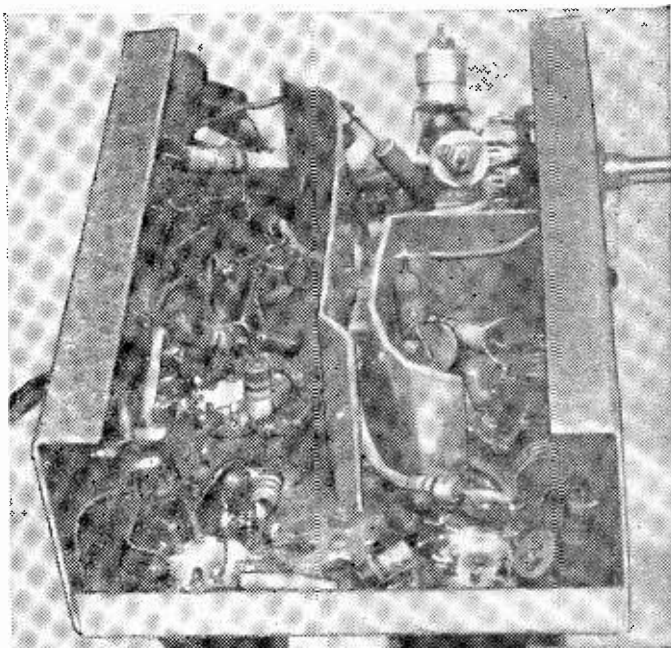

The underchassis wiring of the Everest.

the detector in the F.M. set will respond to A.M. then a method will have to be found to remove the amplitude modulation prior to the detector. This is the function of the limiter stage.

The limiter valve is operated with low anode and screen grid potentials; this has the effect of reducing the voltages necessary at the grid of the valve to give saturated anode current and to cut off the anode current completely. The result is that if the input signal is large enough, the valve anode current is saturated and cut off on alternate

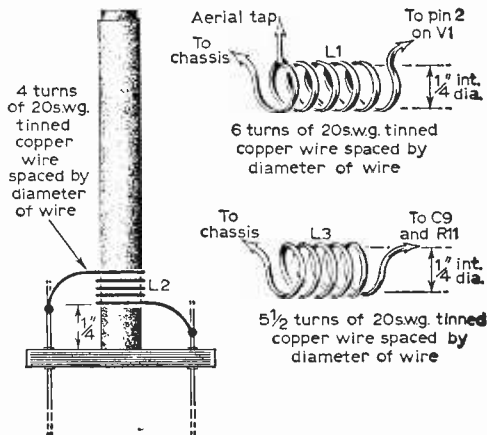

Fig. 8—The construction of L1, L2, and L3.

signal half-cycles. The peak excursions of the waveform are cut off by this process and, as it is the peaks which are mainly affected by amplitude modulation, this is removed or reduced considerably. The valve operates with grid current flowing and the time constant of the components in the grid circuit (R16 and C19) is arranged further to reduce the effects of amplitude modulation.

Discriminator Circuit

The detector circuit or discriminator comprises IFT3 and V6, a double diode. The circuit used is of the Foster-Seeley type rather than the ratio type—it was felt that the former circuit would make construction easier for the amateur constructor. The operation of the circuit will not be dealt with here since it can be found in many text-books.

can be close-wound on a former of about 1/4 in. diameter, such as a pencil, which is then removed, and L2 can be wound direct on to its former. Note that L1 and L3 are self-supporting and use no former—see Fig. 8. Finally, the turns of each coil can be pulled apart to give the correct turns-spacing.

The tinned copper wire used for the coil and transformer lead-out wires (18 or 20s.w.g.) should be prepared by unwinding about 4ft. from the reel and clamping the end in a vice. The other end is then gripped in a pair of pliers and the wire is stretched until a distinct "give" is felt and the wire lengthens slightly. The wire will now be found to be stiff and springy.

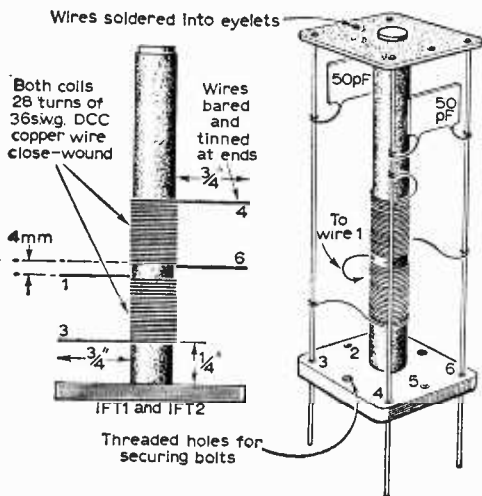

Fig. 9—The winding data for IFT1 and IFT2.

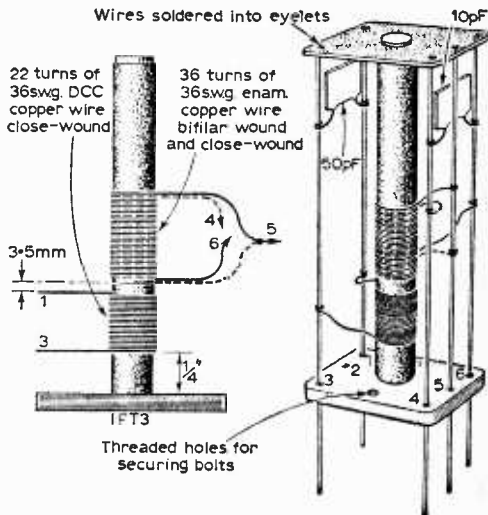

Fig. 10—The construction of IFT3.

The audio output appears across R19 and R20 which are in effect in series across V6A and V6B. The audio signals are fed via R21 and C25 to the audio output socket. R22 and C26 comprise the de-emphasis network (at the transmitter, the higher audio frequencies are emphasised and must be corrected in the receiver).

The power supply used for the tuner should give a well smoothed H.T. output at about 150V and be rated at 50mA. A 6.3V supply is needed for the valve heaters; it should be rated at 2A.

Construction

Construction of the receiver should begin with drilling and preparing the chassis (see Fig. 3). The chassis can be made larger than that given on the Blueprint if desired and this would give improved heat dissipation (to be mentioned next month). Chassis drilling details for the I.F. transformers are given in Fig. 7 (page 116).

When the chassis has been prepared, the coils and transformers should be constructed. Full details are given in Figs. 8, 9 and 10. L1 and L3

TABLE I

| STC Crystal | BBC Transmitters | Crystal Frequencies (Mc/s) | | |
|-------------|------------------|----------------------------|------|------|
| | | LIGHT THIRD HOME | | |
| 4434/A | Wrotham | 78.4 | 80.6 | 82.8 |
| 4434/B | Peterborough | 79.4 | 81.6 | 83.8 |
| 4434/C | Rosemarkie | 78.9 | 81.1 | 83.3 |
| 4434/D | N.H. Tor | 77.4 | 79.6 | 81.8 |
| 4434/E | Sutton Coldfield | 77.6 | 79.8 | 82.0 |
| 4434/F | Pontop Pike | 77.8 | 80.0 | 82.2 |
| 4434/G | Meldrum | 78.0 | 80.2 | 82.4 |
| 4434/H | Blaen Plwyf | 78.0 | 80.2 | 82.4 |
| 4434/I | Holme Moss | 78.6 | 80.8 | 83.0 |
| 4434/J | Rowridge | 77.8 | 80.0 | 82.2 |
| 4434/K | Divis | 79.4 | 81.6 | 83.8 |
| 4434/L | Douglas | 77.7 | 79.9 | 82.1 |
| | Kirk O' Shots | 79.2 | 81.4 | 83.6 |
| | Llanddona | 78.9 | 81.1 | 83.3 |
| | Llangollen | 78.2 | 80.4 | 82.6 |

Standard Telephones and Cables Limited, Quartz Crystal Division, Harlow, Essex

Before L2 can be fixed in position, two 5in. wires, prepared as described above, must be passed through holes 3 and 4 in the base of the coil former and soldered to the eyelets leaving about 1in. to project inside the coil can and about 4in. outside. The screening can may then be placed in position and the retaining lugs bent over. A meter can be used to check that neither wire is contacting the screening can.

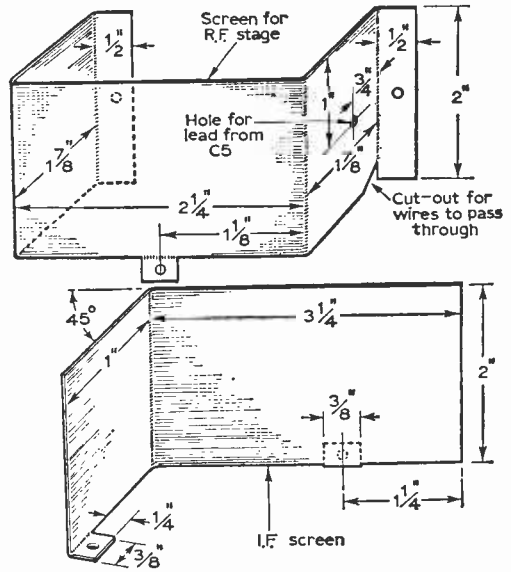
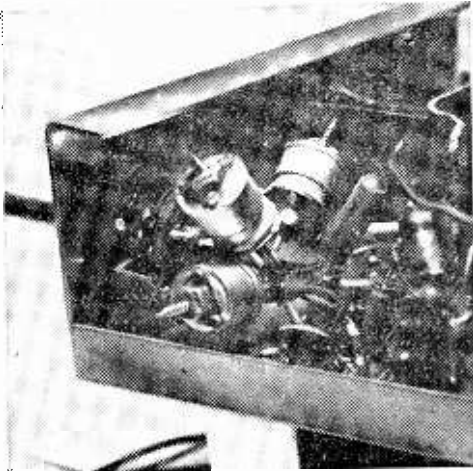

Fig. 11 (top)—The dimensions of the R.F. screen.
Fig. 12 (bottom)—The dimensions of the I.F. screen.



The arrangement of the concentric trimmers around the programme switch.

Making IFT1 and IFT2

In the construction of IFT1 and IFT2 (Fig. 9), the coil nearest to the base of the former is wound on first. The coil wire is anchored by passing it through one of the eyelets and a few overlapping turns wound on. The required number of turns, side by side, then follow and a further number of overlapping turns is wound on. Balsa cement is then thinly applied to the turns to fix them in position. When the cement is dry, the surplus (overlapping) turns are unwound and the ends of the coil reduced to 3/4 in. in length and bared for about 1/8 in. and tinned with solder.

In order to wind the second coil, several overlapping turns of wire are wound on to the former touching the lower winding and in the same direction. Then, about 35 turns should be wound on and anchored with Balsa cement. When the cement has dried, turns should be unwound from the end of the coil nearest to the lower coil until the start of the second coil is at the required distance from the lower coil—4mm. Turns should then be removed from the upper coil until the correct number of turns remains (28).

Completing the I.F. Transformers

The ends of the second coil are, like the first, shortened to about 3/4 in. and bared for about 1/8 in. and tinned with solder. The eyeletted paxolin wafers should now be placed in position at the tops of the formers. The 18 or 20s.w.g. tinned copper wire that was previously stretched and straightened may now be cut into lengths of about 5in. and passed through holes 1, 3, 4 and 6 of the

formers of IFT1 and IFT2 (Fig. 9). The wires should be soldered to the two eyelets through which each passes, one in the base of the coil and one in the paxolin wafer at the top of the coil. Care should be taken to ensure that the wires do not protrude so far through the eyelets in the paxolin wafer that they will contact the screening can of the coil when this is in position.

The ends of the coils can now be soldered to their appropriate wires taking care not to make bulky joints which will contact the screening can. Next, the 50pF condensers can be soldered to the wire connections as shown in Fig. 9, positioning them at the tops of the coils.

Meter Check

If a meter is available, it is as well at this stage to check that there is continuity between wires 1 and 3 and 4 and 6 of the coils. The screening cans may now be placed over the formers and the fixing lugs bent over to hold them in position (make sure that the holes in the lugs coincide with the threaded holes in the bases of the coil formers). The meter may now be used to check that none of the coil wires is shorting to the cans.

Making IFT3

For IFT3, the lower winding is wound on in the same manner as for IFT1 and IFT2. Full winding details are given in Fig. 10. The upper winding of IFT3 is "bifilar" wound. This is wound by taking two 1yd lengths of the coil wire (36s.w.g. enam. in this instance) and winding on the required number of turns (18 turns of the double wire are required making in effect 36 turns). The spacing between the two coils is 3.5mm and must be accurate even if several attempts at winding the coils have to be made.

(Continued on page 145)

How to make A.C. AMMETERS

USING READILY AVAILABLE TRANSFORMERS TO GIVE LINEAR SCALES ON HOME-BUILT METERS

By S. W. Hunt

THE method of calculating the main shunt value was described last month. Fig. 4 shows the universal shunt arrangement (which can be extended to any desired number of ranges, by tapping at suitable points), and the calculation of the authors' shunt is given in full below Fig. 4 as a typical example.

Trial and Error

It may also be mentioned that trial-and-error methods for making shunts are equally permissible for the non-mathematical experimenter, provided these are made carefully, and at first using very small test currents, so that there is no danger of overloading the meter movement. Several yards of bare tinned copper wire of about 0.7mm diameter can be stretched zig-zag between two supports and fed with a small known A.C. current from a heater transformer and series resistor. Short thick leads with test-prods are connected to the winding "a" of the transformer (Fig. 2 last month), and touched very close together on to the current-carrying wire. The prods are then slowly slid apart until the meter shows the deflection desired for the current flowing in the wire. The length of wire then between the two test-prods is the length of the same wire required for the necessary shunt, and it should be measured and cut off from insulated wire of the same diameter.

This procedure just described should be made for the most sensitive range desired. For all higher ranges, this shunt will be tapped, and the taps can be found by trial-and-error as follows: the required shunt for the most sensitive range having been found as above, it should be cut and soldered to the transformer winding "a", using for the present bare wire. The test prods are now wired in series with a low voltage A.C. supply and variable resistor set so that the desired full-scale current flows when the prods are shorted together. One prod is then securely fixed to one end of the existing shunt, which is going to be the "common" terminal (it does not matter which is taken). The other prod is at first also touched on to this point, and then slowly slid away along the existing shunt, until the meter reads full-scale. The moving prod has then arrived at the correct point for making a tap for the range in question. In this way, all the taps for all the desired ranges can be found, and

(Continued from page 30 of the May issue)

in fact this method is probably the simpler, even for mathematically minded constructors, if many ranges are desired. It is in cases of one single range, or at most two ranges, that calculation is simpler and quicker than trial-and-error. To complete the trial-and-error method, there is still one final step. When all taps required on the experimental shunt have been located, the question of current-carrying capacity must be considered when replacing the experimental shunt by separate final shunts between the input terminals of the various ranges. Each sub-shunt must be capable of carrying the current represented by the input terminal to which it is connected on the side away from the common terminal. Any length of wire, as shunt between two terminals, which is to be capable of

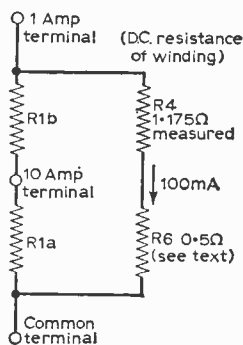

Fig. 4—The circuit of a 2-range universal shunt.

CALCULATIONS:

1A range:

$$\begin{aligned} R1a + R1b &= \frac{100R4 + 50}{1 - 100} \\ &= \frac{(100 \times 1.175) + 50}{1000 - 100} \\ &= 0.186\Omega \end{aligned}$$

10A range:

Here $R1a$ is the shunt, and $R1b$ is added to $R4$.

Thus,

$$\begin{aligned} R1a &= \frac{100(R4 + R1b) + 50}{1 - 100} \\ &= \frac{100(1.175 + R1b) + 50}{10,000 - 100} \end{aligned}$$

which simplifies to

$$99R1a - R1b = 1.675\Omega$$

The equations are thus:

$$99R1a - R1b = 1.675 \quad \dots \dots \dots (1)$$

$$R1a + R1b = 0.186 \quad \dots \dots \dots (2)$$

$$(1) + (2) \text{ give } 100R1a = 1.861$$

$$R1a = 0.0186\Omega$$

Thus, from (2),

$$R1b = 0.167\Omega$$

carrying a current "n"-times larger than its actual rated current, must be replaced by "n" strands of the same wire in parallel, each "n" times as long, when making the final sub-shunts. Current-rating should be very conservative, to avoid any heating, which would cause variation of copper resistance and consequent drift of readings. Not more than 2A per strand of 0.7mm diameter tinned copper wire should be allowed. This does not, of course, apply for the experimental shunt for determining the position of taps—but work at high current should then be rapid, so as not to give the shunt wire time to heat up.

Of course, copper is in one sense undesirable for shunts because of its high temperature coefficient of resistance, but the use of resistance wires has its problems, too. Most resistance wires in the hands of the amateur cannot take solder, so that pinches and cleats are required, with consequent dangers of insecure contacts after a time, which—in the author's experience—can often cause errors exceeding the thermal errors of copper, in

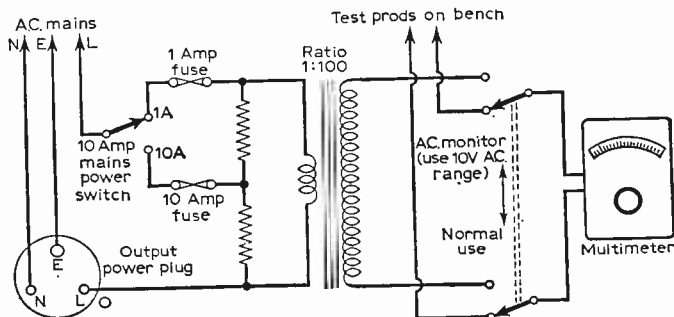

Fig. 5—An adaptor mains-monitor for a multimeter.

such low-resistance circuits. If the constructor has solderable resistance wire available, all well and good. The author has a type known as Isotan-Soft, which solders excellently, has an extremely low temperature coefficient, and good current-capacity. With great difficulty he has been able to obtain two reels of this, one of 10 Ω per yard, and the other of 2.5 Ω per yard. But the necessary lengths for the shunts here required are very short with this wire, so that cutting error easily exceeds the thermal errors of copper. Thus, in spite of the availability of resistance wire which could be soldered, copper shunts were chosen.

The trial-and-error systematic method of making shunts and universal shunts, described above, is of course not limited to the type of A.C. ammeter described in this article. It is applicable just as well to D.C. shunting of moving-coil meters.

D.C. Ranges

The type of A.C. ammeter described in this article is, of course, not usable on D.C., though D.C. within the rated A.C. range values should normally cause no damage: apart from possibly an initial kick, the meter reading is simply zero on D.C. It is, however, a very useful and neat extension for the ambitious constructor to make R3 in Fig. 1 (last month) in the form of a universal shunt as just described, fitted with its own set of terminals.

The meter is then usable on A.C. or as a D.C. ammeter, according to which set of terminals is used. It is not necessary to disconnect R2 or the rectifier when using the D.C. shunt; these components cause no disturbance. Thus no switching whatsoever is required.

The extensions can be carried even further: the negative side of the meter, bottom of R3, and the A.C. amps common terminal may be wired together and used as common/minus for everything, A.C. and D.C. The positive meter terminal may be connected through the usual series resistors to further terminals, giving D.C. voltage ranges. In the same way (but now switching is required), A.C. voltage and ohms ranges may be added, to complete a whole multimeter. Alternatively, merely the transformer and main shunt R1 are required, the winding "b" of the transformer feeding direct into an existing multimeter on a low voltage A.C. range. The author has built such a unit as an addition to his multimeter, which is fixed (removable at will) on a bracket above the workbench. The

10V A.C. range is used. It has a resistance of 40k, which transforms to 4 Ω at the input to the 1:100 transformer, and with these values the shunts were calculated accordingly, as described above. Fig. 5 shows the circuit of this unit, in fact built as a mains-power consumption meter in series with the mains power-plugs on the workbench.

Calibration

As already said as a main feature of this type of A.C. ammeter, the scale is virtually linear, as for a D.C. moving-coil ammeter. There is, however, a very slight remaining cramping below about 10% of full scale, and thus calibration is advisable for best accuracy. This is not essential, however, and a linear scale 0 to 10 will do reasonably well, the final adjustment being made with R2 as described in the text above.

Marking the Scale

The author suggests the following procedure, which automatically includes any calibration necessary:

The meter should first of all be connected up into the circuitry as described in this article, and all shunts, etc. finalised, working on full-scale deflections on the existing-scale of the meter. The current should then be reduced in steps of one-tenth of an amp, working on the 1A range. The corresponding readings on the existing scale should be noted for later use. The current itself may be measured either with another ready calibrated A.C. ammeter in series, or by measuring the voltage drop across a known series resistor, using the lowest A.C. voltage range of a multimeter.

The meter should then be opened and the scaleplate carefully removed by unscrewing the two holding screws. Whilst working on this scaleplate, the meter casing should be closed again to avoid unnecessary entry of dirt or other foreign bodies.

(Continued on page 146)

SERVICING TAPE RECORDERS

THE MAGNETIC RECORDING TAPE

By T. S. Smith

A GENERAL picture of the recording process and the various circuit sections involved has been given in previous articles in this series; this article will be concerned with a more detailed discussion. Let us begin with the tape itself. It is not intended to delve into the construction of magnetic recording tape in any detail, but one or two points will be of interest. Magnetic recording tape was first made with paper as the base, but it was not long afterwards that cellulose acetate took its place. Then development was towards a polyvinyl chloride (PVC) base. The overall development in this direction is just about being completed by the use of a polyester film base, and this is now replacing PVC tape—in America it is used almost exclusively.

Magnetic recording tape requires about six major features. These are [i] freedom from "pinholes", thereby reducing drop-out effects ("drop-outs" refer to lack of recording due to some imperfection in the tape); [ii] good flexibility, which permits the tape to remain in intimate contact with the heads (it also facilitates winding); [iii] maximum strength to avoid frequent breakages; [iv] high resistance to temperature changes and storage defects; [v] immunity to curling and good dimensional stability over a wide range of conditions of temperature and humidity; and [vi] the best possible finish to avoid undue wear of the heads and to enhance recording and replay quality.

All these features are given by the modern tapes now available and, as already intimated, improvements are always being made towards better and better quality. The tape base is, of course, coated with an iron oxide of characteristics to provide low noise and good high-frequency sensitivity (i.e., high coercivity—see page 53, May issue). Where the base is of PVC, a homogeneous mixture of the plastic and the magnetic material is arranged in the form of a finish for the working side of the tape. Even so, some of the oxide ultimately leaves the tape and often finds its way on to the heads and associated mechanism, as we shall see later. The recording pattern, in terms of magnetism, is thus imparted to the oxide side of the tape, and in that way the sound signals are stored.

(Continued from page 54 of the May issue)

Tape Tracks

There are three chief recording systems. These are sometimes called "whole track", "half track" and "quarter track" (or "single track", "two-track" and "four-track" respectively) and are illustrated in Fig. 9.

Single-track recording (Fig. 9a) is used essentially by professional recordists for extremely high quality studio work at a tape speed of 30in./sec. Two-track recording (Fig. 9b) is practised by the majority of amateur operators, and most domestic recorders in present use employ two-track working. This type of recording is also used professionally. Four-track recording (Fig. 9c) is gradually

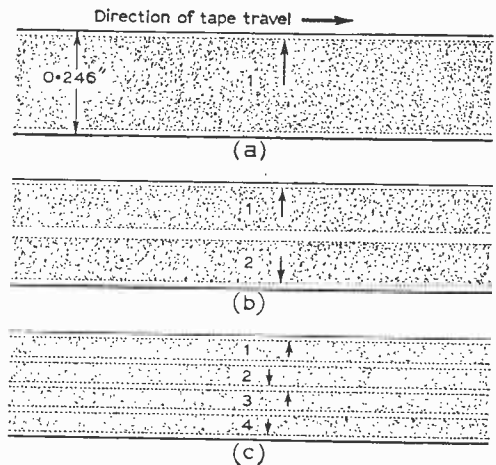

Fig. 9—Recording tracks and directions: (a) single track recording, (b) two-track recording and (c) four-track recording. (The arrows on the tracks indicate the top of each track during the recording process.)

becoming more popular, but there are several schools of thought concerning the desirability of dividing a $\frac{1}{2}$ in. tape into four tracks.

There is no doubt that it is possible to secure better results in a less exacting manner by using as much tape width as possible. With full-track recording, the replay gap length covers about 0.215in. of the oxide face. With half-track operation this is reduced to about 0.1in., with 0.03in. between the two tracks, and with four-track

working the width of each track is about 0.043in., with 0.025in. spacing between the tracks.

However, at the time of writing it would seem that four-track parameters have not been finalised, since some machines are arranged for 0.039in. and (at least one) 0.031in. track widths. The track spacing also tends to differ somewhat, as also do the equalisation recommendations.

General Parameters

The generally recommended direction of tape motion (for all systems) is from left to right with the coated side of the tape away from the observer and the recording being made on the upper track. It is thus usually necessary to remove the spools and invert the tape (by transposing the two spools) for recording and replay on the other track unless the machine features switching to enable recordings to be made on the lower track with the tape movement reversed.

Four-track operation is undoubtedly useful for stereo work as it gives the same playing time as mono on a two-track system (assuming the same speed, of course). A four-track record/replay head has two gaps and two windings. Thus, in one direction of the spools two tracks are catered for and by changing over the spools (as for two-track working) the other two tracks are produced. This arrangement gives compatibility for playing back two-track tapes—as will be seen shortly.

The idea can be better understood by reference to Fig. 10. In Fig. 10a it will be seen that with the tape placed on the left-hand spool and travelling in the direction shown, tracks 1 and 3 can be recorded or replayed. If we assume two-channel stereo, then track 1 will accommodate the signal of one channel (A), and track 3 the signal of the other channel (B). In order to record on the other two available tracks the tape is simply inverted as shown by the positions of tracks 1 and 3 in Fig. 10b. Tracks 4 and 2 may then be recorded or replayed.

On four-track mono it is usual first to record on track 1 with gap A, reverse the tape physically by transposing the spools to record on track 2 with gap B, reverse the tape again to record on track 3 with gap B and finally reverse the tape to record on track 4 with gap A. Replay, of course, follows exactly the same pattern.

There is, at least, one tape deck, shortly to become generally available, which will replay mono on four tracks, automatically switching from the finished track to the next and so on through the whole tape. When the four tracks have been played in that manner the whole process is automatically repeated if required. The track configuration is somewhat different in this case, since the tape direction changes on track change.

It should be noted that the signal across the replay head winding of a four-track system is appreciably below that on a single or two-track system and, for that reason, greater amplification is essential fully to drive the power amplifier. Moreover, for equipment of a given specification, the signal-to-noise ratio on four-track working is poorer than that on single or two-track systems. The equalisation required for optimum replay quality also differs as the track width is made smaller.

Four-track Compatibility

The two gaps of a four-track recorder are arranged so that they will scan a part of the track of a two-track mono or stereo tape record. Fig. 11 shows how this is accomplished. When replaying a two-track mono recording, for example, gap A works in conjunction with track 1. For the other track gap A is still used and the tape is inverted as for normal two-track working.

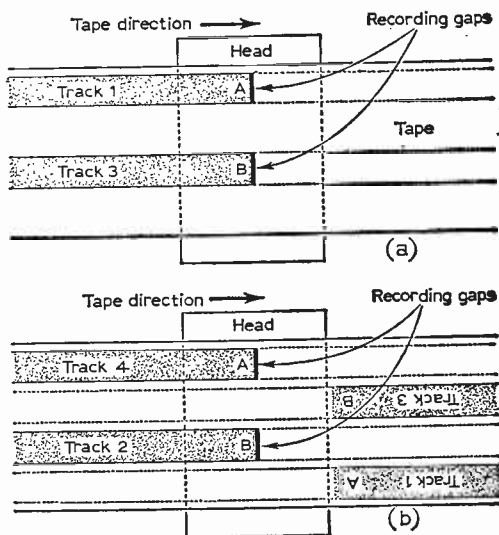

Fig. 10—These diagrams show how the four tracks are put into order by the use of two gaps and tape reversal.

For stereo, gaps A and B are used simultaneously, as is already the case with two-track stereo. Although the gaps embrace only a part of the recorded track, the signal is nevertheless complete, but the output across the replay winding will be of a smaller level as compared with that obtained from a head with a gap embracing the whole of the track width.

Of course, one is sometimes tempted to arrange a machine in a way that the second track is recorded by switching gaps, thereby avoiding removing the spools and inverting the tape. There is nothing against this technically provided the "recording sense" of the tape is clearly labelled for future reference. (Some two-track and four-track machines have switching and multiple heads to enable recordings to be made on all tracks without the need to transpose the spools, at the same time keeping to the correct recording senses.) In future articles in this series we shall be investigating the detailed mechanism of specific tape decks, but there are several items which are common to all decks and these will be considered first.

Heads and Their Alignment

To achieve optimum high-frequency performance from any tape recorder the gap of the replay head must be exactly at right-angles to the edges

of the tape except where a machine is used solely to replay its own recordings. In this case any effects occur equally on record and replay and the results of a small misalignment are counteracted. However, where the same machine is used to replay either tape records or recordings produced on another machine, misalignment will produce undue background noise and loss of treble.

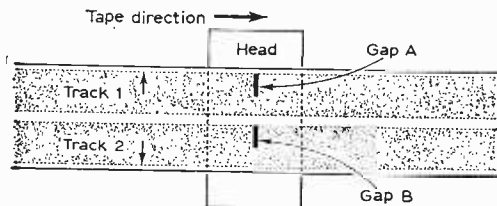

Fig. 11—How a four-track, two-gap head can be used to replay two-track stereo or mono recordings. For mono, gap A only is used and track 2 is replayed by inverting the tape, while for stereo both gaps are used simultaneously.

Most machines provide adjustments for setting both the angle of the face of the head to the vertical and the angle of the gap itself to the vertical (known as azimuth adjustment). These adjustments are provided in a diversity of ways, depending upon the design and type of machine, but a popular arrangement incorporates three adjusting screws arranged appropriately around the baseplate of the head as shown in Fig. 12. Coiled springs or rubber washers are sometimes used between the head baseplate and the panel of the deck at each screw to maintain a constant tension and to hold the head firm at all adjustment settings.

The idea is first to set the face angle adjustment so that when the tape is running past the head with the pressure pad released and with the tape guides in correct alignment the tape remains in contact with the centre of the gap area over its whole width without curling, twisting or jumping. Under this condition the face of the head will be parallel with the back of the tape.

Azimuth Angle Adjustment

There is only one method of setting the azimuth angle for optimum results and that is by playing back a test tape carrying a constant level, high frequency recording. Test tapes of this nature are available commercially. The azimuth screws should then be very carefully adjusted to give maximum output of the test tone.

As small changes in level at high frequencies are extremely difficult to detect by ear an A.C. voltmeter or output meter, which is capable of responding to the test tone, should either be connected across the loudspeaker or across a suitable load resistor used in place of the loudspeaker. The load resistor should be of the wire-wound variety and its resistance should closely approximate to the impedance of the loudspeaker.

The replay volume control should be adjusted to give a little under half-scale deflection on the meter, but care should be taken to avoid overloading the replay amplifier in order to achieve sufficient deflection. If the desired deflection

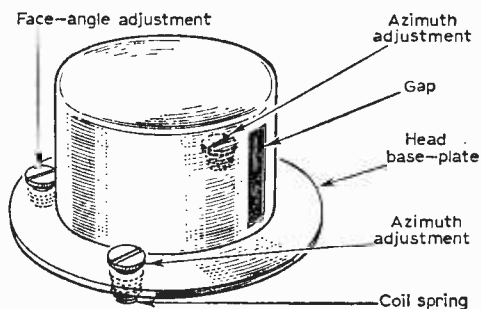

Fig. 12—One arrangement used for the face-angle adjustment and the azimuth adjustment of the record/replay head.

cannot be obtained with the replay volume control set to about three-quarters, a more sensitive output meter or A.C. voltmeter is required.

On two- and four-track machines the height of the head is of considerable importance to ensure correct alignment with all tracks. It may be necessary, therefore, first to set the height for maximum output on one track of a multi-track test tape (frequency is not so important here). Then the face-angle adjustment must be set and, finally, the azimuth adjustment for maximum high-frequency response. All the other tracks should then be in correct alignment.

On some machines the height of the head may not be adjustable, as the azimuth adjustment may pivot on a small dimple on the head baseplate, in which case there may be only two adjusting screws. On the other hand, some machines have four adjusting screws, which are best dealt with in pairs. Normally it is not desirable to interfere with the overall height of the head, the main adjustment being that of the azimuth, which can usually be set without disturbing any of the other adjustments.

Magnetised Tools

Residual magnetism is a very real danger so far as tape recorders are concerned, and it is most important that all adjustments in proximity to the heads and associated mechanism are carried out with non-magnetic tools. Almost all steel screwdrivers, for example, used for radio work are endowed with slight magnetism, picked up from loudspeaker fields and so on.

Non-magnetic screwdrivers are available and a set is well worth acquiring if much work is done on tape recorders. A bulk eraser can be used for clearing magnetism from small tools, and there are other methods of dealing with the problem, as will be given later. It must be remembered, though, that residual magnetism on a tape guide, mu-metal screen or head, considerably impairs the noise performance and can introduce hiss on to a tape record which was previously noise free.

(To be continued)

REMEMBER TO BUY
OUR COMPANION JOURNAL
PRACTICAL TELEVISION
1/9 Every Month

BRAND NEW AM/FM (V.H.F) RADIOGRAM CHASSIS AT £14 (Carriage Paid)

A.C. ONLY. Chassis size 15 x 6 1/2 x 5 1/2 in. high. New manufacture. Dial 1 1/4 x 4 in. in 2 colours predominantly gold. Pick-up. Ext. Speaker. Ae. E. and Dipole Sockets. Five push buttons—OFF L.W., M.W., F.M. and Gram. Aligned and tested. O.P. Transformer. Tone Control. 1,000-1,900 Mc. & 200-300 Mc.; 88-99 Mc/s. Valves E280 rect., ECC81, EF84, EABC80, EL84, ECC85. Speaker and Cabinet to fit chassis (table model), 47/6 (post 2/6). 9 x 6 in. ELLIPTICAL SPEAKER, 20/-, to purchasers of this chassis. **TERMS:**—(Chassis) £5 down and 5 Monthly Payments of £2, or with Cabinet and Speaker £5.10.0 down and 6 Monthly Payments of £2. Cheap Room Dipole for V.H.F. 12/6. Feeder 6d. yard. Circuit diagram 2s. 6d.

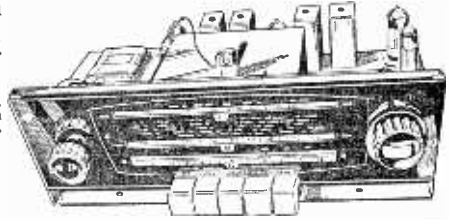

THE "CANTATA" 6-TRANSISTOR AND DIODE PORTABLE

COMPLETE KIT FOR ONLY **£7.19.6** (post 3/6)



500mW push-pull output. Ferrite rod aerial. Car aerial socket and coil. M.W. and L.W. full coverage. Operates on two 4.5v. cells. Printed circuit board 8 1/2 x 2 1/2 in. All holes drilled and component positions marked. Instructions 2/6 (or 1/6p. (re-undeed on purchase of kit). Size 9 x 3 1/2 x 7 1/2 in. 8 x 2 1/2 in. P.M. high quality speaker. Attractive Vynair covered cabinet, two tone. Two batteries 5/6 the pair (Ever Ready 126). Mullard transistors OC44, 2 x OC45, OC81D, and 2 x OC91. Top grade Weymouth Radio Coils and transformers. Alignment service if required 17/6 (inc. post). Write for list of prices. All parts supplied separately. Built in two hours.

COMPLETE V.H.F./A.M. RADIO FOR £12.10.0 (carr. paid)

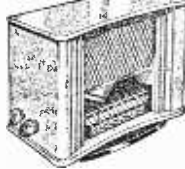

Brand new set, in superb walnut cabinet (size 19 x 8 1/2 x 14 1/2 in. high). Covering 88-100 Mc/s. 16-49M., and 200-500 M. Mains trans. 200-250 v. Ferrite rod aerial for A.M. (Controls: volume on/off, tone, tuning, w/change). Gram. and ext. speaker position provided. Valves 12AT7, 12AH6, 6XJ6, EABC80, 6BW6 and metal rectifier. Fully guaranteed. Today's Value £20.

COLLARO STUDIO TAPE TRANSCRIBTOR. 3 MOTORS, 3 SPEED. 11, 3 1/2 and 7 1/2 I.P.S. Push buttons, £10.17.6 (10/- carr.) incl. spool.

SUPERIOR GRAMOPHONE AMPLIFIER 3 valves, 4 watt

13 1/2 x 7 1/2 in. (2 1/2 in. front to back). 3 front controls, bass, treble, vol. on-off, 6 1/2 in., round speaker; UY85, UF80 and UL84. Mains trans. 200-240ac; "gold" fret front. **ONLY 74/-** (p.p. 4/-).

GRAMOPHONE AMPLIFIER
With 5in. SPEAKER Baffle 12 1/2 x 6in. ECL82 and Rectifier. Tone and Volume On/Off switch. Two Knobs. Ready to play. Useful for Stereo. **ONLY 57/-**, post 4/-.

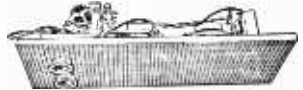

BUILD YOUR OWN RECORD PLAYER FOR £12.10.0

Fully built 2 valve amplifier

B.S.R. autochanger, case 17 x 15 x 8 1/2 in. Assembled in 15 mins. Similar cabinet for tape recorder with plain board only £3. carr. paid. Attractive colours.

or with 3 valve amplifier 15/- extra

AUTOMATIC RECORD CHANGERS. 4-SPEED WITH TURN-OVER CRYSTAL CARTRIDGE (carr. 5/- extra). Latest UA14, £7.10.0. Motor board for UA8, UA14 5/- (post 1/6). 3/6 post paid when purchased with autochanger. Motor Board for Collaro C60 4/- post paid

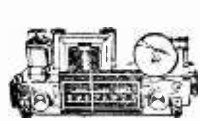

SELF-POWERED VHF TUNER CHASSIS. Covering 88-95 Mc/s. Mullard permeability Tuner. Dims. 10 1/2 x 4 1/2 x 5 1/2 in. high. ECC83, EF91, EF91 and 2 diodes. Metal Rectifier. Mains transformer. Fully wired and tested. Only £7.14.0 (carr. pd.). Attractive Vynair Cabinet 20/- Room dipole 12/6. 300 ohm twin feeder, 6d. yd.

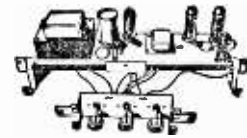

PUSH-PULL AMPLIFIER £5.5.0 (5/- Carr.)

Brand new 200-240 A.C. mains Bass, treble and vol. controls. With valves E280, ECC83 and E-EL84 giving full 8 w. Chassis 12 x 3 1/2 x 3 1/2 in. With o.p. trans. for 2-3 ohm speaker.

Front panel (normally screwed to chassis) may be removed and used as "flying panel". Stereo version 2 x 4 w. same price.

BATTERY ELIMINATOR

For 4 Low Consumption Valves (96 range). 90v. 15mA and 1.4v. 125mA. 45/- (2/6 post). 200-250v. A.C. Also for 250mA. 1.4v. and 90v. 15mA at same price. In two sections H.T. and L.T. to replace existing batteries.

3-VALVE AMPLIFIER (Inc. RECT.)

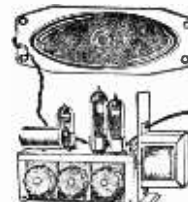

4 watts. Valves ECC83, EL84 and E280. Controls, volume, bass and treble. On/off switch. Chassis size 6 1/2 x 3 x 2 1/2 in. 6 1/2 in. round or 7 x 4 in. elliptical speaker. Not suitable for microphone input. A.C. only. 67/- P. & P. 3/-.

BEREC BATTERY RADIO. Valves DK96, DF56, DA76, DL96. Two short Wavebands 16 to 49 M. and 25 to 75 M. Cabinet 12 x 7 1/2 x 6 in. **ONLY £5** (2/6 p. & p.); MW and SW. £5.4.0 (plus 2/6 p. & p.). Or as Kit 75/-.

THIS SUPERB SET FOR £10

6-transistor radio covered in sponge clean Duracour fabric, in latest two tone shades. M.W. and L.W., ferrite rod, provision for car aerial. 2-colour scale. With PP9 battery giving 300 hours use. Weighs under 4 lbs. With carrying handle. 12 x 7 1/2 in. high x 4 1/2 in. at base tapering to 2 1/2 in. at top. Brand new, fully guaranteed. £10. Carr. paid. Worth £16.

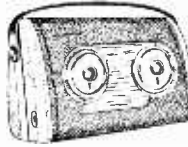

TERMS AVAILABLE ON ITEMS OVER £5
Send 6d. (stamps will do) for 20 page illustrated catalogue. All New Goods. Delivered by return. (C.O.D. -/- extra).
ALL ITEMS GUARANTEED 12 MONTHS VALVES 3 MONTHS—CLOSED SATURDAY.

GLADSTONE RADIO
"SCALA," CAMP RD., FARNBOROUGH, Hants.
Farnborough 3371

It's NEW!!**THE "NORPAK"
MAINS POWER PACK
KIT
FOR TRANSISTOR
RADIOS**

We are delighted at the response and enthusiasm of readers to this fine new kit.

Saves battery costs, boosts and greatly extends life of old batteries.

Miniature Size—4 x 2 x 1½ in. In attractive two-tone plastic case. Assembled in an hour. Normal output 9 v. 100 mA. (Adjustable) Full Mains Transformer. Full wave germanium diodes. Cartridge fuse.

Complete Kit with Plans
35/- Plus 1/6 P.P.
(Ready assembled 45/-).

NEW MODIFIED VERSION!

★ **'PW' 6-TRANSISTOR** ★
**MEDIUM & LONG WAVE
POCKET SUPERHET**

The latest version of this fine performer incorporates improvements giving even greater sensitivity and all round performance.

- 250 mW Push-Pull Output on 2½ in. P.M. Speaker.
- Guaranteed first grade Matched Transistors.

- High Q Internal Ferrite Rod Aerial.
- Printed Circuit and full instructions.

All parts required

£8.10.0

Plus 2/- P.P.

★ All parts sold separately. Send for illustrated building plans, 1/6 plus post. (Free with kit.)

Every item down to the last nut and bolt is supplied together with easy to follow, step by step instructions—no extras to buy.

★ **ALIGNMENT SERVICE** ★

We guarantee to make your set work

We have aligned and tested many hundreds of these fine receivers, and offer a very comprehensive service, including fault finding, at very reasonable charges. *Please write for details.*

PAY AS YOU BUILD SCHEME

At no extra cost this kit may be bought in 3 complete stages of £2.16.8, plus 1/6 p. & p. (Specify A, B or C when ordering.)

INTRODUCING !!

THE NEW

P.W. "MERCURY"

6 transistor portable kit in Printed Circuit Version

Big brother to the famous PW 6 Pocket Superhet.

We confidently predict that this fine set is going to prove a winner and will carry the full facilities of our PW 6 alignment service and "pay as you build" scheme. *Write for details.*

**POCKET RADIO
CABINET**

We stock the brilliant new contemporary case by Osamor Ltd., which is suitable for most of the pocket radio designs in this journal. Size 5½ x 3½ x 2 in. 12/6. Plus 1/3, P. & P.

NORCOL LTD

**CASTLE ROAD, CAMBERLEY,
SURREY**

Phone: Camberley 22760

**SPECIAL FOR THE "HAMS"
RADIO STATION**

Illustrated

½ inch detachable bit
soldering instrument
List No. 70

Combined Protective Unit
with Wiper/Abrasion Pad
and Solder Reel
List No. 700

Apply **SALES & SERVICE**

ADCOLA
PRODUCTS LIMITED
Large Trade Marks

**ADCOLA HOUSE
GAUDEN ROAD
LONDON, S.W.4**

Telephones:
MACaulay 4272-3101

British & Foreign
Patents, Registered
Designs, etc.
Telegrams:
"SOLJOINT, LONDON, S.W.4."

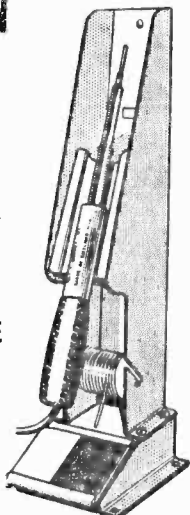

**ANOTHER NEW 4-TRACK
MARTIN 'RECORDAKIT'
FOR THE KEEN
CONSTRUCTOR**



To an outstanding successful range of kits is now added Recordakit 'D', designed for use with the Coliaro 4-track Studio Deck. Like all Martin Recordakits, it is on a printed circuit base and complete with valves, controls, transformers, leads, etc., down to the last screw. Even the wire supplied is cut to length.

Amplifier 'D' as above, 12 gns. Speaker and Case assembly, 5 gns. With Deck, Case, Speaker and Amplifier 34 gns.

From radio and audio stockists. In case of difficulty send direct. For free leaflet, cut out this ad. and send it with your name and address.

MARTIN ELECTRONICS LTD

155 High Street,
Brentford,
Middlesex,
Tel: Brentford 3585

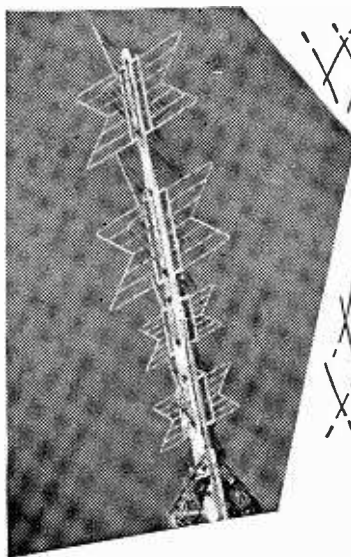

On Your Wavelength

By THERMION

quencies around 125, 86 and 70kc/s. These stations, of course, are not used for communication purposes, but transmit a continuous-wave carrier which operates automatic navigational and position-finding equipment on board ships and aircraft. So the long waves are by no means dead, or even dying!

"In closing, I may mention that I have been a reader of PRACTICAL WIRELESS (and its predecessor AMATEUR WIRELESS) since issue No. 1, and have therefore been reading your column for something like 40 years!"

It was certainly nice to hear from a reader of such long standing. I am, of course, aware of the Rugby and similar transmissions, but when first I mentioned long waves, I was thinking more of the much longer wavelengths such as were used for the above-mentioned "Mars signals", and it is these, I feel, which may eventually prove most interesting. Still, only time will tell!

Meteorological Research

Shortly after I had finished writing the above note, I received a letter from a reader in Germany giving very similar notes concerning Rugby etc., but adding the information that the ultra long waves are used extensively in meteorological research on tracking thunderstorms, as the latter radiate particularly efficiently at these frequencies. He goes on to say that there is little point in using the ultra long waves for communications, as echo-satellites and directional VHF will give a better combination of range and signal-to-noise ratio. Yet for meteorological purposes, the ultra long waves continue to be of high value, as such stations can track thunderstorms and regions of atmospheric disturbance, and locate them accurately on the map, even if they are thousands of miles distant from the tracking receiving stations.

Peculiar Faults

I have received a lot of correspondence at different times on faults of a strange nature, which normal servicing procedures or techniques could not solve. I must say that one of which I recently heard was indeed strange, and just shows how careful one has to be, and in fact makes one think that besides being an electrician, a good radioman has also to be a chemist! This fault arose because an amateur constructor had used a particular adhesive to stick some silk-covered wire to a former made of paxolin or some similar material. Apparently a chemical action has been set up by the adhesive and paxolin in combination, and this had attacked the silk covering of the wire. The wire was rather thin and it had been eaten away by the corrosion to a length of over $\frac{1}{2}$ in.

Any more cases of chemical trouble?

My recent comments on some old-time long wave signals and experiments has, as I expected, brought a number of comments from readers, amongst which is an interesting one from a Mr. Atkin of the Western Isles, who tells me that the long waves are not, in fact, dead. He says, "As one of the 'older' experimenters referred to, I was interested in your note on long wave radio communication (April issue). I well remember the first radio signals I ever heard, back early in 1921, when I listened on a crystal receiver to Eiffel Tower (FL) and Nauen (Germany) on 2600 and 3200m respectively. These were both spark transmitters, and to reach these long wavelengths we had strings of honeycomb coils, in series, festooned around the shack! I also well remember the 'signals from Mars' experiment, and recall reading a description of the 30-valve (all triodes) receiver, but I never found out what the results were.

"But my purpose in writing to you is to point out that these long and very long wavelengths are by no means unoccupied at the present time. I myself have logged quite recently about 20 or 30 stations between 14kc/s and 150kc/s—all modern CW or MCW valve transmitters—on a rather old four valve marine (TRF) receiver. Also, the American Navy is operating at least half-a-dozen stations in the U.S.A. between 14kc/s and 70kc/s, and, of course, our own GBR (Rugby) is still active daily on 16kc/s, with a transmitter which has been completely rebuilt and modernised since the last war. Its horseshoe aerial of 1000ft masts has been a landmark for many years besides the main Euston/Crewe railway at Hillmorton, just outside Rugby.

"Last but not least I myself am at this moment a maintenance engineer at a navigator transmitting station here, transmitting continuously on a frequency of 133kc/s. Other stations of this type (there are 16 in the British Isles alone), use fre-

POWER Rectifier Circuits

A SURVEY OF PRINCIPLES OF
PRACTICAL IMPORTANCE, AND
USES OF SUCH CIRCUITS

By L. N. Nash

A NUMBER of very useful and thorough practical articles have appeared in recent months in *PRACTICAL WIRELESS* and *Practical Television* concerning rectifiers, rectifier circuits, metal rectifiers, crystal diodes, etc. It is now felt that a useful addition to this series would be a practical discussion of power-rectifier circuits in particular, and consequently the author has compiled the present article from his own practical experience in the workshop, in building the most varied of such circuits.

Varied Circuits

After a preliminary discussion of some important general principles, and a brief survey of conventional circuits as a brief recapitulation of more detailed material in past articles, the author will proceed to introduce a number of more unusual and unconventional power-rectifier circuits, pointing out their individual advantages and disadvantages. These circuits form the actual main subject of this article. All circuits given have actually been built and used by the author, principally in the form of the power-supply portion of a chassis of equipment. Where actual component values are quoted in the diagrams, these may be used directly by constructors if they wish to build any of the circuits concerned as power-supply portions of a chassis of equipment for any purpose they may desire. All circuits bearing specific component values have been built and proved by the author. Those circuits intended to illustrate only a principle, however, will bear a note to that effect since some component values specified will be approximate, and the circuits should then be treated merely as the basis for the constructor's own experiments.

Naturally, if the same circuit is desired, but a different output voltage or current or both, modifications may be necessary even to those component values specified. It is highly likely that the constructor will have gained sufficient knowledge from this article and other rectifier-articles in this magazine to be able to judge the extent and direction of such possibly necessary modifications.

Construction and Layout

It is assumed that almost all power-rectifier circuits connected with the normal experimenter's

common and
uncommon

work receive a 50c/s mains-frequency input, so that all questions of critical layout and short wiring as arising in high-frequency circuits do not apply here. The layout is thus not in any way critical in any of the circuits, and leads of even considerable length are perfectly tolerable if deemed necessary for any particular purpose, such as bringing a particular switch or fuse to the front panel, etc.

Far more important is the question of adequate and substantial insulation. Many modern wires with plastic insulation soften at relatively low temperatures, and it is inadvisable, for example, to run such wires unprotected hard against cores of transformers which heat up considerably in normal operation. A good quality oil-fabric sleeving should be used for such wires at all such danger points, and for voltages above about 500 it is the author's practice to use two such sleeveings pushed over each other, having different diameters to suit. All leads going through the chassis should be protected by substantial rubber grommets. Apart from the danger of mechanical damage by chafing, unprotected chassis holes for wires promote danger of flashover at higher voltages, due to the concentration of the electrostatic field at sharp corners. This is very important here, because it is for the various higher voltage rectifier circuits that the full advantages of the unusual circuits to be introduced in this article become apparent.

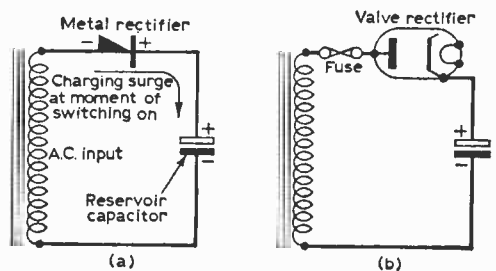

Fig. 1a—A fuse taken direct from the transformer would be likely to blow easily on switching on, due to the charging surge of the reservoir condenser; b—with a valve rectifier, the condenser charges more slowly as the valve heats up.

Fusing Considerations

It is necessary to use switches of adequate voltage rating, and to pay proper attention to any fuses that may be deemed necessary. A fuse in the lead direct from the transformer to the rectifier protects against rectifier and smoothing condenser faults as well as output overloads, but has the disadvantage of easily blowing upon switching on, due to the charging surge of the reservoir condenser (Fig. 1a). This trouble is present if a metal rectifier is used. With a valve rectifier, the reservoir condenser charges more slowly as the valve heats up, and thus this form of fuse is then more applicable (Fig. 1b).

It is of course necessary to use a sufficient number of fuses to ensure complete cut-off in the event of a failure. Thus, in the conventional full-wave valve rectifier circuit of Fig. 2, a single fuse placed at A will protect against output overloads, but a pair of fuses is necessary at B and C to protect adequately against internal faults of the circuit as well as output overloads. A single fuse at D is to be considered dangerous, as in the event of a short between anode and cathode of one diode, the transformer winding is then shorted through the other diode on one half-cycle, which renders the transfer of the fuse from A to D pointless.

Comprehensive Protection

In small power units of normal voltage output, an output fuse at A and a mains fuse in the transformer primary circuit (which takes care of internal faults) are sufficient. But for high-voltage or high power units, this simple protection is not sufficient. If other circuits (heaters, subsidiary H.T. voltages, etc.) are fed from the same large transformer, it may be impossible to make the rating of the mains primary fuse low enough for it to blow before excessive fault currents could flow in the faulty rectifier circuit in question. In such cases fuses at such positions as B and C in Fig. 2 are necessary. For conventional rectifier circuits, the matter need not be taken too critically, but for the more unusual circuits, where faults could have a whole chain of expensive consequences, proper fuse protection is well worth the extra expense and trouble. This does not mean that the unusual circuits here to be discussed are in any way unreliable or prone to breakdown due to improper operation of components other than under specified conditions. On the contrary, no components are operated under other than permissible conditions in the specified circuits, and the author has found a high degree of reliability of such circuits, under periods of continuous operation even as long as a week at a time.

Modulation Hum

A rectifier is the basis of normal detector circuits, as will be known to all experimenters. The question of "detection", i.e. removal of the audio or video signal from the modulated R.F. carrier, is in principle little different from the reverse process, that of "modulation" of the R.F. carrier with the audio signal at the transmitter, so that in principle the same rectifier circuit could function for both purposes.

If in any way the wiring connected to a power

rectifier picks up an R.F. signal, over the mains wiring in the house, or by any other available process, then the rectifier (be it a valve or a metal rectifier, that makes no difference) will invariably modulate this picked-up signal with the 50c/s mains hum, in addition to any modulation it may already have. If now the same circumstances which led the rectifier wiring to receive the R.F. signal enable it to be radiated again, then any receiver picking up this re-radiated signal cannot distinguish the original modulation from the distant transmitter from this local "modulation hum". Consequently a powerful hum is present on the radio concerned, but only when stations are tuned in. Normally only local stations are affected, as distant weak stations provide insufficient signal at the power rectifier. However, it is perfectly possible for even weak stations to be affected if the power rectifier circuit picks up and modulates an R.F. signal and re-radiates it to an I.F. stage in a poorly screened receiver. In such a case hum will be present as soon as any station whatsoever is tuned in.

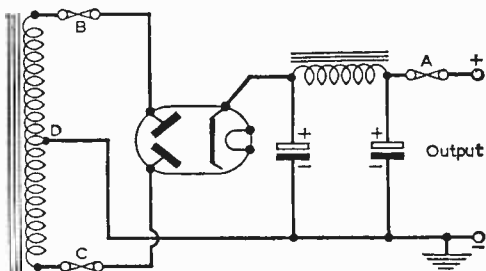
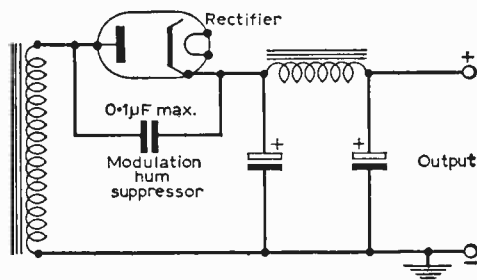

Fig. 2 (above)—Possible positions for fuses in a full-wave rectifier circuit.

Fig. 3 (below)—Shunting a condenser across a power rectifier, to remove modulation hum.



Remedies

Now for the practical consequences of this discussion! Two measures are available to combat modulation hum. The first is to render the power rectifier inoperative as a rectifier for R.F. whilst being unaffected at mains frequency. This is achieved by shunting a condenser across it between anode and cathode. Naturally, this shunt condenser (see Fig. 3) forms an A.C. bleeder together with the reservoir condenser, and thus increases the A.C. ripple on the D.C. output. Thus there is an upper limit to the size of the shunt condenser usable. It is a good rule of thumb to use a shunt-

capacity of about 1% of the value of the reservoir condenser used, but not exceeding 0.1 μ F.

The second measure is to assign the rectifier a proper place on the chassis in relation to other circuits. The power rectifier should always be as far away from all R.F. and I.F. circuits as possible, and the latter should be adequately screened, for this and other reasons. A mains transformer with a shield between primary and secondary is very helpful. In high-voltage circuits, where shunt-condensers across the rectifiers may be impossible, because maximum values tolerable on account of the low values used for the reservoir condenser are useless to shunt R.F., it may be necessary to use a good transformer with a screen and build the whole rectifier circuit into a screening can. But such severe cases should be extremely rare.

Neighbouring Receivers

It must be added on this topic that the author has several times been called upon to repair a receiver suffering from "severe hum", and finally cured the fault by shunting the rectifiers in a radio belonging to a completely different family, in some cases several floors removed in the same house. Careful work with a portable direction-finding receiver was necessary to locate the offender, and such work is really the job of GPO interference-tracing vans. It is here mentioned merely as an example of the surprising range of re-radiated signals with modulation hum, under "favourable" conditions. One can cause considerable annoyance

It is virtually impossible ever to make an A.C./D.C. set run free of modulation hum without a shunt-condenser, which then takes a familiar simple form of a 0.1 μ F condenser straight across the mains input to the set. Whilst this measure virtually cures modulation hum in the set concerned, it is sometimes less effective in older domestic mains installations using long runs of wire without conduit, which function as efficient aeri-als. In such cases, the addition of the items in Fig. 4 may help.

Peak Inverse Voltage and A.C. Input Rating

The *peak inverse voltage* of a rectifier is the maximum voltage it can withstand in the non-conducting direction (i.e., with anode negative and cathode positive) without breakdown. The *A.C. input rating* is the maximum permissible r.m.s. voltage output of the transformer winding feeding the rectifier and smoothing circuits. Sometimes the one and sometimes the other is quoted in the characteristics for a rectifier, and there exists a definite relation between the two.

Considering the simple conventional half-wave rectifier circuit of Fig. 5, it is clear that the reservoir condenser charges up until it reaches a D.C. voltage equal to the *peak* of the applied A.C. voltage. Now this peak is roughly one-and-a-half times the r.m.s. value for the mains sine wave (exactly, peak=1.414 r.m.s.).

Inverse Voltage Stress

On the subsequent half-cycle, in which the rectifier is blocked because the transformer voltage has reversed, the peak condenser voltage and the negative peak transformer voltage (another one-and-a-half r.m.s.) act additively in series across the rectifier in the non-conducting ("inverse") direction. Thus, the total inverse voltage stress on the rectifier is *three times* the A.C. r.m.s. voltage output of the transformer.

Thus for a 350V r.m.s. A.C. transformer winding, the rectifiers must be rated for "350V A.C. input", or for "1000V peak inverse voltage", both statements amounting to the same thing. It is this factor which limits the use of metal rectifiers at the higher voltages. In principle, sufficient elements of metal rectifiers may be connected in series to withstand the inverse voltage, but this becomes prohibitively expensive if high-current operation is desired. In such cases one finds valves more economical.

Valves

At normal H.T. current ratings of 50mA to 100mA it is at present relatively uneconomical to

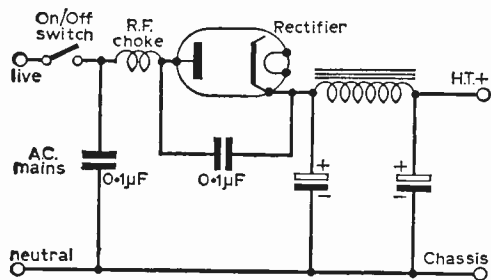

Fig. 4 (above)—Curing modulation hum in older mains installations sometimes requires more than just a shunt-condenser.

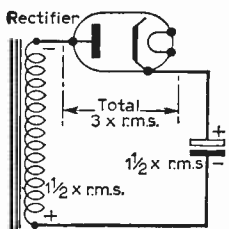

Fig. 5 (left)—The relation between r.m.s. input and peak inverse voltage (PIV) ratings.

to one's neighbours with an unsuitable rectifier circuit, as well as impair the performance of one's own equipment. Notorious offenders are A.C./D.C. sets drawing H.T. through a rectifier connected direct to the mains, as this arrangement offers easy entry and exit of R.F. signals over the mains. Sets using a transformer are far better, and in many cases the R.F. losses of the mains transformer are high enough to remove all trace of modulation hum even without rectifier-shunt condensers.

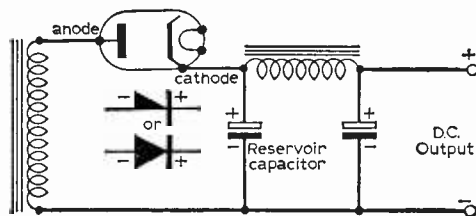

Fig. 6a—Basic half-wave rectifier circuit.

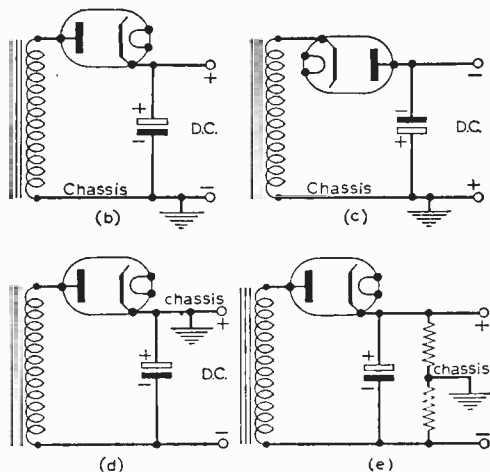

Fig. 6b—Positive-output half-wave rectifier circuit; c and d—negative-output half-wave rectifier circuits, e—obtaining positive and negative outputs simultaneously in a half-wave circuit.

construct metal rectifier elements for A.C. input voltages exceeding at the very most 500V (peak inverse voltage 1,500), though series piles of elements for low-current EHT rectifiers are relatively cheap and common, even up to A.C. inputs of many thousands of volts. The modern developments in silicon power-diodes capable of carrying currents up to some amps in the larger types have a present peak inverse voltage limit of about 1000, so that maximum A.C. inputs of about 350V are permissible. There is nothing except the price, to prevent the use of two or more such diodes in series (to increase the voltage rating in direct proportion), but a valve would almost always be more economical in such cases. The silicon diodes need a heat sink in the form of a metal plate to which they are bolted, and if several such diodes are connected in series, the heat sinks will be at different potentials, and must be adequately insulated. This can introduce problems outweighing the disadvantages of a valve rectifier in the particular application envisaged.

Combination of Rectifier Types

The author is of the opinion that the "valve rectifier versus metal rectifier" controversy is largely futile. The truth is that the scope open to the constructor has been enriched by the availability of both types of rectifier. There are a number of applications where the ideal solution of a problem involves the use of a mixed circuit, using both valve and metal rectifiers, as will become apparent in the course of this article. However, as a general principle, valves score on their high inverse voltage rating, but are clumsy and require heater voltage, and generate appreciably more heat. Metal rectifiers of copper oxide, selenium or silicon types score on high current ratings, but have limited inverse voltage rating. As a result, modern circuit practice has justifiably relegated valves to the higher voltage circuits.

When connecting metal rectifiers in series to increase the voltage rating, only identical types may be used in each series connection, as the series-connection of different types with different inverse resistances cannot enable the desired equal sharing of voltage to be realised. To allow for tolerances, it is not advisable to run a pair of series connected rectifiers to a voltage higher than $1\frac{1}{2}$ times the rating of a single rectifier of the same type.

Conventional Half-wave Rectifier Circuits

The rectifier diodes in all the following circuits of conventional type have been drawn in the form of valves. They are of course equally applicable to the use of metal rectifiers or silicon diodes, bearing in mind the remarks in the previous paragraph.

Fig. 6a gives details of the simplest conventional rectifier circuit, the "half-wave" circuit, together with the most common equivalent symbols for valves and other types of rectifier. It is very important that the constructor familiarise himself with the accepted circuit symbols and representation of polarity of rectifiers because connection of a rectifier with wrong polarity in a circuit can lead to serious consequences. It is conventional to make the thin line of a metal rectifier symbol correspond to the valve-cathode, and this corresponds to the terminal marked "+" or "red" or "cathode" in a metal rectifier. The "triangle" or "arrow" of the metal rectifier symbol corresponds to the valve anode.

Chassis Connections

According to which side of the D.C. output of the half-wave circuit of Fig. 6a is connected to chassis (earthed), we can get a negative or a positive output voltage with respect to chassis, as shown in Figs. 6b and 6c. The "positive" form of Fig. 6b is used for H.T. supplies in A.C./D.C. sets, where the transformer winding of the diagram is actually replaced directly by the mains. Fig. 6b is used as it stands, with input from a mains transformer secondary winding of the desired voltage, in H.T. supplies for the simpler forms of A.C. mains radios, amplifiers, etc, where the current drain is not high enough to warrant the expense of the more efficient full-wave circuit. The "negative" version of Fig. 6c is often used to provide the input D.C. voltage to a negative grid-bias voltage-bleeder chain in such circumstances which require higher grid bias voltages than are easily obtainable by the use of cathode resistors for the valves, or other conventional methods. An independent grid-bias supply of this type also has the advantage of greater stability and of fundamental independence from the anode currents flowing in the valve circuits being biased.

The half-wave rectifier circuit of Figs. 6a to e derives its name from its simple function. When the transformer winding voltage is of the same polarity as the ultimate output D.C. voltage, i.e. on alternate half cycles of the A.C. waveform, the rectifier conducts to charge the smoothing condensers. On the other half cycles, the rectifier is blocked, and the inverse voltage, discussed in the previous paragraph, is operative across the rectifier.

(To be continued)

BOOKS REVIEWED

ELEMENTS OF ELECTRONIC CIRCUITS—by J. M. Peters. 94 pages. Published by Iliffe Electrical Publications Limited. Price 21s.

THE most complex-looking electronic circuit is usually capable of being reduced to a number of recognisable elements. If the function of all such circuit elements is thoroughly understood, then the operation and function of the whole complex circuit can generally be deduced without much difficulty.

Hitherto the only information available on many such basic circuit elements has been scattered among diverse publications, embracing collectively practically the whole field of electronic technology. Now, for the greater convenience of students, engineers and the more general reader alike, in this book are gathered together clear descriptions of the operation of the more widely used basic circuits employing valves. The emphasis is on physical explanations and mathematics are kept to the minimum. Detailed waveform and circuit diagrams accompany each description, but it is felt that the use of inferior letters (letters below the line of the others) and figures in circuit references, such as R_a , I_a and the confusing mixture of roman and italic type tends to spoil the otherwise concise text.

Subjects covered include: time constants and differentiation, clamping or D.C. restoration, amplitude limiting, multivibrators, electronic markers, gates and coincidence circuits, delay circuits, performance of mathematical functions.

This publication forms a valuable source of reference for both amateur and professional.

PROBLEMS IN RADIO ENGINEERING—by E. T. A. Rapson. 170 pages. Published by Sir Isaac Pitman and Sons Limited. Price 15s.

THIS book sets out, in a comprehensible form, typical problems that the National Certificate student in radio communication is likely to meet in his examinations. The questions are drawn from past examination papers of the City and Guilds of London Institute in Radio Communication, the Institute of Electrical Engineers in Electrical Communications, and the University of London in Telegraphy and Telephony. All students of radio engineering, no matter for which examinations they are preparing, will find this book invaluable.

There are forty-nine chapters covering every aspect of radio communications fully and no attempt has been made to cram too many subjects into one chapter, so that "series resonance", for example, has one complete chapter devoted to it and is not included in the chapter concerning "series circuits". Each set of problems is preceded by a number of formulae with which it is imperative that the student be acquainted, in order that he be able to answer the question fully.

All the answers are listed in one chapter at the end of the book.

This is the eighth edition of this book, bringing it right in line with all recent advances made in the field of radio communications.

THE ELECTRONIC MUSICAL INSTRUMENTS MANUAL—by Alan Douglas. 301 pages. Published by Sir Isaac Pitman and Sons Limited. Price 37s. 6d.

THIS is the fourth edition of a useful book which was first published in 1949. It deals very fully with the many note generators, vibrato generators and tone formant circuits which are now employed, and it may safely be said that there is no electronic musical instrument at present on the market which does not employ at least one of the many circuits which are illustrated. The latter part of the book is devoted to a brief description of the major circuitry of some of the commercial instruments now on the market, and this includes the Gulbransen transistorised organ, probably the most up-to-date instrument to appear in this very large market. Although much thought has obviously gone into the preparation of this Manual it is clear that much of the data has been taken straight from manufacturers service manuals etc., and as a result the experimenter will find that many of the circuits leave out certain essential data, such as condenser and resistor values, so that experimental work on these circuits cannot easily be carried out. It is also felt that there is a wide gap in the information covering key switching, which we think is at times more important than generator or tone formant circuitry. However, for the student there is much to be found in this particular volume which we do not think can be found in any other publication, even on the American market, and it should help many who are interested in either finding out how a modern electronic organ functions, or in trying to design one for their own use.

RADIO AND TELEVISION RETAILERS' HANDBOOK—by F. X. Carus. 216 pages. Published by George Newnes Limited. Price 35s.

THIS is believed to be the first work of its kind, devoted to the business and managerial aspects of radio and television retailing.

After reviewing the growth of the Radio Trade and assessing its future prospects, the author discusses the problems associated with the setting-up of a retail business. The merits of the various trading arrangements, i.e. sole trader, limited company and partnerships are analysed in detail.

Four chapters are devoted to the selection and training of staff, selling techniques, window displays, advertising and similar subjects.

Emphasis is given to the "after sales" aspect of retailing in a very informative chapter on the service section. In addition to the practical matters concerning the layout and organisation of an efficient servicing department, sound advice is offered on servicing philosophy.

The book-work involved in the retail business is well covered, together with other responsibilities of management such as work study, staff comfort, sales analysis and market research.

The last two chapters of the book provide an authoritative exposition of the Law as affecting retailers.

PORTABLE RADIO OR CAR RADIO

NOW THE SUPER SEVEN 4-WAVEBAND RADIO

(7 Transistors plus 2 Diodes)

- ★ 3 R.F. STAGES.
 - ★ Mullard and Surface Barrier Transistors.
 - ★ Coverage of Medium, Long Waves, Trawler Band and approximately 20-60 metres short wave
 - ★ Use as domestic radio, car radio or fit with strap (not supplied) for carry-about.
 - ★ No aerial required except for use as car radio and for short waves.
 - ★ 3-inch speaker but will drive a larger speaker.
 - ★ Performance comparable to many receivers costing treble.
 - ★ 400 milliwatts output stage.
 - ★ Minimum of 30 stations tuned in excluding S.W.
- May be built for **£6.19.6** plus 3/6 post, etc. SIZE: 7½ x 5½ x 1½ in.



PARTS PRICE LIST AND EASY BUILD PLANS 2/-

TRANSONA-4

(4 Transistors, plus 2 Diodes)

New design now uses moving coil speaker.

FERRITE ROD AERIAL
MW/LW & T.B.
Slide Switches
Handsome pocket case.

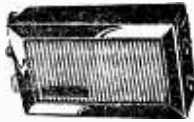

May be built for **55/-** P.P. 3/-.

"Best transistor set I have ever built—dozens of stations."—A.G.H., Deal, Kent.

PARTS PRICE LIST AND EASY BUILD PLANS 1/6

BEGINNERS PUSH-PULL FIVE

(5 Transistors, plus Diode)



- ★ 2½ in. M/C Speaker.
- ★ Ferrite rod aerial.
- ★ Tuning condenser.
- ★ Volume/oscillator control.
- ★ Case with speaker grille in red.
- ★ Fully tunable over med/long waves.
- ★ Simple assembly diagrams.
- ★ 250 Milliwatts output stage.

★ Can be built for **59/6** P.P. 3/-, or with 3" speaker **68/-**
PARTS PRICE LIST, etc. 2/-.

BEGINNERS POCKET 5

(MW/LW and TRAWLER BAND)

(5 Transistors, plus 2 Diodes)

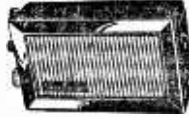

Designed round supersensitive **FERRITE ROD AERIAL** and 3in. moving coil speaker. Attractive case in black with speaker grill in red. On test Home, Light, Radio Lux., and many Continental stations were received.

Total cost of all parts **£2.19.6** P.P. 3/-.

"Truly amazing, station after station."—A.D. Surbiton

EASY BUILD PLANS AND PARTS PRICE LIST 1/6

TRANSONA-6

(6 Transistors, plus 2 Diodes)

M/L & T. BAND

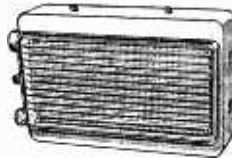

350 Mw Mullard push-pull output Transistors. Powerful magnet 3in. high grade speaker. Push-pull transformers. This is a top performing receiver. Nearly 30 stations listed in one evening including Luxembourg loud and clear. A pleasure to listen to. **FERRITE ROD AERIAL**. All parts sold separately, including pale blue gleaming polystyrene case with duo-diffusion grilles in red. Uses 9 volt battery.

Sockets for car aerial.

Total building cost **£5.9.6** P.P. 3/-. Size 6½ x 4½ x 1½ in.

"Agreeably surprised with Trawler Band reception. Luxembourg as loud as local. Your easy build diagram helped a lot... my first attempt."—H. S., Penzance, Cornwall (poor reception area).

PARTS PRICE LIST AND EASY BUILD PLANS 1/6

NEW SUPER SIX DESIGN

MED/LONG WAVES, TRAWLER BAND AND S.W. TO APPROX. 40 METRES

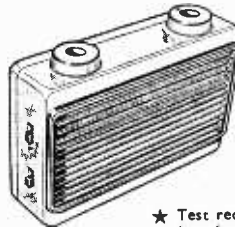

- ★ 6 1st grade Transistors (inc. Mullard and Surface Barrier) plus 2 DIODES.
- ★ Top grade 3in. L/speaker.
- ★ 2 R.F. Stages for extra boost.
- ★ High Q 7in. Ferrite Rod Aerial.
- ★ Easy build diagrams. No aerial or earth required (except as car radio).
- ★ Attractive pale blue case with speaker grilles in red.
- ★ 350 Milliwatts output stage
- ★ Sockets for car radio.

★ Test receiver tuned in over 30 stations. (inc. Luxembourg loud and clear.)

THIS FINE RECEIVER MAY BE BUILT FOR **£6.9.6**

PARTS PRICE LIST AND EASY BUILD PLANS 2/-

PARTS SOLD SEPARATELY

AFTER SALES SERVICE

NAME AND ADDRESS CAPITAL LETTERS PLEASE

RADIO EXCHANGE COMPANY

27 HARPUR STREET, BEDFORD
(Opposite Co-op)

PHONE 2367

10 a.m. to 1 p.m. SAT.

HOME RADIO OF MITCHAM

(Dept. P), 187 London Road, Mitcham, Surrey.
 MIT 3282
 Shop hours 9 a.m. to 6 p.m. Wed. 9 a.m. to 1 p.m.

"P.W." BLUEPRINT DESIGNS

We carry all parts in stock for the Practical Wireless Blueprint designs including:—
 ★ THE REGENCY. ★ TUTOR. ★ MINI-AMP.
 ★ CITIZEN. ★ INTERNATIONAL SHORT-WAVE TWO. ★ MINUETTE. ★ TRANSISTOR SIX. Detailed price lists are available for these designs and will be forwarded on request with 3d. stamp stating models required.

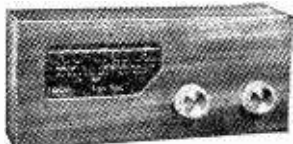

**JASON
"ARGUS"
TUNER**

This three transistor superhet tuner kit makes an ideal addition to your tape-recorder or Hi-Fi system. Completely self contained with own battery and self contained ferrite rod aerial. Just plug in to hear or record all the main Medium and Long wave stations including BBC and Luxembourg etc. PRICE OF KIT £7.10.0, post 1'6. All other JASON FM/VHF TUNERS IN STOCK.

BUILD A MARTIN RECORDAKIT

It's so easy to build a quality Tape Recorder with these complete trouble-free kits. The high quality amplifiers are already assembled and wired on to printed circuit boards and a few simple tools are all that is required to build. Send 3d. stamp for fully illustrated leaflet.

Recordakit "A". Four track BSR deck complete with amplifier, two-tone leatherette covered case and speaker, and full instructions. PRICE 24 Gns.

Recordakit "B". Two track BSR deck complete with amplifier, two-tone leatherette covered case and speaker, and full instructions. PRICE 21 Gns.

Recordakit "C". Two track 3-speed Collaro Studio tape deck complete with high quality amplifier, two-tone leatherette covered cabinet with Hi-Fi 9 x 5in. speaker and full instructions. Professional quality instrument.

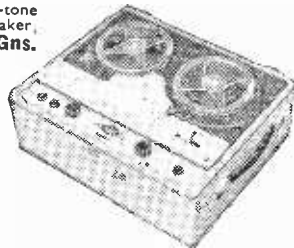

PRICE £29.18.6

We are actual stockists: o. HEATHKITS

IMPORTANT NOTICE

WITH EFFECT FROM 1st MAY 1962, THIS SHOP WILL CLOSE AT 6.0 p.m. (WEDNESDAY 1.0 p.m.). OPEN ALL-DAY SATURDAY UNTIL 6 p.m.

MULLARD TRANSISTORS

Prices Down Again! Brand New and Boxed OC44 9'3, OC45 9'4, OC70 6'6, OC71 6'6, OC72 8'1, OC75 8'1, OC76 8'1, OC78 8'1, OC81 8'1, OC140 3'6, OC170 1'3'6, OC171 1'4'6, OC71 1'9'6. Please add 6d. postage to order.

Learn Basic Electronics and Radio by Picture Book Method

This is an exciting and fascinating way of learning the basic theory and practice of radio. Based on the latest research into simplified teaching techniques, only the essential facts are explained simply and clearly with an individual illustration for each one. These wonderful books were originally developed for training Service personnel and are now available for all. Complete course comprises six books which are available separately, Price 14/-, each post 1/-.

SEND 3d. STAMP FOR ILLUSTRATED BROCHURE ON THESE BOOKS.

NEW! DO-IT-YOURSELF TRAINING TECHNIQUE in RADIO & ELECTRONICS

You LEARN while you BUILD...

SIMPLE...PRACTICAL...FASCINATING... 1st stage receiver

ANNOUNCING—after many years of highly successful operation in the U.S.A. and in Europe—the latest system in home training in electronics is now introduced by an entirely new British training organisation. **AT LAST**—a comprehensive and simple way of learning—by practical means—the basic principles of radio and electronics, with a minimum of theory. **YOU LEARN BY BUILDING** actual equipment with the components and parts which we send you. You advance by simple steps using high quality equipment and performing a whole series of interesting and instructive experiments. No mathematics! **INSTRUCTION MANUALS** and our teaching staff employ the latest techniques for showing clearly how radio works in a practical and interesting manner. You really have fun whilst learning! And you end by possessing a first rate piece of home equipment with the full knowledge of how it operates and—very important—how to service and maintain it afterwards. A full library of magnificent illustrated textbooks are included with the Courses. **IN FACT** for the "Do-It-Yourself" enthusiast, the hobbyist, or those wanting help with their radio career training, or to set up their own full or part-time servicing business—then this new and exciting instructional system is exactly what is needed and it can all be provided at very moderate cost. Easy payments available. Post the coupon now, for full details. There is no obligation.

BUILD YOUR OWN • RADIO EQUIPMENT • TEST GEAR • HI-FI INSTALLATION—AND LEARN AS YOU DO IT

RADIOSTRUCTOR

BRITAIN'S LEADING RADIO TRAINING ORGANISATION



To: RADIOSTRUCTOR (Dept. G107), Reading, Berks.

Name
 Address
) BLOCK CAPS PLEASE

(821) We do not employ representatives 6-62

A 4-valve Signal Tracer

THIS INSTRUMENT WILL ALSO PROVIDE A SIGNAL FOR TESTING AUDIO AMPLIFIERS

By V. E. HOLLEY

THIS versatile piece of equipment is a worthwhile addition to any bench. It will trace a signal through all the stages of a radio receiver from the grid of the first valve onwards and will itself provide a signal of good quality for testing audio amplifiers or loudspeakers; it can also be used as a general purpose bench amplifier and when not in use for any of these purposes, will serve as a portable local station receiver for the workshop or the house.

Signal Production

The first stage, which employs a high gain R.F. pentode, EF91, is concerned entirely with the provision of a signal, the source of which may be any radio transmission which is readily receivable at consistent strength. In the area in which the prototype is used, the Light programme on 200kc/s is the only one which meets this requirement and it was accordingly selected. As will be seen from Fig. 1, a ferrite rod aerial with long-wave coil, tuned by a fixed capacitor of 330pF, collects the signal and presents it to the grid of V1, the anode load of which is the 4.7k resistor, R2. The amplified signal passes through the capacitor C4 to a miniature jack socket J1, and thence through C5 to the following stage. Decoupling is provided by

resistor R1 and capacitor C2, while bias is obtained in the usual manner by means of a by-passed cathode resistor.

R.F. Tracing

Signals to be traced are fed in at J1, where insertion of a plug applies them to the grid of V2 and breaks the connection between this point and the first stage. It was found that the miniature socket used in the prototype had sufficient capacity to pass on a small portion of V1 output despite the disconnection, and the switch S1 had to be fitted to silence it. The valve V2, another R.F. pentode, accepts and amplifies signals of any radio frequency and the tracing range is limited only by the characteristics of the choke Ch1, which loads the anode circuit. This is an "all-wave" component which, in the prototype, has a range of from 0.2Mc/s to 60Mc/s.

Demodulation

Diode D1 accepts for demodulation the signals appearing at V2 anode. Resistors R8 and VR2 form the load proper, and R7 completes the D.C. continuity of the circuit. Capacitors C9 and C11 remove the now unwanted radio frequencies and

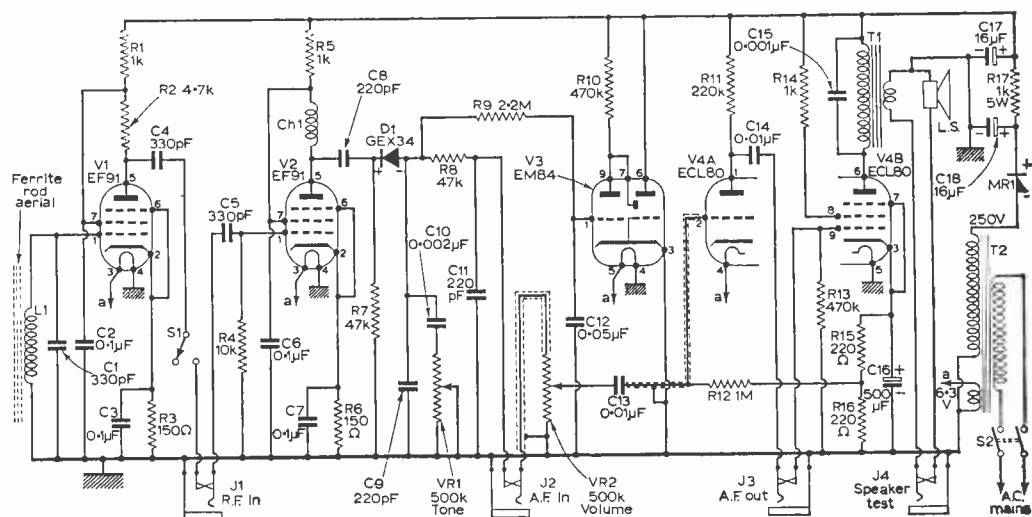

Fig. 1—The circuit of the instrument.

LIST OF COMPONENTS

Resistors ($\frac{1}{2}$ W unless otherwise stated)

| | | | |
|-----|--------------|-----|----------------|
| R1 | 1k | R11 | 220k |
| R2 | 4.7k | R12 | 1M |
| R3 | 150 Ω | R13 | 470k |
| R4 | 10k | R14 | 1k |
| R5 | 1k | R15 | 220 Ω |
| R6 | 150 Ω | R16 | 220 Ω |
| R7 | 47k | R17 | 1k, 5W |
| R8 | 47k | | |
| R9 | 2.2M | VR1 | 500k |
| R10 | 470k | VR2 | 500k with D.P. |

Capacitors:

| | | | |
|----|-------------------|-----|------------------------|
| C1 | 330pF mica | C10 | 0.002 μ F 250VW |
| C2 | 0.1 μ F 350VW | C11 | 220pF |
| C3 | 0.1 μ F 350VW | C12 | 0.05 μ F 350VW |
| C4 | 330pF | C13 | 0.01 μ F 350VW |
| C5 | 330pF | C14 | 0.01 μ F 350VW |
| C6 | 0.1 μ F 350VW | C15 | 0.001 μ F 350VW |
| C7 | 0.1 μ F 350VW | C16 | 500 μ F 15VW elec. |
| C8 | 220pF mica | C17 | 16 μ F 350VW elec. |
| C9 | 220pF mica | C18 | 16 μ F 350VW elec. |

Diode: GEX34 or similar

Valves:

| | |
|----|------------------------|
| V1 | EF91, B7G base |
| V2 | EF91, B7G base and can |
| V3 | EM84, B9A base |
| V4 | ECL80, B9A base |

Transformers:

Mains 250V half-wave, 50mA, 6.3V 1.5A

Output 60 : 1 30mA primary

Rectifier: Contact-cooled, 250V, 50mA

Miscellaneous:

RF Choke—all wave, 0.2 to 60Mc/s
4 miniature jack sockets
2 miniature jack plugs

Audio and Output Stages

A triode-pentode valve ECL80, is employed here. The triode section is arranged as a resistance-coupled amplifier with an anode load of 220k and included in its output circuit is the

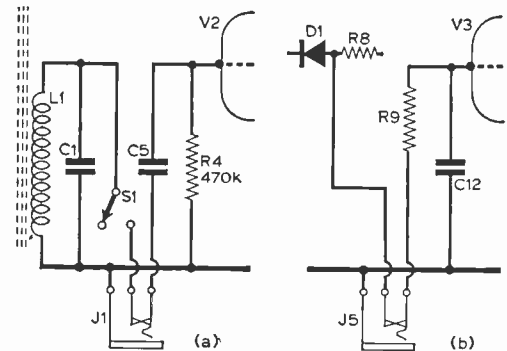

Fig. 2a—A modification of the circuit, omitting V1;
b—An additional input to the grid of V3.

socket J3. Insertion of a plug here provides an audio output which, controlled by VR2, can be made large enough to load any normal output stage.

The two sections of the ECL80 share a common cathode but require different bias voltages; the triode grid resistor R12, is therefore returned to a tapping on the cathode resistor instead of to chassis. For satisfactory operation, this cathode network must be by-passed by a really large capacitance and C16 has accordingly been given a value of 500 μ F. The optimum load of the pentode section of V4 is 11,000 Ω , and the output transformer should have a ratio of 60 : 1 to suit a 3 Ω speaker. Suitable transformers are readily available. The primary windings of these com-

the audio output is passed on for amplification via C13. It will be noticed that a simple top cut tone control (C10/VR1) is connected to the diode circuit; this relates entirely to the receiver service and was added to reduce television whistle which is apt to be troublesome on 200kc/s.

Visual Tracing

In addition to the audio frequencies, there appears across the diode load a negative D.C. voltage proportional to the strength of the signal at V2 anode. This is used to control a tuning indicator valve V3, so that unmodulated or frequency modulated signals which, of course, produce no sound output, may be traced visually. Resistor R9 isolates the indicator grid from audio frequencies and capacitor C12 removes any which may reach this point.

Audio Tracing

Socket J2, which is included in the diode circuit, is the A.F. tracing input. Insertion of a plug transfers VR2 from the diode to the test lead,

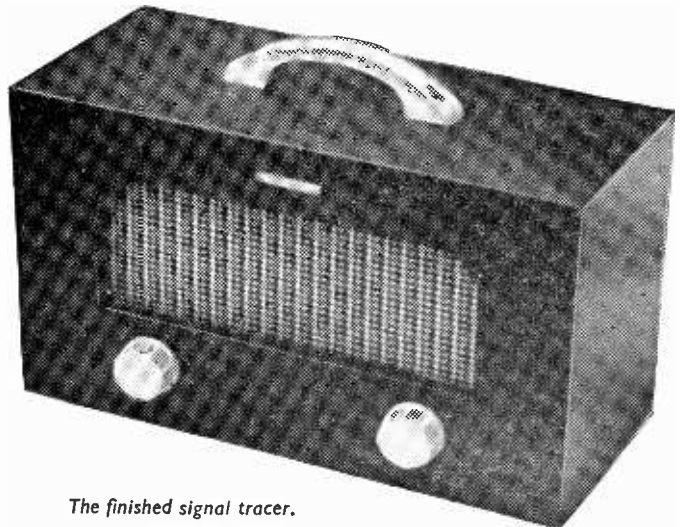

The finished signal tracer.

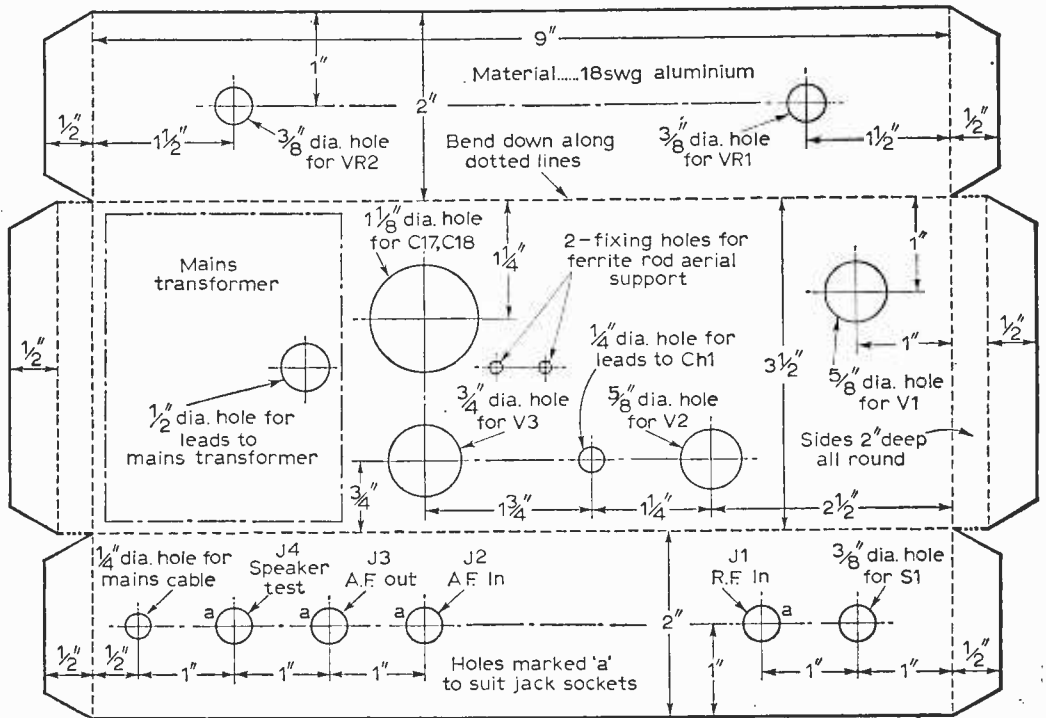

Fig. 3—The drilling dimensions of the chassis.

ponents usually have sufficient resistance to produce a noticeable voltage drop at the valve anode and resistor R14 is included in the screen supply so that the voltage here will not exceed that at the anode. Connected across the transformer primary is the capacitor C15, which corrects the response at the higher audio frequencies. The output from the transformer secondary is fed to a loudspeaker via a jack socket, J4. Insertion of

a jack here provides a low impedance audio output for testing loudspeakers.

Power Supply

The total H.T. requirement is 45mA at 250V. and a supply of 1.2A at 6.3V is needed for the valve heaters. This is provided by a half-wave mains transformer and a contact-cooled metal rectifier, MR1. Smoothing is by resistor, R17 in conjunction with the electrolytic capacitors C17 and C18. The value of the resistor may need adjustment to provide the correct H.T. line voltage of 200, depending on the output of the transformer-rectifier combination employed.

Modifications

If the tracer is to be used in an area of good signal strength, V1 may be omitted, the ferrite aerial being connected through socket J1 to the grid of V2 as shown in Fig. 2(a). In this case, R4 will need to be increased to avoid excessive damping of the tuned circuit and R17 must also be increased to take account of the reduced current requirement.

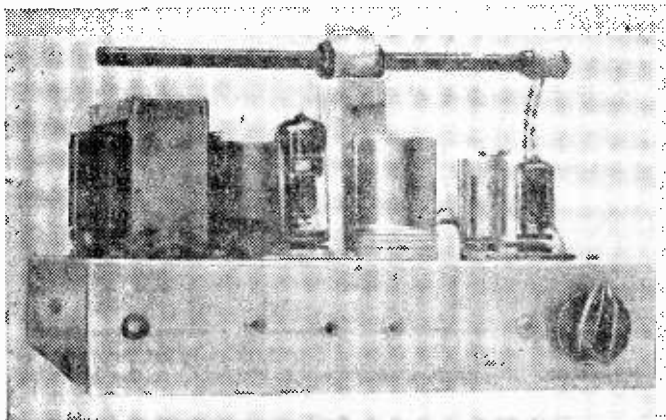

The unit without its cabinet.

(To be continued)

How Transistors Work

By B. N. Rolfe

A BASIC NON-MATHEMATICAL EXPLANATION

(Continued from page 38 of the May issue)

Anode Heating

In a thermionic valve, the electrons from the cathode are accelerated to a very high speed by the positive anode, and since the electrons have mass, on striking the anode they liberate their kinetic energy and in that way cause the anode to become hot. The maximum anode dissipation of a valve is related to the maximum permissible values of cathode current and anode voltage, and, in turn, these ratings depend upon the size and physical construction of the valve.

From the foregoing, therefore, it will be appreciated that a transistor has a collector dissipation rating. This is usually denoted pc and is given by the product of the maximum collector voltage ($V_c \text{ max}$) and the maximum collector current ($I_c \text{ max}$). However, with a transistor, there is also another important factor—temperature. As indicated in previous articles in this series, the maximum junction temperature (which is often the same as the maximum storage temperature) is in the region of 75°C for most germanium transistors. This means that if the temperature of a transistor is allowed to rise above that value it may well cease to work as a transistor and change into an ordinary resistor. The same applies if a transistor is stored for any length of time at a temperature much above 75°C .

Thermal Resistance

It is thus necessary to introduce a temperature

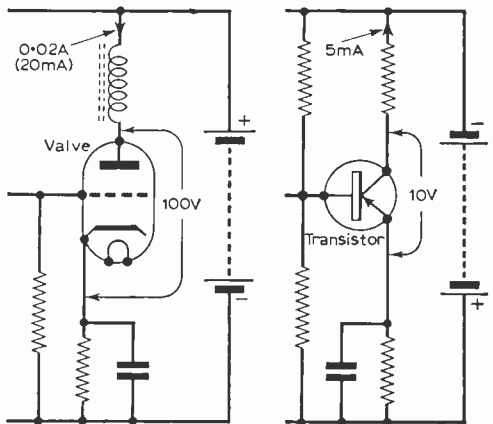

Fig. 24 (left)—A thermionic valve has an anode dissipation value equal to the anode voltage times the anode current.

Fig. 25 (right)—The collector dissipation of a transistor is given by $(I_c \times V_c)$.

LAST month we learnt more about the semi-conducting process: how the two “ p ” and “ n ” types of semi-conducting materials are produced by the addition of “impurities”, how the two types are integrated to form either a simple diode rectifier or three-element transistor and, most important, we discovered that minority-carriers quickly increase in number if the semi-conducting device is allowed to rise in temperature.

Normally, the collector current increases with increase in base current, but, due to minority carriers, the collector current will also rise with increase of temperature of the junction. Previous articles in this series revealed how the operating temperature of a transistor is stabilised from the circuit aspect, and this article will start with a few more notes on the operating limits of transistors.

Collector Dissipation

Dissipation in the context considered is the “power” that a device can safely withstand. Power is usually rated in watts. Take an ordinary resistive circuit across which is a potential of 50V and through which a current of 0.02A (e.g., 20mA) is flowing—see Fig. 23. The product of the voltage and the current in amperes gives

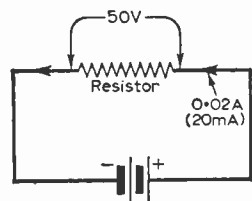

Fig. 23—The power dissipation in a resistor in watts is equal to the voltage multiplied by the current in amperes.

the power dissipation in watts. Thus, in Fig. 23, the power dissipation is 50 times 0.02, which works out at 1W.

An ordinary thermionic valve has an anode dissipation value which is calculated in the same way as with a resistor. In Fig. 24 is shown a simple valve circuit with 100V on the anode and, again, 0.02A of current (called anode current). The product of the two works out in this example to 2W.

The maximum dissipation of a resistor is, of course, determined by its physical size and, if wire-wound, the diameter of the resistance wire used coupled with the heat withstanding property of the former on which the wire is wound. Power dissipation produces heat, and in a resistor this is caused by the resistance that the wire or conductor possesses to the flow of electric current.

factor into the equation dealing with maximum collector dissipation. This factor is called thermal resistance and is given on transistor data sheets in terms of °C/mW for small units.

A typical value is 0.33°C/mW. This relates the collector dissipation to the rise of temperature of the junction. It is not really as complicated as it sounds, as a simple example will show.

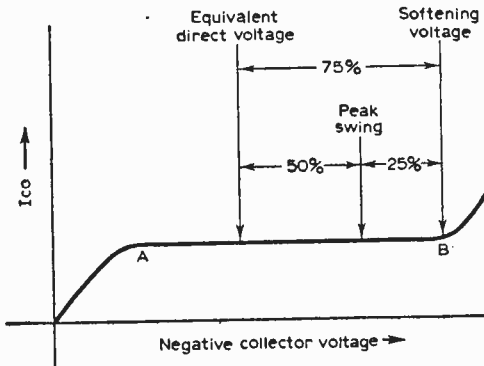

Fig. 26 (above)—Curve showing the voltage limits at the collector.

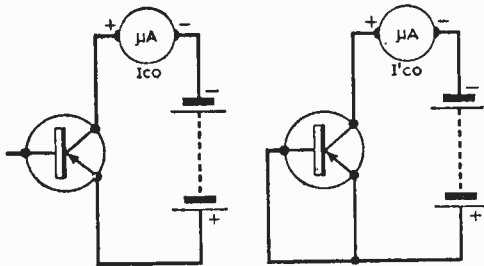

Fig. 27—With the base open-circuit, the collector current present is usually denoted I_{co} (a—left); and with the base connected to the emitter I'_{co} (b—right).

As we are considering a rise in temperature from the ambient, there are four factors which have to be considered. These are (i) collector dissipation p_c , (ii) junction temperature T_j , (iii) ambient temperature T_a and (iv) thermal resistance R_t . These are used in the following equation to permit the calculation of collector dissipation:

$$p_c = (T_j - T_a) / R_t$$

Suppose $T_j = 75^\circ\text{C}$, $T_a = 50^\circ\text{C}$, and $R_t = 0.33$. Then, $p_c = (75 - 50) / 0.33$ which works out to a little under 76mW. This means that a transistor with a thermal resistance rating of 0.33 and a maximum junction temperature of 75°C working in an ambient temperature of 50°C has a permissible collector dissipation of 76mW.

Increased Dissipation

A small transistor would probably not require to operate with a collector dissipation in excess of 76mW, so all is well. However, larger transistors may be called upon to dissipate a power in excess of that allowed by the "free air" thermal

resistance. This is possible by the use of a heat sink which consists of a good conductor of heat on which the transistor is mounted and which drains away the heat produced; is not to be confused with a heat shunt which is used primarily for by-passing the heat from a soldering iron away from a transistor during soldering.

In effect, a heat sink keeps the junction temperature below that which would have been reached under free-air conditions for a given collector dissipation. Thus, a transistor with a free-air thermal resistance rating of, say, 0.4°C/mW may well have its rating modified to 0.3°C/mW by the use of a suitable heat sink.

For example, a transistor with a thermal resistance in free air of 0.4°C/mW , with a maximum junction temperature of 75°C and working in an ambient temperature of 50°C would have a collector dissipation of about 62mW. However, by the use of a heat sink (thereby reducing the thermal resistance, say, to 0.3°C/mW) the same transistor could have a collector dissipation of about 83mW—a useful increase.

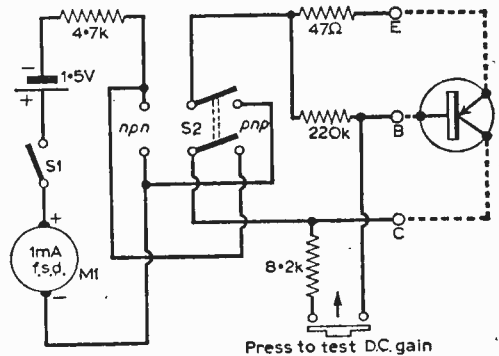

Fig. 28—A circuit of a simple transistor and semi-conductor diode comparator.

After finding the permissible collector dissipation, we can then put voltage and current values in the collector circuit, as shown in Fig. 25. Let us suppose that we found that the collector dissipation was 50mW. Then, the circuit elements would have to be arranged so that the product of the voltage and current did not exceed that value. This would be satisfied by 10V and 5mA.

The maximum voltage, however, is somewhat related to signal swing at the collector, whereas the maximum current has its limit in terms of permissible collector dissipation. For example, it is possible to operate a transistor at a very low voltage and draw from it relatively high currents.

Maximum Collector Voltage

The converse is not possible (e.g., a very low current and relatively high voltage) as already intimated. Without going into too much theory, we can see why this is the case by referring to the curve in Fig. 26.

It will be recalled that the base-emitter junction is biased by the power source in the reverse direction (e.g., negative at the collector and

(Continued on page 165)

The

Troub

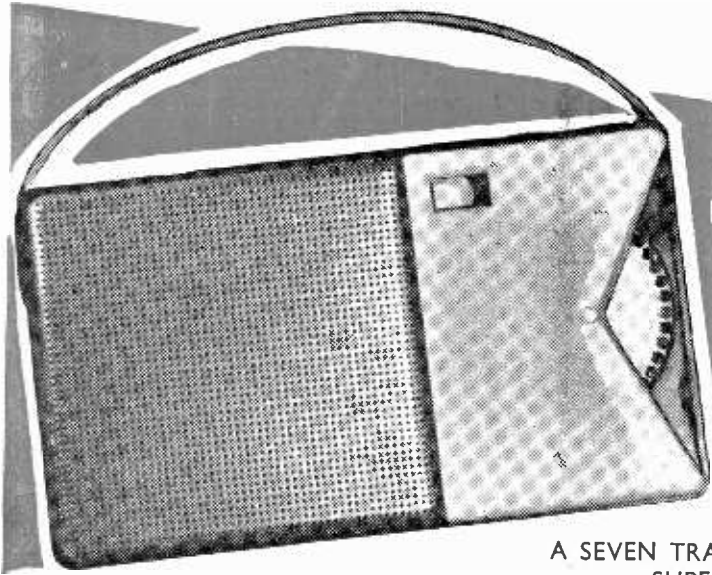

A SEVEN TRANSISTOR, DUAL-WAVE,
SUPERHET RECEIVER

THIS receiver uses seven transistors in a superhet circuit, and will be found to give very good results indeed, with ample volume in even unfavourable circumstances. It tunes both medium and long waves and fits in a ready-made cabinet which is approximately $5\frac{1}{2}$ in. x $3\frac{1}{2}$ in. x 2in. (external dimensions). It is thus very compact and portable, and is capable of a really good output from the internal speaker.

Circuit

The circuit is shown in Fig. 1 on Blueprint 3, and is very satisfactory for this type of set. VC1 and VC2 constitute the twin-gang tuning condenser, and TC1 and TC2 are for trimming the aerial and oscillator circuits on the M.W. band. TC3 and TC4 permit trimming and padding on the L.W. band. These adjustments are not particularly difficult, and will be dealt with next month. After two stages of intermediate frequency amplification, diode D1 acts as detector, and provides some measure of automatic volume control bias for Tr2, via R7.

Tr4 is a high gain, low noise audio amplifier, and should employ a genuine OC71 or comparable transistor; Tr5 is the driver, the output stage using a matched pair of NKT251 transistors. These permit high volume output when wanted, yet have a low resting current under "no signal" condi-

tions, or when volume is lower. This is important, for long life from a miniature battery. As plenty of gain is available, it is possible to provide negative feedback, via R23, including Tr5, Tr6 and Tr7, and both audio transformers; quality of reproduction is therefore good.

If other transistors are to hand, and it is wished to try these, satisfactory results should generally be possible, with comparable types. In general, the values of R14, R18 and R22 might then need changing, to obtain proper working conditions.

Paxolin Panel

The receiver is constructed on a piece of $\frac{1}{8}$ in. thick paxolin $5\frac{1}{2}$ in. x $3\frac{1}{2}$ in. The correct positions for all holes are shown in Fig. 5, and if this is followed it will allow parts to be mounted easily. Small holes, for leads, can be made with a $\frac{1}{16}$ in. drill. For the oscillator coil and IFT pins, $\frac{1}{8}$ in. holes will do well, and these will also suit the three 6B.A. securing bolts. A hole nearly $\frac{1}{4}$ in. in diameter is required for the tuning condenser, and three $\frac{3}{16}$ in. or similar holes for the 4B.A. bolts holding this item.

After drilling, check that parts will fit, and that the holes for the three 6B.A. securing bolts agree with the matching holes in the cabinet front. A small round file may be used to elongate or enlarge any holes which have been inaccurately drilled.

The opening for the loudspeaker magnet is made by drilling a few holes close together each side, so that a small saw may be used. After cutting out the piece, level up the edges with a flat file.

The whole work of preparing the panel should prove to be quite straightforward. Rough edges and holes are cleaned up, and the panel is dusted off. No further drilling or similar preparation will be needed, though if any holes have been missed it is possible to make these later, taking great care not to damage parts already fitted.



P.W.

adour

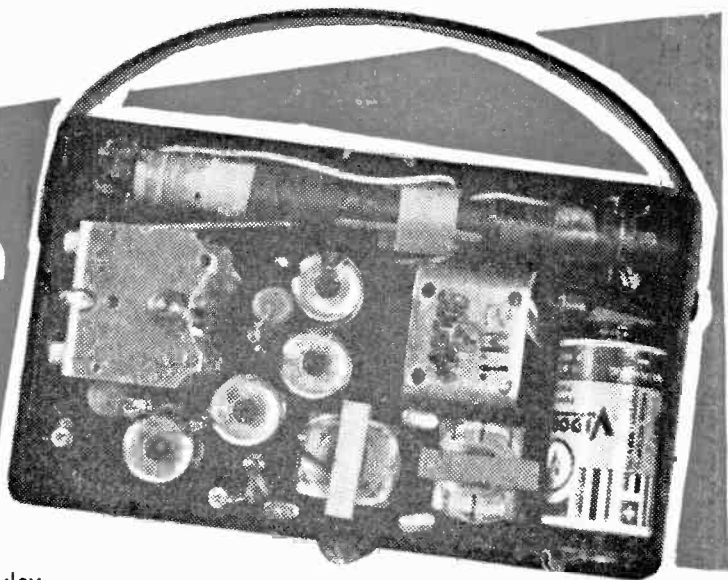

By T. R. Huxley

Ferrite Aerial

When the ferrite rod has been fitted to the receiver, a little confusion may arise in wiring it correctly. This can be prevented by soldering colour coded leads to the various tags, in advance. Very thin coloured flex is satisfactory for this purpose, and can be obtained in the required colours. Alternatively the leads can be marked with pieces of coloured sleeving, or with temporary paper tags, or any other convenient system.

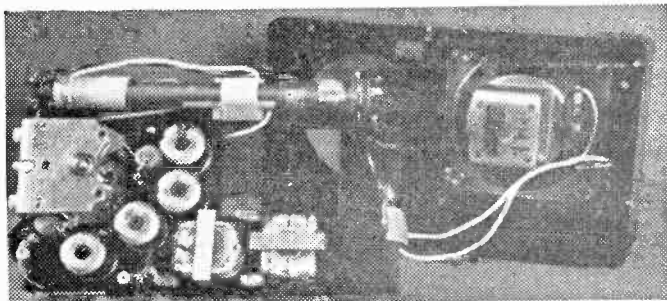

The chassis complete and connected to the loudspeaker, ready for mounting in its case.

Fig. 6 shows the aerial connections. Each winding is so placed on the rod that its tagged end is outwards, as in Fig. 6. The M.W. winding has one tag bent up, to identify the end of the tuned section. This is coded white, and goes to TC3 and the wavechange switch. The next tag (clockwise) is the beginning of the coupling winding, and goes to C1, being coded black. The orange tag is the end of this winding, and goes to the L.W. tap. The final tag on the M.W. portion goes to the tuning condenser VC1 and TC1, this lead being marked green.

With the L.W. section, the unused tag identifies the connections. Viewing the coil from its tagged end, the next tag clockwise also has a white lead, for TC3 and the wavechange switch. Next is the tapping, connected to the orange lead, as already mentioned. Finally, a red lead provides a connection for the "earthed" end of the L.W. winding.

After soldering about 6in. of thin flex to each tag, to agree with Fig. 6, the aerial is put aside, as it is not wired until last. The wires can then be cut down to suitable lengths, but left a trifle slack, so that the windings can be moved along the rod.

Fitting Components

The three intermediate frequency transformers are inserted as in Figs. 2 and 4, taking care to use the blue spot transformer for IFT3. The oscillator coil will fit in either of two positions, but one position is wrong, and a coloured spot identifies pins 1 and 6. This spot must therefore be towards the ferrite rod. Bend the can tags out slightly, to hold the IFT's and oscillator coil in position.

The tuning condenser is fitted as in Fig. 2, tags being placed under two bolts, as in Fig. 4. These three bolts must be very short, or have extra washers, to avoid shorting or damaging the condenser.

Insert the driver and output transformer leads so that they emerge as in Fig. 4. "Durofix" or a similar adhesive will hold these items to the panel. It may prove necessary to reverse the two output transformer secondary connections. This always arises in circuits with negative feedback.

The volume control is held with an 8B.A. 1/4in. countersunk-headed bolt, the nut being near the tuning condenser (Fig. 2). The control tags are bent flat, so that leads may be soldered to them.

The slide switch is held by two 10B.A. $\frac{1}{2}$ in. countersunk-headed bolts. A tag is placed under one nut, and trimmers TC1 and TC2 are soldered to this, as in Fig. 2. A lead connects this tag to the tuning condenser frame (via hole B).

Trimmer TC3 has one tag inserted through a hole, this being wired to the positive line (via hole D). All three trimmers are kept close against the paxolin, to avoid obstructing the ferrite rod.

C17 is mounted by passing its appropriate ends through the holes. A short piece of thin flex, subsequently fitted with a battery clip, is soldered to the negative tag. The positive tag merely passes through the paxolin (hole K) to support the condenser.

All other small parts are generally held by their wire ends, and are added as wiring progresses.

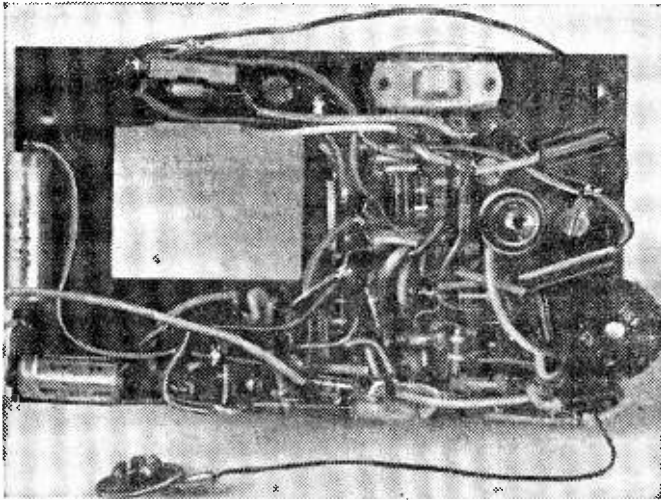

A view of the front of the chassis when nearing completion.

Transistors

All the transistor holes are placed so that they are closely in line, for each transistor, with increased spacing between base and collector. This increased spacing agrees with the space between leads, for Tr5, Tr6 and Tr7. With transistors Tr1, Tr2, Tr3 and Tr4, a red spot identifies the collector leads.

Transistors Tr2, Tr3, Tr4 and Tr5 each have an emitter resistor, with a condenser in parallel. These components are placed near the transistors. All the transistors may thus be prepared as in Fig. 3; Tr1, Tr6 and Tr7 have all leads passing directly through the paxolin. About $\frac{1}{2}$ in. of 1mm sleeving is placed on the centre lead of each transistor, to space it from the paxolin, and avoid shorts.

Transistors Tr2, Tr3, Tr4 and Tr5 are all prepared in the same way. With Tr2, solder C6 and R5 closely together, cutting both leads of R5 short. Place insulation on the emitter and base leads of the transistor. Bring the emitter lead up, cut it to length, and solder it to the junction of C6 and R5, as in Fig. 3. Do not bend the emitter lead immediately at the bottom of the transistor. The two remaining transistor wires, and lead from

C6 and R5, are then inserted through the appropriate holes.

Tr3, Tr4 and Tr5 are added in exactly the same manner. C14 and C16 are electrolytics, and the positive ends must go to the positive line. If the 0.1 μ F condensers C6 and C9 have a band, or one end marked O.F., this denotes the outside foil connection, and it should preferably be wired to the positive line.

The few remaining leads in Fig. 2 may be added, and this completes this side of the panel, except for adding the aerial.

Remainder of Wiring

Fig. 4 shows the other side of the panel. All the can tags and earth points can be connected together first using 26s.w.g. tinned copper or similar wire, and 1mm sleeving. It is quite a good plan to use red sleeving for all "earth" (battery positive) wiring, and black for all negative line wiring, as this greatly simplifies checking. Another colour is used for other leads, if this system is followed. One yard each, of red, black and yellow sleeving will easily be more than enough.

The large capacity condensers are all electrolytics, and have positive and negative ends, which must be connected as shown. The cans of these condensers are negative. Other condensers, and all resistors, may be wired in either way round. Each resistor value should be carefully checked as it is inserted, because a mistake will upset the working of the set.

Insulation

No bare leads or joints must touch each other, or other parts. This includes the cans of electrolytic condensers, which can be wrapped with tape if necessary. This particularly applies to C15.

A careful check on work can be kept, if desired, by inking over each part on the diagrams, as it is added, and inking over each lead, as it is soldered. There should then be little chance of omitting anything.

Trimmer TC4 only requires initial adjustment on long waves, so it is placed as in Fig. 4, its leads and a touch of adhesive holding it in position.

Transistor Leads

Transistor leads should not be overheated while soldering. There is no need at all to cut these leads as short as possible. All parts and wiring on the right of the panel in Fig. 4 should be kept down to the level of the body of the wavechange switch, which will rest flush against the cabinet front. To the left of the panel, around the loud-speaker opening, the clearance is greater, for TC4, C12 and C17.

The secondary ends of the output transformer, marked "enamelled wires" in Fig. 4, should be left temporarily disconnected.

(To be continued)

Using your MULTIMETER

By G. J. King

THE USE OF THE MULTIMETER IN RADIO CONSTRUCTION AND SERVICING

(Continued from page 70 of the May issue)

THE D.C. or "static" operating condition of a valve or transistor circuit can speedily be determined simply by making a voltage measurement across the cathode or emitter resistor, as shown by Test 1 in Figs. 6(a) and 6(b). The fact that a voltage is recorded indicates conclusively that current is flowing in the resistor, and in the case of the valve this is the total cathode current due to the sum of the anode and screen currents—or the anode current alone in a triode. In a transistor, it is due to the current in the collector and base circuits.

Conditions

The value of the voltage is governed by two factors: one, the current in the resistor and, two, the value of the resistor. For example, a reading of 10V across a 1k resistor would reveal that the current was 10mA (from Ohm's law, where the current in amperes is equal to the voltage divided by the value of the resistor in ohms).

This measuring technique can be employed in almost any current-carrying circuit, and allows the current in the circuit to be assessed by measuring the voltage across an associated resistor without breaking the circuit. The alternative method, of

course, is to break the circuit and insert a milliammeter, as shown by Test 2 in Figs 6(a) and 6(b).

In some cases, Test 1 is not sufficiently accurate owing to the shunting effect of the voltmeter, as discussed in last month's article. However, in the cathode or emitter circuit, the resistor is of a relatively low value in comparison with the resistance of the meter, and there will thus be very little error indeed.

Expected Voltages

At this point the value of the voltage to be expected across the cathode or emitter resistor should be considered. In a valve circuit, the voltage may range from about 0.5 to 15 or more, depending on the type of circuit. The voltages are usually given in the service sheet or manual, and if there were a marked deviation between what they should be and what they actually measure, this would indicate fairly conclusively that there was trouble in the stage. A high reading would mean that the valve was passing more current than it should, while a low reading could indicate a low emission valve or an increase in value of a resistor in the screen or anode feed circuits.

In a transistorised circuit, the emitter voltage is usually little more than 1 and may be even less than that, depending on the stage and type of transistor concerned. This shows the importance of using a voltmeter with a full-scale deflection of 1V or 2.5V. A reading which is definitely above normal could indicate excess collector leakage current, since that current would flow in the emitter resistor. Lack of base current would cause a marked fall in the reading, while excessive base current would cause a rise in the reading.

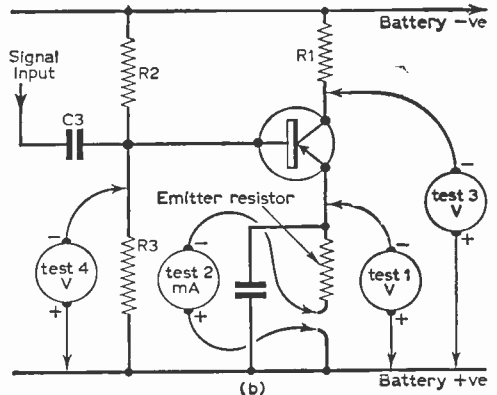
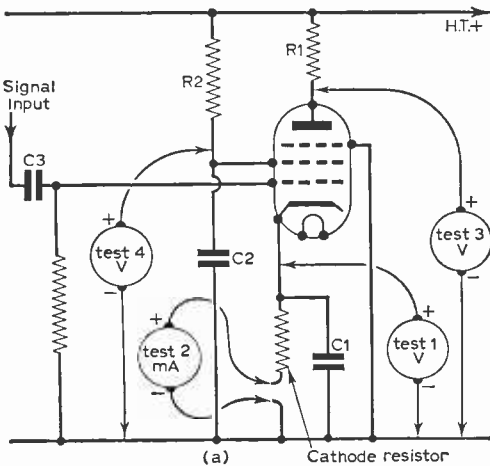

Fig. 6a (above)—Voltage and current tests in a valve circuit.

Fig. 6b (right)—Tests in a transistor circuit.

Further Checks

It should be stressed, of course, that cathode and emitter readings, whilst indicating the presence or otherwise of a fault, do not show precisely where the fault lies. Other follow-up checks are necessary.

For example, if in the valve circuit, there were zero cathode voltage and C1 were not short-circuited, then a voltage measurement would be made at the anode, as shown by Test 3 in Fig. 6(a) and, if the reading were normal, it would be followed by a voltage check at the screen grid—Test 4. If there were no voltage at the anode—yet the H.T. line voltage were normal—R1 would be open-circuited. Similarly, R2 could be open-circuited if zero voltage were recorded at the screen grid. There is also another possibility here, and that is a short-circuit in the by-pass capacitor C2. With the set switched off, this can be checked by switching the multimeter to an "ohms" range.

Leaky Capacitors

In A.F. amplifier and output stages, the coupling capacitor sometimes leaks and makes the control grid slightly positive. This counteracts the bias produced by the voltage drop across the cathode resistor and, as a consequence, causes an increase in anode current, which is reflected as an increase in voltage across the cathode resistor.

A conclusive check if such trouble is suspected is to check the cathode voltage with C3 (Fig. 6a) disconnected from the control grid and then, while observing the voltmeter, reconnect the capacitor. Should this cause the cathode voltage to rise, the capacitor has too great a leakage and should be replaced.

In the transistorised circuit, follow-up checks are shown by Tests 3 and 4, at the collector and base respectively. The same reasoning as with the valve circuit applies here also. R1 is the collector load which, if open-circuited, would prevent any emitter current, while resistors R2 and R3 form the base-bias potential-divider. If R2 were open-circuited, there would be no base current and very little emitter current, while if R3 were open-circuited, the base current might rise above the normal value and cause an increase in emitter current.

Meter Loading

Service sheets and manuals give anode and screen voltages when taken with a certain meter of specified sensitivity. If a different type of meter or one with greater or lesser sensitivity were used, then the voltages would be bound to differ from those given in the manual. The amount of error would depend on the difference between the meters and the value of the resistance connected to the point where the measurement is made.

For example, R2 in Fig. 6(a) may be in the region of $220,000\Omega$, and if a meter with a sensitivity of, say, $2,000\Omega/V$ were used on the 100V range, R2 would be shunted with $200,000\Omega$ (the meter resistance). Thus the actual voltage read would be approximately half of that which is present with the meter disconnected. A meter with a greater sensitivity would read a greater voltage and a meter of lower sensitivity would read a smaller voltage.

However, if any meter is connected to the H.T. line, the reading should be almost the same as that given in the manual; say $\pm 5\%$. This is because H.T. supplies have very low internal resistances and will deliver even the current required by a meter of quite low sensitivity without the voltage dropping. These factors tend to confuse the experimenter when comparing voltage readings with those given in manuals, and may well lead to incorrect diagnosis.

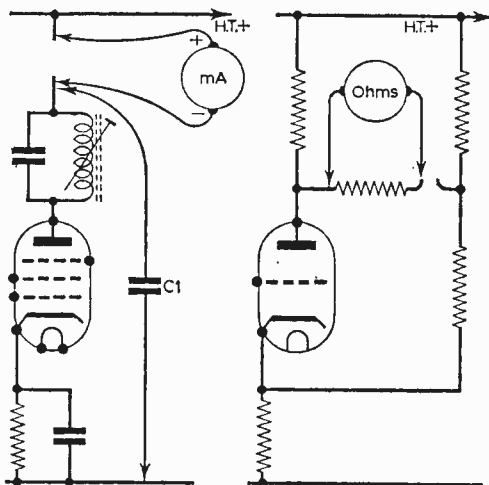

Fig. 7 (left)—When measuring current in an R.F. circuit, the milliammeter should be connected at the low-signal-potential side of the circuit, as shown. In certain cases—to avoid instability—a by-pass capacitor may be required, such as C1.

Fig. 8 (right)—Resistance measurements in complex networks should be made with one side of the resistor disconnected.

Current Measurements

It sometimes becomes necessary to measure anode and screen currents in R.F. or signal stages. The set should be switched off and the H.T. feed circuit should be broken at the low signal potential side so that a milliammeter may be inserted, as shown in Fig. 7. Care should be taken to ensure that the meter is connected the right way round (positive to H.T. positive input and negative to the actual circuit which is being fed), and that the correct current range is selected. To be on the safe side in the latter connection, a range higher than the expected current should be selected initially. The set should then be switched on.

As the valve warms up the meter deflection will rise, and eventually settle at a steady value. If a small deflection only is given on the selected range, the set should be switched off and the multimeter should be set to the next lower current range. The aim should be to obtain a deflection a little beyond the centre of the scale, where the most accurate readings can be taken.

In R.F. circuits, instability may result due to the meter leads. As this could cause an incorrect current reading, a small ($0.1\mu F$) by-pass capacitor should be connected between the negative side of the circuit and chassis, as shown by C1 in Fig. 7.

Ohmmeter Tests

Under no circumstances should an ohmmeter be connected to a component with the set connected to the power supply and switched on. In some cases it is possible to measure the value of a resistor or the insulation of a capacitor without removing the component from the circuit. For example, R1 and R2 of Fig. 6(a) could be checked *in situ*, as also could C2. C1 would require disconnecting because it is in parallel with the cathode resistor.

In complex networks it often happens that one component has shunted across it the resistance of one or more other components, thereby making a test *in situ* impossible. The same may apply to capacitors. Thus, if a check *in situ* gives a reading completely removed from that expected, the component should be isolated and the test performed again. It is necessary to disconnect only one side of the component under measurement, as shown in Fig. 8.

In transistor circuits, forward current in the transistor junctions may occur with the ohmmeter connected round one way, while a very small reverse current would then flow with the test leads reversed. This latter connection would give less error when performing measurements *in situ* in transistor sets.

Capacitor Checks

An ohmmeter can give a reasonable indication

Fig. 9—Two methods of measuring A.C. (signal) output voltage. The capacitor C should have a value of 0.1 μ F.

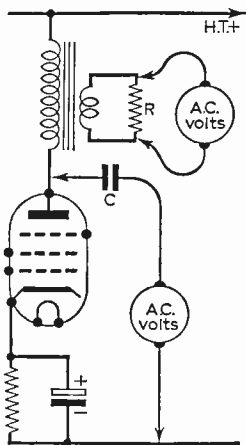

The P.W. Everest Tuner

(Continued from page 119)

Bifilar-Winding Connections

As before, the ends of the coils are shortened to about $\frac{1}{8}$ in., bared for $\frac{1}{8}$ in. and tinned with solder—the ends of the enamelled wire will have to be scraped lightly. Five connecting wires are required for this transformer as shown in Fig. 10, and the coil wires should be connected as shown. Note that the two outer wires of the bifilar winding are connected together to form the secondary centre-tap connection. If there is any doubt as to which two to connect together, check that when two are joined, the two coils of the bifilar winding are effectively in series. The 10pF and 50pF condensers may now be soldered in position and the screening can be placed over the coil. The meter may be used to check for continuity of the windings and for lack of short circuits to the can.

Although complete winding details have been

of the quality of a capacitor. For example, if the leads of the ohmmeter are connected across an electrolytic capacitor one way round, the capacitor will acquire a small charge from the ohmmeter battery. There will be a deflection on the meter which will quickly reduce almost to read "infinite resistance", as the capacitor charges. Now, if the test leads are reversed, the charge will flow out of the capacitor and there will be a tendency for it to re-charge in the opposite polarity. This will produce a definite kick on the pointer, thereby indicating that the component is, at least, still useful.

The lowest resistance range should be used on electrolytics, while higher ranges are more suitable for checking smaller paper units. By adopting the procedure detailed, even an 0.01 μ F capacitor should give a small kick on a high "ohms" range. If a permanent reading is obtained, then, of course, the component is useless.

Output and Power Measurements

The A.C. voltage ranges are also useful for checking A.F. signals and power—in addition to heater and A.C. power checks as detailed last month. By connecting the meter across the loudspeaker or, preferably, across a resistor used in place of the loudspeaker having a value equal to the impedance of the loudspeaker (R in Fig. 9), a small A.C. voltage will be recorded, the value of which varies with the sound signal.

The A.F. power across the load R is equal to the square of the voltage recorded divided by the value of the resistor R in ohms. Thus, if a reading of 2V A.C. is recorded on a peak and R is 4 Ω , the power of the peak is 1W.

A greater deflection is possible by connecting the meter between the anode of the output valve and chassis, via a capacitor (C in Fig. 9). A peak reading of about 50V A.C. is possible, depending on the power of the output stage. It is difficult to measure power output by this method, however, but it is useful as an output meter when making adjustments to the receiver's alignment. ■

given for the I.F. transformers, commercial transformers may be purchased and used in their place if desired. For IFT1 and IFT2, standard 10.7Mc/s F.M. I.F. transformers may be used, and for IFT3, a standard 10.7Mc/s Foster-Seeley discriminator transformer. Coils L1, L2 and L3 are easy to make and substitution of other coils is not to be recommended.

Underchassis Screens

Next, the underchassis screens may be cut out, drilled, and bent to shape—note that the one in Fig. 11 differs slightly from that indicated on the Blueprint. The alteration has been made to give increased screening between the oscillator circuit and the R.F. stage.

All required components may now be bolted to the chassis, taking care to include soldering tags under fixing bolts where indicated in the wiring diagram (Fig. 2) on the Blueprint. Wiring should follow the Blueprint wherever possible since the layout has been carefully designed for maximum efficiency.

(To be continued)

Short-wave Listeners' Log

It is very easy indeed to set up a short-wave listening station, and much interest can be obtained from one. Simple equipment serves quite well, when used in such a way as to give best results.

The receiver is naturally essential. A receiver tuning all bands from about 14 to 170m (21 to 1.8Mc/s) will prove to be very satisfactory, though a more restricted coverage will also bring in many interesting transmissions. For home construction, simple 1, 2 and 3-valvers are capable of astonishing range, and are easily built, or an ordinary domestic set, with S.W. bands, may be utilised. There are, of course, specially sensitive and selective receivers designed for such purposes, and termed "communications" receivers, but many S.W. listeners commence activity with small sets.

For general listening, an all-band aerial will be needed, and it can be any of the types previously described here. Many S.W. listeners spend a lot of operating time on a particular band, such as the long distance 14Mc/s and 21Mc/s bands. In such cases, it is a good plan to have a second aerial, designed for optimum results on the chosen band. This might be a dipole, made as previously described. A 2-way switch will allow selection of either aerial.

Provision for using either phones or speaker may be required, especially with a fairly small receiver, or to avoid disturbing other persons. The normal receiver speaker can be silenced by having an on/off switch in one lead from the output transformer to the speaker speech coil. With battery sets, high impedance phones can be connected across the transformer primary. A switch giving easy choice of phones or speaker is handy. With mains sets, the phones must be isolated by a coupling transformer, or 750VW condensers. Weak transmissions can give ample phone volume, while being almost inaudible with a speaker. It may be convenient to fit a jack with extra contacts, so that plugging in the phones automatically silences the speaker.

A log book of results will be useful. This can include wavelength or frequency of stations heard, time, signal strength, aerials used, and other information. If 300 is divided by any wavelength in metres, this will give the frequency in Mc/s. Each S.W. band has a period of maximum coverage of various parts of the world, as previously described.

Some S.W. listeners collect QSL cards. These are acknowledgements of reception reports, obtained from transmitting stations. Some listeners have "SWL" cards printed for this purpose. These have spaces to fill in frequency, time, signal strength, type of receiver and aerial, etc. They can be filled up from information noted in the station log book.

Some means of checking frequency is often useful. This can be a signal generator, crystal frequency standard, absorption meter, or similar device. A simple wavemeter, of moderate accuracy, is very handy indeed for locating the

various bands on home-built receivers. More elaborate equipment, such as a crystal marker, will allow frequencies to be read off with great accuracy. Some other test gear and similar equipment will probably be added from time to time.

Quite a number of S.W. listeners read Morse, to increase the scope of operation, and with a view to having their own transmitting licence one day. But even without a knowledge of Morse, there will always be stations of interest audible, on some bands, at any hour.

How to make A.C. AMMETERS

(Continued from page 121)

A piece of relatively thin paper should now be cut to the correct size and shape, and glued carefully over the existing scale. The author has found the type of rubber-plastic solution used for gluing lino or Formica sheeting on to plywood to be the most ideal glue for this purpose. It allows a neat uniform film to be applied, which is not easily possible with other adhesives. Scales glued on with cellulose glues, especially when of paper, as here, tend to have uneven bumps which could contact the pointer, and at least spoil the appearance. This trouble is not experienced with rubber solution. A few streaks should be squeezed out of the tube on to the middle of the new paper scalepiece, which is lying on a sheet of paper. These streaks are then smudged into a thin even film with the finger, taking good care to overlap over all edges on to the surrounding sheet of paper. No film of glue is applied to the metal meter scaleplate. The paper piece is then carefully positioned on to the scale plate, another new sheet of paper laid over the top, and fixture ensured by means of pressure from the fingers.

The choice of paper used for this new glued-on scale should have been such that the original scale is *just* still legible through the glued-on paper. The author finds normal typing paper in every way satisfactory for this purpose. As soon as the glue has dried fully, the scale 0 to 10 may be marked on, using the corresponding reference points determined above, on the still faintly visible original scale. The scale-arc should then also be traced through. For all this marking, a good blue-black ink, or preferably Indian ink, should be used. The contrast is then so great that the faint scale showing through the paper is virtually invisible.

The scaleplate should then be replaced on the meter, taking great care not to damage the pointer. The casing should be closed by replacing the grub-screws, and the calibration is finished.

This method of providing a meter with a new scale, here just described in detail, is used by the author whenever he needs to carry out such work—which is in fact with practically every meter he uses, as the original scale on a surplus meter is seldom usable as it stands.

SPECIAL BARGAIN OFFER! RECORD PLAYER KITS

AUTO CHANGER KIT—Comprising three Units. Contemporary styled Cabinet—2 valve, 2 watt amp. and 7 x 4in. quality speaker. Variable tone and Volume Controls with feedback circuit and B.S.R. 4-speed 12 Record Mixer. Auto Changer Unit
BARGAIN PRICE £12.10s. only
Cabinet Size: 17 x 14 1/2 x 6 1/2 ins. Carr. 7/6

SINGLE PLAYER KIT—Similar spec. to Autochanger Kit except Player is 4-speed B.S.R. T.U.9. Single Record Player Unit. Attractive Contemporary Styled Cabinet. Size: 13 1/2 x 13 x 6 1/2 ins. with splendid volume and reproduction.
BARGAIN PRICE £8.19.6 only
Carr. 5/

ALL UNITS READY WIRED, SIMPLE SCREWDRIVER ASSEMBLY ONLY
FULL SATISFACTION—REFUND GUARANTEE
Send for leaflet. Full details—3d. stamp.

7 VALVE AM/FM RADIOGRAM CHASSIS

Valve line-up: ECC85 ECH61 EF85 EHB60
EL84 EM61 EZ60.

Three Waveband and Switched Gram position. Med. 200-500 m., Long 1,000-2,000 m., VHF-FM 88-95 Mc/s. Philips Continental tuning insert with permeability tuning on FM and combined AM/FM IF transformers, 460 Kc/s and 10.7 Mc/s. Dust core tuning all coils. Latest circuit including AVC and Neg. Feedback. Three watt output, sensitivity and reproduction are of a very high standard. Chassis size 13 1/2 x 4 1/2 in. Height 7 1/2 in. Edges illuminated glass dia 11 1/2 x 3 1/2 in. Vertical position. Horizontal station names. Gold on brown background. A.C. 200/250 v. operation.

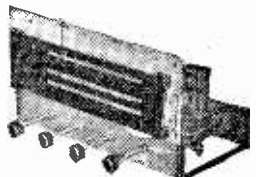

Aligned and tested ready for use **£13.10.0** Carr. & ins., 7/6.

Complete with 4 Knobs—walnut or ivory to choice. Indoor FM Aerial, 3/6 extra. Three-ohm P.A. speaker unit required. Recommended quality speakers, 10in. Rola (Heavy Duty), 25/-. 8in. Rola (heavy duty), 25/-. p. & p. 2/6.

BARGAINS 4-SPEED PLAYER UNITS

Single Players Carr. 3/6
Garrard 4 S.P. £6.1.8
Garrard TA Mk.2 £7.10.9
Collaro "Junior" 7/5-
B.S.R. Latest TU12 7/6
E.M.I. Junior '985' 8/0/6

Auto-Changers Carr. 5/-
Collaro "G 60" £7.1.0
B.S.R. (UA14) £7.10.0
Garrard "Auto-slim" £8.12.6
Garrard Model "A" Transcription Unit. £18.19.6. Carr. 7/6

J.A. ON FM TUNER UNITS
Designer-approved kits of parts:

FMT1, 5 gns, 4 valves, 20/-
FMT2, £7. 5 valves, 37/6
JTY MERCURY 10 gns.
JTY2 £13.18.6. 4 valves, 32/6

NEW JASON FM HANDBOOK, 2/6. 48 hr. Alignment Service 7/6. P. & P. 2/6.

SPECIAL BARGAIN OFFER

"6 + 1" TRANSISTOR RADIO KIT

...using 3 latest type surface Barrier Transistors.

Now only

£6.19.6

Complete Kit carr. 2/6



MANUFACTURERS SURPLUS BARGAIN OFFER. PRICE BARRIER SLASHED—A further bulk purchase of this popular Kit enables us to pass on latest price reduction direct to Constructor. Kit is a modern, sensitive, quality Receiver with all latest circuit features and is complete with 7 x 3 1/2 in. Speaker (3 ohms), and all circuit and assembly instructions. 6 BVA Transistors and Germ. Diode. Printed Ckt. Med. and 1/V. Ferrite Aerial and Car Radio coupling. 500 MW output. Attractive tilt dial and Slow Motion Drive with "Clear View" Tuning Knob, etc. Contemporary two-tone Cabinet 6 1/2 x 5 x 3 1/2 in. available 25/- extra.

RECORD PLAYER CABINETS

Cabinet Price

£33.30

Carr. & Ins. 5/-



Contemporary style, rexine covered cabinet in mottled red and white polka dot. Size 18 1/2 x 13 1/2 x ht. 8 1/2 in., fitted with all accessories including battle board and anodised metal fret. Space available for all modern amplifiers and autochangers, etc. Uncut record player mounting board 14 x 13 in. supplied.

2-VALVE 2-WATT AMPLIFIER
Twin stage ECL82 with vol. and neg. feedback Tone control. A.C. 200/250 v. with knobs, etc. ready wired to fit above cabinet. £2.17.6
& P. 1/6
6in. Spkr. & Trans., 22/- P. & P. 2/-

Condensers—Silver Mica, All values. 2pF to 1,000pF, 6d. each. Ditto. Ceramics 3d. Tub. 450V T.C.C., etc. 0.001 mfd. to 0.01 and 0.1/350V., 9d. 0.02-0.1500V 1/-, 0.25 Hunts 1/6. 0.5 T.C.C. 1/9, etc., etc. (Close 185 2/6) Mica—10% 5pF-500pF 8d. 600-3,000pF 1/-, 1% 2pF-100pF 9d. 100pF-500pF 11d. 575pF-5,000pF 1/6. Resistors—Full Range 10 ohms-10 megohms 20% 1/ and 1w 3d., 1w5d. (Midget type modern ratings) 1w 6d., 2w 9d., 1/2-Stab 10% 1w 5d., 1w 7d. 5% 1w 9d., 1% 1w 1/6.

RECORDING TAPE—Special Offer

Famous American Columbia (CBS) Premier Quality Tapes at **NEW REDUCED PRICES!** A genuine, recommended Quality Tape—TRY IT! Brand new, boxed and fully guaranteed. Fitted with leader and stop foils.

| | Standard | Long Play | Double Play |
|------|---------------|---------------|---------------|
| 5in. | 600ft. 13/- | 900ft. 17/6 | 1,200ft. 31/6 |
| 5in. | *300ft. 16/- | 1,200ft. 19/6 | 1,800ft. 37/6 |
| 7in. | 1,200ft. 21/- | 1,600ft. 29/6 | 2,400ft. 47/6 |

* P. & P. per reel 1/-, 6d. on each additional reel.

SPECIAL BARGAIN. 3in. mtrs. Tape 225ft. 4/9. P. & P. 6d. Plastic Tape Reels . . . 3in. 1/3. 5in. 2/-, 3 1/2 in. 2/-, 7in. 2/3 Plastic Spool Containers . . . 5in. 1/6. 3 1/2 in. 2/-, 7in. 2/3

BSR TAPE RECORDER KIT £16.10s.



Latest 5-valve circuit based on Mullard's design. Magic eye and tone controls. Printed Circuit. Radio and Mike inputs. A sensitive quality recorder at special Unit Kit prices.
Amp. Kit 90/- || BSR MONARDEK 4 Valves 27/6 || TAPE UNIT Power Pack 38/6 || £8.10.0
Send 3d. stamp for full detail Handbook, circuit and instructions 2/6

ENAMELLED COPPER WIRE—1lb. reels, 14c-20c, 2/6; 22c-23c. 3/-; 30c-40c. 3/9.

Other gauges quoted for. Speakers: P.M.—3 ohms, 2 1/2 in. Elac. 17/6. 3 1/2 in. Goodmans 18/6. 5in. Rola 17/6. 6in. Elac 18/3. 7 x 4 in. Goodmans, 18/6. 8in. Rola 20/-. 10in. R. x A. 25/-, 10 x 6 in. Goodmans 25/-, E.M.I. Erskin 29/6. Erskin 29/6. 50/60 40/40 3d. per vard. 1lb. 2/6, etc.

Volume Controls—5K-2 Meg. ohms, 3in. Spindles Morganite Midget Type, 1 1/2 in. diam. Guar. 1 year. LOG or LIN ratios less Sw. 3/-, DP. Sw. 4/3. Twin Stereo less Sw. 4/6. D.P. Sw. 8/-.

Pre-set Taps 25 ohms to 10K, 5W 1/3, 10W 1/6, 15W 2/-, Pre-set T/A Pots, W/W 25 ohms 50 K 3/-, 50 K-2 Meg. (Carbon) 50/-

NEW BOXED VALVES

| | All Guaranteed | |
|-----------|----------------|------------|
| 1T4 6/- | ECC83 8/- | PC84 9/6 |
| 1R5 7/6 | ECL82 10/6 | PCF80 9/6 |
| 1S5 2/6 | ECL80 10/6 | PCL83 12/6 |
| 384 7/6 | EF80 8/- | PCL84 12/6 |
| 3V4 7/6 | EF86 12/6 | PL81 12/6 |
| DAF95 9/6 | EL81 5/6 | PL82 9/6 |
| DF98 9/6 | EY51 9/6 | PL83 10/6 |
| DK99 9/6 | EY85 10/- | PY32 12/6 |
| DL98 9/6 | EZ81 7/6 | PY81 9/6 |
| ECC81 8/- | GZ22 12/6 | PY82 7/6 |
| ECC82 8/- | EM81 9/6 | U25 12/6 |

TRANSISTOR BARGAINS

| Brand New | BVA | 1st Grade |
|-----------|------|------------|
| OC44 | 10/6 | 874 9/6 |
| OC45 | 9/6 | GET114 6/6 |
| OC81 | 7/6 | OC72 7/6 |
| 2/OC81 | 15/6 | OC70 5/6 |
| XA102 | 10/- | OC71 7/6 |
| XA101 | 9/6 | OC78 6/6 |
| XB103 | 7/6 | GEX34 2/9 |
| XC101 | 6/6 | OA70 2/- |
| 873 | 9/- | OA81 2/9 |

Special offer: One OC44, two OC45: 21/6.

COAX 50 OHM CABLE
High grade low loss Cellular air spaced Polythene—1in. diameter. Stranded cond. Famous mfrs. Now only 6d. per yard. Bargain Prices—Special Lengths—
20 yds. 9/-, P. & P. 1/6.
40 yds. 17/6 P. & P. 2/-.
60 yds. 25/-, P. & P. 3/-.
Coax Plugs 1/-, Sockets 1/-.
Couplers 1/3, Outlet Boxes 4/6.



Send for detailed bargain lists, 3d. stamp. We manufacture all types Radio Mains Transf. Chokes, Quality O/P Trans., etc. Enquiries invited for Specials, Prototypes for small production runs. Quotation by return.

RADIO COMPONENT SPECIALISTS

70 Bristock Rd., Thornton Heath, Surrey. Hours: 9 a.m.-6 p.m., 1 p.m. Wed. THO 2188. Terms C.W.O. or C.O.D. Post and Packing up to 1lb. 9d., 1lb. 11s. 2/3. 2 1/2 lbs., 2/9; 8lb., 3/6.

MINISETS LTD. Hatherley Mews London E17

6-STAGE PORTABLE TRANSISTOR RADIO

- ★ All parts including transistors direct from manufacturers
- ★ Pre-assembled circuit board ensuring ease of construction
- ★ Full medium-wave coverage
- ★ After-sales service
- ★ Attractive two-tone case 9 x 6 x 4 in.
- ★ Push-pull output, 350 milliwatts
- ★ 5in. high flux speaker
- ★ Built-in Ferrite Rod aerial. No external aerial or earth required
- ★ High performance, many stations received on test

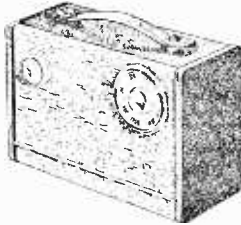

Can be built for **£5.40** P.P. 3/-

Or with long-wave 8/- extra.
Full instructions 1/6 (Free with order).

6-STAGE TRANSISTOR POCKET PORTABLE

- ★ Can be built for **£4.19.6** P.P. 2/6
- ★ Completely self contained, no aerial or earth required
- ★ Push-pull output, 250 milliwatts
- ★ 3in. high flux speaker
- ★ Pre-assembled circuit board with simple instructions ensuring easy construction
- ★ High Q Ferrite Rod Aerial
- ★ After-sales service

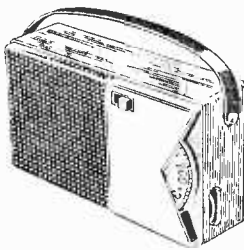

Can be supplied with long-wave 6/- extra.
Full instructions, price list 1/6 (Free with order).

3-TRANSISTOR RADIO (plus 2 diodes)

Total building **70/-** P.P. 2/6

- ★ Pre-assembled circuit board, ensuring easy construction
- ★ Full medium-wave coverage
- ★ Attractive case 5 1/2 x 3 x 1 1/2 in.
- ★ All components including transistors are brand new and direct from manufacturers
- ★ Ferrite Rod aerial coil, no external aerial or earth required
- ★ 2 1/2 in. high flux speaker direct from manufacturer
- ★ After-sales service

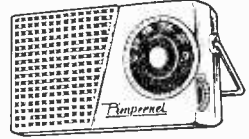

Send 1/6 for instructions, circuit and price list

2-TRANSISTOR RADIO (plus 2 diodes)

Ideal for personal listening

- ★ Built-in Ferrite aerial
- ★ Sensitive earpiece
- ★ All parts including transistors direct from manufacturers
- ★ Pre-assembled circuit board and easy-to-follow instructions
- ★ After-sales service
- ★ Can be built for **50/-** P.P. 2/-

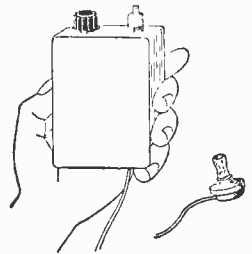

Full instructions, etc., 1/6 (Free with order).

TRANSISTORS AND DIODES

A set of Transistors comprising 1 OC44, 2 OC45, 1 OC81D, 2 OC81, 37/6, set.

| | | | | | | | | | |
|-------------|------|-------|------|--------------|------|--------------|-------|-------|-------|
| OC73 | 16/- | OC75 | 8/- | OC71 | 25/- | OA79 | 3/9 | Red | |
| Transistors | OC77 | | 12/- | Matched Pns. | OA81 | | 2/6 | Spot | 3/6 |
| OC35 | 18/- | OC78 | 8/- | 2x | OC72 | 16/- | OA85 | 3/- | White |
| OC36 | 21/6 | OC81 | 8/- | 2x | OC78 | 16/- | OA91 | 3/- | Spot |
| OC44 | 6/- | OC84 | 8/6 | Diodes | OA95 | | 3/6 | GEX34 | 5/- |
| OC45 | 6/- | OC170 | 9/6 | OAS | 6/- | Sundry types | G-X35 | 3/- | |
| OC70 | 6/6 | OC171 | 10/6 | OA10 | 8/- | PXA102 | 4/- | XD201 | 1/- |
| OC71 | 5/- | OC201 | 31/- | OA70 | 3/- | GEC SI | | | |
| OC72 | 8/- | OC202 | 26/- | OA73 | 3/- | Audio | 3/6 | | |

PRACTICAL WIRELESS POCKET TRAN-SISTOR SUPERHET. The New Version in a re-designed Cabinet with Carrying Strap.

Components Price List: Coil Set (Osc. and 3 I.F.'s), 22/-; Driver Transformer, Type PW/DT, 8/3; Output Transformer, Type PW/OT, 8/-; Ferrite Rod Aerial, Type PW/FR, 8/6; Printed Circuit Board, 7/6; 2 Gang Capacitor, Type "00", 12/6; Volume Control, Type V.C. 1545, 8/-; Switch, 3/6; Hardware (Screws, nuts, washers, spacers, battery clips, cable cradles, cable studs, cable strapping), 4/-; Transistors Type YC (Set of 6), Xtal Diode? Type GD9, 43/-; Speaker: Case, 12/6; Capacitors, 15/-; Resistors, 5/-; Trimmers, Type MT31/4A (3 required), 3/9. Constructional Leaflet and "Blown-up" Circuit Diagram. PRICE FOR THE COMPLETE KIT £7.19.6.

1962 CATALOGUE

Our 1962 Catalogue is now available. Please send 1/- in stamps for your copy. Trade Catalogue also available for which, please attach your business letter: heading.

METAL RECTIFIERS
Battery Charger Types 12-volt. 2 amp. 7/-; 3 amp. 10/-; 4 amp. 12/6; 5 amp. 14/6.
AUTOMATIC RECORD CHANGERS
BSR Monarch UA14 £6.19.6.
Collaro C60 Studio £7.19.6.
Garrard Autoslim £8.19.6.
SINGLE RECORD PLAYERS
E.M.I. 4-speed with pick-up £4.9.6.
BSR Monarch GU6 £4.19.6.

All components for Practical Wireless "REGENCY" and "INTERNATIONAL SHORT WAVE TWO" in stock, send for detailed price list.

MICROPHONES
Acos Mic. 39/1; Stick Type 32/6.
Table Stand for above, 7/6.
Floor Stand Adaptor, 12/6.
TSL Type MI Dual Impedance Microphone with High (50,000 ohms) or Low (200 ohms), Matching, 84/-.
TSL Stick Microphone MX3, 35/-.

Acos Mic. 40, 19/6.
Acos Mic. 45, 29/6.
Microphone Model BM3, 45/-.
Table Stand to suit above, 12/6.

RECORD PLAYER CASES
Baseboard cut suitable for a BSR UA14, available in red, turquoise, grey, and black/yellow, 63/- each. Amplifier and Loudspeaker to suit above, 65/-.

ALPHA RADIO SUPPLY CO



130 LEEDS TERRACE
WINTOUN STREET
LEEDS 7

TERMS: Cash with Order or C.O.D. Postage and Packing Charges extra. Single valves 9d., Minimum Parcel Post charges 2/-. Please include sufficient postage with your order. Minimum C.O.D. fees and postage 3/6. These Postal Rates apply to U.K. only. For full terms of business see inside cover of catalogue. Personal shoppers 9 a.m. to 5 p.m. Mon. to Friday, Saturday 10 a.m. to 1 p.m.

FAULTS IN VHF/F.M. RECEIVERS

7—SERVICING

By G. J. King

(Continued from page 62 of the May issue)

PREVIOUS articles in this series have dealt with the installation of receivers, VHF tuners, combined receivers (both valve and transistorised), circuit techniques, and general faults relating to the circuits described. In this, concluding, article we shall be looking at some fairly common troubles which occur in both F.M.-only and A.M./F.M. models, but which are often persistent and difficult to cure.

One such trouble is station drift and, although relatively common, particularly in the older models, its cause is not usually fully understood. The symptom is well known; although a station may be accurately tuned when the set is first switched on, the tuning point drifts as the set warms up. On F.M., detuning causes distortion accompanied by impaired A.M. limiting.

Ratio Detector

Most sets feature the popular ratio detector, the circuit of which is given in Fig. 17. This gives an audio output across the impedance of CI (which is the A.F. load) of a frequency equal to the rate of change of the signal frequency and of an amplitude proportional to the frequency deviation of the signal.

This happens because of phase changes associated with the tuned circuits of the ratio detector transformer resulting from a change of frequency. There are many good books describing the effect in great detail for those who are interested.

Most F.M. detectors have two diodes like the ratio detector, and are thus "balanced" so far as the signal is concerned.

This causes the response at the detector to be rather like that in Fig. 18(b). Response A results from one half of the circuit, while response B results from the other half.

If the circuit is balanced, the nominal I.F. carrier will occur accurately in the centre between the two responses, as shown by f_c . Now, when the signal is frequency-modulated, each deviation from the resting frequency (f_c) will give an audio output. Maximum modulation in BBC transmissions is equal to a frequency deviation of ± 75 kc/s. This means that, on loud music, the signal may deviate from f_c by ± 75 kc/s.

This will be all right on the curve shown, as the signal will not deviate outside the limits of the points marked "X". This part of the combined curve is straight (linear), which means that there will be very little distortion and extremely good audio quality should be obtained.

Tuning Drift

What happens when the tuning drifts? This is shown in Fig. 18(c) over a drift of about 50kc/s

on the same curve. The range of maximum modulation (between points "X") is still within the linear part of the curve, so the reproduction should be hardly impaired.

However, trouble starts when the drift is sufficient to cause peaks of modulation to reach the curved (non-linear) portions of the response, and this would happen should the carrier point f_c shift by about 75kc/s on the curve in Fig. 18(c).

In practice, one would not expect the local oscillator to cause such a big drift, but drift does occur, nevertheless. In the illustrations, we have

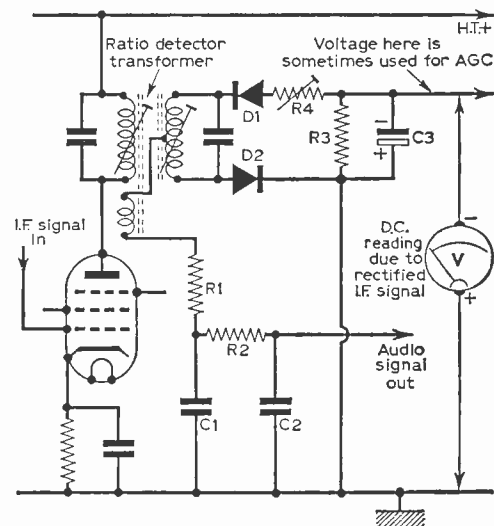

Fig. 17—The basic circuit of a ratio detector, showing the load across which a direct voltage is developed due to the I.F. signals being rectified by the series-connected diodes. C1 is the A.F. load, R1 a current-limiting resistor, and R2 and C2 the de-emphasis network. The pre-set resistor R4 facilitates a balance adjustment for optimum A.M. limiting.

assumed that the bandwidth of the detector is ± 200 kc/s. This is an ideal value, but is rarely found in commercial receivers for various reasons. To achieve such a passband, the response of the I.F. channel would have to be something like that in Fig. 18(a). Most commercial sets can be aligned to give a response of that kind, but only at the expense of gain.

Most sets are aligned with a passband of about 100kc/s. This is reasonable from the aspect of quality of reproduction, but does not always provide sufficient tolerance for oscillator drift. Some sets handled by the author had bandwidths of

only about 50kc/s and some also had a very distorted I.F. response curve.

Limited Response

The overall I.F. response curve on a set with a $\pm 100\text{kc/s}$ bandwidth is shown in Fig. 19(a). This is quite a good curve since it has a fairly flat top and, provided the ratio detector were correctly

balanced, the detector response would be something like the curve in Fig. 19(b). This would handle full modulation over the linear part of the curve as long as the undeviated carrier were kept fairly close to the centre of the linear part (at point f_c). A small deviation from this centre, however, would cause the signal to enter the curved part of the response and result in severe distortion.

A drift of only 50kc/s would cause the signal to traverse between the points marked "X" on the curve.

Clearly, then, the more limited the overall response, the more critical becomes the tuning, and the more oscillator drift is magnified. On a set with a bandwidth less than 100kc/s, it is virtually impossible to maintain accurate tuning for any length of time without automatic correction (AFC).

Distorted Response

A distorted response, which is also limited in bandwidth, makes results even worse, as revealed by the curves in (c) and (d) of Fig. 19. In Fig. 19 (c) the top of the I.F. response is far from flat, and this is reflected into the ratio detector response as severe non-linearity between the two responses. At a certain critical tuning point it may be possible to cause a signal with low-level modulation to ride over a reasonably linear portion of the response with not too much distortion, but a small drift from the critical point or an increase in modulation level would result in extremely poor quality.

Unlike A.M., F.M. produces multiple sidebands which extend up to about six times the modulation frequency. Thus, if the modulation frequency is, say, 16kc/s, then the sidebands would extend up to about 96kc/s. A fairly wide pass-band is necessary, therefore, simply from the sideband angle — to avoid attenuation of the higher audio frequencies.

Older Sets

With the advent of VHF/F.M., much of the country was in the fringe of the service areas and sets with the highest possible gain were needed. As gain and bandwidth are not compatible, many early models were aligned for extra high gain and reduced bandwidth, and such adjustment resulted in the problems described in the foregoing text.

As VHF/F.M. became a country-wide with the erection
(Continued on page 153)

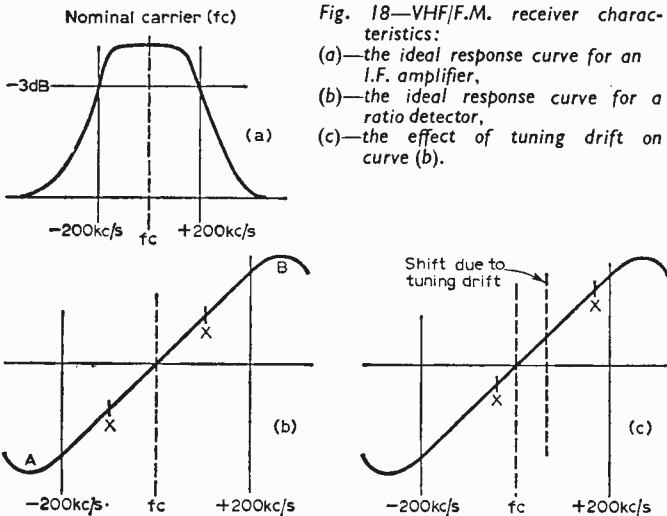
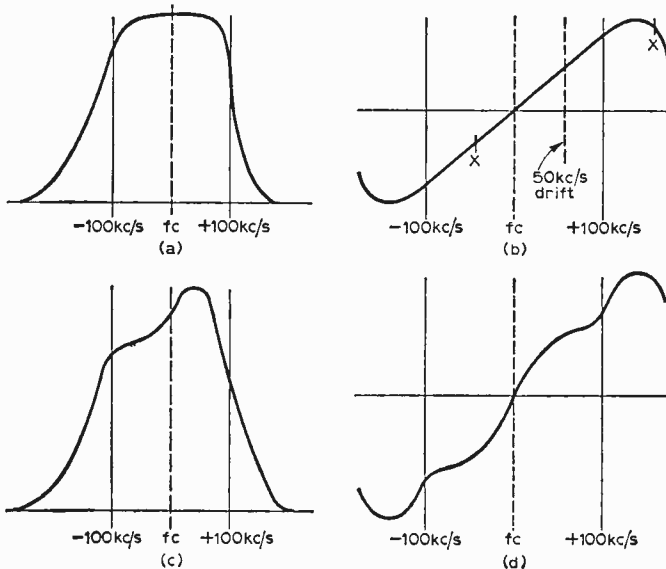

Fig. 18—VHF/F.M. receiver characteristics:
(a)—the ideal response curve for an I.F. amplifier,
(b)—the ideal response curve for a ratio detector,
(c)—the effect of tuning drift on curve (b).

Fig. 19 (below)—With a narrow I.F. bandwidth (a), and a linear discriminator response (b) of only 100kc/s, tuning drift would cause distortion when the signal frequency excursions reached the curved parts of the discriminator characteristic—as at X—X. An asymmetrical I.F. response (c) would give rise to lack of linearity in the discriminator response (d).



SURBITON PARK RADIO LTD

for POST HASTE—POST FREE SERVICE

F.M. TUNERS

JASON F.M. TUNER KITS

| | |
|--|----------|
| FMT1 Complete with valves | £6.17.6 |
| Deposit 27/6 and 6 monthly | £1.1.8 |
| FMT2 Complete less power | £7.17.6 |
| Deposit 31/6 and 6 monthly | £1.4.4 |
| FMT2 Complete with power | £9.15.0 |
| Deposit 39/- and 6 monthly | £1.9.4 |
| FMT3 Complete less power | £9.12.8 |
| Deposit 38/6 and 6 monthly | £1.9.0 |
| FMT3 Complete with power | £12.0.0 |
| Deposit 43/- and 8 monthly | £1.6.6 |
| Power Pack Kit ready drilled chassis | £2.12.6 |
| The instruction book is included in all the above kits, but otherwise is 2/6 | |
| JTV/2 Switched TV sound, powered | £14.15.0 |
| Deposit 60/- and 12 monthly | £1.1.6 |
| Mercury 2 2-wave band tuner kit, in attractive wooden case | £10.15.0 |
| Deposit 43/- and 8 monthly | £1.4.0 |

The instruction book is again included, but otherwise 3/6.

REQUIRED CHANNELS MUST BE SPECIFIED FOR ALL SWITCHED TUNERS

Argus Transistor 2-wave band tuner kit, in attractive wooden case

Book 3/6.

ARMSTRONG RADIO CHASSIS

| | |
|---|----------|
| T4B VHT Tuner, self powered | £23.0.0 |
| Deposit £4.12.0 and 12 monthly | £1.13.8 |
| ST/3 Mk.2 AM/FM Tuner, powered | £28.10.0 |
| Deposit £5.14.0 and 12 monthly | £2.1.8 |
| AF208 AM/FM Radio chassis, bass and treble controls, P.U. inputs, Single ended output stage | £23.15.0 |
| Deposit £4.15.0 and 12 monthly | £1.14.10 |
| Jubilee Mk.2 AM/FM Radio chassis with push-pull output stage | £31.15.0 |
| Deposit £6.7.0 and 12 monthly | £2.6.6 |
| Stereo 55 AM/FM Radio chassis, single ended output stage, on both channels. Separate tone and volume | £33.15.0 |
| Deposit £6.15.0 and 12 monthly | £2.9.6 |
| Stereo 12 Mk.2 AM/FM Radio chassis. Push-pull on both channels, eye rate control | £44.15.0 |
| Deposit £8.19.0 and 12 monthly | £3.5.6 |

Individual leaflets giving full description and technical specification available.

Marriott Tape Heads, 4 track R/PB and erase with mounting plate for Collaro Deck

PAIR COMPLETE

£4.4.0

2 Track R/PB only, with mounting bracket for Studio deck. Ideal for third head position

£1.7.6

MARTIN RECORDAKITS

We are able to offer for the first time, a proprietary range of Recorders in kit or assembled form. This enables you to take advantage of mass production techniques and prices, should you wish to assemble yourself. The components used are the finest available, with BVA valves, and the decks are the latest having all the improvements B.S.R. and Collaro make from time to time, heads, etc.: The amplifiers are packed in special cartons with instructions which enable anyone to build. We are confident you will find these Recorders very good value, they have been built up to a standard and not down to a price

| | |
|---|---------------------------|
| B.S.R. TD3 Monardeck, latest model 5 1/2 in. spools | £9.9.0 |
| Hire purchase deposit £1.19.0 and 6 monthly | £1.8.4 |
| Tape Amplifier for B.S.R. deck, printed circuit ready wired, with EUC83, EC182, EM85 and EZ81. Complete with all plugs, sockets, panels, knobs, etc. The whole amplifier mounts on to the deck, making a self-contained unit. CASH PRICE | £8.8.0 |
| Hire purchase deposit £1.14.0 and 6 monthly | £1.5.8 |
| Cabinet for above including 7 x 4 in. speaker | £4.4.0 |
| Total kit as above | £22.0.0 |
| Hire purchase deposit £4.10.0 and 12 monthly | £1.21.1 |
| The above recorder can be supplied complete with Mic: tape assembled and tested for | CASH PRICE £25.0.0 |
| Hire purchase deposit £5.0.0 and 12 monthly | £1.16.8 |
| Collaro Studio Deck . Very latest model 3 speeds | £12.10.0 |
| Hire purchase deposit £2.10.0 and 8 monthly | £1.7.6 |
| Tape Amplifier for Studio Deck, with ready wired printed circuit, control and input panels, mains and output trans., complete with knobs, plans, screws, etc. EPM6, EUC83, EM84, EZ81, OA81 and 2 E184, 3 watts output. Magic eye, Radio and Mic. inputs. EX 1/8 socket. Tone control. Can be used as an amplifier. COMPLETE CASH | £11.11.0 |
| Hire purchase deposit £2.7.0 and 8 monthly | £1.5.6 |

| | |
|--|---------------------|
| Cabinet for above including 9 x 5 in. speaker | £5.5.0 |
| Total kit as above | CASH £29.0.0 |
| Hire purchase deposit £6.0.0 and 12 monthly | £2.2.2 |
| We can supply the above recorder, complete with tape and Mic., in a 12 LUX cabinet, assembled for | £35.0.0 |
| THIS MACHINE IS LISTED £41.0.0 BY MAKERS AND IS A VERY GOOD BUY. | |
| Hire purchase deposit £7.0.0 and 12 monthly | £2.11.4 |
| Tape Pre-amplifier , for recording and playback, as above less output stage, with power supplies | £8.8.0 |
| Hire purchase deposit £1.14.0 and 6 monthly | £1.5.8 |
| Microphone for the above recorders, Acom MIC 40, 25/-, 8/C plug 4/6. Synchronape 3 in. 600ft. 15/- 5 in. 900ft. 19/6. Finest 5 1/2 in. 850ft. 19/6 5 1/2 in. 1200ft. 22/6. Based Tin. 1200ft. 22/6 7 in. 1800ft. 32/6 | |
| Tape Recorder Superhet Cabinet, corner, 20 x 10 in. High class finish in two-tone Grey "Vynair" | £2.15.0 |
| With 9 x 5 in. high flux speaker | £4.0.0 |
| BM3 Crystal Microphone, with table stand, and on/off switch, black and chrome finish, supplied complete with neck band, and input lead. VERY GOOD VALUE. | £2.10.0 |
| DX29 Dynamic Moving Coil, with desk stand | £3.10.0 |

GRAMOPHONE EQUIPMENT

| | |
|--|---------|
| B.S.R. UA14 T88/H cartridge | £7.15.0 |
| Hire purchase deposit £1.11.0 and 6 monthly | £1.4.0 |
| Collaro C66 Microchange "O" cartridge | £3.15.0 |
| Hire purchase deposit £1.15.0 and 6 monthly | £1.6.8 |
| Garrard "Autoslim" 67/2 cartridge | £9.3.4 |
| Hire purchase deposit £1.17.4 and 6 monthly | £1.7.8 |
| Philips AG1018 New semi-auto player | £14.3.6 |
| Hire purchase £3.3.6 and 12 monthly | £1.0.2 |

REGENCY

Resistors 2/8, Controls 9/-, Condensers 15/-, Knobs 2/8, Station dial 5/6, Jackson gang 8/-, Mullard OC45 10/- each, OC72 Matched pair 16/-, OA71 3/-, Battery 1/-, Wave change switch 2/6, Repanco TT49, TT45, TT16, all 5/- each. FR2 12/6, RFL1 2/6, 7 x 4 inch speaker 17/6, Groupboard 1/3. Complete kit (less cabinet) £8.10.0.

TRANSISTORS

MULLARD HAVE REDUCED THE PRICE OF MANY TYPES TO OC44 11/-, OC45 10/-, OC70 6/6, OC71 6/6, OC72 8/-, OC75 8/-, OC76 8/-, OC78 8/-, OC81 8/-, ABOVE ARE THEIR NEW LIST PRICES. WHY BUY SURPLUS? MATCHED PAIRS ONLY. Mullard OC72 at 16/- pair.

— TRANSISTOR SUPERHET KITS —

"PRACTICAL WIRELESS" POCKET SUPERHET

Osmon Rod Aerial, 8/8, I.F.T.'s and Osc. Coils, 22/-, Osmon Driver, 8/3, Osmon Output, 9/6, Set resistors and diodes, 43/-, J.B. Gang, 12/6, Trimmers, 1/3 ea. Set condensers, 15/-, Set resistors, 5/-, Ardent volume control, 8/-, Switch, 3/6, Speaker, 17/10, Hardware 4/-, Printed circuit, 7/6. New case dial and knob, 12/6, Battery PF4, 2/-, Leaflet giving full illustrated details, 1/6.

ALL THE ABOVE COMPONENTS IF PURCHASED AT ONE TIME, 28.10.0

Osmon undertake to align this receiver for 10/- Modification kit, 10/-

"WEYRAD"

WEYMOUTH RADIO 6 Transistor Superhet using the P50 coils, as they advertise in this journal. P50/1A/C Osc. Coil, 5/4, P50/2A/C 1st and 2nd I.F.T.'s, 5/7 ea. P50/3A/C 3rd I.F.T., 6/-, R2A/W Rod Aerial, 12/6, LFDT4 Driver, 9/8, PUA1 Printed Circuit, 9/8, Instruction Book, 2/-, Set Resistors, 7/6, Vol. Control D.P., 5/6, Set Condensers, 20/-, J.B. Gang, 12/6, Beehive Trimmers, 1/3 ea. W.C, 3/6, Dial and Knob, 5/6, Battery PP11, 5/8, OA81 3/-, Set MULLARD transistors, 53/6, Car Aerial Coupling Coil, 1/-

48 SURBITON ROAD, KINGSTON-UPON-THAMES, SURREY

Established over 30 Years

Telephone KIN 5549

We pay all postage and insurance.

All orders despatched same day.

Money refund guaranteed

Hours: 9 a.m.—6 p.m. (1 p.m. Wednesday)

Orders do not close for lunch.

Open all day Saturday

LASKY'S RADIO

MINIATURE DISTLER ELECTRIC MOTORS

6 v. high speed (as used in Clarion Tape Recorder). Ideal for all electric models, speedboats, railways, etc. Size 2 1/2 in. long x 1 in. diameter.

LASKY'S PRICE **7/11** Post 2/6

TRANSISTOR RECORD PLAYER

Can be Built for **£9.19.6** Carr. free

6 v. operation. For all L.P. and standard records. All components available separately.

AMPLIFIER. 300 milliwatts push-pull output using two OC71 and two OC72 transistors. Fully assembled. 69/8. Knobs, 3/6 extra. P. & P. 2/6.

LOUDSPEAKER. 30 ohms 7 x 4 in. elliptical, matched to Amplifier, 25/-.

3-SPEED TURNABLE. 6 v., complete with t.f. crystal cartridge and two sapphire styl. 79/6. P. & P. 3/6.

CARRYING CASE. Smart two-tone finish. 17 x 14 x 5 1/2 in. 49/6. P. & P. 7/6. Batteries extra.

SAVE ON COMPONENTS! Send for the new edition of Lasky's 100-page Components Catalogue. Price 2/-, post 6d. Latest 20-page Bargain Bulletin included free.

TRANSISTOR POCKET RADIOS

THE "TORONTO 3"

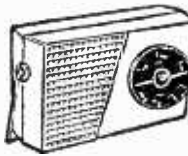

Size 5 1/2 x 3 x 1 1/2 in. Uses 3 transistors plus germanium diode, ferrite rod aerial. Tunable over med. and long waves. Can be built for **32/6** Post 3/6

All components available separately.

The New "ALBERTA 5" Mk. II

Now using printed circuit and supplied with miniature earphones for personal listening at no extra cost.



Push-pull, 200 milliwatts output. Five transistors and one diode. 2 1/2 in. moving coil speaker, ferrite rod aerial. Med. and long wave. Smart plastic Case, 4 1/2 x 3 1/2 in. overall.

CAN BE BUILT FOR **59/6** Post 3/6
All components available separately. Full details, circuit diagram, 1/6 post free.

LASKY'S CAR RADIO



12 v. operation. Transistor output. Medium and long waves. Permeability tuning. T.C.C. Printed Circuit. Small size, will fit any car.

CAN BE BUILT COMPLETE WITH SPEAKER FOR £9.19.6. Post 3/6. Booklet 2/6 (refunded if you order).

● KAPURA Model U1 ●

MULTI TEST METERS FURTHER GREAT PURCHASE!

- Complete with test leads.
- Brand new, fully guaranteed.

Sensitivity: 1,000 ohms per volt A.C. and D.C. Ranges: (A.C. and D.C.) 0-15-50-250-500-1000 v. D.C. current 0-100-500 M/A-0-1 M/A. (Used at 0-10 v. range). Resistance: 1-2000 ohms (centre 24 ohms). 100-200,000 ohms (centre 2.4 K.). Size: 5 x 3 x 2 1/2 in.

LASKY'S PRICE **39/6**
Carriage and Packing 5/-

207 EDGWARE ROAD, LONDON, W.2.

Near Praed St. PADDINGTON 3271/2

33 TOTTENHAM COURT ROAD, W.1.

Nearest Stn. Goudge St. MUSEUM 2605

BOTH OPEN ALL DAY SAT. Early Closing Thurs. Mail Orders to Dept. P.W. Edgware Road.

CABINETS & HI-FI EQUIPMENT

We can supply any Cabinet to your own specification

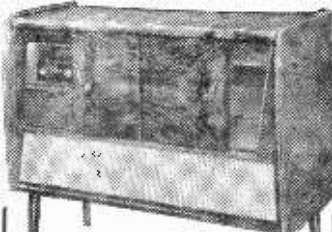

"Grosvenor" £22.1.0

This is only one example taken from our extensive range of stock cabinets. Write for our NEW 24 page fully illustrated catalogue on:

THE LARGEST RANGE OF CABINETS IN THE COUNTRY

Equipment is also our speciality. SEND TODAY for a free copy of the Lewis Radio cabinet catalogue—the most comprehensive ever prepared.

LEWIS radio

100 (P.W.62) Chase Side, Southside, London, N.14 Pal 3733/9666

VALVES SAME DAY SERVICE NEW! TESTED! GUARANTEED!

SETS 1R5, 1S5, 1T4, 3S4, 3V4, DAF91, DF91, DK91, DL92, DL94 .. Set 4 for 19/6
DAF96, DF96, DK96, DL96 4 for 27/6

| | | | | | | | | | | | |
|-------|-------|---------|------|--------|------|-------|------|--------|------|--------|------|
| 0A2 | 11/6 | 6L18 | 10/- | 30L15 | 11/- | EBL21 | 13/6 | E281 | 6/8 | U52 | 4/8 |
| 1A7GT | 11/- | 6L19 | 10/- | 30P19 | 14/6 | ECC40 | 13/6 | KT30C | 7/- | U78 | 4/6 |
| 1D5 | 7/6 | 6LD20 | 8/- | 35A5 | 14/- | ECC81 | 5/- | KT41 | 11/6 | U191 | 14/6 |
| 1HG7 | 9/- | 6P1 | 7/- | 35L8GT | 8/3 | ECC82 | 6/3 | KT44 | 5/9 | U281 | 17/- |
| 1NSGT | 9/- | 6P25 | 8/6 | 35Z4GT | 5/8 | ECC83 | 7/- | KT61 | 9/8 | U281 | 16/6 |
| 1R5 | 8/- | 6P28 | 12/- | 35Z5GT | 8/3 | ECC84 | 8/3 | KT66 | 6/6 | U301 | 17/- |
| 1S4 | 8/- | 6Q7G | 6/- | 50CDEG | 27/3 | ECC85 | 7/9 | MU14 | 6/6 | U901 | 21/- |
| 1S5 | 5/3 | 6Q7GT | 8/8 | 50L6GT | 8/3 | ECP80 | 7/6 | N18 | 7/- | UABC80 | 6/6 |
| 1T4 | 3/6 | 6SL7GT | 5/9 | 85A2 | 11/6 | ECP82 | 8/6 | PC95 | 10/- | UAF42 | 8/3 |
| 1U5 | 5/9 | 6SN7GT | 4/9 | AZ31 | 9/6 | ECH1 | 13/6 | PC97 | 7/6 | UB41 | 8/6 |
| 3A5 | 5/9 | 6U4GT | 9/9 | E36 | 7/6 | ECH35 | 8/6 | PC98A | 7/6 | UBC41 | 7/9 |
| 3Q4 | 7/- | 6V6G | 4/6 | ECL33 | 12/3 | ECH42 | 8/9 | PC98B | 9/3 | UBF80 | 8/3 |
| 3S4 | 8/- | 6V6GT | 7/- | DAC32 | 9/- | ECH81 | 7/9 | PCF80 | 7/9 | UBF89 | 8/3 |
| 3V4 | 7/- | 6X4 | 4/6 | DAF91 | 5/3 | ECL80 | 7/6 | PCF82 | 8/3 | UCC84 | 13/3 |
| 5V4G | 4/6 | 6X5GT | 4/9 | DAF96 | 7/6 | ECL82 | 9/- | PCF88 | 9/- | UCC85 | 7/6 |
| 5V4G | 8/9 | 7B6 | 9/6 | DC90 | 9/- | ECL85 | 15/- | PCL82 | 9/6 | UCF80 | 14/8 |
| 5Y3GT | 6/- | 7B7 | 7/6 | DF33 | 9/- | EP39 | 8/6 | PCL83 | 10/6 | UCH21 | 13/6 |
| 5Z4G | 9/- | 7C5 | 7/6 | DF91 | 3/6 | EP40 | 11/6 | PCL84 | 10/6 | UCH42 | 8/- |
| 6A15 | 3/9 | 7C8 | 7/6 | DF96 | 7/6 | EP41 | 7/9 | PCL85 | 10/6 | UCH81 | 8/9 |
| 6AM5 | 3/6 | 7H7 | 7/6 | DH76 | 4/9 | EP80 | 4/9 | PENA4 | 11/- | UCL82 | 9/9 |
| 6AC5 | 6/- | 7S7 | 8/6 | DH77 | 6/9 | EP85 | 4/9 | PEN36C | 8/9 | UCL83 | 13/3 |
| 6AT6 | 6/9 | 7Y4 | 8/6 | DH81 | 9/- | EP86 | 9/- | PX4 | 11/8 | UF1 | 7/- |
| 6BA6 | 5/9 | 12AT6 | 7/- | DK32 | 11/- | EP89 | 7/9 | PL81 | 9/6 | UF42 | 5/6 |
| 6BE6 | 5/9 | 12AT7 | 5/- | DK91 | 6/- | EP91 | 3/6 | PL82 | 7/9 | UF89 | 7/9 |
| 6BE6 | 5/9 | 12AU7 | 6/3 | DK92 | 7/6 | EP92 | 3/9 | PL83 | 7/6 | UL41 | 8/6 |
| 6B6 | 5/9 | 12AX7 | 7/- | DK96 | 7/6 | EL33 | 8/6 | PL84 | 8/6 | UL84 | 6/- |
| 6BH7 | 9/6 | 12K7GT | 4/9 | DL33 | 8/- | EL41 | 9/6 | PX4 | 10/4 | UM4 | 14/- |
| 6BW6 | 8/- | 12K8GT | 9/6 | DL35 | 9/6 | EL42 | 9/- | PX25 | 8/9 | URIC | 8/6 |
| 6CD6G | 27/3 | 12Q7GT | 4/9 | DL92 | 6/- | EL84 | 6/6 | PY32 | 11/6 | UY21 | 13/6 |
| 6F1 | 10/- | 12SN7GT | 7/6 | DL94 | 7/- | EM34 | 7/3 | PY30 | 7/6 | UY41 | 6/6 |
| 6F6G | 4/6 | 12Z5 | 10/8 | DL96 | 7/6 | EM80 | 8/- | PY81 | 7/- | UY85 | 6/6 |
| 6F13 | 10/- | 20P2 | 17/- | EABC80 | 5/6 | EM81 | 5/- | PY32 | 6/6 | VP4B | 9/6 |
| 6F14 | 10/- | 20L1 | 16/- | EAF42 | 8/6 | EM84 | 9/6 | PY83 | 7/9 | VP41 | 5/- |
| 6P23 | 10/- | 20P5 | 14/9 | EB91 | 3/9 | EY51 | 7/6 | T41 | 7/9 | VP1321 | 16/6 |
| 6KTG | 11/11 | 25A6G | 8/- | EBC33 | 5/- | EY66 | 7/9 | U22 | 7/3 | W76 | 4/9 |
| 6KTGT | 5/- | 25L6GT | 7/9 | EBC41 | 8/- | EZ40 | 6/9 | U25 | 12/- | W77 | 3/9 |
| 6K9G | 8/- | 25Z4G | 8/8 | EBF89 | 9/- | EZ41 | 7/6 | U26 | 9/3 | X81M | 9/- |
| 6K8GT | 9/- | 30P5 | 7/- | EBF89 | 8/9 | EZ80 | 6/- | Z77 | 6/9 | Z77 | 3/6 |

READERS RADIO

24, COLBERG PLACE, STAMFORD HILL LONDON, N.16

STA. 4587

Post 6d. per valve extra.
Any Parcel insured Against Damage in Transit 6d. extra.
Any C.O.D. Parcel 3/- extra.

(Continued from page 150)

of main stations and translators, and as the figure of merit of valves improved, so it has been possible on later receivers to provide sufficient gain coupled with adequate bandwidth. Thus, more recent models are considerably less prone to critical tuning and distortion than their "vintage" counterparts.

Nevertheless, there are many thousands of the older VHF/F.M. sets still in use, and a very large percentage of these can be brought into line with the new models by nothing more elaborate than careful realignment.

Simple Alignment Check

Many experimenters and service technicians immediately concentrate attention on the oscillator stability of the VHF tuner on a set which suffers badly from tuning drift. This is a good point but rarely the cause of the trouble (or effect). All VHF oscillators drift as they warm up. Much has been done to reduce the effect by the use of positive and negative temperature coefficient capacitors arranged in critical proportion in the oscillator tuned circuits. But drift still occurs in a small way, and it is unlikely whether improvement could be achieved by changing the positions or coefficients of the capacitors. The designers

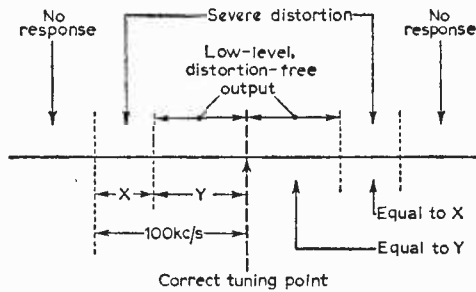

Fig. 20—Judging the alignment of a F.M. set by tuning through a station—see text.

spent a lot of time in the first place to reduce drift by these means, so unskilled tampering with the oscillator circuits of the tuner would probably make matters even worse. In nearly all cases the trouble is the inability of the I.F. passband to cater for "reasonable" drift.

A rough assessment of the bandwidth and alignment of an F.M. set can be secured by tuning the set over a station while observing certain factors. Detuning either side of a transmission will result in bad distortion, as we have already seen, but if the distortion occurs the same distance away from the station either side of the correct tuning point it can be assumed that the ratio detector response is reasonably symmetrical.

On low-level modulation, a distortion-free but reduced output should be obtainable either side of the correct tuning point — just before the areas of heavy distortion (due to the signal riding up and down only one half of the linear detector response) as shown in Fig. 20. The distances from the correct tuning point to the points of no response either side should be equal, and the distance between the correct tuning point and the

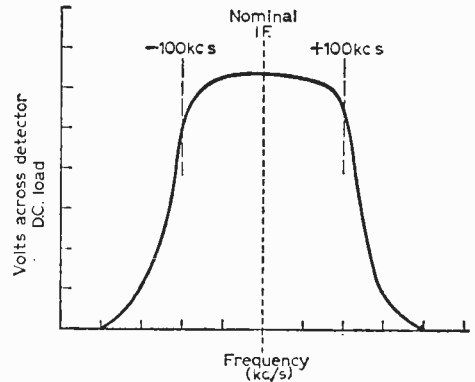

Fig. 21—The overall pass-band of the receiver can be plotted by measuring the D.C. load voltage at the ratio detector against the input infrequency.

point of no response one side should equal at least 100kc/s for good quality and freedom from excessive drift effects.

Use of a Signal Generator and Voltmeter

As it is rather difficult to measure frequency on the scale of an ordinary VHF/F.M. set a better way is to plot the overall passband on graph paper by measuring the voltage across the D.C. load of the ratio detector at various spot frequencies within the I.F. passband—see Fig. 21. The voltmeter is connected across the load as shown in Fig. 17, and an unmodulated signal at the nominal I.F. is injected into the mixer grid. The signal input should be adjusted to give about 10V on the meter (more is likely to overload the set and bring in any other A.M. limiters that may be in circuit), and the frequency should be adjusted in steps of about 10kc/s either side of the nominal I.F.

A curve such as that shown in Fig. 21 would be ideal. Usually, however, it is either narrower or asymmetrical, indicating that realignment is necessary. In this event the set should be completely realigned in accordance with the service sheet or manual. The best idea, of course, is to use an oscilloscope and wobulator so as to obtain a display of the response on the screen of the CRT. The cores of the I.F. transformers may then be adjusted, while observing the response, to secure the required passband and symmetry. Such alignment procedures have been dealt with in past pages of this magazine.

JOIN THE PRACTICAL GROUP

- PRACTICAL TELEVISION** 1/9
Every Month
- PRACTICAL MECHANICS** 1/6
Every Month
Devoted to Mechanics, Science and Invention
- PRACTICAL MOTORIST** 1/6
Every Month
- PRACTICAL HOUSEHOLDER** 1/3
Every Month

Club News

REPORTS OF CURRENT ACTIVITIES

AMATEUR RADIO MOBILE SOCIETY

Hon. Sec.: G3FPK, 79 Murchison Road, London, E.10.

Sunday, June 24th, has been selected for this year's International Mobile Rally and A.R.M.S. annual general meeting, which will once more be held at Barford St. John. The largest gathering of mobile hams during April was at the North Midlands Mobile Rally held on April 29th.

Future Events:

May 6th—South Eastern Counties Mobile Rally.
June 17th—Longleat Mobile Rally.

BARNSELY AND DISTRICT AMATEUR RADIO CLUB

Hon. Sec.: P. Carbutt, G2AFV, 19 Warner Road, Barnsley, Yorkshire.

On April 13th members heard a talk, given by J. Walker, on workshop practice, and on the 27th of the same month, V. Lee gave a lecture on VFO/CO mixers.

Future Event:

May 11th—Transistors in a station, by J. Ward.

BRADFORD RADIO SOCIETY

Hon. Sec.: M. T. G. Powell, G3NNO, Gledhow Avenue, Roundhay, Leeds 8.

A sale of spare equipment was held on April 10th and on April 25th the arrangements for the field day were discussed.

Future Event:

May 8th—A visit to an automatic telephone exchange.

EXETER AMATEUR RADIO SOCIETY

Hon. Sec.: S. Line, 46 Roseland Crescent, Heavitree, Exeter, Devon.

At the meeting on March 6th, members of the society challenged amateurs from the Torquay club in a general knowledge quiz. The meeting which was well attended, proved an enjoyable evening, with Torquay ending up the victors by a narrow margin.

FLINTSHIRE RADIO SOCIETY

Hon. Sec.: H. T. Jones, GW3NQP, "Bedwyn", Queens Walk, Rhyl.

GW3JGA/T gave a talk on amateur colour television on March 26th, and on April 30th, members enjoyed a film show.

GUILDFORD AND DISTRICT RADIO SOCIETY

Hon. Sec.: J. Barker, G3PDX, 35 Banders Rise, Merrow, Guildford, Surrey.

At the meeting on March 23rd, E. Drackley gave a talk on aerial tuning units and aerial couplers.

The election of officers for 1962/3 was one of the items on the agenda of the annual general meeting which was held on April 12th.

HALIFAX AND DISTRICT AMATEUR RADIO SOCIETY

Hon. Sec.: G. Sunter, 24 Booth Fold, Luddenden Foot, Halifax, Yorkshire.

Life on two metres was the subject of a talk given to members on May 8th, by G5YY.

Future Events:

May 22nd—Ragchew.
June 5th—Visit to Ferranti.

MEDWAY AMATEUR RECEIVING AND TRANSMITTING SOCIETY

Hon. Sec.: W. E. Nutton, G6NU, 42 Richmond Road, Gillingham, Kent.

Elliott's radio society has combined with the Medway society to hold a Hamfest and Mobile Rally at Rochester Airport. It is to be held on May 20th and will start at 2.30 p.m. There will be parking space for 300 mobiles. Admission will be by ticket and these may be obtained from the address given above or at the door.

NORTHERN HEIGHTS AMATEUR RADIO SOCIETY

Hon. Sec.: A. Robinson, G3MDW, Candy Cabin, Ogden, Halifax, Yorkshire.

Recently members have heard a talk, given by G3GJV, on his activities as a mobile amateur. On May 2nd members visited the Leeds and Bradford airport at Yeadon.

Future Events:

May 16th—Converters, by G3OGV.
May 30th—Visit to the Holme Moss television station.

PETERBOROUGH RADIO SOCIETY

Hon. Sec.: D. Byrne, G3KPO, Jersey House, Eye, Peterborough, Northamptonshire.

At the invitation of the Telephone Manager of the Peterborough automatic telephone exchange, members toured the exchange at their March meeting. On April 6th members attended a lecture on short-wave communication receivers. 'Aerials' was the subject of the talk given at the meeting on May 4th.

PRESTON AMATEUR RADIO SOCIETY

Hon. Sec.: W. K. Beazley, 9 Thorngate, Penwortham, Preston, Lancashire.

Meetings are held on the second and fourth Tuesdays of each month. They are held at St. Paul's school in Preston, and commence at 7.30 p.m. All local licenced amateurs and SWL's are invited to any meeting.

Basic valve circuits was the title of the illustrated tape lecture given on April 10th.

RHONDDA VALLEY RADIO SOCIETY

Hon. Sec.: A. Chapman, Royal Hotel, Trealaw, Rhondda.

Despite the extremely cold weather and an outbreak of small-pox in the area, many members turned out for the society's annual dinner on March 1st, to make it a memorable occasion. The guest speaker was Mr. A. Williams, the zonal representative of the R.S.G.B. in Port Talbot.

ROYSTON AND DISTRICT RADIO CLUB

Hon. Sec.: H. E. Taynor, G3NAH, 103 Cross Lane, Royston, near Barnsley, Yorkshire.

On April 19th members heard about a modulator for a top-band transmitter, and on May 3rd a power supply for a transmitter or receiver was the subject for the meeting.

SOUTH MANCHESTER RADIO CLUB

Hon. Sec.: M. Barnsley, G3HZM, "Greenways", 11 Cemetery Road, Denton, Manchester, Lancashire.

The address of the club's new headquarters is; Fallowfield Bowling and Lawn Tennis Club, 81 Wellington Road, Fallowfield, Manchester 14.

The title of G3HZM's talk on April 6th was "Simple transmitters, methods of modulation". On April 13th, single sideband transmitting and receiving techniques were discussed in the lecture given by G3GRO. The club's transmitter was on the air at the meeting on May 4th.

SLADE RADIO SOCIETY

Hon. Sec.: C. N. Smart, 110 Woolmore Road, Erdington, Birmingham 23.

T. J. Hayward—G3HHD—gave a lecture on aerials at the meeting on April 6th, and on April 20th, an evening direction finding contest was held.

SPEN VALLEY AMATEUR RADIO SOCIETY

Hon. Sec.: N. Pride, 100 Raikes Lane, Birstall, near Leeds.

Railway signalling was the subject chosen for the meeting on April 11th and on 25th of that month, L. Stevenson talked about simple maths.

Future Event:

May 9th—More about counting, by Dr. N. H. Chamberlain.

TORBAY AMATEUR RADIO SOCIETY

Hon. Sec.: Mrs. G. Western, G3NQD, 118 Salisbury Avenue, Torquay, Devon.

At the society's annual dinner held on March 3rd, trophies were presented to the five winners in each class.

The annual general meeting was held in April.

Future Event:

May 12th—Discussion on preparation for N.F.D.

YORK AMATEUR RADIO SOCIETY

Hon. Sec.: N. Spivey, G3GW1, 80 Melton Avenue, Clifton, York.

At the AGM held on March 1st, G. F. Nottingham was elected chairman and N. Spivey was elected secretary and treasurer. The committee was also elected.

The club transmitter was the subject under discussion at the meeting on March 29th and on April 26th plans were laid for the N.F.D.

SUPERB COMMUNICATION RECEIVERS

AMERICAN AR88D RECEIVERS. Fresh release of these renowned sets. 14 valves, 6 wavebands, covering 500 Kc/s-32 Mc/s. Incorporate every possible refinement & have internal A.C. mains pack for nominal 115/230 v. Thoroughly reconditioned, immaculate in appearance, and in perfect working order. **ONLY £55** (add carriage 30/- and 50/- deposit on returnable transit case). S.A.E. brings illustrated leaflet.

MARCONI CR. 100/S COMMUNICATIONS RECEIVER. Covers 60 Kc/s to 30 Mc/s. Complete with all valves, makers instruction manual, and internal A.C. Power unit (or 200/250 volts. **BRAND NEW IN ORIGINAL TRANSIT CASES.** Aerial tested before despatch. **ONLY £35** (carr. etc. 40/-). S.A.E. for full details.

TEST METERS FOR EVERY PURPOSE & POCKET

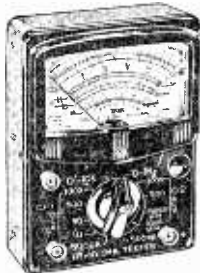

2,000 O.P.V. MODEL TP-10. Reads A.C. & D.C. Volts up to 1,000; D.C. Current to 500mA; Resistance to 1 Meg; Capacitance to 1µF; Decibels from -20 to +36; Output jack for Audio Measurements. Size 3 1/2 in. x 5 in. x 1 1/2 in.

£3.19.6



20,000 O.P.V. MODEL TP-5S. Reads voltage up to 1,000; D.C. at 20,000 ohms per volt and A.C. at 10,000 o.p.v.; D.C. Current to 500mA; Resistance to 10 Megs.; Capacitance to 0.1µF; Decibels from -20 to +36. Size 3 1/2 in. x 5 1/2 in. x 1 1/2 in.

£5.19.6

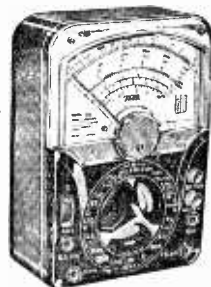

30,000 O.P.V. MODEL 500. Volts to 1,000; D.C. at 30,000 O.P.V. A.C. at 20,000; 12 Amps D.C. Current; 60 Megs Resistance; -20 to +56 Dbs; Internal buzzer short circuit warning. Size 3 1/8 in. x 6 1/2 in. x 2 1/2 in.

£8.19.6

All New Stock, with leads, prods. and internal batteries. Fully guaranteed. Details S.A.E.

AMPLIFIER TYPE A418. Ex R.A.F. For normal A.C. Mains use. 574 Rectifications with 6V9 output. Input and output jack sockets, gain control, fully fused. 600 ohms output transformer easily changed for 3 ohms type. Standard rack mounting size 19" x 7" x 6". Used, good condition. **ONLY 59/6** (carriage etc. 10/6).

AMERICAN HALLICRAFTERS 6 VOLT VIBRATOR PACK. Output 300 volts D.C. at 170mA. Designed to run Communications Receivers from 6 volt car battery. Size 6 1/2 in. x 6 1/2 in. x 7 1/2 in. Complete with 2 valves 6X5, and instructions, in makers cartons. **BRAND NEW & UNUSED. ONLY 29/6** (carr. etc. 3/6).

12 VOLTS AMERICAN DYNAMOTORS. Deliver 220 volts at 100mA. Size 5 1/2 in. x 3 1/2 in. diameter. Ideal for running Electric Shaver etc. from Car battery. **ONLY 32/6** (post 2/6).

B.C. 221 FREQUENCY METERS. The famous American crystal controlled, portable frequency measuring standard. Coverage 125 Kc/s-20 Mc/s. With original calibration book. Perfect order. Illustrated details on request. **ONLY £16.**

PCR COMMUNICATION RECEIVERS
Manufactured by Pye & Philips. One of the Army's most versatile and sensitive sets. RF stage and 2 of I.F., using 6 British I.O. type valves. Large 130 degree illuminating and calibrated Dial. Flywheel Tuning with locking device. Aerial Trimmer. Tone and Vol. Controls. Band Switch from panel jacks for speaker or phones. In black metal case, size 17 1/2 in. L x 8 in. H x 10 1/2 in. D. Model PCR covers 6-18 Mc/s, 200-550 metres and 850-2,000 metres and has internal 5 in. speaker. REM2 reconditioned as new. **£8.19.6.** Model PCR has similar L & M waveband coverage. Short wave 6-22 Mc/s, but no speaker. Used but excellent condition **£5.10.6.** Every receiver aerial tested before des. Add 10/6 carr. all models. Designed to operate from bulky EXTERNAL power supply, but any set can be fitted with **BRAND NEW COMPONENTS INTERNAL PACK** for 200/250 v. A.C. at extra cost of £2.
S.A.E. FOR ILLUSTRATED LEAFLET

"P.W." 6 TRANSISTOR PERSONAL RECEIVER

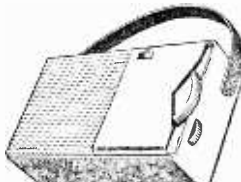

Designed by the technical staff of *Practical Wireless* easy to build using printed circuit and 1st Grade Matched Transistors and Diode. Full Medium and Long Wave coverage to internal speakers. All parts sold separately (new components only) enabling you to buy as required and full detailed price list will be sent on request. Constructional details 1/6.

Newly designed OSMOR Cabinet and reduced price. **TOTAL COST INCLUDING BATTERY AND CABINET NOW £8.10.0.**

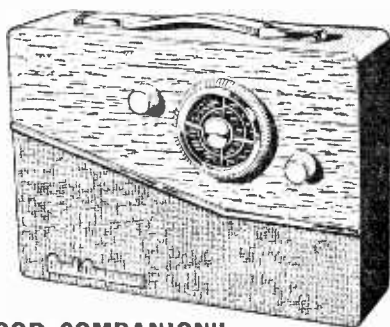

THE "GOOD COMPANION"

THE FINEST COMBINED PORTABLE AND CAR RADIO YET DESIGNED FOR THE HOME CONSTRUCTOR

- ★ 750 m/W output. ★ 6 transistors and 2 diodes. ★ Full Medium and Long Wave coverage. ★ Quality speaker. ★ Pre-aligned I.F.T's. ★ Brilliantly styled 2 tone cabinet, size 11 x 8 x 3ins. ★ Very fine tuning with calibrated dial. ★ Latest printed circuit. ★ Internal high gain aerial, with car aerial socket. ★ Easy to follow construction data (available separately 3/6).

All parts sold separately and full illustrated details will be sent on request.

Total Cost **£9.19.6**

With alternative luxury cabinet using 7 x 4in. speaker **£10.19.6.** Either type, plus 5/- post and ins. (Battery 3/6 extra).

"POCKET 4" TRANSISTOR RECEIVER

Uses miniature speaker, proper tuning condenser, and volume control. Built-in aerial makes unit efficient and portable. Ideal for the beginner. Full medium wave coverage. All components and case for only **42/6** (p. & p. 2/6). Ten-page constructional book free with parts or separately 1/6. S.A.E. for parts price list.

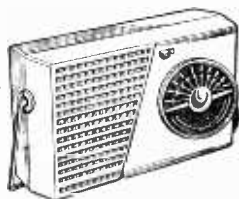

HARRIS ELECTRONICS 138 Gray's Inn Road, London, W.C.1
(LONDON) LTD (Phone TERminus 7937)

Please include carriage costs on All Items. (Open until 1 p.m. Saturdays), we are 2 mins. from High Holborn. (Chancery Lane Station) and 5 mins. by bus from King's Cross.

EXPLORE THE WORLD ON THIS I-VALVE SHORT-WAVE RADIO

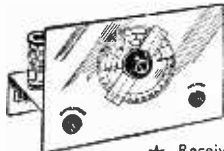

Total Building Costs **35/-** P. & P. 2/-.

★ **Receives speech and music from all over the world.** Construction price includes valve and one coil. Covering 40-100 metres. Can be extended to cover 10-100 metres. Can be converted to 2 or 3 valve.

PUT YOUR FAVOURITE PROGRAMME ON TAPE with the R.C.S. TAPE TUNER

Will operate on all types of Recorder. High impedance output. Variable Medium wave tuning. Triple wound Super Hi-Q coil. Chassis and components colour coded. Easily constructed from full instruction data and layout diagrams. Size 3 x 1 1/2 x 1 1/2.

Total Building Costs **30/-** Plus P. & P. 1/6.



The "PIRETTA"

TWO TRANSISTOR SET
Designed for Personal Listening. An amazing little set, with built-in ferrite rod aerial bringing in medium wave at wonderful volume. Sturdy case. Size only 1 1/4 x 3 x 4 1/2. Fits into the palm of the hand. Drilled chassis colour coded for easy assembly. Two top grade transistors plus diode. Supplied with earpiece.

Total Building Costs **50/-** Plus P. & P. 2/-.

R.C.S. for MINI-SETS

All parts available separately. Constructional details on any one of our Mini-Sets, 1/6 each. (Supplied free with orders)

OUR NEW 5-STAGE POCKET TRANSISTOR PORTABLE



In attractive two-tone contemporary case, with gold plated speaker grille and attractive dial. Size only 5 1/2 x 3 1/2 x 1 1/2ins. No aerial or earth required—completely self contained. Genuine 3in. high flux PM speaker. First grade transistors. Push pull output—250 milliwatts. Volume control with on/off switch. Condenser tuning. Easy assembly on coveletted circuit board. Total Building **£4.19.6** Socket for personal listening. P. & P. 2/6. Earpiece 9/- extra if required.

EASY TO BUILD TWO STAGE TRANSISTOR SET

The set that looks like a Radio Set. Attractive Case. Mini .0005 Tuner. High Q. Litz Coil. Works for months off No. 8 Battery. Simple to construct in 15 min.

Total Building Costs **25/-** P. & P. 1/6.

The "BOBETTE" 5 - STAGE SUPER SENSITIVE TRANSISTOR PORTABLE

Simple to Build. All First Grade Components. A truly portable transistor radio giving full medium wave reception. Incorporates 5in. High Flux Speaker, pull-push output, first grade transistors. High-Q ferrite aerial, socket for car aerial, pre-tagged circuit board for easy construction. Attractive two-tone case.



Total Building Costs **£5.2.6** P. & P. 2/6.

CRYSTAL RECEIVER

Covering medium wave band. Ideal for the beginner! All components including case for **12/6** transistor or 2-stage transistor receiver

The "BIJOU"



You can't go wrong. We guarantee good results

Trade Enquiries **R.C.S. PRODUCTS (RADIO) LTD.** 11 OLIVER RD., LONDON, E.17 Mail Order only
Welcomed

AVO METERS

MODEL 7 £11.10.0. MODEL 7 MARK II £12.10.0.
Guaranteed perfect. Complete with leads and batteries. Registered post and packing 5/- extra.

AVO VALVE TESTERS. Roller panel type. Can be used with adaptors for all types. Circuit data supplied. Tested, £5.18.6/76 carriage. Details S.A.E.

FERRANTI TESTMETER TYPE Q. An extremely compact self-contained multimeter. Volts 0 to 30, 150, 600 AC/DC with additional 0.3 v. DC and 0-15 v. AC ranges; millamps 0 to 7.5, 30, 150 and 750 DC; ohms 0-25 K Ω . Accuracy BSS first grade. Knife-edge pointer and clearly calibrated 2 1/2in. scale. 500 Ω /volt. With leads, prods, battery and instructions. In fitted velvet-lined 4 x 7 x 3in. case. Brand new condition, tested, 49/6. P.P. 2/7.

R107 RECEIVERS. 1.2 Mc/s—17.5 Mc/s continuously. 3 wave bands. Completely self contained with speaker and power unit for A.C. mains and 12 v. battery operation. Guaranteed perfect. £13.10.0. Carr. 30/-.

PCR COMMUNICATIONS RECEIVER
Type PCR. Has self-contained speaker. Covers 850-2000, 200-550 and 16-50 metres.
AS NEW CONDITION. £6.19.6
Type PCR-2. Requires external speaker. Covers 850-2000, 200-500 and 13-50 metres.
USED (Good condition). £5.19.6
Carriage (any type) 10/6. Full details S.A.E. Any model fitted with BRAND NEW INTERNAL POWER SUPPLY, guaranteed ready for use on A.C. mains. £2 extra.

Moving Coil Phones. Finest quality Canadian, with Chamols ear muffs and leather-covered headband. With lead and jack plug. Noise excluding, supremely comfortable, 19/6, post 1/6.

We now stock **The Pocket 4**, a neat little job which can be made for 42/6. (Printed Circuit Version 52/6). and **The Good Companion** (a super job equal to the best). Easily constructed for only £9.19.6. Gladly demonstrated to callers.

CHARLES BRITAIN (RADIO) LTD.
11 Upper Saint Martins Lane, London, W.C.2

TEMple Bar 0545

Shop Hours 9-8 p.m. (9-1 p.m. Thursday)
Open all day Saturday.

My Transistor Battery lasts for ages. Why don't YOU fit a Battery Eliminator

Will also Charge your Battery

COMPLETE KIT 35/-
Constructed in 10 mins.

OSMOR 418 BRIGHTON ROAD, S. CROYDON, SURREY



Trade News

ROTARY SWITCH WITH ADJUSTABLE STOP

MADE available recently, by N.S.F. Limited, are a number of Oak rotary wafer switches, model JK. These switches incorporate a readily adjustable stop.

The switches can be supplied with one, two or three wafers, with one, two or four poles per wafer and giving 2 to 12, 2 to 7 or 2 to 4 positions, depending upon the number of poles. Shorting or non-shorting contacts are optional.

Indexing is in 30° steps and the detent mechanism is of positive single-ball type. One fixed and one adjustable stop are provided; the latter is adjustable to operate at any position between the second and eleventh and is omitted where 12-position switching is required.

N.S.F. Limited, 31-32, Alfred Place, London W.C.1.

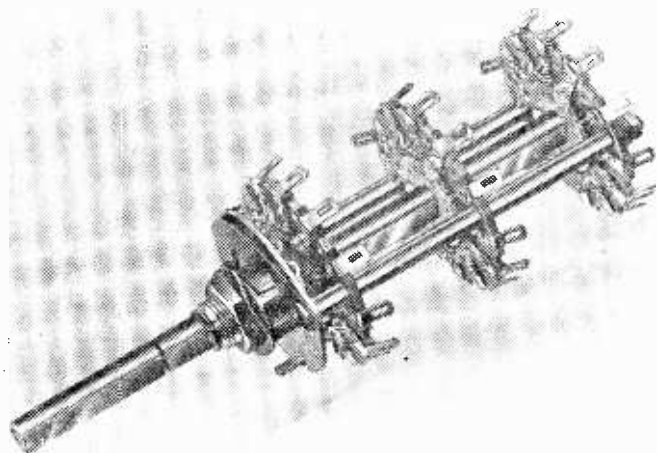

The model JK rotary switch from N.S.F. Limited.

HI-FI CABINETS

A RANGE of cabinets designed specifically for hi-fi equipment has recently been introduced by G.K. Developments. The range goes under the name of "Spacemaker".

The standard "Spacemaker" units will accommodate most makes of amplifiers or record players, and consists of two cabinets—one for equipment, the other, a speaker enclosure. The equipment cabinet measures 35½ in. x 11 in. x 16 in. and is finished in sapele woodgrain with the fascia and sides in black, gold and silver. The speaker enclosure is constructed throughout of ¾ in. non-

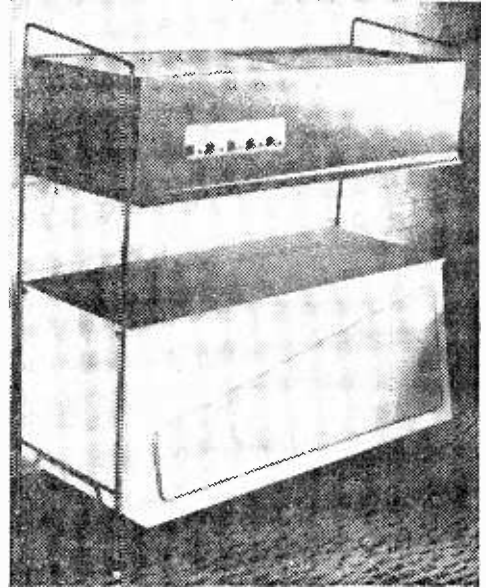

Above—A newly designed hi-fi cabinet by G.K. Developments.

resonant material, and is of bass reflex design, fitted with internal filter, suitable for speakers up to 10 in. (12 in. version available). The top is veneered in sapele mahogany and the fascia and sides in white, gold and silver.

The "Spacemaker" units are made by G.K. Developments (Sound Division), 18 Albany Road, London N.14.

MULTIMETERS

THERE are two models of the Selectest multimeter, made by Salford Electrical Instruments Limited: the Super K and the Super 50.

Most of the components in both models are mounted on a printed circuit board, enclosed in a strong, two-tone moulded case. The overall dimensions of this case are approximately 9½ in. x 7 in. x 4½ in.

Three scales are provided, with a mirror inset and knife-edged pointer to eliminate parallax errors. On the Super K model, two scales, 0 to 75 with 75 divisions and 0 to 300 with 150 divisions are used for all current and voltage ranges, and the third, 0 to 1,000 Ω covers all three ohm ranges. The Super 50's current and voltage scales are 0 to 100 with 100 divisions and 0 to 25 with 50 divisions.

The range required is selected by two rotary multi-position switches capable of continuous rotation in either direction.

The sensitivity of the Super K D.C. voltage ranges is 1,000 Ω /V, and A.C. voltage ranges 500 Ω /V. The sensitivity of the Super 50 D.C. voltage ranges is 20,000 Ω /V, A.C. voltage ranges 2,000 Ω /V, and 2.5V A.C. range 167 Ω /V.

Salford Electrical Instruments Limited, Peel Works, Silk Street, Salford 3, Lancashire.

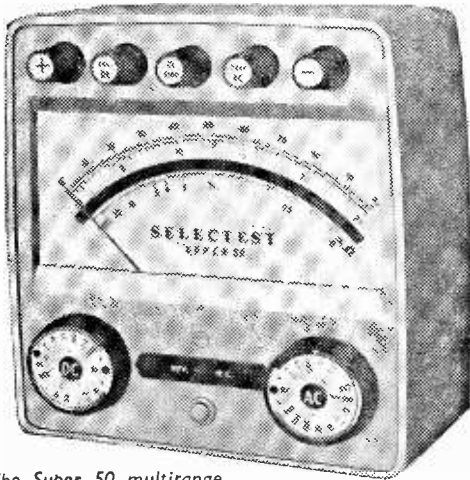

The Super 50 multirange instrument made by Salford Electrical Instruments Limited.

RANGE OF TAPE RECORDERS

AT this year's International Audio Festival and Fair, Grundig (Great Britain) Limited exhibited their current range of tape recorders—the TK1, TK14, TK40 and TK60.

The TK40 is a four track model, incorporating every facility that the keen amateur enthusiast could possibly need — three speeds, facilities for superimposition, synchronised superimposition and the mixing of two inputs etc. It has a frequency response of 60-18,000c/s and costs 75 guineas.

The model TK1 has a speed of 3 $\frac{1}{2}$ in./sec. and uses a 3in. spool. It weighs only 8lb and has a frequency response of 100 to 8,000c/s. The price of this model is 29 guineas.

The TK14 also runs at 3 $\frac{1}{2}$ in./sec. but uses a 5 $\frac{1}{2}$ in. spool. The frequency response is somewhat better than the TK1, being 60 to 12,000c/s. This machine costs 35 guineas.

One of the range of Grundig tape recorders recently exhibited at the Audio Festival and Fair.



The TK60 is the most expensive of the range, costing 128 guineas. This model has two speeds; 3 $\frac{1}{2}$ or 7 $\frac{1}{2}$ in./sec. The TK60 weighs 55lb. and has a frequency response of 50 to 15,000c/s.

Grundig (Great Britain) Limited, Newlands Park, Sydenham, London S.E.26.

PORTABLE RADIO

THE model TB.61, from Pam Radio and Television Ltd., is a new transistorised portable receiver. It includes six transistors and features printed circuit design. Primarily the receiver uses an internal ferrite rod aerial but provision has been made for its use with an external aerial. The set covers both medium and long wavebands and tuning is achieved by a slow-motion tuning dial.

The receiver is finished in tan and grey with a silver and black fascia. It measures only 9 $\frac{1}{2}$ in. x 5in. x 3in. and weighs 2 $\frac{1}{2}$ lb. The price of the TB.61 is 15 guineas and it is manufactured by *Pam Radio and Television Ltd., 295 Regent Street, London, W.1.*

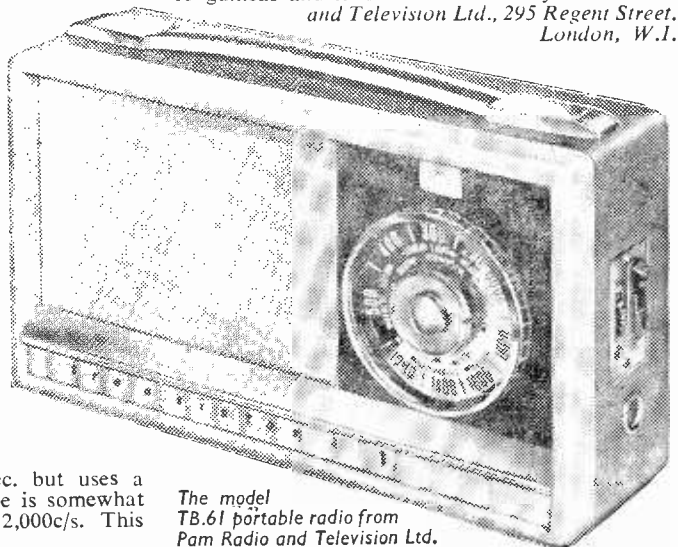

The model TB.61 portable radio from Pam Radio and Television Ltd.

★ VALVES ★

by return of post

THE MOST COMPREHENSIVE COMPETITIVE VALVE LIST IN THE COUNTRY

Table with 3 columns: 10% DISCOUNT SPECIAL OFFER TO PURCHASERS OF any SIX VALVES marked in black type (15% in dozen). Post: 1 valve, 6d., 2-11, 1/-.

Main valve list table with columns for valve type, manufacturer (e.g., 12A5, 6AK5), and date.

Tubes

Table showing tube models and prices under 'NEW TYPES' column: MW 31/74 £4-0-0, MW 36/24 £5-0-0, CRM 172 £4-0-0, MW 43/64 £6-0-0.

13 CHANNEL T.V.s. Table Models, Famous Makes. Absolute Quality. These sets are unequalled in value...

F.M. TUNER KITS. Well known make. Comprising F.M. Tuning Head, guaranteed none drift...

P.V.C. CONNECTING WIRE. 100 yds. 30 mil; Special Price 7/6, 200 yds. 30 mil; special price, 12/6.

PICK-UP CARTRIDGES. "Acous" 55.3. 22/6, "Sonetone" 17/-. "Stag and Reuter", 17/6. Power Point, 17/-.

HEADPHONES. Ex-Govt. quality with Jack-plate. 7/6 pair. P.P. 1 s.

NEW SPEAKER CABINETS covered in attractive Resin. Gold Metal trim 11/-. Or complete with 7 x 4 Speaker, 19/-.

TRAVLER TAPE RECORDER Superior, Transistorized, Portable Fast Rewind...

UA20 Autochangers. Latest B.S.T. 10 mixed records, Brand New...

100 RESISTORS 6/6 100 CONDENSERS 10/-

A.M./F.M. RADIOS. Latest Super German press button, long, medium, short and F.M., normally approx. £30.

VALVE HOLDERS 876. 8d. ea., with Screen 3d. ea. 89A. 6d. ea. with Screen 8d. ea.

TECHNICAL TRADING CO.

Post: 2 lbs. 2/-. 4 lbs. 2/6, 7 lbs. 3/6, 15 lbs. 4/-. etc. No C.O.D. ALL ITEMS LESS 5% AND POST FREE IN DOZENS.

THE LINEAR L1/10

A 10-WATT HIGH FIDELITY ULTRA LINEAR AMPLIFIER WITH INTEGRAL PRE-AMP

Full advantage has been taken of latest component miniaturisation developments to produce a 10-watt Hi-Fi push-pull amplifier incorporating tone control pre-amplifier stages within the measurements of 9 x 7 x 5 ins. In addition two high impedance input sockets are provided for microphone and gram., etc. With selector switch and vol. control, five B.V.A. valves are employed ECC83, ECC83, EL84, EL84, EZ81, H.T. and L.T. power supply point is included for a radio tuner.

FREQUENCY RESPONSE

± 1 d.b., 30-20,000 c.p.s.

MAXIMUM POWER OUTPUT

in excess of 14 watts.

SENSITIVITY

L.P. 220 m.v. for 10 watts. 78 r.p.m. 220 m.v. for 10 watts. Radio/Microphone 40 m.v. for 10 watts.

TREBLE LIFT CONTROL

+ 10 d.b. to -22 d.b. at 12,000 c.p.s.

BASS CONTROL

+ 14 d.b. to -10 d.b. at 50 c.p.s.

HUM LEVEL

Referred to maximum output and including integral pre-amp.—70 d.b.

NEGATIVE FEEDBACK

21 d.b. in main loop.

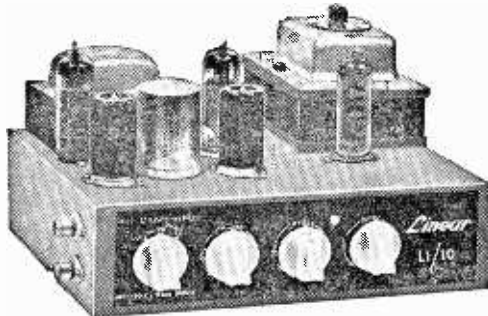

HARMONIC DISTORTION Less than 0.1% measured at 8 watts at 1000 c.p.s. Weight 10 lbs. Power consumption 90 watts. For 200-230-250 v. 50 c.p.s. A.C. mains. Outputs for 3 and 15-ohm speakers. Chassis finish stoved Gold hammer.

HIGHEST QUALITY Retail Price
MAXIMUM RELIABILITY **13**
AT A PRICE YOU CAN **GNS.**
AFFORD

Send S.A.E. for descriptive literature

TRADE ENQUIRIES to

Also Available—**THE L.45.A compact High Quality 4-5 watt amplifier.** Size approx. 7-5 x 5 in. high. Sensitivity is 28 millivolts so that the input socket can be used for either microphone or gram., tape, radio tuner etc. B.V.A. valves used are ECC83 EL84, EZ80. Controls are: Vol. Treble and Bass with mains switch. The Tone controls provide full compensation for long playing records. Output matching for 3 ohm loudspeaker. Retail price £5.19.6.

THE LT45 TAPE DECK AMPLIFIER. A complete unit (power pack and oscillator incorporated) ready for connection to A.C. mains. 3 ohm loudspeaker and practically any make of deck. Negative feedback equalisation adjustment by multi-position switch for 1½, 3½ and 7½ in. per second. Retail price 12 gns.

DIATONIC 10-14 WATT. High Fidelity amplifier with integral pre-amplifier. Retail 12 gns.

CONCHORD 30 WATT. Hi-Fi amplifier with two separately controlled inputs. Retail 16 gns.

L50 50 WATT AMPLIFIER. Size approximately 14 x 10 x 8 in. Sensitivity 25 mV. Output for 3 and 15 Ω speakers. Retail price 22 gns.

L5/5 STEREO AMPLIFIER 5 + 5 watt 12 gns.

LINEAR PRODUCTS LTD.

ELECTRON WORKS, ARMLEY LEEDS

SOLDERING EQUIPMENT

by



PRECISION SOLDERING for the ELECTRONICS INDUSTRY

Comprehensive range—Robust & Reliable - Light weight - Rapid heating - Bit sizes 3/32in. to 3/8in. - 'Permatite' or Copper bits - All voltage ranges 6/7v. to 230/250v. - Prices from 21/-.

Also

- Plastic Cable Strippers
- Miniature Solder Pots
- Heat Guards
- Long Life Bits

Illustrated is the 25w. 3/16in. replaceable bit model with safety shield.

ADAMIN— new range of precision micro-soldering instruments— Have you had details?

Brochure No. S10 sent free on request.

Sole proprietors and manufacturers: LIGHT SOLDERING DEVELOPMENTS LTD.

28 Sydenham Road, Croydon, Surrey
Phone: CROYdon 8589 Grams: Litesold Croydon



GZAK: This Month's Bargains

★ SHADED POLE MOTORS ★

230v. or 110v. operation. Ideal for fans, blowers or models. One only, 12/6, plus 2/- p. & p. Or pair, £1, plus 2/6 p. & p'

★ AERIAL EQUIPMENT

TWIN FEEDER. 300 ohm twin ribbon feeder, similar K25, 6d. per yard. K35B Telecon (round) 1/6 per yard. Post on above feeder and cable 1/6 any length.

COPPER WIRE. 14 G., H/D 140ft. 17/-; 70ft. 8/6. P. & P. 2/-. Other lengths *pro rata*.

RIBBED GLASS. 3in. aerial insulators, 1/9 each. P. & P. 1/6. up to 12.

CERAMIC FEEDER SPREADERS. 6in. type F.S. 10d. each. P. & P. 2/-.
CERAMIC "T" PIECES. Type A.T. for centre of dipoles, 1/6 each. P. & P. 1/-.
2 METRE BEAM 5 ELEMENT W. S. YAGI. Complete in box with 1 x 25in. mast head bracket. PRICE 49/-.

SUPER AERIAL CABLE. 75 ohm, 300 watts, very low loss, 1/8 per yard. P. & P. 2/-. 50 ohm, 300 watt coax, very low loss, 1/9 yd. P. & P. 2/-.
ABSORPTION WAVEMETERS. 3.00 to 35.00 Mc/s in 3 switched bands, 3.5, 7, 14, 21 and 28 Mc/s. Ham Bands, marked on scale. Complete with indicator bulb. A MUST for any Ham shack. 22/6 post free.

VARIABLE CONDENSERS. All brass with ceramic end plates and ball race bearings. 50 pF, 5/9. 100 pF, 6/6. 160 pF, 7/6. 240 pF, 8/6, and 300 pF, 9/6. All fitted with rear extension for ganging. P. & P. 1/-. Also Flexible Couplers, 1/- each. B.I. 8 MFD. 1,200 v. D.C. VVkg. Capacitors, 12/6 each. P. & P. 2/-.
CHAS. H. YOUNG LTD.
THE COMPONENT SPECIALISTS
Dept. "P", 110 Dale End, Birmingham 4. (CEN 1635)
(No C.O.D. under £1 please). (By return service)

A VERSATILE LOW-CURRENT VARIABLE

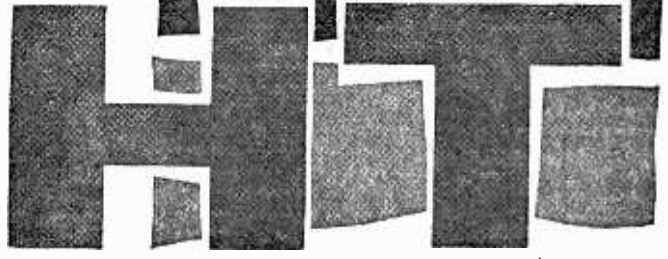

SUPPLY

USING AN OUTPUT PENTODE AS GRID-CONTROLLED H.T. RECTIFIER, A WIDE RANGE OF VOLTAGE CONTROL CAN BE ACHIEVED IN A VERY SIMPLE CIRCUIT.



By D. A. Brandon

*I*N the course of experiments and constructional work, it repeatedly happens that a small one- or two-valve circuit has been built, which requires a small H.T. current of a few milliamps, at voltages between about 100 and 300. Unless the constructor has built, or purchased, a universal variable stabilised power unit (which will, of course, be the ultimate aim of most serious constructors) it is always a problem to meet such low-power H.T. needs. The output voltage of

normal H.T. units is generally too high, so that various series-resistor voltage-droppers are used. These serve the purpose very well for rough adjustment of the final output voltage, but do not lend themselves well to providing continuous regulation, so that a particular desired voltage may be set exactly. If control down to very low voltages is desired, high-resistance variable resistors would be needed, whilst these must also be capable of carrying the maximum current. Consequently potentiometers of high wattage are required, which are expensive.

Output Valve as Rectifier

It would thus be more economical to use an output-valve as the series resistor, controlled by means of its grid-bias voltage. The grid-bias potentiometer can be of normal carbon type, as negligible power is needed in the grid circuit. Now the ultimate benefit of this type of circuit is apparent when it is further realised that the *same valve* can be made to function as H.T. rectifier, and to supply its own control grid bias, as well as an automatic limiting bias to prevent excessive current if the output is short-circuited.

It is the subject of this article to discuss such a circuit, with special attention to the factors governing the choice of the most suitable type of output valve to use as "grid-controlled rectifier", and also to some other important practical factors to be observed.

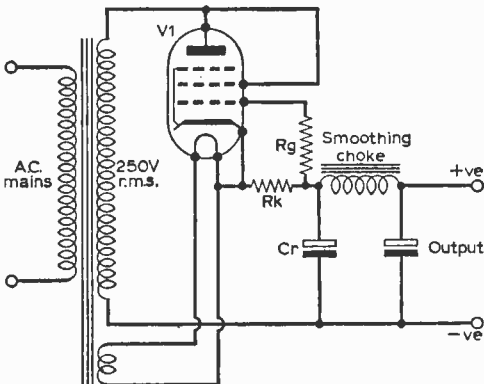

Fig. 1—Using the normal cathode bias and grid leak resistors with an output valve as rectifier.

Electrode Connections

It is, in principle, possible to strap all electrodes except the cathode together, for use as "anode", to make any valve whatsoever function as a rectifier diode, and in practice this will also work very well—up to a certain maximum voltage of operation, which is usually very low.

It is necessary to pay careful attention to peak voltages, especially inverse voltages (i.e., for the non-conducting direction, when the anode is negative to cathode), and also to the question of "what to do with the grid", when using an output valve as an H.T. rectifier. It is most certainly not permissible to strap the grid to the anode, even via a series-resistor of normal grid-leak value to limit grid current on positive half-cycles to a safe value, unless the operating voltage is to be very low (not exceeding about 50V r.m.s. applied A.C.). The smoothing condensers charge up to the peak of the applied A.C. on positive half-cycles (about 1.5 times the r.m.s. voltage), which thus constitutes the cathode voltage of the valve (see Fig. 1). On the peak of the negative half-cycles, where the valve does not conduct, the anode will be negative to chassis by about 1.5 times the r.m.s. A.C. voltage—i.e., negative to the cathode by a total of three times the r.m.s. A.C. voltage. If the grid were strapped to the anode, even via a large resistor, this large voltage difference would appear between grid and cathode. If a 250V r.m.s. transformer winding were used, the grid would thus go to a peak of about 750V negative to the

is already apparent, for if the output terminals in Fig. 1 are completely short-circuited, the valve is seen to have actually degenerated to the normal output-valve connection, apart from the minor difference that the loudspeaker transformer is

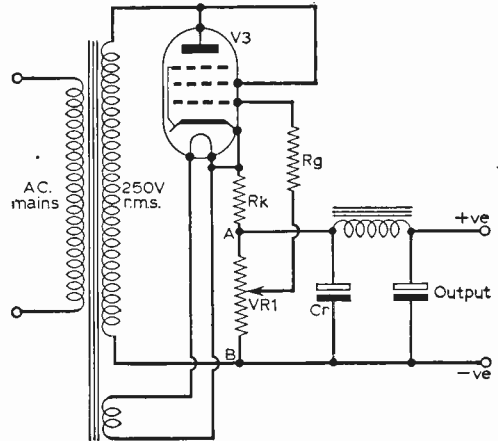

Fig. 3—A variable output circuit using an EL34.

missing in the anode circuit, and that A.C. instead of D.C. feed is used. The latter means that the full voltage is only present some of the time instead of all the time at the anode, so that the maximum current through the valve and into the short-circuit certainly cannot exceed the normal anode current of the valve. The circuit is thus necessarily short-circuit proof. Furthermore, initial surge-current into a discharged reservoir condenser Cr cannot ever exceed the normal H.T. current of the valve, for the same reasons. Thus the usual restrictions on the maximum size of reservoir condenser present for diode rectifiers are not required, and very large smoothing and reservoir condensers may be used, to give excellent smoothing if needed.

Anode and Screen

This has taken care of the grid. It remains to consider the voltage stresses on anode and screen. If these electrodes are strapped together, as is normally permissible in this circuit, and as is shown in Fig. 1, the peak inverse voltage impressed on these, relative to the cathode, is three times the r.m.s. transformer voltage, for reasons explained above. It may safely be assumed that the peak inverse voltage rating is at least as large as the peak positive normal operating voltage at these electrodes. Thus the problem of choice of output valve resolves to finding one of suitably high peak anode and screen voltage rating. The use of line-output valves from television circuitry is immediately suggested, as these are built for very high transient anode voltages occurring in a line timebase output stage. Thus one would consider, for

(Continued on page 165)

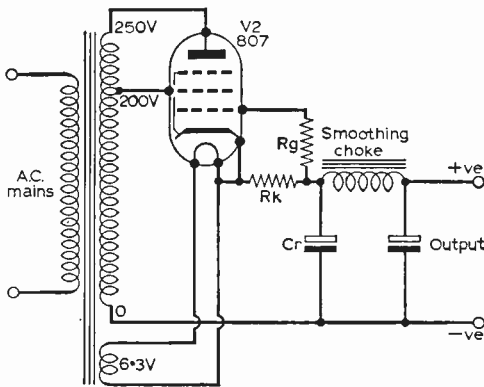

Fig. 2—Feeding the screen from a tap on the transformer instead of strapping it to the anode.

cathode, if it is strapped to the anode, which will certainly produce breakdown in any ordinary output valve.

Normal Cathode Resistor

This discussion shows that it is necessary to connect the grid to some point with a potential in the region of that of the cathode. Thus, the next most obvious thing to do is to use the normal cathode bias resistor Rk, and grid-leak Rg, for the valve, and connect these in exactly the same way relative to the valve as if it were used for its normal purpose as an output valve. This is shown also in Fig. 1. One advantage of doing this

WOLVERHAMPTON RADIO & T.V. SUPPLIES

(KIT SPECIALISTS)

43 Birmingham Road : Wolverhampton

TEL: WOLVERHAMPTON 20315

| VALVES by Return of Post | | |
|--------------------------|------|------------------|
| IC2 | 9/- | 5Y3 7/6 AC2/PEN/ |
| IC1 | 8/6 | 6BR7 7/6 DO 12/6 |
| ISS | 8/6 | 6K7 8/6 DCC90 |
| IT4 | 8/- | 6SH7 3/6 12/6 |
| 3A4 | 8/6 | 6X5 7/6 DL91 8/- |
| 3A5 | 12/6 | 6X5 7/6 DK69 9/- |
| 3S4 | 8/6 | 7AN7 10/6 ECH42 |
| SU4 | 8/6 | 30C1 13/- 12/- |

Mullard Boxed, New, Guaranteed
PCC84 EY86 9/- PL81 11/-
10/6 ECL80 9/6 PY81 10/-
PCF80 10/6 PL84 10/- PCL82 12/-

WE HAVE MOST OTHER TYPES AT APPROX SAME PRICES
Transistor Set Cabinets. 5½ x 3 x 1½ in. with chrome handle, tuning dial and scale. 7/6. P.P. 1/6.
Crystal Earpieces, with Jack Plug min. 5/-. P.P. 6d.
Record Player, Cabinet Straps, c/w, Chrome Brackets, Fixing Bolts, etc. Only 2/6 (Blue).
13 amp fused plug tops, 2/3 ea.

Good Companion Car Radio, portable. £9.19.6. Equals an 18 gns. commercial set. Send for inst. book 3/-. deducted from the kit if you purchase. P.P. 5/-. Battery 3/9.
Transistors: OC76 4/6, OC71 5/-, Japanese Audio 2/6, G.E.C. S1 Black Audio 3/-, S2, Blue driver 3/-, SB305 9/-, OC170 10/-, OC77 12/6, 2N398 10/-, SB240 7/6, OC42 3/6, XA701 6/-, GET 103 6/-, OA10 6/-, OA2 203 7/6, OA5 diode 5/-, OA2 202 7/6. Latest miniature diode OA90 2/11, XC141 power output as OC16, only 10/-, XA116 6/-, general purpose diodes 1/-, P.P. 4d. on each transistor. All these are new.

OC28 19/6, OC35 19/6, OCP71 19/6, OC200 12/6, P.P. 6d. OC72 5/-, P.P. 3d. OC44 5/6. OA47 V.H.F. or h/speed switching diode 3/6.

Speakers: 7 x 4in. E'ac high flux, absolutely new 12/6, P.P. 1/6. Goomans latest 3in. 80 a. transistor type 18/6, P.P. 1/6. Ex. TV Speakers, all at 5/-. P.P. 1/6.

B.S.R. UA20 Record Decks. Four-speed auto, wired for stereo-head, £7.19.6. P.P. 5/6.

Ultra Twin-telescopic TV Aerials (heavy chrome on brass). 16/-, P.P. 1/-.
Miniature Mains Soldering Irons. Designed for transistor kit work, 30 watt, specially light weight, handle unscrews to cover bit so that iron can be carried even when hot, supplied with handsome pocket case in grey leather cloth P.V.C. Spares always available—ONLY 17/6. Post paid.

4 Watt Amplifier Chassis, complete new working order, few only at 59/6. P.P. 4/-, with base treble and twin inputs.

Acos Mike Inserts (crystal), ½ x ¼ in. square, only 5/-. P.P. 4d.
Nylon Through Chassis Insulators, with solder pins, 1/3 per dozen.
16-way Miniature Tag Board, 2 x 1½ in. with fixing screws, 8d. P.P. 3d.
Co-ax Cable Airspaced 8d. yd.

TRANSISTOR RADIO KITS

FULLY PORTABLE

(An aerial is NOT required)

Everyone is making them! Don't think about it any longer—

SEND YOUR ORDER NOW!

If you have tried a cheaper kit bought elsewhere and had no success, don't worry! We Guarantee you will get results. Clear, concise instruction book, 10 pages, Guaranteed Components (not Govt. surplus), After Sales Service and Free Advice Bureau—

WE ARE THE SPECIALISTS

Our kits are unbelievably powerful—giving full coverage of medium and long waves. Luxembourg is guaranteed!! At Wolverhampton we receive 30 Continental Stations any evening—even Radio Moscow.

- ★ Elegant dial, graduated in medium and long waves.
- ★ Built-in wavechange switch (not pre-set).
- ★ Ferrite rod aerial (machine wound 7/6 extra).
- ★ Attractive case in cream, with chrome handle.
- ★ It does fit in your pocket.
- ★ Built-in speaker.
- ★ Surface barrier transistors, battery 10½d., last 8 weeks.

ALL THIS FOR 52/6
P.P. and Ins. 2/6

If you want even Greater Volume have the High Power Model—59/6
P.P. and Ins. 2/6

REMEMBER—

WE ARE THE SPECIALISTS

NOTE—These kits can be Tuned Down to 160 metres and Trawler Band.

12-way Tag Board, with resistors and condensers as follows, all ¼ in. watt transistor type: two 10 meg., two .01, one 3.9 M., 5.6 M., 3.3 M., 1.2 M., 2.2 M., 470 Ω. 470K. All for 2/-. P.P. 3d.
6000 Ω P.O. Relays. Platinum contacts. 3 way normal open, few only at 12/6. P.P. 9d.
500 pF Stamp Trimmers, only 9d. each.

Accumulators. 2 volt 40 A.H. unspillable, self tap fixing lead. New, 9/6 P.P. 2/6.

Spark Plug. Screwdriver tester, 3/-, P.P. 6d.

Resistors. ¼ and ½ w. all values 2d. ½ w. transistor type 3d.

Assorted Resistors. 50 popular values (or choose your own) for 8/9.

Assorted Condensers. 5 pF to .1 mfd. 25 for 8/6.

4 Transistor Amplifier, printed circuit with circuit 2/-. P.P. 3d. Parts available, but not plans.

Ferrite Rods, 4 x ¼ in. 1/6. P.P. 4d.

F.T.R. II, Tape Recorder Kit. Sub-assembled, finished in one hour. Size: 6 x 8½ x 2½ in. Fully portable, 20 min. play. Send for illustrated leaflet. S.A.E. Kit cost £6.19.6. P.P. 3/6.



B7G Valve Holders, with can 9d. P.P. 3d., less can 6d. P.P. 3d.
Guaranteed TV Tubes. 9 to 17in. All at 90/-. Ins. and carr. 15/6. £1 extra charged against odd tube, but refunded if returned in packing box in 14 days.

2 Watts. P.P. output transformers, 1½ x 1½ in. British make, 3/6. P.P. 6d.
Car Aerials. Adjustable angle telescopic. 12in. closed, 36in. extended with Co-ax plug, 17/6. Post paid.
Window Fixing, type for portable, 17/6. post paid.

500K Printed Circuit. Type pots new, 1/6. P.P. 3d.

WANTED

Valves, transistors, miniature components, all types of radio equipment, any quantity, but must be new, cash paid by return.

Suppliers to: Educational Authorities, Forces' Radio Clubs, Export, Etc.

WEYRAD

IMPROVED COMPONENTS FOR THE 6-TRANSISTOR 2-WAVE SUPERHET RECEIVER

NEW ROD AERIAL AND DRIVER TRANSFORMER FOR SIMPLER ASSEMBLY AND HIGHER PERFORMANCE

ROD AERIAL—RA2W

6 in. long, 3/8 in. diameter, connections to tags on Coils. For 208 pF tuning capacity ... 12/6
Car Aerial coupling Coil ... 1/-

OSCILLATOR COIL—P50/1AC

M.W. covered with 176 pF tuning capacity.
L.W. by extra padder ... 5/4

I.F. TRANSFORMERS

1st and 2nd Stage—P50/2CC ... 5/7
(2 required)

3rd Stage—P50/3CC ... 6/-

DRIVER TRANSFORMER—LFD74

redesigned to reduce size and improve performance. Six spalls for mounting and connections ... 9/6

PRINTED CIRCUIT—PCA1

Size 2 3/4 in. x 8 1/4 in. Ready drilled and printed with component positions ... 9/6

WE CAN NOW OFFER A CIRCULAR TUNING SCALE PRINTED IN BLACK ON GOLD FOIL PRICE 6d.

CONSTRUCTOR'S BOOKLET WITH FULL DETAILS AND FREE SCALE ... 2/-
COILS, TRANSFORMERS AND ROD AERIAL FOR THE P.W. "CITIZEN" ... 35/- PER SET

WEYMOUTH RADIO MANUFACTURING CO., LTD.

REGENT FACTORY, SCHOOL STREET,
WEYMOUTH, DORSET

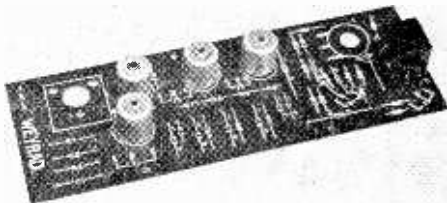

D.C. SUPPLY KIT, 12 v. 1 a. consisting of a partially drilled metal case, mains trans., F.W. Bridge Rectifier, 2fuseholders and fuses. Change Direction switch, variable Speed regulator and circuit. For 200-250 v. A.C. mains. Suitable for Electric Trains. Limited number available at 33/9.

SELENIUM RECTIFIERS

F.W. BRIDGE 24 v. 2 a. ... 14/9
6/12 v. 1 a. ... 3/11
6/12 v. 2 a. ... 6/11 H.T. TYPES H.W.
6/12 v. 3 a. ... 9/9 150 v. 40 mA ... 3/9
6/12 v. 4 a. ... 12/3 250 v. 50 mA ... 3/11
6/12 v. 6 a. ... 15/3 250 v. 60 mA ... 4/11
6/12 v. 10 a. ... 25/9 250 v. 80 mA ... 5/11
6/12 v. 15 a. ... 35/9 250 v. 250 mA ... 11/9
CONTACT COOLED, 250 v. 75 mA, F.W. (Bridge) 10/11, 250 v. 50 mA, F.W. (Bridge) 8/11. H.W. 250 v. 60 mA ... 5/11

TELEVISION RECTIFIERS, 250 v., 200 mA. Small size. Only 6/9.

B.S.R. MONARDECK TAPEDECKS Speed 3in. per sec. With high quality recording heads. £6.19.6. Carr. 5/- Cabinets, 39/6.

EX. GOVT. CASES. Size 14-10in. High. Well ventilated, black crackle finished, undrilled cover. IDEAL FOR BATTERY CHARGER OR INSTRUMENT CASE OR COVER COULD BE USED FOR AMPLIFIER. Only 9/9, plus 2/- postage.

LINEAR TREMOLO/PRE-AMP UNIT Type TPL/1, with 3 controls, volume, amplitude and frequency. Inputs for guitar and microphone. Requires power supply of 250 v. 10 mA and 6.3 v. 1 a., available from any R.S.C. or LINEAR amplifier. The unit is merely connected to normal input socket of hi-fi amplifier or Guitar amplifier. Only 5 gns.

R.S.C. GRAM. AMPLIFIER KIT, 3 watts output. Negative feedback. Controls Vol. Tone and Switch. Mains operation 200-250 v. A.C. Fully isolated chassis. Circuit etc., supplied. Only 39/9, Carr. 3/9.

HI-FI 10 WATT AMPLIFIERS

Brand new. Manufacturer's discontinued line. Fitted latest Mullard valves. Dual inputs for "mike" and gram., etc. Bass and Treble Controls. High sensitivity and quality. Output for 3 ohm or 15 ohm speaker. For 200-250 v. A.C. **£7.19.9** Carriage 7/6.

THE SKYFOUR T.R.F. RECEIVER. A design of a 3 valve long and medium wave 200-250 v. A.C. Mains receiver with selenium rectifier. High gain H.F. stage and low distortion detector. Valve line-up 6K7, SP6L, 6V6G. Selectivity and quality excellent. Simple to construct. Point-to-Point wiring diagrams, instructions and parts list. 1/9, maximum building costs £4.19.6, inc. attractive Walnut veneered wood cabinet 12 x 6 1/2 x 5 1/2 in.

R.S.C. TRANSISTORISED GRAM AMPLIFIER. Output 1 watt, for 3 ohm speaker. Transistors Mullard OCT1, OC81D, OC81. Suitable for any normal crystal pick-up. Only 69/9.

MULTI-METERS.

CARY M1. Sensitivity 2000 ohms per volt. A.C. and D.C. 54/-.
CARY A10. Basic meter sensitivity 155 micro-amps. A.C. and D.C. ranges £4.17.6.
CARY B20. Sensitivity up to 10,000 ohms per volt. A.C. and D.C. £6.10.0.
S.A.E. will bring leaflets on A10 or B20.

RELAYS. Carpenters' Type. Polarised 2 times 3,500 turns at 1,685 ohms. 13/9. Miniature Type C.E.C. 670 Sealed, wire ends, 4 c/overs, platinum M1095, 12/9.

EX. GOVT. SMOOTHING CHOKES. 200 mA, 3-5 H, 50 ohms, Parmeko 8/9; 100 mA, 5 H, 100 ohms 3/11; 150 mA, 10 H, 50 ohms 9/9; 80 mA, 20 H, 900 ohms 5/9; 120 mA, 12 H, 100 ohms 8/9; 50 mA, 50 H, 1,000 ohms 6/9; 100 mA, 10 H, 100 ohms 6/9; 60 mA, 3-10 H, 250 ohms 2/11-

EX. GOVT. MAINS TRANSFORMERS Primaries 200-250 v. 50 c.p.s. A.C.

250v. 60mA 6.3v. 2a. ... 11/9
250-0-250v. 60mA 6.3v. 2a. ... 12/9
275-0-275v. 100mA 6.3v. 7a. 5v. 3a. ... 22/9
300-0300v. 60mA 6.3v. 2a. ... 12/11
3,500v., 5mA 2v. 2a. ... 39/9
0-35-40-45-50v., 300mA 6.3v. 3a. ... 17/9
12v. 20a. (carr. 7/6) ... 59/9

COMPLETE POWER PACK KIT, 19/11 Consisting of Mains Trans., Metal Rectifier, Double electrolytic, smoothing choke chassis and circuit. For 200-250v. A.C. mains. Outputs 250v. 60mA, 6.3 v. 2a.

R.S.C. POWER PACK, 39/9. Louvred metal case only 8 x 5 1/2 x 2 1/2 ins. Stove enamelled. For 200-250v. A.C. mains. Output at 4 pin plug and socket 250 v. 60 mA, fully smoothed and 6.3v. 2a. Suitable for power requirements of almost any Pre-amp or Radio Tuner.

EX. GOVERNMENT ACCUMULATORS. Size 7 1/2 x 4 2 in. 2v. 16 A.H. brand new. 6/9 ea., 3 for 15/6.

R.S.C. BARY ALARM or INTER-COMM. KIT. Complete set of parts with diagrams, etc. Master Unit housed in veneered walnut cabinet. High sensitivity. For 200-250v. A.C. mains. Fully isolated. Only 79/6, carr. 5/-, Or assembled ready for use £5.15.0.

R.S.C.

(Manchester)
Ltd.

SHEFFIELD:

13 Exchange St.

51 Saville

St. (half

day hours)

or Exchange Stations)

MAIL ORDERS to: 29-31 Moorfield Road, Leeds 12.

TERMS: C.W.O. or C.O.D. No C.O.D. under £1.

Postage 1/9 extra, under £2

3/3 extra, under £5. Open 9 to 6. Weds. until 1 p.m. except Manchester, open all week. Trade supplied. S.A.E. with all enquiries please.

LIVERPOOL:

73 Dale St., 2 (8

56 Morley St.

(above Alhambra

Theatre)

51 Saville

mins. from Lime St.

day hours)

or Exchange Stations)

MAIL ORDERS to: 29-31 Moorfield Road, Leeds 12.

TERMS: C.W.O. or C.O.D. No C.O.D. under £1.

Postage 1/9 extra, under £2

BRADFORD:

56 Morley St.

(above Alhambra

Theatre)

51 Saville

mins. from Lime St.

day hours)

or Exchange Stations)

MAIL ORDERS to: 29-31 Moorfield Road, Leeds 12.

TERMS: C.W.O. or C.O.D. No C.O.D. under £1.

Postage 1/9 extra, under £2

3/3 extra, under £5. Open 9 to 6. Weds. until 1 p.m. except Manchester, open all week. Trade supplied. S.A.E. with all enquiries please.

LEEDS:

5-7 County

(Mecca) Arcade,

Briggate

51 Saville

mins. from Lime St.

day hours)

or Exchange Stations)

MAIL ORDERS to: 29-31 Moorfield Road, Leeds 12.

TERMS: C.W.O. or C.O.D. No C.O.D. under £1.

Postage 1/9 extra, under £2

3/3 extra, under £5. Open 9 to 6. Weds. until 1 p.m. except Manchester, open all week. Trade supplied. S.A.E. with all enquiries please.

(Continued from page 162)

example, using a PL36 here. This is rated at 7000V transient peak anode voltage, which is ample under all circumstances for our present purposes, but the screen rating is only 250V peak, which is too low for safety. A further disadvantage is the 23V heater voltage, which is not easily available. A normal output valve of the 6V6-type, or an EL84, has a normal 6.3V heater, but maximum anode and screen voltage ratings of about 300. This would not safely allow a transformer input voltage of more than about 100V r.m.s. to be used in Fig. 1 if breakdown were to be avoided.

Test Circuit

The writer, for purposes of a practical test, has however, set up the circuit of Fig. 1 with a 6V6, using a transformer A.C. voltage as high as 350V r.m.s. This arrangement was left operating for many hours and did not break down, nor showed the slightest tendency to do so, although the peak

inverse anode voltage must have been nearly 1000V under these conditions, at least three times as high as the normal rating of a 6V6. The fact that this circuit worked for a long period without breakdown should not be taken as recommendation for its copying by experimenters, but rather as an indication of the quality of modern components. The writer remains doubtful of the reliability of a 6V6 in this circuit for really long-term operation. We must look further for a really suitable valve. The 807, with a peak anode rating of 600V, screen 300V, is easily obtainable on the surplus market for a few shillings, and in view of the results mentioned already for a 6V6, is almost certain to provide long-term reliability in the circuit of Fig. 1. The writer would thus safely recommend the use of an 807 for an r.m.s. A.C. voltage up to 250 at the transformer (the 6V6, of lower rating, was tested at 350V r.m.s.). It might be advisable to feed the screen from a tap at about 200V on the transformer, instead of strapping to the anode, as shown in Fig. 2.

(To be continued)

How Transistors Work

(Continued from page 139)

positive at the base—see Fig. 25). This, then, gives the curve of Fig. 26 which, for a circuit in the common base mode, is really a representation of the leakage current (I_{co}).

This leakage current rises to a constant value with increase in negative collector voltage from point A to point B. Point B is sometimes called the "softening voltage" (rather the same as the turn-over voltage of a semi-conductor diode biased for reverse conduction). When point B is reached, I_{co} starts to rise rapidly. The peak voltage swing of the collector is usually limited to a value which is about 25% below the softening voltage, while the maximum equivalent direct voltage of the collector is usually considered as being about 75% below the softening voltage, as shown on the curve.

When a transistor is arranged in the common emitter mode, then the factors as described above still apply, but the whole curve is scaled down, since, under this condition, the softening voltage occurs at a value below that for common base operation. The curve then shows leakage current with the base open-circuited, usually denoted I'_{co} —see Fig. 27.

Tester for Comparative Checks

From the foregoing it will be understood that both I_{co} and I'_{co} increase in value with increase in temperature. Either when a transistor is too warm or in some way defective the value of I_{co} or I'_{co} rises considerably and in severe cases could result in a reversed conduction approaching the value of forward conduction. It is then that a transistor ceases to operate as such.

The D.C. gain of a transistor is really a measure of the ratio of I_{co} and collector current when base current is flowing. In Fig. 28 is given a simple circuit which facilitates ratio measurements of this kind on both *npn* and *pnp* transistors. With

a transistor connected correctly to the terminals indicated, and with S2 in the appropriate position, a very small reading will be recorded on M1 when S1 is closed. This is effectively the leakage current between emitter and collector with the base open (e.g., I_{co}). On a good transistor the reading should not exceed 0.1mA (100 μ A), but should normally be less than this.

This reading will be influenced by the air temperature around the transistor, as already explained, and the temperature sensitivity can vividly be demonstrated simply by bringing the heat from a soldering iron towards the component under test (avoid too much heat!).

Transistors are also light sensitive, which is one of the reasons why they are painted black or sealed in a light-proof container. If there is any leakage of light through the case I_{co} will change with room illumination.

Indication of D.C. Gain

Now, when the button marked "press to test D.C. gain" is depressed, the base circuit is closed through the 8.2k resistor which goes back to the battery at the appropriate polarity. The meter reading will then rise up to the region of 0.6mA at least; and it is this change in current which gives an indication of the D.C. gain. The greater the change, the greater the gain.

Clearly, then, the tester can be used to select transistors from a bunch and will, at least, allow comparative checks and show whether a unit is serviceable or not. It can also be used to select matched pairs of transistors for push-pull output stages. It is fairly fool-proof as the battery voltage almost prevents burning out transistors.

The circuit can also be used to test semi-conductor diodes. The diode is simply connected between the "E" and "C" terminals and the reverse and forward conduction ratio can be assessed by switching S2 from one position to the other. With a good diode, the current change should not be less than about 0.6mA.

(To be continued)

Letters to the Editor

The Editor does not necessarily agree with the opinions expressed by his correspondents.

Whilst we are always pleased to assist readers with their technical difficulties, we regret that we are unable to supply diagrams or provide instructions for modifying commercial or surplus equipment. We cannot supply alternative details for receivers described in these pages. **WE CANNOT UNDERTAKE TO ANSWER QUERIES OVER THE TELEPHONE.** If a postal reply is required a stamped and addressed envelope must be enclosed with the coupon from page iii of the cover.

P.W. MINUETTE

SIR,—I have just constructed the P.W. Minuette, which was described in the January and February issues of PRACTICAL WIRELESS, and I am very pleased with the results. Among dozens of other stations it receives Luxembourg loud and clear.

I have omitted the telescopic aerial and used a 5½ in. ferrite slab instead. I have also fitted a personal earpiece socket.

The tuning condenser I have used is a solid dielectric type and I have found that a 100k reaction control works well instead of the 50k potentiometer shown in the issue.—V. LOWE (Droylesden, Lancashire).

TELEVISION SOUND

SIR,—I know that much has already been said about the reception of television sound on short waves, but most reports mention signals picked up on the 80m band. One evening while listening on short waves, TV sound came in quite loud on 15m. The signal was definitely being emitted from the receiver downstairs, as my commercial superhet receiver picked up whichever channel was selected on the television.

I see that one reader suggests that the signals come from the A.F. stages of the TV receiver, but I doubt if this is the case, as reception of ITV sound was much weaker than BBC, no matter how high the volume of the television.—P. FOSTER (Denmead, Hampshire).

CORRESPONDENTS WANTED

SIR,—I have only recently taken up radio and electronics as a hobby and I would like to correspond with English radio amateurs wishing to exchange ideas, news and information on these subjects. I will answer all letters received.—AHMED AWAD ABOL ENIEN (8 Ebn fernas Street, Fleming, Alexandria, United Arab Republic).

PURCHASING BY POST

SIR,—I often hear complaints about the service given by mail order firms—about slow service, wrong components sent, etc. But I wonder how often it is the fault of the purchaser and not the supplier that causes problems when ordering components by post.

I am sure that if people indicated precisely which articles are required, addressed the envelopes correctly and enclosed the exact cost of all, including the postage, many more of the public would realise that mail-order firms are a very convenient sales medium. By experience I have found that careful attention to the above three points will, in nearly all cases, ensure swift service, and if there is any delay—caused by heavy demands for a particular component, for example—patience or a polite reminder note will work wonders.—P. S. HARRISON (Guildford).

LOCAL STATION PICK-UP

SIR,—I have experienced a trouble which appears, from my chats with workmates, to be fairly common. The effect I refer to is the direct pick up of the local station on a tape-recorder, when this is set up to make recordings with an ordinary microphone—not with a radio jack. It appears to be due, in many instances, to the input valve of the recording amplifier “bottom bending” and I have improved this with a modification in the value of the cathode bias resistor. In other cases, this was ineffective and the only cure was to shorten the microphone lead, and to use coaxial cable in place of thin screened lead as fitted to the microphone. It would be interesting if other readers’ cures for this trouble could be enumerated, as there appears to be a real fault with this type of apparatus, and there must be a single “cure-all” for all types of recorder.—R. FERGUSON (Barnet).

THE AMATEUR TRANSMITTER

SIR,—With reference to G. D. Thornton’s remarks in the November issue. “Let would-be hams join the C.D.” I agree, but, what about those who cannot, such as serving soldiers? Let’s face it, the licensing regulations were written when Marconi was a boy and are still in force. With the GPO now clamping down on Radio Clubs, no person, who is not a licence holder, will be allowed to transmit, no wonder there are pirates and Ghost Clubs with no members. No wonder why, on 40m and 80m I have heard G’s saying, “Sorry O.M. unmodulated S9 carrier”. If a person could operate and study, the result would be no, or very few pirates. As the transmitter stands today, a child could operate one, and keep it TVI-proof (cost £50+£3 10s. for low pass filters—TVI-proof; I’ve done it). The manufacturer has taken the first step and produced a low cost, good Tx. Now let the GPO act. A simple test of ability to tune and erect aerials should give grace for 18 months to take the R.A.E.—E. J. BOOTH (EX 9M2, DL2, now BRS15100), York.

Easy-to-build kit-sets of



highest quality at lowest cost



SB-10U

SINGLE SIDEBAND ADAPTOR, Model SB-10U. May be used with most AM transmitters. Less than 3 w. R.F. input power required for 10 w. output. Operation on 80, 40, 20, 15 and 10 m bands on USB, LSB or DSB £37.60

THE "MOHICAN" GENERAL COVERAGE RECEIVER. Model GC-1U.

Fully transistorised, including 4 piezo-electric transistors. The very latest and an excellent portable or general purpose receiver for the Amateur and short-wave listener £38.15.0



GC-1U

AMATEUR TRANSMITTER. Model DX-40U. Self-contained. 80-10 m. Power input 75 w. C.W., 60 w. peak, C.C. phone. Output 40 w. to aerial. Provision for V.F.O. £32.10.0

VAR. FREQ. OSCILLATOR. Model VF-1U. Calibrated 160-10 m. fundamentals 160-40 m. Ideal DX-40U and similar transmitters £11.2.0

R.F. SIGNAL GENERATOR. Model RF-1U. Gives accurate source of R.F. up to 100 Mc/s on fundamentals and 200 Mc/s on harmonics. Up to 100 mV output on all bands £11.18.0

AUDIO SIGNAL GENERATOR. Model AG-9U. 10 c/s-100 Kc/s, switch selected. Distortion less than 0.1%. 10 v. sine wave output metered in volts and dB's £19.19.6

VALVE VOLTMETER. Model V-7A. Measures volts to 1,500 (C.C. and RMS) and 4,000 pk to pk. Res. 0.1Ω-1,000 MΩ. D.C. input impeded. 11 MΩ. With test prods, leads and standardising battery. £13.00

PORTABLE SERVICE OSCILLOSCOPE. Model OS-1. Compact portable scope ideal for servicing and general work. Y amplifier sensitivity 10 mV/cm; response, 3 dB 10 c/s-2.5 Mc/s. Time base 15 c/s-150 Kc/s. Printed circuits. Case 7 3/4 x 4 1/2 x 12 1/2 in. long. Wt. only 10 1/2 lb. £19.10.0

5in. OSCILLOSCOPE. Model O-12U. Wide-band amplifiers essential for TV servicing. F.M. alignment etc. Vertical freq. response 3 c/s-5 Mc/s without extra switching. T/B covers 10 c/s-500 Kc/s in 5 ranges £36.10.0

RES.-CAP. BRIDGE. Model C-3U. Measures capacity 10 pF-1,000 μF, resistance 100Ω-5MΩ and power factor. 5-450 v. test voltages. Safety switch. £8.6.6

SINGLE CHANNEL AMPLIFIER. Model MA-12. 10-12 watt Hi-Fi amplifier. Extremely low distortion and wide frequency range £10.19.6

HI-FI EQUIPMENT CABINETS. Range available to meet various needs. Details on request. (MALVERN equipment cabinet illustrated bottom left) from £11.5.6 to £17.18.6

GRID DIP METER. Model GD-1U. Coverage from 1.8 Mc/s to 250 Mc/s. Complete set of plug-in coils provided £10.9.6



MALVERN

TAPE RECORDING/PLAYBACK AMPLIFIER. Model TA-1. Monaural (TA-1M) £18.2.6

Conversion unit to Stereo £6.10.0

Stereo (TA-1S) £23.6.0

"PACKAGED DEALS" of Hi-Fi equipment including TAPE DECKS, RECORD PLAYERS and DECCA ffs PICK-UPS.



F.M. TUNER



S.33



S.8b



DX-40



UXR-1



OS-1



SSU-1

AMATEUR TRANSMITTER. Model DX-100U. Covers all amateur bands. 160-10 m. 150 w. D.C. input. Self contained including power supply. Modulator, V.F.O. (illustration bottom right). £71.10.0

SHORTWAVE TRANSISTOR PORTABLE. Model RSW-1. Two short bands, trawler and medium £22.10.0

6-TRANSISTOR PORTABLE. Model UXR-1. Preamplified I.F. transformers, printed circuit, 7 x 4in. high flux speaker. Real hide case £14.18.6

HI-FI F.M. TUNER. Tuning range 88-108 Mc/s. Tuning Unit (FMT-4U) with 10.7 Mc/s I.F. output (£3.5.0 inc. P.T.) I.F. Amplifier (FMA-4U) complete with cabinet and valves (£11.1.0). Total £14.16.0.

6-W STEREO AMPLIFIER. Model S-33. 3 w/chl. inputs for radio/tape and gram., Stereo or Mono, ganged controls. Sensitivity 200 mV. £12.8.6

HI-FI 16W STEREO AMPLIFIER. Model S-88. 20 mV basic sensitivity (4 mV model available, 7/6 extra). Ganged controls. Stereo/Mono gram., radio and tape recorder inputs. Push-button selection. Two-tone grey metal cabinet £26.12.6

TRANSCRIPTION RECORD PLAYER. Model GL-58. Goldring-Lenco four speed unit. G.60 pick-up arm and infinitely variable speed adjustment between 33 and 80 r.p.m. with fixed speed at 16 r.p.m. Balanced turntable (3 1/2 lb.). Stereo £20.12.0

HI-FI SPEAKER SYSTEM. Model SSU-1. Ducted-port bass reflex cabinet "in white". Twin speakers. Pedestal model £11.18.6. Bookcase model £10.17.6

"COTSWOLD" HI-FI SPEAKER SYSTEM. Acoustically designed enclosure "in the white". 26 x 23 x 15 1/2 in. 12in. bass speaker with 2in. speech coil, elliptical middle speaker. Pressure unit covers the full freq. range of 30-20,000 c/s., complete with cross-over unit, level control, etc. £21.19.0

COMPLETE MATCHED STEREO OUTFIT. Includes record player, S-33 amplifier and twin SSU-1 speaker systems. (Pedestal speaker legs optional £2.2.0) £44.9.4

STEREO CONTROL UNIT USC-1. Luxury model with press-button inputs to suit any pick-up or tuner and most tape-heads. Output 1.3 v. R.M.S. per channel. Printed circuit construction £18.18.6

STEREO HEAD PREAMPLIFIER USP-1. Ideal for boosting tape-head output and low output pick-ups (e.g. Decca ffs) £6.17.6

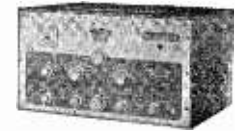

DX-100U

Deferred Terms available on orders over £10

Prices include free delivery UK

Please send me FREE CATALOGUE (Yes/No).....

Full details of model(s).....

NAME

ADDRESS

PW6

DAYSTROM LTD.

Dept. P.W.6, GLOUCESTER, ENGLAND

A member of the Daystrom Group, manufacturers of the WORLD'S LARGEST-SELLING ELECTRONIC KITS

"CODAR CLIPPER" ALL BAND RECEIVERS 10-2000 METRES

LISTEN TO AMATEURS, AIRCRAFT, SHIPPING, SHORT, MEDIUM, LONG WAVE BROADCAST STATIONS THROUGHOUT THE WORLD.

THE MINI-CLIPPER

The ORIGINAL and finest one valve all band receiver. Outstanding performance. New first grade components ensure top efficiency. Low loss air spaced tuners, high gain polystyrene plug-in coils. Satin Silver metal panel with engraved dials, grey pointer knobs. Provision for adding 2 transistor amplifier stage. Chassis ready punched. Total building cost, all parts, one coil 20-60 meters, wire solder, full plans, 36/6. P. & P. 2/6. Other coils 10-2000 meters and electrical bandsread available. Parts sold separately. Plans and parts list, 2/-.

NEW LOW PRICE **36/6**

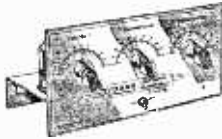

THE SUPER CLIPPER 88/6

This world-famous hybrid receiver has achieved remarkable success. Tremendous performance with Hi-gain valve detector PLUS two Ediswan transistor amplifiers which are supplied assembled, only 3 wires to connect. Large precision dial, 7 x 4in., with 2 pointers, bandset and bandsread, dual slow-motion drives, air spaced variables. Punched chassis 8 x 5 1/2in. Batteries last months. Covers 10-2000 metres (5 coils). Total building cost including chassis, valve, 2 transistor stages, 2 coils 20-60 and 55-190 metres. Step-by-step pictorial plans, nuts, bolts, wire 88/6. P. & P. 2/6. Plans only, 2/6. THE CLIPPER. As above but one transistor stage, 79/6. P. & P. 2/6. Optional Front Panel, Silver Hammer finish, all holes, 6/9.



THE NEW CR45 ★ NEW STYLING TOP PERFORMANCE

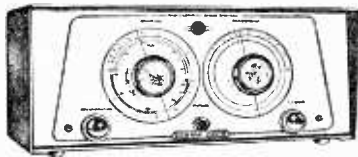

Previously produced exclusively for Export, the de-luxe version of this famous ALL BAND receiver is now also available for the home market. Superb new styling, satin silver front panel, frequency calibrated scales, grey and silver trim knobs, perspex disc cursors. High gain circuit with ECC81 duotriode, EL84 output, EZ80 full wave rectifier. Power output 3 1/2 watts for 2/3 ohm speaker. 3 Planetary vernier slow motion drives, separate electrical bandsread. Covers 10-2000 metres (5 Coils). World wide reception. For A.C. supply 200-250 volts (Export version 105-120 volts). Total building cost all parts, valves, front panel, ready punched chassis, 2 coils, 20-60 and 55-190 metres, wire, solder, instruction manual. P. & P. 3/6. Optional extra. CR45 Cabinet 12 x 5 x 7in., slide flap for easy coil changing, Silver grey finish, 27/6.

£6.19.6

No technical knowledge required to build these fine receivers. Send 3d. stamp for illustrated leaflets, testimonials, etc. Now available, the NEW 1962 CR 66 A.C. SUPERHET COMMUNICATION RECEIVER.

CODAR RADIO COMPANY, COLEBROOK ROAD, SOUTHWICK, SUSSEX G31RE
Canadian Distributors: JAYCO ELECTRONICS, TWEED, ONTARIO. **G31PA**

EXPRESS ELECTRONICS ROSEDENE LABORATORIES KINGSWOOD WAY, SELSDON, SURREY

VALVES NEW TESTED AND GUARANTEED FOR THREE MONTHS

| | | | | | | | | | | | |
|-------|-----|--------|------|------------|------|-------|------|-------|------|-------|------|
| 1C1 | 7/8 | 6BA6 | 6/- | 12AT7 | 6/- | 1D7H7 | 6/- | EF86 | 9/- | PL81 | 12/6 |
| 1C3 | 8/- | 6BE6 | 7/- | 12AU7 | 3/8 | DH142 | 8/8 | EP91 | 4/- | PL82 | 7/- |
| 1F1 | 8/- | 6BH6 | 5/8 | 12AX7 | 8/8 | DH130 | 10/- | EP92 | 5/6 | PL83 | 7/8 |
| 1F3 | 7/8 | 6BJ6 | 6/8 | 12BE6 | 8/8 | DK91 | 7/8 | EL41 | 9/6 | PY81 | 8/8 |
| 1FD1 | 8/- | 6BR7 | 8/8 | 12BH7 | 10/8 | DK92 | 7/8 | EL84 | 7/- | PY82 | 7/8 |
| 1FD9 | 7/8 | 6BW6 | 7/8 | 12K8GT11/- | DK96 | 5/- | EM84 | 10/- | PY83 | 7/8 | |
| 1L4 | 8/8 | 6BW7 | 7/6 | 12Q7GT | 7/8 | DL92 | 7/8 | EM85 | 10/6 | R19 | 11/6 |
| 1P1 | 8/- | 6D2 | 4/- | 16A5 | 5/8 | DL94 | 8/8 | EY31 | 7/8 | U26 | 9/6 |
| 1P10 | 7/8 | 6F12 | 4/- | 25A8G | 8/8 | DL96 | 8/- | EY81 | 10/- | U37 | 11/8 |
| 1P11 | 7/8 | 6H8GT | 8/- | 25L8GT | 7/8 | E891 | 4/- | EZ40 | 7/8 | U32 | 7/8 |
| 1R3 | 6/- | 6J7GT | 7/8 | 25Z4G | 9/- | EBC41 | 10/- | EZ80 | 8/6 | U78 | 7/6 |
| 1R5 | 6/- | 6K7G | 6/8 | 30C1 | 7/8 | E8F80 | 8/8 | EZ81 | 8/8 | U78 | 5/6 |
| 1T4 | 7/8 | 6K8G | 8/- | 30L1 | 7/8 | ECC81 | 6/- | HVR2 | 9/8 | UBC41 | 8/8 |
| 1U5 | 5/8 | 6K7J | 6/8 | 33L8GT | 9/- | ECC82 | 8/8 | KT33C | 6/- | UC142 | 9/6 |
| 3Q4 | 8/- | 6SLGT | 8/- | 33W4 | 8/8 | ECC83 | 6/8 | KT96 | 11/8 | UF41 | 8/8 |
| 3S4 | 7/8 | 6SN7GT | 8/- | 33Z4GT | 8/- | ECC84 | 7/8 | N17 | 7/8 | UL41 | 8/8 |
| 3V4 | 6/8 | 6V8G | 7/8 | 38K1 | 10/8 | ECC80 | 8/8 | N18 | 8/- | UY41 | 7/8 |
| 5U4G | 7/8 | 6X4 | 5/- | 5763 | 7/8 | ECP82 | 8/- | N19 | 7/8 | W76 | 5/6 |
| 6Y3GT | 5/- | 6Y6G | 9/- | 88 | 6/- | ECH43 | 9/- | N709 | 7/- | W142 | 8/6 |
| 6Z4G | 9/8 | 6X5GT | 8/- | DAF91 | 7/8 | ECH81 | 10/8 | PX84 | 7/8 | X17 | 7/8 |
| 6AK6 | 6/8 | 787 | 9/8 | DAF96 | 8/8 | ECL90 | 8/8 | PCF80 | 7/8 | X142 | 9/- |
| 6AL5 | 4/- | 8D3 | 4/- | DF91 | 8/- | ECL92 | 9/- | PCF82 | 7/8 | X150 | 9/- |
| 6AM6 | 4/- | 12AD6 | 11/8 | DF96 | 8/- | EP41 | 9/- | PCL82 | 8/- | Z77 | 4/- |
| 6AT6 | 6/- | 12A118 | 10/- | DH76 | 7/8 | EP80 | 8/- | PCL84 | 7/8 | ZD17 | 6/6 |

High Stability Resistors 1W 5% 50 Ω to 1M, 9d. Midget Ceramics 500 v. 9d. Coax. Super quality 1in., 8d. 5d. Plugs 9d. Sockets 9d. Siltcon H.T. Rects. 1R5, 1T4, 1R5, 884, or 8V4. Contact Cooled 250v. 50 MA 6/8, 85 MA 8/6.

VOLUME CONTROLS MIDGET SIZE LONG SPINDLES. D. P. switch 4/- Less switch 2/6. Values 10K to 2M, 1B9A 57G v. holders 9d., Screens 9d.

VALVES MATCHED IN PAIRS

EL84 17/-, N709 17/-, 8Y9G 17/-, 6BW6 18/- per pair. Push Pull O.P. Transformers for above 3-15 Ω 14/6, P. & P. 1/6. 12in. P.M. Speakers. 8 Ω 24/6. Baker's "Selhurst" 12in. 16 Ω 15W, 90/-, 12in. Stereo Model, 87.7.0.

SETS OF VALVES

DK91, DF91, DAF91, DL92 or DL84 ...18/8
DK96, DF96, DAF96, DL96 ...27/6
1C8, 1P1, 1FD1, 1P1 ...27/8
1R5, 1T4, 1R5, 884, or 8V4 ...19/8
Postage and packing 6d. Over £1 post free. C.O.D. 2/6.

RECONDITIONED TV SETS!

ALL MAKES ★ ALL FULLY SERVICED ★ ALL GUARANTEED ★ ALL GENUINE 13 CHANNEL SETS —NOT CONVERTED EARLY MODELS

14 Fully guaranteed 3 months, including valves and tube. **from £5 to £8.10.0**

Examples: G.E.C. 14" £5; McMICHAEL PORTABLE £8.10.

17 With 12 months guarantee on tube, and 3 months guarantee on valves and components. **from £11.10.0 to £19**

Examples: Philips 17" £11.10.0; Stella Semi-Slim £19.

The examples given above are only intended to act as a guide. All sets vary in price between the prices given according to the make and model. As our stock continually fluctuates please send S.A.E. for our price list of quality sets available.

BUY WITH CONFIDENCE!

Carriage and Insurance 25/- extra.

PARK LANE RADIO LTD.
548 ROMFORD ROAD, MANOR PARK, LONDON E.12.

Telephone: ILFord 6044

NEONS

in the Experimenter's Power Pack

A discussion of some factors of fundamental practical importance in the design of circuits using neon-tubes, leading to some simple but worthwhile further improvement to the "Experimenter's Power Pack" published in PRACTICAL WIRELESS, January 1962 etc.

By M. L. Michaelis

AFTER completing nearly 2,000 operating hours successfully, mostly non-stop for periods of over a week at a time, the author's prototype of the "Experimenter's Power Pack" was taken down for a routine inspection.

This inspection was carried out extremely thoroughly, as it was of great experimental interest to examine all effects of such prolonged non-stop usage. Thus not only were voltages and currents checked at every point of importance in the circuit, using a meter, but also all such points were tested for the slightest A.C.-components of voltages present, using an oscilloscope with a sensitive Y-deflection amplifier. This oscillographic investigation was primarily intended to test for possible deteriorations regarding hum-levels after such drastic long period usage. No drifts in this respect were found compared with the original values noted just after the original completion of the unit, but some other, most unexpected and mysterious effects were shown up on the oscilloscope, in that various A.C.-components of frequencies vastly different from the mains (anything from a few cycles per second, to many kc/s) were present, chiefly of good sawtooth waveform, often amplitude of frequency modulated at mains frequency or harmonics. These A.C.-components were present at the most varied points of the circuit, and their exact waveforms and frequencies depended greatly on the magnitude of loadings placed on the various outputs of the unit. They appeared and disappeared in an apparently haphazard manner, too, as the loadings at the outputs were changed.

Levels

All amplitudes were, however, invariably very small, seldom amounting to more than about 1% or 2% of the actual D.C. voltages present at the points concerned. Thus they were invariably of the same order of magnitude as hum levels to be expected in simple unstabilised power supplies of conventional design which is the reason why these peculiar oscillations here had not manifest themselves earlier as interference in apparatus fed from the unit, but were noticed only during the routine inspection. Nevertheless, they represent a definite "fault" to be diagnosed and cured, particularly as this unit, being a fully stabilised power supply, has very low intrinsic hum-levels.

Initial checks after completion of the original construction also included oscillographic checks,

and showed no such peculiar oscillations whatsoever in the final design at that time. These oscillations have thus definitely appeared some time during the long and continuous usage since.

Investigation

Being thoroughly puzzled as to the exact cause and method of cure for these oscillations, the author decided to extend what was originally supposed to be a routine check, in order to perform a detailed experimental investigation of these effects, with a view to understanding them and removing them. The cathode-ray oscilloscope and an electronic audio frequency meter proved invaluable tools for a successful conclusion of these experiments. Knowledge gained therefrom is considered to be of such fundamental practical importance that it has formed the basis of this article.

Some hours were spent in a systematic recording of all frequencies, waveforms and amplitudes observed at all important points, for systematic

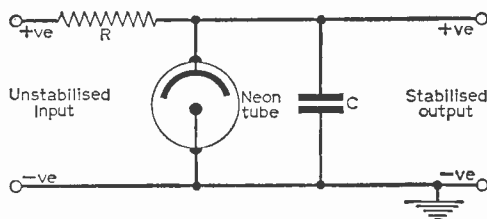

Fig. 1—Basic neon stabiliser circuit; a very steady voltage appears across C and the neon tube. This voltage is constant for large variations in the current drawn from the output. The neon is permanently struck and the current through it is always such that, when added to the output current, the correct voltage drop is given across R to keep the voltage across the neon (output voltage) constant.

variation of load-currents in steps at the outputs. With the tabulated results, circuit diagrams, valve data tables, etc. an interpretation was worked out and circuit modifications devised which thereupon ought to effect a full cure. Upon returning to the workshop and performing the small circuit-modifications devised, the cure was in fact immediate and complete. It was no longer possible to induce the slightest trace of low-amplitude oscillations under any circumstances within the normal ratings of the outputs.

Causes of the Instability

The causes of the peculiar instability were traced to be entirely due to the neon-tubes. Fig. 1 shows a conventional neon-stabiliser circuit, four of which appear in the 'Experimenter's Power Pack'. Fig. 2 shows a conventional neon-oscillator giving a sawtooth waveform output. It is at once seen that there is *absolutely no outwardly visible difference* between the two circuits. Yet the one is supposed to oscillate, and the other to stabilise (i.e. suppress oscillation—etc.)—two contradictory functions from

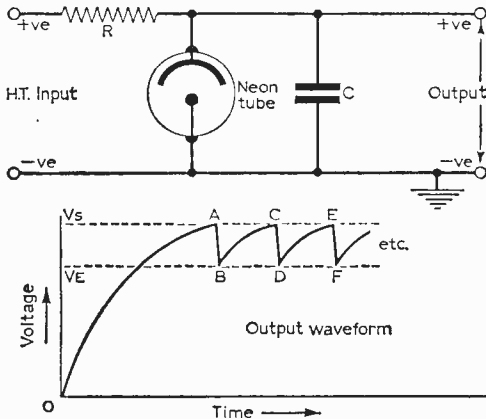

Fig. 2—Basic neon oscillator circuit with the output waveform. The circuit is apparently identical to Fig. 1, yet it is an oscillator with a sawtooth output instead of a stabiliser.

C charges through *R* until the striking voltage of the neon is reached at time *A*. The neon strikes, and *C* is rapidly discharged to the extinguishing voltage, which is reached at time *B* shortly after *A*. The neon is then extinguished, and *C* recharges slowly through *R* until at time *C* the striking voltage is reached once again. The cycle repeats *CDEF*, etc., and thus a sawtooth waveform appears at the output.

apparently identical circuit arrangements. That the same circuit in fact does perform both functions is an experimentally proved fact, and thus it is obvious that the precise operating conditions of voltage and current must determine which of the two opposing functions the circuit will actually perform. There will be a region of operating points promoting oscillation, and a region of operating points promoting stabilisation. The border-line between the two regions may be more or less ill-defined, giving rise to erratic behaviour partially oscillating and partially stabilising, which was clearly the case with the author's power supply. The fact that the main function in his case was still pretty good stabilisation, with only very small amplitude oscillation of erratic character, shows that his operating points lay within the "stabilisation region", but not far enough from its boundary to secure absolute stability. It was necessary to obtain a clear understanding of the factors which determine whether an operating point lies within the "oscillation" range or the "stabilisation" range, and subsequently to modify values of resistors to secure operating points further within the "stabilisation" ranges.

Negative Resistance

This magazine is of a practical nature, and does not wish to burden its readers with matters of theory. Nevertheless, small theoretical points must be dealt with briefly if these are necessary for a proper appreciation of practical matters, and thus no apology is needed for the following brief discussion of negative resistance.

The concept of negative resistance can be looked at in two ways. A greater current flowing through such a resistance causes less voltage drop instead of more voltage drop across it, i.e. it obeys Ohms Law in reverse. To drive a larger current through a negative resistance we need to *reduce* the voltage. The other way of looking at it is to say that current passing through a negative resistance does not consume power, but *generates* power. Now it is obvious that such a peculiar thing as a negative resistance, were it to be connected into a circuit containing otherwise normal components, could not settle down to a particular voltage and current value, as its own requirements for a relation between the two defy all the normal rules of electricity. Consequently, the voltages and currents must oscillate up and down continuously, in a futile attempt to find a stable operating point. The result is simply an oscillator circuit.

If a net resulting negative resistance is present in any circuit whatsoever, i.e. a negative resistance component in excess of that necessary to compensate the total normal positive resistance present in the circuit, *then the circuit always oscillates*, without exception. The converse is also true: if a circuit oscillates in any form whatsoever, then net negative resistance must be present in it, without exception. Oscillation and negative resistance never occur separate from one another. Consequently, if a circuit is unstable, we must seek the causes of a negative-resistance component, which is certain to be present. On the other hand, if we wish to cause a circuit to oscillate, we must take steps to create sufficient negative resistance in it, i.e. create a portion in its characteristic where either decreasing the voltage causes the current to increase, or where increasing the current causes decrease of power consumption (increase of power generation).

Examples

The conventional valve-oscillator using some form of reaction coil is the most familiar example. Here the grid-circuit is caused to go negative in its net resistance value, for the following reasons. If current increases in the grid circuit, greatly amplified power is fed back into the grid circuit from the anode circuit, via the reaction coil, so that the net consumption of power in the grid circuit is reduced, representing the conditions of negative resistance. In other forms of valve oscillators or their transistor equivalents the power-feedback to create negative resistance is via internal or external valve capacities, etc. Similar, though more involved, forms of reasoning are applicable to the various multivibrator types, etc. used in timebase circuits. All these oscillators are of the "externally produced" negative resistance type, i.e. the characteristics of negative resistance are created by using external influences to modify an otherwise normal, stable, positive resistance circuit element.

(To be continued)

COYNE'S NEW JOB TRAINING BOOKS

Put Money-Making Time Saving Know-how At Your Fingertips!

Just Like Having An Electronics Expert Right At Your Side!

Shows you the way to easier TV—Radio repair—time saving, practical working knowledge that helps you to repair sets faster! How to install, service and align ALL radio and TV sets, even colour-TV, UHF, FM and transistorized equipment! New photo-instruction shows you what makes equipment "tick." No complicated maths or theory—just practical facts you can put to use immediately right in the shop, or for ready reference at home. Look over the list. Select up to three books you wish to see. Send only ONE THIRD of the total purchase price (including postage) with order, then 20/- per month or 10/- each two weeks until books are paid for. Money refunded if not satisfied and books returned in clean condition within 7 days. Previous paid up customers need not send deposit—just write "previous account" on margin of coupon.

No. 1. SPECIAL OFFER COYNE ELEMENTARY PRACTICAL RADIO-TELEVISION SET OF THREE VOLUMES total 1,038 pages, sturdy Vinyl washable covers. £3 12s. 6d. the set!

These three volumes present the principles of construction, operation and testing of radio and television equipment in a SIMPLE, EASY TO FOLLOW manner.

One very important way in which these books differ from many other radio and television books is that the publishers did not try to assume the "extent of technical knowledge" of the reader. Every subject is explained COMPLETELY—while at the same time keeping it brief and to the point.

You will find hundreds of photos, charts, diagrams, etc., in these books. These have been provided to make it easier to understand the explanations.

No. 2. COYNE TELEVISION SERVICING CYCLOPEDIA. Harold P. Manly. Quick and concise answers to TV problems in alphabetical order, cross indexed, fully illustrated, covers hundreds of questions involving radio TV, electronics operation and repair. 450 illustrations; photos, diagrams, charts, test patterns, etc., 860 pages. Washable Vinyl cloth covers. Price 47/6

No. 19. REFRIGERATION SERVICE MANUAL. H. P. Manly. Learn Refrigeration! This manual is a course in itself. Packed solid with information to enable you to do that repair job yourself. Used by many leading refrigeration firms as a standard reference. Features 864 pages together with 157 illustrations bound in cloth. An excellent buy at only 24/- plus postage.

No. 8. PIN POINT TV TROUBLES IN 10 MINUTES. Your most useful on-the-job "tool"! Quickly and easily pin-points the exact trouble in any TV set. Covers 70 symptoms, 700 trouble spots. Over 340 cross-indexed pages; 50 time-saving Check-Charts; 290 diagrams and photos; explanation of circuits and designs. Thousands already sold. This is a must for every TV enthusiast. Only 31/6.

No. 7. TRANSISTOR CIRCUIT HANDBOOK. Louis E. Garner, Jr. A practical Transistor Circuit Reference Handbook by the eminently qualified Louis E. Garner, Jr., one of the greatest writers on transistor applications. Dozens of how-to-do-it illustrations with more than 200 circuit diagrams. Over 400 pages. Washable Vinyl cloth covers. Price 47/6.



Free Trial Offer!

No. 4. LATEST INSTRUMENTS FOR SERVICING RADIO AND TELEVISION.

This up-to-the minute book tells all about modern radio, TV and electrical testing equipment and how to use it. Money-making short cuts on trouble-shooting, servicing, construction, and other jobs. Over 350 pages, 220 photos and diagrams. All data has been pre-tested in the Coyne radio shops. Washable Vinyl cloth covers. 26/-.

No. 5. PRACTICAL TELEVISION SERVICING AND TROUBLE SHOOTING MANUAL.

A book of fast time saving methods for servicing TV receivers. Includes dozens of new testing ideas all of which have been proven on the job. Contents include TV Servicing methods, TV Servicing Instruments, Tuners, Video I.F., Amplifiers, alignment, etc., with 200 crystal clear photos and diagrams. 437 pages. Washable vinyl cloth covers. Price 34/-.

No. 9. PIN POINT TRANSISTOR TROUBLES IN 12 MINUTES.

Trouble-shoot every type of circuit in ALL transistorized equipment! 325 pages; hundreds of illustrations; 120 check charts. 47/6.

No. 39. SIMTECH RADIO & ELECTRONICS BASIC COURSE. 36/-.

POST COUPON NOW FOR SPECIAL OFFER WITH MONEY BACK GUARANTEE

To **SIM-TECH BOOK COMPANY (U.K.)**
Mail Order Division, DEPT. PW21, Gaters Mill, West-End, Southampton, Hants.

- SEND (Insert Book number here) () () ()
- Tick here if enclosing full price, we pay postage. Same 7 day money-back guarantee.
- ENCLOSED please find ONE-THIRD purchase price amounting to £ : s. d. with order. I agree to remit the balance as per offer.

NAME

ADDRESS

CITY..... County.....

Postage charges: Orders under £3 allow 1/6. Over £3 allow 2/- extra.

NEW REPANCO TRANSISTOR COMPONENTS

- Push Pull Driver Transformer Type TT45, 5/-
- Push Pull Output Transformer Type TT46, 5/-
- Interstage Transformer Type TT49, 5/-
- Dual Range Ferrite Aerial Type FR2, 12/6
- 2.5 millihenry Choke Type CHI 2/6

Radio Experimental Products Ltd.
33 MUCH PARK STREET, COVENTRY

SURPLUS RADIO SUPPLIES

2 LAING'S CORNER MITCHAM, SURREY

SEND TODAY FOR OUR CATALOGUE

400 BARGAINS

At prices below manufacturing cost. Price 2/6, post free. 2/- refunded on first order of 10/- or over.

F.M. Kit, consisting of 1 Discriminator, 2 I.F.'s, 1 F.M. Gang, 2 grade 1 Diodes. Price 12/6. Post Free.

4-TRANSISTOR POCKET RADIO

WITH MOVING COIL SPEAKER
NO SOLDERING

NO DRILLING NO AERIAL REQUIRED



4 Transistors and 2 diodes; 5-stage reflex circuit; push-pull output; size 5 1/2 x 3 x 1 1/2 in.; full medium wave; simple instructions and assembly tool provided.

85/- Plus battery 2/3 extra. Postage and packing 2/9. All parts sold separately

or the SAVOY SUPER-3 with 3 transistors and 2 diodes, - 49/6 Battery 1/- Size 4 1/2 x 2 1/2 x 1 1/2 P & p 2/-

SAVOY ELECTRONICS LTD.
15 Maiden Lane, Strand, London, W.C.2 (Back of Adelphi Theatre)

RECEIVERS & COMPONENTS

SPEAKER REPAIRS. Cones/Fields fitted. Clock Coils Wound. L. S. REPAIRS, Pluckley, Ashford. Kent.

NEW AND SURPLUS Valves, guaranteed, from 3/6. Also reclaimed Valves, perfect, from 1/6. Many bargains. S.A.E. for complete list. LEWIS, 46 Woodford Avenue, Ilford, Essex.

BRAND NEW MEDIUM WAVE BROADCAST RECEIVERS

200-540 meters. In brown wooden cabinet with glass covered dial, 8in. speaker. Valves 6K8, 1F, 6K7, 6Q7, 6V6, complete with circuit and vibrator pack to run off 6 volts. Size approx. 1ft. 10in. x 1ft. x 1ft. Brand New in waterproof sealed cartons. £4.10.0. Carr. 7/6.

R107 RECEIVERS

New, but have been loose stored, very good throughout, every one checked to highest standards. 1.2-17.5 Mc/s in 3 ranges, 3 kc/s or 7.5 kc/s bandwidth, 9 valve superhet, sensitivity 2-6µV. Power 100-250V A.C., or 12V D.C. £15.10.0. Carr. 30/-, or 1st Class used sets £12.10.0. Carr. 30/-.

J. T. SUPPLY

309 MEANWOOD ROAD, LEEDS 7

"HEATHKITS" can now be seen in London and purchased on easy terms. Free brochure. DIRECT TV REPLACEMENTS LTD., Dept. PW 7/5, 138 Lewisham Way, SE14. Tideway 6666

COMPONENTS, VALVES Tubes, etc. Write or phone for free list. ARION TELEVISION, 4 Maxted Road, Peckham, SE15 (New X 7152).

ANY KIT built and tested: Radios, Amplifiers, Test Gear, etc. Good workmanship, prompt return. Send details of kit and S.A.E. for quotation. Ready built: Good Companion £11/15/-, and Pocket Companion £8/19/6. R. J. DYMOKE, 16 Haycroft Road, Stevenage, Herts.

VALVES 9d.

6AL5, 6AM6, 6D2, 6F12, 6F13, 6F14, 6F15, 8D3, 9D2, 15D23, 78, D1, D77, D152, DD6, EB91, EF50, EF91, P61, P624, UB41, UF42, VR35, VR51, VR107, VR137, VR201, Z77.

More at 9d., 1/9, 2/9 and 5/9. Post 1-9d., 6-1/6. Speakers 8/9, 6in.-8in. and 7in. x 4in. Salvage. Post 2/9. Many items in stock. Stamp for free list. P.P. COMPONENTS LTD., - 623 Romford Road, Manor Park, London E12.

TRANSISTOR SETS. OC44, 2OC45, OC81D, 2OC81 35/6. OC44 9/-, OC45 8/6, OC71 6/3, XA102 9/-, XA101 8/6, XB103 6/3. Red Spot 3/6. White Spot 4/-. Diodes General 1/-. OA79 3/-. OA70 3/-. OA71 2/9, OA81 2/9. GEX34 2/9. Bar pieces complete with plugs and jacks 100, 250 and high Z 7/9 each. Min Caps. 1 to 32 MFD. 1/9 each, p. and p. paid by CHAPPEL RADIO, 107 Neasden Lane, NW10.

RATES: 6/6 per line or part thereof, average five words to line, minimum 2 lines. Box No. 1/- extra. Advertisements must be prepaid and addressed to Advertisement Manager, "Practical Wireless," Tower House, Southampton St., London W.C.2.

RECEIVERS & COMPONENTS (continued)

TO BE CLEARED

New wire ended electrolytic condensers. 25 for 3/6. Post Free.

Transistors—Mullard OC44, 6/6; OC45 5/-; OC71 (TS1) 4/3; AX116 (1F or LF) 5/6; TS17 (OC72) 6/-; and GEC types (A.F.), (R.F.) and (output) 3/6 each. Diodes, top quality 1/- each. Post 6d.

Sound Vision, 137 Moulsham St., Chelmsford.

A.1. POST FREE BARGAINS. First grade transistors. OC44 9/-. OC45 7/9. OC70 OC71 5/6. OC72 OC78 OC81 7/-. OC170 12/6. OC171 12/9. OA70 OA79 OA81 2/9. OA91 OA95 3/-. Reclaimed valves. 8D2, 6F13, 6F14, 6F15, 6F12, 8D3, EB91, EA50, EF80, EF91, EF50, D77, D152, L63, Z77, Z152, Z719 1/3; 6P1, 6P25, 6P28, 10D1, B36, U31 2/-; 6AB8, 10F1, 10P13, 20D1, 6P18, ECL80, LN152, PL33 3/3; 19Y3, 20F2, 20L1, PY81, U154, PZ30 4/6. Postal dry battery service.—A.1. Radio Components, 14 The Borough, Canterbury, Kent.

"WEYRAD" TRANSISTOR RECEIVER

Long and Medium Wave, P.P. Output, all components available. Total cost £8.0.0. Cabinet to suit, 17/6. Constructor's booklet, 1/4.

"P.W." CITIZEN

Ferrite Rod Aerial RA2W and Coupling Coil. P.50/1AC, P.50/2CC, P.50/3CC.

"Weyrad" 1 Watt or 500 mW Amplifier to suit "Citizen" (As Kit or Assembled). Send S.A.E. for shopping lists.

R.A. 35 ohm Speakers. 5K Pots, Jackson Type '00' Tuning Gangs.

WESTHAM RADIO SUPPLIES

Rear of 176 Abbotsbury Road, Weymouth, Dorset.

RADIO KITS BUILT, quotations free. Ready built Capri. £9. Osborn "P.W." 6. £9/10/-; Good Companions from £11/18/6; Contessa, £12/10/-. Lists —tools, books, etc.—M COLTON, 21 Maplewood Drive, Blackpool.

TRANSFORMERS

L Output F R A M E N Oscillator Scan Coils E

ALBA: T801, T304, T394, T484, T494, etc. 44/6
 BUSH: TV11A, 11B, 12A, 12B, TVG12A, 12B, TRG12A, 12B 44/-
 TVG28, TV32, TV33, TVG34, TVG34A, T36, TV36, TVG36, TV36C, TVG36C, TV43 88/6
 TV53, TV56, TV57, TVG58, TV62, TV63, TV67, etc. 94/-
 TV80 with EV51 100/-
 COSCOR: 930 and T931, 933-4-5, 937, 938A, and F, 939 and A and F 61/6
 943T, 940-946, 945, 945B 58/6
 954F, 947, 949 63/6
 DECCA: D17 and C 68/6
 DM1, DM2C, DM3, DM4 74/-
 DM5, DM14, DM17, 444, 555 74/-
 D-FLIANT: TR1453, TR1753 58/6

DYNATRON:
 EKCO: T893, TC8102, TS105, TS114, TR124, TC138, TS188, TS193 54/-
 TR139, TC140, T141, TV142 78/6
 T161, TC162, T164, T166, etc. 78/6
 TV206, TV209, T231, T251, T231P, T248, T288, T284, T293, etc. 58/6

FERGUSON: 107, 105T, 113T, 135T, 145T 58/6
 941T-953T inclusive 58/6
 991T-997T inclusive 68/6
 997T-248T inclusive 68/6
 300T, 308T 64/-

FRERRANT: 14T3, 14T3F, 13T4 47/6
 17K3 and F, 17T3 and F 47/6
 17K4 and F, 178K4 and F 47/6
 17T4 and F 47/6
 14T5, 178K5, 17K5 47/6

G.E.C.: BT1251, BT1252, BT1746, BT1746, BT4743 48/6
 BT4643, BT5147, BT5246-48 88/6
 BT8348-BT6643R inclusive 48/6

H.M.V.: 1821 and A to 1831 inclusive 88/6
 1840, 1841, 1842-1843 68/6
 All models available. and

INVICITA: T118, T119, T120 54/-
 All other models available.

K.B.: LFT50, LFT50, LFT50, MV60 108/6
 All models available.

MARCONI: All models available.
MASTERADIO: Most models in stock.

METHEL: Most models in stock.
MURPHY: P.200, V202C 58/6
 V240, V250 94/-

PETO SCOTT, PHILCO: Most models in stock.
PAM: 905, 909, 952, 953, 958 54/-
PHILIPS: 1768U, 2168U 104/-
 1100V, 1200V, 1250V 74/-
 1291U, 1296V, 1298V 74/-
 1141UP, 114UM, 115U 74/-
 1437U, 1446U 74/-

Most models in stock.
PILOT: Most models in stock.
PYE: CTM4, FV46, FV46C 54/-
 V4, VT4, V7, V17 54/-
 LV30, FV1, FV1C 68/6
 CV17F, CTM17F, CW17 68/6
 CV17C, CW17C, CW17P, etc. 68/6

Most models in stock.
RAYMOND: Most models in stock.
REGENTONE: All models available.
 R.G.D.: 6017T, 7017, C54, etc. 58/6

Most models in stock.
SOBEL: TS17, T546 64/-
Most models in stock.

STELLA: ST5721U 104/-
 ST5817U, ST5821U 104/-
 ST4917U 104/-
 ST6414U, ST6417U 74/-
 ST6419U 74/-

ULTRA: 86 series, 815 series, with U25, etc. complete 78/6
Most models in stock.

VIDOR: CN4217-CN4231 inclusive 64/-
 Post and Packing 3/6

Also: Used O.P. Tx's, Scan Coils, etc.
ALL GUARANTEED 90 DAYS
 (All enquiries S.A.E.)

Write for SAME DAY DISPATCH to
MARLEY SUPPLIES
 21 Pittlake, Croydon, Surrey

Croydon SN00
 And at 2 Wellfield Road, S.W.16 (near Streatham Library)

BRIAN E. HAMPSHEIR (R & T) LTD.

Dept. PWA 23 NORTHCROSS ROAD S.E.22.

6F13 EF80 EF91 6P25 10F1 Z77 ECL80
 EB91 6P28 6F1 EF50 L63 6F12 25L6GT

GUARANTEED 100% ALL AT ONE PRICE

£1 for 10, p. & p. FREE

RECEIVERS & COMPONENTS

(continued)

KINGSLAND

ELECTRONIC COMPONENTS

Stupendous Offers

5in. Speaker, new. 3 ohms, 15/9. High gain Transistors and Ferrite Aerials 3/9 each. Diodes, 1/9. All with circuits. XA116 Transistors. Ideal I.F. amp. 455 kc/s. or L.F. driver gain 12.5, 5/6 each.

New, lightweight Headphones, 2000 ohms. General use, adjustable ready for use, 14/6. Driver and Output Transformers, sub-miniature, 10/6 pair. Volume controls, edgewise movement with switch 5K, 20K, 1 meg., miniature, 8/6 each.

Earpieces, crystal, 9/6. Magnetic, 9/-, complete with sub-miniature Jack and Socket or Jack and Socket, only 3/9.

P.W. Pocket 6 Transistor Kit. Complete with printed circuit board, transistors and speaker. Osrom designed kit and full instructions, all parts guaranteed new. This is the kit for the Ambitious constructor, £9.10.0.

Try our surprise pack of accessories, if not satisfied return within seven days and money will be refunded, 7/6, p. & p. 2/6. 6 assorted voltage droppers, 6/-, p. & p. 1/6. 100 assorted condensers, 6/-, p. & p. 1/6. 6 volt or 12 volt vibrators, 3/6 each p. & p. 1/6. Mike and pick-up transformers ideal for baby alarms, 4/6, p. & p. 1/-.

6 assorted potentiometers, 5/-, p. & p. 1/9. 50 assorted resistances and condensers, 6 miniature valve holders, 2 bag strips, 40 separate contacts, each 4/9, p. & p. 1/9.

192 KINGSLAND RD., SHOREDITCH, E.2. Tel: SH0 6572. Sorry! U.K. only.

KITS BUILT. "Good Companion" from £11/15/-. R. E. RYCROFT, Spencer House, Fence, Burnley, Lancs.

CLEARANCE AMPLIFIER OFFERS

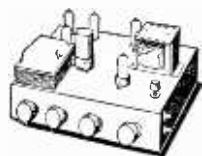

High Fidelity Push-Pull. 15 watt. Twin input. Very high sensitivity. Valves used ECC83, ECC83, EL84, EL84, EZ81. Negative feedback. Separate Bass and Treble Controls. 3 and 15 ohms outputs. £7.10.0. plus 7/6 carriage. Similar 35 watt, £10.10.0. plus 7/6 carriage. SEND FOR FREE LEAFLET

STROUD AUDIO

Bath Road, Stroud, Gloucester

FOR SALE

100 BAYS of brand new adjustable Steel Shelving, 73in. high by 34in. wide by 12in. deep. stove enamelled dark green. Sent unassembled. Six shelf bay £3'15/-. Sample delivered free. Quantity discounts. N. C. BROWN LTD., Eagle Steelworks, Heywood, Lancs. Tel.: 69018.

AMATEUR LICENCE Morse Records. The Rhythm Method of teaching Morse is the quickest and cheapest known. For full details and special beginners offer. S.A.E.: "MORSE-REC", 45 Green Lane, Purley, Surrey.

HIGH QUALITY R.C.A. Varacoustic Microphones, model L.M. 12203 (600/250/50 ohms). Reconditioned £10 each. Second-hand in working order £3 each. C.W.O. MOSS EMPIRES LTD., Sound Dept., Cranbourn Mansions, Cranbourn Street, London WC2.

DON'T READ THIS

unless you repair Radio and TV sets. Halve the cost of repairs by using our surplus or reclaimed Valves and Tubes. Most comprehensive selection at keenest prices. All valves re-tested before despatch and guaranteed to be in good working order.

| | | | | | |
|--------|------|-------|-----|-------|------|
| 2X2 | 4/6 | D77 | 2/- | PCL83 | 6/- |
| 6AB8 | 4/6 | DH77 | 4/6 | PL33 | 4/6 |
| 6AC7 | 4/6 | EB91 | 2/- | PL38 | 10/- |
| 6AL5 | 2/- | EB90 | 4/6 | PL81 | 4/6 |
| 6AM6 | 2/6 | EBF80 | 6/- | PL82 | 4/6 |
| 6BG6 | 12/6 | ECC81 | 3/- | PL83 | 4/6 |
| 6BL8 | 6/- | ECC82 | 4/6 | PL820 | 7/6 |
| 6BN6 | 3/- | ECC83 | 4/6 | PY31 | 4/6 |
| 6C9 | 6/- | ECC85 | 6/6 | PY32 | 7/6 |
| 6CD6 | 17/6 | ECC88 | 6/- | PY80 | 4/6 |
| 6CJ6 | 4/6 | ECP80 | 6/- | PY82 | 4/6 |
| 6CJ6 | 4/6 | ECP82 | 6/- | PY82 | 4/6 |
| 6F1 | 2/- | ECL80 | 4/6 | PY83 | 4/6 |
| 6F12 | 2/- | EF50 | 2/- | PZ30 | 6/- |
| 6F13 | 4/6 | EF54 | 4/6 | SP41 | 2/- |
| 6F14 | 4/6 | EF80 | 3/- | SP61 | 2/- |
| 6F15 | 4/6 | EF91 | 2/6 | ST61 | 4/6 |
| 6F93 | 4/6 | EL38 | 6/- | R19 | 10/- |
| 6K25 | 7/6 | EL42 | 7/6 | TH41 | 10/- |
| 6L1 | 6/- | EL81 | 4/6 | T41 | 4/6 |
| 6L18 | 7/6 | EL821 | 6/6 | U22 | 4/6 |
| 6L19 | 7/6 | EN31 | 4/6 | U24 | 10/- |
| 6LD20 | 6/- | EY35 | 4/6 | U25 | 10/- |
| 6P28 | 6/- | LY81 | 4/6 | U31 | 4/6 |
| 6N8 | 6/- | EY86 | 7/6 | U33 | 7/6 |
| 6U4 | 6/- | HVR1 | 5/- | U35 | 4/6 |
| 6U4 | 6/- | HVR2 | 5/- | U37 | 12/6 |
| 10F1 | 4/6 | KT36 | 4/6 | U132 | 4/6 |
| 10LD11 | 6/- | KT36 | 6/- | U153 | 4/6 |
| 10P13 | 6/- | KT45 | 5/- | U191 | 10/- |
| 10P14 | 6/- | KT45 | 5/- | U281 | 6/- |
| 12BH7 | 7/6 | LN152 | 4/6 | U282 | 10/- |
| 12BY7 | 7/6 | LN309 | 6/- | U301 | 10/- |
| 20P2 | 6/- | LZ319 | 4/6 | U319 | 4/6 |
| 20L1 | 6/- | N37 | 6/- | U403 | 6/6 |
| 20P1 | 6/- | N142 | 4/6 | U404 | 4/6 |
| 20P3 | 7/6 | N152 | 4/6 | U801 | 15/- |
| 20P4 | 12/6 | N153 | 4/6 | UB41 | 2/- |
| 20P5 | 7/6 | N154 | 4/6 | UF42 | 3/- |
| 27SU | 12/6 | N309 | 4/6 | UL41 | 4/6 |
| 30C1 | 4/6 | N329 | 4/6 | UL44 | 4/6 |
| 30P5 | 4/6 | N393 | 4/6 | UL83 | 4/6 |
| 30FL1 | 6/- | P41 | 4/6 | U8 | 10/- |
| 30L1 | 4/6 | P61 | 4/6 | UY41 | 4/6 |
| 30L12 | 6/- | PCC84 | 4/6 | Z66 | 6/- |
| 30PL1 | 7/6 | PCC80 | 4/6 | Z77 | 2/- |
| 61B1 | 10/- | PCL82 | 6/- | Z142 | 3/- |
| 61SPT | 7/6 | PCL82 | 4/6 | Z152 | 3/- |

Most pre-war 4, 5, 7, 8 and 9 pin valves. British, American, Continental, 5/- each. Postage and packing (all valves) 6d. each. Orders over £1.0.0 post free.

NEW TRANSISTORS. Red spot 2/6. OC45, OC72, OC76 7/6. OC201 (silicon) 17/6. 5PK5 5in. 5/-, 7 pin 4in. 7/6. P. & P. 2/-.

LANE O. Tr. from 20/- many types. **CONSTRUCTOR'S PARCEL.** 2 lbs. assorted parts from TV sets. Resistors, condensers, potentiometers, electrolytics, valve holders, 7/6. P. & P. 2/6.

VALVE PARCEL. 12 valves all different as taken out of TVs. Ideal for spares, testing, etc. 8/6. Postage 1/6.

Please send S.A.E. for Free List of 1000 Valves and Terms of Business. All letters S.A.E. please.

"St. John's Radio." Mail Order Dept., 3 Jews Row, London S.W.18. Phone: VAN 8622

"LITON" PHOTOELECTRIC CONSTRUCTION MANUAL

10 Interesting PHOTOELECTRIC PROJECTS, fully described with building plans and circuit diagrams which can be easily made by amateurs from standard components. Hints on the use of photocells and phototransistors. A mine of practical information for the experimenter. All units available, ready built or in kit form.

1. Battery burglar alarm. Kit 65/-.
2. Mains burglar alarm.
3. Light savor.
4. Customer announcer.
5. Simple garage door opener.
6. Photoelectric counter.

Price (2-6) Kit £4.12.6. Built £5.10.0. 7. Long range infra-red mains alarm.

8. "MIRA." Miniature infra-red battery alarm. Total consumption 0.2 watt.

9. Motorised garage door opener.

10. Door opener with electronic lock.

Units are interesting in electronics and electro-mechanical gadgets send 1/- stamp for this 24-page, profoundly illustrated publication to:

"ST. JOHN'S RADIO," 3 Jews Row, London SW18. Phone: VAN 8622

FOR SALE

(continued)

ASK your dealer for American Ferro-dynamics. "Brand Five" Recording Tapes—the best tape value!

POWER SUPPLY UNIT. 200-230-250V A.C. input 12-24-36V D.C. 2 amp. smoothed output, suitable for transistor equipments. £8/15/-. Enquiries to IRVING & DICKINS, 29 Lyncroft Gardens, London, N.W.6.

WANTED

WANTED New valves and transistors any quantity. S. N. WILLETS, 43 Spon Lane, West Bromwich, Staffs. Tel.: WES 2392.

NEW VALVES bought, state price. A.D.A. MANUFACTURING CO., 172 Aldreton Road, Nottingham.

A PROMPT CASH OFFER for your Surplus Brand New Valves and Transistors. R.H.S. Beverley House, Manville Terrace, Bradford 7.

WANTED. TEST GEAR. Meters, Valves, Components, Communication sets, Amplifiers. HUGGETS LTD., 2-4 Pawnsons Road, West Croydon, Surrey.

WANTED! New valves and transistors any quantity. Phone: Cherrywood 3955. D & B Television, 131 & 131a Kingston Road, South Wimbledon, S.W.19.

WANTED: Command Receiver BC453 (190-550kcs).—Organ, 170 Henleaze Rd. Bristol.

NEW VALVES WANTED

Any type, any quantity

CASH PAID

R.S.T. 211 Streatham Road, Mitcham, Surrey.

Telephone: MITCHAM 6201

SOUND RECORDINGS

RECORDING TAPE. save up to 30% send for list; also 50 second-hand recorders in stock. E. C. KINGSLAY & CO., 132 Tottenham Court Road, London W1. EUS 6500.

MISCELLANEOUS

TRANSISTOR KITS wired, tested, repaired.—Box 36.

ELECTRONIC MUSIC ?

Then how about making yourself an electric organ? Constructional data available—full circuits, drawings and notes. It has 5 octaves, 2 manuals and pedals with 24 stops—uses 41 valves. With its variable attack you can play Classics and Swing.

Write NOW for free leaflet and further details to C. & S., 20 Maude Street, Darlington, Durham. Send 2d. stamp.

PUBLIC APPOINTMENTS

AIR MINISTRY require Examiners in the Radio and Electrical Instruments trades at Henlow, Stafford, Sealand (nr Chester), Carlisle and various units mainly in West of England. Duties include inspection and testing of R.A.F. Wireless, Radar and Electrical equipment. Qualifications: Full apprenticeship or equiv. training plus ONC (elect.) or C & G Telecoms plus Radio II or equiv. quals. Appointments will be unestablished but opportunities for permanent (pensionable) posts likely to arise. Salary on scale £749-£988; starting pay age 28 or over £884; under 28, according to age. Opportunities for promotion to higher posts with maximum salary of £1,747. Application forms and further details from Air Ministry, C.E.3f, London, W.C.1., or enquire at any Employment Exchange quoting City O/N 333.

SITUATIONS VACANT

RADIO MECHANIC required for work on transistor kits. Good wages and prospects for capable person. Savoy Electronics Ltd. 15 Maiden Lane, Strand, WC2. Phone: TEM 5484.



FIELD ENGINEERS FOR ELECTRONIC DATA PROCESSING EQUIPMENT

There are attractive vacancies in our Field Engineering Section for electronic engineers to maintain (after training) I.C.T. Electronic Calculators and Computers installed in the Greater London area.

Applicants should be aged from 24 to 32 and possess the following:

Experience in the maintenance and repair of pulse technique equipment either in industry or H.M. Forces; ability to handle bench tools and instruments, and an appreciation of the effects of electrical and electronic circuits on complex mechanisms.

Qualifications: National Certificate (Electrical) or, at least, coverage of Section B of the City and Guilds Certificate in telecommunications.

Applications from men with experience of radar equipment in H.M. Forces will be welcomed.

These are permanent salaried positions which offer real scope for advancement. Retirement and sick pay schemes are excellent and holiday entitlements extend to three weeks after five years service.

If you are interested in a career as a Field Engineer with I.C.T. write (quoting reference PW/FE/3) to:

**Assistant Manager,
Field Engineering Staff Group,
I.C.T. Computer Centre,
Putney Bridge Approach,
London S.W.6.**

SITUATIONS VACANT

(continued)

ENGINEERS REQUIRED, experienced in audio techniques and relay circuitry for work on public address systems. Also VHF test engineer for television equipment. Write giving details to: CLARKE & SMITH MFG. CO. LTD., Hanworth Air Park, Feltham, Middlesex.

TV AND RADIO, A.M.Brit.I.R.E., City and Guilds, R.T.E.B. Cert., etc. on "No pass—no fee" terms. Over 95% successes. For details of exams and courses (including practical apparatus) in all branches of Radio TV and Electronics, write for 148-page handbook, free B.I.E.T. (Dept. 243G) 29 Wright's Lane, London W8.

**UNITED KINGDOM
ATOMIC ENERGY AUTHORITY
ATOMIC ENERGY
ESTABLISHMENT, WINFRITH**

ELECTRONIC/INSTRUMENT MECHANICS

A.E.E. Winfrith require experienced men with knowledge of electronic equipment and/or industrial instrumentation for fault diagnosis, repair and calibration of a wide range of instruments used in nuclear reactors and associated experiments.

Men with Services, Industrial or Commercial background of radar, radio, Television, industrial or aircraft instruments are invited to write for further information. Training in Specialised Techniques is provided for successful applicants having suitable background.

Married men living beyond daily travelling distance may be eligible for housing and this will be determined at time of interview. A lodging allowance is payable whilst waiting for housing. Working conditions are good and include sick pay and pension schemes.

An application form may be obtained by sending a post card quoting your name, address and the reference EL/INST/SK to the Labour Department, A.E.E. Winfrith, Nr. Dorchester, Dorset.

A.M.I.Mech.E., A.M.Brit.I.R.E., City and Guilds, G.C.E., etc., brings high pay and security. "No pass—no pay" terms. Over 95% successes. For details of exams and courses in all branches of Engineering, Building, Electronics, etc., write for 148-page handbook, free B.I.E.T. (Dept. 242B) London W8.

CITY AND GUILDS (Electrical, etc.) on "No pass—no fee" terms. Over 95% successes. For details of Electrical, Engineering, Applied Electronics, Automation, etc., send for our 148-page handbook, free and post free. B.I.E.T. (Dept. 242A), 29 Wright's Lane, London W8.

EDUCATIONAL

LEARN RADIO AND ELECTRONICS the new and practical way! Hosts of absorbing experiments carried out at home under expert guidance to teach you Radio in a new, enjoyable and interesting way. Construction, servicing and faultfinding on equipment made easy for the first time! No previous experience needed. No mathematics used. Free brochure from: Dept. 11, P.W. RADIO-STRUCTOR, Reading.

EDUCATIONAL

(continued)

**Radio
Television
& Electronics**

Learn at home with the world's largest home study organisation, Brit.I.R.E.; City & Guilds; R.T.E.B., etc. Also Practical Courses with equipment. No books to buy.

Write for **FREE** prospectus stating subject to

I.C.S.

(Dept. 541), Intertext House, Parkgate Road, London, S.W.11

The Incorporated Practitioners in Radio and Electronics (I.P.R.E.) Ltd. Membership Conditions booklet 1/- Sample copy of I.P.R.E. Official Journal, 2/- post free. Secretary, 20 Fairfield Road, London N8.

$$X = \frac{-b \pm \sqrt{b^2 - 4ac}}{2a}$$

DON'T FUMBLE with Formulae. Master Mathematics quickly and easily the Understandable Way.



The Dryden School of UNDERSTANDABLE MATHEMATICS
 1166 Dryden Chambers, Oxford St. London, W.1.

Name _____
 Address _____

WIRELESS. See the world as a Radio Officer in the Merchant Navy; short training period; low fees; scholarships, etc. available. Boarding and Day students. Stamp for prospectus. WIRELESS COLLEGE, Ceiwyn Bay.

ELECTRONICS

Key to YOUR future? An exciting career - A new Hobby - Your own spare or full-time BUSINESS!



New experimental course includes big kits for building test gear and a complete AM/VHF receiver.

FREE brochure from **RADIOSTRUCTOR** DEPT. E77, READING, BERKS.

EDUCATIONAL (continued)

"HOW AND WHY" of Radio and Electronics made easy by a new, non-maths, practical way. Postal instruction based on host of experiments and equipment building carried out at home. New courses bring enjoyment as well as knowledge of this fascinating subject. Free brochure from: Dept. P.W. 12, RADIOSTRUCTOR, Reading.

SERVICE SHEETS

SERVICE SHEETS, Radio, TV, 5,000 models. List 1/-. S.A.E. enquiries: TELRAY, 11 Maudland Bk., Preston.

SERVICE SHEETS; also Current and Obsolete Valves for sale. — JOHN GILBERT RADIO, 20 Extension, Shephard's Bush Market, London W12. (Phone: SHE 3052).

SERVICE SHEETS for all makes of radio and TV, 1930-1962. Prices from 1/- with free fault-finding guide. Catalogue of 6,000 models 1/6-125 Radio/TV sheets covering 370 popular models 20/-. S.A.E. enquiries HAMILTON RADIO, Western Road, St. Leonards, Sussex.

WHY TOLERATE DELAY when we can supply your Radio or TV Service Sheet by return of post at 4/- each, plus postage. List 1/-. Also Manuals for sale and hire. List 1/-. S.A.E. with inquiries, please. Mail orders only to S.P. DISTRIBUTORS, 44 Old Bond Street, London, W.1.

FAULTFINDER FILES, showing common faults that each receiver is prone to and other useful servicing information, 2/- each. List 9d., plus postage. Mail orders only. S.P. DISTRIBUTORS, 44 Old Bond Street, London, W1.

SERVICE SHEETS, Radio and TV, 4/- each. List 1/-. All orders dispatched on day received. Also manuals for sale and hire. List 1/-. S.A.E. please. SULTAN RADIO, Pantiles Chambers, Tunbridge Wells, Kent.

CIRCUIT INFORMATION

18 SET TRANSMITTER RECEIVER
Description, Operation, Values, Diagrams, Tests etc. P.O. 5/-.
38 SET WALKIE TALKIE

Alignment procedure, Faults, Components, Description, Diagrams etc. P.O. 5/-.
CAMPBELL

Everland Road, Hungerford, Berks.

BOOKS & PUBLICATIONS

FIND TV SET TROUBLES IN MINUTES from the great book "The Principles of TV Receiver Servicing", 10/6 all bookhouses and radio wholesalers. If not in stock, from Secretary, I.P.R.E., 20 Fairfield Road, London N8.

METAL WORK

METALWORK. All types cabinets, chassis, racks, etc., to your specifications. PHILPOTT'S Metalworks Ltd., Chapman St., Loughborough.

RADIO CLEARANCE LTD.

The oldest Component Specialists in the Trade
27 TOTTENHAM COURT, ROAD LONDON, W.1.

Telephone: MUSHUM 5188

TRADE ENQUIRIES INVITED

EST. 30 YRS.

IN THE HOME, IN THE CAR, BY THE SEA, IN FIELDS AFAR, THE

"CONTESSA" IS VOTED BEST OF ALL

A really remarkable 2-Band 6-Transistor Superhet Radio—25,000 satisfied customers and still in huge demand.

The Contessa is the professional looking set with the professional performance.

Study these brilliant features which cannot be found in any other Radio—

- Waveband coverage of 530 kc/s to 1,620 kc/s and 160 kc/s to 270 kc/s.
- Assured reception of at least a dozen stations in daylight!
- Large clearly-calibrated station-named dial.
- Internal high-gain ferrite aerial.
- 5:1 ratio slow motion tuning.
- Fitted with the latest 12,000-line high flux loudspeaker.
- Power of 40 milliwatts from the single-ended push-pull final stage.
- Specially designed aerial matching coil for use in a CAR.
- Only first-grade fully guaranteed matched transistors and diodes are used.
- Double tuned IF transformers for maximum gain and knife-edged selectivity.
- Fully drilled printed circuit panel marked with component numbers.
- The two-colour case measures 10 x 7 1/4 x 3 1/2 in. and weighs approx. 4 lbs. when assembled.
- Battery lasts 6 months with normal usage.
- Book supplied with detailed assembly instructions, diagrams and circuitry.
- Anyone can build this set—everything supplied just a soldering iron required.

Inclusive price for all associated components, cabinet and battery, complete in every detail, or our BUY AS YOU BUILD SCHEME, any parts sold separately. Send for comprehensive descriptive Manual and Parts List, 3/6 post free Plus 3/6 P. & Pk.

£10.19.6

You can hold Europe in the palm
of your hand with—

THE "CAPRI"

A MINIATURE pocket transistor Radio that REALLY works, retaining the most attractive features of the famous "Contessa". SIX first-grade Mullard transistors and diode are employed in a highly sensitive superhet MV and preset LW circuit embodying the most modern design practice. A special 2 1/2 in. high gauss loudspeaker provides surprising volume and a personal earpiece socket is also available. An attractive two-tone pl. stic case is supplied in two colours, Ivory/Red or Ivory/Blue, the full constructional details being given with each set of parts. The total MEASUREMENTS of the "Capri" are 4 x 2 1/2 x 1 1/2 in.
SEE AND HEAR A WORKING MODEL TODAY

Inclusive price for all associated components, case and constructional data, complete in every detail or on our BUY AS YOU BUILD SCHEME. ANY PARTS SOLD SEPARATELY. 9 v. battery 2/6 extrn.

£7.10.0

plus 2/- P. & Pkg.

STAMPED and ADDRESSED ENVELOPE with any enquiry please. But regret no lists or catalogues—our stocks move too quickly!

PLEASE ALLOW FULL POSTAGE AND PACKING CHARGES

Terms of Business:

CASH WITH ORDER OR C.O.D. ON ORDERS OVER 10/-.



THE WORD **MAXI-Q** IS THE REGISTERED
 TRADE MARK
 OF DENCO (CLACTON) LIMITED
 IT IS ALSO A GUARANTEE OF
 WORKMANSHIP & TECHNICAL PERFORMANCE

OUR RANGE OF PRODUCTS IS SO GREAT THAT WE NOW HAVE TO REQUEST THE AMOUNT OF 1/6d FOR OUR GENERAL CATALOGUE AND TO SAVE YOU POSTAL ORDER POUNDAGE CHARGE WE REQUEST SEND 1/6d. IN STAMPS.

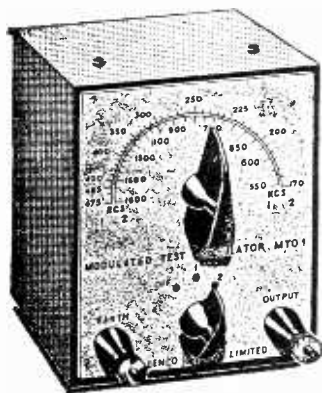

MODULATED TEST OSCILLATOR MTO. 1

- ★ Provides a modulated signal suitable for I.F. alignment, also trimming and tracking R.F. circuits.
- ★ Frequency is continuously variable from 170-475 kc/s and 550-1,600. kc/s.
- ★ Suitable for the alignment of transistor receivers.
- ★ Operates from a single 9-volt grid-bias battery (not supplied) which is housed within the unit.
- ★ The case is manufactured from steel and is finished in silver hammer. The front panel is gloss black bearing white lettering. Dimensions are 5 1/16in. x 4 1/16in. x 3in.
- ★ Supplied with full operating instructions.

PRICE £3/17/6

PLEASE SEND S.A.E. WITH ALL ENQUIRIES

DENCO (CLACTON) LTD.

(DEPT. P.W.)

357/9 OLD ROAD, CLACTON-ON-SEA, ESSEX

STOP PRESS:

TDO.3 Tape Oscillator Coil for Mullard, 3 watt Tape Amplifier, 7/6 each.

**THE
 PEMBRIDGE
 COLLEGE
 OF ELECTRONICS
 OFFERS TRAINING
 IN RADIO
 TELEVISION
 AND ELECTRONICS**

ATTENDING COURSE

(A) Full-time One Year Course in Radio and Television. College course in basic principles for prospective servicing engineers. Next course commences 4th September, 1962.

This course is recognised by the Radio Trades Examination Board (R.T.E.B.) for the Radio and Television Servicing Certificate examinations.

Provides excellent practical experience on valve and transistor radio receivers and all well-known makes of television receivers.

HOME-STUDY COURSES

(B) Courses in Radio, Telecommunications and Mathematics for the City and Guilds Telecommunication Technicians' Certificates.

To: The Pembridge College of Electronics.
 (Dept. P11), 34a Hereford Road, London, W.2.
 Please send, without obligation, details of
 A___ B___ (Please tick.)

Name _____

Address _____

The least expensive way to high fidelity is an *Armstrong* chassis

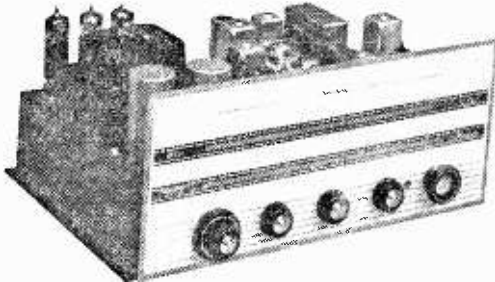

An Armstrong chassis is more than just a radio-gram chassis. It is a carefully designed combination of tuner, control unit and amplifier in one compact unit which can be used as the basis of a complete high fidelity system. A system which can include tape recording and playback as well as radio and record reproduction.

ARMSTRONG WIRELESS & TELEVISION CO. LTD. WALTERS RD. LONDON N.7. NORTH 3213

STEREO 12 MK.2 £44.15.0

8 watts push-pull output from each channel, 16 watts total. VHF, with automatic frequency control, medium and long bands. A hi-fi system on one compact chassis.

STEREO 55 (Illustrated) £33.15.0

A junior version of the Stereo 12 Mk. 2. 5 watts per channel. 10 watts total. VHF and medium bands. Inputs for tape, pick-ups and possible future stereo radio.

JUBILEE MK.2 £31.15.0

A mono chassis of 8 watts push-pull output and covering VHF, medium and long bands. Separate tone controls. A.F.C. Pick-up and tape inputs.

AF208 £23.15.0

An AM/FM mono chassis of 5 watts output covering VHF and medium bands. An inexpensive version of the Jubilee Mk.2.

Post this coupon or write for catalogue or call at our showroom for full demonstration and professional advice on your installation. Open 9-5 including Saturdays.

NAME _____ PJC

ADDRESS _____

SUPER QUALITY HI-FI DYNAMIC (M/C) MIKE

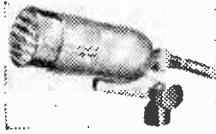

with BUILT-IN TRANSFORMER 50 k. impedance Suitable for hand or stand use. Complete with screened lead. OUTSTANDING VALUE MODEL M.D.180 **£4.15.0** Post Free

TELESCOPIC FLOOR STD.

HEAVY 9in. dome chromium base, chromium stand with screw top. Extends to approx. 6ft. Suitable for Above mikes, etc. £2.15.0. Carr. 5/-

NEW AND UNUSED ACCUMULATORS

12 v. 25 A.H. Size 10 x 10 x 4 1/2in. Carr. 8/6.
2 v. 16 A.H. 7 1/4 x 4 x 2 in. 5/- each. P. & P. 3/6.
6 v. 40 A.H. Metal box with hinged lid and carrying handle, 39/6. Carr. 7/6.
8 v. 75 A.H. Ideal for starting or storage, 59/6. Carr. 8/6.
6 v. 20 A.H. Comprising three 2 v. celluloid-cased cells in wooden case. Overall size 5 x 3 x 7 1/2in. 17/6. P. & P. 1/-

MINIATURE LEAD ACID ACCUMULATORS

2 v. 1.5 A.H. Size 4 x 1 1/2 x 1 1/2in. Weight approx. 1lb. 6/6. P. & P. 1/6.
12 v. 0.75 A.H. Size 4 x 3 x 1 1/2in. Weight approx. 2 lb., 22/6. P. & P. 1/6.

OUTSTANDING BARGAINS IN

RECORDING TAPE

ALL BRAND NEW, BOXED & GUARANTEED

"GEE'S" SUPER QUALITY P.V.C. TAPE

- 5in. Std. 600ft. 10/-
- 7in. Std. 1,200ft. 17/6
- 5in. L.P. 900ft. 15/-
- 5 1/2in. L.P. 1,200ft. 17/6
- 7in. L.P. 1,800ft. 24/-
- 5in. D.P. 1,200ft. 21/-
- 5 1/2in. D.P. 1,800ft. 30/-
- 7in. D.P. 2,400ft. 39/6



- ### AMERICAN "CBS" TAPE
- 5in. Std. 600ft. (CIP-6) 13/-
 - 5 1/2in. Std. 900ft. (CIP-9) 16/-
 - 7in. Std. 1,200ft. (CIP-12) 21/-
 - 5in. L.P. 900ft. (LP-9) 17/6
 - 5 1/2in. L.P. 1,200ft. (LP-12) 19/6
 - 7in. L.P. 1,800ft. (LP-18) 28/6
 - 5in. D.P. 1,200ft. (CMXP-12) 32/-
 - 5 1/2in. D.P. 1,800ft. (CMXP-18) 37/-
 - 7in. D.P. 2,400ft. (CMXP-24) 47/-

P. & P. 1/6 per order. (Orders over £3 post free). Many other types available including "Scotch," "EMI," "BASF," "Triton," "Synchrotape," etc. Send including "Scotch," "EMI," "BASF," "Triton," "Synchrotape," etc. Send including S.A.E. for our huge money-saving literature on Tapes and Accessories.

POCKET TEST METER MODEL TK.60

(4,000 O.P.V.) FOR ONLY **£4** POST FREE

A pocket size individual circuit tester with bakelite panel and metal cabinet. Complete with test leads batteries and ready to use. Ranges: D.C. Volts: 10-50-250-1,000 v. A.C. Volts: 10-50-250-1,000 v. (2,000 o.p.v.), D.C. Current: 250µA/10 mA/250 mA. Resistance: 0-10 K ohms/0-1 M ohms (by 3V internal battery). Decibels: -20 to +22db (0dB - 0.775v. -600 ohms). Size: 4 1/2in. x 3 1/2in. x 1 1/2in.



Also available: **MODEL TK.50** 1,000 o.p.v. Ranges: D.C. mA: 1-250 mA. D.C. and A.C. Volts: 10-250-500-1,000 v. Ohms: 0-10K ohms 0-100K ohms. £3.7.6.

GEE BROS. RADIO LTD

15 LITTLE NEWPORT STREET, LONDON, W.C.2.

Telephone: GERrard 6784/1453
Adjoining Leicester Square Tube Station Open 9-6 Mon.-Fri. 9-1 Sat.

BARGAIN OF THE YEAR!

Telefunken Stereo Hi-Fi Amplifier Latest model S82 with balance control **ONLY 7 Gns.**



YES - ONLY 7 Gns.

110/250 v. A.C. 5 watt undistorted output (10 watts nominal) size 12 x 9 x 2 1/2in., weight 9 lb. Complete with spec. and instructions.

12 VOLT D.C. AMPLIFIER

(Ardente). As new, 15 watt push-pull output mike and gram inputs, tapped output transformer. £9.19.6. Carr. 10/6. (Hand microphone for above 30/- extra).

BEAM PROJECTION EXPONENTIAL HORN

19in. long, 12in. square flare. Complete with mounting bracket. Ideal for mobile use. Brand new. £6.10.0. Carr. 10/6.

SUPER QUALITY TEST LEAD KIT No. 520 8/6

P. & P. 1/6. Comprises leads and probes, English and Continental type plugs, spade terminals and crocodile clips. Complete in attractive case.



RADIO MAIL ORDER Co.,

108, FITZJOHN'S AVE., N.W.3.

NEW 4-SPEED TRANSISTOR

RECORD PLAYER usual price £23,

to make up as follows: Luxurious covered cabinet in red or blue containing 1-watt transistor amplifier, 9" x 4" quality L.S. Motor board takes E.M.I. 4-Spd. unit. Dimensions 7" x 13" x 14". £7. 10. 0d. P.P. & Ins. 7/6d.



4-speed E.M.I. motor, turntable and pick-up £3. 10. 0d. P.P. & Ins. 6/-.

All items may be purchased separately but if ordered together send

10 gns. plus 13/6d P.P. & Ins.

TERMS: Cash with order only.

NEW AUTO-CHANGE HI-FI RECORD PLAYER usual price £30,

to make up as follows: Beautiful cabinet in red and beige complete with push/pull Hi Fi amplifier. Dimensions 9" x 16" x 17". Mains Indicator, separate Bass/Treble controls, large speaker. Complete with motor board ready to accept Collaro Studio Auto Changer. £10. 0. 0d. plus £1. P.P. & Ins. Collaro Studio Auto Changer new and ready to fit. £7. 19. 6d. plus 7/6d. P.P. & Ins.



All items may be purchased separately but if ordered together send

17 gns. plus £1. P.P. & Ins.



NEW TAPE RECORDER normally £50

Complete and cartoned. Latest Collaro Studio Unit with 3 motors. 3-Speeds, all equalised. Fast re-wind. Digital counter and pause control. Superimposing facilities. Safety switch and sockets for radio or gram inputs. Recording level indicator. Piano key controls. Pocket in lid with microphone, tape and spare reel. Dimensions 9" x 16" x 18". Housed in luxuriously styled wooden cabinet covered with imitation leather and Vynair.

Send

24 gns. plus 21/- P.P. and Ins.

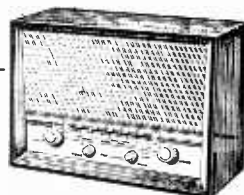

TABLE RADIO cabinet in selected walnut veneers measuring 9" x 13" x 6". Cost manufacturer £2. Our price 15/- plus 2/6d. P.P. & Ins.

7-Transistor radio chassis to fit above cabinet complete with knobs and scale. 7-transistors, 2-diodes. Large ferrite aerial. Long and medium wave. 600 m.W. into 7" x 4 1/2" L.S. £12. 0. 0d. plus P.P. & Ins. 10/-.

Each item sold separately but if bought together send £12. 12. 0d. only plus 12/6d. P.P. & Ins.

EACH UNIT GUARANTEED NEW AND UNUSED.

TESTED AND WORKING PERFECTLY BEFORE DESPATCH.

SUPER 5 TRANSISTOR POCKET RADIO

INCORPORATING

Printed Circuit —

Miniature earpiece

Completely portable

No Aerial or Earth

is required

★ Size 4 1/2 x 3 1/2 x 1 1/2 in.

★ Output 200mW

★ 5 First quality transistors

★ Push-pull output

★ Fitted 2 1/2 in. high-flux moving coil speaker



ONLY

59/6

3/6 P. & P.

Complete with internal high-gain ferrox aerial and twin tone case in Red and Black. Med/Long wave. Earpiece has sub-min jack and socket with 3ft. fine cable. Almost invisible in use. All parts available separately. Circuit diagram 1/6—Free with parts.

SOUTHERN RADIO'S WIRELESS BARGAINS

PORTABLE TEST METERS. (As featured in March 1961, issue, pages 1005 to 1010) 0-5000 ohms; 0-60mA; 0-15 v., 0-3 v., 12/6 each.

TRANSMITTER RECEIVERS. "Type 38" with 5 valves. New but untested. No guarantee, 25/- each. Post paid.

ATTACHMENTS FOR "38" TRANSMITTER-RECEIVER; Headphones 15/6; Throat Microphones, 4/6; Junction Boxes, 2/6; Aerials, No. 1, 2/9, No. 2, 5/3, Webbing, 4/-; Haversacks, 5/6; Valves—A.R.P.12 4/6. A.T.P.4, 3/6. Set of five valves, 19/-.

Postage on each item 1/6 extra (except valves). **TYPE "18" RECEIVING PORTION ONLY** with 4 valves. S.W. 6-9Mc/s, 35/- each.

ATTACHMENTS FOR "18" TRANSRECEIVER. Headphones, 15/6; Microphone 4s, 12/6; Aerials, 5/-; Morse Key, 6/6; Valves—A.R.P.12, 4/6, A.T.P.4, 3/6, A.R.8, 7/6; Set of six valves, 25/-.

Official booklet "19" T.R. Circuits, etc., 6/6 post paid. Postage extra (except valves) 1/6 each item.

QUARTZ CRYSTALS. Types F.T. 241/243 2-pin $\frac{1}{2}$ in. space. **FREQUENCIES:** (F.T.243) 5706 kc/s to 8625 kc/s. **FUNDAMENTAL** (F.T.241) 20 Mc/s to 38.9 Mc/s. (54th and 72nd Harmonics) 4/6 each. Lists available if frequencies stocked.

CRYSTAL BASES: F.T.241, F.T.243, 1/6 each. **CRYSTAL CASES:** F.T.241/243. 10/6 per dozen.

DYNAMOTORS for attaching to B.C. SERIES COMMAND RECEIVERS. 28v. D.C. to 250v. D.C. 17/6.

VARIOMETERS for "19" Sets. NEW. 2/- each. **RECORDING BLANKS.** New 13in., 6/- each or 15 complete in Tin, 4/-.

BOMBSIGHT COMPUTERS. Ex-R.A.F. Wealth of gears, motors, blowers, etc. Ideal for experimenters, £3.12.6, carr. paid.

RESISTANCES. 100 Ass'd. Useful values, new, 12/6 per 100. **CONDENSERS.** 100 Ass. Mica Elec., Tub., etc. New 15/- per 100. **LUBBRA HOLE CUTTERS.** Adjustable. $\frac{1}{2}$ in. to 3 1/2 in., 7/9.

VISUAL INDICATORS (10Q4). Type 3 with 2 meter movements, 2 neons. New 12/-.

MAGNETS. Strong Bar, 2in. x $\frac{1}{2}$ in., 1/6 each.

POST OR CARRIAGE EXTRA, FULL LIST OF RADIO BOOKS, ETC., 3d.

SOUTHERN RADIO SUPPLY LTD.
11 LITTLE NEWPORT ST., LONDON W.C.2. GER. 6653

RADIO & TV LTD. (Dept. 5T)
HIGH STREET, ACTON, LONDON, W.3.

D. & B. TELEVISION

Phone: Cherrywood 3955
Dept. A.6 131 & 131A KINGSTON ROAD
SOUTH WIMBLEDON, S.W.19

Open Mon.—Sat. 10 a.m.—7 p.m. (Except Wed. 1 p.m.).
Nearest Tube Station South Wimbledon (Northern Line).
"COMPARE OUR PRICES"

FOR THE FINEST, FASTEST SERVICE IN THE COUNTRY
Your problems are our Business

LOOK! TRANSISTOR PRICES DOWN AGAIN.
MULLARD OC41 9/-, OC45 8/-, OC71 5/-, *OC72 8/-, *OC76 7/-, *OC77 12/-, *OC81 7/-, *OC81D 6/-.
Complete set of 6 Mullard Transistors only 35/-, comprising OC44, two OC45's, OC81D, two OC81's. Matched Pair.
MULLARD DIODES: OA81 2/6, OA60 2/6, OA91 2/6.
G.E.C. Transistors: GET875 1/3, GET874 8/11, GET873 6/10, *GET115 7/6, *GET114 4/8.
Complete Set of 6 G.E.C. Transistors, comprising: GET 874, two GET873's, GET114, Matched Pair GET114, Only 28/6.
COMPLETE SET 6 S.T.C. Transistors: Only 25/6.
(*Available in matched pairs, 1/- extra).

COMPLETE NEW RANGE OF TRANSISTOR COMPONENTS IN STOCK

THREE BRAND NEW *STAR* BARGAINS
Designed for quality and outstanding value.

NEW R.T.D. 6 Watt Monaural Amplifier, using heavy duty, double-wound mains Transformer. With separate rectifier winding. Valves: Rectifier Driver and Output. 5 Controls: Switch, Volume, Base, Treble, Middle. Heavy duty output Transformer. METAL CHASSIS. All components brand new. Ready built.....ONLY £5.5.0. COMPLETE or all parts in kit form. ONLY £3.15.0. P. & P. 3/6.

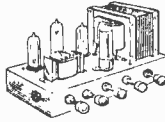

NEW FOUR VALVE, Inc. RECTIFIER. A.C. ONLY MAINS RADIO. Medium and Long Wave. Heavy Duty Mains Transformer. Metal Chassis. Ferrite Rod Aerial. Extremely attractive cabinet, two-tone grey. Splendid finish. Ready built for use. ONLY £8.0.0. Supplied with slow motion tuning. 10/- extra.



Or, all parts in kit form. ONLY £8.5.0. P. & P. 7/6. You will be delighted with this purchase. All parts sold separately.

NEW Undoubtedly the best deal ever offered in Transistor Radios. The most attractive professional finish ever in kit form. 6-Transistor Pocket Superhet. Using the latest components from America. Transistors. Printed circuit. First Grade Transistors and Components. Ferrite rod aerial long and medium wave bands. Must be seen to be believed.



ONLY £16.0.0. P. & P. 3/6. EASY TO BUILD. All parts sold separately. Send 6d. for lists of transistor components, Speakers, Transformers, etc.

ALL VALVES ARE SOLD SUBJECT TO FULL GUARANTEE CURRENT VALUE LIST

| Model | Price | Model | Price | Model | Price | Model | Price |
|--------|-------|--------|-------|-------|-------|--------|-------|
| AZ81 | 8/6 | ECX65 | 7/6 | KT30 | 8/6 | SP11 | 2/3 |
| 136 | 5/6 | ECT90 | 8/- | KT61 | 8/3 | U22 | 6/6 |
| CRL31 | 20/- | E.H.21 | 15/- | KT43 | 6/3 | U22 | 10/- |
| CH135 | 12/6 | ECH35 | 9/- | KT61 | 5/6 | U26 | 12/- |
| CL83 | 10/- | ECH42 | 7/6 | KTW63 | 5/6 | U26 | 9/6 |
| D77 | 3/- | EBH81 | 7/6 | LB3 | 2/6 | U31 | 7/7 |
| DAP91 | 5/- | ECL90 | 7/6 | PCC84 | 7/6 | U37 | 17/- |
| DAF96 | 7/- | ECL22 | 6/6 | PCC89 | 18/6 | U50 | 5/0 |
| DF91 | 3/6 | ECL83 | 11/6 | PCF80 | 7/6 | U62 | 5/- |
| DF96 | 7/6 | EF39 | 4/6 | PCP82 | 7/6 | U81 | 9/6 |
| DI62 | 6/- | EP50 | 1/3 | PCP86 | 14/6 | U81 | 9/6 |
| DI77 | 4/6 | EP90 | 4/6 | PL22 | 7/- | U82 | 12/6 |
| DK90 | 4/- | EP85 | 6/3 | PLC83 | 9/6 | U80 | 17/6 |
| DR92 | 7/6 | EP46 | 8/6 | PLC84 | 7/6 | U81 | 22/- |
| DK96 | 7/6 | EP89 | 8/6 | PLC85 | 15/- | UACB80 | 8/6 |
| DL91 | 8/6 | EP91 | 3/- | PL33 | 8/- | UAF42 | 8/6 |
| DL92 | 7/6 | EP92 | 4/6 | PL32 | 7/- | UCD8 | 25/6 |
| EL94 | 7/- | EL3 | 7/6 | PL38 | 14/6 | UB41 | 7/6 |
| DL98 | 7/- | EL38 | 12/- | PL41 | 8/6 | UB31 | 7/6 |
| EABC80 | 7/6 | EL41 | 7/6 | PL42 | 8/6 | UB2 | 4/6 |
| EAF42 | 6/6 | EL84 | 6/6 | PL83 | 8/6 | UC85 | 12/6 |
| EB41 | 6/6 | EM80 | 8/6 | PL82 | 8/6 | UC86 | 14/6 |
| EB41 | 3/- | EM11 | 6/6 | PL82 | 7/- | UCF90 | 14/6 |
| EIC33 | 4/6 | EM34 | 9/6 | PY31 | 10/- | UCH21 | 12/3 |
| EBM41 | 7/6 | EY31 | 7/6 | PY40 | 8/- | UCH42 | 7/6 |
| EBF90 | 7/6 | EY86 | 7/6 | PY81 | 8/- | UCH81 | 8/6 |
| EBF99 | 8/3 | EZ40 | 6/6 | PY82 | 9/- | UCS3 | 12/6 |
| EUL31 | 20/- | EA11 | 6/6 | PY83 | 8/- | UF42 | 3/6 |
| EC81 | 4/6 | EZ20 | 6/6 | PY88 | 12/- | UL41 | 7/- |
| EC82 | 5/6 | GZ32 | 8/6 | PZ30 | 8/- | UL44 | 10/6 |
| EC82 | 6/3 | GZ34 | 12/6 | RI1 | 10/- | UL46 | 7/- |
| EC83 | 7/6 | KT30C | 6/- | RP41 | 2/3 | UL84 | 7/6 |

We pride ourselves that we can obtain and supply any TV spare. Please ask us for ANY components you may require we are almost certain to have them.
TERMS: S.A.E. all enquiries. C.W.O. or C.O.D. 3/- extra. Postage on Valves, 6d. each. C.R.T.s 12/6 inc. Insurance. SATISFACTION ASSURED. RETURN POST SERVICE.

RETURN-OF-POST SERVICE

● "BRAND FIVE" RECORDING TAPE
Standard 1-Ply: 600ft. (5") 16/-; 1,200ft. (7") 25/-
Long Play: 900ft. (5") 18/6; 1,800ft. (7") 23/6; 1800ft. (7") 35/-
Double Play: 1,200ft. (5") 37/6; 2,400ft. (7") 60/- (All Post Free.)

● LATEST TEST METERS
Cash Price Deposit Mthly/Pmts.
AVO Model Mark II .. £24. 0/0 £4.16.0 12 of £1.15. 2
AVO Model 7 Mark II .. £21. 0/0 £4. 4/0 12 of £2.10.10
AVO Multimor .. £20.10.0 £1.18.0 12 of 14/4
TAYLOR MODEL 127A .. £10.10.0 £2. 2/0 12 of 15/8
CABY A-20 .. £4.17.0 £1. 7/6 3 of £1. 6/8
CABY B-20 .. £6.10.0 £2. 0/0 3 of £1.13.4
CABY M-1 .. £2.14.0
Full details of any of the above supplied free on request. The AVO Models 7 and 8 are both latest models from current production—not to be confused with Government Surplus.

● TAPE RECORDING EQUIPMENT
TAPE DECKS Hire Purchase
ALL CARRIAGE FREE Cash Price Deposit Mthly/Pmts.
B.S.R. TD2 .. £9.19.6 £1.16.6 12 of 13/7
Latest COLLARO Studio .. £12.19.6 £2.12.6 12 of 19/-
TAPES & HEADERS
MARTIN RECORDER KITS. 8311V for Collaro Studio Deck. 11 gms. 8312M for B.S.R. Deck, 8 gms. Carrying cuses available. H.P. Terms on Decks, Amplifiers and Cassettes, send for quote.

TAPE PRE-AMPLIFIERS Hire Purchase
ARMSTRONG PA10-3 .. £14.18.0 £1.5.6
Deposit £3.8.0, and 12 monthly payments of £1.4.7.
MULLARD TAPE C PRE-AMPLIFIER. We stock complete kits and all components. Send for list.
MARTIN. Pre-amp kit for Collaro Studio Deck £8.8.0.

● JASON F.M. TUNER KITS
We stock complete kits for FMT1, FMT2, FMT3, Mercury 2, and JTV2 at competitive prices. Send for list.

● P.W. BLUEPRINTS
Kits and components for Recency, VHF/FM Receiver, Short Wave Two, Mains Receiver, Transistor Portable, Tutor, Citizen and Mini-Amp. Full lists available.

● LOUDSPEAKERS
GOODMANS: Axiom 110 10in. £5.2.0; Axiom 112 10in. £8.14.0;
Axiom 8in. £6.15.0; Axiom 300 12in. £1.5.6.
WHITELEY: HF 10in 10in. £3.4.0; HF 10in 10in. £5.2.6;
All Goodmans and Whiteley units supplied. H.P. available.

● STEREO COMPONENTS
Mortantite ganged potentiometers as specified for the Mullard circuits. ● Low/Low 500k, 500k, 1 meg., 2 meg. ● Low/Low 50k, 200k, 1 meg., 2 meg. ● Lin/Lin 250k, 500k, 1 meg. All 10/6 each.

● TRANSISTORS
MULLARD. Reduced prices. Current production, not rejects. All in makers' boxes. Post 3d. on each transistor.
GEC 912 P45. Detailed list on request. H.P. 12/6. JCV2 Matched Pairs 16/-; OC73 8/-; OC81 8/-; OC170 9/6; OC171 10/6.

● AMPLIFIER KITS
We have full stocks of all components for the Mullard 510, Mullard 3-3, Mullard 2 and 3 Valve Pre-amp. Mullard Stereo. GEC 912 P45. Detailed list on request. H.P. 12/6. JCV2 Matched Pairs 16/-; OC73 8/-; OC81 8/-; OC170 9/6; OC171 10/6.

● GRAMOPHONE EQUIPMENT
ALL LATEST MODELS Hire Purchase
ALL POST FREE Cash Price Deposit Mthly/Pmts.
RECORD CHANGERS
GARRARD AUTOSLIM
(GC8 PU) .. £8.5.0 £1.12.0 12 of 12/8
COLLARO C60 (GP67 PU) .. £8.5.0 £1.13.0 12 of 12/8
B.S.R. UA4 (TC8 PU) .. £7.19.6 £1.12.6 12 of 12/3
B.S.R. UA4 Monaural (TC8 Stereo/LA7B) .. £8.19.6 £1.16.0 12 of 13/7
SINGLE RECORD PLAYERS
GRENOUAT 45 UNIT
(Battery 9v) .. £5. 8.0 £1.11.0 3 of £1.9.0
GARRARD TA (GC8 PU) .. £8.10.0 £1.14.0 12 of 13/-
B.S.R. TUP (TC8 PU) .. £4.10.7 £1. 5.0 3 of £1.5.0

TRANSCRIPTION UNITS
GARRARD JHF (GC8 PU) £18.18.0 £3.16.0 12 of £1.7.8
PHILIPS AG1016 .. £14. 3.5 £2.17.6 12 of £1.0.9
Many of the above can be supplied for stereo working. See our Gramophone Equipment List for details.

● ILLUSTRATED LISTS are available on LOUDSPEAKERS, TAPE DECKS, TEST GEAR, RECORDING TAPES, GRAMOPHONE EQUIPMENT AMPLIFIERS. Any free upon request.

● TERMS OF BUSINESS
Cash with order or C.O.D. We charge C.O.D. orders as follows. Up to £3. minimum of 3/2. Over £3 and under £5. 1/6. Over £5 and under £10. 1/8. Over £10, no charge. Postage extra on CASH orders under 25 except where stated. Postage extra on Overseas orders irrespective of price.

WATTS RADIO (MAIL ORDER) LTD.
54 CHURCH STREET, WEYBRIDGE, SURREY
Telephone: Weybridge 4556
Please note: Postal business only from this address.

SENSATIONAL NEW 1962 DESIGNS—BY CONCORD

LOW PRICES ★ PICTORIAL STEP-BY-STEP PLANS ★ EASY AS A.B.C.

THE NEW "LISBON"

TRANSISTOR SET

This is a pocket 2-stage transistor set not much larger than a matchbox. Excellent clear reception covering all medium waves, works for months off a tiny 1½ or 3 volt battery costing only 3/4d. Easy to build and an excellent introduction to transistor circuitry. Everything can be supplied down to the last nut and bolt incl. **SIMPLE PICTORIAL STEP-BY-STEP PLANS FOR ONLY 19/6**, plus post and packing 1/6. (C.O.D. 2/- extra). Parts sold separately, priced parts list 1/-.



OUR NEW 4 STAGE "MINUETTE"

Build this newly-designed "MINUETTE" 4-STAGE transistor set in very strong ready drilled **ULTRA-MODERN CASE**, size only 6 x 3½ x 1½. Uses three transistors and diode and **SELECTED LOUD SPEAKER**. Very sensitive, ideal for office, bedroom, holidays, etc. Months and months of listening off an sd. battery. Can be built **FOR ONLY 39/6**, including **PROPER CASE**, miniature speaker, etc. **SIMPLE AS A.B.C. PICTORIAL STEP-BY-STEP PLANS** etc., plus post and packing 1/6 (C.O.D. 2/- extra). Parts sold separately, priced parts list 1/-.

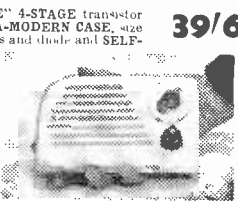

THE NEW "FLORIDA" VALVE RADIO

This sensational "FLORIDA" model is one of our most sensitive valve radios. It is a highly compact, self-contained miniature push button base, valve pocket radio at absolutely rock bottom building cost. Covers all medium waves with very latest circuitry bringing in stations from all over Europe without fuss. Size only 4½ x 2½ x 1½ in. A fascinating pocket radio. We can supply all the parts including beautiful 2-tone case and **SIMPLE AS A.B.C. PICTORIAL STEP-BY-STEP PLANS**, screws, wire, etc. Can be built for the exceptionally **LOW PRICE OF 27/6**, plus post and packing 1/6 (C.O.D. 2/- extra). Parts sold separately, priced parts list 1/-.

27/6



THE NEW "SAN REMO" ONLY 37/6

This All Transistor Speaker Radio—The "San Remo"—covers all medium waves including "Home", "Light", etc. Reliable and lightweight—Slips easily into the Pocket or Handbag—size only 4½ x 2½ x 1½ in. Works for Months off 8d. Battery! Ideal for holidays, Camping, Bedroom, etc. Anyone can assemble it in an hour or two with our simple-as-A.B.C. PLANS! Complete set of parts including miniature speaker—everything—only 37/6, plus 2/6 P. & P. (C.O.D. 2/- extra.) Parts can be bought separately.



CONCORD ELECTRONICS Dept. 14/4
210, Church Road, Hove, Sussex

Cheques accepted. Cash on delivery 2/- extra. Please print name and address in block letters. Suppliers to Schools. Electronics, Government and Research Establishments. Complete range of components and values stocked. Regret no C.O.D. abroad. DEMONSTRATIONS DAILY AT WORKS.

H.A.C. SHORT-WAVE EQUIPMENT AND SHORT-WAVE KITS

Famous for over 25 years for S.W. Receivers and Kits of Quality.

H.A.C. were the original suppliers of **SHORT-WAVE RECEIVER KITS** for the amateur constructor. Over 10000 satisfied customers—including Technical Colleges, Hospitals, Public Schools, Hams, etc.

Improved designs with Denco coils: **One-valve Kit, Model "C"**, Price 25/-; **Two-valve Kit, Model "E"**, Price 50/-; **New Addition: Model "K"**, Super sensitive "All Dry" Receiver. Special inc. price. Complete Kit, 77/-.

All kits complete with all components, accessories and full instructions. Before ordering call and inspect a demonstration receiver, or send for descriptive catalogue and order form.

POST THIS COUPON NOW!

"H.A.C." SHORT-WAVE PRODUCTS

(Dept. TH), 44 Old Bond Street, London, W.1

Please send me FREE, and without obligation your 1962 literature.

NAME

ADDRESS

BBC - ITV - F.M. AERIALS



B.B.C. (BAND 1), Telescopic loft, 19/6. External S/D, 26/3.

ITV. (BAND 3), 3 Element loft array, 24/-; 5 Element, 32/6. Wall mounting, 33/6; 5 Element, 41/3.

COMBINED B.B.C. + ITV, Loft 1+3 Element, 41/3; 1+5 Element, 48/9. Wall mounting, 1+3 Element, 56/3; 1+5 Element, 63/6. Chimney and mast mounting units also available.

F.M. (BAND 2), Loft "H", 28/-; 3 Element loft, 52/6. S/D loft, 12/6. External S/D, 26/3. State channel when ordering. C.W.O. or C.O.D. P.P. 2/6. Coaxial cable, 8d. yd. Coaxial plugs, 1/3. Send 6d. stamps for illustrated lists.

K.V.A. ELECTRONICS (Dept. P.W.)
3B, Godstone Road, Kenley, Surrey.

TRANSISTOR PORTABLE RADIO KIT, 25.17.8, plus post 3/6. Covers medium and long waves, no aerial or earth required. No difficult aigning necessary. Build for your holidays now. Also Pocket Radio Kit, 85/-, post 2/-, with personal earphone. M. and L. wave. Red Spot Transistors 2/8; White Spots 2/3; Yellow 3/3; OC1, 6/-; OC2, 7/6; OC4, 9/6; OC45, 9/-; Sub-min. electrolytics 2, 4, 8, 10, 16, 32, 50 mfd, 2/-; 100 mfd, 3/9; 250, 500, 1000 mfd 3/3; Silicon rectifier bargain 70 p.p. 3 amp., 3/3. Transistor Tape Recorder, 41.11 (215 elsewhere). Trans-former 250-0-250 v., 6 v., and 5 v., 15/-; Super Coax. 75 ohms, 6d. yd. Electrolytics 82pF, 500 v., 2/3; 8 + 15µF., 3/3; 100 + 100 (375 v.), 3/8. V. Cont., two gang 0.0005 trimmers and slow motion 9/6. Transistor holders, 1/-; Resistors 10%, tol. 4d.; 5% tol. 8d. Tanno Mike 3/6. Crystal inserts (new), 7/6. Gorer Units, 1 watt amplifier, 92/6; 1 P. Amplifier (400 kc/s, pre-igned), 92/6; 3 waveband converter 90/3; Manual No. 107 describing and circuits, 2/9, post free. TERMS: C.W.O. Post extra, excess refunded. Send 10d. stamps for Transistor Notes.

MOORE'S EXPERIMENTAL SUPPLIES (Dept P)
8 & 10 GRANVILLE STREET, SHEFFIELD 2

FIRST-CLASS RADIO COURSES...

GET A CERTIFICATE!
QUALIFY AT HOME—IN SPARE TIME

After brief, intensely interesting study—undertaken at home in your spare time—YOU can secure your professional qualification or learn Servicing and Theory. Let us show you how.

FREE GUIDE

The New Free Guide contains 132 pages of information of the greatest importance to those seeking such success-compelling qualifications as **A.M.Brit.I.R.E., City and Guilds Final Radio, P.M.G. Radio Amateurs' Exams, Gen. Cert. of Educ. London B.Sc. (Eng.), A.M.I.P.E., A.M.I.Mech.E., Draughtsmanship (all branches)** etc., together with particulars of our remarkable Guarantee of **SUCCESS OR NO FEE**. Write now for your copy of this invaluable publication. It may well prove to be the turning point in your career.

FOUNDED 1885—OVER 150,000 SUCCESSSES

NATIONAL INSTITUTE OF ENGINEERING
(Dept. 461), 148 HOLBORN LONDON, E.C.1

S. Africa: P.O. Box 8417, Jo'burg.
Australia: P.O. Box 4570, Melbourne.

Premier RADIO

23 TOTTENHAM COURT ROAD,
and at 309 EDGWARE ROAD,

LONDON W1
LONDON W2

Telephone: MUSEUM 3451/2
Telephone: PADDINGTON 4963

THE "PETITE" PORTABLE



JAY Bz. BUILT FOR £7.00 P. & P. FOR 3/-
Batteries extra: H.T. 10/- (Type B129) or equivalent, L.T. 1/8 (Type AD 35) or equivalent.

- High Q frame aerials.
- High sensitivity on both wavebands.
- Medium and long wave superhet circuit.
- Instruction book 1/6

TRANSISTOR SUPERHET RADIO

MAY BE BUILT FOR

£8.19.6

plus 2/6 P. & P.
PP3 Battery extra at 2/6

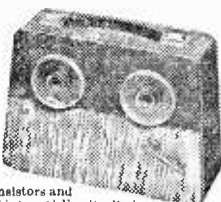

Using six Transistors and one Diode and internal Ferrite Rod Aerial, with provision for Car Radio Aerial. Full medium and long waveband coverage and 6 x 4 High Fidelity Speaker. When constructed the receiver is housed in an attractive two tone case, size 10 1/2 x 7 1/2 x 3 1/2 in.

WE HAVE BEEN APPOINTED STOCKISTS FOR FULL RANGE OF STERN'S RADIO

(Fleet Street)
Famous Mullard Designs such as

Type 40' Tape Pre-amplifier and Erase Unit, including separate Power Supply.
Complete Kit of Parts..... £14. 0. 0
or Completely assembled and tested..... £17. 0. 0
Also available Less Power Supply at £11.15.0 and £14.10.0 respectively.

Stern's Model HETR3 MR.2. Tape Amplifier
Complete Kit of Parts..... £13.4. 0
or Completely assembled and tested..... £17. 0. 0

Complete Mullard 5-10 Amplifier with Pre-amplifier on same Chassis
Complete Kit with Pametto O/P and Main Transformer..... £11.10. 0
Completely assembled and tested..... £13.10. 0

Complete Mullard 3-5 Amplifier Kit..... £7.10. 0
Completely assembled and tested..... £8.19. 6
P. & P. 6/6

Mullard 10-10 Stereo Power Amplifier based on the famous Mullard 5-10
Complete Kit of Parts..... £18.10. 0
Completely assembled and tested..... £21. 0. 0
(Control Unit on Main Chassis)

Also available with separate dual-channel Pre-amp. Complete Kit for Power Amp. & Pre-amp £28.0.0
Complete assembled and tested..... £30.0.0

ALL COMPONENTS USED IN THESE KITS ARE OF THE HIGHEST POSSIBLE STANDARDS AND STRICTLY TO CIRCUIT SPECIFICATIONS.
Full descriptive literature available on these products and Circuit Diagrams may be purchased separately.

STAR FEATURE PURCHASE!

WE CAN OFFER THE FABULOUS SAVILLE DOUBLE 12 STEREO POWER AMPLIFIER AND MATCHING SAVILLE 12P CONTROL UNIT FOR ONLY

25 Gns.

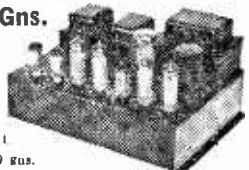

P. & P. 12/6

ORIGINAL PRICE 49 gns.

Brief Specifications:

Input sensitivity P.U. 3 and 45 mv. Tape 1 and 20 mv. Radio 50 mv. Output 12 watts per channel, 20 watts peak. 2 EL84 push-pull output per channel. Control 6-pos. sel. volume on/off, bass, treble and balance.

THIS

ARTICLE

IS BRAND

NEW AND

GUARANTEED



LOOK! TRANSISTORS FROM 1/6.

AUDIO TRANSISTORS for Experimental Circuits 1/6 each.
YELLOW SPOT A.F. TRANSISTORS 6 volt. 2/3 each.
RED SPOTS 3/- each, 3 for 8/6.
WHITE SPOTS 3/- each, 3 for 8/6.
YELLOW/GREEN 3/3 each, 3 for 9/-.
RED/YELLOW R.F. 4/6 each.
MULLARD TRANSISTORS DOWN IN PRICE
OC44 9/3, OC45 9/-. OC170 9/6, OC171 10/6, AF114 11/-. AF115 10/6, OC116 10/-. AF117 9/6, OC71 6/6, OC72 8/-. matched pairs 16/-. OC78 8/-. OC81 8/-. matched pair 16/-.
MULLARD DIODES OA70, OA79, OA81, OA90 or OA95, all 3/- each.
LOOK, MINIATURE GERMANIUM DIODES 3/- for only 2/- or 7/- per doz.
CRYSTAL EARPIECES with LEAD and PLUG 7/6.
LOW IMP EARPIECES 7.5 ohms with LEAD and PLUG 7/3.
MINIATURE TRANSISTOR TRANSFORMERS, P.P. Driver 4.5:1 P.P. Output 20:1 Boxed with Spec., 9/6 pair.
DRX1 CRYSTAL SET COIL M.L. With circuit, 2/6.
REPANCO TRANSFORMERS. Types TT49, TT45 or TT46, 5/- each.
REPANCO TRR2. Dual Range Coil, 4/-.
REACTION CONDENSERS. .0001 3/-. .0003 3/9. .0005 4/- each.
J.B. DILECON CONDENSERS. .0001, .0002, .0003 or .0005, all 4/9 each.
TRANSISTOR HOLDERS, 3 pin or 5 pin 1/3 each, 3 for 3/6.
ALL SENT POST FREE IN U.K. by
PETHERICK'S RADIO SUPPLIES
22 High Street, Bideford, N. Devon
Tel.: Bideford 1217
S.A.E. WITH ALL INQUIRIES PLEASE

NEW VALUES!

Guaranteed Set Tested
24-HOUR SERVICE

1R5, 1S5, 1T4, 354, 3V4, DAF91, DF91, DK91, DL92, DL94, SET of 4, 18/6.
DAF96, DF96, DK96, DL96, SET of 4, 28/-

| | | | | | |
|--------|------|-------|------|-------|------|
| 1D5 | 7/- | DL36 | 9/6 | PCF85 | 9/6 |
| 1E5 | 5/6 | DL32 | 5/11 | PCF80 | 7/9 |
| 1S5 | 4/6 | DL94 | 6/9 | PCF82 | 7/6 |
| 1T4 | 3/3 | DL96 | 6/9 | PCI82 | 8/3 |
| 354 | 5/11 | FB91 | 3/- | PCL83 | 10/- |
| 3V4 | 6/9 | EBC11 | 7/6 | PCL84 | 9/9 |
| 5U4 | 4/9 | EP300 | 7/9 | PL81 | 10/9 |
| 5Y3GT | 5/9 | 1BL21 | 12/- | PL81 | 8/6 |
| 5Z4G | 8/6 | ECC40 | 13/- | PL82 | 6/6 |
| 6AM6 | 2/9 | FCC41 | 4/9 | PL83 | 6/6 |
| 6K7G | 1/9 | FCC42 | 5/9 | PL84 | 5/- |
| 6X3G | 4/9 | ECC83 | 6/9 | PY32 | 11/- |
| 607G | 5/6 | ECC84 | 8/- | PY80 | 7/- |
| 6V8G | 4/- | ECC85 | 7/6 | PY81 | 7/- |
| 6V8GT | 6/6 | ECC90 | 7/3 | PY82 | 6/- |
| 6X5GT | 4/6 | ECC92 | 8/3 | PY83 | 7/3 |
| 12K7GT | 4/6 | LGH24 | 2/- | U25 | 11/6 |
| 12K8GT | 9/- | ECH42 | 7/9 | UAB80 | 8/- |
| 12Q7GT | 4/6 | ECL80 | 6/9 | UAF42 | 8/- |
| 12S7GT | 7/3 | EF40 | 11/- | UBC41 | 7/- |
| 3L8GT | 5/- | EP41 | 7/6 | UBF90 | 9/6 |
| 3Z4GT | 5/- | EP42 | 4/9 | UC83 | 7/1 |
| CL33 | 8/9 | EP85 | 4/6 | UCH21 | 11/6 |
| DAC32 | 8/6 | EP86 | 8/6 | UCH42 | 7/6 |
| DAF91 | 4/6 | EP89 | 6/9 | UCH81 | 8/9 |
| DAF96 | 6/9 | EP91 | 2/9 | UCL82 | 9/3 |
| DF91 | 3/3 | EL41 | 9/- | UCL83 | 13/- |
| DF96 | 3/9 | EL44 | 6/3 | UF41 | 6/6 |
| EP33 | 8/6 | EY51 | 7/3 | UF89 | 6/9 |
| EP81 | 6/9 | EY86 | 7/6 | UL41 | 7/6 |
| EP86 | 8/- | EZ40 | 6/9 | UL84 | 6/6 |
| EP87 | 6/9 | EZ41 | 6/9 | UY21 | 13/- |
| DK32 | 10/8 | EZ40 | 5/9 | UY41 | 5/6 |
| DK91 | 5/6 | EZ41 | 6/- | UY85 | 6/3 |
| DK92 | 7/3 | MU14 | 6/- | VP4B | 8/6 |
| DK96 | 7/6 | PCC84 | 7/- | Z77 | 2/9 |

Postage 6d. per valve extra. Any Parcel Insured Against Damage in Trans-8.6d. extra
Any C.O.D. Parcel 3/- extra.
Office address, no callers.

GERALD BERNARD
(Note new address—formerly of Leeds)
83 OSWALDESTON ROAD,
STOKE NEWINGTON, LONDON, N.16

RADIO BOOKS

A BRILLIANT NEW Pictorial approach to understanding BASIC ELECTRICITY

In Simple straight-forward words and Clear Explanatory Pictures. The Reader is taken Step by Step from Picture to Picture.

PLAIN WHILE YOU PAY
FOR ONLY 2/6 PER WEEK
Write for FREE Illustrated Prospectus giving details of instalment plan.

WORLD RADIO HANDBOOK, 16/6.
TRANSISTORISED TEST EQUIPMENT AND SERVING MANUAL, 4/-.
TRANSISTOR AUDIO AMPLIFIERS MANUAL, 5/6.
BUMPER BOOK OF TRANSISTOR CIRCUITS FOR BOYS, 8/6.
MULLARD CIRCUITS FOR AUDIO AMPLIFIERS, 9/6.
OSCILLOSCOPE BOOK, Bradley, 5/6.
OSCILLOSCOPE EQUIPMENT, 5/6.
RECORDS & GRAMPHONE EQUIPMENT, By Bradley, 9/6.
EXTRA EQUIPMENT FOR YOUR TAPE RECORDER, 6/6.
TRANSISTOR CIRCUITS for Radio Controlled models, Howard Boys, 8/-.
COIL DESIGN AND CONSTRUCTION MANUAL, 5/6.
BOY'S BOOK OF CRYSTAL SETS, 3/-.
HIFI SPEAKER ENCLOSURES, 5/6.
TRANSISTOR SUPERHET RECEIVERS
Circuit diagrams of 50 Receivers, 8/-.
RADIO VALVE DATA W.W.7th Edn, 7/-.
BRIMAR VALVE MANUAL, No. 9, 7/-.
GUIDE TO BROADCASTING STATIONS (Wireless World) 12th edition, 4/-.
MULLARD REFERENCE MANUAL OF TRANSISTOR CIRCUITS, 13/6.
ELECTRONIC NOVELTIES, Bradley 5/6.
ELECTRONIC CIRCUITS, Bradley 4/-.
SERVICING TRANSISTOR RECEIVERS
New and enlarged edition, Pettit, 7/6.
BEGINNERS GUIDE TO RADIO, Camm
New and Revised Edition, 8/6
All above titles include postage.
SEND STAMP FOR LISTS

SELRAY BOOK CO.
60 HAYES HILL, HAYES, BROMLEY, KENT.
Tel. HURstway 181

Home Constructors LOOK!

CRYSTAL MICROPHONES

| | |
|-----------------------|--------|
| Hand Type | 25/- |
| Stick | 32/6 |
| B.M.3 (Stick) | 39/6 |
| Stand for B.M.3 | 12/6 |
| Lapel Type | 15/- |
| Dynamic Microphones | |
| DX29 and Base | 3 gns. |
| Tie Pin | 27/6 |
| P. & P. 1/6. | |

SYNCHROTAPE

| | |
|-------------------------------|------|
| High fidelity recording tapes | |
| 5in. Standard play, 650ft. | 12/- |
| 5 1/2in. " " 850ft. | 15/6 |
| 7in. " " 1200ft. | 19/6 |
| 5in. Long play, " 900ft. | 16/- |
| 5 1/2in. " " 1200ft. | 18/6 |
| 7in. " " 1800ft. | 27/6 |
| Double Play Tape | |
| 5in. 1200ft. | 32/6 |
| 5 1/2in. 1800ft. | 39/6 |
| 7in. 2400ft. | 45/- |
| P. & P. 1/6. | |

TAPE DECKS

| | |
|------------------------|----------|
| B.S.R. | £6.15.0 |
| Collaro Studio Deck .. | £10.19.6 |
| P. & P. 7/6. | |

TAPE SPOOLS

| | |
|---------------|-----|
| 3in. | 1/- |
| 5in. | 2/- |
| 5 1/2in. | 2/3 |
| 7in. | 2/6 |
| P. & P. 9d. | |

AUTO CHANGERS

| | |
|--|----------|
| B.S.R. UA14 | £7.19.6 |
| Collaro C60 | £7.19.6 |
| Collaro Junior complete with p/u | £3.15.0 |
| EM1985 complete with p/u | £4.9.0 |
| Garrard 4HF | £19.18.0 |
| P. & P. 3/6. | |

CARTRIDGES

| | |
|----------------|------|
| B.S.R. | 18/- |
| Collaro | 18/- |
| Ronnette | 25/- |
| P. & P. 1/6. | |

LOUD SPEAKERS

| | |
|------------------------------|--------|
| 5in. Speaker | 14/6 |
| 6 1/2in. " | 16/- |
| 8in. " | 16/6 |
| 6 x 4in. " | 14/6 |
| 7 x 4in. " | 15/- |
| 8 x 5in. " | 23/- |
| 10in. " | 30/- |
| 10 x 6in. " | 25/- |
| 12in. " | 32/6 |
| All above 3 ohms impedance. | |
| 12in. 15 ohm Celestion | £4.9.6 |
| P. & P. 2/6. | |

TRANSISTORS

| | |
|----------------------|------|
| Audio | 3/6 |
| R.F. | 4/6 |
| Driver V15/20P | 15/- |

THE VERY LATEST BARGAINS FROM WIRECOMP

TRANSISTOR KITS

TRANSISTOR POCKET RADIO

'JUNIOR MkII' OUR IMPROVED VERSION OF THE 'JUNIOR 5'

NOW SUPPLIED COMPLETE WITH PRINTED CIRCUIT BOARD AND FREE GIFT OF MINIATURE EAR PIECE. An easy "first step" set for the young constructor. This miniature marvel with the BIG performance has an internal Ferrite rod aerial—5 transistors and 1 diode—separate medium and long waveband control—200 milliwatt push-pull output—2in. moving coil speaker—unbreakable plastic case with carrying handle. Complete with full instructions. Circuit diagram 1/6, free if all parts bought. All parts sold separately.

£2.19.6
P. & P. 2/-

PORTABLE SUPERHET

'REVEL 6'

TRANSISTOR RADIO

This two-wave band superhet receiver incorporates six first grade Mullard Transistors and one Diode. Printed circuit. Internal Ferrite rod aerial; develops 400mW push-pull output driving 8 x 3 speaker; M.W. and L.W.; operates on two 4.5 v. batteries. Although full portable (ear aerial socket provided) this set has a performance superior to many mains radios of much greater size.

£7.19.6 Attractive two-tone cabinet—size 9 1/2 x 3 x 3 1/2in. Price includes full assembly and alignment instructions.
All parts sold separately.

P. & P. 3/6

THE SUPER VALUE

'SONIC SIXTY'

TRANSISTOR RADIO KIT

6 Mullard transistors, 1 diode, internal ferrite rod aerial, 7 x 4 high quality speaker, printed circuit, 500mW push-pull output. MW and LW calibrated direct drive assembly. Highly polished handsome walnut cabinet. Inst. Book 2/6. Complete kit, inc. Battery. All parts sold separately.

£8.19.6
P. & P. 4/6

WIRECOMP ELECTRONICS

378 HARROW ROAD, LONDON, W9.
TEL: CUNNINGHAM 9530
Hours of business: 9 a.m. to 6 p.m. Open all day Saturday. Opposite Paddington General Hospital. Buses 18B and 36 pass the door.

FREE TO AMBITIOUS ENGINEERS

— THE LATEST EDITION OF ENGINEERING OPPORTUNITIES

Have you sent for your copy?
ENGINEERING OPPORTUNITIES is a highly informative 156-page guide to the best paid engineering posts. It tells you how you can quickly prepare at home for a recognised engineering qualification and outlines a wonderful range of modern Home Study Courses in all branches of Engineering. This unique book also gives full details of the Practical Radio & Electronics Courses, administered by our Specialist Electronics Training Division—the B.I.E.T. School of Electronics, explains the benefits of our Employment Dept. and shows you how to qualify for five years promotion in one year.

We definitely Guarantee "NO PASS — NO FEE"

Whatever your age or experience, you cannot afford to miss reading this famous book. If you are earning less than £25 a week, send for your copy of "ENGINEERING OPPORTUNITIES" today—FREE.

WHICH IS YOUR PET SUBJECT?

- Mechanical Eng.,
- Electrical Eng.,
- Civil Engineering,
- Radio Engineering,
- Automobile Eng.,
- Aeronautical Eng.,
- Production Eng.,
- Building, Plastics,
- Draughtsmanship,
- Television, etc.

GET SOME LETTERS AFTER YOUR NAME!

- A.M.I.Mech.E.
- A.M.I.C.E.
- A.M.I.Prod.E.
- A.M.I.M.I.
- A.I.O.B.
- A.F.R.Ae.S.
- B.Sc.
- A.M.Brit.I.R.E.
- City & Guilds
- Gen. Cert. of Education
- Etc., etc.

PRACTICAL EQUIPMENT

Basic Practical and Theoretical Courses for beginners in Radio, T.V., Electronics, Etc., A.M.Brit.I.R.E. City & Guilds Radio Amateurs' Exam. R.T.E.B. Certificate P.M.G. Certificate Practical Radio Radio & Television Servicing Practical Electronics Electronics Engineering Automation

INCLUDING TOOLS!

The specialist Electronics Division of B.I.E.T. (Incorporating E.M.I. Institutes) NOW offers you a real laboratory training at home with practical equipment. Ask for details.

B.I.E.T. SCHOOL OF ELECTRONICS

POST COUPON NOW!

Please send me your FREE 156-page "ENGINEERING OPPORTUNITIES" (Write if you prefer not to cut page)

NAME.....
ADDRESS.....

SUBJECT OR EXAM THAT INTERESTS ME..... (SE/21)

BRITISH INSTITUTE OF ENGINEERING TECHNOLOGY (Incorporating E.M.I. Institutes) (Dept. SE/21), 29 Wright's Lane, London, W.8

THE B.I.E.T. IS THE LEADING ORGANISATION OF ITS KIND IN THE WORLD

PADGETTS RADIO STORE

OLD TOWN HALL, KNOWLER HILL, LIVERSEDGE, YORKS.

Phone: Cleckheaton 2866

Brand New, Boxed, Wireless Remote Control Unit No. 1 (Canadian) Intermoc. Set. 12/6, carr. B.R.S. 6/-. Two for £1, carr. 8/-. Less phones and mike.

Complete TV Chassis for Spares, Less valves, 12in., four for 10/-, carr. B.R.S. 7/6; 14in. chassis, four for 15/-, carr. 8/6.

Bomb-stings Computers, full of gears and blower motors, etc. New condition. 30/-, carr. 8/6.

P.M. Speakers, All 3 ohms, removed from TV sets, Perfect condition. Rola 6 x 4 in., 5/-; Goodman 7 x 4in., 6/-; Philips 5in, round, 6/-; Rola and R. and A. 6in, round, 3/6; 8in, round 6/-. Post extra on any speaker, 2/-, up to six can be sent for 3/6.

Front Glasses from TV Sets, 12 and 14in. 6d. each, post 2/-, 5/- per doz., carr. 5/-; Perspex 2/- each, post 2/-.

NEW VALVES, EX-units, All Post Free. 6KT 2/-, 6X5 4/-, 6V8 3/-, 6VGGT 4/-, 8C4 2/-, KT83 4/-, DH63 4/-, EF91 1/6, EB91 1/6, 6J6 2/6, EF50 1/6, 6/- per doz., 5U4 4/6, 5Z4 5/6, 954 1/6, 9001 9d., 5/- per doz., VR150/30 4/-.

Valves Removed from TV Sets, All tested on a Mullard Valve Tester and are 100% as new. They carry a 3 months' unconditional guarantee. All Post Free. EF80 1/6, 10/- per doz. Grade 2, 8d., 4/- per doz.

| | | |
|-----------|---------------|-----------|
| ECL90 4/6 | 8LD20 5/- | KT36 5/- |
| ECC82 5/- | 6SN7 2/9 | PL81 5/- |
| EL38 4/6 | 10C2 2/- | PY81 4/- |
| EY51 2/6 | 10P1 2/- | PL82 5/- |
| EBF80 4/6 | 10P1 per doz. | PY82 5/- |
| EB91 9d. | 10P14 5/- | PY80 5/- |
| EF91 1/- | 10P13 5/- | PL38 5/- |
| 6P25 4/- | 20D1 3/- | PY90 4/- |
| 6P28 4/- | 20P1 5/- | PCF80 4/6 |
| 6F1 2/6 | 20L1 5/- | PCC84 4/6 |
| 6F13 2/6 | 185BT 8/6 | PL83 5/- |
| 6F14 5/- | U25 5/- | PL33 4/- |
| 6S87 2/- | U282 5/- | B36 4/- |
| 6G6 2/6 | U281 5/- | N37 5/- |
| 6Y8 2/6 | U229 5/- | L63 3/- |

Complete TV Sets Untested, 12in. 20/-, 14in. 30/-, 14in. 12-channel 50/-, 17in. BBC only 50/-, Carriage on any set 10/-, If you wish to insure against damage, 8/6 extra.

TV Converters, Less valves and knobs. Coils fitted 2 and 10. Ekco, Ultra, Pye, Marconi, Murphy, etc., 2/6, post 2/-.

Cydon Converters, Complete with knobs less valves, Coils fitted 2 and 10 only, 10/-, Post 2/-.

TV Tubes, Regunned, 12 months' guarantee. Old glass not required. 12, 14, 15, 16, 17in. Any make, All same price, £.15.0. Carr. and Ins., 7/6.

Perfect Reclaimed Tubes, 6 months' guarantee. 12in. 17/-, 14in. Mullard only £1.10.0. Carr. and Ins. 7/6.

A.R.R.L. RADIO AMATEURS HANDBOOK 1962

New Edition 38/-, Postage 2/6.

World Radio and TV Handbook 1962, for Listeners, by Johansen, 18/9, postage 1/-.

Amateur Radio Handbook by R.S.G.B. New edition 34/-, postage 2/3.

How to Listen to the World by Johansen, new edition, 12/6, postage 1/-.

The Oscilloscope Book by Bradley, 5/-, postage 6d.

The Microphone Guide by Borwick, 7/6, postage 8d.

Radio Control Handbook by McEntee, 40/-, new edition, postage 1/6.

Transistor Circuits for Radio Controlled Models by Boys, 7/6, postage 6d.

Transistor Audio Amplifier Manual Book 2 by Sinclair, 6/-, postage 6d.

UNIVERSAL BOOK CO.

12 Little Newport Street, London, W.C.2 (adjoining Lisle Street)

Elements of Electronic Circuits

This book covers a multitude of circuit devices in such branches of electronics as radar, television and computers. Invaluable both as reference book and as an instruction manual for students and service technicians.

by J. M. Peters. Postage 1/-.

21/- THE RADIO AMATEUR'S HANDBOOK by A.R.R.L. 1962 ed. 32/-, Postage 2/-.

RADIO CONTROL HANDBOOK by H. G. McEntee, new ed. 40/-, Postage 1/-.

HINTS AND KINKS for TV RADIO AND AUDIO, by M. Clifford. 18/6. Postage 9d.

INDUSTRIAL ELECTRONICS, Made Easy by T. Jaski. 32/-, Postage 1/-.

RADIO VALVE DATA, 7th ed. Compiled by "W.W." 6/-, Postage 10d.

AMATEUR RADIO CALL BOOK, R.S.G.B. 1962 ed. 4/6. Postage 6d.

COMPLETE CATALOGUE 1/-.

THE MODERN BOOK CO.

BRITAIN'S LARGEST STOCKISTS of British and American Technical Books

19-21 PRÆD STREET

LONDON, W.2

Phone: PADDington 4185

Open 6 days 9-6 p.m.

2 METRES!

The thrills of 144 Mc/s can now be yours for only 39/6, complete kit! Tunable range 150-100 Mc/s, simplified construction, etc., write today for descriptive literature, also if a newcomer-beginner to Amateur Radio ask for free copy of the world-famous "Globe-King" kits and receivers—stamp to cover postage costs appreciated. Write now to makers:

JOHNSONS (Radio)

St. Martins Gate, Worcester

18,000 O.P.V.

MULTIMETER KITS

Ranges 0-0.25 and 2.5V D.C.; 10, 25, 100, 250, 500, 1000V A.C., D.C., and output volts; Ohms 100 ohms to 10 MΩ. (two ranges); 0.25, 2.5, 25, 250mA D.C. (2.5A range 4/- extra). Kit comprises new 3 x 2 1/2in. Weston 0-50 microamps m.e. meter, all 1% multipliers, 1% ready adjusted shunts, padding resistor adjusted for each meter, 3 other resistors, 1 condenser, meter rec., knobs, switches, sockets, pots, circuit instructions, wiring diag., scale (ohms, dB, μF, mA & V, 10V A.C. scales) i.e. everything except case and battery. Details of 200P-0.5μF range. Price 69/11, post free. Scale fitted to meter, 2/6 extra.

Ston. Press. 1% stability multipliers now supplied while stocks last at no extra cost. Meter only, as above, with circuit, multi-meter scale, etc., 22/6, post 1/6. The resistance of every meter is measured before despatch. Circuit, scale, wiring diag., 8d., free with meter or kit.

PLANET INSTRUMENT CO.

25 DOMINION AVE., LEEDS 7

EDDY'S (NOTTM.) LTD.

116 ALFRETON ROAD NOTTINGHAM

New or Surplus VALVES—

Guaranteed and Tested by Return Post.

| | | |
|------------|-------------|-------------|
| 1D5 7/6 | 6V6M 8/6 | EF86 8/11 |
| 1R5 5/6 | 6X4 4/6 | EF91 3/6 |
| 1S5 4/6 | 7C6 6/6 | EL32 6/11 |
| 1T4 3/6 | 7G6 7/11 | EL41 8/11 |
| 3A4 4/11 | 10F1 5/- | EL84 7/11 |
| 3V4 4/11 | 10P13 9/6 | EL91 4/6 |
| 5U4G 4/9 | 12A6 5/- | EY51 7/11 |
| 5Y3GT 5/11 | 12K7 5/3 | EY86 7/11 |
| 5Z4G 7/6 | 12Q7 5/3 | EZ40 5/11 |
| 6AC7 4/- | 20D1 8/6 | EZ41 6/9 |
| 6AM6 3/6 | 20P1 9/6 | EZ80 5/11 |
| 6AG5 3/6 | 20P3 12/6 | EZ81 6/11 |
| 6BW6 7/6 | 25L6GT 7/6 | GTIC 5/6 |
| 6BW7 7/6 | 30F5 6/11 | HL23DD 6/11 |
| 6B8G 2/11 | 35L6GT 7/11 | KT33C 6/6 |
| 6B16 6/11 | 35Z4 5/3 | MU14 6/6 |
| 6C4 3/6 | 80 6/11 | OZ4 5/11 |
| 6CH6 8/6 | 954 1/6 | PCC84 7/11 |
| 6F1 5/- | 955 3/6 | FCC89 9/- |
| 6F15 5/- | 956 2/6 | FCF80 8/6 |
| 6F13 5/- | 185BT 15/6 | FCF82 7/11 |
| 6F33 6/6 | AC2/ | FCL82 8/6 |
| 6J5G 2/9 | PENDD 9/6 | PCL83 11/6 |
| 6J5GT 3/9 | CIC 9/6 | PCL84 9/6 |
| 6J5M 4/3 | CL33 11/9 | PCL85 9/6 |
| 6J7G 5/- | CY31 9/6 | PL36 10/6 |
| 6K6 3/11 | EB41 4/11 | PL81 9/6 |
| 6K7G 1/11 | EB91 3/6 | PL82 7/6 |
| 6K8G 5/6 | EBF80 7/9 | PL83 7/6 |
| 6P25 9/6 | ECC40 14/6 | PY31 9/6 |
| 6P28 9/6 | ECC81 5/3 | PY32 10/11 |
| 6Q7G 5/11 | ECC84 8/11 | PY80 6/11 |
| 6SA7M 5/9 | ECC85 6/11 | PY81 6/11 |
| 6SG7M 4/9 | ECF82 8/3 | PY82 5/11 |
| 6SJ7M 5/9 | ECL80 7/11 | PY83 7/6 |
| 6SL7GT 6/6 | ECL82 9/- | PEN 8/- |
| 6SN7GT 4/3 | EF36 3/- | 36C 3/6 |
| 6U4GT 12/6 | EF37A 5/11 | PZ30 9/6 |
| 6V6G 4/9 | EF39 5/11 | SP41 2/6 |
| 6V6GT 6/- | EF40 12/3 | TDD4 7/6 |

BUILD YOUR OWN CAR RADIO!

- 7 Transistor
- Long and Medium Wave
- Two Watts Output
- R.F. Stage and Automatic Gain Control



10 1/2 Gns. P & P 5/6 extra

6 or 12 volts (state which) Supplied with full instructions Size 7 1/2 x 7 1/2 x 2 1/2in. SPEAKER, extra 17/11

NIFE ACCUMULATORS. 1.25 v. Size 3 x 2 1/2 x 1 1/2in. 7 amp hrs. Weight 13 ozs. 2/11 each. P. & P. 2/-, one only add 9d. per cell.

GERMANIUM DIODES. 9d. each 7/1-dozen. Post 6d.

THROAT MIKES 2/- each, Post 10d. Super quality model 3/-. Could be used for electrifying musical instruments, etc.

VIBRATORS. 12 v. 4 pin 5/11, 6 v. 4 pin 8/11. Post 1/6.

Any parcel insured against damage in transit for only 6d. extra per order. All uninsured parcels at customer's risk. Post and Packing 6d. per valve extra. C.W.O. or C.O.D. only. C.O.D. charge 3/- extra. S.A.E. with enquiries.

3/4 WATT 4 TRANSISTOR AMPLIFIER

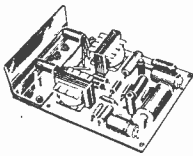

● 1 watt peak output.
±3db 70c/s to 12 kc/s.
Output to 3 ohm speaker
9 volt operated.
Details on request.

Built and Tested Kit of Parts
69/6 OR 62/6
P.P. 1/6 P.P. 1/6

A printed circuit high gain amplifier size 4 x 2 1/2 x 3/4 in. using Mullard OC71/OC81D and 2-OC81 Transistors. Ideal for Intercomm., Record Player, Tuner Amplifier or any application requiring a quality and reliable amplifier.
Suitable 5in. speaker 15/-.

R208 COMMUNICATIONS RECEIVER "SPUTNIK SPECIAL"

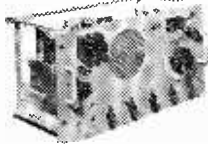

THE WORLD IN YOUR HOME

New offer of this well-known Three-Wave Band Short Wave Receiver. Coverage 10-60 Mc/s (5-30 metres). Plugs into standard mains (or 6 volt accumulator). Built-in 6 1/2 in. speaker. BFO slow motion tuning. 6-valve Superhet with R.F. stage and 2 Mc/s I.F.

In Absolutely New Condition with Full Handbook in Steel Case.

£11.19.6
Carriage 15/-

TRANSISTORS

New Price Reductions

| | | | | | |
|-------|------|-------|------|-------|------|
| AF117 | 9/6 | OC83 | 6/- | OC139 | 13/6 |
| AFZ12 | 35/- | OC84 | 8/6 | OC140 | 29/- |
| AC107 | 14/6 | OC75 | 7/- | OC200 | 10/6 |
| OC71 | 5/6 | OC35 | 18/- | OC201 | 31/- |
| OC72 | 7/- | OC44 | 9/3 | OC22 | 23/- |
| OC76 | 7/- | OC45 | 8/6 | OC71 | 29/- |
| OC81 | 7/- | OC170 | 9/6 | OC41 | 9/6 |
| OC78 | 7/- | OC171 | 10/6 | OC42 | 9/6 |

Send for New List of Fully Guaranteed Transistors, Diodes, Zener Diodes, Silicon Rectifiers, etc.

SPECIAL REDUCTIONS FOR SETS

BATTERY RECORD PLAYER



● 6-7 1/2 volt Garrard turntable with crystal pick-up. Plays 45 r.p.m. Ideal for above amplifiers
65/- P.P. 1/6.
● Suitable cabinet for amplifier and player 22/6.

Henry's Radio Ltd

PADDINGTON 1008/9

5 HARROW ROAD, LONDON W2

Open Monday to Sat. 9-6, Thurs. 1 o'clock

TRADE SUPPLIED

PLEASE TURN TO BACK PAGE

A Selection of items available from stock

- 4-Transistor Two-way Intercomm. 2-way buzzing, 2-speakers, ready to use, **8 gns.**, P.P. 2/6.
- Miniature 15 watt Solder Iron, 1/2 bit. Ideal for all printed circuit work, **29/6**, P.P. 1/6.
- New Model Control Book with 60 pages of transistor circuits, **7/6**, P.P. 6d.
- Complete Set of Meter Leads with Prods. Clips etc. with pouch, **8/6**, P.P. 1/-.
- Telephone Recording Coil to record conversations. For all amplifiers and recorders, **14/-**, P.P. 9d.
- Printed Circuit Kit, toetch your own circuits. Complete with boards and details, **19/6**, P.P. 1/-.
- Miniature 850 ohm Record/Playback Head, with mounting block, **12/6**, P.P. 9d.
- 4,000 ohm lightweight Headphones with leads. Very sensitive, **12/6**, P.P. 1/-.
- Transistor Pocket RF, IF Generator for Radio, TV etc. Fault finding, **52/6** P.P. 1/-.
- 8-Range All Transistor Signal Generator, 200 kc/s to 220 mc/s: RF, AF, IF, HF, etc., **£7.10.0**, P.P. 3/6.
- GS12C (Dekatron) Bi-directional 12 way indicator tube. Brand new, **12/6**.
- Caby M1 Pocket Multimeter, 2,000 ohms per volt. With leads and instructions, **54/-**, P.P. 1/6.
- 4 1/2-9 volt Tape Recorder Motor, **12/6**, P.P. 1/-.
- 30 watt Pocket Solder Iron, with pocket pouch and mains plug, **18/6**, P.P. 1/-.
- 931A Photo Multiplier. Brand new, **60/-**.
- 1 Kc/s Transistor Audio Test osc., variable output, **39/6**, P.P. 1/6.
- Crystal Contact Microphone. Very sensitive. Ideal for Guitar, **12/6**, P.P. 9d.
- 4-Transistor Telephone Amplifier. Amplifies without connection to phone. Ideal for office, works or home, **£5.10.0**, P.P. 2/6.
- Practical Transistor Circuits. 40 circuits to build, **3/6**.
- Personal Earphones with leads, Jack plug and socket, 600 ohm **10/6**; 1000 ohm **12/6**; Crystal **9/6**.
- W/W Erase Head, FE7, **7/6**, P.P. 6d.
- Dynamic Microphone, **49/6**, P.P. 1/6.
- Battery Eliminator and Charger, for PP3 type 9 volt batteries. To run pocket Radios from mains and charge battery, **29/6**, P.P. 1/-.
- Extension Speaker Unit. Plugs into phone socket or most portables. Gives big set volume. Ideal for car use, **57/6**, P.P. 1/6.
- 200H Pocket Multi-meter, 20,000 ohms per volt, with instructions etc., **£6.19.6**, P.P. 1/6.

| Miniature Panel Meters | Components |
|------------------------------|---|
| 0/50µA (DC) 39/6 | We stock the largest range of miniature components in the country. Send 1/- stamp for new catalogues. |
| 0/500µA (DC) 32/6 | |
| 0/1mA (DC) 27/6 | |
| 0/5mA (DC) 27/6 | |
| 0/300 volts (DC) 27/6 | |
| Brand New Boxed | |

- 7-Section Telescopic Aerial, **12/6**, P.P. 1/-.
- LA1 Ferrite Pot Core, **12/6**, P.P. 6d.
- FX1011 Miniature Ferrite Pot Core, **17/6**, P.P. 6d.
- Miniature Jack and Socket, **3/6** P.P. 6d.
- No. 19 Set Crystal Calibrator with Handbook, **79/6**, P.P. 2/-.

4 TRANSISTOR PUSH-PULL AUDIO MODEL PK-543 AMPLIFIER

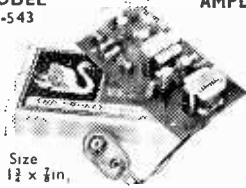

Size 3 x 1 1/2 x 3/4 in.

A ready built miniature 250mW push-pull amplifier incorporating input and output transformers, 4 transistors, 9 volt battery snap cord, speaker and volume connection leads. Ideal for use with record players, intercoms, hearing aids, tape recorders, etc. Complete with full instructions and circuit diagram.

PRICE 52/6 P.P. 1/6

SUITABLE 2 1/2 inch SPEAKER 16/6

AVO-7

Famous Multi-meter. Reconditioned and fully guaranteed. Full A.C./D.C. voltage and current.



resistance, dB, power, etc., etc. Supplied with Batteries, Leads and Instructions.
£11.10.0 Regd. Post 5/-.

CRYSTAL MICROPHONES

- ACOS 39-1.** Stick Microphone with screened cable and stand (list 5 gns.), **32/6**, P.P. 1/6.
- ACOS 40.** Desk Microphone with screened cable and built-in stand (list 50/-), **15/-**, P.P. 1/6.
- ACOS 45.** Hand Microphone with screened lead, very sensitive, **25/-**, P.P. 1/6
- 100 C.** Stick Microphone with muting switch and screened cable, detachable desk stand, cord and neck, **39/6**, P.P. 1/6.
- MC 24.** Stick Microphone with muting switch and cable, **25/-**, P.P. 1/6.
- LAPEL.** Miniature Mic. With clip. Ideal for recording **15/-**, P.P. 1/-.

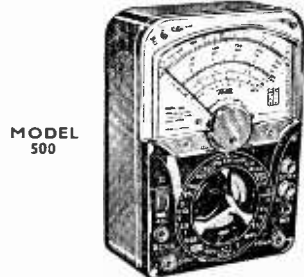

MODEL 500

30,000 ohms per volt multimeter. 8 Ranges D.C. volts to 1 kV. 7 Ranges A.C. volts to 1 kV. 5 Ranges D.C. current to 12 amps. 3 Range resistance to 60 meg. Short circuit, Buzz test, Output meter, dB etc., etc. Size 6 1/2 x 4 1/2 x 2 1/2 in. With Leads, Batteries and Instructions.
£8.19.6. P.P. 2/-.

Practical Wireless

BLUEPRINT

SERVICE

ALL OF these blueprints are drawn full-size and although the issues containing descriptions of these sets are now out of print, constructional details are available free with each blueprint except for the PW Monophonic Electronic Organ and the PW Roadfarer.

The Index letters which precede the Blueprint Number indicate the periodical in which the description appeared. Thus PW refers to PRACTICAL WIRELESS; AW to *Amateur Wireless* and WM to *Wireless Magazine*.

Send (preferably) a postal order to cover the cost of the Blueprint (stamps over 6d. unacceptable) to

PRACTICAL WIRELESS, Blueprint Dept., George Newnes, Ltd., Tower House, Southampton Street, London, W.C.2.

SPECIAL NOTE

THE following blueprints include some pre-war designs and are kept in circulation for those constructors who wish to make use of old components which they may have in their spares box. The majority of the components for these receivers are no longer stocked by retailers.

| Title | Number | Price | Title | Number | Price |
|--|--------|-------|--------------------------------------|--------|-------|
| CRYSTAL SETS | | | | | |
| Junior Crystal Set | PW94 | 2/- | A.C. Fury Four | PW20 | 2/6 |
| Dual-wave Crystal Diode | PW95 | 2/6 | Experimenter's Short Wave | PW30a | 2/6 |
| STRAIGHT SETS | | | | | |
| Battery Operated | | | | | |
| Modern One-valver | PW96 | 2/6 | Midget Short Wave Two | PW38a | 2/6 |
| All-dry Three | PW97 | 3/6 | Band-Spread Three (Battery) | PW68 | 2/6 |
| Modern Two-valver | PW98 | 3/6 | Crystal Receiver | PW71 | 2/- |
| SUPERHETS | | | | | |
| A.C. Band-pass Three | PW99 | 4/- | Signet Two (Battery) | PW76 | 2/6 |
| A.C. Coronet-4 | PW100 | 4/- | Simple S.W. One-valver | PW88 | 2/6 |
| A.C./D.C. Coronet | PW101 | 4/- | Pyramid One-valver | PW93 | 2/6 |
| The PW Pocket Superhet | — | 5/- | <hr/> | | |
| MISCELLANEOUS | | | | | |
| The PW 3-speed Autogram | — | 8/- | BBC Special One-valver | AW387 | 2/6 |
| The PW Monophonic Electronic Organ | — | 8/- | A One-Valver for America | AW429 | 2/6 |
| <i>(No constructional details are available with this blueprint)</i> | | | | | |
| The PW Roadfarer | — | 5/- | Short-Wave World Beater | AW436 | 3/6 |
| <i>(No constructional details are available with this blueprint)</i> | | | | | |
| TELEVISION | | | | | |
| The PT Band III converter | — | 1/6 | <hr/> | | |
| | | | Standard Four Valve S.W. | WM383 | 3/6 |
| | | | Enthusiast's Power Amplifier | WM387 | 3/6 |
| | | | Standard Four Valve | WM391 | 3/6 |
| | | | Listener's 5-Watt Amplifier | WM392 | 3/6 |

QUERY COUPON

This coupon is available until 7th June, 1962, and must accompany all queries in accordance with the notice on our "Letters to the Editor" page.

PRACTICAL WIRELESS, JUNE, 1962

WE GUARANTEE 100% SUCCESS

● DETAILS OF ANY MODEL FREE ON REQUEST

● THOUSANDS OF SATISFIED CUSTOMERS—YOU CAN BECOME ONE TOO ●

"CAPRI" - POCKET SIX RADIO



Size only $4\frac{1}{2} \times 2\frac{1}{2} \times 1\frac{1}{2}$ in.

Really Pocket Size!

£7.10.0 P.P. 2/- (Battery 2/6).

A new design 6-Transistor Printed Circuit Superhet for Medium and Long Waves. Uses all sub-miniature parts. Sub-min. Mullard Transistors. Quality speaker output, fitted earphone/record Sockets. Cabinets Red/White or Blue/White with Gold fittings.

"RANGER 3"

Size $4\frac{1}{2} \times 3 \times 1\frac{1}{2}$ in.



A Three Transistor Two Diode Personal Radio for Medium Waves and Amateur top band and shipping. Quality output on personal phone. Fitted air spaced tuner, vol. control. No aerial or earth. Luxembourg guaranteed.

69/6 P.P. 1/6.

"TRANSFIVE" PORTABLE RADIO



Medium and Long Wave Portable $8\frac{1}{2} \times 6\frac{1}{2} \times 3\frac{1}{2}$ in.

£6.19.6 P.P. 2/6

A 5-Transistor and Diode, Printed Circuit, Medium and Long Wave Portable. Features 5in. speaker, Car aerial socket, Mullard transistors and carded components. **THE IDEAL PORTABLE.**

- PW Regency.
- PW Minuette.
- PW Tutor
- PW Mini-amp.
- PW Citizen.
- PW Superhet
- PW Shortwave 2.
- PW Tuner

All parts in stock for these PW Designs. Parts Lists on Request.

Henry's Radio Ltd

PADdington 1008/9
5 HARROW ROAD, LONDON W2
 Open Monday to Sat. 9-6 Thurs. 1 o'clock
 Send 1/- Stamp for New Illustrated Price Lists.

← PLEASE TURN PAGE

"CONTESSA" PORTABLE CAR RADIO
 6 TRANSISTOR MEDIUM AND LONG WAVE SUPERHET RADIO.



Unbeatable in performance and appearance.

Features the latest in design and performance, giving ease of station selection. Excellent Tone and Volume with amazing sensitivity and selectivity. Attractive two colour cabinets. Size $10 \times 7\frac{1}{2} \times 3\frac{1}{2}$ in. Blue/White or Red/White. Fitted 5-inch speaker giving up to 425mW Push-Pull quality output. Full avc. fitted car aerial socket. 6-matched transistors. 2-diodes.

Total Cost £10.19.6 P.P. 3/6

GUARANTEED THE BEST OBTAINABLE



MODEL TH-L33
 2,000 ohms per volt AC/DC. Size $7\frac{1}{2} \times 3\frac{1}{2} \times 1\frac{1}{2}$ in.

79/6 P.P. 1/6. with test leads, battery and instructions.

0/10, 50/250/500/1000 volts D.C.,
 0/10, 50/250/500/1000 volts A.C.,
 0/500µA, 10/250mA., D.C.
 3 ranges resistance 0/10K/100K/1 Meg. Capacity and dB ranges.

BABY SITTER



ALL TRANSISTOR BABY OR INVALID ALARM

HOUSED IN ATTRACTIVE GOLD HAMMER FINISH PORTABLE CABINET. Battery operated, push-pull, 400mW output. Low impedance microphone enables unit to be used up to 200 yards. Output on quality speaker.

- ★ GUARANTEED FOR 12 MONTHS and 100% SAFE.
- ★ MICROPHONE is placed within 10ft. of baby; twin flex is taken to amplifier unit and placed in any room required. COMPLETELY BUILT & TESTED. P.P. 2/6. **£5.10.0**
- ★ Used All Night, Every Night. Battery Life 3 to 4 months.

"QUINTET" POCKET RADIO

Size $5\frac{1}{2} \times 3 \times 1\frac{1}{2}$ in.

Red or Blue and Gold trim

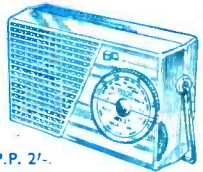

£5.10.0 P.P. 2/-

A Five Transistor Medium and Long Wave Printed Circuit Loudspeaker Radio, with Excellent Results including Luxembourg, guaranteed with full station separation. Supplied with Mullard Transistors and Carded Components. Fitted earphone/record socket.

Performance will amaze you.

"RANGER 2"



A Two Transistor Two Diode Personal Pocket Radio. Covering medium waves and top band.

Supplied with battery and quality Personal Phone. No aerial or earth.

Size $4\frac{1}{2} \times 3 \times 1\frac{1}{2}$ in. **55/-** P.P. 1/6.

"PW-6" SUPERHET RADIO

Medium and Long Wave Radio

Size $5\frac{1}{2} \times 3\frac{1}{2} \times 2\frac{1}{2}$ in.



£8.10.0 P.P. 2/-

Modified version of previously advertised "PW" Superhet. Now with new style Two Tone Cabinet. 1st grade components and transistors. Printed circuit.

TRANSISTOR PORTABLE TAPE RECORDER for home, office or travel

- Play/record up to 30 mins.
- Built-in speaker volume control batteries and play/record/re-wind.
- Perfect speech recording.
- Sturdy case $6 \times 8\frac{1}{2} \times 2\frac{1}{2}$ in.

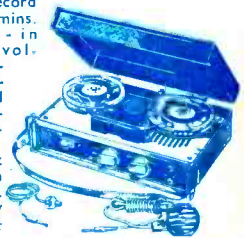

£11.19.6 Ready To Use Fully Guaranteed

Supplied complete with microphone, tape, batteries and personal phone.

712