

APRIL
1962

31
Practical 2/-
WIRELESS

FREE inside!

**DOUBLE-SIDED
BLUEPRINT**

for

★ **BATTERY-OPERATED
SHORT WAVE
RECEIVER**

★ **4-TRANSISTOR
M.W. / L.W.
PORTABLE**



THE P.W. REGENCY

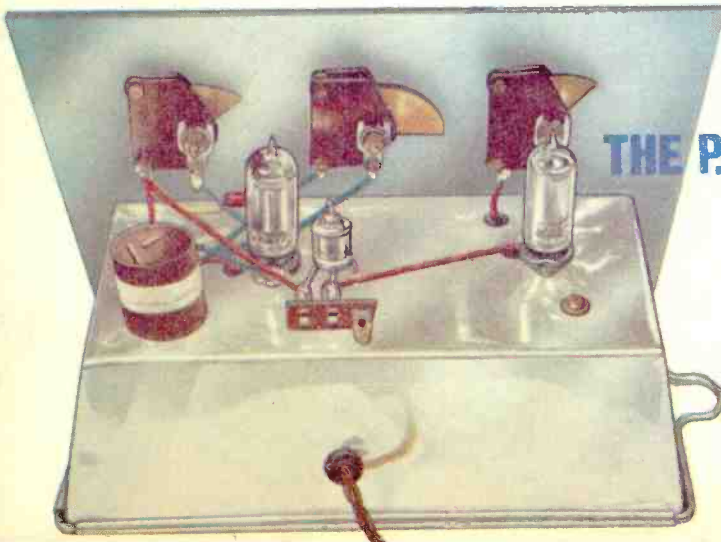

**THE P.W. INTERNATIONAL
SHORT WAVE TWO**



Stentorian



This range of Stentorian loudspeakers, incorporating the patented cambric cone, was developed to provide reproduction that takes full advantage of the television and V.H.F. sound transmissions and high fidelity recordings now available. The cone of the loudspeaker is made from uncured cambric and bonded pulp, the whole being completely cured together and made into one composite cone.

| Type | Flux Density | Price | Type | Flux Density | Price |
|-------------|--------------|----------------------------------|---------------|--------------|----------|
| 8" H.F.816* | 16,000 gauss | £7.0.9 | T.186 | 16,000 gauss | £6.13.3 |
| 8" H.F.812* | 12,000 gauss | £4.5.6 | T.12 tweeter | 16,000 gauss | £13.4.6 |
| 8" H.F.810 | 10,000 gauss | £3.3.6 | T.10 tweeter | 14,000 gauss | £4.8.3 |
| 6" H.F.610 | 10,000 gauss | £2.12.9 Steel £2.15.0 diecast | T.359 tweeter | 9,000 gauss | £1.15.10 |

MODEL H.F. 1016

10" Unit H.F. 1016. 16,000 gauss. Instantaneous matching at 3, 7.5 and 15 ohms. Handling capacity 10 watts. Frequency response 30 c.p.s. to 15,000 c.p.s. Bass resonance, 35 c.p.s.

Price £8.4.0 (inc. P.T.)

* Incorporates a universal impedance speech coil.

WHITELEY ELECTRICAL RADIO CO. LTD. MANSFIELD, NOTTS

Telephone: MANSFIELD 1762-5

London Office: 109 Kingsway, London, W.C.2

WA3

JACKSON

the big name in **PRECISION** components

Precision built radio components are an important contribution to the radio and communications industry.

Be sure of the best and buy Jackson Precision Built Components.

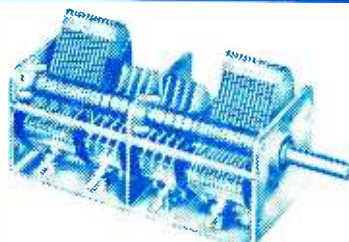

AM/FM
Gang
Condenser
Type 5320

JACKSON BROS. (LONDON) LTD.

KINGSWAY-WADDON, SURREY

Phone: Croydon 2754-5 Grams: Walfico, Souphone, London

SPECIAL FOR THE "HAMS" RADIO STATION

Illustrated

$\frac{1}{8}$ inch detachable bit soldering instrument
List No. 70

Combined Protective Unit with Wiper/Abrasion Pad and Solder Reel
List No. 700

Apply **SALES & SERVICE**

ADCOLA
PRACTICE STOVES
(High Grade wire)

**ADCOLA HOUSE
GAUDEN ROAD
LONDON, S.W.4**

Telephones:
MACaulay 4272-3101

Telegrams:
"SOLJOINT, LONDON, S.W.4."

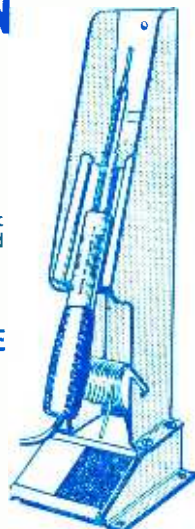

British & Foreign
Patents, Registered
Designs, etc.

Tel: Mitcham 6201
Open Daily to Callers



All Valves Brand New
and Fully Guaranteed

211 STREATHAM ROAD, MITCHAM, SURREY

Special 24 Hour Express Mail Order Service

| | | | | | | | | |
|-------------|------------|--------------|--------------|------------|-------------|------------|------------|-------------|
| AC2PEN21/- | ECC91 4/- | EZ35 6/- | PCF80 9/6 | U12 9/- | UY85 7/- | 524GT 12/6 | 6LD20 14/- | 12C8 8/6 |
| AC2PEN | ECF80 8/6 | EZ43 7/- | PCF82 7/- | U14 9/- | VMS4B 12/6 | 6A7 9/- | 6P25 10/6 | 12J5GT 4/- |
| DD 21/- | ECF82 21/- | EZ49 7/- | PCF34 16/- | U22 8/- | VP4 15/- | 6A8G 8/6 | 6P28 17/6 | 12J7GT 8/6 |
| ACTP 32/- | ECH3 22/- | EZ81 7/- | PCF85 15/- | U24 21/- | VP4A 17/6 | 6A8GT 13/6 | 6Q7 6/6 | 12K7GT 5/- |
| ACVP1 17/6 | ECH21 22/- | EZ93 7/- | PCL82 9/6 | U25 12/6 | VP4B 17/6 | 6A8B 9/- | 6Q7GT 8/6 | 12K8GT 10/- |
| AZI 13/6 | ECH42 5/6 | EL143 2/- | PCL83 12/6 | U26 10/- | VR10530 7/- | 6A1B 9/6 | 6SA7 7/- | 12Q7GT 6/6 |
| AZ31 10/- | ECH85 10/- | FC2 21/- | PCL84 10/6 | U27 8/- | VR15030 7/- | 6AK5 5/- | 6S7 7/- | 12SA7 8/6 |
| B3C 12/6 | ECH81 8/- | FC2A 21/- | PCL85 16/- | U31 9/- | VU39 9/- | 6AK8 7/6 | 6SH7 6/- | 12SK7 6/- |
| CB131 21/- | ECL80 9/6 | FC2A 21/- | PENA4 17/6 | U35 17/6 | VU111 2/6 | 6AL5 6/- | 6S7 6/6 | 12SQ7 8/6 |
| CC3H35 21/- | ECL82 9/6 | FC4 15/- | PENB4 17/6 | U37 17/6 | VU120 2/6 | 6AM5 5/- | 6S7 6/6 | 12SL7 8/- |
| CL33 18/6 | ECL32 9/6 | FC13C 21/- | PEN4DD 25/- | U43 8/6 | W6 11/- | 6AM6 4/- | 6SL7GT 6/- | 12SN7 10/- |
| CY1 15/9 | ECL83 12/- | FW4/500 9/- | PEN4VA 17/6 | U45 10/- | W76 5/- | 6AN5 7/6 | 6SN7GT 5/6 | 13D3 12/6 |
| CY31 15/9 | EF6 21/- | FW4/300 9/- | PEN36C 21/- | U47 12/6 | W77 4/- | 6AQ5 9/6 | 6SU7 8/6 | 14H7 10/- |
| D77 4/- | EF9 21/- | GZ30 10/6 | PEN45 17/6 | U50 7/6 | W81 6/- | 6AQ8 9/3 | 6UAGT 10/- | 14R7 10/- |
| DAC32 9/6 | EF22 14/- | GZ32 10/6 | PEN45DD 22/6 | U52 4/- | W81M 6/- | 6AT6 6/- | 6U5G 7/6 | 14S7 15/- |
| DAF91 7/6 | EF36 4/- | GZ33 19/3 | PEN46 5/- | U76 7/6 | X17 8/6 | 6A16 9/- | 6V6 4/6 | 19AQ5 8/- |
| DAF96 8/9 | EF37 8/- | GZ34 13/6 | PEN45DD 22/6 | U73 4/6 | X18 9/- | 6B8G 3/- | 6V6GT 8/- | 19B6G 21/- |
| DDCC90 14/6 | EF37A 8/- | GZ37 19/3 | PEN46 5/- | U251 12/6 | X21 15/- | 6BA6 6/- | 6X5 7/6 | 20D1 10/- |
| DF33 10/- | EF39 4/- | HABC80 10/- | PEN45DD 22/6 | U281 18/- | X61 12/6 | 6BE6 6/- | 6X5GT 8/6 | 20F2 17/6 |
| DF91 4/- | EF40 15/- | HL41DD 8/6 | PEN46 5/- | U282 19/6 | X65 12/6 | 6BE6 6/- | 6X6 15/- | 20L1 17/6 |
| DF92 7/6 | EF41 8/- | HL92 8/6 | PEN45DD 22/6 | U301 22/6 | X76 12/6 | 6BH6 8/- | 6X6 15/- | 20P1 25/- |
| DF96 8/6 | EF42 10/- | HL133DD 25/- | PEN45DD 22/6 | U329 2/- | X76 12/6 | 6B8 6/- | 6X6 15/- | 20P3 25/- |
| DF97 9/6 | EF50A 3/6 | HN309 20/- | PL33 15/- | U339 15/- | X76 12/6 | 6B7A 12/6 | 6X6 15/- | 20P4 22/- |
| DH63 6/- | EF50E 3/6 | IW4/350 10/- | PL38 21/- | U403 10/- | X78 21/- | 6B87 12/6 | 6X6 15/- | 20P5 25/- |
| DH77 7/- | EF80 5/- | IW4/500 10/- | PL81 12/- | U404 10/- | X79 21/- | 6B87 12/6 | 6X6 15/- | 21B6 12/6 |
| DK32 11/6 | EF85 5/- | IW4/500 10/- | PL82 8/- | U80 29/- | Y6 10/- | 6BW6 7/- | 6X6 15/- | 25A6 8/- |
| DK91 8/- | EF86 10/6 | KT33C 8/- | PL83 10/6 | UABC80 7/6 | Y66 9/6 | 6BW7 5/- | 6X6 15/- | 25L6 8/- |
| DK92 8/6 | EF89 9/- | KT36 17/6 | PL84 10/6 | UABC80 7/6 | Z63 7/6 | 6BX6 5/- | 6X6 15/- | 25Y5 8/- |
| DK96 8/6 | EF91 4/- | KT55 17/6 | PL84 10/6 | UBA1 7/6 | Z66 10/6 | 6C4 3/6 | 6X6 15/- | 25Z4 7/6 |
| DL33 8/6 | EF92 4/- | KT61 9/6 | PL82 10/6 | UBC41 8/6 | Z77 4/- | 6CSGT 8/- | 6X6 15/- | 25Z5 8/- |
| DL35 10/6 | EF95 9/6 | KT66 15/- | PL82 10/6 | UBC81 10/- | Z152 5/- | 6C6 6/6 | 6X6 15/- | 25Z6 8/- |
| DL92 7/6 | EF97 12/6 | KT75 10/- | PL82 10/6 | UBF80 8/6 | ZD17 8/- | 6C9 12/6 | 6X6 15/- | 25Z7 8/- |
| DL93 7/6 | EF99 12/6 | KT81 15/- | PL82 10/6 | UBF80 8/6 | ZD152 8/- | 6C9 12/6 | 6X6 15/- | 25Z8 8/- |
| DL94 8/- | EF183 18/- | KT88 21/- | PL82 10/6 | UCF87 7/6 | OZ4 5/- | 6C6 10/- | 6X6 15/- | 30C1 9/6 |
| DL95 8/6 | EF184 14/- | L63 5/- | PL82 10/6 | UBL21 21/- | IA7 11/6 | 6D2 4/- | 6X6 15/- | 30F5 10/- |
| EA50 2/- | EK32 8/6 | LNI52 9/- | PL82 10/6 | UCC84 10/6 | IC1 8/6 | 6D6 5/6 | 6X6 15/- | 30FL1 10/6 |
| EABC93 6/- | EL2 21/- | LN309 12/6 | PL82 10/6 | UCC85 7/6 | IC2 9/- | 6E5 10/6 | 6X6 15/- | 30L1 9/6 |
| EAC91 4/- | EL3 21/- | LZ319 12/6 | PL82 10/6 | UCF80 13/6 | IC3 9/- | 6E5 10/6 | 6X6 15/- | 30L15 11/6 |
| EAF42 9/6 | EL6 21/- | MKT4 17/6 | PL82 10/6 | UCH21 21/- | IC5 10/6 | 6F1 10/6 | 6X6 15/- | 30P12 10/- |
| EB34 2/6 | EL32 4/6 | M54B 17/6 | PL82 10/6 | UCH42 9/6 | IC5 10/6 | 6F6 6/6 | 6X6 15/- | 30P16 9/6 |
| EB41 7/6 | EL33 10/- | MVSPEN 17/6 | PL82 10/6 | UCH81 8/- | ID5 8/6 | 6F11 10/- | 6X6 15/- | 30P18 15/- |
| EB91 4/- | EL34 15/- | MVSPEN 17/6 | PL82 10/6 | UCH81 8/- | ID6 10/6 | 6F12 4/- | 6X6 15/- | 30P19 10/- |
| EB33 21/- | EL35 10/- | MVSPEN 17/6 | PL82 10/6 | UCH81 8/- | ID6 10/6 | 6F13 10/- | 6X6 15/- | 30P19 10/- |
| EBC33 4/6 | EL37 17/6 | MVSPEN 17/6 | PL82 10/6 | UCH81 8/- | ID6 10/6 | 6F14 10/- | 6X6 15/- | 30P19 10/- |
| EBC41 9/- | EL38 21/- | MU14 9/- | PL82 10/6 | UCH81 8/- | ID6 10/6 | 6F15 12/6 | 6X6 15/- | 30P19 10/- |
| EBC81 10/- | EL41 10/- | MX40 15/- | PL82 10/6 | UCH81 8/- | ID6 10/6 | 6F19 12/6 | 6X6 15/- | 30P19 10/- |
| EBF80 8/6 | EL42 10/- | N13 8/- | PL82 10/6 | UCH81 8/- | ID6 10/6 | 6F23 10/6 | 6X6 15/- | 30P19 10/- |
| EBF33 8/6 | EL81 12/6 | N37 14/- | PL82 10/6 | UCH81 8/- | ID6 10/6 | 6F33 5/6 | 6X6 15/- | 30P19 10/- |
| EBF89 8/6 | EL84 6/6 | N73 17/6 | PL82 10/6 | UCH81 8/- | ID6 10/6 | 6H6 2/6 | 6X6 15/- | 30P19 10/- |
| EBL1 22/6 | EL85 10/- | N108 18/- | PL82 10/6 | UCH81 8/- | ID6 10/6 | 6I5 4/6 | 6X6 15/- | 30P19 10/- |
| EBL21 23/- | EL93 6/6 | N303 20/- | PL82 10/6 | UCH81 8/- | ID6 10/6 | 6J5 4/6 | 6X6 15/- | 30P19 10/- |
| EBL31 21/6 | EL91 4/- | N339 30/- | PL82 10/6 | UCH81 8/- | ID6 10/6 | 6J6 3/6 | 6X6 15/- | 30P19 10/- |
| ECC34 15/- | EL95 10/6 | N369 10/6 | PL82 10/6 | UCH81 8/- | ID6 10/6 | 6J7 5/6 | 6X6 15/- | 30P19 10/- |
| ECC35 8/- | EM80 8/6 | OD3 5/- | PL82 10/6 | UCH81 8/- | ID6 10/6 | 6K7 2/6 | 6X6 15/- | 30P19 10/- |
| ECC40 21/- | EM81 8/6 | OZ4 5/6 | PL82 10/6 | UCH81 8/- | ID6 10/6 | 6K7GT 8/6 | 6X6 15/- | 30P19 10/- |
| ECC81 5/9 | EM84 9/6 | P2 10/- | PL82 10/6 | UCH81 8/- | ID6 10/6 | 6K8 5/- | 6X6 15/- | 30P19 10/- |
| ECC82 8/6 | EM85 10/- | PABC80 13/- | PL82 10/6 | UCH81 8/- | ID6 10/6 | 6K8GT 9/6 | 6X6 15/- | 30P19 10/- |
| ECC83 7/6 | EY51 8/6 | PCC84 9/- | PL82 10/6 | UCH81 8/- | ID6 10/6 | 6K8GT 9/6 | 6X6 15/- | 30P19 10/- |
| ECC84 8/6 | EY81 8/6 | PCC85 9/- | PL82 10/6 | UCH81 8/- | ID6 10/6 | 6K8GT 9/6 | 6X6 15/- | 30P19 10/- |
| ECC85 8/- | EY83 15/- | PCC88 15/- | PL82 10/6 | UCH81 8/- | ID6 10/6 | 6K8GT 9/6 | 6X6 15/- | 30P19 10/- |
| ECC88 17/6 | EY86 8/6 | PCC89 9/6 | PL82 10/6 | UCH81 8/- | ID6 10/6 | 6K8GT 9/6 | 6X6 15/- | 30P19 10/- |

METAL RECTIFIERS

| | | | |
|------------|---------------|--------------|-------------------|
| RM1 5/3 | 14RA 1-2-8-2 | 17/6 (FC31) | 14A97 25/- |
| RM2. 7/6 | 16RC 1-1-16-1 | 8/6 | 14A100 27/- |
| RM3 7/9 | 14RA 1-2-8-3 | 19/- (FC31) | 16RD 2-2-8-1 12/- |
| RM4 14/- | 18RA 1-1-16-1 | 6/6 (FC116) | 16RE 2-1-8-1 8/6 |
| RM5 19/6 | 18RA 1-2-8-1 | 11/- | 18RA 1-1-8-1 4/6 |
| 14A86 17/6 | 18RD 2-2-8-1 | 15/- (FC124) | |

SPECIAL OFFER

EABC80 6/-, EAC91 4/-, EB91 4/-, EBF89 8/6, ECC81 5/9, ECC85 8/-, ECC91 4/-, ECH81 8/-, EBC33 4/6, EF39 4/-, EF50 3/6, EF80 5/-, EF85 5/-, EF91 4/-, DF91 4/-, EL84 6/9, PCC89 9/6, PL84 9/-, UABC80 7/-, UBF89 7/6, UF41 7/6, UL41 8/6, UF89 6/6, UL84 7/-, UY85 7/-, W81 6/-, OZ4 5/-, SU4 4/-, 6AQ5 6/6, 6BA6 6/-, 6BE6 6/-, 6D2 4/-, 6K7 2/6, 6K8 5/-, 6L6 7/6, 6Q7 6/6, 6SL7 6/6, 6SN7 5/6, 6V6 4/6, 6X5 5/-, 8D3 4/-, 807 5/-, 12AT7 6/6, 12AH8 9/-, 12BA6 7/6, 12BE6 7/6, 12K7 5/-, 12Q7 6/6,

OBsolete VALVES A SPECIALITY.
QUOTATIONS GIVEN ON ANY TYPE NOT LISTED

CLEARING DEPOT!

Unused, good quality equipment being offered at very keen prices!

Variable Rheostats, 4 or 80 heavy duty slider resistor rated at 25 amps. Ideal for dimmer circuits, etc. Sale price 7/6, plus 6d. postage.

Rectifier Bargain. Selenium rectifier 25 v. 25 amp., easily rebuilt into 6 full-wave charger rectifiers, each suitable 6 or 12 v. battery at 3 amps. Sale price 15/-, plus 3/6 postage.

80 ohm Coax. low loss expanded polythene, normally 9d. per yard. Sale price 6d. yd. Superhet 7 v. 5 Waveband Chassis. Unused, less valves and power pack, 75/-. Coil pack worth twice as much. Carriage and insurance 7/6.

Geiger Counter Tube, 20th Century. No. G25 with circuit gear, counter. Sale price 27/6. Transistor A.F. Equivalent to red spot. Sale price 2/6, 24/- doz.

Bakelite Wall Switch, household type, 6/- doz., one way 8/- doz. two way.

Wall Switch by Crabtree, two way and off. Sale price 1/- each.

Double pole, double throw toggle switch, heavy duty, 10 amp., 250 volts, suitable for controlling photoflood lamps, sale price 1/9 each, 18/- doz.

Multi-speed Motor with gearbox, works on A.C. or D.C. mains, gives any speed from 1 r.p.m. Sale price 17/6, plus 2/6 postage.

Chief Microphone, excellent American make with adjustable mouthpiece, 6/6, plus 1/6.

Singscope, "Cat's Eye" for seeing in the dark. Will work burglar alarms, circuits, etc. Sale price 4/-, plus 1/- post.

R.F. 25 Tuner Unit, complete, new condition. Sale price 8/6, plus 2/6 post.

Stud Switch, heavy duty, 30 amp. contacts, for dimmer, charger, regulator, etc. Sale price 5/6, plus 2/- post.

Canadian Telephone Sets, although originally intended for use with transmitters, these make excellent telephones for calling over long distances in noisy situations. Distances up to 3 or 4 miles (using our versatile wire, 6/6 for 1/2 mile) can be covered using these sets, which contain hand generator, telephone bell, hand microphone, Morse key, indicator lamp, buzzer, relay, etc. Sets complete 27/6, with full instructions, complete in carrying case.

Paekard Bell Pre-Amp. complete with 8B17 and 2B17 valves, relay leads, jacks, input and output transformers, etc. 7/6. 5/2- post less case.

VER517 Cathode Ray Tube is a plug in replacement for the VCR97, 8/6, carriage and insurance 4/6.

10 Valve 1 1/2 metre Superhet contains 9 valves, 6 I.F. Transformers and hundreds of useful spares. Brand new 29/6. Carriage and insurance 10/-.

R.F. Tuning Unit No. 24 in solid condition, but contains valves and many useful components, 3/6. carriage 3/6.

Rotary Switch by Arrow, carry 15 amp. A.C. 4 position hot, off, cold, off. Bulbless hair dryer, air-conditioning plant etc. 3/6, post 1/-.

Sapphire Gramophones, Neelies, miniature or standard 78 r.p.m. type, 12/- doz. 1/6 each.

Push-Pull Transformers, input and output, midget potted. Sale price 5/- pair, plus 1/6.

Metal Rectifiers, 250 v. 60-80 mA, ideal for mains set or instrument, or to replace that expensive valve. Sale price 3/6.

Dinshy Mast, Tubular aluminium extends from 15in. to 9ft. Sale price 4/6, plus 1/6 post.

Magneto Generator (hand), as used in telephones. Sale price 7/6, plus 1/6 post.

P.O. Type 3000 Relays, 2,000 ohm coil, 6 contacts 7/6, 4 contacts 6/6, 2 contacts 5/6, plus postage 1/-.

Versatile Wire, single strand 18 gauge with p.v.c. covering. New 1/2 mile on drum. Sale price 6/6, plus 3/6 carriage.

Wire Joiner (welder for 22 gauge or thinner), in bakelite case with trigger switch, works off step-down transformer. Sale price 2/6, plus 9d. postage.

Centre Zero Meter 3 1/2in. movement. Flush mounting, 500-0-500 micro Amp. Sale price 30/-, plus 1/6 post.

Unbreakable mains leads, as fitted to electric razors, etc. Makes ideal lead for test meters.

Twin 6 1/2, long 6d. per lead, 5/- doz.

THIS MONTH'S SNIP

BRAYHEAD TURRET TUNER

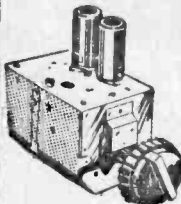

complete with Band 1 and Band 3 coils. New but removed from unused equipment. Less valves 15/- each or with valves 25/- each. Post 2/6.

INFRA-RED HEATERS

Make up one of these latest type heaters ideal for bathroom, kitchen, bedroom, etc. They are simple to make from our easy to follow instructions—uses silica enclosed elements designed for the correct infra-red wavelength (3 microns). Price for 750 watt element and instructions 15/6, plus 2/6 post and insurance.



BATTERY CHARGER BARGAIN

Car Battery Charger—ready-made high output battery charger in stove enamelled sheet steel louvered case. New, complete and ready to work. Rated at 12 v. 5 amps. and variable rate selector for trickle charging, also a meter to show charging rate. Suitable for 230/250. A.C. mains. Special snip price of 65/-, plus 3/6 post and ins.



"SUNVIC SIMMERSTAT" HEATER

REGULATOR, suitable to control elements or heaters up to 2,500 watts on A.C. The unit which is a ceramic body with bakelite case comprises a thermostat, adjustable for various temperature settings and in addition there is a heater coil so that the thermostat can be used as an intermittent make or break (simmerstat arrangement), thus giving complete control. SPECIAL SNIP PRICE of this unit is 12/6, plus 1/6 postage and insurance. COPPER CLAD ELEMENT, 1,500 watts. 230 volts. 2 1/2" long, 17/6 each. Post 2/6. Ideal for rayector heater, which could be controlled by the above.

LIMITED QUANTITY ONLY!

Waterproof heater wire. 16 yds. length. 70 watts. Self regulating temperature control. 10/-. Post Free.

INFRA-RED BINOCULARS

These if fed from a high voltage source will enable objects to be seen in the dark, providing the objects are in the rays of an infra-red beam. Each eye tube contains a complete optical lens system as well as the infra-red cell. The binoculars form part of the army night driving (Tabby) equipment. They are unused and believed to be in good working order, but sold without a guarantee. Price £2.17.6. Plus 10/- carriage and insurance. Handbook 2/6.



PHILCO STEREO RECORD PLAYER

CABINET. A beautifully made fabric covered cabinet size 17 x 15 x 9 1/2in., designed to take amplifier, autochanger and two speakers. Top speaker being removable for stereo. Must have cost at least £4 each to make, available at the special snip price of 45/-, plus 5/- carriage and insurance.

Building A Scope?



3in. oscilloscope tube, American made type No. 3FP7, 6.3 v. 0.6 amp. heater, electrostatic deflection, brand new and guaranteed with circuit diagram of scope, 15/- each, plus 1/6 post and insurance.

Transistors for R.F., F.M., TV and U.H.F.

Frequencies quoted are approx. cut-off. S11 078 1-20 Mc/s 8/6 S11 305, 20-30 Mc/s 8/6 S11 231R, 40-60 Mc/s 15/- American 2N1727, 100-150 Mc/s 15/- American 2N1728, 100-150 Mc/s, 12/6 American 1N832, 1,000-1,300 Mc/s, 35/- American 1N833, 1,000-1,300 Mc/s, 25/- SEND S.A.E. for transistor list and circuits.

"Dim and Full" Switch

Particularly useful for controlling photoflood lamps which have only a short life at full brilliance. This switch has three positions; the first position puts two lamps in series at half brilliance for setting up, the second position is off and the third position full brilliance for the operation shots. Also useful for controlling night lights, heaters, etc. Price 3/6 each, post 9d. Circuit diagram included. Ditto but without the off position, i.e. d.p.d.t., 10 amp. 2/6.

Component Storage Drawers

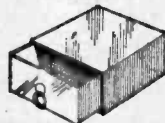

Stout board construction, these drawers are ideal for small parts. Supplied complete with simple erection instructions—1/6 each or 12 drawers each 2 x 2 1/2 x 1 1/2in., 13/6, post 2/-.

1 1/2 WATT TRANSISTOR AMPLIFIER

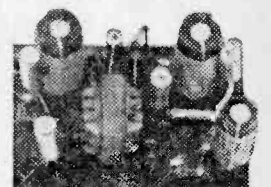

4 transistors including two in push-pull—input for crystal or magnetic microphone for pick-up—feed back loops—sensitivity 5 mv—output 1 1/2 watt peak into 35 ohm speaker. Speakers available. Price 62/6. Postage and insurance 2/6.

Morganite Potentiometers

Single and 2-gang types available. Standard size with good length spindle, all new and boxed. Single types, 1/- each, values available: 5K, 10K, 25K, 50K, 100K, 250K, 1 meg., 2 meg. Gang type 3/- each—values available: 5K ± 5K, 10K ± 100K ± 1 meg., 2 meg. ± 2 meg.



Britain's MOST Popular Portable . . .

The "GOOD COMPANION"

CAR RADIO & PORTABLE

One of the finest of its kind available. The design is the combined efforts of our technicians and of those of several of the leading manufacturers in the country, and the resulting set has a performance as good as if not superior to those selling at £20 and more. It has the *eight transistor set performance*. Features include *American Philco R.F. transistors and Mullard A.F. transistors—Q.F.F. output giving 750 mW—full coverage on Medium and Long—very fine tuning arrangement—excellent reception of difficult stations like 208—variable feed-back control—full tonal qualities—realy superior looking cabinet size 11 x 8 x 3in. approximately—car aerial attachment—sev. ral months' operation from battery costing only 3/6.* Circuit employs six transistors and two diodes, it incorporates all latest refinements, and oscillator, I.F. Transformers are pre-aligned so no instruments are necessary. Anyone who can solder competently can make this set. The instructions are fully comprehensive with plenty of illustrations. Service is available in the unlikely event of your getting into difficulties. All components fully guar.

Price of all components **£9.19.6**
and Standard Cabinet
or with De Luxe Cabinet £1 extra.

Post and Insurance 5/-
Battery 3/6 extra.

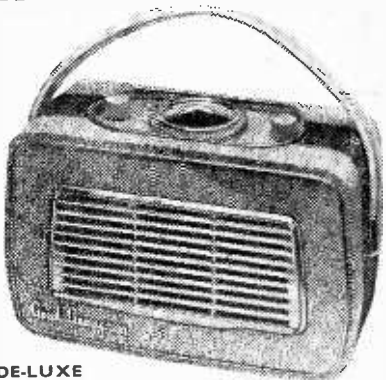

DE-LUXE CABINET 20/- extra

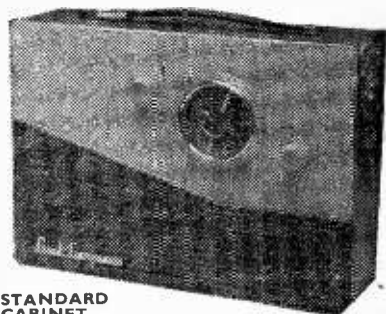

STANDARD CABINET

MK2 CIRCUIT

uses latest ceramic transistors in place of the normal I.F. transformers. This saves alignment problems and improves performance. Price 10/- extra.

AGENTS

wanted to build up our Companion Receivers. Send addressed envelope for full particulars

The "POCKET COMPANION"

This is without doubt the most modern and best pocket set available. It uses the very latest I.F. transistors, Philco R.F. transistors, airspaced tuning condenser in Superhet circuit covering M.W. and L.W. Complete building cost £6.15.0. Battery 2/- Post and Ins. 2/6. Data free with parts or separately 2/6.

The "TREMENDO COMPANION"

If you don't mind the battery consumption being a little higher and you want really big output then order The "Tremendo". This has an undistorted output of almost 11 watts and is probably the most powerful home constructor set available today. Complete building cost of this is £19.15.7, which includes the transformer (Mk. II circuit) batteries cost 3/6 (two required).

All components for the IMPROVED PIMPERNEL

5 Transistor Radio

that works really well!

ONLY
69'6

Postage and Insurance 2/6
Battery 2/-

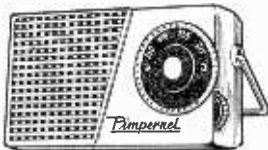

This remarkable little receiver uses 5 transistors and 2 diodes. 3in. Moving Coil Speaker, Tuning Condenser, Volume Control with On/Off switch, latest type circuitry, giving excellent station separation and ample volume at good tone. Push-pull output circuit ensures long life from PP3 battery.

All components included for Medium Wave operation in handsome plastic case with carrying handle as illustrated.

Demonstrations at all branches

Circuit diagram FREE with parts or 2/- separately.

OPTIONAL EXTRAS

All components and switch for Long Waves 8/6
Motif "Pimpernel" 2/-

THE POCKET "4"

Proved without
doubt the
easiest of all
to make!

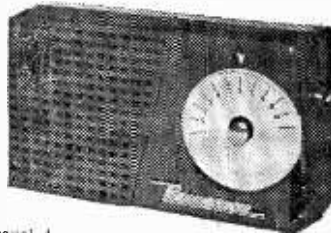

Circuit comprises 2 HF transistors reflexed to equal 4 diode stages. Permanent germanium diode and high gain AF output stage, fitted with miniature speaker, proper tuning condenser, volume control and in case with handle as illustrated (less monogram), completely portable. No aerial or earth required. Pocket 4 uses 3 transistors and 1 diode, price 42/6, plus 2/6 post and insurance. Pocket 5 uses 4 transistors and 1 diode and has feedback control, price 55/-, plus 2/6 post and insurance. Prices are for medium wave models, long or medium versions 6/6 extra.

(GOOD) RESULTS EVERYWHERE

Nothing can be more disappointing than to find that despite care in making up your radio just will not work or needs a long high serial and water pipe earth. We can prove good results in all areas and we guarantee all components for 12 months. Hundreds of testimonials received. Send in confidence. Plans free with parts, or separately 1/6. Demonstrations at all branches.

ELECTRONIC PRECISION EQUIPMENT LTD.

post orders are dealt with from Eastbourne, so for prompt attention please post your orders to 66 Grove Road, Eastbourne, marked Department 7. Callers may use any one of the Companies below.

- | | | | | |
|---|---|---|---|--|
| 288 London Road, Croydon. Phone: CRO 6558 Half day Wednesday | 29 Stroud Green Rd., Finsbury Park, N.4. Phone: ARChway 1049 Half day Thursday | 520 High Street North Manor Park, E.12. Phone: ILFord 4011 Half day Thursday | 42-46 Windmill Hill, Ruislip, Middx. Phone: RUslip 5780 Half day Wednesday | 246 High Street, Harpenden, N.W.3. Phone: ELGar 444 Half day Thursday |
|---|---|---|---|--|

STERN'S MULLARD DESIGNS

Designed by MULLARD—presented by STERN'S strictly to specification

COMPLETE KIT OF PARTS

MULLARD "5-10" MAIN AMPLIFIER

For use with the MULLARD 2-valve pre-amplifier with which undistorted power output of up to 10 watts is obtained. We supply SPECIFIED COMPONENTS AND NEW MULLARD VALVES, including PARMEKO MAINS TRANSFORMER and choice of the latest Ultra-Linear PARMEKO or the PARTRIDGE Output Transformer. COMPLETE KIT OF PARTS (PARMEKO Output Trans.) **£10.00**

Alternatively we supply ASSEMBLED AND TESTED, **£11.10** INCORPORATING PARTRIDGE OUTPUT TRANSFORMER, **£1.60** EXTRA.

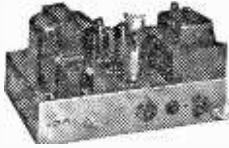

MULLARD'S PREAMPLIFIER TONE CONTROL UNIT

Employing two 6F86 valves, and designed to operate with the MULLARD MAIN AMPLIFIERS, but also perfectly suitable for other makes.

PRICE COMPLETE KIT OF PARTS **£6.60** ASSEMBLED AND TESTED **£8.00**



Supplied strictly to MULLARD'S SPECIFICATION and incorporating:
 • Equalisation for the latest R.I.A.A. characteristics.
 • Input for Crystal Pick-ups, and variable reluctance magnetic tapes.
 • Input (a) Direct from High Imp. Tape Head. (b) From a Tape Amplifier or Pre-Amplifier.
 • Sensitive Microphone Channel. • Wide range BASS and TREBLE Controls.

COMPLETE MULLARD "5-10" AMPLIFIER

The popular and very successful complete "5-10" incorporating Control Unit providing up to 10 watts high quality reproduction. Only Specified Components and new MULLARD VALVES are supplied including PARMEKO MAINS TRANSFORMERS and choice of the latest PARMEKO or PARTRIDGE ULTRA-Linear Output Transformers.

KIT OF PARTS **£11.10.0** OR ASSEMBLED AND TESTED **£13.10.0**

H.P. Dep. **£2.6.0**, 12 months at **£1.12.0** D.D. **£2.14.0** 12 months at **19/10** ABOVE incorporating PARTRIDGE OUTPUT TRANS. **£1.60** extra.



COMPLETE MULLARD "3-3"

THE IDEAL AMPLIFIER FOR A SMALL HIGH QUALITY INSTALLATION PROVIDING EXCELLENT REPRODUCTION OF UP TO 3 WATTS OUTPUT. COMPLETE KIT **£7.10.0** OR ASSEMBLED AND TESTED **£8.19.6** (plus 6/6 carriage and insurance) H.P. Terms: Deposit **£2.0.0** and 8 months at **£1.0.0**. Complete to MULLARD'S SPECIFICATION including Mullard valves and a PARMEKO OUTPUT TRANSFORMER.

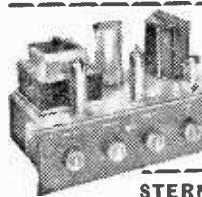

STERN'S INTER-COMM BABY ALARM

A small versatile Unit employing the new MULLARD ECL86 valve and designed to provide two (or three) way conversation up to extreme distances. Operates from A.C. mains 200 to 250 Volts.

PRICES . . . MASTER UNIT and ONE EXTENSION

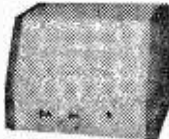

KIT OF PARTS **£6.17.6** ASSEMBLED AND TESTED **£8.0.0**

Consists of a MASTER UNIT, size only 8 1/2 x 5 1/2 x 6 in. and ONE EXTENSION (a second extension may be added to any time). The Master Unit incorporates switching and power supply and with the chassis completely isolated from the mains is operated in absolute safety. Cases covered in quality leatherette.

ARMSTRONG RADIOGRAM CHASSIS

FULL RANGE IN STOCK, please enclose S.A.E. for leaflets.

STEREO 12 (MK. 2) (Illustrated)

£44.15.0

Deposit **£9.0.0**, 12 months at **£3.5.7**

The most complete chassis ever produced, combines AM and FM Tuners, a Stereo Control Unit and two High Fidelity Amplifiers in one compact unit, provide a total of 16 watts for both mono and stereo. Other features include: Inputs for tape recording, play back, pick-ups and stereo radio (should this come about); separate wide range bass and treble controls and balance control.



STEREO 55 **£33.15.0**

Deposit **£6.15.0**, 12 months at **£2.9.6**
 A junior version of the Stereo 12 Mk. 2 providing ten watts output, five watts from each amplifier and covering the VHF and Medium wavebands.

COMBINED ORDER PRICE REDUCTIONS

(a) The KIT OF PARTS to build both the "5-10" Main Amplifier and the 2-valve PRE-AMP CONTROL UNIT H.P. Dep. **£8.7.0** and 12 months at **£1.2.9** **£15.15.0**
 (b) The "5-10" and the 2-stage PRE-AMP both ASSEMBLED and TESTED H.P. Dep. **£3.16.0** and 12 months at **£1.7.8** **£18.18.0**
 With Partridge 'Output Transformer **£1.60** extra.

RECORD PLAYERS

The Latest Models are in stock, many at reduced prices.

Send S.A.E. For Illustrated Leaflet. THE NEW GARRARD "AUTOSLIM" 4-speed Autochanger with Crystal Pick-up **£8.10.0**

COLLARO "WINNER" 4 SPEED SINGLE RECORD PLAYER with separate Crystal Pick-up Carriage and Insurance 5/- Above Pick-up separately for **£1.6.6**

The NEW COLLARO C60 4-speed Autochanger unit with Studio "00" Pick-up **£7.19.6**

The F.M.L. 4-speed Single Record Player with crystal Pick-up **£6.9.6**

B.S.R. MODEL UA14. A 4-speed Mixer Autochanger with Crystal Pick-up **£7.10.0**

Available incorporating the B.S.R. STEREO Pick-up, plays L.P. and 78 Records **£8.13.10**

GARRARD MODEL TAMR11 4-speed Player fitted high output Crystal Pick-up. **£8.10.0**

GARRARD MODEL RC210. Autochanger 4-speed. High output. Crystal Pick-up. **£9.19.6**

Carriage and Insurance on each above 5/- extra.

SPECIAL CASH OFFER

This very attractive PORTABLE AMPLIFIER CASE together with a good quality GRAM AMPLIFIER and a matched P.M. SPEAKER. ALL for ONLY **£87.6** (Plus 7/6 Carr. & Ins.)



The Amplifier consists of a 2-stage design incorporating 3 modern B.V.A. valves and has separate BASS and TREBLE CONTROLS.

The Portable Case will also accommodate almost any make of Autochanger and is attractively finished in Mushroom Grey Rexine.

WE ALSO SUPPLY SEPARATELY—

(a) The 2-stage (plus Rectifier) AMPLIFIER **£4.2.6**

(b) THE PORTABLE CARRYING CASE **£3.17.6**

(c) 6in. P.M. SPEAKER 18/9. Carriage and Insurance 4/- extra.

MULLARD FOUR CHANNEL MIXER UNIT

Self powered with Cathode follower output. Incorporates Two inputs for MICROPHONES One for CRYSTAL PICK UP and a fourth for RADIO or TAPE Complete Kit of Parts **£8.8.0**

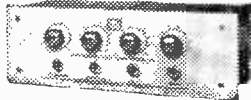

Assembled and Tested **£10.0.0**

TERMS: Deposit **£2** and 12 months at **15/-**.

MODEL I.L. one microphone input matched for moving coil or Ribbon Mike. **£1.17.0** extra.

JUBILEE MK. 2 **£31.15.0**

Deposit **£6.7.0** 12 months at **£2.6.7**

A Hi-Fi mono chassis giving eight watts push-bull output and covering VHF, medium and long bands. Tape recording and play back inputs.

AF208 **£23.15.0** Deposit **£4.15.0** 12 months at **£1.14.10**. An AM/FM chassis providing 5 watts output and covering the full VHF and medium wavebands. Tape recording and playback inputs.

STERN RADIO LTD.

Dept. P.W. 109 FLEET ST., LONDON, E.C.4

Telephone: FLEET STREET 5812/3/4

TRUVOX

TAPE EQUIPMENT SERIES

80

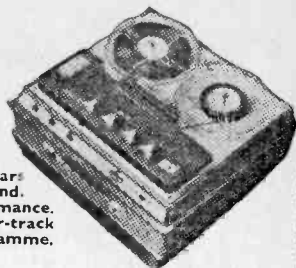

This newly developed range of Truvox equipment is the fruit of more than twelve years experience in fulfilling the requirements of the enthusiastic listener to recorded sound. The precise construction and finish of the range ensures an outstanding performance. Complete Recorders, Decks and Tape Units—signal the entry of Truvox into the four-track field. Top quality allied to economy, is the result of this development programme.

MODEL R82

A complete Twin Track MONO
PORTABLE TAPE RECORDER **£57.15.0**
Deposit £11.1.0, and 12 months of £4.4.8

MODEL R84

A complete Four Track Mono
Portable Tape Recorder incorporating outputs
for STEREO reproduction **£61.19.0**
Deposit £12.8.0, and 12 months of £4.10.10.

Two Recorders, beautifully styled; equipped with every modern feature and facility, 7in. reels. Interlocked push buttons, input mixing, superimposition, auto-stop. Instant mechanical brakes, fast wind and rewind. Twin independent inputs, 4 watts output, 8 ohm and 15 ohm ext. speaker matching, two hi-fi connections and monitor speaker switch. (Stereo outlet on R84 models).

Recorders supplied with 1200 ft. tape, spare reel, stick microphone and recording lead.

"SERIES 80" TAPE DECKS are available separately MODEL D82

Incorporating TWIN TRACK **£26.5.0**
HEADS Deposit £5.5.0, and 12 months at £3.11.10.

MODEL D84

With FOUR TRACK HEADS **£29.8.0**
and Track Switch for MONO/STEREO output
Deposit £6.0.0, and 12 months of £2.9.11.

These decks are ruggedly constructed, beautifully styled and precision engineered for outstanding dependability. Three motors, 7in. reels, speed selector/off switch for 7 $\frac{1}{2}$ and 3 $\frac{1}{2}$ l.p.s. Instant mechanical brakes, fast wind and rewind (80 secs. per 1200 ft.). Push button operated with perfect interlock. Numerical counter. Pause lever, for short or long stops. Efficient hubs for true and silent running of spools. Outstanding head performance. Auto stop available as optional extra.

FULLY DESCRIPTIVE LEAFLETS FREELY AVAILABLE

MODEL PD82

Complete Twin
Track Mono Recorder-Preamplifier Unit **£42.0.0**
Deposit £8.8.0, and 12 months of £3.1.7.

MODEL PD84

Complete Four Track Mono
Recorder-Preamplifier Unit incorporating outlets
for STEREO reproduction **£46.0.0**
Deposit £9.4.0, and 12 months of £3.7.6.

Two self-contained units, self-powered to add full tape facilities to existing sound reproduction installations (high fidelity equipment, radiograms, record reproducers, or good radio receivers). Comprising a Series 80 Tape Deck, plus integral record amplifier, play-back pre-amplifier and push-pull erase/bias oscillator, ready for easy connection.

The Unit is built to high fidelity standard. Frequency response is 40-20,000 c.p.s. at 7 $\frac{1}{2}$ l.p.s. and 40-12,000 c.p.s. at 3 $\frac{1}{2}$ l.p.s. Two Independently controlled inputs for programme mixing. Superimposition for adding commentaries. Auto stop. Two output connections; 1 v. at 47K ohms and up to 10 v. at 250K ohms to match any ancillary equipment.

DUAL CHANNEL PREAMPLIFIER

Incorporates two Mullard 2-valve Preamplifiers combined into a Single unit enabling it to be used for both STEREOPHONIC or MONAURAL operation. It is designed primarily to operate with our range of MULLARD MAIN AMPLIFIERS but will also operate equally well with any make of Amplifiers requiring an input of 250 mvolts.

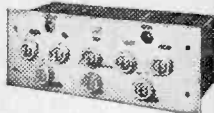

COMPLETE KIT **£12.10.0**
OF PARTS
H.P. £2.10.0 & 12 mths. at 18/4

ASSEMBLED **£15.0.0**
AND TESTED
H.P. £3.0.0 & 12 mths. at £1.2.0

MULLARD'S "10 PLUS 10"

STEREO POWER AMPLIFIER

A high fidelity design based on the famous Mullard "5-10". Provides up to 10 watts (per channel) Superb reproduction. Frequency response flat to within 3 db from c/s. to 60 Kc/s at 30 Mw.

Total Harmonic Distortion at 10 watts 0.1%
(a) ASSEMBLED COMPLETE AMPLIFIER, including CONTROL UNIT (as Illustrated),
Deposit £4.4.0, 12 months at £1.10.10. **PRICE: £21.0.0**

(b) A complete KIT OF PARTS **£18.10.0**
Deposit £3.14.0, 12 months at £1.7.2.

Built to the very highest technical standards and presented strictly to MULLARD'S specification. Incorporates complete Mullard valve line-up including two of the new valves, type ECL86, in each channel. Two specially designed GILSON OUTPUT TRANSFORMERS with 20 taps are used for ultra linear operation.

The matching CONTROL UNIT is designed to be either attached to the Amplifier (as Illustrated) or can be detached for separate mounting on a Cabinet panel. Provides inputs for CRYSTAL PICK-UPS, RADIO TUNING UNIT, and TAPE RELAY.

AS AUDIO SPECIALISTS WE CONFIDENTLY RECOMMEND THIS DESIGN, it is a MUST to the serious minded sound enthusiast. We also supply the assembled MAIN AMPLIFIER only (excludes control unit) for operation with our DUAL CHANNEL PREAMPLIFIER, this provides for a more versatile or elaborate installation and would be essential if a low output Magnetic Pick-Up, such as the Decca, is to be used.

(a) THE ASSEMBLED MAIN AMPLIFIER with the ASSEMBLED DUAL CHANNEL PREAMPLIFIER **PRICE: £30.0.0**
Deposit £6.0.0, 12 months at £2.4.0.

(b) A complete KIT OF PARTS for both Units **£26.0.0**
Deposit £5.4.0, 12 months at £1.18.2.

Illustrated and Descriptive Brochure available. Please enclose S.A.E.

STEREO "TWIN THREE" AMPLIFIER with specially designed PORTABLE CASE

A most compact portable design consisting of TWIN CHANNEL AMPLIFIER based on the latest design by MULLARD LTD., incorporating top grade Output Transformers and the new audio Triode-Pentode Valves Mullard E.C.L.86 Separate Bass and Treble controls. Suitable for use with Crystal Pick Ups, and capable of genuine high quality reproduction up to 3 Watts per channel. An attractive and contemporary portable Case in two tone colours. The unique feature of the design is the loudspeaker mounting. Two 8 x 5in. p.m. elliptical loudspeakers are separately baffled and mounted in the lid, which is detachable, allowing for each speaker to be individually positioned. A versatile stereo arrangement tested and guaranteed which can be assembled in the minimum of time.



PRICE for the ASSEMBLED AMPLIFIER, Two 8 x 5in. ROLA SPEAKERS and PORTABLE CASE **£14.0.0**
Deposit £2.16.0, 12 months at £1.0.6.

ASSEMBLED AMPLIFIER supplied for **£7.15.0**

8 x 5in. ROLA LOUDSPEAKERS (3 ohms) each. **£1.1.0**

PORTABLE CASE **£5.0.0**

A CHOICE OF SINGLE RECORD PLAYERS and AUTOCHANGERS is available from Stock (Send S.A.E. for details)

STERN RADIO LTD.



Stern's "fidelity" TAPE RECORDERS

There are no better value-for-money Tape Recorders on the market—if you can't call and hear them send S.A.E. for fully descriptive leaflet.

For truly "Hi-Fi" Recordings

MODEL CR/3S Incorporates the COLLARO "STUDIO" TWIN TRACK 3-speed Deck, operating at 1 1/2-in., 3 1/2-in. and 7 1/2-in. speeds includes 1,200ft. tape and crystal microphone. H.P. Terms: Deposit £7.18.0 and 12 months of £2.17.11.

£39.10.0

EACH MODEL INCORPORATES THE MODEL HT/TR3 MK.II TAPE AMPLIFIER (Described below)

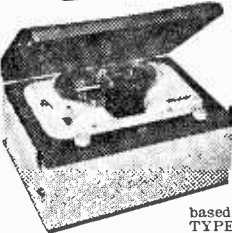

The MODEL HFG/2R PORTABLE TAPE RECORDER (Original Price £33.0.0) **FOR ONLY 22 gns.**

H.P. Dep. £4.14.0. 12 months £1.13.9. (Carr. and Ins. 10/- extra). Incorporates THE LATEST GARRARD "MAGAZINE" TAPE DECK and a HIGH QUALITY AMPLIFIER which is entirely based on the very successful MULLARD TYPE "A" DESIGN and specifically

designed to operate the GARRARD DECK. Price INCLUDES SUPPLY OF THE GARRARD TAPE MAGAZINE and 4in. SPOOL OF DOUBLE PLAY TAPE. Comprises a Twin Track Recorder operating at 3 1/2in/sec. speed and providing up to 1 hour 10 mins. playing time. Truly "Portable", weighs only 22 lbs. Outstanding features are excellent performance and simplicity of operation.

ADD "HI-FI" TAPE RECORDING TO YOUR EXISTING AUDIO INSTALLATION WITH MULLARD TYPE "C" TAPE PRE-AMPLIFIER—BRASS UNIT



The "Hi-Fi" link to add full tape recording facilities to High Fidelity home installations. Incorporates FERROXUBE POT CORE PUSH PULL OSCILLATOR and 3-speed treble equalisation by FERROXUBE POT CORE INDUCTOR FOR WEARITE-COLLARO-TRUVOX OR BRENELL TAPE DECKS. Includes separate power supply unit.

KIT OF PARTS Deposit £2.16.0. **£14.0.0** 12 mths. at £1.0.6 (Excluding power unit £11.15.0 and £14.10.0 respectively.) **OR ASSEMBLED** Deposit £3.8.0 **£17.0.0** 12 months at £1.4.11

"SPECIAL COMBINED ORDER" PRICES

- (a) The COLLARO "Studio" Deck with the Model "C" Pre-amplifier and POWER SUPPLY UNIT ASSEMBLED AND TESTED **£29.10.0**
Deposit £5.18.0. 12 monthly payments of £2.3.3
- (b) As above but the TYPE "C" Unit and POWER UNIT supplied as COMPLETE KIT OF PARTS Deposit £5.6.0. 12 monthly payments of £1.18.10 **£26.10.0**
- (c) The BRENELL Mk.V Deck with the Model "C" PREAMPLIFIER and POWER UNIT. ASSEMBLED AND TESTED **£46.0.0**
Deposit £9.4.0 and 12 months at £3.7.6
- (d) As above but the Model "C" PREAMPLIFIER and POWER UNIT supplied as a COMPLETE KIT OF PARTS **£43.0.0**
Deposit £8.12.0. 12 monthly payments of £3.3.1
- (e) THE WEARITE MODEL "A" DECK with ASSEMBLED AND TESTED Model "C" PRE-AMPLIFIER and POWER UNIT incorporating WEARITE HEAD LIFT TRANSFORMER, Etc. **£60.10.0**
Deposit £12.2.0 and 12 months at £4.8.9 (Carriage and Insurance on above is 10/- extra.)

HF/TR3 MK.II TAPE AMPLIFIER

(Mullard Type "A" design) A very high quality Amplifier incorporating 3-speed treble equalisation, by the latest FERROXUBE POT CORE INDUCTOR FOR COLLARO TRUVOX - BRENELL WEARITE Tape Decks, has GILSEN Output Transformer. Includes separate Power Supply Unit.



KIT OF PARTS £13.13.0. Deposit £2.15.0. 12 months at £1.0.0. **ASSEMBLED** £17.0.0. Deposit £3.8.0. 12 months at £1.4.11.

THE 'ADD-A-DECK'

Incorporating GARRARD TAPE DECK and MODEL HFG/2R PRE-AMPLIFIER

Supplied on ONE CHASSIS (as illustrated) READY 18 Gns. FOR USE (Carr. & Ins. 10/- extra.)

Price includes Garrard Magazine and a 4in. Spool Double Play Tape. H.P. Deposit £3.16.0. and 12 months of £1.7.8. Provides complete tape recording facilities and designed to operate through the pick-up sockets of the standard type of RADIO RECEIVER, or an AMPLIFIER, from which really first class reproduction is obtained. It consists of a Twin Track Deck connected to the Pre-amplifier and operates at 3 1/2in/sec. speed providing up to 1 hr. 10 mins. playing time.



BUILD A HIGH FIDELITY TAPE RECORDER

← LIKE THIS for **£35.0.0** Deposit £7.0.0 12 months at £2.11.4



FOR THIS WE SUPPLY

- ★ Complete Kit of Parts to Build the HFTR3 Tape Amplifier.
- ★ The New Collaro "Studio" Tape Deck.
- ★ Portable Carrying Case (as illustrated).
- ★ Rola/Celestion 10 x 6in. p.m. Loudspeaker.

★ ACOS Crystal Microphone and 1,200ft. Spool E.M.I. Tape. Alternatively for those who prefer another make of Tape Deck—we will supply precisely as above—but in place of the Collaro "Studio" Deck. We will include: The Truvox MK VI Deck. **£40.10.0**

- Deposit £8.2.0. 12 months at £2.19.5.
- (a) For Constructors with their own cabinet—WE OFFER— **£26.0.0**
 (a) COMPLETE KIT to build the HF/TR3 AMPLIFIER with the COLLARO "STUDIO" DECK Deposit £5.4.0. 12 monthly payments of £1.18.2
- (b) As above but with the HF/TR3 supplied ASSEMBLED AND TESTED **£29.10.0**
 Deposit £5.18.0. 12 monthly payments of £2.3.4
- (c) COMPLETE KIT to build the HF/TR3 AMPLIFIER with the BRENELL Mk. V TAPE DECK. Deposit £8.8.0. 12 monthly payments of £3.1.7 **£42.0.0**
- (d) As above but with HF/TR3 supplied ASSEMBLED AND TESTED **£45.10.0**
 Deposit £8.2.0. 12 monthly payments of £3.6.9
- (e) THE ASSEMBLED AND TESTED HF/TR3 AMPLIFIER with the WEARITE MODEL 4A DECK. Incorporates Wearite Head Lift Transformer etc. Deposit £12.12.0. 12 monthly payments of £4.8.9. **£60.10.0**
 (Carriage and Insurance on each above is 10/- extra.)

BRAND NEW!—ROLA CELESTION

- 6in. x 4in. P.M. Loudspeaker. 3 ohm. V/Coil. 18/6
 - 8in. x 5in. P.M. Loudspeaker. 3 ohm. V/Coil. £1.1.0
 - 10in. x 6in. P.M. Loudspeaker. 3 ohm. V/Coil. £1.10.0
 - 6in. dia. P.M. Loudspeaker. 3 ohm. V/Coil. 18/6
 - 10in. dia. P.M. Loudspeaker. 3 ohm. V/Coil. £1.7.6
- Please enclose extra 1/- to cover postage.

AN ATTRACTIVE CORNER FITTING CASE for the 8in. x 5in. and 10in. x 6in. LOUSPEAKERS is AVAILABLE for **£2.10.0** (Size 20in. high x 10in. x 7in. deep.) Please enclose S.A.E. with all Enquiries.

Dept. P.W. **109 FLEET ST., LONDON, E.C.4**
Telephone: **FLEET STREET 5812/3/4**

R.S.C. HI-FI TAPE RECORDER KIT

REALISM AT INCREDIBLY LOW COST. CAN BE ASSEMBLED IN HALF AN HOUR
The Recorder Incorporates the Latest Collaro Studio Tape Transcriber. The Linear LT45X High Quality Tape Amplifier listed £12.12.0 High Flux F.M. Speaker listed 30/- empty Tape Spool, a Reel of Best quality Tape listed 22/6, and a Handsome Portable carrying Cabinet with latest attractive two-tone polychrome finish, size 18 x 13 x 9 in. high, listed £4.10.0, and circuit. Total cost if purchased individually approximately £40. Performance equal to units in the £60-£80 class. S.A.E. for leaflet.

HIGH FIDELITY 12-14 WATT AMPLIFIER TYPE A11

PUSH-PULL ULTRA LINEAR OUTPUT "BUILT-IN" TONE CONTROL PRE-AMP STAGES

Two input sockets with associated controls allow mixing of 'trunks' and gram, as in A10. High sensitivity. Includes 5 valves, ECC83, ECC83, EL84, EL84, 5Y3. High Quality sectionally wound output transformer specially designed for Ultra Linear operation and reliable small condensers of current manufacture. **INDIVIDUAL CONTROLS FOR BASS AND TREBLE** "Lift" and "Cut" Frequency response +3 d.B. 30-30,000 c/s. Six negative feedback loops. Hum level 60 d.B. down. **ONLY 23 millivolts INPUT** required for **FULL OUTPUT**. Suitable for use with all makes and types of pick-ups and microphones. Comparable with the very best designs. For **STANDARD or LONG PLAYING RECORDS**. For **MUSICAL INSTRUMENTS** such as **STRING BASS, GUITARS, etc.** **OUTPUT SOCKET** with plug provides 300 v. 30 mA. and 8.3 v. 1.5 a. For supply of a **RADIO FEEDBACK UNIT**, Size approx. 12-9-7/16. For A.C. mains 200-250 v. 50 c.p.s. Output for 3 and 15 ohm speakers. Kit is complete to last nut. Chassis is fully punched. Full instructions and point-to-point wiring diagrams supplied. **Only 8 Gns.** Carr. 10/- (or factory built 51/- extra).
If required louvred metal cover with 2 carrying handles can be supplied for 19/8. **TERMS ON ASSEMBLY DEPOSIT 24/8**, and 9 monthly payments of 24/8. Send S.A.E. for illustrated leaflet detailing Ready-to-assemble Cabinets, Speakers, Microphones, etc., with cash and credit terms.

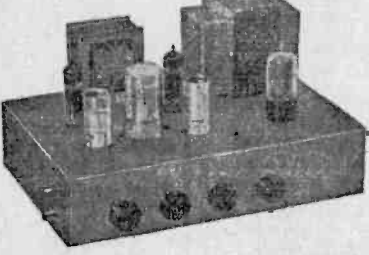

25 1/2 GNS.

Carr. 17/6

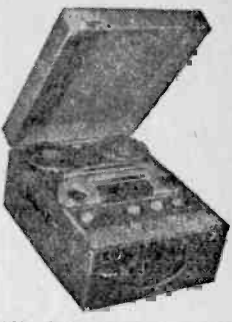

H.P. TERMS. Deposit £5.7.6 and 12 monthly payments of 2 gns. Cash price if settled in 3 months.

BRADMATIC RECORDING HEADS. High Impedance Record/Playback 22/- Low Impedance Erase 12/6.
TELEVISION RECEIVERS 250 v. 200 mA. small size. Only 6/8 each.
COLLARO CONQUEST 4-8PEFD AU-O-CHANGER, with high fidelity Studio list. Pick-up. Latest model. For 200-250 v. 50 c.p.s. A.C. mains. Our price £219.6. Carr. 5/6.
COLLARO RC 457 4 SPEED MIXER AU-O-CHANGERS. Turnover Studio Pick-up head, for 200-250 v. A.C. £7.19.6. Carr. 4/6.

THE SKYFOUR T.R.F. RECEIVER. A design of a 3 valve long and medium wave 200-250 v. A.C. Mains receiver with selenium rectifier. High gain H.F. stage and low distortion detector. Valve line-up 6K7, SP61, 6V8G. Selectivity and quality excellent. Simple to construct. Point-to-Point wiring diagrams, instructions and auto-change unit. Maximum building costs £4.19.6, inc. attractive Walnut veneered wood cabinet 12 x 6 1/2 x 5 1/2 in.
GLA MINIATURE 2-3 WATT GRAM AMPLIFIER. For use with any single or auto-change unit. Output for 2-3 ohm speaker. For 200-250 v. A.C. mains. Size 11 1/2 x 2 1/2 x 2 1/2 in. Controls: Vol. and Tone with switch. Only 5/6.

R.S.C. STEREO/TEN HIGH QUALITY AMPLIFIER

A complete set of parts for the construction of a stereo-phonio amplifier giving 5 watts high quality output on each channel (total 10 watts). Sensitivity is 50 millivolts, suitable for all crystal stereo heads. Ganged Bass and Treble Control give equal variation of "lift" and "cut". Provision is made for use as straight (monaural) 10 watt amplifier. Valve line-up ECC83, ECC83, EL84, EL84, E281. Outputs for 2-3 ohm speakers. Point-to-Point wiring diagrams and instructions supplied. Send S.A.E. for leaflet. **8 Gns.** Full constructional details and price list 2/6. Carr. 10/-.

Kit can be supplied assembled, ready for use, for 59/6 extra.

R.S.C. BATTERY CHARGING EQUIPMENT

HEAVY DUTY CHARGER KIT 6/12 v. 6 amps. variable output. Consisting of Mains Transformer 0-230-250 v. 50 c.p.s. (Bridge), Selenium Rectifier, Ammeter, Variable Charge Rate Selector Panels, Plugs, Fuses, Fuseholder and circuit. 59/6. Carr. 4/6.

DEAF AID EARPIECES. Low Impedance with lead. 9/8. High Impedance Crystal 8/8.

MICROPHONE INSERTS. Crystal type 8/8.

SOLDERING IRONS. 200-250 v. 30 watts. First quality. For Radio work. 18/8. Spare elements and bits available.

Assembled 6/12v. 4-5 amps.
Fitted ammeter and variable charge rate selector. Also selector plug for 6 v. or 12 v. charging. Louvred steel case with stoved blue hammer finished. Fused 69/9 and ready for use with Carr. 5/- mains and output leads. T. 3 m.s. Deposit 13/8 and 5 monthly payments 13/8. 6/12 v. 3-4a. all facilities as above. Only 59/9. carr. 3/6.



All for A.C. Mains 200-250v., 50c.c. Guaranteed 12 months.

ASSEMBLED CHARGER
6 v. or 12 v. 2 amps.
Fitted Ammeter and selector plug for 6 v. or 12 v. Louvred metal case finished attractive hammer blue. Ready for use with mains and output leads.
Double Only Fused. Carr. 3/9 **49/9**

BATTERY CHARGER KITS
Consisting of Mains Transformer, F.W. Bridge, Metal Rectifier, well ventilated steel case, Fuses, Fuseholders, Grommets, panels and circuit. Carr. 3/6 extra.
6v. or 12v. 1 amp. 24/9
As above, with Ammeters 32/9
6 v. 2 amps. 25/9
6v. or 12v. 2 amps. 31/6
6 v. or 12 v. 2 amps. inclusive of Ammeter 42/9
6 v. or 12 v. 4 amps. 49/9
6 v. or 12 v. 4 amps. with Ammeter and variable charge rate selector 59/9
CHARGER AMMETERS:
0-15 a., 0-3 a., 0-4 a., 0-7 a., 0-25 a., 0-60 a. 8/8.

R.S.C. MAINS TRANSFORMERS (FULLY GUARANTEED)

Interleaved and Impregnated. Primaries 200-230-250 v. 50 c/s. Screened **TOP SHROUDED DROP THROUGH**
250-0-250 v. 70 mA. 6.3 v. 2a. 5 v. 2a. 17/9
350-0-350 v. 80 mA. 6.3 v. 2a. 5 v. 2a. 18/9
250-0-250 v. 100 mA. 6.3 v. 2a. 6.3 v. 1a. 21/9
250-0-250 v. 100 mA. 6.3 v. 3.5 a. C.T. ... 19/9
250-0-250 v. 100 mA. 6.3 v. 4a. 5 v. 3a. 25/9
300-0-300 v. 130 mA. 6.3 v. 4a. 6.3 v. 1a. 26/9
for Mullard 510 Amplifier ... 29/9
300-0-300 v. 100 mA. 6.3 v. 4a. 5 v. 3a. 26/9
300-0-350 v. 100 mA. 6.3 v. 4a. 5 v. 3a. 26/9
350-0-350 v. 100 mA. 6.3 v. 4v. 4a. C.T. 0-4 v. 3 a. 29/9
350-0-350 v. 150 mA. 6.3 v. 4a. 5 v. 3a. 28/9
FULLY SHROUDED UPRIGHT
250-250 v. 60 mA. 6.3 v. 2a. 6.5-6.3 v. 2a. Midgest type 21-3-31n. 17/11
250-0-250 v. 100 mA. 6.3 v. 4a. 5 v. 3a. 27/9
300-0-300 v. 100 mA. 6.3 v. 4a. 5 v. 3a. 27/11
350-0-350 v. 100 mA. 6.3 v. 4a. 5 v. 3a. 27/11
350-0-350 v. 150 mA. 6.3 v. 4a. 5 v. 3a. 35/9
425-0-425 v. 200 mA. 6.3 v. 4a. C.T. 6.3 v. 4a. C.T. 5 v. 3 a. 49/9

FILAMENT TRANSFORMERS
All with 200-250 v. 50 c/s. Primaries 6.3 v. 1.5 a. 5/9; 6.3 v. 2 a. 7/8; 0-4-6.3 v. 2 a. 7/8; 12 v. 1 a. 7/11; 6 v. 3 a. 8/11; 6.3 v. 6 a. 17/9; 12 v. 1.5 a. twice 17/6.
OUTPUT TRANSFORMERS
Midgest Battery Pentode 66.1 for 354, etc. 3/8
Small Pentode, 500 Ω to 3 Ω ... 3/8
Small Pentode 78,000 Ω to 3 Ω ... 3/8
Standard Pentode 5,000 Ω to 3 Ω ... 5/9
Standard Pentode 78,000 Ω to 3 Ω ... 5/9
10,000 Ω to 3 Ω ... 5/9
Push-Pull 6 watts, EL84, or 6V6 to 3 Ω or matched to 15 Ω ... 9/9
Push-Pull 10-12 watts to match 6V6 or EL84 to 2.5-8 or 15 Ω ... 19/9
Following types for 3 and 15 Ω speakers:
Push-Pull 10-12 watts 6V6 or EL84 ... 18/9
Push-Pull 15-18 watts. 6L6, KT66 22/9
Push-Pull for Mullard 510 Ultra Linear ... 29/9
Push-Pull 20 watts, sectionally wound, 6L6, KT66, 807, etc. 49/9

MIDGET MAINS
Primaries 200-250 v. 50 c/s.
50-0-50 v. 60 mA. 6.3 v. 2 a. 11/9
250-0-250 v. 60 mA. 6.3 v. 2 a. 12/8
Both above size 21 x 21 x 2 1/2 in.
SMOOTHING CHOICES
150 mA. 7-10H 250 ohms ... 11/9
150 mA. 1H 200 ohms ... 8/9
80 mA. 10 H 350 ohms ... 5/9
60 mA. 10 H 400 ohms ... 4/11
PARMEKO POTTED TYPES
300 mA. 12 H 100 ohms ... 16/9
120 mA. 30 H 200 ohms ... 18/9
120 mA. 6 H 10 ohms ... 13/9
CHARGER TRANSFORMERS
All with 200-230-250 v. 50 c/s Primaries:
0-9-15 v. 1 1/2 a. 11/8; 0-9-15 v. 2 a. 14/8; 0-9-15 v. 3 a. 16/8; 0-8-15 v. 5 a. 18/8; 0-8-15 v. 3 a. 20/8; 0-15 v. 1 a. 26/8.
AUTO (Step up/Step down) TRANS.
110-120-230/250 v. 60-80 watts. 13/9; 250 watts. 39/9; 150 watts. 27/9.
MICROPHONE TRANSFORMERS
120:1 high grade, clamped. 6/8; 120:1 Potted. Mu-metal screened. 9/8.

R.S.C. (Manchester) HULL, LIVERPOOL, LEEDS, BRADFORD, MANCHESTER Ltd.

R.S.C. A12 STEREPHONIC AMPLIFIER KIT WITH TWIN SPEAKERS

A complete set of parts to construct a good quality Stereo amplifier with an undistorted output total 6 watts. For A.C. mains input of 200-250 v. Outputs for matched 2-3 ohm speakers. Sensitivity 130 m.v. Ganged Vol. and Tone Controls. Preset balance control. Full instructions and point-to-point wiring diagrams supplied.

STEREO EQUIPMENT OFFER-
Comprising All Kit 2 £6.19.6
Matched 8in. Speakers
and Acos T70 Stereo head
suitable most pickups.

PICK-UP ARMS complete with Hi-Fi turnover crystal head. Acos GP54. Limited number brand new, perfect at approx. half price. Only 29/11.

ACOS CRYSTAL MICROPHONES. M40 standard model. Listed 13s. Only 27/9. 39-1 Stick type. Listed 3 gns. Only 39/6.

R.S.C. 30 WATT ULTRA LINEAR HIGH FIDELITY AMPLIFIER A10
A highly sensitive Push-Pull high output unit with self-contained Pre-amp. Tone Control Stages. Certified performance figures compare equally with most expensive amplifiers available. Hum level 70 db. down. Frequency response 3 db. 30-30,000 c/s. A specially designed sectionally wound ultra linear output transformer is used with 807 output valves. All components are chosen for reliability. Pick-ups are used EF86, EF88, ECC83, 807, 807, GZ33. Separate Bass and Treble Controls are provided. Minimum input required for full output is only 12 millivolts so that ANY KIND OF MICROPHONE OR PICK-UP IS SUITABLE. The unit is designed for CLUBS, SCHOOLS, THEATRES, DANCE HALLS or OUTDOOR FUNCTIONS, etc. For use with Electronic ORGAN, GUITAR, STRINGS, HANS etc. For standard or long-playing records. **OUTPUT SOCKET PROVIDER L.T. and H.T. for a RADIO FEEDER UNIT** An extra input with associated vol. control is provided so that two separate inputs such as Gram, and 'Mike' can be mixed. Amplifier operates on 200-250 v. 50 c/s. A.C. Mains and has output for 3 and 15 ohm speakers. Complete kit of parts with fully punched chassis and point-to-point wiring diagrams and instructions. If required perforated carrying cover with carrying handles can be supplied for 19/9. The amplifier can be supplied, factory built with EL34 output valves and 12 months guarantee, for 14 gns. **TERMS: DEPOSIT 33/9 and 9 monthly payments of 33/9.** Suitable microphones and speakers available at competitive prices.

FULL RANGE OF LINEAR AMPLIFIERS ALWAYS IN STOCK.

COLLARO JUNIOR 4-speed single player units and Hi-Fi crystal pick-up with turn-over head. £3-19-6.

B.S.R. CAS 4-SPEED AUTO-CHANGERS with Hi-Fi turnover pick-up head. £6-19-6. Carr. 5/-.

4 Gns.

Carr. and pkg. 5/-

Jason FM1 V.H.F.FM Radio Tuner design. Total costs of parts including valves. Tuning dial, Escutcheon. etc. £6-19-6.

LINEAR I45 MINIATURE 4/5 WATT QUALITY AMPLIFIER. Suitable for use with any record playing unit, and most microphones. Negative feedback 12db. Separate Bass and Treble Controls. For A.C. mains input of 200-250 v. 50 c/s. Output for 2-3 ohm speaker. Three miniature Mullard valves used. Size of unit only 7-5-5in. High. Guaranteed for 12 months. Only £5-19-6. Send S.A.E. for illustrative leaflet. Terms: Deposit 22/6 and 5 monthly payments of 22/6.

R.S.C. 45 WATT A5 HIGH-GAIN AMPLIFIER

A highly-sensitive 4-valve quality amplifier for the home, small club, etc. Only 50 millivolts input is required for full output so that it is suitable for use with the latest high fidelity pick-up heads, in addition to all other types of pick-ups and practically all 'mikes'. Separate Bass and Treble Controls are provided. These give full long-playing record equalisation. Hum level is negligible being 71db. down 15db. of Negative feedback is used. H.T. or 300 v. 25 mA. and L.T. or 6.3 v. 1.5 a. is available for the supply of a Radio Feeder Unit, or Tape-Deck pre-amplifier. For A.C. mains input of 200-250 v. 50 c/s. Output for 2-3 ohm speaker. Chassis is not active. Kit is complete finish and point-to-point wiring diagrams and instructions. Exceptional value at only £4-15-0, or assembled ready for use 25/- extra. plus 3/6 carr.; or Deposit 22/6 and 5 monthly payments of 22/6 for assembled unit.

230-250 v. 50 c/s. Output for 2-3 ohm speaker. Chassis is not active. Kit is complete finish and point-to-point wiring diagrams and instructions. Exceptional value at only £4-15-0, or assembled ready for use 25/- extra. plus 3/6 carr.; or Deposit 22/6 and 5 monthly payments of 22/6 for assembled unit.

B.S.C. PORTABLE GUITAR AMPLIFIERS. (For 200-250v. A.C. Mains) Junior 5 watts High Quality output. Separate Bass and Treble "Cut" and "Boost" controls. Sensitivity 15 m.v. Twin inputs. High Flux 8 in. Loudspeaker "built-in". Handsome, strongly made Cabinet (size approx. 14 x 14 x 7 in.) finished in attractive and durable polycrome, and fitted carrying handle. Terms: Deposit £1 and 9 monthly payments of £1. Carr. 10/-

Senior 10 watts High Fidelity output Separate Bass and Treble "Cut" and "Boost" controls. Twin separately controlled high gain inputs so that two instruments such as Guitar and String Bass can be used at the same time. Two loudspeakers are incorporated, a High Flux 8in. for Bass notes and a 7 x 4 m. elliptical for Treble. Cabinet is well made and finished as Junior model. Size approx. 18 x 18 x 9in. **15 Gns.** H.P. Terms. Deposit 34/9 and 9 monthly payments of 34/9. Carr. 10/-

Super Hi-Fi 15 Watt. All facilities as 10 watt. Cabinet size 20 x 15 x 12ins. Terms: Deposit £2-11-6. and nine monthly payments of 51/6. 22 gns. Carr. 12/6.

12in. 10 WATT HIGH QUALITY LOUD-SPEAKER IN POLISHED WALNUT FINISHED CABINET

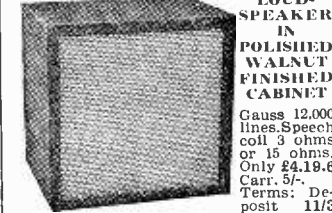

Gauss 12,000 lines. Speech coil 3 ohms or 15 ohms. Only £4-19-6 Carr. 5/-
Terms: Deposit 11/3 and 9 monthly payments of 11/3.

12in. 20 WATT HI-FI LOUD-SPEAKERS IN CABINETS. Size 18 x 18 x 10in. Finish as above. Terms: Deposit 17/9 and 9 monthly payments of 17/9. Only £7-19-6. Carr. 8/6.

R.S.C. BASS REFLEX CABINETS, JUNIOR MODEL. Specially designed for W.B. Hi-Fi 10" Speaker, but suitable for any good quality 10in. speaker. Accoustically lined and ported. Polished walnut veneer finish. Size 18 x 12 x 10in. Handsome appearance. Ensure superb reproduction for only £2-19-6.

STANDARD MODEL. As above but for 12in. speakers. Size 20 x 15 x 13in. Especially recommended for Plessey Dual Concentric Speaker. £5-19-6. Suitable legs with brass ferrules, 25/- per set. 0/4.

PLESSEY DUAL CONCENTRIC 12in. 15 ohms HIGH FIDELITY SPEAKER (12,000 lines) with built-in tweeter (completely separate unit) and speaker with choke, condensers, etc.) providing extraordinarily realistic reproduction when used with our All or similar amplifier. Rated 10 watts. Price only £5-19-6.

P.M. SPEAKERS. 2-3 ohm. Berdo 2 1/8". 5in. 17/9. 6in. 16/9. 8in. 19/9. 8 x 5in. 25/9. 10in. 29/9. 10 x 6in. 29/9. 12in. 29/11. 10in. W.B. Stentorian 3 or 15 ohms type HiFi 12 watts. High fidelity type. Recommended for use with our All Amplifier. £4-12-9. 12in. R.A. 3 ohms 10 watts (12,000 lines). 59/6.

TWEETERS. Plessey 3in. 19/9. 1.5in. 25/9.

HI-FI CRYSTAL PICK-UP HEADS. (Turnover type with sapphire stylus.) Acos. Standard replacement for Garrard. B.S.R. and Collaro. 19/9. Acos Stereo-Monaural 49/9. Ronette Stereo/Monaural 59/9.

R.S.C. EQUIPMENT CABINET. Dimensions and outer appearance identical with Standard Bass Reflex Cabinet. Top hinged. Bass board adjustable. Will take Tape Deck or Player Unit and Amplifier plus P.M. or A.M./F.M. Unit. Only 6 gns.

SUPERHET FEEDER UNIT. Design of a high quality Radio Tuner Unit (specially suitable for use with any of our Amplifiers). Delayed A.V.C. Controls are Tuning, W/Ch. and Vol. Only 250 v. 15 mA. H.T. and L.T. of 6.3 v. 1 amp. required from amplifier. Size of unit approx. 9-6-7in. High. Simple alignment procedure. Point-to-point wiring diagrams, instructions and priced parts list with illustration, 2/6. Total building cost £4-15-0. For leaflet send S.A.E.

11 Gns.

Carr. 10/- carrying handles can be supplied for 19/9. The amplifier can be supplied, factory built with EL34 output valves and 12 months guarantee, for 14 gns. **TERMS: DEPOSIT 33/9 and 9 monthly payments of 33/9.** Suitable microphones and speakers available at competitive prices.

FULL RANGE OF LINEAR AMPLIFIERS ALWAYS IN STOCK.

COLLARO JUNIOR 4-speed single player units and Hi-Fi crystal pick-up with turn-over head. £3-19-6.

B.S.R. CAS 4-SPEED AUTO-CHANGERS with Hi-Fi turnover pick-up head. £6-19-6. Carr. 5/-.

R.S.C. BATTERY TO MAINS CONVERSION UNITS

Type BM1. An all-dry battery eliminator. Size 6 1/2 x 2 1/2 in. approx. Completely replaces battery supplying 1.4 v. and 90 v. where A.C. mains 200-250v. 50 c/s is available. Suitable for all battery portable receivers requiring 1.4 v. and 90 v. This includes latest low consumption types.

Complete kit with diagrams. 39/9. or ready to use. 46/9.

Type BM2. Size 8 x 5 1/2 x 2 1/2 in. Supplies 130 v. 90 v. and 60 v. 40 mA. and 2 v. 0.4 a. to 1 amp. fully smoothed. Thereby completely replacing both H.T. batteries and L.T. 2 v. accumulators when connected to A.C. mains supply 200-250 v. 50 c/s. **SUITABLE FOR ALL BATTERY RECEIVERS** normally using 2 v. accumulator. Complete kit of parts with diagrams and instructions. 49/9. or ready for use. 56/9.

TERMS: C.W.O. or C.O.D. No C.O.D. under £1. Post 1/9 extra under £2. 3/8 extra under £5. Open 9 to 6. Weds. until 1 p.m. except Manchester open all week. Trade supplied. S.A.E. with all enquiries.

R.S.C. Ltd.

51 Savile St., Hull
73 Dale Street, Liverpool 2
5-7 County (Mecca) Arcade, Briggate, Leeds 1

Mail Orders to 29-31 Moorfield Road, Leeds 12.
Personal Shoppers to any of branches below—
8-10 Brown St. Manchester 2
56 Morley Street, (Above Alhambra Theatre), Bradford

TREMENDOUS DEMAND! for the new NOMBREX

Our order book shows that this highly efficient and compact signal generator is the finest value in instruments anywhere in the world.

Designed after months of research in our own laboratory, and custom-built to the highest standards in our own factory, it is the ideal instrument for radio service engineers, radio enthusiasts, and for technical training colleges.

NOTE THESE STAR FEATURES

- ★ Compact and portable—only 6½" x 4½"
 - ★ Truly lightweight—under 2lb weight
 - ★ Operates from standard 9V transistor battery
 - ★ Fully transistorised—negligible consumption
 - ★ 8 ranges fully covering 220 kc/s-220 Mc/s
 - ★ Printed circuit for absolute reliability
 - ★ Accuracy better than 2% (average 1%)
 - ★ Modulated or unmodulated R.F. output, 100mW
 - ★ Audio output, sine wave, approx. 1,000 c/s
- COMPLETE WITH OUTPUT PLUG ONLY

Send your order in now for earliest possible delivery.

S.A.E. for full technical leaflet.

TRANSISTORISED WIDE-RANGE
SIGNAL GENERATOR 27
220 kc/s to 220 Mc/s.

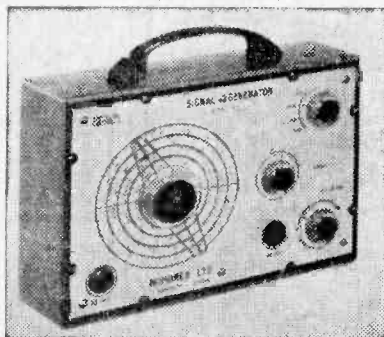

RETAIL **£7.10.0** Post and Ins. 3/6
Battery 2/-
CASH WITH ORDER. REGRET NO C.O.D.
NOW IN QUANTITY PRODUCTION
ALL ORDERS IN STRICT ROTATION
Trade and Export Enquiries Invited

NOMBREX LTD.

Instruments
Division 26

ESTUARY HOUSE, CAMPERDOWN TERRACE,
EXMOUTH, DEVON. Phone: 3515.

THE
PEMBRIDGE
COLLEGE
OF ELECTRONICS
OFFERS TRAINING
IN RADIO
TELEVISION
AND ELECTRONICS

ATTENDING COURSE

- (A) Full-time One Year Course in Radio and Television. College course in basic principles for prospective servicing engineers. Next course commences 25th April 1962. This course is recognised by the Radio Trades Examination Board (R.T.E.B.) for the new Servicing Certificate examinations.

HOME-STUDY COURSES

- (B) Radio and Television Servicing
1 Introductory course.
2 Basic course covering R.T.E.B. Intermediate Radio and Television Servicing Certificate examination.
- (C) Courses in Radio, Telecommunications and Mathematics up to City and Guilds Telecommunication Technicians' Final Certificate.

To: The Pembridge College of Electronics.
(Dept. P11), 34a Hereford Road, London, W.2.
Please send, without obligation, details of
A B C (Please tick.)

Name _____

Address _____

HARVERSON SURPLUS Co. Ltd.

PLEASE TURN OVER FOR ADDRESS AND MORE BARGAINS

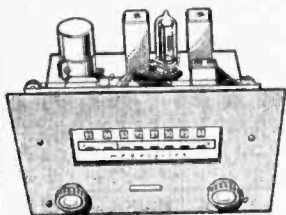

BUILD THIS F.M. TUNER F.M. UNIT MARK II

We proudly announce our MK11 F.M. Tuner. This equipment combines quality (only specially selected top grade components are used) with simplicity of construction. The refinements provided, and the performance achieved are equal to many commercial models at twice the price. The completed tuner is supplied with an attractive metal front panel, finished in a choice of black crackle, glossy hammer green, or glossy hammer grey enamel.

- ★ F.M. Tuning Head by famous maker. ★ Guaranteed Non-drift.
- ★ Permeability Tuning. ★ Frequency coverage 88-100 Mc/s.
- ★ OAB1 Balanced Diode Output. ★ Magic eye tuning. ★ Smart front panel. ★ Two I.F. Stages and Discriminator. ★ Attractive maroon and gold dial (7 x 3in. glass).
- ★ Self-powered, using a good quality mains transformer and valve rectifier. ★ Valves used ECC85, two EF80's, EZ80 (rectifier) and magic eye. ★ Fully drilled chassis. ★ Everything supplied, down to the last nut and bolt.
- ★ All parts sold separately. Circuit diagram and illustrations, 1/6, post free.

£6.12.6 P. & P. 10/-

COIL and TRANSFORMER SET FOR TRANSISTOR SUPERHET

3 I.F. Transformers, one oscillator coil, one driver transformer, and wound ferrite aerial (Med., Long and aerial coupling) 28/6 complete, post 1/-, 6-transistor printed circuit board to match 8/6, post 9d. Circuit diagram 1/6 extra.

CONDENSER/RESISTOR PARCEL

50 mixed P.F. Condensers and 50 mixed Resistors. An assortment of useful valves—all new—a must for the serviceman and constructor

ONLY **10/-** P. & P. 1/-

SPECIAL OFFER 54-in. LOUDSPEAKER SILKS

Heavily woven in ivory and gold. Original price 35/- per yard length. OUR SPECIAL PRICE, 13/6 per yard length. P. & P. 1/6.

E.M.I. 4-SPEED PLAYER AND PICK-UP

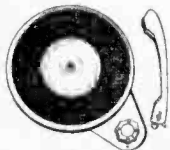

Heavy 8 $\frac{1}{2}$ in. metal turntable. Low flutter performance 200/250V shaded motor with tap at 80V for amplifier valve filament if required. Turnover LP/78 head.

PRICE 89/6 Plus 4/6 P. & P.

A FEW ONLY HARVERSON'S MARK I F.M. TUNER

As previously advertised, this is a first class F.M. tuner. The basic design of this is similar to that of our Mark 11 Unit (described above) but does not incorporate some of the lavish refinements of the latter. Emphasis has been placed on simplicity of construction and this unit is quite within the capabilities of the comparative novice. Coverage 88-100 Megacycles. Self powered, with valve rectifier. All parts complete with 4 valves, attractive glass, dial and comprehensive instructions.

ONLY **£4.19.6** Plus 8/6 P. & P.

METAL CASE FOR THE ABOVE TUNER

Metal Case of robust construction (using front panel as supplied with our Mark 11 unit) fully ventilated. Attractively finished in a choice of black crackle, glossy hammer green, or hammer grey enamel.

25/- P. & P. 1/9. (Front panel only 10/6. P. & P. 9d.).

THE HARVERSON 6 TRANSISTOR & DIODE SUPERHET KIT

A first class 2 wave band transistor superhet in kit form.

- ★ Printed circuit panel (size 8 $\frac{1}{2}$ x 23ins.)
- ★ 3 Pre-aligned I.F. Transformers.
- ★ Output Transformer.
- ★ 5 inch 5 Ω Speaker.
- ★ High gain Ferrite rod aerial.
- ★ First grade G.E.C. transistors.
- ★ Car aerial socket.
- ★ Push/Pull output.
- ★ All parts sold separately.

Owing to a fortunate purchase of components, all parts down to the minutest item with simple instructions.

ONLY **£4.19.6** Plus 2/6 P. & P.



SUPER TABLE RADIO CABINET

A very fortunate purchase allows us to offer this quality table radio cabinet for only 18/6 (this cabinet cost the manufacturers 35/- each to make). The positions of the controls make it ideal for housing our 6 TRANSISTOR SUPERHET KIT described above. Beautifully finished in walnut and tygan.

OUR PRICE ONLY **18/6** Plus 1/6 P. & P. ins.

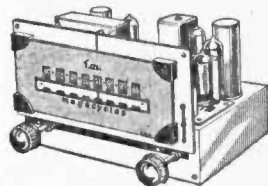
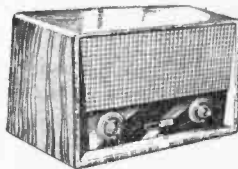

HARVEYSON SURPLUS CO. LTD.

HARVERSONS

GREAT OBSOLETE VALVE LIST

DON'T DISCARD THAT OLD SET! GET A NEW VALVE FROM US AND KEEP IT WORKING. —ALL VALVES NEW • GUARANTEED • IN ORIGINAL BOXES • GENUINE MULLARD, MAZDA, MARCONI, ETC. • POSTAGE & PACKING 6d. PER VALVE.

| | | | | | | | | | | | | |
|-----------|-------------|-----------|-----------|---------------|----------|------------|------------|-----------|------------|-----------|--------------|------|
| A30D | 9/6 CY32 | 11/- EL3 | 5/- KT96 | 28/- P41 | 9/- R3 | 9/- U351 | 12/- WT40 | 15/- 6AC7 | 3/- 6SH7 | 8/- 19 | 8/6 79 | 8/- |
| A50A | 9/6 D4 | 5/- EL3A | 5/- KT41 | 17/6 P215 | 9/- R31 | 9/- U382 | 18/6 X34 | 21/- 6AG5 | 4/- 6S7 | 8/- 19X3 | 8/6 80 | 8/- |
| A50N | 12/6 D41 | 10/6 EL32 | 5/- KT42 | 22/- PA20 | 9/- S11A | 9/- U389 | 18/6 X41C | 10/- 6B4 | 5/- 6817GT | 8/- 20F2 | 18/6 83 | 12/- |
| A70B | 12/6 D3 | 8/6 EL33 | 12/6 KT44 | 12/- PC/PEN | S11D | 9/- U403 | 14/- X61 | 10/- 6B5 | 6/- 6857 | 8/- 20P1 | 18/6 84 | 12/- |
| A70C | 17/6 D43 | 10/6 EL34 | 15/- KT45 | 12/- G Pin | 8d | 10/- U405 | 10/- X71M | 12/- 6B7 | 9/- 6877M | 6/- 20P4 | 18/6 85A1 | 12/- |
| A70D | 17/6 D63 | 5/- EL35 | 18/6 KT3 | 15/- Terminal | S215VM | 9/- U409 | 9/- X8G | 5/- 6B7M | 7/6 69Q7GT | 9/- 25A6G | 18/6 87 | 12/- |
| AC/PEN | U433 | 10/- EL37 | 18/6 KT68 | 12/6 | | 9/- U414 | 11/- Y63 | 6/- 6B8G | 6/- 688Y | 8/- 25L6 | 10/6 89 | 12/- |
| AC/HL | 15/- DA10 | 8/6 EL38 | 18/6 KT71 | 12/6 PL33 | 18A | 9/- U41 | 11/- Y63 | 6/- 6B8G | 7/6 6887 | 8/- 25Y5 | 10/6 117Z6GT | |
| AC/ME | 15/- DC/HL | 8/6 EL39 | 10/6 KT74 | 12/6 PM2 | 7/- | 9/- UB121 | 18/6 Z21 | 6/- 6BAG | 7/6 6887 | 8/- 35Y5G | 10/6 184V | 12/- |
| AC/P4 | 18/6 DC SG | 10/6 EM1 | 12/6 KT75 | 12/6 PM2A | 7/- | 9/- UCH11 | 18/6 Z31 | 8/6 6C4 | 5/- 6887 | 7/- 3574 | 8/6 184V | 8/- |
| AC/SP1 | 12/6 DD-PEN | EN31 | 32/- KT74 | 7/- PM-HL12 | 12/6 | 12/6 UCL11 | 14/6 Z63 | 7/6 6C5 | 6/- 6U7G | 8/- 27 | 8/6 184V | 8/- |
| AC/SC6 | 10/6 | 18/6 E22 | 9/- KT238 | 7/- PM2B | 7/- | 12/6 UR1C | 18/- Z90 | 12/6 6C6 | 6/- 6U8G | 8/- 28D7 | 6/- 202DDT | |
| AC/62PEN | DD13 | 18/6 EZ3 | 15/- L12 | 6/- PM3 | 9/- | 12/6 UR3 | 16/- Z8159 | 12/6 6C8 | 6/- 6V8GT | 7/- 30F7 | 7/- 202PT | 18/6 |
| AC/3 | 18/6 DD101 | 10/6 PC4 | 15/- L42 | 6/- PM3A | 9/- | 12/6 UR3 | 16/- Z8159 | 12/6 6C8 | 6/- 6V8GT | 7/- 30F7 | 7/- 202PT | 18/6 |
| AC/8XV17 | DD207 | 10/6 PC13 | 15/- L63 | 6/- PM4DX | 9/- | 12/6 UR3 | 16/- Z8159 | 12/6 6C8 | 6/- 6V8GT | 7/- 30F7 | 7/- 202PT | 18/6 |
| AC/PT | 30/- DD4020 | PC13C | 15/- LP2 | 6/- | | 12/6 UR3 | 16/- Z8159 | 12/6 6C8 | 6/- 6V8GT | 7/- 30F7 | 7/- 202PT | 18/6 |
| AC/TH118 | 6/6 | 8/6 LP2 | 6/- | 6/- PM5B | 9/- | 12/6 UR3 | 16/- Z8159 | 12/6 6C8 | 6/- 6V8GT | 7/- 30F7 | 7/- 202PT | 18/6 |
| AC/VP115 | DDL-4 | 10/6 | 8/6 | 9/- PM12M | 9/- | 12/6 UR3 | 16/- Z8159 | 12/6 6C8 | 6/- 6V8GT | 7/- 30F7 | 7/- 202PT | 18/6 |
| AC/HL | DDT9 | 8/6 | 8/6 | 12/6 PM2A | 10/- | 12/6 UR3 | 16/- Z8159 | 12/6 6C8 | 6/- 6V8GT | 7/- 30F7 | 7/- 202PT | 18/6 |
| AC/2PEN | DDT13 | 10/6 | 10/6 | 12/6 PM22A | 10/- | 12/6 UR3 | 16/- Z8159 | 12/6 6C8 | 6/- 6V8GT | 7/- 30F7 | 7/- 202PT | 18/6 |
| ATP4 | 17/6 | DT19 | 5/6 | 12/6 PM24A | 10/- | 12/6 UR3 | 16/- Z8159 | 12/6 6C8 | 6/- 6V8GT | 7/- 30F7 | 7/- 202PT | 18/6 |
| AC3 | 10/6 | DH76 | 5/- | 12/6 PM24M | 10/- | 12/6 UR3 | 16/- Z8159 | 12/6 6C8 | 6/- 6V8GT | 7/- 30F7 | 7/- 202PT | 18/6 |
| AC4 | 10/6 | DH101 | 8/- | 12/6 PM202 | 10/- | 12/6 UR3 | 16/- Z8159 | 12/6 6C8 | 6/- 6V8GT | 7/- 30F7 | 7/- 202PT | 18/6 |
| AC/3PEN | DL43 | 18/6 | 18/6 | 12/6 PM24M | 10/- | 12/6 UR3 | 16/- Z8159 | 12/6 6C8 | 6/- 6V8GT | 7/- 30F7 | 7/- 202PT | 18/6 |
| AC/5PEN- | DL82 | 12/6 | 12/6 | 12/6 PM24M | 10/- | 12/6 UR3 | 16/- Z8159 | 12/6 6C8 | 6/- 6V8GT | 7/- 30F7 | 7/- 202PT | 18/6 |
| DD | 12/6 | DL810 | 10/6 | 12/6 PM24M | 10/- | 12/6 UR3 | 16/- Z8159 | 12/6 6C8 | 6/- 6V8GT | 7/- 30F7 | 7/- 202PT | 18/6 |
| AG8 | 10/6 | DN41 | 7/6 | 12/6 PM202 | 10/- | 12/6 UR3 | 16/- Z8159 | 12/6 6C8 | 6/- 6V8GT | 7/- 30F7 | 7/- 202PT | 18/6 |
| AGX2270 | DC20 | 10/6 | 10/6 | 12/6 PM24M | 10/- | 12/6 UR3 | 16/- Z8159 | 12/6 6C8 | 6/- 6V8GT | 7/- 30F7 | 7/- 202PT | 18/6 |
| AL1 | 8/6 | DS | 8/- | 12/6 PM24M | 10/- | 12/6 UR3 | 16/- Z8159 | 12/6 6C8 | 6/- 6V8GT | 7/- 30F7 | 7/- 202PT | 18/6 |
| APP4A | 8/6 | DW2 | 12/6 | 12/6 PM24M | 10/- | 12/6 UR3 | 16/- Z8159 | 12/6 6C8 | 6/- 6V8GT | 7/- 30F7 | 7/- 202PT | 18/6 |
| APP4B | 17/6 | DD4/500 | 10/6 | 12/6 PM24M | 10/- | 12/6 UR3 | 16/- Z8159 | 12/6 6C8 | 6/- 6V8GT | 7/- 30F7 | 7/- 202PT | 18/6 |
| APV4 | 8/6 | | 18/6 | 12/6 PM24M | 10/- | 12/6 UR3 | 16/- Z8159 | 12/6 6C8 | 6/- 6V8GT | 7/- 30F7 | 7/- 202PT | 18/6 |
| ARF38 | 6/6 | EAB1 | 9/6 | 12/6 PM24M | 10/- | 12/6 UR3 | 16/- Z8159 | 12/6 6C8 | 6/- 6V8GT | 7/- 30F7 | 7/- 202PT | 18/6 |
| ARTH2 | 5/6 | EAB4 | 9/6 | 12/6 PM24M | 10/- | 12/6 UR3 | 16/- Z8159 | 12/6 6C8 | 6/- 6V8GT | 7/- 30F7 | 7/- 202PT | 18/6 |
| AS4120 | 12/6 | EB34 | 1/6 | 12/6 PM24M | 10/- | 12/6 UR3 | 16/- Z8159 | 12/6 6C8 | 6/- 6V8GT | 7/- 30F7 | 7/- 202PT | 18/6 |
| ATH43 | 10/6 | EB3C | 18/6 | 12/6 PM24M | 10/- | 12/6 UR3 | 16/- Z8159 | 12/6 6C8 | 6/- 6V8GT | 7/- 30F7 | 7/- 202PT | 18/6 |
| ATP4 | 5/- | EB3C | 8/- | 12/6 PM24M | 10/- | 12/6 UR3 | 16/- Z8159 | 12/6 6C8 | 6/- 6V8GT | 7/- 30F7 | 7/- 202PT | 18/6 |
| AW2 | 5/- | EBF11 | 9/- | 12/6 PM24M | 10/- | 12/6 UR3 | 16/- Z8159 | 12/6 6C8 | 6/- 6V8GT | 7/- 30F7 | 7/- 202PT | 18/6 |
| AW3 | 5/- | EBF11 | 9/- | 12/6 PM24M | 10/- | 12/6 UR3 | 16/- Z8159 | 12/6 6C8 | 6/- 6V8GT | 7/- 30F7 | 7/- 202PT | 18/6 |
| AW6 | 5/- | EBL21 | 18/6 | 12/6 PM24M | 10/- | 12/6 UR3 | 16/- Z8159 | 12/6 6C8 | 6/- 6V8GT | 7/- 30F7 | 7/- 202PT | 18/6 |
| AZ1 | 19/7 | EC31 | 5/6 | 12/6 PM24M | 10/- | 12/6 UR3 | 16/- Z8159 | 12/6 6C8 | 6/- 6V8GT | 7/- 30F7 | 7/- 202PT | 18/6 |
| AZ2 | 18/7 | EC30 | 6/6 | 12/6 PM24M | 10/- | 12/6 UR3 | 16/- Z8159 | 12/6 6C8 | 6/- 6V8GT | 7/- 30F7 | 7/- 202PT | 18/6 |
| AZ11 | 18/7 | EC32 | 5/6 | 12/6 PM24M | 10/- | 12/6 UR3 | 16/- Z8159 | 12/6 6C8 | 6/- 6V8GT | 7/- 30F7 | 7/- 202PT | 18/6 |
| AZ31 | 9/6 | EC53 | 5/6 | 12/6 PM24M | 10/- | 12/6 UR3 | 16/- Z8159 | 12/6 6C8 | 6/- 6V8GT | 7/- 30F7 | 7/- 202PT | 18/6 |
| AZ50 | 12/6 | EC54 | 5/6 | 12/6 PM24M | 10/- | 12/6 UR3 | 16/- Z8159 | 12/6 6C8 | 6/- 6V8GT | 7/- 30F7 | 7/- 202PT | 18/6 |
| B21 | 15/- | EC90 | 13/6 | 12/6 PM24M | 10/- | 12/6 UR3 | 16/- Z8159 | 12/6 6C8 | 6/- 6V8GT | 7/- 30F7 | 7/- 202PT | 18/6 |
| B36 | 15/- | EC81 | 10/6 | 12/6 PM24M | 10/- | 12/6 UR3 | 16/- Z8159 | 12/6 6C8 | 6/- 6V8GT | 7/- 30F7 | 7/- 202PT | 18/6 |
| B85 | 7/6 | EC82 | 5/6 | 12/6 PM24M | 10/- | 12/6 UR3 | 16/- Z8159 | 12/6 6C8 | 6/- 6V8GT | 7/- 30F7 | 7/- 202PT | 18/6 |
| BR201 | 10/- | EC33 | 8/6 | 12/6 PM24M | 10/- | 12/6 UR3 | 16/- Z8159 | 12/6 6C8 | 6/- 6V8GT | 7/- 30F7 | 7/- 202PT | 18/6 |
| BR10650 | 5/6 | EC3 | 18/6 | 12/6 PM24M | 10/- | 12/6 UR3 | 16/- Z8159 | 12/6 6C8 | 6/- 6V8GT | 7/- 30F7 | 7/- 202PT | 18/6 |
| B20 | 10/- | BECH34 | 5/6 | 12/6 PM24M | 10/- | 12/6 UR3 | 16/- Z8159 | 12/6 6C8 | 6/- 6V8GT | 7/- 30F7 | 7/- 202PT | 18/6 |
| BU200 | 10/- | EH35 | 5/6 | 12/6 PM24M | 10/- | 12/6 UR3 | 16/- Z8159 | 12/6 6C8 | 6/- 6V8GT | 7/- 30F7 | 7/- 202PT | 18/6 |
| C1 | 12/6 | EF50 | 5/6 | 12/6 PM24M | 10/- | 12/6 UR3 | 16/- Z8159 | 12/6 6C8 | 6/- 6V8GT | 7/- 30F7 | 7/- 202PT | 18/6 |
| C1C | 12/6 | EF5 | 5/6 | 12/6 PM24M | 10/- | 12/6 UR3 | 16/- Z8159 | 12/6 6C8 | 6/- 6V8GT | 7/- 30F7 | 7/- 202PT | 18/6 |
| CP5P/ENDD | EF6 | 10/6 | 10/6 | 12/6 PM24M | 10/- | 12/6 UR3 | 16/- Z8159 | 12/6 6C8 | 6/- 6V8GT | 7/- 30F7 | 7/- 202PT | 18/6 |
| C10B | 18/6 | EF34 | 18/6 | 12/6 PM24M | 10/- | 12/6 UR3 | 16/- Z8159 | 12/6 6C8 | 6/- 6V8GT | 7/- 30F7 | 7/- 202PT | 18/6 |
| C20C | 8/6 | EF11 | 18/6 | 12/6 PM24M | 10/- | 12/6 UR3 | 16/- Z8159 | 12/6 6C8 | 6/- 6V8GT | 7/- 30F7 | 7/- 202PT | 18/6 |
| C23B | 8/6 | EF37A | 11/6 | 12/6 PM24M | 10/- | 12/6 UR3 | 16/- Z8159 | 12/6 6C8 | 6/- 6V8GT | 7/- 30F7 | 7/- 202PT | 18/6 |
| C38A | 12/6 | EF39 | 6/6 | 12/6 PM24M | 10/- | 12/6 UR3 | 16/- Z8159 | 12/6 6C8 | 6/- 6V8GT | 7/- 30F7 | 7/- 202PT | 18/6 |
| CB11 | 21/- | EF50 | 5/6 | 12/6 PM24M | 10/- | 12/6 UR3 | 16/- Z8159 | 12/6 6C8 | 6/- 6V8GT | 7/- 30F7 | 7/- 202PT | 18/6 |
| CB4 | 21/- | EF51 | 5/6 | 12/6 PM24M | 10/- | 12/6 UR3 | 16/- Z8159 | 12/6 6C8 | 6/- 6V8GT | 7/- 30F7 | 7/- 202PT | 18/6 |
| CV40 | 10/6 | EF54 | 5/6 | 12/6 PM24M | 10/- | 12/6 UR3 | 16/- Z8159 | 12/6 6C8 | 6/- 6V8GT | 7/- 30F7 | 7/- 202PT | 18/6 |
| CV1092 | 5/6 | EF2 | 8/6 | 12/6 PM24M | 10/- | 12/6 UR3 | 16/- Z8159 | 12/6 6C8 | 6/- 6V8GT | 7/- 30F7 | 7/- 202PT | 18/6 |
| CY1 | 18/6 | EK32 | 9/6 | 12/6 PM24M | 10/- | 12/6 UR3 | 16/- Z8159 | 12/6 6C8 | 6/- 6V8GT | 7/- 30F7 | 7/- 202PT | 18/6 |
| CY10 | 18/6 | EK3 | 5/6 | 12/6 PM24M | 10/- | 12/6 UR3 | 16/- Z8159 | 12/6 6C8 | 6/- 6V8GT | 7/- 30F7 | 7/- 202PT | 18/6 |

MODERN VALVES - Nearly every type in stock at bargain prices. Write, call or phone for your needs.

F.M. TUNER HEAD



A permeability tuned tuner head by a famous maker, supplied without valve (EC85) 18/- plus 1/9 P. & P. Valve 8/6 extra.

SPECIAL OFFER

MIDGET 2 GANG CONDENSERS

Polystyrene cased, with built-in trimmers. Size 1 x 1 x 7/16 ins. Not used, but removed from printed circuit boards.

UNBEATABLE VALUE 9/- P. & P. 2 for only 1/-

PUSH-BUTTON TRANSISTOR SWITCH

A 3 push-button switch, specially designed for transistor radios. Button functions provided are on-off, long and medium wave. The back of switch is also equipped with a rack for mounting a Ferrite Aerial. Easily worth 15/-.

OUR PRICE ONLY 5/6

83 HIGH STREET, MERTON, S.W.19

CHerrywood 3985/6

QUALITY RECORD PLAYER AMPLIFIER KIT

A top quality record player amplifier in kit form. This amplifier (which is used in a 29-gn. record player) has a printed circuit and has an internal fully smoothed power supply (input AC/DC Mains) using a mains dropper and contact cooled rectifier. A flying panel is supplied accommodating BASS, TREBLE AND VOLUME — ON/OFF controls. 2 valves (UL84 and UF89) and linear output transformer give crisp reproduction from all records at 4 watts. Our price for the complete kit of parts (including valves) ONLY plus P. & P. 6/6. Simple instructions 1/6. (Free with kit).

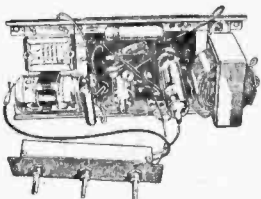

59/6

Introducing HARVERSON'S Monaural Amplifier Kit

39/6

In response to numerous requests from delighted purchasers of our "SUPER STEREO KIT" we have produced a "MONAURAL AMPLIFIER" on similar lines.

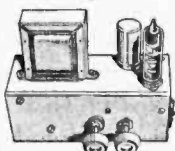

★ A UCL 82 valve provides a triode amplifying stage, and a pentode output stage (3 watts), enabling good amplification and sparkling reproduction to be combined with physical compactness (amplifier size, 7 x 3 1/2 x 8 1/2 in. high).

★ Modern circuitry design, good quality O.P. transformer (to match 3Ω) keep hum and distortion to a low level.

★ The controls, volume on/off, and tone, are complete with attractive cream and solid knob.

★ The amplifier has a built-in fully smoothed power supply, using a good quality mains transformer (A.C. mains only) and metal rectifier.

★ All you need is supplied including easy to follow instructions which guarantee good results for the beginner and expert. All components, leads, chassis, valve, knobs, etc., are first grade items by prominent manufacturers.

OUR PRICE 39/6

Plus 4/6 Post and Packing. 5in. LOUDSPEAKER TO SUIT 14/6—EXTRA
ALL PARTS SOLD SEPARATELY

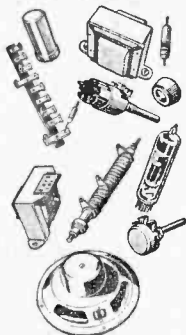

SPECIAL OFFER...

6 TRANSISTOR RADIO IN KIT FORM

Special offer. Limited quantity only of new ex-manufacturer's parts to make a 6 transistor 2 wave band superhet chassis. Ideal for portable or table radio. All parts including transistors ferrite aerial, printed circuit, etc., but EXCLUDING speaker and cabinet. Few Only. P. & P. 2/6
Simple instructions 1/6 (Free with kit).

£4.5.0

THE HARVERSON COMPLETE F.M./V.H.F. RECEIVER KIT £6.19.6

AT LAST—A COMPLETE F.M. RECEIVER IN KIT FORM!

Specially designed with the home constructor in mind, this kit enables the construction of a completely self-contained V.H.F. receiver, at fraction of the normal cost of comparable equipment. This is basically a quality self-powered F.M. tuner plus 2 separate audio amplifier stages, and output transformer and speaker.

- ★ F.M. Tuning Head by famous maker.
- ★ Guaranteed Non-drift.
- ★ Permeability Tuning.
- ★ Frequency coverage 88-100 Mc/s.
- ★ OA81 Balanced Diode Output.
- ★ Two I.F. Stage and Discriminator.
- ★ Self powered using a good quality mains transformer and valve rectifier.
- ★ Valves used ECC85, two EF80's, ECL82 and EZ80 (rectifier).
- ★ Fully drilled chassis.
- ★ Good quality speaker.
- ★ Well designed output transformer.
- ★ Attractive maroon and gold glass dial.
- ★ Two output stages (using ECL82).
- ★ Everything supplied, down to the last nut and bolt.
- ★ Compact size.
- ★ All parts sold separately.

OUR PRICE **£6.19.6** P. & P.

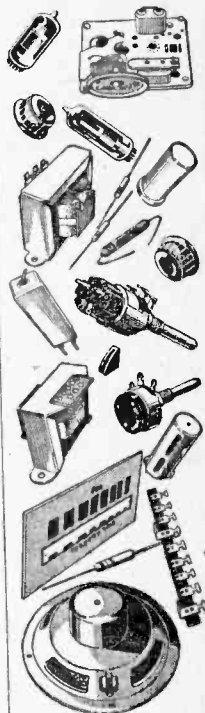

14 WATT HI-FI AMPLIFIER KIT

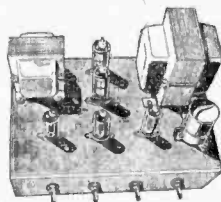

A kit designed to meet the exacting requirements of the radio enthusiast, yet remain within the price range of the average constructor. A stylishly finished monaural amplifier with an output of 14 Watts from 2 EL84's in push pull. Super reproduction of both music and speech

(Frequency response $\pm 3\text{dB}$ c/s-60 Kc/s with negligible hum.) Separate inputs for mike and gram allow records and announcements to follow each other and make this amplifier ideal for small halls, youth clubs, etc. Fully shrouded Ultra Linear output transformer (to match 3-15 Ω speaker), and fully shrouded mains transformer (these alone are worth over £3.10.0). 2 independent volume controls, and separate Bass and Treble controls are provided, giving good lift and cut. Valve line up 2 EL84's, ECC83, EF86 and EZ80 rectifier. All parts down to the last nut and bolt, including valves, knobs, heavy gauge metal chassis finished in glossy hammer green enamel, mains and output transformers finished to match.

P. & P. 6/6 (simple instruction booklet 1/6, free with kit).

ONLY £6.19.6

All parts sold separately.



Valves *by return post*

| | | | | | | | |
|-----------|-------|---------|-------|----------|-------|---------|------|
| AZ1 | 10/- | FC13 | 5/6 | VR105/30 | 8/- | 6SK7 | 6/- |
| AZ31 | 10/- | FW4/500 | | VR150/30 | 7/6 | 6SL7GT | 8/- |
| DAF96 | 8/- | | 10/- | VU39 (M) | 12/14 | 6SN7GT | 7/6 |
| DF96 | 8/- | GZ32 | 11/6 | | 8/9 | 6SQ7 | 7/6 |
| DK96 | 8/- | HL23DD | 8/6 | Y63 | 7/6 | 6UJ4GT | 12/- |
| DL96 | 8/- | HL42DD | | IA7GT | 13/6 | 6V6G | 5/9 |
| EABC80 | 9/- | | 10/- | IC2 | 11/6 | 6V6GT | 7/6 |
| EAF42 | 9/6 | KT2 | 5/- | IHSGT | 12/6 | 6X4 | 7/6 |
| EB91 | 4/6 | KT33C | 6/- | 1CSGT | 9/- | 6X5G | 7/6 |
| EBC33 | 6/9 | KT61 | 10/- | IN5 | 10/6 | 6X5GT | 7/- |
| EBC41 | 8/9 | KT101 | 6/- | IR5 | 7/6 | 6/30L2 | 12/6 |
| EBC90 | 8/6 | KTW61 | 6/6 | IS5 | 6/6 | 786 | 10/6 |
| EBC91 | 8/6 | OZ4 | 4/6 | IT4 | 5/6 | 787 | 8/6 |
| EBF80 | 9/9 | PCC84 | 12/- | 3D6 | 5/- | 7CS | 8/- |
| EBF83 | 13/11 | PCC85 | 8/6 | 3Q4 | 7/6 | 7C6 | 8/- |
| EBF89 | 9/6 | PCC80 | 8/9 | 3Q5GT | 9/6 | 7H7 | 8/- |
| EBL21 | 23/3 | PCF82 | 11/6 | 354 | 7/6 | 757 | 9/6 |
| EBL31 | 23/3 | PCL83 | 13/6 | 3V4 | 8/- | 7Y4 | 6/6 |
| EC90 | 4/6 | PCL84 | 10/- | 4D1 | 3/- | 10F1 | 12/6 |
| EC91 | 15/11 | PL36 | 13/6 | 5R4G | 9/6 | 10P13 | 22/3 |
| ECC81 | 8/- | PL81 | 11/6 | SU4G | 5/- | 12A6 | 5/- |
| ECC82 | 7/6 | PL82 | 8/6 | 5V4 | 11/6 | 12AH8 | 12/- |
| ECC83 | 9/- | PL83 | 9/6 | 5Y3G | 8/- | 12AT7 | 7/6 |
| ECC84 | 10/- | PL84 | 9/6 | 5Y3GT | 7/6 | 12AU7 | 8/- |
| ECC85 | 9/6 | PX25 | 12/6 | 5Z4G | 9/- | 12AX7 | 8/- |
| ECF80 | 12/- | PY80 | 7/6 | 6A7 | 10/- | 12BA6 | 9/- |
| ECF82 | 10/6 | PY81 | 8/6 | 6A8G | 9/- | 12BE6 | 9/- |
| ECH42 | 9/6 | PY82 | 7/6 | 6AK5 | 5/- | 12C8 | 7/6 |
| ECH81 | 9/6 | PY83 | 8/6 | 6AL5 | 4/- | 12I7GT | 10/6 |
| ECL80 | 9/6 | PEN4VA | 6/6 | 6AM5 | 7/6 | 12K7GT | 6/6 |
| ECL82 | 10/6 | | 10/- | 6AM6 | 4/- | 12K8GT | 13/6 |
| ECL83 | 15/- | PEN25 | 5/- | 6AQ5 | 7/6 | 12K8M | 13/- |
| EF36 | 3/6 | PEN45 | 8/- | 6AT6 | 8/6 | 12Q7GT | 6/6 |
| EF41 | 9/6 | SP4 | 5/- | 6BA6 | 7/6 | 12SK7 | 6/- |
| EF50 | 5/- | TH21C | 9/6 | 6BE6 | 7/6 | 12SL7 | 8/- |
| EF50SYL | 7/- | TP22 | 8/- | 6BH6 | 9/- | 12SN7GT | |
| EF80 | 7/- | U10 | 9/6 | 6BJ6 | 9/- | 15D2 | 7/9 |
| EF85 | 7/6 | U25 | 13/6 | 6BW6 | 9/- | 15D6 | 8/- |
| EF86 | 18/6 | U26 | 12/- | 6C4 | 4/6 | 25A6G | 10/- |
| EF89 | 8/9 | U50 | 8/- | 6C5GT | 6/- | 25L6GT | 10/- |
| EF91 | 5/9 | UABC80 | 9/6 | 6C6 | 5/6 | 25Z4 | 9/6 |
| EF91(BVA) | 7/6 | UAF42 | 8/6 | 6C6 | 5/- | 25Z5 | 7/- |
| EF92 | 6/- | UBC41 | 11/6 | 6C6 | 7/6 | 25Z6 | 10/- |
| EF183 | 15/- | UBF80 | 9/6 | 6CH6 | 7/6 | 30FL1 | 10/6 |
| EF184 | 15/- | UCC84 | 10/11 | 6J5GT | 7/6 | 30L15 | 23/3 |
| EK32 | 7/- | UCC85 | 9/6 | 6J5M | 6/6 | 30P4 | 15/- |
| EL33 | 10/- | UCH42 | 9/6 | 6J6 | 4/- | 30P12 | 12/6 |
| EL41 | 9/- | UCH81 | 9/6 | 6J7G | 6/6 | 35Z3 | 12/6 |
| EL84 | 9/- | UCL82 | 11/6 | 6K7G | 3/6 | 36L6GT | 10/- |
| EL91 | 4/6 | UCL83 | 13/6 | 6K7M | 6/9 | 25Y5 | 9/- |
| EM34 | 9/6 | UF85 | 9/- | 6K8G | 6/6 | 35Z4GT | 8/- |
| EM80 | 9/6 | UF89 | 9/- | 6K7GT | 5/9 | 42 | 8/- |
| EM81 | 10/6 | UL41 | 9/- | 6K8GT | 10/- | 35Z5GT | 9/6 |
| EY51 | 9/6 | UL84 | 9/- | 6L6G | 8/- | 50L2GT | 8/6 |
| EY86 | 10/- | U06 | 19/3 | 6L6M | 9/6 | 75 | 10/6 |
| EZ40 | 7/6 | UY1 | 12/6 | 6L18 | 11/6 | 80 | 8/6 |
| EZ80 | 7/- | UY85 | 7/- | 6N7GT | 7/6 | 142B | 3/6 |
| EZ81 | 7/6 | VP23 | 5/- | 6Q7G | 7/6 | 210DDT | 4/6 |
| | | | | 6Q7GT | 9/6 | 210VPT | 3/6 |

AUTOMATIC RECORD CHANGERS
 BSR Monarch UA14.....£6.19.6
 Collaro C60 Studio.....£7.19.6
 Garrard Autoslim.....£8.19.6
SINGLE RECORD PLAYERS
 E.M.I. 4 speed with pick-up £4.9.6
 BSR Monarch GU6.....£4.19.6

METAL RECTIFIERS
 Battery Charger Types, 12 volt. 2 amp 7/-, 3 amp 10/-, 4 amp 12/6, 5 amp 14/6.

CHASSIS
 Aluminium, undrilled, all 2 1/2 in. deep.
 6 x 4 in. 4/6, 8 x 6 in. 6/3, 10 x 7 in. 7/3,
 12 x 3 in. 5/9, 12 x 5 in. 6/9, 12 x 8 in. 8/6,
 14 x 3 in. 6/-, 14 x 9 in. 12/-, 16 x 6 in. 9/3,
 16 x 10 in. 14/-.

LOUDSPEAKERS—
ALL 3 OHM IMPEDANCE
 Round Types—1 1/2 in. 17/6, 2 1/2 in. 17/6,
 5 in. 15/-, 6 1/2 in. 16/6, 8 in. 17/6, 12 in. 29/6.
 Square Types—2 1/2 in. 18/6, 3 in. 19/6,
 4 in. Tweeter 12/6.
 Elliptical Types—6 x 4 in. 15/6, 7 x 4 in.
 15/6, 8 x 6 in. 17/6, 10 x 6 in. 21/-.
 We also have in stock TSL Lorenz
 LPH65 £1.17.8, WB HF812 £4.5.6,
 WB HF912 £4.10.6, WB HF1012
 £5.2.6, 12 in. RTC 15 ohms unit £5.5.0.

MICROPHONES
 Acos Mic. 39/1. Stick Type 37/6.
 Table Stand for above 7/6.
 Floor Stand Adaptor 12/6.
 TSL Type M1 Dual Impedance
 Microphones with High (50,000 ohms) or
 Low (200 ohms) matching 84/-.
 TSL Stick Microphone MX3 35/-.
 Acos Mic.40 19/6.
 Acos Mic.45 29/6.
 Microphone Model BM3 45/-.
 Table Stand to suit above 12/6.

CHASSIS CUTTERS
 Type 1A, 3/4 x 3 in. 23/-; Type 2A, 1 x
 1 in. 26/9; Type 3A, 1 1/2 x 1 1/2 in. 27/3;
 Type 4A, 1 1/2 x 2 in. 36/3.

EXTENSION LOUSPEAKERS
 Plastic covered cabinet, cream and grey,
 with 8 in. unit and volume control, 37/6.
 As above, 5 in. unit, without volume
 control, £27/6.

LOUDSPEAKER CABINETS
 Baffle type, walu: finish, for 8 in.
 units, 21/-; 10 in. units, 25/6; 7 x 4 in.
 units, 17/6.

MAINS DROPPING RESISTORS
 For Ultra Twin 50, both types, 5/3 ea.
 For Philips 141U, 5/3 ea. For Pye
 Piper, 6/9 ea. For KB Rhapsody 7/6 ea.

TV DOUBLE POTENTIOMETERS
 For Ekco T208, T209, etc., 13/6. For
 Bush TV53, 56, 57, etc., 13/6 ea.
 For Pye V14C, etc., 13/6.

RECORDING TAPE
 5 in. reel, 600ft., Acetate.....13/6
 5 in. reel, 900ft. PVC.....21/-
 7 in. reel, 1200ft., Acetate.....23/-
 7 in. reel, 1800ft., PVC.....37/6

RECORD PLAYER CASES
 Baseboard cut suitable for a BSR UA14,
 available in red, turquoise, grey and
 black/yellow. 63/- ea.
 Amplifier and Loudspeaker to suit
 above, 65/-.

MARTIN RECORDAKIT
 Kit for use with the Collaro Studio
 Deck.
 Amplifier assembled and tested,
 switches, transformers, knobs and
 full instructions. 3 watts output.
 Magic Eye indicator, separate
 volume controls for recording level
 and built-in loudspeaker. Input
 sockets for: use with microphone
 radio and pick-up, etc. External
 speaker socket.....£11.11.0
 This amplifier can be fitted into
 your own cabinet, or a smart two
 tone leatherette covered wooden
 case complete with 9 x 5 in. high
 quality loudspeaker can be pur-
 chased for £5.5.0.
 The Collaro Studio Deck, complete
 at £10.19.6.

BLUE PRINTS AS ISSUED WITH
"PRACTICAL WIRELESS".
 SEND STAMPED ADDRESSED
 ENVELOPE FOR DETAILED
 PRICE LISTS FOR MINI-AMP,
 CITIZEN, TUTOR.

MULTI-RANGE TEST METERS
 Pifco All in One Radio Meter, 32/6.
 Test Master Model 200H, 20,000 ohms
 per volt, £6.19.6.
 Caby Model A10, £4.17.0.
 Caby Model B20, £6.10.0.
 Taylor Model 127A, £10.10.0.

TRANSISTOR KITS, ETC.
 Alpha Kit, Six Transistor, 2 Wave-
 band superhet, £10.19.6.
 P.V. Printed Circuit Transistor Six,
 in the new cabinet, £7.19.6.
 3 Valve TRF Kit, in contemporary
 wooden cabinet, £5.19.6.
 Repanco 1 Valve Battery Receiver Kit,
 complete with headphones, battery,
 etc., 45/-.

OUR CATALOGUE IS NOW AVAILABLE. PLEASE SEND IN STAMPS FOR YOUR COPY. TRADE CATALOGUE ALSO AVAILABLE, FOR WHICH PLEASE ATTACH YOUR BUSINESS LETTER HEADING



103 LEEDS TERRACE
 WINTON STREET
LEEDS 7

TERMS: Cash with Order or C.O.D.
 Postage and Packing Charges extra.
 Single valves 9d., Minimum Parcel
 Post charges 2/-. Please include
 sufficient postage with your order.
 Minimum C.O.D. fees and postage
 3/6. These Postal Rates apply to
 U.K. only. For full terms of business
 see inside cover of catalogue.
 Personal shoppers 9 a.m. to 5 p.m.
 Mon. to Friday, Saturday 10 a.m.
 to 1 p.m.

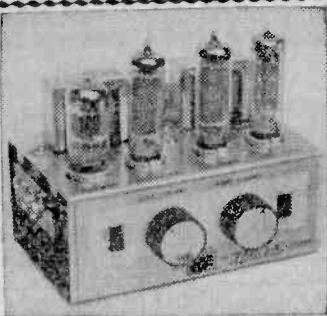

NEW! TRU-TEST
5 watt STEREO
AMPLIFIER

- Individual Stereo Volume Balance Controls
- For both Stereo and Monaural
- Fully wired, ready for Stereo

Controls include stereo/mono switch, tone control switch and on/off switch. Inputs for crystal or ceramic cartridge. Speaker output terminals. A.C. mains. 330 v. Size 1 1/2 x 5 1/2 x 4 1/2 in.

£6.19.6 Never before such value!

TELEGRAPH TRANSMITTER AND MORSE PRACTICE OSCILLATOR



Can be set up with others for net work practice in classrooms, groups, house to house, etc. Adjustable spring tension and contact clearance. Complete with buzzer, 50ft. wire on reel, ground spike and wire, crystal ear-phone, morse sheet. Only 6 ounces. Uses 1.5 v. battery.

19/6 P. & P. 2/6 **TWO FOR 40/-** Post Free.

DIGITAL COUNTER

Registers up to 99,999. Complete with arm and spring. May be manually or solenoid operated. Side knob easily resets to zero from any number. Size 2 1/2 x 1 1/2 x 1 1/2 in. overall **27/6** P. & P. 2/6.

FULL RANGE HIGH FIDELITY!
12in. Mechanical Two-way Loudspeaker Model CR.12AE
This speaker embodies two reproducing cones mounted coaxially with power coming from the same voice coil. The large cone produces the lower frequencies and the small cone gives you efficient high frequencies reproduction. Due to the double cone construction, a smooth crossover is possible and brings you the finest high fidelity music reproduction. Specification: Freq. response: 45 ± 10 c.p.s.



30 to 16,000 c.p.s. Resonant freq: 45 ± 10 c.p.s.
Capacity: 10-20 watts Sensitivity: 102 db/w. Voice coil impedance: 16 ohms Mechanical crossover freq: 1800 c.p.s. Diameter: 12in. Depth: 4in. Voice Coil diameter: 2in. Baffle opening diameter: 11in.
ONLY £8.8.0 P. & P. 4/-

PORTABLE MAINS SOLDERING IRON MODEL SPI



30 watts. Designed on an entirely new principle for light weight applications. Highly stable heat characteristics ensure long life and safety in use. The Model SPI features a removable handle that may be used to cover the tip and barrel to permit the iron to be carried safely even while hot. Supplied complete with Vinyl bag, mains lead and plug. All for only 18/6.

Our goods must be seen to be fully appreciated—visit to 87 Tottenham Court Road will be most rewarding.

MAIL ORDERS TO
(DEPT. P.), 32a COPTIC STREET,
LONDON, W.C.1

BUDGET UNIVERSAL TEST LEAD KIT IN PLASTIC CASE



(clips), all slide directly onto banana plugs. 9/6. P. & P. 1/6.

Consists of 4 1/2 in. long x 1 1/2 in. dia. red and black plastic handle pin prods with heavy duty 37in. rubber leads with 5000v. breakdown insulation terminating 2in. long x 1/2 in. dia. plastic grip banana plugs. 3 sets of interchangeable terminals are included (3 pad e plugs, phone clips, alligator clips). 9/6. P. & P. 1/6.

TRANSISTORISED 1000 C/S SPOT AUDIO GENERATOR

Battery operated, simplest operation. Ideal for all types of alignment of amplifiers, receivers, transmitters. Used for measurement of gain, fault finding, distortion. Test all audio requirements. 39/6.

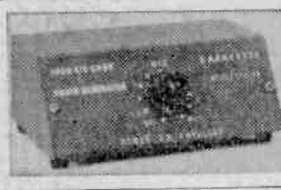

A MINIATURE TAPE RECORDER IN KIT FORM

Consisting of three transistor amplifier, record/play, volume control, miniature speaker, forward-stop-rewind-switch, reel of tape and spare reel, motor, attractive coloured case, Mic and earphone sockets, pick-up coil, mike, earphone and carrying handle supplied. Standard battery operated. Simple to put together in less than one hour. Brand new and guaranteed.

ONLY £6.19.5

A guaranteed saving of at least 24! Results comparable with similar built-up recorders selling at around 12 gns. S.A.E. for further details. Order early.

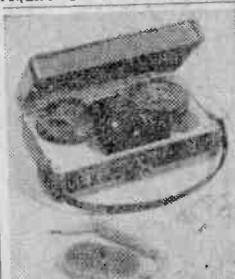

able with similar built-up recorders selling at around 12 gns. S.A.E. for further details. Order early.

4 TRANSISTOR PUSH-PULL AUDIO AMPLIFIER MODEL PK-543

A ready built miniature amplifier incorporating input and output transformers, 4 transistors, 9 volt battery snap cord (for Power) speaker and volume connection leads. Ideal for use with record players, intercoms, hearing aids, tape recorders, etc. Complete with full instructions and circuit diagram.

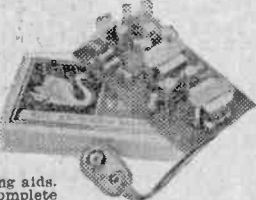

PRICE 52/6 P. & P. 1/6

9V BATTERY CHARGER AND A.C. ELIMINATOR MODEL L.A.6P

A "MUST" for every transistor set owner! Over 20,000 already sold. Rush your order NOW.



Save those batteries by running your transistor set direct from A.C. Mains. Reactivate all your old 9V batteries. Unit contains neon indicator and standard battery connections with nearly 2 yards of mains lead and plug. Also snap cord for connection to set.

PORTABLE TRANS/RECEIVER SETS

Consisting of trans/receiver covering 7.4-9 Mc/s range up to 10 miles, complete with 6 valves headphones, microphones, junction box and 6ft. telescopic aerial. Only requires 120 v. and 3 v. dry battery. Only 60/- per set. P. & P. 4/- Two for 28/- Post free. Batteries 20/- per set extra.

MINIATURE COMPONENTS

As previously advertised

- PS.35 Sub-miniature plug and socket 3/6 pr.
- CB.25 "Tiny" plug and socket 2/6 pr.
- CR.305 Chrome sub-miniature plug and socket 3/6 pr.
- K2.16 5k Edgewise volume control with switch 4/6 ea.
- CR/5 Crystal earpiece 8/- ea.
- MR.4 Magnetic earpiece 8/- ea.
- MC.1 Crystal mike insert 6/6 ea.
- P.217A 2 1/2 in. square 8ohm miniature speaker 16/6 ea.
- TP.22K 2 1/2 in. round 75 ohm miniature speaker 17/6 ea.
- LT.44700 Miniature driver and output transformer 200mW 9/6 pr.
- T.108 Mains 3amp DF/DT Switch 3/6 ea.
- PVC.200 288P mini-tuning condenser 12/6 ea.

Please add P. & P. on above items

CALLERS WELCOME AT
87 TOTTENHAM COURT ROAD,
LONDON, W.1 MUS 9636



BRAND NEW AM/FM (V.H.F.) RADIOGRAM CHASSIS AT £14 (Carriage Paid)

A.C. ONLY. Chassis size 15 x 6 1/2 x 5 1/2 in. high. New manufacture. Dial 1 1/2 x 1/2 in. in black and gold.
 Pick-up. Ext. Speaker. Ae. E., and Dipole Sockets. Five push buttons—OFF L.W., M.W., P.M. and Gram. Aligned and tested O.P. Transformer. Tone Control. 1,000-1,900 M.; 200-500 M.; 88-98 Mc/s. Valves E230 rect., ECH81, EF89, EABC80, EL84, ECC85.
 Speaker and Cabinet to fit chassis (table model), 47/6 (post 2/6). 10 x 6 in. ELLIPTICAL SPEAKER, 20/-, to purchasers of this chassis.
TERMS:—(Chassis) £5 down and 5 Monthly Payments of £2, or with Cabinet and Speaker £5.10.0 down and 6 Monthly Payments of £2 Cheap Room Dipole for V.H.F. 10/-, Feeder 6/1, yard.

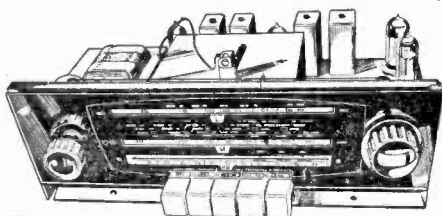

THIS SUPERB SET FOR £10

A really elegant 6-transistor radio covered in sponge clean Duracour fabric, in latest two tone shades. M.W. and L.W., ferrite rod, provision for car aerial, 2-colour scale. With PP9 battery giving 300 hours use. Weighs under 4 lbs. With carrying handle. 12 x 7 1/2 in. high x 4 1/2 in. at base tapering to 2 1/2 in. at top. Brand new, fully guaranteed. £10. Carr. paid. Worth £16.

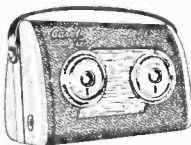

COMPLETE V.H.F./A.M. RADIO FOR £12.10.0

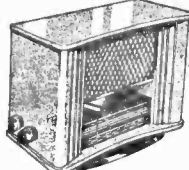

(carr. paid)
 Brand new set, in superb walnut cabinet (size 19 x 8 1/2 x 1 1/2 in. high). Covering 88-100 Mc/s. 16-49 M., and 200-500 M. Mains trans. 200-250 v with 2 tappings. Ferrite rod aerial for A.M. Controls: volume on/off, tone, tuning, w/change. Gram and ext. speaker position provided. Valves 12AT7, 12AH6, 6B76, 1 ABC80 6BW6 and metal rectifier. Fully guaranteed. Today's Value £20.

AUTOMATIC RECORD CHANGERS, ALL 4-SPEED WITH TURN-OVER CRYSTAL CARTRIDGE (carr. 5/- extra). Latest UA14, £7.10.0. Collaro C.50 Studio model, plays any records, 7-12 in. only £7.15.0. Motor board for UA8, UA14 or Collaro 3/6 (post 1/6). Both UA14 and C.50 fitted monaural cartridge but wired for stereo.

BEREC BATTERY RADIO IN MAKER'S CARTON. Valves DK96, DF96, DAF96, DL96. Two Short Wavebands 16 to 49 M., and 25 to 75 M. Cabinet 12 x 7 1/2 x 6 in. ONLY £5 (2/6 p. & p.); MW and SW £5.4.0 (plus 2/6 p. & p.).

SELF-POWERED VHF TUNER CHASSIS. Covering 88-95 Mc/s. Mullard permeability Tuner. Dims. 10 1/2 x 4 1/2 x 5 1/2 in. high ECC85, EF91, EF91 and 2 diodes. Metal Rectifier. Mains transformer. Fully wired and tested. Only £7.14.0 (carr. pd.). Room dipole 10/-, 300 ohm twin feeder, 6d. yd. Tuner without power pack £6.14.0 (carr. paid).

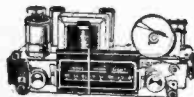

COLLARO STUDIO TAPE TRANSCRIBER, 3 MOTORS, 3 SPEED, 11, 31 and 7 1/2 I.P.S. Push buttons. £10.17.6 (10/- carr.) incl. spool.

SUPERIOR GRAMOPHONE AMPLIFIER 3 valves, 4 watt

13 1/2 x 7 1/2 in. (2 1/2 in. front to back), 3 front controls, bass, treble, vol. on-off, 6 1/2 in. round speaker; UY85, UF80 and UL84. Mains trans. 200-240ac; "gold" fret front. ONLY 70/- (p. & p.).

GRAMOPHONE AMPLIFIER

With 5 in. SPEAKER Baffle 12 x 6 in. ECL82 and Rectifier. Tone and Volume On/Off switch. Two Knobs. Ready to play. Useful for Stereo. ONLY 57/-, Post 3/-.



3-VALVE AMPLIFIER (Inc. RECT.)

2 1/2 watts. ECC83, ECL82 and E230. Controls, volume, bass and treble. On/off switch. Mains and O.P. trans. and 6 1/2 x 4 1/2 in. Celestion speaker. Suitable for microphone input and for Guitar. Chassis as for push-pull amplifier. 85/- P. & P. 4/-.

Also acts as telephone amplifier using pick-up coil, price 14/-, Chassis 12 x 3 1/2 x 3 1/2 in. Fixed front panel. Price includes handsome walnut finish polished cabinet, 13 x 7 1/2 in. fascia containing high quality 3 ohm P.M. speaker 5 1/2 x 4 1/2 in.

MAINS OPERATED RADIO CHASSIS AND AMPLIFIER OF FAMOUS MANUFACTURE

Chassis 10 x 5 1/2 x 4 in. front to back. Valves: UB41, UC141, EF89, UL84 with metal rectifier. 1 1/2 in. speaker. Ferrite rod aerial. Tone, vol. and gram. position. Covers L. and M. waves. Limited quantity at only £6 (5/- carr.) Complete with small dial. Unused and in working order.

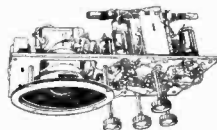

UNREPEATABLE OFFER OF AM-FM CHASSIS AT ONLY £9.9.0 carr. pd.

A small quantity of Printed Circuit chassis by famous manufacturer. Valves UY85, UCH81, UF89, UABC80, UL84 and UCC85. O.p. trans. for 2-3 ohm speaker. Chassis 14 x 7 x 7 1/2 in. Front controls concentric, left—Vol. and Tone; right—W/c and Tuning. "Gold" centre knobs provided, 2-dial bulbs. Sockets. AE: E; Ext. sp. P. U. Mains isolating transformer free. Covers Long, Med., VHF (87-101 Mc/s). Unused slightly tarnished, but not dirty; New Mullard Valves; not our manufacture, so no guarantee. Dial in gold and brown. size 13 x 3 1/2 in.

Send 6d. (stamps will do) for 20 page illustrated catalogue. All New Goods. Delivered by return. (C.O.D. 2/- extra). ALL ITEMS GUARANTEED 12 MONTHS—B.V.A. VALVES 3 MONTHS—CLOSED SATURDAY.

GLADSTONE RADIO

"SCALA," CAMP RD. FARNBOROUGH, Hants. Farnborough 3371

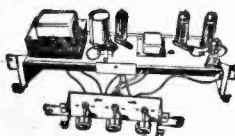

PUSH-PULL AMPLIFIER £5.5.0 (4/- Carr.)

Brand new 200-240 A.C. mains Bass, treble and vol. controls With valves E230, ECC83 and 2-EL84 giving full 8 w. Chassis 12 x 3 1/2 x 3 1/2 in. With o.p. trans. for 2-3 ohm speaker.

Front panel (normally screwed to chassis) may be removed and using as "flying panel". Stereo version £ 4 w. same price.

"SAXONY" MINIATURE FULLY BUILT 4V. BATTERY PORTABLE

For full M.W. coverage, in tan or black cowhide case. 6 1/2 x 3 1/2 x 2 1/2 in. Carrying handle. 2 1/2 in. P.M. Speaker. Ferrite aerial. Valves 1R5, 1T4, 1S5, 3SA. Under 1 1/2 lbs. Fantastic performance. Foreign. B153 and U2 batteries included. £6.12.6, carr. paid. Earpiece 7/6.

"LEECO" COMPLETE 6 TRANSISTOR POCKET PORTABLE

For M.W. coverage. 1 1/2 in. speaker. 4 1/2 x 2 1/2 x 1 1/2 in., under 8 ozs. £8.19.6 inc. earpiece and case.

TRANSISTOR BABY ALARM

Two attractive moulded units with connecting lead. Just plug the units together. FULLY BUILT, not a kit. Battery included, lasts months. Is excellent intercomm. ONLY £5, carr. paid.

TAPE

Top quality in attractive boxes. Std. 5 1/2 in. 850ft., 15/-; 7 in. 1200ft., 17/6; Long play, 5 1/2 in. 1200ft., 18/-; 7 in. 1800ft., 28/-; All plus 1/6 post.

**THE "CANTATA"
6-TRANSISTOR
AND
DIODE PORTABLE**

COMPLETE KIT FOR ONLY

£7.19.6

(post 3/6) NO EXTRAS

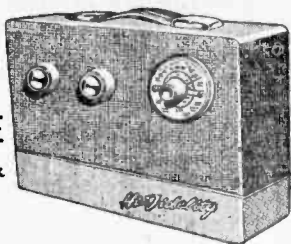

- ★ 500mW push-pull output. ★ Ferrite rod aerial.
- ★ Car aerial socket and coil. ★ M.W. and L.W. full coverage
- ★ Operates on two 4.5v. cells. ★ Printed circuit board 8 1/2 x 2 1/2 in.
- ★ Mullard transistors OC44, 2 x OC45, OC81D, and 2 x OC81.
- ★ All holes drilled and component positions marked on reverse side of board.
- ★ Booklet of full instructions 2/6 for 16p. (refunded on purchase of kit).
- ★ Size 9 x 3 1/2 x 7 in. ★ 8 x 2 1/2 in. P.M. high quality speaker.
- ★ Attractive Vinalac covered cabinet, two tone.
- ★ Two batteries 5/6 the pair.
- ★ High Sensitivity. ★ Good selectivity.
- ★ Mullard transistors OC44, 2 x OC45, OC81D, and 2 x OC81.
- ★ Top grade Weymouth Radio Coils and transformers.
- ★ Alignment service if required 17/6 (inc. post).
- ★ Write for list of prices.
- ★ All parts supplied separately. ★ Built in two hours.
- ★ Transistor kit giving 400 m.w., generally similar to "Cantata" and in same case, only £6, carr. paid.

TO CLEAR

A few CONTINENTAL STEREO AMPLIFIERS with piano key actions. 12 x 9 x 2 1/2 in. For mike, pick-up, tape, etc. 2 x 24 watts. 200-240v. A.C. Special Price £7 (post 5/-).

BRAYHEAD "TRANSTRONIC" TRANSISTOR CONSTRUCTION KIT

Two Mullard transistors and diode. Seven circuits can be built inc. transmitter and receiver. 15 page instruction book. Includes all necessary components. Just the gift for a beginner. Originally over £5. Our price £2/6 (post 2/6).

3-VALVE AMPLIFIER (Inc. RECT.)

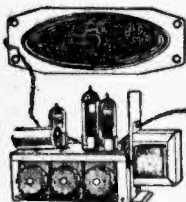

4 watts. Valves ECC83, EL84 and EZ80. Controls, volume, bass and treble. On/off switch. (Chassis size 6 1/2 x 3 x 2 1/2 in.) 6 1/2 in. round or 7 x 4 in. elliptical speaker. Not suitable for microphone input. A.C. only. 67/- P. & P. 3/-.

SPECIAL OFFER OF GOOD-MAN 10 x 6 in. SPEAKER. High gauss, with doped cone specially suitable for high fidelity work. Price 27/6 (post 2/6).

TAPE RECORDER FOR ONLY £17.10

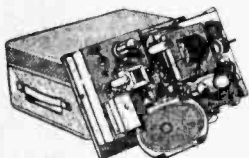

A QUALITY ARTICLE
Valves EZ80, ECC83, ECL82, DMT0, Acos Crystal "mike", 850ft. Tape and extra spool. 3 1/2 in./sec. Mike and Radio inputs. Vol. on/off tone, Ext. L.S. and Monitor. Fast forward and reverse. Cannot be accidentally erased. Magic Eye Indicator. 6 x 4 in. Speaker. Cabinet 14 x 11 1/2 x 7 in. Supplied completely built and in cabinet.

B.S.R. "MONARDEK" TAPE DECK SINGLE SPEED

Our price only £7.2.6 (5/6 carr.). 850ft. first grade tape 5 1/2 in. plastic spool, 16/- post 1/-.

BATTERY ELIMINATOR

For 4 Low Consumption Valves (36 range), 90v. 15mA and 1.4v. 125mA. 42/6 (2/6 post). 200-250v. A.C. Size 5 1/2 x 3 1/2 x 2 in. Also for 250mA. 1.4v. and 90v. 15mA at same price.

**TECHNICAL
TRAINING
in radio
television and
electronics**

Whether you plan to have your own business, to become an electronics engineer, to take up a career in industry, or to brush-up your knowledge and study new developments, transistors, etc., an I.C.S. Course will help you to success. You learn at home in your own time, under expert tuition. Moderate fees include all books.

EXAMINATION COURSES FOR:—

C. & G. Radio and TV Servicing Certificate
(R.T.E.B.)

C. & G. Radio Amateurs' Exam.
(Amateurs' Transmitting Licence)

British Institution of Radio Engineers, etc.
C. & G. Telecom. Technician's Cert.

LEARN AS YOU BUILD

Practical Radio Servicing Course

A basic course in radio electronic and electrical theory backed by thorough practical training. You build radio receivers, signal generator and multimeter.

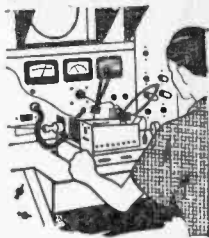

Post this Coupon TODAY! for FREE book on careers in Radio, and full details of other I.C.S. Courses

INTERNATIONAL CORRESPONDENCE SCHOOLS
(Dept. 171), Intertext House, Parkgate Road, London, S.W.11.

Please send book on.....

Name..... Age.....
(Block Letters Please)

Address.....

Occupation..... 4.62

INTERNATIONAL CORRESPONDENCE SCHOOLS

Brand new, individually checked and guaranteed
VALVES

| | | | | | |
|--------|------|--------|------|---------|------|
| AL60 | 6/- | EBC90 | 5/- | EY91 | 3/6 |
| AR8 | 5/- | EC52 | 8/- | EZ40 | 7/- |
| ARDD5 | 2/- | EC70 | 10/- | EZ41 | 6/9 |
| ARP3 | 3/- | EC90 | 20/- | EZ80 | 6/- |
| ARP4 | 3/6 | EC88 | 5/6 | EZ81 | 6/9 |
| ARP12 | 2/9 | EC82 | 6/6 | FW4/500 | |
| ARP21 | 5/6 | EC83 | 7/- | | |
| ARP24 | 3/6 | EC84 | 7/- | G120/1B | 9/- |
| ARP34 | 4/- | EC85 | 8/- | GL450 | 10/- |
| ARTH2 | 7/- | EC91 | 4/- | GL464A | 10/- |
| ATP4 | 2/9 | ECF82 | 8/6 | GZ32 | 9/- |
| AU7 | 5/6 | ECH42 | 7/6 | H63 | 7/- |
| AU1 | 5/- | ECH81 | 7/9 | HL23 | 6/- |
| AU4 | 5/- | ECL80 | 8/- | HL23DD | 8/- |
| AW3 | 4/- | ECL82 | 9/- | HVR2 | 12/6 |
| AZ31 | 8/- | EF22 | 7/- | KRN2A | 19/- |
| BS4A | 5/6 | EF36 | 3/6 | KT31 | 8/- |
| BT45 | 15/- | EF37A | 8/- | KT32 | 8/- |
| BT9B | 20/- | EF39 | 4/- | KT33C | 8/- |
| BT83 | 22/6 | EF50 | 2/6 | KT44 | 6/3 |
| CV54 | 5/- | EF54 | 3/3 | KT63 | 5/- |
| CV264 | 20/- | EF50 | 5/- | KT76 | 10/- |
| CY31 | 7/6 | EF70 | 4/- | KTW62 | 7/6 |
| D41 | 3/3 | EF73 | 6/- | KTW63 | 6/6 |
| D77 | 4/3 | EF80 | 5/6 | KTZ41 | 6/- |
| DA30 | 12/6 | EF85 | 6/6 | MH4 | 3/6 |
| DAF70 | 35/- | EF86 | 6/6 | MH41 | 5/- |
| DAF91 | 6/- | EF89 | 7/9 | ML4 | 4/- |
| DAF96 | 7/6 | EF91 | 3/6 | ML6 | 6/- |
| DD41 | 4/- | EF92 | 3/6 | MS/PEN | 6/- |
| DETS | 15/- | EF95 | 5/- | NT2 | 9/- |
| DET19 | 3/6 | EL32 | 3/9 | OB3 | 7/- |
| DF22 | 7/- | EL33 | 8/- | OC3 | 5/- |
| DF39 | 4/- | EL35 | 6/- | OD3 | 5/- |
| DF72 | 7/6 | EL41 | 8/- | OZ4 | 5/- |
| DF91 | 3/3 | EL42 | 8/- | PCC84 | 7/- |
| DF96 | 8/- | EL84 | 7/- | PCC85 | 8/- |
| DK96 | 7/3 | EL85 | 10/- | PCC80 | 7/- |
| DL92 | 6/- | EL91 | 4/6 | PFC82 | 8/- |
| DL94 | 6/- | EM80 | 8/- | PCL82 | 8/6 |
| DL96 | 8/- | EM84 | 9/- | PCL83 | 11/- |
| EA50 | 1/6 | EN31 | 15/- | PCL84 | 9/- |
| EABC80 | 7/3 | EP71 | 6/6 | PEN45 | 4/6 |
| EAC91 | 4/6 | EP72 | 5/- | PEN46 | 5/- |
| EB34 | 1/6 | ESU208 | 6/- | PEN65 | 6/6 |
| EB91 | 3/9 | EY51 | 8/- | PEN220A | 3/- |
| EBC41 | 7/9 | EY86 | 8/- | PL36 | 10/6 |

| | | | | | |
|---------|------|----------|------|--------|-----|
| PL81 | 9/- | VP41 | 5/6 | 6AK7 | 7/6 |
| PL82 | 8/- | VR99 | 8/- | 6AM5 | 5/- |
| PL83 | 9/- | VR105/30 | | 6AM6 | 4/- |
| PT15 | 10/6 | | 7/6 | 6AQ5 | 7/- |
| PT25H | 7/6 | VR150/30 | | 6AT6 | 5/- |
| PX4 | 19/- | | 7/3 | 6B7 | 5/6 |
| PX25 | 9/- | VT4C | 25/- | 6BBG | 2/6 |
| PY32 | 12/- | VU39 | 6/- | 6C4 | 2/6 |
| PY80 | 6/9 | W31 | 7/- | 6C5 | 6/- |
| PY81 | 7/- | X66 | 8/- | 6C6G | 3/- |
| PY82 | 8/- | Y63 | 5/- | 6CBG | 5/- |
| PY83 | 7/3 | Y65 | 4/- | 6D6 | 4/- |
| PZ1-35 | 9/- | Y66 | 8/- | 6F7 | 5/- |
| QV04/7 | 6/9 | Z31 | 6/- | 6F8G | 5/- |
| R3 | 8/- | IA3 | 3/- | 6F12 | 4/6 |
| R3/10 | 4/- | IA5GT | 5/- | 6F17 | 5/- |
| R10 | 12/6 | IC5GT | 7/6 | 6G6G | 2/6 |
| REL21 | 25/- | ID8GT | 6/- | 6H6M | 1/6 |
| RK34 | 2/6 | IE7G | 7/6 | 6I5 | 3/6 |
| RX235 | 10/- | IG6GT | 6/- | 6I5G | 3/6 |
| SP2 | 4/- | IL4 | 2/6 | 6I6 | 4/3 |
| SP13C | 4/6 | ILD5 | 5/- | 6I7G | 6/- |
| SP41 | 2/6 | IR5 | 6/- | 6K6GT | 6/- |
| SP61 | 2/- | IS5 | 5/9 | 6K7GT | 4/3 |
| SU2150A | | IT4 | 4/- | 6K8G | 5/9 |
| | | IW4 | 6/- | 6K8GT | 8/3 |
| | | 2A3 | 5/- | 6K8M | 8/6 |
| | | 2A5 | 6/- | 6L5G | 6/- |
| | | 2A6 | 7/- | 6L6 | 9/- |
| | | 2C34 | 2/6 | 6L6G | 6/6 |
| | | 2X2 | 4/- | 6L7G | 5/- |
| | | 3A4 | 5/- | 6L34 | 4/6 |
| | | 3B7 | 5/- | 6N7G | 5/9 |
| | | 3B24 | 5/- | 6N7GT | 6/- |
| | | 3E29 | 5/- | 6Q7G | 6/- |
| | | (829B) | 60/- | 6R7 | 6/- |
| | | 3Q4 | 6/- | 6SA7 | 6/- |
| | | 3Q5GT | 9/- | 6SC7G | 4/6 |
| | | 3S4 | 5/- | 6SC7GT | 5/- |
| | | 3V4 | 6/- | 6SG7 | 5/- |
| | | 5T4 | 9/- | 6SH7 | 3/- |
| | | 5U4G | 8/- | 6S17 | 5/6 |
| | | 5V4G | 8/- | 6S17GT | 5/9 |
| | | 5Y3GT | 6/- | 6S17Y | 6/6 |
| | | 5Z4G | 8/6 | 6SK7 | 5/3 |
| | | UL41 | 7/- | 6SL7GT | 6/6 |
| | | UL84 | 7/6 | 6SD7 | 6/- |
| | | UL85 | 7/- | 6A7 | 6/- |
| | | UU9 | 5/6 | 6AJ7 | 4/3 |
| | | UY41 | 6/- | 6AK5 | 5/- |
| | | UY85 | 6/6 | | |
| | | VP23 | 3/6 | | |

| | | | | | |
|--------|------|--------|------|------|-----|
| 6V6GT | 5/- | 80 | 5/6 | 9001 | 3/- |
| 6X4 | 5/- | 81 | 9/- | 9002 | 5/6 |
| 6X5GT | 5/- | 82 | 8/- | 9003 | 6/- |
| 6Y6G | 6/- | 83V | 8/- | 9004 | 2/6 |
| 6Z4 | 5/6 | 84 | 8/- | 9006 | 2/6 |
| 7B7 | 7/6 | 85A1 | 9/- | | |
| 7H7 | 7/3 | 85A3 | 15/- | | |
| 7C6 | 7/- | 89 | 6/- | | |
| 7C7 | 6/6 | 210VPT | | | |
| 7Q7 | 7/- | 7-pin | 2/6 | | |
| 7V7 | 5/- | 250TH | £9 | | |
| 7Y4 | 6/- | 350B | 8/- | | |
| 7Z4 | 4/6 | 393A | 15/- | | |
| 8D2 | 2/6 | 705A | 15/- | | |
| 9D2 | 3/- | 715B | 60/- | | |
| 12A6 | 2/6 | 717A | 8/6 | | |
| 12A7 | 5/6 | 801 | 6/- | | |
| 12A7 | 5/6 | 803 | 22/6 | | |
| 12A7 | 5/6 | 804 | 55/- | | |
| 12A7 | 6/- | 805 | 30/- | | |
| 12A7 | 6/- | 807 | 30/- | | |
| 12C8 | 3/- | 807BR | 6/- | | |
| 12E1 | 22/6 | 808 | 8/- | | |
| 12H6 | 2/6 | 813 | 60/- | | |
| 12K7GT | 4/6 | 816 | 40/- | | |
| 12K8M | 7/6 | 826 | 10/- | | |
| 12J5GT | 3/6 | 829A | 30/- | | |
| 12Q7GT | 4/6 | 832 | 35/- | | |
| 12SA7 | 7/6 | 832A | 35/- | | |
| 12SC7 | 4/- | 832A | 7/4 | | |
| 12SG7 | 3/- | 843 | 7/4 | | |
| 12SH7 | 3/- | 866 | 10/- | | |
| 12S17 | 5/6 | 872 | 20/- | | |
| 12S27 | 3/6 | 930 | 8/- | | |
| 12S7 | 7/- | 934 | 4/- | | |
| 12SN7 | 8/- | 955 | 2/6 | | |
| 12SR7 | 6/- | 956 | 2/6 | | |
| 15D2 | 6/- | 957 | 5/- | | |
| 20A2 | 17/6 | 958A | 5/- | | |
| 21B6 | 9/- | 1616 | 3/- | | |
| 30 | 5/- | 1619 | 5/- | | |
| 35L6GT | 8/- | 1625 | 6/- | | |
| 35T | 17/6 | 1626 | 6/- | | |
| 35Z4GT | 7/- | 1629 | 4/- | | |
| 519 | 37 | 4043C | 13/6 | | |
| 516 | 38 | 6064 | 10/- | | |
| 517 | 58 | 6120 | 4/- | | |
| 518 | 59 | 7193 | 1/9 | | |
| 519 | 61 | 7475 | 3/- | | |
| 520 | 66 | 8013A | 25/- | | |
| 521 | 67 | 8020 | 10/- | | |
| 522 | 78 | | | | |

Cathode Ray Tubes
ACR1 15/-
CV1596
(09J) 55/-
09D 50/-
3PF7 25/-
5BP1 35/-
5CP1 42/6
5FP7 45/-
7BP7 40/-
12DP7 60/-
VCRX258
(with scanning coil) 45/-
VCR138 30/-
VCR139A 15/-

Photo Tubes
CMG8 9/-
CS16 12/6

Special Valves
2J31 45/-
3A/1481 45/-
3J/170/E £35
3J/192/E £37.10
4J31 £35
4J50 £35
5D21 £3
723A/B 50/-
725A 30/-
726A 27/6
ACT6 160/-
ACT9 £12.10
CV193 30/-
CV980 3/-
ESU77 200/-
KR6/3 £4
LS7B 30/-
WL417A 15/-

AND MANY OTHERS IN STOCK, INCLUDING CATHODE RAY TUBES AND SPECIAL VALVES. All U.K. Orders below 10/-. 1/- P. & P. 2/6 over 10/-. Orders over £3, P. & P. free. C.O.D. 2/6 extra. Overseas Postage extra at costs.

TELESCOPIC MAST. 34ft. Consisting of 6 sections of steel tubing of such internal and external diameter that the smaller sections may be collapsed with the largest section. Immediate erection. Absolutely complete with brackets, guys, pegs, spikes etc. £12.10.0. Carriage and packing 18/-. As above but 20 ft. £7.10.0. Carriage and packing 18/-.
FIELD TELEPHONE TYPE "L"
Excellent guaranteed condition, £55.00 per pair, carriage paid.
RECEIVER TYPE BC342. 110 v. A.C. 1.5-18 Mc/s. £22.10.0, carriage 30/-.
RECEIVER TYPE BC312. As above but 12 volt battery. £22.10.0, carriage 30/-.
R109 RECEIVER. Covering 2-8 Mc/s 6 v. D.C. with set of spare valves and carrier. Brand new in original packing case, £6.18.0, including delivery in U.K.
R109A RECEIVER. Covering 2-12 Mc/s £7.15.0. Free delivery in U.K.
VIBRATOR UNIT. 12 v./160 v. 35 mA. Exceedingly well filtered and smoothed. Excellent for car radios. Including one 6X5G valve and vibrator 17/6. P. & P. 7/-.
MARCONI SIGNAL GENERATOR. TF144G. 85 kc/s, 25 Mc/s. Made up to new standard. £70 delivered free.
SPECIALY BUILT POWER PACK for TC5 Receiver. 230 v. A.C. mains, including 6X5GT valve, £3.10.0. Carr. 5/-.
VACUUM CONDENSER. 32,000 v. 50pF. 12/6. P. & P. 3/6.
AR 83's. Completely rebuilt with new PVC wiring. Type 'D' £75; Type 'L' £70.
CARBON INSET MICROPHONE. G.P.O. Type 2/6. P. & P. 1/6.

BRAND NEW ORIGINAL SPARE PARTS FOR AR88 RECEIVERS
I.F. Transformers. 1st, 2nd, 3rd, 4th (for type D), 12/6 each or complete set of 6, 60/-.
I.F. Transfs. Crystal Load, 12/6 each. Plates escutcheons (for D and LF), 15/- each.
Dials (for type D), 10/- each.
Logging Dial (for D and LF), 10/- each.
Filter Chokes (for D and LF), 22/6 each.
Output Transformers (for LF), 30/- each.
Antenna Trimmers (LF and D), 2/6 each.
Filter Condenser 3 x 4µF, £2.10.0.
Condensers:
3 x .25µF (D and LF), 2/6 each.
3 x .01µF (D and LF), 2/6 each.
RF Antenna Inductors (D and LF), 7/6 each.
Mains Transformers (LF), £3 each.
Small Trimming Tool, 7/-.
Small Mica Condensers, various values, 1/6 each.
Instruction Manual for AR88D, £1.

RECEIVER TYPE R.308. Amplitude/Frequency modulated. Very high class double super heterodyne incorporating its own power unit for 100-250 v. A.C. or 12 v. battery operation and employing fourteen valves and one vibrator. Frequency range 20 mc/s to 145 mc/s in 5 bands. In as new tested condition. £27.10.0. Carriage and Packing 15/-.

RECEIVER TYPE R.206. Frequency 0.55 mc/s to 30 mc/s in 6 bands. 100-250 v. A.C. or 12 v. D.C. Loud speaker in power supply unit. High performance super heterodyne. eleven valves including a separate local oscillator valve, beat oscillator valve and two valves (Amplifier and Detector) in the A.B.C. system. In very good condition £15.10.0, including power pack. Carriage and Packing 15/-.

R209 RECEPTION SET. A 10-valve High-Grade Super Heterodyne Receiver with facilities for receiving RT (A.M. or F.M.) and C.W. Frequency 1-20 Mc/s. Hermetically sealed. Built on miniature valves and incorporating its own vibrator power supply unit driven by a 6 v. battery (2-point connector included). The set provides for reception from rod, open-wire or dipole aerial with built-in loud-speaker or phone output. Overall measurements: Length 12in., width 8in., depth 9in. Weight 23 lb. In as new, tested and guaranteed condition £23.10.0, including special headphones and supply leads. Carriage £1.

FAMOUS T.17 CAREON MICROPHONES. £25.0. Post & packing 3/6.

P. G. RADIO LTD.
170 GOLDHAWK RD., W.12
Shepherds Bush 4546

CHECK with these

BARGAINS

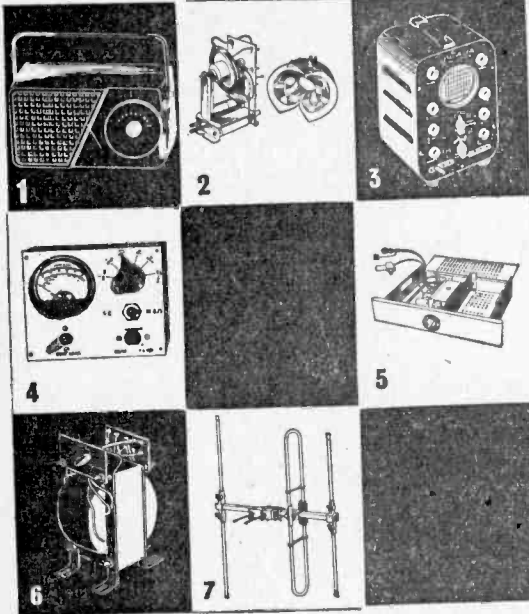

- 10. **SIGNAL GENERATORS.** Cash \$4.19.6. P. & P. 5/6. Coverage 120 kc/s to 34 Mc/s. Case 10 x 6 1/2 x 4 1/2 in. Size of Scale 6 1/2 x 3 1/2 in. 2 valves and rectifier. A.C. mains 230-250 v. Internal modulation of 400 c.p.s. to a depth of 30 per cent, modulated or unmodulated R.F. output continuously variable 100 millivolts. C.W. and mod. switch, variable A.F. output and moving coil output meter. Accuracy \pm 2 per cent.
- 11. **BATTERY RECORD PLAYER AND AMPLIFIER.** 45 r.p.m. "Star" motor "Acoro" crystal pick-up, 3 transistor push-pull amplifier complete with transistors. Output 500 milliwatts, 49/6. P. & P. 4/-.
- 12. **3-watt PUSH-PULL 5 VALVE AMPLIFIER.** A.C. mains 200-250 v. Size 10 1/2 x 6 1/2 x 2 1/2 in. 5 valves. For use with all makes and types of pick-up and mike. Negative feed back. Two inputs, mike and gram. and controls for same. Separate controls for Bass and Treble lift. Response flat from 40 cycles to 15 kc/s. \pm 2 db down to 20 kc/s. Output 3 watts at 5 per cent total distortion. Noise level 40 db down all band. Output transformer tapped for 3 and 15 ohms speech coils. For use with Std. or L.P. records musical instruments such as guitars, etc. Suitable for small halls, £3.19.6. P. & P. 6/-. Crystal mike to suit 15/-, P. & P. 2/- . 8in. P.M. Speaker to suit 18/6, P. & P. 2/-.
- 13. **E.S.E. MONARCH UA9 WITH FUL-FI HEAD.** 4-speed, plays 10 records. 12in., 10in., or 7in. at 16, 33, 45 or 78 r.p.m. Internerizes 7in., 10in. and 12in. records of the same speed. Has manual play position: colour brown. Dimensions: 12 1/2 x 10 1/2 in. Space required above baseboard 4 1/2 in. below baseboard 2 1/2 in. Fitted with Full-Fi turnover crystal head. £6.19.6. P. & P. 5/6 With Stereo Head £7.19.6. P. & P. 5/6.
- 14. **TRANSISTOR TESTER.** For both P.N.P. and N.P.N. transistors incorporating moving coil meter. In metal case, size 4 1/2 x 3 1/2 x 1 1/2 in. Scale marked in gain and leakage. 19/6. P. & P. 3/-.
- 15. **PUSH-PULL OUTPUT STAGE** inclusive of transistors with input and output transformers to match 3 ohms speech coil, suitable for use with the POCKET RADIO. Kit of parts, including transistors. 19/6, P. & P. 2/- . Wiring diagram 1/6, free with parts.
- 16. **PORTABLE AMPLIFIER.** On printed circuit for A.C. Mains 200/250 v. Size 4 x 3 in. with tone and volume control. Complete with Valves: 6XLE2 and 6Z80. Output 2 watts, 39/6, P. & P. 3/-.

- 1. **3-TRANSISTOR POCKET RADIO** with MINIATURE SPEAKER, FERRITE ROD and 2 GERMANIUM DIODES. The only 3 transistor radio available at the price. Build it in 1 evening! Tunable over 31L waves. Complete with easy-to-follow instructions and all components (less batteries obtainable anywhere 1/3). 27/6. P. & P. 2/6. (All parts available separately).
- 2. **LINE E.H.T. TRANSFORMERS.** Built-in line width control, 14kV. Scan coil 90in. deflection on ferrite tubes. Frame O.P. transformer pl. 18kV smoothing condenser, suitable for 14in., 17in. or 21in. tubes. With circuit diagram, 29/6 plus 4/6 P. & P. As above, but for 625 lines, £2.10.0, plus 4/6 P. & P. Suitable Focus Magnet (static tube), 10/- plus 3/- P. & P.
- 3. **OSCILLOSCOPE** for D.C. and A.C. APPLICATIONS. A high gain extremely stable differential V-amplifier (30 mV/C.M.). Provide ample sensitivity with A.C. or D.C. inputs. Especially suitable for measurements of transistor operating conditions where maintenance of D.C. levels is of paramount importance. Push-pull X amplifier. Fly-back suppression; Internal Time-base Scan Wave form available for external use; pulse output available for checking TV line O/P Transformers, etc. Provision for external 31P and C.R.T. Brightness Modulation. A.C. mains 200/250 v., £15.15.0, P. & P. 8/- or 30/- deposit, plus P. & P. 8/- and 12 monthly payments of 28/6. **FULL 12 MONTHS' GUARANTEE INCLUDING VALVES and TUBE.**
- 4. **A.C./D.C. POCKET MULTI-METER KIT.** 2in. moving coil meter, scale calibrated in A.C./D.C. volts ohms and milliamps. Voltage range A.C./D.C. 0-50, 0-100, 0-250, 0-500. Milliamps 0-10, 0-100. Ohms range 0-10,000. Front panel, range switch, wirewound pot (for ohms zero setting), toggle switch, resistor and rectifier, 19/6, P. & P. 9/- . Wiring diagram 1/-, free with parts.
- 5. **CHANNEL TUNER.** Will tune to all Band I and Band III stations. Complete with P.C.C.84 and P.C.F.80 valves (in series) I.P. 16-19 or 33-38. Can be modified as an aerial converter (instructions supplied), 59/6, plus 4/- P. & P. **HEATER TRANSFORMER** to suit above, 200-250 v. 8/-, plus 2/- P. & P.
- 6. **MAINS TRANSFORMER.** All with tapped primaries, 250-500 v. 70 mA 6.3 v. 2 amp, 19/6, P. & P. 3/- . 280-280 70mA 6.3v. 2A, 6.3v. 3A, 17/6, P. & P. 3/6.
- 7. **WOLSEY 3-ELEMENT FOLDED DIPOLE.** I.T.V. Aerial less mounting bracket for external use, complete with 12 yds. of coaxial cable, 15/-, P. & P. 4/-.
- 9. **SIGNAL GENERATORS.** Cash £6.19.6 or 25/- deposit and 6 monthly payments of 21/6, P. & P. 5/6. Coverage 100 kc/s to 100 Mc/s on fundamental and 100 Mc/s to 200 Mc/s on harmonics. Case 10 x 6 1/2 x 4 1/2 in. Three miniature valves and Metal Rectifier. A.C. mains 200/250 v. Internal modulation of 400 c.p.s. to a depth of 30 per cent. Modulated or unmodulated R.F. output continuously variable 100 millivolts. C.W. and mod. switch, variable A.F. output. Magic eye as output indicator. Accuracy \pm 2 per cent.

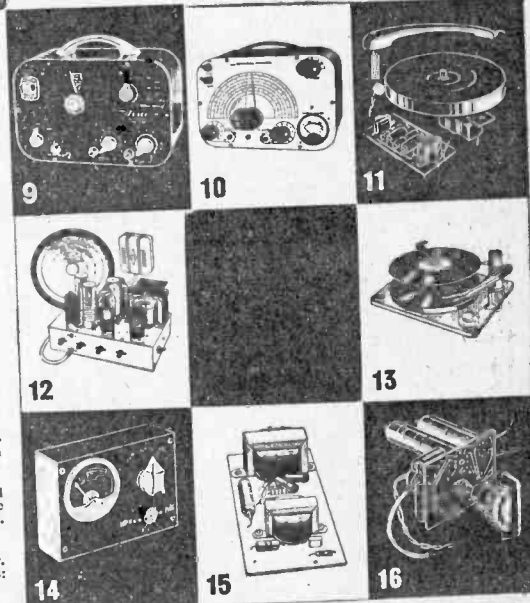

RADIO & T.V. COMPONENTS
(Acton) LTD.

23B HIGH STREET, ACTON LONDON, W.3.

ALL ENQUIRIES S.A.E.
GOODS NOT DISPATCHED OUTSIDE U.K.

UNIVERSAL AVOMETERS

Guaranteed perfect working order. Supplied complete with Leads, Batteries and instructions.

Model "D", 34 range .. £8.19.6
 Model "7", 50 range .. £11.10.0
 Model "8", 20,000 Ω/volt model .. 15 Gns.
 Registered Post 5/- extra.

SET OF S.T.C. TRANSISTORS
 1 R.F., 2 x I.F., 1 driver, 2 x output plus GDI7 tube. Brand New, 19/6. P. & P. 9d.

MINE DETECTORS No. 4A
 Will detect all types of metal. Complete equipment with instructions, 39/6. Carr. 10/6. Batteries 8/- extra.

HOOVER ROTARY TRANSFORMERS
 Input 12 volt D.C. Output 310/360 volt 30 mA D.C. Brand New, boxed, 10/- each. P. & P. 1/3.

Class D. WAVEMETERS No. 2
 Frequency coverage 1.2-19.2 Mc/s. Operation 12 volt D.C. or 230 volt A.C. Complete with valves, crystal, and calib. charts (Like BC.221). Complete with valves, crystal £6.19.6. Carriage 10/-.

230/250 volt A.C. MOTORS
 Size 4 1/2 in. x 3 in. dia. 90 watt rating, 5,000 r.p.m. lin. drive shaft. Brand New, 22/6 each. P. & P. 1/6.

SELENIUM L.T. RECTIFIERS
 Full wave bridge connected.

| | | | |
|--------------|------|-------------|------|
| 12/18v. 1A. | 4/3 | 24/36v. 1A. | 18/6 |
| 12/18v. 2A. | 6/9 | 24/36v. 1A. | 45/6 |
| 12/18v. 4A. | 9/9 | 24/36v. 1A. | 47/6 |
| 12/18v. 5A. | 12/6 | 48/60v. 2A. | 18/6 |
| 12/18v. 15A. | 37/6 | 48/60v. 1A. | 82/6 |
| 24/36v. 1A. | 9/6 | PI.EASE ADD | |
| 24/36v. 2A. | 13/6 | POSTAGE. | |

L.T. TRANSFORMERS
 All Primaries tapped 200/250 volts, 3.5, 9 or 17 volts 1 amp. 9/6
 Ditto 2 amp, 14/3. Ditto 4 amp, 16/6
 9 or 17 volt, 6 amp. 26/-
 3, 4, 5, 6, 8, 10, 12, 18, 20, 24 or 30 volt, 2 amp. 18/6
 Ditto 4 amp. 27/6
 Please add postage.

PARMECO TABLE TOP TRANSFORMER
 230v. Primary, 620-0-620v. 250 mA. tapped 550 and 375v. 2 x 5v. 3 amp. 45/- each. P. & P. 5/-.

PAINTON MINIATURE JONES PLUGS/SOCKETS
 2 pin, 2/6 pr.; 4-pin, 3/6 pr.; 6-pin, 4/- pr.; 8-pin, 4/6 pr.; 12-pin, 5/6 pr.; 35-pin, 10/6 pr. Postage extra.

G.E.C. SELECTEST MULTI-RANGE TESTMETERS



1000 ohms per volt. 37 ranges A.C./D.C. fitted with automatic cut-out. Supplied in perfect condition. Complete with batteries and leads. £9.19.6 each. Reg. post 5/- extra.



R.C.A. AR88 L.F. RECEIVERS

World famous 14 valve receiver. Frequency coverage on six bands 75-550kc/s and 1.5-30 Mc/s. Variable selectivity, crystal, B.F.O., mechanical bandspread, noise limiter, etc. Operation 110/200/250V A.C. output for phone or 3 Ω speaker. Supplied in perfect working order. £32.10.0 ea. Carr. 30/-.

NATIONAL H.R.O. RECEIVERS

Senior Model, table or rack mounting. Supplied with a full set of 9 coils covering 50kc/s-30Mc/s. Special features include: S meter, crystal phasing, B.F.O. etc. Output for phones or speaker. Supplied fully tested, superb condition throughout. 21 Gns. Carr. 10/-. Power units available 59/6 extra.

R.206 RECEIVERS

Superb receivers covering 550 kc/s to 30 Mc/s on 6 bands. Super vernier slow motion drive. All usual facilities. Built-in speaker and power supply. Available Brand New £17.10.0 each. Carriage £2.

CLASS "D" WAVEMETERS MK. II

Frequency coverage 1,900-4,000 kc/s and 4,000-8,000 kc/s. 6 volt D.C. input. Supplied complete with crystal and spare 8 Ω vibrator. Brand New with instructions, 59/6 each. P. & P. 3/6.

COLLARO STUDIO TAPE TRANSCRIPTORS

Very latest model with interlock button and fitted with Bradmatic heads, 3 speeds, 1 1/2, 3 1/2, 7 1/2 per sec. 3 motors, digital counter, press button switching. Complete with instructions and spare 7-inch spool. Supplied Brand New and Guaranteed, 10 Gns. each. P. & P. 3/6.

FIELD TELEPHONES TYPE F

Ideal for all intercom. systems, house, garage, office, building sites, etc. Generator bell ringing, 2 line connection. Supplied complete with batteries and wooden carrying case, fully tested, £4.19.6 per pair. P. & P. 5/-.

COMBINATION PRECISION VOLT/METER/AMMETER

A.C. and D.C. 2 separate precision instruments housed in polished wood case. Manufactured by Elliott Bros. 6in. mirror scales, knife edge pointers. Ranges: Volts A.C. and D.C. 160, 300 and 600 volts. Amps A.C. and D.C. 25, 50, 150 and 200 amp. Supplied with all current shunts, leads and leather carrying case. Ideal for labs, schools, etc. Brand New, fully checked, £9.19.6 each. Carriage 7/6.

TRANSISTOR BARGAINS

| | |
|--|------|
| ALL BRAND NEW AND GUARANTEED | |
| MAZDA R.F. DRIFT TRANSISTORS | |
| XA103 I.F. | 3/6 |
| XA104 R.F. | 4/6 |
| XB112 L.F. | 3/- |
| XC141 Audio Output, 11w. at 80°C. | 10/- |
| White Spot R.F. | 2/6 |
| Yellow Spot L.F. | 3/- |
| Diodes, general purpose 6d. | 2/- |
| Please add postage. | |

| | |
|------------------------|-----|
| XA123 | 7/6 |
| XA124 | 7/6 |
| XA125 | 7/6 |
| XA126 | 7/6 |
| Yellow/Green O/P | 3/- |
| Yellow/Red R.F. | 4/6 |
| Yellow Band—OA81 .. | 2/- |
| Please add postage. | |

C.B.S. AMERICAN RECORDING TAPE

| | |
|---|------|
| All fitted with Leader Tape and Stop Foil. | |
| 5in. std. play, 600ft. | 13/- |
| 5in. long play, 900ft. | 18/6 |
| 5in. dble play, 1200ft. | 32/- |
| 5in. long play, 1200ft. | 19/6 |
| 5in. std. play, 600ft. | 12/- |
| 5in. long play, 900ft. | 16/- |
| 5in. dble play, 1200ft. | 27/6 |
| 5 1/2in. long play, 1200ft. | 18/6 |
| Special L.F. 225ft. 4/8 | |
| Spare Spools: 3in. 1/-; 4in. 1/6; 5in. 2/-; 5 1/2in. 2/3; 7in. 2/6. | |
| Plastic Spool Containers: 5in. 1/6; 5 1/2in. 2/-; 7in. 2/3. | |
| SEND FOR FULL LISTS. Please Add Postage | |

P.C.R. COMMUNICATION RECEIVERS

6 valves. Frequency coverage on three bands: 850-2,000 metres, 190-550 metres, 6-18 Mc/s. Super slow motion drive, A.E. trimmer, tone control, built-in speaker. AS NEW £8.19.6. Carriage 7/6.

P.C.R.3 Communications Receiver. 190-550 metres, 2-7 Mc/s, 7-23 Mc/s. Output for phone or 3 Ω speaker. AS NEW 8 Gns. Carr. 7/6. Both above models are available with internal power unit to operate on 200/250 volt A.C. at 39/6 extra or alternatively plug-in external power units are 35/-.



SET OF MULLARD TRANSISTORS

1xOC44, 2xOC45, 1xOC81D, 2xOC81. Brand new 30/- P. & P. 9d.

CADMIUM SULPHIDE PHOTOCELLS

Type PX1/1. Sub-miniature, wire ended. Extremely sensitive. 12/6 each. P. & P. 6d. Data supplied.

PERSONAL EARPHONES

Complete with Lead, Jack and Plug. Available High (crystal) or Low (max.) Imp. 5/- each. P. & P. 6d.

CR.100 SPARES KITS

Contain 15 valves, condenser and resistor packs, pots, output transformer, etc. Brand New, 59/6 each. P. & P. 3/6.

24 D.C. VOLT PUMPS

100 G.P.H. Impeller type. 15/6 each P. & P. 2/6.

B.T.H. 18-inch SPEAKERS

Heavy Duty type, 15 ohm speech coil. £9.19.6 each. Carriage 10/-.

2 volt ACCUMULATORS

Celluloid unspillable type, 7 A.H. Ideal for Models, 5/6 each. P. & P. 1/3.

AUTO TRANSFORMERS

Step Up, Step Down, 115-200-250 volts. 15 w. 9/-; 60 w. 12/6; 150 w. 18/6; 300 w. 27/6; 1000 w. 99/6. Postage extra.

AR88 SPARES

Complete Wavechange Switch Assembly with Screens, New, Boxed 17/6 each. P. & P. 2/6. 1st I.F. Transformer, Boxed, 3/6. P. & P. 9d.

1,000 watt ISOLATION TRANSFORMERS

230 volt Primary, 230 volt Secondary. Ex-Admiralty, Boxed, £5 each. Carriage 10/-.

7.5 kVA AUTO TRANSFORMER

Step Up, Step Down, 115-230 volts. Brand New. Boxed, £15 each. Carriage 10/-.

20,000 O.P.V. TESTMETERS

A.C. and D.C. voltage up to 1000 v. D.C. Current up to 500 mA. Resistance up to 5 megohm. Capacitance up to 0.1 mfd. Decibels —20 to +36. Brand New. Guaranteed. Supplied with Leads, Battery and instructions. 5 Gns each. P. & P. 2/6.



CW. SMITH & CO (RADIO) LIMITED

Phone: GERRARD 8204/9155
 Cables: SMITHEX LESQUARE
 3-34 LISLE STREET, LONDON, W.C.2

NEW P.W. POCKET SUPERHET

TRANSISTORISED PRINTED BOARD VERSION

The case is black/off-white or red/off-white plastic with gold grille, well finished and in good taste. Top faces detachable exposing speaker, tuning control, wave-change switch and built-in edge volume control.

Suitable for many popular designs which appear currently in radio periodicals as well as for older designs which have appeared during the past year or so.

Case Price 12/6d.

Size

5 3/4" x 3 1/2" x 2"

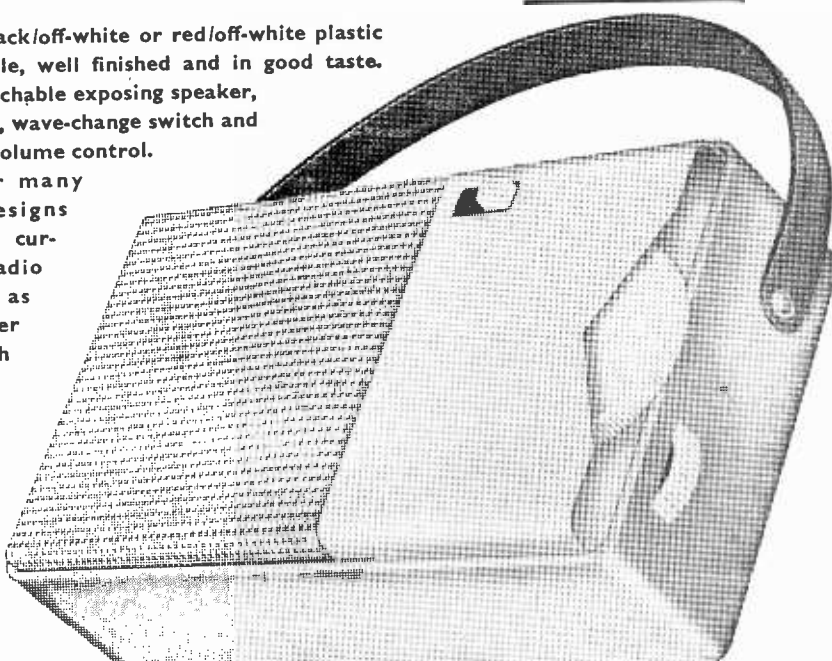

Coloured photo-illustration on request.

The new "P.W." Pocket Superhet is pepped-up and improved version of the original design; a high quality miniature receiver for operation on Medium and Long Waves. The circuit uses 6 special transistors and incorporates modern miniature matched components of the best quality which combine to give superb performance now proved and well known. The printed board construction ensures success to anyone able to follow the simple Step by Step instructions.

**NEW A-Z
SIMPLE "STEP-BY-STEP"
INSTRUCTIONS
INCLUDING
WIRING DIAGRAMS
THEORETICAL CIRCUIT
PHOTOGRAPHS
AND BLOWN UP DIAGRAMS
116d.**

OSMOR RADIO PRODUCTS LTD.,
418 BRIGHTON ROAD, S. CROYDON

PLEASE SEND A-2 INSTRUCTIONS 1/6d. FREE FURTHER INFORMATION

NAME.....

ADDRESS.....

.....

ALIGNMENT & FAULT FINDING SERVICE
(Details on Request)

OSMOR

(Trade Enquiries Invited)

418 BRIGHTON ROAD, S. CROYDON, SY.

ARMSTRONG AF208 AM/FM RADIOGRAM CHASSIS

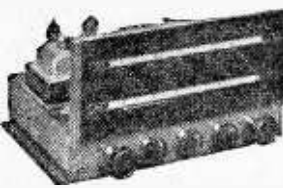

★ Full VHF Band (87-108 Mc/s) and Medium Band, 187-570M ★ Valves ★ 5 Watts Output ★ 15db Negative Feedback ★ Separate wide range Bass and Treble Controls ★ 2 Compensated Pick-up Inputs ★ Frequency Response 30-22,000 c.p.s. ±2db ★ Tape Record and Playback Facilities ★ Continental Reception of Good Programme Value ★ For 3, 7 and 15 ohm speakers. Send S.A.E. for leaflet.

PRICE 22 GUINEAS Carr. Free

LATEST "EMI" 4 SPEED SINGLE RECORD PLAYER

Acos Hi-Fi Pick-up for LP. and/or 78, 7, 10 and 12in. records. Silent motor, heavy turntable, auto stop. Complete on Base-plate.

Special offer **£6.50** post free, or with Stereo/Monaural pick-up **£6.19.6**.

SINGLE-PLAYER BARGAIN

Ready-built, complete with BSR TU9 4-speed gram pick-up unit. Handsome portable case. 3-watt amplifier with 2 valves and speaker. List price £12.10. **OUR PRICE £8.19.6**. Fully guaranteed in manufacturer's sealed cartons.

New Boxed VALVES 90-day Guarantee

| | | | | | | | |
|-------|-----|-------|------|-------|------|-------|------|
| 1R5 | 7/6 | 6K8G | 7/6 | EA50 | 1/6 | EZ80 | 7/6 |
| 1S5 | 7/6 | 6L6G | 10/6 | EAB30 | 8/6 | EL148 | 7/6 |
| 1T4 | 6/- | 6N7M | 6/6 | EB91 | 6/- | HAB30 | |
| 2X2 | 3/6 | 6Q7G | 8/6 | EBC38 | 8/6 | | 12/6 |
| 3B4 | 7/6 | 6BA7 | 6/- | EBC41 | 8/6 | HVR2A | 9/6 |
| 3V4 | 7/6 | 6R3M | 6/6 | EB30 | 10/6 | MU14 | 9/- |
| 5U4 | 7/6 | 6SN7 | 6/6 | ECC84 | 9/6 | PCR34 | 9/6 |
| 5Y3 | 7/6 | 6V6G | 6/6 | ECC90 | 9/6 | PCR80 | 9/6 |
| 5Z4 | 9/6 | 6X4 | 7/6 | ECH42 | 10/6 | PCL82 | 11/6 |
| 6AM6 | 5/- | 6X5 | 6/6 | ECL90 | 10/6 | PEN25 | 8/6 |
| 6BS | 5/- | 12A6 | 7/6 | ECL92 | 10/6 | PL21 | 12/6 |
| 6BB6 | 7/6 | 12AT7 | 8/- | EP39 | 5/6 | PL92 | 10/6 |
| 6BB6 | 9/6 | 12AU7 | 8/- | EP41 | 5/6 | PY80 | 7/6 |
| 6BW6 | 9/6 | 12AX7 | 8/- | EP50 | 6/6 | PY81 | 9/6 |
| 6D8 | 8/- | 12BE6 | 8/6 | EP80 | 8/- | PY82 | 7/6 |
| 6F6 | 7/6 | 12K7 | 6/6 | EP86 | 12/6 | SP61 | 3/6 |
| 6H6 | 3/6 | 12Q7 | 6/6 | EP82 | 5/6 | UB41 | 8/6 |
| 6J5 | 5/6 | 35L6 | 6/6 | EL32 | 5/6 | UCH42 | 9/6 |
| 6J7 | 5/6 | 35Z4 | 7/6 | EL41 | 8/6 | UF41 | 9/6 |
| 6V7G | 6/6 | 80 | 9/6 | EL84 | 8/6 | UL41 | 8/6 |
| 6KGGT | 6/6 | 807 | 5/6 | ESY1 | 6/6 | UY41 | 8/6 |
| 6K7G | 5/- | 854 | 1/6 | EZ40 | 7/6 | UZ2 | 8/- |

SETS OF VALVES

| |
|--|
| DK96, DF96, DAF96, DL96, 8/6 each or 27/6 set. |
| 1R5, 1T4, 1S5, 3B4 or 3V4. 19/6 |
| 6K3, 6K7, 6Q7, 6V6, 5Z4 or 6X5. 27/6 |
| ECH42, EP41, EB30, EL41, EZ40. 37/6 |
| ECH81, EP89, EB30, EL84, EZ80. 37/6 |
| 12K3, 12K7, 12Q7, 35L6, 35Z4. 35/- |

NEW ELECTROLYTICS

FAMOUS MAKES

| TUBULAR | TUBULAR | CAN TYPES |
|-------------|------------------|-----------------------|
| 1/350V 2/- | 50/350V 5/6 | 16/45V 5/- |
| 2/350V 2/3 | 100/25V 3/- | 32/350V 4/- |
| 4/450V 2/3 | 250/25V 3/- | 100/270V 5/6 |
| 8/450V 2/3 | 500/15V 3/- | 2,000/6V 5/6 |
| 8/500V 3/6 | 8 + 8/450V 3/6 | 5,000/6V 5/- |
| 16/450V 3/- | 8 + 8/500V 5/- | 32 + 32/350V 5/6 |
| 16/500V 4/- | 8 + 16/450V 3/6 | 32 + 32/450V 6/- |
| 32/450V 3/6 | 8 + 16/500V 6/6 | 32 + 32 + 32/350V 7/- |
| 32/25V 1/6 | 16 + 16/450V 4/3 | 50 + 60/350V 7/- |
| 50/25V 2/- | 16 + 16/500V 6/6 | 54 + 120/350V 11/6 |
| 5/50V 2/- | 32 + 32/350V 4/6 | 100 + 200/275V 12/6 |

COMPLETE RADIO £4.19.6 post free



4 Mullard valves, 5in. speaker, frame aerial. 4 pre-set stations. 1 long, 3 med. wave. Superhet Circuit. **BRAND NEW.** Size 9 x 6 x 5 1/4in. high. Tested by us ready for use. 200/250 v. A.C.—D.C. Mains.

DE-LUXE MODEL

BRAND NEW quality 4-wave A.C./D.C. superhet chassis. Long and Medium wave coverage. Fitted with a cord and drum reduction tuning drive and attractive illuminated glass dial (size 6 1/2 x 2 1/4in.). Controls: Volume on/off, tuning and wave change. The receiver is self-powered, employing a mains dropper and a valve rectifier. Chassis dimensions 6 1/2 x 9 x 5 1/4in. high. Supplied complete with a good quality 5-inch loudspeaker, valves (UCH42, UAF42, UL41, UY41), AC/DC mains input lead, ivory knobs, etc. Tested by us before despatch. **£5-19-6** Post free.

MAINS TRANSFORMERS 200/250 v. A.C.

Postage 2/- each transformer.

| |
|---|
| STANDARD, 250-0-250, 80 ma, 6.3 v. 3.5 a. tapped 4 v. 4 a. Rectifier 6.3 v. 1 a 5 v. 2 a or 4 v. 2 a. 22/6 ditto, 350-0-350 .. 20/6 |
| MINIATURE 200 v. 20 ma, 6.3 v. 1 a. 10/6 |
| MIDGET, 220 v. 45 ma, 6.3 v. 2 a. .. 15/6 |
| SMALL, 220-0-220, 50 ma, 6.3 v. 2 a. .. 17/6 |
| STD., 220-0-220, 66 ma, 6.3 v. 3.5 a. .. 17/6 |
| HEATER TRANS., 6.3 v. 1 1/2 amp. .. 7/6 |
| Ditto, tapped sec. 2, 4, 6.3 v. 1 1/2 amp. .. 9/6 |
| Ditto, sec. 6.3 v. 3 amp. ... 10/6 |
| GENERAL PURPOSE LOW VOLTAGE, 2 amp 3.3, 5, 6, 8, 9, 10, 12, 15, 18, 24, 30 v. ... 22/6 |
| AUTO TRANSFORMERS, 150 v. ... 23/6 |
| 0, 120, 200, 220, 250 v. 300 v. ... 22/6 |
| MULLARD "50" Mains transformer ... 30/- |

O.P. TRANSFORMERS. Heavy Duty 50 ma, 4/6. Multiratio, push-pull, 7/6. DITTO, 10 w., 15/8. Miniature, 324m etc., 5/8. L.P. CHOKES 15/10H, 60/85 ma, 5/-; 10 H. 85 ma, 10/8; 10 H., 150 ma, 14/-.

TELEVISION REPLACEMENT Line Output Transformers

from 45/- each, New Stock and other timebase components. Most makes available. S.A.E. with all enquiries.

FULL WAVE BRIDGE SELENIUM RECTIFIER: 2, 6 or 12 v. 11 amp, 9/9; 3 a., 11/8; 4 a., 17/6. CHARGER TRANSFORMERS, Tapped input 200/250 v. for charging at 2, 6 or 12 v., 1 1/2 amps, 15/6. 2 amps, 17/6; 4 amps, 22/6. Circuit included. 4 AMP CAR BATTERY CHARGER with amp meter Leads, Fuse Case, etc., for 6 v. or 12 v., 69/6.

BOOKS list S.A.E.

40 Circuits for Germanium Diodes 3/- "V.V." Radio Valve Data, 6/- High Fidelity Speaker Enclosure, 5/- Valve and TV Tube Equivalents, 9/6 TV Fault Finding, 5/- Quality Amplifiers, 4/6 Radio Valve Guide, Books, 1, 2, 3 or 4, 5/- each. Transistor Superhet Receivers, 7/6. Practical Radio for Beginners, 3/6. Master Colour Code Chart, 1/6. Transistor Controlled Models, 7/6.

C.R.T. BOOSTER TRANSFORMERS for cathode ray tubes having heater cathode short circuit, and for C.R. tubes with falling emission. Full instructions supplied.

Type A optional 25% and 50% boost. 2v. or 4v. or 6.3v. or 10.8v. or 13.3v. Mains input. **PRICE 12/6.**

LOUDSPEAKER P.M. 3 OHM. 2 1/2, 3, 4in. 19/6. 5in. Rola, 17/6; 8in. Plessey, 19/6; 7 1/2, 3 in. Rola, 15/-; 6in. Rola, 18/6; 10 x 6in. 27/6; 10 in. Rola, 30/-; 4in. Tweeter, 25/-; 12in. R.A. 30/-; 1 1/2 x 1in 45/- STENTORIAN HF1012, 10in. 3-15 ohms, 10 w., 95/-

BAKER SELHURST LOUDSPEAKERS



Detail S.A.E. 12in. Baker 15w. Stalwart 3 or 15 ohms, 45-13,000 c.p.s. ... 80/- 12in. Baker Stalwart, 40w suspension, 15 ohms, 40-13,300 c.p.s. ... 26 12in. Stereo, 12w., 35-10,000 c.p.s. ... 48 12in. Baker Ultra Twelve, 20 c.p.s. to 25 kc/s. £17.10 15in. Auditorium, 12 w., Bass, 20 c.p.s. to 15 kc/s. £15

TWIN GANG TUNING CONDENSERS. 365 pF, miniature lin. x 1 1/4in. x 1 1/4in., 10/-, 500pF standard with trimmers, 9/-; midjet, 7/6; with trimmers, 9/6.

SMALL 3 gang 500 pF, 17/- SINGLE 25 pF, 60 pF, 75 pF, 100 pF, 180 pF, 5/6. Solid dielectric 100, 300, 500 pF, 8/6. CONDENSERS, New stock, 0.01 mfd. 7 kV; T.C.C., 5/6; Ditto, 20 kV, 9/6; 0.1 mfd., 7 kV, 9/6. Tubular 500 v. 0.001 to 0.05 mfd., 9d., 0.1, 1/-; 0.25, 1/60 0.5/500 v., 1/80 0.1/350 v., 9d. 0.1/2,000 v. 0.1/1,000 v., 1/8; 0.1 mfd., 2,000 volts, 3/6. JERAMIC COND. 500 v. 0.3 pF to 0.01 mfd., 9d. SILVER MICA CONDENSERS. 10% 5 pF to 500 pF, 1/-; 600 pF to 3,000 pF, 1/3. Close tolerance. (± 1 p.p.t) 1.5 pF to 47 pF, 1/6. Ditto 1% 60 pF to 815 pF, 1/9; 1,000 pF to 5,000 pF, 2/-.

465 kc/s SIGNAL GENERATOR Total cost 15/- Uses B.F.O. Unit. ZA 30038 ready made. POCKET SIZE 2 1/2 x 4 1/4 in. Slight modifications required, full instructions supplied. Battery 7/6 extra 69V+11V. Details S.A.E.

Wavechange Switches. 2 p. 2-way. 3 p. 2-way, short spindle, 2/8; 8 p. 4-way 2 waffer, long spindle, 6/6; 2 p. 6-way 4 p. 2-way, 4 p. 3-way, long spindle, 3/6; 6 p. 4-way, 1 p. 2-way, long spindle, 3/6.

Wavechange "MAKITS" Wafers available: 1 p. 12 waffer, 2 p. 6 waffer, 3 p. 4 waffer, 4 p. 3 waffer, 6 p. 2 waffer, 1 waffer, 8/6; 2 waffer, 12/6; 3 waffer, 16/-; additional wafers up to 14, 3/6 each extra.

Toggle Switches, s.p., 2/-; d.p., 3/6; d.p.d.t., 4/-; Ex. Gov. s.p.d.t., 1/-.

CRYSTAL MIKE INSERT by ACOS 8/6 Precision engineered. Size only 1 1/4in. dia x 1 1/4in.

ACOS CRYSTAL MIKE 40 .. 25/- DE LUXE STICK MIKE .. 35/-

Valveholders. Pax. int. oct., 4d. EA50, 6d. B12A, CRT, 1/3. Eng. and Amer. 4, 5, 6 and 7 pin, 1/- MOULDED Mazda and int. oct., 6d.; BTG, B8A, B8C, B9A, 9d. BTG with can. 1/6. B9A with can, 1/9. Ceramic EP50, BTG, B9A, int. oct., 1/-; B7G, B9A cans, 1/- each.

THE ORIGINAL RADIO COMPONENT

Our written guarantee with every purchase. Bus 133 or 66 pass door S.R. Station Selhurst

Volume Controls

Long spindles. Midget
5 K ohms to 2 Meg.
No. Sw. D.P.S.w.
3/- 4/6
Linear or Log Tracks.

80 ohm
C.A.B.L.K. spaced
semi-dia. spaced
1/4 in.
COAX
6d. yd.
1/- yd.

TELESCOPIC CHROME AERIALS. 13in. extending to 43in. 5/6 ea. Coax Adaptor Plug. 1/6 extra. TRIPLEXES Bands I, II, III 12/6
COAX PLUG 1/- **LEAD SOG. ET.** 2/-
PANEL SOCKETS 1/- **OUTLET SOCKES** 3/6
BALANCED TWIN FEEDER yd. 6d. 80 or 300 ohms. DITTO SCREENED per yd. 1/6. 80 ohms only. WIRE-WOUND POTS, 3 WATT. Pre-set Min. TV Types. All values 10 ohms to 25 K. 3/- ea. 50 K. 50 K. 4/- (Carbon 50 K., to 2 meg. 3/-)
WIRE-WOUND 4 WATT POT. 100m spindle. Values, 50 ohms to 50 K. 6/6; 100 K. 7/6.
PHILIPS TRIMMERS, 50 pF. 1/-
TRIMMERS, Ceramic. 20, 50, 70 pF. 9d.; 100 pF. 15p pF. 1/3; 250 pF. 1/6; 500 pF. 75p pF. 1/8.
TRIMMER, 1000 pF. with knob 2/-.
RESISTORS, preferred values. 10 ohms to 10 meg., 1 w., 4d.; 1/2 w., 4d.; 1 w., 6d.; 1 1/2 w., 3d.; 2 w., 1/-.
HIGH STABILITY, 1 w., 1/6; 2/-, preferred values. 10 Ω to 10 meg. 15/10 to 5%, 100 Ω to meg., 2d.
5 watt 1/3
10 watt 2/6
15 watt 25 ohms-10,000 ohms 1/6
25 watt 1/3
12.5K to 50K 10w 2/-

Convert your battery portable to mains operation—COSSOR M12Z BATTERY ELIMINATOR
This Eliminator is completely assembled and supplied with all components. Read and On/Off Switch. It is housed in 2 units the same size as the AD35 and B126 Batteries, and suitable for receivers using DK36 range valves. 200-250V. A.C. mains. Size: L.T. Unit 3in. x 2 1/2in. x 1 1/2in. H.T. Unit 4in. x 2 1/2in. x 2in. Original price 3 gns. **39/6**
OUR PRICE

JACKS, English open circuit, 2/6. Closed circuit, 4/-. Crundie type, 3 ohm, 1/8.
JACK PLUGS, English. 3/-; Screened 4/-. Grundig, 3 pin, 3/-.
Wirewound Ext. Speaker Control, 10 Ω , 3/-
ALADDIN FORMERS and cores, 1in., 6d.; 1in., 10d.
6 1/2in. FORMERS 5837 of 8 and cans TV1 or 2, 4in. sq. x 2 1/2in. or 3in. sq. x 1 1/2in. 2/- with cores.
SLOW MOTION DRIVES, Epicyclic ratio 6:1, 2/3.
SOLENOID IRON, 25W, 200V or 230V. 24/-

JASON FM TUNER COIL, SET. 29/-, H.F. coil, aerial coil, oscillator coil, two I.T. transformers 10.7 Mc/s, detector transformer and heater choke. Circuit and component book using four 6AM6, 2/6. Complete Jason FM T. Kit, Jason chassis with calibrated dial, components and 4 valves, £8.5.0.

MAINS DROPPER, 3 x 1 1/2in. With adjustable slider. 0.3A, 1,000 ohms, 4/3; 0.2A, 1,000 ohms, 4/3.
LINE COILS, 0.3A 60 ohms per foot, 0.2A 100 ohms per foot, 2-way, 1/- per foot, 3-way 1/- per foot.
MIKE TRANS. 50-1, 3/9; 100-1, potted, 10/6.
P.V.C. Conn. Wire, 8 colours, single or stranded, 2d. yd. Sleaving, 1.2mm. 2d.; 4mm. 3d.; 6mm. 5d. yd.
SPEAKER FRIT, Gold cloth, 1 1/2 x 2 1/2in., 5/-; 2 1/2 x 3 1/2in., 10/-, Tyan, 52in. wide. 10d.; 22in. wide, 5/-; 1 1/2 x 3 1/2in., S.A.E. Expanded Metal, Gold, 12 x 12in., 4/-.

I.F. TRANSFORMERS 7/6 pair
465 kc/s slug tuning miniature ca. 1 1/2 x 1 1/2 in. High Ω and good band width. Data sheet supplied.

"REGENT" 4 VALVE "96" RANGE VALVES KIT PRICE £6. 6. 0. carr. 4/-



PRINTED CIRCUIT BATTERY PORTABLE KIT

Medium and low wave. Powerful 7 x 4in. high Flux Speaker. T.C.C. Printed Circuit and Condensers. Components of most quality clearly identified with assembly instructions. Osmore Ferrite Aerial Coils. Reline covered atatche case cabinet. Size 12in. x 8in. x 4in. Batteries used B126 (L5512) and AD35 (L5040) 100/- extra. Instructions 9d. (with kit). Mains Unit ready made for above, 39/6. Sold separately. Details free.

MONARCH RECORD PLAYER



BUILD IT YOURSELF USING 4-SPEEL BSI READY BUILT SW. AMPLIFIER. HANDSOME PORTABLE CASE. HIGH FLUX LOUD-SPEAKER. FULL INSTRUCTIONS SUPPLIED.
Total Price **£12.10.0**
Carr. and ins. 5/-.
The BSI way to success
World's Best Copied Autograph

RECORD PLAYER BARGAINS
Post 2/- each
4 Speed Autochangers:
BSR, U.A.8 £8.18.0
BSR, U.A.12 £7.10.0
BSR, U.A.12 Stereo/Mono £8.5.0
Garrard "Autoslim" £8.17.6
3 speed Single Players:
Garrard Mk. II £8.0.0
Model 4SP £8.17.8
Garrard 4 HF Transcription £17.18.8
Garrard Stereo Heads £2 extra.
All Sapphire Stylus available from 6/-.

ARDENTE TRANSISTOR TRANSFORMERS
Type D3035, 7.3 CT; Push Pull to 3 ohms for OC72, etc., 1 x 1 x 1 in., 9/6.
Type D3034, 1.75; 1 CT, Push Pull Driver for OC72, etc., 1 x 1 x 1 in., 9/6.
Type D3054, 11.5; 1 Output to 3 ohms for OC72, etc., 1 x 1 x 1 in., 9/6.
Type D1017, 18.2; 1 Output to 3 ohms for OC72, etc., 1 x 1 x 1 in., 12/-.
Type D239, 4.5; 1 Driver Transformer, 1 x 1 x 1 in., 10/-.
Type D240, 8.5; 1 Driver Transformer, 1 x 1 x 1 in., 10/-.
Type D3035, 7.3 CT; Push Pull to 3 ohms for OC72, etc., 1 x 1 x 1 in., 9/6.
Type D3034, 1.75; 1 CT, Push Pull Driver for OC72, etc., 1 x 1 x 1 in., 9/6.
Type D3054, 11.5; 1 Output to 3 ohms for OC72, etc., 1 x 1 x 1 in., 9/6.
Type D1017, 18.2; 1 Output to 3 ohms for OC72, etc., 1 x 1 x 1 in., 12/-.
Type D239, 4.5; 1 Driver Transformer, 1 x 1 x 1 in., 10/-.
Type D240, 8.5; 1 Driver Transformer, 1 x 1 x 1 in., 10/-.
Type VC1545, 5K with switch, dia. 0.9in., 1/6-
Type VC1700, 5K with switch, dia. 0.7in., 10/6
Deaf aid ear piece xtal or magnetic, 7/6.

ARDENTE TRANSISTOR VOLUME CONTROLS
Type VC1545, 5K with switch, dia. 0.9in., 1/6-
Type VC1700, 5K with switch, dia. 0.7in., 10/6
Deaf aid ear piece xtal or magnetic, 7/6.

WEYRAD

COILS AND TRANSFORMERS FOR A 2-WAVE TRANSISTOR SUPERHETERODYNE PRINTED CIRCUIT AND PORTABLE BATTERY AERIAL.
Long and Medium Wave Aerial—RA2W. On 6in. rod, 7/16in. diameter, 208pF tuning, 12/6.
Oscillator Coil P50/1AC. Medium wave. For 176pF tuning, 5/4.
Driver Transformers—P50/2CC. 470 kc/s, 1/16in. diameter by 1in. high, 5/7.
3rd I.F. Transformers—P50/3CC, to feed diode detector, 6/-.
Driver Transformer—LFDT2, 1 5/16 x 1 1/2 in., 9/6.
Printed Circuit—PCA1, Size 2 1/2 x 8 1/2 in. Ready drilled and printed with component positions, 9/6.
1 1/2 x 4 in., 35 ohm speaker, 25/-.
These components are approved by transistor makers and performance is guaranteed.
Constructor's Booklet 2/-.

NEW MULLARD TRANSISTORS
Audio OC71 6/- R.F. OC45 10/6
OC72 7/6 OC45 9/6
Sub-miniature Electrolytics (15V). 1uF, 2uF, 4uF, 5uF, 8uF, 25uF, 50uF, 100uF, 2/6. Diodes OA71, OA81, 3/-, GEX 34, 4/-.

R.R.C. Pocket 2 Transistor. M.W. and L.W. Radio Kit, 22/6. Phones 7/6 or deaf aid earpiece, 7/6. Batt. 2/-.

"P.W." POCKET 2 TRANSISTOR KIT MK.II WITH LATEST OSMOR MODIFICATIONS. ALL PARTS, PRINTED CIRCUIT AND NEW CABINET. OSMOR DESIGNED KIT, £8.15.0.

AMERICAN "BRAND FIVE" PLASTIC RECORDING TAPE

| | | |
|--------------------------------------|--------------------------------|---------------|
| Double Play 7in. reel, 2,400ft. 60/- | Spare 6in. reel, 1,200ft. 37/6 | Plastic Reels |
| Long Play 7in. reel, 1,800ft. 35/- | 7in. reel, 1,200ft. 23/6 | 3in. 1/6 |
| | 6in. reel, 900ft. 18/6 | 4in. 2/- |
| | | 5in. 2/- |
| Standard 7in. reel, 1,200ft. 25/- | 7in. reel, 600ft. 16/- | 5 1/2in. 2/- |
| | | 1in. 2/6 |

"Instant" Bulk Tape Eraser and Head Defuser, 200/250 v. A.C., 27/6.

CRYSTAL SET BOOKLET 1/-
CRYSTAL DIODE G.E.C. 2/- **GEX34** 4/- **OA81** 3/-
HIGH RESISTANCE PHONES, 4,000 ohms, 15/- pair.
MIKE TRANSF. 50:1, 3/3 ea.; 100:1, 1 Potted, 10/6.
SWITCH CLEANER Final 1/4 squirt snout, 4/6 tin.

HIGH GAIN TV PRE-AMPLIFIERS BRAND I B.C.
Tunable channels 1 to 5. Gain 18db. ECC84 valve. Kit price 29/6 or 49/6 with power pack. Details 6d. (PCC84 valves if preferred.)
BAND III I.V.A.—Same prices. Tunable channels 8 to 13. Gain 17db.

Faxolin Panels, 8 x 6in., 1/3.
Miniature Contact Coated Rectifiers, 250V 50mA, 7/6; 250V 80mA, 8/6; 250V 85mA, 9/6; 300V 20mA, 27/6.
TV etc. Silicon Sub-Min. Rectifier, 125V, 300mA, 6/6; 250V, 300mA, 14/6.
Selenium Rect. 300V 85mA, 15/-.
Coils Weatrite "Q" type, 3/- each.
Osmor Midret "Q" type, adj. dust core, from 4/- each. All ranges.
Teleton D.W.R. L. and Med. T.R.F. with reaction, 3/6.
Ferrite Aerials, M, 8/9; M. and L., 12/6.
Osmor Ferrite Rod Aerials, L. and M. for transistor circuits, 10/- each.
Ferrite Rods, 8 x 1in., 2/6; 8 x 5/16in., 2/6.
H.F. Chokes, 2/6. Osmor QCL, 6/9.
T.R.F. Coils, A/7F, 7/- pair; HAX, 3/-.
Repanco DREG, 4/-, DRX, 2/6.
Radio Screwdriver, 5in., 6d.
Neon Mains Tester Screwdriver, 5/-
Solder Radiograde, 4d. yd., 4lb, 5/-
Black Crackle Paint, Air drying, 3/- tin.

Aluminium Chassis, 18 s.w.g. Plain, undrilled, 4 sides, riveted corners, lattice fixing holes, 2 1/2in. sides, 7 x 4in., 4/6; 9 x 7in., 5/9; 11 x 7in., 6/9; 13 x 9in., 9/6; 14 x 11in., 10/6; 15 x 14in., 12/6; 18 x 15 x 3in., 16/6.
Aluminium Panels, 18 s.w.g., 12 x 12in., 4/6; 14 x 9in., 4/-; 12 x 8in., 3/-; 10 x 7in., 2/3, 8 x 6in., 2/-.

COMPONENT SHOP SPECIALISTS

P. and P. charge 1/-, over £3 post free. C.O.D. 2/-.

337 WHITEHORSE ROAD WEST CROYDON

Telephone: THO 1665 (Export welcome, Send remittance and extra postage).

NOW **YOU can MASTER ELECTRONICS!**

**BRITAIN'S MOST COMPREHENSIVE
PRACTICAL COURSE
IN RADIO · ELECTRONICS
TELEVISION!**

**THESE SPECIAL TRAINING
KITS — YOURS TO KEEP**



**Multi-Range
TEST METER**

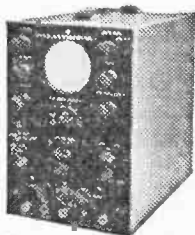

**CATHODE RAY
OSCILLOSCOPE**



**AM and VHF/FM
LUXURY RECEIVER**

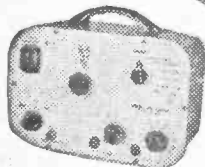

SIGNAL GENERATOR



**Complete set of
Picture Way books and
Experimental Manuals**

**LEARN BY BUILDING
NOW for your
CAREER · HOBBY
OWN BUSINESS**

YOU RECEIVE

- ★ Complete kits of equipment as illustrated.
- ★ Complete set of experimental manuals.
- ★ Complete set of "picture-way" theory books.
- ★ Modern test-yourself examination sheets.
- ★ Study programme.
- ★ Unlimited consultation with Tutors.



**FREE
BROCHURE**

POST NOW

RADIOSTRUCTOR

TO RADIOSTRUCTOR (DEPT. M.82)
READING, BERKS.

Name _____ **BLOCK**

Address _____ **CAPS**

_____ **PLEASE**

(We do not employ representatives)

4/62

Practical Wireless

Vol. XXXVII No. 662 APRIL, 1962.

Editorial and Advertisement
Offices:

PRACTICAL WIRELESS

George Newnes, Ltd., Tower House,
Southampton Street, W.C.2.

© George Newnes Ltd., 1962

Phone: Temple Bar 4363

Telegrams: Newnes, Rand, London,
Registered at the G.P.O. for trans-
mission by Canadian Magazine Post.

SUBSCRIPTION RATES

including postage for one year

Inland - - - £1.9.0 per annum
Abroad - - - £1.7.6 per annum
Canada - - - £1.5.0 per annum

Contents

| | Page |
|---|------|
| Editorial | 1097 |
| Round the World of Wireless | 1098 |
| International Short Wave Two | 1100 |
| Transistor Short Wave Tuner | 1104 |
| Digital Counter | 1107 |
| Experimenter's Power Pack ... | 1111 |
| Constructional Faults | 1115 |
| Direct-reading Frequency- meter | 1119 |
| Servicing Tape Recorders | 1122 |
| Practical Wireless Regency | 1124 |
| On Your Wavelength | 1130 |
| How Transistors Work | 1133 |
| Mini-Amp Intercom | 1138 |
| Home-made Radiogram Cabinet | 1141 |
| Short-wave Listeners' Log | 1146 |
| Faults in Transistor Mixer Stages | 1149 |
| Club News | 1157 |
| Truvox Tape Recorder | 1158 |
| Trade News | 1161 |
| Letters to the Editor | 1165 |

The Editor will be pleased to consider articles of a practical nature. Such articles should be written on one side of the paper only, and should contain the name and address of the sender. Whist the Editor does not hold himself responsible for manuscripts, every effort will be made to return them if a stamped and addressed envelope is enclosed. All correspondence intended for the Editor should be addressed: The Editor, PRACTICAL WIRELESS, George Newnes, Ltd., Tower House, Southampton Street, London, W.C.2. Owing to the rapid progress in the designs of wireless apparatus and to our efforts to keep readers in touch with the latest developments, we give no warranty that apparatus described in our columns is not the subject of letters patent.

Copyright in all drawings, photographs and articles published in PRACTICAL WIRELESS is specifically reserved throughout the countries signatory to the Berne Convention and the U.S.A. Reproductions or imitations of any of these are therefore expressly forbidden. PRACTICAL WIRELESS incorporates "Amateur Wireless."

OUR DOUBLE-SIDED BLUEPRINT

As promised last month, every copy of this issue of Practical Wireless contains a free, double-sided blueprint. This blueprint gives full details of the latest P.W. designs—the International Short Wave Two and the Regency. These two receivers are numbers 1 and 4 of a series of graded designs; numbers 2 and 5 will form the subjects of another double-sided blueprint to be given away with the May issue, and numbers 3 and 6 will be dealt with on the June blueprint.

The International Short Wave Two is a battery-operated set covering short waves—25m to 49m—although the exact coverage can easily be modified as described in the article on page 1100. Full details of the construction are given on Blueprint No. 1 and even the beginner should have little difficulty in making the receiver. In view of the simplicity of the circuit, it may be thought that the results to be expected from the set will be limited. However, short wave transmissions can be received from very large distances on the most simple equipment and the set will pick up stations from many foreign countries.

The Regency is a four-transistor portable for medium and long waves and has its own internal ferrite rod aerial. Again, details of the construction are given on the blueprint—Blueprint No. 4. The associated article on page 1124, although quite long because of the detail which is included, has been published in full in this issue so that constructors may complete this design without waiting for a second part.

Next month's designs will be a two-valve mains-operated TRF receiver and a six-transistor battery-operated superhet receiver for medium and long waves. Be sure to order your copy of the May issue now!

OUR FILM SHOW

Shortly before this issue went to press, nearly four hundred readers attended our annual film show at Caxton Hall, Westminster. This event was arranged as in previous years in association with Mullard Limited. The first film was "Special Quality Valves" and dealt with the type of research which goes on at Mullard factories to produce valves intended for uses where reliability and high performance are required. The film also showed how many of the improvements developed during this research are used in valves for domestic equipment where manufacturing time and expense permit.

The second film, which was shown after an interval during which refreshments were provided for all the audience, was a description of the uses and manufacture of the transistor. The way in which the transistor has been developed during its comparatively short existence was illustrated clearly by comparisons between early production methods and those at present in use.

The final film was a humorous comparison between the early days of radio and television and the present time and was entitled "Then and Now".

The film show was enjoyed by all who attended, many having travelled many miles in order to be present—the meeting closed with the hope that a similar film show will be held next year.

Our next issue dated May, will be published on April 6th.

Round the World of Wireless

POTENTIAL AND CURRENT NEWS

Broadcast Receiving Licences

THE following statement shows the approximate number of Broadcast Receiving Licences in force at the end of December, 1961, in respect of wireless receiving stations situated within the various Postal Regions of England, Wales, Scotland and Northern Ireland. The numbers include Licences issued to blind persons without payment.

| Region | Total |
|--|------------------|
| London | 665,304 |
| Home Counties | 619,610 |
| Midland | 451,203 |
| North Eastern | 479,234 |
| North Western | 413,962 |
| South Western | 565,834 |
| Wales and Border Counties | 218,482 |
| Total England and Wales | 3,200,629 |
| Scotland | 347,125 |
| Northern Ireland | 111,052 |
| Grand Total | 3,658,806 |

Round the World Telephone Cable

TRANSMISSION equipment for Compac, the Pacific Ocean section of the Commonwealth round-the-world telephone cable system, is being supplied by Associated Electrical Industries Ltd. The equipment is to be installed in terminal stations at Sydney (Australia), Auckland (New Zealand), Suva (Fiji), Oaha (Hawaii), Port Alberni (Vancouver Island) and Vancouver (Canada).

This apparatus will form an integral part of a system which, when completed during 1964, will enable at least 60 telephone subscribers to talk simultaneously between London and Sydney. The U.K.-Canada section, known as Cantat is already in use.

Equipment being supplied for Compac includes directional filters, cable frequency translating equipment, test racks, pilot recorder racks and engineers' telephone and telegraph maintenance circuits.

Manufacture is being carried out by AEI Telecommunications Division at Woolwich.

Electronics Trainer

A NEW aid to the teaching of electronics will soon be available to schools, technical colleges and training establishments in this country.

The Mullard Electronics Trainer enables the lecturer to

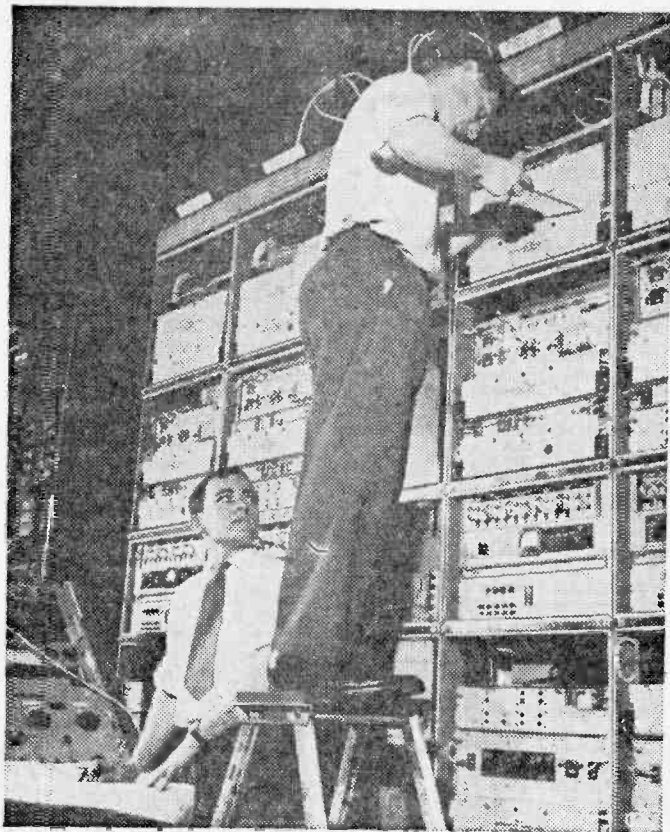

Engineers at the Woolwich works of Associated Electrical Industries completing factory tests on transmission equipment which is to be installed at Sydney, the Australian terminal station of the Pacific section of the round-the-world Commonwealth telephone cable system.

build-up working circuits, in diagrammatic form, simply by plugging-in the appropriate components to specially-designed circuit panels. In this way, students can follow the construction of the circuit stage-by-stage, and afterwards use it experimentally. Once a complete circuit is built up, its electrical characteristics can be demonstrated, and the effects of changing individual component values on the working diagram may be observed.

It consists of a floor-standing cabinet to which is attached a vertical display frame designed to accommodate up to ten exchangeable circuit panels. The bench top of the cabinet is fitted

with a number of mains sockets which can be used to power oscilloscopes, signal generators and other equipment for demonstrating the operation of the circuit.

Circuit components are soldered into small plastic plug-in units having detachable covers on which the conventional symbol of the component is shown. For demonstration purposes, faults can be studied by soldering a faulty component into a plug-in unit.

When the circuit is finally built up, the necessary power can be taken from the power supply circuit panels supplied with the trainer, or from the stabilised power supply mounted within the cabinet.

Radar Station for R.A.F.

ANOTHER tactical control radar has just been handed over to the Royal Air Force by Associated Electrical Industries Limited.

The surface-to-air missile system is designed to detect and counter long-range enemy supersonic aircraft. Three types of radar are being used—early warning radar, tactical control radar and target illuminating radar. AEI, in conjunction with the Royal Radar Establishment, Malvern, was responsible for the design and manufacture of the tactical control radar and the target illuminating radar, and for the co-ordination of the overall radar systems.

The tactical control radar continuously provides an accurate three-dimensional picture of all aircraft in the battle zone with facilities for rapidly "locking on" to selected targets the precision target illuminating radar.

AEI Equipment on Three New Ships

THREE newly built ships are fitted with radio, radar, intercommunication, navigational and other equipment supplied by the Telecommunications Division of Associated Electrical Industries Limited. They are the "Gorjistan" of the Strick Line, the "Australind" of the Australind Steam Shipping Company, and the "Port St. Lawrence" of the Port Line. Radio officers from AEI sea-going staff have been appointed to all three ships.

The "Gorjistan" is fitted with the latest AEI H.F. and M.F. radio transmitters of 600W output.

The "Port St. Lawrence" in addition to her usual radio equipment, is fitted with VHF equipment with remote speaking positions on each wing of the bridge for pilotage use.

To enable the crew of the "Australind" to use their own radio receivers a communal aerial system with 38 cabin outlet boxes has been provided.

The equipment has been supplied by Marine Department, AEI Telecommunication Division, Woolwich, London, S.E.18.

NATO V.L.F. Aerial System

AN order from Continental Electronics Systems Inc., of Dallas, Texas, USA, for the design, supply and erection of 13

high masts—complete with aerials for the North Atlantic Treaty Organization's new very low frequency transmitting station at Anthon, near Carlisle — has been given to British Insulated Callender's Construction Co. Ltd.

The scheme involves one central mast and two concentric rings of six masts each. The inner ring will be 1300ft from the centre, the radius of the outer ring being 2100ft. The height of the masts varies from 745ft at the centre to 600ft at the outer ring. They have been designed to withstand head loads of 48 tons resulting from suspended aerial panels.

The mast designs were prepared with the aid of an electronic computer which enabled a study to be made of over 100 loading conditions on the three mast types. The computer programme was compiled in conjunction with the Engineering Department of Cambridge University and it is believed to be the only one of its kind in existence.

There will be six aerial panels,

rhombic in shape, and each will contain approximately 20 tons of cadmium copper strand or steel-cored aluminium conductor. The panels will be constructed and prestressed on the site.

The earthing system will be formed from a network of soft copper wires, totalling nearly 75 miles, buried 12in. below ground.

The VLF transmitting system at Anthon, which is expected to take just over two years to complete, will be the largest of its kind in Europe.

Engineering Appointment

THE BBC has announced the appointment of Mr. M. J. L. Pulling, C.B.E., M.A., M.I.E.E., to the post of Assistant Director of Engineering with effect from 1st January 1962.

He is responsible, under the Director of Engineering, Sir Harold Bishop, for the Operations and Maintenance Departments, the Engineering Establishment Department and the Engineering Training Department.

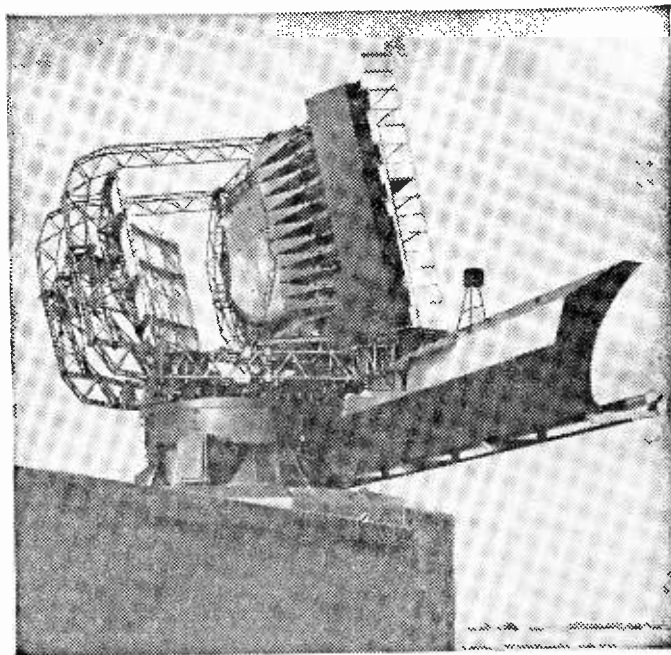

Part of one of the tactical control radar stations of the surface-to-air missile system, designed to detect and counter long-range enemy supersonic aircraft. AEI in conjunction with the Royal Radar Establishment, Malvern, was responsible for the design and manufacture of the tactical control radar and the target illuminating radar, and for the co-ordination of the overall systems.

A BATTERY-OPERATED
RECEIVER FOR THE
COMPARATIVE NEWCOMER
TO RADIO CONSTRUCTION

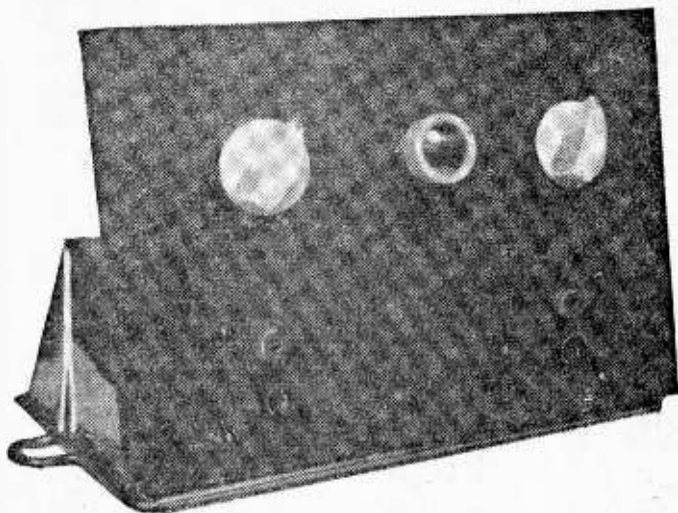

International

THIS receiver—the P.W. International Short-Wave Two—is Blueprint No. 1 on the double-sided blueprint sheet given away free inside every copy of this issue. As mentioned on page 1097, the designs described in this issue are Numbers 1 and 4; No. 1 is a design for the comparative beginner while No. 4 is intended for the more advanced constructor. Four more designs will be dealt with on the following two blueprints and thus, the three blueprints will constitute a series of designs numbered from 1 to 6 and graded in the same order.

This short-wave set is intended for the constructor who, for instance, has completed the "Tutor" series (October 1961 issue of P.W.) and wishes to improve his knowledge of radio construction by building another simple receiver of different design. However, other enthusiasts will find this receiver of equal interest if only on account of the long distance reception which is possible with such a simple and inexpensive circuit.

Components

The blueprint gives all the essential information for building this receiver, including a list of components required. The more experienced constructor will, however, find it possible in the light of his knowledge, to use slightly different parts and circuitry, but the beginner is advised not to vary any of the details given since this may result in poor reception.

Circuit Details

The detector stage in this set (valve V2) is of

the reacting kind in which increased gain is obtained by bringing the stage almost to the point of oscillation (see Fig. 1 on Blueprint 1). However, the objection to this type of circuit is that if it is allowed to oscillate, it is possible that interference may be caused to other receivers. In this set, two measures have been taken to reduce or eliminate this type of interference. Firstly, the aerial is coupled to the receiver via a small pre-set trimming condenser, and secondly, the detector stage is not fed directly from the aerial but via an R.F. stage (valve V1). Thus, provided that the receiver is constructed and adjusted as described here, there will be no problem so far as radiated interference is concerned.

In addition to the two measures mentioned above, experienced constructors may like to divide the underside of the chassis into two parts by means of a metal screen further to reduce unwanted coupling between R.F. and detector stages.

The coils used are home-made and those described on the blueprint give a coverage from about 25m to 50m, but details will be given later of how to modify the coverage of the receiver to suit personal requirements, although the range given will be found adequate in most cases. More coverage could have been obtained by a band-switching arrangement, but this was thought not to be worthwhile in view of the added complications. Those constructors having sufficient knowledge to understand band-switching should also be capable of incorporating it for themselves.

Separate tuning is used for the R.F. and detector stages, instead of using a two-gang tuning condenser. This simplifies construction of the receiver without complicating the tuning unduly. When

using the set, it is merely necessary to keep the two tuning dials in step by means of the semi-circular scales which are fixed on the front panel. The R.F. tuning is in any case broader than the detector tuning and when the desired station has been tuned on VC2, VC1 may be rotated for best results.

Construction

The chassis may be of aluminium, about 9in. x 6in. x 2½in., or consist of a baking tin which is readily available in this size. Aluminium has the advantage that it is more rigid than tin-plate. However, the tin-plate chassis is cheaper and easier to work; the required holes can be made in tin-plate by the use of an awl, widening the holes where necessary with a suitable instrument, but holes in aluminium must either be made with suitable metal punches or by drilling a number of small holes and using a metal-cutting fret-saw or coping saw. Also, of course, wires can be soldered to tin-plate but not to aluminium.

Front Panel

There is a choice of material for the front panel—it may be of hardboard or metal. Hardboard is easier to work than metal but, in this design, it will be necessary to glue aluminium foil to the rear of the hardboard front panel to reduce



front panel to the chassis. Next, the four sockets for aerial, earth and headphones should be placed in position using red sockets for the aerial and the upper of the two headphone sockets, and black sockets for the remaining two. (If a tin-plate chassis is used, the burr produced when making the required holes may have to be flattened before the sockets can be fixed.)

The three variable condensers and the on/off switch may now be mounted, followed by the valveholders and the underchassis tag-strip (Fig. 3).

Coils

The construction of the coils is shown clearly in Fig. 7 on the blueprint. The coil formers are 1in. diameter cardboard tubes—certain sweet containers are suitable—and two 1¼in. lengths will be required. To wind L1, two adjacent holes should be pierced in the former (the left-hand pair on the diagram of L1 in Fig. 7). The coil wire is then

Short-Wave Two

By J. B. Halsworthy

undesired effects which would otherwise occur when tuning the receiver—hand-capacity effects.

Having outlined the requirements, construction may now begin. The metal chassis should be drilled as shown in Fig. 8 on the blueprint (Blueprint No. 1). The front panel can be prepared by drilling the required holes, including four at the bottom for bolts to secure it to the chassis. Naturally, holes will also be required in the front side of the chassis and these will correspond in position with those below the dotted line in Fig. 4 which gives the drilling details of the front panel. When the holes have been drilled in the front panel, this may be used as a template for drilling the front side of the chassis and this procedure is recommended to ensure that the holes in the front panel and chassis coincide. A hole will also be required in the front of the chassis, but not in the front panel, for the bolt holding the underchassis tag-strip—a countersunk bolt is best.

The front panel, if of hardboard, will need to be covered with a layer of aluminium foil (cooking foil) and a piece of foil should be cut out about 8½in. x 5½in. When it has been stuck to the rear of the panel, holes may be made in it corresponding to those in the panel.

Four bolts should now be used to secure the

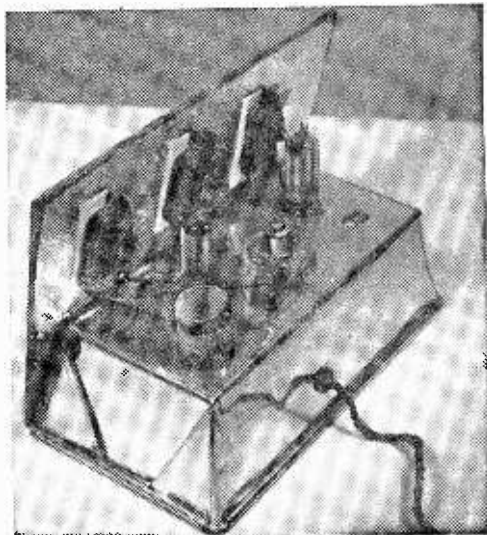

Rear view of the set.

International Short-wave Two

threaded through this pair of holes as shown to leave a 6in. length free. Thirteen turns are then wound on, side by side, and the coil wire is terminated by threading it through another pair of holes and leaving 6in. free before cutting the wire. The wire is double cotton covered and is easily secured in position by a dab of balsa cement where it passes through the pairs of holes and also at other points around the coil if this is found necessary to hold the turns in place.

A circular cardboard end-piece must then be cut out slightly larger in diameter than the coil former. An $\frac{1}{4}$ in. hole is required in the centre of this cardboard disc which is then fixed with balsa cement to one end of the coil former of L1 as shown in Fig. 7.

Making L2/L3

This coil is made in a similar manner to L1, but L2 must be positioned nearer to the end of the former than L1. Coil L3 is wound with seven turns of wire in the same direction as L2, and spaced from L2 by about $\frac{1}{4}$ in. The turns of wire are again fixed in position with balsa cement and the cardboard end-piece is attached. Again, 6in. lengths of wire are left at each end of each coil.

The coils may now be fixed in position as indicated in Figs. 2 and 3, L1 being mounted under the chassis and L2/L3 on top of the chassis.

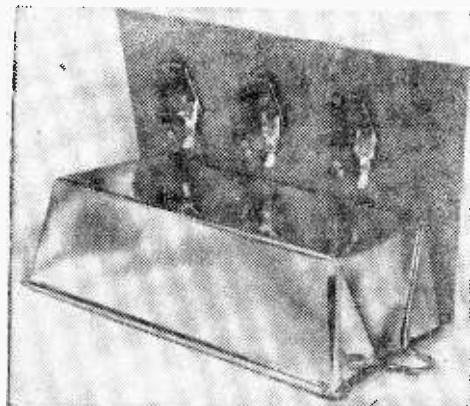

Rear view of the set after trial assembly of chassis and panel.

Wiring

The wiring of the receiver is given in detail, except for the coil connections, in Figs. 2 and 3. The coil wiring is given in Fig. 7. The wiring should be carried out as shown but omitting the battery connections and the wiring-in of the coils. The battery leads are wired to the tag-strip and switch under the chassis as shown in Fig. 3 and a three-way lead will be required having different coloured insulation on each lead—red, black and yellow are suggested. These three leads may be plaited together or enclosed in large diameter sleeving. At the other end of this three-way lead, the battery plug must be wired. If the battery has a metal cap, remember to place this over the wire before fixing the plug itself.

To fix the battery plug to the leads, first remove about $\frac{1}{4}$ in. of the insulation from each of the three

leads and push each wire into its correct pin so that the bare wire just protrudes through the hole at the end of the pin. If a hot soldering iron is now placed in contact with the end of the pin and solder applied to the hole at the tip, the solder will run down inside the pin and make a good joint. If the solder is allowed to run down the outside of the pin, it may be difficult later to insert the plug in the battery. Note that it is necessary to join the L.T.—and H.T.—pins by a short length of wire. The required connections are shown in Fig. 1 with the battery plug viewed on the connecting side.

Valveholder Connections

It will be noticed that in Fig. 3 no connections are shown to pin 5 of each valve although in Fig. 5 pin 5 is shown as connected to filament negative and g3. No connection is made to pin 5 since this pin is joined to pin 1 inside the valve.

Returning to Fig. 2, the connections from the moving plates of each condenser to chassis (M.C.) will not be required if the front panel is of metal and it is also possible to omit them if aluminium-backed hardboard is used. However, whichever type of panel is used, care should be taken that the tuning condensers are not fixed at a slight angle to the panel, thus allowing the bolts through the fixed plates to contact the metal or foil which will prevent any results at all from being obtained when the set is tested.

Coil Wiring

By reference to Fig. 7 the coils can be wired into circuit, but before soldering the leads to their respective positions each coil wire should be cut to length and $\frac{1}{4}$ in. of the cotton insulation removed. The coil wires, now of the correct length, may be covered with insulating sleeving.

Testing the Set

Before any attempt is made to test the receiver, the wiring must be checked very carefully against the diagrams on the blueprint. In particular, make sure that the battery connections are in order; if the H.T. supply were accidentally wired to the filament circuit, the valves would be ruined at once.

An aerial and earth should be connected, together with headphones and the battery. Condensers VC1 and VC2 should be turned so that the moving vanes are each at half rotation and condenser VC3 should be fully open. The set should now be switched on and some sound may be heard in the headphones. If the setting of VC3 is now increased slowly, a hiss should be heard as the detector circuit oscillates. The aim, when operating the receiver should be to keep the setting of VC3 just below the point of oscillation or many stations will not be heard. VC2 is the main tuning condenser but VC1 should always be adjusted in step with it and, to help in this, pointer

knobs should be used on VC1 and VC2 with semi-circular scales on the front panel as shown in Fig. 9.

The method of keeping the set just below the point of oscillation and VC1 and VC2 in step will become readily apparent after using the set for a few minutes.

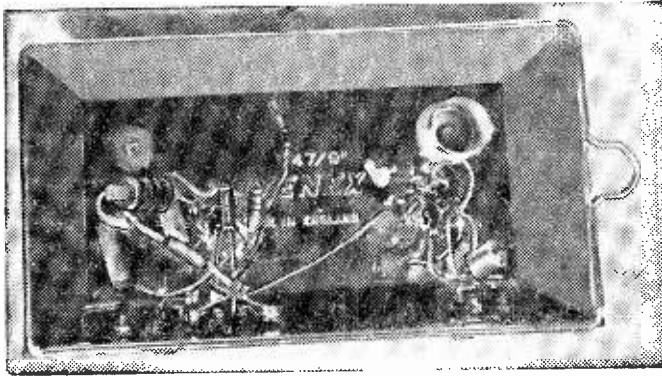

Under-chassis view of the completed receiver.

The trimmers TC1 and TC2 are adjusted to give best results; it will often be found that a half-way or low setting is required for each, but some experiment will be necessary.

The headphones used should be of the high resistance type; poor results will be obtained if low resistance types are used.

International Short-wave Two

Aerials and Earth

With this receiver a long-wire aerial will be found to give the best results; it should be as high as possible and away from buildings. The connection of an earth will in some areas make little difference to results, but the effect of its addition is worth trying.

At any time of the day, several stations should be heard but reception will improve greatly in the evening and experience will soon tell what times are best for long distance reception which, however, will only be obtained by correct use of the reaction and tuning controls.

Alternative Coils

The coils given for this receiver will, as mentioned earlier, cover from about 35m to 50m, but other coils may be used, provided L1 has the same number of turns as L2, and L3 about half the number of turns of L2. Wire gauges are not particularly critical and once the constructor has made the set, valuable experience can be obtained by wiring in different coils.

New VHF Sound and Television Broadcasting Station at Redruth, Cornwall

THE BBC's new television and VHF sound broadcasting station, which has been built at Four Lanes, near Redruth, Cornwall, was brought into service on Monday, 26th February.

Daily test transmissions throughout normal programme hours started on Monday, 12th February. These were for engineering purposes to assist the radio trade in the installation and adjustment of aerials and receivers.

This new station is one of several that the BBC is building to extend and improve the coverage of its television and VHF sound services. The greater part of Cornwall is already served by the BBC's television and VHF sound broadcasting station at North Hessary Tor, but there are some areas where satisfactory reception cannot be obtained because of the screening effect of the hilly country. The Redruth station will improve reception in most of these areas, particularly in West Cornwall and along the north Cornish coast, and it is estimated that some 200,000 people will benefit.

The Redruth station, which has been designed to work without staff in continuous attendance,

will receive its television and sound programmes by radio from the BBC station at North Hessary Tor. It will re-transmit the television programmes on Channel 1 (vision 45.0Mc/s, sound 41.5Mc/s) and the sound programmes on VHF on the following frequencies: West of England Home Service 94.1Mc/s, Light Programme 89.7Mc/s, Third Programme/Network Three 91.9Mc/s.

In both cases the transmissions will be horizontally polarised, which means that receiving aerials should be mounted horizontally.

Television aerials previously used for reception from North Hessary Tor on Channel 2 will have been designed for vertical polarisation and will not be suitable for reception from Redruth on Channel 1. Viewers are advised to consult their radio dealers regarding the most suitable type of aerial for a particular location. Horizontal aerials that have been used for reception of the sound programmes on VHF from North Hessary Tor will still be satisfactory for VHF sound from Redruth but in some cases may need to point in a different direction.

16m TO 175m TRANSISTOR S.W. TUNER

FINAL WIRING AND TESTING THE UNIT

(Continued from page 1015 of the March issue)

By F. Neville Hart

AFTER completing the wiring described last month, the 750pF series condenser may be soldered on the "top-band" position on the switch. This may have to be made up with a 500pF and 250pF condenser in parallel, using as small a physical size as possible.

When the I.F. portion is wired, it can be mounted, and leads from the volume control taken to their respective terminals. The inside angle-bracket of the I.F. section should be found to be touching one of the soldering tags on the switch of the volume control, and so this can be soldered with a hot iron on to the bracket, taking care to clean it well, to make a good joint. This gives extra support for the I.F. panel, and makes a good earth connection.

Leads

The other switch tag is taken to the main tag strip, to which the battery positive lead is soldered. About eight inches of black and red flex is used, being joined at the other end to a two-pin battery connector, to fit the 7.5V battery used for the set. The aerial lead from the tag on the wave-change switch has a miniature crocodile clip soldered to it and can then be clipped on to the base of the aerial in the cabinet.

The tags on the outside wafer of the wave-change switch should be bent out at right-angles in order to give the wires better clearance and spacing. It is advisable to keep all leads to the R.F. coils as well spaced as possible.

Transistors

When all the three panels are wired and joined, the transistors are soldered into place. Do not cut their leads, but place sleeving on each one, and of course take the greatest care to prevent overheating them.

Extending Aerials

There are a number of suitable extending aerials nowadays, and those with rubber suckers or clips, for temporary use in cars could be utilised.

Before starting to test the set, it is necessary to make a trimming tool, for the slugs in the coils and I.F. transformers are so small and delicate that a metal object thrust into the slots would most certainly split them. A simple one can be made from celluloid. Cut it narrow enough to be inserted the whole way into the slot in the coil cores, filing it to ensure easy entry. One end can be glued into a stick of wood to form a handle. The other end of this handle can be adapted to make a trimming tool for the bee-hive trimmers by pushing on either a short piece of rubber tubing or a piece of large gauge insulating sleeving.

Testing

Plug in the battery, clip the aerial lead on to the aerial, plug the unit into an amplifier, and switch on. If all is correctly wired, and a voltmeter is connected to the chassis, and the other lead tapped on the aerial, a click should be heard. If a normal aerial is available, wind 4 or 5 turns around the extending aerial, reducing the

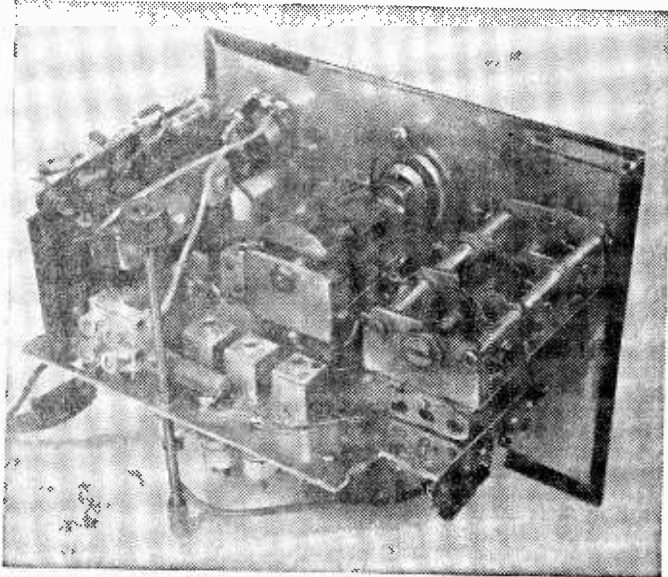

An above-chassis view.

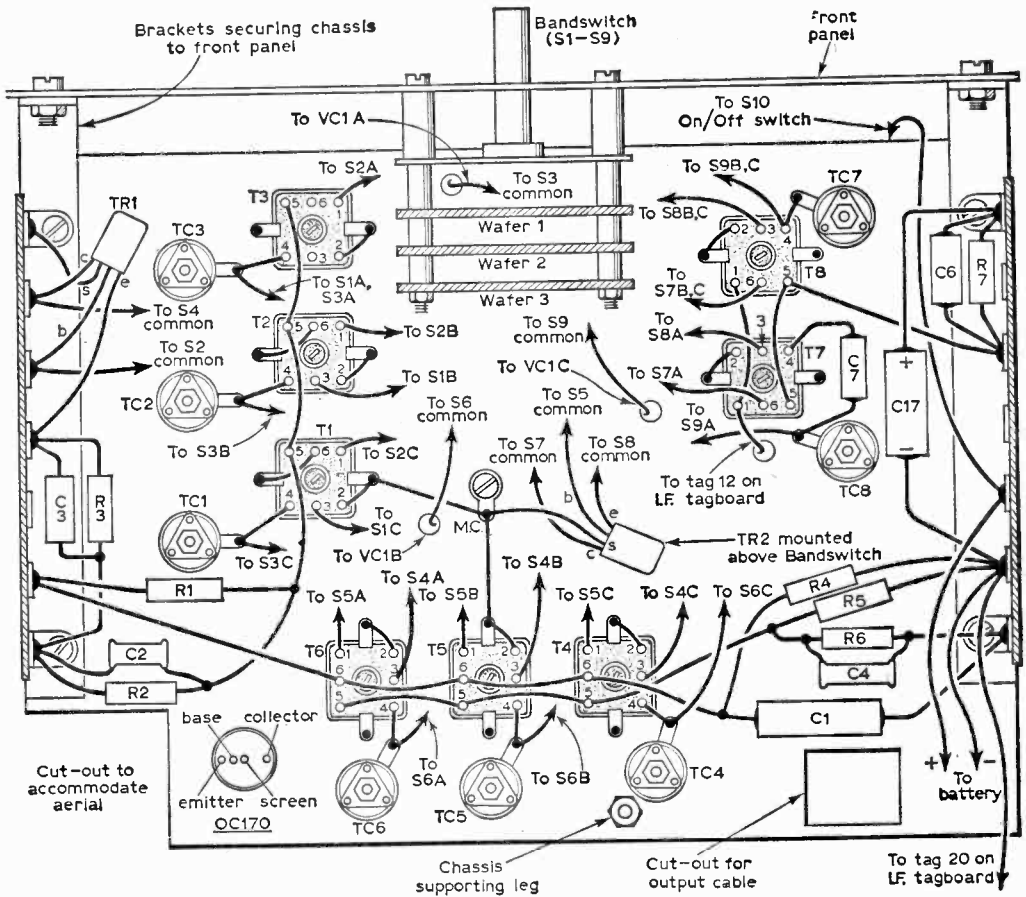

Fig. 7—The under-chassis wiring and layout.

number as alignment progresses.

Undo all the beehive trimmers about two turns from the fully closed position. Switch to the middle band and locate a loud signal at the high frequency end of dial.

When the first strong signal is received, the I.F. transformer cores should be carefully adjusted for best results, but avoid altering the position of the the first I.F. core. The coils have been aligned at the factory and should not need much adjustment; particularly avoid moving the slugs of the two oscillator coils. In all the following operations the bandsread condenser should be at minimum. Now adjust the aerial trimmer and then the R.F. trimmer for maximum output. Turn the dial to about 45° to receive the 49m band. Adjust the core of aerial coil and then the core of the R.F. coil for maximum output.

The 49m band can be identified usually by signals from Paris (French programme), Hilversum, or West Germany. If oscillation is present, indicated by whistles when tuning, and it does not disappear after careful alignment, the value of the 2.2k dropping resistor (R4) in the negative lead to

the R.F. transistor should be increased to 3.3k. Make sure, however, that the oscillation is not in the I.F. section of the set. This can be proved by slightly detuning the slug of the XT27. If the oscillation persists, it is definitely in the R.F. section.

Now switch to the shortest waveband, and locate a signal at about 19m, adjusting the aerial trimmers and then the R.F. trimmers. The 19m band should come in about 25°. When a good signal is obtained, try for the 16m band at about 10°.

If the 19m band comes too near minimum capacity of the tuning gang, the 16m band will not be heard, so the oscillator trimmer should be reduced in capacity a turn at a time, keeping the aerial and R.F. trimmers in step. Remember that every alteration of oscillator trimming will affect the alignment of the middle band, since the same coil is used for the two bands, so this band may have to be re-adjusted on concluding the alignment of the highest frequency band.

When the 16m band has thus been located, the 31m band is next. Adjust the aerial cores and

then the R.F. cores for maximum signal. This band should appear about 70°. The 25m band at 45° should now be located and a compromise adjustment found to suit both these latter bands. Repeat the process at the high frequency end with the trimmers.

Turning the switch to the top band, the 80m amateurs should come in at about 15° of the rotation of the condenser. It may be necessary to reduce the oscillator trimmer, as on the shortest waveband, a turn at a time. Now put the condenser to maximum capacity. If a medium waveband station is heard, the oscillator core should be screwed out, a turn at a time, until this is just tuned out, keeping the aerial and R.F. cores in step. Try now for 160m, which should be at about 65° on the dial. Repeat the process until optimum results are obtained.

Fewer Stages

The unit can be built without the R.F. stage, and in that case only a 6-pole, 3-way switch is required, one OC170 and one less 3000pF condenser and substitution of a 1000pF by a 0.01μF. The 15k and two 2.2k resistors will also not be required. Naturally, only 2 gang tuning condensers are needed, cutting out the extra 208pF. Alignment will be simplified, but second channel interference will be present.

If there is difficulty in lining up the tuning coils, a simple and easy way is to do it with the mixer transistor only, before mounting the R.F. transistor.

A lead is taken from the mixer base, to the soldering tag on the switch which will be used for the base of the R.F. transistor (instead of to the tag to which it will eventually be wired). Alignment is then carried out by adjusting the aerial and mixer coils (omitting the R.F. coils). Mark on the dial in pencil, the positions of the various bands after satisfactory alignment, taking care to use the highest frequency position of the two places in which each falls, for when the R.F. stage is added, only one, in most cases, will appear, and if the lower one is used, correct ganging will not be possible.

New Ceramic Triode for R.F. Heating

A NEW type of valve for industrial radio-frequency heating applications has been introduced by Standard Telephones and Cables Limited.

The new valve is a power triode and has an all-ceramic envelope which permits operation at much higher frequencies than were possible with similar valves having glass envelopes.

The first valve of this type is known as the 3RC/223E and is a near equivalent to the established 3J-Q-R-Z/222E family of valves which

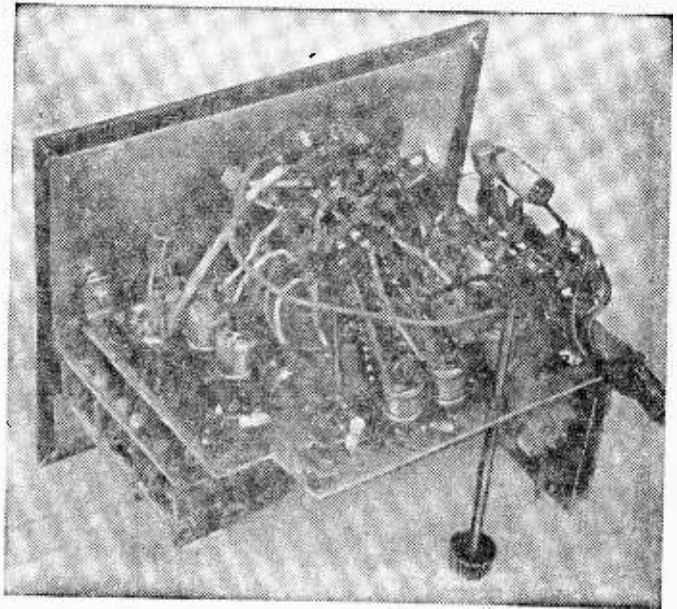

An under-chassis view of the tuner.

The R.F. transistor can now be mounted, and the mixer base joined to its correct tag on the switch. Then, without touching the aerial and mixer coils, the R.F. coils are aligned until full volume is obtained.

Feedback

If it is desired to increase the gain of the R.F. stage by introducing a certain amount of reaction, and to sharpen up tuning by bringing it to the point of oscillation, a variable dropping resistor 10k can be used in place of the fixed 2.2k resistor in the R.F. base circuit (R2). This is useful because the sensitivity of the shortest waveband is not quite so good as the other two, which may also be stabilised with its use.

There is room on the front panel for this variable resistor if a small one is chosen; it may be mounted under the volume control. Care should be taken to ensure that these are mounted low enough on the panel to clear the beehive trimmers safely.

operate from a 6000V supply and develop up to 24kW of output power at a high frequency.

Whereas the anode voltage of the glass versions must be lowered for operation at frequencies above 50Mc/s, these ceramic valves may be operated at full rated voltage at up to 100Mc/s.

Other improvements in the new valves include a shorter coaxial stem making for ease of cavity mounting; and an improved cathode in forced-air-cooled, vapour-cooled and water-cooled versions. Standard Telephones and Cables Limited, 29/30 Glasshouse Yard, Aldersgate Street, London, E.C.1.

DIGITAL 2509 COUNTER

(Continued from page 1005 of the March issue)

USING rainwater samples prepared as described last month, the author detects initial rates of decline leading to halving of the activity in very short times, followed by subsequent rates of decline leading to halving in about 8 days. The initial behaviour is very variable; sometimes very great initial activities are observed, but these are due to causes of natural origin, for an explanation of which relevant textbooks should be consulted. The behaviour at least a week after initial effects have subsided, is fairly constant at present for all rainfall investigated by the author, and is representative of present levels of atomic-bomb test fall-out.

The details which have been given in this series of articles should prove highly enlightening for the newcomer to this field, showing him the essential *statistical* nature of atomic radiation problems, and the method of tackling such problems experimentally. It would be far too tedious, although of course normally in principle possible, to plug a pair of headphones into the output socket of Fig. 2 (Feb. issue), and sit counting the ticks heard. This would require concentration over several hours non-stop, and in this time one could not do anything else. Counts of a few minutes, as explained above, are relatively useless. The need for an automatic digital counter is thus clear. This can be left running, and read off once every few hours. The digital GPO relay counts up to 9999 before starting again at zero, and therefore a count overnight is possible without ambiguity, and is of great value in providing significant results.

Precautions

If counting is made unattended for long periods, then, apart from proper attention to the necessary fuses for safety, one further point is worth considering. The H.T. should be wired via the contacts of a relay which is itself energised from the H.T. after passing the said contacts. H.T. can then be switched on by means of pushing a bell-push momentarily shorting the relay contacts. If there is a power cut during the night, even for a short period, then the relay falls off and cannot re-energise even when the power comes back. One sees then, when coming to take a reading in the morning, that the equipment has stopped, indicating that there has been a power-cut. Otherwise short power-cuts would merely produce somewhat low readings, which would be misleading, as they would not be conclusive evidence of a power-cut. If a mains electric clock (not self-starting) is used for the necessary timing, then this will stop, too, at the time of the power-cut, so that the count registered up to that time can at least still be used, because the clock will still show the time appropriate to that count. Alternatively, a self-starting electric clock could be used, which would automatically reduce the time accordingly in case of power-cuts, so that the equipment need not be prevented from restarting when the power returns.

The Normal Count of About 20/minute

The origin of this counted radiation, from which one can never escape, even in the innermost rooms of a house, the deepest cellars or tunnels, or anywhere else, is what is called cosmic radiation. It comes chiefly from outer space, and astronomers are still debating its exact source. A part of this "normal background count" also originates from normal radioactive minerals and deposits on earth. Normally wall-plaster is sometimes slightly radioactive, and it is an interesting preliminary experiment after constructing the apparatus here described to check this. The long-period average count may be significantly higher if the Geiger head is placed hard against a plastered wall than if it is left in the middle of the room during the count. A number of spa-waters are also naturally radioactive, and the experimenter will find much amusement checking any samples he can obtain.

In testing spa-waters, or any other natural waters which may be radioactive from mineral sources, the same concentration procedure should be used as described in detail for rainwater. The exact amount of concentration required will be extremely variable, and should be determined by trial and error, starting with a high factor of about 500 initially, and decreasing for subsequent tests *on the same material* if this is found more than ample.

In testing tap-water, higher concentration factors are mostly required than for rainfall, as an efficient waterworks removes a good proportion of the radioactive traces originally present in the rainfall. However, this can vary greatly from location to location, and would provide an interesting field for experiment for the amateur building the apparatus described in this article. The author finds that recent levels in local tap-water are about 20% of present rainfall values.

At any rate, it is clear from the above-mentioned wall-radioactivity that one should not move the position of the Geiger counter between a "background count" and a following "sample-count" for the comparison of which the background count in question is intended to be used. One should also not move luminous clocks and watches about in the vicinity of the apparatus during such measurements, as they could cause appreciable error.

There is, of course, no need whatsoever to remove all luminous clocks, watches or other instruments from the room. It is merely required to keep them *fixed in position* at least for the duration of each measurement consisting of a background count and a sample count.

The same applies to any prepared radioactive samples or purchased calibration-standards. All samples not actually being measured may be left in the same room, but should not be placed too close to the Geiger head, and should not be moved about during a measurement.

High-voltage equipment which could generate spurious X-rays should not be operated in the same room during a measurement.

Detecting and Measuring X-rays

The apparatus is also fully sensitive to normal X-rays, which are simply the same as ordinary wireless waves in nature, but of exceedingly shorter wavelength. Wavelengths of only billionths of a metre are involved, and these are normally produced to some extent whenever electrons which are accelerated up to some ten thousand volts or so suddenly hit anything and are stopped. The energy is then partially radiated as X-rays, in the same way as slower electron decelerations in normal aerial wires cause radiation of part of the energy as ordinary wireless waves. It is thus clear that virtually the only parts of electronic equipment normally handled by the amateur which are likely to produce any X-rays are EHT rectifier

valves, television tubes and possibly some high-voltage rectifiers and power amplifiers in ham transmitters. Significant X-rays are unlikely at voltages under 2000. The above-named electronic components are nowadays normally manufactured in such a way as to minimise their X-ray production to negligible proportions. A count made as close to a running television tube as is possible to be with the Geiger head, without danger from the high voltage, should often give no immediately apparent rise in the count, but certainly not a count greater than about 100/minute.

External to the closed television receiver cabinet, at a distance of about 1ft, some hours of counting should be necessary before anything significant is detectable. It must be stressed that one should not be over-anxious in this matter. Even if individual, older, TV sets give higher X-ray counts, this need not necessarily be dangerous. It may be said, with a very good approximation, that the limit of resolution of counting of the described apparatus in this article just about represents the absolute limit of what the human body could stand indefinitely without too serious a risk of real harm.

Counting Speed

This is why no attempt has been made to increase the speed of counting even further, by means of electronic pulse-scaler circuits, etc. Any radiation intensity requiring such an increased speed would be dangerous, requiring shielding and professional precautions. Thus the amateur would have no use for such apparatus, and would not be entitled by law to possess or experiment with radioactive materials of appropriate strength.

Nevertheless, some older types of pocket watches with generous luminous figures will be found to drive the counter of this article virtually up to its maximum speed, if held very close to the

(Continued on page 1114)

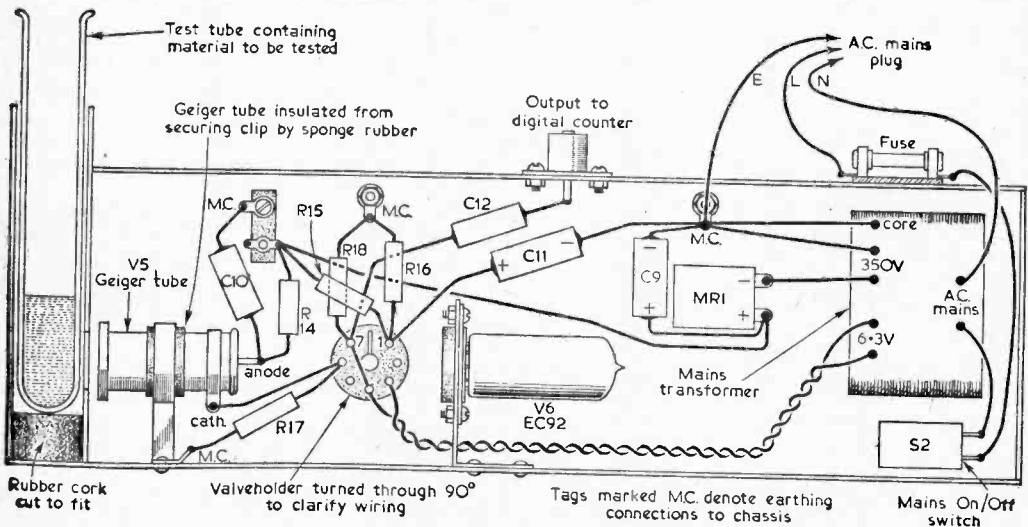

Fig. 4—The construction of a suitable Geiger head (the circuit was given on page 926 of the February issue).

Easy-to-build kit-sets of



highest quality at lowest cost



SINGLE SIDEBAND ADAPTOR, Model SB-10U. May be used with most AM transmitters. Less than 3 w. R.F. input power required for 10 w. output. Operation on 80, 40, 20, 15 and 10 m. bands on USB, LSB or DSB **£37.6 0**

AMATEUR TRANSMITTER, Model DX-40U. Self-contained. 80-10 m. Power input 75 w. C.W., 60 w peak, C.C. phone. Output 40 w. to aerial. Provision for V.F.O. **£32.10 0**

VAR. FREQ. OSCILLATOR, Model VF-1U. Calibrated 160-10 m. fundamentals 160-40 m. Ideal DX-40U and similar transmitters. **£11.2 0**

R.F. SIGNAL GENERATOR, Model RF-1U. Gives accurate source of R.F. up to 100 Mc/s on fundamentals and 200 Mc/s on harmonics. Up to 100 mV output on all bands **£11.18 0**

AUDIO SIGNAL GENERATOR, Model AG-9U. 10 c/s-100 kc/s, switch selected. Distortion less than 0.1%. 10 v. sine wave output metered in volts and dB's **£19.19 6**

VALVE VOLTMETER, Model V-7A. Measures volts to 1,500 (D.C. and RMS) and 4,000 pk to pk. Res. 0.1 Ω-1,000 MΩ. D.C. input impeded. 11 MΩ. With test probes, leads and standaring battery. **£13.0 0**

PORTABLE SERVICE OSCILLOSCOPE, Model OS-1. Compact portable scope ideal for servicing and general work. Y amplifier sensitivity 10 mV/cm; response. 3 dB 10 c/s-2.5 Mc/s. Time base 15 c/s-150 kc/s. Printed circuits. Case 7 1/4 x 4 1/2 x 12 1/2 in. long. Wt. only 10 1/2 lb. **£19.10 0**

5In. OSCILLOSCOPE, Model O-12U. Wide-band amplifiers essential for TV servicing, F.M. alignment etc. Vertical freq. response 3 c/s-5 Mc/s without extra switching. T/B covers 10 c/s-500 kc/s in 5 ranges **£36.10 0**

RES.-CAP. BRIDGE, Model C-3U. Measures capacity 10 pF-1,000 μF, resistance 100Ω-5MΩ and power factor. 5-450 v. test voltages. Safety switch. **£8.6 6**

SINGLE CHANNEL AMPLIFIER, Model MA-12. 10-12 watt Hi-Fi amplifier. Extremely low distortion and wide frequency range **£10.19 6**

HI-FI EQUIPMENT CABINETS. Range available to meet various needs. Details on request. (MALVERN equipment cabinet illustrated bottom left) from **£11.5 6** to **£17.18 6**

GRID DIP METER, Model GD-1U. Coverage from 1.8 Mc/s. to 250 Mc/s. Complete set of plug-in coils provided **£10.9 6**



MALVERN

TAPE RECORDING/PLAYBACK AMPLIFIER, Model TA-1. Monaural (TA-1M) **£18.2 6**

Conversion unit to Stereo **£6.10 0**
Stereo (TA-IS) **£23.6 0**

"PACKAGED DEALS" of Hi-Fi Equipment, including **TAPE DECKS, RECORD PLAYERS** and **DECCA ffs PICK-UPS.**

THE "MOHICAN" GENERAL COVERAGE RECEIVER, Model GC-1U.

Fully transistorised, including 4 piezo-electric transistors. The very latest and an excellent portable or Fixed Station receiver for the Ham and short-wave listener. **£38.15 0**



GC-1U

AMATEUR TRANSMITTER, Model DX-100U. Covers all amateur bands. 160-10 m. 150 w. D.C. input. Self contained including power supply. Modulator, V.F.O. (illustration bottom right). **£81.10 0**

SHORTWAVE TRANSISTOR PORTABLE, Model RSW-1. Two short bands, trowler and medium **£22.10 0**

6-TRANSISTOR PORTABLE, Model UXR-1. Preamplified I.F. transformers, printed circuit, 7 x 4in. high flux speaker. Real hide case **£14.18 6**

HI-FI F.M. TUNER, Model S-88. Tuning range 88-108 Mc/s. Tuning Unit (FMT-4U) with 10.7 Mc/s I.F. output (£3.5 0 inc. P.T.) I.F. Amplifier (FMA-4U) complete with cabinet and valves (£11.1 0). Total **£14.16 0**

4-W STEREO AMPLIFIER, Model S-33. 3 w/chl. Inputs for radio/tape and gram., Stereo or Mono, ganged controls. Sensitivity 200 mV. **£12.8 6**

HI-FI 16W STEREO AMPLIFIER, Model S-88. 20 mV basic sensitivity (4 mV model available, 7/6 extra). Ganged controls. Stereo/Mono gram., radio and tape recorder inputs. Push-button selection. Two-tone grey metal cabinet **£26.12 6**

TRANSCRIPTION RECORD PLAYER, Model GL-58. Goldring—Lenco four speed unit. G.60 pick-up arm and infinitely variable speed adjustment between 33 and 80 r.p.m. with fixed speed at 16 r.p.m. Balanced turntable (3 1/2 lb.). Stereo **£20.12 2**

HI-FI SPEAKER SYSTEM, Model SSU-1. Ducted-port bass reflex cabinet "in white". Twin speakers. Pedestal model **£11.18 6**. Bookcase model **£10.17 6**

"COTSWOLD" HI-FI SPEAKER SYSTEM. Acoustically designed enclosure "in the white". 26 x 23 x 15 1/2 in. 12in. bass speaker with 2in. speech coil, elliptical middle speaker. Pressure unit covers the full freq. range of 30-20,000 c/s., complete with cross-over unit, level control, etc. **£21.19 0**

COMPLETE MATCHED STEREO OUTFIT. Includes record player, S-33 amplifier and twin SSU-1 speaker systems. (Pedestal speaker legs optional **£2.2 0**) **£44.9 4**

STEREO CONTROL UNIT USC-1. Luxury model with press-button inputs to suit any pick-up or tuner and most tape-heads. Output 1.3 v. R.M.S. per channel. Printed circuit construction **£18.18 6**

STEREO HEAD PREAMPLIFIER USP-1. Ideal for boosting tape-head output and low output pick-ups (e.g. Decca ffs) **£6.17 6**



DX-100U

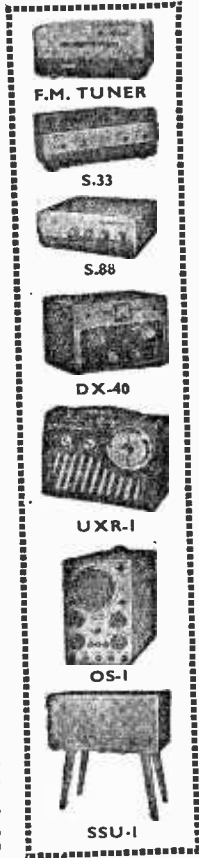

F.M. TUNER

S.33

S.88

DX-40

UXR-1

OS-1

SSU-1

Deferred Terms available on orders over **£10**

Prices include free delivery UK

Please send me FREE CATALOGUE (Yes/No) _____

Full details of model(s) _____

NAME _____

ADDRESS _____

PW4

DAYSTROM LTD.

Dept. P.W.4, GLOUCESTER, ENGLAND

A member of the Daystrom Group, manufacturers of the **WORLD'S LARGEST-SELLING ELECTRONIC KITS**

LOOK! EX-RENTAL SETS

17in. £11.10.0

Excellent table models. ITA/BBC. Famous manufacturer. Personal collection advised. Ins., carr., 25/4. (Regret some delay.) 12 months' guarantee on tubes. 3 months' guarantee on chassis and valves.



14in. £7.10.0

ITA/BBC. As 17in. Ideal for caravans, chalets, weekend bungalows, etc. Personal collection advised. Ins., carr., 20/4. Various makes and sizes available for inspection.

TV TUBES

12, 14, 15in.

70/-

Ins., Carr. 15/6



17in.

21in.

90/-

99/6

12 months' Guarantee

£1 extra without old bowl, refundable if same received within 14 days.

14in.

36/24 — 14KP4

Large Purchase of Rental Replacement Stock. Carr. 5/-

35/-

VALVES

★ SALVAGE GUARANTEED

3d. Each 6AL5, 6AM6, 6D1, 6D2, 6F12, 6F13, 6F14, 6F15, 8D3, D77, D152, DD6, EA50, EB91, ECC31, ECC34, EF50, EF91, UB41, UF42, Z77.

1/9 Each 6F1, 6L1, 6K7, 6P25, 6P28, 10D1, 16Z5, B36, EB41, EL32, KT33C, KTW61, N142, U22, U31, U35, UAF42, UBF80, W76, W77.

2/9 Each 6AB8, 6L18, 10F1, 10P13, 20D1, 20P3, EBC90, ECL80, EF80, EF92, EY51, KT36, N145, LN152, PL33, UCH42, U151.

5/9 Each 6F6, 12Q7, 15A6, 16A5, 17Z3, 19Y3, ECC83, EL33, EL41, EL42, EY85, KT63, PL820, PY80, PY81, PY82, PZ30, U154, 6V6.

Postage: 1-7d., 6-1/6., 12-2/6.

De-Luxe Recorder Cabinets

79/6

Beautifully styled rexine covered cabinet in Red or Beige. Size 14 1/2 x 13 x 9 1/2 in. Storage comp. in lid for tapes and mike. Easily adapted to Record Player Cabinet. Ins., Carr. 5/-.



Look 29/9

Beautifully made Tape Recorder Cabinet Size: 13 x 10 1/2 x 7 in. Covered in two-tone coloured rexine cloth. Stylish design. Easily adapted to Record Player Cabinet. P. & P. 5/-.

INSTALLING HI-FI?

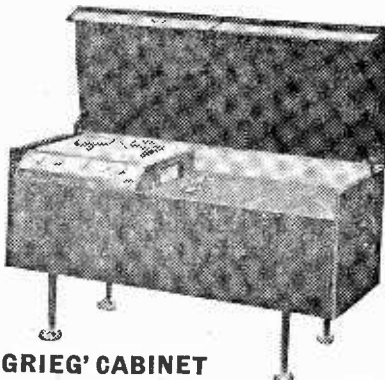

THE 'GRIEG' CABINET

HOUSES IT ALL HANDSOMELY: 24 gns.

The newest and largest of our wide range of hi-fi furniture. The Grieg can house your tape-deck, turntable, pre-amp, amplifier, tuner; takes a Ferrograph tape recorder, complete in its case.

Finishes: medium walnut or mahogany. Overall Size: 48in. long, 21in. deep, 18in. high, plus 9in. legs. Mounting boards: 20in. x 19in. and 26in. x 19in.

Write today for details of full range and nearest stockists.

RECORD HOUSING

(DEPT. PW462) BROOK ROAD, LONDON N.22

Please state location of convenient shopping centres.

THERMIONIC VALVE CIRCUITS

by Emrys Williams, Ph.D. B.Eng., M.I.E.E. M.Brit.I.R.E.

Students and teachers, as well as practising electronic engineers will welcome this, the fourth edition of this well-known work, which has already established a solid reputation as both text and reference book. Valve circuits in all their complexity are related to the simple bases of underlying theory. Numerous graphs and circuit diagrams add clarity to a highly readable text. An interesting new feature of this edition is the inclusion of numerous problems and exercises, many of them discussed at length. 27/6 net.

DUKE & CO. (London) Ltd. 621/3 ROMFORD RD. MANOR PARK, E12

Stamp for Free List

ILFord 6001/3

PITMAN

Experimenter's

POWER-PACK

(Continued from page 1058 of the March issue)

THE RECTIFIER SUB-CHASSIS WIRING AND MAKING THE METER SHUNTS

By M. L. Michaelis

IN last month's article, the method of using accumulators to stabilise the low voltage D.C. supplies was described. However, it would be possible to devise a transistorised version of the main H.T. stabiliser circuit, for stabilising the low voltage D.C. output, and this was in fact originally planned to be included by the author in the power supply here published. But, upon examining the problem more closely, the expense of the necessary power transistors, etc. would have been out of all proportion to the purposes envisaged, and the degree of stabilisation would not have been nearly as good as with buffered accumulators. Accordingly, the author purchased three accumulator cells, enabling stabilised voltages of 2V, 4V, and 6V to be obtained. These

are lead accumulators. A small NiCd accumulator cell enables a stabilised voltage for valves with 1.4V heaters to be obtained in the same way. External switching enables the accumulators also to be used independently of the power supply, or to be charged normally. Even if the accumulators are never used for anything except buffering, they should be given a charge, according to the maker's instructions, regularly once every 2 to 4 weeks, and topped up with distilled water as required. It is essential not to mount the accumulator cells anywhere near the power unit itself, or any other electrical equipment, to avoid any danger of acid corrosion. They are best mounted in a safe corner under the workbench, and wired with substantial insulated cable. It is also essential to mount the lead acid accumulators well clear of the NiCd accumulator cell, as the two types of accumulator are chemically mutual enemies. The size of accumulators purchased will depend on the power desired. It is suggested that the size matching the power unit output be obtained—namely, the 20Ah at the 10-hour rate capacity.

Fig. 8, last month, gave general details of low-voltage D.C. stabilisation by means of buffered accumulators. The feature is of course optional in this power supply unit, the smoothing and control range of VR2 being normally adequate for almost all purposes even without buffered accumulators.

Circuit Description—(2) H.T. Circuits

All rectifiers D1, D2 and D3 (see circuit diagram February issue) are of the modern flat chassis-mounting type, and are fitted with associated circuitry on an aluminium bracket chassis, shown in Fig. 9. The nomenclature used is as follows:

- First letter E: Half-wave.
- First letter B: Full-wave Bridge.
- Number after first letter: A.C. voltage applied (max. allowed).

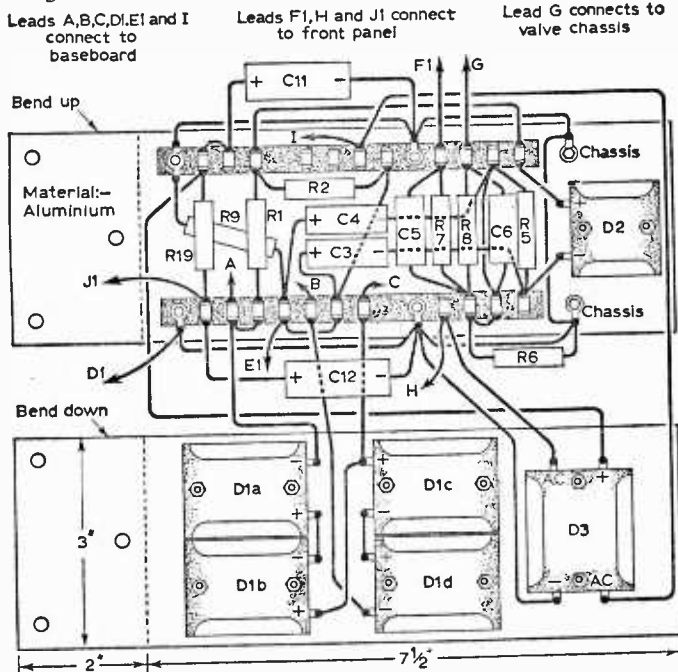

Fig. 9—The wiring of the rectifier sub-chassis. (Note: The letters used to mark leads should not be confused with references to parts: e.g. lead D1 is not related to diode D1 etc.).

Second letter: "C" for "Current."

Number after second letter: Rated D.C. current in mA.

This nomenclature is already becoming standard for rectifiers in general in many circles, and is equally applicable to valve rectifiers.

D1 is the main H.T. rectifier, using four E250C130 flat selenium elements, in two pairs replacing the two halves of a conventional valve fullwave rectifier, but saving the space and heat

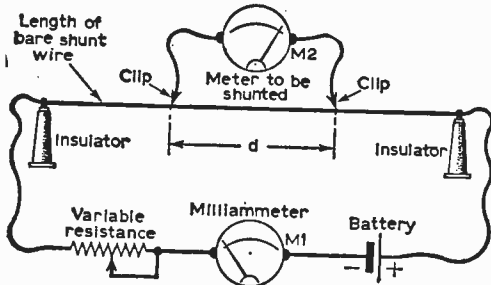

Fig. 10—The method of making the meter shunts.

generation of the valve. If E400C130 elements are obtainable, then the voltage rating is sufficient for using only two instead of four. C1, C2 and the 10H smoothing choke give a D.C. supply at V1 anode of about 400 to 500V. R3 and R4 serve to discharge the condensers after switching off. For best efficiency, C1, C2 and C9 are metallised paper types in the author's prototype, but these are often a little expensive. It is perfectly in order to use good electrolytics of suitable voltage rating for

these condensers if desired. All other smoothing condensers are electrolytics even in the author's unit.

Circuit Description—(3) Monitor Meter Circuits

Fig. 7 (last month) showed the full monitor circuit. The resistance values and shunts will need to be modified if the constructor uses meters other than those here specified (which is, of course, perfectly permissible). It is also possible to omit the meters altogether, though this is hardly advisable, as it would impair the versatility of the whole power supply greatly. Especially would the usefulness of the low voltage D.C. output suffer without the meters.

Many articles concerning meters, shunts, multipliers, etc., have already appeared in the pages of this magazine, and the knowledge gained by constructors from these articles can be put to good use in building the monitor circuit in this power supply.

Meters

The author purchased two small 2in. flush-mounting round moving coil meters, of the thermocouple-type for 750mA R.F. now being offered by various advertisers at about 6s. 6d. each. As they stand, these meters are (except for transmitters) relatively useless, and require some patience and skill for modification to normal moving-coil use. This probably accounts for the very reasonable price of these excellent precision movements. It is necessary to remove the thermo-shunt and thermocouple, and transfer the leads from the moving coil on to the output terminals instead of the thermocouple. The difficulty is that the whole meter scale and movement has to

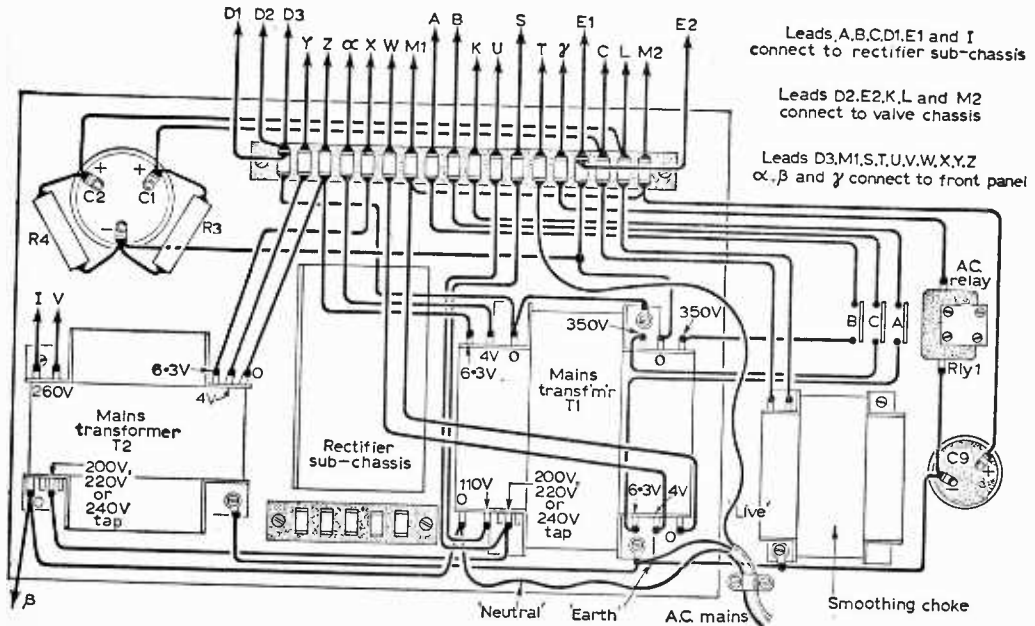
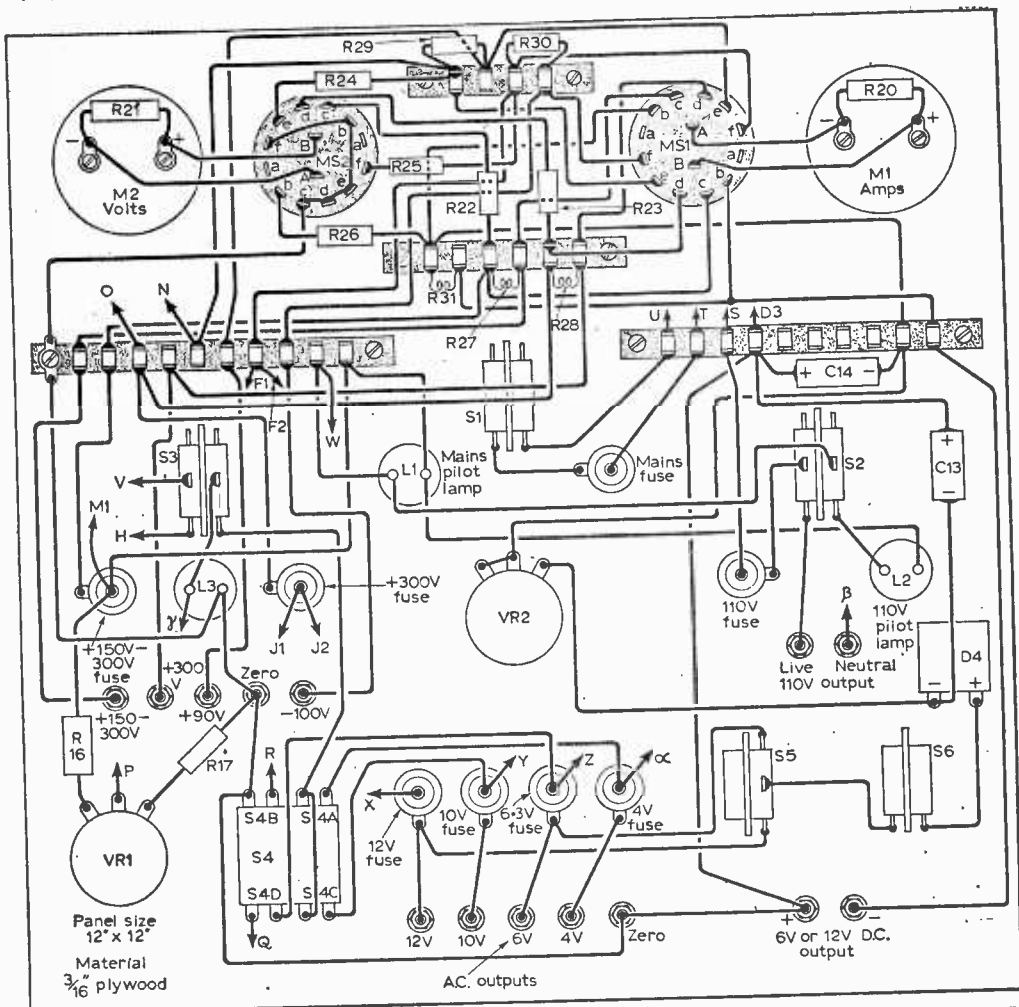

Fig. 11—The baseboard wiring.



Leads D3, M1, S, U, V, W, X, Y, Z, α, β and γ connect to baseboard

Leads F1, H and J1 connect to rectifier sub-chassis

Leads F2, J2, N, O, P, Q and R connect to valve chassis

Fig. 12—The wiring on the front panel.

be dismantled to reach these parts, but about an hour of patient, careful work should suffice for successful modification of the two meters in this respect. New connections should be soldered cleanly, using an iron no larger than necessary. It will be found that in the meters as purchased, some leads are soldered direct on to the thread of bolts after the nuts are screwed on, and one now has to undo these bolts to dismantle the meter. In this case, do not attempt to cut or unsolder the bolt, but simply cut the wire off close, and unscrew the nut with small pliers. It will cut its own thread in the soft solder, finally cleanly breaking the solder off, leaving the bolt clear for later easy replacement of the nut. Any more violent methods could damage the delicate exposed moving coil movement.

The moving coil itself will be found to have a full scale deflection of about 2mA, and a resistance of a fraction of an ohm. Connections to the thermocouple will be found to exist using spirals of resistance wire raising the total resistance to about 5Ω. These should be retained, and soldered to the main terminals, after removal of the shunt and thermocouple. The polarity should be determined using a single dry cell in series with a 1k resistor, so that the positive side of the meter coil can be soldered to the terminal marked +ve.

After reassembling the meter movements on to the bakelite chassis, the scales are recalibrated. Suitable pieces of paper are glued over the existing scales, and the one scale marked "AMPS," with linear scale 0 to 100 and 0 to 2 inserted. The scaleplate of the other meter is similarly marked

"VOLTS" and given a linear calibration 0 to 400 and 0 to 20. The scales can then be screwed on to each meter again, and the cases closed. Each meter is now fitted externally with a 5Ω w.w. resistor in parallel (R20 and R21). This serves as damping, and is essential to prevent the pointers swinging about too long before coming to rest. Each meter is thus finally an instrument of 2.5Ω with $4mA$ FSD.

Shunts

The shunts R27 to R31 should next be prepared. R29 and R30 need little comment, as they are simple carbon resistors not even requiring any great accuracy. They serve simply for continuity when the meter is switched away from these lines, the meter being used at full sensitivity there and thus in principle not requiring any further shunts. R27 and R28 are best made of (preferably) thick solderable resistance wire going under the names of "Constantan" or "Eureka", or other proprietary names, or else fairly thin, tinned copper wire may be used. R31 will need to be of fairly thick tinned copper wire, and will even then require to be only an inch or two long. The safest, simplest and quickest method of determining the correct lengths of the shunts is as follows (see Fig. 10). A good length of the wire to be used is stretched between two supports on the workbench, and fed with current from a suitable power source in series with a variable resistance and an already calibrated ammeter/milliammeter. The current is set to approximately the desired full-scale deflection of the new meter, in fact, a little less. Two small leads with small crocodile clips are affixed to the meter to be shunted, and clipped as close as possible to each other on to the resistance wire. They are then slid apart until the new meter reads almost full scale. The main current is then turned up to the exact desired full scale value, and the clips slightly moved until the new meter also reads exactly full scale. The length of wire between the clips is then the required shunt length, and, allowing for a little extra for soldering, may be cut off. It is not possible to damage the meter by this method *provided* one always starts with the clips very close together, and never moves them apart until it is seen that full-scale deflection has not yet been reached. (See Fig. 10).

The rest of the monitor circuitry is straightforward. The switches MS1 and MS2 are wafer types specially obtainable for meter circuits, which always break the previous contact position before making the next. When purchasing these switches, this point should be carefully checked, as serious internal short circuits and flashovers can result if the wiper at any time makes contact with more than one stud when switching over. Immediate burn-out of the meter could result through the use of an unsuitable switch. As regards their function, 2-pole 5-way types are required, or 2-pole

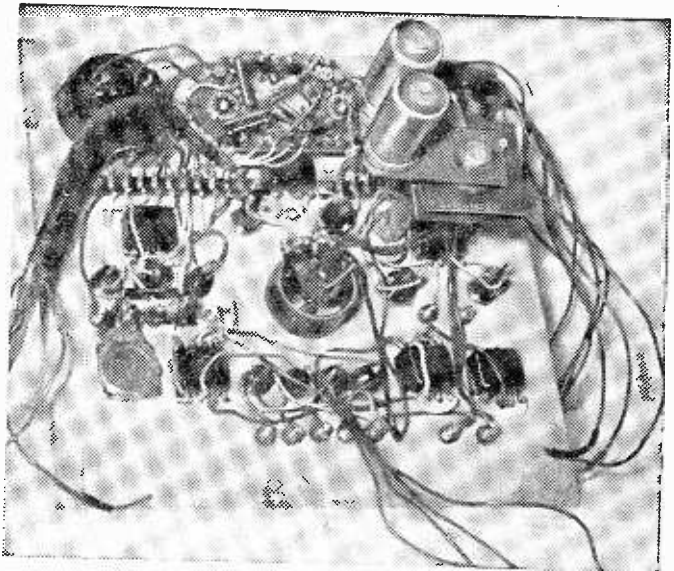

A view of the wiring on the front panel.

6-way if an "off" position is desired, as in the author's unit.

(To be continued)

DIGITAL COUNTER

(Continued from page 1108)

Geiger head. Of course, such clocks and watches are not very advisable, and certainly are, if anything, harmful rather than good.

Rapid Counting

IMPORTANT. It may actually happen, that an apparatus as described in this article suddenly starts counting at a high rate, this is the *quite normal* symptom of a Geiger tube which has reached the end of its useful life, or which has been damaged mechanically in certain ways. It can happen if the tube is operated at too high a voltage, if it is run for long periods with too high a value of C10. In either case, it is a sign that the tube has been destroyed, and is useless. If the specified component values and voltages are strictly adhered to, and the tube handled very carefully mechanically, then a very long life should be expected. Any soldering of tube connections should be made with a heat-shunt, as in handling transistors.

A fault in the digital counter circuit could also cause sudden high counting, if the circuit thereby goes into slow oscillation. To minimise this, V2 has been made a special form of multivibrator which is normally unlikely to run free. But certain defects in the neon, V3, could possibly cause spurious high counting. ■

Constructional Faults

CORRECTING ERRORS
IN HOME-MADE
EQUIPMENT

By P. B. le Ferrier

THERE are three stages to the building of a new piece of electronic equipment, such as a radio set, amplifier, test instrument and so on. One is the basic circuit design, the second is the actual construction and the third is making the finished equipment work correctly.

Layout

Producing the basic circuit design is a rather specialised exercise and one which the constructor usually leaves to those well versed in the arts. Invariably, therefore, he follows a previously worked-out circuit. The construction is well within his scope and he either follows a component layout and wiring plan or works out his own layout and wiring direct from the circuit diagram.

The third stage—making the equipment work correctly—often results in a few late nights and, sometimes, in a complete rebuild. Why is this? The main reason is that the initial circuit design is very closely tied up with the layout of the components and to the pattern of the wiring connecting the various components to form a practical circuit.

"Strays"

When one studies a circuit diagram it is usual to consider only those components which are shown; but, unfortunately, there are many more hidden "components" which appear only when the circuit is transferred from paper to wire. Capacitors, for example, appear in practice in the most unexpected places owing to the capacitance between components and wiring. Likewise, inductors are introduced in the practical circuit owing to the inductance of the connecting wires. The positions and values of such spurious components are governed solely by the wiring, and while one pattern of values may be introduced by one person, another person wiring the same circuit may well introduce an entirely different pattern of values.

How the equipment will be affected will depend to a large extent on whether stray capacitances and inductances were taken into account when the circuit was evolved. If the circuit is essentially the product of a thought in the mind of the designer, then they have possibly not been considered in constructional detail. It would be left to the constructor to work these things out for himself and arrange the practical circuit accordingly.

Observe Component Layout and Wiring

On the other hand, if the circuit is part of a complete design, then it would have been produced in direct relation to the layout, wiring and dimensions, which would also be a part of the design. When such a design is reproduced, therefore, it is absolutely necessary for the constructor

to follow faithfully not only the circuit but also the component layout and wiring. Failure to observe this most important factor may well lead to poor results, parasitic oscillations and instability and may make it necessary ultimately to rebuild in the way that the designer intended.

One is sometimes tempted to use only the circuit of a complete design and arrange the layout to one's own requirements. This is fair enough, and the results obtained are often quite good, but one can never blame the designer if the performance does not come up to specification.

Some circuits and designs are inherently stable and quite a few liberties can be taken without disturbing the normal working condition. Other designs are just the opposite and, unless very careful attention is given to the layout, one may have to spend hours working on the set, and even then instability may show up at the least provocation. This applies particularly to VHF equipment where the inductance of a lead may be a sufficiently high value to cause feedback. Similarly, in such designs it is possible for the parts

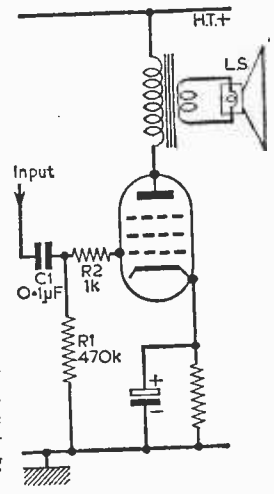

Fig. 1—The low value resistor R2 connected close to the control grid is for suppressing parasitic oscillations. R1 is the normal grid resistor and C1 is the coupling capacitor.

of the circuit that are supposed to be earthed to attain quite high R.F. potentials which may be inadvertently coupled to some critical part of the circuit through stray wiring capacitances.

The inductance of VHF coils is also computed in relation to wiring inductance and stray capacitances, including valve capacitances, to tune over the required frequency. It only needs a long connecting lead from one of the coils or too much stray capacitance around the coil and connecting lead to throw the whole circuit out of balance and, in some cases, to make it impossible to tune over the required frequency band.

Although low frequency equipment is less difficult in this respect, undue liberties cannot be taken.

Parasitic Oscillations

An insignificant carbon resistor, possibly labelled 1k and connected close to the tag of the control grid of the output valve indicates almost conclusively that the designer had trouble with parasitic oscillations. Looking in the list of components, one would probably find that the resistor's function is given as "grid stopper" or "anti-parasitic resistor". Both titles have the same meaning.

The value of the resistor is so small that it could barely have any effect on the normal A.F. operation of the circuit, as is shown in Fig. 1. Here the normal grid resistor, R1 is valued at 470k, while R2, which is the anti-parasitic component, is valued at 1k. This is how it should be and, indeed, the value is chosen so that the normal circuit operation is not affected. But before we can understand how an anti-parasitic component works we must first find out what a parasitic oscillation is, and how it is caused.

Briefly, a parasitic oscillation is an unwanted oscillation created by circuit conditions. Moreover, since it is an oscillation, the circuit conditions must be right (or wrong) for oscillation to occur. The difference between ordinary instability and parasitic oscillation is that while instability usually sets up an oscillation at a frequency directly related to the type of equipment and components used, a parasitic oscillation may be far removed in frequency from that handled normally by the equipment.

Let us take the case of an audio amplifier. This may have a passband from, say, 40c/s to 15,000c/s and instability would cause an oscillation somewhere within that passband, resulting in motor-boating, whistling, screeching or some other audible disturbance from the speaker. Parasitic oscillation, on the other hand, does not do that. This is one of the dangers, as such oscillation may not be suspected. With audio equipment it often falls in the R.F. or even VHF range.

Likewise, with I.F. or R.F. amplifiers, parasitic oscillation is likely to be totally removed from the normal operating frequency, while instability would cause oscillations at a frequency governed by the normal circuit components, and this would be quite close to the normal working frequency.

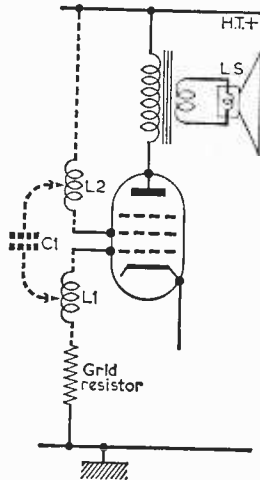

Fig. 2—Parasitic oscillation sometimes occurs caused by unwanted coupling between the control grid and screen grid. Here L1 and L2 are formed of wiring inductance, and the coupling is enhanced by the stray capacitance C1.

How Is Parasitic Oscillation Caused?

In order for oscillation to occur, there must be a feedback path from the output to the input of an amplifier or section of an amplifier. Moreover, there must be zero phase change between the voltage fed back and the input of the amplifier. If the voltage fed back undergoes a phase shift of 180° then the feedback is said to be negative which, instead of encouraging oscillation, tends to suppress it. When there is 0° phase shift (or 360° phase shift which is really back to zero again), the feedback is said to be positive.

Feedback, of course, can be promoted by stray capacitances and inductances due to poor construction and layout, as already described. The greater the gain of the amplifier, the greater is the possibility of feedback resulting in oscillation, for, provided the signal fed back is no smaller in amplitude than the signal applied, and the phase is correct, oscillation will most definitely commence.

Frame grid valves now make very high gains possible, and a gain of 10,000 is not uncommon. Such an amplifier would turn into an oscillator, provided the feedback conditions allow it, when only $1/10,000$ th of the output voltage is fed back to the input. It does not require much in the way of strays for this to happen.

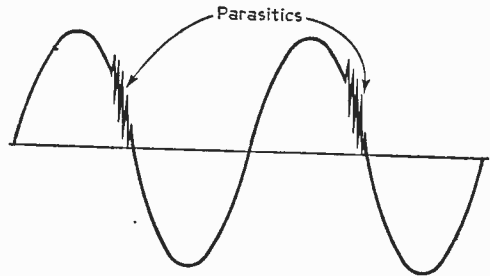

Fig. 3—When viewed on an oscilloscope, parasitic oscillations show up as bursts of R.F. on the waveform.

Tuning

The frequency at which the oscillation occurs depends on various impedance factors in the circuit. If, for example, oscillation is occurring in an R.F. amplifier simply because of poor design or inadequate decoupling, then the tuned circuits would act as the major impedances and oscillation would take place at a frequency very close to that of the tuned circuits. This type of fault would be put down to pure instability.

Parasitics, on the other hand, rely on spurious impedances which are unwittingly put in the circuit in terms of stray capacitances and inductances. The amplifier may be highly stable within its passband, but impedances well up in the R.F. ranges may be created by the inductances of connecting wires and ineffective screens.

H.F. Resonance

As an example, Fig. 2 shows two inductors, L1 and L2, formed by the wiring in the control grid and screen grid circuits of an A.F. output stage. These may resonate at, say, 50Mc/s, and due to

(Continued on page 1146)

UNIQUE COMMUNICATIONS RECEIVERS

Never before offered in this condition, **BRAND NEW AND UNUSED** in original Army transit cases.

MARCONI C.R.100/8. Covers 60 Kc/s to 30 Mc/s. Complete with all valves, instruction manual and internal A.C. power unit for 200/250 v.

ONLY £35 (carr. etc. 40/-).

NATIONAL H.R.O. SENIOR. Covers 480 Kc/s to 30 Mc/s, using 6 general coverage plug-in coil sets. Complete with all valves and instruction manual. Uses external power unit (available 5/6 extra. P.P. 4/-).

ONLY £25 (carr. 30/-).

All receivers tested and guaranteed perfect working order before despatch. Further details on either sent on request.

TEST METERS FOR EVERY PURPOSE & POCKET

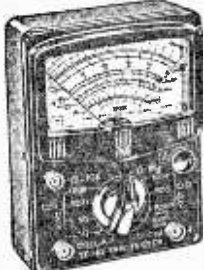

2,000 O.P.V. MODEL TP-10. Reads A.C. & D.C. Volts up to 1,000; D.C. Current to 500mA; Resistance to 1 Meg; Capacitance to 1µF; Decibels from -20 to +36; Output Jack for Audio Measurements. Size 3 1/4 in. x 5 in. x 1 1/2 in.

£3-19-6



20,000 O.P.V. MODEL TP-55. Reads voltage up to 1,000; D.C. at 20,000 ohms per volt and A.C. at 10,000 o.p.v.; D.C. Current to 500mA; Resistance to 10 Megs.; Capacitance to 0.1µF; Decibels from -20 to +36. Size 3 1/4 in. x 5 1/2 in. x 1 1/2 in.

£5-19-6



20,000 O.P.V. MODEL 500. Volts to 1,000; D.C. at 30,000 O.P.V.; A.C. at 20,000; 12 Amps D.C. Current; 60 Megs Resistance; -20 to +56 Dbs; Internal buzzer short circuit warning. Size 3 1/4 in. x 6 1/4 in. x 2 1/4 in.

£8-19-6

All New Stock, with leads, prods, and internal batteries. Fully guaranteed. Details S.A.E.

AMERICAN ARSED RECEIVERS. Fresh release of these renowned sets. 14 valves, 6 wavebands, covering 500 Kc/s-32 Mc/s. Incorporate every possible refinement & have internal A.C. mains pack for nominal 115/230 v. Thoroughly reconditioned, immaculate in appearance, and in perfectly working order. **ONLY £35** (add carriage 3/-) and 50/- deposit on returnable transit case). S.A.E. brings illustrated leaflet.

B.C. 221 FREQUENCY METERS. The famous American crystal controlled, portable frequency measuring standard. Coverage 125 kc/s-20 Mc/s. With original calibration book. Perfect order. Illustrated details on request. **ONLY £18.**

10/- CONSTRUCTION PARCEL. 10 yards each of 6 colours wiring wire, solder, 24 each assorted Resistors and Condensers. **RESISTORS,** 100 assorted values. **NEW 10/-.**

CONDENSERS, 100 assorted mica and silvermica. **NEW 12/6.** **SPRAGUE CONDENSERS.** Metal cased, wire ends. New 0.01 mfd. 1,000 volt, and 0.1 mfd. 500 volt. 7/6 per dozen. Special quotes for quantities.

MINIATURE MOTORS. Ideal for models. Operates on 3-6v. D.C. Size 1 1/2 x 1 1/2 in. plus 1/4 in. spindle. Brand New 5/-.

PCR COMMUNICATION RECEIVERS

Manufactured by Pye & Philips. One of the Army's most versatile and sensitive sets. RF stage and 2 of I.F., using 6 British I.O. type valves. Large 180 degree illuminating and Calibrated Dial. Flywheel Tuning with locking device. Aerial Trimmer. Tone and Vol. Controls. Band Switch from panel jacks for speaker or phones. In black metal case, size 1 1/2 in. L x 8 in. H x 10 in. D. Model PCR covers 6-16 Mc/s. 200-550 metres and 850-2,000 metres and has internal 5in. speaker. REME reconditioned as new. **£8-19-6.** Model PCR2 has similar L & M waveband coverage. Short wave 6-22 Mc/s. but no speaker. Used but excellent condition **£5-19-6.** Every receiver aerial tested before des. Add 10/6 carr. all models. Designed to operate from bulky EXTERNAL power supply, but any set can be fitted with **BRAND NEW COMPONENTS INTERNAL PACK** for 200/250 v. A.C. at extra cost of **£2.** S.A.E FOR ILLUSTRATED LEAFLET

"P.W." 6 TRANSISTOR PERSONAL RECEIVER

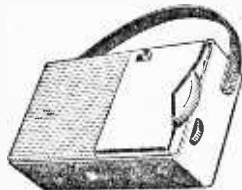

Designed by the technical staff of Practical Wireless: easy to build, using printed circuit and 1st Grade Matched Transistors and Diode. Full Medium and Long Wave coverage to internal speakers. All parts sold separately (new components only) enabling you to buy as required and full detailed price list will be sent on request. Constructional details 1/6.

Newly designed OSMOR Cabinet and reduced price. **TOTAL COST INCLUDING BATTERY AND CABINET NOW £8.10.0.**

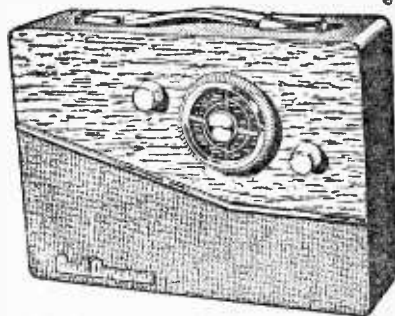

THE "GOOD COMPANION"

THE FINEST COMBINED PORTABLE AND CAR RADIO YET DESIGNED FOR THE HOME CONSTRUCTOR

★ 750 mW output. ★ 6 transistors and 2 diodes. ★ Full Medium and Long Wave coverage. ★ Quality speaker. ★ Pre-aligned I.F.T's. ★ Brilliantly styled 2 tone cabinet, size 11 x 8 x 3 ins. ★ Very fine tuning with calibrated dial. ★ Latest printed circuit. ★ Internal high gain aerial, with car aerial socket. ★ Easy to follow construction data (available separately 3/6).

All parts sold separately and full illustrated details will be sent on request. **Total Cost £9.19.6**

With alternative luxury cabinet using 7 x 4in. speaker **£10.19.6.** Either type, plus 5/- post and ins. (Battery 3/6 extra.)

"POCKET 4" TRANSISTOR RECEIVER

Uses miniature speaker, proper tuning condenser, and volume control. Built-in aerial makes unit efficient and portable. Ideal for the beginner. Full medium wave coverage. All components and case for only 42/6 (p. & p. 2/6). Ten-page constructional book free with parts or separately 1/6. S.A.E. for parts price list.

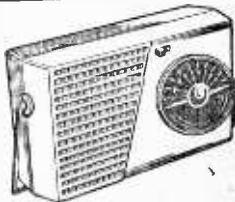

HARRIS ELECTRONICS 138 Gray's Inn Road, London, W.C.1
(LONDON) LTD (Phone TERminus 7937)

Please include carriage costs on All Items (Open until 1 p.m. Saturdays). We are 2 mins. from High Holborn. (Chancery Lane Station) and 5 mins. by bus from King's Cross.



Whether you're building your own amplifier or servicing a complete installation—for fault finding on anything from pre-amplifier to speaker—you'll find the MULTIMINOR to be "just right". You'll enjoy using this neat pocket instrument giving readings over nineteen ranges on a clear open scale. A.C. and D.C. voltage, D.C. and Resistance measurements are made by means of only two sockets. The robust, easy-to-read range selector has a smooth, clean, positive action. "Can you afford it?" Let's say rather—"Can you really afford to be without it?"

Designed and Manufactured by

AVO LTD AVOCET HOUSE - 92-96 VAUXHALL BRIDGE ROAD - LONDON - S.W.1

MM.10

Telephone: VICTORIA 3404 (12 lines)

M
GROUP

The least expensive way to high fidelity is an *Armstrong* chassis

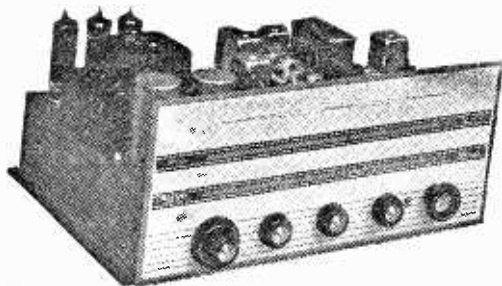

An Armstrong chassis is more than just a radio-gram chassis. It is a carefully designed combination of tuner, control unit and amplifier in one compact unit which can be used as the basis of a complete high fidelity system. A system which can include tape recording and playback as well as radio and record reproduction.

ARMSTRONG WIRELESS & TELEVISION CO. LTD., WARLTERS RD. LONDON N.7. NORTH 3213

Indispensable

THE

MULTIMINOR

19 Ranges

D.C. Voltage: 0-1,000V in 7 range.

A.C. Voltage: 0-1,000V in 5 ranges

D.C. Current: 0-1A in 5 ranges

Resistance: 0-20,000 Ω , 0-2M Ω

Pocket Size: 5 $\frac{1}{2}$ x 3 $\frac{1}{2}$ x 1 $\frac{1}{2}$ inches.

Weight: 1 lb. approx.

List Price **£9 : 10s.**

Complete with Test Leads and Clips
Leather Case if required 39/-.

Sensitivity
10,000 ohms per volt
on D.C. voltage ranges.
1,000 ohms per volt
on A.C. voltage ranges.

Accuracy
On D.C. 3% of full
scale value.
On A.C. 4% of full
scale value.

To meet special
requirements, instru-
ments can be supplied
to a higher degree of
accuracy for a small
additional charge.

STEREO 12 MK.2 **£44.15.0**

8 watts push-pull output from each channel, 16 watts total. VHF, with automatic frequency control, medium and long bands. A hi-fi system on one compact chassis.

STEREO 55 (Illustrated) **£33.15.0**

A junior version of the Stereo 12 Mk.2. 5 watts per channel, 10 watts total. VHF and medium bands. Inputs for tape pick-ups and possible future stereo radio.

JUBILEE MK.2 **£31.15.0**

A mono chassis of 8 watts push-pull output and covering VHF, medium and long bands. Separate tone controls. A.F.C. Pick-up and tape inputs.

AF208 **£23.15.0**

An AM/FM mono chassis of 5 watts output covering VHF and medium bands. An inexpensive version of the Jubilee Mk.2.

Post this coupon or write for catalogue or call at our showroom for full demonstration and professional advice on your installation. Open 9-5 including Saturdays.

NAME _____ PAC

ADDRESS _____

A direct-reading FREQUENCY- METER

WITH THIS INSTRUMENT, THE FREQUENCY OF AN INPUT WAVEFORM WILL BE SHOWN ON A LINEAR SCALE ON A MOVING COIL METER.

By E. Dexter

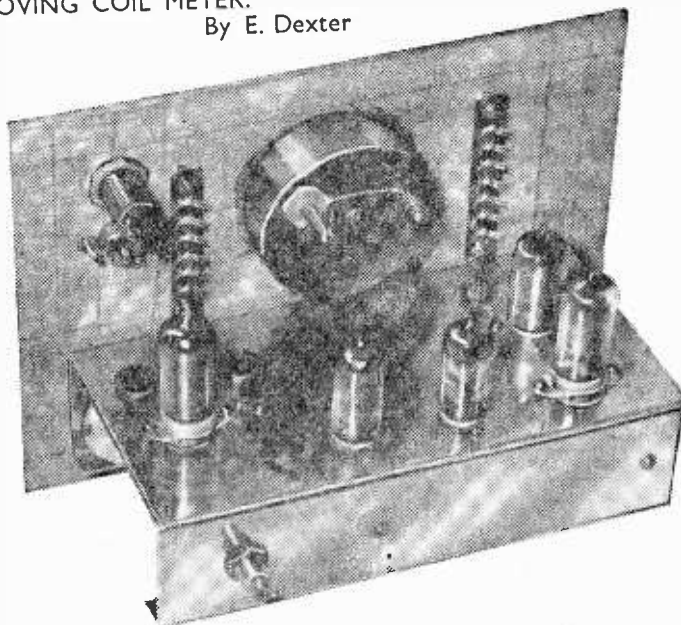

(Continued from page 1027 of the March issue)

IF the instrument is to be used primarily at the lowest frequencies, as will be the case if one of the principal uses is to be as pulse-rate indicator for a Geiger counter to give direct indication of radiation intensity, then even the lowest range given here will probably be too high. It is then desirable to have a lowest range where 10c/s gives full-scale deflection, and this will be achieved by making C12 about 0.5 μ F. The other ranges could then be made 100c/s, 1kc/s, and 10kc/s, by appropriate choices of C13 to C15. It is up to the constructor to choose his own ranges for whatever purpose he has in mind, and he may even use a switch with more positions for S1a and S1b if more than four ranges are desired. If all circuitry associated with V5 is wired carefully and neatly, and components of

the minimum size possible are used (all to reduce stray capacitances), then performance on the higher ranges will be enhanced.

Circuit Principles

V1 is an EF86 connected as an ordinary audio pre-amplifier with a gain of exactly 100 in the circuit arrangement used. This circuit may be built by itself, up to and including C6, by anybody desiring merely such a pre-amplifier, e.g., for feeding an ordinary amplifier from a microphone of low output. V2 is an output cathode follower, from which the amplified signal from the pre-amplifier is externally available at SK2. An input drive of about a quarter of a volt r.m.s. on sine wave is required, with VR1 at full gain, to give the maximum undistorted output of 25V r.m.s. at SK2, and this drive is more than sufficient to operate the subsequent frequency measuring circuits. However, with input signals of unknown or varying amplitudes, it is of advantage to over-drive V1 if the signal at SK2 is not required. In particular, if the main input waveform is poor in the sense that it is hum-modulated, as can be the case if it originates from a signal generator of poor quality or from an experimental circuit, the frequency-indication may be erratic if V1 is not driven hard enough, i.e., with at least a volt or two peak positive at full gain. This may cause grid-current in V1, and thus the large value of R2 is included to prevent any blocking effects on C1 as a result.

Input Voltage

It is permissible to use a drive of even 100V at the input, even if VR1 is at full gain. This can do no damage and will give a perfectly good frequency reading on the meter. The input is tested to withstand the full mains voltage in any position of VR1, but if the mains is fed in

direct, VR1 should at any rate be turned down appropriately in normal operation. There will normally be little purpose in connecting the mains itself to the input, but virtually the same thing could arise if the constructor were building some of the modern emergency power-supply circuits appearing. These use transistor-converters generating 230/250V 50c/s A.C. from 6V car batteries or 12V car batteries, to operate mains equipment in the field or in case of a power-cut. The output may be connected direct into the frequency-meter here described, to adjust the converter frequency to the correct value—but, as said above, VR1 should then be turned down reasonably. In general, if the constructor is experimenting with transistorised power-converters of any kind, the present instrument is ideally suited for monitoring the operating frequency.

Triggering

Valve V3 is another EF86, connected in a high-impedance circuit arrangement normally resting at its saturation current, with very low voltages on screen and anode. A negative-going signal (corresponding to the positive-going part of an input waveform) cuts V3 off as long as it exceeds some 15V to 20V in amplitude. This causes a sharp positive rise at V3 anode, followed by a subsequent fall back to the condition of saturation current as soon as the negative portion of the waveform at V3 grid has ended. The result is thus a reasonably good square wave at V3 anode. Now we are subsequently interested in the positive-going transient of this square wave, as it is used to "trigger-off" V5 to pass an exactly defined pulse of current into C19, one such pulse for every trigger. If this positive transient

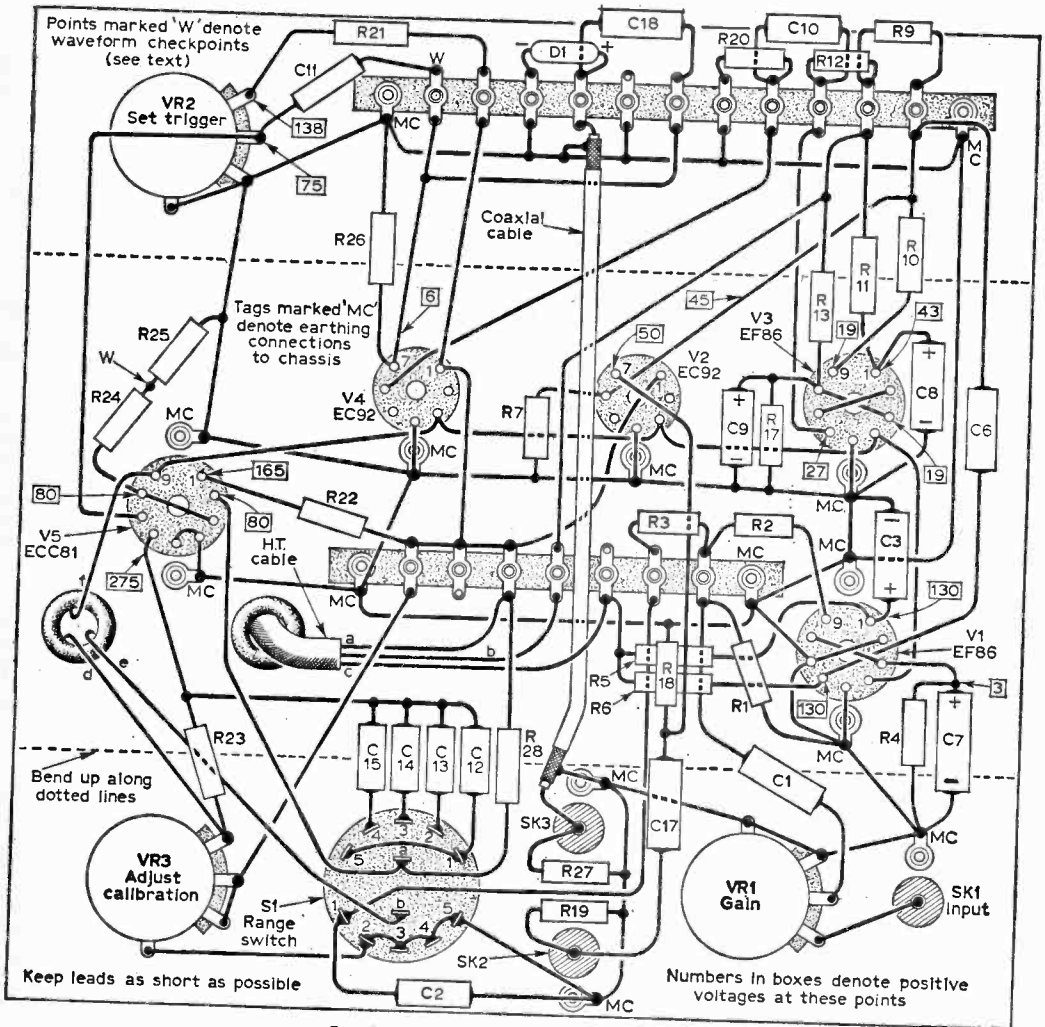

Fig. 4—The underchassis wiring diagram.

of the waveform at V3 anode is not sharp enough, due to stray capacities, triggering of V5 may be erratic or absent. It is thus essential to use neat short wiring for V3 anode, R12, C10, R20 and V4 grid. All leads should be of the absolute minimum length consistent with Fig. 4, and all other components should be bent to lie somewhat removed from the leads concerned and the critical components named.

Valve V4 serves as output cathode follower for the square wave at V3 anode, so that there is no back-reaction from V5 to V3, and also to enable an externally-available version of the "trigger" to be taken to SK3 at the same time as triggering V5, without mutual interference. C18 and R27 differentiate the square wave for the purpose of providing the output trigger at SK3, while C11 and VR2 differentiate the square wave for the purpose of triggering V5.

Differentiation of a Square Wave

Neglecting the mathematical aspects of the matter, the process of differentiating a square wave amounts to keeping the transients in it, i.e., the sudden positive-going and negative-going transitions, but rejecting all else. Thus Fig. 5a shows an ideal square wave, and Fig. 5b the

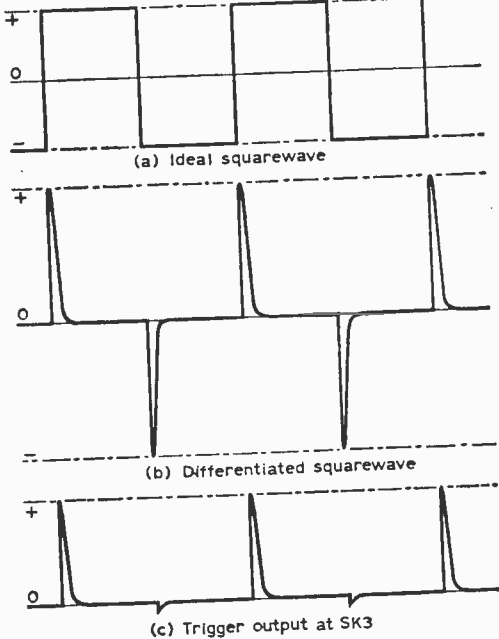
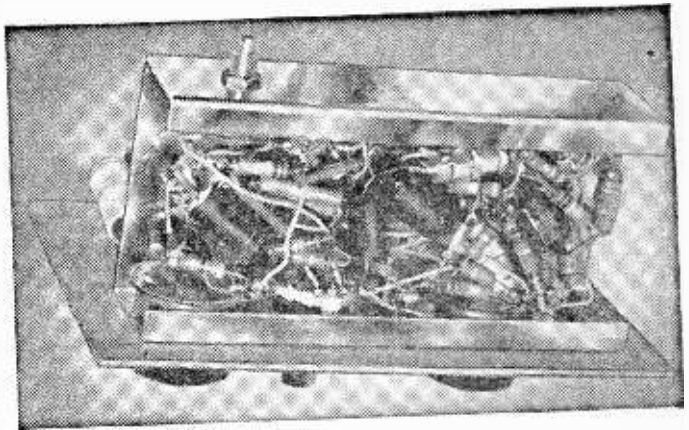

Fig. 5a—An ideal square wave; b—the ideal square wave of "a" differentiated; c—the trigger output at SK3—the negative spikes have been shorted out by the silicon diode D1.



An underchassis view of the instrument.

result of differentiating it. As far as circuitry is concerned, it is extremely simple to differentiate a square wave, this being performed simply by a very small coupling condenser and resistor combination to the next stage. The reason is also simple, for any transient, corresponding necessarily to high-frequency components, will be passed on, whereas all slower portions of the waveform will allow the small coupling condenser to follow immediately with its charged voltage.

In the trigger output taken to SK3, we desire only the positive trigger spikes, so the negative ones are shorted out by the silicon diode D1. This is a small rectifier of the type now advertised for about 250V, 250 or 500mA, the exact type being in no way critical. This class of diode is used here on account of the high voltage tolerated and the very low forward resistance. The resulting waveform at SK3 is shown in Fig. 5c. This may be used for starting the timebases in a triggered oscilloscope.

It is thus apparent now that the instrument described in this article has the further important use in that it will deliver both square wave and trigger-pulse outputs at the frequency of virtually any reasonable input waveform. Thus if V1 is driven sufficiently hard, i.e., at least a volt or two input at SK1 with VR1 at full gain, there will be a reasonably good square wave output at SK2 (which can be further improved by inserting a grid stopper of about 1M at pin 6 of V2), and there will be an output of positive trigger-pulses at SK3. It is very useful, for numerous experiments, to have such a handy squarer and trigger-generator available.

Mains Frequency Output

For many experiments it is of value to have available a ready source of square waves and short pulses at precisely the mains frequency. It should be pointed out that the instrument described in this article is fully capable of providing these signals, which are available at SK2 and SK3 respectively when Sla/S1b is set to the calibration adjust position.

(To be continued)

SERVICING TAPE RECORDERS

FAULTS, SYMPTOMS AND THEIR
REMEDIES FOR DOMESTIC
EQUIPMENT

By T. S. Smith

*I*N Fig. 4 (page 1038 last month) a simplified version of the record/playback change-over system was given.

In the "record" position, the tape first passes the erase head, which is energised from the bias oscillator via S1. After the tape is "cleaned" of old recordings, it passes the recording head, which is receiving an amplified signal from the microphone via switches S2 and S3. The recording head also receives a bias signal in addition to the recording signal, via switch S4.

In the "replay" position, the input of the amplifier is connected to the replay head via switches S2 and S4. The microphone is disconnected, as also is the erase head, the latter by S1. The output of the amplifier is switched from the recording head to the loudspeaker by S3.

With the above information alone, it is possible to diagnose a number of faults that may occur on a simple machine. For example, serious distortion would now probably lead to an investigation of the bias oscillator and associated switching arrangements.

Record Distortion and No Erase

Let us suppose that a "clean" tape is used for a normal recording, say from a microphone. If severe distortion is present on replay, two things should be done. Firstly, a tape recording known to be free of distortion, or a previously recorded tape should be run through the machine. If the reproduction is now completely clear of distortion this is sufficient proof that the replay sections of the amplifier system are free from faults.

Secondly, the "distorted" tape should be put back on the machine and an attempt should be made to erase it by switching to "record" and running the tape back through the machine with the gain controls turned right down. If the recording is still present on replay, there is little doubt that both troubles are caused by a fault in the bias oscillator. The most usual cause of the trouble is valve failure.

Erase Normal

If it is discovered that the erase function is working correctly, the recording distortion could still be caused by lack of bias, but in this case the trouble would exist somewhere after the bias

(Continued from page 1057 of the March issue)

oscillator section—between that section and the recording head. A check should be made on the components and wires feeding the bias signal to the recording head. Switches are involved here, and are often sources of trouble.

Similar trouble would occur due to over-recording. This often happens when the programme material is being taken from a radio receiver or record player, especially if the coupling circuit (between the radio or record player and the input to the tape recorder) is frequency sensitive.

Some recording-level indicators are designed so that they show the level of the input signal over a fairly narrow band of frequencies, so if one is over-recording at, say, a low-frequency, the effect may not be indicated on the recording-level "eye" or meter. Nevertheless, over-recording would result.

If this trouble is suspected, a second recording should be made at a much lower level. If the recording is now of a reasonable quality, attention should be given to the input signal coupling arrangements.

No Replay

If, after making a recording, there is no replay, the fault could lie either in the recording section or in the replay section (or both). The best thing to do is to try replaying a tape recording or previously recorded tape. If that replays normally, then, of course, the trouble lies in the recording section of the equipment.

If there is still no output from a previously recorded tape, the tape which was used for the original recording should be tried on a friend's machine. If that replays, then the trouble lies in the recording section of the machine. The trouble would be common to both recording and replay, of course, if the tape was proved to have no recording on it.

Some of these techniques are obvious, but if they are adopted they can most definitely save a lot of time in searching aimlessly in fault-free sections of the system.

Typical Record System

We must now graduate to a real circuit before we can obtain very much more servicing data. Such a circuit is given in Fig. 5, and this applies in essence to the Truvox Type "K" Tape Recorder Amplifier.

As drawn, the circuit is switched to the "record" position. V1 (EF86) is the first voltage amplifier, and it is to that valve that the microphone signal is coupled, via Jack 1. This is coupled to the first triode, V2A, through an equalising arrangement. Coupling to the second triode, V2B, is effected through the volume or "recording gain" control, R18.

Signal to Record Head

It will be seen that switch "D" couples the A.F. from the anode of V2B, via C17, to switch "A" through an R/C network comprising C18, C19, C21, R24, R26 and R27. Switch "A" then couples the signal to the record/replay head. The R/C network provides a constant-current recording signal to the record head

a different tap on the oscillator coil, where the signal is slightly stronger, through C28 and switch "J."

The power supply system is reasonably straightforward. Full isolation from the mains is provided by the double-wound mains transformer and full-wave H.T. rectification is adopted. H.T. smoothing is provided by the electrolytics C27 and C30 and H.T. for the earlier stages by R38. Mains feeds are provided for the motor, and the brake solenoid is fed from the H.T. line, via R39 and the appropriate contacts on the tape deck.

Replay

On "replay", the output from the record/replay head is coupled to the input of V1 through

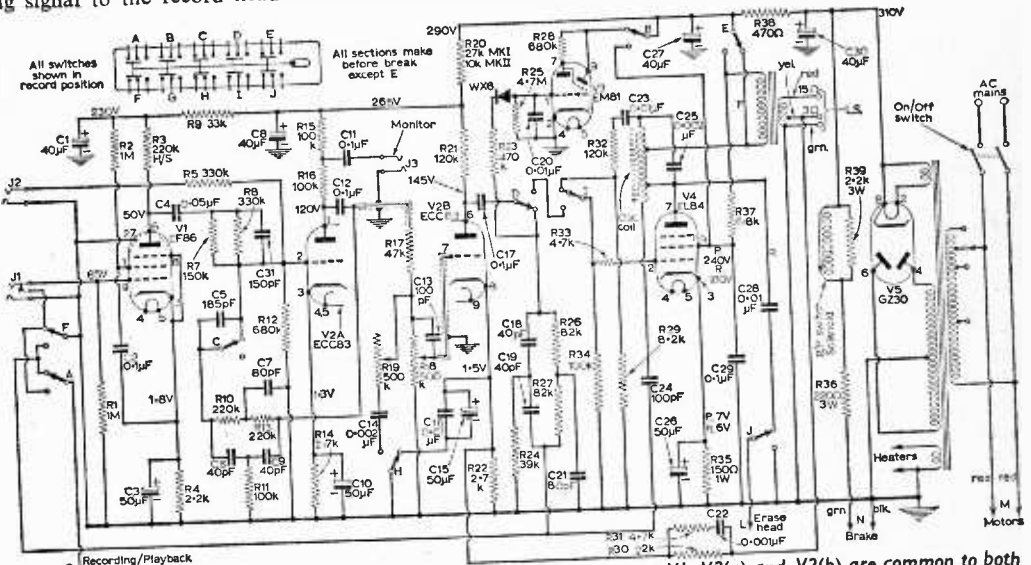

Fig. 5—The circuit diagram of a tape recorder amplifier, in which stages V1, V2(a) and V2(b) are common to both playback and record, while stage V4 operates as playback output and bias oscillator on playback and record respectively.

Thus, only the first three stages are used for the recording proper. V3 is the recording-level indicator, of the magic eye variety, and works in the following way. A portion of the A.F. recording signal is coupled through R23 to the rectifier WX6. A D.C. voltage is thus developed across its load, R25, and applied to the control grid. With increase in strength of the signal so a greater bias is applied to the grid and a suitable deflection occurs in the "eye", this being proportional to recording-level. C20 is simply the rectifier reservoir capacitor.

Bias Oscillator

In the "record" position, V4 (EL84) acts as the bias oscillator valve. The oscillator coil is connected in the anode circuit, while coupling to the control grid, to produce a feedback path, is accomplished by C23, R32 and switch "I". The oscillator signal is fed to the recording head through C24. Signal for the erase head is fed from

switch "A". V1 now acts as a voltage amplifier for the replay head signal. The equalisation network, coupling V1 to V2A, is altered slightly by switch "C". Switch "H" changes over and removes the cathode by-pass capacitors, C15 and C16 from V2B and switches in the tone control, R19 and C14.

Switches "D" and "I" operate to disconnect the A.F. from the recording head feed circuits, remove the oscillator feedback components and couple the signal to the control grid of V4, which now acts as the output valve. H.T. is applied to the top of the output transformer by switch "E," and the normal screen operating conditions for V4 are established by switch "B", which also disconnects the recording-level indicator.

Fault Finding

As there are several interconnected stages, input and monitor points on most recorders, fault finding is considerably facilitated if a logical approach is adopted.

(Continued on page 1145)

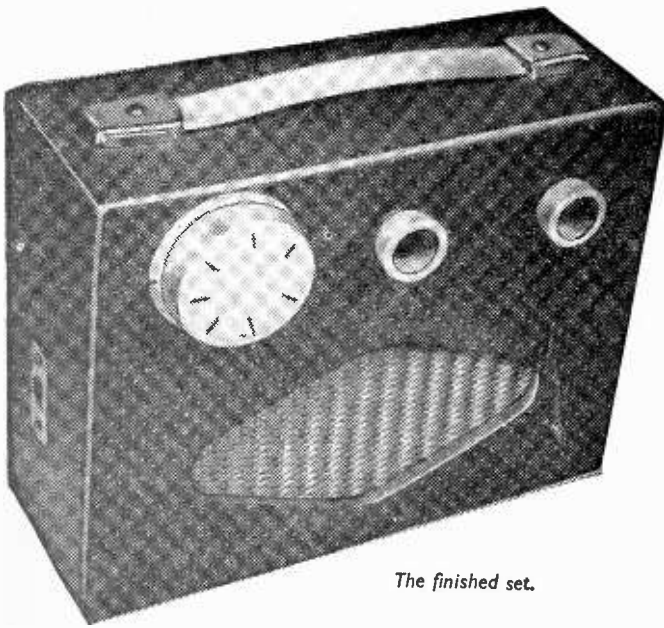

The finished set.

BLUEPRINT

A SENSITIVE
REFLEXED RECEIVER
FOR MEDIUM AND
LONG WAVES

Practical Wireless RE

Note that Figs. 1—9 appear on the blueprint given away with every copy of this issue.

THIS receiver has been designed as an inexpensive lightweight, medium and long-wave receiver of good fidelity for general use in town and country.

Measuring about 9in. x 7in. and less than 4in. deep, the receiver is easily handled, while the weight, even with the high-flux loudspeaker recommended is a mere 54oz., including the battery.

The receiver is not a superhet but a regenerative-reflex type of unusual circuitry, giving great sensitivity without instability in use. It is single-tuned and requires no instruments of any sort to align it for use, so that it should be well within the scope of the average constructor.

One of the prototypes has been in constant use for five months and has accompanied the writer on all his travels during this time. It has never failed to give a programme at good volume within the area bounded by Leeds, Skegness, London and Caernarvon, so that as a local station receiver it may reasonably be expected to work anywhere in the country using only the self-contained aerial.

The illustration opposite showing the general layout viewed from the rear of the case reveals that the speaker occupies most of the width of the set and about three-fifths of its height. In

the writer's judgment, good reproduction of orchestral music cannot be achieved with any speaker of normal quality less than about 7in. x 4in., and this size has therefore been chosen, the remainder of the set being built around it. The use of push-pull output ensures adequate loading under most conditions.

By extending the case only half-an-inch beyond the ends of the speaker, an 8in. ferrite rod aerial (the largest size normally obtainable) can just be accommodated. This ensures maximum pick-up of available signal.

The remaining qualities of the receiver derive from the fact that it has actually six stages and by careful choice of components and rather novel circuitry, very little of the available energy goes needlessly to waste.

Most of the components in the receiver are connected to a single large tagboard which is arranged to slide into position; this should clearly be seen in the illustration as a panel dividing the box into two quite separate compartments, the upper one containing only the aerial, transistors and controls. This "empty box" arrangement may be partly responsible for the receiver's noticeably good bass response.

The Cabinet

The cabinet of the prototype illustrated was actually modified from a commercially available cabinet, but a substantially equivalent case may be easily constructed as follows:

Six pieces of $\frac{1}{4}$ in. three-ply wood are cut, two $8\frac{1}{2}$ in. x $6\frac{1}{2}$ in., two 9in. x $3\frac{1}{2}$ in., and two $6\frac{1}{2}$ in. x $3\frac{1}{2}$ in. Also required are four 3in. lengths of $\frac{1}{4}$ in. quadrant beading. The four $3\frac{1}{2}$ in.

wide pieces are joined together with glue and a few panel pins to form a rectangular frame, outside measurement 9in. x 7in. The top and bottom pieces should overlap the two side pieces and vice versa (see Fig. 9 on the blueprint). The corners are strengthened and trued by using the pieces of $\frac{1}{4}$ in. fillet. These should be glued in centrally, that is, with $\frac{1}{4}$ in. space at each end, and not flush with one of the 9in. x 7in. faces.

The front panel $8\frac{1}{2}$ in. x $6\frac{1}{2}$ in. can now be prepared, Fig. 5 showing all the necessary dimensions for drilling and cutting the four holes. An approximation to an ellipse, somewhat smaller than the paper cone of the speaker is good enough in practice, but if the ultimate efficiency is aimed at, then the exact shape of the cone can be cut as follows: Place a sheet of thin paper flat over the mouth of the speaker to be used and, without allowing it to slip, run a finger around it, feeling for the sharpish inside edge of the face plate. (This is usually metal or thick cardboard). The above action will leave a slight but perfectly clear

crease of the correct shape. This shape can then be traced on to the plywood or cut out and used as a template.

Panel Fixing

The front panel is fixed with glue and panel pins, using the end faces of the four quadrant fillets as the main supports.

The back panel, fitted to the four quadrants with woodscrews, is a plain rectangle, $8\frac{1}{2}$ in. x $6\frac{1}{2}$ in. with one or more holes cut or drilled opposite to the speaker. As the area of these holes affects both volume and tone, the reader may care to experiment here using a temporary cardboard back for trials. In practice, a rectangle, 5in. x 2in., cut exactly opposite the loudspeaker works very well. Both this and the loudspeaker hole should be covered with suitable cloth stuck on from the inside to exclude dust, etc., and to protect the speaker cone.

The case can be finished with Rexine, or one of the self-adhesive plastics readily obtainable from hardware shops. A suitable handle can be made, but the commercially available ones are so elegant and inexpensive that it is hardly worth the trouble involved.

A small wooden block and a piece of hardboard may be glued into the case to hold the flat $4\frac{1}{2}$ V battery which is the source of power (see Fig. 8).

Tagboard Rails

Finally, two 3in. strips of hardboard or plastic (preferably only $\frac{1}{4}$ in. or so thick) can be stuck on each side of the case on the inner surface near the top, between which the tagboard can slide. The gap between these "rails" need not exceed $\frac{1}{8}$ in. so that the board fits easily, without rattling when the set is moved. The gap should be arranged exactly $2\frac{1}{2}$ in. below the top inner surface of the case (see Fig. 9).

If a choice of wavebands is required, a change-over switch must be provided, and a convenient place for this is about 2in. from the bottom, on the opposite side to the battery. If a push-button switch (table lamp type) or a toggle switch is used, then a simple $\frac{1}{4}$ in. diameter hole can be drilled in the required position. Both these types however, tend to protrude more than is graceful and a slide-switch gives a much smarter effect.

Fitting the Wavechange Switch

Fitting such a switch requires three holes to be made; two are $\frac{3}{8}$ in. diameter and the middle one is rectangular, $\frac{1}{4}$ in. x $\frac{1}{4}$ in. Since making rectangular holes neatly is normally rather tedious, the following method of producing a quick, neat result may be employed. From a strip of opaque plastic (such as celluloid) cut with a razor-blade, the shape shown in Fig. 7. The central hole is now cut or drilled in the side of the case in a rough-and-ready manner and the plastic cover plate prepared is secured by the same two nuts and bolts (6B.A.) that hold the slide-switch itself.

GENCY

By D. B. Pitt

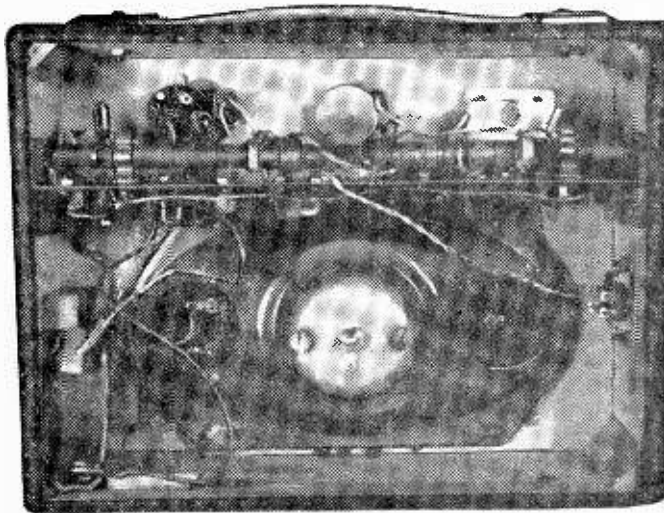

An interior view of the assembled receiver.

The Circuit

The theoretical circuit of the receiver appears in Fig. 1 on the blueprint. At first glance it may appear rather complicated, but its action is fairly easily understood.

As mentioned before, the circuit is of the regenerative-reflex-type which, properly designed, can develop greater efficiency than a small superhet measured as the ratio of total sensitivity to the number of transistors employed.

This particular circuit is reflexed over two stages, that is, both Tr1 and Tr2 are each used to amplify twice. The idea is not new, but hitherto the gain of such a system has had to

impedance, otherwise instability may arise. The value of 2.5mH for the R.F. choke represents a compromise between the requirements of medium- and long-wave reception, to avoid switching.

First Stages of Construction

The first step in construction of the circuitry is to prepare a suitable tagboard. This is nominally 8 1/2 in. x 3 in., but a safer width is 2 1/2 in. and slightly less than 8 1/2 in. (say 8 7/8 in.) to allow an easy-sliding action of the chassis within the cabinet (see Fig. 2 on the blueprint).

Any type of laminated plastic board of about 1/8 in. thickness can be used for the tagboard. The solder points (29 in all) and the three holes, X, Y, Z, are first marked out, then drilled. The prototype shown in the illustrations employed 6B.A. soldering tags, fixed with short 6B.A. screws and hexagonal nuts. Tubular brass rivets (preferably tinned) are an alternative; these require a special clinching tool for fixing but are cheaper and much less trouble. It is important to ensure that the centre of hole Y is 1/2 in. from one edge of the board and 1 1/2 in. from the other. The layout of points should be followed as closely as possible. Point 12 (see Fig. 3) is used for a number of wires, and if tags are used, three tags on the same bolt will help when soldering is in progress.

The next step is to mount the three transformers. The colour-coding shown is as seen with the transformer tags facing upwards, away from the board. It is most important not to confuse the transformers and they must all be mounted as shown in Fig. 4. This arrangement reduces inductive interaction to a minimum.

A quick-drying synthetic glue should be used to secure the transformers, and if necessary the board should be roughened with coarse sandpaper at the three positions before applying the glue.

The connecting wires from the three transformers to the various points on the board as shown in Fig. 4 can now be soldered in.

This completes the first stage of construction.

Small Components

The resistors and capacitors may be mounted next as shown in Fig. 4. The R.F. choke, two diodes, and four transistors should be left until last, as these require rather special treatment.

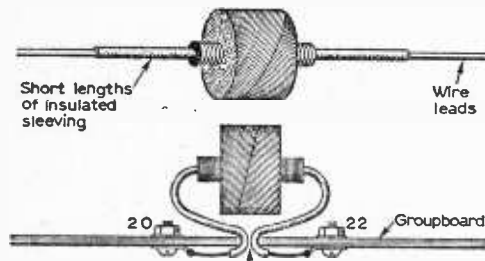
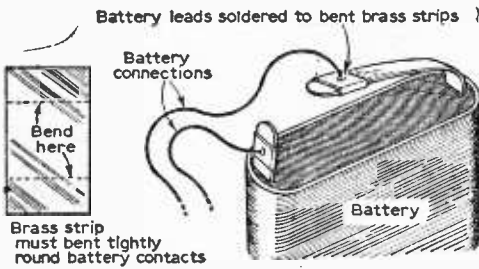

Fig. 10 (above)—Mounting the R.F. choke.

Fig. 11 (below)—Clamps for the battery connections.



be restricted deliberately in order to avoid instability. By using a novel system of feedback, both Tr1 and Tr2 in this circuit can be operated in a condition of high gain, stability being achieved by the inclusion of a large measure of AGC.

Regeneration is obtained by inductive coupling between the R.F. choke and the tuning-coil. Capacitative coupling is possible, but the low value components required make control difficult.

The receiver is designed to run from a 4 1/2 V battery supply. This keeps the running costs low and enables component economies to be made in the way of very simple biasing arrangements, etc. However, against these advantages, existing components values must be adhered to rather rigidly. Under no circumstances must collector circuit components be increased in either resistance or

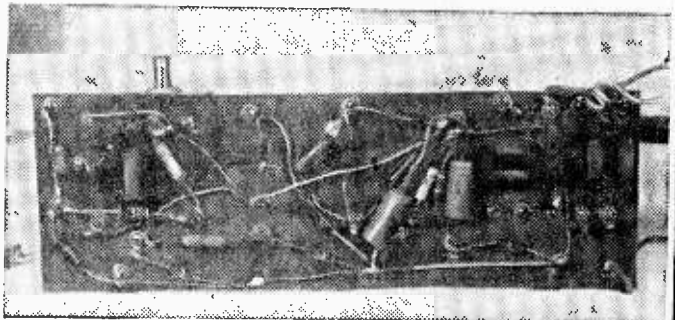

The wiring on the underside of the groupboard.

It is important that all electrolytic capacitors are mounted with due respect to polarity. If in doubt, the terminal connected directly to the aluminium casing should be taken as negative.

As a further guide, ensure that only positive electrolytic connections are made to point 12. The other three positive ends occur at points 18 and Y.

A note about point Y is now in order. All soldering at this point should be made to a large 4B.A. solder tag held in position temporarily by a nut and bolt. At a later stage a 4B.A. bolt ($\frac{1}{4}$ in. of threaded shank) is to pass through this solder tag and the board to engage with the base of the tuning condenser.

Next comes the turn of the transistors. A piece of PVC sleeving (stripped from connecting wire) about $\frac{1}{2}$ in. long, should first be slipped over the *middle* lead (the base) and pushed right up to the body of each transistor. The leads should not be shortened but soldered in as they are, using a heat shunt (e.g., a pair of pliers gripping the lead between the soldering iron and the transistor body). Soldering should be carried out as quickly as possible even with this precaution. (Note: SB305 transistors may be used in place of the OC45's specified.)

The two diodes can now be soldered in position with the same care as for the transistors, Fig. 4, showing their correct polarity (red = positive). If this polarity is not observed, the receiver will not work at all.

In addition to these components, there are the connecting wires (power lines) shown on the diagram. These should preferably be insulated but may be bare wire where they do not cross the path of any component leads.

So far, the only components mounted on the opposite side to the transformers and main components are the transistors. This arrangement is to allow to maximum space for the transformers.

However, a glance at Fig. 3 will show that these are not the only components on the reverse side. There are also the various control flyleads, the tuner, the aerial arrangements, and the R.F. choke.

Mounting the R.F. Choke

The small wire-ended R.F. choke specified must first be prepared as shown in Fig. 10 (page 1126) by slipping a short piece of plastic sleeving (from standard connecting wire) over each end. The sleeving must be pushed right up to the body of the coil. The wires should now be bent as shown and fastened in position by pushing both insulated wires through hole X from the reverse side and soldering to points 20 and 22 on the *transformer side* of the tagboard.

If difficulty is experienced in doing this, because the choke leads are rather short, then hole X may be ignored and the choke terminations soldered *directly* to points 20 and 22 on the *reverse side*. In this event, the two wires, where their sleeves touch, should be bound tightly together with a few turns of strong thread to simulate the restraining effect of hole X.

During the remainder of the construction, care should be taken that the choke coil is not rubbed against any abrasive surface (such as the top of a table or work-bench). If there appears to be any danger of this, a few turns of Sellotape round the coil will keep it safe until the chassis is finally slid into the cabinet.

The Two Controls

The connections to the two controls are shown in Fig. 3, the flyleads being twisted into a flex wherever this is possible. The length of the leads may be found experimentally by sliding the tag-

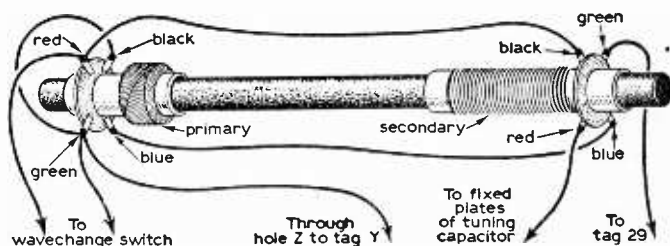

Fig. 12—The ferrite rod aerial connections.

board into the case and measuring with a piece of string or wire. The side of the tagboard with the bulk of the components faces *downwards*, only the choke and the four transistors appearing on the upper surface of the chassis.

Looking into the open back of the case, the left-hand hole is to receive the volume control (5k) and switch, the central hole, the 100k sensitivity control, and the right-hand hole the shaft of the tuning condenser (not yet mounted).

To avoid tailoring the fly-leads individually, a six-inch length may be used for each. This will work well enough but may not, of course, look quite so neat when completed.

Three details appearing in Fig. 3 are worthy of comment. Firstly, both potentiometers are shown as seen from *above* in the positions they will finally occupy. Secondly, note the 3·3k resistor fitted by its own wire leads between the tags of the volume control; this is the only resistor in the Components List which does not appear on the tagboard.

Thirdly, make sure that when soldering the fly-leads to points 26 and 27 a heat shunt is used as before on the two transistor leads involved, to prevent damage by conducted heat.

The Tuning Condenser

Connections to point Y were made to a 4B.A. solder tag fixed in the hole by a temporary nut and bolt. This nut and bolt must now be removed, leaving the solder tag supported by the component wires. A 4B.A. bolt with $\frac{1}{4}$ in. of threaded shaft is now required; this may, of course, be obtained by sawing off the end of a longer bolt. This bolt (preferably *not* with a countersunk head) is pushed through the 4B.A. solder tag, through hole Y, and screwed into the threaded hole in the base of the tuning condenser until this component is secured to the tagboard with its shaft pointing *over the edge of the board*.

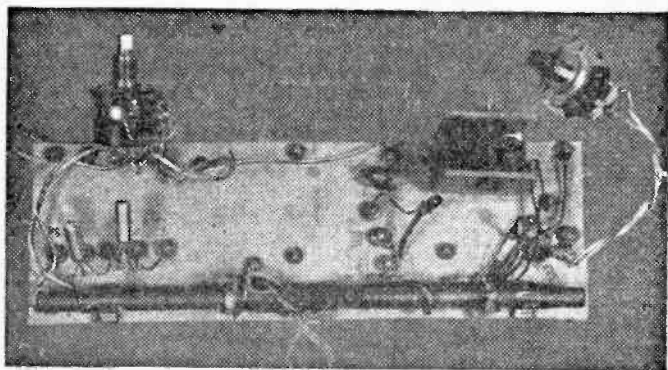

The components on the top side of the groupboard.

In practice, a slightly longer bolt than $\frac{1}{4}$ in. is permissible, but under no circumstances must the end protrude through the hole in the condenser base and touch the underside of the fixed vanes. Fortunately this danger can be foreseen by looking into the lower part of the condenser from one side as the bolt is tightened up.

If a standard tuning knob or pointer is to be used on the shaft, only $\frac{1}{8}$ in. will be required, the remainder being sawn off as neatly as possible with a sharp hacksaw either at this point in the construction or later, when the reader has decided what sort of tuning knob or pointer device will look best.

If a flat plastic pointer disc is to be mounted on the shaft, it is worth noting that tuning condensers of the type specified, but with the shaft tapped to accept a bolt for fixing the disc, can be obtained from component retailers at special order. These condensers so modified are slightly more expensive and will require all but $\frac{1}{4}$ in. or $\frac{1}{2}$ in. of shaft to be removed before use.

During the remainder of the construction, the tuning condenser should be kept in its *closed* (i.e., fully intermeshed) position so that accidental damage to the moving vanes is avoided.

Battery and Loudspeaker Leads

The two battery leads and the two loudspeaker leads can now be soldered to points 1 and 10 and points 8 and 9 respectively, all on the front face of the tagboard along with the main components. The connecting wires from points 8 and 9 to the loudspeaker terminals may conveniently be a twisted "flex," but if the battery leads from points 1 and 10 are treated in the same way, then different colours should be chosen for the two wires, preferably black (negative) for the wire from point 1; and red (positive) for the lead from point 10.

If the same colour is used for both battery leads, then the ends of the wires must be *clearly labelled* in some way so that there is *no possibility of confusion*.

Sufficient length of loudspeaker leads should be allowed so that the tagboard chassis may be slid easily in and out of the case without having to remove the loudspeaker from the case.

Convenient clips for the flat type of battery suggested are miniature crocodile clips, but much

better clips can easily be made out of two pieces of brass strip (from a spent battery of the same kind). These only take a minute or two to manufacture with the aid of a pair of pliers, and are extremely efficient in use. (See Fig. 11).

Preliminary Testing

When the loudspeaker has been coupled to the set, some preliminary tests can be made. These are commenced by fixing a knob to the shaft of each of the two potentiometers and turning them fully anti-clockwise (looking at the front of the knob). This puts the on-off switch in the "off" position.

The two power leads can now be clipped to the $4\frac{1}{2}$ V battery. On the flat type specified, the long brass strip is negative (black wire) and the short strip, positive (red wire).

Test 1.—Turn the knob of the combined volume control and switch slightly clockwise to operate the switch. This can be repeated and each time a slight click should be heard from the loudspeaker.

Test 2.—Turn the same knob *fully* clockwise. A faint but steady hiss should be heard from the speaker.

Test 3.—Touch point 11 with a moistened finger and repeat if necessary. A faint click should be heard at each contact.

(These three tests check the switch, power supply, and output stage respectively.)

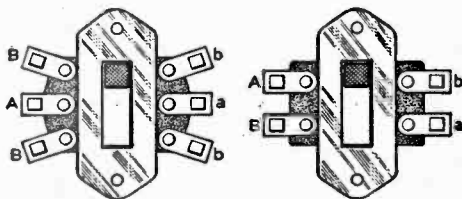

Fig. 13—Two types of slide switch; see text.

Test 4.—Connect a fairly long aerial wire to point 20. Turn the sensitivity control (100k) fully clockwise. Faint sounds of local stations should be discernible. This checks the detector stage.

Test 5.—With both controls still fully clockwise, touch point 29 with a moistened finger. Local stations should be heard clearly if within 20 miles or so. If doubtful, connect the aerial wire to point 29 and turn back the sensitivity control if necessary. This tests the R.F. stages.

The above tests need not be carried out in the quoted order and are given in order to enable the reader to narrow down the search for any fault to the part of the circuit concerned.

The Tuned Circuit

Although a commercially available dual-waveband ferrite rod aerial is specified for this receiver, it is usual for writers in this magazine to give some guidance for readers who like to wind their own.

A Simple Medium-Wave Aerial

Even if a commercial aerial is to be fitted, the following frame aerial may well be used as an additional check of the receiver as constructed so far.

Four panel pins are driven into the back panel of the cabinet *inside*, so that they lie at the corners of a rectangle, 8in. × 6in. Starting at a bottom corner, a turn or two of 30s.w.g. enamelled wire is made round a pin to anchor it (leaving about 6in. free), then the wire is led round the frame of four pins, stopping when the original pin is reached. A 6in. loop may now be twisted in the wire to form a "tapping", and winding recommenced in the same direction, completing a further 16 turns around the frame (17 turns in all). The wire is anchored as before and a final 6in. left free.

The start of the coil is connected to point Y, the tapping to point 29, and the finish to the side tag on the tuning-condenser if necessary passing through hole Z. This frame aerial covers the medium and "top" amateur band. If required as a permanent aerial, the panel pins should be covered with sleeving to prevent chafing of the coil wire, or small wooden pegs substituted for the pins. In addition, the wires connecting the chassis to the frame aerial should be of connecting wire rather than coil wire to avoid accidental breakage in handling.

A simple rod aerial of comparable performance can be made by close-winding 45 turns of 30s.w.g. enamelled wire on a paper sleeve at the mid-point of an 8in. ferrite rod. The tapping is made after the seventh turn.

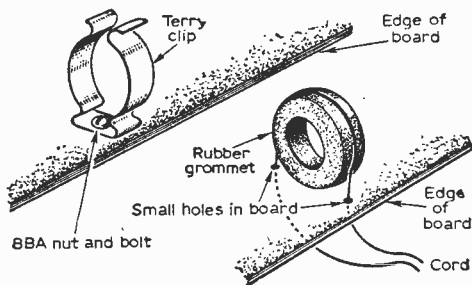

Fig. 14—Two methods of mounting the ferrite rod; note that bare wire should not be used to fasten the rod in position.

As before, the start goes to point Y, the tapping to point 29, and the finish to the side tag on the tuning condenser.

Both these forms of medium-wave aerial require the R.F. choke to be twisted into the best working position, as described later. In the case of the frame aerial this *must* be done by a number of tests with the chassis and back panel *in position*.

Fitting the Dual-Wave Aerial

Interconnections of the Repanco FR2, a typical dual-wave ferrite rod aerial, appear in Fig. 12. Care should be taken that the colour-coding is correctly followed.

In addition, there is a twin fly-lead to the wave-change switch, the fitting of which to the cabinet was described earlier. Connections to the switch are obvious if a simple type is employed, but if a slide-switch is used, the number of terminations is more than required and connections should be made to any "a" and "b", or to any "A" and "B" as marked in Fig. 13.

After all connections have been made, the ferrite rod should be pushed into its clips or otherwise secured (see Fig. 14), the two coils being left free to slide on the rod.

Adjustment

Adjustment of the receiver is best carried out with a new battery and several hours after sunset when medium-wave reception is at its optimum.

As the R.F. choke has been deliberately placed slightly off-centre on the tagboard, the direction in which the ferrite rod is fixed on the chassis, will depend on whether, in the user's locality, the medium-wave stations or the Light Programme (1500m) needs the greater sensitivity. Generally speaking, the slim coil (medium-wave) will need to be nearest to the tuning-condenser.

Adjustment is carried out as follows:

- 1—Slide the two coils as far apart as possible on the rod.
- 2—Twist the R.F. choke so that its core lies at right-angles to the ferrite rod.
- 3—Turn both controls fully clockwise.
- 4—Move the wave-change switch to "M.W."
- 5—Tune in the most powerful local station.
- 6—Twist the R.F. choke one way and note whether this *increases* or *decreases* the sensitivity. If the sensitivity *decreases*, reverse the direction of rotation.
- 7—Continue to rotate the choke until instability in the form of a "chugging" noise *just* commences, then reverse the movement slightly to restore stability.
- 8—Move the wave-change switch to "L.W."
- 9—Tune in the Light Programme on 1500m.
- 10—Slide the long-wave loading coil (the short, thick coil) towards the centre of the rod until loud reception with no distortion is obtained, adjust the tuning to keep the programme "peaked" all the time.
- 11—If instability occurs at the loading coil's *first* position, then slide the *medium-wave* coil (the slim coil) a little towards the centre of the rod and repeat instructions 1 to 10 until a fair balance is reached.
- 12—Fix both coils to the rod with wax or a spot of adhesive at the edge of each former.

The various parts can now be arranged correctly in the case, the two controls being fixed by means of their own nuts and washers, as supplied and the shafts shortened to about $\frac{1}{2}$ in. to accept the knobs chosen. The hole in the tagboard at Y has been made larger than required for a 4B.A. bolt. This is to make possible a small amount of adjustment in the position of the tuning condenser in order to align the tuner shaft with the hole in the front panel.

Tuning scales in the form of paper discs can be purchased ready made, but it is more interesting to construct one's own by tuning in stations the wavelength of which is known and marking them on a blank disc.

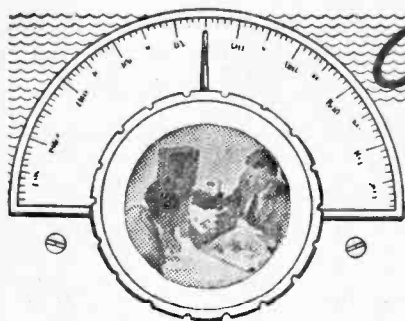

On Your Wavelength

BY THERMION

Fiction and Fact

IT is most interesting to compare the present developments in radio, TV and space investigation with many of the science fiction stories which were current when I was very much younger. Unfortunately, I think, the type of books to which I refer are no longer available, and the modern science fiction magazines are, I think, far too "pseudo-scientific", although probably in years to come these will fall into the place now being taken by the older types of book to which I refer. I well remember reading about space-craft which the illustrators had drawn almost as though they were able to see today's experimental craft, but it was in the realm of radio and television apparatus which I found the greatest revelations. It was very many years ago that I read the story which deals with the relaying of television signals throughout the world by bouncing the signals off a space vehicle designed for the purpose and June will see this actually taking place if all goes well. The present attempt is experimental but it would appear that every angle has been considered and some interesting developments are expected. It is many years since the former President of the British Interplanetary Society suggested that by putting up three satellites of a certain type at a certain height, the effect would be that they would appear to be stationary from any part of the earth's surface, and thus a master radio station would be able to send signals to be bounced off the satellites to cover any part of the world. It does not take much imagination to see the value of this arrangement—both for good and evil!

The moon satellite which the Americans fired at the beginning of the year was a disappointment, and it would have been nice if it could have sent us some pictures from the far side of the moon, and better still if it could have landed and sent back radio signals giving the essential data of the surface, atmosphere, etc. However, no doubt the time will come when we shall look back on these failures with ridicule and my younger readers will laugh when they remember the various efforts now being made.

Old Inventions

Whilst recalling the old times, I often wonder about some of the various inventions which have been proposed or even used, from time to time, and which now appear to have died out. One point

which I recall was the use of the long waves. Older experimenters will remember the Post Office transmissions from the old Rugby station (on, I think, something like 20,000m). There was a time when it was claimed that the long waves offered the solution to long-distance reception, and gave the most scope for receiver design. It will be remembered that H.F. amplifiers (of course, this was before the advent of the S.G. or H.F. pentode valve) were difficult to stabilise and called for numerous tuned circuits. The superhet avoided the latter, but it is possible on the very long waves to use resistance-capacity coupling of the same types as is used for L.F. working. This simplifies design, and by suitable layout and screening, stability is obtained.

I believe I am right in saying that the original signals which purported to come from Mars were on these long waves and that the 30-valve receiver which was constructed in the old days to pick up these signals employed an H.F. amplifier of over 20 stages. So far as I can remember, there are no experiments now being conducted on the ultra-long waves, and I often wonder if we are missing something. After all, the ultra-short waves are limited in their range, and distances are covered by using directional aerial arrays. The very long waves, on the other hand, do not need the directional arrangements, but are not so susceptible to atmospheric disturbances. Or are they?

Amateur Satellite

It is well known that much of the ground-work for short-wave long-distance working was carried out by enthusiastic amateurs on both sides of the Atlantic, and full marks should now be given to those amateurs who have pioneered the first amateur satellite. This group of American amateurs, with the co-operation of the American authorities, designed and constructed a satellite which was put into orbit towards the end of last year and the first signals to be heard on this side of the Atlantic were recorded by an amateur living at Finchley in North London. This satellite, officially known as OSCAR (Orbital Satellite Carrying Amateur Radio) transmitted 'HI' on 145Mc/s and was reported by amateurs in various parts of the world. This effort is amateur-designed, amateur-built, and in fact a complete amateur effort, except for the launching which took place by including it as a piece of "make weight" on an official launching. It is interesting to note the co-operation which was given to this enterprise by the American authorities!

REMEMBER TO BUY
OUR COMPANION JOURNAL
PRACTICAL TELEVISION
1/9 Every Month

SURBITON PARK RADIO LTD

for POST HASTE—POST FREE SERVICE

F.M. TUNERS

JASON F.M. TUNER KITS

| | |
|--|----------|
| FMT1 Complete with valves | £6.17.8 |
| Deposit 27/6 and 6 monthly | £1.1.8 |
| FMT2 Complete less power | £7.15.8 |
| Deposit 31/6 and 6 monthly | £1.4.4 |
| FMT3 Complete with power | £8.15.0 |
| Deposit 38/- and 6 monthly | £1.9.4 |
| FMT3 Complete less power | £9.12.6 |
| Deposit 38/6 and 6 monthly | £1.9.0 |
| FMT3 Complete with power | £12.0.0 |
| Deposit 48/- and 8 monthly | £1.6.6 |
| Power Pack Kit ready drilled chassis | £2.12.6 |
| The instruction book is included in all the above kits, but otherwise is 2/6 | |
| JTV2 Switched, TV sound, powered | £14.15.0 |
| Mercury 2 as above less power | £11.8.0 |
| Deposit 45/- and 8 monthly | £1.4.0 |

The instruction book is again included, but otherwise 3/6.

ARMSTRONG RADIO CHASSIS

| | |
|--|----------|
| T4B VHT Tuner , self powered | £23.0.0 |
| Deposit £4.12.0 and 12 monthly | £1.13.8 |
| ST/3 Mk.2 AM/FM Tuner , powered | £28.10.0 |
| Deposit £5.14.0 and 12 monthly | £2.1.8 |
| AF208 AM/FM Radio chassis , bass and treble controls, P.U. inputs, Single ended output stage | £23.15.0 |
| Deposit £4.15.0 and 12 monthly | £1.14.10 |
| Jubilee Mk.2 AM/FM Radio chassis with push-pull output stage | £31.15.0 |
| Deposit £8.7.0 and 12 monthly | £2.6.6 |
| Stereo 55 AM/FM Radio chassis , single ended output stage, on both channels. Separate tone and volume | £32.15.0 |
| Deposit £8.15.0 and 12 monthly | £2.9.6 |
| Stereo 12 Mk.2 AM/FM Radio chassis . Push-pull on both channels, separate controls | £44.15.0 |
| Deposit £8.19.0 and 12 monthly | £2.5.6 |

Individual leaflets giving full description and technical specification available.

REQUIRED CHANNELS MUST BE SPECIFIED FOR ALL SWITCHED

| | |
|---|---------|
| Argus Transistor 2-wave band tuner kit , in attractive wooden case | £7.10.0 |
| Less transistors (OC44 and 2 OC45) | £6.10.0 |
| Book 3/6. | |

READY BUILT TUNER

F.M. Tuner aligned and assembled, using Philips tuning head with EC085, EF85, EF85, EZ31 and EM84 and two diodes. SELF POWERED. UNREPEATABLE BARGAIN! £7.10.0

MARTIN RECORDAKITS

We are able to offer for the first time, a proprietary range of Recorders in kit or assembled form. This enables you to take advantage of mass production techniques and prices, should you wish to assemble yourself. The components used are the finest available, with 6V4 valves, and the decks are the latest having all the improvements B.S.R. and Collaro make from time to time, which enable anyone to build. We are confident you will find these Recorders very good value, they have been built up to a standard and not down to a price.

| | |
|--|---------------------|
| B.S.R. TD3 Monardek , latest model 5 1/4 in. spools | CASH £9.9.0 |
| Hire purchase deposit £1.19.0 and 6 monthly | £1.8.4 |
| Tape Amplifier for B.S.R. deck, printed circuit ready wired, with EX383, EOL-32, EM55, EZ51. Complete with all plugs, sockets, panels, knobs, etc. The whole amplifier mounts on to the deck, making a self-contained unit. | CASH PRICE £8.8.0 |
| Hire purchase deposit £1.14.0 and 6 monthly | £1.6.8 |
| Cabinet for above including 7 x 4 in. speaker | £4.4.0 |
| Total kit as above | CASH £22.0.0 |
| Hire purchase deposit £4.10.0 and 12 monthly | £1.12.1 |
| The above recorder can be supplied complete with Mic: Tape assembled and tested for | CASH PRICE £25.0.0 |
| Hire purchase deposit £5.0.0 and 12 monthly | £1.16.8 |
| Collaro Studio Deck . Very latest model 3 speeds | £12.10.0 |
| Hire purchase deposit £2.10.0 and 8 monthly | £1.7.6 |
| Tape Amplifier for Studio Deck, with ready wired printed circuit, control and input panels, mains and output trans, complete with knobs, plugs, screws, etc. EF85, EC083, EM84, EZ51, OA81 and 2 EL44, 3 wats output. Magic eye, Radio and Mic. inputs. EX 1/8 socket. Tone control. Can be used as an amplifier. | CASH PRICE £11.11.0 |
| Hire purchase deposit £2.7.0 and 8 monthly | £1.5.0 |

| | |
|---|------------------------|
| Cabinet for above including 9 x 5 in. speaker | £5.5.0 |
| Total kit as above | CASH £29.6.0 |
| Hire purchase deposit £6.0.0 and 12 monthly | £2.2.8 |
| We can supply the above recorder, complete with tape and Mic, in a DE LUXE cabinet, assembled for | £35.0.0 |
| THIS MACHINE IS LISTED £41.0.0 BY MAKERS AND IS A VERY GOOD BUY. | |
| Hire purchase deposit £7.0.0 and 12 monthly | £3.11.4 |
| Tape Pre-amplifier , for recording and playback, as above less output stage, with power supplies | £12.0.0 |
| Hire purchase deposit £1.14.0 and 6 monthly | £1.3.8 |
| Microphone for the above recorders, Acos MIC 40, 2b/-, 8/6 | 4/6 |
| Synchrotape 5 in. 600ft. 15/- | 5 in. 900ft. 18/6 |
| Finest 5 1/2 in. 850ft. 19/6 | 5 1/2 in. 1200ft. 22/6 |
| Boxed 7 in. 1200ft. 22/6 | 7 in. 1800ft. 32/6 |
| Tape Recorder Speaker Cabinet , corner, 20 x 10 in. High class finish in two-tone Grey "Vynair" | £2.15.0 |
| With 9 x 5 in. high flux speaker | £4.0.0 |
| Marriott Tape Heads , 4 track R/P/B and Erase with mounting plate for Collaro deck | PAIR COMPLETE £4.4.0 |
| List price for this set of heads is £5.14.0. | |

GRAMOPHONE EQUIPMENT

| | |
|--|---------|
| B.S.R. OA14 TC8/11 cartridge | £7.15.0 |
| Hire purchase deposit £1.11.0 and 6 monthly | £1.4.0 |
| Collaro C60 Autochanger "O" cartridge | £8.15.0 |
| Hire purchase deposit £1.15.0 and 6 monthly | £1.8.8 |
| Garrard "Autoslim" 672 cartridge | £9.3.4 |
| Hire purchase deposit £1.12.4 and 6 monthly | £1.7.8 |
| Philips AG1018 New semi-auto player | £14.8.8 |
| Hire purchase deposit £3.8.8 and 12 monthly | £1.0.2 |

MINI AMP P/W November issue, Resistors 6/-, V/C 6/-. Condensers 9/-. Transistors V6/R2 9/-. OC71 6/6, OC72 pr. 16/-. T/T3 15/-, T/T2 9/9, PP9 3/6. Press studs 1/-. Speaker 7 x 4 in. 17/6, Group/b 2/8. All the above if ordered at one time, £4.15.0. Diagram may be obtained from "Practical Wireless", 5/-.

CITIZEN P.W. Transistor tuner, December issue, Resistors 5/-. Condensers 11/-. W/C 3/6, OA70 3/-. Group boards 2/8 ea., Transistors 31/- set. Coil set 22/6, RAZW 12/6, 12. 12/6 with trimmer.

TRANSISTORS

MULLARD HAVE REDUCED THE PRICE OF MANY TYPES TO OC44 11/-. OC45 10/-. OC70 6/8, OC71 6/6, OC72 9/-. OC73 8/-. OC75 8/-. OC78 8/-. OC81 8/-. ABOVE ARE THEIR NEW LIST PRICES. WHY BUY SURPLUS? MATCHED PAIRS ONLY. Mullard OC72 at 16/- pair.

— TRANSISTOR SUPERHET KITS —

"PRACTICAL WIRELESS" POCKET SUPERHET

OSMOR printed circuit version. Osmor Rod aerial 10/-, I.F.T.s and Osc. Coils, 22/6. Osmor Driver, 11/6. Osmore Output, 10/6. Set MULLARD transistors, 53/8, OA81 Diode, 3/-. J.B. Gang, 11/6. Trimmers, 2/8 pr. Set Condensers, 15/-, Set Resistors, 8/6. Argente Vol. Control, 9/-. Argente W/C, 3/6. Speaker, 20/4. Hardware, 4/8. Printed Circuit, 9/-. Case and Knob 12/6. Dial, 6d. Batteries PF4, 2/-, Leaflet giving full illustrated details, 1/8. All the above components if purchased at one time £9.9.0. OSMOR undertake to align this receiver for a charge of 10/-. Modification Kit, 11/-. New contemporary case, 12/6, now included in kit, Dial, 6d.

"WEYRAD"

WEYMOUTH RADIO 6 Transistor Superhet using the P50 coils, as they advertise in this journal. P50/1AC Osc. Coil, 5/4. P50/2CC 1st and 2nd I.F.T.s, 5/7 ea. P50/3CC 3rd I.F.T., 6/-. RAZW Rod Aerial, 12/6. LF4 Driver, 8/6. ICAI Printed Circuit, 9/6. Instruction Book, 2/-. Set Resistors, 7/8. Vol. Control D.P., 5/6. Set Condensers, 20/-. J.B. Gang, 11/6. Bechive Trimmers, 1/3 ea. W/C, 3/6. Dial and Knob, 5/6. Battery PP11, 5/6. OA81, 3/-. Set MULLARD transistors 53/8. Car Aerial Coupling Coil, 1/-.

48 SURBITON ROAD, KINGSTON-UPON-THAMES, SURREY

Established over 30 years Telephone KIN 5549
 We pay all postage and insurance. All orders despatched same day. Money refund guarantee.
 Hours: 9 a.m.—6 p.m. (1 p.m. Wednesday) We do not close for lunch. Open all day Saturday.



**The "PIRETTE"
TWO TRANSISTOR SET
DESIGNED FOR
PERSONAL LISTENING**

An amazing little set, with built in ferrite rod aerial bringing in medium wave at wonderful volume. Sturdy case. Size only 1 1/2 x 3 x 4 in.

plus diode. Supplied with earpiece.
Total Building Costs **50/-** P. & P. 2/-.

CRYSTAL RECEIVER

Covering medium wave band. Ideal for the beginner! All components including case for 12/6. P. & P. 1/6. Easily converted to 1-transistor or 3-stage transistor receiver.

**EXPLORE THE WORLD ON THIS
I-VALVE SHORT-WAVE RADIO**



Total Building Costs **35/-** P. & P. 2/-.

★ Receives speech and music from all over the world. Construction price includes valve and one coil covering 40-100 metres. Can be extended to cover 10-100 metres. Can be converted to 2 or 3 valve.

OUR NEW

5-STAGE

POCKET

TRANSISTOR

PORTABLE

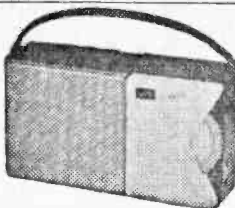

In attractive two tone contemporary case, with gold plated speaker grille and attractive dial. Size only 8 1/2 x 3 1/2 x 1 1/2 in. No aerial or earth required—completely self contained. Genuine 3in. high flux FM speaker. First grade transistors. Push pull output—250 milliwatts. Volume control with on/off switch. Condenser tuning. Easy assembly on eyeletted circuit board. Total Building **£4.19.6** Socket for personal listening. P. & P. 2/6. Earpiece 9/- extra if required.

R.C.S. for MINI-SETS

All parts available separately. Wiring diagrams and parts lists supplied free with orders or separately 1/6 each item.

**The "RENETTE"
THREE TRANSISTORS PLUS
TWO DIODES**

A highly sensitive receiver using top grade transistors and components. Fully tunable over medium waves. High flux moving coil speaker. Built in ferrite rod aerial. Specially designed coils for maximum signal strength. Volume/on/off control.



Earpiece socket.

Easy to follow building plans. Ideal for the beginner in transistor set construction.

Total Building Costs **70/-** Plus P. & P. 2/6.

Earpiece 9/- extra if required (as above but push-pull output 85/-, plus P. & P.).

**The "BOBETTE"
5 - STAGE SUPER SENSITIVE
TRANSISTOR PORTABLE**
Simple to Build. All First Grade Components.

A truly portable transistor radio giving full medium wave reception. Incorporates 5in. High Flux Speaker, push-pull output, first grade transistors, High-Q ferrite aerial, socket for car aerial, pre-tagged circuit board for easy construction. Attractive two-tone case.

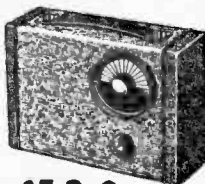

Total Building Costs **£5.2.6** P. & P. 2/6.

Trade Enquiries **R.C.S. PRODUCTS (RADIO) LTD. 11 OLIVER RD., LONDON, E.17** Mail Order Welcomed. Only

NEW! DO-IT-YOURSELF TRAINING TECHNIQUE in RADIO & ELECTRONICS

You LEARN while you BUILD...

SIMPLE... PRACTICAL... FASCINATING... 1st stage receiver

ANNOUNCING—after many years of highly successful operation in the U.S.A. and in Europe—the latest system in home training in electronics is now introduced by an entirely new British training organisation. **AT LAST**—a comprehensive and simple way of learning—by practical means—the basic principles of radio and electronics, with a minimum of theory. **YOU LEARN BY BUILDING** actual equipment with the components and parts which we send you. You advance by simple steps using high quality equipment and performing a whole series of interesting and instructive experiments. No mathematics! **INSTRUCTION MANUALS** and our teaching staff employ the latest techniques for showing clearly how radio works in a practical and interesting manner. You really have fun whilst learning! And you end by possessing a first rate piece of home equipment with the full knowledge of how it operates and—very important—how to service and maintain it afterwards. A full library of magnificent illustrated textbooks are included with the Courses. **IN FACT** for the 'Do-it-Yourself' enthusiast, the hobbyist, or those wanting help with their radio career training, or to set up their own full or part-time servicing business—then this new and exciting instructional system is exactly what is needed and it can all be provided at very moderate cost. Easy payments available. Post the coupon now, for full details. There is no obligation.



BUILD YOUR OWN • RADIO EQUIPMENT • TEST GEAR • HI-FI INSTALLATION—AND LEARN AS YOU DO IT

RADIOSTRUCTOR
BRITAIN'S LEADING RADIO TRAINING ORGANISATION

FREE- POST TODAY

To: **RADIOSTRUCTOR (Dept. G107), Reading, Berks.**

Name

Address

.....

BLOCK CAPS PLEASE

(821) We do not employ representatives 4-62

How Transistors Work

By B. N. Rolfe

A BASIC NON-MATHEMATICAL EXPLANATION

SO far we have seen how transistors amplify and how they may be compared with triode thermionic valves. We have also investigated various simple ways in which transistors may be tested. The key components which are common to most transistor circuits for a specific and basic purpose have also been dealt with.

In this article we shall consider further circuits, but before going on to those it will be instructive to clear up one or two more points about the transistor itself.

Transistor Function

If we continue the transistor/valve analogy in the common emitter mode, where the collector is likened to the anode, the base to the grid and the emitter to the cathode, we find that in a *pnp* transistor (the type mainly in domestic use in this country) the collector will be at a negative potential with respect to the base and the emitter, and that if a small A.C. signal is to be amplified it will be injected into the base circuit.

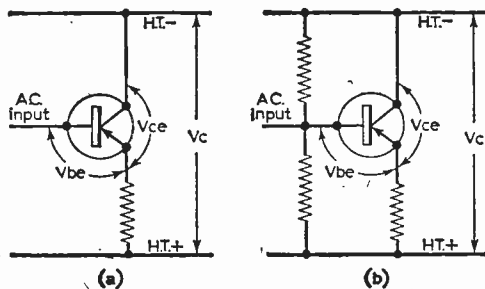

Fig. 14—The biasing arrangements and potentials of a common-emitter transistor stage, where the small A.C. signal voltage to be amplified is injected into the base circuit.

The base bias will be supplied either through a resistance in series with the emitter to battery positive (often earth or chassis) or by a potential divider across the supply voltage, the tap of which is connected to base, or by a combination of both methods.

Potentials

The biasing produces three potentials: one, the collector voltage (V_c) from collector to earth; two, the collector-emitter voltage (V_{ce}); three, the base-

(Continued from page 1016 of the March issue)

emitter voltage (V_{be}). The biasing arrangements and potentials are shown in Fig. 14 (a) and (b). It should also be noted that transistor amplifiers may be classified in a similar way to valve amplifiers. That is, when collector current flows continuously throughout the cycle of the applied signal, the amplifier is called "class A". Likewise, when the transistor is biased to cut-off so that the collector current changes only through one half-cycle of the applied signal, the amplifier is called "class B".

Class B output stages are employed in most domestic portables for two reasons; one, to provide greater output power and two, as a battery economy device, for it will be appreciated that with class B stages the battery consumption is related to the sound output. When there is no output (i.e. with the set switched on and with the volume control turned right down) a battery current of only a few milliamps flows, but when the volume control is turned up, a current of 50 or more milliamps may be taken from the battery, depending on the power output of the final stage.

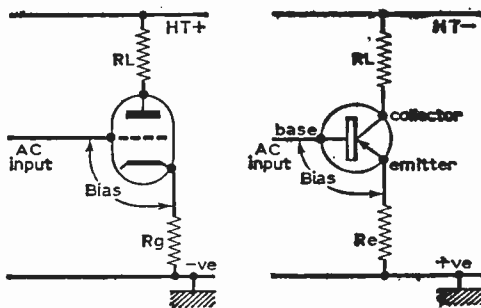

Fig. 15 (above)—These diagrams summarise the analogy between a common-emitter transistor amplifier and a common-cathode valve amplifier. The amplified signal is developed across R_L in both cases.

Similarly, transistors may be operated as class AB1, class AB2, class C and so on, just like valves. Large power amplifiers for public address work may use class AB2, since such operation represents a compromise between power output and power consumption (and quality of reproduction). Class C operation may occur in some oscillators and R.F. power amplifiers for small transmitters.

Fig. 15 summarises the analogy between a common-emitter transistor amplifier and a common-cathode valve amplifier. It is well worth noting that in both cases the amplified signal voltage across R_L is 180° out of phase with the applied

signal. Some of the foregoing was discussed in Part 2 of this series.

Transistor Curves

The collector characteristics of a transistor are rather like the anode characteristics of a pentode valve. This is illustrated in Fig. 16, where at (a) is shown typical pentode characteristics and at (b) typical transistor characteristics. There is one major difference, of course, and that is of direction. This is because the collector of a *pnp* transistor is negative with respect to emitter, while the anode of a valve is positive with respect to cathode. This can easily be rectified graphically by turning round (b) so that

is sometimes denoted by "beta", like the amplification factor of a valve is denoted by "mu", which is the current gain equivalent, it being equal to the ratio of the signal voltage in the anode to the signal voltage in the grid.

Transistor stages in the common-emitter mode possess a low input impedance which, unfortunately, varies greatly with collector current. For example, at 1mA the input impedance may be around 1k, while at 20mA (collector current) it may drop to as low as 200Ω. The output impedance at the collector itself also decreases with increase of collector current, and may fall from 20k at 1mA to 2k at 20mA, depending on the type of transistor.

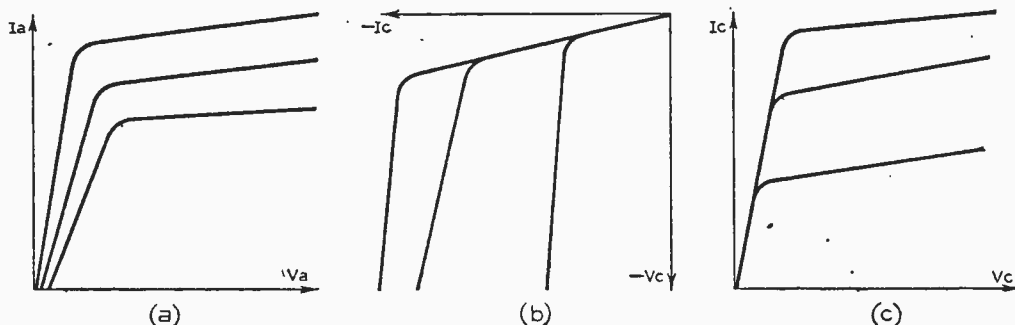

Fig. 16—At (a) is shown typical pentode anode characteristics and at (b) typical transistor collector characteristics. Because the collector of a transistor is negative and the anode of a valve positive, (b) is inverted with respect to (a). This is corrected graphically by turning (b) round, as shown at (c). This clearly reveals that (c) has much in common with (a).

it looks like (c). Now it may be seen that (c) has much in common with (a). The transistor curves are those in the common-emitter mode (equivalent to the common-cathode mode of a valve), which is the most general form adopted in small sets.

Other Factors

The current gain of a transistor in the common-emitter configuration is equal to the ratio of the signal current in the collector to the signal current in the base, and current gain values in excess of 100 are not uncommon these days. Current gain

Other Configurations

Aside from the common-emitter configuration, transistors may be operated, for instance, in the common-base mode (equivalent to the common, earthed- or grounded-grid valve circuit) where the input signal is applied to the emitter (see Fig. 17). Here the base is connected to R.F. "earth" or chassis.

This gives a current gain of less than unity, a low input impedance (compared with a medium input impedance of the earthed-emitter mode) and a relatively high output impedance. This arrangement allows for the maximum operating frequency, which is why it is used in VHF F.M. receivers and in television tuners. It is also inherently stable since there is zero phase shift between input and output signals.

The circuit produces a high voltage gain (or power gain) owing to the high ratio of the output to the input impedance. Such a circuit is useful for transformer coupling and for microphone and tape amplifiers and so on, which call for a low input impedance and high output impedance. Finally, there is the common-collector mode,

(Continued on page 1137)

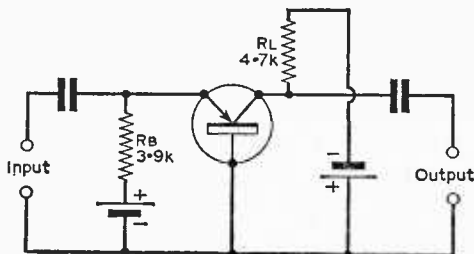
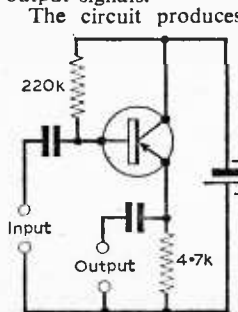

Fig. 17 (above)—A common-base transistor circuit, which is equivalent to the common-grid valve circuit.

Fig. 18 (right)—A common-collector transistor circuit, which is equivalent to the valve cathode-follower.



CLYNE RADIO LTD.



18 TOTTENHAM COURT ROAD, W.1
162 HOLLOWAY ROAD, LONDON N.7
9 CAMBERWELL CHURCH STREET, S.E.5

THE COMPONENT SPECIALISTS

MUSum 5929/0095
NORth 6295/6/7
RODney 2875

All post orders etc. to 162 HOLLOWAY ROAD, LONDON N.7

The "CLYMAX"



ONLY **£6.16.6**

At last a 6-transistor pocket size superhet for Medium and Long Wave at a price you can afford. All required components

Nothing more to buy! Plus 3/6 P. & P.
★ Completely self contained. No external aerial or earth required. ★ Full medium wave coverage, plus switched Light programme on Long Wave. ★ Push pull output—250 milliwatts. ★ Matched set of latest type Mullard transistors. ★ Genuine 3in. P.M. Speaker. ★ H&H-Q Coils. ★ Ferrite rod aerial with high selectivity. ★ Size: 5 1/2 x 3 1/2 x 1 1/2in. Two tone cabinet. ★ Precision etched printed circuit with components references clearly marked. Alignment service available. All parts available separately. Full assembly instructions and individually priced parts list. 2/- post free.

P.W. "TUTOR"
COMPLETE KIT AS SPECIFIED. Stages 1-4, 65/-, plus 2/- P. & P. All parts available separately. Send stamp for list.

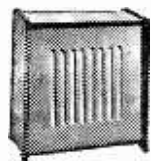

EXTENSION SPEAKER CABINETS

New design in light oak. Two sizes available. For 6 1/2" or 8" speaker at 22/6. For 10 1/2" speaker at 25/- only. Each plus 2/6 P. & P. Suitable reconditioned 8" P.M. unit at 13/6 only, plus 1/6 P. & P.

Full range of competitively priced new speakers in stock. Ask for list.

OUTSTANDING METER IMPORT!

20,000 ohms per volt!
MODEL 200H. Volt-ohm-Milliammeter



Ranges: A.C. Voltage: 10, 50, 100, 500, and 1000 volts (10,000 ohms per volt). D.C. Voltage: 5-25, 50, 250, 500, and 2.5k. (20,000 ohms per volt). D.C. Current: 0-50 microamps, 0-2.5 ma. 0-250 ma. Resistance: 0-5k, 0-5 meg. (300 ohm and 30k at centre scale). Capacitance: 10 pF to .001 mfd. —20 to +22 dB.

A fully guaranteed pocket size meter (actual size: 4 1/2" x 3 1/2" x 1 1/2") knife edge pointer, top quality supplied complete with test leads and full operating instructions at **£5.19.6 ONLY**. Post Free Optional extra. Attractive carrying case 15/- only. (Bonafide trade enquiries invited). Leadset available. **ALSO AVAILABLE! MODEL TE10.** Identical in appearance and size with rotary type switch but 10,000 Ohm. Ranges: D.C. Voltage: 0-6-30-120-600-1200 volts (10,000 ohms per volt). A.C. voltage: 0-6-30-120-600-1200 volts (10,000 ohms per volt). D.C. Current: 0-120 microamp, 0-3-300mA. Resistance: 0-30k, 0-3 Meg. (150 ohm and 15k at centre scale). Capacitance: 50 pF to 0.01 mfd., 0.001 mfd. to 0.15 mfd. Decibels: —20 to +63 dB in 5 ranges. **PRICE £5.19.6.** Post Free.

The "HIGHWAYMAN"

At last a quality Car Radio to build yourself, at an economical price. Look at these features:—
★ Attractive styling. ★ Push pull output. ★ 3 latest Mullard transistors plus valves type EBF 83 and ECH 83. ★ No Buzz. High Output and sensitivity. ★ Printed circuit (newest type). 7" x 4" High flux p.m. speaker. ★ Medium and Long Waves. ★ Push Buttons for fingertip control. ★ Extremely low Battery consumption (less than 1 amp). ★ Easy to fit any make car (Positive earth only). ★ 12 volt operation. ★ Compact size measures only 7" x 7" x 2" deep. ★ Easy assembly, supplied with dial and drive already mounted.

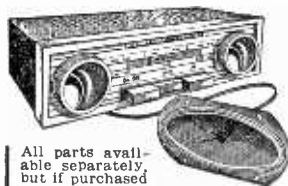

All parts available separately, but if purchased at one time, the whole will be supplied at a special inclusive price of only **£10.19.6** Plus 4/- P. & P. Parts list and comprehensive instruction booklet 2/6, post free. (Deducted from cost if complete parcel purchased later.)

"POPULAR FOUR"

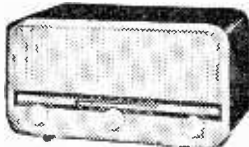

IMPROVED APPEARANCE AND PERFORMANCE
A new three valve plus miniature contact-cooled rectifier, mains T.R.F. Receiver is now available. New Deluxe Cabinet polished walnut finish, cream trim, attractive horizontal dial (as illustrated). Quality 5in. F.M. speaker. Specially wound high class super-sensitive Denco coils. Medium and Long Wavebands. Excellent Continental reception! Overall dimensions: 12in. x 5in. x 5in. A.C. 200/250. Simple construction with guaranteed results. Easy to follow practical and theoretical diagrams supplied. All necessary components, down to the last nut and bolt, are offered at a **SPECIAL INCLUSIVE PRICE OF £5.5.0**, plus 3/6 p. & p. Instruction book available separately 1/6, post free. The same circuit is available in attractive White or Brown Bakelite Cabinet with rectangular dial at 9/7.6 ONLY, plus 3/6 P. & P. **ALL PARTS AVAILABLE SEPARATELY.**

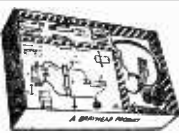

THE NEW SIGNAL INJECTION PROBE MODEL IT 1

Ideal companion for the service-man and hobbyist, making rapid checks on radios, amplifiers, tuners, TV etc. The IT 1-1 injects a signal into the circuit at any given point. Produces a signal rich in harmonics from a miniature transistor oscillator, built into the probe. Powered by four standard pen-lite cells. Push-button operation, and neon battery strength indicator. Price complete with batteries 52/6 only, plus 1/6 P. & F.

THE "WAVEMASTER" 7-TRANSISTOR LUXURY PORTABLE

NEW LOW PRICE £9.19.6

400 Milliwatt Output



To build Yourself, in 40 minutes! ★ Medium and Long Waves—Push-Pull Superhet ★ V.C. Perfect Car Radio reception Size 10in. x 6in. x 4in. at base tapering to 4in. at top. Very attractive two-tone grey Vynide covered cabinet with black and gold printed escheutron plate, cream and gold knobs, handle and cabinet fittings—Weight—with long-life 7v battery—4 lb. ★ Mullard high-grade transistors throughout. ★ High-Flux 7in. x 4in. Elliptical Speaker. ★ Slow motion tuning. ★ Co-axial socket at rear for direct connection to Car Radio Aerial. ★ Improved reception by use of five-section plated telescopic aerial disappearing into Cabinet when closed. 34in. above Cabinet when fully extended. Construction simplified by Bakelite chassis board with the following components already mounted: I.F. Transformers (3), Oscillator Coil, Trimmer Bank, Output Transformer, Interstage Transformer, Aerial Brackets and Earth Bar. **SPECIAL INCLUSIVE PRICE** for all required components. Full assembly instructions—nothing more to buy—is **£9.19.6**, plus 3/6 P. & P. Alignment service available. Full assembly instructions and individually priced parts list, all of which are available separately. 2/6. Post Free.

THE "CITIZEN" NEW LOW PRICE 85/-

Our Sensitive 5 Stage (4 transistor plus diode) pocket transistor receiver, for full medium wave reception—with the following outstanding features:



★ Completely self-contained—No external aerial or earth required. ★ Genuine 2 1/2in. High Flux F.M. Speaker. ★ 250 milliwatts. ★ Genuine Mullard transistors. ★ Socket provided for personal listening. ★ Socket provided for connection to Car Aerial. ★ Volume Control with on/off electronic Condenser tuning. ★ Easy assembly on pre-tagged circuit board. ★ Attractive red polystyrene cabinet measures 5 1/2 x 3 x 1 1/2in., chrome handle, attractive dial. All required components including full instructions, solder, etc., and battery at special inclusive price of only 85/- (Yes, Eighty-Five Shillings Only!) Plus 2/6 P. & P. Nothing more to spend. Suitable crystal dead-air type miniature earpiece fitted with miniature Jack plug at 7/6 extra only if required. All parts available separately—itemised list and full assembly instructions, sent for 1/6 post free. Hear this amazing little receiver working, at any of our branches.

LAST CHANCE TO BUY!

The well-known Brayhead Trans Tronic "SUPER 60" Radio Kit. A complete kit to make your own transistorised Transmitter and Receiver. No soldering read. 7 different circuits to build. In original manufacturers coloured box with instructions. Ideal gift for the electronically minded youngster. (As nationally advertised at £5.4.8.) Few only at 49/6. P. & P. 4/-.

Premier RADIO

23 TOTTENHAM COURT ROAD, LONDON W.1
and at 309 EDGWARE ROAD, LONDON W.2

Tel: MUSEUM 3451/2
Tel: PADDINGTON 6963

A COMPLETE SELF POWERED

FM TUNER Mk II

May be built **£6.12.6** plus 7/6
for only p. & p.

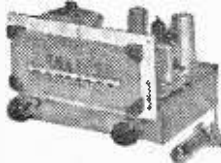

This tuner has been designed to the highest possible modern standards with all the features found only in the more expensive units and yet still within a price range that all can afford. This Tuner is supplied complete with metal

- front plate finished in a choice of black crackle, hammer finished green or grey enamel. No extras required.
- STAR FEATURES:**
- ★ EM94 Magic Eye Tuning Indicator.
 - ★ Permeability Tuning.
 - ★ Philips FM Tuning Unit.
 - ★ Absolutely no drift.
 - ★ Attractive metal Front Plate.
- Attractive full vision moroon and gold Glass Dial, size 7 x 3in., overall dimensions of Tuner: 3 x 7 1/2 x 5 1/2in. Mk I Tuner at £4.19.6 still available.*
- ★ Frequency coverage: 88-100 Mc/s.
 - ★ Two I.F. Stages & Discriminator
 - ★ OA81 balanced diode output.
 - ★ Valve lineup: EOC85, 2—EF80, EM84 Magic Eye, EZ30 Rectifier.

THE TELEFUNKEN STEREO HI-FI AMPLIFIER

Original price 18 gns.

NOW ONLY **£7.19.6** p. & p.



BRIEF SPECIFICATIONS:

- ★ Power Output 5 watts total (2½ watts per channel).
- ★ Total harmonic distortion less than 1% at 1 watt output.
- ★ Frequency Response: 30 c/s to 40 Kc/s ±dB. 45 c/s to 30 Kc/s ±dB.
- ★ Tuning sufficient for all normal inputs from Tape Recorders, Pick-ups, Microphones, Radios.

- ★ Power Requirements 110, 125, 150, 220, 240 volts A.C.
- ★ Piano key selecting.
- ★ Presettable tone control.
- ★ Size: 12in. wide x 9in. deep x 3in. high.
- ★ Weighs 9lbs.
- ★ Finish: Hammered enamel in grey/green with gold trimmings. Controls and press buttons in cream with black, blue and red lettering.

★ STAR FEATURE PURCHASE

WE CAN OFFER THE FABULOUS SAVILLE DOUBLE 12 STEREO POWER AMPLIFIER AND MATCHING SAVILLE 12P CONTROL UNIT

FOR ONLY **25 Gns.** p. & p. 12/6 PRICE 49 Gns.

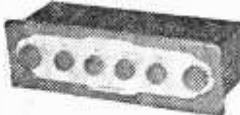

Brief Specifications:—
Input sensitivity P.U. 3 and 45 mv. Tape 1 and 20 mv. Radio 50 mv.
Output 12 watts per channel. 20 watts peak.
2 EL24 push-pull output per channel.
Control 8-pos. sel. volume on/off bass, treble and balance.



THIS ARTICLE IS BRAND NEW AND GUARANTEED.

*“There is no Virtue
without Courage—
No Reward without
Labour”*

Not simply a school motto but at B.N.R.S. a creed and a way of life. We owe to it all we have and are. If you are prepared to make it your motto and live up to it, we can help you get to the top. It will take time, it will take effort, it will take courage, and on top of all this you will actually be charged fees.

If we haven't succeeded in putting you off, write for details, today, to:

Mr. J. SYKES

(M.I.E.E., M. Brit. I.R.E., M.I.N.)

Principal:

BRITISH NATIONAL RADIO SCHOOL
Red Lion Court, Staibridge, Dorset

Britain's premier Radio Correspondence School specialising in City and Guild's examinations.

SOUND REPRODUCERS (LONDON) LTD.

NOTE OUR NEW ADDRESS:
Dept. P.W. 15, 16 St. Botolphs Row, Aldgate,
LONDON E.C.3.

AGENTS REQUIRED

INTRODUCING... THE ROVER

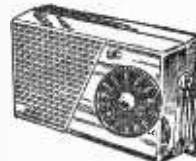

Our well-known Traveller is now supplied with printed circuit, 3 top quality transistors, 2 diodes in latest circuitry.

The second of our Transistor Radio designs. 4 Mullard transistors in a circuit specially designed around the new AF117 diffused alloy R.F. transistor. OC81D-20C81. Push-pull output on printed circuit. Sensitivity approx. 1 mV per metre. Air-spaced tuner. Luxembourg guaranteed at excellent volume (if normally receivable).

Both sets of components have following outstanding features. Supplied complete with full Easy-to-follow Instructions. Physical layout and theoretical circuits. 3in. Moving Coil Speaker. Fully tunable on Medium Waves. Ferrite Rod Aerial. Solenoid Wound Coils. Plug in 9 v. Battery. Fully portable. No Aerial or Earth required. All components tested and guaranteed 12 months. Complete satisfaction or money refunded. All components supplied separately. Instruction Book 1/6 post free. Supplied free with set of components. BUILT UP £6.5.0 with 12 months guarantee.

TRAVELLER

£3.17.6

TRADE SUPPLIED

£4.19.6

ROVER

£4.19.6

ALL PARTS and BLUE PLASTIC CASE AS ILLUSTRATED. Post and packing 3/6. Personal earpiece with instructions 9/-.
Battery extra. P. & P. 3/6.

—SNIPS—

SB078, 8/-; AF117, 12/6; OC81D-2-OC81, 22/6; 6in. Ferrite Rod, 1 or 3in., 1/9; Litz wire, 3d. yard; 10 MFD 15v. Wkg., 6d MFD 15v. Wkg. Sub-miniature Condensers, 1/9 each. G.E.C. S1, G.E.C. S3, GET 4, 3/6 each.

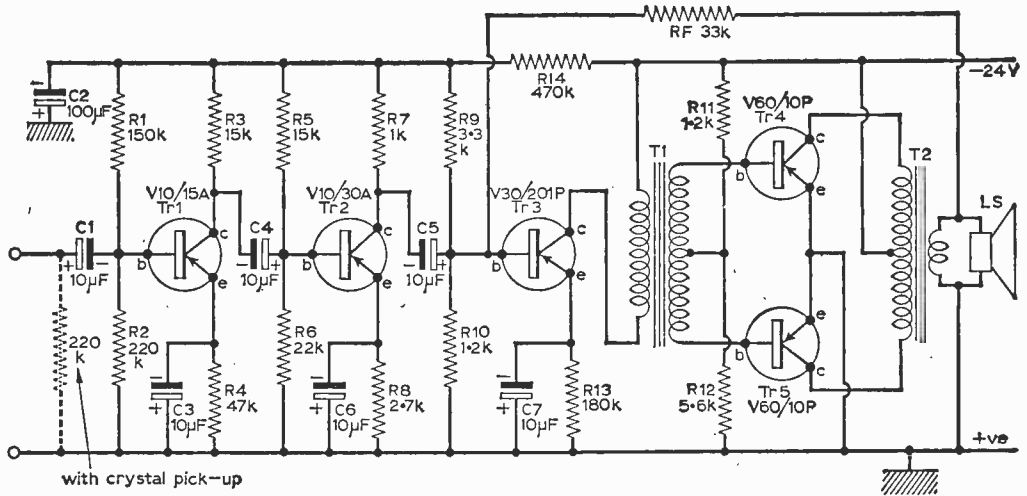

Fig. 19—The circuit of a 10W transistor A.F. amplifier developed by Newmarket Transistors.

(Continued from page 1134)

which corresponds to the cathode-follower valve circuit (sometimes called the "emitter-follower"). The basic circuit is given in Fig. 18, where it will be seen that the collector is effectively "earthed" so far as signal is concerned. The input is applied at the base and the output is taken from the emitter.

This gives a high impedance input and a low impedance output, as does the valve cathode-follower and, likewise, the voltage gain is less than unity. The circuit is ideal as a buffer stage or impedance matching device, where the demand is to feed a low impedance circuit from a high impedance source. It makes an ideal output stage for A.M. or VHF F.M. tuners to feed over a fairly long line to the input of a hi-fi amplifier. Again, the theoretical input-to-output phase-shift is zero.

Further Notes on Temperature

The transistor is remarkably temperature sensitive. This is so different from the valve which can become really hot and still function without ill effect. There is always a current flowing in a transistor, often designated I_{co} . This is the current between the base and the collector with the emitter disconnected (leakage current), a typical value being $5\mu A$ at $68^\circ F$ ($20^\circ C$).

This leakage current, however, tends to increase rapidly with temperature increase (depending on the "thermal resistance" of the transistor, which will be considered in greater detail in a future article). The current could, in fact, double with every $12^\circ F$ rise in temperature—giving, for instance, $20\mu A$ I_{co} at $90^\circ F$.

When the emitter is earthed, I_{co} is multiplied by the "amplification factor," and it is for this reason that transistors are given a maximum temperature rating, above which the I_{co} increases and the transistor changes to a resistor. The thermal stabilising resistor in the emitter helps in this respect, as was considered in Part 2.

There is also a maximum temperature at which

a transistor may be stored (sometimes in the region of $140^\circ F$ or $60^\circ C$), and above that a transistor no longer works as such.

So much for theory, let us now look at a practical circuit.

10W Audio Amplifier

In Fig. 19 is shown a 10W A.F. amplifier which is suitable for public address work or ordinary home amplification.

**LIST OF PARTS FOR
10-WATT AMPLIFIER OF FIG. 19**

Transistors (Newmarket):
 Tr1 A.F. type V10/15A
 Tr2 A.F. type V10/30A
 Tr3 Intermediate power type V30/20IP
 Tr4 and Tr5 Power type V60/10P (matched pair)

Driver Transformers (T1):
 Primary to secondary turns ratio 3 : 1 + 1
 Minimum primary inductance 1H
 Maximum primary D.C. resistance 20Ω

Output Transformers (T2):
 Primary to secondary turns ratio 1 : 1 + 1
 Minimum total primary inductance—280mH
 Maximum primary D.C. resistance—1 + 1Ω

Resistors (All 10% tolerance):

| | | |
|---------|----------|----------|
| R1 150k | R6 22k | R11 1.2k |
| R2 220k | R7 1k | R12 5k |
| R3 15k | R8 2.7k | R13 180k |
| R4 47k | R9 3.3k | R14 470k |
| R5 15k | R10 1.2k | RF 33k |

Capacitors:

| | | |
|----------|---------|---------|
| C1 10µF | C4 10µF | C6 10µF |
| C2 100µF | C5 10µF | C7 10µF |
| C3 10µF | | |

The circuit is based on a design by Newmarket Transistors, using that company's transistors throughout.

(Continued on page 1138)

Loudspeaker "MINI-AMP"

INTERCOM

THIS SYSTEM MAKES USE OF THE PRACTICAL WIRELESS "MINI-AMP"

By M. Thomas

THIS instrument was built to give a reliable communications system between a house and a workshop and to provide additional radio relay in the workshop. The system consists of an amplifier, two suitable loudspeakers, a microphone transformer and suitable switches and relay.

A most suitable amplifier is the PRACTICAL WIRELESS "Mini-Amp", which is recommended. If a substitute is used it must be ensured that one side of the speech coil output, loudspeaker and input of the amplifier are common as is the case with the PRACTICAL WIRELESS "Min-Amp".

If the Mini-Amp has not yet been built, it is suggested that a larger tagboard is bought to accommodate the microphone and transformer. This transformer must be of good quality and be of ratio 100:1 and preferably screened. The loudspeakers can be 2½ in. to 8 in. permanent magnet types of 3Ω impedance. The main Speak/Listen switch associated with the master unit is a two-pole change-over key switch. If the circuit diagram Fig. 1 is studied it will be seen that the operation of S2 gives the master station contact with the sub-station.

For sub-station to master calling facilities, an orthodox bell or buzzer can be used, but a 3V or 6V relay is recommended. This switches on the

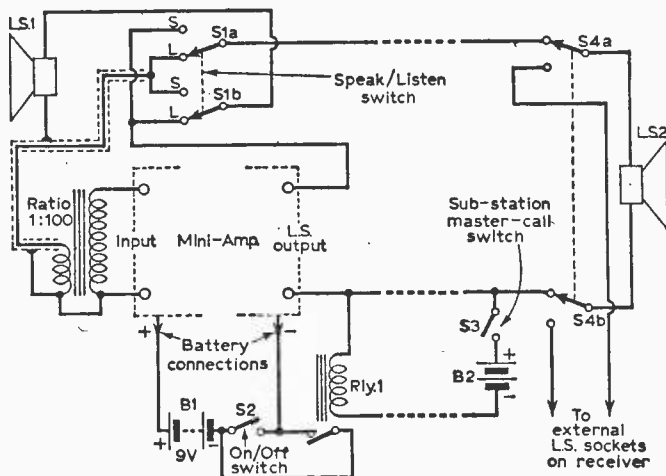

The simple circuit of the system

amplifier current and the sub-station can then call the master by operating S3.

The cable between stations need not be screened, but where screening is indicated it should be used. A further 2-pole change-over switch (S4) can be used to give radio relay facilities at the sub-station.

Circuit details of the Mini-Amp have not been given as they were supplied with the blueprint in the November 1961 issue. (This issue is now unfortunately out of print.—Ed.)

HOW TRANSISTORS WORK

(Continued from page 1137)

This operates from a 24V battery, and the battery should be capable of providing 0.8A of current without undue fall-off, which represents the full output drain of the circuit. The quiescent current is around 0.1A. The output is suitable for use with a 15Ω speaker of conventional design.

The input impedance is about 80Ω, but can be used with a high impedance pick-up of variable reluctance or crystal design. With the latter, however, a 220k resistor should be connected across its terminals. An input of 6mV is required for the full 10W output.

It will be seen that earthed-emitter stages are used throughout, and for instruction the various

components can be identified by referring to Part 2 of this series.

Transistors Tr4 and Tr5 should be clamped direct to 7 in. x 7 in. heat sinks of 16s.w.g. aluminium, but since these are in electrical connection with the collectors they must be insulated from the chassis if this is metal. A similar heat sink (3 in. x 3 in. plate, insulated) must also be used with Tr3.

For optimum results the collector current of Tr1 should be adjusted to 0.3mA by varying R1, the collector current of Tr2 to 5mA by varying R5, the collector current of Tr3 to 50mA by varying R9 and the collector current of Tr4 and Tr5 (total) to 120mA by varying R11.

(To be continued)

WOLVERHAMPTON RADIO & TV SUPPLIES

(KIT SPECIALISTS)

43 Birmingham Road : Wolverhampton

TEL: WOLVERHAMPTON 20315

VALVES by Return of Post

| | | |
|----------|-----------|----------|
| 1C2 9/- | 5Y3 7/6 | AC2/PEN/ |
| 1C1 8/6 | 6BR7 7/6 | DO 12/6 |
| 1S5 8/6 | 6K7 8/6 | DCC90 |
| 1T4 8/- | | 12/6 |
| 3A4 8/6 | 6SH7 3/6 | DL91 8/- |
| 3A5 12/6 | 6X5 7/6 | DK96 9/- |
| 354 8/6 | 7AN7 10/6 | ECH42 |
| 5U4 8/6 | 3OC1 13/- | 12/- |

WE HAVE MOST OTHER TYPES AT APPROX. SAME PRICES

Transistor Set Cabinets. 5½ x 3 x 1½ in. with chrome handle, tuning dial and scale. 7/6. P.P. 1/6.

Car Radio Portable. Now uses transistors instead of I.F.s. No more alignment problems. See February P.W.

Transistors: OC76 4/6, OC44 5/6, OC71 5/-, Japanese Audio 2/6, G.E.C. S1 Black Audio 3/6, S2, Blue driver 3/6, SB305 9/-, Diode 1/-, P.P. S.A.E.

Speakers: 7 x 4in. Elac high flux, absolutely new 12/6, P.P. 1/6. Goodmans latest 3in. 80 ohm transistor type 18/6, P.P. 1/6. Ex. TV Speakers, all at 5/-, P.P. 1/6

B.S.R. UA20 Record Decks. Four-speed auto, wired for stereo-head, £7.19.6. P.P. 5/6.

Ultra Twin-telescopic TV Aerials (heavy chrome on brass), 16/-, P.P. 1/-.

Miniature Mains Soldering Irons. Designed for transistor kit work, 30 watt, specially light weight, handle unscrews to cover bit so that iron can be carried even when hot, supplied with handsome pocket case in grey leather cloth P.V.C. Spares always available —ONLY 17/6. Post paid.

Acos Mike Inserts (crystal), 7/6, post paid.

TRANSISTOR RADIO KITS

FULLY PORTABLE

(An aerial is NOT required)

Everyone is making them! Don't think about it any longer—

SEND YOUR ORDER

NOW!

If you have tried a cheaper kit bought elsewhere and had no success, don't worry! We **Guarantee** you will get results. Clear, concise instruction book, 10 pages, Guaranteed Components (not Govt. surplus), After Sales Service and Free Advice Bureau—

WE ARE THE SPECIALISTS

Our kits are unbelievably powerful—giving full coverage of medium and long waves. Luxembourg is guaranteed!! At Wolverhampton we receive 30 Continental Stations any evening—even *Radio Moscow*.

- ★ Elegant dial, graduated in medium and long waves.
- ★ Built-in wavechange switch (not pre-set).
- ★ Ferrite rod aerial (machine wound 7/6 extra).
- ★ Attractive case in cream, with chrome handle.
- ★ It does fit in your pocket.
- ★ Built-in speaker.
- ★ Surface barrier transistors, battery 10½d., lasts 8 weeks.

ALL THIS FOR 52/6

P.P. and Ins. 2/6

If you want even *Greater Volume*, have the *High Power Model*—**59/6**

P.P. and ins. 2/6

REMEMBER—

WE ARE THE SPECIALISTS

NOTE—These kits can be Tuned Down to 160 metres and Trawler Band.

12-way Tag Board, with resistors and condensers as follows, all ¼ in. watt transistor type: two 10 meg., two .01, one 3.9 M, 5.6 M, 3.3 M, 1.2 M, 2.2 M, 470 Ω. 470K All for 2/-, P.P. 3d.

Accumulators. 2 volt 40 A.H. unspillable, self tap fixing lead. New, 9/6. P.P. 2/6.

Spark Plug. Screwdriver tester, 3/-, P.P. 6d.

Resistors. ½ and ¼ w. all values 3d. ½ w. transistor type 5d.

Extension Speaker Cabinets Wood, polished veneer finish, extremely attractive blend with all types of furnishing, complete with Elac 7 x 4in. speaker and 30ft. flex. All for 29/6. P.P. 2/-.

Guaranteed TV Tubes. 9 to 17in. All at 90/-, Ins. and carr. 15/6. £1 extra charged against old tube, but refunded if returned in packing box in 14 days.

Car Aerials. Adjustable angle telescopic. 12in. closed, 36in. extended with Co-ax plug, 17/6. Post paid.

Transtronic Construction Kit. Make your own transmitter and receiver. With components supplied, you can build seven different circuits, full size wiring diagram for mounting on peg board 15 x 9in. supplied. All components new and tested. OC44, OC72, Diode, etc. No soldering required. Supplied in attractively coloured box. Ideal gift for the young radio enthusiast.

WANTED!

Valves, transistors, miniature components, any quantity, but must be new (cash by return).

Suppliers to: EDUCATIONAL AUTHORITIES, FORCES RADIO CLUBS, EXPORT, Etc.

NOW! The WIRECOMP 'JUNIOR MK II' TRANSISTOR POCKET RADIO

OUR IMPROVED VERSION OF THE 'JUNIOR 5' **£2.19.6**

An easy "first step" set for the young constructor. This miniature marvel with the BIG performance has an internal Ferrite rod aerial—5 transistors and 1 diode—separate medium and long waveband control—200 milliwatt push pull output—2½ in. moving coil speaker—unbreakable plastic case with carrying handle. Complete with full instructions.

NOW SUPPLIED COMPLETE WITH PRINTED CIRCUIT BOARD AND FREE GIFT OF MINIATURE EARPIECE.

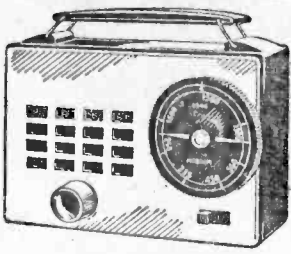

Circuit diagram 1/6, free if all parts bought. P. & P. 2/-
All parts sold separately.

BARGAIN OFFER! INDOOR

ITV/BBC/FM AERIAL **15/6**

P. & P. 1/6
Made by well known maker, this High Quality Aerial is supplied complete with standard fitting co-axial plug ready to plug straight into your TV set or VHF Tuner. The two dipoles—finished in heavy chrome—extend to give an overall length of 7ft. and are fully directional.



ONLY A FEW LEFT IN STOCK !!! HIGH QUALITY V.H.F./A.M. RADIO

£12.12.0

Brand new set, in superb walnut cabinet (size 19 x 8½ x 14in. high). Covering 80-100 Mc/s. 16-49 M., 200-500 M. and 1,200-2,000 M. Mains trans. 200-250 v. with 3 tapings. Ferrite rod aerials for A.M. Controls: volume on/off tone, tuning, w/change, gram, and ext. speaker position provided. Fully guaranteed. Post and packing 5/- extra.

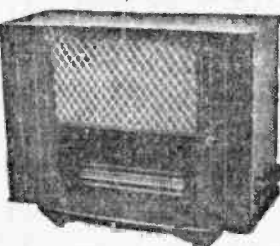

THE VERY LATEST WIRECOMP BARGAINS! THE PETIT FULMITER

A.C. ELIMINATOR AND 9V. BATTERY CHARGER **18/6** P. & P. 1/6

Converts your Miniature Transistor Set to Mains for the winter and charges your Battery for summer use outdoors; for use with all 9V. Transistor Receivers (approx. same size as P.P.3 battery). Complete with flex.

HIGH QUALITY DYNAMIC DX29 Only 3 gns. MICROPHONES Complete with Base—Lead—Black Crackle Finish. P. & P. 1/6.



WIRECOMP ELECTRONICS

378 HARROW ROAD, LONDON, W.9
TEL: CUNNINGHAM 9530
Hours of business: 9 a.m. to 6 p.m. Open all day Saturday, Opposite Paddington General Hospital. Buses 18B and 36 pass the door.

RECONDITIONED TV SETS!

ALL MAKES ★ ALL FULLY SERVICED ★ ALL GUARANTEED ★ ALL GENUINE 13 CHANNEL SETS —NOT CONVERTED EARLY MODELS

14" Fully guaranteed 3 months, including valves and tube. **from £5 to £8.10.0**

Examples: G.E.C. 14" £5; McMICHAEL PORTABLE £8.10.

17" With 12 months guarantee on tube, and 3 months guarantee on valves and component. **from £11.10.0 to £19**

Examples: Philips 17" £11.10.0; Stella Semi-Slim £19.

The examples given above are only intended to act as a guide. All sets vary in price between the prices given according to the make and model. As our stock continually fluctuates please send S.A.E. for our price list of quality sets available.

BUY WITH CONFIDENCE!

Carriage and Insurance 25/- extra.

PARK LANE RADIO LTD.

548 ROMFORD ROAD, MANOR PARK, LONDON E.12.

Telephone: ILFord 6044

EXPRESS ELECTRONICS ROSEDEAN LABORATORIES KINGSWOOD WAY, SELSDON, SURREY

VALVES NEW TESTED AND GUARANTEED FOR THREE MONTHS

| | | | | | | | | | | | |
|-------|-----|--------|------|----------|------|-------|------|-------|------|-------|------|
| 1C1 | 7/6 | 6B46 | 6/- | 8D3 | 4/- | DF94 | 8/- | EP41 | 8/- | PCL84 | 7/6 |
| 1C3 | 8/- | 6BE6 | 7/- | 12A10 | 10/- | DH76 | 7/6 | EP90 | 8/- | PL81 | 12/6 |
| 1F1 | 8/- | 6BH6 | 5/6 | 12A7 | 8/- | DH77 | 6/- | EP86 | 8/- | PL82 | 7/- |
| 1F3 | 7/6 | 6BJ6 | 6/9 | 12A7 | 6/6 | DH143 | 8/6 | EP91 | 4/- | PL85 | 7/6 |
| 1FD1 | 8/- | 6BR7 | 8/6 | 12A7 | 6/6 | DH150 | 10/- | EP92 | 5/6 | PY81 | 8/9 |
| 1FD9 | 7/6 | 6BS7 | 10/6 | 12B56 | 8/6 | DK91 | 7/6 | EL41 | 8/6 | PY82 | 7/6 |
| 1L4 | 6/6 | 6BW6 | 7/6 | 12BH7 | 10/6 | DK92 | 7/6 | EL84 | 7/- | PV98 | 7/6 |
| 1P1 | 8/- | 6BW7 | 7/- | 12K90T11 | - | DK96 | 8/- | EM94 | 10/- | R19 | 11/6 |
| 1P10 | 7/6 | 6C10 | 9/- | 12Q7T | 7/6 | DL92 | 7/6 | EM95 | 10/- | U36 | 9/6 |
| 1P11 | 7/6 | 6D3 | 4/- | 16A5 | 8/- | DL94 | 6/6 | EV61 | 7/6 | UG2 | 7/6 |
| 1R3 | 8/- | 6EP3 | 4/- | 25A8G | 8/6 | DL96 | 8/- | EV81 | 10/- | U78 | 7/6 |
| 1S5 | 6/- | 6H8GT | 8/- | 25LGT | 7/6 | EB91 | 4/- | EZ40 | 7/6 | U78 | 5/- |
| 1T4 | 7/6 | 6J7GT | 7/6 | 25Z4G | 9/- | EB04 | 1/1 | EZ80 | 6/- | UBC41 | 8/6 |
| 1U5 | 5/6 | 6K7G | 5/6 | 30C1 | 7/6 | EBF90 | 8/6 | EZ81 | 6/6 | UCH42 | 9/6 |
| 324 | 8/- | 6K8G | 6/- | 30L1 | 7/6 | EC91 | 6/- | UF41 | 8/6 | UF41 | 8/6 |
| 384 | 7/6 | 6Q7G | 5/6 | 35LGT | 9/- | EC82 | 6/6 | K786 | 11/6 | UL41 | 8/6 |
| 3V4 | 6/6 | 6S17GT | 6/- | 38W4 | 8/6 | EC83 | 6/9 | N17 | 7/6 | UY41 | 7/6 |
| 5U4G | 7/6 | 6S27GT | 6/- | 33ZGT | 8/- | EC04 | 8/6 | N18 | 8/- | W76 | 6/6 |
| 5Y3GT | 6/- | 6V6G | 7/6 | 59K10 | 10/6 | EBF90 | 8/6 | N19 | 7/6 | W142 | 8/6 |
| 5Z4G | 9/6 | 6X4 | 5/- | 5763 | 7/6 | EBF92 | 8/- | N69 | 8/6 | X17 | 7/6 |
| 6A3G | 6/6 | 6X5G | 6/- | 80 | 8/6 | EB42 | 9/- | PCC94 | 7/6 | X142 | 9/- |
| 6AL5 | 4/- | 6X5GT | 6/- | DAF91 | 7/6 | ECH81 | 10/- | PCF90 | 7/6 | X150 | 9/- |
| 6AM6 | 4/- | 1B7 | 7/6 | DAF96 | 8/- | ECL40 | 8/6 | PCF92 | 7/6 | Z77 | 4/- |
| 6AT6 | 6/- | 1B7 | 8/6 | DF91 | 7/6 | ECL92 | 9/- | PCL82 | 8/- | ZD17 | 7/6 |

High Stability Resistors 1W 5% 50 Ω to 1M, 9d. Midget Ceramics 500 v. 9d. Coax. Super quality 1/4in. 8d. yd. Plugs 8d. Sockets 9d. Silicon H.T. Rects. 250v. 300 MA 1/2in. x 1/4in. 17/6. Contact Cooled 250v. 50 MA EA 8d. 35 MA 8/6.

VOLUME CONTROLS MIDGET SIZE LONG SPINDLES. D. P. switch 9d. Less switch 2/6. Valves 10K to 2M. B9A B7G v. holders 9d., Screens 9d.

VALVES MATCHED IN PAIRS

ET84 17/-, N760 17/-, 6V6G 17/-, 6BW6 18/- per pair. Push Pull O.P. Transformers for above 3-15 Ω 14/6, P. & P. 1/6. 12in. P.M. Speakers 3 Ω 24/6. Baker's "Sehurst" 12in. 15 Ω 15W, 90/- 12in. Stereo Model, 27/0.

SETS OF VALVES

| | | |
|---------------------------------|------|---------------------|
| DK91, DP91, DAF91, DL92 or DL94 | 19/6 | EB42, EP41, EBC41, |
| DK96, DF96, DAF96, DL96 | 27/6 | EL41, EZ40 |
| 1C3, 1F1, 1FD1, 1P1 | 27/6 | UCH42, UF41, UBC41, |
| 1R3, 1T4, 1S5, 384, or 3V4 | 19/6 | UL41, UY41 |

Postage and packing 6d. Over £1 post free. C.O.D. 2/6.

HOME-MADE RADIOGRAM CABINET

By B. W. Hollinshead

A DESIGN REQUIRING THE LEAST AMOUNT
OF SKILL IN ITS CONSTRUCTION

MANY readers will, no doubt, have constructed excellent pieces of radio and audio equipment, the performance of which has led them to feel that they would like to keep them as a permanent installation. To construct a conventional cabinet to do full justice to the electronics often demands skill which the constructor feels is beyond his capabilities. The writer found himself faced with a similar problem to find a housing for two separate mono amplifiers, radio tuner and record playing deck. This resulting design is here offered as a basis for those constructors who would like to build a similar unit.

Design

Before deciding on a design the following requirements were considered important:—

The cabinet had to be "modern" in style to blend with similar furniture already in the room.

It had to be made with a limited number of simple woodworking tools.

It had to compare favourably in appearance and cost with a commercial cabinet.

The following design was arrived at which is both pleasing in appearance, costs under five pounds and can be made by anyone with a knowledge of the use of simple tools.

Construction

The material used in the construction of the cabinet was a proprietary brand of faced chipboard sold in standard sizes. This chipboard is faced with African Redwood and most shops catering for Do-it-Yourself enthusiasts have it in stock. The writer advises would-be builders to go to a shop which has a large stock and select the four panels needed so that the veneers match as closely as possible. One word of warning, the writer has used a fair number of these panels in different projects, and whilst panels are nominally of the same size he has known differences of as much as $\frac{1}{16}$ in. between two "similar" pieces. Also, it is advisable to check that the lid and bottom panels are square by laying one on top of the other. A

similar procedure is adopted for the front and rear pair.

Whilst it is appreciated that the size of the cabinet will have to be varied to suit the equipment of the constructor, the dimensions used by the writer in his model are such that adequate room is available and none of the panels need be cut. This is convenient for, if the panels are cut, the edges will have to be reveneered with strips of

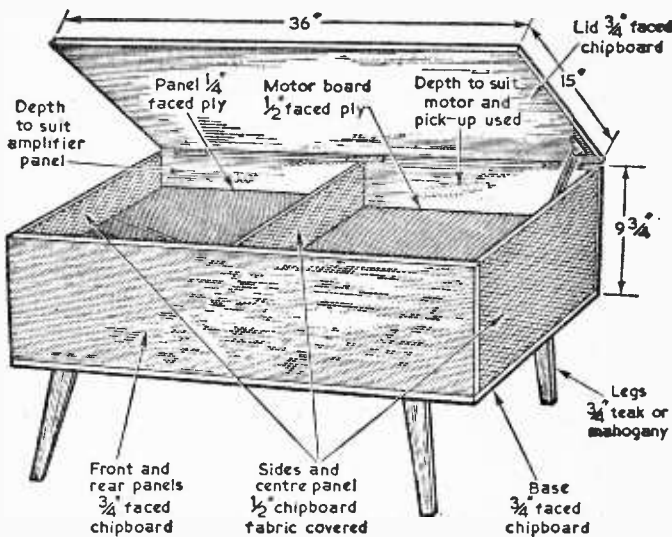

Fig. 1—The assembled cabinet.

veneer available from the shop supplying the panels. The sizes required are 36in. x 15in.—2 off, 36in. x 9in.—2 off.

Construction

The layout of the cabinet is shown in Fig. 1 and an "exploded" view of the main parts in Fig. 2. When the layout has been finally decided upon by the individual constructor, suitable ventilation is provided by means of a cut-out in the bottom panel in the amplifier compartment. This may then be covered with expanded wire mesh. The cut-out or cut-outs are best made by first marking the outlines on the panel in pencil, drilling a hole at

each corner and cutting out with a fine keyhole saw, cleaning up the edges on completion with file and sandpaper.

Next, the front and rear panels are screwed to the base leaving an $\frac{1}{4}$ in. overlap at the front and rear. Brass screws ($1\frac{1}{4}$ x No. 8) are used in counter-sunk holes and are placed approximately 2 in. apart. The resulting assembly is very strong and the screw heads are concealed.

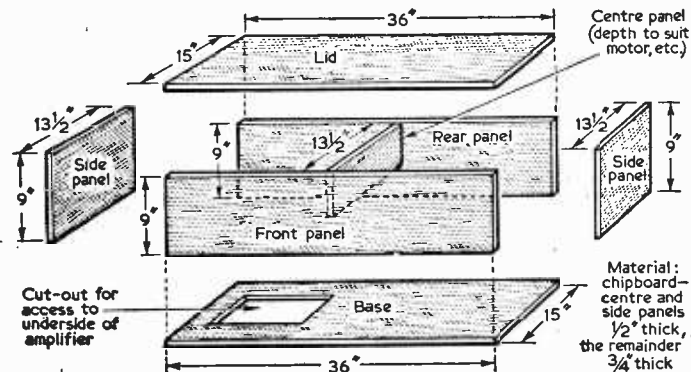
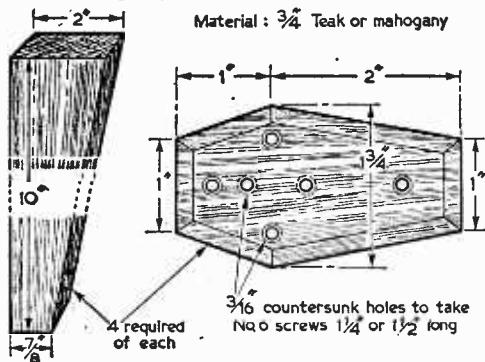

Fig. 2. (above)—An 'exploded' view which clearly shows the method of construction.

Fig. 3 (below)—The details of a leg and its fixing block.



The end panels and also the panel dividing the amplifier and motor compartments are cut from $\frac{1}{4}$ in. unfaced chipboard. This chipboard is cut $\frac{1}{16}$ in. smaller than the actual inside measurement between front and rear panels and is covered by a light fawn coloured fabric as used by tailors for interfacing. As this fabric was also used on the front of the speaker cabinets, a pleasing effect was obtained. No doubt other constructors could use material to match their own speaker cabinets. Ventilation cut-outs can be made in these end panels if required, the fabric effectively concealing the hole.

Compartments

The centre panel dividing the amplifier compartment from that of the record player extends to 3 in. from the bottom of the cabinet. This allows freedom of air circulation and also for the pick-up leads and mains lead to the motor. When com-

pleted, these panels are glued in place using one of the synthetic resin glues, care being taken to avoid glue adhering to parts of the fabric which can be seen. After gluing, the whole carcass is clamped together and the glue allowed to set. The glue should be used sparingly otherwise it will be forced out during the clamping operation and spoil the fabric.

It is next necessary to decide the layout of the panels. The writer's amplifiers and radio tuner were each built on a chassis measuring 8 in. x 4 $\frac{1}{2}$ in., the amplifiers each having four control knobs. Adequate depth was therefore, to be found in the 9 in. deep cabinet. The amplifiers and tuner were suspended by drilling the panel to correspond with the control spindles and using locknuts to hold each unit in place. Some constructors may think a piece of $\frac{1}{4}$ in. faced ply to be rather frail to accept such a weight but this is not the case in practice.

Control Knobs

The decision to use faced plywood for the panel stems from the writer's experience of home construction equipment. It was decided at all costs to avoid the unattractive appearance, resulting from various panel designs all mounted on one board. Consequently it was decided to show the control knobs alone with no surrounding adornments. A symmetrical layout is by far the best to achieve wherever possible and in the prototype Bulgin K370 black pointer knobs with skirts were used giving a professional appearance. The numbered surrounds which are available for these knobs were not used as they were considered over elaborate in this particular instance. The controls were marked with white model aeroplane transfers which are neat in appearance and easy to apply. Those used were $\frac{1}{4}$ in. high.

When the correct position for the control panel has been decided upon, a rail of 1 in. x 1 in. soft wood is glued and screwed around the inside edges of the amplifier compartment at the height required. This is then checked with a spirit level after which the mahogany faced panel is then cut to size, care being taken over this as unsightly gaps would only spoil the finished appearance.

Motor Board

A similar operation is carried out in the record player compartment, the motor board being cut from $\frac{1}{4}$ in. faced plywood. It is doubly essential to check that this board is level for obvious reasons. Sufficient clearance must be allowed above and below the board and also the turntable should be mounted so that there is sufficient clearance all around when a 12 in. record is on the turntable. Similarly, if the motor is started by moving the pick-up outwards, sufficient room must be left for this operation. The writer used a Garrard TA Mk II unit but a Philips AG2009 or Collaro RP594 should fit. For larger transcription

(Continued on page 1145)

RETURN-OF-POST SERVICE

We offer a really efficient Mail Order Service on all items stocked. All cash orders are dealt with on the day of receipt.

★ Hire purchase orders are subject to slight delay but this is kept to the absolute minimum

● TAPE RECORDING EQUIPMENT

| TAPE DECKS | Hire Purchase |
|-----------------------|--------------------------------|
| ALL CARRIAGE FREE | Cash Price Deposit Mthly/Pmts. |
| B.S.R. TD2 .. | £8.19.6 £1.16.6 12 of 13/7 |
| Latest COLLARO Studio | £12.19.6 £2.12.6 12 of 19/7 |

TAPE AMPLIFIERS
We now stock the Martin Recorder Kits. These are partly assembled kits for complete tape recorders. The Amplifier Printed Circuit panels are completely wired, but the assembly of this and external components is left to the constructor. Very complete instructions are supplied. Send for leaflet. MODEL C for Collaro Studio Deck £11.11.0.

MODEL B for BSR TD2 Deck, £8.8.0.
CARRYING CASES. Smart carrying cases are available to take the above amplifiers and decks. Fitted with speaker. For Model C Amplifier and Collaro Deck, £5.5.0. For Model B Amplifier and BSR Deck, £4.4.0.
H.P. Terms available for amplifiers, cases and decks.

TAPE PRE-AMPLIFIERS
ARMSTRONG PA80-3. This is a ready made version of the Mullard Tape C Pre-amplifier. Price £16.16.0. Hire Purchase Deposit £3.8.0. and 12 monthly payments of £1.4.7.

MULLARD TAPE C PRE-AMPLIFIER. We stock complete kits and all components. Send for list.
MARTIN. Pre-amp kit for Collaro Studio Deck £8.8.0.

★ "P.W. MINI-AMP" AND "CITIZEN" ★

We can supply kits in accordance with the P.W. articles. Full instructions supplied FREE with each kit. Send for fully detailed Parts List.

● LATEST TEST METERS

| | Cash Price | Deposit | Hire Purchase |
|---|------------|---------|----------------|
| AVO Model 8 Mark II | £24.0.0 | £4.16.0 | 12 of £1.15.2 |
| AVO Model 8 with leather carrying case | £27.18.0 | £5.12.0 | 12 of £2.0.11 |
| AVO Model 7 Mark II | £21.0.0 | £4.4.0 | 12 of £2.10.10 |
| AVO Multiminor | £9.10.0 | £1.18.0 | 12 of 14/4 |
| AVO Multiminor with leather carrying case | £11.9.0 | £2.5.0 | 12 of 17/- |
| TAYLOR MODEL 127A | £10.0.0 | £2.0.0 | 12 of 15/- |
| CARY A-10 | £4.17.6 | £1.7.8 | 3 of £1.6.8 |
| CARY B-20 | £6.10.0 | £2.0.0 | 3 of £1.13.4 |

Full details of any of the above supplied free on request.
The AVO Models 7 and 8 are both latest models from current production—not to be confused with Government Surplus.

● "BRAND FIVE" RECORDING TAPE

Standard Play: 600ft. (5"), 16/-; 1,200ft. (7") 25/-.
Long Play: 900ft. (5"), 18/6; 1,200ft. (5"), 23/6; 1,800ft. (7"), 35/-.
Double Play: 1,200ft. (5"), 37/6; 2,400ft. (7"), 60/- (All Post Free.)

★ JASON FM TUNERS

Send for details FMT1, FMT2, FMT3, — PRICES SLASHED ★

● TRANSISTORISE YOUR CRYSTAL SET

We have two new designs for Transistor amplifiers which can be used to greatly improve the signal from any crystal set. Leaflet available.

RLD4 Kit. One stage 19/- post free.
RLD5 Kit. Two stage 21/- post free.
The kits are easy to build and very detailed instructions are supplied.

● MULLARD CATHODE RAY TUBES

ALL AT THE NEW REDUCED PRICES
We supply both Mullard Radiant Screen (brand new factory fresh) and Mullard Luminar (re-builds by Mullard with reclaimed bulbs—all other parts brand new). List of types available with prices and hire purchase terms.

● "P.W. TUTOR"

Everything in stock. Stage 1 including brand new light-weight headphones, 39/6. Less headphones, 23/6. Stage 2 19/-; Stage 3 21/6. Stage 4 11/6. All Stages 1 to 4 £4.8.6. Less headphones £3.13.6. All post free. Please note that the hardboard, wood, Terry Clips and cement not included. All items available separately—send for list.

● TRANSISTORS

MULLARD. Reduced prices. Current production types, not rejects. All in makers' boxes.
OC44, 11/-; OC45, 10/-; OC70 and OC71, 8/6; OC72, 8/-; OC72 Matched Pairs 16/-; OC78, 8/-; OC81, 8/-; OC170, 13/6; OC171, 14/6. Postage 3d. on each transistor.

● LOUDSPEAKERS

GOODMANS: Axiom 110 10in. £5.2.0; Axiom 112 10in. £8.14.0; Axiote 8in. £6.15.0; Axiom 300 12in. £11.5.0; Axiom 400 12in. £16.1.0; Audiom 60 Bass, 12in. £9.12.9; Trebax Tweeter £6.4.0; CX 500 Cross-over Unit £1.19.0.
WHITELEY: HF 10in. 10in. £5.6.0; HF 1013 10in. £5.2.6; HF16 8in. £7.0.9; TF16 8in. £8.10.0; T19 Tweeter £4.8.3; T359 Tweeter £1.15.10; CX3900 Cross-over unit £1.11.8; CX1500 Cross-over unit £2.0.0. H.P. Terms available.

● SPECIAL OFFERS

TAPE HEADS. Bradmatic Tape Recording head as fitted to Collaro Studio Deck. Erase and record playback. 32/6 per pair. Post Free.
PICK-UP CARTRIDGES. B.S.R. TC8H and TC8M. Brand new and complete with fixing brackets. 19/6 each type. Post Free.

● AMPLIFIER KITS

We have full stocks of all components for the Mullard 510, Mullard 3-3, Mullard 2 and 3 Valve Pre-amp, Mullard Stereo, Mullard Mixer, GEC 312 Plus. Fully detailed list on any of these sent upon request.
Instructional Manuals: All Mullard Audio Circuits in "Circuits for Audio Amplifiers". 9/5. GEC912. 4/6. All post free.

● GRAMOPHONE EQUIPMENT

| ALL LATEST MODELS | Cash Price | Deposit | Hire Purchase |
|-------------------|------------|---------|---------------|
|-------------------|------------|---------|---------------|

GARRARD AUTOSLIM RECORD CHANGERS
(GC8 PU) .. £8.5.0 £1.13.0 12 of 12/8
COLLARO C60 (GEP5 PU) .. £8.5.0 £1.13.0 12 of 12/8
B.S.R. UA14 (TC8 PU) .. £7.19.6 £1.12.8 12 of 12/8
B.S.R. UA11 Monarch (TC8S Stereo/LP78) .. £8.19.6 £1.16.6 12 of 12/7

● GRENCOAT 45 UNIT SINGLE RECORD PLAYERS

(Battery 9v.) .. £5.8.0 £1.11.0 3 of £1.9.0
GARRARD TA (GC8 PU) .. £8.10.0 £1.14.0 12 of 13/-
B.S.R. TU12 (TC8 PU) .. £4.10.0 £1.5.0 3 of £1.5.0
E.M.I. (Acos Stereo/Mono PU) .. £6.15.0 £1.7.0 12 of 10/8

● TRANSCRIPTION UNITS

GARRARD 4HF (GC8PU) .. £18.18.0 £3.18.0 12 of £1.7.8
PHILLIPS AG1016 .. £14.3.8 £2.17.8 12 of £1.0.9
Many of the above can be supplied for stereo working. See our Gramophone Equipment List for details.

— PRICES SLASHED ★

MERCURY 2 and JTV2, all available.

● ILLUSTRATED LISTS

Illustrated lists are available on LOUDSPEAKERS, TAPE DECKS, TEST GEAR, RECORDING TAPES, GRAMOPHONE EQUIPMENT, AMPLIFIERS. Any will be sent free upon request.

● OUTPUT TRANSFORMERS

GILSON: W0696A, W0696B, 50/6, post 2/6. W0710, 55/6, post 2/6. W0892, 62/3, post free; W0767, 27/-, post 1/6. W0196A, 57/6, post 2/6.

PATRIDGE: P3667, 60/-, post Free, P4014, 98/6, post free; P4131, 60/-, post free; P3591A, 99/-, post free; P5202, P5203, 95/-, post free; P4133, 52/6, post 2/6; P4073, 45/-, post 2/6.

● MAINS TRANSFORMERS

GILSON: W071AB, 63/-, post free; W0838, 48/6, post 2/9; W0132A, 58/6, post 3/6.

PATRIDGE: H300/110, 77/6, post free; P4132, 84/-, post free; P3677, 66, post free; P4013, 66/-, post free.
EISENBERG: MTMU, 45/-, post 3/6; MT3M, 35/-, post 3/6.
PARKER: P2631, 32/3, post 2/6.

● STEREO COMPONENTS

Morganite ganged potentiometers as specified for the Mullard circuits. ● Log/Anti-Log, 500k, 1 meg., 2 meg. ● Log/Log, 50k, 250k, 1 meg., 2 meg. ● Lin/Lin 250k, 500k, 1 meg. All 10/6 each. Pick-up cartridges, B.S.R. TC8S £2.5.11. Turn-over type for Stereo, L.P. and 78 records. List of all components for Mullard Stereo Designs is available.

● TERMS OF BUSINESS

Cash with order or C.O.D. We charge C.O.D. orders as follows: Up to £3, minimum of 3/2, Over £3 and under £5, 1/6. Over £5 and under £10, 1/6. Over £10, no charge. Postage extra on CASH orders under £3 except where stated. Postage extra on overseas orders irrespective of price.

WATTS RADIO

(MAIL ORDER) LTD.

54 CHURCH ST., WEYBRIDGE
SURREY

Telephone: Weybridge 4556

Please note: Postal business only from this address

● HIRE PURCHASE TERMS

are available on any item. Repayments may be spread over 3, 6 or 12 months. Details as follows: Three months: Deposit 6/- in the £. Service charge 5 per cent but minimum charge of 10/-. Six and Twelve months: Deposit 4/- in the £. Service charge 10 per cent, but minimum charge 20/-.

THE LINEAR L1/10

A 10-WATT HIGH FIDELITY ULTRA LINEAR AMPLIFIER WITH INTEGRAL PRE-AMP

Full advantage has been taken of latest component miniaturization developments to produce a 10-watt Hi-Fi push-pull amplifier incorporating tone control pre-amplifier stages within the measurements of 9 x 7 x 5 ins. In addition two high impedance input sockets are provided for microphone and gram., etc. With selector switch and vol. control, five B.V.A. valves are employed ECC83, ECC83, EL84, EL84, EZ81, H.T. and L.T. power supply point is included for a radio tuner.

FREQUENCY RESPONSE

± 1 d.b., 30-20,000 c.p.s.

MAXIMUM POWER OUTPUT

in excess of 14 watts.

SENSITIVITY

L.P. 220 m.v. for 10 watts. 78 r.p.m. 220 m.v. for 10 watts. Radio/Microphone 40 m.v. for 10 watts.

TREBLE LIFT CONTROL

+ 10 d.b. to -22 d.b. at 12,000 c.p.s.

BASS CONTROL

+ 14 d.b. to -10 d.b. at 50 c.p.s.

HUM LEVEL

Referred to maximum output and including integral pre-amp.—70 d.b.

NEGATIVE FEEDBACK

21 d.b. in main loop.

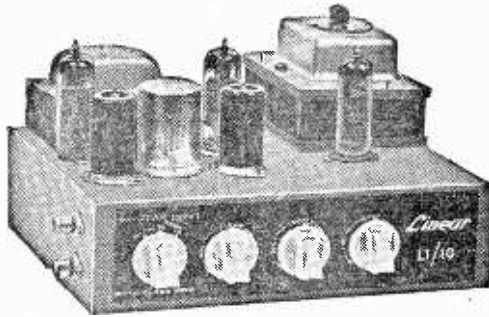

HARMONIC DISTORTION Less than 0.1% measured at 8 watts at 1000 c.p.s. Weight 10 lbs. Power consumption 90 watts. For 200-230-250 v. 50 c.p.s. A.C. mains. Outputs for 3-and 15-ohm speakers. Chassis finish stoved Gold hammer.

HIGHEST QUALITY Retail Price
MAXIMUM RELIABILITY **13**
AT A PRICE YOU CAN AFFORD **GNS.**

Send S.A.E. for descriptive literature

TRADE ENQUIRIES to

Also Available—THE L.45.A compact High Quality 4.5 watt amplifier. Size approx. 7-5 x 5 in. high. Sensitivity is 28 millivolts so that the input socket can be used for either microphone or gram., tape, radio tuner etc. B.V.A. valves used are ECC83 EL84, EZ80. Controls are: Vol. Treble and Bass with mains switch. The Tone controls provide full compensation for long playing records. Output matching for 3 ohm loudspeaker. Retail price £5.19.6.

THE LT45 TAPE DECK AMPLIFIER. A complete unit (power pack and oscillator incorporated) ready for connection to A.C. mains. 3 ohm loudspeaker and practically any make of deck. Negative feedback equalisation adjustment by multi-position switch for 1½, 3½ and 7½ in. per second. Retail price 12 gns.

DIATONIC 10-14 WATT. High Fidelity amplifier with integral pre-amplifier. Retail 12 gns.

CONCHORD 30 WATT. Hi-Fi amplifier with two separately controlled inputs. Retail 16 gns.

L50 50 WATT AMPLIFIER. Size approximately 14 x 10 x 8 in. Sensitivity 25 m.v. Output for 3 and 15 Ω speakers. Retail price 22 gns.

L5/5 STEREO AMPLIFIER 5 + 5 watt 12 gns.

LINEAR PRODUCTS LTD.

ELECTRON WORKS, ARMLEY LEEDS

SENSATIONAL NEW 1962 DESIGNS—BY CONCORD LOW PRICES ★ PICTORIAL STEP-BY-STEP PLANS ★ EASY AS A.B.C.

THE NEW "LISBON" TRANSISTOR SET

This is a pocket 2-stage transistor set not much larger than a matchbox. Excellent clear reception covering all medium waves, works for months off a tiny 1½ or 3 volt battery costing only 3/6. Easy to build and an excellent introduction to transistor circuitry. Everything can be supplied down to the last nut and bolt incl. **SIMPLE PICTORIAL STEP-BY-STEP PLANS FOR ONLY 18/6**, plus post and packing 1/8. (C.O.D. 2/- extra). Parts sold separately, priced parts list 1/-.



THE NEW "FLORIDA" VALVE RADIO

This sensational "FLORIDA" model is one of our most sensitive valve radios. It is a highly compact, self-contained miniature push button base, valve pocket radio at absolutely rock bottom building cost. Covers all medium waves with very latest circuitry bringing in stations from all over Europe without fuss. Size only 4½ x 2½ x 1½ in. A fascinating pocket radio. We can supply all the parts including beautiful 2-tone case and **SIMPLE AS A.B.C. PICTORIAL STEP-BY-STEP PLANS**, screws, wire, etc. Can be built for the exceptionally **LOW PRICE OF 27/6**, plus post and packing 1/8 (C.O.D. 2/- extra). Parts sold separately, priced parts list 1/-.

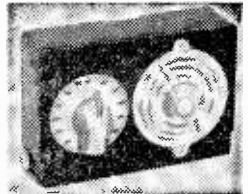

OUR NEW 4 STAGE "MINUETTE"

Build this newly-designed "MINUETTE" 4-STAGE transistor set in very strong ready drilled ULTRA-MODERN CASE, size only 6 x 3½ x 1½. Use 4 transistors and diode and **SELF-OBTAINED LOUD SPEAKER**. Very sensitive, ideal for office, bedroom, holidays, etc. Months and months of listening off an 8d. battery. Can be built **FOR ONLY 39/6**, including **PROPER CASE**, miniature speaker, etc. **SIMPLE AS A.B.C. PICTORIAL STEP-BY-STEP PLANS** etc., plus post and packing 1/8 (C.O.D. 2/- extra). Parts sold separately, priced parts list 1/-.

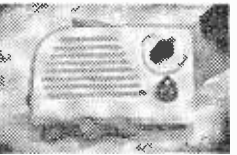

THE NEW "SAN REMO" ONLY 32/6

This All Transistor Speaker Radio—The "San Remo"—covers all medium waves including "Home," "Light," etc. Reliable and lightweight—Slips easily into the Pocket or Handbag—size only 4½ x 2½ x 1½ in. Works for months off 8d. Battery! Ideal for holidays, Camping, Bedroom, etc. Anyone can assemble it in an hour or two with our simple-as-A.B.C. PLANS! Complete set of parts including miniature speaker—everything—only 27/6, plus 2/6 P. & P. (C.O.D. 2/- extra). Parts can be bought separately.



CONCORD ELECTRONICS Dept. 14/2
210, Church Road, Hove, Sussex

Cheques accepted. Cash on delivery 2/- extra. Please print name and address in block letters. Suppliers to Schools, Universities, Government and Research Establishments. Complete range of components and values stocked. Export no C.O.D. abroad. **DEMONSTRATIONS DAILY AT WORKS.**

(Continued from page 1142)

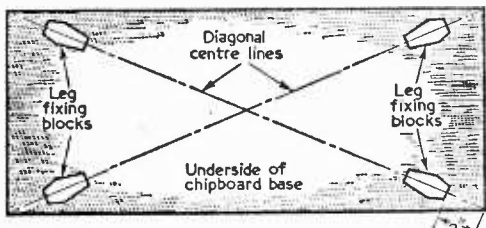

Fig. 4—The positions of the leg fixing blocks on the underside of the base.

units the width of the cabinet may have to be increased to 18in.

When the motor board has been cut to the manufacturer's template, and fitted, the lid of the cabinet can now be fixed by means of a piano hinge about 35in. in length. The hinge is held by small 3/8in. brass countersunk screws. If the lid is fitted flush at the rear of the cabinet the front when closed will be found to overlap the front by approximately 1/4in. This overlap does away with the need for a lifting handle. A lid stay is fitted to ensure that no damage is caused by accidentally allowing the lid to drop, particularly when a record is being played.

LIST OF MATERIALS

- Two faced-chipboard panels 36in. x 15in. x 3/8in.
- Two faced-chipboard panels 36in. x 9in. x 3/8in.
- Two plain chipboard panels 15in. x 9in. x 1/2in.
- One plain chipboard panel 13 1/2in. x 6in.
- 10ft softwood, 1in. x 1in. (nominal)
- One piece 1/2in. mahogany-faced plywood (to suit panel)
- One piece 1/2in. mahogany-faced plywood (to suit motor-board)
- Four legs
- Four fixing blocks for legs
- Thirty-six 1 1/2in. x 6 countersunk brass screws
- Eight 1 1/2in. x 6 countersunk steel screws
- One piano hinge, 34in. long and screws
- One lidstay
- Fabric for end and centre panels
- Model aeroplane transfers for control marking
- One 3-way terminal block
- One coaxial socket
- Expanded metal for ventilation cut-out

Legs

It is the writer's opinion that the ready made legs sold for home constructors do not do justice to this cabinet. This applies either to the plain wooden or ebonised legs. It is not difficult or tedious to cut four well-proportioned legs which will look pleasing when fitted. No doubt there will be those who favour ready made legs and the choice is left to them.

The legs are cut to the dimensions shown. It is preferable to make a cardboard template and mark the four legs with the aid of this. The four fixing blocks are also cut and the legs glued and screwed to these with 1 1/2in. countersunk wood-screws. If care is taken with the mating faces and

the screws really screwed home tight, the legs are certainly well able to bear the weight of the cabinet. Fig. 3 shows the dimensions of the legs and Fig. 4 the fixing positions on the cabinet base.

Finishing

When the cabinet has been completed it is first rubbed down with fine sandpaper and given a coat of linseed oil. This applies to the motor board and panel as well. When the linseed oil has dried the whole is given a coat of "Lactoid" which is rather like the clear dope used for model aeroplanes. It is recommended that this is carried out in a warm atmosphere and applied quickly and evenly with a fairly large soft brush. The cabinet is once again rubbed down with very fine sandpaper and given a final thin coat of linseed oil and allowed to dry.

A three-way connecting block is screwed to the bottom of the cabinet near the rear panel and a hole drilled alongside to take the three core mains lead. From this block, current is taken to the amplifier, tuner, and motor. A coaxial socket is fitted in a convenient place at the rear of the cabinet to connect the F.M. aerial to the tuner.

Transfers

When the amplifier and tuner have been fitted and the knobs replaced, the functions of the controls can be marked with transfers. A small pair of tweezers is useful here and the transfers should be applied after the panel has been varnished.

In conclusion, the writer would like to emphasise that the arrangement is very flexible. Some constructors might like to put a tape deck in place of the amplifier panel and make suitable cut-outs in the front of the cabinet for various controls. This arrangement would be quite satisfactory although care would have to be taken in the positioning of the power supply unit in order to avoid hum. However, whatever arrangement individual constructors care to adopt, if care is taken with the construction and finishing, the builder will have a cabinet of which he will justly feel proud.

SERVICING TAPE RECORDERS

(Continued from page 1123)

For example, if it were discovered that a recorder replayed a tape recording, but would not record from a microphone, and yet the microphone were in order, a very speedy check would be to apply a signal to the "radio input" or other higher voltage input socket, such as Jack 2 in Fig. 5. If a recording were then possible, the voltage amplifier (V1) would be an immediate suspect.

The "monitor" socket is also useful in this respect, as the signal applied to any of the input sockets should be heard in a pair of headphones connected to the monitor point, such as Jack 3 in Fig. 5.

Level Indicator

Another good check is the recording-level indicator. For instance, if a recording cannot be made and yet the recording-level indicator operates normally when a signal is applied, the trouble would most likely lie in the recording head feed and switching circuits.

(To be continued)

Short-wave Listeners' Log

FOR best long distance reception, an efficient aerial is needed, and this is sometimes difficult to arrange in confined spaces. A poor aerial is likely to give much lower signal strength, and may pick up more noise, so that reception of weak, distant stations is almost impossible.

For serious Dx reception, an aerial designed for the purpose is almost essential. Fortunately, the aerial may be of simple type, and as it will be needed for one of the high frequency bands, it will not have to be exceptionally long.

If Dx reception on one band only is in view, the 14Mc/s band may be chosen, as world-wide coverage can best be expected around these frequencies. A doublet for about 14.2Mc/s will be around 32ft 11in. long. The aerial can be made from two pieces of 14s.w.g. or similar wire, each about 17ft long (the extra length is needed to pass through the insulators). A length of 75Ω twin-lead or coaxial cable long enough to reach from the centre of the aerial to the receiver is also required, and three insulators. Both aerial wires are attached to the centre insulator or spacer, and the twin-lead or coaxial cable is soldered on here, one conductor going to each wire. Another insulator is then secured to each half of the aerial, so that the whole is about 32ft 11in. long, overall.

The aerial will work effectively over a band of frequencies, around that for which it is cut. It may be suspended from handy supports, and need not have the top portion horizontal, though a slope changes the directivity. If there is not space for the full horizontal 32ft 11in., equal lengths each end may be allowed to hang downwards, extra insulators holding them against swaying.

For the 21Mc/s band, the aerial only requires a top portion 22ft long (two 11ft wires, with a little for twisting round the insulators). This band is generally less useful than the 14Mc/s band, but often carries Dx signals.

A reasonably effective aerial for both 21Mc/s and 14Mc/s can be made by cutting the top to a "middle" length of about 27ft, and using a piece of 300Ω twin-lead feeder from its centre to the receiver.

Specialised S.W. receivers will have a dipole input (two sockets or terminals). If a receiver only has an aerial and earth terminals, it may be satisfactory to take one feeder lead to each of these. If the receiver is home-built, and has aerial coils fitted with aerial coupling windings, these windings can be disconnected from earth. One feeder wire is taken to each end of the coupling winding.

When local noise is bad, and space is very limited, a Marconi aerial can be tried. This is one-half as long as the dipoles described. One end of the wire is taken to the inner conductor of 52Ω or similar coaxial cable. At the receiver, this conductor goes to the aerial terminal, and the coaxial sheath is taken to the earth terminal. At the aerial end, the sheath is cut back half an

inch or so, to avoid possible shorts. Exposed ends of coaxial cable may need sealing with wax to keep out moisture.

When local interference does not spoil reception of distant signals, an end-connected aerial, of no particular length, can give quite good results on many bands. It should be well insulated at all points, and should be as far as possible from all earthed objects, such as walls, gutters, etc., as well as being as high as can be arranged. Extra height will always give improved results. It is not necessary that the down-lead be vertical, nor need the top portion be horizontal. The total length will depend on what supports are available. Such an aerial gives no discrimination against local noise.

If a dipole is wanted for a band other than those mentioned, its length can easily be found. To do this, divide 468 by the required frequency in Mc/s. This gives the overall length in feet. The length of a 75Ω or similar feeder is unimportant, and need not be measured.

CONSTRUCTIONAL FAULTS

(Continued from page 1116)

stray capacitive coupling between the leads, shown by C1, conditions of phase and so on may well be set up for the stage to oscillate at 50Mc/s. The introduction of a low value resistor in the control grid circuit serves to damp the spurious oscillatory circuit and thus make it considerably less susceptible to feedback.

It should be noted that parasitic oscillation in high power audio amplifiers can do much to damage the output transformer and the output valves. Such oscillation uses power in providing a signal which is not required. It causes excessive grid current in the output valves and puts them well off their correct operating point for distortion-free amplification.

Tracing Parasitics

One of the best ways of checking for parasitics is by lightly coupling the Y-plates of an oscilloscope to the output stage anode circuit. If the amplifier is fed with an audio signal and the oscilloscope is adjusted to display this, the parasitics will show up as bursts of R.F. on the waveform, as shown in Fig. 3.

A neon screwdriver held close to the anode pin of one of the output valves usually detects heavy parasitics by lighting up without there being an electrical connection. Another method is to connect a milliammeter in the H.T. feed to the output valves and then connect a 10pF capacitor between the control grid of each output valve in turn and chassis. If there is a definite change in current, parasitic oscillation is present.

Parasitics also occur in fluorescent lamp circuits and sometimes in ordinary filament lamps when they are approaching the end of their useful life, and are the cause of excessive radio and television interference. ■

PORTABLE RADIO OR CAR RADIO

NOW THE SUPER SEVEN 4-WAVEBAND RADIO

(7 Transistors plus 2 Diodes)

- ★ 3 R.F. STAGES.
- ★ Mullard and Surface Barrier Transistors.
- ★ Coverage of Medium, Long Waves, Trawler Band and approximately 20-60 metres short wave
- ★ Use as domestic radio, car radio or fit with strap (not supplied) for carry-about.
- ★ No aerial required except for use as car radio and for short waves.
- ★ 3-inch speaker but will drive a larger speaker.
- ★ Performance comparable to many receivers costing treble
- ★ 400 milliwatts output stage.
- ★ Minimum of 30 stations tuned in excluding S.W.



May be built for **£6.19.6** plus 3/6 post, etc. SIZE: 7½ x 5½ x 1½ in.

PARTS PRICE LIST AND EASY BUILD PLANS 2/-

BEGINNERS POCKET 5

(MW/LW and TRAWLER BAND)

(5 Transistors, plus 2 Diodes)

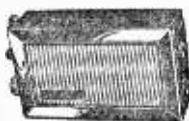

Designed round supersensitive **FERRITE ROD AERIAL** and 3in. speaker. Attractive case in black with speaker grill in red. On test Home, Light, Radio Lux., and many Continental stations were received.

Total cost of all parts **£2.19.6** P.P. 3/-.

EASY BUILD PLANS AND PARTS PRICE LIST 1/6

TRANSONA-4

(4 Transistors, plus 2 Diodes)

Miniature speaker. **FERRITE ROD AERIAL**. MW/LW

Handsome pocket case.

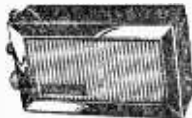

May be built for **55/-** P.P. 3/-.

"Best transistor set I have ever built—dozens of stations."—A.G.H., Deal, Kent.

PARTS PRICE LIST AND EASY BUILD PLANS 1/6

TRANSONA-6

(6 Transistors plus 2 Diodes)

M/L & T. BAND

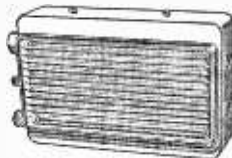

350 Mw Mullard push-pull output Transistors. Powerful magnet 3in. high grade speaker. Push-pull transformers. This is a top performing receiver. Nearly 30 stations listed in one evening including Luxembourg loud and clear. A pleasure to listen to. **FERRITE ROD AERIAL**. All parts sold separately, including pale blue gleaming polystyrene case with duo-diffusion grilles in red. Uses 9 volt battery. Sockets for car aerial.

Total building cost **£5.19.6** P.P. 3/-.

Size 6½ x 4½ x 1½ in.

"Agreeably surprised with Trawler Band reception. Luxembourg as loud as local. Your easy build diagram helped a lot... my first attempt."—H. S., Penzance, Cornwall (poor reception area).

PARTS PRICE LIST AND EASY BUILD PLANS 1/6

BEGINNERS PUSH-PULL FIVE

(5 Transistors, plus Diode)



- ★ 2½ in. M/C Speaker
- ★ Ferrite rod aerial
- ★ Tuning condenser
- ★ Volume/oscillator control
- ★ Case with speaker grille in red.
- ★ Fully tunable over med/long waves.
- ★ Simple assembly diagrams.
- ★ 250 Milliwatts output stage.

★ Can be built for **59/6** P.P. 3/-, or with 3" speaker **68/-**

PARTS PRICE LIST, etc. 2/-

NEW SUPER SIX DESIGN

MED/LONG WAVES, TRAWLER BAND AND S.W. TO APPROX. 40 METRES

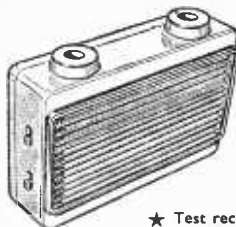

- ★ 6 1st grade Transistors (inc. Mullard and Surface Barrier) plus 2 DIODES.
- ★ Top grade 3in. L/speaker.
- ★ 2 R.F. Stages for extra boost.
- ★ High Q 7in. Ferrite Rod Aerial.
- ★ Easy build diagrams. No aerial or earth required (except as car radio).
- ★ Attractive pale blue case with speaker grilles in red
- ★ 350 Milliwatts output stage
- ★ Sockets for car radio.
- ★ Test receiver tuned in over 30 stations (inc. Luxembourg loud and clear.)

THIS FINE RECEIVER MAY BE BUILT FOR **£6.9.6** Plus 3/- P.P.

PARTS PRICE LIST AND EASY BUILD PLANS 2/-

AFTER SALES SERVICE

RADIO EXCHANGE COMPANY

27 HARPUR STREET, BEDFORD

PHONE 2367

(Opposite Co-op)

10 a.m. to 1 p.m. SAT.

LASKY'S RADIO

MINIATURE DISTLER ELECTRIC MOTORS

6 v. high speed (as used in Clarion Tape Recorder). Ideal for all electric models, speedboats, railways etc. Size 2 1/2 in. long x 1 in. diameter.

LASKY'S PRICE 7/11 Post 2/6.

TRANSISTOR RECORD PLAYER

Can be Built for **£9.19.6** Carr. free.

6 v. operation. For all L.P. and standard records. All components available separately.

AMPLIFIER. 300 milliwatts push-pull output using two OC71 and two OC72 transistors. Fully assembled. 69/6. Knobs, 3/6 extra. P. & P. 2/6.

LOUDSPEAKER. 30 ohms 7 x 4 in. elliptical, matched to Amplifier, 25/-.

3-SPEED TUNTABLE. 6 v., complete with t.f. crystal cartridge and two sapphire styli, 79/6. P. & P. 3/6.

CARRYING CASE. smart two-tone finish, 17 x 14 x 5 1/2 in. High 49/6. P. & P. 7/6. Batteries extra.

SAVE ON COMPONENTS! Send for the new edition of Lasky's 100-page Components Catalogue. Price 2/-, post 6d. Latest 20-page Bargain Bulletin included free.

TRANSISTOR POCKET RADIOS

THE "TORONTO 3"

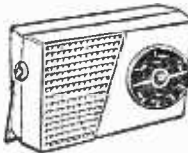

All components available separately.

Size 5 1/2 x 3 x 1 1/2 in.
Uses 3 transistors plus germanium diode, ferrite rod aerial. Tunable over med. and long waves.
Can be built for **32/6**

Post 3/6.

The New "ALBERTA 5" Mk. II

Now using printed circuit and supplied with miniature earphone for personal listening at no extra cost.

Push-pull, 200 milliwatts output. Five transistors and one diode, 2 in. moving coil speaker, ferrite rod aerial. Med. and long wave. Smart plastic Case, 4 1/2 x 3 1/2 x 1 1/2 in. overall.



CAN BE BUILT FOR **59/6** Post 3/6.
All components available separately. Full details, circuit diagram, 1/6 post free.

BUILD THE NEW LASKY FM TUNER

Non-drift permeability lining pack by famous manufacturer. frequency 88/100 Mc/s. OAS1 balanced diode output 21F stages and discriminator. Smart gold and maroon glass dial 7 x 3 in. Self powered. Valve line up ECC85, two EF80's, EZ80 rectifier. Everything ready for assembly. All components available separately. Dimensions: 8 x 8 x 5 1/2 in. Optional extra EM84 magic eye tuning indicator, 8/6. Circuit diagram and full data supplied 1/6 post free.

CAN BE BUILT FOR **£4.19.6** P. & P. 8/6

NEW TAPE RECORDER KIT

Handsome 2-tone blue carrying case, 17 1/2 x 6 x 16 1/2 in., goldline fittings, removable lid, cut to fit Collaro studio tape deck. Amplifier uses 4 Valves—EF86, ECC83, EL84, EM81, level indicator, 2 inputs, mike and radio, low level output jack, separate power pack, contact cooled rectifier. All component parts sold separately. Amplifier complete with valves and power pack. **£8.19.6** P. & P. 3/6.

1 1/2 x 7 1/2 x 4 1/2 in. Loudspeaker, 16/6, P. & P. 1/6.

Carrying Case 75/-, P. & P. 13/6.

LASKY'S SPECIAL PRICE for the above 3 items **£12.19.6** Carr. 12/6.

COLLARO Studio Tape Deck. 3 motors, 3 speeds, etc. **£10.19.6** Carr. 12/6.

LASKY'S PRICE **£10.19.6** Carr. 12/6.

207 EDGWARE ROAD, LONDON, W.2. | 33 TOTTENHAM COURT ROAD, W.1.
Near Praed St. PADDINGTON 3271/2 | Nearest Stn. Gooch St. MUSEUM 2605

BOTH OPEN ALL DAY SAT. Early Closing Thurs. Mail Orders to Dept. P.W. Edgware Road.

MAXI-Q REGD.

COIL PACKS

CP.3/370 pF and CP.3/500 pF. These 3 waveband Coil Packs are available for use with either 370 pF or 500 pF tuning condensers. The coverages are: Long Wave 800-2,000 metres. Med. Wave 200-250 metres, Short Wave 16-50 metres. Designed for use with "MAXI-Q" glass scale type S2. Retail price of each unit: 32/- plus 10/8 P.T.—total 42/8.

CP.3/G. As above but with Gram. position, suitable for use with 500 pF tuning condenser: 39/- plus 13/- P.T.—total 52/-.

C.P.3/F. This Coil Pack is for use with a 500 pF tuning condenser and covers the standard, Long, Med. and Short wavebands with the addition of the band 50/160 metres. This covers the Trawler band, Aeronautical and the 80 and 160 metre Amateur bands: 49/- plus 16/4 P.T.—total 65/4.

CP.3F/G. As CP.3/F but with Gram. position: 57/- plus 19/- P.T.—total 76/-.

CP.4/L and CP.4/M. These compact 4-station Coil Packs are available for either 1 Long Wave and 3 Medium Wave Stations (CP.4/L) or 4 Medium Wave Stations (CP.4/M.). They are fully wired and require only four connections for use with any standard frequency changer valve. 25/- plus 8/4 P.T.—total 33/4.

C.P.4L/G and CP.4M/G. As CP.4/L and CP.4/M but with provision for Gram. position. 31/- plus 10/4 P.T.—total 41/4.

See Technical Bulletin DTB.9 for details of all Coil Packs, 1/6.

GENERAL CATALOGUE covering full range of components, send 1/6 in stamps or P.O. PLEASE SEND S.A.E. WITH ALL OTHER ENQUIRIES.

DENCO (Clacton) LTD. (Dept.P.W.) 357/9 Old Road, Clacton-on-Sea, Essex
STOP PRESS: MULLARD "Twin Three-Three" Stereo Amplifier. Punched Aluminium Chassis and Hammered Gold printed Front Panel, 25/9.

CP.3/F

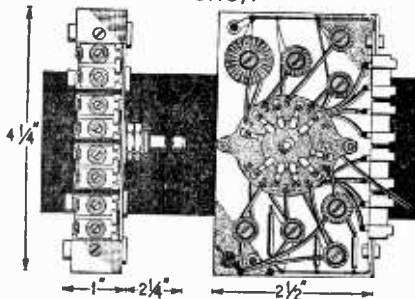

Faults in Transistor Mixer Stages

By J. Christy

DEFECTS IN THE FREQUENCY-CHANGER STAGE OF A SUPERHET RECEIVER ARE USUALLY EASILY LOCATED

TRANSISTOR superhets of every type have a mixer or frequency-changer, which is generally the first stage in the receiver. Faults in this stage, which may arise from unsuitable components, layout, or connections, or merely from wrong alignment, can greatly reduce efficiency. Fortunately such troubles are usually fairly easily located.

The mixer usually has a gang condenser, which simultaneously tunes the aerial circuit and oscillator coil. The oscillator coil should tune to a different frequency from the aerial circuit, the difference being equal to the receiver intermediate frequency. For example, suppose the set tunes from 200m to 500m. This is a range of 1,500kc/s to 600kc/s. If the receiver I.F. is 470kc/s, the oscillator should tune from 1,970kc/s to 1,070kc/s. This difference between aerial and oscillator frequencies (470kc/s) should be maintained as accurately as possible through the tuning range.

Medium Wave Mixer

If the set tunes M.W. only, alignment in this stage is easier. If it tunes both M.W. and L.W.,

it is usually possible to deal with the M.W. band first, separately.

Fig. 1 shows a typical self-oscillating mixer. It is essential that the transistor is in good condition, and is intended for such applications. It must maintain stable oscillation up to about 2Mc/s (2,000kc/s) which means that its cut-off frequency needs to be in the region of 10Mc/s to 15Mc/s. A suspected transistor should be replaced by one of named manufacture and in good condition, or good results may never be achieved.

Fig. 1 includes typical component values, though other values are also used. Lack of any results at all from this stage may arise from the transistor not oscillating. If no wiring errors, bad joints, or similar defects are present, the oscillator coil may be wrongly connected. If connections to the collector coil, emitter coil, or oscillator coil main windings are reversed, the transistor will probably not oscillate. The stage cannot operate at all if it is not oscillating.

Current Change

Oscillation may generally be checked by including a sensitive meter between the emitter resistor (3.9k) and positive line. There should be a slight change in current when oscillation is stopped by shorting the oscillator coil. This change is small—only 0.1mA to 0.025mA or so. If there is no change at all, the transistor was not oscillating.

Lack of oscillation may be caused by a poor or unsuitable transistor, in addition to wrong connections, or by wrong component values, so these should be checked.

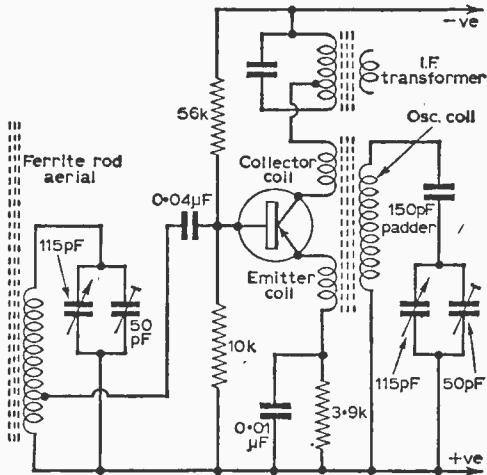

Fig. 1 (above)—A self-oscillating mixer for medium waves only.

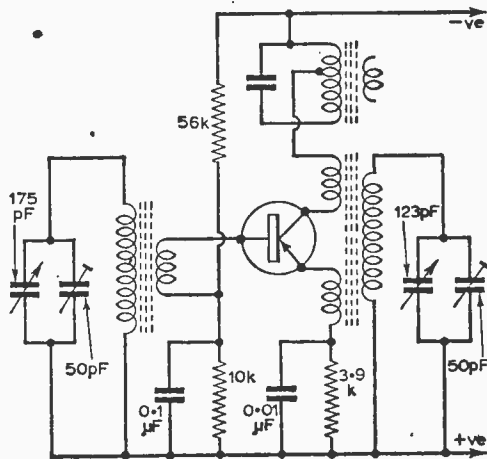

Fig. 2 (right)—Another M.W. mixer stage.

If the receiver gives some kind of results, the stage is oscillating. If oscillation is rather weak, results may be poor, even when alignment is correct.

If oscillation is too fierce, squegging may arise. This is the simultaneous oscillation of the stage on both a high and low frequency. The lower frequency may be audible, or a heavy background hiss may be heard. The squegging may cease on some parts of the band, or vary in severity. This is most likely to happen with a highly efficient transistor, especially when using an oscillator coil intended for a transistor giving lower gain. If values are otherwise correct, the trouble can usually be cleared by adding a low value resistor in series with the collector, or in series with the emitter. High values will prevent oscillation. The best value is that which is as low as possible, but which prevents squegging. Suitable values are in the range of about 10Ω to 47Ω .

Values

The $0.01\mu\text{F}$ condenser in parallel with the emitter resistor has an important effect on operation, and a larger value may easily cause squegging. It is possible to reduce this condenser to $0.005\mu\text{F}$, but $0.01\mu\text{F}$ should normally be adequate.

It should be noted that many circuits employ a 2-gang tuning condenser with a screen fitted between the sets of fixed plates. If this type of condenser is specified, it must be used, as stray feedback may cause oscillation on other frequencies. For the same reason, stray capacity between wiring or components must be kept extremely low, to avoid unwanted coupling between aerial and oscillator.

M.W. Alignment

In Fig. 1 there is a 50pF aerial trimmer, and 50pF oscillator trimmer. These are adjusted at the high-frequency end of the band, in the region $1,500\text{kc/s}$ to $1,200\text{kc/s}$, or 200m to 250m . Adjustment can be for maximum sensitivity; or for maximum sensitivity and agreement with a correctly located dial reading.

Trimmers of somewhat different capacity may be present, such as 60pF . Some such trimmers have three plates, in which only the top plate has much effect on capacity. This leaves a minimum capacity in the region of 25pF or so. If this is too great, the lower plates should be carefully separated.

At the low-frequency end of the band, in the region of 600kc/s , or 500m , alignment is secured by changing the inductance of the aerial or oscillator coil. Changes to aerial inductance are made by sliding the winding along the rod. If the M.W. winding is in two separate sections, adjusting the spacing between these changes the aerial inductance.

The oscillator coil generally has an adjustable core. The inductance of aerial and oscillator coils may be adjusted for best results, or for best results and agreement with dial readings. If the padder is pre-set, or a fixed condenser with a trimmer in parallel, this is adjusted at the low-frequency end of the band, exactly as is the coil core.

If a signal generator is available, and the receiver has the usual push-pull output stage, a

milliammeter may be included in one battery lead, and the generator may be switched to provide modulated R.F. The meter will then show peak settings.

If adjustment is by ear, keep the R.F. input to the receiver down to a very low level, and have the receiver audio gain control at maximum.

If stations are used for aligning, initial adjustments can be made with strong stations, but weak stations must be chosen for final adjustments. Adjustments should be repeated until no further improvement is possible. A completely insulated trimming tool is essential, not merely a metal tool with an insulated handle. A plastic knitting needle may be filed to engage with the trimmers and oscillator coil core.

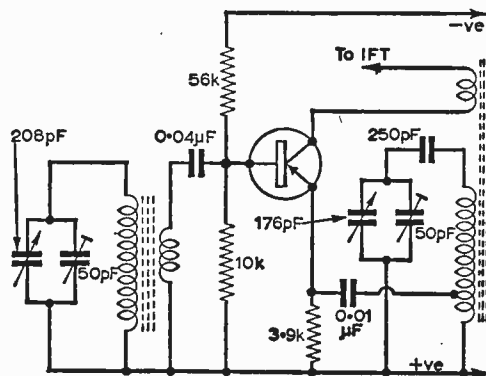

Fig. 3—The use of a tapped oscillator coil.

Further M.W. Mixers

The circuit in Fig. 2 is slightly different from that in Fig. 1. The base has a separate winding, and the base potential is applied through this, instead of as in Fig. 1. This has no effect on the points mentioned.

In Fig. 2, the aerial condenser is 175pF , and the oscillator condenser is 123pF . Trimming is carried out as already explained, but there is no padder, as in Fig. 1. Alignment towards the low-frequency end of the band must therefore be by adjusting the aerial inductance, or oscillator coil core, as described.

In Fig. 3, a tapped oscillator coil is used. The ganged tuner is $208/176\text{pF}$, with 250pF padder. This circuit is similar in effect to those described earlier. There are only five tags to the oscillator coil. Squegging, if present, could be removed by including a resistor in series with the $0.01\mu\text{F}$ condenser as mentioned above.

A little examination of the circuit will show if a receiver uses the arrangements in Fig. 1, Fig. 2, or Fig. 3. The actual gang tuning condenser capacity may, of course, be different from that shown. But in home-constructed circuits it is essential to use the aerial, oscillator coil, tuning condenser, and padder values specified, or alignment may be impossible.

Dual-Wave Circuit

Fig. 4 shows a dual-wave circuit in which individual coils are provided for M.W. and L.W.

(Continued on page 1153)

D. & B. TELEVISION

Phone: Cherrywood 3955
Dept. A4 131 & 131a KINGSTON ROAD
SOUTH WIMBLEDON, LONDON, S.W.19
"Compare our prices with any others"

For the **FINEST, FASTEST SERVICE** in the COUNTRY We are open from 10 a.m. Until Midnight. (1 p.m. Wednesday.) For any information or problems you have, Call or Phone, we are always pleased to help.

NEW!
SEND FOR OUR COMPREHENSIVE L.O.P.T. Scan Coil L.B.O., F.B.O., F.O.P.T. LIST. Prices of nearly all makes and models, 2/6, post 6d. Invaluable as a service aid. The finest list ever compiled.

HUGE PURCHASE ENABLES US TO SELL TRANSISTORS AT THESE ASTONISHING PRICES

Mullard: OC44, 9/-; OC45, 8/-; OC70, 6/-; OC71, 5/-; *OC72, 6/-; OC76, 7/-; OC78, 7/-; *OC81, 7/-; OC81D, 6/-.
G.E.C.: GET874, 8/-; GET873, 7/6; *GET114, 5/-.

* Available in matched pairs at 1/- extra.
Mullard Diodes: OA70, 2/9; OA79, 2/9; OAB1, 2/9; OA91, 3/6.
G.E.C.: GEX34, 3/3.

TURRET TUNERS, Various Makes: 10, 16, 38 Mc/s. 40/-.
EKCO 221/283 TUNERS special price £2.10.0 including valves.

| EXAMPLE OF TRANSFORMER LIST | | L.O.P.T. | | SCAN COILS | |
|-----------------------------|--------------------|----------|--------|-------------|--------|
| | | (New) | (Used) | (New) | (Used) |
| EKCO | 221, 283 | 57/9 | 30/- | — | — |
| | 284, 231 | 57/9 | — | — | — |
| | 311, 327, 310, 326 | 57/9 | — | — | — |
| FERGUSON: | | (New) | (Used) | (New) | (Used) |
| | 103T, 105T | 69/9 | 35/- | 60/- | 35/- |
| | 992/4/6/8 | 69/9 | 35/- | 60/- | 35/- |
| PYE: | | (New) | (Used) | (New) | (Used) |
| | V4, VT4, V7 | 55/- | 35/- | 55/- | 35/- |
| | V77, CTM4 | 55/- | 35/- | 55/- | 35/- |
| MURPHY: | | (New) | (Used) | (Used only) | |
| | V214, V240, V250 | 68/6 | 35/- | 45/- | |

REGUNNED CATHODE RAY TUBES
all with 12 months' Guarantee
ALL MAKES: 12in., £3.15.0; 14in., £4.5.0; 17in., £4.15.0.
ADD: 10/- for 90°, 15/- for 110°,
5/- for Electrostatic Types.

10/- allowance on old tube if in good condition.
ALL VALVES ARE SOLD SUBJECT TO FULL GUARANTEE

| CURRENT VALVE LIST | | | | | | | | | | | |
|--------------------|------|-------|------|-------|------|--------|------|-------|------|-------|------|
| AZ31 | 8/6 | ECC85 | 7/6 | KT36 | 8/6 | SP61 | 2/9 | U08 | 14/6 | 705 | 6/9 |
| B36 | 6/8 | ECC90 | 8/- | KT61 | 8/3 | U22 | 6/6 | U09 | 6/8 | 708 | 7/- |
| CB1L1 | 19/- | ECH21 | 12/3 | KT63 | 6/3 | U24 | 10/- | UY41 | 6/- | 787 | 8/9 |
| CH38 | 12/8 | ECH35 | 9/- | KTW61 | 5/9 | U25 | 12/- | UY85 | 6/6 | 7Y4 | 6/9 |
| CL33 | 10/- | ECH42 | 8/8 | KTW63 | 5/8 | U28 | 9/6 | W77 | 4/- | 10FL | 4/8 |
| L77 | 3/- | ECH81 | 7/8 | L83 | 2/9 | U31 | 7/7 | Z77 | 3/- | 10CL1 | 10/- |
| DAF91 | 4/6 | ECL39 | 6/9 | PCC84 | 7/- | U37 | 18/5 | S04 | 4/9 | 10C22 | 13/- |
| DAF96 | 6/8 | ECL82 | 9/3 | PCC89 | 8/9 | U50 | 5/6 | SV4 | 8/9 | 10P13 | 8/9 |
| DF91 | 3/3 | ECL83 | 11/9 | PCF80 | 7/7 | U52 | 5/6 | SY3 | 5/9 | 10P14 | 8/9 |
| DF96 | 6/8 | EF39 | 4/3 | PCF89 | 7/9 | U91 | 9/- | S24 | 10/- | 12AT6 | 7/3 |
| DH63 | 6/- | EF60 | 1/3 | PCF86 | 14/8 | U281 | 9/- | 8AL5 | 3/- | 12AT7 | 4/8 |
| DH77 | 4/6 | EF80 | 4/8 | PCL82 | 7/- | U282 | 14/6 | 8AM6 | 3/- | 12AU7 | 7/8 |
| DK91 | 6/6 | EF85 | 6/3 | PCL83 | 9/9 | U301 | 1/6 | 8AT8 | 5/8 | 12AX7 | 6/3 |
| DK92 | 7/- | EF86 | 8/9 | PCL84 | 7/- | U501 | 22/- | 8B36 | 12/- | 19B06 | 14/6 |
| DK95 | 6/8 | EF89 | 6/8 | PCL85 | 15/- | UABC80 | 8/8 | 8B36 | 7/6 | 20D1 | 8/8 |
| DL91 | 7/8 | EF91 | 3/- | PL33 | 9/- | UAF42 | 3/- | 6C06 | 25/6 | 20P2 | 8/8 |
| DL92 | 5/8 | EF92 | 4/- | PL36 | 9/9 | UB41 | 7/9 | 6D2 | 3/- | 20L1 | 12/8 |
| DL94 | 6/8 | EL33 | 7/8 | PL33 | 14/6 | UBC41 | 7/9 | 6F1 | 4/6 | 20P3 | 12/- |
| DL94 | 6/8 | EL38 | 12/- | PL31 | 8/8 | UBC41 | 7/9 | 6F12 | 3/- | 20P4 | 14/6 |
| EABC80 | 7/8 | EL41 | 7/9 | PL32 | 6/8 | UBC41 | 7/9 | 6F13 | 6/8 | 20P5 | 14/6 |
| EA94 | 7/8 | EL54 | 6/9 | PL33 | 6/8 | UBC41 | 7/9 | 6F14 | 9/- | 20P6 | 14/6 |
| EB41 | 6/8 | EM40 | 8/8 | PL34 | 8/9 | UBC41 | 7/9 | 6F15 | 8/8 | 20P7 | 14/6 |
| EB91 | 3/- | EM81 | 8/6 | PY31 | 7/- | UCP80 | 14/6 | 6F16 | 9/- | 27A0 | 14/- |
| EB93 | 4/6 | EM84 | 8/6 | PY32 | 10/- | UCF42 | 7/9 | 6F18 | 3/8 | 30P1 | 7/- |
| EB94 | 7/8 | EY51 | 7/9 | PY30 | 6/- | UCF42 | 7/9 | 6L1 | 12/- | 30P1 | 7/- |
| EB95 | 7/8 | EY96 | 7/6 | PY31 | 6/- | UCF42 | 7/9 | 6L8 | 9/9 | 30P4 | 7/- |
| EBF89 | 8/3 | EZ40 | 6/9 | PY30 | 6/- | UCF42 | 7/9 | 6L13 | 8/- | 30P12 | 7/8 |
| EEL31 | 20/- | EZ41 | 6/9 | PY33 | 8/- | UP42 | 3/9 | 6L19 | 4/- | 52K0 | 10/- |
| EOC81 | 4/6 | EZ80 | 6/- | PY83 | 12/- | UL41 | 7/9 | 6S7 | 4/6 | 52K0 | 10/- |
| EOC82 | 5/8 | EZ82 | 8/9 | PZ30 | 8/- | UL44 | 10/8 | 6V8 | 5/- | 54E0 | 8/8 |
| EOC83 | 6/8 | EZ84 | 12/6 | E18 | 10/- | UL46 | 7/6 | 6V8 | 5/- | 54E0 | 8/8 |
| EOC84 | 7/9 | KT33C | 6/- | BP41 | 2/8 | UL84 | 7/8 | 78U04 | 10/- | 185BT | 14/- |

These are only examples of our valves; if you do not see what you require send stamped addressed envelope for special quotation.

We pride ourselves that we can obtain and supply any TV spare. **OUR GIGANTIC STOCKS INCLUDE:** Line, Frame and Sound Output, Line and Frame Blocking, Osc., Trans., and Scan Coils for any make or model Television. Please ask us for ANY components you may require we are almost certain to have them. TERMS: S.A.E. all enquiries. C.W.O. or C.O.D. 3/- extra. Postage on Valves, 6d. each. C.R.T.S. 12/6 inc. insurance. SATISFACTION ASSURED. RETURN POST SERVICE.

SOLDERING EQUIPMENT

by **LITESOLD**
1962 TRADE MARK

PRECISION SOLDERING for the ELECTRONICS INDUSTRY



Comprehensive range - Robust & Reliable
- Light weight - Rapid heating - Bit sizes 3/32in. to 3/8in. - 'Permatic' or Copper bits - All voltage ranges 6/7v. to 230/250v. - Prices from 21/-.

- Also
- Plastic Cable Strippers
 - Miniature Solder Pots
 - Heat Guards
 - Long Life Bits

Illustrated is the 25w. 3/16in. replaceable bit model with safety shield.

ADAMIN—new range of precision micro-soldering instruments—Have you had details?

Brochure No. S10 sent free on request. Sole proprietors and manufacturers: LIGHT SOLDERING DEVELOPMENTS LTD.

28 Sydenham Road, Croydon, Surrey
Phone: CROYdon 8589 Grams: Litesold Croydon

GIVE YOUR RADIO A PROFESSIONAL FINISH



SET OF LUSTRE CRYSTAL PLASTIC KNOBS, PUSH-ON TYPE, SUITABLE FOR ANY RADIO OR RADIOGRAM.

- Diameters: Large 2 1/2in., Small 1 1/2in.
- | | | |
|--|---|-----|
| 47/48 | Three knobs, as illustrated, for direct drive tuning, with attractive red centre discs..... | 7/6 |
| 46/48 | As above, with cursor dial for slow-motion..... | 8/6 |
| 49 | Tuning scale, diameter 2 1/2in., lustre gilt finish, printed MW and LW stations and wavelengths in red and black..... | 2/6 |
| | Above knobs, with smart gold lustre centres, extra per set..... | 1/- |
| RADIO CASE TRIMMINGS AND COMPONENTS | | |
| 51R | Case handle brackets, red plastic, to suit fin. flexible handle, 4 BA x 1/4 in. fixings..... | 2/3 |
| 51G | Brackets as above, but brilliant gilt lustre finish pair..... | 2/6 |
| 52R | Speaker escutcheon grille, red plastic, 5in. x 3in..... | 3/6 |
| 52G | Grille as above, but attractive gilt lustre finish..... | 4/6 |
| 59 | Feet for case, black plastic, 1/4 in. x 1/4 in..... Set of 4..... | 1/8 |
| 55G | Personal set escutcheon, 4in. x 3in. brilliant gilt finish..... | 3/- |
| 54 | Tuning knob for above, edge control, 200-500M and long..... | 1/9 |

TRANSISTOR RADIO CASE
Complete set of parts for home assembly of smart fabric-covered case, 10 x 9 x 3 1/2ins., with gilt escutcheon and handle brackets, strap handle and feet. Full assembly instructions. No skill required, £1.5.0.

Six transistor Basic components, as previously advertised, still available, 55/-. Circuit diagrams and manual, 2/6. Send S.A.E. for full list of transistor components. Trade and export enquiries invited. Prompt despatch. No C.O.D. under £2 in value. Please include postage.

NOMBEX LTD. (DEPT. P.8) Phone: 3515
Estuary House, Camperdown Terr., Exmouth, Devon

(Continued from page 1150)

reception. When the switch is in the M.W. position, the circuit is effectively the same as already described, the L.W. part of the aerial being shorted to avoid absorption effects. With the receiver switched to the M.W. band, alignment or other defects can be checked as already explained.

When the receiver is switched for L.W. reception, the larger L.W. aerial windings are in circuit. The 180pF fixed condenser, with 50pF trimmer, is switched across the oscillator coil, to lower the frequency for L.W. reception.

To secure best results with this type of circuit on the L.W. band, align for best M.W. reception first. The two L.W. trimmers are then adjusted at a fairly high frequency on the L.W. band, and the position of the L.W. aerial winding on the rod is adjusted at a fairly low frequency. Adjustments should be repeated a few times.

Due to the small tuning capacity, the L.W. band will frequently be slightly restricted, but a coverage of about 1,100m to 1,900m is generally possible.

Adjustments to the oscillator coil core or oscillator trimmer will affect L.W. results, so that re-adjustment of the L.W. trimmers and coil will be necessary. It is for this reason that the set is aligned on M.W. first.

Simplified Switching

A dual-wave circuit with much simplified switching is shown in Fig. 5. Here, T1 is the oscillator trimmer, and T2 is the aerial trimmer. These trimmers are adjusted on the M.W. band, in the way already described.

Tracking at the low-frequency (high wavelength) end of the M.W. band is obtained by adjusting the position of the M.W. winding on the aerial rod, and by means of the oscillator coil core, as explained.

With the set switched to L.W., T3 allows adjustment of the oscillator circuit, and T4 permits trimming of the aerial circuit. The position of the L.W. winding on the rod is adjusted at the low-frequency (high wavelength) end of the band, as explained.

Remember that all adjustments should be repeated a few times, to obtain optimum results. When two windings are in series for L.W. reception, as in Fig. 5, it is essential they be in the same "sense". To check this, begin at point X and proceed to the junction of M.W. and L.W. sections, and from there to Y. All turns should be in the same direction. That is, there must not be a reverse in direction at the junction of the

coils. It is also essential that the tapping is near the end Y.

Fault Symptoms

If the points described have been checked, it is not likely that any fault can remain. But if alignment seems very difficult, the following points may help correct this.

If one trimmer has to be screwed hard down, the companion trimmer in the other circuit may be set at too great a capacity. For example, if T2 in Fig. 5 requires to be hard down, it may be desirable to unscrew T1 slightly, then readjust T2. Similarly, if one trimmer is fully open, this may arise because the companion trimmer is too far unscrewed. If so, readjust this trimmer. Ideally, all trimmers should peak up for best sensitivity at some intermediate setting—not fully closed, nor fully open.

If a winding is found to be too far off the aerial rod for aligning at a low frequency, the oscillator coil core is probably too far out of the coil.

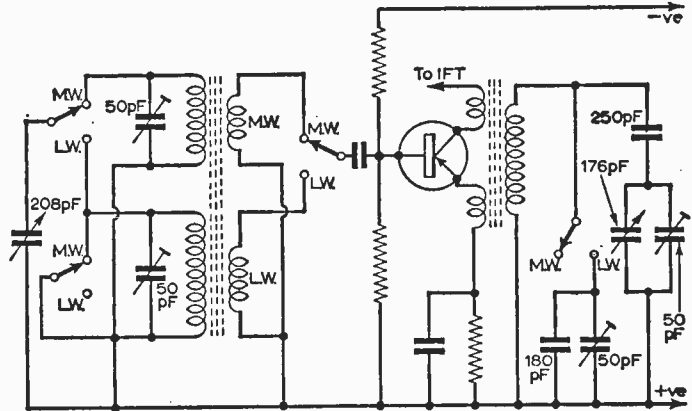
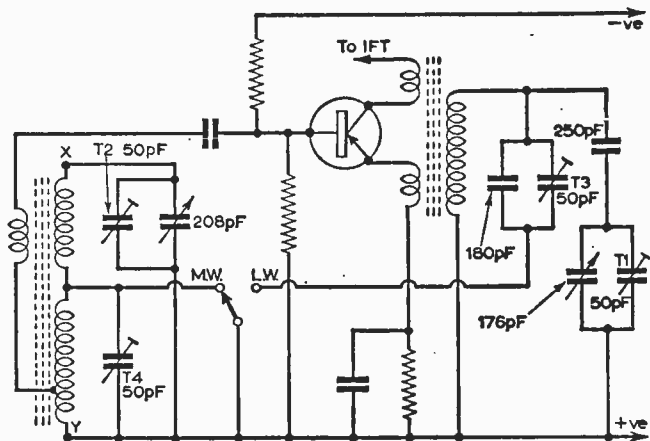

Fig. 4 (above)—A dual-wave circuit with individual aerial coils.

Fig. 5 (below)—A simplified circuit with dual-wave switching.



It should be screwed in a $\frac{1}{4}$ -turn or $\frac{1}{2}$ -turn or so, and it should then be possible to slide the winding back on to the aerial rod. Insufficient *padding* capacity causes the same trouble.

Trimmers or other adjustments which are for L.W. alignment only should not be confused with those used for M.W. adjustments, or the whole process may become very confused and difficult.

In most transistor sets of this kind, tuning values and stray capacities are very small indeed. It is important to avoid unnecessary stray capacity in wavechange switching, or wiring. If not, it may

is shown in Fig. 6, but many other circuits exist. Here, it will be seen that the first transistor acts as mixer only, and the aerial, or signal-frequency circuit is similar to that in Fig. 2. Defects in the mixer stage may cause low sensitivity, but this stage is less critical than the oscillator.

The oscillator shown operates in the common base mode. Trimming and alignment will be as already described. The 25pF or similar feedback condenser is adjusted, if necessary, to obtain proper results throughout the band. A test for oscillation can be made as described for Fig. 1.

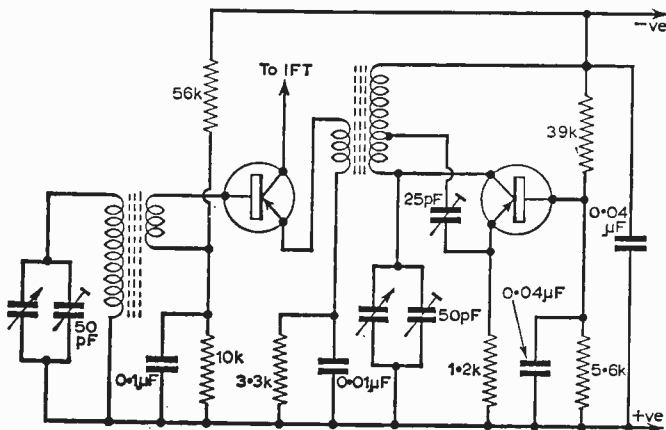

Fig. 6—Separate mixer and oscillator stages.

be impossible to trim the circuit correctly, or whistles, squegging, and other troubles may arise. Adequate separation of aerial and oscillator circuits and wiring is very necessary.

Separate Oscillator

Some receivers, especially those for short wave use, have a separate oscillator. A typical circuit

of wiring and components, and sufficient R.F. filtering in the early A.F. circuits, will help prevent this.

In the mixer stage itself, leads should be short and direct. Trimmers and wiring in the aerial circuit should be adequately spaced from components and wiring in the oscillator circuit. The oscillator coil screen should be connected to the positive, or earth line of the receiver. ■

Plastic Film Capacitors

TWO entirely new types of plastic film capacitor, with improved characteristics and designed to work under conditions of extreme humidity, are now included in the G.E.C. range offered by Salford Electrical Instruments Ltd. They are a sealed polyester capacitor, type A596, and an encapsulated polystyrene capacitor, type A597.

The polyester capacitor, type A596, has an extended range of temperature working and is available in the range 0.05μF to 2.0μF with a rated D.C. working voltage of 150. This capacitor has been developed to meet the requirements for a non-metallic cased capacitor with a high insulation resistance, good charge retention characteristics and a high stability of capacitance over a wide range of ambient temperature. The sealing and construction of the capacitor ensure that it will meet the H.I requirements of the pro-

posed B.S. specification for polyester capacitors.

The polystyrene capacitor type A597 is available in the range 150pF to 510,000pF at D.C. voltage ratings of 125, 350 750 and 2,000. An important characteristic of this range of capacitors is the close control of temperature co-efficient that is achieved. The A597 is fully encapsulated and will meet the H 1 humidity requirements of RCS 137. Salford Electrical Instruments Limited, Peel Works, Silk Street, Salford 3, Lancashire.

CORRECTION

The full page advertisement of Daystrom Ltd., Gloucester, which appeared in the March issue of PRACTICAL WIRELESS, unfortunately contained two errors. The price of the "Shortwave transistor portable—Model RSW-1" should have been £22 10s. 0d. and not £72 10s. 0d.; and the illustrations of the Models GC-1U and DX-100U were transposed.

5 "Technically Luxurious" HI-FI TAPE UNITS TO CHOOSE FROM

▶ **MODEL PD83**
Professional 2-Track
£48.10.0



▶ **MODEL PD82**
Standard 2-Track
£42.0.0

▶ **MODEL PD84**
Standard 4-Track
£46.0.0

▶ **MODEL PD85**
Professional 4-Track
£52.10.0

▶ **MODEL PD86**
STEREO
£63.0.0

The most economical way to add tape to your existing system. These units consist of a "Series 80" Deck with pre-amp and recording amplifier, push-pull erase bias oscillator and power supply, all mounted in an attractive plinth. Easy connection to mains and hi-fi amplifier, radiogram or even good class radio. Precision engineered by Truvox—the ideal add-on unit.

TRUVOX **80**
SERIES

Full technical details from

TRUVOX LTD., NEASDEN LANE, LONDON, N.W.10. (Dollis Hill 8011)

HOME RADIO OF MITCHAM

(Dept. P), 187 London Road, Mitcham, Surrey.
 MIT 3282
 Shop hours 9 a.m. to 6.30 p.m., Wed, 9 a.m. to 1 p.m.

NOMBREX SIGNAL GENERATOR

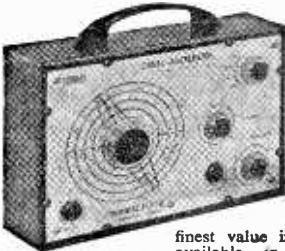

Completely portable transistor signal generator covering 200 Kc/s to 220 Mc/s in eight ranges. Built to highest standards and the finest value in instruments available in the world.

Accuracy better than 2% on all ranges. RF output modulated or unmodulated. Audio output 1 Kc/s. Weighs under 2 lb. and size only 6½ x 4½ ins. An essential test instrument for all engineers and constructors. I

PRICE £7.12.0, complete with battery. Post and packing 1/6.

CABY MODEL M.I. TESTMETER

New compact moving coil Testmeter at a very competitive price.

RANGES:
 AC 6, 30, 120, 600, 1,200 volts
 DC 6, 30, 120, 600, 1,200 volts
 DC 30 & 300 milliamps.
 Resistance—0—100,000 ohms.

Accuracy 3%
 Sensitivity 2,000 ohms per volt.

Ideal instrument for the service engineer, experimenter, and constructor. Supplied complete with test prods, instructions, and battery.

PRICE 54/- post 1/6

WE ALSO STOCK TEST METERS AND GEAR BY AVO, TAYLOR, PULLIN, etc.

SUPER CATALOGUE 2/- post 9d.

REPANCO COMPONENTS

Transformers TT45, TT46, TT47, and TT48 5/- each. Coils XMA43, XMF42, XMF44, 7/6 each. Aerials FS48 7/6, FR2 12/6, Chokes CH1 2/6. ALL OTHER REPANCO COMPONENTS IN STOCK. TRANSISTOR TYPE SB305. AVAILABLE Price 6/6.

WE ARE ACTUAL STOCKISTS FOR HEATHKITS

NEW GOODMAN'S SPEAKERS

AXIETTE 8in. £5.10.0

AXIOM 10in. £6.2.6

S.A.E. FOR LEAFLET

WE CARRY FULL RANGE OF EDDYSTONE RECEIVERS AND COMPONENTS

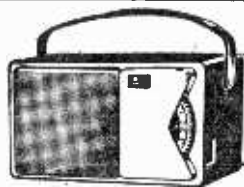

P.W. BLUEPRINTS

P.W. TRANSISTOR SIX

Now available in the new style modern streamlined case. 6 transistor superhet on printed circuit for easy assembly. Ferrite rod aerial and 2½in. speaker. Equal to commercial receiver. Pocket sized but with excellent performance and quality. FULL CONSTRUCTIONAL DATA 1/6, post 9d. COMPLETE KIT OF PARTS with brand new Mullard transistors £8.19.6, post 1/6. All parts available separately.

All parts in stock for these designs including TUTOR, MINI-AMP, CITIZEN, MINUETTE, TRANSISTOR SIX, etc., S.A.E. for lists.

VALVES SAME DAY SERVICE

NEW! TESTED! GUARANTEED!

SETS

1R5, 1R5, 1T4, 834, 3V4, DAF9, DFR1, DK1, DL2, DL4 .. Set 4 for 19/6
 DAF9, DFR, DK8, DL2 4 for 27/6

| | | | | | |
|------------|-------------|-------------|------------|------------|-------------|
| 1A7GT 11/- | 6L19 12/- | 30C15 13/6 | EBC41 8/- | EZ41 7/- | U50 6/- |
| 1D5 8/- | 6LD20 8/- | 30FL10 10/- | EBF80 8/- | EZ80 6/- | U52 4/6 |
| 1H6GT 9/- | 6P1 10/- | 30F5 7/- | EBF89 8/9 | EZ81 6/6 | U78 4/6 |
| 1N5GT 8/- | 6P25 5/6 | 30L15 11/- | EBL21 13/6 | KT39C 7/- | U191 14/6 |
| 1R5 8/- | 6P28 12/- | 30PL1 10/- | EC040 15/- | KT41 11/8 | U251 12/- |
| 1S4 8/- | 6Q7G 6/- | 30P4 11/- | ECC81 5/- | KT44 5/9 | U281 17/6 |
| 1S5 5/3 | 6Q7GT 8/6 | 30P19 14/6 | ECC82 6/3 | KT61 9/6 | U291 16/6 |
| 1T4 3/6 | 6SL7GT 5/9 | 35A5 14/6 | ECC83 7/3 | KT63 6/6 | U301 18/9 |
| 1U5 5/9 | 6SN7GT 4/9 | 35L6GT 8/3 | ECC84 8/3 | MU14 6/8 | UABC80 6/6 |
| 3A5 8/- | 6U4GT 9/9 | 35Z4GT 8/3 | ECC85 7/9 | MX40 14/- | UF42 8/3 |
| 3Q4 7/- | 6V6G 4/6 | 35Z5GT 8/3 | ECC86 7/6 | N18 7/- | UB41 8/6 |
| 3S4 6/- | 6V6GT 6/6 | 50CD8G 27/3 | ECP82 8/6 | PC95 10/- | UBC41 7/9 |
| 3V4 7/- | 6X4 4/6 | 50L8GT 8/3 | ECH21 13/6 | PCC84 7/6 | UBF90 8/3 |
| 5U4G 4/6 | 6X5GT 4/9 | AZ31 9/6 | ECH35 6/3 | PCC99 9/3 | UF89 8/- |
| 5V4G 7/6 | 7B8 8/6 | B36 9/6 | ECC42 8/9 | PC'80 7/9 | UC24 19/3 |
| 5Y3GT 6/- | 7B7 7/6 | CL33 12/3 | ECH81 7/9 | PCF82 8/- | UC85 8/6 |
| 5Z4G 9/- | 7C5 7/6 | DAC32 9/- | ECL80 7/6 | PCF86 14/- | UCF80 14/6 |
| 6AL5 3/9 | 7C8 7/6 | DAF91 5/3 | ECL82 9/- | PCL82 9/- | UCH21 13/6 |
| 6AM6 3/6 | 7H7 7/6 | DAF98 7/6 | EF39 4/6 | PCL83 11/6 | UCH42 8/9 |
| 6AQ5 8/- | 7S7 8/- | DCC90 9/- | EF34 12/6 | PCL84 10/- | UCR31 8/9 |
| 6AT8 6/9 | 7Y4 6/- | DF33 9/- | EF41 4/9 | PCL85 13/6 | UCL82 8/9 |
| 6BA6 5/9 | 10C1 12/- | DF91 3/6 | EF80 4/9 | PENA4 11/- | UCL83 13/3 |
| 6BE6 5/9 | 10P13 14/6 | DF98 7/6 | EF85 4/9 | PEN36C 8/- | UF41 7/6 |
| 6BH6 5/9 | 12AT6 7/6 | DH78 4/9 | EF88 9/9 | PL36 11/6 | UF42 5/6 |
| 6BQ6 5/9 | 12A7 5/- | DH77 6/9 | EF99 6/9 | PL41 9/6 | UC24 18/6 |
| 6BR7 12/6 | 12AU7 6/3 | DK32 11/- | EF91 3/6 | PL82 9/- | UL41 8/- |
| 6BW8 8/- | 12AX7 7/- | DK91 6/- | EF92 3/9 | PL83 7/6 | UL84 6/6 |
| 6CD6G 27/3 | 12K7GT 4/9 | DK92 7/6 | EL33 9/6 | PL84 8/6 | UM4 14/- |
| 6F1 10/- | 12Q7GT 8/6 | DK98 7/6 | EL41 9/6 | PC32 11/6 | UR1C 8/- |
| 6F8G 8/6 | 12Q7GT 8/6 | DL33 8/- | EL42 9/- | PY30 7/6 | UR21 8/6 |
| 6F13 10/- | 12SN7GT 7/6 | DL35 9/6 | EL34 6/6 | PY81 7/- | UY41 13/6 |
| 6F14 10/- | 12Z3 10/6 | DL92 6/6 | EM34 6/9 | PY82 6/6 | UY85 6/6 |
| 6F22 10/- | 14S7 19/6 | DL94 7/6 | EM80 8/- | PY83 7/9 | VP4B 9/6 |
| 6K7G 11/6 | 20P2 17/- | DL98 7/6 | EM21 5/- | T41 9/6 | VP41 5/- |
| 6K9GT 5/- | 20L1 17/- | EAB80 5/6 | EM94 9/6 | P22 7/9 | VP1321 16/6 |
| 6KB9 5/- | 25A6G 8/- | EAF42 8/6 | EY51 7/6 | U24 17/6 | W76 4/9 |
| 6K9GT 9/- | 25L6GT 7/9 | EB91 3/9 | EY36 7/9 | U25 12/- | W77 3/9 |
| 6L18 10/- | 25Z4G 8/6 | EBC33 5/- | EZ40 6/9 | U28 10/- | ZT7 3/6 |

READERS RADIO
 24, COLBERG PLACE, STAMFORD HILL,
 LONDON, N.16 STA. 4587

1962 EDITION RADIO AMATEUR'S HANDBOOK

36/- by The A.R.R.L. Post 2/6

- WORLD RADIO TV HANDBOOK 16th ed. 1962, 18/9. Postage 1/-.
- TELECOMMUNICATIONS. PRINCIPLES & PRACTICE by W. T. Perkins, 21/-. Postage 1/-.
- THE AMATEUR RADIO HANDBOOK. R.S.G.B., 34/-. Postage 2/-.
- THE ALL-IN-ONE TAPE RECORDER BOOK, by J. M. Lloyd, 12/6. Postage 6d.
- TRANSISTOR SUPERHET RECEIVERS by C. Sinclair, 7/6. Postage 6d.
- RADIO VALVE DATA, Compiled by "WW" 7th Ed. 1961. 6/-. Postage 10d.
- VALVE & TELETYPE MANUAL No. 9, by Brimar, 6/-. Postage 1/-.
- COMPLETE CATALOGUE, 1/-.

THE MODERN BOOK CO.

BRITAIN'S LARGEST STOCKISTS of British and American Technical Books
 19-21 PAED STREET
 LONDON, W.2
 Phone: PADdington 4185
 Open 6 days 9-6 p.m.

Club News

REPORTS OF CURRENT ACTIVITIES

AMATEUR RADIO SOCIETY OF CHESHAM AND DISTRICT

Hon. Sec.: R. J. Hopkins, G3NLX, 16 Glenister Road, Chesham, Buckinghamshire.

A summary of 1961 shows an increased membership and during the last quarter of the year three members obtained licences.

The first training course for 1962 commenced in February.

EXETER AMATEUR RADIO SOCIETY

Hon. Sec.: S. Line, 46 Roseland Crescent, Heavitree, Exeter, Devon.

The Annual General Meeting, held on January 2nd, was well attended, and after the formal business had been dealt with, members heard an interesting talk on chassis construction, aluminium soldering and receiver design, by J. Bright.

Club meetings are held on the first Tuesday of each month, at the Y.M.C.A., St. Davids Hill, Exeter, and commence at 7.30 p.m.

MANCHESTER AND DISTRICT AMATEUR RADIO SOCIETY

Hon. Sec.: A. B. Langfield, 2 Rowland Street, Moston, Manchester 10.

At the recent Annual General Meeting, Mr. Niman was elected chairman, Mr. A. B. Langfield elected secretary and Mr. F. Collinge elected treasurer.

The annual constructors competition was also judged at this meeting, and prizes in the adult section went to G3PJK, G3MYR and G80J. Prizes were also awarded to three members in the junior section.

Future Events:

March 21st—Morse and R.A.E. instruction.

March 14th—Practical construction.

March 28th—Radio theory lecture.

NORTHERN HEIGHTS AMATEUR RADIO SOCIETY

Hon. Sec.: A. Robinson, G3MDW, Candy Cabin, Ogdon, Halifax.

The first Annual General Meeting, held recently, was attended by a large number of members.

Future Events:

March 21st—Mobile equipment described by G3GJV.

PURLEY AND DISTRICT AMATEUR RADIO CLUB

Hon. Sec.: E. R. Honeywood, G3GKF, 105 Whytecliffe Road, Purley, Surrey.

On March 16th, the club will be holding an exhibition and competition of members' home constructed equipment. The competition is designed for every class of entry and cash prizes will be awarded to the winning exhibits.

The club holds its meetings on the first and third Fridays of each month.

SLADE RADIO SOCIETY

Hon. Sec.: C. N. Smart, 110 Woolmore Road, Erdington, Birmingham 23.

On February 9th members heard an interesting lecture on the use of transistors in radio receivers, given by Mr. R. A. Lampitt. On February 23rd, members held a sale of surplus equipment. At Thursday evening meetings, instructional morse classes are given, and slow morse transmission are radiated each Monday evening.

Future Event:

March 9th—Film show.

SOUTH YORKSHIRE AMATEUR RADIO SOCIETY

Hon. Sec.: M. E. Brailsford, 15 Ayrsoe Walk, Cantley 4, Doncaster.

At the recent Annual General Meeting, J. Clonell was elected chairman, L. Bennett elected treasurer and Margaret Brailsford elected secretary.

January 25th was Quiz Night and on February 8th, G3IHC gave a talk on simple aerials. "The junction transistor in radio receivers" was the title of the film shown to members on February 22nd.

Future Event:

March 8th—Basic principles of radar.

SUTTON COLDFIELD RADIO SOCIETY

Hon. Sec.: L. E. R. Hall, G3IGI, 24 Calthorpe Road, Walsall.

At the meeting on February 8th, test instruments and their construction was the subject discussed by W. V. Sutton, K. M. Varney and L. E. R. Hall.

Future Events:

March 8th—D.F. receiver construction, by G. Collins.

April 12th—Equipment Sale.

FREE!

ANOTHER DOUBLE-SIDED
BLUEPRINT

inside the MAY ISSUE!

Two-valve mains-operated receiver, with coverage of medium and long waves, and provision for using it with a record-player.

Six-transistor superhet battery-operated receiver, covering medium and long waves. Very sensitive and selective, comparing favourably with many commercial sets.

Coming!

Another invaluable Double-Sided BLUEPRINT will be presented FREE inside the June issue

With detailed instructions to build these grand sets:—

Practical WIRELESS

ORDER FROM YOUR NEWSAGENT NOW!

The TRUVOX

Hi-Fi TAPE UNIT Model PD.82

A NEW series of tape recorders has recently been marketed by Truvox Limited and two models in this series will be of particular interest to hi-fi enthusiasts. Many readers of this magazine no doubt have their own radio and record reproduction system which they themselves have constructed from designs published in our pages. Probably the majority of these readers have often thought about acquiring a tape recorder to add to the installation but have been deterred because generally only complete tape recorders were easily obtainable—these would include an internal loudspeaker and complete audio amplifier which, although of high quality, might not compare with the constructor's existing equipment.

Of course, many constructors have assembled, and sometimes designed, their own tape recorders using a commercial deck as a basis and built a tape pre-amplifier and bias and erase unit for use with the deck. However, this is a procedure which many constructors feel is beyond them and while they are quite prepared to build their own hi-fi amplifier and its associated pre-amplifier, they are not prepared to attempt to build a tape pre-amp in which construction is more critical—in particular, it is often very difficult to obtain a satisfactorily low hum level in home-built equipment.

There has thus been a need for the manufacture of a tape deck with its own internal pre-amp and bias and erase unit. This need was realised by Truvox who have included, in their new Series 80 of tape recorders, two "tape units", one twin-track and one four-track. The PD82, which we have had the opportunity of testing, is the twin-track tape unit and consists of a Truvox twin-track tape deck and an integral pre-amp unit suitable for coupling to a hi-fi amplifier. The pre-amp/erase and bias unit uses four valves, a germanium diode,

a "metal" H.T. rectifier and a silicon subsidiary H.T. rectifier. The high gain stage uses an EF86 and is followed by an ECC81. The oscillator circuit uses two halves of an ECC82 in a push-pull circuit which, of course, reduces harmonic distortion in the bias signal which in turn improves the signal-to-noise ratio of the recordings. The recording level indicator is an EM87.

The tape unit features two inputs of differing



The Truvox tape recorder.

(high and low) sensitivities. The sensitivities are 1mV at 2M and 150mV at 500k for the high and low inputs respectively.

The frequency response of the deck is very good, the makers' specification giving 40c/s to 12,000c/s +3dB at 3½in./sec and 40c/s to 20,000c/s +3dB at 7½in./sec. Two outputs are provided for feeding to an amplifier or headphones.

(Continued on page 1165)

THE *Common*  *Core* SERIES

COMMON-CORE

ILLUSTRATED COURSES OF ELEMENTARY TECHNICIAN TRAINING

BASIC ELECTRICITY (5 PARTS)

- PARTS 1 AND 2: D.C. CIRCUITS
- PARTS 3 AND 4: A.C. CIRCUITS
- PART 5: A.C. AND D.C. MACHINES

"... The publishers of this set of books describe them as a 'brilliant new illustrated course' in the subject, and I am inclined to agree with them."

"The A.E.U. Monthly Journal"

BASIC ELECTRONICS (6 PARTS)

- PART 1: POWER SUPPLIES AND RECTIFIERS
- PARTS 2 AND 3: AMPLIFIERS AND OSCILLATORS
- PARTS 4 AND 5: TRANSMITTERS AND RECEIVERS
- PART 6: FREQUENCY MODULATION: TRANSISTORS

"... Every technical phrase is clearly explained and very little mathematics is used. Beginners starting a study of radio and schoolboys interested in the subject should find this an excellent book on which to start."

"The Times Educational Supplement"

BASIC SYNCHROS & SERVOMECHANISMS (2 PARTS)

IN PREPARATION

BASIC RADAR (3 PARTS)

PART 1: AN OUTLINE OF RADAR will be ready in MAY 1962

BASIC ELECTRONIC CIRCUITS

Ask your bookseller about
THE "PICTURE BOOK" WAY

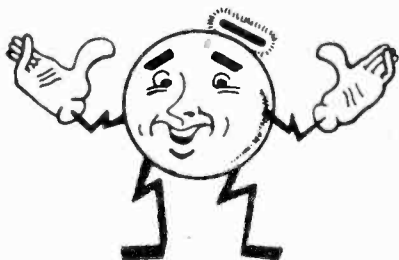

or fill in the coupon →

COUPON - SEND NOW!

To THE TECHNICAL PRESS LTD.

112 Westbourne Grove, London, W.2.

Please send me your FREE prospectus, describing "BASIC ELECTRICITY" "BASIC ELECTRONICS" and "BASIC SYNCHROS and SERVOMECHANISMS"

NAME _____

ADDRESS _____

_____ PW

WEYRAD

IMPROVED COMPONENTS FOR THE 6-TRANSISTOR
2-WAVE SUPERHET RECEIVER

NEW ROD AERIAL AND DRIVER TRANSFORMER FOR SIMPLER ASSEMBLY
AND HIGHER PERFORMANCE

ROD AERIAL—RA2W

6 in. long, 3/8 in. diameter, connections to tags
on Coils. For 208 pF tuning capacity 12/6
Cor Aerial coupling Coil 1/-

OSCILLATOR COIL—P50/1AC

M.W. covered with 176 pF tuning capacity.
L.W. by extra padder 5/4

I.F. TRANSFORMERS

1st and 2nd Stage—P50/2CC 5/7
(2 required)

3rd Stage—P50/3CC 6/-

DRIVER TRANSFORMER—LFDT4

redesigned to reduce size and improve perform-
ance. Six spills for mounting and connections 9/6

PRINTED CIRCUIT—PCA1

Size 2 3/4 in. x 8 1/4 in. Ready drilled and printed with component positions 9/6
WE CAN NOW OFFER A CIRCULAR TUNING SCALE PRINTED IN BLACK ON GOLD FOIL PRICE 6d.

CONSTRUCTOR'S BOOKLET WITH FULL DETAILS AND FREE SCALE 2/-

COILS, TRANSFORMERS AND ROD AERIAL FOR THE P.W. "CITIZEN" ... 35/- PER SET

WEYMOUTH RADIO MANUFACTURING CO., LTD.

REGENT FACTORY, SCHOOL STREET,

WEYMOUTH, DORSET

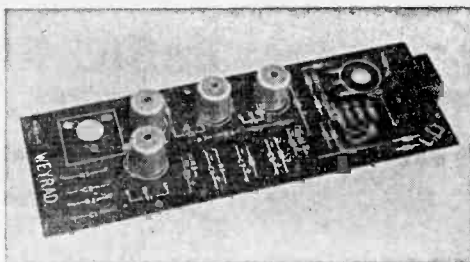

KITS THAT 'BUILD THEMSELVES'

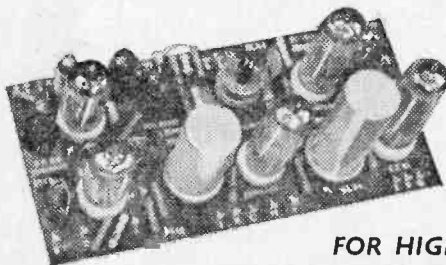

- HI-FI quality printed-circuit amplifiers, supplied checked and assembled.
- Complete with valves, transformers and everything down to wire cut to length.

Produced by the makers of amplifiers for some of today's best known recorders and backed by years of experience in audio design. The specially designed kits offered here set entirely new standards of performance and finish for the home constructor. Amplifier available separately or with case and speaker and deck. **EASY TO FOLLOW INSTRUCTIONS.** All equipment complete and guaranteed.

From radio dealers, or in cases of difficulty please write direct.

**FOR HIGH QUALITY
TWO & FOUR TRACK TAPE RECORDERS**

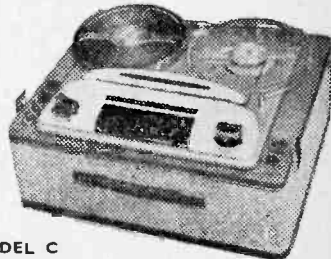

- AMPLIFIER 'C' for Collaro Studio Deck (illustrated above). 11 gns.
- Case and Speaker for above. 5 gns.
- AMPLIFIER 'A' (4-TRACK) for BSR Monardeck. 9 gns.
- AMPLIFIER 'B' (TWO TRACK) for BSR Monardeck. 8 gns.
- Two-tone covered wooden case with speaker for above. 4 gns.
- KIT 'A' with Deck, Case and Speaker. 24 gns.
- KIT 'B' with Deck, Case and Speaker. 21 gns.
- KIT 'C' with Case, Speaker and Deck (as illustrated). 28 1/2 gns.

All amplifiers supplied assembled on printed circuit boards with valves.

MODEL C

**MARTIN
RECORDAKITS**

Leaflet free on request.
Set of full instructions for
any one model 2/6d. post
free. (Allowable on pur-
chasing kit).

COUPON BRINGS DETAILS

MARTIN ELECTRONICS LIMITED,
155 HIGH ST., BRENTFORD, MIDDX.

Leaflet on Martin Recordakits please

NAME _____

ADDRESS _____

(In Block Letters.)

P.W.4

T rade N ews

PRINTED CIRCUITS—EDUCATIONAL TOYS

A NEW toy by Tri-ang—Tri-onic Electronic Construction Kit—made by Lines Bros. Ltd., uses printed circuits produced by Mills and Rockleys (Electronics) Limited, of Coventry, from copper clad Bakelite Laminate.

All components used in the kit are basically the same as those from which commercial radio and television receivers are built, and this, the manufacturers believe, will give a child the maximum amount of radio education as well as enjoyment. The radio component modules are plugged in position on the Tri-onic printed circuit boards, instead of being soldered, so that they can be dismantled quite easily when the child wishes to build a more advanced receiver.

Each printed circuit board carries an outline print in orange with the theoretical circuit symbol representing the component in its position within the outline. The component circuit numbers

are printed in a second colour which further simplifies assembly. With the help of the detailed instruction book supplied, a child can build in turn six radio receivers from the six printed circuit boards supplied with the kit.

The printed circuits are made from Bakelite Laminate produced by Bakelite Limited, 12-18 Grosvenor Gardens, London, S.W.1.

NEW MICROPHONE

A NEW compact microphone, the Sonodyne II, has recently been introduced by Shure Electronics Limited.

An unusual feature of this instrument is the variable frequency response which has been included to enable the user to select the best microphone characteristic for the application.

The microphone—model 540S—has a high output dynamic element with a frequency response of 60-10,000/c/s. The list price is £16 13s. 4d.

This is one of the latest microphones from Shure Electronics Limited, 84 Blackfriars Road, London, S.E.1.

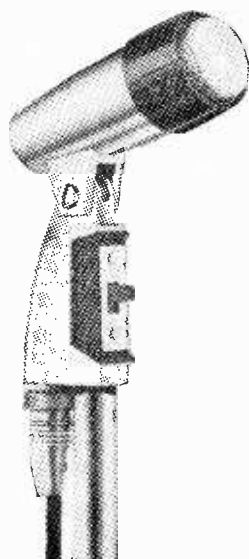

The Shure Sonodyne II microphone.

ELECTRONIC FAULT FINDER

THE model 22 Electronic Fault Finder, made by Taylor Electrical Instruments Limited, has been designed for signal tracing and rapid analysis of faults in defective receivers or audio circuits.

The instrument is particularly suitable for transistor receivers as the highly sensitive amplifiers incorporated, together with the R.F. Probe, enable a thorough investigation to be made of transistor sets from aerial to output stages. This overcomes the very difficult and often hazardous task of removing transistors for individual checking, as faulty components can be traced in a very short time whilst still in circuit.

The loudspeaker can be used to replace the speaker in the receiver either with or without the matching transformer, and the incorporated amplifier can be substituted for circuits which are suspect. The magic eye is available separately for A.C. or D.C. indication.

This new fault finder is manufactured by Taylor Electrical Instruments Ltd., Monrose Avenue, Slough.

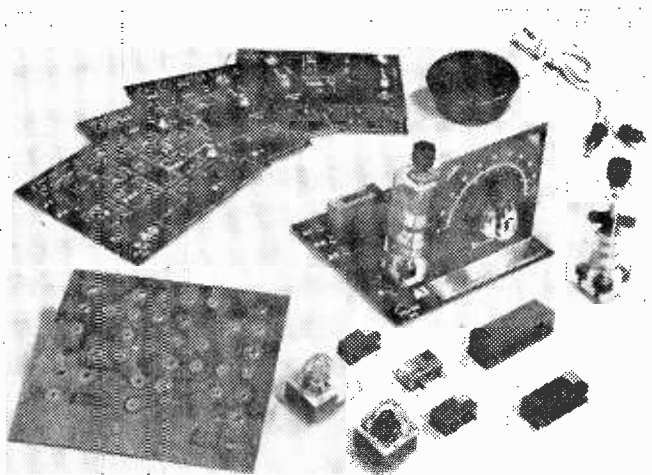

Some of the components which are included in Tri-ang's new Tri-onic Electronic Construction Kit "A".

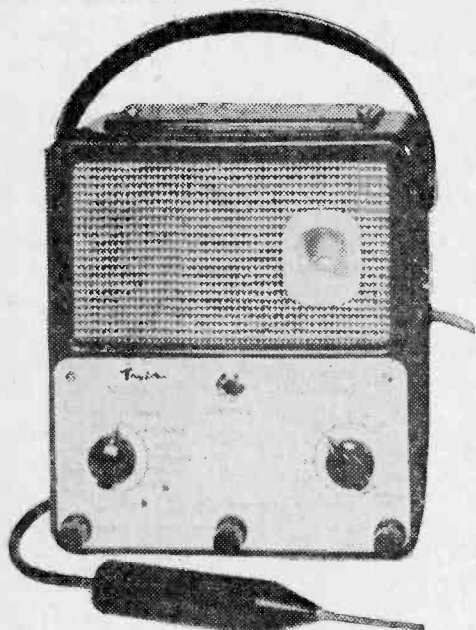

(Above)—The Taylor Electronic Fault-finder.

THERMOSTATICALLY CONTROLLED SOLDERING IRON

THIS new miniature thermostatically controlled soldering iron, has recently been developed by the Cardross Engineering Company Limited.

The iron weighs only 1½oz and is ready for use 20 seconds after being switched on. It has a 50W rating and will be made available in the following range of voltages, 12, 24, 50, 110 and 240. There is also

(Right)—Avo Transistor Analyser Mains Unit.



(Below)—The new thermostatically controlled soldering iron by the Cardross Engineering Co. Ltd.

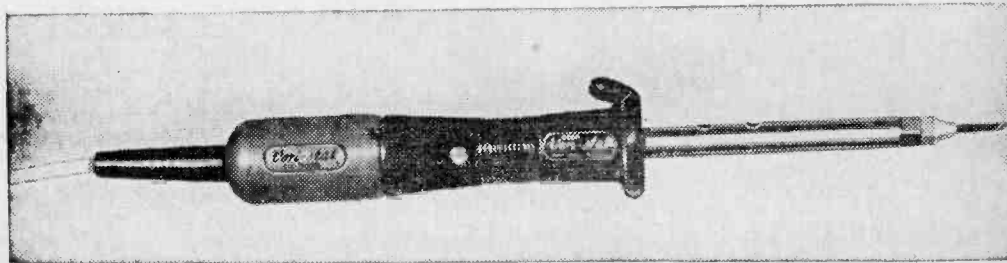

a range of bit sizes which consists of $\frac{1}{8}$ in., $\frac{1}{16}$ in. and $\frac{3}{32}$ in.

One of the principal advantages of this iron is the fact that it maintains a constant temperature which can be set to suit the requirement of the job to be done.

The price of the iron is £2 15s. 0d. and it is made by the *Cardross Engineering Company Limited, Levenford Works, Woodyard Road, Dumbarton.*

TRANSISTOR ANALYSER MAINS POWER UNIT

THIS is a new addition to the AVO range of instruments, which has been made for mains operation of the AVO Transistor Analyser.

The power supply is directly interchangeable with the existing battery unit and provides two ranges of voltage from 0.6 and 6-12 up to a continuous current rating of 1A. Provision is made for *pnp, npn* polarity reversal. The unit is fitted with an electronic cut-out which limits the maximum current drain to 1.25A thus protecting the instrument and the power unit against damage in the event of a transistor failing through short circuit. The power unit is designed for operation from 100-110V, 200-250V, 50-60c/s A.C. supply.

AVO Ltd., Avocet House, 92-96 Vauxhall Bridge Road, London, S.W.1.

★ VALVES ★ BY RETURN OF POST

THE MOST COMPREHENSIVE COMPETITIVE VALVE LIST IN THE COUNTRY

| | | |
|---------------------|---|---|
| 10% DISCOUNT | NEW LOW PRICES GUARANTEED 3 MONTHS | FREE TRANSIT INSURANCE. All valves are new or of fully guaranteed ex-Government origin. Satisfaction or Money back Guarantee on goods if returned unused within 14 days. |
|---------------------|---|---|

| | | | | | | | | | | | |
|-------|------|---------|------|---------|------|-----------|--------|--------|------|----------|------|
| 024 | 5/- | 6J5GT | 4/- | 12E1 | 17/8 | DF96 | 7/3 | EM80 | 7/9 | 8U25 | 16/- |
| 1A3GT | 5/- | 6A8 | 4/- | 12U7GT | 8/9 | DL68 | 6/- | EM81 | 8/8 | 8U2150 | 16/- |
| 1A7GT | 11/- | 6J7 | 8/6 | 12K7GT | 4/9 | DH76 | 5/5 | EM82 | 9/- | 7A1 | 7/6 |
| 1C6GT | 9/- | 6J7G | 4/9 | 12K8 | 11/- | DK32 | 11/- | EM85 | 10/- | TD4 | 7/8 |
| 1D5 | 8/- | 6J7GT | 7/6 | 12N8GT | 9/8 | DK91 | 5/6 | EN31 | 16/- | U14 | 8/- |
| 1D5GT | 9/8 | 6A8 | 8/6 | 12Q7GT | 5/- | DK92 | 7/- | EY51 | 7/1 | U18 | 8/- |
| 1H5GT | 9/8 | 6K25 | 6/6 | 12S7GT | 5/- | DK96 | 7/3 | Small | 7/9 | U22 | 8/9 |
| 1L4 | 3/3 | 6K7 | 5/6 | 12T8 | 7/6 | DL33 | 8/- | EY86 | 8/6 | U24 | 16/- |
| 1LD5 | 5/6 | 6K7G | 2/3 | 12S7 | 5/6 | DL35 | 6/- | EZ35 | 5/6 | U25 | 11/6 |
| 1LN5 | 4/9 | 6K7GT | 4/6 | 12SK7 | 4/8 | DL65 | 6/- | EZ40 | 6/6 | U26 | 9/9 |
| 1N5GT | 9/8 | 6K8GT | 8/9 | 12SN7GT | 7/9 | DL75 | 6/- | EZ41 | 7/- | U31 | 7/- |
| 1R5 | 5/6 | 6K25 | 7/8 | 11F7 | 14/9 | DL92 | 9/- | EZ40 | 6/- | U33 | 14/- |
| 1R4 | 8/- | 6L1 | 12/8 | 12RAQ5 | 7/6 | DL91 | 9/- | EZ41 | 6/6 | U35 | 12/6 |
| 1R5 | 4/6 | 6L6G | 6/6 | 12R6G | 6/6 | DL92 | 6/- | FW4500 | 8/- | U37 | 26/6 |
| 1T4 | 3/6 | 6L18 | 6/- | 11F7 | 14/9 | DL94 | 6/9 | FW4800 | 8/- | U37 | 26/6 |
| 2A3 | 6/6 | 6L19 | 11/- | 20D1 | 9/6 | DL101 | 7/3 | GTIC | 7/- | U52 | 4/9 |
| 2A7 | 6/6 | 6L1D3 | 8/- | 20F2 | 9/6 | DW4/350 | 8/2 | GZ32 | 8/9 | U76 | 5/9 |
| 3A4 | 4/9 | 6L1D12 | 6/6 | 20L1 | 10/- | 8/1 | GZ34 | 12/6 | U78 | 5/- | |
| 3A5 | 6/6 | 6L1D20 | 8/6 | 20P1 | 8/6 | DW4/500 | 7/1 | HW4350 | 7/6 | U81 | 5/9 |
| 3D6 | 4/6 | 6K7 | 7/8 | 20P3 | 12/6 | 8/1 | HL14LD | 1/19 | 12/6 | U91 | 12/6 |
| 3Q4 | 7/- | 6P1 | 7/8 | 20P4 | 18/- | EABC80 | 6/9 | 8/3 | U282 | 9/9 | |
| 3Q5GT | 8/- | 6P25 | 8/6 | 20P5 | 15/- | EAC91 | 4/8 | HN309 | 19/- | U301 | 15/6 |
| 3R4 | 6/- | 6P28 | 12/6 | 23A6G | 8/- | EAC42 | 3/7 | HR192 | 10/6 | U309 | 6/9 |
| 3R5 | 6/6 | 6P28G | 8/6 | 23L6G | 8/6 | EAC49 | 7/1 | HW4350 | 7/6 | U329 | 6/9 |
| 3Y4GY | 12/6 | 6Q74T | 8/6 | 23HGT | 7/9 | EBC91 | 3/7 | FW4500 | 7/6 | U329 | 6/9 |
| 5T4 | 8/- | 6-6 5T4 | 8/6 | 25Y6G | 8/- | EBC33 | 4/9 | KLL32 | 6/6 | U339 | 11/- |
| 5U4G | 4/9 | 68A7 | 5/6 | 25Z4G | 7/- | EBC41 | 4/8 | KL732 | 6/9 | UABC50 | 9/9 |
| 5V4G | 7/9 | 68G7 | 4/9 | 25Z5 | 8/- | EBC81 | 7/9 | KL733C | 4/6 | UAF42 | 7/9 |
| 5Y3G | 5/9 | 68H12 | 5/3 | 25Z6G | 8/- | EBC80 | 7/9 | KL736 | 12/6 | U841 | 7/9 |
| 5Y3GT | 5/9 | 68K7 | 5/3 | 26P1 | 7/1 | EBC43 | 7/6 | EBC43 | 7/6 | U841 | 7/9 |
| 5Y4G | 11/- | 68L7GT | 4/9 | 30F5 | 6/- | EBC89 | 8/6 | KT45 | 8/6 | U841 | 7/9 |
| 6Z4 | 11/- | 68N7GT | 4/6 | 30F11 | 8/6 | EBC121 | 12/6 | KT61 | 8/6 | U849 | 7/6 |
| 6Z4G | 7/8 | 68Q7 | 5/9 | 30L1 | 6/6 | EBC131 | 17/6 | KT63 | 5/9 | U8L21 | 14/6 |
| 6Z4GT | 11/- | 68S7 | 5/9 | 30P4 | 9/6 | EBC31 | 4/6 | KT78 | 8/6 | UCC4 | 14/6 |
| 6B0L2 | 6/6 | 6L4GT | 10/6 | 30P12 | 7/8 | EBC31 | 7/6 | KW61 | 5/9 | UCC5 | 7/6 |
| 6A6 | 4/9 | 6V6G | 5/- | 30P16 | 6/6 | EBC32 | 4/6 | KTW62 | 5/9 | UCC5 | 7/6 |
| 6A7 | 10/- | 6V6GT | 4/9 | 30P11 | 9/6 | EBC33 | 4/6 | KTW63 | 5/9 | UCC1 | 13/- |
| 6A8G | 8/6 | 6X2 | 7/8 | 33L6GT | 8/6 | EBC34 | 8/6 | KTZ3 | 5/9 | UCH42 | 7/3 |
| 6AGT | 13/6 | 6X4 | 5/- | 33T | 25/- | EBC35 | 8/6 | LB3 | 2/9 | UCH81 | 8/6 |
| 6AB6 | 7/- | 6A8 | 6/6 | 33U1 | 6/6 | EBC39 | 14/- | LM152 | 8/6 | U841 | 7/6 |
| 6AC7 | 3/3 | 6X6GT | 5/6 | 33Z4GT | 5/6 | EBC31 | 5/6 | M14 | 11/- | UCL32 | 13/6 |
| 6AU5 | 3/- | 6V6G | 7/8 | 33ZGT | 8/- | EBC82 | 6/- | N37 | 11/- | UCL43 | 7/6 |
| 6AU7 | 7/8 | 7/4 | 8/6 | 34 | 7/6 | EBC83 | 8/6 | N78 | 13/- | U142 | 5/6 |
| 6AK5 | 5/- | 7B6 | 9/- | 34 | 7/6 | EBC84 | 8/6 | N108 | 16/- | U180 | 7/6 |
| 6AL5 | 3/- | 7H7 | 7/8 | 35C5 | 8/6 | EBC85 | 7/9 | N122 | 8/6 | U180 | 9/6 |
| 6AM6 | 3/- | 7C5 | 7/3 | 50C6G | 8/6 | EBC88 | 16/- | P41 | 4/6 | U185 | 7/6 |
| 6AQ5 | 6/- | 7C6 | 7/6 | 50C7 | 19/- | EBC91 | 4/- | P61 | 2/9 | U185 | 14/8 |
| 6AT5 | 5/9 | 7I7 | 7/3 | 50L6GT | 8/6 | EBC90 | 8/6 | PBC80 | 8/6 | U141 | 7/- |
| 6AU5 | 7/8 | 7K7 | 8/6 | 52K10 | 10/6 | EBC92 | 3/6 | PL28 | 11/6 | U144 | 11/- |
| 6B7 | 8/6 | 7O7 | 8/6 | 53L1 | 10/6 | EBC94 | 12/6 | PCC84 | 8/6 | U146 | 7/6 |
| 6B8G | 3/- | 7R7 | 10/6 | 61BPT | 11/- | DL133 | 7/6 | PCC85 | 8/6 | U184 | 7/6 |
| 6BA6 | 5/9 | 7R7 | 10/6 | 61BPT | 11/- | DL133 | 7/6 | PCC85 | 8/6 | U184 | 7/6 |
| 6BE8 | 5/9 | 7V7 | 7/9 | 75 | 6/6 | EBC111 | 7/9 | PC20 | 9/- | U16 | 12/6 |
| 6B8G | 15/- | 7Y4 | 6/9 | 78 | 6/6 | EBC183 | 8/3 | PC450 | 6/6 | U17 | 9/6 |
| 6B8G | 6/6 | 7A4 | 7/4 | 80 | 5/6 | EBC180 | 6/6 | PC482 | 7/9 | U17 | 9/6 |
| 6B16 | 6/- | 8D3 | 3/3 | 8 | 8/6 | EBC182 | 9/6 | PC4 | 16/- | U18 | 17/- |
| 6BR7 | 9/8 | 10C1 | 11/8 | 18S8T | 19/8 | EBC183 | 11/7 | PCL2 | 7/3 | U18 | 11/- |
| 6BW6 | 7/6 | 10C2 | 14/8 | 80S | 12/- | EBC122 | 7/6 | PCL3 | 10/6 | U141 | 6/- |
| 6BW7 | 5/6 | 10C14 | 8/- | 80T(A) | 5/6 | EBC36 | 3/3 | PL4 | 7/6 | U55 | 6/6 |
| 6BX6 | 4/9 | 10F1 | 5/9 | 80K | 7/6 | EBC39 | 4/8 | PXM45 | 8/6 | U41 | 5/6 |
| 6C5 | 3/6 | 10F9 | 5/9 | 10G13 | 55/- | EBC10 | 12/- | PL7 | 46 | VR105/30 | 8/6 |
| 6C5 | 5/6 | 10L14 | 7/- | 82A | 14/- | EBC41 | 8/- | PL33 | 8/6 | VR105/30 | 8/6 |
| 6C6 | 3/9 | 10L18 | 7/9 | 86G4 | 11/6 | EBC42 | 7/6 | PL36 | 9/6 | VR150/30 | 6/9 |
| 6C9 | 11/- | 10L11 | 14/8 | 9004 | 7/- | EBC50-BR2 | 2/3 | PL38 | 16/6 | 6/9 | 6/9 |
| UCD6G | 18/6 | 10L1D12 | 5/- | ATP4 | 2/9 | USA | 3/- | PL4 | 8/6 | W61M | 11/- |
| 6C14 | 7/8 | 10L13 | 8/6 | EAC31 | 8/6 | DL231 | 3/3 | PL22 | 8/6 | W76 | 4/9 |
| 6D2 | 3/- | 10P14 | 4/1 | B38 | 7/9 | EBC90 | 4/9 | PL3 | 8/6 | W81 | 7/3 |
| 6D3 | 4/9 | 10P18 | 7/1 | CTC | 9/6 | EBC95 | 6/6 | PL4 | 8/6 | N1M | 11/- |
| 6D6 | 3/3 | 12A6 | 4/9 | EBC11 | 26/6 | EBC96 | 0/- | PL20 | 8/6 | N1M | 11/- |
| CFP | 4/9 | 12A06 | 15/- | EBC131 | 21/- | EBC99 | 6/9 | N1 | 12/6 | N33 | 8/6 |
| 6F81 | 6/6 | 12A06 | 17/- | EBC133 | 14/- | EBC91 | 0/- | PL27 | 8/6 | N33 | 8/6 |
| 6F12 | 3/- | 12A26 | 13/9 | CL3 | 9/6 | EBC92 | 4/6 | PL31 | 9/- | N65 | 11/- |
| 6F13 | 6/9 | 12A18 | 4/- | EY31 | 9/- | EBC96 | 3/- | PL32 | 11/- | N76M | 11/- |
| 6F14 | 9/6 | 12A76 | 7/6 | D77 | 3/6 | EL32 | 4/8 | PL50 | 6/9 | N78 | 21/- |
| 6F15 | 9/6 | 12A77 | 8/6 | DL152 | 5/9 | EL33 | 7/9 | PL81 | 6/8 | N1M | 9/3 |
| 6F16 | 8/6 | 12A06 | 9/6 | EAC30 | 12/6 | EBC35 | 7/6 | PL82 | 8/6 | N79 | 16/6 |
| 6F19 | 8/6 | 12A07 | 9/6 | EAC32 | 8/6 | EBC41 | 8/- | PL83 | 8/6 | Y63 | 6/3 |
| 6F23 | 6/6 | 12A26 | 6/6 | DAP91 | 4/6 | EL42 | 8/9 | PZ30 | 9/6 | Z33 | 4/9 |
| 6F32 | 6/6 | 12B3A6 | 7/6 | DAP96 | 7/3 | EL43 | 11/- | R18 | 11/- | Z68 | 9/6 |
| 6F33 | 6/6 | 12B3E6 | 7/6 | DET19 | 2/9 | EL44 | 7/- | R19 | 11/- | Z152 | 4/9 |
| 6J5 | 4/3 | 12B17 | 8/6 | D85 | 8/6 | EL51 | 4/1 | R19 | 11/- | Z2718 | 4/9 |
| 6J56 | 3/- | 12C8 | 6/6 | DF91 | 3/6 | EBC34 | 7/6 | SP61 | 2/6 | ZD132 | 7/8 |

Tubes

Carr. & Ins. 12/6

| MOST MULLARD, | 12in. | 12 Months | 12 Months | NEW TYPES |
|-----------------|----------|----------------|----------------|-----------|
| MAZDA, COSSOR, | | £1.15.0 | £3.10.0 | MW 31/74 |
| EMITRON, EMI- | 14in. | £2. 0.0 | £4. 0.0 | MW 36/24 |
| SCOPE, BRIMAR, | 15/17in. | £2.15.0 | £4.15.0 | 55-0-0 |
| FERRANTI TYPES, | 21in. | £3.15.0 | £5.15.0 | CRM 172 |
| | | | | MW 48/64 |
| | | | | £6-0-0 |

13 CHANNEL T.V.s

Table Complete. Famous Makes. Absolutely Complete. These sets are unequalled in value due to huge purchase direct from source. They are untested, and not guaranteed to be in working order. Carr. etc. 15/-.

£2.19.0 14in. **£4.19.0**

TRANSISTORS

RED SPOT 3/9 each. 42/- doz. WHITE SPOT 5/6 each. 63/- doz.

RECTIFIERS

For Chargers, selenium full wave, 12 volt, 3-4 amps, 9/6; (Carr. 1/-). 250 v. 80 mA, 5/-; R.M. 15/6; R.M2, 8/-; R.M3 9/-; R.M4, 15/6; R.M5, 21/-; 14A86, 17/-; 14A97, 23/-; 14A100, 25/-; 16RC1-1-16-1, 7/9; 18RA1-1-16-1, 7/9; 18R D2-2-8-1, 14/-; 18RA1-2-8-2, 17/-; 18RA1-2-8-3, 20/-.

13 CHANNEL TUNERS

B.C.P.S. 14A. famous makes complete P.C.F.80, P.C.C.84. 38 M/c. I.F. **19/-** Amazing value.

SILICON DIODES

125 v., 300 mA, 2 in. series make germanium R.M.4, or R.M.5, etc. **8/-** Each

4-speed Record Players

Latest Turntable, together with lightweight Stuur (galaxy dual sapphire crystal turner pick-up head). Amazing value (pick-up only 18/-). **£3.10.0** Carr. 2/-.

CONDENSERS

25 Mixed, Electrolytic. Many popular sizes. List Value £5. Our **10/-** Price.

RECORDING TAPE

"Brand Five" 7in. 1200 ft., 23/6; 7in. 1,800 ft., 32/6; 5in. 600 ft. 15/-; 3 1/2in. 1,200 ft., 21/6.

HEADPHONES

Exp-Govt. quality, with Jack. **7/6** Price. Pair post.

EXTENSION SPEAKERS

covered in Attractive Velveteen. (Gold Metal) Fret. Size: 8 x 6 x **21/6** 3 1/2in.

Battle Type. Polished wood front with Gold Metal Fret. Size: **22/6** 1 1/2 x 7 x 3 1/2in.

CO-AX standard and low loss.

25 yds., 12/6; 50 yds., 22/6; 100 yds., 42/6. Co-ax Plugs 13/.

Wall outlet boxes 3/6.

100 RESISTORS 6/6

100 CONDENSERS 10/-

Miniature Ceramic and Silver Mica Condensers 3 pF to 5,000 pF. LIST VALUE OVER £3.

STAAR GALAXY SPARES

Huge quantity (Autochangers). S.A.E. enquiries.

MICROPHONES. "Eagle" 100C, With stand **49/6**

T.S.L. Crystal Stick .. do. **25/-**

"Jensen-Crown" M.C.-110 .. do. **45/-**

B.M.-3 Crystal .. do. **55/-**

"Eagle" Lapel Mike .. do. **55/-**

"Romagna" Crystal Mike .. **17/6**

'TRAVELLER' TAPE RECORDER

Superior, Transistorized, Portable Fast Rewind, Built-in High Output Speaker. Unrepeatable, Listed **29 gns.** OUR PRICE **15 gns.**

"GARRARD" Slimline.

Very latest Compact Autochanger. Just released. Amazing value, £219.0. Also available Garrard Model 208, £219.0. P. & P. 4/-.

RECORDERS.

"Verdik" Track Deck, Collaro 3 Speed Transcription. Superior reproduction. Streamlined Portable Case. Complete with Mike. Market value approx. **£45.** OUR SPECIAL PRICE **28 gns.**

ALL WAVE TRANSISTOR.

Terrifically sensitive on short wave. Due to fortunate purchase, we can offer at **18 gns.** ONLY.

MULTI-METERS.

"Jensen" Model 2011. D.C. Voltage. 5-25-50-250-500-2.5K (20,000 ohms per V.). A.C. Voltage. 10-50-100-500-1000 volt. (10,000 ohms per V.). A.C./D.C. Current. 0-50-100-0-25 mA. 0-250 mA. £5.19.0. "Jensen" Model M.T.-316. D.C. Voltage. 0-10-50-250-500-1000 volts. (20,000 ohms per V.). A.C. Voltage. 0-10-50-250-500-1000 volts. (5,000 ohms per V.). D.C. current. 0-50µA. 0-25-500µA., £5.19.0.

P.V.C. CONNECTING WIRE.

100 yds., 30 mil; Special Price 7/6. 200 yds. 30 mil; special price, 12/6. 25ft. Coil, 1/-, 5 Cols different colours, 4/6.

MAINS AMPLIFIERS.

3 valve, 3 watt, loudspeaker, in case with controls. Ideal for record players, 19/6. P. & P. 5/6.

TRANSISTOR INTERCOM.

High sensitivity, complete with batteries, usually **29**, DISCOUNT PRICE **£7.15.0.**

LOUDSPEAKERS

Top makes-manufacturer fresh

24in. 13/-; 5in. 16/-; 8in. 19/-; 10in. 22/6; 7 x 4 1/8"; 8 x 8 1/8"; 8 x 13 29/-.

GET15 Latest G.E.C. High Power.

Contact cooled Manufacturer's matched pair Transistors, with Push-pull Input and Output Transformers and Amplifier Circuit. Knock Out Price. **29/-**

"CODAR CLIPPER" ALL BAND RECEIVERS 10-2000 METRES

LISTEN TO AMATEURS, AIRCRAFT, SHIPPING, SHORT, MEDIUM, LONG WAVE BROADCAST STATIONS THROUGHOUT THE WORLD.

THE MINI-CLIPPER

The ORIGINAL and finest one valve ALL BAND receiver. Outstanding performance. New first grade components throughout ensure top efficiency. Low loss air spaced ball bearing tuners—no solid dielectric. High gain Polystyrene Coils. Smart satin silver metal panel with engraved dials and grey pointer knobs. Chassis ready punched. Provision for extra valve stage. Total building cost, with one coil 20-60 metres, nuts, bolts, solder, step by step plans 36/6. P. & P. 2/6. Other coils 10-2000 metres and electrical breadboard available. Parts sold separately. Full plans, parts list 2/-.

NEW LOW PRICE! **36/6**

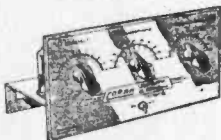

THE SUPER CLIPPER 88/6

This world-famous hybrid receiver has achieved remarkable success. Tremendous performance with Hi-gain valve detector PLUS two Edison transistor amplifiers which are supplied assembled, only 3 wires to connect. Large precision dial, 7 x 4in., with 2 pointers, bandset and bandspread, dual slow-motion drives, air spaced variables. Punched chassis 8 x 5in. Batteries last months. Covers 10-2000 metres (5 coils). Total building cost including chassis, valve, 2 transistor stages, 2 coils 20-60 and 55-190 metres. Step-by-step pictorial plans, nuts, bolts, wire 88/6. P. & P. 2/6. Plans only, 2/6. THE CLIPPER. As above but one transistor stage, 79/6. P. & P. 2/6. Optional Front Panel, Silver Hammer finish, all holes, 6/9.

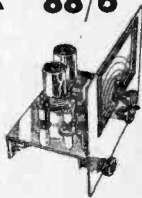

THE CLIPPER CR45

£6.17.6



This A.C. Mains receiver is the latest model in the famous CLIPPER Series and combines really top performance with superb professional finish. It is the finest ALL BAND receiver at the price with a new high gain circuit using ECC81 double triode, EL84 output, EL80 full wave rectifier. Power output 3½ watts for 2/3 ohm speaker. Covers 10-2000 metres (5 coils). World-wide reception. Outstanding features include 3 planetary slow motion drives, separate electrical breadboard, air spaced low loss variable, satin silver dials, silver hammer front panel. Total building cost, including 10 x 5in. punched chassis, valves, front panel, 2 coils 20-60 and 55-190 metres, nuts, bolts, wire, etc., 10 pages pictorial plans, £6.17.6. P. & P. 3/6. Optional extra. Modern styled Cabinet, rear panel, silver hammer finish, 27/6. Parts sold separately Full plans, parts list, 10 pages, 3/6 post free.

No technical knowledge required to build these fine receivers. Send 3d. stamp for Illustrated leaflets, testimonials, etc. Advance Details now available for the NEW 1962 CR 66 A.C. SUPERHET COMMUNICATION RECEIVER.

CODAR RADIO COMPANY, COLEBROOK ROAD, SOUTHWICK, SUSSEX
G31RE Canadian Distributors: JAYCO ELECTRONICS, TWEED, ONTARIO. G31PA

SPEAKERS

Brand new quality units by famous maker

We offer the following range at these very attractive prices (tax paid)

| | |
|------------------------|-------|
| 10in. x 6in. | 32/10 |
| 9in. x 5in. | 20/6 |
| 8in. x 3in. | 16/5 |
| 7in. x 4in. | 19/4 |
| 7in. x 3in. | 16/5 |
| 5in. round | 16/5 |
| 3in. round (tweeter) — | 16/5 |
| 2½in. round | 17/10 |

All the above are standard matching. P. & P. 1/6 on each.

MAINS POWER PACK KIT FOR TRANSISTOR RADIOS

9 volts—100 m.a. Miniature size. Price 35/-. (Ready assembled 45/-.)

NEW MODIFIED VERSION!

★ 'PW' 6-TRANSISTOR ★ MEDIUM & LONG WAVE POCKET SUPERHET

The latest version of this fine performer incorporates improvements giving even greater sensitivity and all round performance.

- 250 mW Push-Pull Output on 2½in. P.M. Speaker.
- Guaranteed first grade Matched Transistors.
- High Q Internal Ferrite Rod Aerial.
- Printed Circuit and full instructions.

★ All parts sold separately. Send for illustrated building plans, 1/6 plus post. (Free with kit).

Every item down to the last nut and bolt is supplied together with easy to follow, step by step instructions—no extras to buy.

★ ALIGNMENT SERVICE ★

We guarantee to make your set work

We have aligned and tested many hundreds of these fine receivers, and offer a very comprehensive service, including fault finding, at very reasonable charges. Please write for details.

PAY AS YOU BUILD SCHEME

At no extra cost this kit may be bought in 3 complete stages of £2.16.8, plus 1/6 p. & p. (Specify A, B or C when ordering).

TELESCOPIC AERIALS

Beautifully made, ideal for portable radios. Heavily chrome plated. 6½in. closed, extending to 2ft. 6in. in 5 sections.

BARGAIN at 8/- P. & P. 1/-

TV PICTURE EQUALISER

CUT OUT TV RETUNING!! with our Aerial Attenuator. Switch channels without any adjustment to your set. Fitted in one minute. Rejects pattern. (Type 1—channels 1, 2 and 3. Type 2—Channels 4 and 5). Price 10/6. P.P. 1/-.

POCKET RADIO CABINET

We stock the brilliant new contemporary case by Osmor Ltd., which is suitable for most of the pocket radio designs in this journal. Size 5½ x 3½ x 2in. 12/6. Plus 1/3, P. & P.

NORCOL LTD

CASTLE ROAD, CAMBERLEY, SURREY

Phone: Camberley 22760

Letters to the Editor

The Editor does not necessarily agree with the opinions expressed by his correspondents

Whilst we are always pleased to assist readers with their technical difficulties, we regret that we are unable to supply diagrams or provide instructions for modifying commercial or surplus equipment. We cannot supply alternative details for receivers described in these pages. **WE CANNOT UNDERTAKE TO ANSWER QUERIES OVER THE TELEPHONE.** If a postal reply is required a stamped and addressed envelope must be enclosed with the coupon from page iii of cover.

OSCILLOSCOPE DATA

SIR,—Recently a number of No. 11 oscilloscopes (made by Cossor) were put on the market, together with modification data.

I bought one of these instruments, but without the data, and now it appears to be virtually unobtainable. Therefore, I would be grateful to any reader who would be prepared to lend or sell me the relevant information. — C. C. WIGMORE (64 Sisters Avenue, Battersea, London, S.W.11).

SOLDERING TRANSISTORS

SIR,—Mr. Walters (February issue) is in error in dispensing with heat sinks because he is using a special type of soldering iron, as the functions of a heat sink is not to protect a transistor—or other semi-conductor—during the operation of soldering, but to ensure that the heat of the device itself, during operation, shall be sufficiently rapidly conducted away from it, that the temperature will not rise more than a degree or so above that of the surrounding air.

The maximum permissible dissipation of a transistor in operation without a heat sink is less than that permissible with a heat sink fitted; consequently the possible output is also less—1W may be obtainable from a device with a heat sink, whereas only 500 or 750mW could be obtained without one.

The TRUVOX Hi-Fi TAPE UNIT

(Continued from page 1158)

The performance of the model which we tested was to the makers' specification. The design of the deck itself is clean and modern and the controls are very clearly marked. The plastic cover can easily be removed to allow the surface of the heads to be cleaned, and loading of the tape into the slot is very easy.

A feature which should be included on all tape recorders is some means of clamping the spools of tape to the pivots on which they fit; Truvox do this by means of "Hublocs"—the spools of tape fit over a metal collet which is expanded to hold the spools firm simply by turning the knurled shaft at the top of each pivot. Vibration of the spools during record, play-back, or fast rewind is thus prevented.

Whether a heat sink is or is not necessary depends entirely upon what the transistor in question is required to handle—safe values with and without sinks are given by the makers.—E. C. DAVIES (Southampton).

UNIVERSAL SHUNTS

SIR,—I was very interested in Mr. R. Traynor's article in your January issue. It takes me back to the 1920's, when I was using a Paul Universal Set for locating underground cable faults.

An important feature of the Universal Shunt is that it does away with the necessity of "double switching", as with this method there is no risk of overloading or damaging the meter movement when a faulty contact develops on the range switch.

I should like to point out that, although it is true that the deflections for a given current truly follow the multipliers of the shunts, regardless of the resistance of the meter, the error of the instrument will only be under one per cent. if the internal resistance of the meter is not more than one per cent. of the total resistance of the shunt.

To confirm this, refer to Fig. 1 in Mr. Traynor's article (page 834). With the switch on position 1, and applying 100mA to the terminals; then assuming that the meter has an internal resistance of 500Ω (i.e., 5 per cent. of the shunt value) we find by a simple sum that 4.77mA will pass through the shunt and 95.23mA flow through the meter, giving an error of nearly 5 per cent.

However, as any error will be constant throughout all the ranges it can be easily allowed for.—V. W. GOSS (Blackburn).

To judge from the PD82, the Truvox Series 80 is a set of tape recorder designs which can be recommended with confidence; the presentation, style, specification and manufacture are good and as stated previously, the hi-fi enthusiast will be especially interested in the PD82 and PD84 (four track) models for the extension of his sound reproduction facilities. Two other tape units, the PD83 (twin-track) and the PD85 (four-track) are also available and of especial interest to schools. These have GPO jack sockets for input and output and a meter for the recording-level indicator. ■

PRACTICAL WIRELESS CIRCUITS

17th Edition

By F. J. CAMM

1976 by post 187

from
GEORGE NEWNES, LTD.,
Tower House, Southampton Street, London W.C.2.

RECEIVERS & COMPONENTS

SPEAKER REPAIRS. Cones/Flelds fitted. Clock Coils wound. **L. S. REPAIRS.** Pluckley, Ashford, Kent.

NEW AND SURPLUS Valves, guaranteed, from 3/6. Also reclaimed Valves, perfect, from 1/6. Many bargains. S.A.E. for complete list. **LEWIS, 46** Woodford Avenue, Ilford, Essex.

6 VALVE 1466 RECEIVERS NEW

Slow motion tuning with tuning dial 30.40 Mc/s. Alloy chassis screening cans etc. Valves 3-902, 1-802, 1-1502. Fx-changer, 1-4D1. A gift at 27/6, plus 5/6 Carr. R1392(D). Few only, crystal controlled, £4.19.6, plus 7/6 Carr., or as new Air Tested £6.19.6, plus 7/6 Carr. 95-155 Mc/s.

J. T. SUPPLY

309 MEANWOOD ROAD, LEEDS 7

TRANSISTOR SETS. OC44, 20C45, OC81D, 20C81, 35/6, OC44 9/-. OC45 4/8. OC71 6/3. XA102 9/-. XA101 8/8. XB103 6/3. Red Spot 3/6. White Spot 4/-. Diodes General 1/-. OA79 3/-. OA70 3/-. OA71 2/8. OA81 2/9. GEX34 2/9. Ear pieces complete with plugs and jacks 100, 250 and high Z 7/9 each. Min Caps. 1 to 32 MF, 1/9 each, p. and v. Paid by CHAPLEB RADIO, 107 Neasden Lane, NW10.

MANUFACTURER'S STOCKS of radio cores, components and measuring instruments for disposal; send for free lists, enclosing S.A.E. to: S.E.I., Stock Disposals, Gee Street, Heywood, Lancs.

KINGSLAND ELECTRONIC COMPONENTS Stupendous Offers

5in. Speaker, new. 3 ohms. 15/9. High gain Transistors and Ferrite Aerials 2/9 each. Diodes, 1/8. All with circuits. XAL16 Transistors. Ideal 1.F. amp. 455 kc/s. or L.F. driver, gain 12.5, 5/6 each. New, lightweight Headphones, 2000 ohms. General use, adjustable ready for use. 14/6. Driver and Output Transformers, sub-miniature, 10/6 pair. Volume controls, edgewise movement with switch 5K, 20K, 1 meg., miniature, 8/6 each. Earpieces, crystal, 5/8. Magnetic, 9/- complete with sub-miniature Jack and Socket or Jack and Socket, only 3/9. P.W. Pocket 6 Transistor Kit. Complete with printed circuit cabinet, transistors and speaker. Osmon designed kit and full instructions, all parts guaranteed new. This is the Kit for the Ambitious constructor. 29.10.0. Try our surprise pack of accessories, if not satisfied return within seven days and money will be refunded. 7/6, p. & p. 2/6. 6 assorted voltage droppers, 5/-, p. & p. 1/8. 100 assorted condensers, 8/-, p. & p. 1/9. 6 volt or 12 volt vibrators, 3/6 each p. & p. 1/6. Mike and Pick-up Transformers ideal for baby alarms, 4/8, p. & p. 1/- 6 assorted potentiometers, 5/-, p. & p. 1/9. 50 assorted resistances and condensers, 6 miniature valve holders, 2 tag strips, 40 separate contacts each 4/9, p. & p. 1/9. **182 KINGSLAND RD., SHOREDITCH, E.C.2. Tel: SHO 6872. Sorry! U.K. only.**

RATES: 6/6 per line or part thereof, average five words to line, minimum 2 lines. Box No. 1/- extra. Advertisements must be prepaid and addressed to Advertisement Manager, "Practical Wireless," Tower House, Southampton St., London W.C.2.

TELEVISION TUBE SHOP

now stock

Tubes for every make of set OVER 600 TUBES IN STOCK

- 12 inch Mullard type ... £4. 5.0
- 12 inch Mazda type ... £4. 15.0
- 14 inch Mullard type ... £5. 5.0
- 14 inch Mazda type ... £5. 10.0
- 15 inch Mazda type ... £5. 15.0
- 16 inch G.E.C. & Mullard type £6. 12.6
- 17 inch Mazda & Mullard type £6. 10.0
- 17 inch G.E.C. & Brimar type £6. 15.0
- 21 inch Mullard type ... £C. 0.0

Add 10/- for insured carriage to your door within 48 hours, or 5/- via B.R.S. Terms £2 down (plus carriage). All tubes tested before despatch and guaranteed for 12 months. Guarantee cards enclosed with each tube.

New Purchase of 110", 17 inch tubes—

Slight mark, Guaranteed for 12 months. Mazda CME 1703 } replace AW43-88 GEC7405A } £5

Shop Soiled Tubes. (Slight scratches or marks). Guaranteed 12 months. Ideal for second set. 12in. 3/18, 3/31 37/6. MW31-74 50/-, 14in. MW 36-44 52/6. CRM141 55/-, 17in. CRM171, MW 43-64 60/-.

Others available from time to time. Please enquire old bulb required. **Service Engineers** Our Rebate Scheme shows real savings—send for details.

Television Tube Shop 48 Battersea Bridge Road, S.W.11

BAT 6859

Just South of the Bridge. Open Saturdays until 4 p.m.

COMPONENTS, VALVES. Tubes, etc. Write or phone for free list. **ARION TELEVISION, 4 Macted Road, Peckham, SE15 (New X 7152).**

"HEATHKITS" can now be seen in London and purchased on easy terms. Free brochure. **DIRECT TV REPLACEMENTS LTD., Dept. PW/7/3, 138** Lewisham Way, SE14. Tideway 6666.

"WEYRAD" TRANSISTOR RECEIVER

Long and Medium Wave, P.P. Output, all components available. Total cost £8.0.0. Cabinet to suit, 17/6. Constructor's booklet, 1/4.

"P.W." CITIZEN

Ferrite Rod Aerial RA2W and Coupling Coil. P.50/1AC. P.50/2CC. P.50/3CC. "Weyrad" 1 Watt or 500 mW Amplifier to suit "Citizen" (As Kit or Assembled). Send S.A.E. for shopping lists.

R.A. 35 ohm Speakers. 5K Pots, Jackson Type '00' Tuning Gangs.

WESTHAM RADIO SUPPLIES Rear of 176 Abbotbury Road, Weymouth, Dorset

TRANSFORMERS

Output Oscillator Scan Coils

- ALBA: T301, T304, T394, T484, T494, etc... 46/6
- BUSH: TV11A, 11B, 12A, 12B, TVG12A, 12B, TRG15A, 12B ... 44/-
- FRIG: T326, TV32, TV33, TVG34, TVG34A, T36, TV36, TVG36, TV36C, TVG36C, TV45 ... 68/6
- TV53, TV56, TV57, TVG58, TV62, TV63, TV68, TV67, etc. ... 94/-
- TV80 with EY32 ... 109/-
- LOSSOR: 930 and T.931, 933-4-5, 937, 938A, and F. 939 and A and F ... 61/6
- 943T, 940-946, 945, 945B ... 58/6
- 945F, 947, 949 ... 68/6
- DECCA: D17 and C ... 88/6
- D81, DM22, DMS, DM4/C ... 74/-
- DM5, DM14, DM17, 444, 555 ... 74/-
- DEFIANT: TR1438, TR1753 ... 58/6

DYNATRON: EKCO: T802, TC8102, T8105, T8114, T8124, TC138, T8188, T8193 ... 54/- TRC139, TC140, T141, TV142 ... 79/6 T161, TC162, T164, T165, etc. ... 78/6 TC208, TV209, T231, T221, T231F, T248, T283, T284, T295, etc. ... 58/6

FERGUSON: 103T, 106T, 118T, 130T, 149T 941T-963T inclusive ... 58/6 991T-997T inclusive ... 68/6 302T-246T inclusive ... 68/6 306T, 308T ... 64/-

FRANKEL: 1473, 1473F, 15T4 ... 47/6 17K3 and F, 17T3 and F ... 47/6 17K4 and F, 17K4 and F ... 47/6 17T4 and F ... 47/6

1475, 17K5, 17K5 ... 47/6 **HT201, BT1592, BT1746, BT1748, BT1743** ... 48/6 **BT4643, BT5147, BT5246-48** ... 88/6 **BT5348-BT5648** inclusive ... 48/6

H.M.V.: 1824 and A to 1831 inclusive and 1840, 1841, 1842-1848 ... 66/6 All models available. **INVICTA:** T118, T119, T120 ... 54/- All other models available. **K.B.:** LPT50, LPT60, LPT80, MV60 ... 106/6 All models available.

MARCONI: All models available. **MASTERADIO:** Most models in stock. **MICHOEHL:** Most models in stock. **MURPHY:** V200, V292C ... 56/6 V240, V250 ... 94/-

PETO SCOTT, PHILCO: Most models in stock. **PAM:** 908, 909, 932, 933, 938 ... 54/- **PHILLIPS:** 1768U, 2168U ... 104/- 1100V, 1200V ... 74/- 1224U, 1235V, 1238V ... 74/- 114UF, 114UM, 116U ... 74/- 1437U, 1446U ... 74/-

Most models in stock. **PILOT:** Most models in stock. **PYE:** CTM4, FV4C, FV4COL ... 54/- V4, VT4, V7, VT7 ... 54/- LV30, FV1, FV1C ... 88/6

CS17C, CTM17F, CW17 ... 88/6 **CW17F, CW17CF, CW17F, etc.** Most models in stock. **RAYMOND:** Most models in stock. **REGENTONE:** All models available. **R.G.D.:** 60171, 7017, C54, etc. ... 58/6

Most models in stock. **SOBELL:** T817, T846 ... 64/- Most models in stock. **STELLA:** ST6721U ... 104/- ST6715U, ST8021U ... 104/- ST8017U ... 104/- ST8414U, ST8417U ... 74/- ST8314U ... 74/-

ULTRA: 86 series, 815 series, with U25, etc., complete. **VIDOR:** ON4217-CN4231 inclusive ... 64/-

Post and Packing 3/6 Also: Used O.P. Txs., Bean Coils, etc. **ALL GUARANTEED 90 DAYS** (All enquiries S.A.E.) Write for SAME DAY DISPATCH to

MARLEY SUPPLIES 21 Pittake, Croydon, Surrey

Croydon 8800 And at 2 Wellfield Road, S.W.16 (near Streatham Library)

DON'T READ THIS

unless you repair Radio and TV sets. Halve the cost of repairs by using our surplus or reclaimed Valves and Tubes. Most comprehensive selection at keenest prices. All valves re-tested before despatch and guaranteed to be in good working order.

| | | | | | |
|-------|------|-------|------|---------|------|
| 1A7 | 10/- | 7S | 7/6 | BF93 | 4/6 |
| 1D5 | 7/6 | 10C1 | 7/6 | BF94 | 4/6 |
| 1H6 | 7/6 | 12A6 | 6/- | BF95 | 4/6 |
| 1N4 | 7/6 | 12E1 | 12/6 | LK2 | 7/6 |
| 2A3 | 5/- | 12J7 | 7/6 | EK32 | 7/6 |
| 4T14A | 5/- | 12K7 | 4/6 | EK90 | 4/6 |
| 5U4 | 4/6 | 12K7 | 6/- | EL33 | 6/- |
| 5V4 | 6/- | 12SN7 | 6/- | EL41 | 6/- |
| 5Z4 | 6/- | 25A6 | 6/- | EL81 | 6/- |
| 6A7 | 7/6 | 25L6 | 6/- | EL90 | 6/- |
| 6A8 | 7/6 | 25Z4 | 6/- | EL91 | 4/6 |
| 6AQ5 | 3/- | 25Z6 | 6/- | EM34 | 7/6 |
| 6AK5 | 6/- | 25Z6 | 6/- | EY91 | 6/- |
| 6AQ5 | 6/- | 35L6 | 6/- | EZ90 | 4/6 |
| 6AU6 | 4/6 | 35Z4 | 6/- | KT61 | 6/- |
| 6AV6 | 4/6 | 43 | 5/- | KT66 | 7/6 |
| 6BA8 | 4/6 | 50C5 | 4/6 | KT67 | 7/6 |
| 6BB8 | 4/6 | 50L6 | 6/- | KT81 | 7/6 |
| 6BJ6 | 6/- | 75 | 5/- | KTW61 | 4/6 |
| 6BQ7A | 7/6 | 78 | 5/- | KTW63 | 4/6 |
| 6BW6 | 6/- | 80 | 6/- | L63 | 4/6 |
| 6C5 | 4/6 | 85A1 | 6/- | M44 | 5/- |
| 6C6 | 5/- | 807 | 6/- | MU12 | 5/- |
| 6C9 | 6/- | 854 | 3/- | N78 | 6/- |
| 6D6 | 5/- | 5783 | 6/- | NI08 | 7/6 |
| 6F6 | 4/6 | 7475 | 6/- | OA2 | 6/- |
| 6J6 | 4/6 | 9002 | 3/- | OA3 | 6/- |
| 6K5 | 4/6 | 9003 | 3/- | OB3 | 6/- |
| 6L7 | 4/6 | AZ1 | 7/6 | OC3 | 6/- |
| 6H6 | 2/- | AZ31 | 7/6 | OM4 | 4/6 |
| 6L6 | 7/6 | CBL31 | 15/- | OM6 | 6/- |
| 6L7 | 6/- | COH85 | 7/6 | OM9 | 4/6 |
| 6LD20 | 6/- | L33 | 15/- | OM10 | 7/6 |
| 6M7 | 4/6 | CY31 | 4/6 | Pen 36C | 7/6 |
| 6N7 | 6/- | DH83 | 4/6 | Pen 45 | 4/6 |
| 6P1 | 7/6 | DL83 | 4/6 | U50 | 6/- |
| 6Q7 | 4/6 | EAC91 | 4/6 | U62 | 4/6 |
| 6S47 | 5/- | EAF42 | 6/- | UAF42 | 6/- |
| 6S47 | 4/6 | EBC31 | 4/6 | UBC41 | 6/- |
| 6S7 | 4/6 | EBC41 | 6/- | UBL21 | 12/6 |
| 6SL7 | 6/- | EBC90 | 4/6 | UCH21 | 12/6 |
| 6SN7 | 4/6 | E88C | 6/- | UCH42 | 6/- |
| 6SS7 | 4/6 | ECH35 | 6/- | UF41 | 6/- |
| 6U5 | 6/- | ECH42 | 6/- | UI8 | 7/6 |
| 6V6 | 4/6 | EF36 | 4/6 | UU7 | 7/6 |
| 6X4 | 4/6 | EF37A | 6/- | W77 | 4/6 |
| 6X5 | 4/6 | EF39 | 4/6 | X61 | 6/- |
| 7B7 | 7/6 | EF41 | 6/- | X77 | 4/6 |
| 7C5 | 6/- | EF92 | 4/6 | X79 | 7/6 |

Most pre-war 4, 5, 7, 8 and 9 pin valves. British, American, Continental, 5/- each. Postage and packing (all valves) 6d. each. Orders over £1.00 post free.

NEW TRANSISTORS. Red spot 2/6. OC45, OC72, OC78 7/6. OC21 (silicon) 7/6. 5PK85 5in. 7 x 4in. 7/6. P. & P. 2- LINE O. Tr. from 20/-. Many types.

CONSTRUCTOR'S PARCEL. 2 lbs. assorted parts from TV sets. Resistors, condensers, potentiometers, electrolytics, valve holders, 7/6. P. & P. 2/6.

VALVE PARCEL. 12 valves all different as taken out of TVs. Ideal for spares, testing, etc. 8/6. Postage 1/6.

Before you decide to purchase anything send a S.A.E. for our complete FREE list of 1,000 valves, tubes and transistors. You will be amazed at our prices. For quotation by telephone ring VAN 8822, "St. John's Radio", 3 Jews Row, London S.W.18.

"LITON" PHOTOELECTRIC CONSTRUCTION MANUAL

10 Interesting PHOTOELECTRIC PROJECTS, fully described with building plans and circuit diagrams which can be easily made by amateurs from standard components. Hints on the use of photocells and photo-resistors. A mine of practical information for the experimenter. All units available, ready built or in kit form.

1. Battery burglar alarm. Kit 65/-. 2. Mains burglar alarm.
3. Light saver.
4. Customer announcer.
5. Simple garage door opener.
6. Photoelectric counter. Price (2-6) Kit £4.12.6. Built £5.10.0.
7. Long range infra-red mains alarm.
8. "MIRA" Miniature infra-red battery alarm. Total consumption 0.2 watt.
9. Motorised garage door opener.
10. Door opener with electronic lock.

If you are interested in electronics or electro-mechanical gadgets send 1/- stamp for this 24-page, profoundly illustrated publication to:

"ST. JOHN'S RADIO," 3 Jews Row, London SW18. Phone: VAN 8822

RECEIVERS & COMPONENTS (continued)

Send S.A.E. for Latest List of Disposals

VALVES
TUBES
RADIOS
ELECTRICALS
STEREOS
HI-FI
AERIALS
Etc. Etc.

(STATE REQUIREMENTS)
WE'LL DO OUR BEST

MAZEL RADIO DISPOSALS
124/138 LONDON ROAD
MANCHESTER 1.
LANCS.

POWER IN PACKETS. The following HT Batteries have just arrived and are of very recent manufacture. Get yours while you can—first come, first served. 18in. set Hts 162 x 12 x 3v. 90 x 60 x 4 1/2 Erass Cap. 126v cell-type fully tapped from 60v. All batteries shown 8/6 each plus 4/3 postage. Xtal control units 1 Xtal, valve and dozens of components. 10/- each plus 5/- postage. DIGGINS. 129/131 Radnor St., Hulme. Manchester 15.

CLEARANCE AMPLIFIER OFFERS

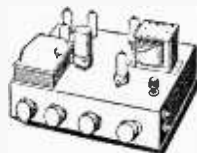

High Fidelity Push-Pull. 15 watt. Twin input. Very high sensitivity. Valves used: ECC83, ECC83, EL84, EL84, EZ81. Negative feedback. Separate Base and Treble Controls. 3 and 16 ohm outputs. £7.10.0, plus 7/6 carriage. Similar 35 watt, £10.10.0, plus 7/6 carr.

SEND FOR FREE LEAFLET
STROUD AUDIO
Bath Road, Stroud, Gloucester

RECEIVERS & COMPONENTS (continued)

A.1. BARGAINS. Post free. OC70, OC71 5/9. OC72, OC78, OC81 6/9. OC45 8/9. OC44: 9/9. OC171, OC170 12/9. OC65 20/-. OC68 22/-. OC19 OC16w 42/-. 2-OC72 13/3. OA70, OA78. OA81 2/9. OA91, OA95 3/3. EF80 6D2. EB91, EF91 1/3. ECL80 4/3. 8F1 1/9. 10F1 2/3. RTC. crystal mikes hand/table 19/6. Few last month's bargains available. Let us quote for any of your needs. C.W.O. A.1 RADIO COMPONENTS. 14 The Borough, Canterbury, Kent.

ANY KIT Built and Tested. Radios, Amplifiers, Test Gear, etc. Good workmanship, prompt return. Send details of kit and S.A.E. for quotation. Ready built: Good Companion £11/15/-, and Pocket Companion £8/19/6. R. J. DYMOKE, 16 Haycroft Road, Stevenage, Herts.

MISCELLANEOUS

ELECTRONIC MUSIC ?

Then how about making yourself an electric organ? Constructional data available—full circuits, drawings and notes. It has 5 octaves. 2 manuals and pedals with 24 stops—uses 41 valves. With its variable attack you can play Classical and Swing. Write NOW for free leaflet and further details to C. & S., 20 Maude Street, Darlington, Durham. Send 2d. stamp.

SOUND RECORDINGS

RECORDING TAPE, save up to 30%, send for list; also 50 second-hand recordings in stock. E. C. KINGSLEY, & CO., 132 Tottenham Court Road, London, W1. EUS 6500.

THE FAMOUS "TELEFUNKEN" TAPE HEADS. 30/20 Kcs. TWIN TRACK. RECORD/REPLAY AND ERASE BRAND NEW 30/- The Pair LIST 5 Gns.

A. Fanthorpe Ltd., 4-8 Hapworth Arcade, Hull, Yorkshire.

BOOKS & PUBLICATIONS

FIND TV SET TROUBLES IN MINUTES from the great book "The Principles of TV Receiver Servicing" 10/6 all book houses and radio wholesalers. If not in stock, from Beery-Taylor, I.P.R.E., 20 Fairfield Road, London, N8.

METAL WORK

METALWORK. All types cabinets, chassis racks, etc. to your specifications. PHILPOTT'S, Metalworks Ltd. Chapman St, Loughborough.

BRIAN E. HAMPSHEIR (R & T) LTD.

Dept. PWA 23 NORTH CROSS ROAD S.E.22
6F13 EF80 EF91 6P25 10F1 Z77 ECL80
EB91 6P28 6F1 EF50 L63 6F12 25L6GT

GUARANTEED 100% ALL AT ONE PRICE
£1 for 10, p. & p. FREE

FOR SALE

100 BAYS of Brand New adjustable Steel Shelving, 73in. high by 34in. wide by 12in. deep, stove enamelled dark green. Sent unassembled. Six shelf bay £3/15/0. Sample delivered free. Quantity discounts. N. C. BROWN LTD., Eagle Steelworks, Heywood, Lancs. Tel: 69018.

ASK your dealer for American Ferro-dynamics. "Brand Five" Recording Tapes—the best tape value!

AMATEUR LICENCE Morse Records. The Rhythm Method of teaching morse is the quickest and cheapest known. For full details and special beginner's offer. S.A.E.: "MORSE-REC", 45 Green Lane, Furley, Surrey.

ITY CONVERTERS, Stirling, Aerialite 50/- post paid. O.D.B., 25 Ramshead Approach, Leeds 14.

OPENING OFFERS FROM AUDIO CENTRE. We are celebrating our opening as high fidelity specialists by offering up to £10 worth of FREE gifts. Tapes, Loudspeakers, Records, etc., to new customers. Send for lists, stating your requirements, or order now for rapid mail-order service, post free. Examples of equipment available immediately: Brenell Stereo Tape Deck £39/8/-; Garrard 4HF transcription unit with stereo pick-up £20/17/-; B.S.R. TU9 4-speed turntable with pick-up £5/12/3; Garrard TPA12 transcription pick-up arm £4/16/5; Garrard EV26 stereo ceramic cartridge £2/8/2; "Dust Bag" £1/4/1; Audio Fidelity's amazing stereo record "Baldwin Organ" this will test your bass speakers! 46/-; all Tapes including Zonatape 1,200ft (5in.) 35/-; 1,800ft (7in.) 50/-. In fact, we can supply all your high fidelity equipment with all the free advice you need. Mail Order only or by appointment. Terms C.W.O. **AUDIO CENTRE**, Britannia House, Corporation St., Sheffield 3. (Phones Sheffield 47320 and 20588.)

HIGH QUALITY R.C.A. Varacoustic Microphones, model L.M. 16203 (600/250/50 ohms). Reconditioned £10 each. Second-hand in working order £8 each. C.W.O. MOSS EMPIRES LTD., Sound Dept., Cranbourn Mansions, Cranbourn Street, London WC2.

CAR AERIAL SOCKET kit of parts and instructions for fitting to any type radio. No soldering. 10/- post free. R.R. RADIO, Bramall Lane, Sheffield 2.

WANTED

WANTED New valves and transistors any quantity. S. N. WILLETS, 43 Spon Lane, West Bromwich, Staffs. tel: WES 2392.

A PROMPT CASH OFFER for your surplus Brand New Valves, Speakers, Components, Test Instruments, etc. R.H.S., Beverley House, Mannville Terrace, Bradford 7.

WANTED VALVES

All types for prompt cash. Must be new. State quantity.

WILLIAM CARVIS LTD.
103 North Street, Leeds 7

WANTED

(continued)

WANTED. TEST GEAR. Meters. Valves, Components, Communication sets, Amplifiers. HUGGETTS LTD., 2-4 Pawsons Road, West Croydon, Surrey.

NEW VALVES WANTED

Any type, any quantity

CASH PAID

R.S.T. 211 Streatham Road, Mitcham, Surrey.
Telephone: MITCHAM 6201

NEW VALVES bought, state price. A.D.A. MANUFACTURING CO., 172 Alfreton Road, Nottingham.

WANTED. Engineer to build transistor oscillator. Private or trade. Box 34.

SERVICE SHEETS

SERVICE SHEETS, Radio, TV, 5,000 models. List 1/-. S.A.E. enquiries: TELRAY, 11 Maudland Bk., Preston.

SERVICE SHEETS; also Current and Obsolete Valves for sale. JOHN GILBERT RADIO, 20 Extension, Shepherd's Bush Market, London W12. (Phone: SHE 3052).

SERVICE SHEETS for all makes of radio and TV, 1930-1962. Prices from 1/- with free fault-finding guide. Catalogue of 6,000 models 1/6. 125 Radio/TV sheets covering 370 popular models 20/-. S.A.E. inquiries HAMILTON RADIO, Western Road, St Leonards, Sussex.

38 SET WALKIE TALKIE

CIRCUIT INFORMATION

Alignment procedure. Faults. Components Diagrams etc. P.O. 5/-.

18 SET TRANSMITTER RECEIVER

CIRCUIT INFORMATION

Description operation. Values. Diagrams, Tests, etc., P.O. 5/-. Your address in block capitals, please.

CAMPBELL

Everland Road, Hungerford, Berks.

SERVICE SHEETS. Radio and Television 4/- each, list 1/-. All old and modern receiver sheets available. Faultfinder files, 2/- each. List now available 1/-. SP DISTRIBUTORS, 44 Old Bond Street, London W1.

FAULTFINDER FILES, showing common faults that each receiver is prone to and other useful servicing information, 2/- each. List 9d, plus postage. S.P. DISTRIBUTORS, 44 Old Bond Street, London, W1.

SERVICE SHEETS, Radio and TV 4/- each. List 1/-. All orders despatched on day received. Also manuals for sale and hire. S.A.E. please. SULTAN RADIO, Pantiles Chambers, Tunbridge Wells, Kent.

EDUCATIONAL

LEARN RADIO AND ELECTRONICS the new and practical way! Hosts of absorbing experiments carried out at home under expert guidance to teach you Radio in a new, enjoyable and interesting way. Construction, servicing and fault-finding on equipment made easy for the first time! No previous experience needed. No mathematics used. Free brochure from: Dept. 11 P.W. RADIO-STRUCTOR, Reading.

THE Incorporated Practitioners in Radio and Electronics (I.P.R.E.) Ltd. Membership Conditions booklet 1/- Sample copy of I.P.R.E. Official Journal, 2/- post free. Secretary, 20 Fairfield Road, London N8.

$$X = \frac{-b \pm \sqrt{b^2 - 4ac}}{2a}$$

DON'T FUMBLE with Formulae. Master Mathematics quickly and easily the Understandable Way.



The Dryden School of UNDERSTANDABLE MATHEMATICS

11F Dryden Chambers, Oxford St. London, W.1.

Name _____

Address _____

"HOW AND WHY" of Radio and Electronics made easy by a new, non-maths, practical way. Postal instruction based on host of experiments and equipment building carried out at home. New courses bring enjoyment as well as knowledge of this fascinating subject. Free brochure from: Dept. P.W., 12 RADIOSTRUCTOR, Reading.

WIRELESS. See the world as a Radio Officer in the Merchant Navy: short training period; low fees; scholarships, etc. available. Boarding and Day students. Stamp for prospectus. WIRELESS COLLEGE, Colwyn Bay.

ELECTRONICS

Key to YOUR future?
An exciting career - A new Hobby - Your own spare or full-time BUSINESS!



New experimental course includes big kits for building test gear and a complete AM/VHF receiver.

FREE brochure from
RADIOSTRUCTOR
DEPT. E77, READING, BERKS.

EDUCATIONAL

**Radio
Television
& Electronics**

Learn at home with the world's largest home study organisation, Brit.I.R.E.; City & Guilds; R.T.E.B., etc. Also Practical Courses with equipment. No books to buy.

Write for **FREE** prospectus stating subject to

I.C.S.

(Dept. 541), Intertext House, Parkgate Road, London, S.W.11

SITUATIONS VACANT

SITUATIONS VACANT

TV AND RADIO, A.M.Brit.I.R.E. City and Guilds, R.T.E.B. Cert., etc. non "No pass—no fee" terms. Over 95% successes. For details of exams and courses (including practical apparatus) in all branches of Radio, TV and Electronics, write for 148-page handbook, free. B.I.E.T. (Dept. 242G), 29 Wright's Lane, London W8.

A.M.I.Mech E., A.M.Brit.I.R.E., City and Guilds, G.C.E. etc., brings high pay and security "No pass—no pay" terms. Over 95% successes. For details of exams and courses in all branches of Engineering, Building, Electronics, etc., write for 148-page handbook, free. B.I.E.T. (Dept. 242B), London W8.

ENGINEERS REQUIRED, experienced in audio techniques and relay circuitry, for work on public address systems. Also VHF test engineer for television equipment. Write giving details to: **CLARKE & SMITH MFG. CO. LTD.** Hanworth Air Park, Feltham, Middlesex.

SITUATIONS VACANT

**UNITED KINGDOM
ATOMIC ENERGY AUTHORITY**

**ATOMIC ENERGY
ESTABLISHMENT, WINFRITH**

Vacancies exist at the A.E.E., Winfrith, for

**ELECTRONIC
INSTRUMENT MECHANICS**

Applicants should have experience of electronic equipment and industrial process control instruments, and of work involving fault diagnosis, repair and calibration for a wide range of instruments used in nuclear reactors and associated experiments. The work requires a good knowledge of instruments for measuring and automatically controlling flow pressures and temperatures of liquids and gases, as well as pulse techniques, wide band and D.C. amplifiers, counting circuits and associated test equipment.

Excellent working conditions including sick pay and pension scheme.

Further details and an application form may be obtained on request from

THE LABOUR DEPARTMENT,

A.E.E., WINFRITH, Dorchester, Dorset, quoting ref. IM/NAT/JN.

MINISTRY OF AVIATION (Inspection Division)

Skilled Inspectors

required for

- (1) Radio, Radar, Components and Electrical Ancillaries.
- (2) Gauges, Tools, Instruments and Engineering Products.

Posts (including some for aircraft engines and guided weapons) exist at Bromley, Woolwich, London and Home Counties areas, Manchester, and elsewhere in United Kingdom.

Varied and interesting work with opportunities for gaining valuable experience and further training.

Pay **£13 6s. 0d. to £14 1s. 0d.** per week or **£14 6s. 0d. to £15 6s. 0d.** per week (London rates [slightly less elsewhere] for 5-day week) according to ability and class of work available. Excellent prospects of promotion to grades with pay ranging up to £1,400 a year.

Post coupon (or telephone Imperial 2600 Extn. 19) for further information.

To: The Personnel Officer, Inspection Division,
Aquila, Golf Road, Bromley, Kent. (P.W.)

Please send me further details of skilled inspector posts
in _____ (type of work desired)
at _____ (area).

Name _____
Address _____

RADIO MECHANIC required for work on transistor kits. Good wages and prospects for capable person. **SAVOY ELECTRONICS LTD.,** 15 Maiden Lane, Strand, London, WC2. Phone TEM 5484.

ELLIOTT

Due to increased commitments in this Division, vacancies now exist at our Rochester establishment for

**INSTRUMENT MECHANICS
SERVICE ENGINEERS**

Applicants for positions as Instrument mechanics must have had experience in the overhaul, repair and modification of airborne mechanical, electrical and electronic instrumentation, and selected applicants will be expected to deal with complex equipment from the latest types of British and American automatic pilots.

Service engineers, in addition to the above requirements, must produce evidence of previous employment in a similar capacity or demonstrate their ability to represent the Company at all levels.

If you are interested in either of these positions and would like to work within easy reach of the South Coast resorts, please apply by letter in the first instance to the Personnel Manager, quoting ref: 277 when an interview will be arranged. Working conditions, salaries and promotion prospects will be discussed at this interview.

ELLIOTT BROTHERS (London) LTD
AVIATION SERVICE AND REPAIR DIVISION
AIRPORT WORKS, ROCHESTER, KENT.

CITY AND GUILDS (Electrical, etc.) on "No pass—no fee" terms. Over 95% successes. For details of Electrical Engineering, Applied Electronics, Automation, etc., send for our 148-page handbook, free and post free. B.I.E.T. (Dept. 242A), 29 Wright's Lane, London, W8.

**MAKE ALL
SOLDERING
JOBS
EASY
with**



ORYX
MINIATURE SOLDERING INSTRUMENTS

ALL THE
HEAT IS
IN THE TIP

MAIN VOLTAGE
200/220 and 230/250
volts with 10 watts
for 470°F or 15
watts for 715°F.
Price 32/8.

LOW VOLTAGE
Range of 6, 12, 24
and 50 volts, with 6
to 24 watts for up
to 932°F operation.
Prices from 25/-.

W. GREENWOOD ELECTRONIC LTD.
677 Finchley Rd., London, N.W.2. Tel.: SW15 Cottage 3383/4

GZAK: This Month's Bargains

★ **SHADED POLE MOTORS** ★
230v. or 110v. operation. Ideal for fans, blowers or models.
One only, 12/6, plus 2/- p. & p. Or pair, £1, plus 2/6 p. & p.

★ **AERIAL EQUIPMENT**
TWIN FEEDER. 300 ohm twin ribbon feeder, similar K25, 6d. per yard. K35B Telecon (round) 1/6 per yard. Post on above feeder and cable 1/6 any length.
COPPER WIRE. 14 G., H/D 140ft. 17/-; 70ft. 8/6. P. & P. 2/-.
Other lengths *pro rata*.
RIBBED GLASS. 3in. aerial insulators, 1/9 each. P. & P. 1/6. up to 12.
CERAMIC FEEDER SPREADERS. 6in. type F.S. 10d. each P. & P. 2/-.
CERAMIC "T" PIECES. Type A.T. for centre of dipoles, 1/6 each. P. & P. 1/-.
2 METRE BEAM 5 ELEMENT W.S. YAGI. Complete in box with 1 x 25in. mast head bracket. PRICE 49/-, P. & P. 3/6.
SUPER AERAXIAL CABLE. 75 ohm, 300 watts, very low loss, 1/8 per yard. P. & P. 2/-.
50 ohm, 300 watt coax, very low loss, 1/9 yd. P. & P. 2/-.
ABSORPTION WAVEMETERS. 3.00 to 35.00 Mc/s in 3 switched bands, 3.5, 7, 14, 21 and 28 Mc/s. Ham Bands, marked on scale. Complete with indicator bulb. A MUST for any Ham shack. 22/6 post free.
VARIABLE CONDENSERS. All brass with ceramic end plates and ball race bearings. 50 pF, 5/9. 100 pF, 6/6. 160 pF, 7/6. 240 pF, 8/6, and 300 pF, 9/6. All fitted with rear extension for ganging. P. & P. 1/-. Also Flexible Couplers, 1/- each. B.I. 8 MFD. 1,200 v. D.C. Wkg. Capacitors, 12/6 each. P. & P. 2/-.

CHAS. H. YOUNG LTD.

THE COMPONENT SPECIALISTS
Dept. "P", 110 Dale End, Birmingham 4. (CEN 1635)
(No C.O.D. under £1 please.) (By return service.)

LOOK! PRICES DOWN
TRANSISTORS
YELLOW SPOT A.F. 6 volt, Now only 2/3.
RED SPOT 3/- each, 3 for 8/6.
WHITE SPOT 3/- each, 3 for 8/6.
YELLOW/GREEN 3/3 each, 3 for 9/-.
RED/YELLOW NOW ONLY 4/6.
MULLARD TRANSISTORS, NOT SURPLUS
OC71 6/6, OC72 8/-. matched pairs 16/-.
OC78 8/-. OC81 8/-. OC44 11/-. OC45 10/-.
OC170 13/6, OC171 14/6.
GERMANIUM DIODES, 1/- each, 3 for 2/6.
MULLARD DIODES OA70, OA79 or OA81 3/-, OA91 or OA95 Miniatures 3/6.
OSMOR COMPONENTS for P.W. Superhet, DOWN IN PRICE.
PRINTED CIRCUITS, NOW ONLY 7/6.
FERRITE ROD AERIALS, NOW 8/6.
DRIVER & OUTPUT TRANSFORMERS REDUCED TO 16/3 pr.
LATEST CABINETS for POCKET SUPERHET, 12/6 each.
CRYSTAL EARPIECES with LEAD and PLUG REDUCED TO 7/6.
LOW IMP EARPIECES with LEAD and PLUG, DOWN TO 7/3.
MINIATURE TRANSISTOR TRANSFORMERS, P.P. Driver 4. 5:1 P.P. Output 20:1 Boxed with Spec., ONLY 9/6 pr.
DRX1 CRYSTAL SET COILS M. & L. with Circuit, 2/6.
TRANSISTOR HOLDERS, 1/3 each., 3 for 3/6.
REACTION CONDENSERS .0001 3/-, .0003 3/9, .0005 4/-.
ALL SENT POST FREE IN U.K. by
PETHERICK'S RADIO SUPPLIES
22 High Street, Bideford, N. Devon
Tel.: Bideford 1217
S.A.E. WITH ALL INQUIRIES PLEASE

BBC - ITV - F.M. AERIALS

B.B.C. (BAND 1). Telescopic loft, 19/6. External S/D. 26/3.
I.T.V. (BAND 3). 3 Element loft array, 24/-, 5 Element. 32/6. Wall mounting, 3 Element, 33/6. 5 Element, 41/3.
COMBINED B.B.C. + I.T.V. Loft 1+3 Element, 41/3. 1+5 Element, 45/9. Wall mounting, 1+3 Element, 56/3. 1+5 Element, 63/9. Chimney and mast mounting units also available.
F.M. (BAND 2). Loft "H", 28/-, 3 Element loft, 52/6. S/D loft, 12/6. External S/D. 28/3. State channel when ordering. C.W.O. or C.O.D. P.P. 2/6. Coaxial cable. 6ft. yd. Coaxial plugs, 1/3. Send 6d. stamps for illustrated lists.
K.V.A. ELECTRONICS (Dept.P.W.)
3B, Godstone Road, Kenley, Surrey.

A.R.R.L. RADIO AMATEURS HANDBOOK 1962
New Edition 36/-. Postage 2/6.
World Radio and TV Handbook 1962 by Johansen, 18/9. Postage 1/-.
Amateur Radio Handbook by R.S.G.B. New edition 34/-. Postage 2/3.
Transistor Circuits for Radio Controlled Models by Boys, 7/6. Postage 6d.
Transistor Subminiature Receivers for the constructor. 5/-. Postage 6d.
Guide to Broadcasting Stations 1962 by W.W. 3/6. Postage 6d.
RADIO, TV Tube, Diode and Transistor Equivalents Manual, 9/6. Postage 9d.
Radio Valve Data. New edition, by *Wireless World*, 6/-. Postage 9d.
Mullard Reference Manual of Transistor Circuits. 12/6. Postage 1/-.
UNIVERSAL BOOK CO.
12 Little Newport Street, London, W.C.2 (adjoining Lisle Street)

H.A.C. SHORT-WAVE EQUIPMENT AND SHORT-WAVE KITS
Famous for over 25 years for ...
S.W. Receivers and Kits of Quality.
H.A.C. were the original suppliers of SHORT-WAVE RECEIVER KITS for the amateur constructor. Over 10,000 satisfied customers—including Technical Colleges, Hospitals, Public Schools, Hams, etc.
Improved designs with Denco coils: One-valve Kit, Model "C", Price 25/-. Two-valve Kit, Model "E", Price 50/-. New Addition: Model "K", Super sensitive "All Dry" Receiver. Special inc. price. Complete Kit, 77/-.

All kits complete with all components, accessories and full instructions. Before ordering call and inspect a demonstration receiver, or send for descriptive catalogue and order form.

POST THIS COUPON NOW!
"H.A.C." SHORT-WAVE PRODUCTS
(Dept. TH), 44 Old Bond Street, London W.1
Please send me FREE and without obligation your 1962 literature.
NAME.....
ADDRESS.....
.....

EDDY'S (NOTTM) LTD.

172 Alfreton Road, Nottingham

New or Surplus VALVES

Guaranteed and Tested by Return Post.

| | | | | |
|-------|--------|-------|--------|------|
| AC2/ | EF95 | 6/11 | VP23 | 6/6 |
| PENDD | EF184 | 12/6 | Z63 | 5/- |
| | EL32 | 6/11 | Z77 | 3/6 |
| C1C | EL85 | 10/3 | 1D5 | 7/6 |
| CL33 | EL91 | 4/6 | 1L4 | 3/6 |
| CY31 | EZ40 | 6/3 | 1R5 | 5/6 |
| DAF91 | EZ41 | 7/- | 1S5 | 4/9 |
| DF91 | EZ80 | 6/3 | 1T4 | 3/6 |
| DF92 | GT1C | 6/11 | SZ4G | 7/6 |
| DF96 | HL23DD | 6/6 | 6AG5 | 3/11 |
| DK96 | KT33C | 6/6 | 6AC7 | 4/- |
| DK91 | L63 | 3/11 | 6C4 | 3/6 |
| DL93 | MU14 | 7/- | 6F1 | 6/6 |
| DM70 | OZ4 | 5/11 | 6F13 | 6/11 |
| EAC91 | PCC85 | 9/6 | 6F15 | 6/6 |
| EB34 | PCC88 | 12/6 | 6F33 | 6/6 |
| EB41 | PCC89 | 10/6 | 6I7G | 5/- |
| EB91 | PCF82 | 9/6 | 6K7G | 1/11 |
| EBC33 | PCL34 | 12/6 | 6K8G | 5/6 |
| EBC41 | PCL85 | 10/6 | 6P25 | 9/6 |
| EBC81 | PL36 | 13/6 | 6Q7G | 5/11 |
| EBF80 | PY31 | 9/6 | 6SA7M | 5/9 |
| ECC35 | PY32 | 12/6 | 6SG7M | 4/9 |
| ECC81 | PY80 | 6/6 | 6SL7GT | 6/6 |
| ECC85 | PY82 | 5/11 | 6SN7GT | 4/3 |
| ECH42 | PZ30 | 9/6 | 7C5 | 6/11 |
| ECL82 | PEN46 | 4/6 | 10F1 | 4/6 |
| EF36 | PEN36C | 8/- | 12A6 | 5/- |
| EF37A | SP61 | 2/6 | 12AH7 | 2/6 |
| EF39 | TDD4 | 7/6 | 20D1 | 8/6 |
| EF40 | U25 | 12/6 | 20P1 | 9/6 |
| EF41 | U26 | 10/11 | 25L6GT | 8/6 |
| EF42 | UBC41 | 7/6 | 80 | 6/11 |
| EF50 | UCH42 | 7/6 | 954 | 1/6 |
| EF91 | UF41 | 8/11 | 955 | 3/6 |
| EF92 | UF42 | 9/6 | 956 | 2/6 |
| EF94 | UY41 | 6/3 | | |

BUILD YOUR OWN CAR RADIO!



7 Transistors Long and Medium Waves. Two watts output RF stage and automatic gain control. (6 or 12 volts, please state). Supplied with full instructions at 10¹/₂ Gns. Size: 7 1/2 x 7 1/2 x 2 1/2 in. Speaker 17/11 extra (7 x 4 ellipt) if required. Postage and packing 5/- extra per kit.

NIFE ACCUMULATORS. 1.25v. Size 3 x 2 1/2 x 1/2 in. 7 amp hrs. weight 13 ozs. 2/11 each. P. & P. 2/-, one only add 9d. per cell.

POCKET RADIO. 2 Trans. with min. speaker, complete with all parts. Wiring diagram and full instructions. 27/6. Batt. 1/-, P. & P. 2/-.

THROAT MIKES. 2/- ea. Post 10d., could be used for electrifying musical inst., etc.

VIBRATORS. 12 volt, 4 pin, 4/11. 6 volt, 4 pin, 8/11. Post 1/6.

GERMANIUM DIODES, 9d. each, 7/- dozen. Post 6d.

NEON MAINS TESTERS, and screw-drivers, 3/6. Post 6d.

HAND MIKES. Carbon 4/11. Post 1/6.

All Above are New and Guaranteed

Any parcel insured against damage in transit for only 6d. extra per order. All uninsured parcels at customer's risk. Post and packing 6d. per valve extra. C.W.O. or C.O.D. only. C.O.D. charge 3/- extra. S.A.E. with enquiries.

RADIO CLEARANCE LTD.

The oldest Component Specialists in the Trade

27 TOTTENHAM COURT ROAD, LONDON, W.1.

Telephone: MUSEUM 9188

TRADE ENQUIRIES INVITED

EST. 30 YRS.

IN THE HOME, IN THE CAR, BY THE SEA, IN FIELDS AFAR, THE

"CONTESSA"

IS VOTED BEST OF ALL

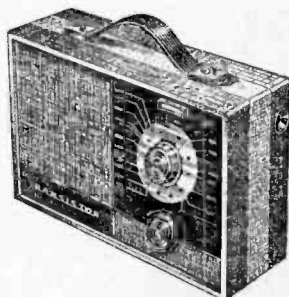

A really remarkable 2-Band 6-Transistor Superhet Radio—25,000 satisfied customers and still in huge demand.

The Contessa is the professional looking set with the professional performance.

Study these brilliant features which cannot be found in any other Radio—

- Waveband coverage of 530 kc/s to 1,620 kc/s and 160 kc/s to 270 kc/s.
- Assured reception of at least a dozen stations in daylight!
- Large clearly-calibrated station-named dial.
- Internal high-gain ferrite aerial.
- 5:1 ratio slow motion tuning.
- Fitted with the latest 12,000-line high flux loudspeaker.
- Power of 410 milliwatts from the single-ended push-pull (fina) stage.
- Specially designed aerial matching coil for use in a CAR.
- Only first-grade fully guaranteed matched transistors and diodes are used.
- Double tuned IF transformers for maximum gain and knife-edged selectivity.
- Fully drilled printed circuit panel marked with component numbers.
- The two-colour case measures 10 x 7 1/2 x 3 1/2 in. and weighs approx. 4 lbs. when assembled.
- Battery lasts 4 months with normal usage.
- Book supplied with detailed assembly instructions, diagrams and circuitry.
- Anyone can build this set—everything supplied just a soldering iron required.

Inclusive price for all associated components, cabinet and battery, complete in every detail, or our BUY AS YOU BUILD SCHEME, any parts sold separately. Send for comprehensive descriptive Manual and Parts List, 3/6 post free Plus 3/6 P. & Pkg.

£10.19.6

And now this is what you have been eagerly waiting for—

THE "CAPRI"

A MINIATURE pocket transistor Radio that REALLY works, retaining the most attractive features of the famous "Contessa". SIX first-grade Mullard transistors and diode are employed in a highly sensitive superhet MW and preset LW circuit embodying the most modern design practice. A special 2 in. high gauss loudspeaker provides surprising volume and a personal earpiece socket is also available. An attractive two-tone plastic case is supplied in two colours, Ivory/Red or Ivory/Blue, the full constructional details being given with each set of parts. The total MEASUREMENTS of the "Capri" are 4 1/2 x 2 1/2 x 1 1/2 in.

SEE AND HEAR A WORKING MODEL TODAY

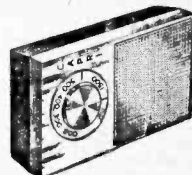

Inclusive price for all associated components, case and constructional data, complete in every detail, or our BUY AS YOU BUILD SCHEME, ANY PARTS SOLD SEPARATELY. 9 v. battery 2/6 extra.

£7.10.0

plus 2/- P. & Pkg.

STAMPED and ADDRESSED ENVELOPE with any enquiry please. But regret no lists or catalogues—our stocks move too quickly!

PLEASE ALLOW FULL POSTAGE AND PACKING CHARGES

Terms of Business:

CASH WITH ORDER OR C.O.D. ON ORDERS OVER 10/-

3-TRANSISTOR POCKET RADIO

WITH MINIATURE LOUDSPEAKER
**ABSOLUTELY NO SOLDERING
REQUIRED**

Unique
Design

39/6

Superb appearance. Simple instructions. Built in an evening. No drilling. No soldering. Complete in every detail. Receives entire broadcast band. Aerial required in certain areas. Pocket size 4½x2½x1½in.



Or the more powerful

SAVOY SUPER 3
Three transistors and 2 diodes in a 5 stage reflex circuit.

55/6

ALL PARTS SOLD SEPARATELY
Battery 1/- extra. P. & P. 2/-.

(PW) SAVOY ELECTRONICS LTD.

15 Maiden Lane, Strand, London, W.C.2
(Back of Adelphi Theatre)

PADGETTS RADIO STORE

OLD TOWN HALL, KNOWLER HILL,
LIVERSEDGE, YORKS.

Phone: Cleckheaton 2868

Test Set Type 74A. This is a Scope all but made, complete with 3 in. tube, all valves and 230 volt A/C power pack. 50/-, carriage B.R.S. 8/6. Condition good.

Complete TV Chassis for Spares. Less valves, 12in., four for 10/-, carr. B.R.S. 7/6; 14in. chassis, four for 15/-, carr. 8/6.

SCR522, RX and TX. Less valves and crystals, otherwise complete, 15/-, carr. 8/6. B.R.S. Receivers only 7/8, carr. 5/-.

F.M. Speakers. All 3 ohms, removed from TV sets. Perfect condition. Rola 6 x 4in., 5/-; Goodman 7 x 4in., 6/-; Phillips 5in. round, 6/-; Rola and R. and A. 6in. round, 3/6; 8in. round, 6/-. Post extra on any speaker, 2/-; up to six can be sent for 3/6.

Front Glasses from TV Sets, 12 and 14in., 6/- each, post 2/- 5/- per doz., carr. 5/-. Perspex 2/- each, post 2/-.

NEW VALVES, Ex-units. All Post Free. 6K7 2/-, 6X5 4/-, 6V6 3/-, 6V6GT 4/-, 6C4 2/-, 6T83 4/-, DH63 4/-, EF91 1/8, EB91 1/8, 6J6 2/6, EF50 1/6, 6/- per doz. 5U4 4/6, 5Z4 5/6, 654 1/6, 600L 9d., 5/- per doz. VR150/30 4/-.

Valves Removed from TV sets. All tested on a Mullard Valve Tester and are 100% as new. They carry a 3 months unconditional guarantee. All Post Free. EF80 1/6, 10/- per doz. Grade 2, 6d., 4/- per doz.

| | | | | | |
|-------|-----|--------------|-----|-------|-----|
| EC180 | 4/8 | 6LD20 | 5/- | KT36 | 5/- |
| ECC82 | 5/- | 6SN7 | 2/9 | PL81 | 5/- |
| EL38 | 4/6 | 10C2 | 2/9 | PY81 | 4/- |
| EY31 | 2/6 | 10F1 | 2/- | PL22 | 5/- |
| EBF80 | 4/6 | 10A per doz. | 5/6 | PC93 | 5/- |
| EB91 | 9d. | 10P14 | 5/- | PY80 | 5/- |
| EF91 | 1/- | 10P13 | 5/- | PL38 | 5/- |
| 6P25 | 4/- | 20D1 | 3/- | PZ30 | 4/- |
| 6P28 | 4/- | 20P1 | 5/- | PCF80 | 4/6 |
| 6P30 | 2/- | 20F1 | 5/- | PC54 | 4/6 |
| 6F13 | 2/- | 185BT | 8/6 | PL83 | 5/- |
| 6F14 | 5/- | U25 | 5/- | PL33 | 4/- |
| 6SS7 | 2/- | U282 | 5/- | B36 | 4/- |
| 6G6 | 2/6 | V281 | 5/- | N37 | 5/- |
| 6Y6 | 2/6 | V322 | 5/- | L63 | 3/- |

Complete TV sets. Untested. 12in. 20/-, 14in. 30/-, 14in. 13-channel 50/-, 17in. EBC only 50/-. Carriage on any set 10/-. If you wish to insure against damage, 8/6 extra.

TV Converters. Less valves and knobs. Coils fitted 2 and 10. Ekco. Ultra, Pye, Marconi, Murphy, etc., 2/6, post 2/-.

Cyclon Converters. Complete with knobs less valves. Coils fitted 2 and 10 only. 10/-, Post 2/-.

TV Tubes. Regunned. 12 months' guarantee. Old glass not required. 12, 14, 15, 16, 17 in. Any make. All same price, £3.15.0. Carr. and ins., 7/6.

Perfect Reclaimed Tubes, 6 months' guarantee. 12in. 17/-, 14in. Mullard only £1.10.0. Carr. and ins. 7/6.

RADIO BOOKS

A BRILLIANT NEW Pictorial approach to understanding BASIC ELECTRICITY AND ELECTRONICS in Simple straight-forward words and Clear Explanatory Pictures. The Reader is taken Step by Step from Picture to Picture.

LEARN WHILE YOU PAY FOR ONLY 2/6 PER WEEK Write for FREE Illustrated Prospectus giving details of instalment plan.

MULLARD CIRCUITS FOR AUDIO AMPLIFIERS, 9/6. TRANSISTOR CIRCUITS FOR THE CONSTRUCTOR. By Bradley. No. 1, No. 2, No. 3, 4/-.

OSCILLOSCOPE BOOK. Bradley, 5/-. OSCILLOSCOPE EQUIPMENT. Basterling, 5/6.

RECORDS & GRAMOPHONE EQUIPMENT. By Bradley, 9/6. RADIO, TELEVISION & ELECTRONIC DATA BOOK 4/-.

EXTRA EQUIPMENT FOR YOUR TAPE RECORDER, 6/6. PRACTICAL TRANSISTOR AUDIO AMPLIFIERS for home constructor 4/-.

III-FI TRANSISTOR FM TUNER, 4/- TRANSISTOR CIRCUITS for Radio Controlled models. Howard Boys, 8/-. SUPER SENSITIVE TRANSISTORISED POCKET RADIO, 4/-.

INTERNATIONAL STATION LIST, 3/- COIL DESIGN AND CONSTRUCTION MANUAL, 5/6.

HI-FI TAPE RECORDER, 3/- ONE VALVE RECEIVERS, TWO VALVE RECEIVERS, THREE VALVE RECEIVERS, FOUR VALVE RECEIVERS. Each book gives full comprehensive instructions, diagram, etc. 1/9 each.

BOY'S BOOK OF CRYSTAL SETS, 3/- HOW TO GET THE BEST OUT OF YOUR TAPE RECORDER. By Guy, 9/-. HI-FI SPEAKER ENCLOSURES, 5/6.

TRANSISTOR SUPERHET RECEIVERS. Circuit diagrams of 50 Receivers, 8/- 40 CIRCUITS USING GERMANIUM DIODES, 3/6.

RADIO VALVE DATA (Wireless World) 7th edition, 7/- BRIMAR VALVE MANUAL No. 9, 7/- GUIDE TO BROADCASTING STATIONS (Wireless World) 12th edition, 4/-.

MULLARD REFERENCE MANUAL OF TRANSISTOR CIRCUITS, 13/6. ELECTRONIC NOVELTIES, BRADLEY 5/6.

ELECTRONIC GADGETS, Bradley 4/- RADIO CONTROL OF MODELS. By Sommerhoff 5/6.

SERVICING TRANSISTOR RECEIVERS Pettit, 7/- USING AN OSCILLOSCOPE. 7/- BEGINNERS GUIDE TO RADIO. Camm. New and Revised Edition, 8/6.

RADIO TESTER MANUAL, 3/- TRANSISTOR SUB-MINIATURE RECEIVERS MANUAL 5/6.

RADIO SERVICING. By Patchett. Vol. I. Basic Electro-Technology 5/6. Vol. II. Intermediate radio Theory 9/-. Vol. III. Final Radio Theory 6/6.

Vol. IV. Fault Finding 5/6. All above titles include postage. SEND STAMP FOR LISTS

SERLAY BOOK CO.

60 HAYES HILL, HAYES, BROMLEY KENT. Tel. Hurstway 1818

TRANSISTORS

RED SPOT 3/-
WHITE SPOT 3/6

XB102, 9/-; OC70, 6/6; OC71, 6/6; OC72 8/-; (matched pair 16/-); OC44, 11/-; OC45, 10/-. All other types in stock. CRYSTAL DIODES 1/-; Mullard OAO, OAB, 3/-; Substrate condensers for all transistor sets—0.01 mfd., 0.02 mfd., 0.03 mfd., 0.1 mfd., 0.2 mfd., 0.4 mfd., 0.5 mfd., all 1/- each. 1 mfd., 1/3; sub mfd., 2 mfd., 8 mfd., 2/6. Connecting Wire, 6 colours, 1 yd. each 1/8; 2 yds. each 2/6.

Resistors: All Values 10% watt. 6d. ea. The New JOURNEYMAN "6". It's amazing; plans etc., 1/6, or send S.A.E. for lists.

OAKFIELD RADIO
121 MACCLESFIELD ROAD,
HAZEL GROVE, STOCKPORT, CHESHIRE
MAIL ORDER ONLY

The NEW 'SAVOY' 4-TRANSISTOR POCKET RADIO

WITH MOVING COIL SPEAKER
ABSOLUTELY NO SOLDERING

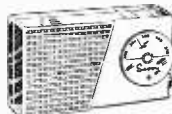

**NO
DRILLING
NO AERIAL
REQUIRED**

4-Transistors and 2 diodes; 5-stage reflex circuit; push-pull output; size 5½ x 3 x 1½in.; full medium wave; simple instructions and assembly tool provided.

95/- Plus battery 2/- extra
Postage and packing 3/-
All parts sold separately

(PW) SAVOY ELECTRONICS LTD.

15 Maiden Lane, Strand, London, W.C.2
(Back of Adelphi Theatre)

2 METRES!

The thrills of 144 Mc/s can now be yours for only 39/6, complete kit! Tunable range 150-100 Mc/s, simplified construction etc., write today for descriptive literature, also if a newcomer-beginner to Amateur Radio, ask for free copy of the world-famous "Globe-King" kits and receivers—stamp to cover postage costs appreciated. Write now to makers:

JOHNSONS (Radio)

8t. Martins Gate, Worcester

POCKET RADIO - - - Astounding Results, Medium & Long Wave.

Completely portable, personal earphone. ALL PARTS 65/-, plus post 2/- . Write for details (3d. stamp) before you buy elsewhere. Red Spot Transistors 2/3; White Spots 2/3; Yellow/Green 3/3; OC71, 6/-; OC72, 7/6; OC44, 9/6; OC45, 9/- . Sub-min. electrolytics 2, 4, 8, 10, 16, 32, 50 mfd 2/-; 100 mfd 2/9; 250, 500, 1000 mfd 3/3; Silicon rectifier bargain 70 p.p. ½ amp., 3/3. Packard Bell Amplifiers, new, 12/6. Parsons Pocket Radio Kit, 52/6. Transistor Tape Recorder, £11.11 (£15 elsewhere). Transformer 250-0-250 v., 6 v., 5 v., 15/-; Hearing Aid Mike 31/6. Super Coax, 75 ohms, 6d. yd. Electrolytics 8uF, 500 v., 2/3; 8 + 15uF., 3/3; 100 + 100 (375 v.), 3/9. V. Cond., twin gang .0005 trimmers and slow motion 7/6. Transistor holders, 1/- . Resistors 10% tol. 4d; 5% tol. 9d. Tannoy Mike 3/6. Crystal Inserts (new), 7/6. Gortler Units, 1 watt amplifier, 92/6; I.F. Amplifier (460 kc/s. pre-aligned), 92/6; 3 waveband converter 90/3; Manual No. 167 describing and circuits, 2/9, post free. High and low imp. earphone 8/6.

TERMS: C.W.O. Post extra, excess refunded. Our Reflex Rx. best 2 transistor receiver. Send 10d. stamps for Notes.

MOORE'S EXPERIMENTAL SUPPLIES Tel.: 27461
8 & 10 Granville Street, Sheffield 2

FREE TO AMBITIOUS ENGINEERS

— THE LATEST EDITION OF ENGINEERING OPPORTUNITIES

Have you sent for your copy?
ENGINEERING OPPORTUNITIES is a highly informative 156-page guide to the best paid engineering posts. It tells you how you can quickly prepare at home for a recognised engineering qualification and outlines a wonderful range of modern Home Study Courses in all branches of Engineering. This unique book also gives full details of the Practical Radio & Electronics Courses, administered by our Specialist Electronics Training Division—the *B.I.E.T. School of Electronics*, explains the benefits of our Employment Dept. and shows you how to qualify for five years promotion in one year.

We definitely Guarantee
“NO PASS — NO FEE”

Whatever your age or experience, you cannot afford to miss reading this famous book. If you are earning less than £25 a week, send for your copy of “ENGINEERING OPPORTUNITIES” today—FREE

BRITISH INSTITUTE OF ENGINEERING TECHNOLOGY (Incorporating E.M.I. Institutes)
 (Dept. SE/21), 29 Wright's Lane, London, W.8

THE B.I.E.T. IS THE LEADING ORGANISATION OF ITS KIND IN THE WORLD

WHICH IS YOUR PET SUBJECT?

- Mechanical Eng.
- Electrical Eng.
- Civil Engineering
- Radio Engineering
- Automobile Eng.
- Aeronautical Eng.
- Production Eng.
- Building, Plastics, Draughtsmanship, Television, etc.

GET SOME LETTERS AFTER YOUR NAME!

- A.M.I.Mech.E.
- A.M.I.C.E.
- A.M.I.Prod.E.
- A.M.I.M.I.
- A.I.O.B.
- A.F.R.Ae.S.
- B.Sc.
- A.M.Brit.I.R.E. City & Guilds
- Gen. Cert. of Education Etc.. etc.

PRACTICAL EQUIPMENT

Basic Practical and Theoretical Courses for beginners in Radio, T.V., Electronics, Etc., A.M.Brit.I.R.E. City & Guilds Radio Amateurs' Exam. R.T.E.B. Certificate P.M.G. Certificate Practical Radio Radio & Television Servicing Practical Electronics Electronics Engineering Automation

INCLUDING TOOLS!

The specialist Electronics Division of B.I.E.T. (Incorporating E.M.I. Institutes) NOW offers you a real laboratory training at home with practical equipment. Ask for details.

B.I.E.T. SCHOOL OF ELECTRONICS



POST COUPON NOW!

Please send me your FREE 156-page “ENGINEERING OPPORTUNITIES” (Write if you prefer not to cut page)

NAME

ADDRESS

SUBJECT OR EXAM THAT INTERESTS ME (SE/21)

SOUTHERN RADIO'S WIRELESS BARGAINS

PORTABLE TEST METERS. (As featured in March 1961, issue, pages 1005 to 1010) 0-5000 ohms; 0-60 mA; 0-15 v., 0-3 v., 12/6 each.

TRANSMITTER RECEIVERS. “Type 38” with 5 valves. New but untested. No guarantee, 25/- each. Post paid.

ATTACHMENTS FOR “38” TRANSMITTER-RECEIVER: Headphones 15/6; Throat Microphones, 4/6; Junction Boxes, 2/6; Aerials, No. 1, 2/9, No. 2, 5/3; Webbing, 4/-; Haversacks, 5/6; Valves—A.R.P.12 4/6. A.T.P.4, 3/6. Set of five valves, 19/-. Postage on each item 1/6 extra (except valves).

ATTACHMENTS FOR “18” TRANSRECEIVER. Headphones, 15/6; Microphone 4a, 12/6; Aerials, 5/-; Morse Key, 6/6; Valves—A.R.P.12, 4/6, A.T.P.4, 3/6, A.R.8, 7/6; Set of six valves, 25/-. Official booklet “18” T.R. Circuits, etc., 6/6 post paid. Postage extra (except valves) 1/6 each item.

QUARTZ CRYSTALS. Types F.T.241/F.T.243 2 pin $\frac{1}{2}$ in. spacing. F.T.241 20 to 38.9 Mc/s (54th and 72nd Harmonic). F.T.243 5700 to 8650 kc/s (Fundamental), 4/6 each. Lists of available frequencies on request. Crystal Holders for F.T.241/243, 1/3. F.T.241/243 Crystals. New but not guaranteed (ideal for using the case or regrinding). 12/6 per dozen. Post paid.

RECORDING BLANKS. New 13in., 6/- each or 15 complete in Tin, £4.

BOMBSIGHT COMPUTERS. Ex-R.A.F. Wealth of gears, motors, blowers, etc. Ideal for experimenters, £3.12.6, carr. paid.

RESISTANCES. 100 Assd. Useful values, new, 12/6 per 100.

CONDENSERS. 100 Ass. Mica Elec., Tub., etc. New 15/- per 100.

MORSE PRACTICE SETS. Key with Buzzer on Base, with battery, 12/6, postage 2/-.

LUBFRA HOLE CUTTERS. Adjustable. $\frac{1}{2}$ in. to $\frac{3}{4}$ in., 7/3.

STAR IDENTIFIERS. 1-AN. Covers both hemispheres, 5/6.

VISUAL INDICATORS (10Q4). Type 3 with 2 meter movements, 2 neons. New 12/-.

MAGNETS. Strong Bar, 2in. x $\frac{1}{2}$ in. 1/6 each.

COMMAND RECEIVERS B.C. 455 6-9 Mc/s. Complete with 6 valves, 47/6 each.

POST OR CARRIAGE EXTRA, FULL LIST OF RADIO BOOKS, ETC., 3d.
SOUTHERN RADIO SUPPLY LTD.
 11 LITTLE NEWPORT ST., LONDON W.C.2. GER. 6653

SUPER 5 TRANSISTOR POCKET RADIO

INCORPORATING
 Printed Circuit —
 Miniature earpiece
 Completely portable
 No Aerial or Earth
 is required

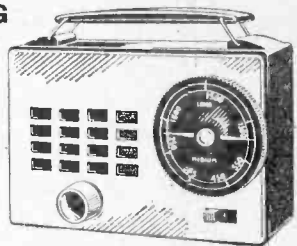

- ★ Size 4 $\frac{1}{2}$ x 3 $\frac{1}{2}$ x 1 $\frac{1}{2}$ in.
- ★ Output 200m W
- ★ 5 First quality transistors
- ★ Push-pull output
- ★ Fitted 2 $\frac{1}{2}$ in. high-flux moving coil speaker

ONLY **59/6**
 3/6 P. & P.

Complete with internal high-gain ferrox aerial and twin tone case in Red and Black. Med/Long wave. Earpiece has sub-min jack and socket with 3ft. fine cable. Almost invisible in use. All parts available separately. Circuit diagram 1/6—Free with parts.

RADIO & TV LTD. (Dept. 5T)
 HIGH STREET, ACTON, LONDON, W.3.

CABINETS & HI-FI EQUIPMENT

We can supply any Cabinet to your own specification

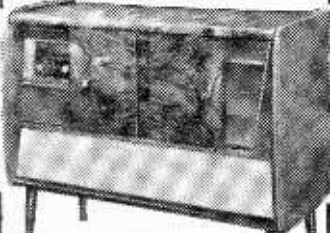

"Grosvenor" £22.10

This is only one example taken from our extensive range of stock cabinets. Write for our NEW 24 page fully illustrated catalogue only.

THE LARGEST RANGE OF CABINETS IN THE COUNTRY. Equipment is also our speciality. SEND TODAY for a free copy of the Lewis Radio cabinet catalogue—the most comprehensive ever prepared.

LEWIS radio

100 (P.W.42) Chase Side, Southgate, London, N.14. Tel 3733/9666

NEW VALVES!

Guaranteed Set Tested 24-HOUR SERVICE

| | | |
|---|--|------------|
| IR5, 1S5, 1T4, 3S4, 3V4, DAF91, DF91, DK91, DL92, DL94, SET of 4, 18/6. | DAF96, DF96, DK96, DL96, SET of 4 28/- | |
| 1D5 7/- | D135 9/6 | PCCR8 9/- |
| 1R5 5/- | DL92 5/11 | PCF80 7/9 |
| 1S5 4/6 | DL94 6/9 | PCF82 7/6 |
| 1T4 3/3 | DL96 6/9 | PCL82 8/3 |
| 3S4 5/11 | EB91 3/- | PCL83 11/6 |
| 3V4 4/6 | EB91 3/- | PCL84 9/9 |
| 5U4G 4/6 | EBF80 7/9 | PL38 10/9 |
| 5Y3GT 5/9 | EBL21 12/6 | PL81 8/6 |
| 5Z4G 8/6 | ECC40 14/6 | PL82 6/6 |
| 8AM6 2/9 | ECC81 4/9 | PL83 6/6 |
| 6V6GT 6/6 | ECC82 5/9 | PL84 8/- |
| 6X5GT 4/6 | ECC83 6/9 | PY32 11/6 |
| 12K7GT 4/3 | ECC84 8/- | PY80 7/- |
| 12K8GT 9/- | ECC85 7/6 | PY81 7/- |
| 12Q7GT 4/6 | ECC86 7/3 | PY82 6/6 |
| 12SN7GT 7/9 | EF40 12/3 | PY83 7/3 |
| 35LGT 5/- | EF41 4/3 | U25 11/6 |
| 35Z4GT 5/- | EF90 4/3 | UABCO 6/- |
| AZ31 8/9 | EF95 4/6 | UAF42 8/- |
| CL33 11/9 | EF98 8/9 | UCH42 7/6 |
| DA C32 8/6 | EF99 6/9 | UCH81 8/9 |
| DAF91 4/6 | EF91 8/9 | UCL82 9/3 |
| DAF96 6/9 | EL41 9/- | UCL83 13/- |
| DF33 8/6 | EL84 6/3 | UF41 6/9 |
| DF91 3/3 | EY51 7/3 | UR89 6/9 |
| DF96 6/9 | EF98 7/6 | UL41 7/6 |
| DH77 6/9 | EZ40 6/- | UL84 6/6 |
| DK32 10/6 | EZ41 6/9 | UY21 13/- |
| DK91 6/- | EZ90 5/9 | UY41 5/6 |
| DK92 7/3 | EZ91 6/- | UY85 6/3 |
| DK96 7/3 | MU14 6/- | VP43 8/6 |
| DL33 7/6 | PCC84 7/- | Z77 2/9 |

Postage 6d. per valve extra. Any Parcel Insured Against Damage in Transit 6d. extra. Any C.O.D. Parcel 3/- extra. Office address, no callers.

GERALD BERNARD

(Note new address—formerly of Leeds) 83 OSBALDESTON ROAD, STOKE NEWINGTON, LONDON, N.16

35' TV SETS

Tube, valves, speaker, cabinet, etc. Not guaranteed. Carr. 15/6. Scotland & Ireland 20/-.
EACH TV TUBES 14K F4 and 36/24. Replacements. Carr. 10/-.
A.C. for light-weight application. Can be carried safely while hot. In vinyl bag, with lead and plug. Carriage FREE.

5/6 TV CHASSIS

Resistors, condensers, valve holders, rectifiers, chokes, etc. Ideal for spares. Working when stored. Carr. 7/6, Scot. and Ireland 10/-. (Plus circuit).

PORTABLE SOLDERING 18/9 IRON

30 w. 230 v. 4 1/2 in long. A.C. for light-weight application. Can be carried safely while hot. In vinyl bag, with lead and plug. Carriage FREE.

9D. VALVES

6D1, 6D2, 6F12, 6F13, 6F14, 6F15, 8D3, 9D2, 15D2, 78, EA60, EB91, ECUC31, ECUC34, EF50, EF91, PM202, SP61, UB41, UF42, VR35, VR51, VR107, VR137, VR201, Z77.

1/9 6F25, 6F28, 10D1, 1625, B36, EB41, EL32, N142, U92, U91, U35, W76, W77, 2/9 6AB8, 6L18, 10F1, 10P13, 20J1, 20F3, EBC80, ECL50, FFP2, RY51, KT36, N145, LN152, PL33, U151.

P.P. COMPONENTS LTD.

623 Romford Rd., Manor Park, E. 12
Mail order only. Stamp for FREE list.

PRECISION WIREWOUND RESISTORS
1 watt 1 ohm to 1K, 1% 2/9, 1% 3/-, 0.2% 4/3; to 5K 1% 3/3; 1% 3/6, 0.2% 4/9; to 20K 1% 4/-; 1% 4/3, 0.2% 6/-. Your value wound to order! High Stability Resistors, 1W 1%, 2/- each, standard values plus 5K, 9K, 9.5K, 25K, 30K, 40K, 50K, 60K, 70K, 80K, 90K, etc. up to 10M. Surplus 1% High Stabs. List on request. 2% Hinstabs 2/- doz. our assortment. 2% Carbon Resistors, any value 4d. 30 assorted 2/6, post 1/6. Instrument Rectifiers, new. Salford 1mA or 5mA, 7/6. Ex-Govt. 50uA-1mA. 3/6. Postage 9d. Special this month only. Salford 1mA rec. with 1% multipliers for 10, 100, 250, 500 and 1,000V A.C., usually 17/6, now 11/-. Post. 9d. Choke, 3H 70 ohm 200mA, 1/6. Post 1/6. Dropper, 350 ohm 20W with slider 1/6. P.P. 1/- WW Pots, 200 ohm, 1K, 5K, 7.5K, 1/6 ea. P.P. 9d. Mains Suppressor Choke on panel with 0.1 and .02uF, 1/-, Post 9d. Postage extra. S.A.E. enquiries please.

PLANET INSTRUMENT CO.

25 DOMINION AVE., LEEDS 7

PROFITABLE SCRIPTWRITING FOR TV and RADIO

by Gale Pedrick
Gale Pedrick, the B.B.C.'s first Script Editor, has put all his vast knowledge and experience at the service of the would-be television and radio script-writer in this encouraging book. Much of the "know-how" he gives had to be learned the hard way but those who follow his advice and guidance on the techniques involved will soon acquire a solid background to this fascinating and important subject. The market for good script-writers is growing daily, particularly with the expansion of television—Gale Pedrick, a real professional, shows you how to meet this demand and make a profit. 208 pages.

21s. FROM ALL BOOKSELLERS. . . . or in case of difficulty, 22s. 3d. by post from C. ARTHUR PEARSON LTD., Tower House, Southampton St., London, W.C.2. (Descriptive Leaflet available.)

FIRST-CLASS RADIO COURSES . . .

GET A CERTIFICATE!
QUALIFY AT HOME—IN SPARE TIME

After brief, intensely interesting study—undertaken at home in your spare time—YOU can secure your professional qualification or learn Servicing and Theory. Let us show you how.

FREE GUIDE
The New Free Guide contains 132 pages of information of the greatest importance to those seeking such success-compelling qualifications as A.M.Brit.I.R.E., City and Guilds Final Radio, P.M.G. Radio Amateurs' Exams, Gen. Cert. of Educ. London B.Sc. (Eng.), A.M.I.P.E., A.M.I.Mech.E., Draughtsmanship (all branches) etc., together with particulars of our remarkable Guarantee of

SUCCESS OR NO FEE
Write now for your copy of this invaluable publication. It may well prove to be the turning point in your career.

FOUNDED 1885—OVER 150,000 STUDENTS

NATIONAL INSTITUTE OF ENGINEERING (Dept. 461), 148 HOLBORN LONDON, E.C.1

S. Africa: P.O. Box 8417, Jo'burg. Australia: P.O. Box 4570, Melbourne.

FIELD'S RADIOCENTRE

PRINTED CIRCUIT BOARD, 11 x 8 1/2 in; 12 x 10 in. 5/-; 16 x 10 in. 7/-. All p. & p. 1/3
NEW PAKMEKO 025-0-215V at 100mA, 6c at 1 amp, 6.3 amp, 3.2 amps, 10/- each, p. & p. 3/6
MEDIO-SIZED OUTPUT TRANSFORMERS, Push-pull 15 ohms, suitable for 6V6 or E.L.84, 5/- each, p. & p. 2/-
P.C.R. Vibrator Power Packs. Complete with spare vibrators, bulbs, fuses, all leads 12V input 230V, 100mA output. Brand new in original carton. Price £1 each, p. & p. 5/-
CARBON HAND MIKES. With pressa switch. Price 5/- each, p. & p. 2/-
BUILT YOUR OWN BATTERY CHARGER, 6 or 12V 1 1/2 amp, transformer and rectifier, complete with circuit, 12/- plus 2/6 p.p. Or 4 amp. kit as below:—
4 AMP TRANSFORMER, 17/6.
4 AMP RECTIFIER, 9/6.
METER (OPTIONAL) 2in., 10/6.
LARGE TERMINALS, 1/3 pair.
LARGE CROCODILE CLIPS, 3/- pair.
All new stock. Complete Kit 39/6 plus 3/- p.p.
PORTABLE AERIAL. Ex Radio Sonda. Spring base, 2 section flick action, makes good car aerial. 3/6, plus 1/6 p.p.
POCKET VOLTMETER, 0-15V, 0-150V, 35 ohm volt., D.C. 12/6 plus 1/6 p.p.
SMOOTHING CHOKES, Ex Govt., 10 henry 100mA. Fully shrouded, 5/- plus 2/- p.p.
TUNING CONDENSERS, AIR SPACED, .0003 plus .0005 twin gang slow motion geared drive, beautifully made, 3/6, plus 1/6 p.p.
SHORT WAVE CONDENSERS, Ex R.F. unit No. 26 and 27. Brand new 75 plus 75 pF, silver plated, 2/6 plus 1/- p.p.

67 LONDON ROAD, CROYDON, Surrey (Croydon 1512)

RES/CAP. BRIDGE 38/-

Checks all types of resistors, condensers 6 RANGES p. & p. 2/6
Built in 1 hour. Direct reading.
READY CALIBRATED
Stamp for details of this and other kits.
RADIO MAIL (DEPT. WP)
Raleigh Mews, Raleigh Street, Nottingham

D.C. SUPPLY KIT. 12 v. 1 a. consisting of a partially drilled metal case, mains trans., F.W. Bridge Rectifier, 2 fuseholders and fuses. Change Direction switch, variable Speed regulator and circuit. For 200-250 v. A.C. mains. Suitable for Electric Trains. Limited number available at 3/3/8.

SELENIUM RECTIFIERS

F.W. BRIDGE H.T. Types H.W.
 6/12 v. 1 a. ... 3/11 150 v. 40 m.a. ... 3/19
 6/12 v. 2 a. ... 6/11 250 v. 50 m.a. ... 3/11
 6/12 v. 3 a. ... 9/9 250 v. 60 m.a. ... 4/11
 6/12 v. 4 a. ... 12/3 250 v. 80 m.a. ... 5/11
 6/12 v. 6 a. ... 15/3 250 v. 250 m.a. ... 11/9
 6/12 v. 10 a. ... 25/9 **CONTACT COOLED**
 6/12 v. 15 a. ... 35/9 250 v. 80 m.a. H.W.
 24 v. 2 a. ... 14/9 6/11. 250 v. 50 m.a.
 F.W. (Bridge) 6/11.

B.S.R. MONARDECK TAPEDECKS
 Speed 3 1/2 in. per sec. With high quality recording heads, £6.19.6. Carr. 5/-.
 Cabinets, 3/9/6.

SPECIAL OFFER OF BRAD NEAV BRUMAR TRANSISTORS 12S1 Audio lots of three, 8/11; TS7 R.F. three for 14/9.

EX. GOVT. CASES. Size 14-10 1/2 in. High Well ventilated, black crackle finished, undrilled cover. IDEAL FOR BATTERY CHARGER OR INSTRUMENT CASE OR COVER. COULD BE USED FOR AMPLIFIER. Only 9/9, plus 2/- postage.

LINEAR TREMOLO/PRE-AMP UNIT
 Type TP0/A, with 3 controls, volume, amplitude and frequency. Inputs for guitar and microphone. Requires power supply of 250 v. 10 m.a. and 6.3 v. 2 a. Available from any R.S.C. or LINEAR amplifier. The unit is merely connected to normal input socket of hi-fi amplifier or Guitar amplifier. Only 5 gns.

R.S.C. GRAM AMPLIFIER KIT. 3 watts output. Negative feedback Controls Vol. Tone and Switch. Mains operation 200-250 v. A.C. Fully isolated Chassis. Circuit etc., supplied. Only 39/9. Carr. 3/9.

10-110 WATT AMPLIFIERS

Brand new. Manufacturer's discontinued line. Fitted latest Mullard valves. Dual Inputs for "mixe and gram", etc. Bass and Treble Controls. High sensitivity and quality. Output for 3 ohm or 15 ohm speaker. For 230-250 v. A.C. **£7.19.6**
 Carriage 7/6.

PORTABLE TRANSISTOR RADIO DESIGN with 7 1/2 in. loudspeaker and Car Aerial Socket. Attractively designed and covered cabinet. Size 8 x 10 1/2 x 3 1/2 in. Gold dials with revolving perspex covers. M. and L. wavebands. Six first grade Brimar Transistors and Printed circuit. Easy to follow instructions and diagrams. 2/6. Total cost of parts only £9.19.6, carr. 3/9. Demonstration models at all branches.

R.S.C. TRANSISTORISED GRAM AMPLIFIER. Output 1 watt, for 3 ohm speaker. Transistors Mullard OC71, OC81D, OC91, OC91. Suitable for any normal crystal pick-up. Only 69/9.

MULTI-METERS.
C.M.10. Basic Meter sensitivity 155 micro-amps. A.C. and D.C. ranges £4.17.6. **CABY H29.** Sensitivity up to 10,000 ohms per volt. A.C. and D.C. £6.10.0. S.A.E. will bring leaflets on A10 or B29.

RELAYS. Carpenters Type. Polarised 2 times 9.500 Lums at 1,655 ohms. 13/9. Miniature Type G.R.C. 670 Sealed, wire ends, 4 covers, platinum M1093, 12/9.

SPECIAL OFFER EX. GOVERNMENT SELENIUM RECTIFIERS. 12 v. 15 amp. with large square cooling fins. 10/9 each.

EX. GOVT. SMOOTHING CHOKES.
 200 mA. 3-5 H. 50 ohms, Parmeko 8/9;
 100 mA. 5 H. 100 ohms 3/11; 150 mA. 10 H. 50 ohms 6/9; 80 mA. 20 H. 900 ohms 5/9; 120 mA. 12 H. 100 ohms 8/9; 50 mA. 30 H. 1,000 ohms 6/9; 100 mA. 10 H. 100 ohms 6/9; 60 mA. 5-10 H. 250 ohms 2/11.

EX. GOVT. MAINS TRANSFORMERS

Primaries 200-250 v. 50 a.p.s. A.C.
 250v. 60mA 6.3v. 2a. ... 11/9
 250-0-250v. 60mA 6.3v. 2a. ... 12/9
 270-0-275v. 100mA 6.3v. 7a. 5v. 3a ... 22/11
 300-0-300v. 60mA 6.3v. 2a. ... 12/9
 300-0-300v. 100mA 6.3v. 2a. 5v. 2a ... 18/9
 3,500v., 91a., v. 2a. ... 39/9
 0-35-40-45-50v. 300mA 6.3v. 3a ... 17/9
 12v. 20a. (carr. 7/6) ... 49/0

COMPLETE POWER PACK KIT. 19/11. Consisting of Mains Trans., Metal Rectifier, Double electrolytic, smoothing choke chassis and circuit. For 200-250v. A.C. mains. Outputs 250v. 60mA. 6.3 v. 2a.

R.S.C. POWER PACK. 39/9. Louvred metal case only 8 x 5 1/2 x 2 1/2 ins. Stove enamelled. For 200-250v. A.C. mains. Output at 4 pin plug and socket 250 v. 60 mA, fully smoothed and 6.3v. 2a. Suitable for power requirements of almost any Pre-amp or Radio Tuner.

EX. GOVERNMENT ACCUMULATORS. Size 7 1/4 x 2 1/2 in. 2v. 16 A.H. brand new, 6/9 ea., 3 for 15/6.

R.S.C. BABY ALARM or INTER-COMM. KIT. Complete set of parts with diagrams, etc. Master Unit housed in veneered walnut cabinet. High sensitivity. For 200-250v. A.C. mains. Fully isolated. Only 79/6, carr. 5/-. Or assembled ready for use £5.15.0

R.S.C.
 (Manchester) Ltd.

Personal **HULL:** 51 Savile St. **LIVERPOOL:** 73 Dale St., 2 **BRADFORD:** 56 Morley St. **MANCHESTER:** 8-10 Brown St. **LEEDS:** 5-7 County (Mecca) Arcade, Briggate.

MAIL ORDERS to: 29-31 Moorfield Road, Leeds 12. TERMS: C.W.O. or C.O.D. No C.O.D. under £1. Post 1/9 extra under £2. 3/8 extra under £5. Open 9 to 6. Weds. until 1 p.m., except Manchester open all week. Trade supplied, S.A.E. with all enquiries please.

SURPLUS RADIO SUPPLIES

2 LAING'S CORNER, MITCHAM SURREY

SEND TO-DAY FOR OUR CATALOGUE

400 BARGAINS

At prices below manufacturing cost. Price 1/6, post paid.

A Crystal Diode Transistor Kit. Can be assembled easily in 30 mins. Using small screwdriver (no soldering). Aerial and earth required, 37/6, post free.

NEW REPANCO TRANSISTOR COMPONENTS

- Push Pull Driver Transformer Type TT45 ... 5/-
- Push Pull Output Transformer Type TT46 ... 5/-
- Interstage Transformer Type TT49 ... 5/-
- Dual Range Ferrite Aerial Type FR2... 12/6
- 2.5 millihenry Choke Type CHI ... 2/6

RADIO EXPERIMENTAL PRODUCTS LTD.
 33 MUCH PARK STREET, COVENTRY

AVO METERS

MODEL 7 £11.10.0. MODEL 8 £15.15.0. MODEL 9X £17.10.0. Guaranteed perfect. Complete with leads and batteries. Registered post and packing 5/- extra.

AVO VALVE TESTERS. Roller panel type. Can be used with adaptors for all types. Circuit data supplied. Tested, £5.19.6. 7/6 carriage. Details S.A.E.

FERRANTI TESTMETER TYPE Q. An extremely compact self-contained multimeter. Volt's 0 to 30, 150, 500 A.C./D.C. with additional 0-3 v. DC and 0-15 v. A.C. ranges, 50 Ohms 0 to 7.5, 30, 150 and 750 DC; ohms 0-25 K Ω . Accuracy BSS first grade. Knife-edge pointer and clearly calibrated 2 1/2 in. scale, 500 Ω /volt. With leads, prods, battery and instructions. In fitted velvet-lined 4 x 7 x 3 1/2 in. case. Brand new condition, tested, 49/6. P.P. 2/7.

R107 RECEIVERS. 12 Mc/s—17.5 Mc/s continuously, 3 wave bands. Complete self contained with speaker and power unit for A.C. mains and 12 v. battery operation. Guaranteed perfect. £13.10.0. Carr. 30/-.

PCR COMMUNICATIONS RECEIVER

Type PCR. Has self-contained speaker. Covers 850-2000, 200-550 and 16-50 meters.
 AS NEW CONDITION. ... £6.19.6
 Type PCR-2. Requires external speaker. Covers 850-2000, 200-500 and 13-50 meters. ... £5.19.6
 Used (Good condition). Full details S.A.E. Any meter fitted with BRAND NEW INTERNAL POWER SUPPLY, guaranteed ready for use on A.C. mains. £2 extra.

Moving Coil Phones. Finest quality Canadian with Chamols ear muffs and leather-covered headband. With lead and jack plug. Noise excluding, supremely comfortable, 19/6, post 1/6.

We now stock The Pocket 4, a neat little job which can be made for 42/6. (Printed Circuit, Version 52/6), and The Good Companion (a super job equal to the best). Easilly constructed for only £9.19.6. Gladly demonstrated to callers.

CHARLES BRITAIN (RADIO) LTD.

11 Upper Saint Martins Lane, London, W.C.2

TEmple Bar 0545

Shop Hours 9-6 p.m. - 9-1 p.m. Thursday
 Open all day Saturday.

ALL-TRANSISTOR TIME SAVER
OFFICE OR HOME TELEPHONE PICK-UP AMPLIFIER

★ No more "holding on" wasting time waiting for your call to come through. When it does the amplifier can be switched off if required. No connections, just press the pick-up coil to back of phone as below. Fully Guaranteed. Housed in attractive Gold Finish Cabinet.



BUILT, TESTED, READY TO USE

£5.10.0
P.P. 2/6.



CRYSTAL LAPEL MICROPHONE
Ideal for portable tape recording, etc.
15/-. P.P. 1/-.



4000 Ohm Headphones
Lightweight very sensitive.
12/6. P.P. 1/-.

BATTERY ELIMINATOR AND CHARGER

Replaces PP3 or T6003 9 volt batteries to run transistor radios from mains. Also charges to give 5 times normal battery life. Fitted neon indicator and supplied with full details. 29/6. P.P. 1/6.

CRYSTAL MICROPHONE FULLY GUARANTEED



ACOS 39-1. Stick Microphone with screened cable and stand (list 5 gns.), 32/6, P.P. 1/6.

ACOS 40. Desk Microphone with screened cable and built-in stand (list 50/-), 15/-. P.P. 1/6.

ACOS 45. Hand Microphone with screened lead, very sensitive, 25/-. P.P. 1/6

100 C. Stick Microphone with muting switch and screened cable, detachable desk stand, cord, etc., 39/6. P.P. 1/6.

GUITAR CONTACT MICROPHONE. High Impedance Guitar Contact Microphone with screened lead. Plugs into any valve amplifier. Very sensitive. 15/-. P.P. 1/6.

CRYSTAL MIC INSERTS

- ★ ACOS 43-2 2in. round, 10/6. P.P. 6d.
- ★ ACOS 1 1/2in. round, 7/6. P.P. 6d.
- ★ 2in. square, 3/6. P.P. 6d.

Type 38, Transmitter Receiver

Complete with 5 valves. In new condition. These sets are sold without guarantee but are serviceable. 22/6 P.P. 2/6.
Headphones 7/6 pair. Junction Box 2/6. Throat Mike 4/6. Aerial Rod 2/6.

R208 COMMUNICATIONS RECEIVER "SPUTNIK SPECIAL"

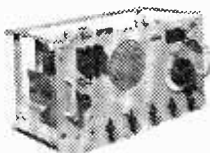

THE WORLD IN YOUR HOME

New offer of this well-known Three-Wave Band Short Wave Receiver. Coverage 10-60 Mc/s (5-30 metres). Plugs into standard mains or 6 volt accumulator. Built-in 6 1/2in. speaker. BFO slow motion tuning. 6-valve Superhet with R.F. stage and 2 Mc/s I.F.

In Absolutely New Condition with Spares and Full Handbook in Steel Case.

£11.19.6

Carriage 15/-

TRANSISTOR PORTABLE TAPE RECORDER

- Play/record up to 60 mins.
- Built-in speaker
- in-volume control
- batteries and play/record/rewind.
- Quality reproduction.
- Sturdy case 6 x 8 1/2 x 2 1/2in.



£11.19.6

Post free Fully Guaranteed

Supplied complete with microphone, tape, batteries and personal phone.

BABY SITTER



ALL TRANSISTOR BABY OR INVALID ALARM

NOW HOUSED IN ATTRACTIVE GOLD HAMMER FINISH PORTABLE CABINET. Battery operated, push-pull, 400MV output. Low impedance microphone enables unit to be used up to 200 yards. Output on quality speaker.

★ GUARANTEED for 12 MONTHS and 100% SAFE.

★ MICROPHONE is placed within 10ft. of baby; twin flex is taken to amplifier unit and placed in any room required. COMPLETELY BUILT & TESTED. P.P. 2/6. **£5.10.0**

★ Used All Night, Every Night. Battery Life 3 to 4 months.

WE CAN SUPPLY MOST OF THE COMPONENTS USED ON CIRCUITS PUBLISHED IN THIS & OTHER MAGAZINES. QUOTATIONS BY RETURN.

3/4 WATT 4 TRANSISTOR AMPLIFIER

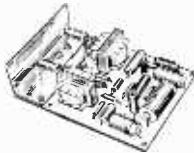

● 1 watt peak output.

±3db 70cs to 12 kc/s.

Output to 3 ohm speaker

9 volt operated.

Details on request.

Built and Tested Kit of Parts
6916 OR 6216
 P.P. 1/6 P.P. 1/6

A printed circuit high gain amplifier size 4 x 2 1/2 x 3 1/2in. using Mullard OC71/OC81D and 2-OC81 Transistors. Ideal for Intercomm., Record Player, Tuner Amplifier or any application requiring a quality and reliable amplifier.

NEW RANGE OF REPANCO COILS

Aerial, H.F. coils and I.F. transformers. Types TT45, TT46, TT47, TT49, 5/- each. XMA41, XMF42, XLA43, XLS44, FS48, 7/6 each. FR2, 12/6. CH1, 2/6. All including circuits. P.P. 6d. each.

Min. double tuned I.F. transformer, 6/9. P.P. 6d.

BATTERY RECORD PLAYER



● 6-7 1/2 volt Garrard turntable with crystal pick-up. Plays 45 r.p.m. Ideal for above amplifier. 65/- P.P. 1/6.

● Suitable cabinet for amplifier and player 22/6

TAPE HEADS. Wright and Wearite Record and Erase Heads, Type FF7 and FR7. Brand new. P.P. 2/-. 19/6 pair.

PRACTICAL TRANSISTOR CIRCUITS 3/6 (Post Free)

Contains easy to follow plans of 40 all transistor units, including light operated switches, amplifiers, transmitters, receivers, test oscillators, signal tracers, hearing aids, radio control, etc. All parts available separately.

★ 600 ohm PERSONAL EARPHONE With jack plug and socket. 10/6. P.P. 1/-.

★ 1000 ohm Earphone with Jack Plug and Socket, 12/6.

★ SUB-MINIATURE JACK PLUGS and SOCKETS, 3/6 pair.

★ All Transistor Short Wave Radios. Send for details.

STEREO AMPLIFIER

BARGAIN OFFER

Built and tested ready for use.
 ★ 2 watts per channel.
 ★ Full tone, balance and volume controls.
 ★ Complete with sockets dials etc.
 NOW **79/6** P.P. 2/6.

Suitable Speakers 8 x 5in., 49/6 pair. UA1 Stereo Deck. £7.19.6. P.P. 3/6

MINIATURE PANEL METERS (D.C.)
 0/500 microamp 39/6 Vu meter 42/6
 0/500 microamp 32/6 "S" meter 35/-
 0/1 milliamp 27/6 Brand New!

Henry's Radio Ltd

5 HARROW ROAD - LONDON W.2

Opposite Edgware Road Tube Station
 OPEN MON. to SAT. 9-6, THURS. 1 o'clock
 Telephone PADDington 1008/9

PLEASE TURN TO BACK PAGE

OUR SPECIALITIES
 Transistors, Valves, Quartz, Crystals, Components at Competitive Prices
 Let us quote for your circuit.

Practical Wireless

—BLUEPRINT—

—SERVICE—

ALL OF these blueprints are drawn full-size and although the issues containing descriptions of these sets are now out of print, constructional details are available free with each blueprint except for the PW Monophonic Electronic Organ and the PW Roadfarer.

The Index letters which precede the Blueprint Number indicate the periodical in which the description appeared. Thus PW refers to PRACTICAL WIRELESS; AW to *Amateur Wireless* and WM to *Wireless Magazine*.

Send (preferably) a postal order to cover the cost of the Blueprint (stamps over 6d. unacceptable) to

PRACTICAL WIRELESS, Blueprint Dept., George Newnes, Ltd., Tower House, Southampton Street, London, W.C.2.

SPECIAL NOTE

THE following blueprints include some pre-war designs and are kept in circulation for those constructors who wish to make use of old components which they may have in their spares box. The majority of the components for these receivers are no longer stocked by retailers.

| Title | Number | Price |
|-------|--------|-------|
|-------|--------|-------|

CRYSTAL SETS

| | | |
|---------------------------------|------|-----|
| Junior Crystal Set | PW94 | 2/- |
| Dual-wave Crystal Diode | PW95 | 2/6 |

STRAIGHT SETS

Battery Operated

| | | |
|---------------------------|------|-----|
| Modern One-valver | PW96 | 2/6 |
| All-dry Three | PW97 | 3/6 |
| Modern Two-valver | PW98 | 3/6 |

SUPERHETS

| | | |
|--------------------------------|-------|-----|
| A.C. Band-pass Three | PW99 | 4/- |
| A.C. Coronet-4 | PW100 | 4/- |
| A.C./D.C. Coronet | PW101 | 4/- |
| The PW Pocket Superhet | — | 5/- |

MISCELLANEOUS

| | | |
|--|---|-----|
| The PW 3-speed Autogram | — | 8/- |
| The PW Monophonic Electronic Organ | — | 8/- |
| <i>(No constructional details are available with this blueprint)</i> | | |
| The PW Roadfarer | — | 5/- |
| <i>(No constructional details are available with this blueprint)</i> | | |

TELEVISION

| | | |
|-----------------------------------|---|-----|
| The PT Band III converter | — | 1/6 |
|-----------------------------------|---|-----|

| Title | Number | Price |
|-------------------------------------|--------|-------|
| A.C. Fury Four | PW20 | 2/6 |
| Experimenter's Short Wave | PW30a | 2/6 |
| Midget Short Wave Two | PW38a | 2/6 |
| Band-Spread Three (Battery) | PW68 | 2/6 |
| Crystal Receiver | PW71 | 2/- |
| Signet Two (Battery) | PW76 | 2/6 |
| Simple S.W. One-valver | PW88 | 2/6 |
| Pyramid One-valver | PW93 | 2/6 |

| | | |
|----------------------------------|-------|-----|
| BBC Special One-valver | AW387 | 2/6 |
| A One-Valver for America | AW429 | 2/6 |
| Short-Wave World Beater | AW436 | 3/6 |

| | | |
|--------------------------------------|-------|-----|
| Standard Four Valve S.W. | WM383 | 3/6 |
| Enthusiast's Power Amplifier | WM387 | 3/6 |
| Standard Four Valve | WM391 | 3/6 |
| Listener's 5-Watt Amplifier | WM392 | 3/6 |

QUERY COUPON

This coupon is available until 6th April, 1962, and must accompany all queries in accordance with the notice on our "Letters to the Editor" page.

PRACTICAL WIRELESS, APRIL, 1962

"CAPRI" - POCKET SIX RADIO



Size only
4½ x 2½ x 1½ in.

Really
Pocket
Size!

£7.10.0 P.P. 2/-
(Battery 2/6).

A new design 6-Transistor Printed Circuit Superhet for Medium and Long Waves. Uses all sub-miniature parts. Sub-min. Mullard Transistors. Quality speaker output, fitted earphone. Record Sockets. Cabinets Red/White or Blue/White with Gold.

PERFECTION

"RANGER 3" A Three Transistor Three Diode Personal Radio for Medium Waves.

Size 4½ x 3 x 1½ in.



Amateur top band and shipping. Quality output on 'phone. Fitted airspaced tone, vol. control, Mullard transistors. No aerial or earth. Luxembourg guaranteed.

79/6 P.P.
1/6.

"TRANSFIVE" PORTABLE RADIO



Medium
and
Long Wave
Portable
8½ x 6½ x 3½ in.

£6.19.6

P.P. 2/6.

A 5-Transistor and Diode, Printed Circuit, Medium and Long Wave Portable. Features 5in. speaker, Car aerial socket, Mullard transistors and carded components. Excellent results guaranteed.



MODEL TH-L33

2,000 ohms per volt AC/DC. Size 5 x 3½ x 1½ in.

79/6 P.P. 1/6.

with test leads, battery and instructions.

0/10/50/250/500/1000 volts D.C., 0/10/50/250/500/1000 volts A.C., 0/500µA/10/250 mA., D.C. 3 ranges resistance 0/10K/100K/1 Meg. Capacity and dB ranges.

FULLY GUARANTEED.

POCKET SOLDERING IRON

Pocket Soldering Iron, 220/250 v. A.C./D.C. 30 watts, complete with mains plug, case, etc. Handle unscrews to cover element, enabling iron to be carried in pocket. 18/6. P.P. 1/-.

TRANSISTOR RADIOS TO BUILD YOURSELF

- FULLY ILLUSTRATED BUILDING PLANS AND DETAILS.
 - AFTER SALES SERVICE.
 - ALL PARTS GUARANTEED AND SOLD SEPARATELY
 - CALL FOR DEMONSTRATION
- DETAILS OF ANY MODEL FREE ON REQUEST

"CONTESSA" PORTABLE CAR RADIO 6 TRANSISTOR MEDIUM AND LONG WAVE SUPERHET RADIO.



Features the latest in design and performance, giving ease of station selection. Excellent Tone and Volume with amazing sensitivity and selectivity. Attractive two colour cabinets. Size 10 x 7½ x 3½ in. Blue/White or Red/White. Fitted 5-inch speaker giving up to 425mW Push-Pull quality output. Full avc. fitted car aerial socket, slow motion tuning.

Total Cost **£10.19.6** P.P. 3/6
GUARANTEED THE BEST OBTAINABLE

AVO-7

Famous Multi-meter.
Reconditioned and fully guaranteed.

Full A.C./D.C. voltage and current, resistance, dB, power, etc., etc.

Supplied with Batteries, Leads and Instructions.

£11.10.0 Regd. Post 5/-.

(Normal price £19.10.0.)
Leather case 30/- extra.



Henry's Radio Ltd

PADDINGTON 1008/9

5 HARROW ROAD, LONDON W2

Open Monday to Sat. 9-6 Thurs. 1 o'clock

Send 1/- Stamp For New Illustrated Price Lists.

PLEASE TURN PAGE

"QUINTET" POCKET RADIO

Size
5½ x 3 x 1½ in.

Red or Blue
and
Gold trim

£5.10.0 P.P. 2/-.



A Five Transistor Medium and Long Wave Printed Circuit Loudspeaker Radio, with Excellent Results including Luxembourg, guaranteed with full station separation. Supplied with Mullard Transistors and Carded Components. Fitted earphone/record socket.

Performance will amaze you.

"RANGER 2"

A Two Transistor Two Diode Personal Pocket Radio. Covering medium waves and top band.



Supplied with battery and quality Personal 'Phone.

No aerial or earth. **59/6** P.P. 1/6.

"PW-6" SUPERHET RADIO

Medium
and
Long Wave
Radio

Size,
5½ x 3½ x 2 in.

£8.10.0 P.P. 2/-.

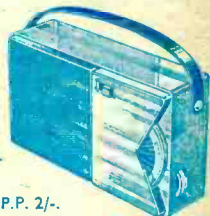

Modified version of previously advertised "PW" Superhet. Now with new style Two Tone Cabinet. 1st grade components and transistors. Printed circuit.

MODEL 200H

20,000 ohms per volt. Size only 4½ x 3½ x 1½ in.

£6.19.6 P.P. 1/6.

With Test Leads, Battery and Instructions.

6 Ranges D.C. voltage to 2½ kV.

5 Ranges A.C. voltage to 1 kV.

3 Ranges D.C. current to 250 mA. Resistance to 6 meg.

Capacity and db ranges.

FULLY GUARANTEED

TRANSISTOR SIGNAL INJECTOR

A new design pocket size tester for fault finding on valve or transistor radios, T.V., amplifiers, etc. Built-in indicator and batteries with detachable probe, 52/6.