

DECEMBER
1961

Practical

2/-

WIRELESS

FREE inside!

THE 'CITIZEN'
BLUEPRINT
for *TRANSISTORISED*
2-UNIT
SUPERHET TUNER

The P.W. 'Citizen'

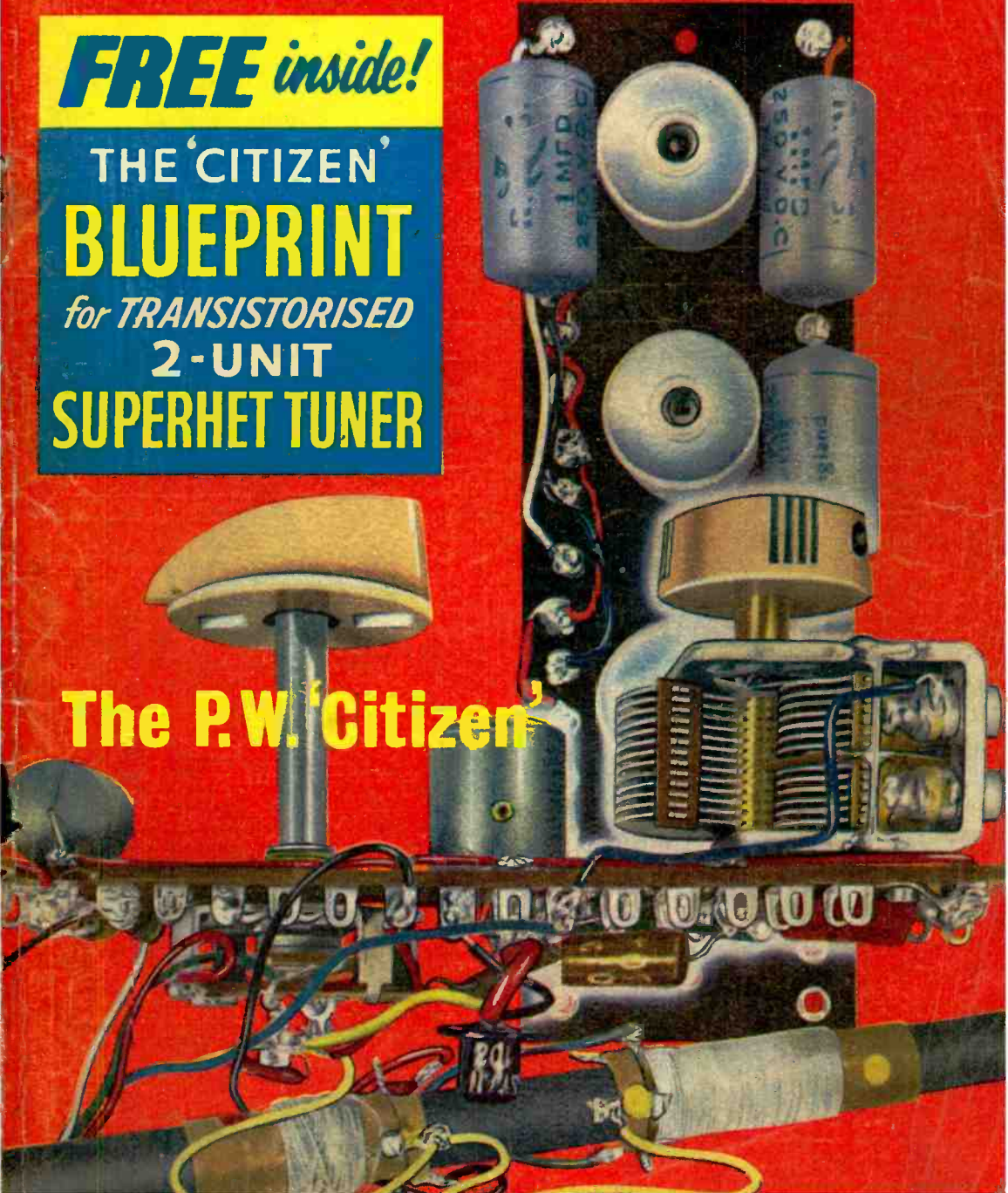



Stentorian



This range of Stentorian loudspeakers, incorporating the patented cambric cone, was developed to provide reproduction that takes full advantage of the television and V.H.F. sound transmissions and high fidelity recordings now available. The cone of the loudspeaker is made from uncured cambric and bonded pulp, the whole being completely cured together and made into one composite cone.

Type	Flux Density	Price	Type	Flux Density	Price
8" H.F.816*	16,000 gauss	£7.0.9	T.186	16,000 gauss	£6.13.3
8" H.F.812*	12,000 gauss	£4.5.6	T.12 tweeter	16,000 gauss	£13.4.6
8" H.F.810	10,000 gauss	£3.3.6	T.10 tweeter	14,000 gauss	£4.8.3
6" H.F.610	10,000 gauss	£2.12.9 Steel £2.15.0 diecast	T.359 tweeter	9,000 gauss	£1.15.10

MODEL H.F. 1016

10" Unit H.F. 1016. 16,000 gauss. Instantaneous matching at 3, 7.5 and 15 ohms. Handling capacity 10 watts. Frequency response 30 c.p.s. to 15,000 c.p.s. Bass resonance, 35 c.p.s.

Price £8.4.0 (inc. P.T.)

* Incorporates a universal impedance speech coil.

WHITELEY ELECTRICAL RADIO CO. LTD. MANSFIELD, NOTTS
 Telephone: MANSFIELD 1762-5 London Office: 109 Kingsway, London, W.C.2

WA3

SPECIAL FOR THE "HAMS" RADIO STATION

Illustrated

¼ inch detachable bit soldering instrument
 List No. 70

Combined Protective Unit with Wiper/Abrasion Pad and Solder Reel
 List No. 700

Apply SALES & SERVICE

ADCOLA

(Regd. Trade Mark)

ADCOLA HOUSE
 GAUDEN ROAD
 LONDON, S.W.4

Telephones:
 MACaulay 3272-3101



British & Foreign Patents, Registered Designs, etc.

Telegrams: "SOLJOINT, LONDON"

Well paid to see the world

A really interesting and worthwhile job as a Radio Officer in the Merchant Navy awaits you if you are the holder of a current P.M.G. certificate. Salary and allowances are good from the start, rising by regular increments to well over the four figure mark with all found. Your job can take you all over the world, and you get generous annual leave besides off-duty time in foreign ports. Sea service offers ample opportunity to study for further technical qualifications and many well-paid shore appointments are open to you later on.

A tradition second to none

Marconi Marine Radio Officers have a long and proud tradition of service extending back to the early years of this century. Among them are to be found names hallowed in the history of the sea. Moreover, many men in the highest public and administrative positions today began their careers as Radio Officers in the Marconi Marine Company.

Write for particulars to: F. E. ASH, Esq.

THE MARCONI INTERNATIONAL MARINE COMMUNICATION CO. LTD.,

English Electric House, Strand, London, W.C.2



TUBULAR BAFFLE EXTENSION SPEAKER MODEL TS.30

Mounts vertically—mounts horizontally—mounts on wall—sits on desk! Designed for use with transistor radios, valve radios, car radios, amplifiers, auxiliary speakers in Hi-Fi and numerous other applications where quality reproduction of sound is required.

The cabinet is finished in beige leather, with contemporary gold baffles at each end. Complete with 12 ft. extension cord fitted with miniature plugs, individually cartoned and guaranteed.

57/6

P. & P. 2/6

Size: 9 1/4 in. x 3 1/2 in. diameter.

NEW DYNAMIC MICROPHONE

MODEL DM-175 Beautifully designed and attractively finished, lightweight dynamic microphone complete with stand. Output impedance 1K ohm, frequency response 150-9000 c.p.s. \pm 3db. Sensitivity: -73db. Perfect for almost all applications and offered at only 49/6 p. & p. 2/6

3-WAY SLIM CRYSTAL MICROPHONE MODEL 100C

May be hand held, stand mounted or suspended by Lavalier Cord. Response 60-10,000 Cps. Built in on/off switch. Output level—62db. Omni-directional head. Clips on or off standard stand adaptor, permitting tilting for multi-angle use. Satin chrome finish complete with 7ft. shielded cable, stand adaptor and Lavalier Cord. ONLY 39/6 P. & P. 2/6. (Stand 8/6 extra.)

LAPEL MICROPHONE MODEL M178



Precision engineered Crystal Microphone—for lapel or hand use. Only 1 1/4 in. diameter. Exceptionally sensitive. Chrome plated case and clip includes 5ft. shielded cable. Only 17/6. P. & P. 1/-.

CH. 395 CHROME MINIATURE PLUGS AND SOCKETS

Size: plug barrel 1", socket 1". These will give your equipment that expert finish! 3/6 Per Set.

P217A.

MINIATURE 2 1/4 in. SPEAKER

A miniature Hi-Fi speaker that outperforms all others. Designed to meet today's requirements for transistor, miniature and sub-miniature applications. Size 2 1/4 in. sq. x 1 in. deep. Voice coil impedance: 8 ohms. Freq. range: 150-5000 c/s. Power: 200mW. 16/6. P. & P. 1/-.

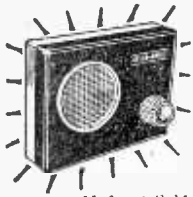

Made available owing to public demand!

SUPER TRANSISTOR RADIO With Miniature Speaker. Simple instructions enable anyone to build this miniature radio. Gives reception over the entire broadcast band. Each kit is supplied with all latest miniature parts including: ★ two transistors ★ ferrite rod ★ speaker ★ coloured plastic case ★ step by step illustrated instructions. Size 4 x 3 x 1 1/2 in.

ONLY 27/6 P. & P. 1/6.

Battery 1/- ex.



EP.10K MULTI-METER

10,000 O.P.V. on BOTH A.C. and D.C. Ranges. D.C. Voltage: 0-6-30-120-600-1,200 v. (10,000 o.p.v.). A.C. Voltage: 0-6-30-120-600-1,200 v. (10,000 o.p.v.). D.C. Current: 0-120 μ A. 0-12-300 mA. Resistance: 0-20K. 0-2 Meg. (150 ohm 15K at centre scale). Capacitance: 0.005 to 0.15 μ F (at A.C. 6 v.). Decibels: -20 to +63db (600 ohms 1 mW., odbm = 0.775 v.). Accuracy: D.C. voltage and current \pm 2% f.s. A.C. Voltage \pm 4% f.s. Resistance \pm 3% of total scale length. Size: 4 1/4 in. x 3 1/4 in. x 1 in. Complete with test leads, battery and instructions. Only 25.19.6.

MINIATURE CLEAR PLASTIC PANEL METERS

"S" METER MODEL SR. 2P. Standard "Ham" Signal strength indicator. Calibrated in "S" units from 0-9 with scale terminating in + 10 to + 30 db calibrations. Additional full scale calibrations of 0-5 + 0-10 in linear scale divisions. A "must" for radio amateurs for conversion of any Communication Receivers with A.V.C.

VU METER MODEL VR. 1P. Calibrated and damped in accordance with standard VU Meter Practice. Upper scale reads -20 to +3VU. Lower scale 0-100% modulation. Uses precision carbon film multiplier resistor and full wave rectifier. 42/6.



DC MICROAMMETERS Model MR.25 0 to 50 μ A. 39/6
Model MR.250 0 to 500 μ A. 32/6

DC MILLIAMMETER Model MR.21 0 to 1mA 27/6
All models individually boxed and Fully Guaranteed. P. & P. 2/6 each.

SF-20 RADIO HEADPHONES

Hi-impedance—2,000 ohm—general use headset. Black and ivory plastic cased electro-magnetic units with adjustable head-band for comfortable fit. Individual listening for all types of applications. Individually packed, with flexible cord attached. 14/6, post paid.



MINIATURE EARPHONES

Fully Guaranteed and complete with transparent ear insert. 3 feet cord, miniature plug and socket. CR-5 High Imp. crystal MR-4 Low Imp. magnetic



8/- Each Post 1/-

TRANSISTOR SPECIAL! 5K. EDGEWISE MINIATURE VOLUME CONTROL MODEL K2. 16, with switch and ivory knob. As used in all miniature transistor radios. 4/6 each.

PVC. 200 TRANSISTOR MINIATURE 2-GANG TUNING CONDENSERS. 208pF. As used in latest transistor sets. Capacity: Aerial section 7-200pF. Osc. section 7-87pF. Trimmer capacity more than 50pF. Q factor: more than 200 at 50pF. 10 Mc/s. Size 1 x 1 x 1/4 in. PRICE 12/6 each.

SUB-MINIATURE TRANSFORMERS

Ideal for miniature transistor portables, etc.
Driver Model LT44: Primary: 20k. Secondary: 1k. Centre Tapped. Ratio: 5 : 1
Output Model LT700: Primary: 1.2k. Centre Tapped. Output: 3.2 ohms. Ratio: 2 : 1, complete with detailed instructions. Only 9/6 per pair. P. & P. 1/6.

All Transistor 2-STATION INTERCOM and Baby Alarm

Here is an Intercom system for both calling and conversing which uses the highest quality transistors and is operated from a single battery. May be used for multi-purpose applications especially where there is no local electrical supply and also where voltage fluctuations are severe. Specially suited for use in offices, manufacturing plants, hotels, restaurants, residences and wherever conversation is required between two or more locations. Ideal Baby Alarm. Brief Spec: 3 transistors, 200 mW output, 9 v. battery, built-in 2 1/4 in. speakers. The Master station incorporates individual volume control to ensure perfect speech reproduction. The Sub-station incorporates a unique "buzzing" call system which ensures maximum efficiency. S.A.E for further details.

MODEL
TI.302
12 Gns.

Complete with battery and 60 ft. of wire.



CALLERS WELCOME AT
87 TOTTENHAM COURT ROAD,
LONDON, W.1 MUS 9806

MAIL ORDERS TO
(DEPT. P.), 32a COPTIC STREET,
LONDON, W.C.1

Relda Radio

PYE COMMUNICATION RECEIVERS

World coverage on these famous Communication Receivers. They are the simplest type to use yet bring in stations that will amaze you. The ideal domestic receiver for medium wave during the day with Amateur stations at night. All have been converted to 230 v. A.C. mains and are guaranteed to work immediately. Incorporate Wave Switch, Audio gain aerial trimmer, high and low tone control, station locking device, aerial and earth inputs, speaker output sockets, etc. Size 17 x 8 x 9 1/2 in. Black crackle finish front panel. On demonstration at 87 Tottenham Court Road.

- P.C.R.3. Medium wave and 2-7 and 7-23 Mc/s. Less speaker. Few only. Brand new **£12.12.0**
- P.C.R.2. Medium and long waves and 6-23 Mc/s. Less speaker. **£8.19.6**
- P.C.R.1. Medium and long waves and 6-18 Mc/s. With speaker. **£9.19.6**

Carriage 10/6 each type

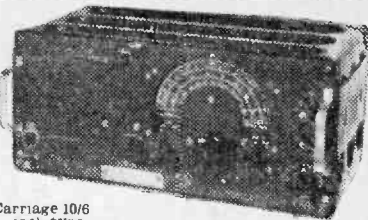

(All the above P.C.R. Receivers have been completely reconditioned).

12v. VIBRATOR PACK

(Supply Unit No. 9.) As used with P.C.R. Receivers giving 250 v. output at 80 mA. Fully smoothed. Size 10 x 8 x 6 in.

ONLY 25/- EACH.
P. & P. 5/-.

19 SET Mk. III POWER SUPPLY

With 2 dynamotors. H.T.31. 12 v. input, 250 v. output at 125 mA. H.T.32. 12 v. input, 450 v. output at 80 mA.

DON'T MISS THIS BUY!

ONLY 25/- P. & P. 5/-.

HI-FI HEADPHONES

These miniature HI-FI Phones use high quality permanent magnetic speakers with regulated voice coil. The soft rubber ear moulds give correct spacing for optimum acoustic load. Each unit has a built-in miniature HI-FI transformer to ensure the finest music and voice reproduction. Supplied free is a small transformer unit which steps impedance up to 4000 ohms.

Only 15/- P. & P. 2/6.

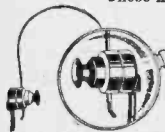

HOOVER ROTARY TRANSFORMERS

12 v. input, 500 v. output at 65 mA. or 6v. input, 250 v. output at 75 mA. Only 10/6 each. P. & P. 2/-.



SPARE VALVE KIT
Here's a gift for all 38 and 18 Set owners! Case contains 4 ARF12 & AT P 4 valves. Only 10/- P. & P. 2/6



U.S.A. DYNAMOTORS
Manufactured by EICOR. Input 12 v., output 400 v. at 180 mA. Size 7 x 4 x 4 1/2 in. Brand new 45/- P. & P. 3/6.

AERIAL VARIOMETERS

These magnificent instruments will enable you to receive maximum signal strength on all S.W. receivers. Precision, calibrated control 12/6. P. & P. 2/6.



V. H. F. MOBILE AERIAL and base, with PYE connections, 27in. overall, as used by Taxis, Police, etc. 7/6.



U.S.A. WHEE AERIALS 12ft. 10" COMPLETE HEADPHONE and MICROPHONE ASSEMBLY 10/- P. & P. 3/6.



ACCUMULATORS 2 volts 16 A.H. (unspillable) Ideal for 6 and 12 volts supply, etc. Brand new. Original cartons. Size 4in. x 7in. x 2in. 5/6 each. P. & P. 1/6. 3 for 15/- P. & P. 3/6. 6 for 27/6. P. & P. 5/-.

No. 7 MOVING COIL MICROPHONE INSERTS. Ultra sensitive. As used in many Govt. Microphones! Size 1 1/2 in. dia. x 1 1/2" deep. Brand new and guaranteed. 6/6 each.

CRYSTAL MICROPHONE INSERTS MODEL MC.1 Precision disc type crystal microphone cartridge. Output—53dB. Response: 100—6,000 c.p.s. PRICE 6/6.

ONLY 60/- Per Set P. & P. 4/-.

PORTABLE TRANS/RECEIVER SETS

Consisting of trans/receiver covering 7.4-9 Mc/s range up to 10 miles, complete with 5 valves, headphones, microphone, junction box and 6ft. telescopic aerial. Only requires 120 v. and 3 v. dry battery. **TWO FOR 26.** Post Free. **SPECIAL 135 v. H.T. BATTERIES.** Ideal for above. 12/6 each.



Precision all-purpose Pocket Binoculars — centre focus—aligned lenses — brilliant design — carry them everywhere for sport, theatre, etc.—open and close instantaneously. Terrific value at only 3/6.



RELDA OFFERS THE FINEST SURPLUS AERIAL MAST AND INSTALLATION OF ALL TIME!

This 30ft. mast can be used as a complete aerial by fixing the heavy duty insulator at the base or just as a mast with the insulator at the top holding the 12ft. Aerial Whip giving a height of 42ft. The 12ft. whip can be used separately if required. Complete kit comprises:

Complete installation offered at **ONLY 65/-**

Carr. 15/-

- 1 Large Canvas Bag.
- 10 Rods 3ft. x 1/2 in. dia.
- 1 Heavy Duty Insulator.
- 1 Large Base Stake.
- 1 Small Stake with Insulator.
- 1 Metal Carrying Case.
- 1 Hammer.
- 1 Small Canvas Bag.
- 1 Aerial Adaptor.
- 10 Ground Stakes.

Also all necessary Guy Ropes, Link Insulators, etc.

Fantastic Scope Buy!

DOUBLE TUBE INDICATOR

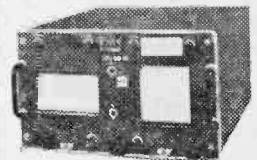

Complete in black crackle case size 11 x 7 x 1 1/2 in. Contains 2 new 5FP7 Tubes. All controls accessible on front. All connections at rear. Thousands already converted for TV Monitoring. Brand New. **ONLY 30/-** P. & P. 5/- FEW REMAIN!

MAIL ORDERS TO
(DEPT. P.), 32a COPPIC STREET,
LONDON, W.C.1



CALLERS WELCOME AT
87 TOTTENHAM COURT ROAD,
LONDON, W.1 MUS 9606



Radio Society

of Great Britain

INTERNATIONAL RADIO HOBBIES EXHIBITION

Royal Horticultural Old Hall

VINCENT SQUARE,
WESTMINSTER, LONDON S.W.1.

Wednesday to Saturday

NOVEMBER
22nd to 25th 1961

11 a.m. to 9 p.m. Admission
2/-

HOME CONSTRUCTION

DO-IT-YOURSELF FEATURES:

Kits of parts to build—Receivers, Transmitters, Television, Test Gear, Tape Recorders, Aerials, Hi-Fi Amplifiers, Transistor Equipment, Latest Communication Receivers of the World.

**G.P.O. RESEARCH BRANCH,
ARMY, NAVY and R.A.F. DISPLAYS
TECHNICAL BOOKSHOPS.**

Amateur Radio Station Talking to the World.
Prize Winning Home Built Equipment.

WIN A £185

HAMMARLUND

HQ170 World Famous
Communication Receiver

Presented by K. W. ELECTRONICS LTD.,
Heath Street, Dartford, Kent.

Cut out this square along dotted line and hand in at door
for your entry form.

Official Opening by **Mr HENRY LOOMIS**
Director of VOICE OF AMERICA

Further details from:—

P. A. THOROGOOD, G4KD, 35 GIBBS GREEN, EDWARE, MIDDLESEX

R.S.C. HI-FI TAPE RECORDER KIT

REALISM AT INCREDIBLY LOW COST. CAN BE ASSEMBLED IN HALF AN HOUR
The Recorder incorporates the Latest Collaro Studio Tape Transcriber. The Linear LT45X High Quality Tape Amplifier listed £12.12.0 High Flux P.M. Speaker listed 30/-, empty Tape Spool, a Reel of Best quality Tape listed 2/6, and a Handsome Portable carrying Cabinet with latest attractive two-tone polychrome finish, size 14 x 13 x 9 in. high, listed £4.10.0, and circuit. Total cost if purchased individually approximately £40. Performance equal to units in the £50-£80 class. S.A.E. for leaflet.

HIGH FIDELITY 12-14 WATT AMPLIFIER TYPE A11

PUSH-PULL ULTRA LINEAR OUTPUT "BUILT-IN" TONE CONTROL PRE-AMP STAGES

Two input sockets with associated controls allow mixing of "mike" and gram, as in A10. High sensitivity. Includes 5 valves, ECC83, ECC83, EL84, EL84, 5Y3. High Quality sectionally wound output transformer specially designed for Ultra Linear operation and reliable small condensers of current manufacture. **INDIVIDUAL CONTROLS FOR BASS AND TREBLE** "Lit" and "Cut" Frequency response \pm 3 D.B. 30-30,000 c/c.s. Six negative feedback loops. Hum level 60 D.B. down. **ONLY 23 millivolts INPUT required for FULL OUTPUT.** Suitable for use with all makes and types of pick-ups and microphones. Comparable with the very best designs. **FOR STANDARD or LONG PLAYING RECORDS.** For **MUSICAL INSTRUMENTS** such as **STRING BASS, GUITARS**, etc., **OUTPUT SOCKET** with plug provides 300 v. 30 mA. and 6.3 v. 1.5 A. For supply of a **RADIO FEEDER UNIT.** Size approx. 12-9-7in. For A.C. mains 200-250 v. 50 c.p.s. Output for 3 and 15 ohm speakers. Kit is complete to last nut. Chassis is fully punched. Full instructions and point-to-point wiring diagrams supplied. **Only 8 Gns.** Carr. 10/- (Or factory built 51/- extra).
If required louvred metal cover with 2 carrying handles can be supplied for 18/9. **TERMS ON ASSEMBLED UNITS. DEPOSIT 24/9, and 9 monthly payments of 24/9.** Send S.A.E. for illustrated leaflet detailing Ready-to-assemble Cabinets, Speakers, Microphones, etc., with cash and credit terms.

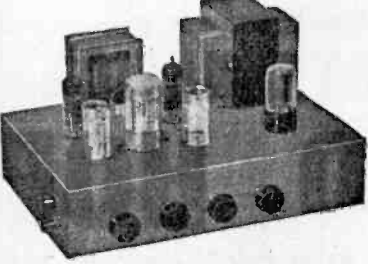

25 1/2
GNS.

Carr. 17/6



H.P. TERMS. Deposit £5.7.6 and 12 monthly payments of 2 gns. Cash price if settled in 3 months.

TELEVISION RECTIFIERS 250 v. 200 mA, small size. Only 6/9 each.

COLLARO CONQUEST 4-SPEED AUTO-CHANGER, with high fidelity Studio pick-up. Latest model. For 200-250 v. 50 c.p.s. A.C. mains. Our price £6.19.6. Carr. 5/6.

COLLARO RC 457 4 SPEED MIXER AUTO-CHANGERS, Turnover Studio Pick-up head, for 200-250 v. A.C. £7.19.6. Carr. 4/6.

THE SKYFORER I.R.F. RECEIVER. A design of a 3-valve long and medium wave 200-250 v. A.C. Mains receiver with selenium rectifier. High gain H.F. stage and low distortion detector. Valve line-up 6K7, 6P61, 6V6G. Selectivity and quality excellent. Simple to construct. Point-to-Point wiring diagrams, instructions and parts list, 1/9, maximum building costs £4.19.6, inc. attractive Walnut veneered wood cabinet, 12 x 9 1/2 x 5 1/2 in.

GL3A MINIATURE 2-3 WATT GRAM AMPLIFIER. For use with any single or auto-change unit. Output for 2-3 ohm speaker. For 200-250 v. A.C. mains. Size 11 x 2 1/2 x 2 in. Controls: Vol. and Tone with switch. Only 5/9/6.

R.S.C. STEREO/TEN HIGH QUALITY AMPLIFIER

A complete set of parts for the construction of a stereophonic amplifier giving 5 watts high quality output on each channel (total 10 watts). Sensitivity is 50 millivolts, suitable for all crystal stereo heads. Ganged Bass and Treble Controls give equal variation of "Lit" and "cut". Provision is made for use as straight (monaural) 10 watt amplifier. Valve line-up ECC83, ECC83, EL84, EL84, EZ81. Outputs for 2-3 ohm speakers. Point-to-Point wiring diagrams and instructions supplied. Send S.A.E. for leaflet. **8 Gns.** Carr. 10/- Full constructional details and price list 2/6. Carr. 10/-



R.S.C. BATTERY CHARGING EQUIPMENT

HEAVY DUTY CHARGER KIT 6/12 v. 6 amps. variable output. Consisting of Mains Transformer 0-230-250 v. F.W. (Bridge) Selenium Rectifier. Ammeter. Variable Charge Rate Selector Panels, Plugs, Fuses, Fuseholder and circuit. 59/9. Carr. 4/6.

DEAF AID EARPIECES. Low Impedance with lead. 8/9. High Impedance Crystal 8/9.

MICROPHONE INSERTS. Crystal type 8/9.

SOLDERING IRONS. 200-250 v. 30 watts. First quality. For Radio work, 19/9. Spare elements and bits available.



Assembled 6 v. or 12 v. 4 amps.
Fitted Ammeter and variable charge rate selector. Also selector plug for 6 v. or 12 v. charging. Louvred steel case with stoved blue hammer finished. Fused 6/9/6 and ready for use with Carr. 5/- mains and output leads. Terms: Deposit 13/8 and 5 monthly payments 13/3. 6/12 v. 3a., all facilities as above. Only 59/9, carr. 3/9.

All for A.C. Mains 200-250v., 50ccs. Guaranteed 12 months.

BATTERY CHARGER KITS
Consisting of Mains Transformer, F.W. Bridge, Metal Rectifier, well ventilated steel case, Fuses, Fuse-holders, Grommets, panels and circuit. Carr. 3/6 extra.
6v. or 12v. 1 amp. 24/9
6v. or 12v. 2 amp. 32/9
6 v. 2 amps. 25/8
6v. or 12v. 2 amps. 31/6
6 v. or 12 v. 2 amps. inclusive of Ammeter. 42/6
6 v. or 12 v. 4 amps. 49/9
6 v. or 12 v. 4 amps. with Ammeter and variable charge rate selector 59/9
CHARGER AMMETERS.
0-1.5 a., 0-4 a., 0-4 a., 0-7 a., 0-25 a., 0-60 a. 8/9.

R.S.C. MAINS TRANSFORMERS (FULLY GUARANTEED)

Interleaved and Impregnated. Primaries 200-230-250 v. 50 c/s. Screened TOP SHROUDED DIPOLE THROUGH
250-0-250 v. 70 mA. 6.3 v. 2a. 5 v. 2a. 17/9
350-0-350 v. 80 mA. 6.3 v. 2a. 5 v. 2a. 18/9
250-0-250 v. 100 mA. 6.3 v. 2a. 6.3 v. 1a. 21/9
250-0-250 v. 100 mA. 6.3 v. 3.5 a. C.T. 19/9
250-0-250 v. 100 mA. 6.3 v. 4a. 5 v. 3a. 25/9
300-0-300 v. 130 mA. 6.3 v. 4a. 6.3 v. 1a. 29/9
for Mullard 510 Amplifier 29/9
300-0-300 v. 100 mA. 6.3 v. 4a. 5 v. 3a. 28/9
350-0-350 v. 100 mA. 6.3 v. 4a. 5 v. 3a. 26/9
350-0-350 v. 100 mA. 6.3 v. 4 v. 4 a. C.T. 26/9
0-4-5 v. 3 a. 2/9
350-0-350 v. 150 mA. 6.3 v. 4 a. 5 v. 3 a. 29/9
FULLY SHROUDED UPRIGHT
250-250 v. 60 mA. 6.3 v. 2a. 5 v. 2a. 17/11
Midget type 24-250 v. 60 mA. 6.3 v. 2a. 5 v. 3a. 27/9
300-0-300 v. 100 mA. 6.3 v. 4a. 5 v. 3a. 27/11
350-0-350 v. 100 mA. 6.3 v. 4a. 5 v. 3 a. 27/11
350-0-350 v. 150 mA. 6.3 v. 4 a. 5 v. 3 a. 35/9
425-0-425 v. 200 mA. 6.3 v. 4 a. C.T. 49/9
6.3 v. 4 a. C.T., 5 v. 3 a. 49/9

FILAMENT TRANSFORMERS
All with 230-250 v. 50 c/s. primaries 6.3 v. 1.5 a. 5/9; 6.3 v. 2 a. 7/6; 0-4-6.3 v. 2 a. 7/9; 12 v. 1 a. 7/11; 6.3 v. 3 a. 8/11; 6.3 v. 6 a. 17/6; 12 v. 1.5 a. twice, 17/6.
OUTPUT TRANSFORMERS
Midget Battery Pentode 66:1 for 354, etc. 3/9
Small Pentode. 600 Ω to 3 Ω 6/8
Small Pentode 7/8,000 Ω to 3 Ω 3/9
Standard Pentode 5,000 Ω to 3 Ω 5/9
Standard Pentode 7/8,000 to 3 Ω 5/9
Push-Pull 8 watts. EL84 or 6V6 to 3 Ω or matched to 15 Ω 9/9
or EL84 to 35-8 or 15 Ω 19/9
Following types 10 Ω and 15 Ω speakers:
Push-Pull 10-12 watts 6V6 or EL84 18/9
Push-Pull 15-18 watts. 6L6, KT66 22/8
Push-Pull for Mullard 510 Ultra Linear 29/9
Push-Pull 20 watts sectionally wound. 6L6, KT66, etc. 49/8

MIDGET MAINS
Primaries 200-250 v. 50 c/s.
250 v. 60 mA. 6.3 v. 2 a. 11/9
250-0-250 v. 100 mA. 6.3 v. 2 a. 12/8
Both above size 2 1/2 x 2 1/2 x 2 1/2 in.

SMOOTHING CHOKES
150 mA. 7-10 H 250 ohms 11/9
100 mA. 10 H 350 ohms 8/9
80 mA. 10 H 350 ohms 5/9
60 mA. 10 H 400 ohms 4/11

PARTIALLY POTTED TYPES
200 mA. 12 H 100 ohms 16/9
120 mA. 30 H 200 ohms 16/9
120 mA. 8 H 150 ohms 13/9

CHARGER TRANSFORMERS
All with 200-230-250 v. 50 c/s Primaries.
0-8-15 v. 11 a. 19/9; 0-8-15 v. 2 a. 14/8; 0-8-15 v. 3 a. 16/9; 0-8-15 v. 5 a. 19/8; 0-8-15 v. 6 a. 23/9; 0-8-15 v. 8 a. 28/9.

AUTO (Step up/step down) TRANS.
0-110-120-200/250 v. 50-80 watts, 13/8;
1-110-120-200/250 v. 150 watts, 27/8.

MICROPHONE TRANSFORMERS
120-1 high grid, clamped. 6/9; 120-1 Potted. Mu-metal screened. 9/8.

R.S.C. (Manchester) LIVERPOOL, LEEDS, BRADFORD, MANCHESTER Ltd.

R.S.C. A12 STEREOPHONIC AMPLIFIER KIT

A complete set of parts to construct a good quality Stereo amplifier with an undistorted output total 6 watts. For A.C. mains input of 200-250 v. Outputs for matched 2-3 ohm speakers. Sensitivity 130 m.v. Ganged Vol. and Tone Controls. Preset balance control. Full instructions and point-to-point wiring diagrams supplied.

STEREO EQUIPMENT OFFER-
Comprising A12 Kit, 2 matched 8in. L/Spakers, and Aco's T70 Stereo head suitable most pickups. **£6.19.6** Carr. 7/6.

PICK-UP ARMS complete with Hi-Fi turnover crystal head. Aco's GP54. Limited number brand new, perfect at approx. half price. Only 29/11.

ACOS CRYSTAL MICROPHONES. M40 stand or desk. Listed 35/-, Only 27/9. 39-1 Stick type. Listed 3 gns. Only 39/6.

R.S.C. 30 WATT ULTRA LINEAR HIGH FIDELITY AMPLIFIER A10
A highly sensitive Push-Pull high output unit with self-contained Pre-amp. Tone Control. Stages. Certified performance figures compare equally with most expensive amplifiers available. Hum level 70 db. down. Frequency response +3db. 30-30,000 c/s. A specially designed sectionally wound ultra linear output transformer is used with 807 output valves. All components are chosen for reliability. Six valves are used EF86, EF98, EC63B, 807, 807, QZ33. Separate Bass and Treble Controls are provided. Minimum cost required for full output is only 12 millivolts so that ANY KIND OF MICROPHONE OR PICK-UP IS SUITABLE. The unit is designed for CLUBS, SCHOOLS, THEATRES, DANCE HALLS or OUTDOOR FUNCTIONS, etc. For use with Electronic ORGAN, GUITAR, STRING BASS etc. For standard or long-playing records. **OUTPUT SOCKET PROVIDES L.T. and H.T.** for a RADIO FEEDER UNIT. An extra input with associated vol. control is provided so that two separate inputs such as Gram, and 'Mike' can be mixed. Amplifier operates on 200-250 v. 50 c/s. A.C. Mains and has output for 3 and 15 ohm speakers. Complete kit of parts with fully punched chassis and point-to-point wiring diagrams and instructions. If required carry-perforated cover with carrying handles can be supplied for 19/9. The amplifier can be supplied, factory built with EL34 output tubes and 12 months guarantee, for 14 Gns. **TERMS: DEPOSIT 33/9** and 9 monthly payments of 33/9. Suitable microphones and speakers available at competitive prices.

FULL RANGE OF LINEAR AMPLIFIERS ALWAYS IN STOCK.

COLLARO JUNIOR 4-speed single player units and Hi-Fi crystal pick-up with turn-over head. £3.19.6.

B.S.R. UAS 4-SPEED AUTO-CHANGERS with Hi-Fi turnover pick-up head. £6.19.6. Carr. 5/-.

R.S.C. BATTERY TO MAINS CONVERSION UNITS

Type BM1. An all-dry battery eliminator. Size 5 1/4 x 4 1/2 x 2 1/2 approx. Completely replaces battery supplying 1.4 v. and 90 v. where A.C. mains 200-250v. 50 c/s is available. Suitable for all battery portable receivers requiring 1.4 v. and 90 v. This includes latest low consumption types. Complete kit with diagrams, 39/9, or ready to use, 46/9.

LINEAR TAPE PRE-AMPLIFIER Type LP1. Switched Negative feedback equalisation. Positions for Record (in. 3rin, 7 1/2in and Playback, EM54 Recording Level Indicator. Designed primarily as the link between a Collaro Tape Transcriber and a high fidelity amplifier, but suitable for almost any Tape Deck. Only 9 gns. S.A.E. for leaflet.

4 Gns.
Carr. and pkg, 5/-

JASON FMTI V.H.F./F.M. Radio Tuner design. Total cost of parts including valves, Tuning dial, Escutocheon, etc. £6.19.6.

LINEAR L45 MINIATURE 4/5 WATT QUALITY AMPLIFIER. Suitable for use with any record playing unit, and most microphones. Negative feedback 12db. Separate Bass and Treble Controls. For A.C. mains input of 200-250 v. 50 c/s. Output for 2-3 ohm speaker. Three miniature Mullard valves used. Size of unit only 7-5in. high. Guaranteed for 12 months. Only £5.19.6. Send S.A.E. for illustrated leaflet. Terms: Deposit 22/6 and 5 monthly payments of 22/6.

R.S.C. 4-5 WATT AS HIGH-GAIN AMPLIFIER

A highly-sensitive 4-valve quality amplifier for the home, small club, etc. Only 50 millivolts input is required for full output so that it is suitable for use with the latest high fidelity pick-up heads, in addition to all other types of pick-ups and practically all suitable microphones. Separate Bass and Treble Controls are provided. These give full long-playing record equalisation. Hum level is negligible being 71db. down 15db. of Negative feedback is used. H.T. or 300 v. 25 mA. and L.T. or 0.3 v. 1.5 a. is available for the supply of a Radio Feeder Unit. Tape-Deck pre-amplifier. For A.C. mains input of 200-250 v. 50 c/s. Output for 2-3 ohm speaker. Chassis is not alive. Kit is complete finished and includes fully punched chassis (with baseplate) with Blue hammer finish and point-to-point wiring diagrams and instructions. Exceptional value at only £4.15.0, or assembled ready for use 25/- extra, plus 3/6 carr.; or Deposit 22/6 and 5 monthly payments of 22/6 for assembled unit.

R.S.C. PORTABLE GUITAR AMPLIFIERS (For 200-250v. A.C. Mains)

Junior 5 watts High quality output. Separate Bass and Treble "Cut" and "Boost" controls. Sensitivity 15 m.v. Twin inputs. High Flux 5in. Loudspeaker "built-in" Handsome, strongly made Cabinet (size approx. 14 x 14 x 7in.) finished in attractive and durable polychrome, and fitted carrying handle. **TERMS: DEPOSIT £1** and 9 monthly payments of £1. Carr. 10/-

Senior 10 watts High Fidelity output Separate Bass and Treble "Cut" and "Boost" controls. Twin separately controlled high gain inputs so that two instruments such as Guitar and String Bass can be used at the same time. Two loudspeakers are incorporated. A high Flux 12in. for Bass notes and a 7 x 3 in. elliptical for Treble. Cabinet is well made and finished as Junior model. Size approx. 18 x 18 x 9in. **15 Gns.** H.P. Terms. Deposit 34/9 and 9 monthly payments of 34/9. Carr. 10/-

Super Hi-Fi 15 Watt. All facilities as 10 watt. Cabinet size 18 x 18 x 10ins. Terms: Deposit £2.11.6, and nine monthly payments of 51/8. Cash 22 Gns. Carr. 12/6.

12in. 10 WATT HIGH QUALITY LOUD-SPEAKER

POLISHED FINISHED CABINET
Gauss 12,000 lines. Speech coil 3 ohms or 15 ohms. Only £4.19.6. Carr. 5/-.
Terms: Deposit 11/3

12in. 20 WATT HI-LOUD-SPEAKERS IN CABINETS. Size 19 x 18 x 10in. Finish as above. Terms: Deposit 17/9 and 9 monthly payments of 17/9. Only £7.19.6. Carr. 6/6.

and 8 monthly payments of 11/3.

R.S.C. BASS REFLEX CABINETS, JUNIOR MODEL. Specially designed for W.B. HF1212 Speaker, but suitable for any good quality 10in. speaker. Acoustically lined and ported. Polished hand-tone veneer finish. Size 18 x 12 x 10in. Wandsome appearance. Ensure superb reproduction for only £3.19.6.

STANDARD MODEL. As above but for 12in. speakers. Size 20 x 15 x 13in. Especially recommended for Plessey Dual Concentric Speaker, £5.19.6. Suitable legs with brass ferrules, 25/- per set of 4. **PLESSEY DUAL CENTRIC 12in. 15 ohms HIGH FIDELITY SPEAKER** (12,000 lines) with built-in tweeter (completely separate elliptical speaker with choke, condensers, etc.) providing extraordinarily realistic reproduction when used with our A11 or similar amplifier. Rated 10 watts. Price only £5.19.6. **P.M. SPEAKERS.** 2-3 ohm. 2in. Perdio 21/9. 5in., 17/9. 6in., 16/9. 8in., 19/9. 8 x 5in. 25/9. 10in. 26/9. 10 x 6in. 29/9. 12in. 29/11. 10in. W.B. "Stentorian" 3 or 15 ohms type HF1012 10 watts, high fidelity type. Recommended for use with our A11 Amplifier. £4.10.9. 12in. R.A. 3 ohms 10 watts (12,000 lines), 59/6. **TWEETERS.** Plessey 3Ω 19/9, 15Ω 25/9. **HI-FI CRYSTAL PICK-UP HEADS.** (Turnover type with sapphire 547/us.) Aco's. Standard replacement for Garrard and B.S.R. B.S.R. Ful-A. Garrard GC2. 19/9. Aco's. Stereo-Monaural 49/9.

R.S.C. EQUIPMENT CABINET. Dimensions and outer appearance identical with Standard Bass Reflex Cabinet. Top hinged. Bass board adjustable. Will take Tape Deck or Player Unit, and Amplifier plus F.M. or A.M./F.M. Unit. Only 8 gns. **SUPERBET FEEDER UNIT.** Design of a high quality Radio Tuner Unit (specially suitable for use with any of our Amplifiers). Delayed A.V.C. Controls are Tuning, W/ch. and Vol. Only 25 v. 15 mA. H.T. and L.T. of 6.3 v. 1 amp. required from amplifier. Size of unit approx 6 1/2 x 7 1/2 in. High. Simple alignment procedure. Point-to-Point wiring diagrams, instructions and priced parts list with illustration. 2/6. Total building cost £4.15.0. For leaflet send S.A.E.

Type BM2. Size 8 x 5 1/4 x 2 1/2 in. Supplies 120 v. 90 v. and 60 v., 40 mA. and 2 v. 0.4 a. to 1 amp. fully smoothed. Thereby completely replacing both H.T. batteries and L.T. 2 v. accumulators when connected to C.M.C. mains supply 200-250 v. 50 c/s. **SUITABLE FOR ALL BATTERY RECEIVERS** normally using 2 v. accumulator. Complete kit of parts with diagrams and instructions. 49/6, or ready for use, 59/6.

TERMS: C.W.O. or C.O.D. under C.O.D. until £1. Post 19/9 extra under £2, 3/3 extra under £5. Open 9 to 6. Weds. until 1 p.m., except Manchester open all week. Trade supplied. S.A.E. with all enquiries.

R.S.C. Mail Orders to 29-31 Moorfield Road, Leeds 12. Personal shoppers to any of branches below—
(Manchester) 73 Dale Street, Liverpool 2
5-7 County (Mecca) Arcade, Briggate, Leeds 1
8-10 Brown St. (Market St.), Manchester 2
56 Morley Street, (Above Alhambra Theatre), Bradford

HARVERSON SURPLUS CO. LTD.

PLEASE TURN OVER FOR ADDRESS AND MORE BARGAINS

2 BAND SUPERHET CHASSIS with Speaker

ONLY £5.17.6
Plus 6/6 Post & Packing

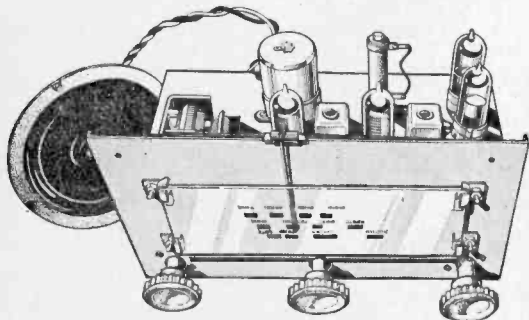

A quality 4 valve AC/DC superhet chassis made by a world famous manufacturer. Long and Medium wave coverage. Fitted with a cord and drum reduction tuning drive and attractive illuminated glass dial (size $6\frac{1}{2} \times 2\frac{1}{2}$ in.). Controls: Volume on/off, tuning and wave change. The receiver is self-powered, employing a mains dropper and a valve rectifier. Chassis dimensions $6\frac{1}{2} \times 9 \times 5\frac{1}{2}$ in. high. Supplied complete with a good quality 5-inch loudspeaker, valves (UCH42, UAF42, UL41, UY41), AC/DC mains input lead, ivory knobs, etc.

DON'T HESITATE, ORDER NOW! This unbeatable bargain is bound to sell out quickly at only £5.17.6, plus 6/6 post and packing.

4 STATION PRESET CHASSIS with Speaker

ONLY £4.17.6

Plus 6/6 P. & P.

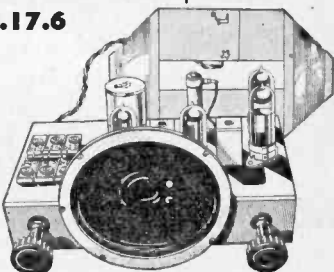

A compact, 4 station preset mains transportable receiver for operation from AC/DC mains. Two simple controls, volume on/off and 4 position station selector. The latter is set to Light Programme (Long Wave), Third Programme, Home Service and Light Programme (Medium Wave), but may of course be adjusted to alternative selections if required. A frame aerial with throw-out extension is supplied, making this receiver ideal as a general purpose transportable set for the home. A fully smoothed power supply is provided from AC/DC main; input by a mains dropper and a valve rectifier. The good tone qualities are assisted by the provision of a quality 5in. speaker, which is readily-mounted on the chassis (this is easily detachable if alternative positioning is required). Valve line up, UCH42, UAF42, UL41, UY41. This chassis (size $9 \times 6\frac{1}{2} \times 5\frac{1}{2}$ in. high) is supplied complete with valves, knobs, mains lead, aerial, etc. It is beautifully made by a famous maker, and is a first-class buy at the rock bottom price of only £4.17.6, plus 6/6 post and packing.

A.M. RADIOGRAM CHASSIS

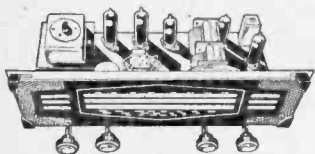

A chassis of distinction, by a famous maker. Covering Long, Med. and Short Wwaves, plus gram position, this chassis (size $15\frac{1}{2} \times 7 \times 6\frac{1}{2}$ in. high) incorporates the latest circuitry, using fully delayed A.V.C., and negative feedback. Controls: Tone, Vol. On/Off, W/Change (L.M.S. and Gram), Tuning. Tapped input 200-250 v. A.C. only. An attractive brown and gold illuminated dial with matching knobs, make this one of the most handsome, in addition to being one of the best performing chassis yet offered. Complete with valves (ECH81, EF89, EBC81, EL84, EZ81), knobs, output transformer, leads, etc. **OUR PRICE ONLY £9.19.6** plus 4/6 post & packing.

THE WORLD FAMOUS E.M.I. ANGEL TRANSCRIPTION P.U. (Model 17A)

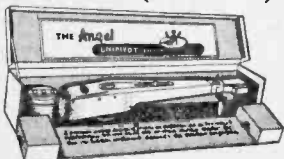

A Pick-up for the connoisseur originally priced at £17.10.0. The last remaining few offered at £5.15.0, plus P. & P. 5/-.

HARVERSON'S F.M. TUNER KIT

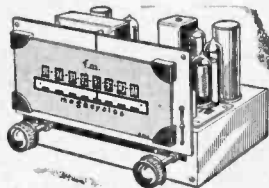

At last a quality F.M. Tuner Kit at a price you can afford. Just look at these fine features, which are usually associated with equipment at twice the price.

- ★ F.M. Tuning Head by famous maker.
- ★ Guaranteed Non-drift.
- ★ Permeability Tuning.
- ★ Frequency coverage 88-100 Mc/s.
- ★ OAB1 Balanced Diode Output.
- ★ Two I.F. Stages and Discriminator.
- ★ Attractive maroon and gold dial (7×3 in. glass).
- ★ Self powered, using a good quality mains transformer and valve rectifier.
- ★ Valves used ECC85, two EF80's, and EZ80 (rectifier).
- ★ Fully drilled chassis.
- ★ Everything supplied, down to the last nut and bolt.
- ★ Size of completed tuner $8 \times 6 \times 5\frac{1}{2}$ in.
- ★ All parts sold separately.

£4.19.6 Plus 8/6 P.P. & Ins.

Circuit diagram and illustrations, 1/6, post free.

NOW AVAILABLE. Superb metal cabinet finished in either Hammer Green, Grey, or Black crackle. With front panel (available separately) complete with aperture for E.M.84 magic eye. 25/-

OUTPUT STAGE & SPEAKER FOR F.M. TUNER UNIT

All parts, including speaker, ECL82 valve, and simple instructions to make two-stage output unit for converting F.M. tuner into F.M. receiver. **ONLY 45/-**, plus 4/6 P. & P.

E.M.I. 4-speed Player and P.U.



Heavy $8\frac{1}{2}$ in. metal turntable. Low flutter performance 200/250V shaded motor with tap at 80V for amplifier valve filament if required. Turnover LP/78 head. Price 89/6. Plus 4/6 P. & P.

SUPER STEREO KIT MK. II

A kit of ready-built units only requiring interconnection. Comprising two midget 3W amplifiers, push button switch, transformer, control unit (bass, treble and vol.), power pack, two speakers, indicator light, valves (ECL82, EZ80 range), and comprehensive instructions.

£3.19.6 Plus 6/6 P. & P.

F.M. TUNER HEAD

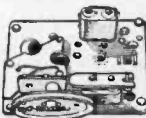

A permeability tuned tuner head by a famous maker, supplied without valve (ECC85) 18/6 plus 1/9 P. & P. Valve 8/6 extra.

HARVERSON SURPLUS CO. LTD.

Introducing HARVERSON'S Monaural Amplifier Kit

39/6



In response to numerous requests from delighted purchasers of our "SUPER STEREO KIT" we have produced a "MONAURAL AMPLIFIER" on similar lines.

★ A UCL 82 valve provides a triode amplifying stage, and a pentode output stage (3 watts), enabling good amplification and sparkling reproduction to be combined with physical compactness (amplifier size, 7 x 3½ x 6½ in. high).

★ Modern circuitry design, good quality O.P. transformer (to match 3Ω) keep hum and distortion to a low level.

★ The controls, volume on/off, and tone, are complete with attractive cream and gold knobs.

★ The amplifier has a built-in fully smoothed power supply, using a good quality mains transformer (A.C. mains only) and metal rectifier.

★ All you need is supplied including easy to follow instructions which guarantee good results for the beginner and expert. All components, leads, chassis, valve, knobs, etc., are first grade items by prominent manufacturers.

OUR PRICE Plus 4/6 Post and Packing. 39/6

Min. LOUDSPEAKER TO SUIT 14/6 EXTRA

ALL PARTS SOLD SEPARATELY



AT ½ PRICE WHILE THEY LAST
GOLD DRING NU-METAL CASED CARTRIDGES
Sapphire Styli. Brand new and boxed
Our Price £2.15.0

P & P 1/6
Including Ins.

BARGAIN MONTH FOR TRANSISTORS

POWER			
OC36	10/-	GET102	7/6
OC44	9/-	XA103	8/6
OC45	8/-	PXA101	9/6
OC71	5/-	PXA102	9/6
OC75	6/6	AMERICAN	
OC76	6/6	2N388	6/6
OC78	6/6	2N1485J	6/6
OC78D	6/6	2S712	7/6
GET15	9/-	DIODE	
GET15 (matched pr.) ...	16/6	OA81	3/-

Please add 6d. postage for each transistor.

TRANSISTOR SPEAKER

Western Electric 3Ω speaker. Size 2½ x ½ in. deep. 12/6 p.p. 1/-.

THE HARVERSON COMPLETE F.M./V.H.F. RECEIVER KIT £6.19.6

AT LAST—A COMPLETE F.M. RECEIVER IN KIT FORM!

Specially designed with the home constructor in mind, this kit enables the construction of a completely self-contained V.H.F. receiver, at fraction of the normal cost of comparable equipment. This is basically a quality self-powered F.M. tuner plus 2 separate audio amplifier stages, and output transformer and speaker.

- ★ F.M. Tuning Head by famous maker.
- ★ Guaranteed Non-drift.
- ★ Permeability Tuning.
- ★ Frequency coverage 88-100 Mc/s.
- ★ OA81 Balanced Diode Output.
- ★ Two I.F. Stage and Discriminator.
- ★ Self powered using a good quality mains transformer and valve rectifier.
- ★ Valves used ECC85, two EF80's, ECL82 and EZ80 (rectifier).
- ★ Fully drilled chassis.
- ★ Good quality speaker.
- ★ Well designed output transformer.
- ★ Attractive maroon and gold glass dial.
- ★ Two output stages (using ECL82).
- ★ Everything supplied, down to the last nut and bolt.
- ★ Compact size.
- ★ All parts sold separately.

OUR PRICE £6.19.6 Plus 4/6 P. & P.



CHILD'S NURSERY LAMP

A child's night light of unusual design. Contemporary styled lampholder of robust construction finished in either red or yellow. Entirely safe (bulb socket shielded from "prying fingers") complete with flex and a push-button switch. 200/250 volts A.C. only. The low-consumption bulb element is made in the shape of either flowers or angel fish, and when switched on, glows in fluorescent colours (the flowers pink with green leaves, or the fish green with purple weed). Made by a famous manufacturer and originally priced at 29/6. Please state lampholder colour preference, and whether fish or flower element is required.



OUR BARGAIN PRICE ONLY 10/9
plus 9d. post and packing.

SUPERHET CHASSIS—less Valves & Cabinet

Modern AC/DC chassis with printed circuit and ferrite rod aerial. Although not completely built, the main components are mounted. L. & M. wave coverage. 4 valves (UBF89, UCL83, UCH81, UY85). Everything supplied except valves and cabinet. With speaker and simple instructions. **£3.6.6** plus 3/6 P. & P.

TRANSISTOR AMPLIFIER KIT

A complete kit of parts to build a compact 4-transistor amplifier with volume control and printed cct. board. Two GT3 driver transistors, transformer coupled. 1 watt output from matched pair GT15. Supplied with output transformer and 2½ in. 3 ohm speaker. Ideal for record player, etc. **59/6** plus 4/6 P. & P.

CONDENSER/RESISTOR PARCEL

50 mixed P.F. Condensers and 50 mixed Resistors. An assortment of useful values. All popular sizes—all new—a must for the serviceman and constructor **ONLY 10/-** P. & P. 1/-.

83 HIGH ST., MERTON, S.W.19

CHerrywood 3985/6

★ HARVERSON'S UNEQUALLED VALVE SERVICE ★

Table of vacuum tube types and prices, organized by AC/PEN (AC/TP, DD, AC6PEN, ATP4, AZI, AZ31, AZ41, B36, BL63, CI, CIC, CBL1, CBL31, CCH35, CK506, CL33, CV63, CYP1, CY31, D1, D15, D63, D77, DAC32, DAF91, DAF96, DD41, DET25, DF33, DF66, DF91, DF96, DF97, DH63, DH76, DH77, DK32, DK91, DK92, DK96, DL33, DL66, DL68, DL72, DL79, DL94, DL96, DM70, E80F, E83F, EA50, EA76, EABC80, EAC91, EAF42, EB34, EB41, EB91, EBC3, EBC33, EBC41, EBC81, EBF80, EBF83).

Transistors and diodes CG1C 716 CG4E 716 CG7E 716 CG10E 716 CG12E 716 GDI3, 4, 5, 6 8 41- OA70 10. OA73 41- OA79 41- OA81 41- OA86 61- OA91 51- OA95 51- OA210 251- OA211 401- OC16 541- OC23 441- OC26 241- OC28 241- OC35 481- OC44 261- OC45 231- OC65 221- OC66 251- OC70 141- OC71 141- OC72 141- OC73 201- OC75 151- OC77 211- OC81 181- OC170 351- OC200 541- OC250 541- T1 401- T32 451- T33 501- TP1 401- TP2 401- TS1 101- TS2 1216

For one month only the above prices less 10%. This list supersedes all previous issues

WE SPECIALISE IN OBSOLETE VALVES—IF YOU DON'T SEE IT ABOVE WRITE AND ASK

SPECIAL OFFER! ONE DOZEN 6K7G £1, plus 2/6 P. & P.

BRAND NEW COSSOR 10-inch TUBE, 108K OR 75K, 18/6, plus 6/6 P. & P.

Regunned Tubes Supplied—Any Type—Any Size. Write for List

OSCILLATOR COIL FOR ANY TAPE DECK, 5/6, plus 6d. P. & P.

PLEASE TURN OVER FOR MORE BARGAINS

HARVERSONS SURPLUS CO. LTD.

THE HARVERSON 6 TRANSISTOR PLUS DIODE SUPERHET KIT



A first class 2 wave band transistor superhet in kit form.

- ★ Printed circuit panel (size $8\frac{1}{2} \times 2\frac{3}{4}$ ins.)
- ★ 3 Pre-aligned I.F. Transformers.
- ★ Output Transformer.
- ★ 5 inch 5Ω Speaker.
- ★ High gain Ferrite rod aerial.
- ★ First grade G.E.C. transistors.
- ★ Push/Pull output.

All parts down to the minutest item with simple instructions. ONLY

£6.19.6 Plus 2/6 P. & P.

Cabinet to Suit (if available) 15/- extra.

4 TRANSISTOR AMPLIFIER KIT AND $2\frac{1}{2}$ INCH SPEAKER



All the components to make a quality transistor amplifier. Printed circuit panel size $3\frac{3}{4} \times 2\frac{1}{2}$ in. 4 G.E.C. transistors. Low loss miniature transformers and quality $2\frac{1}{2}$ in. speaker. Ideal for a record player amplifier, intercom, baby alarm, etc. With simple instructions.

ONLY **59/6** Plus 2/6 P. & P.

MODEL CONTROL UNIT KIT WITH RELAY

A miniature 4 transistor model control receiver with relay. Ideal for boats or aircraft. Guaranteed range 1 mile in air and $\frac{1}{4}$ mile over water. ONLY

FOR ADDRESSES AND 3 MORE PAGES OF BARGAINS PLEASE TURN OVER

57/6 Plus 2/6 P. & P.

CYLDON PUSH BUTTON T.V. TUNER

A compact T.V. tuner of superb design adjustable to any channel. 5 push buttons (on/off and 4 channels). Brand new. Complete with valves (30C15 & 30L15).

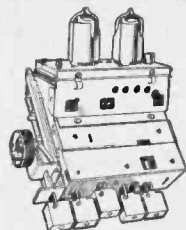

ONLY **75/-**

Plus 4/6 P. & P.

1/6 H.P. MOTOR

140 Watt (approx. 1/6 H.P.). Series wound, 220/250 volt 50 cycle motor. Off load 14,000 rev/min., on load 8,500 rev/min. Ideal small saw, sewing machine, etc. post free. **30/-**

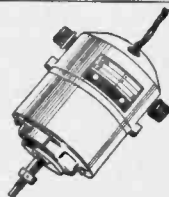

MINIATURE EARPHONE WITH CORD, SUB-MINIATURE PLUG AND SOCKET

A deaf aid type earpiece of top grade quality. Gives an exceptionally crisp reproduction of both speech and music. Brand new and fully guaranteed. Two types available. CR-5 high impedance crystal, MR-4 low impedance magnetic. **7/6** Plus 1/- P. & P.

MAINS PORTABLE SOLDERING IRON

Probably one of the most outstanding soldering instruments yet produced, this iron has a detachable handle which can be placed over the bit and barrel, enabling it to be carried in complete safety even when hot. The provision of an extremely stable 30w element makes this ideal for transistor and all similar lightweight applications. Brand new in P.V.C. bag, with lead and plug. ONLY **18/9**, plus 1/3 P. & P.

HARVERSON'S TRANSISTOR TUNER

At last a compact transistor tuner! Although primarily designed as the partner to our transistor amplifier, this tuner will give excellent results with any good amplifier. We are confident that you will agree that the T.R.F. circuit employed gives a comparable performance to a superhet. Complete Kit including ferrite rod aerial, midget volume control, 2 diodes and 1 transistor, printed circuit board ($2\frac{1}{4} \times 2\frac{1}{4}$ in.) and instructions. ONLY **39/6** Post Free.

TAPE DECKS

B.S.R. Monardeck (single speed) $3\frac{3}{4}$ in. per sec., simple control, uses 5 $\frac{1}{2}$ in. spools. **£7.5.0**, plus 5/6 carr. and ins. (tapes extra).
COLLARO STUDIO DECK £11.5.0, plus 5/6 carriage and ins. (tapes extra).

CRYSTAL MIKES

T.S.L. Stick Mike.....22/6
 ACOS (latest model).....18/6

PLESSEY SPEAKER

8 x 5 inch 3 Ω Speaker.
 Large Pot.....12/6, P.P. 1/6

HI/FI STEREO MONAURAL AMPLIFIER

A 5 valve Hi/Fi amplifier with switched stereo/monaural operation. Output 3 watts per channel, provision for bass and treble speakers on each. Volume and tone controls fitted both channels. All housed in stylish blue/grey metal case, with gold finished knobs and trimmings. **£9.19.6** Plus 4/6 P. & P.

WHARFEDALE 12in. HI-FI FULL FREQUENCY SPEAKER

Mdl. SUPER 12/FS/AL. Aluminium voice coil, 15 ohms, 17,000 lines, foam plastic suspension, 15-30 watts peak. Brand new in maker's cartons. List **£17.10.0**.

OUR PRICE **£12.19.6** Carr. 7/6.

Sets are being kept longer— YOU NEED THIS DATA MORE THAN EVER!

ALL THE CIRCUITS, DIAGRAMS, REPAIR DATA
AND INFORMATION YOU NEED FOR NEARLY

2,700 Models COMPLETE IN 7 VOLUMES

Newnes RADIO AND TELEVISION SERVICING is the greatest money-maker ever offered to the Radio and TV Engineer. It provides at instant call, any time, day or night, all the circuits and data you need for almost all the popular TV and Radio sets in use. It is the only complete library of servicing data and worth its weight in gold!

1954-1961 Popular Models—Over 4,400 Pages

TELEVISION · RADIO · RADIOGRAMS · CAR RADIOS
TAPE RECORDERS · RECORD REPRODUCERS

Servicing Data for all these makes—Ace, Alba, Ambassador, Argosy, Armstrong, Baird, Banner, Beethoven, Berec, Brayhead, B.S.R., Bush, Capitol, Champion, Channel, Collaro, Cossor, Cyldon, Dansette, Decca, Defiant, Dynatron, E.A.R., Eddystone, Ekco, Elizabethan, E.M.I., Emerson, English Electric, Ever Ready, Ferguson, Ferranti, Ford Motor Co., Garrard, G.E.C., Gramdeck, Grundig, H.M.V., Invicta, K-B, McCarthy, McMichael, Marconiphone, Masteradio, Motorola, Murphy, Pageant, Pam, Perdio, Peto Scott, Philco, Philips, Pilot, Portadyne, Portogram, Pye, Pye Telecommunications, Radiomobile, Rainbow, Raymond, Regentone, R.G.D., Robert's Radio, Sobell, Sound, Spencer-West, Stella, Strad, Ultra, Valradio, Vidor, Walter, Webcor.

Every purchaser is entitled to 2 years free postal advisory service



TEST IT ON
7 DAYS

**FREE
TRIAL**

ABSOLUTELY NO
OBLIGATION TO BUY

Make sure of seeing this great profit-maker in the quiet of your own home.

ACT TO-DAY

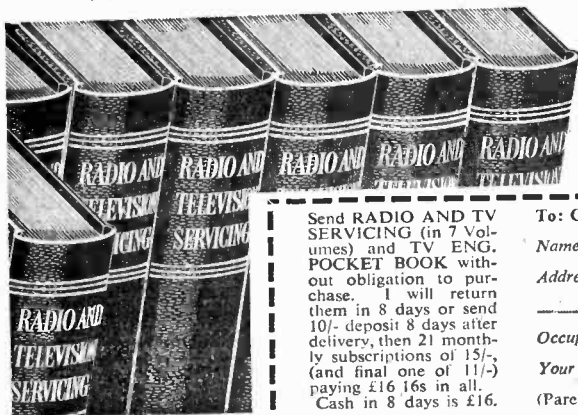

FREE! TELEVISION ENGINEERS' POCKET BOOK (Value 12/6)

This 272-page book is the perfect companion to your servicing set. Covers basic circuitry fault-finding, interference, alignment, valves, etc. Presented to you with Newnes RADIO & TV SERVICING.

Send RADIO AND TV SERVICING (in 7 Volumes) and TV ENG. POCKET BOOK without obligation to purchase. I will return them in 8 days or send 10/- deposit 8 days after delivery, then 21 monthly subscriptions of 15/- (and final one of 11/-) paying £16 16s in all. Cash in 8 days is £16.

To: George Newnes, Ltd., 15-17 Long Acre, London, W.C.2.

Name _____

Address _____

Occupation _____

Your Signature _____

(Parent signs if you are under 21)

Tick (✓) where applicable

HouseOWNER	<input type="checkbox"/>
Householder	<input type="checkbox"/>
Living with Parents	<input type="checkbox"/>
Lodging Address	<input type="checkbox"/>

RV3Y

COMPLETE V.H.F./A.M. RADIO FOR £12.10.0

(carr. paid)

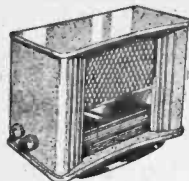

Brand new set in superb walnut cabinet (size 13 x 8 1/2 x 14 1/2 in. high). Covering 80-100 Mc/s. 16-49 M. and 200-500 M. Mains trans. 200-250 v. with 2 tapplings. Ferrite rod aerial for A.M. Controls: volume on/off, tone, tuning, w/change. Gram and ext. speaker position provided. Valves 12AT7, 12AH6, 6B6J, EABC80, 6BW6 and metal rectifier. Fully guaranteed. Today's Value £20.

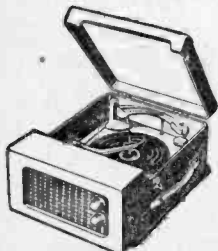
BUILD YOUR OWN RECORD PLAYER FOR £11.10.0

2v. amp 57/-; B.S.R. 4-sp. auto-change £6.10.0; case 17 x 15 x 8 1/2 in. 45/-; carr. 7/6 on any two items of the lot for £11.10.0—carr. paid. Assembled in 15 mins.

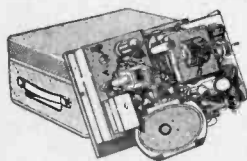
TAPE RECORDER FOR ONLY £17.17.0 (10/- carr.)

A QUALITY ARTICLE. Valves E280, ECC83, ECL82, DM70. Acos Crystal "mike". 850ft. Tape and extra spool. 3 1/2 in./sec. Mike and Radio inputs; Vol. on/off tone. Ext. L.S. and Monitor. Fast forward and reverse. Cannot be accidentally erased. Magic Eye Indicator. 6 x 4 1/2 in. Speaker Cabinet 14 1/2 x 7 in. Supplied completely built and in cabinet.

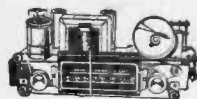

SELF-POWERED VHF TUNER CHASSIS. Covering 88-95 Mc/s. Mullard permeability Tuner, Dims. 10 1/2 x 4 1/2 x 5 1/2 in. high. ECC85, EF91, EF91 and 2 diodes. Metal Rectifier. Mains transformer. Fully wired and tested. Only £7.14.0 (carr. pd.). Room dipole 10/-; 300 ohm twin feeder, 6d. yd. Tuner without power pack £6.14.0 (carr. paid).

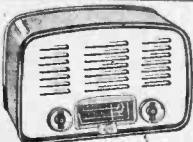

LISTEN WITHOUT INTERFERENCE Fully built V.H.F./F.M. Set for £8.12.0 (carr. pd.). Covers 88/95 Mc/sec. Wired, aligned and tested. Mullard permeability tuner and 4 valves (ECC85, ECL82 and two EF91), 2 diodes. Cheap room dipole. 10/-; 300 ohm twin feeder, or co-axial cable, 6d. yd.

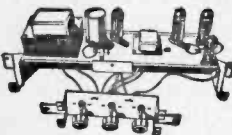
**PUSH-PULL AMPLIFIER £4.15.0**

(4/- Carr.)

Brand new 200-240 A.C. mains. Bass, treble and vol. controls. With valves E280, ECC83 and 2-EL84 giving full 8 w. Chassis 12 x 3 1/2 x 3 1/2 in. With o.p. trans. for 2-3 ohm speaker.

Front panel (normally screwed to chassis) may be removed and used as "flying panel".



3-VALVE AMPLIFIER (INC. RECT.). 4 watts. Valves ECC83, EL84 and E280. Controls, volume, bass and treble. On/off switch. (Chassis size 6 1/2 x 3 x 2 1/2 in.) 6 1/2 in. round or 7 x 4 in. elliptical speaker. Not suitable for microphone input. A.C. only. 67/- P. & P. 3/-

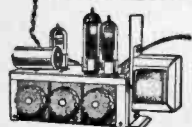

BEEBEE BATTERY RADIO IN MAKER'S CABINET. Valves DK96, DF96, DAF96, DL96. Two Short Wavebands 2.5 to 7 Mc/s and 6.5 to 17 Mc/s. Cabinet 12 x 7 1/2 x 6 in. ONLY £5 (2/6 p. & p.); MW and SW £5.4.0 (plus 2/6 p. & p.).

STEREO AMPLIFIER £4.15.0

(4/- p. & p.)

Brand new. 200-250 A.C. Tone and volume controls each channel. E280; ECC83; and 2-EL84; giving 2 x 4W. Size 12 x 3 1/2 x 3 1/2 in. O.P. Trans. for 2-3 speaker. Separate on/off switch to allow balancing to remain set.

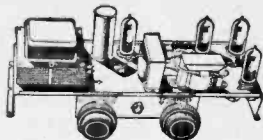
**IN TIME FOR CHRISTMAS**

A really elegant 6-transistor radio covered in sponge clean Duracoon fabric in latest two tone shades. M.W. and L.W., ferrite rod, provision for car aerial. 2-colour scale. With PP9 battery giving 300 hours use. Weighs under 4 lbs. With carrying handle. 12 x 7 1/2 in. high x 4 1/2 in. at base tapering to 2 1/2 in. at top. Brand new, fully guaranteed. £11.11.0. Carr. Paid. Worth 16s.

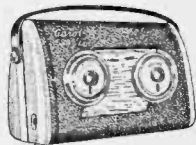

SAVE 10/-. Swiss made Unic Shaver operating from 1.5 v. battery usual price 59/6. Our price 50/- with battery. Takes U2 battery. Not a toy, but a shaver (carr. paid).

COLLARO STUDIO TAPE TRANSCRIPTOR. 3 MOTORS, 3 SPEED, 14. 3/4 and 7 1/2 L.P.S. Push buttons. £10.17.6 (10/- carr.) incl. spool.

SUPERIOR GRAMOPHONE AMPLIFIER 3 valves, 4 watt

13 1/2 x 7 in. (2 1/2 in. front to back). 3 front controls, bass, treble, vol./on-off, 6 in. circ. or 8 x 5 in. speaker; UY85, UF86 and UL84. Mains trans. 200-240ac; "gold" fret front. ONLY 70/- (p.p. 3/6).

NEW LOUDSPEAKER BARGAINS. Good Makes.

2-8 ohm. 13 x 8 1/2 in. 35/- (4/-); 7 x 4 in. 14/6 (2/-); 6 1/2 x 4 1/2 in. 12/6 (2/-); 10 x 6 in. 25/- (3/-); 5 in. 12/- (2/6); 4 in. tweeter 7/6 (2/-); 7 x 5 1/2 in. 17/6 (2/-); 9 x 6 in. 22/- (2/6). Postal charges bracketed.

MAINS OPERATED RADIO CHASSIS AND AMPLIFIER OF FAMOUS MANUFACTURE

Chassis 10 x 5 1/2 x 4 1/2 in. front to back. Valves: UBC41, UCH41, UF89, UL84 with metal rectifier. 5 in. speaker. Ferrite rod aerial. Tone, vol. and gram. position. Covers L. and M. waves. Limited quantity at only £8 (5/- carr.) complete with small dial. Unused and in working order.

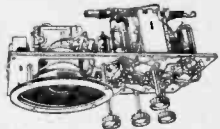
**UNREPEATABLE OFFER OF AM-FM CHASSIS AT ONLY £9.9.0 carr. pd.**

A small quantity of Printed Circuit chassis by famous manufacturer. Valves UY85, UCH81, UF89, UABC80, UL84 and UCC85. O.p. trans. for 2-3 ohm speaker. Chassis 14 x 7 x 7 1/2 in. Front controls concentric, left—Vol. and Tone; right—W/c and Tuning. "Gold" centre knobs provided. 2-dial bulbs. Sockets, AE; E; Ext. sp; P.U. Mains isolating transformer free. Covers Long, Med., VHF (87-101 Mc/s). Unused slightly tarnished, but not dirty; New Mullard Valves; not our manufacture, so no guarantee.

SPECIAL OFFER OF GOODMAN 10 x 6 in. SPEAKER high gauss. with doped cone specially suitable for high fidelity work. Price £7/6 (post 2/6).

B.S.R. "MONARDECK" TAPE DECK SINGLE SPEED. Our price only £7.2.6 (5/6 carr.). 850ft. first grade tape 5 1/2 in. plastic spool. 16/-, post 1/-.

BATTERY ELIMINATOR. For 4 Low Consumption Valves (500 range), 90 v. 15mA. and 1.4 v. 125 mA. 42/6 (2/6 post). 200-250 v. A.C. Size 5 1/2 x 3 1/2 x 2 1/2 in. Also for 250 mA, 1.4 v. and 90 v. 15 mA at same price.

AUTOMATIC RECORD CHANGERS. ALL 4-SPEED WITH TURN-OVER CRYSTAL CARTRIDGE (carr. 5/- extra). Latest UA14, £7.10.0. Collaro C.60 Studio model, plays any records. 7-12 in. only £7.15.0. Motor board 3/6. Both UA14 and C.60 fitted monoaural cartridge but wired for stereo.

BRAND NEW AM/FM (V.H.F.) RADIOGRAM CHASSIS AT £14 (Carriage Paid)

Tapped input 200-225 v. and 225-250 v. A.C. ONLY.
 Chassis size 15 x 6 1/2 x 5 1/2 in. high. New manufacture. 12 mths. guarantee.
 Dial 1 1/2 x 4 in. in black and gold.
 Pick-up. Extension Speaker. A.E., E., hd Dipole Sockets. Five "piano" push buttons—OFF L.W., M.W., F.M. and G.am. Aligned and tested. With all valves and O.P. Transformer. Tone Control Fitted.
 Covers 1,000—1,900 M.; 200-500 M.; 88-98 Mc/s.
 Valves E250 rect., ECC81, EF89, EABC80, EL84, ECC85.
 Speaker and Cabinet to fit chassis (table model), 47/6 (post 3/6).
 10 x 6 in. ELLIPTICAL SPEAKER. 20/-, to purchasers of this chassis.
TERMS:—Chassis) £5 down and 5 Monthly Payments of £2, or with Cabinet and Speaker £5.10.0 down and 6 Monthly Payments of £2. Cheap Room Dipole 10/- Feeder 6d. yard.

This chassis is an ideal partner for the radiogram cabinet appearing on this page

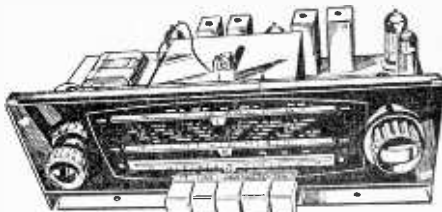

THE "CANTATA"

6-TRANSISTOR AND DIODE PORTABLE KIT

400mW push-pull output: Ferrite rod aerial; M.W. and L.W.; operates on two 4.5 v. cells: printed circuit, board size 8 1/2 x 2 1/2 in. with all holes drilled; booklet of full assembly and alignment instructions; all parts sold separately. Size 9 x 3 1/2 x 7 1/2 in. Mullard transistors. Car aerial socket. Write for list: 8 x 2 1/2 in. speaker. Price of £6.19.8 (post 3/6). Attractive Vynair cabinet 20/- extra. Batteries 5/6 extra. Alignment Service 17/- inc. post. Fully-built Set 10 gns. Carriage paid.

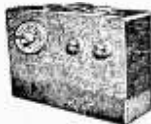

TAPE RECORDER AMPLIFIER KITS

- (a) For COLLARO STUDIO DECK, 11 gns.
 - (b) For B.S.R. MONAR-DECK Twin Track 8 gns.
- Printed circuit amplifiers are tested and assembled complete with valves. Full instructions. Leaflet available. Carriage paid.



SUPERB CONTEMPORARY CABINET

Fitted with 3 sliding doors providing room for Radio, Autochanger, 4 speakers, and record storage. Size 38 x 24 in. high (plus legs 8 in.) x 16 in. Polished walnut.



PRICE 15 Gns.

Free delivery in London area. 35/- carriage elsewhere.

THE "CABY" TEST METERS

Prices include Test Prods. Batteries, Instruction Book. Also measure dB. Accuracy: A.C., 3 per cent, D.C., 2 per cent.

A-10 £4.17.6 B-20 £6.10.0

A.10—2K ohms/v. on A.C. and D.C. volts (10, 50, 250, 500 and 1000 v.); 10K and 1M ohms; 1mA, 25 mA and 250 mA. D.C. Size, 5 1/2 x 3 1/2 x 1 1/2 in. Weight 17 oz.

B.20—10K ohms/v. on 0.5 v. and 2.5 v.; 4K ohms/v. on 10, 50, 250, 500 and 1000 v.; A.C. and D.C. Resistance, 2K, 200K, 2M and 20M ohms; D.C. current, 100 microA, 2.5 mA, 25 mA, 250 mA. Size 5 1/2 x 3 1/2 x 2 1/2 in. Weight 24 oz.



GRAMOPHONE AMPLIFIER

With 5in. SPEAKER. Baffle 12 1/2 x 6 in. E240 and EL41. Tone and Volume On/Off switch. Two Knobs. Ready to play. Useful for Stereo. ONLY 57/-, post 3/-.



MINIATURISED COMPONENTS FOR TRANSISTOR SET. 3 I.F. trans. 7/16in. sq. x 9/16in.; 2-range 165pF plus 65pF; 1 x 1 x 1 in.; input and output trans. each 9/16in. cube; osc. coil. THE LOT for 34/- (post 2/-).

TRANSISTORS, Top Grade. Two matched OC78: 1—OC78D; 1—OC44 (yellow); 2—OC45 (orange and blue). THE LOT of 6 for 37/6 (registered 1/- extra).

MAINS TRANSFORMERS—New, of course

- (A) Primary tapped 200-250 v. Output 275-0-275 v. at 200 mA; 6.3 v.; 6A and 5 v.; 3 A; 4 x 4 x 4 in. Drop thru' top shrouded type. Weight 10 lbs. 35/- (post 4/-).
- (B) Tapped primary 110 v.; 125 v.; 150 v.; 210 v. and 240 v. 250-0-250 out at 100 mA; 6.3 v.; 3 A; 6.3 v.; 1 A. 3 1/2 x 3 1/2 x 3 in. high. Drop thru' type top shrouded. Weight 4 1/2 lbs. Price 22/6 (post 3/-).

AERIALS

Combined B.B.C. (Single Dipole) and Band 3 I.T.A. (5-Element) Aerial, with chimney lashings and Stand-off Arm £3.15.0. I.T.A. (Band 3) Aerials, for clipping to existing mast of diameter 1in. to 2in. Alternatively with wall-fixing plate at same price; 3 element £1.2.0, 5 element £1.10.0, 8 element £2.10.0, 11 element £3.2.6. Chimney lashings and Stand-off Arm 20/- extra for each of above.

Loft Mounting I.T.A. Aerials, 3 element 20/-, 5 element 26/-, Larger aerials for I.T.A. and B.B.C. can be supplied to special order.

Double 6 Element I.T.A. Plus B.B.C. "H" Aerial with loft pole and double chimney lashings, £8.10.0.

All the above aerials are carriage paid.

An I.T.A. Table Top Aerial with amazing performance. The Wolsey Hi-Q at 19/6 (2/6 post). Good reception up to 20 miles. Cross-over unit in base with socket for B.B.C. aerial. Slightly tarnished at 12/6 (2/6 postage).

PERSPEX. 15 x 12 x 1 1/2 in., tinted blue/grey, 6/6; 12 1/2 x 9 1/2 x 1 1/2 in., Clear, 5/-; 16 x 14 x 3/16 in., Clear 7/6. Postage 2/- on 1; 3/- on 2 or more; 6 post paid.

Send 6d. (stamps will do) for 20 page illustrated catalogue. All New Goods. Delivered by return. Terms: One-third down and balance plus 12/6 in four equal monthly payments. Postage with down payment (C.O.D. 2/- extra). See Special Terms for A.M./F.M. Chassis plus 12/6 in four equal monthly payments. ALL ITEMS GUARANTEED 12 MONTHS—B.V.A. VALVES 3 MONTHS.

GLADSTONE RADIO "SCALA" CAMP ROAD, FARNBOROUGH, HANTS.

Farnborough 3371

Also at 247 New Road, Portsmouth, Hants, and 56 Stokes Croft, Bristol 1. Tel. 27809
 Farnborough closed Saturday, Portsmouth and Bristol closed Wednesday.
 Posted Orders to Farnborough Please.

PANEL OF 7 POTS. 10 x 1 1/2 in.—4 x 1M & 3 x 2M. 4/- (post 1/-).



6 DIFFERENT PRE-SET POTN. 2K to 500K, 3/- (post 1/3).

MAINS TRANSFORMER. 6.3v 11A and 200v. 30mA, 7/- (post 1/6).

RECTIFIERS

12 v. 3 1/2 amps, 9/8, RMI, 8/8, RM2, 8/-, RM3, 9/-, RM4, 15/6, RM5, 21/-, 14A86, 17/-, 14A97, 25/-, 14A100, 25/-, 18CR11-16-1 7/9, 18RA11-16-1, 7/9, 18RD2, 2-9-1, 14/-, 14RA1-2-8-2, 17/-, 14BA1-2-8-3, 20/-, Silicone Diodes, 150 v., 500 M.A., 8/-.

VIBRATORS

"Masteradio" 6 v. 5 Pin and 7 Pin, 8/8.

NEW CARTRIDGES

Power Point, 12/-, Accos, GP65, 3G, 22/6. Sonotone by Plessey, 17/-, 25 ASSORTED MIXED Electrolytic Condensers. Many popular sizes. List value approx. £5. Our price 10/- P. & P. 2/-.

AM/FM KIT

Goria, Tuning Head assembled, with 1 L.F. Transformer, A.M. and F.M. and discriminator Transformers. Complete Kit with ECOS5 valve. 49/6 P. & P. 1/6.

GET 15

Latest G.E.C. High Power, Contact Cooled, manufacturer's matched pair Transistors, with Push-on Input and Output Transistors and Amplifier Circuit. Knock-out price 29/- P. & P. 1/6.

SUPER STEREO KIT

Kit of ready built Units, comprising 2 Midset 3 watt Amplifiers, Push Button Switch, Transformer, Control Unit, (Bass, Treble and Vol.), Power Pack, One Speaker (Extra Speaker 7/6), Indicator Light, Valves and Instructions. 59/6 P. & P. 3/-.

PM SPEAKERS

3 ohms, top makes performance guaranteed; 8in. 8/-, 5in. 7 x, 11/-, 10in. 10 x 6 13/-.

Tubes

HIGHEST QUALITY—COMPARE OUR PRICES GUARANTEED Carr. & Ins. 12/6.

Table with columns for tube types (12in., 14in., 15/17in., 21in.), prices (£2-0-0, £3-5-0, £2-10-0, £3-15-0, £3-5-0, £4-10-0, £3-15-0, £5-15-0), and durations (6 Months, 12 Months). Includes 'NEW TYPES' like MW 31/74, MW 36/24, CRM 172, MW 43/64, £6-0-0.

TRANSISTORS

White Spot, 3/8, Red Spot, 3/-, Yellow Spot, 2/6. Diodes General Purpose, Famous make 9d. each 8/- doz.

EX-TAT

Antiference Aerials, 12ft. Whip Aerial, Screened Down Leads, Matched Transformers, Mounting Clips etc. Amazing Value 29/- P. & P. 5/-.

METERS

0-25 amp, 9/-, 0-300 mAamps, 12/8, 0-500 M.A., 12/8, 0-30 M.A., 12/6, 0-1 M.A. 25/-, 0-50 microamps, 45/-.

4-SPD. RECORD PLAYERS

Latest B.S.R. TUB Turntable, together with lightweight 84 Grams dual sapphire crystal turnover pick-up head. Truly amazing value at £3.10.0 Carr. 3/-.

100 RESISTORS 6/6

100 CONDENSERS 10/-

Miniature Ceramic and Silver Mica Condensers, 3pF to 5,500 pF. List VALUE OVER £25.

CO-AX

standard and low loss, 25 yds., 12/6, 50 yds., 22/8, 100 yds., 42/6. Co-ax. Plugs 1/3. Wall outlet boxes 8/6.

UNIVERSAL VOLT OHM MULTIMETER

Reads A.C. and D.C. volts to 1000, 5 ranges at 1000 ohms per volt resistance reading to 200K in 2 ranges. Complete with prods. 58/6, P. & P. 1/6.

EY5 SHORT 4/6 U25 SHORT 8/-

TEST SETS TYPE 74A

A service scope easily convertible for standard use, 200/250 v.a.c., all valves, E.C.R.30. tube, excellent case worth £10. Our Price £4.10.0

COMPLETE RECORD PLAYERS

B.S.R. UA8, 4 Speed Autochanger ... £8 15 0 B.S.R. UA14, 4 Speed Autochanger ... £7 19 0 B.S.R. UA20, Autochanger ... £8 19 0 Garrard 209/210 ... £8 19 0 EMI 4 Speed single Player ... £4 12 0 P. & P. on above 4/-.

LOUDSPEAKERS

TOP MAKES—MANUFACTURER FRESH

3in. 18/-; 5in. 18/-; 8in. 18/-; 10in. 18/-; 7 x 4in. elliptical 18/-; 9 x 6in. elliptical 22/6; 10 x 6in. elliptical 25/6; 5 x 15in. speakers 28/6.

MAINS AMPLIFIERS

3 valves (10F3, 10P14, U9P), 3 watt, 8in. loudspeaker, in two tone cases with controls. Ideal for record players. 19/6 P.P. 6/-.

AUDIOTAPE

3in. Plastic 150 ft., 8/-, 4in. 300 ft., 10/6, 5in. 600 ft., 18/-, 5 1/2in. 650 ft., 24/6, 7in. 1200 ft., 30/-.

★ VALVES BY RETURN OF POST ★ THE MOST COMPREHENSIVE COMPETITIVE VALVE LIST IN THE COUNTRY

10% DISCOUNT SPECIAL OFFER TO PURCHASERS OF our SIX VALVES marked in black type (18% in dozen). Post: 1 valve, 6d., 2-11, 1/-.

NEW LOW PRICES GUARANTEED 3 MONTHS

FREE TRANSIT INSURANCE. All valves are new or of fully guaranteed ex-Government or ex-equipment origin. Satisfaction or Money back Guarantee on goods if returned unused within 14 days.

Large table listing various vacuum tube types (e.g., 0Z4, 1A95GT, 1A7GT, 10CGT, 1D5, 1D6, 1B5GT, 1L4, 1L5, 1L6, 1N5GT, 1B3, 1B4, 1B5, 1T4, 2A3, 2D21, 2A4, 2A5, 8D6, 3Q4, 3Q5GT, 3S1, 6V4, 6R4G, 6T1, 5Y4G, 5Y5G, 5Y3GT, 5Y1Q, 5Z3, 5Z4, 5Z4G, 5Z4GT, 6A6, 6A7, 6A8G, 6AGT, 6B8) and their prices in various columns.

Post: 2 lbs. 1/6, 4 lbs. 2/-, 7 lbs. 2/9, 15 lbs. 3/6, etc. No C.O.D.

TECHNICAL TRADING CO. ALL ITEMS 5% & POST FREE IN DOZENS (Callers always welcome) LIST OF 1000 SNIPS 6d. P.O. BOX (21) W 350-352 FRATTON ROAD, PORTSMOUTH.

STERN'S MULLARD DESIGNS

Designed by MULLARD—presented by STERN'S strictly to specification

COMPLETE KIT OF PARTS

MULLARD "5-10" MAIN AMPLIFIER

For use with the MULLARD 2-valve pre-amplifier with which undistorted power output of up to 10 watts is obtained. We supply SPECIFIED COMPONENTS AND NEW MULLARD VALVES, including PARMEKO MAINS TRANSFORMER and choice of the latest Ultra-Linear PARMEKO or the PARTRIDGE Output Transformer. COMPLETE KIT OF PARTS (PARMEKO Output Trans.) **£10.00** Alternatively we supply ASSEMBLED AND TESTED. **£11.00** INCORPORATING PARTRIDGE OUTPUT TRANSFORMER. **£1.60** EXTRA.

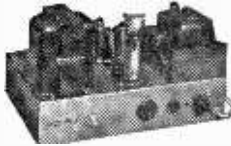

MULLARD'S PRE-AMPLIFIER TONE CONTROL UNIT

Employing two EF86 valves, and designed to operate with the MULLARD MAIN AMPLIFIERS, but also perfectly suitable for other makes. PRICE COMPLETE **£6.60** ASSEMBLED AND TESTED **£8.00**



Supplied strictly to MULLARD'S SPECIFICATION and incorporating:
 ● Equalisation for the latest R.I.A.A. characteristics.
 ● Input for Crystal Pick-ups, and variable reluctance magnetic types.
 ● Input (a) Direct from High Imp. Tape Head. (b) From a Tape Amplifier or Pre-amplifier.
 ● Sensitive Microphone Channel. ● Wide range BASS and TREBLE Controls.

COMPLETE MULLARD "5-10" AMPLIFIER

The popular and very successful complete "5-10" Incorporating Control Unit providing up to 10 watts high quality reproduction. Only Specified Components and new MULLARD VALVES are supplied including PARMEKO MAINS TRANSFORMERS and choice of the latest PARMEKO or PARTRIDGE ULTRA-Linear Output Transformers.

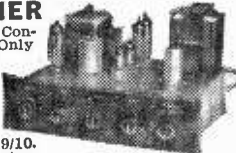

KIT OF PARTS **£11.10.0** OR ASSEMBLED AND TESTED **£13.10.0**
 H.P. (Assembled Amp. only). DEPOSIT **£2.14.0** 12 months at 19/10. ABOVE INCORPORATING PARTRIDGE OUTPUT TRANS. **£1.6.** extra.

COMPLETE MULLARD "3-3"

THE IDEAL AMPLIFIER FOR A SMALL HIGH QUALITY INSTALLATION PROVIDING EXCELLENT REPRODUCTION OF UP TO 3 WATTS OUTPUT. COMPLETE KIT OF PARTS **£7.10.0** OR ASSEMBLED AND TESTED **£8.19.6** (Plus 9/6 carriage and insurance) H.P. Terms: Deposit **£2.0.0** and 8 Months at **£1.0.0**. Complete to MULLARD'S SPECIFICATION including Mullard valves and a PARMEKO OUTPUT TRANSFORMER.



STERN'S INTER-COMM BABY ALARM

A small versatile Unit employing the new MULLARD ECL26 valve and designed to provide two (or three) way conversation up to extreme distances. Operates from A.C. mains 200 to 250 Volts.



PRICES . . . MASTER UNIT and ONE EXTENSION

KIT OF PARTS **£6.17.6** ASSEMBLED AND TESTED **£8.0.0**
 Consists of a MASTER UNIT, size only 8 1/2 x 5 1/2 x 6 in. and ONE EXTENSION (a second extension may be added to any time). The Master Unit incorporates switching and power supply and with the chassis completely isolated from the mains is operated in absolute safety. Cases covered in quality leatherette.

A BULK PURCHASE OF MARCONIPHONE TAPE RECORDING EQUIPMENT ENABLES US TO OFFER The Model MTR/1 PORTABLE TAPE RECORDER FOR ONLY £25.0.0 (Carr. & Ins. 10/- extra)



Deposit **£5.0.0**, 12 months of **£1.16.8** The list price of the MTR/1 is **£44/2/0**. It is a 3-Speed Twin Track Recorder incorporating the latest Collaro "Studio" Tape Deck and operates at 1 1/2, 3 and 7 1/2 in./sec. Speeds. It incorporates a "Pause" Control, a safety interlock device which ensures that a recorded tape cannot be accidentally erased and a low level output socket so that the output may be fed into an external high fidelity amplifier for monitoring purposes or for high quality reproduction on playback.

COMBINED ORDER PRICE REDUCTIONS

- (a) The KIT OF PARTS to build both the "5-10" Main Amplifier and the 2-valve PRE-AMP CON- TROL UNIT..... **£15.15.0**
- (b) The "5-10" and the 2-stage PRE-AMP both ASSEMBLED and TESTED H.P. Dep. **£3.16.0** and 12 months of **£1.7.8**..... **£18.18.0**

RECORD PLAYERS

- The Latest Models are in stock, many at reduced prices. Send S.A.E. For Illustrated Leaflet.
- COLLARO "JUNIOR" 4 SPEED SINGLE RECORD PLAY-ER with separate Crystal Pick-up, Carriage and Insurance 5/- Above Pick-up separately for **£1.6.8**
- THE NEW COLLARO MODEL RP54 4-speed Single Record Player, Studio Cartridge. **£9.18.9**
- THE NEW COLLARO C60 4-speed Autochanger unit with Studio "O" Pick-up..... **£7.19.6**
- The E.M.I. 4-speed Single Record Player with crystal Pick-up..... **£6.9.6**
- B.S.R. MODEL UA14. A 4-speed mixer Autochanger with Crystal Pick-up..... **£7.10.0**
- Available incorporating the B.S.R. STEREO Pick-up, plays L.P. and 78 Records. **£8.13.10**
- GARRARD MODEL TA/MKH 4-speed Player with high output Crystal Pick-up..... **£8.10.0**
- GARRARD MODEL RC210. Autochanger, 4-speeds, High output, Crystal Pick-up..... **£10.10.0**
- Carriage and Insurance on each above 5/- extra.

SPECIAL CASH OFFER

This very attractive PORTABLE AMPLIFIER CASE together with a good quality GRAM AMPLIFIER and a matched P.M. SPEAKER. ALL for ONLY **£8.7.6** (Plus 7/6 Carr. & Ins.)



The Amplifier consists of a 2-stage design incorporating 3 modern B.V.A. valves and has separate BASS and TREBLE CONTROLS. The Portable Case will also accommodate almost any make of Autochanger and is attractively finished in Mustroom Grey Rexine. WE ALSO SUPPLY SEPARATELY—
 (a) The 2-stage (plus Rectifier) AMPLIFIER **£4.2.6**
 (b) THE PORTABLE CARRYING CASE **£3.17.6**
 (c) 6 in. P.M. SPEAKER 18/9 Carriage and Insurance 4/- extra.

MULLARD FOUR CHANNEL MIXER UNIT

Self powered with Cathode follower output. Incorporates Two inputs for MICROPHONES and One for CRYSTAL PICK UP and a fourth for RADIO or TAPE Complete Kit of Parts **£8.8.0** Assembled and Tested **£10.0.0** TERMS: Deposit **£2** and 12 months at 15/-
 MODEL I.L. one microphone Input matched for moving coil or Ribbon Mtko. **£1.17.0** extra.



WE CAN ALSO SUPPLY The MTR/1 Amplifier and Loudspeaker

With the COLLARO "STUDIO" TAPE DECK all assembled on a top board. TESTED AND READY FOR USE. (Carr. & Ins. 10/- extra). Deposit **£4.0.0**, 12 months **£1.9.4**. **£19.19.0**

STERN RADIO LTD.

Dept. P.W. 109 FLEET ST., LONDON, E.C.4
 Telephone: FLEET STREET 5812/3/4



Stern's "fidelity" TAPE RECORDERS

For truly "Hi-Fi" Recordings

MODEL CR3/S Incorporates the COLLARO "STUDIO" TWIN TRACK 3-speed Deck, operating at 14in., 3in. and 7in. speeds **£39.10.0**
H.P. Terms: Deposit £7.18.0 and 12 months of £2.17.11.

MODEL TR3/Mk.VI Incorporates the New TRUVOX Mk. VI TWIN TRACK 2-speed Tape Deck operating at 3in. and 7in. speeds **£44.0.0**
H.P. Terms: Deposit £8.16.0 and 12 months of £3.4.7

The MODEL HF/G2R PORTABLE TAPE RECORDER
(Original Price £33.0.0)
FOR ONLY 22 gns

H.P. Dep. £4.14.0. 12 months £1.13.9. (Carr. and Ins. 10/- extra). Incorporates THE LATEST GARRARD "MAGAZINE" TAPE DECK and a HIGH QUALITY AMPLIFIER which is entirely based on the very successful MULLARD TYPE "A" DESIGN and specifically developed to operate the GARRARD DECK. Price INCLUDES SUPPLY OF THE GARRARD TAPE MAGAZINE and 4in. SPOOL OF DOUBLE PLAY TAPE. Comprises a Twin Track Recorder operating at 3in./sec. speed and providing up to 1 hour 10 mins. playing time. Truly "Portable", weighs only 22 lbs. Outstanding features are excellent performance and simplicity of operation.

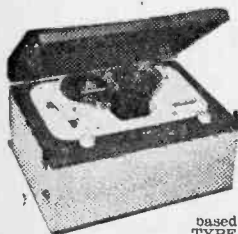

developed to operate the GARRARD DECK. Price INCLUDES SUPPLY OF THE GARRARD TAPE MAGAZINE and 4in. SPOOL OF DOUBLE PLAY TAPE. Comprises a Twin Track Recorder operating at 3in./sec. speed and providing up to 1 hour 10 mins. playing time. Truly "Portable", weighs only 22 lbs. Outstanding features are excellent performance and simplicity of operation.

ADD "HI-FI" TAPE RECORDING TO YOUR EXISTING AUDIO INSTALLATION WITH

MULLARD TYPE "C" TAPE PREAMPLIFIER—ERASE UNIT



The "HI-FI" link to add full tape recording facilities to High Fidelity home installations. Incorporates FEROCUBE POT CORE PUSH PULL OSCILLATOR and 3-speed treble equalisation CORE INDUCTOR FOR WEARITE-COLLARO-TRUVOX OR BRENELL TAPE DECKS. Includes separate power supply unit. OR ASSEMBLED KIT OF **£14.0.0** H.P. £3.8.0 deposit and **£17.0.0** 12 months £1.4.11 (Including power unit £11.15.0 and £14.10.0 respectively).

"SPECIAL COMBINED ORDER" PRICES

- (a) The COLLARO "Studio" Deck with the Model "C" Preamplifier and POWER SUPPLY UNIT ASSEMBLED AND TESTED **£29.10.0**
Deposit £5.18.0. 12 monthly payments of £2.3.3
- (b) As above but the TYPE "C" Unit and POWER UNIT supplied as COMPLETE KIT OF PARTS. **£26.10.0**
Deposit £5.6.0. 12 monthly payments of £1.18.10
- (c) The TRUVOX MkVI Deck (Incorporating Pause Control and Rev. Counter) with the Model "C" PREAMPLIFIER and POWER UNIT ASSEMBLED AND TESTED. **£35.0.0**
Deposit £7.0.0 and 12 months at £2.11.4
- (d) As above but the Model "C" PREAMPLIFIER and POWER UNIT supplied as a COMPLETE KIT OF PARTS **£31.10.0**
Deposit £6.8.0. 12 monthly payments of £2.8.2
- (e) The BRENELL MkV Deck with the Model "C" PREAMPLIFIER and POWER UNIT ASSEMBLED AND TESTED **£46.0.0**
Deposit £9.4.0 and 12 months at £3.7.6
- (f) As above but the Model "C" PREAMPLIFIER and POWER UNIT supplied as a COMPLETE KIT OF PARTS **£43.0.0**
Deposit £8.12.0. 12 monthly payments of £3.3.1
- (g) THE WEARITE MODEL "4" DECK with ASSEMBLED and TESTED Model "C" PREAMPLIFIER and POWER UNIT incorporating WEARITE HEADLIFT TRANSFORMER, Etc. **£56.0.0**
Deposit £11.4.0 and 12 months at £4.2.1
(Carriage and Insurance on above is 10/- extra).

HF/TR3 MK.II TAPE AMPLIFIER

(Mullard Type "A" design) A very high quality Amplifier incorporating 3-speed treble equalisation, by the latest FEROCUBE POT CORE INDUCTOR, FOR COLLARO-TRUVOX-BRENELL WEARITE Tape Decks, has GILSEN Output Transformer. Includes separate Power Supply Unit.



There are no better value-for-money Tape Recorders on the market—if you can't call and hear them send S.A.E. for fully descriptive leaflet.

EACH MODEL INCORPORATES THE MODEL HF/TR3 Mk.II TAPE AMPLIFIER (Described below)

Each price quoted provide for the COMPLETE RECORDER including CRYSTAL MICROPHONE and 1,200ft. Spool of Tape.



THE "ADD-A-DECK"

Incorporating GARRARD "MAGAZINE" TAPE and the MATCHED MODEL HF/G2R PREAMPLIFIER Supplied on ONE CHASSIS (as illustrated) READY FOR USE **18 Gns.** (Carr. & Ins. 10/- extra).

Price includes Garrard Magazine and a 4in. Spool Double Play Tape H.P. Deposit £3.16.0, and 12 months of £1.7.8. Provides complete tape recording facilities and designed to operate through the pick-up sockets of the standard type of RADIO RECEIVER, or an AMPLIFIER, from which really first class reproduction is obtained. It consists of a Twin Track Deck connected to the Pre-amplifier and operates at 3in./sec. speed providing up to 1 hr. 10 mins. playing time.

BUILD A HIGH FIDELITY TAPE RECORDER

← LIKE THIS for £35.0.0



Deposit £7.0.0. 12 months at £2.11.4.

FOR THIS WE SUPPLY

- Complete Kit of Parts to Build the HF/TR3 Tape Amplifier.
- The New Collaro "Studio" Tape Deck.
- Portable Carrying Case (as illustrated).
- Roia/Celestion 10 x 8in. p.m. Loudspeaker

• ACOS Crystal Microphone and 1,200ft. Spool E.M.I. Tape. Alternatively for those who prefer another make of Tape Deck—we will supply precisely as above—but in place of the Collaro "Studio" Deck. We will include: **£40.10.0**
The Truvox Mk.VI Deck
Deposit £3.2.0, 12 months at £2.19.5

- For Constructors with their own cabinet—WE OFFER—
- (a) COMPLETE KIT to build the HF/TR3 Amplifier together with the COLLARO "STUDIO" DECK **£26.0.0**
Deposit £5.4.0. 12 monthly payments of £1.18.2
 - (b) As above but with the HF/TR3 supplied ASSEMBLED AND TESTED. **£29.10.0**
Deposit £5.18.0. 12 monthly payments of £2.3.4
 - (c) COMPLETE KIT to build the HF/TR3 together with the TRUVOX Mk. VI TAPE DECK **£31.10.0**
Deposit £6.6.0. 12 monthly payments of £2.6.2
 - (d) As above but with HF/TR3 supplied ASSEMBLED and TESTED **£35.0.0**
Deposit £7.0.0. 12 monthly payments of £2.11.4
 - (e) COMPLETE KIT to build the HF/TR3 AMPLIFIER with the BRENELL Mk.V. TAPE DECK **£42.0.0**
Deposit £8.8.0. 12 monthly payments of £3.1.7
 - (f) As above but with HF/TR3 supplied ASSEMBLED AND TESTED. **£45.10.0**
Deposit £9.2.0. 12 monthly payments of £3.6.9
 - (g) THE ASSEMBLED and TESTED HF/TR3 AMPLIFIER with the WEARITE MODEL 4A DECK, incorporates Wearite Head Lift Transformer etc. Deposit £11.4.0. 12 monthly payments of £4.2.1
(Carriage and Insurance on each above is 10/- extra) **£56.0.0**

KIT OF PARTS **£13.13.0** H.P. Deposit. £3.8.0 and OR 12 months at £1.4.11. ASSEMBLED **£17**

STERN RADIO LTD.

Stereophonic Sound by Stern's

THE "STP-1" STEREO TAPE PREAMPLIFIER DESIGNED TO OPERATE WITH

- TRUVOX MKVI TAPE DECK incorporating the latest 4-TRACK MINI-FLUX TAPE HEADS.
- PUSH PULL OSCILLATOR CIRCUIT
- 4-SPEED EQUALISATION
- FERROXUBE OSCILLATOR TRANSFORMER
- SENSITIVE METER FOR SIGNAL LEVEL
- SEPARATE GAIN CONTROLS IN EACH CHANNEL
- MULLARD VALVES INCORPORATED

- BRENELL MKV TAPE DECK incorporating similar 4-TRACK MINI-FLUX TAPE HEADS.

- COLLARO "STUDIO" TAPE DECK incorporating the latest 4-TRACK REUTER TAPE HEADS.

OVERALL SIZE CASE 13 1/2 x 3 1/2. FRONT PANEL (Choice of Black or White) 14 x 3 1/2.

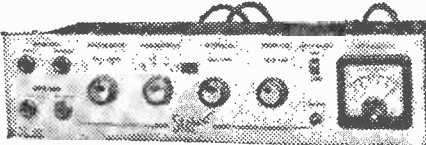

PRICE
£26.0.0

Including separate Power Supply Unit.
Deposit £5.4.0, 12 months £11.18.2.

COMBINED PRICE SCHEDULE

- THE "STP-1" PREAMPLIFIER is offered WITH TAPE DECKS AS FOLLOWS:**
- TRUVOX MKVI 4-TRACK MODEL..... **£45.0.0**
Deposit £9.0.0, 12 months £3.6.0.
 - BRENELL MKV 4-TRACK MODEL..... **£65.0.0**
Deposit £13.0.0, 12 months £4.15.4.
 - COLLARO "STUDIO" 4-TRACK MODEL..... **£41.10.0**
Deposit £8.6.0, 12 months £3.0.11.

THE MULLARD "10+10" STEREO AMPLIFIER

(described below) with the "STP-1" PREAMPLIFIER and one of the TAPE DECKS provide a COMPLETE STEREPHONIC INSTALLATION. WE OFFER

- 10+10" AMPLIFIER, "STP-1" PREAMPLIFIER and the TRUVOX MK VI DECK..... **£65.0.0**
Deposit £13.0.0, 12 months £4.15.4.
- As above with BRENELL MK. V DECK..... **£85.0.0**
Deposit £17.0.0, 12 months £6.4.8.
- As above with COLLARO "STUDIO" DECK..... **£61.10.0**
Deposit £12.6.0, 12 months £4.10.2.

Please enclose S.A.E. with all enquiries.

STEREPHONIC RECORD PLAYER UNITS MICROPHONES & TWIN LOUDSPEAKERS ARE AVAILABLE FROM STOCK

MULLARD'S "10 PLUS 10" STEREO POWER AMPLIFIER

A high fidelity design based on the famous Mullard "5+10". Provides up to 10 watts (per channel) Superb reproduction. Frequency response flat to within 3 db from 0.5. To 60 Kcs at 50 Mw. Total Harmonic Distortion at 10 watts 0.1%.



PRICE:
£21.0.0

- (a) ASSEMBLED COMPLETE AMPLIFIER, including CONTROL UNIT (as Illustrated)..... **£18.10.0**
Deposit £4.4.0, 12 months of £1.10.10.

(b) A complete KIT of PARTS for..... **£18.10.0**
Built to the very highest technical standards and presented strictly to MULLARD'S specification. Incorporates complete Mullard valve line-up including two of the new valves, type ECL86, in each channel. Two specially designed GILSON OUTPUT TRANSFORMERS with 20% taps are used for ultra linear operation.

The matching CONTROL UNIT is designed to be either attached to the Amplifier (as Illustrated) or can be detached for separate mounting on a Cabinet panel. Provides inputs for CRYSTAL PICK UPS, RADIO TUNING UNIT, and also for reamplifying from our STEREO TAPE PREAMPLIFIER (Briefly mentioned opposite).

- AS AUDIO SPECIALISTS WE CONFIDENTLY RECOMMEND THIS DESIGN it is a MUST to the serious minded sound enthusiast. We can also supply the assembled MAIN AMPLIFIER only (excludes control unit) for operation with our DUAL CHANNEL PREAMPLIFIER, this provides for a more versatile or elaborate installation and would be essential if a low output Magnetic Pick Up, such as the Decca, is to be used.

- (a) THE ASSEMBLED MAIN AMPLIFIER with the ASSEMBLED DUAL CHANNEL PREAMPLIFIER **PRICE: £30.0.0**
Deposit £6.0.0, 12 months of £2.4.0.

- (b) A complete KIT of PARTS for both Units will be available in October for..... **£26.0.0**

!! A BARGAIN !! We are able to offer BRAND NEW and FULLY GUARANTEED—TRUVOX MK. VI TAPE DECKS. **£18.18.0**

List Price £26.5.0 for..... (Carr. & Ins. 7/6 extra)

Deposit £3.16.0 and 12 months at £1.7.8.

A twin track model operating on 31 and 7 1/2 in./sec. speeds and incorporating pause Control and Rev. Counter. THE ABOVE INCORPORATING THE LATEST 4-TRACK MINI-FLUX TAPE HEADS FOR STEREO OPERATION IS AVAILABLE FOR..... **£21.10.0** (Carr. & Ins. 7/6 extra). Deposit £4.6.0, 12 months of £1.11.7.

DUAL CHANNEL PREAMPLIFIER

Incorporates two Mullard 2-valve Pre-Amplifiers combined into a Single unit enabling it to be used for both STEREPHONIC or MONAURAL operation. It is designed primarily to operate with our range of MULLARD MAIN AMPLIFIERS but will also operate equally well with any make of Amplifiers requiring an input of 250 mvolts. COMPLETE KIT **£12.10.0** OF PARTS H.P. £3 Dep. and 12 mths. at £1.2.0



ASSEMBLED AND TESTED **£15.0.0**

STEREO "TWIN THREE" AMPLIFIER with specially designed PORTABLE CASE

A most compact portable design consisting of TWIN CHANNEL AMPLIFIER based on the latest design by MULLARD LTD., incorporating top grade Output Transformers, and the new audio Triode-Pentode Valves Mullard E.C.L.86. Separate Bass and Treble controls. Suitable for use with Crystal Pick Ups, and capable of genuine high quality reproduction up to 3 Watts per channel. An attractive and contemporary portable Case in two tone colours. The unique feature of the design is the loudspeaker mounting. Two 8 x 5 in. p.m. elliptical loudspeakers are separately baffled and mounted in the lid, which is detachable, allowing for each speaker to be individually positioned. A very versatile stereo arrangement tested and guaranteed which can be assembled in the minimum of time.



PRICE for the ASSEMBLED AMPLIFIER, Two 8 x 5 in. ROLA SPEAKERS and PORTABLE CASE **£14.0.0**
Deposit £2.16.0, 12 months of £1.0.6.

ASSEMBLED AMPLIFIER supplied for..... **£7.15.0**

8 x 5 in. ROLA LOUDSPEAKERS (3 ohms) each. **£1.1.0**

PORTABLE CASE..... **£5.0.0**

A CHOICE OF SINGLE RECORD PLAYERS and AUTOCHANGERS is available from Stock (Send S.A.E. for details)

Dept. P.W. **109 FLEET ST., LONDON, E.C.4**
Telephone: **FLEET STREET 5812/3/4**

Illustrated and Descriptive Brochures available. Please enclose S.A.E.

Transistorised Stethoscope

Trace signal right through; Radio, T.V., Tape amplifier, Hi-Fi, etc.—simplest way to fault-find—carry it like a fountain pen—all parts including transistor barrel crystal, everything except battery, 12/6 plus 1/6, data included or separately 1/6. Or complete with deal aid type earphone, 20/-.



Speaker Bargain

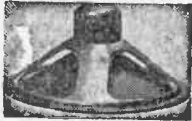

12in. Hi-fidelity loudspeaker. High flux, permanent magnet type with standard 3 ohm speech coil. Will handle up to 12 watts. Brand new by famous maker. Price 32/6, plus 3/6 post and insurance.

Hi-Fi Snip Infinite Wall Baffle

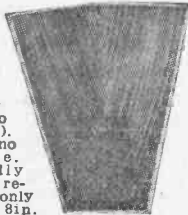

Nicely veneered and polished. Corner fitting (attaches to picture rail). Takes up no floor space. Gives really fantastic results with only low-priced 8in. speaker fitted for tweeter. Only 45/- each, carriage and insurance 3/6.

Smallest Possible 2-gang

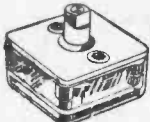

With built in trimmers, polystyrene cased, size only 1 1/4 x 7/16in., price 17/6. Smallest IF and oscillator to match, 21/-, P.P. input and P.P. output transformers, 12/6. Circuit diagram free with any of above.

Building A Scope?

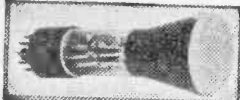

3in. oscilloscope tube. American made type No. 3P7, 6.3 v. 0.6 amp heater, electrostatic deflection, brand new and guaranteed with circuit diagram of scope, 15/- each, plus 1/6 post and insurance.

Transistor Set Cabinet

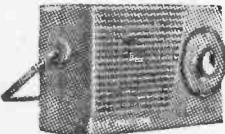

Very modern cream cabinet, size 5 1/2 x 3 x 1 1/2in. with chrome handle, tuning knob and scale. Price 7/6, plus 1/6 postage and packing.

BATTERY CHARGER BARGAIN

Components Would Cost More Car Battery Charger—ready-made high output battery charger in stove enamelled sheet steel louvered case. New, complete and ready to work. Rated at 12 v. 5 amps. and variable rate selector for trickle charging, also a meter to show charging rate. Suitable for 230/250 A.C. mains. Special snip price of 65/-, plus 3/6 post and ins.



MOTOR SNIP

Miniature motor 2 1/2in. long x 1 1/2in. diameter, laminated poles and armature, separate winding for reversing. Operates off 20-30 v. D.C. or off A.C. mains through stepdown transformer. Original cost at least £3 each. Snip price for one month only 8/6, plus 1/6 postage and insurance.



PRACTICAL WIRELESS "TUTOR"

Stage 1 all components except headphones..	20/-
Stage 2 all components	15/-
Stage 3 all components	19/-
Stage 4 all components	9/-
Headphones, high resistance	15/-

PRECISION MULTI-METER at amazing price!

MODEL 20011. 20,000 ohms per volt! Volt-ohm-Milliammeter



Ranges: A.C. Voltage: 10, 50, 100, 500 and 1000 volts (10,000 ohms per volt). D.C. Voltage: 5-25, 50, 250, 500, and 2.5k. (20,000 ohms per volt). D.C. Current: 0-50 microamps, 0-25 mA, 0-250 mA. Resistance: 0-6k, 0-6 meg. (300 ohm and 30k at centre scale). Capacitance: 10 pF to 001 mfd, .001 mfd. to 1 mfd Decibels: -20 to +22 dB.

A fully guaranteed pocket size meter (actual size: 4 1/2 x 3 1/2 in.) knife edge pointer, top quality supplied complete with test prods and full operating instructions at £8.19.6 ONLY. Plus 2/6 P. & P. Optional extra, attractive carrying case 13/6 only.

ALSO AVAILABLE MODEL TE.10. 10,000 O.P.V. at £5.19.6.

FLUORESCENT LIGHT BARGAIN

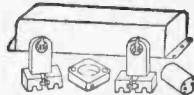

Kit of Parts comprising: choke, two lamp holders, starter holder and starter, 40 watt, 19/6; 80 watt, 23/6. Plus 2/- post and insurance.

INFRA-RED HEATERS

Make up one of these latest type heaters ideal for bathroom, kitchen, bedroom, etc. They are simple to make from our easy to follow instructions—uses silica enclosed elements designed for the correct infra-red wavelength (3 microns). Price for 750 watt element and instructions 15/6, plus 2/6 post and insurance.



THIS MONTH'S SNIP

LIMITED QUANTITY ONLY!

Waterproof heater wire. 16 yds. length. 70 watts. Self regulating temperature control. 10/-, Post Free.

Miniature Earphones

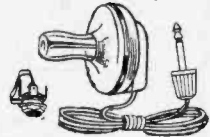

For Transistor Circuits or Deaf Aid! Very lightweight and easy to wear, cord almost invisible, good quality production of music and voice, complete with miniature plug and socket, ready to use—correct impedance OK for red spot and similar transistors. Crystal and Magnetic, 9/-, Post and insurance 1/-.

Jack Plug and Socket

Miniature type, 3/6.

Morganite Potentiometers

Single and 2-gang types available, standard size with good length spindle, all new and boxed. Single types, 1/- each, values available: 5K, 10K, 25K, 50K, 100K, 250K, 1 meg., 2 meg. Gang type 3/- each—values available: 5K ± 5K, 100K ± 100K ± meg. ± 1 meg. 2 meg. ± 2 meg.

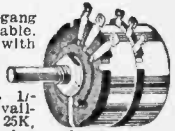

Fluorescent Lighting

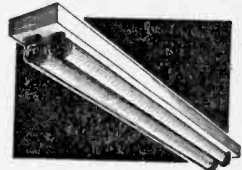

Complete lighting fittings. Built-in ballast and starters—stove enamelled white and ready to work. Ideal for kitchen, workshop—anywhere. Twin 20 approximately 27in. long complete with two 20W tubes, 49/6. Single 40 approximately 41t. long complete with one 40W tube, 39/6. Inductor 80 approximately 5ft. long complete with one 80W tube, 49/6. Carriage and insurance up to 150 miles 7/6, up to 250 miles 8/6. 21in. Miniature complete with 13 watt tube. Ideal for showcase or position where miniature fitting is required. Complete with latest 1in. diameter tube. 49/6 each. Circular. Complete with 40 watt tube, £4.19.6. Carriage and ins. 7/6 any type.

"Dim and Full" Switch

Particularly useful for controlling photofood lamps which have only a short life at full brilliance. This switch has three positions; the first position puts two lamps in series at half brilliance for setting up, the second position is off and the third position full brilliance for the operation shots. Also useful for controlling night lights, heaters, etc. etc. Price 3/9 each, post 3d. Circuit diagram included. Ditto but without the off position, i.e. d.p.d.t., 10 amp 2/9.

Miniature Microphone

American made. Dynamic type, real bargain at 2/6, plus 8d. postage.



SUB-MINIATURE COMPONENTS

1. Ferrite aerial with Long and Medium Wave Coils. 4 1/2 in. long, for pocket superhet, complete with circuit showing component values, etc., 7/6.
2. Ferrite aerial, as above, but 1/2 in. diameter, 8 in. long, for table model receiver or portable, 10/6.
3. Three I.F. Transformers with oscillator coil and circuit details to work with item 1. 19/6.
4. Three I.F. Coils and oscillator to work with item 2. 23/6.
5. Smallest possible electrolytics. 1MFD, 2MFD, 4MFD, 6MFD, 8MFD, 10MFD, 20MFD, 30MFD, 50MFD, 100MFD, 200MFD, all 1/2 each.
6. Smallest 1 watt resistors, all 10 per cent values. 5d. each.
7. Miniature condensers. 1, 1/-; .05, .04, .02, .01, all 8d. values, below this 7d.
8. Miniature slide switch double pole change over. 2/6.
9. Edgewise volume controls, 2K, 5K, 10K and 20K, 2/6 each.
10. Small edgewise controls with switch, 2K, 5K, 10K and 20K, 4/9 each.
11. Red Spot Transistors, tested and suitable all A.F. applications, 2/8.
12. White Spot Transistors tested and suitable as I.F. or mixer, 3/6.
13. Set of six Mullard transistors for superhet Mullards in original packets, fully guaranteed, comprising OC44, OC45, OC81D and matched pair OC31, £2 the set.
14. Special 500 μ sub-miniature diodes, 1/- each.
15. Surface Barrier transistors, 5-10 Mc/s. 6/6 each; 10-15 Mc/s. 8/- each; 20-30 Mc/s. 9/- each; 40-50 Mc/s. 15/- each.
16. Push-Pull Driver and Push-Pull output transformers for pocket superhets, 150 mW, 10/- pair; 400 mW, 15/- pair; 750 mW (driver only, no output needed), 8/6, all complete with circuit details.
17. Smallest Tuning Condenser, size approx. 1/2 in. sq., 165pF and 65pF, with trimmers, 17/6 each.
18. Oscillator coil to suit the above, 6/-.
19. Three I.F.s, 455 k/c sub-miniature to suit items 17 and 18, 18/- the set.
20. Jackson 00 3-gang tuning condensers, 288pF plus 176pF, 1/2 in. spindle, tapped 6BA with trimmers, 10/6, less trimmers 9/6.
21. Tuning condensers for items 1 and 3, 9/6.
22. Tuning condensers for items 2 and 4, 10/6.
23. Printed circuit for items 1 and 3, 6/6.
24. Printed circuit for items 2 and 4, 7/6.
25. 2in. speaker, 3 ohm, 19/6; 80 ohm, 19/6.
26. 3in. speaker, 3 ohm, 18/6; 80 ohm, 18/6.
27. 5in. speaker, 3 ohm, 18/6; 35 ohm HI flux, 19/6; 35 ohm Super HI flux, 22/6.
28. Elliptical speaker, 7 x 4, 3 ohm, 19/6; 35 ohm, 19/6.
29. Battery connectors, large, 1/- pair; miniature, 1/- pair.

POCKET LOUDSPEAKER TRANSISTOR RADIOS!

THE "PIMPERNEL"

You'll hear it here . . .
 You'll hear it there . . .
 You'll hear our "Pimpernel" everywhere!!

FULLY ASSEMBLED **£5.10.0**



Our amazing pocket size transistor set uses five transistors and is an all British product. There is nothing on the market to compare with it and it is many times better than any Japanese set of similar price. It is a complete ready-to-work Radio. Uses only the best and latest components including 3in. Moving Coil Speaker, air spaced tuning condenser, two-tone cabinet, etc.

SEVEN DAYS' FREE TRIAL. Send today, you can keep this set for seven days and if you are not 100 per cent satisfied return it and your cash will be refunded in full.

Post and Ins. 2/6.

Demonstrations at all branches.

THE POCKET "4"

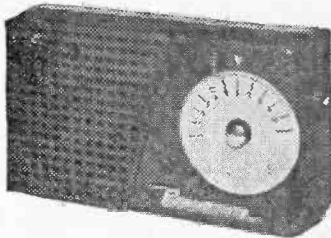

Circuit comprises 2 HF transistors reflexed to equal 4 stages. Permanent germanium diode and high gain AF output stage, fitted with miniature speaker, proper tuning condenser, volume control and in case with handles as illustrated (less monogram), completely portable. No aerial or earth required. Pocket 4 uses 3 transistors and 1 diode, price 42/6, plus 2/6 post and insurance. Pocket 5 uses 4 transistors and 1 diode and has feedback control, price 55/-, plus 2/6 post and insurance. Prices are for medium wave models, long or medium versions 8/6 extra.

GOOD RESULTS EVERYWHERE

Nothing can be more disappointing than to find that despite care in making up, your radio just will not work or needs a long high aerial and water pipe earth. We can prove good results in all areas and we guarantee all components for 12 months. Hundreds of testimonials received. Send in confidence. Plans free with parts, or separately 1/6. Demonstrations at all branches.

NOW THE "GOOD COMPANION" CAR RADIO AND PORTABLE

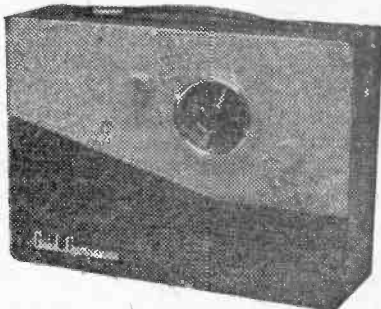

Largely due to the helpful criticisms and suggestions received from purchasers of our previous set "The Real Companion" we have improved and now supersede this with a new set which we call "The Good Companion". We feel confident that this new set is one of the finest of its kind available. The design is the combined efforts of our technicians and of those of several of the leading manufacturers in the country, and the resulting set has a performance as good as if not superior to those selling at £20 and more. It has the eight transistor set performance.

Features include American Philco R.F. transistors and Mullard A.F. transistors—Q.P.P. output giving 750 mW—full coverage on Medium and Long—very fine tuning arrangement—excellent reception of difficult stations like 208—variable feed-back control—full tonal qualities—really superior looking cabinet size 11 x 8 x 3in. approximately—or aerial attachment—several months' operation from battery costing only 3/6.

Circuit employs six transistors and two diodes, it incorporates all latest refinements, and oscillator I.F. Transformers are pre-aligned so no instruments are necessary. Anyone who can solder competently can make this set. The instructions are fully comprehensive with plenty of illustrations. Service is available in the unlikely event of your getting into difficulties. All components fully guaranteed.

Price of all components and cabinet to make set as illustrated **£9.19.6**. Post and insurance 5/-. Battery 3/6 extra.

Alternative Cabinet available if required.

ELECTRONIC PRECISION EQUIPMENT LTD.

post orders are dealt with from Eastbourne, so for prompt attention please post your orders to 66 Grove Road, Eastbourne, marked Department 7. Callers may use any one of the Companies below.

266 London Road, Croydon
 Phone: CR0 8558
 Half day Wednesday

29 Stroud Green Rd., Finchley
 Phone: ARCway 1049
 Half day Thursday

520 High Street North Manor Park, E.12.
 Phone: ILFord 1011
 Half day Thursday

42-46 Windmill Hill, Ruislip, Middx.
 Phone: RUISlip 5790
 Half day Wednesday

246 High Street, Harlesden, N.W.10.
 Phone: ELCar 4444
 Half day Thursday

ARMSTRONG AF208 AM/FM RADIOGRAM CHASSIS

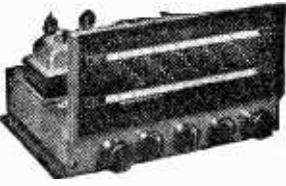

★ Full VHF Band (87-108 Mc/s and Medium Band, 137-570M) ★ 7 Valves ★ 5 Watts Output ★ 15db Negative Feedback ★ Separate wide range Bass and Treble Controls ★ 2 Compensated Pick-up Inputs ★ Frequency Response 30-22,000 c.p.s. ±2db ★ Tape Record and Playback Facilities ★ Continental Reception of Good Programme Value ★ For 3, 7½ and 15 ohm speakers. Send S.A.E. for leaflet.

PRICE 22 GUINEAS Carr. Free

LATEST "E.M.I." 4 SPEED SINGLE RECORD PLAYER

Aocs Hi-Fi Pick-up for LP, and/or 78, 7, 10 and 12in. records. Silent motor, heavy turntable, auto stop.

Special offer **£6.5.0** post free.
Stereo/Monaural **£8.19.6**.

SINGLE-PLAYER BARGAINS

Ready-built, complete with BSR TU9 4-speed gram pick-up unit. Handsome portable case. 3-watt amplifier with 2 valves and speaker. List price **£12.12.0**. OUR PRICE **£9.9.0**. Post 4/-. Fully guaranteed in manufacturer's sealed cartons.

I.F. TRANSFORMERS 7/6 pair

485 kcs/s slug tuning miniature can 1½ x 1 x ¾ in. High Q and good band width. Data sheet supplied.

New Boxed VALVES 90-day Guarantee

1R5	7/8/16K9	7/8/EA50	1/8/EZ90	7/6
1R5	7/6/16L6	10/8/EA8C90	8/8/1148	7/6
1T4	6/-/6N7M	6/8/EB91	6/-/HAB80	8/6
2X2	3/8/6Q7G	8/8/EB33	8/-	12/6
3B4	7/8/6B47	6/8/EB34	9/8/HV2A	8/6
3V4	7/8/6B7M	6/8/EB90	10/-/MU14	9/-
5U4	7/8/6SN7	6/8/EC84	9/8/PC84	9/6
5Y3	7/8/6V9G	6/8/ECF90	9/8/PCF80	9/6
5Z4	9/8/6X4	7/8/ECH42	10/8/PC182	11/6
6AM6	9/-/9X5	6/8/ECL30	10/8/PE285	8/6
6B5	5/-/12A6	7/8/ECL84	10/8/PL1	12/6
6BE6	7/8/12AT7	8/-/EP39	5/8/PL82	10/6
6BH6	9/8/12AU7	8/-/EP41	9/8/PY80	7/6
6BW6	9/8/12AX7	8/-/EP50	5/8/PY81	9/6
6D5	8/-/12BR6	8/8/EP80	8/-/PY82	7/6
6E6	7/8/12CT	8/8/EP81	12/8/SR1	8/6
6HG	8/8/12Q7	6/8/EP92	5/8/UBC41	9/6
6J5	5/8/35L6	9/8/EL32	5/8/UCH42	9/6
6K6	5/8/35Z4	7/8/EL41	9/8/UY41	9/6
6L7G	8/8/80	9/8/EL84	8/8/UY41	9/6
6K8GT	9/8/807	8/8/EP51	9/8/UY41	9/-
6K7G	5/-/84	1/8/EL40	7/8/22	8/6

DE96, DF96, DAF96, DL96, 8/6 each or 30/- set.

NEW ELECTROLYTICS		FAMOUS MAKES	
TUBULAR	TUBULAR	CAN TYPES	
1/350V	2/-	50/350V	5/8
2/350V	2/8	100/25V	3/-
4/450V	2/3	250/25V	2/-
8/450V	3/8	500/12V	3/-
8/500V	2/8	8-9/450V	3/8
16/450V	3/-	8-8/500V	3/8
16/800V	4/-	8-16/450V	9/8
32/450V	3/8	8-16/800V	5/8
32/25V	1/8	16-16/450V	4/8
60/85V	8/-	16-16/800V	6/-
60/80V	9/-	32-32/350V	4/6

C.R.T. BOOSTER TRANSFORMERS

For Cathode Ray Tubes having heater cathode short circuit and for C.R.T. Tubes with falling emission. Full instructions supplied.

Type A. Optional 25% and 50% Boost. 2V or 4V or 6.3V or 10.8V or 13.3V. Mains input. 12/6

Type A2. High quality, low capacity. 10/15pF. Optional boost 25%, 50%, 75%. Mains input. 16/6

Type B. Mains input. Low capacity. Multi output 2, 4, 6.3, 10 and 13V. Boost 25% and 50%. This transformer is suitable for all TV tubes, 21/- each.

COMPLETE RADIO £4.19.6 post free



4 Mullard valves, 5in. speakers, frame aerial, 4 pre-set stations, 1 long, 3 med. wave, Superhet Circuit. Size 9 x 6 x 5½ in. High. Tested ready for use. 200/250 v. A.C.—D.C. Mains.

MAINS TRANSFORMERS 900/250 v. A.C. STANDARD, 250-0-250, 80 mA, 6.3 v. 3.5 a. tapped 4 v. 4 a. Rectifier 6.3 v. 1 a. 6.3 v. 2 a. or 4 v. 2 a. ditto, 250-0-350.	22/6
MINIATURE 200 v. 30 mA, 6.3 v. 1a.	10/6
MIDGET, 220 v. 45 mA, 6.3 v. 2 a.	15/6
SMALL, 220-0-220, 50 mA, 6.3 v. 2a.	17/6
STD., 250-0-250, 65 mA, 6.3 v. 3.5 a.	17/6
HEATER TRANS. 6.3 v. 1½ amp.	7/6
Ditto, tapped sec. 2, 4, 6.3 v., 1½ amp.	8/6
Ditto, sec. 6.3 v. 3 amp.	10/6
GENERAL PURPOSE LOW VOLTAGE, 2a. 3, 4, 5, 6, 8, 9, 10, 12, 15, 18, 24, 30 v.	22/6
Ditto, 110-240 v. 150 v.	22/6
Ditto, 500 v.	32/6

O.P. TRANSFORMERS. Heavy Duty 50 mA, 4/6. Multiratio, push-pull, 7/6. Ditto, 10 v., 15/8. Miniature, 384m each, 4/6. L.F. CHOKES 15/10 H. 60/95 mA, 8/-; 10 H. 65 mA, 10/6; 10 H., 100 mA, 14/-.

TELEVISION REPLACEMENT Line Output Transformers from 45/- each, New Stock

and other timebase components
Most makes available
S.A.E. with all enquiries.

FULL WAVE BRIDGE SELENIUM RECTIFIER: 2, 6 or 12 v., 1½ amp., 9/8; 2 a., 11/3; 4 a., 17/6. CHARGER TRANSFORMERS. Tapped input 200/250 v. for charging at 2, 6 or 12 v., 1½ amp., 15/6. 2 amps., 17/8; 4 amps., 22/6. Circuit included. 4 AMP CAR BATTERY CHARGER with amp meter Leads, Fuse Case, etc., for 6 v. or 12 v., 69/6.

BOOKS

40 Circuits for Germanium Diodes 3/- "W.W." Radio Valve Data, 6/- High Fidelity Speaker Enclosures, 5/- Valve and TV Tube Equivalents, 9/- TV Fault Finding, 5/- Quality Amplifiers, 4/8. Radio Valve Guide. Books 1, 2, 3 or 4, 6/- each. Transistor Superhet Receivers, 7/6.

CRYSTAL MIKE INSERT

by ACOS 8/6 Precision engineered. Size only 1½ in. dia. x 1½ in. ACOS CRYSTAL MIKE 40 .. 25/- DE LUXE STICK MIKE .. 35/-

LOUDSPEAKER P.M. 3 OHM. 2½, 3, 4in. 19/6. 5in. Rola, 17/6; 6in. Plessey, 19/6. 7in. x 4in. Plessey, 18/-; 6in. Rola, 18/6. 10 x 4in. 27/6. 10in. Rola 30/-. 4in. Tweeter, 25/-. 12in. R.A. 30/-; 18½ x 5in. 45/- STENTORIAN HF1012, 10in. 3-16 ohms, 10 v., 95/-.

BAKER SELHURST LOUDSPEAKERS



12in. Baker 15w. Stairwarr 3 or 15 ohms, 45-13,000 cps. 30/- 12in. Baker ditto, (osm) suspension, 15 ohms, 40-13,500 c.p.s. 28/- 12in. Stereo, 12w., 25-16,000 c.p.s. 25/- 12in. Baker Ultra Twelve, 20 c.p.s. to 26 kc/s. £17.10 15in. Auditorium, 35 w., £15

CRYSTAL DIODE G.E.O., 2/-, GEX34, 4/- HIGH RESISTANCE PHONES, 4,000 ohms, 15/- per MIKE TRANSF. 50 : 1, 3/9 ea.; 100 : 1, Potted, 10/6. 8 SWITCH CLEANER, Fluid aquid sprout, 4/8 1in. TWIN GANG TUNING CONDENSERS, 365 pF, miniature lin. x 1½ in. x 1½ in., 10/-, 500pF Standard with trimmers, 9/-; midget, 7/6; with trimmers, 9/- SINGLE, 50 pF, 2/6; 75 pF, 100 pF, 160 pF, 5/6. Solid dielectric 100, 300, 500 pF, 3/6. CONDENSERS. New stock. 0.001 mid. 7 kv; T.C.O., 5/8; Ditto, 20 v., 9/6; 0.1 mid., 7 kv, 9/6. Tubular 500 v. 0.001 to 0.05 mid., 9d., 0.1, 1/- 0.25, 1/8; 0.5/500 v., 1/8; 0.1/350 v., 9d.; 0.01/2,000 v. 0.1/1,000 v., 1/8; 0.1 mid., 2,000 volts, 2/8. CERAMIC CONDS. 500 v., 0.3 pF to 0.01 mid., 9d. SILVER MICA CONDENSERS, 10% 5 pF to 600 pF, 1/-; 500 pF to 3,000 pF, 1/2. Close tolerance. (+ 1 pF) 1.5 pF to 47 pF, 1/6. Ditto 1% 50 pF to 815 pF, 1/8; 1,000 pF to 5,000 pF, 2/-.

485 kcs/s SIGNAL GENERATOR. Total cost 15/- Uses B.F.O. Unit ZA 30038 ready made. POCKET SIZE 2½ x 4½ x 1½ in. Slight modifications required. Full instructions supplied. Battery 7/6 extra 69V +1V. Details S.A.E.

Wavechange Switches. 2 p. 2-way, 3 p. 2-way, short spindle, 2/6; 2 p. 4-way, 2-way, long spindle, 6/8; 2 p. 6-way, 4 p. 2-way, 4 p. 3-way, long spindle, 3/8; 3 p. 4-way, 1 p. 2-way, long spindle, 3/8;

Wavechange "MAKITS". Wafers available: 1 p. 12 wafer, 2 p. 6 wafer, 3 p. 4 wafer, 4 p. 3 wafer, 6 p. 2 wafer, 1 wafer, 8/8; 2 wafer, 12/6; 3 wafer, 16/-; additional wafers up to 14, 3/6 each extra.

Toggle Switches, s.p., 2/-; d.p., 3/6; d.p.d.t., 4/-.

JASON FM TUNER COIL SET, 29/-, H.F. coil, aerial coil, oscillator coil, two I.F. transformers, 10.7 Mc/s, detector transformer and heater choke. Circuit and component book using four 6AM6, 2/8. Complete Jason FMT.1 kit. Jason chassis with calibrated dial, components and 4 valves, £6.5.0.

Valveholders, Pax. int. oct., 4d. EA50, 8d. E2A, CRT, 1/3, Eng. and Amer. 4, 5, 6, and 7 pin, 1/-. MOULDED Mazda and int. oct., 6d.; B7G, B8A, B9A, 9d. B7G with can, 1/6. B9A with can, 1/8. Ceramic, EF50, B7G, B9A, int. oct., 1/-. B7G, B9A cans, 1/- each.

THE ORIGINAL RADIO COMPONENT

Our written guarantee with every purchase. Bus 133 or 68 pass door S.R. Station Selhurst

Volume Controls 80 ohm CABLE COAX
 Long spindles. Midget 1/2-
 5 K ohms to 2 Meg. 40 yds. 17/8. 6d. yd.
 No. 8w. D.F. 8w. 60 yds. 25/-.
 3/- Fringe Quality
 Linear or Log Tracks. Air Spaced. 1/- yd.

TRIPLEXERS Bands I, II, III .. 12/6
COAX PLUG .. 1/-
LEAD SOCKET .. 2/-
PANEL SOCKETS 1/-
OUTLET BOXES .. 4/6
BALANCED TWIN FEEDER rd. 6d. 80 or 300 ohms.
DITTO SCREENED per yd. 1/6. 80 ohms only.
WIRE-WOUND POTS, 3 WATT. Pre-set Min.
 TV Type. All values 10 ohms to 25 K. 3/- ea.
 30 K. 50 K. 4/- (Carbon 30 K., to 2 meg. 3/-.)
WIRE-WOUND 4 WATT Pots. Long Spindle.
 Values. 50 ohms to 60 K., 6/6; 100 K., 7/6.

TRIMMERS Ceramic. 30, 50, 70 pF., 8d.; 100 pF.,
 150 pF., 1/3; 250 pF., 1/6; 500 pF., 750 pF., 1/8.
RESISTORS. Preferred values. 10 ohms to 1 meg.
 1 w., 4d.; 1/2 w., 4d.; 1 w., 6d.; 1 1/2 w., 8d.; 2 w., 1/-.
HIGH STABILITY, 1/2 w., 1%, 2/-. Preferred values.
 10 Ω to 10 meg. Ditto 5%, 100 Ω to 3 meg., 8d.
 5 watt... **WIRE-WOUND RESISTORS** .. 1/3
 10 watt... 25 ohms—10,000 ohms .. 1/8
 15 watt... .. 2/-
 12.5K to 50K 10 w 3/-

**AMERICAN "BRAND FIVE"
 PLASTIC RECORDING TAPE**
 Double Play 7in. reel, 2,400ft 60/- Spare
 5in. reel, 1,200ft 37/6 Plastic
 Long Play 7in. reel, 1,800ft 35/- Reels
 5in. reel, 1,200ft 23/6 3in. 1/6
 5in. reel, 900ft 18/6 4in. 2/-
 Standard 7in. reel, 1,200ft 25/- 5in. 2/-
 5in. reel, 600ft 16/- 7in. 2/6
 'Instant' Bulk Tape Eraser and
 Head Defluxer, 200/250 v A.C. 27/6.
 Leaflet, S.A.E.

Neon Mains Tester Screwdriver, 5/-
 Solder Radiograde, 4d. yd., 4lb. 5/-
 Black Crackle Paint. Air drying. 3/- tin

HIGH GAIN TV PRE-AMPLIFIERS
BAND 1 B.B.C.
 Tunable channels 1 to 5. Gain 18db.
 ECC84 valve. Kit price 29/6 or 49/6
 with power pack. Details 6d. (PCC84
 valves if preferred.)
BAND III I.T.A.—Same prices.
 Tunable channels 8 to 13. Gain 17db.

Paxolin Panels, 10 x 8in. 1/6.
 Miniature Contact Cooled Rectifiers
 250V 50mA, 7/6; 250V 60mA, 8/6; 250V
 85mA, 9/6; 200mA, 21/-; 300mA, 27/6.
 Selenium Rect. 300V 85mA, 7/6.
 Coils. Wearite "P" type, 3/- each.
 Osmor Midget "Q" type, add. dust core,
 from 4/- each. All ranges.
 Teletron D.W.R. L. and Med. T.R.F.
 with reaction, 3/6.
 Ferrite Rod Aerials. M.W.. 8/9; M. and
 L. 12/6.
 Osmor Ferrite Rod Aerials. L. and M.
 for transistor circuits, 10/- each.
 Ferrite Rods, 8 x 1in.. 2/6.
 H.F. Chokes, 2/6.
 T.R.F. Coils, A/HF. 7/- pair; HAX. 3/-,
 DRZ2. 4/-.

Aluminium Chassis, 18 s.w.g. Plain,
 undrilled. 6 riveted corners,
 lattice fixing holes, 2 1/2in. sides, 7 x 4in.
 4/6; 9 x 7in.. 5/9; 11 x 7in.. 6/9; 13 x 9in.,
 8/6; 14 x 11in., 10/6; 15 x 14in., 12/6;
 18 x 16 x 3in., 16/6.
 Aluminium Panels, 18 s.w.g., 12 x 12in.
 4/6; 14 x 9in., 4/-; 12 x 8in., 3/-; 10 x 7in.,
 2/3.

AUTOCHANGER ACCESSORIES
 Amplifier player cabinets (except 63/-
 2-valve amplifier and 6 1/2in. speaker 95/-
 Wired and tested ready for use with above.

QUALITY 2-STAGE HI-FI AMPLIFIER. A.C. only 200-250V. Valves
 ECL82 and EZ80. 3 watt quality out-
 put. Mullard tone circuits, bass boost,
 treble and volume controls. Separate
 engraved Perspex front-panel with de-
 luxe finish. Heavy duty output trans-
 former. Shrouded mains trans-
 former. Stove enamelled chassis size
 6 x 5 x 3in. Bargain price 24.10.0.
 Circuit supplied.

JACKS. English open circuit, 2/6. Closed
 circuit, 4/3. Grundig type, 3 pin, 1/3.
JACK PLUGS. English, 3/-. Grundig,
 3 pin, 3/6.
Wirewound Ext. Speaker Control, 10d.,
 3/-.
ALADDIN FORMERS and cores. 1in.,
 8d.; 1in., 10d.
0.3in. FORMERS 5937 or 8 and cans TV1
 or 2. 1in. sq. x 2 1/2in. or 1in. sq. x 1 1/2in., 2/-
 with cores.
SLOW MOTION DRIVES. Epicyclic
 ratio 6:1, 2, 3.
SOLOIN IRON, 25W, 200V or 230V. 24/-.
MAINS DROPPER. 3 x 1 1/2in. With
 adjustable sliders. 0.3A, 1,000 ohms, 4/3;
 0.2A, 1,000 ohms, 4/3.
LINE CORD. 0.3A 60 ohms per foot,
 0.2A 100 ohms per foot. 2-way, 1/- per foot;
 3-way 1/- per foot.
MIKE TRANS. 50-1. 3/9; 100-1. 10/6
 P.V.C. Conn. Wire, 8 colours, single or
 stranded, 2d. yd. Steeving, 1.2mm, 2d.;
 4mm, 3d.; 6mm, 5d. yd.
Speaker Fret. Gold cloth, 17 x 25in., 5/-
 25 x 35in., 10/-. Tygan, 52in. wide, 10/-
 26in. wide, 5/- ft. Samples, S.A.E.
 Expanded Metal, Gold, 12 x 12in., 8/-.

**ARDENTE TRANSISTOR
 VOLUME CONTROLS**
 Type VC1645, 5K with switch, dia. 0.9in., 3/-
 Type VC1760, 5K with switch, dia. 0.7in., 10/6
 Deaf aid ear piece xtal or magnetic 7/6

"REGENT" 4 VALVE



"96"
**RANGE
 VALVES
 KIT PRICE**
£6. 6. 0.
 carr. 4/-

**PRINTED CIRCUIT BATTERY
 PORTABLE KIT**

Medium and long wave. Powerful 7 x 4in.
 high Flux Speaker. T.C.C. Printed Circuit and
 condensers. Components of finest quality
 clearly identified with assembly instructions,
 Osmor Ferrite Aerial Coils. Hexine covered
 attaché case cabinet. Size 12in. x 8in. x 4in.
 Batteries used B128 (L5512) and AD35 (L6040),
 10/- extra. Instructions 9d. (free with kit).
 Mains Unit ready made for above 39/6. Sold
 separately. Details free.

MONARCH RECORD PLAYER



**BUILD IT YOURSELF USING 4-SPEED BSR
 MONARCH AUTOCHANGER**
**READY BUILT 5W. AMPLIFIER. HANDSOME
 PORTABLE CASE. HIGH FLUX LOUD-
 SPEAKER. FULL INSTRUCTIONS SUPPLIED.**
 Total Price **£12.10.0**
 Carr. and ins. 5/-.

RECORD PLAYER BARGAINS
 4 Speed Autochangers:
 BSR, U.A.14 27.10.0
 Collaro Autochanger .. 27.19.6
 Garrard RC20 29.9.0
 Garrard RC210 210.10.0
 4 speed Single Players:
 Garrard TA Mk. II 28.8.0
 Model 45P 26.17.6
 Garrard 4 HF Transcription 117.19.6
 Garrard Stereo Heads £2 extra.
 All Sapphire Stylus available from 6/-.

**ARDENTE TRANSISTOR
 TRANSFORMERS**

Type D3035, 7.3 CT: Push Pull to 3 ohms
 for OC72, etc. 1 x 1 x 1in., 9/6.
 Type D3034, 1.75: 1 CT: Push Pull Driver
 for OC72, etc. 1 x 1 x 1in., 9/6.
 Type D3058, 11.5:1 Output to 3 ohms for
 OC72, etc. 1 x 1 x 1in., 9/6.
 Type D167, 18.2:1 Output to 3ohms for
 OC72, etc. 1 x 1 x 1in., 12/-.
 Type D238, 4.5:1 Driver Transformer.
 1 x 1 x 1in., 10/-
 Type D240, 8.5:1 Driver Transformer.
 1 x 1 x 1in., 10/-.

WEYRAD

**COILS AND TRANSFORMERS FOR A
 2-WAVE TRANSISTOR SUPER-
 HET WITH PRINTED CIRCUIT
 AND FERRITE ROD AERIAL**
 Long and Medium Wave Aerial—RA2W.
 On 6in. rod, 7/16in. diameter, 208pF
 tuning, 12/6.
 Oscillator Coil P50/1A0. Medium wave.
 For 176pF tuning, 5/4.
 1st and 2nd I.F. Transformers—P50/2CC,
 470 kc/s, 11/16in. diameter by 1in. high,
 5/7.
 3rd I.F. Transformers—P50/8CC, to feed
 diode detector, 6/-.
 Driver Transformer—LFD12, 1 5/16 x
 1 x 1 1/2in., 9/6.
 Printed Circuit—PCAL, Size 21 x 8 1/2in.
 Ready drilled and printed with com-
 ponent positions, 9/6.
 7 x 4in., 38 ohm Speaker, 25/-.
 These components are approved by
 transistor makers and performance
 is guaranteed.
 Constructor's Booklet 2/-.

NEW MULLARD TRANSISTORS
 Audio OC71 8/- R.F. OC44 10/6
 OC71 7/6 OC45 9/6
 Sub-miniature Electrolytics (15V).
 1uF, 2uF, 4uF, 5uF, 8uF, 25uF, 50uF,
 100uF, 2/6. Diodes OA7L, OA81, 3/-, GEX
 34, 4/-.

B.B.C. Pocket 2 Transistor. M.W.
 and L.W. Radio Kit, 32/6. Phones 7/6
 or deaf aid earpiece, 7/6.

**"PW" ROADFARER
 AM/FM RADIO KIT**

Transistorised throughout. Advanced
 design, operated from internal
 batteries or direct from mains. Four
 Sections on all printed circuit. AM
 Tuner, FM Tuner, Audio Amplifier,
 Mains Supply Unit.
 Attractive Plastic Cabinet. Ferrite
 Rod Aerial for AM. Telescopic Aerial
 for FM. Order now. Lowest price £15.

"PVV" Pocket 6 Transistor kit. All
 parts, printed circuit and cabinet.
 Osmor designed kit, £8.15.0.

**COMPONENT SHOP
 SPECIALISTS**

P. and P. charge 1/-, over £3 post free. C.O.D. 2/-.

**337 WHITEHORSE ROAD
 WEST CROYDON**

Telephone: THO 1665

(Export welcome. Send remittance
 and extra postage).

NOW!

YOU can MASTER ELECTRONICS!

BRITAIN'S MOST COMPREHENSIVE PRACTICAL COURSE IN RADIO • ELECTRONICS TELEVISION!

THESE SPECIAL TRAINING KITS — YOURS TO KEEP



Multi-Range TEST METER

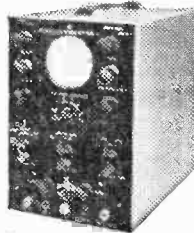

CATHODE RAY OSCILLOSCOPE

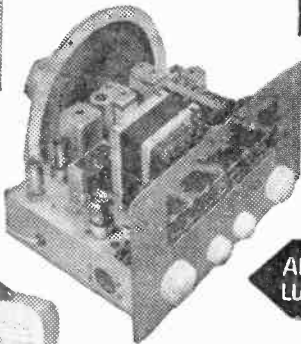

AM and VHF/FM LUXURY RECEIVER

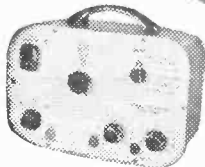

SIGNAL GENERATOR



Complete set of Picture Way books and Experimental Manuals

LEARN BY BUILDING NOW for your CAREER • HOBBY OWN BUSINESS

YOU RECEIVE

- Complete kits of equipment as illustrated.
- Complete set of experimental manuals.
- Complete set of "picture-way" theory books.
- Modern test-yourself examination sheets.
- Study programme.
- Unlimited consultation with Tutors.

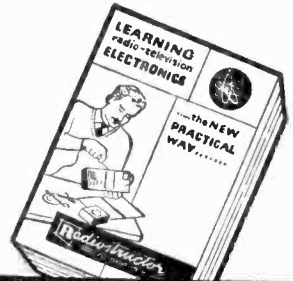

FREE BROCHURE NOW

RADIOSTRUCTOR

TO RADIOSTRUCTOR (DEPT. M.82) READING, BERKS.

Name _____ **BLOCK**

Address _____ **CAPS**

PLEASE

(We do not employ representatives)

12/61

Practical Wireless

VOL. XXXVII No. 658 DECEMBER, 1961

Editorial and Advertisement
Offices:

PRACTICAL WIRELESS

George Newnes, Ltd., Tower House,
Southampton Street, W.C.2.

© George Newnes Ltd., 1961

Phone: Temple Bar 4363
Telegrams: Newnes, Rand, London,
Registered at the G.P.O. for trans-
mission by Canadian Magazine Post.

SUBSCRIPTION RATES

including postage for one year

Inland - - - £1.9.0 per annum
Abroad - - - £1.7.6 per annum
Canada - - - £1.5.0 per annum

Contents

	Page
Editorial	689
Round the World of Wireless	690
A Portable Gramophone	
Amplifier	692
An Improved Valve-Voltmeter	695
Checking Test Instruments ...	699
R.F., I.F. and A.F. Signal	
Generator	703
A Transistorised VHF Superhet	707
On Your Wavelength	708
Understanding Power Supplies	711
Improving the All-band TRF ...	713
The P.W. "Citizen"	716
Faults in VHF/F.M. Receivers	721
Short-wave Section	725
How to Measure Inductances	730
High Sensitivity Bridge	733
Transistor TRF Receiver	738
A Dry-Battery Recharger	741
Tracing Intermittent Faults ...	742
Letters to the Editor	749
Personal Phone for Transistor	
Receivers	750
Club News	753

The Editor will be pleased to consider articles of a practical nature. Such articles should be written on one side of the paper only, and should contain the name and address of the sender. Whilst the Editor does not hold himself responsible for manuscripts, every effort will be made to return them if a stamped and addressed envelope is enclosed. All correspondence intended for the Editor should be addressed to The Editor, PRACTICAL WIRELESS, George Newnes, Ltd., Tower House, Southampton Street, London, W.C.2. Owing to the rapid progress in the designs of wireless apparatus and to our efforts to keep readers in touch with the latest developments, we give no warranty that apparatus described in our columns is not the subject of letters patent. Copyright in all drawings, photographs and articles published in PRACTICAL WIRELESS is specifically reserved throughout the countries signatory to the Berne Convention and the U.S.A. Reproductions or imitations of any of these are therefore expressly forbidden. PRACTICAL WIRELESS incorporates "Amateur Wireless."

THE P.W. 'CITIZEN'

TWO months ago, in our October issue, we presented a Blueprint, free with every copy, designed to introduce the newcomer to radio construction to the simplest of receivers, which we hoped would provide an adequate amount of knowledge from which he could proceed to more ambitious projects. Many such newcomers, spurred on by success with the 'Tutor' (the October Blueprint), rose from the status of "beginner" by building the 'Mini-Amp', the subject of the November Blueprint.

This month, the experienced constructor and student alike can build a transistorised radio—the Blueprint accompanying this issue (and its related article) provide the details necessary to build the 'Citizen', a superhet tuner. The 'Citizen' comprises a frequency-changer and an I.F. amplifier, both of which are assembled by mounting components on to group-boards, in a similar fashion to that adopted for the construction of the 'Tutor' and 'Mini-Amp'.

The 'Citizen' may be used with any suitable amplifier to make a complete receiver, but if the reader decides to make use of the 'Mini-Amp', he will be able to choose an advance design for a cabinet far removed from the conventional 'box' form, which is necessarily employed in much commercial and home-constructed equipment because of the size and shape of the electronic units used. The group-board units which we have described place few or no restrictions before the constructor when the shape of the finished instrument is considered, and for those readers, then, who feel that with this receiver they could with advantage adopt an unusual styling for the case, we are giving in the next issue details of a cabinet, which although unorthodox in design, is extremely attractive in appearance. It will incorporate a 4-speed battery-operated record-player and a large loudspeaker for high undistorted output from all records—LP's and EP's up to 12in. in diameter. The complete unit forms a useful radiogram which works from its own internal aerial and batteries and may be operated anywhere independently of the domestic mains supply.

OUR QUERY SERVICE

ONCE again we must remind our readers of the rules of our Free Query Service. The followings points should be carefully noted:

- (i) We cannot undertake to answer technical queries over the telephone
- (ii) All queries must be accompanied by the query coupon from the current issue
- (iii) If a postal reply is required a stamped and addressed envelope must be enclosed with the query.

We must also point out that we cannot design circuits to readers' specific requirements. Nevertheless we shall continue to help readers as far as possible but it should be remembered that all information necessary for answering the query should be sent to us.

Our next issue dated January, will be published on December 7th.

Round the World of Wireless

POTENTIAL AND CURRENT NEWS

Broadcast Receiving Licences

THE following statement shows the approximate number of Broadcast Receiving Licences in force at the end of August, 1961, in respect of wireless receiving stations situated within the various Postal Regions of England, Wales, Scotland and Northern Ireland. The numbers include Licences issued to blind persons without payment.

Region	Total
London	685,886
Home Counties	644,886
Midland	470,722
North Eastern	503,292
North Western	434,920
South Western	383,886
Wales and Border Counties	222,587
Total England and Wales	3,346,177
Scotland	371,317
Northern Ireland	116,461
Grand Total	3,833,955

Speaking Clock for Sudan

ALAWIA El Fatih El Bedawi, a typist in the Sudanese Embassy, recently went to Tin Pan Alley in London for a recording task which will take her fourteen days. Alawia, who has been a broadcaster in Khartoum, was chosen by her Government to record her voice for a speaking clock which is being installed on four Sudanese telephone exchanges by Associated Electrical Industries Limited.

The system will come into service on 17th November. It will enable telephone users in the Khartoum and Omdurman areas to find out the correct time in Arabic or English, whichever language they choose.

The installation, which has been designed by AEI Telecommunications Division, uses a tape recording system synchronised by a crystal controlled master clock which ensures accuracy equal to a variation of less than a second a month. This accuracy can be maintained completely independently of power failures because the equipment runs on the exchange battery supply.

Photomultiplier Tube Symposium at EMI House

MORE than 100 delegates from government and university research laboratories and industrial establishments throughout the United Kingdom and abroad

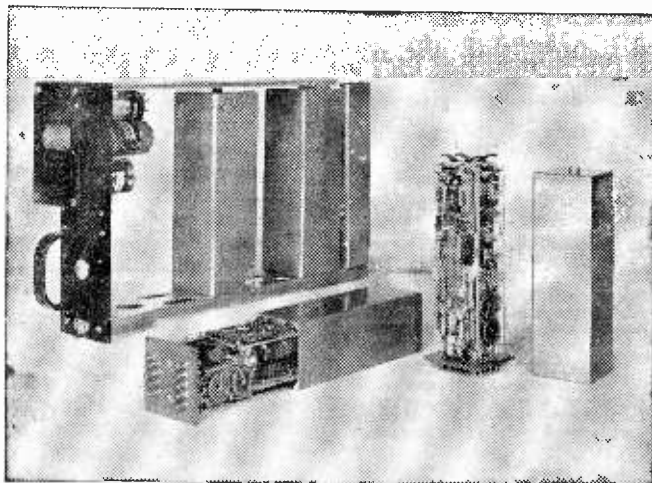

The Marconi navigation unit type 6402 with two of the sealed modules opened for maintenance. Each module may be reassembled and sealed with only four screws, and filled with dry nitrogen to give the added protection of a dry, inert atmosphere.

came to the Symposium of Photomultiplier Tube Applications, held at EMI House from 13th to 15th September.

Aims of the Symposium were to exchange information on the application of photomultiplier tubes in a wide variety of scientific and industrial fields and to encourage discussion on the ways in which improvements can be made and new fields opened.

Percy Allaway, Managing Director of EMI Electronics Ltd., welcomed delegates to the Symposium and Jack Sharpe, of EMI Valve Division, in his capacity as Chairman, opened the proceedings by giving a general introduction to photomultiplier tubes.

Mr. K. Rippon and Dr. M. A. Ford discussed the use of photomultiplier tubes in emission spectrometers and spectrophotometers. The growing importance of the vacuum ultra-violet in the former field was stressed, whilst it became evident that the spectrophotometer requires tubes with as wide spectral range as possible. An extremely elegant application of spectrophotometer techniques for the measurement of the visual pigments in the living human eye was presented by Dr. W. A. Rushton, F.R.S., of the Physiological Laboratory Cambridge. Two applications of

photomultiplier tubes in colour television were described. Mr. Oxenham of Sylvania Thorn dealt with the Zebra colour television display system, while Mr. Hacking of the BBC considered the problems of the colour film scanner.

In a discussion of the nucleonic field, Mr. R. B. Owen of A.E.R.E. Harwell gave a general survey in which he pointed out the importance of photoelectron utilisation and the time characteristics of multiplier tubes.

Lectures were given in the first floor theatre and the ground floor reception room was available as an overflow room where delegates were able to hold discussions in a more relaxed atmosphere. Closed-circuit television linked these two rooms and a sound relay system included a talk-back link so that questions could be put to the speaker from the lower floor.

Four New Transmitters

THE BBC has placed an order with Marconi's Wireless Telegraph Co Ltd. for four 250kW short-wave transmitters. The new transmitters form part of a re-equipment programme for BBC's External Services transmitting stations; two will be installed at the BBC's Daventry

station and two at the station at Rampisham, Dorset. The transmitters are being specially developed and will meet the specified requirements of the BBC. They will operate on any of the broadcasting bands in the frequency range 3.95—26.1Mc/s.

The transmitters are of the single-channel type arranged for manual wavechanging, which can be carried out in under five minutes. The final modulator and final R.F. stages each use two BY.1144 vapour-cooled valves in push-pull, giving a carrier output of 250kW. Valves in the penultimate stages are also vapour-cooled, the smaller valves being air-cooled. The vapour-cooled valves will be made by the English Electric Valve Co. Ltd. In the vapour-cooling system, which saves both plant and space, the heat from the valves produces steam in the water jackets surrounding them. This is led to a condenser, which converts it to water for return to the water jackets.

The vapour-cooling technique is already in use in the two newly installed 10kW short-wave transmitters at the BBC's Rampisham station and will be used in the four 100kW short-wave transmitters on order for the Daventry station.

Special precautions have been taken to minimise the possibility of spurious radiation from the 250kW transmitters causing interference in other bands, particularly the television bands. The R.F. stages are completely enclosed in screening boxes and harmonic filters are fitted in the output transmission lines.

It is expected that these four new transmitters will be brought into service during 1964.

Radio Hobbies Exhibition

MR. HENRY LOOMIS, Director of Voice of America, is to open the 1961 International Radio Hobbies Exhibition on 22nd November.

Mr. Loomis was educated at Harvard University and the University of California and obtained the degree of Bachelor of Science. After being a Lieutenant Commander (Overseas) in the U.S. Navy between 1940 and 1945 he became assistant to the President of Massachusetts Institute of Technology, and from 1950 to 1958 he held U.S. Government appointments, dur-

ing which he was appointed as Director of Broadcasting Service of the U.S. Information Agency—Voice of America.

The 1961 Exhibition is sponsored by the Radio Society of Great Britain and exhibitors will include the Army, Navy and Royal Air Force, each of which have their own radio groups throughout the world.

Exhibits will include new communications receivers from home and overseas; transistor components and kits of parts for build-it-yourself receivers, transmitters and television sets. Aerial equipment will be a feature for short and VHF wavelengths.

Many radio, television, recording, hi-fi and amateur groups will show their latest equipment. A Silver trophy will again be presented at the Opening Ceremony—for the most outstanding home-constructed piece of radio equipment.

The G.P.O. Research Branch will be exhibiting for the first time.

New VHF Sound Broadcasting Station for the Channel Islands

THE new BBC VHF sound broadcasting station for the Channel Islands was brought into service on 16th October. It is located on the same site as the

BBC's television station at Les Platons, Jersey, and is one of the twenty-one new VHF stations so far approved for extending the coverage of the VHF sound service in the United Kingdom.

Starting on 9th October daily test transmissions from the new station were broadcast throughout normal programme hours.

Les Platons receives its programmes from the mainland by radio from the BBC's VHF stations at North Hessary Tor or Rowridge and transmits the West of England Home Service on 97.1Mc/s, the Light Programme on 91.1Mc/s, and the Third Programme with Network Three on 94.45Mc/s. The transmissions are horizontally polarised, which means that listeners' receiving aerials should be mounted horizontally.

Control Equipment for Russia

AN order for eighteen control centres, valued at about £70,000, has been obtained by Motor and Control Gear Division of Associated Electrical Industries Ltd. from Constructors John Brown Ltd.

The equipment will be used to control the electric motors in two projected Russian detergent plants, one at Volgadonsk and the other at Shebekino.

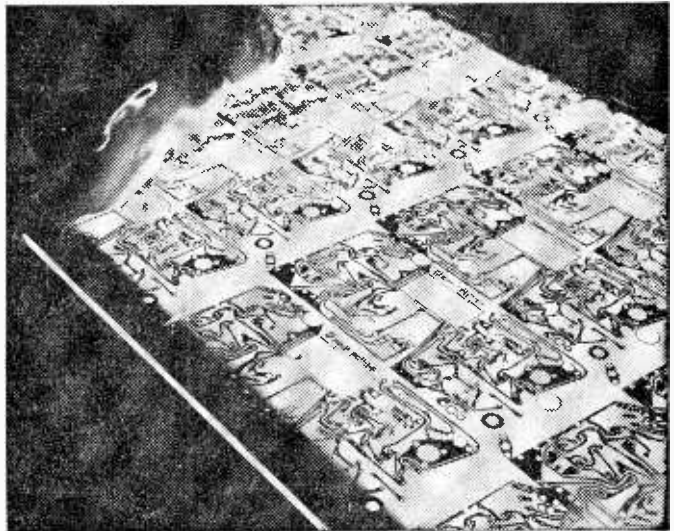

Even with modern electronic devices, visual inspection remains necessary in many instances; above, printed circuit panels are shown under scrutiny at the Boreham Wood factory of Printed Circuits Limited.

a portable GRAMOPHONE AMPLIFIER

BUILDING THIS UNIT WILL PROVIDE A WORTHWHILE MEANS OF USING UP SOME OLD COMPONENTS WHICH WILL BE FOUND IN EVERY "SPARES BOX"

By V. E. Holley

JHIS small amplifier costs very little to build—in fact, many constructors will probably be able to find most of the parts in the spares box. Nevertheless, it has quite a rewarding performance and a gain which is adequate for most types of pick-up, radio feeder unit, etc.

Circuit

The very simple circuit is shown in Fig. 1. The input signal is applied to a volume control, VR1 and thence via the tone control network VR2/C1, to the grid of a resistance coupled pentode voltage amplifier, 6J7. The resistor R3 is the anode load and the screen is fed from a potential divider across the H.T. supply. Normally, the screen of a resistance-coupled pentode must be decoupled by a fairly large capacitance, but if the impedance from screen to cathode can be made reasonably low, as it is in this case, little is lost by omitting the decoupling. The cathode of the valve is tapped on to the potential divider at a lower point which is selected so that the current in the potential divider together with the cathode current of the valve, produce the correct bias across the parallel-connected resistors R4 and R5. These in turn are selected so that their relative values in series cause the desired amount of negative voltage feedback from the output transformer secondary to be injected at the cathode of V1. It will be noted that V1 operates with both current and voltage feedback so that its input impedance is high and only a small capacitance is needed in the tone control network.

Output Stage

The signal from V1 is transferred via C2 to the grid of V2,

which is an output tetrode, 6V6. R6 is the grid resistor and R7 provides cathode bias. It will be seen that R7 is not bypassed so that V2 also operates with negative current feedback. This is undesirable as a rule, because it has the effect of increasing the apparent anode resistance of the valve so that its less desirable qualities are accentuated. In this case, however, this effect is counteracted by the negative voltage feedback and the net result is a reduction in the apparent anode resistance and an improvement in the linearity of the amplifier.

The output transformer in the anode circuit should have a ratio of about 40:1 to match a 3Ω speaker to the optimum load for the valve which is 5,000Ω. Only an inexpensive transformer is required as its deficiencies will be largely made good by negative feedback.

Power Supply

A double-wound mains transformer is used, thus providing complete isolation of the amplifier from the mains. It should have a 250V half-wave secondary capable of supplying 50mA and a 6.3V 1A winding for the valve heaters and indicator lamp: the latter should not consume more than 0.25A if the heater current is to be kept down to 1A. Any type of half-wave metal rectifier can be used so long as it can pass 50mA at 250V. Smoothing is provided by the electrolytic capacitors C3

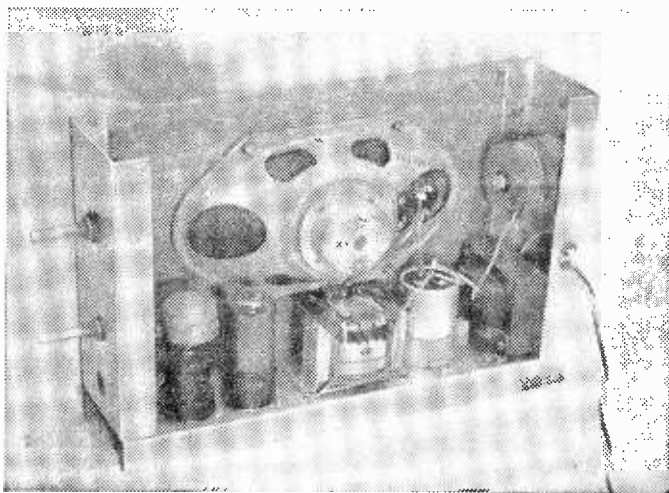

A rear view of the amplifier.

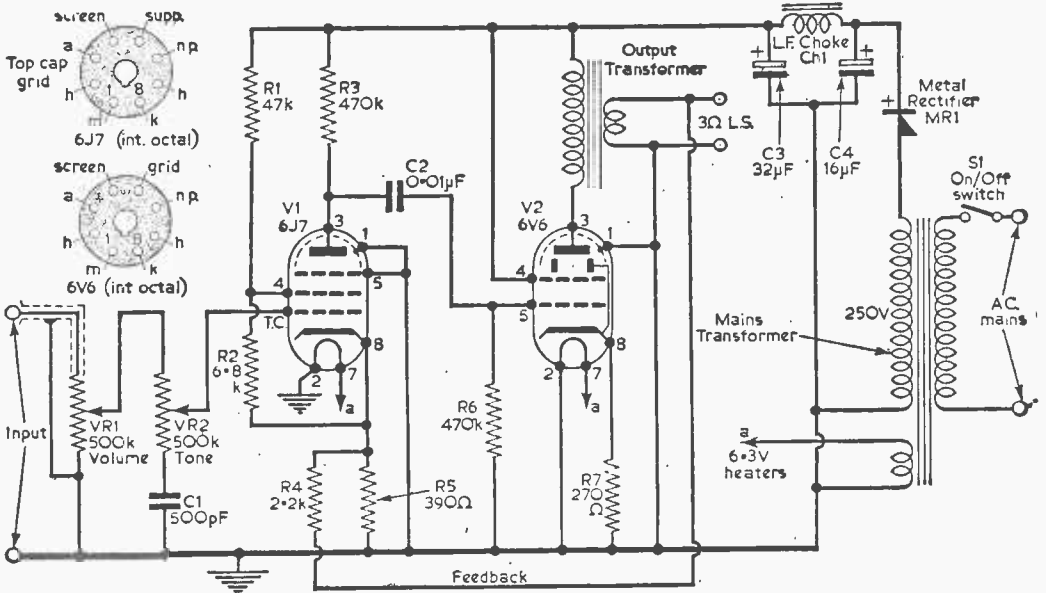
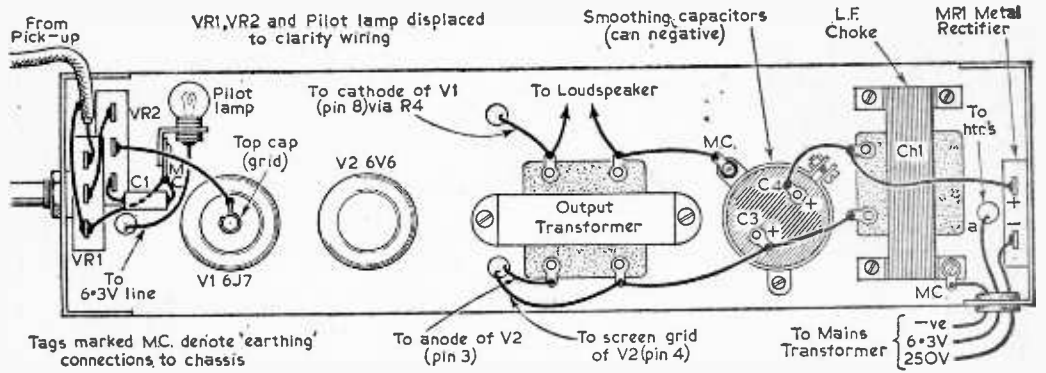

Fig. 1 (above).—The complete circuit diagram.

Fig. 2 (below).—The above-chassis wiring.



and C4 in conjunction with the choke Ch1 and, as the hum is very well taken care of by negative feedback, it is not necessary that the choke should have a large inductance.

Construction

There is nothing critical about the lay-out and the amplifier can be constructed in any form suitable for the purpose for which it is to be used. The prototype was built to fit into a commercial record player cabinet of conventional shape, having a vertical section to the left of the turntable measuring about 12in. x 9in. x 3in. and this form will be described.

The speaker is mounted on a piece of plywood or hardboard .11in. x 6½in. and the amplifier chassis which is 2½in. wide is secured to the hardboard by 4B.A. bolts, two at each side and two at

the bottom. The arrangement will be clear from the illustration. The chassis is of 18-gauge aluminium sheet to the measurements given in Fig. 4. The mains transformer is mounted separately in the player cabinet underneath the motor board, remote from the pick-up, and its output is taken to the chassis at a point adjacent to MR1 by a 3-core cable—H.T., L.T. and common negative. The transformer can thus be of any reasonable shape and size and there will be no interaction between it and other components. The switch S1 is fitted to the cabinet adjacent to the point of entry of the mains lead.

Components and Wiring

All the components are standard and there is plenty of room for them in the chassis—in fact, there is considerable scope for miniaturisation to

suit smaller cabinets. Of the resistors, R1 and R7 should be 1W and the remainder $\frac{1}{2}$ W or $\frac{1}{4}$ W. The capacitors should be 350VW. If valves other than the specified types are used, they should have the same general characteristics or some alteration may be required in the feedback loop. In the illustration, V1 is shown with the top cap screened but this is not really necessary. Wiring diagrams are given in Figs. 2 and 3. Tinned copper wire of 22s.w.g. is suitable for all the wiring and lengths of more than an inch or so should be covered with sleeving.

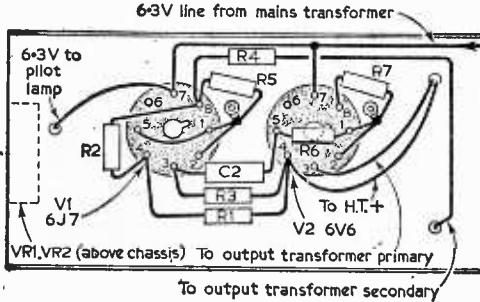

Fig. 3.—The under-chassis wiring.

Operation

When construction is complete, a check should be made with a meter between C4 and chassis to see that there are no shorts in the H.T. wiring. The power can then be switched on and the H.T. voltage checked. If there is instability it will be due to incorrect connection of the voltage feedback circuit and will disappear if the connections to the output transformer primary are reversed. The input arrangements to V1 may, of course, be modified to suit the signal source as desired; the performance will not be affected except insofar as the response may be modified by alterations to the tone control network.

COMPONENTS	
Resistors	
R1 47k 1W	R5 390 Ω $\frac{1}{2}$ W
R2 6.8k $\frac{1}{2}$ W	R6 470k $\frac{1}{2}$ W
R3 470k $\frac{1}{2}$ W	R7 270 Ω 1W
R4 2.2k, $\frac{1}{2}$ W	
Capacitors (350VW)	
C1 0.0005 μ F	C2 0.01 μ F
C3 32 μ F electrolytic	
C4 16 μ F electrolytic	
Choke	
About 10H 50mA	
Valves	
V1 6J7, octal base	} or similar
V2 6V6, octal base	
Rectifier	
Metal—contact cooled (or with fins)	
Transformers	
Mains—250V 50mA, half wave; 6.3V 1A	
Output—About 40:1 for 3 Ω speaker	
Indicator lamp	
6.3V 0.15A	
Single pole on/off switch	
250V 1A	

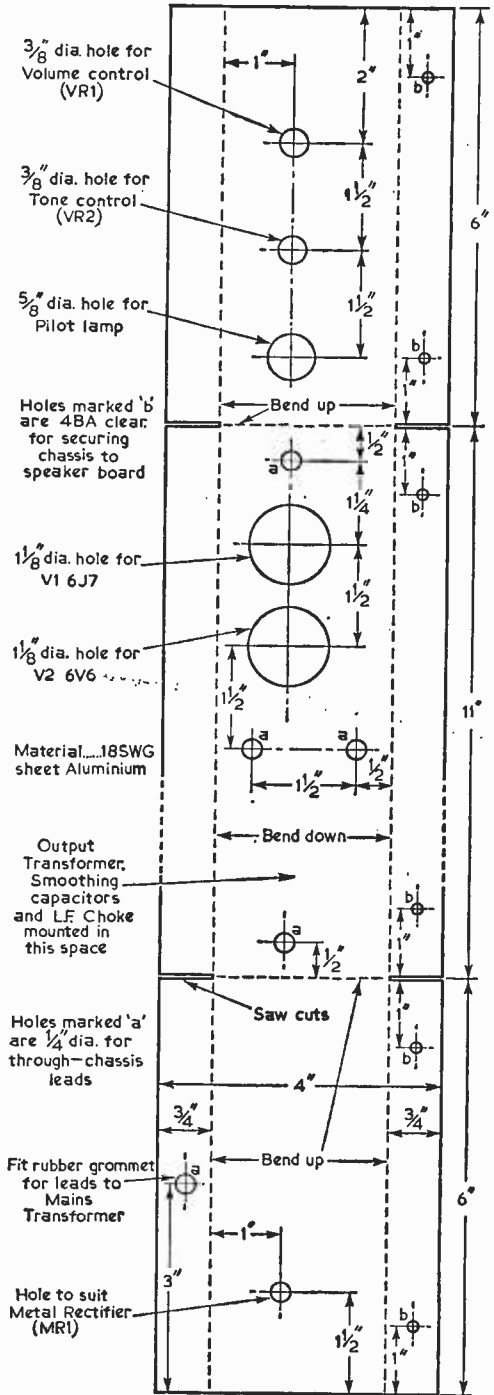

Fig. 4.—The chassis drilling details.

An Improved Valve-Voltmeter

A FEW MODIFICATIONS TO AN INSTRUMENT DESCRIBED IN P.W. MARCH 1961, WILL PROVIDE THE CONSTRUCTOR WITH AN EXTREMELY RELIABLE UNIT.

By M. L. Michaelis

General Description

This circuit is specifically based on the circuit principle already introduced by Mr. J. B. Dance on pages 996 to 998 of the March 1961 issue of *Practical Wireless*. Thus it uses the same form of cathode-coupled balanced D.C. Amplifier as the basic circuit. Upon experimenting with Mr. Dance's circuit, the author devised a number of modifications, which led to the production of this article. This does not mean that any fundamental criticism is intended against the former circuit; on the contrary. Mr Dance's circuit as such is perfectly sound, and was found to function very well when his instructions were exactly followed. This present article is merely intended to present some additions and further ideas.

New Circuit Features

The basic circuit is already taken to be understood from the previous article. If readers do not have the relevant issue of *Practical Wireless* to hand, then that need not disturb practical issues, as completely new theoretical circuit and clear wiring-diagrams are provided here. It is intended to discuss here only the circuit modifications made, and to explain the reasons for them, and then to give such other practical information as is considered necessary to build the present circuit.

The main new feature here is the built-in calibrator circuit. This provides, from the A.C. heater supply, a D.C. reference-voltage of exactly 5V. When the unit has been connected to any available power supply, the range-switch is first set to the "adjust calibration" position, and built-in meter-shunt VR2 (see Fig. 1) is turned until exactly full-scale deflection results. ("Electrical Balance" (Zero) must of course have been set previously with VR1.) In this way the meter sensitivity is automatically adjusted to suit the H.T. voltage which happens to be used, and the calibration holds on the measuring ranges for any H.T. voltage supply for operating the unit, as long as it lies between about 250 and 350V. With the circuit of Mr. Dance, the calibration held only

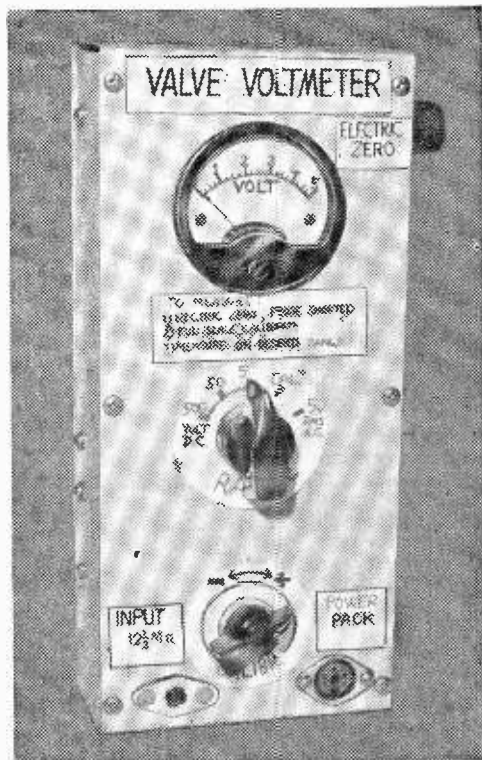

The complete unit.

for one particular H.T. voltage supply, so that his unit needed to be calibrated for use with one particular H.T. supply.

Zener Diode

The calibrator uses a normal meter-rectifier bridge in half-wave connection for rectifying a sample of the heater voltage. C4 acts as smoothing, and the zener diode (D2) with R12 stabilises the D.C. to exactly 5V. A zener diode is a semiconductor-diode much resembling a transistor in appearance, and has the following properties: if its anode is made positive to its cathode, then it conducts exactly as any other diode. If its anode is made negative to its cathode, then at first it does not conduct, again the same as any other diode, but if this negative voltage exceeds a certain value called the zener voltage, then the diode

COMPONENTS LIST

Resistors

Wattage ratings generous for stability
 ±20% tolerance except where otherwise stated

- R1 47k ½W Carbon
- R2, R3 10M 1W ±5%
- R4 2.2M 1W ±5%
- R5 4.7M 1W ±5%
- R6 680k 1W ±5%
- R7, R8 150k 1W ±5%
- R9 220k 1W ±5%
- R10 470k 1W
- R11 100k 1W
- R12 20k ½W
- R13 1k 2W
- R14 4.7k 1W
- R15 47Ω 1W w.w.
- R16, R17 1k 1W
- R18 6.8k 2W
- R19 4.7k 2W
- VR1 1k Lin. w.w. and knob
- VR2 10Ω Lin. w.w. and knob

Condensers

- C1 0.1μF 500VW paper
- C2, C3, C5 0.01μF 500VW paper
- C4 100μF 12VW electrolytic
- C6 8μF 350VW electrolytic

Valves, etc.

- V1 ECC81 B9A base (ceramic)
- D1 OA79 or other R.F. |A.F. Diode
- D2 5-volt zener diode (G.E.C. SX 51)
- MRI Instrument rectifier bridge (from kit)

Sundries

- Coaxial socket
- 12-way tagstrip
- Ceramic wafer switch, 2-pole 5-way and knob
- 3-pole panel socket
- Meter, 2Ω 2mA FSD, moving coil
- Metal box chassis, 2in x 4in. x 9in.
- Wire, solder, tags, etc.

LI: R.F. choke—see text

The construction is founded on chassis, meter, and some other parts, as found in the "Elpreq" multimeter kit, by "Electronic Precision Equipment" advertised in "Practical Wireless".

The existing chassis drilling is maintained. Some holes are enlarged, according to parts used. Extra holes for bolts as required, according to parts to hand.

Power Supply

- 6.3V 0.3A heater
- 300V H.T., 10mA
- (250-350V permissible without loss of accuracy)

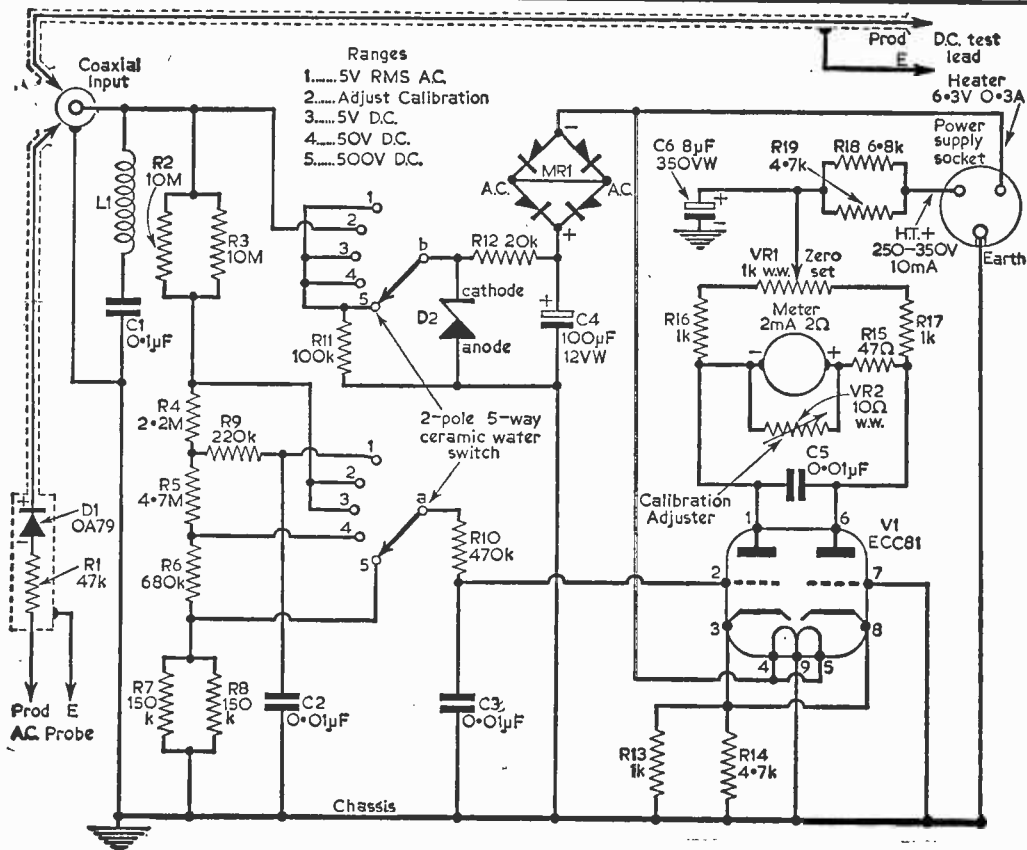

Fig. 1.—The circuit of the instrument.

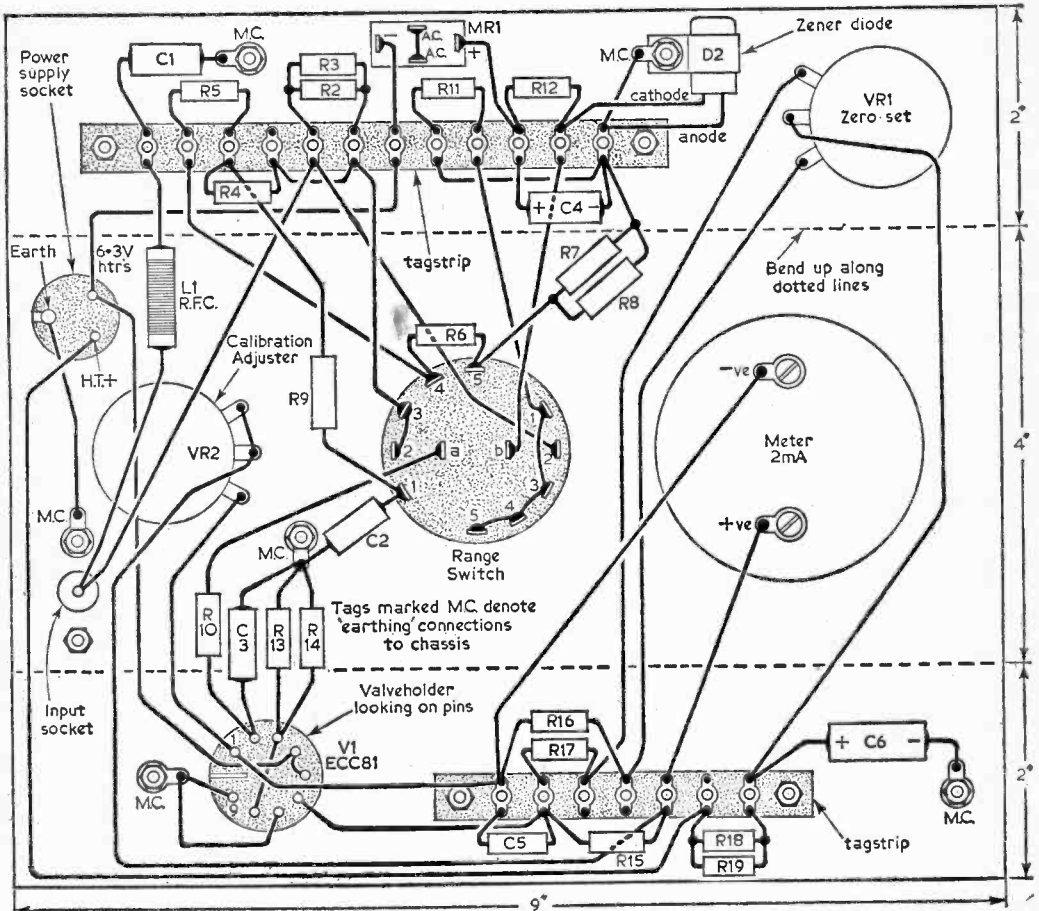

Fig. 2.—The complete wiring diagram—the sides are shown bent flat to clarify the wiring.

suddenly conducts again. Thus, in the circuit here described the zener diode D2, which has a zener voltage of 5, always draws just that amount of current through R12 to keep its cathode at exactly 5V positive to chassis (R12 may be altered in value to bring the cathode voltage of D2 to exactly 5. R12 should not be made less than 2.7k.)

The second major modification to the original circuit is a drastic change in the circuit-values connected with the anode circuits, to make the whole circuit of lower impedance. This is to suit it to a cheaper and less sensitive meter than the one specified by Mr. Dance, whilst nevertheless maintaining the original high input impedance with consequent high overall-sensitivity. The main reason for this modification is that the whole circuit was designed to be built using chassis and many parts of a Multimeter Kit advertised in this magazine. The author has purchased several of these kits, and after building one up as originally intended, experimented by modifying the others to various other circuits. The present instrument is one of the results.

The kits almost always used moving-coil meters of basic sensitivity 2mA FSD, and about 2Ω internal resistance, and the present circuit values were adapted for this type of meter. The 1k potentiometer in the kit, originally intended for "ohms zero", serves here as VR1 for the electrical-zeroing. The meter-rectifier bridge in the kit serves as the calibrator-rectifier, and is connected as half-wave rectifier, by shorting the A.C. connections to each other, and using only the D.C. connections as shown in the circuit diagram. The chassis is used as it is. The holes originally for the two test leads are to take the input coaxial socket and the miniature 3-pole power-supply socket. VR2 is fitted through the existing hole originally intended for the multimeter voltage/current selector, and the range switch maintains its original position. The switch in the kit is rejected to the spare box, and a high-insulation ceramic-wafer switch is here used for the range switch. VR1 maintains its original position. Apart from a few simple holes for mounting-bolts of tagstrips, earthing tags and the valveholder,

virtually no alteration is required to the chassis supplied with the multimeter kit.

Scale

Driving the 2mA FSD meter to full-scale under the circuit conditions existing here represents just about the limit of linear drive which V1, an ECC81, will accept. The meter should be fitted with a linear scale calibrated 0 to 5, and then, in the finished circuit, R14, R15 and R18 are carefully adjusted to give best linearity over the whole scale by comparing readings given with this instrument with those given by another ordinary meter, with various voltages used as test. The author's instrument, after careful trimming, gives 10% accuracy on all ranges, under all H.T. supply voltages between 250V and 350V. Thus it seems hardly worthwhile using resistors of greater accuracy than the 5% ones specified in the parts list. Use of a 1mA FSD meter, if available, would probably increase the accuracy limits sufficiently to warrant 1% tolerance resistors for R2 to R9. If a 1mA meter is used, then R4 to R8 inclusive should be halved in ohms value. VR2 should be chosen to equal about five times the meter resistance, and R15 should be approximately 50Ω, less the meter resistance. But it should be emphasised that the purpose of this instrument is not increase of accuracy, but rather a large decrease of loading imposed on the circuits being measured, so that voltages even on high-impedance resistors chains can be accurately measured without falsification. An accuracy of 10% is the normal tolerance of amateur multimeters anyway.

It should be pointed out that the method of calibration and adjustment with variable shunt and built-in reference voltage used also compensates for change of valve characteristics with age, an added advantage over the original circuit.

Finally, L1 makes C1 inoperative at R.F., so that the same A.C. Probe is usable for A.F. and R.F. Choose L1 so that the resonant frequency of L1 and C1 lies between the highest A.F. frequency and lowest R.F. frequency required to be measured. About 200μH is suitable.

Operation of VR1

As stated, VR1 is used to obtain electrical zero and, normally, zero should be found when VR1 is at the centre of its rotation. However, if VR1 is seriously displaced from the centre of its rotation on the more sensitive ranges, before zero can be found, then the grid (pin 7) may be connected via a resistor of between 1 and 10M to chassis instead of direct to chassis. Alternatively, another wafer on S1—S1c—might be used to switch a suitable resistor from pin 7 of V1 to chassis individually on each range.

Such modifications are not essential, for accuracy is not seriously disturbed even if VR1 is far

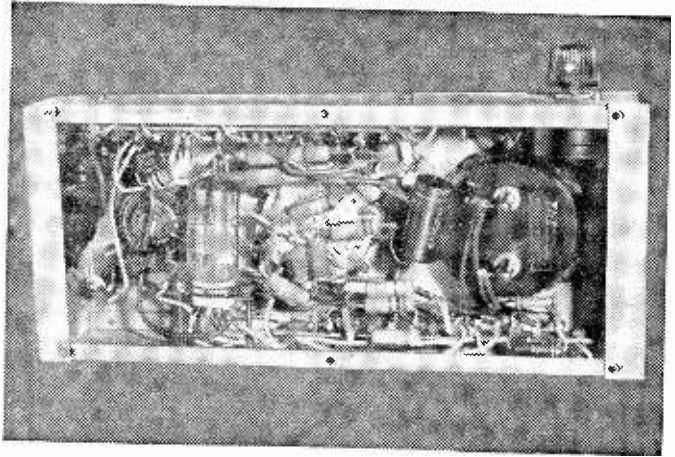

A rear view of the voltmeter.

from the centre of its rotation for balance to be obtained.

Circuit Adjustments

By far the most critical component for influencing the linearity of response, i.e. equal increase of deflection for increase of input voltage being measured, is the cathode resistance combination R13 and R14. The constructor is advised to start with all component values as specified, and if this does not give satisfactory linearity right away, then R14 should be replaced by various other values within about 2.5k and 10k. A fine correction can be made with R15. The value of the combination R18 and R19 largely affects the range of H.T. supply voltages within which satisfactory operation is possible.

Power Supply

Any available power supply of 250 to 350V H.T. and 6.3V A.C. at 0.3A is suitable. The H.T. consumption is about 10mA. One side of the heater supply and H.T. negative may be commoned in the power supply used.

The small 3-pin socket for power-supply connection used by the author consists of one of the fittings now often used for connections on tape-recorders, and a 3-core cable is attached to the fitting plug, with colour-coded wander-plugs fitted at the other end of the cable.

JOIN THE PRACTICAL GROUP

PRACTICAL TELEVISION	1/9
Every Month		
PRACTICAL MECHANICS	1/6
Every Month		
Devoted to Mechanics, Science and Invention		
PRACTICAL MOTORIST	1/6
Every Month		
PRACTICAL HOUSEHOLDER	1/3
Every Month		

Checking TEST Instruments

By G. A. W. Partridge

THIS UNIT WILL ENABLE THE CONSTRUCTOR TO MAKE QUICK, SPOT CHECKS ON HIS TEST EQUIPMENT

THE balanced voltage system is regarded as one of the most accurate methods of checking the readings of ordinary test instruments. Its operation is simple and the apparatus is quite easily constructed.

However, it will be appreciated that this home-made equipment cannot compare with the high grade apparatus on the market, but it will indicate any erratic behaviour of an instrument which may have become unreliable.

Operation

A slide wire is stretched between two terminals mounted on a board (Fig. 1). A scale marked in millimetres is placed close to the slide wire which is connected to the circuit shown in Fig. 2. The battery is connected to the slide wire and the switch is thrown to the left thus bringing into circuit the Standard Cell S.C. which has an EMF of 1.0183V. The slide wire is quickly touched with the test prod along its length until a point is found where no current is indicated on the milliammeter. The position of this point is noted by measurement in millimetres. The test prod must not be left in contact with the slide wire for more than a second at a time to avoid drawing current from the Standard Cell.

As soon as the null point on the slide wire has been found, the switch is thrown to the right, and the null point again found and noted on the millimetre scale. The reading of the voltmeter which is under test is also noted. The correct voltage is calculated from:—

$$\text{Correct Voltage} = \frac{\text{Standard Cell Voltage} \times \text{Slide wire reading with Voltmeter in circuit}}{\text{Slide wire reading with Standard Cell in circuit}}$$

This voltage, which is very accurate, is compared with that indicated on the voltmeter and any discrepancy noted. The same procedure can be carried out over the entire voltmeter range. After a little practice readings can be very quickly taken and worked out.

Additional Ranges

The instrument as it stands will test up to about 2V, so other apparatus will have to be added in order to test voltmeters with higher ranges. Fig. 3 shows how this is achieved.

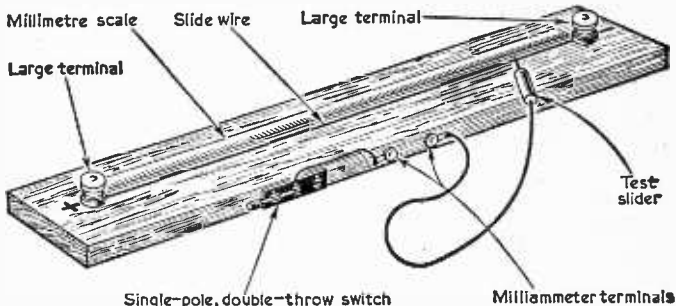

Fig. 1.—The basic slide wire potentiometer.

A number of accurate resistors are connected in series, and the voltmeter under test is connected to the appropriate voltage tap. The potentiometer measures the small voltage which appears across

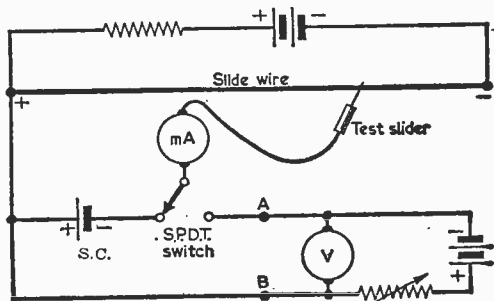

Fig. 2.—The potentiometer circuit for testing a low range voltmeter.

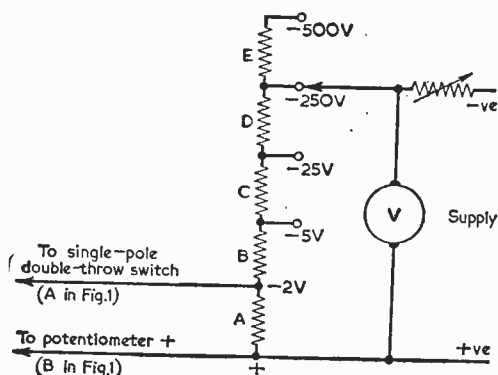

Fig. 3 (above).—Circuit for testing high-range meters.

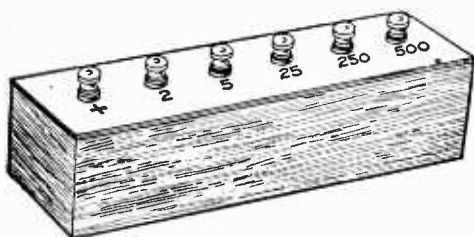

Fig. 4 (above).—The volt-box.

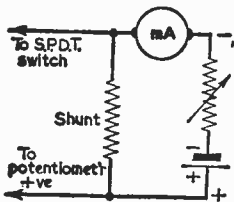

Fig. 5 (left).—Testing a milliammeter.

resistor A which is proportional to the voltage across the voltmeter. The tests are carried out in the same way but the voltage on the potentiometer is multiplied by the appropriate ratio. For example, the voltage across A will be 2 when 250V is applied to the 250V tap. Therefore $250=125$ which is the ratio in this case.

- 2
- The ratios for the taps are:—
 Tap 5 = 2.5
 Tap 25 = 12.5
 Tap 250 = 125
 Tap 500 = 250

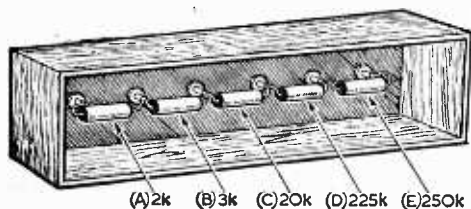

Fig. 6.—Rear view of the volt-box showing the resistors in position.

The measurement of current is also carried out with resistors. Fig. 5 illustrates the method. Assume that the milliammeter is scaled to 100mA. The 100mA shunt is connected as shown and gives 2V when 100mA is flowing through it. The ratio in this case will be 50. For example if the voltage measured is 1.35 then the current flowing through the milliammeter is $1.35 \times 50 = 67.5\text{mA}$.

The slide wire is made from resistance wire of about 2Ω per yard. This is not critical, but the higher the resistance the higher the voltage that can be measured. It is just over a meter in length and is stretched tightly between two terminals one meter apart on a wooden base 4ft. x 4in. x $\frac{1}{2}$ in. The meter rule or tape is held in position by $\frac{1}{2}$ in screws or tacks.

The switch which is of the single-pole-double-throw type is mounted on the side at the centre of the board. Two terminals are placed 2in. apart and about 6in. away from the switch as shown in Fig. 1. The nearest terminal is connected by a small length of bell wire to the centre of the switch. The test prod is connected to the other terminal by 3ft of light flex.

Fig. 4 shows the general idea of the volt-box. A row of terminals are mounted on the box which

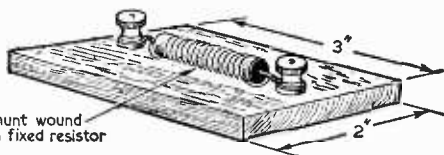

Fig. 7.—A current shunt.

is made from stiff cardboard. Fig. 6 illustrates the internal connections.

When ordering the resistors state that they are for measurement so that the supply firm will provide more accurate resistors than those used for ordinary radio work. They may cost a little more but for accurate tests they are essential. Five $\frac{1}{2}$ W resistors are required, and the values are:—
 A=2000 Ω ; B=3000 Ω ; C=20,000 Ω ; D=225,000 Ω ;
 E=250,000 Ω .

The shunts, or current measuring resistors, are each mounted separately on wooden bases with terminals as shown in Fig. 7 with the current range marked clearly on them. The 10mA shunt is 200 Ω ; the 100mA shunt is 20 Ω ; the 500mA shunt is 4 Ω .

These resistors are obtainable along with the Weston Standard Cell (small type) from the Doran Instrument Co., Stroud, Glos.

There are a few points that must be borne in mind while operating this test set. First, all connections must be as tight as possible. Second, the test prod must not be in contact with the slide wire for more than a second at a time. Third, the Standard Cell must be kept in a cool place. Fourth, not more than 1A must pass through the slide wire. Use two large 1 $\frac{1}{2}$ V dry cells with a 1 Ω 1W resistance in series. Finally, give the slide wire about two minutes to warm up before starting work, and tighten it if necessary.

Easy-to-build kit-sets of



highest quality at lower cost

THE "MOHICAN" GENERAL COVERAGE RECEIVER Model GC-1U

Fully transistorised, including 4 piezo-electric transmitters. The very latest and an excellent portable or Fixed Station receiver for the Ham and short-wave listener. **£38.15.0**

SHORT-WAVE TRANSISTOR PORTABLE Model RSW-1

Extending aerial, leather case, four band (2 short-wave bands Trawler and Medium). **£22.10.0**

6-TRANSISTOR PORTABLE Model UXR-1

Pre-aligned I.F. transformers, printed circuit, 7 x 4in. high-flux speaker. Real hide case. **£14.18.6**

DUAL-WAVE TRANSISTOR RADIO UJR-1

This sensitive headphone set is a fine introduction to electronics for any youngster. **£2.16.6**

HI-FI F.M. TUNER

Tuning range 88-108 Mc/s. For your convenience this is available in two units sold separately: Tuning Unit (FMT-4U) with 10.7 Mc/s. I.F. output £3.5.0 (inc. P.T.). I.F. Amplifier (FMA-4U) complete with cabinet and valves (£11.11.0). **£14.16.0**

HI-FI 16W STEREO AMPLIFIER Model S-88

20mV. basic sensitivity (4 mV. available, 7/6 extra). Ganged controls. Stereo-Monaural gram. radio and tape recorder input. Push-button selection. Two-tone grey metal cabinet. **£26.12.6**

6W STEREO AMPLIFIER Model S-33

3 watts per channel, 0.3% distortion at 2.5 w/chn 20dB N.F.B. Inputs for Radio (or Tape) and Gram. Stereo or Monaural, ganged controls. **£12.8.6**
Sensitivity 200 mV.

TRANSCRIPTION RECORD PLAYER, GL-58

Goldring—Lenco four speed unit. G.60 pick-up arm and infinitely variable speed adjustment, between 33½ and 80 r.p.m. with fixed speed at 16, 33½, 45 and 78 r.p.m. Balanced turntable (3½ lb.). **£20.12.2**
Stereo.

HI-FI SPEAKER SYSTEM Model SSU-1

Ducted-port bass reflex cabinet "in the white" Twin speakers. With legs £11.18.6. **£10.17.6**

"COTSWOLD" HI-FI SPEAKER SYSTEM KIT

Acoustically designed enclosure "in the white" 26 x 23 x 15½in. housing a 12in. bass speaker with 2in. speech coil, elliptical middle speaker and pressure unit to cover the full frequency range of 30-20,000 c/s Complete with speakers, cross-over unit, level control, etc. **£21.19.0**

COMPLETE MATCHED STEREO OUTFIT

includes record player, amplifier and twin speaker systems (pedestal speaker legs optional £2.2.0 extra). **£44.9.4**

STEREO CONTROL UNIT USC-1

Luxury model with press-button inputs to suit any pick-up or tuner and most tape-heads. Output 1.3 v. R.M.S. per channel. Printed circuit construction. **£18.18.6**

MULTIMETER Model MM-1U

Measures wide range of voltage, current, resistance and dB in over 20 ranges. Sensitivity 20,000 ohms/volt D.C. and 5,000 ohms/volt A.C. 0-1.5, 1,500 volts A.C. and D.C. 0-150µA, 15 A D.C. Resistance 0.2Ω to 20 MΩ. 4½in. meter. **£11.18.6**
50 µA f.s.d.

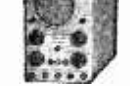

AMATEUR TRANSMITTER Model DX-100U
Covers all amateur bands from 160-10 metres. 150 watts D.C. input. Self-contained including Power Supply Modulator V.F.O. **£81.10.0**

AMATEUR TRANSMITTER Model DX-40U
From 80-10 m. Power input 75 w. C.W., 60 w. peak C.C. phone. Output 40 w. to aerial. Compact and self-contained. Prov. for V.F.O. **£32.10.0**

VAR. FREQ. OSCILLATOR VF-1U
Calibrated 160-10 m. Fundamental on 160 & 40 m. Ideal for our DX-40U and similar transmitters. **£11.2.0**

R.F. SIGNAL GENERATOR Model RF-1U
Up to 100 Mc/s fundamental and 200 Mc/s. on harmonics and up to 100mV. output on all bands. **£11.18.0**

AUDIO SIGNAL GENERATOR Model AG-9U
10 c/s to 100 kc/s. switch selected. Distortion less than 0.1% 10 v. sine wave output metered in volts and dB's. **£19.19.6**

VALVE VOLTMETER Model V-7A
Measures volts to 1,500 (D.C. and R.M.S.) and 4,000 pk. to pk. Res. 0.1 Ω to 1,000 M Ω. D.C. input impeded. 11MΩ. Complete with test prods leads and standardising battery. **£13.0.0**

Portable 2½ in. SERVICE 'Scope Model OS-1
Compact portable scope ideal for servicing and general work. Y amplifier sensitivity 10 mV/cm; response ± 3 dB 10 c/s-2.5 Mc/s. Time base 15 c/s-150 kc/s. Printed circuit. Case 7½ x 4½ x 12½in. **£19.10.0**
Wt. only 10½lb.

5 in. OSCILLOSCOPE Model O-12U
Has wide-band amplifiers, essential for TV servicing. F.M. alignment, etc. Vertical freq. response 3 c/s. to over 5 Mc/s. without extra switching. T/B covers 10 c/s to 500 kc/s. in 5 ranges. **£36.10.0**

RES.-CAP BRIDGE Model C-3U
Measures resistance 100Ω to 5MΩ, capacity 10pF to 1000µF, and power factor. Test voltages 5-450 v. with automatic safety switch. **£8.6.6**

SINGLE CHANNEL AMPLIFIER, MA-12
10-12 watt Hi-Fi amplifier. Extremely low distortion and wide frequency range. **£10.19.6**

HI-FI EQUIPMENT CABINETS
Range of cabinets available with at least one to suit your particular needs. From small to large, housing Tape Deck, Record Player and full equipment. In the white for finishing to personal taste. **From £11.5.6 to £17.18.6**

GRID DIP METER Model GD-1U
Coverage from 1.6 Mc/s. to 250 Mc/s. Complete set of plug-in coils provided. **£10.9.6**

TAPE RECORDING/PLAYBACK AMPLIFIER Model TA-1
Monaural (TA-1M) £18.2.6. Conversion unit to Stereo £6.10.0. Stereo (TA-1S). **£23.6.0**

'PACKAGED DEALS' of HI-FI
Equipment including TAPE DECKS RECORD PLAYERS and DECCA five PICK-UPS. Write in to see how these deals save you further money.

All prices include free delivery to UK
Deferred Terms
available on orders over £10



GC.1U

Please send me FREE CATALOGUE (Yes/No) _____
Full details of model(s) _____
NAME _____
ADDRESS _____
PW12

DAYSTROM LTD.

Dept. P.W. 12, GLOUCESTER, ENGLAND

A member of the Daystrom Group, manufacturers of the
WORLD'S LARGEST-SELLING ELECTRONIC KITS

FOR THE MAN AT HOME

12/6 SOLO SOLDERING TOOL

110 v., 6 v. or 12 v. (special) adaptor for 200/250 v. 10% (extra). Automatic solder feed including reel solder and spare parts. It is a tool for electronic soldering or car wiring. Revolutionary in design. Cannot burn. In light metal case with full instructions for use. Post 4".

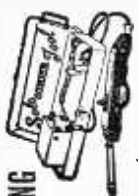

SPEAKERS - 8/9



DELUX RECORDER CABINET 79/6

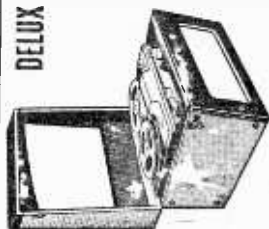

Beautifully styled rexine covered cabinet in Red or Beige. Size 14 1/2 x 13 x 9 1/2 in. Storage comp. in lid for tapes and mike. Easily adapted to Record Player Cabinet. Ins., Carr. 5".

TAPE RECORDER AMPLIFIERS

£9.15/6

By famous manufacturer. Superb 4-valve amplifier. Two controls and superimpose switch. Sockets for Mike and Gram. Size 11 x 4 x 6 in. Ins., Carr. 5". Drawings FREE with order.



5 1/2 in. SCOTCH BOY TAPE 19/9
Limited Quantity. Post Free.

★ XMAS! ★

LOOK -- EX-RENTAL SETS

17 INCH £11.00
Excellent Table models. ITA/BBC. Famous manufacturer. 12 months' guarantee. Terms available. Collection advised. Delivery rate by arrangement up to 50 miles, or despatch in 3 parcels for easy assembly. 25".

14 INCH £7.10.0
ITA/BBC. Identical to 17in. TV. Ideal for Caravans, Weekend Bungalows, Chalets, etc. 12 months' guarantee. Terms available. Carriage 20".



MINIATURE SPEAKER BRAND NEW. 16/9
5, 6, 8 and 7 x 4 in. Ex-manufacturer's salvage. Money back guarantee. Post and packing, 3/3.

TV TUBES

12 MONTHS' GUARANTEE

Terms available

21in. - 99/6

17in. - 90/-

15, 14, 12in. - 70/-

Insurance and carriage 15/6.



£1 extra without old bowl, refundable if same received within 14 days.

14in. TV TUBES 35/-
14KP4 Due to purchase of rental replacement stocks. Carr. 5/6. **36/24**

VALVES

SALVAGE GUARANTEED

1 1/9 each
6AM6, 6AT6, 6F1, 6F12, 6F13, 6F14, 6F15, 6K7, 6P25, 6P28, 8D3, 12S17, D77, DH77, EB41, EF91, PEN46.
2/9 each
6L18, 6SN7, 6U4GT, 10F1, 10P13, 12A17, 20D1, 20P3, B36, ECC31, ECC34, ECC31, EF80, EF92, EL32, EY31, KTY91, N37, PL33, UZ2, U31, U35, U151, U281, U282, UF41, W77.
30/- doz.
60/- doz.
6F6, 6V6, 7AN7, 9BW6, 12AX7, 20P2, 20P1, 20P1, 21A6, 30C1, 30L1, 30PL13, PCF80, PL81, PL83

Postage 1-7d. 6-1/6 12-2/6

ELLIPTICAL SPEAKERS

15/9
Brand new slot type. 8 x 3 in. and 7 x 4 in. P. & P. 3/3.

EXTENSION SPEAKERS



19/9
8in. P.M. Speaker fitted into polished cabinet. Complete P. & P. 4/3.

TRANSISTORS

Per Set **47/6** Post Free
MULLARD
1-OC81D 6/9, 2-OC81 6/9,
1-OC44 9/9, 2-OC45 8/9,
Diode 1/9.
--- GEC ---
114 6/9 EDISWAN
873 8/9 XC121 8/9
2-874 9/9 XB113 8/9

DUKE & CO.
(LONDON) LTD.
621/3 Romford Road,
MANOR PARK, E.12.
9 a.m.-6 p.m. STAMPS FREE
Half Day Thursday I.L.F. 6001/3
CATALOGUE

R.F., I.F. and A.F. Signal Generator

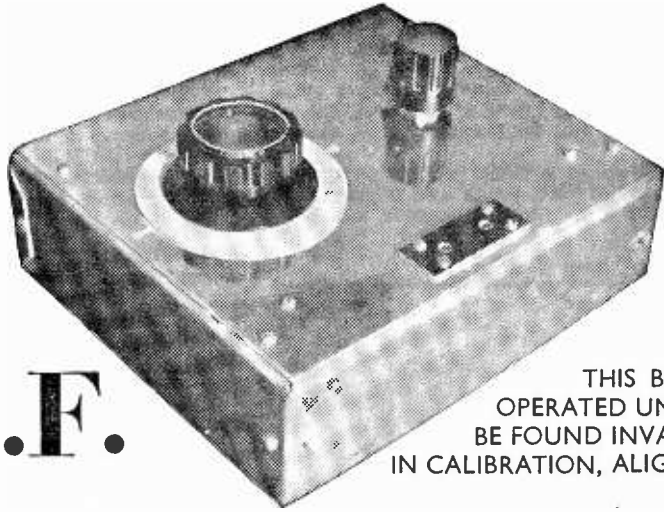

THIS BATTERY-OPERATED UNIT WILL BE FOUND INVALUABLE IN CALIBRATION, ALIGNMENT, ETC.

By F. G. Rayer

The two coils used were arranged to cover about 1,600kc/s to 500kc/s (about 190-600m) and 500kc/s to 170kc/s (about 600-1,800m). This includes 465kc/s, for I.F. alignment, in addition to all the usual medium-wave band, and most of the usual long-wave band. Harmonics are available up to 30Mc/s.

The M.W. coil was a standard air-cored type, with the addition of a dust core. For L.W., a standard-cored L.W. coil was found suitable, with the core almost unscrewed. The coils should be of the type which have reaction windings.

Valves other than the 1S4, may be used, 3S4, DL92, and similar types being satisfactory. The holder must, of course, be wired to suit.

JHIS unit requires very few parts, and runs from a 22½V, B112 or similar miniature layer H.T. battery, with a 1½V cell for the filament. It produces a modulated radio frequency signal, which can be used to test or align R.F. and I.F. stages in a receiver, or to calibrate home constructed sets. An audio output is also available, and this is suitable for stage-by-stage tests of A.F. amplifiers, or the audio circuits of receivers.

It is possible to calibrate the generator tuning dial by means of a receiver, as will be explained. Despite its simplicity, the generator will be found to be very useful for aligning, trimming, and testing TRF and superhet receivers of mains, battery, and transistor type.

Circuit

The circuit is shown in Fig. 1, and component values are so arranged that the R.F. oscillations are interrupted at audio frequency by grid blocking. The A.F. output socket provides an audio tone which is used for testing speakers, and A.F. amplifier stages. The R.F. output socket gives modulated R.F. at the frequency to which the generator is tuned. A single switch selects either of the two tuning ranges, and has an "off" position. A separate filament switch could be used, and a 2-pole, 2-way switch would then suffice for range selection.

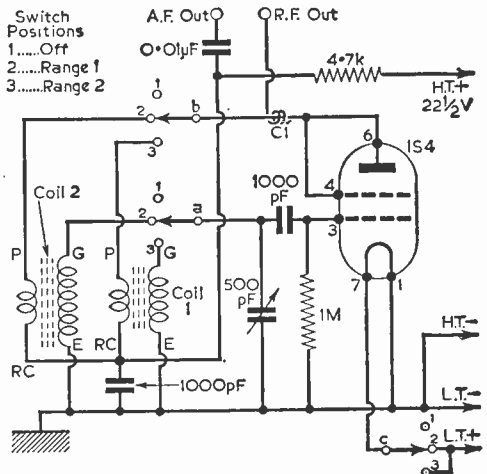

Fig. 1.—The circuit of the instrument.

The cabinet is a 6in. x 7in. x 2in. "universal chassis" with extra 6in. x 7in. back plate. An extra 7in. x 2in. runner forms the chassis.

The panel layout is shown in Fig. 2. The sockets of the twin strip project through clearance holes. The chassis should be bolted to the panel, but the generator should not be installed in its cabinet until finished.

Fig. 3 will act as a guide to marking out the tuning scales. The exact position of markings will depend on the tuning condenser, coils, and other

switch position, coil 1 is in circuit, G1 and P1 indicating Grid and Plate tags of this coil. The filament is also switched on, as before. The coils can be fixed on brackets, or bolted to the chassis.

Points marked M.C. are connected to the chassis in the usual way. Condenser C1 is formed by winding three or four turns of insulated wire round the insulated covering of the lead from valve to switch, as shown. Check connections against Fig. 4 before inserting the valve and installing the batteries.

Use as Audio Generator

For this application, the tuning calibration is of no importance. With the generator switched on, a strong audio tone should be heard in 'phones wired from the A.F. output socket to chassis. The note will vary according to the range selected, and the position of the tuning control.

If this audio tone is heard, this indicates that the generator is also producing its radio frequency signal. If no tone is heard, connections to the reaction windings on the coils may be reversed. Figs. 1 and 4 show usual connections, as indicated by most coil manufacturers. "G" denotes Grid, "P" indicates Plate (reaction) and "R.C." is for Reaction Condenser, with "E" showing the Earth or metal chassis connection.

To make stage-by-stage tests of audio circuits, take an insulated test prod connection from the A.F. output socket of the generator. Apply the prod to A.F. circuit points one by one, working

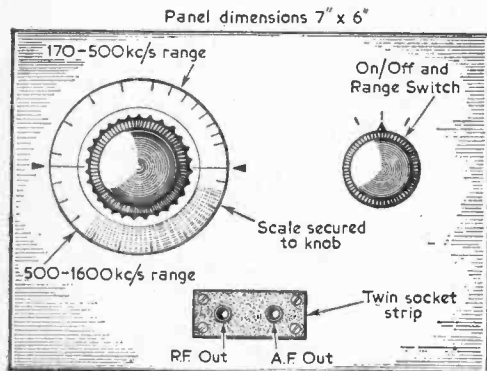

Fig. 2.—The layout of the front panel.

factors, and can be obtained as described later. The scale is cemented to the tuning knob, and rotates with the knob, readings being taken off at the panel markings shown in Fig. 2.

Generator Wiring

Fig. 4 shows connections and components, the underside of the valvholder being included so that pins may be seen. The tuning condenser should be of the full 500pF capacity, for the coverage mentioned, and its frame is in contact with the aluminium panel.

An L-shaped clip is cut from scrap metal, and drilled so that the switch secures it to the panel. The arms of the clip are bent to hold the 1½V filament cell, and 22½V H.T. battery, as in Fig. 4. Current consumption is small, and to avoid crackling, owing to poor contact, the battery leads are soldered directly to the batteries. This should only be done after completing other wiring.

The switch has three positions. One is for "off" and no circuit is completed, the unused contacts being ignored or cut off. With the switch in its next position the filament circuit is on, and the first tuning coil is connected. G2 and P2 indicate Grid and Plate (reaction) tags of coil 2. In the final

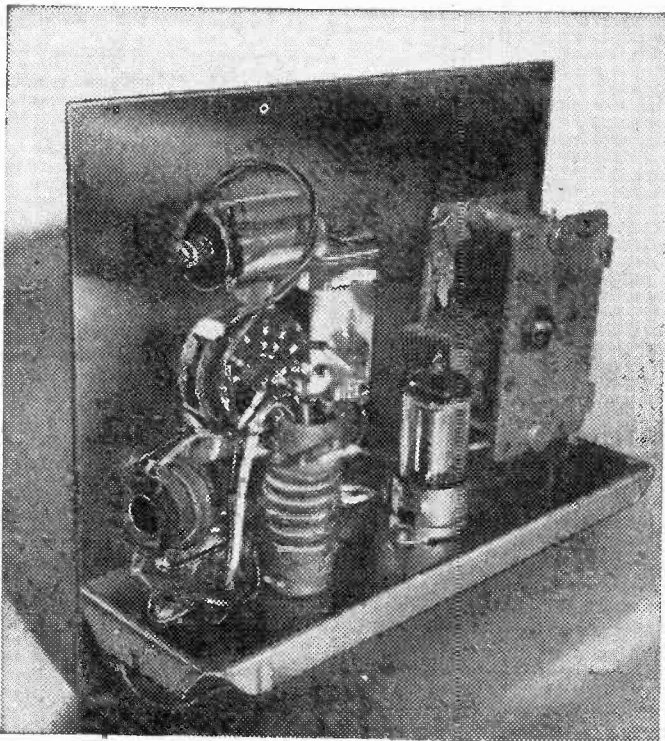

The instrument with its case removed.

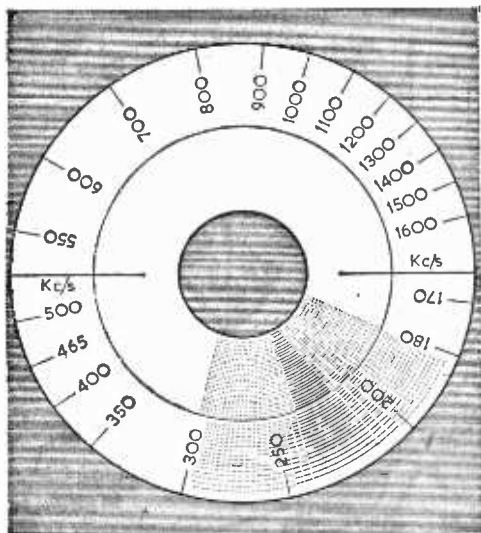

Fig. 3.—The markings of the frequency scale.

backwards from the speaker. Volume should increase, as each extra stage is introduced. When the point at which a fault arises is passed, reproduction of the audio tone will cease. If the audio tone is not heard at the very beginning of these tests, with the prod applied to the output valve anode, then the speaker itself, or its output transformer must be suspected. But note that

the generator cabinet may be wired to the receiver chassis. Take usual precautions with mains equipment, especially A.C./D.C. sets with a "live" chassis.

If tests are made systematically, working backwards through the receiver or amplifier, the source of a fault may be localised to a single component, if this is in a coupling circuit. Otherwise, the fault will be localised to one stage. The valve, and associated resistors, etc., in that stage should then be examined, substituted, or tested with a meter, according to the facilities available.

I.F. Circuit Testing

Point by point tests of intermediate frequency stages are made by plugging the test lead into the R.F. output socket of the generator. Apply the prod to the final I.F. stage anode, and tune the generator until its note is heard on the receiver.

The prod may then be transferred point by point, until the frequency changer anode is reached. If a defect is present in an I.F. transformer winding, or elsewhere, reproduction will cease when this point is passed.

To align I.F. stages, the generator tuning scale must be calibrated. The generator is then tuned to the correct frequency, and the I.F. transformers are adjusted for maximum output.

In all cases where R.F. and I.F. stages are being checked, keep the receiver audio volume control near maximum, and reduce coupling to the generator, if necessary, to obtain a tone of moderate strength in the speaker. Critical adjustments can then be most easily made. If a strong signal is injected to early stages, and the receiver volume control is near minimum, the receiver AVC action will make adjustment difficult. It will often be sufficient merely to place the generator test prod near the appropriate lead of the transformer or coil.

Generator Calibration

If an accurately calibrated receiver is available, place the generator output lead near the aerial socket of the receiver. Tune the receiver to various frequencies, adjust the generator tuning to the same frequency, and mark the dial accordingly. Initially adjust the coil cores to give about the wavebands mentioned.

If a calibrated generator can be borrowed, adjust this to various frequencies, tune the receiver to the same frequency, then tune the 1-valve generator to the same frequency, and mark its dial.

Extremely accurate calibration is possible from a 100kc/s crystal marker. Tune the receiver to the 200kc/s harmonic, adjust the generator to this, and mark its dial.

Then repeat at 100kc/s intervals, marking the generator scale each time.

If none of these means is available, the 1.500m Light Programme will furnish a 200kc/s marker signal. To use this, tune the receiver to 200kc/s

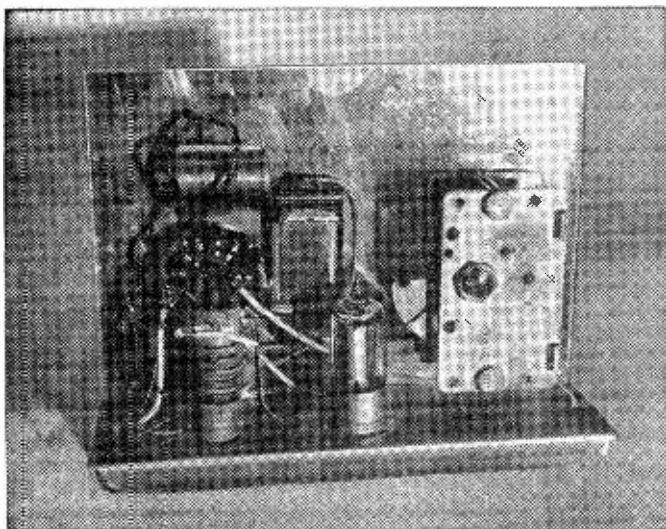

A rear view of the Signal Generator.

volume at this point will be small, as there will be no additional amplification.

In most cases no return connection need be made to the generator. But when volume is very small (as when testing a speaker and transformer)

(e.g. the Light Programme transmitter). Tune the generator to this frequency, and mark its scale. Leave the generator tuning untouched, and tune the receiver until the generator harmonic on 400kc/s is heard. Leave the receiver tuning untouched, and tune the generator harmonic on 400kc/s is heard. Leave the receiver tuning untouched, and tune the generator harmonic on 400kc/s is heard. Leave the receiver tuning untouched, and tune the generator harmonic on 400kc/s is heard. Return the receiver to 200kc/s, readjust the generator to this frequency, then tune the receiver to 600kc/s (ignoring the 400kc/s harmonic already used). Then leave the receiving tuning, and adjust the generator to 600kc/s, and mark its scale. Proceed in this way until the whole of both bands has been calibrated at 200kc/s intervals.

A list of BBC transmitters will give their frequencies, and these furnish additional check points. Tune in the required station, adjust the generator to this frequency, and mark its dial.

A 465kc/s calibration point for the generator can be obtained by placing the output lead near the I.F. stage of a receiver using this frequency, and tuning the generator for maximum response from the receiver.

Harmonics

As the correct use of harmonics can be extremely useful, both for calibrating the generator and for other purposes, it should be noted that these arise at multiples of the frequency to which the generator is tuned. For example, if it is tuned to 200kc/s, its note will be heard at 200kc/s (fundamental), 400kc/s, 600kc/s, 800kc/s, and so on, each harmonic being a little weaker than the previous one.

Similarly, if the generator is tuned to 400kc/s, it will be heard at 400kc/s, 800kc/s, 1,200kc/s, and so on, but not at 200kc/s. That is, its harmonics are always *multiples* of the frequency to which it is tuned.

With an average receiver, the harmonics of 200kc/s can be heard at 200kc/s intervals, right up to 1,600kc/s. With a sensitive receiver, the harmonics may be heard up to 4Mc/s. As the initial setting of the generator can be extremely accurate (e.g. from the 200kc/s Light Programme) the check points thus obtained are very useful indeed for calibrating home-constructed receivers, or similar purposes.

If the generator is tuned to 1,500kc/s, its harmonics can be heard up to 30Mc/s, with a sensitive receiver. With the generator tuned to 1,000kc/s, harmonics may be heard up to about 25Mc/s. These will, of course, be at 1,000kc/s, or 1Mc/s, intervals, and will be extremely useful for calibrating a home-built short-wave set, or for similar purposes.

A simple TRF receiver, with reaction, is very satisfactory for helping to calibrate the generator. With reaction sufficiently advanced,

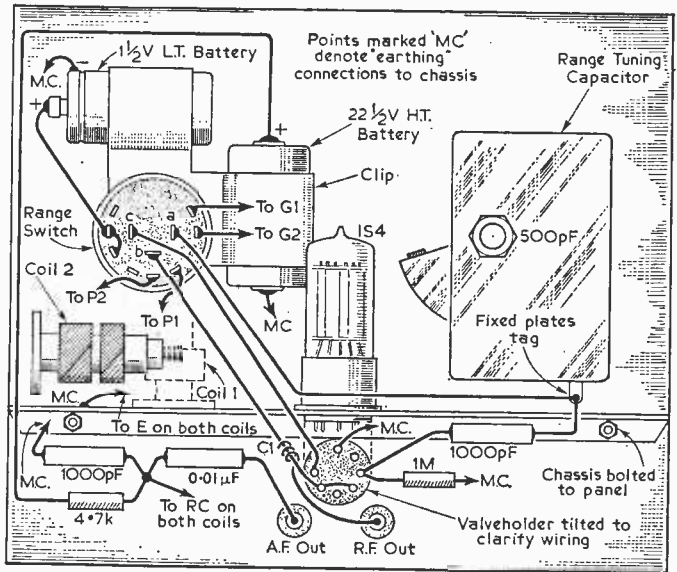

Fig. 4.—The component layout and wiring diagram of the complete unit.

the exact tuning point can easily be found.

An ordinary superhet is suitable, especially if it has a tuning meter or magic eye. In this case, the meter or eye will show the correct tuning point. If there is no meter or eye, turn the receiver volume control to maximum, and reduce volume by providing very loose coupling, as already explained.

When adjusting the generator to the same frequency as a radio station, reduce the volume of both signals, disconnecting the receiver aerial if necessary. With a little care, a standard of calibration sufficiently accurate for normal purposes can be achieved.

Aligning R.F. Stages

To adjust aerial or R.F. circuits, inject a signal of about 1,400kc/s at the aerial terminal, tune to this on the receiver, and adjust the M.W. trimmers for best results. Then inject 600 or 700kc/s, tune to this on the receiver, and adjust M.W. coil cores for best sensitivity. Repeat a few times.

If the receiver has a calibrated tuning dial, adjust trimmers and cores for best accuracy of reading, as well as best results. For a home-constructed receiver with uncalibrated dial, adjust for the expected waveband coverage (say 200-550m on M.W.). The dial can be calibrated at desired points, from the generator.

Treat each band separately. In simple dual-range receivers with only one pair of trimmers, these are usually adjusted for best M.W. reception.

PRACTICAL WIRELESS CIRCUITS

17th Edition

By F. J. CAMM

17/6 by post 18/7

from

GEORGE NEWNES, LTD.,

Tower House, Southampton Street, London W.C.2.

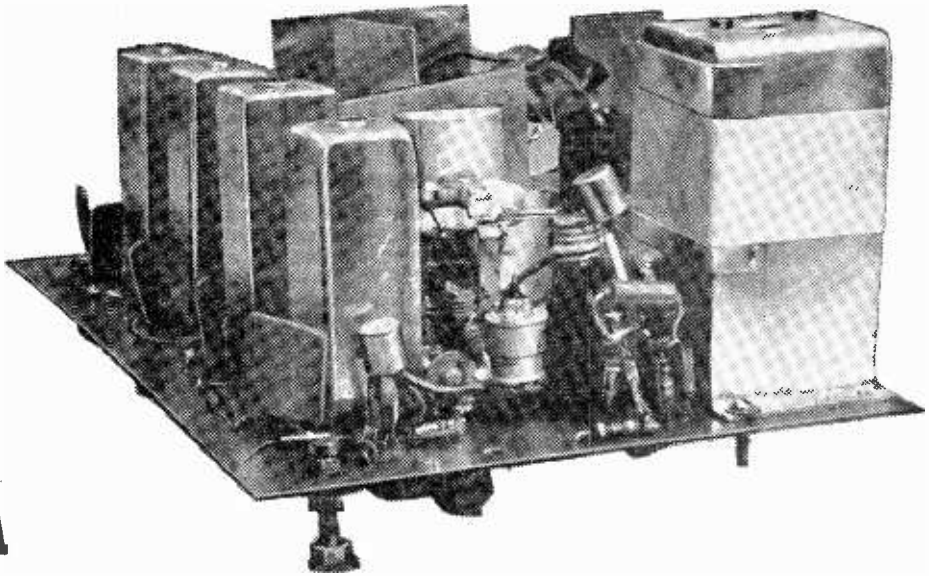

A Transistorised VHF Superhet

COMPLETING THE ALIGNMENT

By D. R. Bowman

(Continued from page 592 of the November issue)

IN last month's issue, the first three parts of the alignment procedure were completed.

4—Switch the signal generator to controlled output. Plug in coaxial lead. Bring it to the board and clip the outer braiding to chassis. Connect coaxial cable core (inner) to the base winding of Tr3 via a 25pF capacitor. Leaving ratio detector core (secondary) alone, re-align for maximum output in the loudspeaker.

5—Transfer the signal generator input to the base of Tr2 (C11). Complete alignment of T2 and T3 as before.

6—Screw in the core of the ratio detector transformer until it overlaps both primary and secondary windings. Adjust the core of the primary for maximum output. Very carefully screw the core of the secondary in towards the primary, keeping adjustment of the primary by slowly withdrawing the primary core. This is a two-handed operation, aimed at varying the coupling between primary and secondary by the adjustment of the coupling core. Continue until maximum output is heard in the loudspeaker. Then, reverse the direction of travel of the coupling core and rotate $1\frac{1}{2}$ turns, adjusting the primary core to maintain resonance. This gives more-than-critical coupling (about 1.5 critical) with little reduction in sound output; the decrease should be just noticeable, not a pro-

nounced drop off in volume. If $1\frac{1}{2}$ turns reversed travel causes a considerable drop in sound, less movement of the core is needed; a reduction of 2dB is ideally required and this may be judged by ear to a sufficient degree of accuracy.

7—Insert a third core in the ratio detector secondary winding. Rotate this to see if a minimum output point can be found. If not, use a brass slug instead of a dust core. Rotate the tuning element, whether iron dust or brass, for a minimum output between positions of high output. This point will be quite sharp and will be characterised by a change of "quality" of the output tone as the minimum output point is traversed.

8—Set the signal generator to 90Mc/s and connect the coaxial lead to the aerial socket. Set C7, C13 to approximately half setting and C12 to half capacitance. Rotate the core of L1 until a signal is heard; if a signal is heard in two positions of the core, the setting which gives least inductance is correct.

9—Set the signal generator to 86Mc/s. Rotate C7, C13 until the signal is heard. This should occur at nearly maximum capacitance; if not, adjust L1.

10—Set the generator to 100Mc/s. Adjust C12 to hear the signal, and the core of T1 for maximum output.

11—Set to 89Mc/s and locate the signal with tuning capacitor C7, C13. Rotate the core of T1 for maximum output.

12—Reset to 100Mc/s and adjust C12 for maximum output.

13—Repeat the adjustments 11—12 until no further improvement results.

(Continued on page 712)

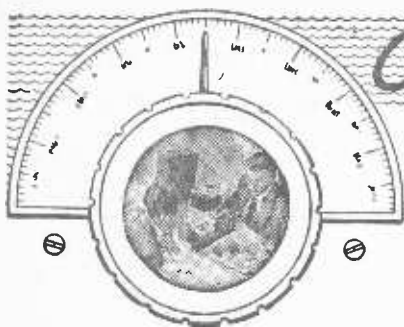

On Your Wavelength

BY THERMION

A Recording Problem

IN the details which I gave in the October issue of a tone problem connected with a tape recorder, many readers wrote with suggestions as to the cause of the trouble, and some very ingenious suggestions were made by some. However, several readers made the same suggestion and it would appear that this is, in fact, the real answer, and it concerns not the material from which the tape is made, nor its manner of storage, but the method of use. A Mr. Berry of Burton-on-Trent says he suffered from this trouble and after experimenting with different types of tape over a period of time without satisfactory results, he turned his attention to the deck, and located the fault in the pressure which was applied to the tape on the playback head. A small adjustment of the arm holding the pressure pad was the remedy, and since doing this he has had no further trouble.

Electronic Games

Some experimenters find a great deal of entertainment in the adaptation of standard electronic techniques to the requirements of equipment and apparatus which is not normally used in the electronic fields. Recently I saw a most ingenious electronic version of noughts and crosses—not the simple electric method which was seen at a Radio Show some time ago. This was truly electronic and made use of a computer network, and I was not really surprised when this was followed shortly afterwards by a modification to enable the game of "Nim" to be played. In this, as most of my readers know, a number of matches are laid out and the object is to make your opponent take the last match. This electronic version guarantees success, without worry, and according to the design cannot be beaten. I wonder how many other well-known parlour games have been adapted in this way. No doubt those who are engaged in designing and building computers for industrial purposes often think of other uses for them, a fact which is bound to come up when development work is being carried out. This is an interesting field for experiment by those readers who can follow simple computer design, and, as usual, we shall always be pleased to see the results of a reader's handiwork, and if interesting enough, to publish them. I am sure there must be some very interesting developments possible, even in such games as poker or bridge.

Artificial Troposphere

The use of the metallic cuttings for a reflecting layer to facilitate world-wide television and communications has, as I expected, raised considerable controversy amongst scientific men throughout the world. You will probably remember that the U.S.A. proposed that a rocket could fire an immense quantity of these strips into space, where they will form a fairly substantial metal layer from which signals could be bounced, but astronomers are complaining that this would make telescopic viewing even more difficult than it now is, whilst radio telescopic investigators complain that it will give false readings. I believe that the idea has been temporarily shelved, but I wonder if any unknown effects are likely to result from the various atomic explosions which are made from time to time. Will not the radiations which result remain for all time in space, and perhaps gradually form up to make a complete screen round our earth, thus preventing scientific observations of a certain kind, and perhaps even eventually preventing satisfactory control of space craft designed for the moon and other planets. I often wonder if it is possible for the men engaged in this work to calculate the possible effects over a period of time or whether they are not more interested in the present, as they will not be here later to feel the results of some of these activities. It would be reassuring if the powers concerned could let us have from time to time information on this aspect, as well as letting us know that a certain type of explosion has taken place.

FRIDAY, FEBRUARY 2nd, 1962

A FILM SHOW

(In collaboration with Mullard Ltd.)

CAXTON HALL, WESTMINSTER

at 7-30 p.m.

Send for your free tickets now marking your envelope "Caxton Hall" in the top left-hand corner and enclosing a stamped addressed envelope (at least 3½ in. x 6 in.) for the tickets.

The films to be shown will be announced later, but, as in previous years, the programme will be arranged to appeal to all who are interested in radio.

The demand for tickets will be great; order yours NOW.

LASKY'S RADIO

★ PER-RETURN MAIL ORDER SERVICE IF YOU CANNOT CALL AT EITHER OF OUR ADDRESSES

STEREO AMPLIFIER

Kit only 56/-

Twinn 4 watt (or 8 watt Monaural) employing two ECL82 and EZ80 RECT Valves, double wound mains transformer, etc., separate panel with base, treble and volume controls. Indicator lamps. Push button on/off switch. Elegant gold/cream knobs. Kit comprises two amplifier units and power unit all 5 x 2in. in size, fully assembled ready to be wired together. Kit is priced without loudspeakers so that you can choose the type and size required.

LASKY'S PRICE for the kit **56/-** post with 3 new Mullard Valves. 6/6 Full data, circuit diagram, assembly instructions and layout supplied.

SPECIAL OFFER OF SPEAKERS WITH THIS KIT

Two 5in. for 20/-; Two 6x4in. for 25/- Suitable cabinets available at bargain prices.

MARTIN RECORDER KITS TAPE AMPLIFIERS as advertised

KIT A. 4TR Amp for MONARDECK LASKY'S PRICE 9 Gns.

KIT B. 2TR Amp for MONARDECK LASKY'S PRICE 8 Gns.

KIT C. For COLLARO Studio Deck 11 Gns. Post free by return.



"CLARION" TRANSISTOR BATTERY TAPE RECORDER

Cassette drive, push-button controls. Constant speed 31 l.p.s. using 3in. spools. Size 9 x 5 x 3 1/2in. with transparent upper. New in maker's carton. LIST 25 Gns. LASKY'S PRICE **16/2** Gas. Carr. with mike and tap. 7/6

BUILD THE NEW LASKY FM TUNER FOR £4.19.6 P.P. 8/6

Non-drift permeability lining pack by famous manufacturer, frequency 88/100 Mc/s. OA81 balanced diode output 21F stages and discriminator. Smart cold and maroon glass dial 7 x 3in. self powered. Valve line up ECC85, two EF80's, EZ80 rectifier. Everything ready for assembly. All components available separately. Dimensions: 8 x 6 x 5 1/2in. Optional extra EM84 magic eye tuning indicator, 3/6. Circuit diagram and full data supplied. 1/8 post free.

BATTERY CHARGER BARGAIN

Mains input 200-250 v. A.C. 6 and 12 volts 2 amp. output. Latest type rectifier. Metal Case 6 x 3 x 3in. Hammered grey finish. P. & P. 3/- LASKY'S PRICE **21/-**



THE NEW "ALBERTA 5" TRANSISTOR POCKET RADIO

Push-pull. 200 milliwatts output. Five transistors and one diode. 2 1/2in. moving coil speaker, ferrite rod aerial. Med. and long wave. Smart plastic Case. 4 1/2 x 3 1/2 in. overall. CAN BE BUILT FOR **59/6** Post 2/-

All components available separately. Full details, circuit diagram, 1/8 post free.

THE "TORONTO 3" TRANSISTOR POCKET RADIO

Size 5 1/2 x 3 x 1 1/2in. Uses 3 transistors plus germanium diode, ferrite rod aerial. Tunable over med. and long waves. CAN BE BUILT FOR **32/6** Post 2/-

All components available separately.

TRANSISTOR RECORD PLAYER

CAN BE BUILT FOR **£9.19.6**

Carr. free



6 v. operation. For all L.P. and standard records. All components available separately.

AMPLIFIER. 300 milliwatts push-pull output, using two OC71 and two OC72 transistors. Fully assembled. 70/6. Knobs, 3/6 extra. P. & P. 2/6.

LOUDSPEAKER. 30 ohms. 7 x 4in. elliptical, matched to Amplifier, 25/-.

3-SPEED TURNABLE. 6 v., complete with L.I. crystal cartridge and two sapphire styl. 79/6. P. & P. 3/6.

CARRYING CASE. smart two-tone finish, 17 x 14 x 5 1/2in. High. 49/6. P. & P. 7/6. Batteries extra.



TELEFUNKEN STEREO HIGH FIDELITY AMPLIFIER

A complete stereo amplifier of unsurpassed quality with inputs for radio, tape recorder, P.M. tuner, etc., either monaural or stereo. 5 watts output (2 1/2 watts each channel), but actual power fed to speaker equals a normal 10-watt amplifier. For A.C. mains 100/250 v. Size: 12in. wide, 8in. deep, 2in. high, green grey enamel finish with gold trim, cream push-buttons. New in maker's cartons, fully guaranteed. LIST 16 Gns. LASKY'S PRICE **£7.19.6** Post 8/6.

THE TRANS TRONIC CONSTRUCTION KIT

Make your own transistorised transmitter and receiver. With components supplied, you can build 7 different circuits. Full size wiring diagrams for mounting on peg board 15 x 9in. supplied. Two transistors OC44 and OC72, 1 XTAL Diode. No soldering necessary.

IDEAL GIFT FOR YOUNGSTERS. All components marked for absolute simplicity, attractively packed in multi-coloured gift box. 16 page instruction booklet. Originally intended to retail at £5.4.6.

LASKY'S SPECIAL OFFER **49/6** complete. P. & P. 4/6. Money refunded if dissatisfied.

RECORD PLAYERS

Complete with p.u. and crystal cartridge. COLLARO Junior 4-spd. auto turntable and separate p.u., 75/-.

B.S.R. TUB, non-auto turntable and separate p.u., 79/6. Post free.

4-Spd. AUTO-CHANGERS: B.S.R., Collaro, Garrard. All types in stock. Send for money-saving list.

NEW TAPE RECORDER KIT

Handsome 2-tone blue carrying case, 17 1/2 x 6 x 16 1/2in., goldline fittings, removable lid, cut to fit.

COLLARO Studio Tape Deck, ECC85, EL84, EM81, level indicator, 2 inputs, mike and radio, low level output jack, separate power pack, contact cooled rectifier. All component parts sold separately. Amplifier complete with valves and power pack. P. & P. 3/6.

LASKY'S PRICE **£8.19.6** P. & P. 1/6. 7 x 7 1/2 x 4 1/2in. Loudspeaker, 16/6. P. & P. 1/6. Carrying Case 75/-, P. & P. 10/6.

LASKY'S SPECIAL PRICE for the above 3 items **£12.19.6** Carr. 12/6.

COLLARO Studio Tape Deck, 3 motors, 3 speeds, etc. LASKY'S PRICE **£10.19.6** Carr. 12/6.

SAVE ON COMPONENTS !!!

Send for the new 1961-2 edition of Lasky's 100-page COMPONENTS CATALOGUE. Price 2/-, post 6d. Our latest 12-page Bargain Bulletin included free.

Full stocks at both addresses

207 EDGWARE ROAD, LONDON, W.2
Few yards from Praed Street. PADDington 3271/2

33 TOTTENHAM COURT ROAD, W.1
Nearest station Goodge Street. MUSeum 2605

Both addresses open all day Saturday. Close 1 p.m. Thursday.
PLEASE ADDRESS ALL MAIL ORDERS TO DEPT. P.W., AT ABOVE EDGWARE ROAD ADDRESS.



Valves by return post

EF86	12/6	G232	11/6	PY83	8/6	UL84	9/-	SR4GY	9/6	6F6M	7/6	6X5GT	7/-	12SL7	8/-
EF89	8/9	HL23DD	8/6	PEN4VA	10/-	UJ6	19/3	SU4G	5/-	6J5GT	5/-	6/30L2	12/6	12SN7GT	10/-
EF91	5/9	HL42DD	10/-	PEN25	5/-	UY1N	12/6	SV4	11/6	6J5M	6/6	7B6	10/6	15D2	7/9
EF91(BVA)	7/6	KT2	5/-	PEN45	8/-	UY41	6/6	5Y3GT	8/-	6J6	4/-	7B7	8/6	25A6G	8/-
		KT33C	6/-	SP4	5/-	VP23	5/-	5Z4G	7/6	6J7G	6/6	7C5	8/-	25L6GT	10/-
EF92	6/-	KT33C	6/-	SP4	5/-	VP23	5/-	5Z4G	7/6	6K7G	3/6	7C6	8/-	25Z4	9/6
EF183	15/-	KT10	10/-	TP22	8/-	VR105/308L	6A2	6A8G	10/-	6K7M	6/9	7H7	8/-	25Z5	7/6
EF184	15/-	KTW61	6/6	U10	9/-	VR150/30716	6A8G	6A8G	9/-	6K8G	5/6	757	9/6	25Z6	9/6
EK32	7/-	MX40	12/6	U25	13/6	VU39 (MU)	6A5	6A5	5/-	6K7GT	5/9	7Y4	6/6	25Z6	10/-
EL33	10/-	OZ4	4/6	U26	12/-	12/14	8/9	6A5	4/-	6K8GT	10/9	10F1	12/6	30FL1	10/6
EL41	9/-	PCC84	12/-	U50	8/-	Y63	7/6	6A5	7/6	6L6M	8/-	10P13	22/3	30L15	23/3
EL84	9/-	PCC85	8/6	UABC80	9/-	IA7GT	13/6	6A6	7/6	6L6M	9/6	12A6	5/-	30P4	15/-
EL91	4/6	PCF80	8/9	UAF42	9/6	IC2	11/6	6A5	7/6	6L18	11/6	12AH8	12/-	30P12	12/6
EM34	9/6	PCF82	11/6	UBC41	8/6	IC5GT	12/6	6A76	8/6	6N7GT	7/6	12A77	7/6	30PL1	12/6
EM80	9/6	PCL83	13/6	UBC81	11/4	IH5GT	9/-	6BA6	7/6	6O7GT	7/6	12A77	8/-	35L6GT	10/-
EM81	10/6	PCL84	10/6	UBF80	9/-	IN5	10/6	6B6E	7/6	6Q7GT	9/6	12AX7	8/-	35Z5Y	9/-
EY51	9/6	PL36	13/6	UCC8410111	IR5	7/6	6BH6	9/6	6S5K7	6/-	12BA6	9/-	35Z4GT	8/-	
EY86	10/-	PL81	11/-	UCC85	9/6	IS5	6/6	6B16	9/6	6S7GT	8/-	12B56	9/-	42	8/-
EZ40	7/6	PL82	8/6	UCH42	9/6	IT4	5/6	6B6W	6/6	6S7GT	7/6	12C8	7/-	35Z5GT	9/6
EZ41	7/6	PL83	9/6	UCH81	9/6	3D6	5/-	6C4	4/6	6U4GT	9/2	12J7GT	10/6	50L6GT	8/6
EZ80	7/-	PL84	9/6	UCL82	11/6	3Q4	7/6	6C5GT	6/6	6V6G	7/6	12K7GT	6/6	75	10/6
EZ81	7/6	PX25	12/6	UCL83	13/6	3Q5GT	9/6	6C6	5/-	6V6GT	5/9	12K8GT	13/-	142BT	3/6
FC13	5/6	PY80	7/6	UF85	9/-	3S4	7/6	6D6	7/6	6X4	7/6	12Q7GT	6/6	210DDT	4/6
FW4/500	10/-	PY81	8/6	UF89	9/-	3V4	8/-	6CH6	7/6	6X5G	7/6	12SK7	6/-	210VPT	3/6
EC90	4/6	PY82	7/6	UL41	9/-	4D1	3/-	6F6G	7/6						

MULLARD TRANSISTORS

OC19	48/-	OC77	10/-
OC35	25/6	OC78	8/-
OC44	11/-	OC78D	8/-
OC45	10/-	OC81	8/-
OC70	6/6	OC84	11/-
OC71	6/6	OC170	13/6
OC72	8/-	OC171	14/6
OC72pr	16/-	OC201	12/6
OC73	16/-	OC202	36/-
OC75	8/-		

A SPECIAL OFFER OF SIX MULLARD TRANSISTORS

1 OC44, 2 OC45, 1 OC81D, 2 OC81. Only 37/6 set.

EDISWAN TRANSISTORS

XA104 12/-, XA103 10/-, XB102 6/6 ea.

RECORDING TAPE

Special Offer of Top quality recording tape, 3 1/2 in. spool 200ft, 5/3, 5 1/2 in. spool 600ft, 13/9, 5 1/2 in. spool 850ft, 18/6, 7 in. spool 1200ft, 23/-. Extra-play tape, 3 1/2 in. spool 300ft, 7/-, 5 in. spool 900ft, 21/-, 5 1/2 in. spool 1275ft, 26/6, 7 in. spool 1800ft, 37/6. Empty spools, 3 1/2 in., 1/6, 5 in., 2 1/2, 7 in., 3/-.

RECTIFIERS

RM1 5/3, RM2 6/9, RM3 7/6, RM4 13/6, RM5 19/6, 14A86 19/6, 14A97 19/6, 14A100 19/6, LV7 17/6, 18RA 1-1-16-1 6/-, FC31 (14RA 1-2-8-3) 22/6, FC101 (14RA 1-2-8-2) 16/6.

HIGH RESISTANCE PHONES

High Resistance Phones, 4,000 ohms, 13/6 pair.

LOUDSPEAKER UNITS

All brand new
 2 1/2 in. square Rola C2526/10
 2 1/2 in. square EMI18/6
 4 in. square Elac Tweeter12/6
 5 in. round Plessey with O.P.T.16/6
 6 1/2 in. round Celestion17/6
 8 in. round Richard Allen18/6
 12 in. round Plessey29/6
 6 in. x 4 in. Plessey19/6
 7 in. x 4 in. Plessey19/6
 8 in. x 5 in. Celestion19/11
 10 in x 6 in. Celestion and Plessey21/6

STENTORIAN HF 1012

10 in. die-cast unit, incorporating 12,000 gauss magnet. Handling capacity, 10 watts. Frequency response, 30 c.p.s.-14,000 c.p.s. Bass resonance, 35 c.p.s. Total price, £5.26

MARTIN RECORDAKIT

Model C for Collaro Studio Deck. Amplifier 8311/V assembled and tested with 5 BVA valves, controls, switches, transformers, knobs and full instructions. £11.10.0.
 Smart 2 tone leatherette covered wooden case and 9 x 5 in. high quality loudspeaker, type C6659/V. £5.5.0.
 Circuit diagram, full instructions, shopping list, etc., 3/6 ea.
 Collaro Studio Deck, £12.12.0
 Illustrated leaflet available.

AUTOMATIC RECORD CHANGERS

★ UA14

Four speed motor. Magid selector enabling 7, 10 and 12 in. records to be selected automatically. "Flu-Fi" turnover crystal cartridge. Attractively styled in cream and grey. Suitable for A.C. mains, 100/125 v. 50 cycles. Unit plate. £6.19.6

★ Collaro C60

Four speed motor for A.C. mains 200/250 v. 50 cycles. Fully mixing changer on 7, 10 and 12 in. records. Complete with Acos GP67/IC crystal cartridge. Unit plate 12 x 13 1/2 in. £7.19.6

★ Garrard Autoslim The latest 4-speed automatic Record Changer from Garrard-Autoslim, £9.0.0.

SINGLE PLAYERS

★ EMI 985

4-speed Turntable Unit complete with Pickup. An extremely reliable and inexpensive Unit suitable for Record Players and Radiograms; a heavy 86 in. dia. Metal Turntable with low flutter performance, 5-position switch, 4 speeds and off, Ivory finish with red T/T mat. 89/6.

★ Garrard TA/Mk II 4-speed single player. Diecast aluminium pickup with GC2 cartridge. Automatic stop. 9 1/2 in. dia. turntable. £8.10.4

TEST METERS A.10

D.C. or A.C. Resistance ohm: 10K ohms. Will also measure decibels. Price £4.17.6. Inclusive of test prods, instruction book and batteries.

B.20

D.C. or A.C. Will also measure decibels. Price £6.10.0. Inclusive of test prods, instruction book and batteries.

SPECIAL OFFERS

Paxolin sheet, 1/4 in. thick, 6 x 6 in. 1/-; 12 x 6 in., 2/-; 12 x 12 in., 4/- each. Special Purchase, ex-Government Rectifiers, 250v., 45mA ... 3/9 each.

CARTRIDGES ACOS 653/G, 17/6

ACOS 73-1. Dual purpose cartridge for Monoaural and Stereo use. A high output cartridge with good separation on Stereo. 32/6.

ALL COMPONENTS FOR THE "PRACTICAL WIRELESS" BLUEPRINTS ARE AVAILABLE FROM STOCK. PLEASE SEND FOR A DETAILED PRICE LIST AND INCLUDE STAMPED ADDRESSED ENVELOPE.

CATALOGUE OUR 1962 CATALOGUE IS NOW AVAILABLE. PLEASE SEND 1/- IN STAMPS FOR YOUR COPY. TRADE CATALOGUE ALSO AVAILABLE, FOR WHICH PLEASE ATTACH YOUR BUSINESS LETTER HEADING.

TERMS: Cash with Order or C.O.D. Postage and Packing Charges extra. Single valves 9d., Minimum Parcel Post charges 2/-. Please include sufficient postage with your order. Minimum C.O.D. fees and postage 3/6. These Postal Rates apply to U.K. only. For full terms of business see inside cover of catalogue. Personal Shoppers 9 a.m. to 5 p.m. Mon. to Friday, Saturday 10 a.m. to 1 p.m.



103 LEEDS TERRACE
 WINTOUN STREET
 LEEDS 7

Understanding POWER Supplies

THE DIODE VALVE AND THE HALF-WAVE RECTIFIER CIRCUIT

By A. Foord

IN order to understand how power supplies work, it is first necessary to understand fully how the diode valve works, since all power supplies are concerned with diodes of one form or another. The power supply circuits used in radio engineering generally use A.C. mains as the power source.

The function of the power unit

The function of the power unit is to provide smooth D.C. voltages as required by valves and other devices. This article will only deal with the more important circuits and not with heater supplies, as similar circuits are used for low voltage supplies and H.T. supplies.

The Diode

When any material is heated sufficiently, electrons (which have a negative charge) are thrown off. When electrons are emitted from a heated cathode they collect around the cathode. Since the cathode loses electrons its perforce becomes positive. This tends to attract the electrons back. Electrons, then, are continually being emitted from the cathode only to fall back. If a positive charge is placed

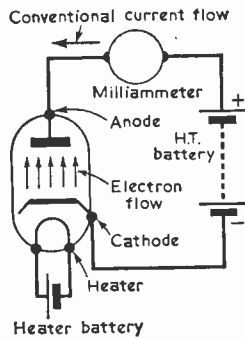

Fig. 1.—The current flow through a diode valve.

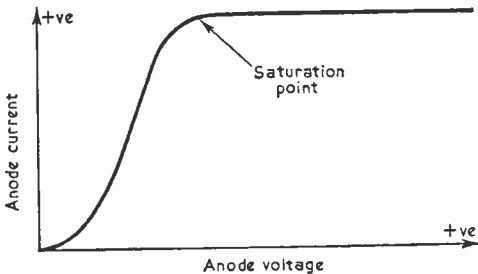

Fig. 2.—The anode voltage to current characteristic of a diode.

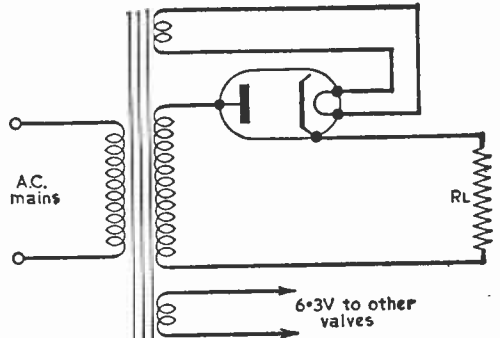
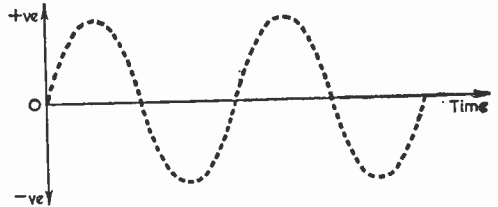

Fig. 3. (above).—A half-wave rectifier circuit.

Fig. 4. (below).—The voltage input to a half-wave rectifier.



on the anode by means of a battery, then electrons are attracted to the anode, and flow through the battery back to the cathode. It will thus be noted that electrons flow in the opposite direction to conventional current. This is due to the fact that the first scientists investigating electrical phenomena chose their direction of current flow before electron flow was discovered. It will thus be seen that when the anode is positive, conventional current flows from anode to cathode, as shown in Fig. 1; but when the anode is negative no current flows. Therefore, the higher the anode voltage the greater the current. This is only true until all the electrons emitted by the cathode reach the anode. When this occurs no more current flows, and the "saturation point" is said to have been reached. If anode voltage is plotted against anode current as in Fig. 2, it will be seen that the curve is not linear. In other words the internal resistance of the diode varies with the current.

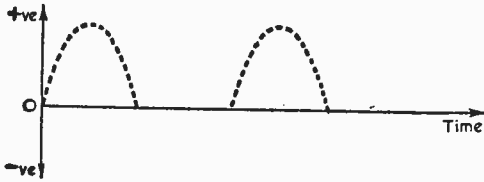

Fig. 5 (above).—The voltage output from a half-wave rectifier.

Fig. 6 (below).—The circuit of Fig. 3 with a reservoir capacitor added.

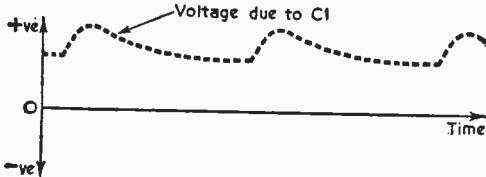
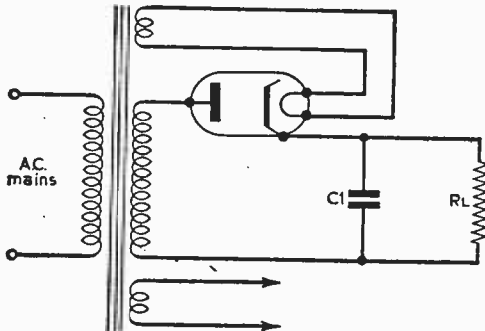

Fig. 7.—The voltage output from a circuit, such as that of Fig. 6.

The half-wave Rectifier Circuit

The complete circuit for half wave rectification is shown in Fig. 3. Basically it consists of a diode rectifier in series with a load resistance R_L . The purpose of the mains transformer is to enable the A.C. voltage applied to the rectifier to be made a suitable value, and also to provide L.T. supplies for the rectifier and the heaters of other valves. Another advantage of the transformer is that it enables the chassis to be isolated from the mains, so that the chassis can safely be earthed. The input to the rectifier is of course a sine wave, as shown in Fig. 4. Since the diode conducts only when its cathode is negative to its anode, then the output voltage would be as given in Fig. 5. This is obviously a long way from a smooth D.C. voltage. The average value of the wave in Fig. 5 will be very much less than the average of Fig. 4, resulting in a low efficiency as well as a high ripple.

If however a reservoir capacitor C_1 is added to the circuit, as shown in Fig. 6, then the output is raised. Very simply, the capacitor is charged to the full peak voltage of the supply by each alternate half wave of the output, and then slowly discharges itself during the interval to the next half wave. The output voltage is then as shown in

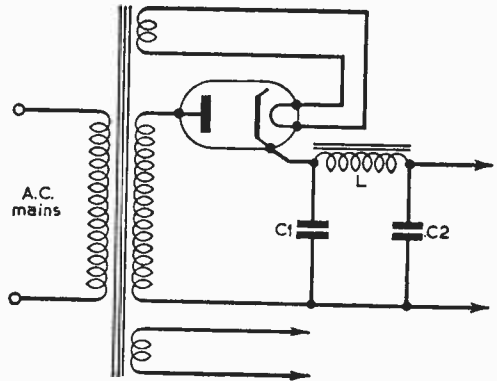

Fig. 8.—A half-wave rectifier circuit, with reservoir and smoothing capacitors and an inductor.

Fig. 7. Although this gives a much higher output voltage, there is still a fair amount of ripple left. To help reduce this to a reasonable value, the smoothing components L and C_2 are added, as shown in Fig. 8. The D.C. voltage passes through L and over C_2 unchanged but the A.C. component will divide itself between L and C_2 according to the reactance of L and C_2 and the frequency concerned (50c/s for normal mains). If the reactance of L were 15 times the reactance of C_2 , then the ripple would be reduced in the same ratio. From the A.C. point of view for every 15mV (say) developed across L , then only 1mV would be developed across C_2 , thus out of 16mV fed into the filter network only 1mV appears on the output.

(To be continued)

A Transistorised VHF Superhet

(Continued from page 707)

Final Inspection

Finally, a check should be made, using the aerial signal, to ensure that the correct band is being covered. If desired, final adjustments to T_1 and C_{12} can be carried out on the Home and Light programmes. The receiver is very sensitive, so if this is done, one must ensure that the same stations are being received each time tuning is changed. The last adjustment is the ratio detector secondary core; this may need $\frac{1}{4}$ turn or so one way or the other, using a programme source of signal, to ensure that the minimum-noise tuning point is that giving best audible quality, and that when no modulation is being transmitted, equal noise each side of the tuning-point is obtained. The adjustment is fairly critical; so care will be needed.

For maximum sensitivity, the voltage across C_{37} should be used to indicate alignment rather than the volume of sound in the speaker. This method of alignment is more accurate and will result in some loss of bandwidth. Voltages measured will be much less than those obtained with a valve-operated receiver; a strong signal at the aerial may only give $\frac{1}{2}$ V or so, and weaker signals only 100mV or so, while good reception is obtained when only a very small voltage is measured across C_{37} . The presence of only small voltages should therefore cause no dismay.

Improving the All-band TRF

ADDING AN R.F. STAGE

By J. L. Wain

*I*T was decided to rebuild the Beginner's T.R.F., described by F. G. Rayer in the March and April 1959 issue, making a few improvements and adding an R.F. stage. The final result was most satisfactory with extremely good sensitivity, selectivity, volume and tone.

The first valve acts as the R.F. amplifier. A 2-pole 5-way switch enables the aerials to be tuned or untuned. VR1 controls R.F. gain. The signal is fed via an R.F. transformer (detector coil) to the second valve, which acts as detector (as before). An EF39 valve was used as V1.

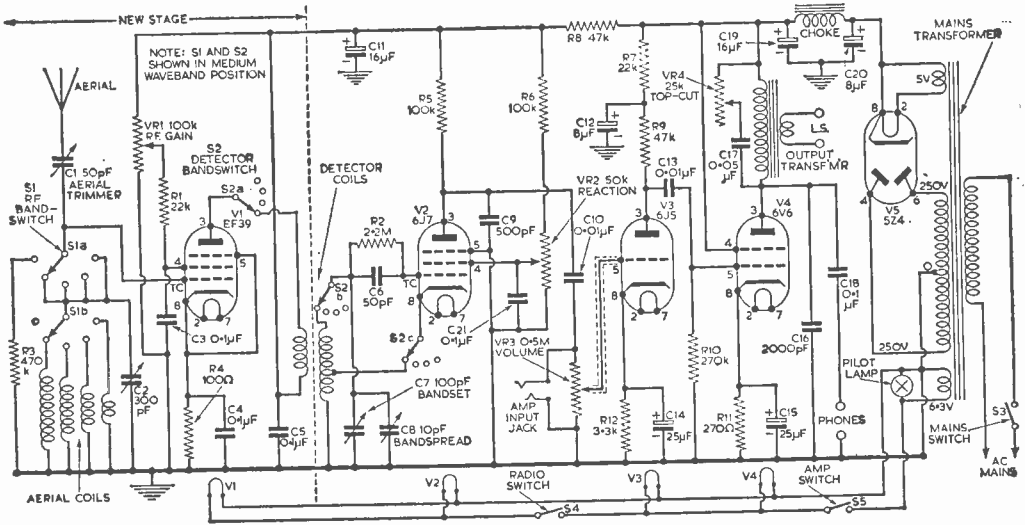

Fig. 1.—The complete circuit diagram of the improved receiver.

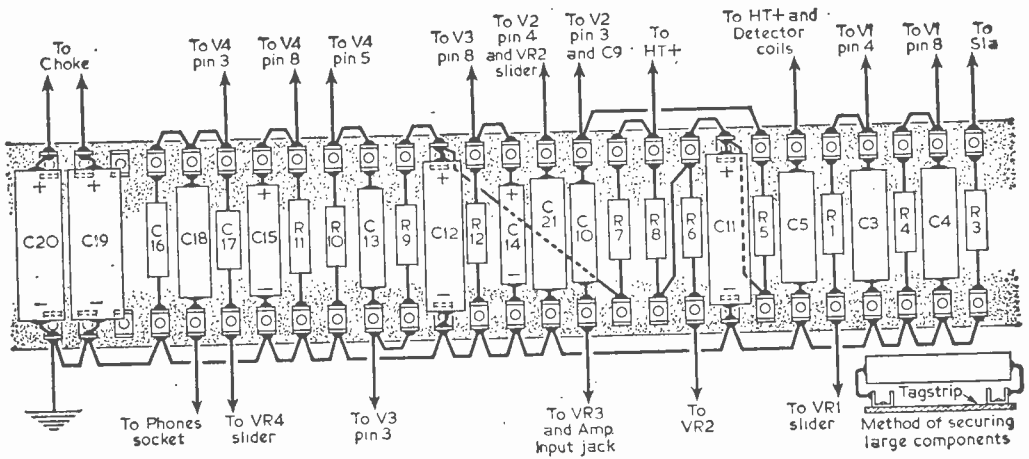

Fig. 2.—The wiring of the components on the large group-board under the chassis.

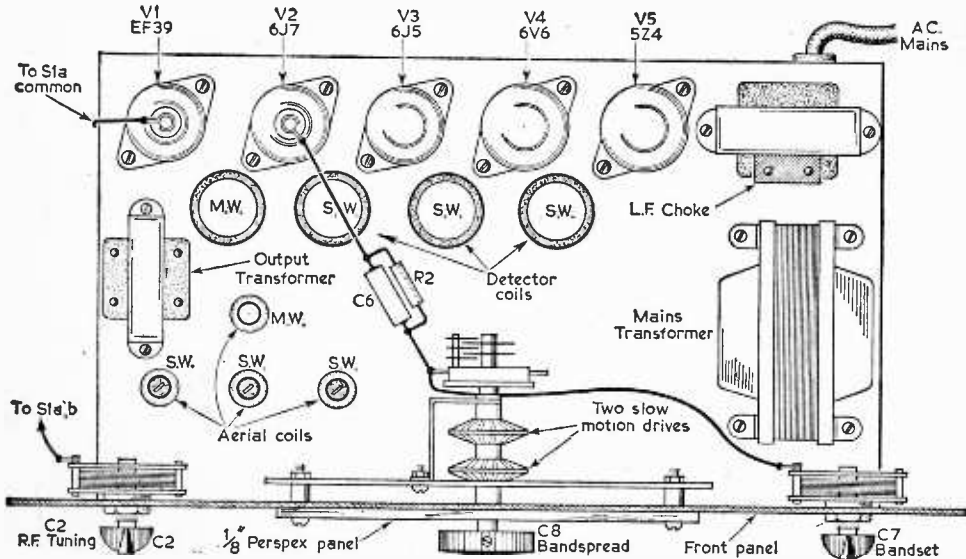

Fig. 3.—The above-chassis layout.

To make the circuit really comprehensive, two switches are included in the heater line, so that the power pack or the amplifier can be used alone. One switch, connected into the heater line between 6J5 and 6J7, is to cut out the tuner and the other connected between 6V6 and 5Z4 is to cut out the amplifier. A screened lead is taken from the volume control to a jack socket to provide an amplifier input.

Plug-in coils, did not appeal, so a 4-way 3-pole wavechange switch was used instead, with the

H.T. and earth connected direct to the coils.

Chassis and Front Panel

The receiver is assembled on a chassis 7in. x 13in. x 2 1/4in., and an aluminium front panel 16in. x 9 in. An aperture is cut in the front panel, with the aid of a fret saw and a half-round file, to allow a slow-motion tuning assembly to be fitted. The rest of the holes can be marked out from Fig. 4.

The extra stage can be added without alteration

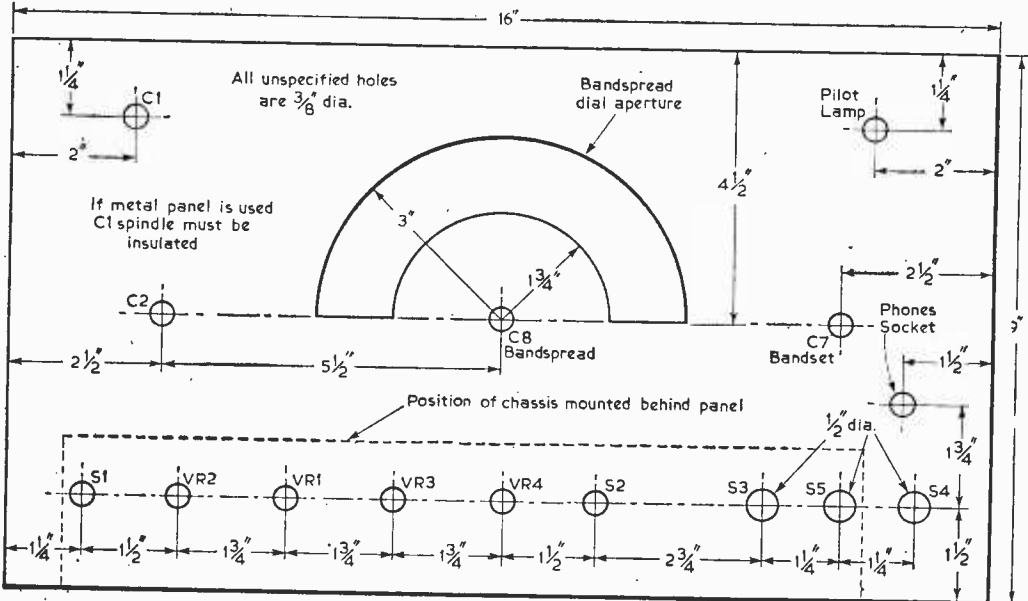

Fig. 4.—The front panel drilling details.

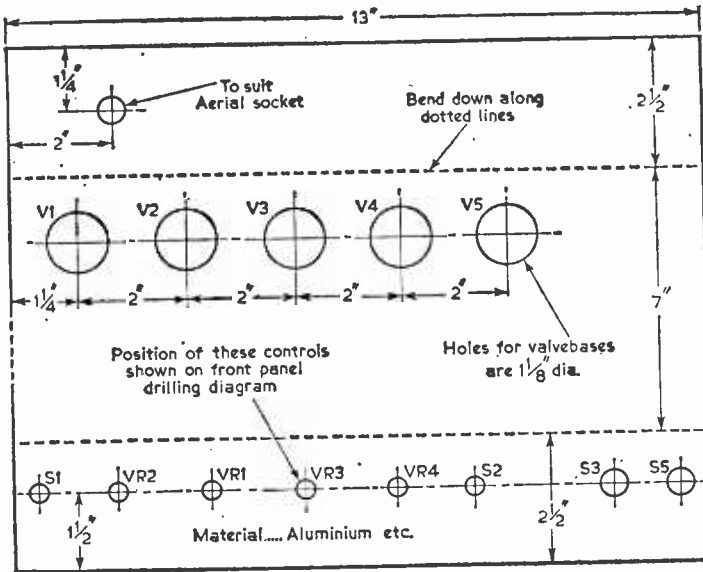

Fig. 5.—The chassis drilling details.

to the original circuit (with the exception of the detector coils), but it is suggested that the receiver is stripped down and the construction started afresh.

Group Board

It was decided that practically all the components should be mounted on a group board, so a large 36-way group board was obtained. The components are arranged as shown in Fig. 2, and the group board is then fixed with the aid of 4B.A. bolts and lock-nuts to the underside of the chassis, and the remainder of the wiring can then be completed. It will be necessary to bend the wires of some of the larger capacitors, in such a way that they may be attached to the outer tags on the group board. It will be noted that C9 from the anode of 6J7 to earth is not included on the group board with the other components, because this was one of the flat mica type of

condensers. A screened lead should be used for the connection from the slider of the volume control to the grid of 6J5.

Slow-motion Drive

The bandspread condenser C8 is fitted with a slow-motion drive so that stations can easily be logged. Two 5:1 drivers were purchased and connected together to give a ratio of 25:1. These drivers are made to fit directly on to the condenser spindle, but have a projecting lug which must be held by a bracket, or a long bolt and lock-nuts, or the drive will not function. A piece of aluminium about 1 1/2 in. x 2 1/2 in. is bent at right angles 1/2 in. from the bottom, to make a bracket for the bandspread condenser. The lugs of the two drives are also anchored to this bracket by the method explained above.

(To be continued)

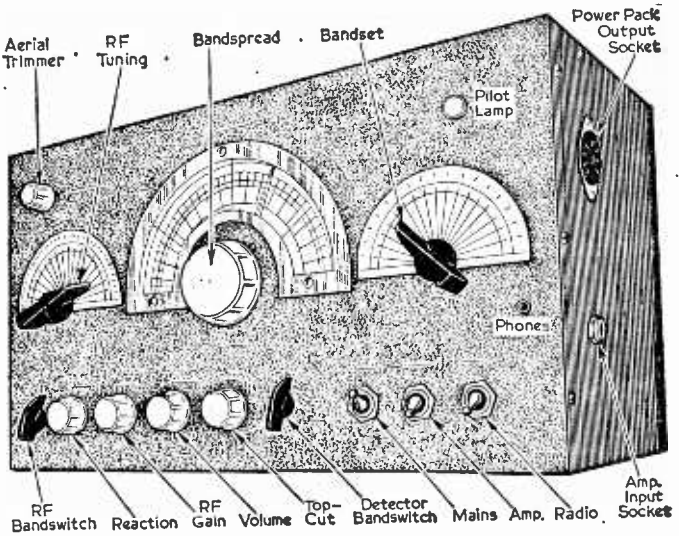

Fig. 6.—The front panel controls.

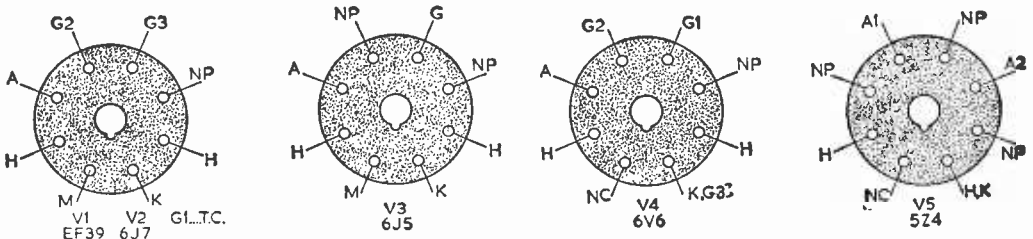

Fig. 7.—The valve base connections.

Practical Wireless

CITIZEN

The P.W. 'Citizen' is the third blueprint design in our progressive series and has been especially designed for successful construction by those who first began building radio sets with 'Tutor' in the October issue.

Preparing the Group Board

Refer to the Blueprint. Notice the numbering of the tags; as in the Mini-Amp, it is a good idea to stick paper strips on to the group board so that there is no confusion when wiring up by the numbers (see Fig. 2 on the "Mini-Amp" Blueprint). The numbering shown is when the strip is viewed with the soldering tags on top. Tags 17 and 35 are carefully removed by drilling partly through (on the rivet side of the board) with a $\frac{1}{8}$ in. drill. The tags are removed so that the undamaged holes in the paxolin may take two small bolts which will eventually hold the tuning capacitor on to the board (see Figs 6 and 7). The spacing of the holes is already correct.

The hole "D" in Fig. 3 is now enlarged to take the $\frac{1}{2}$ in. boss of the wave-change switch (S1), and two more holes are drilled each side of holes F and G as shown in Fig. 3. The position of these is important and therefore a full-size template is given in Fig. 15 (above). Two more holes are drilled near to tags 10 and 28. The oscillator coil should now be tried for a fit (the fixing tags go through the two outside holes). Do not attempt to force it into position for it may be damaged. If the fit is satisfactory, mount the oscillator coil from the rivet side of the group board and solder the fixing tags to tags 10 and 28 (see Fig. 4), making

sure that pin 1 (near the red spot on the base—Fig. 8) lies near tag 10 and not tag 27.

Fixing the Tuning Capacitor and Wave-change Switch

The wave-change switch is mounted with the switch on the tag side of the board and the spindle on the rivet side. It is arranged so that the connections are in a similar position to those in Fig. 4 and the nut is then tightened up using a non-slip washer beneath it. It may be necessary to flatten out tags 4 to 8 and 22 to 26 as shown in Fig. 3, tag 8 being soldered directly, or wired, to the casing of the switch assembly (see Fig. 4).

The variable capacitor should now be examined carefully. It *must* have a metal screen between the two ganged sections and be fitted with small trimming condensers on the back (C1a and C2a—Fig. 7). The smaller section is C2 and the larger section is C1. Although three fixing holes are provided at the front of this condenser, these are not used. Two small threaded holes will be found on the back of the condenser and these are used for mounting. Bolts are fitted with solder tags and passed through holes 17 and 37 (Fig. 4) from the tag side of the strip. Two $\frac{1}{8}$ in. thick washers are fitted on the rivet side of the strip and the bolts are then screwed into the holes on the condenser—the washers, in fact, space the condenser away from the board (see Fig. 7). Be careful that the bolts are not too long or they will badly damage the stators of the condensers. The mounted condenser will appear as in Fig. 7. Note that both the oscillator coil and tuning condenser must be firmly fixed for good stability in operation.

Wiring in the Resistors and Fixed Condensers

Wire in R3 between tag 14 and tag 1 of the oscillator coil, using as little heat as possible, but making a good joint. Make sure that tag 1 is in the position shown in Fig. 4.

Wire R2 from tag 2 to tag 20, join 20 to 21 and connect R1 from 21 to 3 (Fig. 4). Wire C7 between tags 36 and 33 making the connections as short as possible. Fix C5, again with the leads as short as possible, between tag C of S16 and tag 29. Attach C3 between tags A and B of S16. Attach C6 across R3; i.e. from tag 14 to pin 1 on the oscillator coil. The condenser C4 is then soldered on the other side of the board to rivets 2 and 20 as shown in Fig. 6.

Wire tag 28 to coil pin 4, and tag 9 to coil pin 6. Join tag 33 to tag 29 with covered wire and then tag 29 to coil pin 3. Solder one of the soldering tags under the tuning condenser fixing bolts to tag 18 (see Fig. 4). Connect tag A of S16 to tag 8.

Above-chassis Wiring

Connect a red wire between tags 2, 8, 10, 14 and 18 as in Fig. 6. This is what

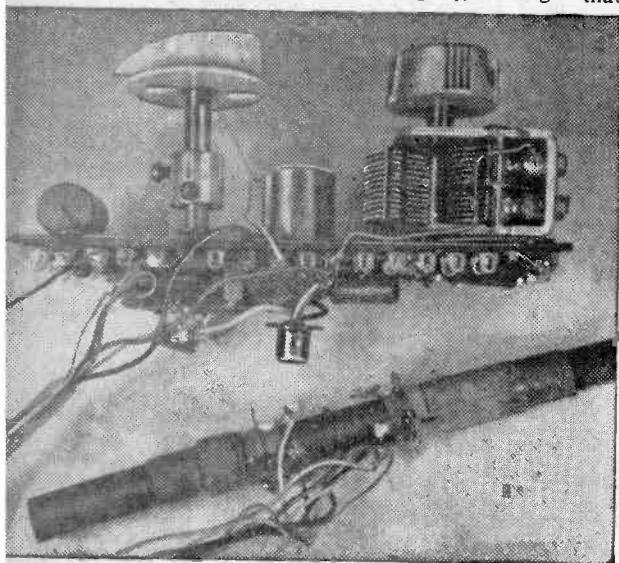

The frequency changer unit

EN

By J. Bisset

THE THIRD OF OUR PROGRESSIVE SERIES OF BLUEPRINT DESIGNS

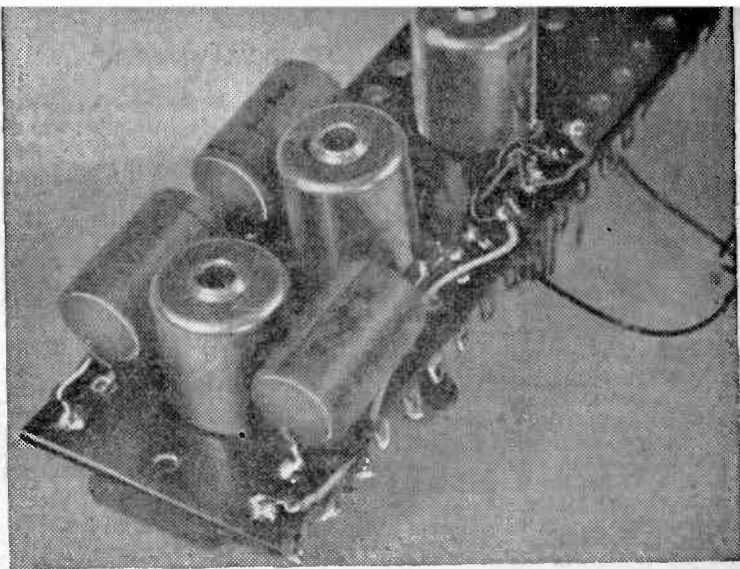

The I.F. amplifier

would normally be called "Earth" or "Chassis", and in this unit, battery positive.

Refer to Figs. 6 and 16 and note the wire connecting tag 11 and the stator of C1, the shape of this lead is quite important to prevent unwanted feedback.

Refer to Fig. 7 and connect a short lead from tag 36 to the stator of the oscillator tuning section C1.

Adding the Transistor

Check the wiring carefully. Put sleeving on the leads of the transistor (TR1) and then quickly solder them as follows (using a heat shunt as on page 509 of the October issue):—the base (centre lead) to tag A of S1a as shown in Fig 5; the collector (nearest the white spot lead) to coil pin 5 and the emitter (remaining lead) to coil pin 2. Position the transistor conveniently but without bending the leads nearer than $\frac{1}{16}$ in. to the bottom flange.

Adding the Aerial

The aerial is made up of three parts (see Fig. 17). The long and medium wave coils are separate and may be slid along the ferrite rod to obtain optimum results. Two types are available (both under the part number RAW2). The type having thin leads from the actual coils connected to a circular tag strip in the middle is not the best for this design as the movement of the coils along the strip is restricted—the type having tag rings on each coil is to be preferred.

The coils are provided with coloured tags. If you have a meter, check that there is a connection between the sets of colours:—blue and yellow; black and yellow; white and green; white and red. (If not, the coil unit is faulty.) Connect leads up about 8 in. long to the coil tags using the same coloured wires as the tag colours if possible, make sure that in soldering to the coil tags, the thin wires of the coils themselves are not detached.

Now test, the ends of the coloured leads as detailed above.

The leads should be held together in places with Sellotape or insulating tape, but should not be twisted together. The ends are connected to the group board unit as follows (see Fig. 5):—red to

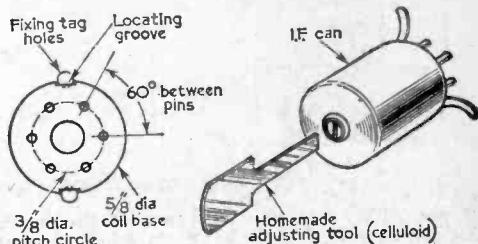

Fig. 15 (left).—The layout of the coil pins (actual size).

Fig. 18 (right).—A simple trimming tool for the oscillator and I.F. coils; the total must be made as shown so that the shank will fit inside the cores of the coils.

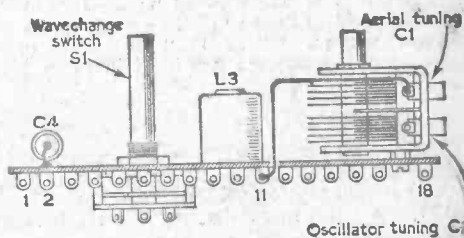

Fig. 16.—The position of the wire from C1 to tag 11 in the frequency changer section; this wire must be arranged exactly as shown to avoid the lower section of the variable capacitor gang (C2).

tag C of S1a; yellow to tag B of S1b; green to tag B of S1a; black to tag 8; white to tag 21; and blue to tag 11. In addition a white lead about 4in. long between the white tags on both coils is required and connect a similar piece of yellow wire between the yellow tags (see Fig. 17).

THE I.F. AMPLIFIER

Preparation of the Group Board

No chassis is required, but some preparation of the board is necessary. Refer to Fig. 9. Note that the board has 12 holes down the centre. Holes C, F and J, are used in the mounting of the transformers, but six other holes have to be drilled before these can be fitted.

Figs. 9, 14 (on the Blueprint) and 15 show that five holes are required to take the pins of each I.F. transformer and two more to take the tags for fixing. Do not force the transformers home; they are fragile, miniature, components and the tags must not be bent in any way.

Mounting the Transformers

These should be tested on receipt to make sure there is no connection between the outer case and

Wires are now soldered to connect the following tags together:—23 to 24, 24 to 5.

Other Wiring

Refer to Fig. 12. A red wire is carefully soldered to the rivets 13, 11, 8, 6 and 3. It is bared only as necessary and care must be taken not to allow any spare or stray strands to short to another tag. A black wire is similarly soldered to tags 12, 9, 4 and 2. A white wire joins 1 to 10. Check these carefully.

Now solder in position the condensers C9, C10 and C11. Make sure the leads cannot touch any other tags but those intended; C10 is between 3 and 5, C9 between 26 and 27 and C11 between 22 and 21.

Fitting the Transistors and I.F. Transformer Leads

The transformer IFT2 is not wired as recommended by the makers but this will be mentioned later.

pin 5 of IFT3 is wired to tag 21;
pin 5 of IFT2 is wired to tag 24;
pin 5 of IFT1 is wired to tag 28;
pin 2 of IFT3 is wired to tag 4;
pin 3 of IFT2 is wired to tag 9;
pin 3 of IFT1 is wired to tag 12.

The diode is now wired in between pin 1 of IFT3

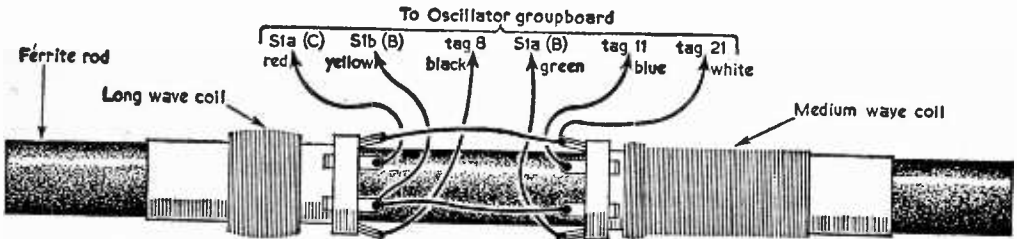

Fig. 17.—The connections to the coils on the ferrite rod aerial assembly.

any pin. They are mounted so that the blank holes fall over H, B and E and pin 3 in each case falls into J, C and F (see Fig. 9).

The transformers are fitted by pushing the pins through the holes and bending the fixing tags to reach the correct tags of the tag strip and then soldering them. The cans must be firmly fixed. A P50/3CC is fitted to tags 3 and 21, a P50/2CC to tags 8 and 26 and a P50/2CC to tags 13 and 30.

Readers may fit a numbered paper strip to the tag board to identify the tags as explained for the oscillator section. Check that no shorts occur between any tag and the can itself in every case, after fitting.

Fitting the Resistors

These are all fitted directly as shown in Fig. 10: R9 between tags 21 and 22; R8 between tags 6 and 24; R7 between tags 4 and 23; R6 between tags 26 and 27; R4 between tags 9 and 28; R5 between tags 10 and 28.

Fitting the Condensers

Condenser C12 is fitted between tags 1 and 19 and C8 (bearing in mind the correct polarity) between 28 and 11.

and tag 1 with the red (or positive) end to the group board. Do not overheat this diode or it will be ruined.

Wire Tr3 as follows:—base (centre) lead, preferably sleeved, to pin 1 of IFT2 using as little heat as possible. The emitter lead is taken to tag 22 and the collector lead to pin 3 of IFT3. Fig. 11 should make this clear.

Tr2 is similarly attached, centre (base) lead duly sleeved to pin 1 of the first IFT1. The emitter lead is wired to tag 27 and the collector to pin 2 on IFT 2.

Supply

The supply may be taken from tag 27 on the "Mini-Amp" and no condenser or dropper resistors need be fitted. Thus, a red wire is taken from tag 13 to tag 2 on the "Mini-Amp" and a black wire from tag 2 to tag 27 on the "Mini-Amp".

Connecting the Unit to the Oscillator Stage

Although a separate 6V supply could be used, it is convenient to take the supply for the oscillator stage from the I.F. Section: a lead (red) is taken

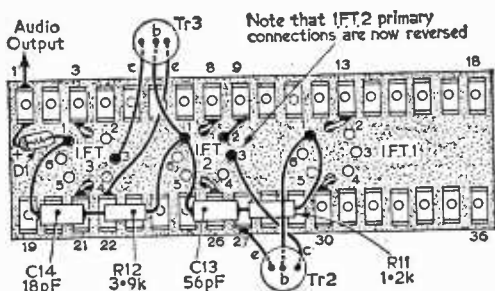

Fig. 19.—The wiring of the extra components necessary for neutralisation of the I.F. amplifier (see text).

from tag 2 of the oscillator to tag 13 of the I.F. amplifier and a black lead from tag 3 of the oscillator to tag 2 of the I.F. amplifier.

The oscillator output at 470kc/s is taken from tag 9 to pin 3 of IFT1 on the I.F. strip as shown in Figs. 5 and 11.

Volume Control

The output from the "Citizen" will be more than that from a crystal pick-up and when used with the "Mini-Amp" the simplest arrangement is to take tag 1 directly to the input of the "Mini-Amp" (centre tag of the amplifier volume control). This will mean Tr1 of the audio amplifier is being used unnecessarily on radio and more interconnection details will be given later, but this method of connection will enable the units to be lined up satisfactorily. Alternatively, for lining up, a pair of headphones can be used (between tags 1 and 3 on the I.F. section).

The I.F. amplifier and the R.F. oscillator are now connected by three flexible leads. One lead is taken from tag 9 on the oscillator board to pin 3 of IFT1 on the I.F. amplifier. The other two leads go from tags 2 and 3 on the oscillator to tags 13 and 12 on the amplifier respectively.

The Alignment

Although it is always best to line up a superhet using a signal generator, it is not too difficult to carry out the alignment process using only signals received. Most constructors of the "Citizen" will not have access to a signal generator and therefore more details will be given of the method of alignment using received signals than that using a signal generator.

Before beginning the alignment, it is worthwhile

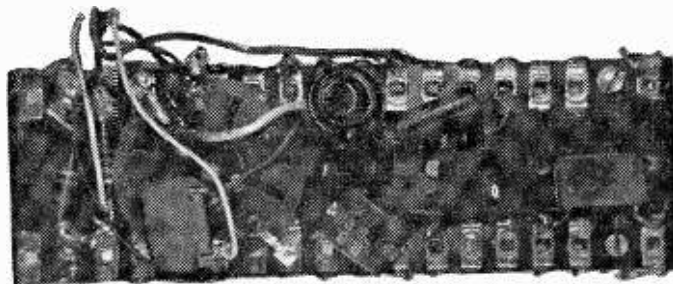

Rear view of the frequency changer unit.

to make another check of the wiring—in particular, make sure that the transistor connections are correct and that the wires for the battery connections are correct and will give the correct polarity. If the transistor or battery connections are incorrect, the errors in wiring will prove very costly when the unit is switched on for the first time.

When satisfied that the wiring is correct, switch on and at once there should be some sign that the unit is working. Of course, it will already be known that the "Mini-Amp" functions correctly, and if, when the "Citizen" is connected to the "Mini-amp", there is no sound from the loud-speaker, then it will be evident that there is a fault in the construction of the "Citizen".

The I.F. transformers in the "Citizen" are already aligned, and therefore it will probably be found that some stations are received right from the moment when the unit is first switched on.

For lining up the I.F. transformers, which is the first operation, a small trimming tool will be required—this can be fashioned from a small piece of celluloid or plastic as shown in Fig. 18. It must have the shape shown in the diagram and not a conventional screwdriver shape or it may damage the fragile cores of the I.F. transformers.

The coils on the ferrite rod should be positioned about one inch from each end of the rod, and then assuming that a station is being received, the rod can be turned so that the signal received from the station is weak—it will be found that when the rod points directly towards the station, the signal from it almost disappears—this is due to the directional effect of the ferrite aerial. The object of turning the aerial to the position of weakest reception is to reduce the effects of the AVC line of the set and thus prevent the effects of the adjustments from being masked.

When the position of weakest reception has been found, the volume control of the amplifier may be turned up to make the weak sound louder. The I.F. transformers may now be aligned.

Using the tool already made, turn the core of IFT3 for maximum loudness from the loud-speaker; repeat the procedure for IFT2 and then for IFT1—as the transformers are lined up, the signal will become progressively louder, and it may be necessary to re-orientate the aerial to reduce the signal. If the volume cannot be reduced sufficiently by repositioning the aerial, it is better to rotate the tuning capacitor to find a weaker signal than to reduce volume by adjusting the volume control. Finally, adjust the cores of each transformer again until no further improvement, in volume, can be obtained.

The I.F. transformers are now aligned and the settings of their cores should on no account be altered again—even as a last resort.

If a signal generator is available, the frequency of alignment is 470kc/s—use the full modulated output of the signal generator and couple it loosely to the I.F. amplifier, reducing the output as the transformers are brought into line. The alignment will be made easier

if a large condenser— $0.1\mu\text{F}$ to $0.5\mu\text{F}$ is temporarily wired across C1.

R.F. Alignment

If a condenser has been used across C1, remove it and switch to medium waves (the anticlockwise position of S1, viewed from the rivet side of the board). When the tuning capacitor is rotated, stations should be received, the number depending upon the state of the circuit and the time of day. The alignment is carried out using two known stations—at night time, Radio Luxembourg and the Third Programme are suggested because these fall at the extremes of the tuning coverage. Other stations may be used, but one must be at the high frequency (short wavelength) end of the medium waveband and the other at the low frequency (long wavelength) end. Radio Luxembourg is specified above as it is broadcast on the highest frequency which it will be required to receive.

Turn the tuning condenser almost to minimum capacity—almost to its fully open position. Screw up the trimmers on the tuning condenser (C1a and C2a) tightly and then unscrew them about one turn. Now adjust the core of the oscillator coil until the station chosen at the high frequency end of the waveband is received. Then turn the tuning condenser to a position where the vanes

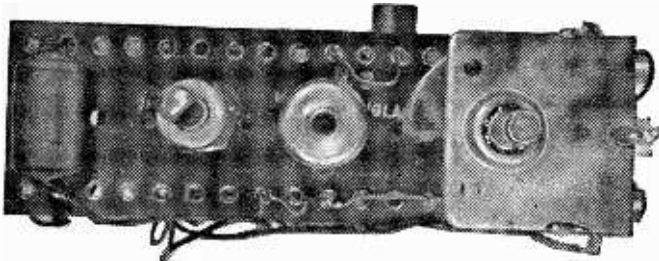

Front view of the frequency changer unit.

are about three-quarter closed—about 30° from being fully enmeshed. It is important to use a knob on the tuning condenser spindle for this operation so that the settings used for the two chosen stations can be found repeatedly. A make-shift cardboard dial could be fastened to the front of the tuning condenser so that pencil marks may be made corresponding to the stations.

When the position has been decided for the Third Programme adjust the oscillator coil core (L3) until the signal is heard at the desired point. Return to the other station at the other end of the waveband and adjust the trimmer C2a until the station is at the desired point. Return to the Third Programme setting—do not tune to the signal which will now be at a different position, but return the tuning condenser to the setting marked previously. Adjust the oscillator coil core to return the signal to the desired point. Return the tuning condenser to the other setting and readjust the trimmer C2a until the signal is heard again. Repeat these adjustments until no further improvement is obtained and until both stations come in at the marked points. The oscillator alignment is then completed.

Next, turn the tuning condenser to the station at the high frequency end of the waveband. Adjust

the trimmer C1a for best results. Set the tuning condenser to the station at the low frequency end of the waveband and adjust the position of the medium wave coil on the ferrite aerial for best results—the medium wave coil is the long, single layer coil, not the pile-wound coil. Repeat these two adjustments until no further improvement is obtained.

It should be noted that this latter part of the R.F. alignment should be carried out when the unit is housed in position in the case intended for it. Of course, the procedure may be carried out twice, once with the unit out of the case and finally with the unit in position to obtain optimum results. When the constructor is satisfied that the results are satisfactory, the medium wave coil may be sealed to the ferrite rod using Balsa cement or Durofix, taking care to keep the adhesive away from the wire of the actual coil.

The long wave alignment is simple and consists of tuning to the long wave Light Programme and adjusting the position of the long wave coil on the ferrite rod for loudest reception. This coil may also be sealed in position on the ferrite rod when results are satisfactory.

Neutralisation

Transistors, being similar to triode valves, have appreciable self feedback which sometimes has to be neutralised. The I.F. amplifier described has been built in three prototypes and no troubles were experienced when IFT2 was wired as shown (Figs. 2 and 4).

Should any reader have trouble over "whistles", this is a sign of poor alignment, or a badly wired oscillator section, or even that neutralisation is required. Fortunately the makers of the I.F. transformers have evolved an effective neutralisation system: connect a

1.2k resistor and a 56pF (1%) capacitor in series between pin 1 of IFT2 and pin 1 of IFT1 on the I.F. amplifier. Connect also a 3.9k resistor and an 18pF (1%) capacitor in series between pin 1 of IFT2 and pin 1 of IFT3 (i.e. to the black end of the diode). Also, reverse the connections to pins 2 and 3 of IFT2 (see Figs. 11 and 19).

(To be continued)

Cable Contract

THE Republic of Indonesia has placed a contract with Associated Electrical Industries Ltd. for the supply of telephone cable. Since negotiations for this order began, cable manufacture within AEI has been rationalised and the cable will be manufactured by Telephone Cables Ltd., of Dagenham, an AEI subsidiary owned jointly with Enfield Cables Ltd.

The cables will be of the paper insulated underground and plastic insulated underground type and delivery will take place over a period of five years. The cable is being supplied to the Ministry of Land Transport, Posts, Tele-communications and Tourism.

FAULTS IN VHF/F.M. RECEIVERS

2 - The I.F. Stages

By G. J. King

(Continued from page 607 of the November issue)

IN Part 1 of this series we considered various faults that are likely to develop in the VHF tuner unit of an F.M.-only receiver or tuner or in the VHF tuner of a composite A.M./F.M. receiver. In the latter type of receiver, a VHF tuner fault is unlikely to affect the performance on A.M., so that while an A.M./F.M. set may function perfectly normally on the medium frequencies, it may be totally dead or exhibit a fault symptom only when switched to F.M. In this event, of course, the VHF tuner should first be investigated, but it should also be noted that similar trouble could occur owing to a fault developing in some other part of the set, as described in this article.

Switching Arrangements

In Fig. 8 is shown the two I.F. stages of a composite A.M./F.M. receiver. The heptode section of V2 functions as the first I.F. amplifier and when the receiver is switched to F.M., which is the position it is switched to in the circuit, the tuner I.F. signal is applied, via screened cable, to the heptode control grid through C22. The VHF tuner is made operative by a part of switch S4 which applies H.T.+2 to the tuner frequency changer, while another part of the same switch removes H.T. from the triode section of V2, which acts as local oscillator on A.M. It will also be noted that on F.M. a part of S2 short-circuits the A.M. AGC line.

These switches sometimes give trouble and can cause total failure or intermittent operation of A.M. or F.M. For example, it there is a poor connection in S4, H.T. may not get through to the VHF tuner. The set would thus work perfectly on A.M. but not at all on F.M. Since H.T. is being switched, sparking occurs between the contacts and after a while this may produce an intermittent connection which would be likely to cause interference effects on F.M., possibly accompanied by tuning drift caused by variation of the H.T. voltage applied to the VHF frequency-changer valve.

Effect on A.M.

Trouble of a like nature may also result on A.M. due to high resistance switch contacts in the A.M. local oscillator circuit. This trouble rarely occurs in the ordinary wavechange switching, however, possibly because there is little or no H.T. current flowing through the switch contacts.

Various types of switch are used in A.M./F.M. receivers; some manufacturers favour the ordinary rotary type made up of several units on a common spindle. The switch units are positioned so

that they are as close as possible to the circuit which they are required to switch, and in this way the connecting leads can be kept as short as possible. This point should be remembered during the course of servicing. Another popular arrangement is the Plessey switch constructed of two long, narrow sections of low-loss insulating material. One section is fixed to the frame and the other is in the form of a slider which can move a limited distance along the fixed section. Switch contacts are situated along the fixed section, while the slider carries small metal contact strips which engage with the fixed contacts to provide the required switching arrangements.

Dual I.F. Transformers

In all composite receivers, the I.F. stages are coupled by two I.F. transformers connected in series. The primary winding of the F.M. I.F. transformer is always connected to the anode of the valve, while the secondary winding of the same transformer is connected to the grid of the following valve, as shown by IFT2 in Fig. 8. The A.M. I.F. transformer windings are then connected in series. The A.M. I.F. is usually 470kc/s, while the F.M.I.F. is 10.7Mc/s. This large difference in frequency allows this method of connection, since the impedance of the A.M. I.F. transformer is very low at 10.7Mc/s and it does not affect the F.M. I.F. coupling. Although there are separate transformers, when viewing the chassis, this may not appear to be so as only a single screening can is used to house both transformers.

Low Gain on A.M.

It sometimes happens that the sensitivity of the receiver falls off badly on A.M. while remaining fairly normal on F.M. Several cases of this symptom were caused by alteration in value of one of the fixed tuning capacitors across the windings of the A.M. I.F. transformers. These capacitors are usually installed inside the screening cans. Each core in the I.F. transformer should peak, but if this fails to happen with one core and it seems that the sensitivity could be improved by screwing the core farther into the former than is, in fact, possible, then the fixed capacitor across the associated winding will almost certainly have decreased in value.

Replacement should be made with components of identical type and value and the A.M. I.F. stages should afterwards be realigned, preferably with a signal generator and output meter, but failing that, by peaking the cores on the local station.

A.G.G. Troubles

In all composite receiver, AGC is applied in the normal manner on A.M. However, when the set is switched to F.M., the A.M. AGC line is usually shorted to chassis, and if there is F.M.

AGC then this is switched into circuit. F.M. AGC is not always used, and rarely used when the circuit features a phase discriminator detector. Where a ratio detector is used, an arrangement similar to that shown in Fig. 8 is used.

Here the F.M. AGC voltage is derived from across the ratio detector load resistor (to be dealt with in a subsequent article) and fed to the suppressor grid of the second I.F. valve, V3. In the event of a very strong signal, a high negative voltage will appear across the ratio detector load and this is used to reduce the gain of the I.F. stage accordingly.

This is a very simple circuit and rarely causes trouble. Nevertheless, should excessive fading and

attributable to failure or low emission of the triode section, even though the heptode section works normally as an I.F. amplifier on F.M. A quick check for oscillator operation is to break the connection between the switch side of R9 and insert a D.C. milliammeter, with the negative terminal to the resistor. If the oscillator is working there will be a marked change of current when a short is applied across C26, the oscillator section of the tuning gang.

Noise on A.M.

Intermittent noise which varies in intensity has often been proved to be caused by a fault in the oscillator anode resistor R6. It is, in fact, possible

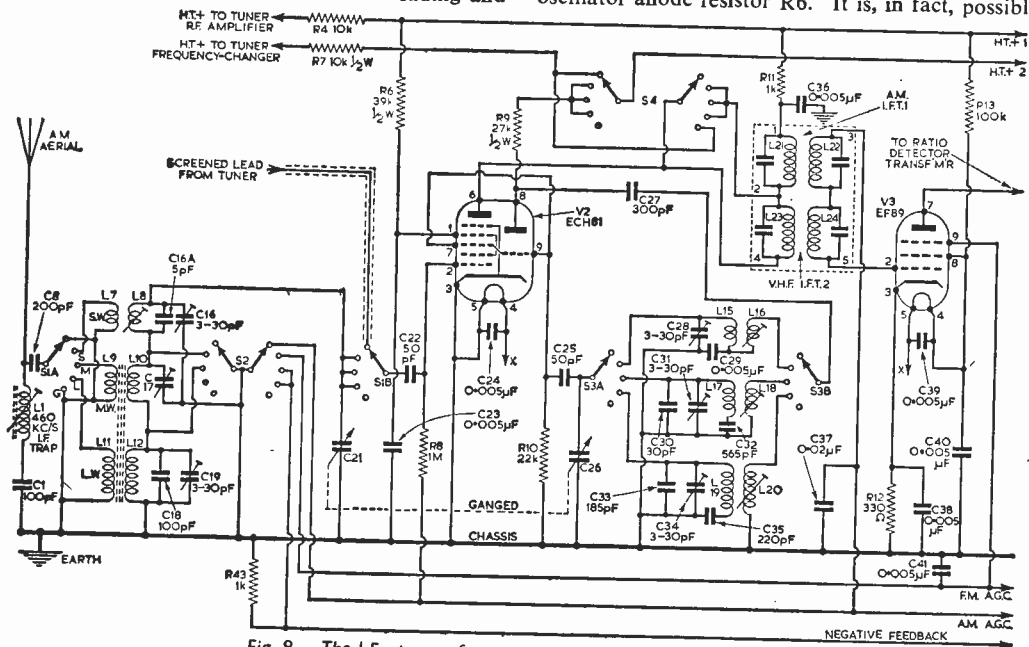

Fig. 8.—The I.F. stages of a typical A.M./F.M. receiver

distortion occur as the result of passing aircraft, for instance, the AGC feed from the ratio detector should be checked, as also should the associated components, such as C41 and switch S2. It has been known for poor insulation to develop on the switch, between two separate contacts, and allow an H.T. voltage to appear in the AGC circuit, thereby completely disturbing the normal operation. Similar trouble sometimes takes place on the printed wiring board, especially after a set has been in service for a number of years and excessive dust has been allowed to accumulate on the wiring.

A.M. Operation

When a composite receiver is switched to A.M., the VHF tuner is no longer used, and the first I.F. amplifier (e.g., V2) is changed to a conventional A.M. frequency changer. The triode section is connected to H.T. and operates as the local oscillator.

Failure on A.M. but not on F.M. is often

to observe the effect on a milliammeter connected as described above by the current fluctuating in sympathy with the crackles and noise. This should lead immediately to replacement of the resistor. However, if this does not clear the trouble, and there is no sign of the noise on F.M., C25 and C27 should also be replaced.

As already intimated, noise may be generated in the oscillator switch, S4, and provided the contacts are not badly burned, the application of a good quality switch cleaner will solve the problem.

Printed Circuits

Most A.M./F.M. receivers use printed circuits which themselves sometimes introduce faults. When soldering parts into such a circuit, extreme caution should be observed to avoid overheating with the soldering iron. In the original type of printed circuit, undue heat results in the foil becoming loose from the board. This trouble may

(Continued on page 729)

RETURN-OF-POST SERVICE

We offer a really efficient Mail Order Service on all items stocked. All cash orders are dealt with on the day of receipt.

★ Hire purchase orders are subject to slight delay but this is kept to the absolute minimum

● LOUDSPEAKERS

GOODMANS: Axion 110 10in. £5.2.0; Axion 112 10in. £2.14.0; Axiatec 4in. £8.15.0; Axion 300 12in. £11.5.9; Axion 400 12in. £16.1.0; Audion 60 Bass, 12in. £9.12.9; Trebax Trebax 26, £4.0; CX 500 Cross-over unit £1.19.0.
WHITELEY: HF 1016 10in. £8.4.0; HF 1012 10in. £5.2.6; HF16 8in. £7.0.9; HF 9in. £6.10.0; H10 Tweeter £4.8.3; T339 Tweeter £1.15.10; CX3000 Cross-over unit £1.11.6; CX1500 Cross-over unit £2.0.0. H.P. Terms available.

● TAPE ACCESSORIES

WEARIE DE-FLUXER: For the regular de-magnetising of Tape Heads, 50/- post 1/-.
BIB TAPE SPLICER: 18/6, post 9d.
EMI TAPE ACCESSORY KIT: 37/6, post 1/-.
SCOTCH BRAND TEST TAPE: Tones from 40 cycles to 10 Kcs, Recorded at 7 1/2 inches per second, 49/6, postage 6d.

● TRANSISTORS

MULLARD: Reduced prices. Current production types, not rejects. All in makers' boxes.
 OC44, 11/-; OC45, 10/-; OC70 and OC71, 8/6; OC72, 8/-; OC72 Matched Pairs 16/-; OC78, 8/-; OC81, 8/-; OC170, 13/6; OC171, 14/6 Postage 3d. on each transistor.

● AMPLIFIER KITS

We have full stocks of all components for the Mullard 510, Mullard 3-3, Mullard 2 and 3 Valve Pre-amp, Mullard Stereo, Mullard Mixer, GEC 912 Plus. Fully detailed lists on any of these sent upon request.
 Instruction Manuals: All Mullard Audio Circuits in "Circuits for Audio Amplifiers", 8/5, GEC 912, 4/6. All post free.

● STEREO COMPONENTS

Morganite ganged potentiometers as specified for the Mullard circuits. ● Log/Anti-Log, 500k, 1 meg, 2 meg. ● Log/Log, 50k, 250k, 1 meg, 2 meg. ● L.P. 1in. 250k, 500k, 1 meg, 2 meg. All 10/6 each. Pickup cartridges, B.S.R. TC8S £2.5.11. Turn-over type for Stereo, L.P. and 78 records. List of all components for Mullard Stereo Designs is available.

● "P.W. TUTOR"

Everything in stock. Stage 1 including brand new light-weight headphones, 39/6. Less headphones, 23/6. Stage 2 19/-; Stage 3 21/6. Stage 4 11/6. All Stages 1 to 4 £4.8.6. Less headphones £3.13.6. All post free. Please note that the hardboard, wood, Terry Clips and cement not included. All items available separately—send for list.

● "P.W. MINI-AMP"

Complete kit for amplifier £4.2.6. Whiteley Speaker P3-585. £1.4.8. All parts available separately, send for list.

● "P.W. TUNER UNIT"

Send for parts list.

● GRAMPHONE EQUIPMENT

ALL LATEST MODELS	Cash Price	Deposit	Hire Purchase	Mthly/Pmts.
RECORD CHANGERS				
COLLARO C69 (G29 PU)	£8.5.0	£1.13.0	12 of	13/6
GARRARD RC10 (G83 PU)	£10.8.0	£2.20.0	12 of	15/4
B.S.R. UA14 (TC8 PU)	£7.18.6	£1.12.6	12 of	12/3
B.S.R. UA14 Monareh (TC8S Stereo/LP/78)	£8.19.6	£1.18.6	12 of	13/7
SINGLE RECORD PLAYERS				
GARRARD TA (G83 PU)	£8.10.0	£1.14.0	12 of	13/6
B.S.R. TU9 (TC8 PU)	£4.12.6	£1.6.6	3 of	£1.5.4
E.M.I. (Acos Stereo/Mono PU)	£6.15.0	£1.7.0	12 of	10/6
TRANSCRIPTION UNITS				
GARRARD IG (G83 PU)	£18.18.0	£3.18.0	12 of	£1.7.8
PHILIPS IG1016	£14.3.8	£2.17.6	12 of	£1.0.9

Many of the above can be supplied for stereo working. See our Gramophone Equipment List for details.

● MAINS TRANSFORMERS

GILSON: W071AB, 63/-, post free; W0839, 48/9, post 2/8; PARTRIDGE: H300/110, 72/-, post free; P4132, 78/6, post free; P3677, £5.12.0, post free; P4013, 80/-, post free.
ELSTONE: MT1MU, 45/-, post 3/3; MT3/M, 35/-, post 3/-.
FARMEKO: P2631, 32/3, post 2/8.

● OUTPUT TRANSFORMERS

GILSON: W0896A, W0896B, 50/6, post 2/8. W0710, W0710/8K, 55/6, post 2/8. W0892, 62/3, post free; W0767, 27/-, post 1/6.
PARTRIDGE: P3667, 52/6, post 2/6; P4014, 99/6, post free; P4131, 60/-, post free; P3591A, 99/-, post free; P5222, P5233, 95/-, post free.
FARMEKO: P2641, 28/-, post 2/8.

● TERMS OF BUSINESS

Cash with order or C.O.D. We charge C.O.D. orders as follows. Up to £3, minimum of 3/2. Over £3 and under £5, 1/6. Over £5 and under £10, 1/8. Over £10, no charge. Postage extra on CASH orders under £3 except where stated. Postage extra on Overseas orders irrespective of price.

● JASON FM TUNER KITS

We supply kits for all the Jason FM Tuners. Fully detailed lists available. Kits are complete with all valves and instruction manuals—definitely nothing else to buy.
FMT1 Standard Tuner with ext. power supply, £6.19.6. Power pack kit, £2.12.6 extra. FMT2 Standard Tuner with Internal power supply, £10.9.6, less power supply, £8.9.6. FMT3 Fringe Tuner with internal power supply, £12.7.6. Less power supply, £10.9.6. Mercury 2 FMTV Sound Switched Tuner. External power supply, £11.7.6. Power pack kit, £2.12.6 extra. JTV2 FMTV Sound Switched Tuner. Internal Power supply, £15.17.6
IMPORTANT.—Please state TV Channels required when ordering Mercury and JTV Kits. Booklet for FMT1, 2 and 3, 2/10. **INSTRUCTION MANUALS.** Booklet for FMT1, 2 and 3, 2/10. Mercury 2, 3/10. JTV2 3/10. All post free. **HIRE PURCHASE** terms available on any kit.

● TRANSISTORISE YOUR CRYSTAL SET

We have two new designs for Transistor amplifiers which can be used to greatly improve the signal from any crystal set. Leaflet available.

RLD4 Kit. One stage 12/- post free.
 RLD5 Kit. Two stage 21/- post free.
 The kits are easy to build and very detailed instructions are supplied.

● MULLARD CATHODE RAY TUBES

ALL AT THE NEW REDUCED PRICES
 We supply both Mullard Radiant Screen (Brand new factory fresh) and external menar (Re-builds by Mullard with reclaimed bulbs—all other parts brand new). List of types available with prices and hire purchase terms.

● LATEST TEST METERS

	Cash Price	Deposit	Hire Purchase	Mthly/Pmts.
AVO Model 8 Mark II	£24.0.0	£4.16.0	12 of	£1.15.9
AVO Model 8 with leather carrying case	£27.18.0	£5.12.0	12 of	£2.0.11
AVO Model 7 Mark II	£21.0.0	£4.0.0	12 of	£1.10.10
AVO Multimeter	£9.10.0	£1.18.0	12 of	14/4
AVO Multimeter with leather carrying case	£11.8.0	£2.5.0	12 of	17/-
TAYLOR MODEL 127A	£10.0.0	£2.0.0	12 of	15/-
CAYB A148	£4.17.6	£1.7.6	3 of	£1.6.8
CAYB 120	£6.10.0	£2.0.0	3 of	£1.13.4

Full details of any of the above supplied free on request. The AVO Models 7 and 8 are both latest models from current production—not to be confused with Government Surplus.

● ILLUSTRATED LISTS

Illustrated lists are available on LOUDSPEAKERS, TAPE DECKS, TEST GEAR, RECORDING TAPES, GRAMPHONE EQUIPMENT, AMPLIFIERS. Any will be sent free upon request.

● "BRAND FIVE" RECORDING TAPE

Standard Play: 800ft. (5") 18/-; 1,200ft (7") 25/-.
 Long Play: 900ft (5"), 18/6; 1200ft (5"), 23/6; 1800ft (7"), 35/-.
 Double Play: 1200ft (5"), 37/6; 2400ft (7"), 60/- (All Post Free.)

● B.A.S.F. RECORDING TAPE

Long Play: 210ft (3"), 9/-; 900ft (5"), 28/-; 1200ft (5ft), 35/-; 1800ft (7"), 50/-.
 Double Play: 300ft (3"), 14/-; 600ft (4"), 25/-; 1200ft (5"), 42/-; 1800ft (5ft), 58/-; 2400ft (7"), 77/6. All post free.

● TAPE RECORDING EQUIPMENT

ALL CARRIAGE FREE	TAPE DECKS	Hire Purchase
B.S.R. TD3	Cash Price	Deposit Mthly/Pmts.
COLLARO Studio	£5.19.6	£1.18.6 12 of 13/7
	£12.19.6	£2.12.6 12 of 19/-

We now stock the Martin Recorder Kits. These are partly assembled kits for complete tape recorders. The Amplifier Printed Circuit panels are completely wired, but the assembly of this and external components is left to the constructor. Very complete instructions are supplied. Send for leaflet.

MODEL C for Collaro Studio Deck £11.11.0
MODEL B for BSR TD2 Deck, £8.8.0.
CARRYING CASES. Smart carrying cases are available to take the above amplifiers and decks. Fitted with speaker.
 For Model C Amplifier and Collaro Deck, £5.5.0.
 For Model B Amplifier and BSR Deck, £4.4.0.
 H.P. Terms available for amplifiers, cases and decks.

ARMSTRONG PABO-3. This is a ready made version of the Mullard Tape C Pre-amplifier. Price £16.16.0. Hire Purchase: Deposit £3.8.0, and 12 monthly payments of £1.4.7.

MULLARD TAPE C PRE-AMPLIFIER. We stock complete kits and all components. Send for list.

HIRE PURCHASE TERMS
 Repayments may be spread over 3, 6 or 12 months. Details as follows: Three months: Deposit 6/- in the £. Service charge 5 per cent but minimum charge of 10/-. Six and Twelve months: Deposit 4/- in the £. Service charge 10 per cent, but minimum charge 20/-.

WATTS RADIO
 (MAIL ORDER) LTD.

54 CHURCH STREET, WEYBRIDGE, SURREY
 Telephone: Weybridge 4556
 Please Note: Postal business only from this address

COMPACT HI-FI

by *Armstrong*

STEREO 55 £33.15.0

(illustrated)

TUNER-AMPLIFIER CHASSIS

A comprehensive and attractively styled chassis combining AM and FM Tuners, a Stereo Control Unit and two High Fidelity 5 watt Amplifiers in one compact unit. In all its functions the Stereo 55 is designed for mono as well as stereo use so that up to 10 watts output is always available.

Full VHF and medium bands. ● Inputs for tape recording and playback ● Alternative pick-up inputs. ● Booster unit available for low output pick-ups. ● Input for possible future stereo radio. ● Separate bass and treble controls and dual volume control for ease of balancing. ● Free instruction booklet with every model.

Post this coupon or write for free catalogue, or call at our Showroom for full demonstration and professional advice on your installation. Open 9—5 including Saturdays.

NAME _____

ADDRESS _____

PDS

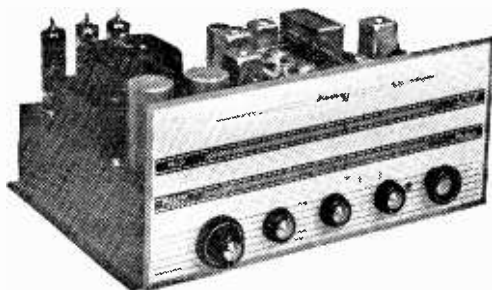

STEREO 12 Mk. 2 £44.15.0

A total of 16 watts output is available from the two 8 watts push-pull amplifiers. VHF, with automatic frequency control, medium and long bands. Inputs for tape recording and playback and for stereo radio if required in the future. The most comprehensive unit ever produced, providing a hi-fi system on one compact chassis.

The name ARMSTRONG is the registered trade mark of ARMSTRONG WIRELESS & TELEVISION Co. Ltd. WALTERS' ROAD, LONDON N.7. Tel.: NOR 3213

THE
PEMBRIDGE
COLLEGE
OF ELECTRONICS
OFFERS TRAINING
IN RADIO
TELEVISION
AND ELECTRONICS

ATTENDING COURSE

(A) Full-time One Year Course in Radio and Television. College course in basic principles for prospective servicing engineers.

Next course commences 3rd January 1962.

This course is recognised by the Radio Trades Examination Board (R.T.E.B.) for the new Servicing Certificate examinations.

HOME-STUDY COURSES

(B) Radio and Television Servicing

1 Introductory course.

2 Basic course covering R.T.E.B. Intermediate Radio and Television Servicing Certificate examination.

(C) Courses in Radio, Telecommunications and Mathematics up to City and Guilds Telecommunication Technicians' Final Certificate.

To: The Pembridge College of Electronics.
(Dept. P11), 34a Hereford Road, London, W.2.
Please send, without obligation, details of
A..... B..... C..... (Please tick.)

Name.....

Address

D.61

SHORT-WAVE SECTION

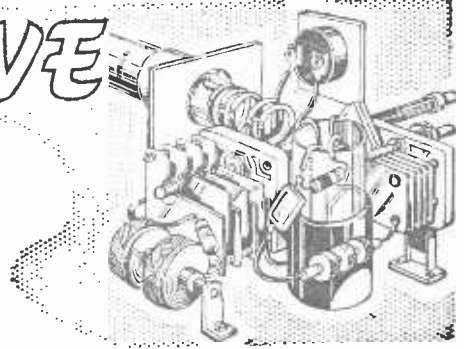

NOISE LIMITERS AND IMPROVING A.V.C.

By "Amateur Transmitter"

A NOISE limiter can be added to virtually any receiver circuit. Such a limiter is provided in some communications receivers, but is absent from some receivers of this kind. It is generally possible to add a limiter to commercially-made or ex-service receivers, though lack of space or other details may make this a little more difficult than with a home-constructed receiver.

Effects

Limiters of the type described here are included in the A.F. section of the receiver, and considerably reduce noise of the impulsive kind, originating in domestic equipment and switches, ignition systems,

Many limiters introduce some comparatively slight audio distortion, or may cause some small reduction in amplification in the stage. For these reasons, a switch may be provided to short circuit the path through the limiter. The limiter is then switched in only when needed.

Self-Adjusting Limiters

It is convenient to have the limiter under the control of the AVC circuit, to obtain automatic adjustment to suit the strength of the signal received.

A circuit using a single diode, and providing limiting of positive peaks, is shown in Fig. 1. When the limiter is included at the time of building the receiver, it will be handy to use a diode

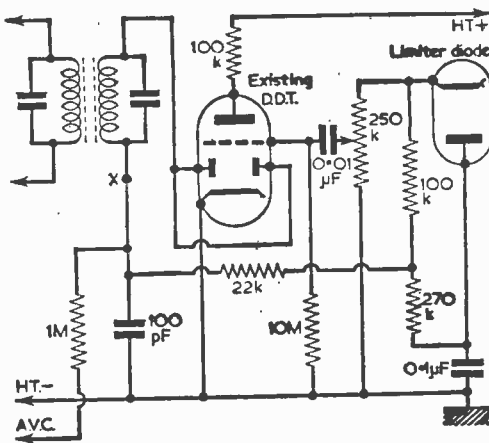

Fig. 1.—A single diode noise limiter.

static discharges, and so on. These impulses are generally of higher amplitude than the average signal being heard, so the limiting device acts by cutting off signals above this level.

Such limiters are not intended to reduce noises such as general background hiss, or interference from other transmissions, or anything of that nature. But they can be very effective in helping clear the type of noise which causes loud, abrupt sounds in the speaker.

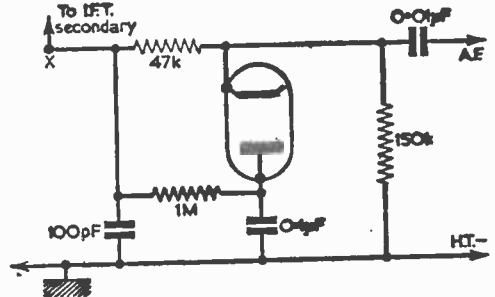

Fig. 2.—Another single diode limiter (see also Fig. 1).

from another stage, but there is no reason at all why a separate diode should not be employed. A suitable miniature diode for this and the other circuits is the 6AL5. If octal valves are preferred, a 6H6 is satisfactory. These valves are in fact double-diodes, but may be used as single diodes by joining the pair of cathodes, and the pair of anodes.

The limiter diode anode remains at about the AVC line voltage, and the valve has little effect on normal A.F. signals. A noise impulse is, however, able to drive the diode cathode negative with respect to the anode, so that the diode conducts, and the impulse is largely bypassed to earth.

A similar circuit, which can also be constructed as a separate unit, and added to an existing receiver, is shown in Fig. 2. The point "X" goes to the I.F. transformer secondary, as indicated by "X" in Fig. 1.

The limiter stage can be constructed on a small chassis, or aluminium plate or bracket, and this can be mounted near the double diode triode stage of the receiver. Leads should be reasonably short, and clear of A.C. circuits, or should be screened, to avoid introducing hum.

Full-Wave Limiter

A very efficient limiter is shown in Fig. 3, and can use either of the valves mentioned. With the switch closed, the limiter is out of action.

When the switch is open, the 500k potentiometer allows adjustment of the audio input, relative to the cathode voltage, which is derived from the AVC circuit, and this enables positive noise to be clipped at almost any required depth of modulation level. Clipping may be at well below 100% modulation level, with a corresponding reduction in noise. The remaining diode clips negative pulses.

As neither half of the valve can conduct when its cathode is positive with respect to its anode, the circuit is very effective in limiting the depth of the audio signal which can pass. There is some loss of signal strength, but this is not very important with a receiver of usual kind having triode and pentode A.F. stages. (The triode will usually be part of the DDT state.)

This circuit may be set to clip at a pre-arranged level, or the potentiometer can be panel mounted. The in/out switch need not be immediately adjacent to the valve, and may thus be on the panel also.

A further limiter, using an 0A81 diode, is shown in Fig. 4. This may be included in an early part

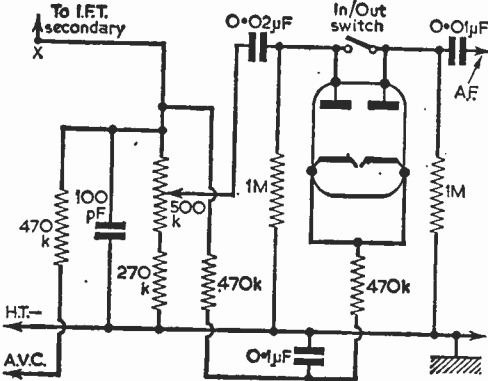

Fig. 3 (above).—A double diode full-wave noise limiter.

Fig. 4 (below).—A limiter using a semiconductor diode.

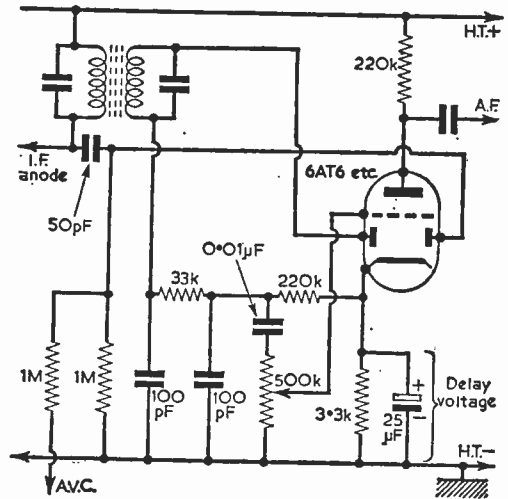

Fig. 5.—Double diode triode circuit with cathode bias.

of the A.F. circuit, for example between the diode detector and first audio stage.

In very small receivers, the limiter can be included before the output stage, especially if this operates headphones. There is no provision for following the signal strength level, in the way described for the self-adjusting limiters, but sudden bursts of noise will be reduced.

As all such random static noises generally are outside the control of the listener, it should not be overlooked that their effect can be much reduced by normal precautions. If they are mains-borne, a mains filter will be helpful. If they are picked up locally by the aerial, down-lead, or earth lead, it may be worthwhile changing the position of these, or using an anti-interference aerial. Static from some causes can be much reduced by employing a dipole or balanced type of aerial, instead of an end-connected aerial.

AVC Efficiency

Many receivers of fairly simple type do not have a very effective AVC system. It may allow overloading on local transmissions, or may be insufficient to counteract even moderate fading. If a signal strength or tuning meter is controlled from the AVC circuit, as is usually the case, this meter may fail to give any reading with weak signals.

A typical circuit providing detection and AVC is shown in Fig. 5. The triode section of the valve has cathode bias, and no AVC voltage is produced until the signal on the AVC diode exceeds the cathode voltage. This arrangement allows maximum gain to be obtained in the earlier stages, since no AVC is applied to weak signals. It also means that weak signals are not able to give a tuning meter reading.

A means of overcoming this is to return the cathode to chassis, as in Fig. 6. The AVC circuit is then able to operate at all signal levels. Bias for the audio amplifier is obtained by the flow of grid

(Continued on page 729)

TEST METERS FOR EVERY PURPOSE & POCKET



1,000 O.P.V. Model U.I. Reads A.C. & D.C. Volts up to 1,000; D.C. Current to 500 mA; Resistance to 200K. Basic movement 300 μ A. Easily read open scale. Size 5 1/2 in. x 3 1/2 in. x 2 1/2 in. **£2.19.6**



2,000 O.P.V. Model TP-10. Reads A.C. & D.C. Volts up to 1,000; D.C. Current to 500mA; Resistance to 1 Meg; Capacitance to μ F; Decibels from -20 to +36; Output jack for Audio Measurements. Size 3 1/2 in. x 5 x 1 1/2 in. **£3.19.6**



20,000 O.P.V. Model TP-5S. Reads voltages up to 1,000 D.C. at 20,000 Ohms per volt and A.C. at 10,000 o.p.v.; D.C. Current to 500mA; Resistance to 10 Megs; Capacitance to 0.1 μ F; Decibels from -20 to +36. Size 3 1/2 in. x 5 1/2 in. x 1 1/2 in. **£5.19.6**



30,000 O.P.V. Model 506. Volts to 1,000 D.C. at 30,000 O.P.V., A.C. at 20,000; 12 Amps D.C. Current; 60 Megs Resistance; -20 to +56 Dbs; Internal buzzer short circuit warning. Size 3 5/16 in. x 6 5/16 in. x 2 1/2 in. **£8.19.6**

All Brand New stock, with test leads, prods, and internal batteries. Fully guaranteed, S.A.E. further details.

UNIVERSAL AVO METERS. In first-class condition, thoroughly overhauled and guaranteed perfect. In the well-known AVO styling with 5 1/2 in. hand calibrated Mirror Scale. Complete with leads and internal batteries. The 500 RANGE MODEL 7, ONLY £12.10.0, and the SUPERLATIVE 20,000 OHMS PER VOLT MODEL 8, ONLY £17.10.0. (Read. P. & F. 5/- on either). S.A.E. for full details.

CRYSTAL CALIBRATOR No. 10. A superb Crystal Controlled Wavemeter just released by the Ministry of Supply. Has directly calibrated dial for nominal coverage of 1.5-10.0 Mc/s. but may actually be used from 500 KC/s. up to 30 Mc/s. Complete with 500 KC/s. Crystal, 2 valves I.T.4, 1 or 1R5 and 1 of CV286 (Neon Stabiliser), and Instruction Book. Size 7 in. x 7 1/2 in. x 4 in., weight 5 lbs. Used but in first class condition. ONLY £2.19.6. Carr. 3/6.

B.C. 221 FREQUENCY METERS. The famous American crystal controlled, portable frequency measuring standard. Coverage 125 KC/s—20 Mc/s. With original numbered calibration book. Perfect order. Illustrated details on request. ONLY £16.

PCR COMMUNICATIONS RECEIVERS

Manufactured by Pye & Phillips. One of the Army's most versatile and sensitive sets. RF stage and 2 of I.F., using 6 British I.O. type valves. Large 180 degrees illuminated and Calibrated Dial. Flywheel Tuning with locking device. Aerial Trimmer, Tone and Vol. Controls. Band Switch front panel jacks for speaker or phones. In black metal case, size 17 in. L x 8 in. H. x 10 in. D. Model PCR covers 6-18 Mc/s. 200-550 metres and 850-2,000 metres, and has internal 5 in. speaker. REME reconditioned AS NEW £9.19.6. OR used very good condition. £7.19.6.

Model PCR 2 has similar L & M waveband coverage. Short wave 6-22Mc/s. but no speaker. Used good cond. sets only avail. £6.19.6

Every receiver aerial tested before despatch. Add 10/6 carr. all models. Designed to operate from bulky EXTERNAL power supply, but any set can be fitted with BRAND NEW COMPONENTS INTERNAL PACK for 200/250 v. A.C. at an extra cost of £2.

"P.W." 6 TRANSISTOR PERSONAL RECEIVER

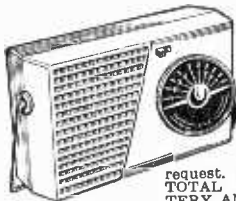

Designed by the technical staff of *Practical Wireless*, easy to build, using printed circuit and 1st Grade Matched Transistors and Diode. Full Medium and Long Wave coverage to internal speakers. All parts sold separately (new components only) enabling you to buy as required, and full detailed price list will be sent on request. Constructional details 1/6. **TOTAL COST INCLUDING BATTERY AND CABINET £8.19.6.**

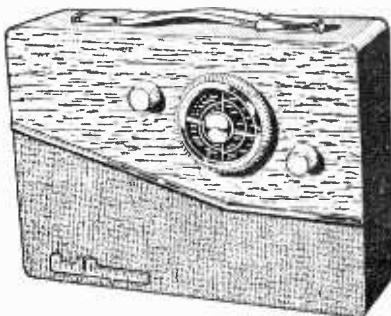

"THE GOOD COMPANION"

THE FINEST COMBINED PORTABLE & CAR RADIO YET DESIGNED FOR THE HOME CONSTRUCTOR

- ★ 750 mW output.
- ★ 6 transistors and 2 diodes.
- ★ Full Medium and Long Wave coverage.
- ★ Quality speaker.
- ★ Pre-aligned I.F.T.'s.
- ★ Brilliantly styled 2 tone cabinet, size 11 x 8 x 3 ins.
- ★ Very fine tuning with calibrated dial.
- ★ Latest printed circuit.
- ★ Internal high gain aerial, with car aerial socket.
- ★ Easy to follow construction data (available separately 3/6.)
- ★ Easy to sold separately and full illustrated details will be sent on request.

Total cost **£9.19.6** plus 5/- post and ins. (Battery 3/6 extra.)

"POCKET 4" TRANSISTOR RECEIVER

Attractive cabinet as illustrated for "P.W. 6". Uses miniature speaker, proper tuning condenser, and volume control. Built-in aerial makes unit efficient and portable. Ideal for the beginner. Full medium wave coverage. All components for only 42/6 (p. & p. 2/6). Ten-page constructional book free with parts or separately 1/6. S.A.E. for parts price list.

HARRIS ELECTRONICS 138 Gray's Inn Road, London, W.C.1
(Phone TERMINUS 7937)
(LONDON) LTD

Please include carriage costs on All Items
(Open until 1 p.m. Saturdays). We are 2 mins. from High Holborn (Chancery Lane Station) and 5 mins. by bus from King's Cross.

SOLDERING IRON

18/9



30-watt 230-volts A.C. Portable for lightweight applications. High stable heat characteristics assure long life and safety in use. Features a removable handle that may be used to cover the tip and barrel to permit the iron to be carried safely even while hot. Complete with vinyl bag, mains lead and plug. Spares available. Element, 4/6; Bit, 1/4. Size: overall length 10 1/2 in. (6 1/2 in. when not in use). Carriage free.

DE-LUXE TAPE CABINET 19/9



Exclusive design. Two-tone rexine. Detachable lid. Can be adapted to R/Player cabinet. Size approx. 12 1/2 x 9 1/2 x 7 ins. Colour Red or Brown. Ins. and Carr. 5/-.

TUBES

MULLARD, Etc.

15/- EX-RENTAL SERVICE STOCK 15" & 12" Carriage 5/-

14" EX-RENTAL REPLACEMENT STOCK 35/- Carriage 5/6

9d. SALVAGE VALVES GUARANTEED

C2C	EB91	ECC31	VR106	4D1	6D2
CV66	EF50	ECC34	VR107	6D1	15D2
D1	SP61	VR35	EF91	6F12	6F14
D152	D77	VR51	VR201	6F13	6F15
EA50					

1/9d.		2/9d.		5/9d.	
PEN46	N309	KT W61	PL33	EBC33	PCF80
Z77	N339	U22	U151	EBF80	PCF82
6F1	KT33C	U31	U281	ECL80	PL38
B36	KT63	U35	UL46	EL33	PL81
DH77	LN152	UF42	ECC81	EL38	PL82
EB41	LN309	UB41	ECC82	EL41	PY80
6P25	LZ319	UBF80	EF42	U152	PY81
N152	EL32	W76	EF80	U251	PY82
			EF92	PCC84	PZ30

Post 1—9d. 6—2/-, 12—3/-.

TV CHASSIS 5/6



Plessey, less valve and tube. Circuit Inc. Ins. and Carr. 7/6. Salvage. Badly Stored.



MAIL ORDER ONLY

PP COMPONENTS LTD.

819 ILFORD LANE, ILFORD, ESSEX

Stamp for FREE Catalogue

Phone: ILF-6003

SOUND REPRODUCERS (LONDON) LTD.

The Transistor Component Specialists
Dept. P.W. 15, 7 Jepson Road, Forest Gate, London E7. (Mail Order Only)



INTRODUCING... THE TRAVELLER

A highly sensitive Transistor Receiver using 3 top quality Transistors and 2 Diodes in latest circuitry.

NOTE THESE FEATURES—

★ Three top quality Transistors by famous makers (no rejects). ★ Moving Coil Speaker. ★ Fully Tunable over Medium Waves. ★ Ferrite Rod Aerial. ★ Solenoid Wound Coils. ★ On/Off Switch. ★ Separate Volume and Reaction Controls. ★ Drilled and Punched Chassis. ★ Double Diode Detector. ★ Plug in 9 v. Battery. ★ Full Easy to Follow Instructions. ★ Point to point wiring diagram. ★ No Radio know-ledge required. This set is fully portable and requires no aerial or earth. All components tested before dispatch and guaranteed 12 months. ★ Complete Satisfaction or money refunded. All components supplied separately.

Instruction Book 1/6 post free.

Supplied FREE with set of components.

SPECIAL INTRODUCTORY OFFER. All Parts and Blue Plastic Case, as illustrated, Post and Packing 3/6. Personal Ear Phone with instructions, 9/-. Post and Packing Free. Battery Extra, PP3, 2/6.

£3.17.6

SNIPS

XA101, 6/-; SB078, 8/-; SB305, 9/-; XB102, 9/-; G.E.C. S.1, 6/6. Miniature Resistors, 4/d.; Electrolytics, 200, 100, 50, 32, 8, 4, 2, mfd., 1/9. Ferrite Rod, 6in. long, 3 or 1/2 in., 1/9. Litz Wire 3d. yd. We can supply all components for the P.W. Tutor. Send for list.

Orders on above, value £1 to £3, 10% reduction, over £3, 15%. Please add 6d. P. & P. up to £1; 1/- £1 to £3; 1/6 over £3.

OSMOR, REPANCO, ARDENTE STOCKISTS
3d. Stamp for Catalogue.

THE SUPERHETERODYNE RECEIVER

By A.T. Witts, A.M.I.E.E.
Seventh Edition

This book describes the operation of Superheterodyne Receivers in the clearest possible manner. It makes every detail of the subject understandable and provides the essential working knowledge required by every student of radio and service engineering. The superheterodyne receiver is, of course, still the basic circuit for the majority of domestic (including television) and communication receivers. In this new edition the book has been thoroughly revised, bringing in completely new chapters on frequency-modulation receivers; transistor superheterodynes and communication -type receivers. 20/- net.

PITMAN

(Continued from page 726)

current through the high value resistor, which should be 5-6M to 10M.

With this type of circuit, tuning meter indications will become possible at very low signal levels. A very similar effect, for comparative purposes, may be obtained by shorting the cathode bias resistor in Fig. 5, though the A.F. amplifier will then be less effective.

The increase in AVC action will bring about a general reduction in volume; since a larger AVC voltage is being obtained, this is unavoidable. With

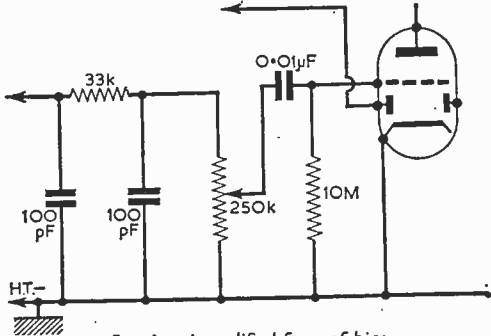

Fig. 6.—A modified form of bias.

very small receivers, the increase in AVC efficiency can still be worthwhile, if sufficient volume is obtained.

Controlled Stages

R.F. and I.F. stages frequently receive the screen grid supply through a single resistor, as in Fig. 7. This is a convenient and economical method, but does not allow best operation of the AVC circuit.

When AVC is applied, the cathode current falls, and there is a drop in current through the 33k resistor. This reduced current also reduces the voltage drop in the resistor, so that the screen grid voltage rises. In many cases this rise is considerable, and, to some extent, it off-sets the reduction in gain caused by the AVC circuit.

If the screen is fed from a potential divider, as in Fig. 8, this effect is greatly reduced. Resistors R1 and R2 are so chosen as to maintain the voltage

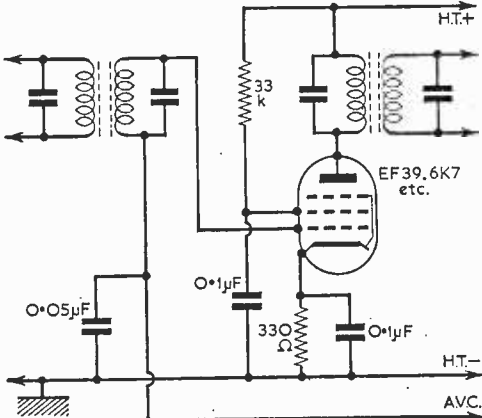
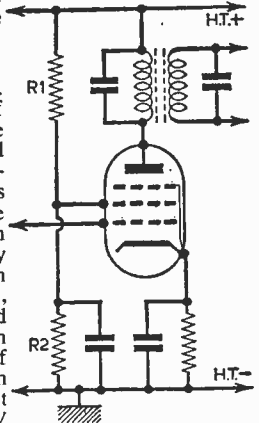

Fig. 7.—An I.F. stage with a dropper for the screen grid.

Fig. 8.—A modification to the circuit of Fig. 7 to increase the effects of the AVC.



at about the usual figure. The lower the value of these resistors, the more stable will the screen grid voltage become. Unfortunately, very low values are impossible because the bleeder current taken from the H.T. supply would be excessive. Even quite high values will, however, help to avoid so much fluctuation in voltage. A total value of about 50k will require an additional H.T. current of 5mA, with a 250V supply.

Calculation

The current through R2 can be found by dividing the required screen grid voltage by the resistance value; for example, it would be about 3mA with 150V on the grid and 47k for R2. The current through R1 is the total of the screen grid current, and the current through R2. That is, 5mA, in this example, if the screen grid takes 2mA. The value of R1 is therefore such as to cause the required voltage drop at this current. If the H.T. line is 250V, then 100V must be dropped. So from V/I the value of R1 is 20k or 22k (the nearest preferred value). The bleeder current is $V/(R1+R2)$, or $250/69k$, or under 4mA. ■

FAULTS IN VHF/F.M. RECEIVERS

(Continued from page 722)

also be caused by the normal operating temperature in the set after several years' continuous use.

These troubles eventually result in a break in one of the printed wires. Unfortunately, the break may not be readily visible without the use of a magnifying glass and may also be of an intermittent nature. In a grid circuit or in the detector, a wiring break may not cause total failure, but could result in curious hum effects which might not show up until the temperature inside the set rose and the disconnection occurred owing to flexing of the printed board.

Such faults can be difficult to locate, but the trouble can often be located by gently flexing the printed board, applying pressure to various sections until the fault condition can either be brought on, or corrected. One must be very careful, however, to ensure that a break is not unwittingly caused by rough handling during this process. When the fracture has been located, it may be repaired either by thoroughly cleaning the surface of the conductor and applying a blob of solder across the break, using the minimum amount of heat for the shortest possible time, or by replacing the whole length of the conductor with a wire between its two ends.

(To be continued)

How to measure INDUCTANCES

CHECKING THE INDUCTANCE OF COILS SHOULD NOT BE OVERLOOKED WHEN FAULT-FINDING By S. Jacob

CAPACITANCE and resistance can quite easily be determined by bridge methods or by using simple measuring instruments. However, inductance measurement is not quite so easy. There is some very complicated inductance testing gear on the market, but most of it is beyond the scope of most amateur needs. For this reason, coils are usually checked for continuity and for any possible earthing shorts and left at that. On the other hand, an inductance test will give a far more accurate indication of the condition of a coil, whether it is for A.F., I.F., or R.F. circuits. Shorted turns in R.F. coils and damaged cores in A.F. chokes are revealed by inductance testing. Resistance and continuity tests are not likely to show up these faults.

The easiest way to test A.F. coils is by the

Now measure the voltage across the coil. Make sure that the supply is as steady as possible so that it remains the same for both tests.

Find the impedance of the coil by dividing the voltage measured across it by the current flowing. Now the inductance of the coil is calculated from:

$$L = \frac{\sqrt{(Z^2 - R^2)}}{314.2}$$

where L is the Inductance in Henries;
Z is the Impedance in Ohms;
R is the Resistance (D.C.) in Ohms.

Let us take an example:

An A.F. choke is checked with an ohmmeter and found to have a resistance of 500Ω. Assuming there is no A.C. milliammeter available, the circuit in Fig. 2 is set up. A 200Ω resistor is used as R. Let us assume that a 12V supply from a transformer is available. First measure the voltage across R. In this case it is, say, 3. Make a note of this and quickly check the voltage across the coil; perhaps it turns out to be 22. Now disconnect the apparatus and get down to calculations.

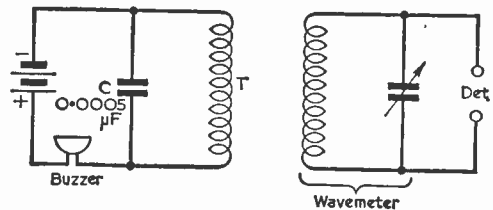

Fig. 3.—Testing an R.F. coil.

First, determine the current flowing through the circuit.

$$I = \frac{E}{R}$$

$$I = \frac{3}{200} \text{ amps}$$

This is from the 3V found across the 200Ω resistor R. Now find the impedance of the coil

$$Z = \frac{E}{I}$$

$$Z = \frac{22}{\frac{3}{200}} = 22 \div \frac{3}{200}$$

$$Z = \frac{1}{22} \times \frac{3}{200} = \frac{3}{4400} = 1467\Omega$$

This is the impedance of the coil calculated from the voltage found across it which was 22, and the current flowing at the time was 3/200A.

Now,

$$L = \frac{314.2}{\sqrt{(Z^2 - R^2)}}$$

or

(Continued on page 737)

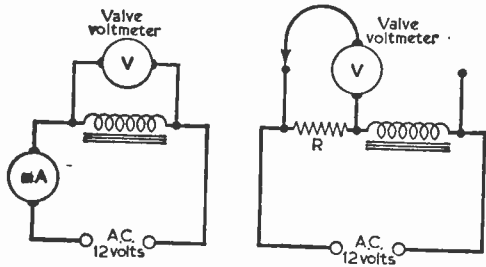

Fig. 1 (left).—Testing an A.F. choke.
Fig. 2 (right).—Determining A.C. flow.

ammeter and voltmeter method shown in Fig 1. First of all the resistance of the choke is measured as accurately as possible, with an ohmmeter, or using the same circuit as Fig. 1, but with a D.C. supply. In this case the resistance is equal to the voltage divided by the current in amperes.

Now a suitable 50c/s supply is connected to the circuit and the volt and milliammeter readings noted. The voltmeter must be a valve voltmeter, calibrated cathode ray oscilloscope, or any other type that does not draw current. If there is no A.C. milliammeter available, use the circuit in Fig. 2. Connect the valve voltmeter or its equivalent across R and determine the current in the circuit by dividing the voltage by the resistance of R.

BOOST MODIFICATIONS

FOR

“PW” POCKET SUPERHET

**SIMPLE A-Z MODIFICATION TO BOOST
AND IMPROVE THIS SET**

The Pocket Superhet is a high quality miniature receiver for operation on Medium and Long Waves. Dimensions are only $5\frac{3}{4} \times 3\frac{1}{2} \times 2$ in. The circuit uses 6 transistors and incorporates modern miniature components of the best quality which combine to give superb performance normally associated with much larger sets. The printed board construction ensures success to every enthusiast able to follow the simple Step by Step instructions.

NEW CONTEMPORARY CASE

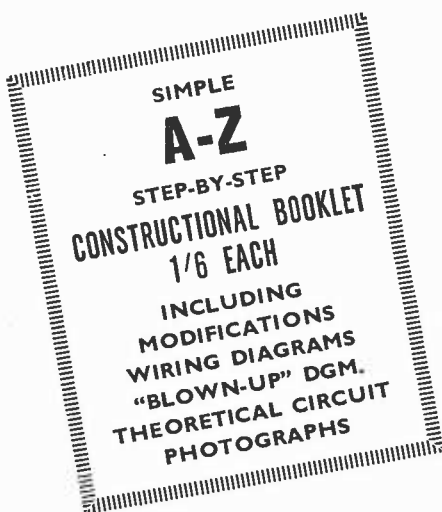

The new contemporary case has been designed to take the early models of this receiver as well as the modified circuit. We feel sure you will find this new case one of the most attractive you have ever seen.

*FREE INFORMATION
from your Dealer or Direct.*

Osmor 418 BRIGHTON ROAD, S. CROYDON. CRO 5148/9



Whether you're building your own amplifier or servicing a complete installation—for fault finding on anything from pre-amplifier to speaker—you'll find the MULTIMINOR to be "just right".

You'll enjoy using this neat pocket instrument giving readings over nineteen ranges on a clear open scale. A.C. and D.C. voltage, D.C. and Resistance measurements are made by means of only two sockets. The robust, easy-to-read range selector has a smooth, clean, positive action.

"Can you afford it?" Let's say rather—"Can you really afford to be without it?"

Designed and Manufactured by

AVO LTD



AVOCET HOUSE - 92-96 VAUXHALL BRIDGE ROAD - LONDON, S.W.1
A MEMBER OF THE METAL INDUSTRIES GROUP OF COMPANIES

Telephone: VICTORIA 3404 (12 lines)

MM.10

Indispensable

THE

MULTIMINOR

19 Ranges

D.C. Voltage: 0-1,000V in 7 ranges

A.C. Voltage: 0-1,000V in 5 ranges

D.C. Current: 0-1A in 5 ranges

Resistance: 0-20,000 Ω, 0-2M Ω

Pocket Size: 5½ x 3½ x 1½ inches.

Weight: 1 lb. approx.

List Price **£9:10s.**

Complete with Test Leads and Clips

Leather Case if required 39/6

Sensitivity
10,000 ohms per volt on D.C. voltage ranges.
1,000 ohms per volt on A.C. voltage ranges.

Accuracy
On D.C. 3% of full scale value.

On A.C. 4% of full scale value.

To meet special requirements, instruments can be supplied to a higher degree of accuracy for a small additional charge.

Premier RADIO

23 TOTTENHAM COURT ROAD, LONDON W.1
and at 309 EDGWARE ROAD, LONDON W.2

Tel: MUSEUM 3451/2
Tel: PADington 6963

THE TELEFUNKEN STEREO HI-FI AMPLIFIER



Original Price 16 gns.

NOW ONLY **£9.19.6**

P. & P. 5/-

BRIEF SPECIFICATIONS:

- ★ Piano key selecting.
- ★ Preset/selected tone control.
- ★ Size: 12in. wide x 9in. deep x 2in. high.
- ★ Weighs 9lbs.
- ★ Finish: Hammered enamel in grey/green with gold trimmings. Controls and press buttons in cream with black, blue and red lettering.

- ★ Power Output 5 watts total (2½ watts per channel).
- ★ Total harmonic distortion less than 1% at 1 watt output.
- ★ Frequency Response: 30 c/s to 40 Kc/s ±2dB, 45 c/s to 30 Kc/s ±4dB.
- ★ Sensitivity sufficient for all normal inputs from Tape Recorders, Pick-ups, Microphones, Radios.
- ★ Power Requirements 110, 125, 150, 220, 240 volts A.C.

THE WALTER

Battery/Mains Transistorised Portable

TAPE RECORDER

Original Price 55 gns.

NOW ONLY **27 Gns.**

Plus P. & P. 20/-



Star Features:

- ★ 7 stage built-in Amplifier with separate bias oscillator and record level indicator. Push-pull output stage with negative feedback. Also separate feedback equalisation.
- ★ Full size, 3-watts undistorted output. ★ 7 x 4in. High Flux Elliptical Speaker. ★ Large 5½in. sp 5½in. Spools. ★ 3½in. i.p.s. Tape Speed. ★ Revolution Counter. ★ Mixing facilities.
- ★ Super-impose facilities. ★ Safety device on record (preventing accidental erasure). ★ Volume on/off and Tone controls.
- ★ Magic Eye Tuning Indicator.

THE LECO

6 TRANSISTOR POCKET RECEIVER

This well designed transistor Receiver is ideally suited for the pocket or handbag being only 4½ x 2½ x 1½in. in size and 7 oz. in weight, it has full medium wave coverage and incorporates 6 high grade transistors and 1 diode in a superhet circuit Available in black, grey, green or cream.

Complete with Earpiece and Plastic Case.

£9.19.6

P. & P. 2/-

PP3 Battery extra 2/6



Why not convert your battery portable to mains operation with the **COSSOR MU2 BATTERY ELIMINATOR?**

This Eliminator is completely assembled and supplied with 4ft of Mains Lead and Torpedo Type of On/Off Switch. It is housed in 2 Metal Containers approximately the same size as the AD35 and B126 Batteries, and suitable for receivers using DK96 range valves for use on 200-250V A.C. mains. Size: L.T. Unit 3in. x 2½in. x 1½in. H.T. Unit 4in. x 2½in. x 2in. Original price 3 gns.

OUR PRICE for a limited period only. **39/6** plus 2/- P. & P.

High Sensitivity Bridge

A CIRCUIT WITH AN AMPLIFIED NULL INDICATOR

By M. A. Harris

THE author was in need of an RC bridge capable of accurate measurements, and the following circuit was evolved.

The basis of this instrument is a Wheatstone bridge for resistance (Fig. 1a) and a de Sauty bridge for capacitance (Fig. 1b).

Cx and Cy should be best quality ceramic or mica components, with very low leakage. They are easily obtainable with a 1 per cent tolerance. Cz, having a value of 1μF, is rather difficult to obtain in anything except a ±20 per cent tolerance, which is useless for this purpose. Except by writing to the manufacturers for a special component (which is likely to be expensive), this component will be impossible to obtain. However this is easily overcome by obtaining a condenser of nominal capacitance 1μF, but which is actually slightly below 1μF in value, and padding it by putting a small capacitance in parallel with it to bring the value up to 1μF exactly. A method of doing this will be described later.

The potentiometer used can be any value from 5k to 250k. For accuracy and long-term stability, it should be a wire-wound component—the larger its size, the better. In the prototype, a 3in. diameter component was used.

Bridge Supply

The A.C. supply for the bridge can be anything from 25V to 120V r.m.s. The prototype used 55V. The only point to be careful with in choosing a transformer is that on the low resistance range (Rx=100Ω) the total resistance in the bridge will be in the order of 200Ω and the current drawn from the transformer may overheat it. Provided that the measurements are made fairly rapidly, all should be well using a transformer rated at 500mA. The circuit is fused for protection.

The null indicator used in this instrument is the dual sensitivity EM34 magic eye. The constructor may use any "eye" though—EM80, 6U5, etc.

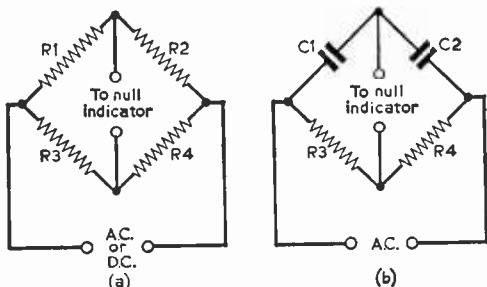

Fig. 1(a).—Basic Wheatstone bridge circuit.

Fig. 1(b).—Basic de Sauty bridge circuit.

At balance $\frac{R1}{R2} = \frac{R3}{R4}$ for the Wheatstone bridge
 and $\frac{C1}{C2} = \frac{R3}{R4}$ for the de Sauty bridge.

The bridge was energised by a small instrument transformer giving approximately 55V A.C. In the practical circuit (Fig. 2), R3 and R4 consist of a 10k w.w. potentiometer—the slider of which goes to the null indicator.

Standards

The circuit, up to now, has become the form of Fig. 2. For the sake of clarity, it is still arranged in the familiar Wheatstone bridge manner. The standards Rx, Ry, Rz, Cx, Cy, Cz, should be as accurate as the constructor can afford. Rx, Ry, Rz are high stability 1 per cent ¼W components, with the exception of Rx which has a 1W rating.

The values are:—Rx 100Ω
 Ry 10k
 Rz 1M

Cx, Cy, Cz again are 1 per cent tolerance. The values are:—

Cx 100pF
 Cy 10,000pF (0.01μF)
 Cz 1μF

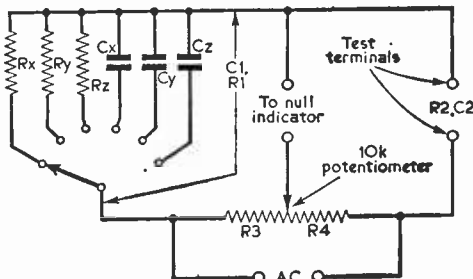

Fig. 2.—Practical combination of Figs. 1(a) and 1(b).

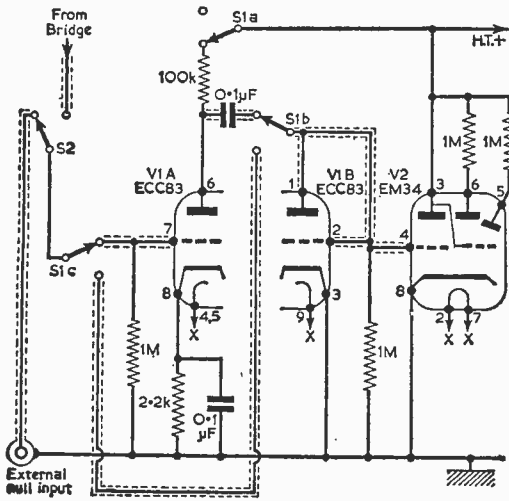

Fig. 3.—The amplified null indicator.

—although the EM34 is the most sensitive. An amplifier is used in conjunction with the magic eye to provide the instrument with greater sensitivity. The amplifier (Fig. 3) is switched out to obtain an approximate balance point, and then switched in to obtain greater accuracy. This facility is provided so that rapid readings are easily obtained. If the amplifier were left permanently connected, the eye would be rather slow to open, especially on the capacitance ranges.

D.C. Restoration

From the amplifier, the signal is D.C.-restored so that only a negative voltage goes to the grid of the magic eye. In the prototype a double triode—an ECC83—was used simply because it was to hand (Fig. 3). One triode was used as the voltage amplifier and the other half strapped as a diode to D.C.—restore the signal. If the constructor wishes, he may use any double triode or a single triode

and a valve rectifier.

A switch was incorporated into the prototype to enable the magic eye and amplifier to be used to detect a null other than that from the bridge. The connection was brought out on to the front panel as a coaxial socket.

Screened lead is used where shown because the bridge uses 50c/s and hum could be picked up in the wiring and this would not enable the magic eye to indicate a sharp, definite null.

Power Supplies

Almost any sort of power supply can be used with this bridge, provided it gives 10mA at 250V and 0.5A at 6.3V. The instrument can be powered from another instrument that has enough power to spare. The prototype used a 250V half-wave winding and a 6.3V winding on a small replacement type of transformer. The rectifier used is an EZ80, so that a separate heater winding is not required. A full-wave winding could be used if the constructor wishes. Since the EZ80 has two anodes (in the prototype these were strapped together), it would serve quite well as a full-wave rectifier. Almost any rectifier could be used, however (a 6H6 or EB34 has been tried and found successful). A metal rectifier would also be suitable, since the rating need only be 10mA or so. An H.T. fuse was fitted.

The on/off switch is of the double-pole variety, thus isolating the equipment completely from the mains. A panel light is fitted—either the neon type wired (via a limiter resistor) across the bridge side of the switch, or an ordinary 6.3V bulb wired across the heater supply.

The circuit of the power supply is straightforward. The supply terminals were brought out to a three-pin miniature mains socket screwed on to the front panel. If the constructor does not wish to go to the expense of buying one of these, the mains lead can go through a hole in the back panel.

For the sake of clarity, the complete circuit diagram is given in Fig. 4, together with a list of parts (page 737). It is advisable to use screened (Continued on page 737)

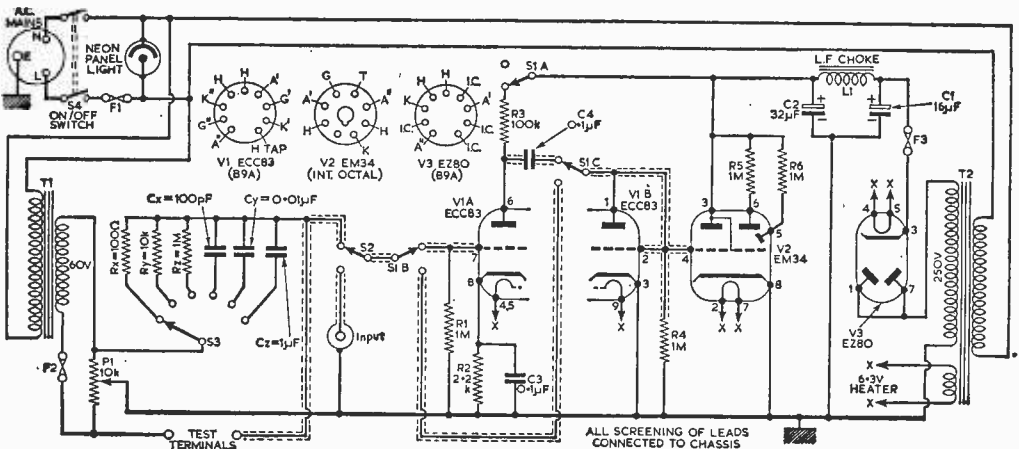

Fig. 4.—The complete circuit diagram of the bridge unit.

TECHNICAL TRAINING in radio television and electronics

Whether you plan to have your own business, to become an electronics engineer, to take up a career in industry, or to brush-up your knowledge and study new developments, transistors, etc., an I.C.S. Course will help you to success. You learn at home in your own time, under expert tuition. Moderate fees include all books.

EXAMINATION COURSES FOR:—

G. & G. Radio and TV Servicing Certificate
(R.T.E.B.)

G. & G. Radio Amateurs' Exam.
(Amateurs' Transmitting Licence)

British Institution of Radio Engineers, etc.
C. & G. Telecom. Technician's Cert.

LEARN AS YOU BUILD

Practical Radio Servicing Course

A basic course in radio electronic and electrical theory backed by thorough practical training. You build radio receivers, signal generator and multimeter.



Post this Coupon TODAY! for FREE book on careers in Radio, and full details of other I.C.S. Courses

INTERNATIONAL CORRESPONDENCE SCHOOLS
(Dept. 171), Intertext House, Parkgate Road, London, S.W.11.

Please send book on _____

Name _____ Age _____
(Block Letters Please)

Address _____

Occupation _____ [2.61]

INTERNATIONAL CORRESPONDENCE SCHOOLS

Electronics (FLEET ST.) Ltd

Dept. B

152-153 Fleet St., London, E.C.4. Tel. Fle 2833
Business Hours: Weekdays, 9-6, Saturdays 9-1 Stockists for AMPLIFIERS, V.H.F. TUNERS, HI-FI SPEAKERS BY ALL THE LEADING MANUFACTURERS

★ THE IDEAL XMAS GIFT ★

ANOTHER CONSIGNMENT AND POSITIVELY THE LAST OF MANUFACTURER'S BARGAIN

COSSOR 4 VALVE SUPERHET PORTABLE

Long and Medium wave bands, 5in. speaker, built-in frame aerial using Ever-Ready B126 90 volt H.T. and AD35 1½ volt Batteries. Attractive 2-tone finish, dimensions 9in. x 8½in. x 4½in. Original Price 15 gns. Our Price £8.19.6. P. & P. 5/-.

Batts. 10/- extra.

Suitable mains unit to fit in place of batteries. Original Price 63/-, Our Price 39/6 P. & P. 2/6. This Cossor Battery eliminator will replace any 90v. HT & 1½v. LT, providing the set uses 96 series valves.



The Transistor Set you "THE FLEET SIX" have been waiting for!

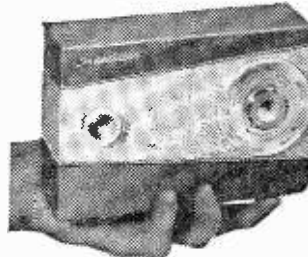

The "Fleet 6," a wow of a transistor set that really gets the stations. New design 6 transistor superhet pocket receiver, using 6 guaranteed first grade transistors, plus sensitive diode, push pull output medium and long wave bands, new type

printed circuit, high Q internal ferrite rod aerial, 2½in. high flux speaker, provision for car aerial, overall size 7½ x 4½ x 2½. Simple to follow instructions. All components guaranteed, service after sales. This is equal to many manufactured sets at double the price. All components including cabinet, transistors, speaker, circuit, etc., only £8.19.6 complete, post and pkg. 3/-. PP4 Battery 2/- extra. All components sold separately. Send S.A.E. for details. Circuit and instructions 2/- post free.

THE FLEET 6 PORTABLE TRANSISTOR RECEIVER

Using 6 guaranteed first grade transistors sensitive diode, p/pull output, medium and long wave bands, printed circuit, high Q ferrite rod aerial, 6 x 4 high flux speaker. Provision for car aerial. Attractive 2 tone cabinet, overall size 10½ x 8 x 3½in. Easy to follow instructions, all components including cabinet, transistors, speaker, circuit etc. £9.19.6, complete P. & Pkg. 3/6. Battery extra. All components guaranteed and sold separately. Send S.A.E. for details. Circuit and instructions 2/-, post free.



(Continued from page 734)

lead where shown on the diagram to prevent the pick-up of hum.

COMPONENTS LIST	
T1	(bridge transformer) 200-250V primary, 40-120V secondary
T2	(mains transformer) 200-250V primary, 250V, 30mA, and 6.3V, 1A secondaries
L1	Choke—almost any small smoothing choke is adequate
R1, R4, R5, R6	1M $\frac{1}{4}$ W
R2	2.2k $\frac{1}{4}$ W
R3	100k $\frac{1}{4}$ W
C1, C2	16 μ F and 32 μ F, 350VW
C3, C4	0.1 μ F 350VW
S1a, b, c	3-pole 2-way switch
S2	Single pole, changeover switch
S3	1-pole, 6-way switch
S4	2-pole, on/off switch
Rx	100 Ω 1 per cent H.S. 1W
Ry	10k 1 per cent H.S. $\frac{1}{4}$ W
Rz	1M 1 per cent H.S. $\frac{1}{4}$ W
V1	EZ80 (6V4)
V2	ECC83 (12AX7)
V3	EM34
Cx	100pF 1 per cent
Cy	100,000pF 1 per cent
Cz	1 μ F 1 per cent
	2 insulated terminals, 1 coaxial socket, knobs, etc

Construction

A suggested layout will be given next month. The pointer of the bridge is made out of $\frac{1}{8}$ in.

thick Perspex glued to the potentiometer knob. In the prototype, the Perspex was obtained from the protective screen of an old television set. A hairline was scratched down the centre, as shown, on both sides. This eliminates any parallax errors in reading off a value from the scale.

The chassis is 2in. deep and U-shaped, the front panel being of hardboard or plywood. An easy and economical way of mounting the magic eye is to bend a piece of metal at right angles, and on the longer side bolt two Terry clips. The inside of these clips is covered in felt or foam rubber. The magic eye slides into this, and it can then be bolted on to the front panel. The resistance and capacitance standards are soldered direct to the range switch. Do not fix Cz (1 μ F) permanently in place, as this will require padding.

The components R4, R5, R6 were soldered direct on to the magic eye holder. The other small components can be wired direct to the associated valve base.

Apart from these above considerations, construction should be relatively straightforward.

Calibration

As with any instrument, the accuracy is limited by (a) the standards employed; (b) by calibration.

The standards employed for this are 1per cent high stability types, and one cannot do better than that.

The calibration can mean extensive use of expensive instruments, but the method to be described next month requires only the use of a protractor, a slide rule, and patience.

(To be continued)

How to measure inductances

(Continued from page 730)

$$L = \frac{\sqrt{(1467)^2 - (500)^2}}{314.2}$$

$$L = \frac{\sqrt{2152089 - 250000}}{314.2}$$

$$L = \frac{\sqrt{1902089}}{314.2}$$

By using a set of square root table or a slide rule we find that 1902089 becomes 1379.

$$\text{Now } \frac{1379}{314.2} = 4.3\text{H.}$$

R.F. Coils

R.F. and I.F. coils are tested by a completely different method. Fig. 3 shows the general idea. High frequency is generated by means of the 0.0005 μ F condenser C, the coil under test T and the buzzer B. A wave-meter is placed nearby, and it is connected to a detector which can be an oscilloscope or a simple crystal circuit with a pair of headphones.

The buzzer is turned on and the wave-meter is tuned to maximum signal strength. The wave-length in metres is used in

$$L = \left(\frac{W}{1884} \right)^2 \times 2000$$

L is the inductance in Microhenries. W is the wave-length in metres.

For example, say the maximum signal were found at 540m. In that case:

$$\begin{aligned} L &= \left(\frac{540}{1884} \right)^2 \times 2000 \\ &= (0.287)^2 \times 2000 \\ &= 0.082 \times 2000 \\ &= 164 \mu\text{H} \end{aligned}$$

This formula holds good provided C is 0.0005 μ F. If it is desired to alter this value the formula:

$$L = \frac{W}{1884} \times \frac{1}{C}$$

has to be used (C is in μ F).

The apparatus for A.F. and R.F. coils are simple and so are the calculations, but a slide rule, or a set of square root tables will help considerably. ■

Transistor TRF Receiver

A SMALL PORTABLE SET EMPLOYING THREE TRANSISTORS

By J. G. Ransome

THE basic requirements to be fulfilled by this design were that it should be an easy circuit to construct and set up; it should be cheap, compact and give acceptable results from the local transmitter. It must be emphasised that this is by no means a long-range receiver (this being the province of the superhet circuit) and it is intended only for use in the primary service area of a transmitter.

Circuit

The R.F. section of the circuit is somewhat unusual, consisting of an R.F. transistor used as a reflexed R.F./A.F. amplifier with regeneration (reaction). The ferrite aerial is tuned by means of

that the collector current drawn by Tr2 is as near as possible to 10mA.

The values of the various components used in the circuit—with the exception of R4—are in no way critical, and the circuit should function perfectly well with components the values of which are within $\pm 20\%$ of those shown.

If "surplus" types of transistor are used, it is suggested that a "white spot" type be used for Tr1, a "red spot" for Tr2, and a "green-yellow spot" type for Tr3. If a red spot type is used the bias on the base may require a little adjustment, and this may be found by a trial and error substitution of R2.

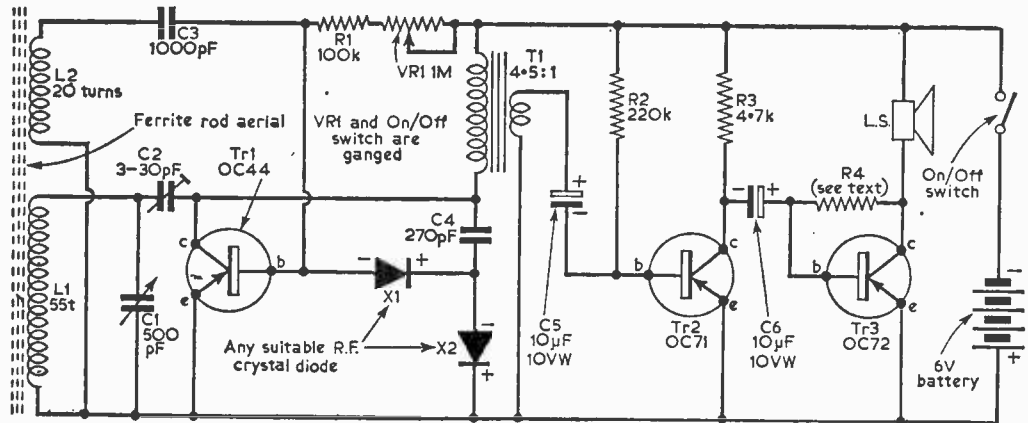

Fig. 1.—The circuit of the receiver.

C1. Regeneration is controlled by C2, which is pre-set for optimum performance, the final, fine adjustment being controlled by R2, which varies the bias on the base of Tr1. The R.F. stage feeds a voltage doubler type of detector in the base circuit of Tr1. T1 serves a triple purpose in this circuit; the primary acts as a collector load for Tr1 and also as an R.F. choke. The transformer then acts as a coupling unit for the detected A.F. and passes it on to the audio section (its proper function).

The A.F. section is a simple, very conventional R/C amplifier, the final output of which is delivered directly into a small, relatively high impedance loudspeaker, obviating the necessity for an output transformer. The bias of the output stage is controlled by R4, which also provides a little feedback. The value of R4 depends on the current drawn by the transistor, which can vary as much as $\pm 50\%$ in transistors of the same manufacture. The value of "R" is chosen so

Construction

The coil L1 consists of 55 turns of 28s.w.g. enamelled wire close wound on a $\frac{3}{8}$ in. diameter

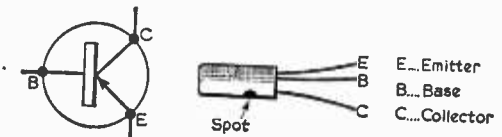

Fig. 2.—The connections of a transistor.

ferrite rod. The rod may be of any length, but it is recommended that the minimum length should be 2in. The coil should be insulated from the ferrite rod by first winding on a layer of Sellotape, and then winding the coil on near the end of the rod. L2 consists of 20 turns of the same gauge wire wound over a paper sleeve so that

(Continued on page 746)

CHECK with these

BARGAINS

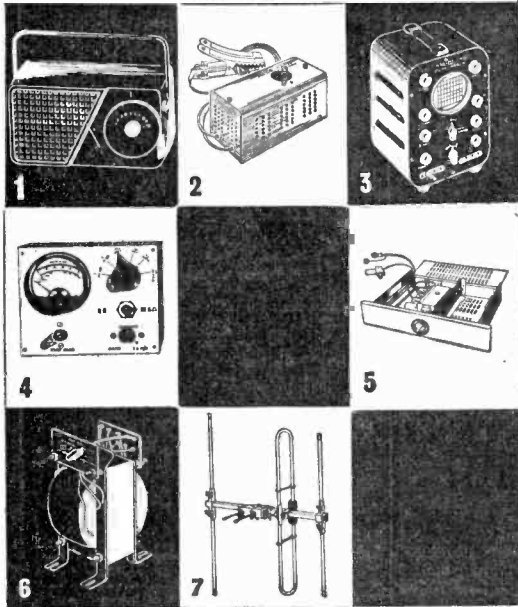

- 3-TRANSISTOR POCKET RADIO** with MINIATURE SPEAKER, FERRITE ROD, and 2 GERMANIUM DIODES. The only 3 transistor radio available at the price. Build it in 1 evening! Tunable over M/L waves. Complete with easy-to-follow instructions and all components (less batteries obtainable anywhere 1/3). 27/8. P. & P. 2/6. (All parts available separately.)
- NO MORE FLAT BATTERIES.** Charge your own battery overnight with this wonderful little charger. Output 6 and 12 Volts, 2 Amps. Input 200-250v A.C. mains. Mains fuse incorporated. Attractive silver hammer finished case, 6 x 3 x 3ins. Complete with leads and battery clips only 21s. P.F. 3/6.
- OSCILLOSCOPE** for D.C. and A.C. APPLICATIONS. A high gain, extremely stable differential Y-amplifier (30 mV/C.M.). Provide ample sensitivity with A.C. or D.C. inputs. Especially suitable for measurements of transistor operating conditions where maintenance of D.C. levels is of paramount importance. Push-pull X amplifier. Fly-back suppression; Internal Time-base Scan Waveform available for external use; plus output available for checking TV line O/P Transformers, etc. Provision for external—1/P and CRT Brightness Modulation. A.C. mains 200/250 v. £16.15.0. P. & P. 8/- or 30/- deposit, plus P. & P. 2/- and 12 monthly payments of 26/6. FULL 12 MONTHS' GUARANTEE INCLUDING VALVES and TUBES.
- A.C./D.C. POCKET MULTI-METER KIT.** 2in. moving coil meter, scale calibrated in A.C./D.C. volts, ohms and milliamps. Voltage range A.C./D.C. 0-50, 0-100, 0-250, 0-500. Milliamps 0-10, 0-100. Ohms range 0-10,000. Front panel, range switch, wirewound pot (for ohms zero setting), toggle switch, resistor and rectifier. 19/8. P. & P. 2/-. Wiring diagram 1/-, free with kit.
- CHANNEL TUNER.** Will tune to all Band I and Band III stations. Complete with P.C.C.84 and P.C.F.90 valves (in series) i.F. 16-19 or 33-38. Can be modified as an aerial converter (instructions supplied). 32/6, plus 4/- P. & P. **HEATER TRANSFORMER** to suit above, 200-250 v., 6/-, plus 2/- P. & P.
- MAINS TRANSFORMERS.** All with tapped primaries, 250-500 v. 70 mA. 6.3 v. 2 amp, 10/8. P. & P. 3/-. 280-0-280v. 70mA 6.3v. 2A, 6.3v. 1A 10/6 p. & p. 3/-. 280-0-280 120mA 6.3v. 2A, 6.3v. 3A 17/6 p. & p. 3/6.
- WOLSEY 3-ELEMENT FOLDED DIPOLE, L.T.V.** Aerial less mounting bracket for external use, complete with 12 yds. of coaxial cable, 15/-, P. & P. 4/-.
- SIGNAL GENERATORS.** Cash £6.19.6 or 25/- deposit and 6 monthly payments of 21/6. P. & P. 5/6. Coverage 120 kc/s to 100 Mc/s on fundamentals and 100 Mc/s to 200 Mc/s on harmonics. Case 10 x 6 1/2 x 5 1/2 in. Three miniature valves and Metal Rectifier. A.C. mains 200/250 v. Internal modulation of 400 cps. to a depth of 30 per cent. Modulated or unmodulated R.F. output continuously variable 100 millivolts. C.W. and mod. switch, variable A.F. output and moving coil output meter. Accuracy ± 2 per cent.

- SIGNAL GENERATORS.** Cash £4.19.6 P. & P. 5/6. Coverage 120 kc/s to 84 Mc/s. Case 10 x 6 1/2 x 4 1/2 in. Size of scale 6 1/2 x 3 1/2 in. 2 valves and rectifier. A.C. mains 250-250 v. Internal modulation of 400 cps. to a depth of 30 per cent, modulated or unmodulated R.F. output continuously variable 100 millivolts. C.W. and mod. switch, variable A.F. output and moving coil output meter. Accuracy ± 2 per cent.
- BATTERY RECORD PLAYER AND AMPLIFIER.** 45 r.p.m. "Star" motor "Acos" crystal pick-up, 3 transistor push-pull amplifier complete with transistors. Output 500 milliwatts, 49/8. P. & P. 4/-.
- 8-watt PUSH-PULL 5 VALVE AMPLIFIER.** A.C. mains 200-250 v. Size 10 1/2 x 6 1/2 x 2 1/2 in. 5 valves. For use with all makes and type of pick-up and mike. Negative feed back. Two inputs, mike and gram. and controls for same. Separate controls for Bass and Treble lift. Response flat from 40 cycles to 15 kc/s, ± 2 db; 4 db down to 20 kc/s. Output 8 watts at 5 per cent total distortion. Noise level 40 db down all lum. Output transformer tapped for 3 and 15 ohms speech coils. For use with Std. or L.P. records, musical instruments such as guitars, etc. Suitable for small halls, £3.19.6. P. & P. 6/-. Crystal mike to suit 15/-, P. & P. 2/-. 8in. P.M. Speaker to suit 12/6. P. & P. 2/-.
- B.S.R. MONARCH UAS WITH FUL-FI HEAD.** 4-speed, plays 10 records, 12in., 10in., or 7in. at 16, 33, 45 or 78 r.p.m. Intermixes 7in., 10in. and 12in. records of the same speed. Has manual play position; colour, brown. Dimensions: 12 1/2 x 10 1/2 in. Space required above baseboard 4 1/2 in., below baseboard 2 1/2 in. Fitted with Ful-Fi turnover crystal head, £6.19.6. P. & P. 5/6 With Stereo Head £7.19.6. P. & P. 5/6.
- TRANSISTOR TESTER.** For both P.N.P. and N.P.N. transistors incorporating moving coil meter. In metal case, size 4 1/2 x 3 1/2 x 1 1/2 in. Scale marked in gain and leakage. 19/8. P. & P. 3/-.
- PUSH-PULL OUTPUT STAGE** inclusive of transistors with input and output transformers to match 3 ohms speech coil, suitable for use with the POCKET RADIO. Kit of parts, including transistors. 19/8. P. & P. 2/-. Wiring diagram 1/6, free with kit.
- PORTABLE AMPLIFIER.** On printed circuit for A.C. Mains 200/250 v. Size 4 x 3 in. with tone and volume control. Complete with Valves: ECL82 and E230. Output 2 watts. 39/6. P. & P. 3/-.

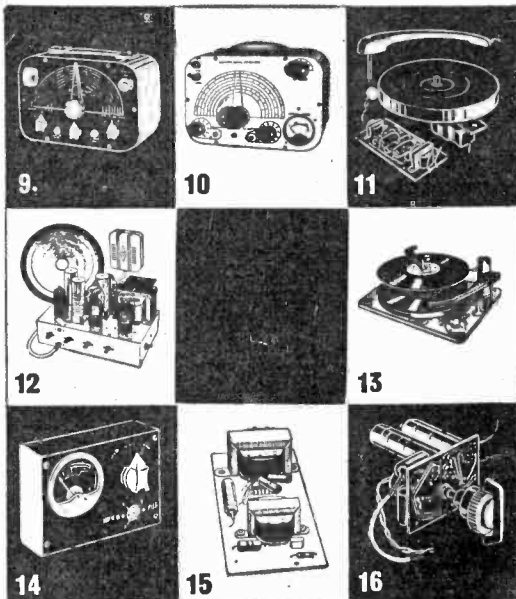

RADIO & T.V. COMPONENTS
(Acton) LTD.

**23B HIGH STREET, ACTON,
LONDON, W.3.**

ALL ENQUIRIES S.A.E.
GOODS NOT DISPATCHED OUTSIDE U.K.



another NEW instrument
from Salford, the
minitest
POCKET-SIZED MULTIRANGE TEST SET

A new compact instrument suitable for the measurement of D.C. voltages and currents, A.C. voltages and ohms. Its high sensitivity renders it suitable for testing and fault location in all types of electrical and electronic circuits. It is well built to ensure long and satisfactory service. The instrument is economically priced and supplied with test leads with plug connections at one end. (Leather carrying case available as an extra).

RANGES: A.C. Volts. 2.5, 10, 25, 100, 250, 1000.
D.C. Volts. 2.5, 10, 25, 100, 250, 1000.
D.C. Amps. 50 μ A, 1mA, 10mA, 100mA, 1A.
Ohms. 2000 200 000 20 M Ω

ACCURACY: D.C. Volts & Amps. $\pm 2\%$ of full scale deflection
A.C. Volts $\pm 3\%$ of full scale deflection
 $\pm 5\%$ at centre scale.

Send for leaflet MIN/6009/PW

neat and compact... with large instrument performance

SALFORD ELECTRICAL INSTRUMENTS LIMITED

Peel Works · Silk Street · Salford 3 · Lancs · Tel: Blackfriars 6688
London Sales Office: Magnet House, Kingsway, W.C.2. Tel: Temple Bar 4668
A Subsidiary of THE GENERAL ELECTRIC CO. LTD, OF ENGLAND



CODAR "CLIPPER" ALL BAND RECEIVERS 10-2000 METRES

LISTEN TO AMATEURS, AIRCRAFT, SHIPPING, SHORT, MEDIUM, LONG WAVE BROADCAST STATIONS THROUGHOUT THE WORLD.

THE MINI-CLIPPER

The miniature valve radio with the BIG SET features. Covers all Short, Medium, Long waves 10-2000 metres (5 coils). Smart all satin silver all front panel with engraved dials, etc. Ball bearing, air spaced variables. Size only 6 $\frac{1}{2}$ x 3 $\frac{1}{2}$ x 4in. Battery lasts months. No drilling. Total building cost including punched chassis, valve, front panel, one coil for 20-60 metres, nuts, bolts, wire, Step-by-step pictorial plans, 39/6. P. & P. 2/-. Additional coils and electrical

39/6



bandsread optional extras. Parts sold separately. Full plans, parts list, 2/-.
P. & P. 2/-. Additional coils and electrical

THE SUPER CLIPPER 88/6

This world-famous hybrid receiver has achieved remarkable success. Tremendous performance with Hi-gain valve detector PLUS two Ediswan transistor amplifiers which are supplied assembled, only 3 wires to connect. Large precision dial, 7 x 4in., with 2 pointers, bandsread and bandspread, dual slow-motion drivers, air spaced variables. Punched chassis 8 x 5 $\frac{1}{2}$ in. Batteries last months. Covers 10-2000 metres (5 coils). Total building cost including chassis, valve, 2 transistor stages, 2 coils 20-60 and 55-190 metres. Step-by-step pictorial plans, nuts, bolts, wire, 88/6. P. & P. 2/6. Plans only, 2/6. THE CLIPPER. As above but one transistor stage, 79/6. P. & P. 2/6. Optional Front Panel, Silver Hammer finish, all holes, 6/9.



THE CLIPPER CR 45

£6.17.6



This A.C. Mains receiver is the latest model in the famous CLIPPER Series and combines really top performance with superb professional finish. It is the finest ALL BRAND receiver at the price with a new high gain circuit using ECC81 double triode, EL84 output, EZ80 full wave rectifier. Power output 3 $\frac{1}{2}$ watts for 2/3 ohm speaker. Covers 10-2000 metres (5 coils). World-wide reception. Outstanding features include 3 planetary slow motion drives, separate electrical bandsread, air spaced low loss variable, satin silver dials, silver hammer front panel. Total building cost, including 10 x 5 $\frac{1}{2}$ in. punched chassis, valves, front panel, 2 coils 20-60 and 55-190 metres, nuts, bolts, wire, etc., 10 pages pictorial plans, £6.17.6. P. & P. 3/6. Optional extra. Modern styled Cabinet, rear panel, silver hammer finish, 27/6. Parts sold separately. Full plans, parts list, 10 pages, 3/6 post free.

No technical knowledge is required to build these fine receivers. Only new guaranteed components are supplied. Send 3d. stamp for illustrated leaflets, testimonials. Suppliers to Educational Authorities, Government Departments, etc. Coming shortly, The Clipper CR 66 A.C. Superhet Communication Receiver.

CODAR RADIO COMPANY, COLEBROOK ROAD, SOUTHWICK, SUSSEX

A Dry-Battery Recharger

"TOPPING-UP"
TRANSISTOR RECEIVER
CELLS

By N. Mears

USERS of transistor receivers are not usually very worried about the cost of battery replacements. There is, however, one special disadvantage about dry batteries, namely the inescapable drop in voltage with use, which progressively limits the undistorted output available from the loudspeaker. While certain cells are made which exhibit the property of constant voltage during their life, these are not readily available "over the counter", and are also decidedly expensive.

Circuit

The simple circuit given here is designed to afford a "topping-up" for dry cells. It can be made up from "spares-box" components, because nothing is very critical. Fig. 1 is self-explanatory.

The transformer in the author's instrument is an old heater transformer, giving a voltage output of 13.3, with a tapping for 25% "boost"; it was previously bought as a cathode ray tube isolating transformer. As an alternative, an old audio output transformer might well be used, as long as a turns ratio between primary and secondary of about 20:1 can be chosen.

The rectifier may be any L.T. rectifier, capable of supplying up to 100mA; or two good selenium elements could be assembled from an old unit.

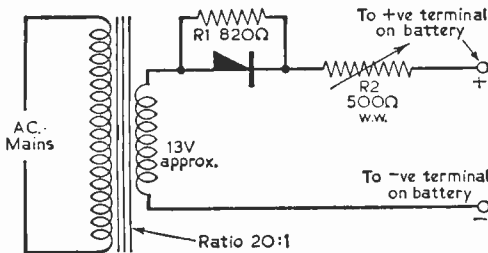

Fig. 1.—The circuit of the instrument.

D.C. Plus A.C.

The resistor in parallel with the rectifier requires some explanation. Experiments with pure D.C. indicate that with dry cells of the usual Leclanché type, uneven depositing of the zinc occurs, and re-charge results in loss of potential life, and considerable over-voltage after charge with rapid drop in service. The superimposition of A.C., and the fact that no reservoir or smoothing circuit is included, enables these difficulties to be avoided. The 500Ω variable resistor should be of the wire-wound type. It serves to adjust the charging current to the required value.

In first putting the unit into service, the charging current should be measured. Batteries of the DT9 size may be recharged overnight at at least 50mA, while smaller sizes should receive proportionately less. If the resistor R2 is provided with a pointer knob, the type of battery can be indicated on a scale and the control set accordingly when recharging.

Connections

Apart from the obvious precaution of ensuring that the battery is properly connected (best made certain by providing non-interchangeable terminal clips) there is little to worry about. It should be noted that it is not practicable to recharge a fully run-down battery, because the zinc will probably be on the point of perforation. However, if, following a few hours' use, a suitable topping-up charge is given, a new battery can be induced to give twice its normal life at least, and of course the voltage is maintained at a much better level in use. The writer uses two DTG batteries for alternate weeks, and after 24 weeks the original voltage of both is still found while the receiver is working. There seems little sign that either battery is nearing the end of its life, although, using the receiver four hours daily, the expected life of each would be about six weeks at the current delivered.

The circuit described above was designed for 9V transistor batteries. These are probably the most often used, but only a variation in series variable resistor is needed to take account of voltage up to 12 and down to 1.5.

The circuit is not at all suitable for running a transistor receiver direct, even if fitted with a reservoir capacitor and smoothing circuit.

Russian Delegation at Marconi's

MR. S. A. MIKOYAN and three other members of the Soviet State Aircraft Committee delegation to Farnborough visited Marconi's Aeronautical Division at Basildon recently. The visit was arranged as a result of discussions at Farnborough last week with the Russian delegation, which included the aircraft designers Antonov and Ilyushin.

The delegation was shown round the Marconi airborne communications and navigational aids laboratories where they were particularly interested in the development of Doppler Navigators for civil aircraft and in the Sixty Series navigation and communication equipment. They were also shown a demonstration of closed circuit television equipment which is currently being used in airborne and airport applications.

Tracing Intermittent Faults

THE PROCEDURE TO USE WHEN
NORMAL METHODS REMOVE THE
FAULT TEMPORARILY

By "Serviceman"

BY far the simplest fault to trace is that which causes complete failure of the set. The reason for this is that the fault condition is constant, and that complete failure must mean that there is an absolute and permanent breakdown somewhere in the circuit. The usual technique is to trace back from the speaker to the front of the set in an endeavour to locate the defective component or broken wire. A process of elimination would be used and it would not be very long before the fault were revealed.

Disappearance of Fault

When the fault is intermittent, however, the problem is often complicated since any slight disturbance to the circuit may clear the trouble temporarily and cause the set to work normally for a while. It may happen simply by connecting a voltmeter or even by scraping the aerial or earth wire on the socket. It is absolutely pointless to make ordinary tests on the now normal receiver, for all will be found to be in perfect order and it is not always possible to promote the fault condition again by circuit disturbance.

The usual exercise is to let the set continue playing out of the cabinet and in an accessible position in the hope that it will go off again so that a further attempt can be made to trace the origin of the trouble. Unless one is very lucky or uses special servicing techniques it may well need many attempts before the fault is eventually located.

There are other intermittent faults such as intermittent distortion, crackling and frying which are equally as complex to diagnose unless they are given special attention, but first let us investigate the intermittent failure fault.

Adjust and Listen

When it has been established that ordinary testing methods cannot be used because any slight disturbance to the circuit causes the set to burst into life, the set should be left running in its cabinet and with the back cover in position until it goes off again. When it goes off, quite a lot of information can be obtained without touching the inside of the set at all. First an ear should be held very close to the loudspeaker to detect the normal residual hum which should be present on all sets.

If hum is present, one can be sure that H.T. supply and L.T. circuits are in order; also the speaker and the output stage. If there is no hum,

then the problem should not be very difficult to solve. The back cover should carefully be removed and the wires connecting the speaker to the output transformer should be moved about and slight tension applied to them to test the soldered joints at both the transformer and speaker tags. A dry joint on the speaker lead is a strong possibility at this stage.

Testing the Loudspeaker

If the trouble persists, it would be a good idea to connect a pair of headphones or another speaker across the existing speaker. If reception is now restored, the set's speaker has an intermittent fault which it may or may not be possible to repair.

Output valves sometimes go intermittent, which can be tested by tapping the valve sharply with

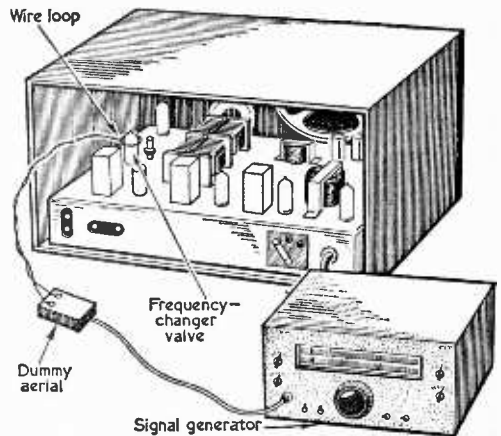

Fig. 1.—To prevent an intermittent fault from being corrected when test instruments are applied, a signal can be applied from a loop of wire slipped over the envelope of the valves, as shown.

the handle of a screwdriver. A series of loud crackles followed by normal reception would indicate that valve replacement would cure the trouble. Triode-pentodes, such as the ECL80 class, are particularly prone to this trouble towards the end of their life.

(Continued on page 745)

TRANSISTOR PRICES DOWN!

TRANSONA-6

(6 Ediswan Transistors plus 2 Diodes)

MEDIUM, LONG WAVE AND TRAWLER BAND EXTENDING TO 80 METRES WITHOUT COIL CHANGING



350 Mw XC101's push-pull output Transistors. Powerful magnet 3in. high grade speaker. Push-pull transformers. This is a top performing receiver. Nearly 30 stations listed in one evening including Luxembourg loud and clear. A pleasure to listen to. **FERRITE ROD AERIAL.** All parts sold separately, including pale blue gleaming polystyrene case with duo-diffusion grilles in red. Uses 9 volt battery. Sockets for car aerial.

Total building cost **£5.19.6** P.P. 3/- . Size 6½ x 4½ x 1½ in.

"Agreeably surprised with Trawler Band reception. Luxembourg as loud as local. Your easy build diagram helped a lot... my first attempt."—H.S., Penzance, Cornwall (poor reception area). "Super car radio."—L.B.V., Liverpool.

TRANSONA-4

(4 Ediswan Transistors, plus 2 Diodes)

Miniature speaker. **FERRITE ROD AERIAL.** MW/LW and Trawler Band coverage down to 80 metres. On test tuned in nearly 30 stations inc. Luxembourg. This sensational new radio is simple to build with our easy-build plans. Handsome pocket case.

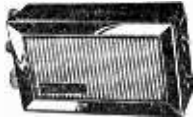

May be built for **52/6** P.P. 3/-.

"Best transistor set I have ever built—dozens of stations."—A.G.H., Deal, Kent.

BEGINNERS PUSH-PULL FIVE

(5 Transistors plus 2 Diodes)

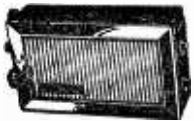

- ★ 2½ in. M/C Speaker
- ★ Ferrite rod aerial
- ★ Tuning condenser
- ★ Volume/oscillator control
- ★ 2-tone case with speaker grille in red
- ★ Fully tunable over med/long waves
- ★ Simple assembly diagrams
- ★ 250 Milliwatts output stage

★ Pocket-sized case.

★ Can be built for **59/6** P.P. 3/-

PARTS PRICE LIST, etc. 1/3.

TRANSONA-5

(MW/LW and TRAWLER BAND)
(5 Ediswan Transistors plus 2 Diodes)



3in. SPEAKER
No aerial required

250 mW output in push/pull for superb tonal quality. 2 R.F. stages for sensitivity. **FERRITE ROD AERIAL.** Pale blue polystyrene case with speaker grilles in red. Volume/sensitivity control.

Total building cost **£4.15.0** P.P. 3/-

ALL PARTS SOLD SEPARATELY

Push-Pull Pocket Six

MEDIUM AND LONG WAVES AND TRAWLER BAND WITHOUT COIL CHANGING.

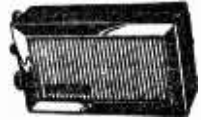

Sensitivity of a superhet, tonal quality of a TRF. Volume control. Tuning condenser. Latest type switches. Handsome two-tone pocket case. Ferrite rod aerial. 3in. quality speaker. Easy-build diagrams. 6 Transistors (including Ediswan and Semiconductors) plus 2 diodes. First class components throughout including transistors.

Total cost of all parts **£5.9.6** P.P. 3/-

ALL PARTS SOLD SEPARATELY

NEW SUPER SIX DESIGN

MED/LONG WAVES, TRAWLER BAND AND S.W. TO APPROX: 40 METRES



- ★ 6 1st grade Transistors (inc. Mullard and Surface Barrier) plus 2 DIODES.
- ★ Top grade 3in. Loud-speaker
- ★ 2 R.F. Stages for extra boost
- ★ High Q 7in. Ferrite Rod Aerial
- ★ Easy-build diagrams
- ★ No aerial or earth required (except as car radio)
- ★ Attractive pale blue case with speaker grilles in red

- ★ 350 Milliwatts output stage
- ★ Sockets for car radio
- ★ Test receiver tuned in over 30 stations (inc. Luxembourg loud and clear.)

THIS FINE RECEIVER MAY BE BUILT FOR **£6.9.6** Plus 3/- P.P.

DATA SHEETS AND PARTS PRICE LIST FOR THE ABOVE 1/3 EACH

ALL PARTS SOLD SEPARATELY

AFTER SALES SERVICE YOUR PROTECTION

RADIO EXCHANGE COMPANY

27 HARPUR STREET, BEDFORD

PHONE 2367

(Opposite Co-op)

CLOSE 1 p.m. SAT.

WEYRAD

IMPROVED COMPONENTS FOR THE 6-TRANSISTOR
2-WAVE SUPERHET RECEIVER

NEW ROD AERIAL AND DRIVER TRANSFORMER FOR SIMPLER ASSEMBLY
AND HIGHER PERFORMANCE

- ROD AERIAL—RA2W
6 in. long, 3/8 in. diameter, connections to tags
on Coils. For 208 pF tuning capacity 12/8
- Car Aerial coupling Coil 1/-
- OSCILLATOR COIL—P50/1AC
M.W. covered with 176 pF tuning capacity.
L.W. by extra padder 5/4
- I.F. TRANSFORMERS
1st and 2nd Stage—P50/2CC 5/7
(2 Required)
- 3rd Stage—P50/3CC 6/-
- DRIVER TRANSFORMER—LFDT4
Redesigned to reduce size and improve perform-
ance. Six spills for mounting and connections 9/8

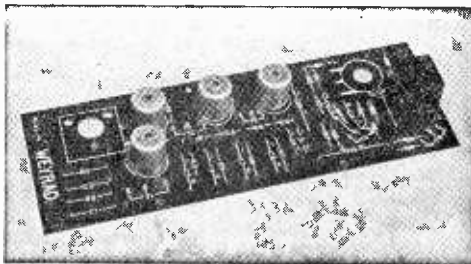

PRINTED CIRCUIT—PCA1
Size 2 3/4 in. x 8 1/4 in. Ready drilled and printed with component positions 9/8

WE CAN NOW OFFER A CIRCULAR TUNING SCALE PRINTED IN BLACK ON GOLD FOIL,
CALIBRATED WITH WAVE-LENGTHS AND STATION NAMES PRICE 6d.

CONSTRUCTOR'S BOOKLET WITH FULL DETAILS AND FREE SCALE 2/-

WEYMOUTH RADIO MANUFACTURING CO., LTD.
REGENT FACTORY, SCHOOL STREET,
WEYMOUTH, DORSET

THE BEST YET IN RECORDER KITS

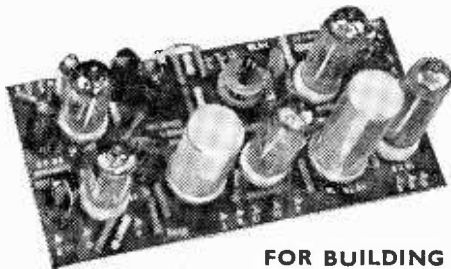

FOR BUILDING
TWO AND FOUR TRACK MODELS USING
LATEST BSR AND COLLARO DECKS

- KIT 'A' (4-TRACK) for BSR Monardeck. Assembled
ready for building in. 9 gns.
- KIT 'B' (TWO TRACK) for BSR Monardeck Assembled
for building in. 8 gns.
- Two-tone covered wooden case with speaker for above. 4 gns.
- KIT 'A' with Deck, Case and Speaker. 24 gns.
- KIT 'B' with Deck, Case and Speaker 21 gns.
- KIT 'C' for Collaro Studio Deck (illustrated above). 11 gns.
- Case and Speaker for above 5 gns.
- KIT 'C' with Case, Speaker and Deck (as illustrated). 28½ gns.

All amplifiers supplied assembled on printed circuit boards with valves.

- Hi-fi quality printed-circuit, amplifiers, individually checked
- Complete with valves, transformers and everything down to wire cut to length

Produced by the makers of recorders for some of today's best known recorders. The specially designed kits offered here set entirely new standards of performance and finish for the home constructor. Amplifiers, case and speaker assemblies and kits complete with decks are available. Well presented instructions are included. All equipment complete and guaranteed.

From radio dealers, or in cases of difficulty please write direct



MODEL C

MARTIN ELECTRONICS LIMITED,
155 HIGH ST., BRENTFORD, MIDDXX.

Leaflet on Martin Recordakits please.

NAME

ADDRESS

(In Block Letters.)

MARTIN RECORDAKITS

Leaflet free on request.
Set of full instructions for
any one model 2/6d. post
free. (Allowable on pur-
chasing kit).

COUPON BRINGS DETAILS →

(Continued from page 742)

Although it is unlikely for the H.T. supply to fail intermittently, a similar, though lighter tap on the rectifier may give some idea of a faulty valve. With early type 5V rectifiers, the filament had a habit of going open-circuit in an old valve when very hot. This would cause a gradual fade-away, however, and would rarely be corrected by circuit disturbance—such trouble can be seen by the filament being out and the valve cold.

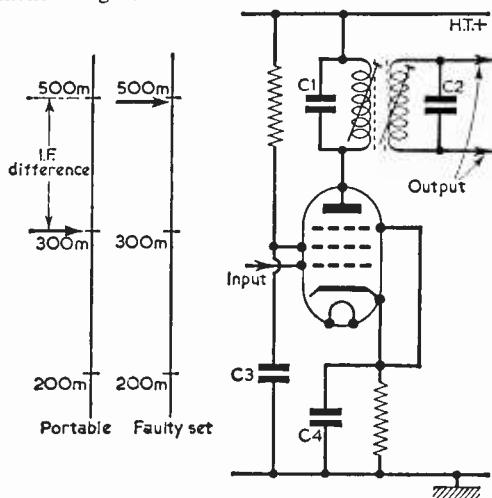

Fig. 2 (left).—The local oscillator of a suspect set can be checked by operating a portable receiver close to its frequency-changer. When the portable is tuned to a station or carrier, a whistle will be heard when the suspect set's oscillator is tuned to the same frequency. The two tuning points are caused by the I.F. difference in relation to the oscillator frequency. Fig. 3 (right).—Intermittent drop in volume is often caused by trouble in the I.F. capacitors C1 and C2. Instability and distortion should lead to a check of capacitors C3 and C4.

Intermittent faults have been known to occur in smoothing resistors from the rectifier cathode and, in some cases, in smoothing chokes. Generally speaking, when there is no residual hum, the intermittent fault is rarely affected by circuit disturbance, and normal fault tracing techniques can be adopted during the period that the fault is present.

Signal Circuits

Intermittent faults may occur on the signal alone; for example, a normal residual hum may be present and the set may exhibit the normal hiss which increases in volume as the volume control is turned up. This is almost the same effect as when the aerial is removed from a set which is working correctly, and is a symptom which is really sensitive to circuit disturbance.

If there is a distinct alteration in the level or the tone of the noise at the speaker when the volume control is turned, or if a slight crackling occurs when the control is rotated, then one can be reasonably sure that the whole of the A.F. section of the receiver is working correctly. At

this stage, and with the volume control at maximum, it may pay to turn the wavechange switch through its various ranges. If there are definite "clicks" when the switch is turned from band to band, then there is little doubt that the I.F. stages are also in order.

Unfortunately, the fault at this time may clear, owing to the disturbance caused by operating the wavechange switch. Should this be the case, the back should be put on the cabinet and the set left running until it fails again.

I.F. Stage Check

The next time the set goes off a more scientific approach to the problem will be necessary. A loop of about twenty turns of 26s.w.g. insulated wire should be prepared of suitable diameter to slip easily over the valves. The ends should be twisted together for about a foot or so and connected to the terminals of a dummy aerial, as shown in Fig. 1. The dummy aerial should then be connected to the R.F. output terminals of a signal generator in the ordinary way.

Now, when the set goes off, the loop of wire should be slipped over the frequency-changer valve and the generator adjusted to full output at the set's I.F. If the set's I.F. stages are in order, the modulation of the generator signal will be heard from the speaker. In this way it is possible to establish what is right and what is wrong in a set without actually touching or disturbing the circuits. If there is no output here, the loop should be transferred to the I.F. amplifier valve. At this point, the signal output may only be very low and it is essential that the generator is on full output and the set's volume control turned full on. The generator will also need to be tuned accurately to I.F. peak.

If there is output from the I.F. amplifier, but not from the frequency changer, the trouble would obviously be somewhere in the first stage. However, if there is also a strong output from the frequency changer, one can be almost certain that the local oscillator is at fault.

Local Oscillator Check

There is a good way of checking local oscillators without touching the suspect set if another radio or small portable is available. When the intermittent set is in one of its "good" conditions, the portable should be held as close as possible to the frequency-changer valve and tuned to a fairly strong station or carrier around 300m (medium-wave). The intermittent set should also be switched to the medium waveband and the tuning adjusted around the 500m mark until a beat note or whistle is heard on the station to which the portable is tuned.

The whistle, of course, is caused by the set's local oscillator beating with the portable's signal. The dial settings will not coincide on the two receivers, since the oscillator frequency is removed from the tuned frequency by the intermediate-frequency, but on most sets the oscillator works at a frequency equal to the tuned frequency plus the I.F. The difference between the two settings is thus the intermediate-frequency, as illustrated in Fig. 2.

When such a beat note has been established, it then remains to wait for the intermittent set to

go off. If the beat note also disappears, the trouble is definitely caused by local oscillator failure.

This idea has been employed effectively to trace intermittent noise. The set would suddenly develop very loud "frying" and crackling noises, but as soon as a test prod was applied to obtain some idea of the cause of the trouble, the disturbance would nearly always clear. The local oscillator was suspected but there was no proof. The beat note set-up was arranged and the whistle was perfectly clear while the set was working correctly, but as soon as the crackle started from the set's own speaker, this was also heard from the portable superimposed on the whistle, thereby proving without doubt that the local oscillator was the culprit.

A valve change did not help, but the trouble was finally located to the capacitor coupling the local oscillator coil to the anode of the oscillator valve. Similar trouble has been located to the grid coupling capacitor in the oscillator circuit and, more often, to the anode feed resistor of the oscillator valve. In very old sets or in sets which have been subjected to damp, the local oscillator coils themselves are often to blame.

Intermittent Drop in Volume

A common intermittent trouble is that the set is working perfectly normally when suddenly there is a marked decrease in volume. Again, if the circuit is disturbed, the fault may correct itself or the fault may be corrected (and sometimes brought on) by operating an electric light switch or electrical appliance somewhere else in the house.

This points conclusively to an R.F. or I.F. fault. The local oscillator is rarely to blame, but in the majority of cases, particularly if the trouble occurs on all wavebands, one of the fixed tuning capacitors across the I.F. transformer windings is responsible. Such components are forgotten since

they are usually housed in the transformer can, and one reaches the stage where pretty well every component in the set has either been checked or replaced.

This type of intermittent trouble is brought on by minute transient currents, as produced by any electrical disturbance, causing intermittent open-circuit (or correcting an open-circuit) in a capacitor carrying R.F. or I.F. such as C1 and C2 in Fig. 3. When such components are subjected to an ordinary capacitance test, the fault rarely shows, and it is only when R.F. or I.F. signals are present that they break down.

The best thing to do in a case like that is to replace all the I.F. transformer capacitors and be on the safe side. This of course should also lead to realignment of the I.F. transformers or, at least, to peaking of the iron-dust cores on a signal.

Effect of Temperature

Temperature has a great effect on intermittent faults, and while a set may exhibit intermittent symptoms when in the cabinet with the back cover on, when the chassis is removed it may work for days without trouble. In this event, the chassis should be worked up to a high temperature by covering it with a cloth or blanket (taking care not to forget about it, though). This should quickly bring on a fault that is sensitive to temperature.

An ordinary domestic hair dryer can be used to advantage to concentrate local heat on a particular circuit section. To localise the heat even more, a soldering iron is useful as it can be held very close to a suspect component. Intermittent instability and distortion are other faults caused by intermittent decoupling capacitors, such as C3 or C4 in Fig. 3, and a soldering iron has been used successfully by the author on many occasions to promote a fault symptom of this kind. ■

TRANSISTOR TRF RECEIVER

(Continued from page 738)

the coil is free to move along the ferrite rod.

The actual physical layout of the components is not at all critical, and any convenient layout may be employed. As the layout will depend upon the size of the cabinet, and this in turn will determine the length of the ferrite rod employed for the aerial coil, no layout details will be given.

Operation

The setting up of the circuit is not very difficult if the following instructions are noted. Having checked the wiring for mistakes, connect the battery as shown, ensuring that the correct polarity is observed. Advance the potentiometer (VR1) to about half way when some sort of sound will be heard from the loudspeaker. With the aid of a milliammeter, adjust the collector current of Tr3 to 10mA by finding a suitable value for R4, either by trial and error, or by making R4 a variable resistor, and adjusting to the right current and then substituting a fixed resistor of equivalent value. The value of the resistor used need only be a near value—there is no real need for great accuracy. L2 should be moved as close as possible to L1 and the beehive trimmer C2 adjusted until the set starts to oscillate. By varying C1 it should be possible to tune in the local station. When this

has been done the trimmer C2 should be backed off until oscillation just ceases. By varying the position of L2 with respect to L1 and by suitably adjusting C2 the position of maximum sensitivity may be found. L2 is then sealed in position with sealing-wax or Sellotape.

It will be found that the sensitivity control will have an effect on regeneration, and this will be found useful in areas where there are two transmitters—one being a little more powerful than the other. ■

COMPONENTS LIST

Resistors

R1 100k $\frac{1}{2}$ W
R2 220k $\frac{1}{2}$ W
VR1 1M (with switch)

R3 4.7k $\frac{1}{2}$ W
R4 see text

Condensers

C1 500pF variable
C2 4-30pF beehive trimmer
C3 0.001 μ F (1,000pF)
C4 270pF
C5 10 μ F 10VW
C6 10 μ F 10VW

T1 type interstage transformer: 4.5 : 1 (Fortiphone 55 or similar)

X1, X2 crystal diodes (any type suitable for R.F.)
Loudspeaker: C.M.S. 50 (T.S.L.)
Ferrite rod, wire for coil, etc.

GLYNE RADIO LTD.

THE COMPONENT SPECIALISTS



18 TOTTENHAM COURT ROAD, W.1. MUSEUM 5929/0095
 162 HOLLOWAY ROAD, LONDON N.7. NORth 6295/677
 9 CAMBERWELL CHURCH STREET, S.E.5. RODney 2875

All post orders and correspondence to 162 HOLLOWAY ROAD, LONDON N.7

OPEN: Tottenham Court Rd., 9 a.m. to 6 p.m. Mon. to Fri., Sat. 1 p.m. Holloway Rd. and Camberwell: 9 a.m. to 6 p.m. daily. Thurs. 1 p.m. Sat. 5.30 p.m. Our Advantageous H.P. and Credit Sale Terms are available on any single item over £5. Your enquiries invited. Please print your name and address.

NEW! NEW! THE "CLYMAX"

At last a 6-transistor pocket size superhet for Medium and Long Wave at a price you can afford. All required components

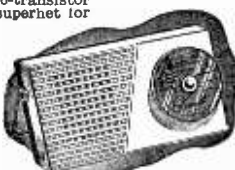

ONLY

£6.16.6

Nothing more to buy!

Plus 2/6 P. & P.

- ★ Completely self contained. No external aerial or earth required.
 - ★ Full medium wave coverage, plus switched Light programme on Long Wave.
 - ★ Push pull output—250 milliwatts.
 - ★ Matched set of latest type Mullard transistors.
 - ★ Genuine 3in. P.M. Speaker.
 - ★ High-Q Coils.
 - ★ Ferrite rod aerial with high selectivity.
 - ★ Size: 5 1/2 x 3 1/2 x 1 1/2in. Two tone cabinet.
 - ★ Precision etched printed circuit with component references clearly marked.
- Alignment service available. All parts available separately. Full assembly instructions and individually priced parts list, 2/- post free.

SPECIAL NOTE! Owing to manufacturers' reductions of transistor prices we are now able to offer our transistor sets at new low prices!

THE "WAVEMASTER" 7-TRANSISTOR LUXURY PORTABLE NEW LOW PRICE £9.19.6

400 Milliwatt Output

To build yourself. Medium and Long Waves—Push-Pull Superhet A. V. C. Perfect Car Radio reception. Size 10in. x 6 1/2in. x 4 1/2in. at base tapering to 4in. at top. Very attractive two-tone grey Vynide covered cabinet with black and gold printed escutcheon plate, cream and gold knobs, handle and cabinet fittings. ★ Weight—with long-life 7 v. battery—4 1/2 lb. ★ Mullard high-grade transistors throughout. ★ High-Flux 7in. x 4in. Elliptical Speaker. ★ Slow motion tuning. ★ Co-axial socket at rear for direct connection to Car Radio Aerial. ★ Improved reception by use of seven-section plated telescopic aerial disappearing into Cabinet when closed. 34in. above Cabinet when fully extended. Construction simplified by Bakelite chassis board with the following components already mounted: I.F. Transformer (3). Oscillator Coil. Trimmer Bank. Output Transformer. Interstage Transformer, Aerial Brackets and Earth Bar. **SPECIAL INCLUSIVE PRICE** for all required components. Full assembly instructions—nothing more to buy—£9.19.6, plus 3/6 P. & P. Alignment service available. Full assembly instructions and individually priced parts list, all of which are available separately, 2/6. Post Free.

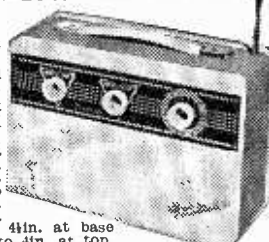

"POPULAR FOUR"



IMPROVED APPEARANCE AND PERFORMANCE

A new three valve plus miniature contact-cooled rectifier, mains T.R.F. Receiver is now available. New Deluxe Cabinet polished walnut finish, cream trim, attractive horizontal dial (as illustrated). Quality 5in. P.M. speaker. Specially wound high gain super-sensitive Denco coils. Medium and Long Wavebands. Excellent Continental reception! Overall dimensions: 12in. x 6in. x 5in. A.C. 200/250 v. Simple construction with guaranteed results. Easy to follow practical and theoretical diagrams supplied. All necessary components, down to the last nut and bolt, are offered at a **SPECIAL INCLUSIVE PRICE OF £5.5.0**, plus 3/6 P. & P. Instruction book available separately 1/6, post free. **ALL PARTS AVAILABLE SEPARATELY.**

STOP PRESS! The well known Brayhead Trans Trans "SUPER 60" Radio Kit. A complete construction kit to make your own transistorised Transmitter and Receiver. No soldering reqd., 7 different circuits to build. Ideal Xmas Gift—beautifully presented in original manufacturers coloured box with all necessary instructions. (As nationally advertised at £5.4.8). Limited quantity only at 49/6. Plus P. & P. 4/-.

"BRAND FIVE"

Recording Tape. An enthusiast's must! High Quality Acetate Base: 5" 600ft. 18/6; 5" 900ft. 18/6; 5 1/2" 2,000ft. 23/6; 7" 1,200ft. 25/-; 7" 1,800ft. 35/-; Extra Quality Mylar Dupont: 3" 300ft. 13/6; 5" 1,200ft. 37/6; 7" 1,800ft. 44/-; 7" 2,400ft. 60/-. Each on plastic spool. All post free. **BRAND NEW—NOT SUBSTANDARD PLASTIC TAPE!** SPOOLS—Best quality 3in. 1/8; 5in. 2/-; 5 1/2; 7in. 2/6. **PLASTIC SPOOL CONTAINERS** for spool sizes 5in. 1/8; 5in. 2/-; 7in. 2/3. Any single item plus 6d. P. & P. Total over 2/- Postfree.

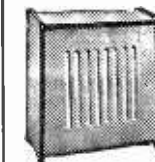

EXTENSION SPEAKER CABINET

New design in light oak. Two sizes available. For 6" or 8" speaker at 22/6. For 10" speaker at 25/- only. Each plus 2/6 P. & P. Suitable reconditioned 8" P.M. unit at 13/6 only, plus 1/6 P. & P. Full range of competitively priced new speakers in stock. Ask for list.

"P.W. TUTOR"

COMPLETE KIT AS SPECIFIED
 Stages 1-4 **65/-** plus 2/- P. & P.
 All parts available separately. Send stamp for list.

OUTSTANDING METER IMPORT!

20,000 ohms per volt!

MODEL 200H Volt-ohm-Milliammeter

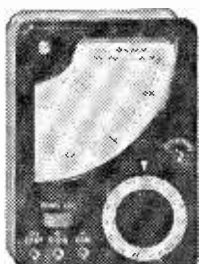

Ranges: A.C. Voltage: 10, 50, 100, 500, and 1000 volts (10,000 ohms per volt). D.C. Voltage: 6-25, 50, 250, 500, and 2,5k. (20,000 ohms per volt). D.C. Current: 0-50 microamps. 0-2.5 ma. 0-250 ma. Resistance: 0-5k, 0-5 meg. (300 ohm and 30k at centre scale). Capacitance: 10 pF to 1001 mid. 1001 mid. to 1 micro. Decibels: -20 to +22 dB.

A fully guaranteed pocket size meter (actual size: 4 1/2 x 3 1/2 x 1 1/2) knife edge pointer. Top quality supplied complete with test prods and full operating instructions at **£6.19.6 ONLY**. Post Free Optional extra. Attractive carrying case 15/- only. (Bonafide trade enquiries invited). Leaflet available. **JUST ARRIVED!** MODEL 2010. Identical appearance and size with rotary type switch but 10,000 Ohm/V. Ranges: D.C. Voltage: 0-6-30-120-600-1200 volts (10,000 ohms per volt). A.C. voltage: 0-6-30-120-600-1200 volts (10,000 ohms per volt). D.C. Current: 0-120 microamp. 0-300mA. Resistance: 0-30 K. 0-3 Meg. (150 ohm and 15 k at centre scale). Capacitance: 50 pF to 0.01 mid., 0.001 mid. to 0.15 mid. Decibels: -20 to +63 dB in 5 ranges. **PRICE £5.19.6**. Post Free.

"The CITIZEN" NEW LOW PRICE 85/-

Our Sensitive 5 Stage (4 transistor plus diode) pocket transistor receiver, for full medium wave reception with the following outstanding features:



- ★ Completely self-contained—No external aerial or earth required. ★ Genuine 2 1/2in. High Flux P.M. Speaker. ★ Push-pull Output—250 milliwatts. ★ Genuine Mullard transistors. ★ Socket provided for personal listening. ★ Socket provided for connection to Car Aerial. ★ Volume Control with on/off switch—Condenser tuning. ★ Easy assembly on pre-tagged circuit board. ★ Attractive red polystyrene cabinet measures 5 1/2 x 3 x 1 1/2in., chrome handle, attractive dial. All required components including full instructions, solder, etc., and battery at special inclusive price of only 85/-. (Yes, Eighty-Five Shillings Only!) Plus 2/6 P. & P. Nothing more to spend. Suitable crystal dead-aid type miniature earpiece fitted with miniature jack plug at 7/6 extra only! If req. All parts available separately—itemised list and full assembly instructions, sent for 1/6 post free. Hear this amazing little receiver working, at any of our branches.

SENSATIONAL NEW 1961 DESIGNS—BY CONCORD

LOW PRICES ★ PICTORIAL STEP-BY-STEP PLANS ★ EASY AS A.B.C.

THE NEW "LISBON" TRANSISTOR SET

This is a pocket 2-stage transistor set not much larger than a matchbox. Excellent clear reception covering all medium waves, works for months off a tiny 1½ or 3 volt battery costing only 3d. Easy to build and an excellent introduction to transistor circuitry. Everything can be supplied down to the last nut and bolt incl. **SIMPLE PICTORIAL STEP-BY-STEP PLANS FOR ONLY 19/6**, plus post and packing 1/6. (C.O.D. 2/- extra). Parts sold separately, priced parts list 1/-.



THE NEW "FLORIDA" VALVE RADIO

This sensational "FLORIDA" model is one of our most sensitive valve radios. It is a highly compact, self-contained miniature push button base, valve pocket radio at absolutely rock bottom building cost. Covers all medium waves with very latest circuitry bringing in stations from all over Europe without fuss. Size only 4½ x 2½ x 1½ in. A fascinating pocket radio. We can supply all the parts including beautiful 2-tone case and **SIMPLE AS A.B.C. PICTORIAL STEP-BY-STEP PLANS**, screws, wire, etc. Can be built for the exceptionally **LOW PRICE OF 27/6**, plus post and packing 1/6 (C.O.D. 2/- extra). Parts sold separately, priced parts list 1/-.

27/6

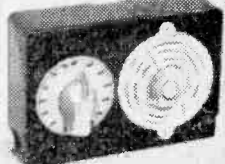

OUR NEW 4 STAGE "MINUETTE"

Build this newly-designed "MINUETTE" 4-STAGE transistor set in very strong ready drilled **ULTRA-MODERN CASE**, size only 6 x 3½ x 1½ in. Uses three transistors and diode and **SELF-CONTAINED LOUD SPEAKER**. Very sensitive, ideal for office, bedroom, holidays, etc. Months and months of listening off an 8d. battery. Can be built **FOR ONLY 39/6**, including **PROPER CASE**, miniature speaker, etc. **SIMPLE AS A.B.C. PICTORIAL STEP-BY-STEP PLANS** etc., plus post and packing 1/6 (C.O.D. 2/- extra). Parts sold separately, priced parts list 1/-.

39/6



THE NEW "SAN REMO" ONLY 32/6

This All Transistor Speaker Radio—the "San Remo"—covers all medium waves including "Home," "Light," etc. Reliable and lightweight—Slips easily into the Pocket or Handbag—size only 4½ x 2½ x 1½ in. Works for Months off 8d. Battery! Ideal for holidays, Camping, Bedroom, etc. Anyone can assemble it in an hour or two with our simple-as-ABC PLAN! Complete set of parts including miniature speaker—everything—only 32/6, plus 2/6 P. & P. (C.O.D. 2/- extra.) Parts can be bought separately.

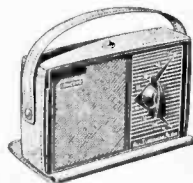

CONCORD ELECTRONICS Dept. PW37
210, Church Road, Hove, Sussex

Cheques accepted. Cash on delivery 2/- extra. Please print name and address in block letters. Suppliers to Schools, Universities, Government and Research Establishments. Complete range of components and values stocked. Regret! no C.O.D. abroad. **DEMONSTRATIONS DAILY AT WORKS.**

NEW EDITION just out!

The
Catalogue
for every
radio
enthusiast

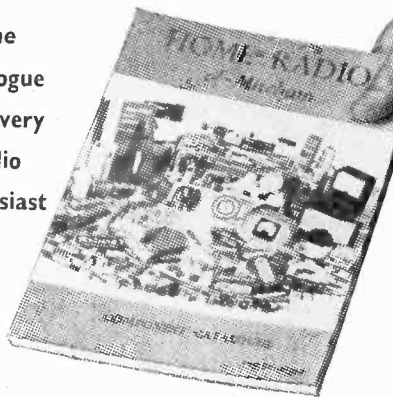

170 pages

Over **600**
illustrations

Over **5000**
components listed

This is today's most up-to-date, most comprehensive component catalogue for the radio constructor, experimenter, electronic engineer and hi-fi enthusiast.

**POST
COUPON
TODAY**
Please send
CATALOGUE
on top left
corner of
envelope.

Please send latest Catalogue. I enclose 3/- for cost & postage.

NAME _____

ADDRESS _____

Home Radio Ltd., Dept. PW, 187 London Road, Mitcham,
Surrey. MITcham 3282

2/-
PLUS 1/-

Letters to the Editor

The Editor does not necessarily agree with the opinions expressed by his correspondents

Whilst we are always pleased to assist readers with their technical difficulties, we regret that we are unable to supply diagrams or provide instructions for modifying commercial or surplus equipment. We cannot supply alternative details for receivers described in these pages. **WE CANNOT UNDERTAKE TO ANSWER QUERIES OVER THE TELEPHONE.** If a postal reply is required a stamped and addressed envelope must be enclosed with the coupon from page iii of cover.

B.B.C. TELEVISION RECEPTION

SIR,—I have seen one or two letters recently about listeners picking up television on wavelengths far removed from the actual transmission, and I would like to offer a suggestion. I have experienced a similar fault, and in some cases it has been direct radiation from a badly adjusted receiver, but in most cases I have investigated it was mains borne. Why the signal should get into the mains I cannot say, unless the mains wiring acts as some sort of aerial, but the fitting of one of the special suppressed plugs into the mains outlet will generally prevent the trouble. Naturally, any aerial which a listener uses should be erected well clear of any television aerial.—F. BAILEY (Willesden).

VINTAGE MODELS

SIR,—How I agree with Mr. Newman (July issue) concerning the reproduction from an old receiver. I do really think that if anyone could recover one of these old sets from a loft or some other place where it has for long been deposited, and get it going again at correct voltages, etc., one would be agreeably surprised at the performance. After all, we rely now mainly on higher efficiency valves for the performance which we obtain, whilst in the older days circuitry was, in my opinion, of much more effect. We had very large coils with a minimum capacity across them, and I feel sure that the response from these efficiently tuned circuits was capable of much wider frequency bands than we get in modern apparatus. Has not F.M. been forced upon us because owing to the modern valves and circuits which they call for cut-off resulted at both ends of the scale? I would very much like to hear one of these old sets cleaned up and put to work on a modern transmission.—J. MANSELL (Warwick).

ADDING COMMUNICATION FEATURES

SIR,—The receiver series under the above title has been most interesting, but I do not think that the addition of the arrangement described will provide a reader with a real communications set. I have used two or three American communications receivers and I feel that much of their efficiency is due to the coils and associated circuitry. I have not seen any English sets with the same types of coils, ceramic formers, silvered wire and reliable switching. Is it that the condi-

tions in America are so poor that the receivers have been developed to make the most of those conditions and as a result are more efficient than those developed in this country?—E. R. Le PAGE (S.E.15).

AMATEUR TRANSMITTING LICENCES

SIR,—Considerable interest has been expressed during recent years by readers on the possibility of the provision of a low power transmitting permit, other than the current Radio Amateur's Transmitting Licence. Whilst it would not appear likely that any form of Novice Licence will be permitted, which frankly could lead to a lot of misguided tinkering with obsolete ex-government transmitters on our already overcrowded L.F. amateur frequency bands, there would appear to be a case for the consideration of a Citizen's Radio Permit similar to that in current operation in the U.S.A. For the benefit of readers who have not previously encountered mention of Citizen's Band Radio, it operates basically as follows; initially in 1949, class A and B Citizen's Radio Licences were originally issued by the FCC for the use of frequencies at UHF, but this did not become popular for the average man in the street for his two-way radio, house to car, fishing boat to shore camp, across town office to home, etc., mainly due to the cost of VHF equipment and very restricted line of site transmission range. However, in 1958 the class D Citizen's Radio Service was inaugurated whereby any American citizen over the age of 18 years could obtain a licence upon application, free of charge, without any form of test, simply by filling in the appropriate form and making postal application to the FCC providing the station is to be used for any legitimate purpose, i.e., private, social, or business communication with other similar stations. Transmissions to take place in the authorised frequency band 26,965kc/s to 27,255 kc/s on any of 23 specified crystal controlled channels spaced 10kc/s apart. (VFO operation not permitted.) Ground wave working only is allowed; attempts to work DX are illegal, as also are CQ calls.

FCC regulations govern the design of equipment, most of which takes the form of low cost transceivers, crystal controlled, maximum legal power input 5W, A.M. phone only, frequency tolerance of 0.005%. The simplest of these consist of single channel crystal controlled TX with super-regenerative receiver section, ranging to the more elaborate multi-channel switched tuned TX with double super crystal controlled receiver. Both mobile and home based stations equipment being available. Kits of parts with pre-wired frequency determining sections being also available for the boys who brew their own rigs. Typical operating ranges are reported as follows:

Mobile-to-mobile 7-10 miles in city, 12 miles in country;

Base-to-mobile 10-15 miles in city, 17 miles in country;

Base-to-base 20 miles in city, 25-30 miles in country.

Very little TVI is encountered due to the low power used, the inclusion of L.P. and H.P. filters taking care of the odd cases.

With regard to a possible service of this nature on our side of the Atlantic the first consideration would probably be which part of the already loaded frequency spectrum to use. The writer would venture to suggest a 300kc/s slice at the H.F. end of the present ten metre amateur band as being suitable and least likely to cause anyone inconvenience, at least it would be more interesting to listen to than the present deadly silence which prevails.—R. ELLIS G3BKM (Huddersfield).

TRANSISTOR NOMENCLATURE

SIR,—As the number of types and makers of transistors grows, are we to be eventually landed with the same bewildering array of cryptic nomenclature as now exists with valves, whereby none but those who are actively connected with their use can readily identify a particular item by means of the figures and letters intended for that purpose. It would seem that in the past the position has been greatly aggravated through the selfish interests of individual manufacturers each producing items bearing identical functional characteristics but with physical differences rendering them not directly replaceable with each other. In the name of sanity, why must this be so? Of American origin a 6J5 is a 6J5, no matter who makes it. Any distinctive merits must surely be judged by the consumers in the end.—P. ASHDOWN (Lancs.).

Personal Phone for Transistor Receivers

A SIMPLE MODIFICATION THAT CAN BE MADE TO MOST TRANSISTOR SETS

By S. Burrows

RECEIVERS such as the PRACTICAL WIRELESS Pocket Super het, and other transistor sets, may be used to operate a personal earpiece, for individual listening. There are circumstances when this is an added convenience, and it avoids disturbing others.

Ample volume is available without using the output stage, so the earpiece can be operated from the driver stage. This is most easily arranged by fitting a miniature twin socket, and wiring it in parallel with the driver transformer primary. That is, from battery negative line to driver collector, as shown in Fig. 1.

If preferred, it is in order to use ordinary medium impedance headphones, but when the maximum portability is required, a miniature personal earpiece will be more suitable. It is essential that the correct type of earpiece, of reliable manufacture, and in proper order, should be employed. If not, volume may be poor, or reproduction may be distorted. A medium impedance unit will be satisfactory, and this can be expected to have a D.C. resistance of approximately 250Ω. The driver will work best into a moderately high impedance, and low impedance units are unsuitable.

The output stage may be rendered inoperative by switching out the battery negative supply to these transistors, as in Fig. 1. A miniature on-off

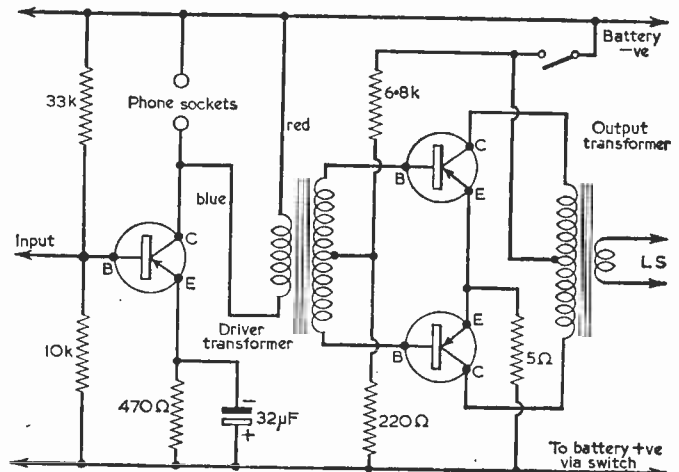

Fig. 1.—The simple circuit modification.

switch can be made from an Ardente S1100 wafer, if desired, or a screw-down type of switch can be made by soldering a 6B.A. nut to a small bracket, and running a short 6B.A. bolt through this. An alternative is to arrange that the earpiece plug opens fixed contacts when inserted in its socket.

Miniature plugs and flexible cord may be obtained for the personal phone. Should any difficulty arise in obtaining these items, they may be obtained from Home Radio (Mitcham) Ltd.

★ **POST HASTE** ★

TRANSISTORS REDUCED PRICES MULLARD HAVE REDUCED THE PRICE OF MANY

TRANSISTORS to			
OC44	11/-	OC71	6/6
OC45	10/-	OC72	8/-
OC70	6/6	OC73	8/-
		OC76	8/-
		OC78	8/-
		OC81	8/-

THESE ARE THEIR NEW LIST PRICES WHY BUY SURPLUS?

MATCHED PAIRS of the above listed transistors, Mullard match only the OC72 at 16/- pair.

"PRACTICAL WIRELESS" POCKET SUPERHET

OSMOR printed circuit version. Osmor Rod Aerial 10/-, I.F.T.s and Osc: Coils, 22/6. Osmor Driver, 11/6. Osmor Output, 10/6. Set MULLARD transistors, 53/6. OAB1 Diode, 3/-, J.B. Gang, 11/-, Trimmers, 2/8 pr. Set Condensers, 15/-, Set Resistors, 6/6. Ardente Vol. Control, 8/-, Ardente W/C, 3/6. Speaker, 19/10. Hardware, 4/6. Printed Circuit, 9/-, Case and Knob, 7/6. Dial, 6d. Battery PP4, 2/-, Leaflet giving full illustrated details, 1/9. All the above components if purchased at one time £9.9.0. OSMOR undertake to align this receiver for a charge of 10/-.

"WEYRAD"

WEYMOUTH RADIO 6 Transistor Superhet using the P50 coils, as they advertise in this journal. P50/1AC Osc: Coil, 5/4. P50/2CC 1st and 2nd I.F.T.s, 5/7 ea. P50/3CC 3rd I.F.T., 6/-, RAZ2V Rod Aerial, 12/6. LFD2 Driver, 9/6. PCA1 Printed Circuit, 9/6. Instruction Book, 2/-, Set Resistors, 7/6. Vol. Control D.P., 5/6. Set Condensers, 20/-, J.B. Gang, 11/-, Beehive Trimmers, 1/3 ea. W/C, 3/6. Dial and Knob, 3/6. Battery PPI1, 5/6. OAB1, 3/-, Set MULLARD transistors, 53/6. 35 ohm Sin. round L/S, 15/-.

JASON F.M. TUNER KITS

We are the Authorised Jason Dealer and the whole kit is as supplied by them. You can therefore safely return to Jason for alignment without them rejecting it for non-standard components. We can also align for the standard charge.

FMT1 Is the standard variable tuner for cabinet mounting, unpowered. Supplied complete with four EF91 valves	£6.17.6
Hire purchase deposit £1.7.6 and 6 monthly	£1.1.8
FMT1 Power pack ready drilled chassis complete...	£2.12.6
FMT2 Is a new tuner in a modern case, green, which can be used for shelf or cabinet mounting, and has the space for power supplies if required. Supplied complete with four EF80 valves.....	£7.17.6
Hire purchase deposit £1.11.6 and 6 monthly	£1.4.4
FMT2 With power. Complete kit.....	£9.15.0
Hire purchase deposit £1.19.0 and 6 monthly	£1.9.4
FMT3 Is the fringe version and should be used when farther than 70 miles from the transmitter. Supplied complete with 6 valves.....	£9.12.6
Hire purchase deposit £1.18.6 and 6 monthly	£1.9.0
FMT3 With power. Complete kit.....	£12.0.0
Hire purchase deposit £2.8.0 and 8 monthly	£1.6.6

The instruction book is included in all kits, but otherwise 2/6.

JASON SWITCHED TUNERS

The JTV/2 and Mercury 2 are both of the pre-set station type with the addition of BBC and ITA sound. They use the latest "Fireball" turret and the A.F.C. ensures freedom from drift. The Mercury 2 is for cabinet mounting with external power, the JTV/2 has the same tuning heart, with power supplies mounted in a case, and can be used for shelf or cabinet.

JTV/2 Complete with valves and book	£14.15.0
Hire purchase deposit £3.0.0 and 12 monthly	£1.1.6
Mercury 2 complete with valves and book.....	£10.15.0
Hire purchase deposit £2.3.0 and 8 monthly...	£1.4.0
Power pack kit for Mercury 2 ready drilled chassis	£2.12.6

Instruction book for switched tuners 4/-.

REQUIRED CHANNELS MUST BE SPECIFIED FOR SWITCHED TUNERS

A more detailed list can be sent upon request.

ALL JASON TUNERS ARE ON DEMONSTRATION, AND ALWAYS IN STOCK.

★ **POST FREE** ★

MARTIN RECORDAKITS

We are able to offer for the first time, a proprietary range of Recorders in kit or assembled form. This enables you to take advantage of mass production techniques and prices, should you wish to assemble yourself. The components used are the finest available, with BVA valves, and the decks are the latest having all the improvements B.S.R. and Collaro make from time to time. Heads, etc. The amplifiers are packed in special cartons with instructions which enable anyone to build. We are confident you will find these Recorders very good value, they have been built up to a standard and not down to a price.

B.S.R. TD3 Monardeck, latest model 5 1/2 in. spools	CASH	£9. 9.0
Hire purchase deposit £1.19.0 and 6 monthly		£1. 8.4
Tape Amplifier for B.S.R. deck, printed circuit ready wired, with ECC83, ECL82, EM85 and EZ81. Complete with all plugs, sockets, panels, knobs, etc. The whole amplifier mounts on to the deck, making a self contained unit.	CASH PRICE	£8. 8.0
Hire purchase deposit £1.14.0 and 6 monthly		£1. 5.8
Cabinet for above including 7 x 4 in. speaker.....	CASH	£4. 4.0
Total kit as above.		£22. 0.0
Hire purchase deposit £4.10.0 and 12 monthly		£1.12.1
The above recorder can be supplied complete with Mic: tape assembled and tested for CASH	PRICE	£25. 0.0
Hire purchase deposit £5.0.0 and 12 monthly		£1.16.8
Collaro Studio Deck. Very latest model 3 speeds...		£12.10.0
Hire purchase deposit £2.10.0 and 8 monthly		£1. 7.6
Tape Amplifier for Studio deck, with ready wired printed circuit, control and input panels, mains and output trans., complete with knobs, plans, screws, etc., EF86, ECC83, EM84, OAB1 and 2 EL84, 3 watts output. Magic eye, Radio and Mic. inputs. Superimposing facilities, EX L/S socket, Low level output, tone control. Can be used as an amplifier.	COMPLETE CASH	£11.11.0
Hire purchase deposit £2.7.0 and 8 monthly		£1. 5. 6
Cabinet for above including 9 x 5 in. speaker.....	CASH	£5. 5.0
Total kit as above.		£29. 0.0
Hire purchase deposit £6.0.0 and 12 monthly		£2.2.0
We can supply the above recorder, complete with tape and Mic., in a DE LUXE cabinet, assembled for.....		£35. 0.0
THIS MACHINE IS LISTED £41.0.0 BY MAKERS AND IS A VERY GOOD BUY.		
Hire purchase deposit £7.0.0 and 12 monthly		£2.11.4
Microphone for the above recorders, ACOS MIC 40, 25/-, S/C plug, 4/6.		
Synchrotape Sin. 600ft. 15/- 5in. 900ft. 19/6		
Finest 5 1/2 in. 850ft. 19/6 5 1/2 in. 1200ft. 22/6		
Boxed 7 in. 1200ft. 22/6 7 in. 1800ft. 32/6		
Tape Recorder Speaker Cabinet , corner, 20 x 10 in. High class finish in two-tone Grey 'Vynair'...		£2.15.0
With 9 x 5 in. high flux speaker		£4. 0.0
F.M. Tuner Aligned and assembled, using Philips tuning head with ECC85, EF85, EF85, EZ81 and EM81, with 2 diodes. SELF POWERED. UNREPEATABLE BARGAIN. CASH		£7.19.6

GRAMOPHONE EQUIPMENT

B.S.R. UA14 TC8/H cartridge.....	£7.15.0
Hire purchase deposit £1.11.0 and 6 mthly	£1. 4.0
Collaro C60 Autochanger "O" cartridge.....	£8.15.0
Hire purchase deposit £1.15.0 and 6 mthly	£1. 6.8
Garrard "Autoslim" GC8 cartridge.....	£9. 3.4
Hire purchase deposit £1.17.4 and 6 mthly	£1. 7.8

A.M. RADIO CHASSIS

2-Band Superhet AC/DC, 4 valves, with speaker. Size 6 x 9 x 6 in. Long and Medium waves...	£5.17.6
4-Station Pre-set chassis with speaker. Valve line up and size as above.....	£4.17.6

WE PAY ALL POSTAGE AND INSURANCE ALL ORDERS DESPATCHED SAME DAY MONEY WILL BE REFUNDED IF REQUESTED

SURBITON PARK RADIO LTD.

(Established over 30 years)

48 SURBITON ROAD, KINGSTON UPON THAMES, SURREY

Telephone: KIN 5549
Hours: 9 a.m. to 6 p.m. 1 p.m. Wed.
We do not close for lunch.
Open all day Saturday

MAXI-Q
REGD.

COIL PACKS

CP.3/370 pF and **CP.3/500 pF**. These 3 waveband Coil Packs are available for use with either 370 pF or 500 pF tuning condensers. The coverages are: Long Wave 800-2,000 metres. Med. Wave 200-250 metres, Short Wave 16-50 metres. Designed for use with "MAXI-Q" glass scale type S2. Retail price of each unit: 32/- plus 10/8 P.T.—total 42/8.

CP.3/G. As above but with Gram. position, suitable for use with 500 pF tuning condenser: 39/- plus 13/- P.T.—total 52/-.

CP.3/F. This Coil Pack is for use with a 500 pF tuning condenser and covers the standard, Long, Med. and Short wavebands with the addition of the band 50/160 metres. This covers the Trawler band, Aeronautical and the 80 and 160 metre Amateur bands: 49/- plus 16/4 P.T.—total 65/4.

CP.3F/G. As CP.3/F but with Gram. position: 57/- plus 19/- P.T.—total 76/-.

CP.4/L and **CP.4/M**. These compact 4-station Coil Packs are available for either 1 Long Wave and 3 Medium Wave Stations (CP.4/L) or 4 Medium Wave Stations (CP.4/M.). They are fully wired and require only four connections for use with any standard frequency changer valve. 25/- plus 8/4 P.T.—total 33/4.

CP.4L/G and **CP.4M/G**. As CP.4/L and CP.4/M but with provision for Gram. position. 31/- plus 10/4 P.T.—total 41/4.

See Technical Bulletin DTB.9 for details of all Coil Packs, 1/6.

GENERAL CATALOGUE covering full range of components, send 1/6 in stamps or P.O. PLEASE SEND S.A.E. WITH ALL OTHER ENQUIRIES.

DENCO (Clacton) LTD. (Dept.P.W.) 357/9 Old Road, Clacton-on-Sea, Essex
STOP PRESS: MULLARD "Twin Three-Three" Stereo Amplifier. Punched Aluminium Chassis and Hammered Gold printed Front Panel, 25/9.

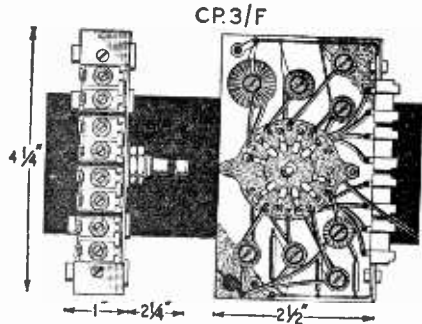

NEW! **DO-IT-YOURSELF**
TRAINING TECHNIQUE
in **RADIO & ELECTRONICS**

You LEARN while you BUILD...

SIMPLE...PRACTICAL...FASCINATING... 1st stage receiver

ANNOUNCING—after many years of highly successful operation in the U.S.A. and in Europe—the latest system in home training in electronics is now introduced by an entirely new British training organisation. **AT LAST**—a comprehensive and simple way of learning—by practical means—the basic principles of radio and electronics, with a minimum of theory. **YOU LEARN BY BUILDING** actual equipment with the components and parts which we send you. You advance by simple steps using high quality equipment and performing a whole series of interesting and instructive experiments. No mathematical **INSTRUCTION MANUALS** and our teaching staff employ the latest techniques for showing clearly how radio works in a practical and interesting manner. You really have fun whilst learning! And you end by possessing a first rate piece of home equipment with the full knowledge of how it operates and—very important—how to service and maintain it afterwards. A full library of magnificent illustrated textbooks are included with the Courses. **IN FACT** for the "Do-it-Yourself" enthusiast, the hobbyist, or those wanting help with their radio career training, or to set up their own full or part-time servicing business—then this new and exciting instructional system is exactly what is needed and it can all be provided at very moderate cost. Easy payments available. Post the coupon now, for full details. There is no obligation.

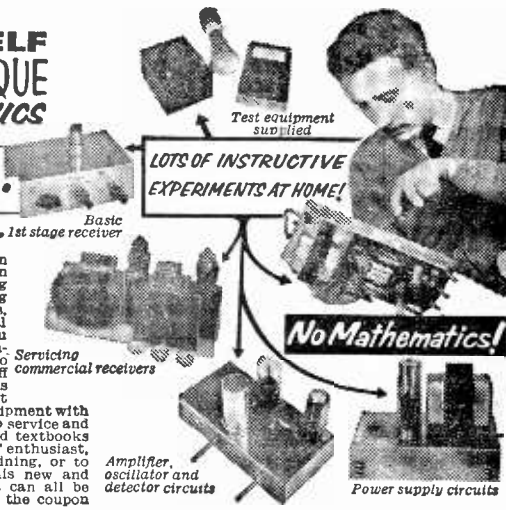

BUILD YOUR OWN • RADIO EQUIPMENT • TEST GEAR
• HI-FI INSTALLATION—AND LEARN AS YOU DO IT

RADIOSTRUCTOR

BRITAIN'S LEADING RADIO TRAINING ORGANISATION

FREE-
POST TODAY

To: **RADIOSTRUCTOR (Dept. G107),**
Reading, Berks.

Name
Address

BLOCK CAPS PLEASE

(821) We do not employ representatives 12-61

Club News

REPORTS OF CURRENT ACTIVITIES

BARNSELEY AND DISTRICT AMATEUR RADIO CLUB
 Hon. Sec.: P. Carbutt, G2AFV, 19 Warner Road, Pogmoor, Barnsley, Yorkshire.

At the Annual General Meeting held in September, the following officers were elected; G. Wigglesworth—President, H. Eyre—Vice-president, P. Carbutt—Secretary, P. Bell—Treasurer and A. Balmforth—Chairman.

Meetings are held on the second and fourth Fridays of each month.
BRADFORD RADIO SOCIETY
 Hon. Sec.: M. T. Powell, G3NNO, 28 Gledhow Avenue, Roundhay, Leeds 8.

On September 12th the first meeting of the new session was held, and a talk on "4 metre mobile" was given by D. Millard.

Meetings commence at 7.30 p.m. Slow morse classes, if previously arranged, are held before meetings.

On October 10th members took part in "Quiz Night", devised by G3EKE. A film show at St. George's Hall was given on October 24th.

In response to several requests the above Society will be holding special Junior Section meetings from 7 to 7.45 p.m. before the meetings which are held at Cambridge House. The purpose of these Junior meetings will be to promote the interest of Radio and Electronics as a hobby by giving short lectures, demonstrations and individual help to our younger members.

It is hoped that by providing these additional facilities to our young members, some of the boys will become so interested that they will wish to carry their studies further and eventually fill posts in the Radio and Electronics field.

Future Event:
 November 15th—"Modern Methods of Communication" by E. M. Price.

BRIDLINGTON AND DISTRICT RADIO SOCIETY
 Hon. Sec.: J. H. Jones, G3GBH, Flat 2, 18 Vernon Road, Bridlington.

The winter programme is now complete and new members or visitors are always welcome at meetings which are held on Wednesday evenings, starting 7.30 p.m., at the The Royal Naval Cadets H.Q., "T.S. Contest", Applegarth Lane, Bridlington.

The classes for the R.A.E. next May, are held each Tuesday evenings at 7.30 p.m. Morse classes are also being held.

The society is to hold a mobile rally and hamfest on Sunday June 24th, 1962, at the Spa Royal Hall, Bridlington.

BURBLEM AMATEUR RADIO CLUB
 Hon. Sec.: W. Luscott, 36 Rothsay Avenue, Sneyd Green, Hanley, Stoke-on-Trent.

The society meets at Burslem Town Hall at 7.45 p.m., on the third Wednesday of each month. An interesting programme is arranged for each meeting, and new members are always welcome. A fifteen minute morse session is included in each meeting.

DERBY AND DISTRICT AMATEUR RADIO SOCIETY
 Hon. Sec.: F. C. Ward, G2CVV, 5 Uplands Avenue, Littleover, Derby.

Recent activity has included the Fifty Years of Wireless Exhibition, a Mobile Rally and Hamfest, and the Festival of Youth Exhibition. A Hitchcock gave a talk on "Direction Finding equipment" on October 18th and a surplus sale was held on November 1st.

Future Event:
 November 11th—RSGB Top Band contest.

GUILDFORD AND DISTRICT RADIO SOCIETY
 Hon. Sec.: J. R. Barker, G3PDX, 35 Banders Rise, Mellow, Guildford.

On October 1st, members took part in a Car Rally, organised by the society, who will put the proceeds towards the club contest transmitter.

On 19th September, Benis Walker, (G3OLM) gave an interesting talk on SSB. A talk about some simple electronic units was given for members on October 12th.

Future Events:
 November 9th—A talk on 2-metres.
 November 24th—A film show.

NORTHERN HEIGHTS AMATEUR RADIO SOCIETY
 Hon. Sec.: A. Robinson, G3MDW, Candy Cabin, Ogden, Halifax, Yorkshire.

At the meeting held on September 6th, members heard a lecture on Radio Astronomy given by Mr. Dougherty. On November 1st, Mr. Falkus gave a talk on Hi-Fi.

Future Events:
 November 15th—An informal evening.
 November 29th—G3OGV will give a talk about converters for 2 and 4 metres.

PETERBOROUGH AND DISTRICT AMATEUR RADIO SOCIETY

Hon. Sec.: D. Byrne, G3KPO, Jersey House, Eye, Peterborough.

The barbecue organised by members of the society, at Alwalton, proved a great success.

On November 3rd, the Annual General Meeting of the Society was held.

Future Event:
 December 1st—Christmas Party.

PLYMOUTH RADIO CLUB

Hon. Sec.: R. Hooper, 2 Chestnut Road, Peverell, Plymouth.

Business meetings are held on the first Wednesday of each month at the Guild of Social Service building and all meetings on Tuesdays are held at the clubroom.

Future Events:
 November 14th—Sale of surplus equipment.
 December 6th—Judging for the "Ernie Hillyard" trophy.

TORBAY AMATEUR RADIO SOCIETY

Hon. Sec.: G. Western, G3NQD, 118 Salisbury Avenue, Barton, Torquay.

After the formal business of the September meeting had been finished, members enjoyed two films.

It was announced at this meeting that two members of this society were placed first and second in the British section of the 1960 Scandinavian Activity Contest. The two members being, first G3LHJ, and second G3GM.

Meetings are held at the Y.M.C.A., Castle Road, Torquay, on the second Saturday of each month.

WANSTEAD AND WOODFORD RADIO SOCIETY

Hon. Sec.: K. Smith, 82 Granville Road, Walthamstow, London E.17.

The junior section of the society have been particularly active recently, and have recently held a Camp and Field Day.

A series of lectures on basic radio knowledge is in progress, and four members are entering this year's Autumn R.A.E.

Meetings of the junior section are held on Tuesdays at 7.30 p.m., and the senior section meets on Wednesdays at 8.00 p.m.



CHRISTMAS GIFT FOR RADIO ENTHUSIASTS

Send them PRACTICAL WIRELESS, of course. A year's subscription will bring them a reminder of your good wishes every month throughout 1962 . . . and all through the year they'll thank you for the interest and help it contains.

Either send your friends' names and addresses, together with your own, and remittance* to cover each subscription, to The Subscription Manager (G.2), PRACTICAL WIRELESS, Tower House, Southampton Street, London, W.C.2, or you may place your instructions with one of the leading newsagents or bookstalls, who will be pleased to make the necessary arrangements.

Whichever way you choose, your friends will receive a Christmas Greetings Card announcing each gift.

*RATES (INCLUDING POSTAGE) FOR ONE YEAR (12 ISSUES):—U.K. £1.9.0, OVERSEAS £1.7.6, CANADA £1.5.0.



RECEIVERS & COMPONENTS

COMPONENTS VALVES. Tubes, etc. Write or phone for free list. ARION TELEVISION, 4 Maxted Road, Pechham, S.E.15 (New X 7152).

"HEATHKITS" can now be seen in London and purchased on easy terms. Free brochure. DIRECT TV REPLACEMENTS LTD., Dept. FW/11, 138 Lewisham Way, S.E.14. Tideway 6666.

CLEARANCE OFFERS
Amplifiers, Tuners, Valves, Components, etc. Autochangers, note prices. B.S.R. UA8 £6/10/0. UA4 £7/5/-. UA14 Stereo £7/19/-. Hi-Fi Amplifiers 15 watt, 5 valves, 5 controls, quality job £8/15/- (list £12). Stereo 5 plus 5 watt, similar £7/15/- (list £14). All 5/6 carr. Amplifier leaflet and bargain catalogue free. **STROUD AUDIO.**
Bath Road, Stroud, Gloucestershire.

A.1. BARGAINS. All post free. Table/Hand crystal mikes, brand new 19/6. Reclaimed valves all tested. 6D2, EP50, SP61, P61 1/3, EP80 1/6, 6P13, 6P25, Z77, PEN45 1/8, 10P13, B36, L63, P.Y31, P.Y81, P.Y82, PL33, P.L81, P.L83, PL82, ECL80 4/3, P.Z30, EP80, 4/3, 10% reduction on dozens. Few of last month's bargains available. **C.W.O. A.1. RADIO COMPONENTS.** 14 The Borough, Canterbury, Kent.

KITS BUILT. S.A.E. details. "Good Companion" ready built £11/18/6. **J. A. KINDER.** 6 Hooker Road, Heatscote, Norwich, Norfolk. Guaranteed Perfect. Ex-equipment

TUBES - VALVES - SPARES

TUBES 6 mon. Guar. **FITTED FREE** 8-10-12in. 30/-, 14in. 40/-, 17in. 50/- **VALVES** 30.00 in stock, 1,000 types. All set tested before despatch.

Examples:

5UA	4/6	EBG41	6/-	N37	4/6
5V4	4/6	EBG30	4/6	N108	10/-
6A1U6	4/6	EBF80	6/-	PCG84	4/6
6A05	4/6	EBL31	12/6	PCP80	4/6
6BA6	4/6	ECC31	2/-	PCP80	4/6
6B96	4/6	ECC82	3/-	PenA4	5/-
6B96	4/6	ECC33	3/-	PL38	10/-
6B96	10/6	ECC94	4/6	PL81	4/6
6C96	4/6	ECC85	4/6	PL82	4/6
6C96	17/6	ECC91	4/6	PL83	4/6
6CH6	4/6	ECH35	6/-	P.Y31	4/6
6C5	6/-	ECH42	6/-	P.Y80	4/6
6K25	4/6	ECF80	4/6	P.Y81	4/6
6L18	4/6	ECL80	4/6	P.Y92	4/6
6P25	4/6	ECL82	6/-	P.Z30	4/6
6V6	4/6	EF30	2/-	R15	7/6
6X4	4/6	EF86	4/6	MU14	5/-
787	4/6	EF92	4/6	T41	2/-
7Y1	4/6	EL33	4/6	U22	4/6
10C2	3/6	EL40	4/6	U24	7/6
10F1	3/6	EL90	4/6	U25	10/-
10P13	6/-	EY51	4/6	U37	12/6
12BH7	6/-	EY81	4/6	U31	4/6
20L1	6/-	EY86	4/6	U35	4/6
20P4	4/6	KT34	5/-	U91	7/6
20P3	6/-	KT36	4/6	U91	6/-
185BT	12/6	K198	7/6	U901	12/6
B38	4/6	K191	4/6	UL41	4/6
DDP4	5/-	K198	7/6	UL44	3/-

Most Pre-war 4, 5, 7 and 9 pin valves of British, European and American manufacture, 5/- each. Postage and packing 6d. per valve. Orders over £1—free.

NEW TRANSISTORS. Red Spot 2/8. OC45, OC72, OC76, 7/8. OC35 (1 watt power). OC201 (Silicon) 20/- Postage 3d. each.

SPEAKERS: 6in. 4/-, Postage 2/-.

LINE OUTPUT TRANSFORMER (from 20V). **CONSTRUCTOR'S PARCEL.** 2lbs. assorted components from TV Sets, resistors, condensers, pots, electrolytics, valveholders, etc. 7/6. Postage 2/6.

VALVE PARCEL. 12 valves, all different, as taken out of TV sets, ideal spares. 3/6. Post and Packing 1/6.

Send stamp with enquiries or for full list of 1,000 valves, tubes, transistors, etc. to: **"ST. JOHN'S RADIO"**, 3 Jews Row, London SW18. Phone: VAN 9822

RATES: 6/6 per line or part thereof, average five words to five, minimum 2 lines. Box No. 1/- extra. Advertisements must be prepaid and addressed to Advertisement Manager, "Practical Wireless", Tower House, Southampton St., London W.C.2.

In Scotland
RENVUE
for Better Value

COMPLETELY REPROCESSED TUBE (NEW GUN, RESCREENED, ALUMINISED)

- 12.6v. and 6.3v., 0.3 amp., .17 and 15in. Types £6.10.0
 - 12.6v. and 6.3v., 0.3 amp., 14in. Types £6. 0.0
 - 12v., 15in. Types £7. 0.0
 - 2v., 12 and 15in. Types £6. 0.0
- Electrostatic 90 degree and 110 degree tubes 10/- extra. Carr. paid.

17in. BBC and STV Receivers ... £19.0.0
COMPLETELY OVERHAULED AND FITTED WITH PROCESSED TUBE
STV and BBC 14in. Receivers ... £2.10.0
COMPLETE WITH VALVES AND TUBE. CALLERS ONLY. CARRIAGE EXTRA.
OPEN SATURDAY AFTERNOON

Renfrew Electronics Ltd.
Anderson Drive
Renfrew Scotland
Tel.: Renfrew 2642

Variable Condensers, transmitting types 2000 v. spacing 7.40, 80, 100 or 150 mm. or 2 x 2.5 or 2 x 40 mm. All 7/6 each (1/8). Electrovoicé Type 500 moving coil microphones with push to talk switch and cord 70p (3/6). I-17 microphones with switch and cord 40/- (2/6). Post Office Table type carbon microphones 12/6 (2/6). Meters 3x 4in. flush 0/1 m/a calibrated 0/30, 30/(2/6). Miniature lin. dia. flush 0/1 m/a calibrated 3 divisions 0/60, 30/(1/6). Helical potentiometers, 5000 ohms 3 turns 12/6 (1/6). Miniature Sealed Relays 1700 + 1700; 300; 15 + 145 or 2.5 ohms all 7/6 each (1/6). TA-12 Transmitters 25 (10/-). AM-36/AIC American Amplifiers with 4 valves and dynamotor (or 28 v. 5 watts output, 25/- (5/-).

24 v. 1A Smooth D.C. Supply. Comprising transformer, metal rectifier, choke, condenser input 200/250 v A.C., the our 27.6 (3/6). Audio Transformers, Bendix, R.C.A. or G.E.C. Mike 7/8 (1/6). Interstage 7/8 (1/6). ET-434 Driver 15/- (3/6). 50 watts Bendix 15/- (3/6). 85 watts Woden 40/- (7/6). 200 watts G.E.C. 85/- (7/6). P.O. Itacks 50/-, high 19in. wide 55/- (10/-). Rectifier Sets 200/250v. A.C. to 110 v. 750 m/a or 50 v. 1A in metal cabinets 55/8 each (7/6). Chokes, high quality, guaranteed plus 50% continuous rated 1H. 270 m/a 15/- (3/6). 20H 400 m/a 20/- (5/-). Morse Keys American J-47. 5/- (1/6). British enclosed 7/8 (2/6).

We have large quantities of "bits and pieces" we cannot list—and invite your enquiries—we can probably help—everyone answered.

Amounts in brackets are carriage England and Wales
P. HARRIS, ORGANFORD, DORSET.

RECEIVERS & COMPONENTS

(continued)

RECLAIMED SPEAKERS 7in. x 4in., 5in., 6in. and 8in. 5/- each plus 2/6 p and p. **J. R. CALVERLEY & CO. LTD.** Fountain Street, Barnbrook, Bury, Lancs.

SPEAKER REPAIRS. Cones/Fields fitted. Clock Coils Wound. L. S. REPAIRS, Pluckley, Ashford, Kent.

TUBES - AERIALS - VALVES

Refurmed tubes, guaranteed one year, full range of aerials and fittings, I.T.V. boosters, valves, grayhead tuners, TV sets, transistor radios and all electrical appliances. Co-axial cables and noise wiring cables, fluorescent fittings. All quotations without obligation. Special terms to the trade, and Home Engineers. S.A.E. for Catalogue.

G. A. STRANGE
BROADFIELD, NORTH WRAXHALL, Nr. Chippenham, Wilt., Tel. Marshfield 236

TRANSISTOR SETS. OC44, 2OC45, OC81D, 2OC81 35/6. OC44 9/-, OC45 8/6. OC71 6/3. XA102 9/-. XA01 8/6. XB103 8/3. Red Spot 3/8. White Spot 4/-. Diodes General 1/-, OA79 3/-. OA70 3/-. OA71 2/8. OA81 2/8. GEX34 2/8. Ear Pieces complete with plug and jacks 100, 250 and high Z 7/8 each. Min. Caps 1 to 32MFD 1/8 each. P. and P. paid by CHAPPEL RADIO, 107 Neasden Lane, N.W.10.

NEW AND Surplus Valves, fully guaranteed. S.A.E. for List. Also Reclaimed Valves, perfect. 5/- maximum. Genuine bargains, valves bought. LEWIS, 46 Woodford Avenue, Iford, Essex.

Television Tube Shop
now stock

Tubes for every make of set
OVER 600 TUBES IN STOCK

- 12 inch Mullard type ... £4. 5.0
- 12 inch Mazda type ... £4.15.0
- 14 inch Mullard type ... £5. 5.0
- 14 inch Mazda type ... £5.10.0
- 15 inch Mazda type ... £5.15.0
- 16 inch G.E.C. & Mullard type £6.12.6
- 17 inch Mazda & Mullard type £6.10.0
- 17 inch G.E.C. & Brimar type £6.15.0
- 21 inch Mullard type ... £8. 0.0

Add 10/- for insured carriage to your door within 48 hours, or 5/- via B.R.S. Terms £2 down (plus carriage). All tubes tested before despatch and guaranteed for 12 months. Guarantee cards enclosed with each tube.

Special Purchase of 110", 17 inch tubes—
Slight mark, Guaranteed for 12 months. Mazda CME 1703 } replace AW43-88, GEC 7405A } £6.

Shop Soiled Tubes.
(Slight scratches or marks) Guaranteed 12 months. Ideal for second set. 12in. 3/18, 3/31 37/6. MW31-74 50/-, 14in. MW 36-44 52/6. CRM141 55/-, 17in. CRM171, MW 43-64 60/-.

Others available from time to time. Please enquire.
Service Engineers
Our Rubate Scheme shows real savings—send for details.

Television Tube Shop
48 Battersea Bridge Road, S.W.11

BAT 6359
Just South of the Bridge. Open Saturdays.

RECEIVERS & COMPONENTS
(continued)

RESISTORS—100 new, wire ended, assorted, all types. 7/6 box, post free.
COOK'S OF BEDFORD, 29 St Mary's Street, Bedford.

FOR SALE

"P.W. TUTOR" All parts inc. coils, panels. Coils etc for "Olympic", "Band II Pre-Amp", "Transistor VHF", "Wobblulator", "Sig-Gen", S.A.E. lists. **AJAX ELECTRONICS**, 572 Fulham Road, London S.W.6.

- GARRARD R.C. 210** £9. 8.6
B.S.R. UA14 £17.15.0
- Makers' Sealed Cartons.**
- B.S.R. TU9** £4. 2.6
B.S.R. TAPE DECK £7.10.0
- Transistors (Famous Make)**
- Seven Transistors** 32/6
- Diode. Driver. Matched Pair.
Mixer. 1st I.F. 2nd I.F.

Standard Goods

AUTUMN LIST NOW READY

H. F. JAMES

21 Claremont Road, Twickenham, Middlesex.
Tel. POPesgrove 3579.

CAR GIGARETTE LIGHTERS 6 or 12V 8/6. **WHITAM ELECTRICAL**, 18 Woodrow Close, Perivale, Middx.

VHF UNIT. Ready built Front End P.M. unit. Coverage 85-100Mc/s, I.F. 10.7Mc/s. Single valve (ECC85). Price, including circuit and data but without valve, £2/12/3, plus 2/- postage.
VHF TUNER UNIT. Ready built without dial and valves. Price, including circuit and data, £6/16/0, plus 3/6 postage. Delivery ex stock.
(DEPARTMENT E/2)
ROTOPONS LIMITED
54 BEDDINGTON LANE, CROYDON, SURREY.

MULLARD High Speed Valve Tester with approx. 1,000 cards—served regularly by Manufacturers. As new and hardly used. Offers to: J. R. CALVERLEY & CO. LTD., Fountain Street, Barnbrook, Bury, Lancs.

FOR SALE (continued)

ASK your dealer for American Ferro-dynamics "Brand Five" Recording Tapes—the best tape value!

Tx-Rx RT 15/ARC-1, complete with 29 valves and crystal, £8.10.0, plus carriage 10/-
Tx-Rx TR 3173A, complete with 20 valves, £3.10.0, carr. 10/-
TB 83-4 Transmitter and Receiver, 60-80 Mc/s, 5 tuning meters, all 24 valves, circuit, £10.10.0, carr. £1
TB 87 Magnetic Controller, 230V D.C. 35/6, carr. 7/6
Receivers: R-9B/APM-4 New, 14 valves, £61/- carr. 10/-
R1382D, 95-156 Mc/s tuning meter, 15 valves, 7/6, carr. 10/-
U.E.L. Type BR1111, input 6V D.C., CV2302 tube and valves, etc. 70/-, carr. 7/6
Panel L.55, contains CV35 Klystron, 30 other valves, Tube CR Unit 36, chokes, coils, etc., one only. Over 24 wts., £12.10.0, carr. 25/-
Marconi Crystal Oscillator, complete with valves, 200-20V A.C. Input, containing thermostatically controlled crystal oven with crystal holders, £5.10.0, carr. 10/-
Speech Amplifier. CME-50055, 110V A.C. Input, 4 phone, meters, 6 vtrs, complete £5.10.0, carr. 10/-
Wavemeter W1646 and **Test Set 223A**, 18-87 Mc/s, graphs, 110 or 230V A.C. Input, £6.10.0, carr. 7/6
Insulation Test Set No. 3, 0-5kV A.C. or D.C. output, with meter, input 200-50 A.C. £8.10.0, carr. 10/-
Range Monitor and **delayed Sync Unit**, 13 modern valves, plus CV1526, CR tube, £2.10.0, carr. 10/-
P.38 and **234 Power Units**, 200-250V A.C. Input, with meter, £2.10.0, carr. 10/-

J.T. SUPPLY
309 MEANWOOD ROAD, LEEDS 7.

100 BAYS of Brand New Adjustable Steel Shelving 72in high x 34in wide & 12in deep; stove enamelled, dark green, sent unassembled. Six shelf bay £3 15s. Sample delivered free. Quantity discounts. N. C. BROWN LTD., Eagle Steelworks, Heywood Lancs. Tel. 69018.

SOUND RECORDINGS

TAPE TO DISC, Adanac Recordings. Send a personal Xmas message this year. E. H. JACKSON, 36 Bannatyne Street, Lanark, Scotland.

THE FAMOUS "TELEFUNKEN"
TAPE HEADS. 30/20 Kcs. TWIN TRACK. RECORD/REPLAY and ERASE. BRAND NEW 30/- The Pair. LIST 5 Gns.

A. Fanthorpe Ltd., 6-8 Hepworth's Arcade, Hull, Yorkshire.

RECORDING TAPE, save up to 30%, send for list; also 50 second-hand recorders in stock.—E. C. KINGSLEY AND CO., 132 Tottenham Court Road, London, W.1. EUS 6500.

CABINETS, ENCLOSURES and EQUIPMENT by STAMFORD

	Cash	Hire Pchase	Dlst.	15pts.
SPEAKERS				
Goodm. Axiotee...	£6.12.1	26/5	6/4	
Goodm. Axiom 110	25. 0.0	20/-	4/10	
Goodm. Axiom 300	£11. 5.9	45/2	10/10	
VE HF 1012	25. 0.0	20/-	4/10	
Golden 10in. FSB	28. 6.7	33/4	8/-	
MOTORS				
Garrd 210 Mono	£12.13.5	50/8	12/3	
Garrd 4 HF Mono	£19. 8.7	77/9	18/10	
Garrd 7A Mk. II Mono	..	£8.19.3	36/-	9/7
CHASSIS				
Armstrong 208 ..	£23.15.0	95/-	22/8	
Armstrong Jubilee	£31.15.0	127/-	30/4	
Armstg's Stereo 55	£33.15.0	135/-	22/3	
Armstg's Stereo 12	£44.15.0	179/-	42/9	
TUNERS				
Armstrong ST3 ..	£28.10.0	114/-	27/3	
Rogers Switched	£15.18.3	84/7	15/3	
Rogers Variable	£25.15.6	103/4	24/5	

A. L. STAMFORD Dept. R28
84/86/88 WEYMOUTH TERRACE
HAGENY ROAD, LONDON, E.2.

WANTED

WANTED NEW valves and transistors, any quantity. S. N. WILLETTTS, 43 Spon Lane, West Bromwich, Staffs. Tel.: WES 2392.

NEW VALVES bought, state price. A. D. A. MANUFACTURING CO., 172 Alfreton Road, Nottingham.

WANTED VALVES

All types for prompt cash. Must be new. State quantity.

WILLIAM CARVIS LTD.
103 North Street, Leeds 7

A PROMPT CASH OFFER for your surplus Brand New Valves, Speakers, Components, Test Instruments, etc. R.H.S., Beverley House, Manville Terrace, Bradford 7.

NEW VALVES WANTED

Any type, any quantity

CASH PAID

R.S.T. 211 Streatham Road, Mitcham, Surrey.
Telephone: MITCHAM 6201

EDUCATIONAL

RADIO & TELEVISION SERVICING. Home-study courses with special schemes of practical work are available from the Pembridge College.
(1) Introductory course for beginners.
(2) More advanced course covering new P.T.E.B. Intermediate Certificate.
Details from: **THE PEMBRIDGE COLLEGE OF ELECTRONICS**, 34a Hereford Road, London W.2.

Radio Television & Electronics

Learn at home with the world's largest home study organisation, Brit.I.R.E.; City & Guilds; R.T.E.B., etc. Also Practical Courses with equipment. No books to buy.

Write for FREE prospectus stating subject to

I.C.S.

(Dept. 541), Intertext House, Parkgate Road, London, S.W.11

THE Incorporated Practitioners in Radio & Electronics (I.P.R.E.) Ltd. Membership Conditions booklet 1/-, Sample copy of I.P.R.E. Official Journal 2/- post free. Secretary, 20 Fairfield Road, London, N.8.

(Continued on next page)



EDUCATIONAL (continued)

"HOW AND WHY" of Radio and Electronics made easy by a new, non-maths practical way. Postal instruction based on host of experiments and equipment building carried out at home. New courses bring enjoyment as well as knowledge of this fascinating subject. FREE brochure from: Dept. P.W., 12 RADIOSTRUCTOR, Reading.

TRAINING in Radio and Television Servicing. Next full-time One Year course commences on 3rd January. Recognised by R.T.E.B. for new Radio and Television Servicing Certificate examinations. Details from: THE PEMBRIDGE COLLEGE OF ELECTRONICS, 34a Hereford Road, London. W.2.

$$X = \frac{-b \pm \sqrt{b^2 - 4ac}}{2a}$$

DON'T FUMBLE with Formulae. Master Mathematics in 6 weeks the Understandable Way.



The Dryden School of UNDERSTANDABLE MATHEMATICS

11F Dryden Chambers, Oxford St. London, W.1.

Name _____
Address _____

LEARN RADIO AND ELECTRONICS the new and practical way! Hosts of absorbing experiments carried out at home under expert guidance to teach you radio in a new, enjoyable and interesting way. Construction, servicing and fault-finding on equipment made easy for the first time! No previous experience needed. No mathematics used. Free brochure from: Dept. 11 P.W., RADIOSTRUCTOR, Reading.

WIRELESS. See the world as a Radio Officer in the Merchant Navy; short training period; low fees; scholarships, etc., available. Boarding and Day students Stamp for prospectus. WIRELESS COLLEGE, Colwyn Bay

ELECTRONICS

Key to YOUR future?

An exciting career - A new Hobby - Your own spare or full-time BUSINESS!



New experimental course includes big kits for building test gear and a complete AM, VHF receiver.



FREE brochure from

RADIOSTRUCTOR

DEPT. E77, READING, BERKS.

MISCELLANEOUS

DIAMOND  STYLIS

FOR DIAMONDS

Manufacturer's offer to users—send us your old stylus arm and we will retip with finest Transcription quality Diamond. To ensure best production every Diamond is inspected for finish and radius with 500 magnification.

FOR £1.00 ONLY

Or we will supply complete with any stylus arm for £1 5s. 0d. Tax Paid and will despatch within 48 hours of receipt, post free.

All Diamonds are Guaranteed for One Year

(Sapphires also supplied 4/6 Tax Paid)

Mail Orders to:—Dasco, Frith Park, Tadworth, Surrey.

ELECTRONIC MUSIC ?

Then how about making yourself an electric organ? Construction, data available—full circuits, drawings and notes. It has 5 octaves, 2 manuals and pedals with 24 stops—uses 41 valves. With its variable attack you can play Classics and Swing. Write NOW for free leaflet and further details to C. & S., 20 Maude Street, Darlington, Durham.

SERVICE SHEETS

SERVICE SHEETS. Radio, TV, 5,000 models. List 1/-. S.A.E. enquiries: TELRAY, 11 Maudland Bk., Preston.

FAULTFINDER FILES. showing common faults that each receiver is prone to and other useful servicing information, 2/- ea. List 9d., plus postage. S.P. DISTRIBUTORS, 44 Old Bond Street, London. W.1.

38 SET WALKIE TALKIE CIRCUIT INFORMATION

Alignment procedure. Faults. Components. Diagrams etc. P.O. 5/-.

18 SET TRANSMITTER RECEIVER CIRCUIT INFORMATION

Description. Operation. Values. Diagrams. Tests, etc., P.O. 5/-. Your address in block capitals, please.

CAMPBELL

Everland Road, Hungerford, Berks.

SERVICE SHEETS. Radio and TV 4/- each. List 1/-. All orders despatched on day received. Also manuals for sale and hire. S.A.E. please. SULTAN RADIO 29 Church Road, Tunbridge Wells, Kent.

SERVICE SHEETS. We have the largest stock of Radio and TV Service Sheets in the country for sale at 4/- each, old type receivers a speciality. Guaranteed return of post service. Service Sheet list 1/-. manufacturers Manuals for sale and hire, list 1/-. S.A.E. please. Mail orders only to S.P. DISTRIBUTORS, 44 Old Bond Street, London W.1.

SERVICE SHEETS; also Current and Obsolete Valves for sale. JOHN GILBERT RADIO, 20 Extension, Shepherd's Bush Market, London. W.12 (Phone: SHE 3052).

SERVICE SHEETS

(continued)

SERVICE SHEETS for all makes of radio and TV, 1930-1962. Prices from 1/-, with free fault-finding guide. Catalogue of 6,000 models 1/6. 125 Radio/TV sheets covering 370 popular models 20/-. SAE inquiries HAMILTON RADIO, Western Road, St Leonards, Sussex.

BOOKS & PUBLICATIONS

FIND TV SET TROUBLES IN MINUTES from that great book "The Principles of TV Receiver Servicing" 10/6 all book houses and radio wholesalers. If not in stock, from Secretary, I.P.R.E., 20 Fairfield Rd., London. N.3.

HANDICRAFTS

JEWELLERY Simply made. Brooches, Rings, Marcasites. List Free. WEBBS, 46 Burnway, Hornchurch, Essex.

SITUATIONS VACANT

SALESMAN REQUIRED, with experience of marine radio telephone equipment. Box 32.

TV AND RADIO. A.M.Brit.I.R.E., City and Guilds, R.T.E.B., Cert., etc., on "No pass—no fee" terms. Over 95% successes. For details of exams and courses (including practical apparatus) in all branches of Radio, TV and Electronics, write for 148-page handbook, free. B.I.E.T. (Dept. 242G), 29 Wright's Lane, London, W.3.

ELECTRIC ORGAN Service Engineer required to deal with the servicing of the Hammond Organ both in this factory and at customers premises. The suitable applicant must be thoroughly experienced in this type of work and good conditions are offered to the right man. Appy: BOOSEY & HAWKES LTD., Deansbrook Road, Edgware, Middx. Tel: EDGWARE 5581.

A.M.I.Mech E., A.M.Brit.I.R.E., City and Guilds, G.C.E., etc., brings high pay and security. "No pass—no pay" terms. Over 95% successes. For details of exams and courses in all branches of Engineering, Building, Electronics, etc., write for 148-page handbook, free. B.I.E.T. (Dept. 242B), London, W.8.

SITUATIONS VACANT
(continued)

WALTHAM CROSS, N. London dealer requires TV engineer and semi-skilled junior. Good pay plus bonuses and commissions. Accommodation possible later. Box 31.

APPOINTMENT VACANT

IBM

UNITED KINGDOM

LIMITED

a
career
in
electronics

IBM offers a number of first class training and career opportunities in the Electric-electronic engineering group at the South Harrow Branch, where electro-mechanical equipment and electronic computers are serviced and rebuilt.

We should like to receive applications from young men aged 18-20 with the ambition to make a career in this highly progressive industry, who have 'O' level mathematics and physics and are studying for National or City & Guilds Certificates.

Every assistance for further studies will be given—progress is on an individual basis and prospects are excellent in this fastgrowing company.

Please apply to the
Manager - Personnel Selection
101 Wigmore Street, London W.1

OR

Mr I. F. Bush
Telephone: WELbeck 6600.

OR

Mr. W. E. Cross (Harrow)
Telephone BYRon 7286.

Quoting Reference CE/PW/85.

RES/CAP. BRIDGE 38/-
p. & p. 2/6

Checks all types of resistors, condensers 6 RANGES Direct reading.
Built in 1 hour. **READY CALIBRATED**

Stamp for details of this and other kits.
RADIO MAIL (DEPT. SV)
Raleigh Mews, Raleigh Street, Nottin'ham

PADGETTS RADIO STORE

40 MEADOW LANE, LEEDS 11
Phone: Cleecheaton 2886

TV Sets. 14in. Pye VT4, 13 channel. Perfect picture. £6.10.0 carr. & ins. 17/-
TV sets. Untested but complete. 14in. 13 channel. 50/-; 14in. 5 channel. 30/-; 12in. 13 channel. 40/-; 12in. 5 channel. 27/- Carr. on any set. 12/-.

P.M. Speakers. Removed from TV sets. All guaranteed perfect working order. Sound cones 6 x 4. 5/-; 7 x 4. 6/-; 8in. round. 6/-; 6in. round. 4/-; 5in. round. 6/- Post 2/-.

TV Tubes. Reunennel, 12 months' guarantee. 14in. and 17in. all at £3.15.0, carriage and insurance 7/6.

NEW VALVES. Ex-units. All post free.

6K7	2/-	EBB1	1/9	1S4	2/-
6X5	4/-	EF50	1/6	5U4	4/6
6V8GT	4/-	EF50 red	2/-	EA50	6d.
6AQ4	3/6	R10	4/-	VR37	6d.
6C4	2/-	Z530933	2/6	U12	5/-
KT88	6/6	E1524	2/-	DL510	10/-
KT88	4/-	2C26A	2/-	9001	9d.
EF91	1/8	VR150/30	4/-	954	1/6
EL91	1/8				

Valves removed from TV sets. All tested on a Mullard Valve Tester, are 100% as new. They carry a 3 months' unconditional guarantee. All valves Post Free.

EF80	2/-	6F13	2/-	185BT	8/8
Grade 2	2/-	6F14	5/-	U801	8/6
EP80	6d.	6S57	5/-	U25	5/-
ECL80	4/6	6G6	2/6	U281	5/-
ECC82	5/-	5P61	1/6	U329	5/-
EL38	4/6	6Y8	2/-	KT96	5/-
EY51	4/-	6LD20	5/-	PL81	5/-
EBP80	4/6	10C2	3/-	PY81	4/6
EB31	1/-	10P1	2/6	PL82	5/-
EF91	1/-	10P14	5/-	PY90	5/-
EL91	1/-	10P13	5/-	PL33	5/-
6P25	4/-	20D1	3/-	PZ30	5/-
6P28	5/-	20P1	5/-	B36	4/6
6K25	5/-	20L1	5/-	N37	3/6
6P1	2/-	PCF80	6/-	L83	3/6

Reclaimed TV Tubes. Not boosted. 5x months' guarantee. 12in. Mullard 17/-; 12in. Mazda 25/-; 14in. Mullard 30/-; Carriage insurance 7/6.

Complete TV Chassis for Spares. Less valves. 12in. four for 10/-, carriage 1/-; 14in. chassis four for 15/-, carriage 7/6

JAMES H. MARTIN & CO.

Radio & Television Component Service
Finstwhaite, Newby Bridge
Ulverston, Lancs.

Lists available. Inland 3d. stamp only Overseas, airmail 5/- refundable.

★★★ Special bargain offer—Complete Kit P.V. Superhet including genuine Ediswan Transistors, £7.15.0—a bargain not to be missed ★★★ Red Spot Transistors, 2/3, White Spots, 2/3; Yell./Gr., 3/3; Ediswan XA102, 9/-; XA104, 8/-; XA103, 8/-; XA101, 8/-; XB103, 7/6; XB104, 6/-; XC101 8/6. Special bargain set for P.V. Superhet 6 Transistors (1-XA102, 2-XA101, 1-XB103, 2-XC101), plus Diode, 42/6; Newarket. V15/10P, 15/-; Diodes, 11/-; 2/-; 3/-; Transistor holders 11/-; Ardente Trans. D239, 8/6; D240, 8/6; D131, 10/-; D132, 10/-; Sub. Min. Electrolytics 2, 4, 8, 10, 16, 32 mfd., 2/6; 50, 100, 200, M.C. Earpiece (used as speaker), 5/-; Balance Inserts (as earpiece or speaker), 3/6. Silicon Rectifier bargain 70 p.i.v. 1/4 amp., 3/3; Westalite Contact Rectifier 250 v., 60 mA, 7/6; Transformer 250-0-250 v., 6v. and 5v., 15/-; Packard Bell Amplifiers, new 12/6; Garrard Portable Record Player, cabinet, battery turntable 45 r.p.m. and pick-up, takes transistor amplifier, £3/10/0, plus carr. 3/3. Real bargain. Limited quantity.

TERMS—Cash with order. Post extra, excess refunded. Our Reflex Rx, best 2-transistor Receiver. Send 10d. stamps for notes.

MOORES EXPERIMENTAL SUPPLIES
8 & 10 Granville St., Sheffield 2 Tel.: 27461

RADIO BOOKS

NEW PICTORIAL APPROACH TO LEARNING BASIC ELECTRICITY, 5 parts. BASIC ELECTRONICS, 6 parts.
The Complete Set sent on payment of first instalment.

LEARN WHILE YOU PAY FOR ONLY 2/6 PER WEEK
Write for FREE Illustrated Prospectus giving details of instalment plan.

TRANSISTOR CIRCUITS for Radio Controlled models. Howard Boys. 8/-
SUPER SENSITIVE TRANSISTORISED POCKET RADIO, 4/-
INTERNATIONAL RADIO LIST 4/-

TRANSISTOR CIRCUITS Nos. 1, 2, 3, 4, 3/- each. Each book gives instruction for building ten different Transistor Units.
COIL DESIGN AND CONSTRUCTION MANUAL 5/6

HIGH FIDELITY TAPE RECORDER FOR THE HOME CONSTRUCTOR, 3/-

ONE VALVE RECEIVERS, TWO VALVE RECEIVERS, THREE VALVE RECEIVERS, FOUR VALVE RECEIVERS, 1/8 each. Each book gives full comprehensive instructions, diagrams, etc.
BOY'S BOOK OF CRYSTAL SETS, 12 different circuits fully illustrated. 3/-
HOW TO GET THE BEST OUT OF YOUR TAPE RECORDER, 9/-

A "Must" for every Tape Recordist!
HIGH FIDELITY LOUSPEAKER ENCLOSURES 5/6.

TRANSISTOR SUPERHET RECEIVERS 8/-. Includes circuit diagrams of 50 different Receivers.

40 CIRCUITS USING GERMANIUM DIODES, 3/6.

RADIO VALVE DATA (Wireless World) 7th edition, 7/-.

GUIDE TO BROADCASTING STATIONS (Wireless World) 12th edition, 4/-.

BRIMAR VALVE MANUAL No. 8.

MULLARD REFERENCE MANUAL OF TRANSISTOR CIRCUITS, 13/6.

ELECTRONIC NOVELTIES, Bradley 5/6

ELECTRONIC GADGETS, Bradley 4/-

SERVICING TRANSISTOR RECEIVERS, Pettit, 6/6.

USING AN OSCILLOSCOPE, Easterling, 7/-.

BEGINNERS GUIDE TO RADIO, Comm. New and Revised Edition, 8/6.

DICTIONARY OF MATHEMATICAL DATA 2/6.

RADIO TEST EQUIPMENT MANUAL 3/-.

HIGH FIDELITY STEREO GRAMOPHONE FOR HOME CONSTRUCTOR, Easterling 5/6.

PORTABLE TRANSISTOR RADIO AND GRAMOPHONE 3/-.

All above titles include postage. SEND STAMP FOR LISTS

SELRAY BOOK CO.
60 HAYES HILL, HAYES, BROMLEY KENT. Tel. HURStway 1818

TV TUBE RESTORER
EXTRA LIFE, EXTRA BRILLIANCE
PLUGS ON TO YOUR TV TUBE ANY SIZE PATENTED



Important! State Make, Model No. Name and Address in Block Letters Please.

STANDARD MODEL .. 22/6
DE LUXE MODEL .. 30/-
Postage 2/6 either model.

SINCLAIR ELECTRONICS Dept. P. T. 3
18 Newport Court Charing X Rd. WC2
Terms: C.W.O., C.O.D.

**★ SUPER CHRISTMAS BARGAIN! ★
★ AN IDEAL GIFT ★**

★ The WIRECOMP "JUNIOR 5" Transistor Pocket Radio Kit. An easy "first step" set for the young constructor. ★ This miniature marvel with the BIG performance covers medium and long wavebands—has an internal Ferrite rod aerial—5 transistors and 1 diode—200 milliwatt push pull output—24in. speaker. Supplied in 4½ x 3½ x 1½in. ★ unbreakable plastic case with carrying handle. Complete with full instructions. All parts sold separately.

★ **£2.19.6** P. & P. 2/-. Circuit diagram 1/6, free with kit.



BATTERY CHARGER FOR ONLY 21/- P. & P. 3/-.

Overnight charging ensures instant winter starting. Size 6 x 3 x 3in. in grey metal case, 6 and 12 volts charging at 2 amps. A.C. Mains 200-250 v. Complete with battery clips.

COMPLETE V.H.F./A.M. RADIO FOR £12.12.0

Brand new set, in superb walnut cabinet (size 19 x 8½ x 14in. high). Covering 80-100 Mc/s. 16-49 M., 200-500 M. and 1,200 - 2,000 M. Mains trans. 200-250 v. with 3 tapings. Ferrite rod aerials for A.M. Controls: volume on/off tone, tuning, w/change, gram, and ext. speaker position provided. Fully guaranteed. Post and packing 5/- extra.



CARTRIDGES

Collaro Studio O	18/-
Collaro Studio P	18/-
B.S.R.	18/-

LOUDSPEAKERS
5in., 14/6, 6½in., 16/-, 8in., 16/6. 6 x 4in., 14/6. 7 x 4in., 15/-, 8 x 5in., 23/-, 10in., 30/-, 10 x 6in., 25/-, 12in., 32/6. All above 3 ohms impedance. P. & P. 2/6.
12in. 15 ohms. Hi-Fi Celestion £4.19.6.

RECORDING TAPE OFFER
STANDARD LONG PLAY
600ft. on 5in. spool 15/- 900ft. on 5in. spool 18/6
850ft. on 5½in. spool 16/6 1200ft. on 5½in. spool 21/-
1200ft. on 7in. spool 21/- 1800ft. on 7in. spool 32/6
P. & P. 1/-.

SEND S.A.E. FOR FREE PRICE LIST OR PAY US A PERSONAL CALL

WIRECOMP ELECTRONICS
378 HARROW ROAD, LONDON, W.9
TEL: CUNNINGHAM 9530
Hours of business: 9 a.m. to 6 p.m. Open all day Saturday. Opposite Paddington General Hospital. Buses 18B and 36 pass the door.

SOLDERING EQUIPMENT



by **LITESOLD**

PRECISION SOLDERING for the ELECTRONICS INDUSTRY

Comprehensive range—Robust & Reliable - Light weight - Rapid heating - Bit sizes 3/32in. to 3/8in. - 'Permatbit' or Copper bits - All voltage ranges 67v. to 230/250v. - Prices from 19/6.

- Also
- Plastic Cable Strippers
 - Miniature Solder Pots
 - Heat Guards
 - Long Life Bits

Illustrated is the 25w. 3/16in. replaceable bit model with safety shield.

ADAMIN—the new range of precision micro-soldering instruments—Have you had details?

Brochure No. S10 sent free on request. Sole proprietors and manufacturers: **LIGHT SOLDERING DEVELOPMENTS LTD.** 28 Sydenham Road, Croydon, Surrey Phone: CROYdon 8589 Grams: Litesold Croydon

PERFECT



INDEPENDENT 200/240 Volt MAINS SUPPLY AMERICAN DYNAMOTOR UNIT

A FULL POWER UNIT

Built for continuous duty not just a rotary converter.

GIVES WONDERFUL RESULTS

Input 12 volts, output 200/240 volts at 100 to 130 watts and 180 watts. Runs RADIOS, TELEVISIONS, Mains Lighting, ELECTRIC DRILLS and thousands of Appliances. Runs anything 200/250 volts universal AC/DC. Built for heavy continuous duty. Will last a lifetime. Brand new condition.

Fully tested and ready for immediate use. **SIMPLY PLUG IN**

COST AMERICAN GOVERNMENT £40 EACH

OUR PRICE ONLY £8

including carr., packing and insurance. SEND S.A.E. FOR FULL DETAILS: (Dept. LP)—**SCIENTIFIC PRODUCTS** Manor Works, Manor Drive, Cleveleys, Blackpool, Lancs.

D. & B. TELEVISION

Phone
Cherrywood 3955.

131 & 131a KINGSTON ROAD,
SOUTH WIMBLEDON, LONDON S.W.19

FOR THE FINEST, FASTEST SERVICE IN THE COUNTRY.
We are Open from 10 a.m. Until Midnight. For any information
or problems you have Call or Phone, we are always pleased to help.

NEW! SEND FOR OUR COMPREHENSIVE
L.O.P.T. SCAN COIL L.B.O., F.R.O., F.O.P.T. LIST
Prices of nearly all makes and models, 2/6 post 6d.
Invaluable as a service aid. The finest list ever compiled.
Special quotations for the trade.

TRANSISTORS

Genuine Mullard Transistors in sets of Six: 1, OC44; 2, OC45's;
1, OC81D; 2, OC81's in matched pair. Including OA81, Diode,
for ONLY £2.2.6.
Genuine G.E.C. Transistors in Sets of Six: 1, GET874; 2, GET
873; 1, GET114; 2, GET114's in matched pair; plus 1, GEX34
for ONLY £1.18.6.

SINGLE TRANSISTORS PRICE LIST

Mullard: OC44, 10/-; OC45, 9/-; OC70, 6/-; OC71, 6/-; *OC72, 7/-;
OC78, 7/-; OC79, 7/-; *OC81, 7/-; OC81D, 6/-;
G.E.C.: GET874, 9/-; GET873, 8/6; *GET114, 5/9.
* Available in matched pairs at 1/- extra.
Mullard Diodes: OA70, 2/9; OA78, 2/9; OA81, 2/9; OA91, 3/6;
G.E.C.: GEX34, 3/3.
All above are genuine manufacturers new 1st grade.

SURPLUS TRANSISTOR

Red Spot, A.F. OC71 and 72. Equivalent 4/3 each
White Spot, R.F. OC44 and 45. Equivalent 5/- each
Diodes, general purpose 1/- each
Various other types in stock. Please ask for prices of types not listed.

TURRET TUNERS, Various Makes: 10, 16, 39 Mc/s. 40/-.

EXAMPLE OF TRANSFORMER LIST

	L.O.T.	(Used)	SCAN COILS	(Used).
FERGUSON:				
103T, 105T	69/9	35/-	60/-	35/-
992/4/6/8	69/9	35/-	60/-	35/-
PYE:				
V4, V7, V7	(New)	(Used)	(New)	(Used)
V4, V7, V7	52/6	35/-	55/-	35/-
V7T, CTM4	52/6	35/-	55/-	35/-
MURPHY:				
V214, V240, V250	60/6	35/-	45/-	(Used)
EKCO:				
221, 283	47/3	35/-	40/-	27/6
221, 284, 293	54/-	35/-	40/6	27/6

REGUNNED CATHODE RAY TUBES

all with 12-month Guarantee
ALL MAKES: 12in., £3.15.0; 14in., £4.5.0; 17in., £4.15.0.
ADD: 10s. for 90° tubes; 15/- for 110° tubes; 5/- for Electro-
static types.
SECONDS, with 12-month Guarantee—ALL MAKES: 12in.,
£2.15.0; 14in., £3.5.0 (when available); 17in., £3.15.0.
SECONDS, No 12-month Guarantee—ALL MAKES: 12in., £1.5.0; 14in.,
£1.15.0 (when available); 17in., £2.15.0.
NOT APPLICABLE TO NO GUARANTEE SECONDS:
10/- allowance on old tube if in good condition.

THE FABULOUS R.T.D. TRANSISTOR SIX

LATEST ON THE KIT MARKET

Spec.: Six transistor plus diode, printed circuit, superhet,
ferrite rod aerial. Automatic gain control to stop overloading.
Output 450mw in push pull. All components brand new and
guaranteed. Neat, small, two-tone grey cabinet. Two radios in
one, portable and car radio. Incorporates car aerial input socket.
Everything to build this superb Transistor Radio. Only £8.9.6.

VALVES—GUARANTEED 90 DAYS

AZ31	8/6	ECL80	6/9	PCL82	10/9	U31	9/8	SP41	2/3	10F1	4/6
B36	5/6	EF39	5/-	PCL83	11/3	U50	8/8	SP61	2/3	10C1	10/-
D77	3/-	EF50	3/6	PCL84	9/8	U52	7/-	W77	5/-	10C2	13/-
DH77	4/8	EF80	4/6	PL33	8/6	U91	9/-	Z77	3/-	10P13	8/-
DK91	5/9	EF91	5/-	PL36	10/9	U281	9/-	5V4	5/-	10P14	9/-
DK92	8/-	EF92	6/-	PL38	14/6	U282	20/-	5V4	9/-	12AT7	5/6
DK92	7/8	EL33	8/6	PL81	8/6	U301	20/-	5Y3	10/6	12AU7	5/6
DL92	5/9	EL38	14/6	PL82	6/9	U301	22/0	5Z4	10/-	20D1	8/6
DL94	6/9	KL84	6/-	PL83	7/-	U4F2	8/-	6AL5	3/-	20F2	9/-
DL96	7/8	KY33E	6/-	PL31	7/-	U4F4	8/-	6AM6	3/-	20L1	12/8
EH91	3/-	EY61	7/9	PL32	10/-	U4H2	7/-	6CD6	27/6	20P1	10/8
EH93	5/-	EY86	7/6	PL80	6/6	U441	8/6	6D2	3/-	20P3	12/-
EF80	9/8	EZ40	6/-	PL81	6/-	U442	3/8	6F1	5/-	20P4	16/6
ECC81	6/3	KT33C	6/9	PL82	6/9	U441	7/6	6F12	8/-	27A4	14/-
ECC82	5/9	KT36	9/8	PL30	10/-	U446	7/6	6F13	7/-	30C1	7/-
ECC84	8/-	KT56	15/-	U22	9/8	U444	11/6	6F14	9/6	30L1	7/-
ECF80	8/-	PCC84	7/-	U24	10/-	U441	6/6	6F15	9/6	30P4	10/9
ECH33	9/-	PCC89	8/6	U25	12/-	U48	14/6	6L1	12/6	18S2B	14/-
ECH81	6/-	PCF80	7/-	U28	12/-	U49	6/6	6V6	5/-	18S2B	14/-

These are only examples of our valves; if you do not see what you require send stamped addressed envelope for special quotation.

We pride ourselves that we can obtain and supply any TV spare
OUR GIGANTIC STOCKS INCLUDE: Line Output, Frame Output,
Sound Output, Line and Frame Blocking, Osc. Trans. and Scan Coils for
any make or model Television. Please ask us for ANY components you
require, we are almost certain to have them.

TERMS: S.A.E. all enquiries. C.W.O. or C.O.D. 3/- extra.
Postage on Valves, 6d. each. C.R.T.'s 12/6 inc. insurance.
SATISFACTION ASSURED. RETURN POST SERVICE.

IN THE HOME, IN THE CAR,
BY THE SEA, IN FIELDS AFAR

THE CONTESSA

IS VOTED BEST OF ALL

A really remarkable

2 BAND 6 TRANSISTOR SUPERHET KIT

(As displayed at the Radio Hobbies Exhibition)

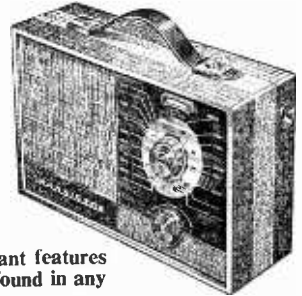

The CONTESSA
is the professional
looking set with
the professional
performance.

Study these brilliant features
which cannot be found in any
other kit . . .

- Waveband Coverage of 530 k/cs to 1620 k/cs and 160 k/cs to 270 k/cs.
- Assured reception of at least a dozen stations in daylight!
- Large clearly-calibrated station-named dial.
- Internal high-gain FerroX Aerial.
- 5.1 ratio slow motion tuning.
- Fitted with the latest 12000 line high-flux loudspeaker.
- Power of 410 milliwatts from the single-ended push pull final stage.
- Specially designed aerial matching coil for use in a CAR.
- Only first grade fully guaranteed Mazda matched transistors and diodes are used.
- Double tuned IF transformers for maximum gain and knife-edged selectivity.
- Fully drilled printed circuit panel marked with component numbers.
- The two colour case measures 10 x 7½ x 3½ in. and weighs approx. 4 lbs.
- Battery lasts 4 months with normal usage.
- Book supplied with detailed assembly instructions, diagrams and circuitry.
- Anyone can build this set—everything supplied just a soldering iron required.

Inclusive price for all associated components,
cabinet and battery, complete in every detail. **£10.19.6**

Or our BUY AS YOU BUILD SCHEME any parts sold
separately. Send for comprehensive descriptive manual
and parts list, 3/6 post free.

See and hear a working model at:—

RADIO CLEARANCE LTD.

27 Tottenham Court Road, London W.1

Telephone: Museum 9188

CONSTRUCTORS

OUT NEW 5 STAGE SUPER SENSITIVE TRANSISTOR PORTABLE

The
"BOBETTE"

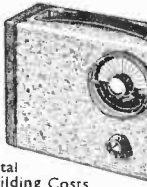

● Simple to Build.
● All first grade components.

A truly portable transistor radio giving full medium wave reception.

Incorporates Sin. High Flux Speaker, push pull output, first grade transistors, High-Q ferrite aerial, socket for car aerial, pre-tuned circuit board for easy construction. Attractive two tone case.

Total Building Costs
£5.2.6 P. & P. 2/6.

All parts sold separately. Send 1/6 for itemised price list and full assembly instructions (Free with order.)

EASY TO BUILD TWO STAGE TRANSISTOR SET

The "BIJOU"

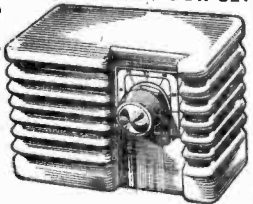

The set that looks like a Radio Set.

- Attractive Case.
- Mini .005 Tuner.
- High Q Litz Coil
- Works for months off No. 8 Battery.
- Simple to construct in 15 min.

Total Building Costs **25/-** P. & P. 2/-

You can't go wrong. We guarantee good results. Components Price List, Layout Plans 1/6 (free with order)

"ENSURE SUCCESS WITH R.C.S."

EXPLORE THE WORLD ON THIS 1-VALVE SHORTWAVE RADIO

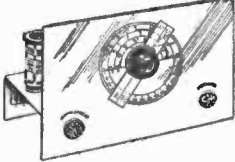

- Receives speech and music from all over the world.
- Construction price including valve and one coil covering 40-100 metres.
- Can be extended to cover 10-100 metres.
- Can be converted to 2 or 3 valve.

Total Building Costs Only **35/-** P. & P. 2/-

Send 2/- for wiring diagram and components price list

IDEAL FOR THE BEGINNER!

Crystal Receiver covering Medium Wave Band. All components including case for only 12/6. P. & P. 1/6. Easily converted to 1-transistor or 2-stage transistor receiver. Send 1/6 for construction details and component price list.

PUT YOUR FAVOURITE PROGRAMME ON TAPE

Tape it with the R.C.S. TAPE TUNER



Will operate on all types of Recorder. High impedance output. Variable Medium wave tuning. Triple wound Super Hi-Q coil. Chassis and components colour coded. Easily constructed from full instruction data and layout diagrams. Size 3 3/4 x 1 1/2 x 1 in.

Total Building Costs Only **30/-** P. & P. 1/6

Send 1/6 for wiring diagram and components price list.

R.C.S. PRODUCTS (RADIO) LTD.
11, OLIVER ROAD, LONDON, E.17
Mail Order only. Trade Enquiries welcomed.

VALVES

SAME DAY SERVICE
NEW! TESTED! GUARANTEED!

SETS	1R5, 1S5, 1T4, 3S4, 3V4, DAF91, DF91, DK91, DL92, DL94 ..	Set 4 for 19/6
1A7GT 11/-	6L19 12/-	5 for 27/8
1D5 8/-	6LD20 8/-	5 for 24/6
1HSGT 9/-	6P1 10/-	
1NSGT 9/-	6P25 8/-	
1R5 8/-	6Q7G 9/-	
1S4 8/-	6Q7GT 8/6	
1S5 5/3	6SL7GT 5/9	
1T4 5/3	6SN7GT 4/9	
1U5 5/9	6U4GT 9/8	
3A5 9/-	6V6G 4/8	
3Q4 7/-	6V6GT 6/6	
3S4 6/-	6X4 5/-	
3V4 4/6	6X5GT 4/9	
5V4G 7/6	7B5 9/-	
5V4 7/6	7C5 7/6	
5V3GT 9/-	7C5 7/6	
5Z4G 7/9	7H7 7/6	
6AL5 3/9	7S7 9/-	
6AR6 3/6	7Y4 7/-	
6AQ5 6/-	10C2 17/-	
6AT6 8/9	10P13 14/6	
6BA6 5/9	12A7 7/-	
6BE6 5/9	12A7T 5/-	
6B6 5/9	12A7T 6/3	
6B16 5/9	12AX7 7/-	
6BR7 12/6	12K7GT 4/9	
6BW6 7/-	12K8GT 9/6	
6CD6G 27/3	12Q7GT 4/9	
6P1 10/-	12S7 7/6	
6P6G 6/6	14S7 19/6	
6R13 10/-	20P2 17/-	
6P14 10/-	20P1 17/-	
6K7G 1/11	20P4 20/-	
6K7GT 5/-	25A6G 8/-	
6K8G 5/-	25B8GT 7/9	
6K8GT 8/-	25Z4G 7/3	
6L18 10/-		

THE PUNCH YOU NEED!

HOLE PUNCHES

Instant Type
3/8" diameter ... 5/6 ea.

Screw-up Type
1/2" diameter ... 6/8 ea.
3/4" " ... 7/2 " B7G
1" " ... 7/8 " B8A, B9A
1 1/8" " ... 8/3 "
1 1/4" " ... 8/7 "
1 1/2" " ... 9/6 "
1 3/4" " ... 10/11 ea. Postage and packing 1/-
1 7/8" " ... 13/3 "
2" " ... 15/6 "
2 1/8" " ... 17/11 "
2 1/4" " ... 20/4 "
2 3/8" " ... 27/8 " Meter
2 3/4" " ... 27/8 " Postage and packing 2/3

Complete set including postage and packing £7.10.0.

OLIVER & RANDALL LTD
Dept. 7.
40 Perry Hill, London, S.E.6
Tel.: BECKenham 8262

READERS RADIO
24, COLBERG PLACE, STAMFORD HILL,
LONDON, N.16
STA. 4587

Post 6d. per valve extra.
Any Parcel insured Against Damage in Transit 6d. extra.
Any C.O.D. Parcel 3/- extra.

ERSIN MULTICORE SOLDERS

for a first class joint every time

Ersin Multicore contains 5 cores of extra-active, non-corrosive Ersin Flux. Prevents oxidation and cleans surface oxides.

SIZE 1 CARTON
5/-



HANDYMAN'S CARTON

Suitable for 200 average joints. **6d.**

HOME CONSTRUCTORS 2/6 PACK

In addition to the well-known Home Constructors Pack (containing 16ft. of 18 s.w.g. 60/40 alloys) a similar pack is now available containing 35ft. of 22 s.w.g. 60/40 alloy especially suitable for printed circuits.



Wherever precision soldering is essential, manufacturers, engineers and handymen rely on MULTICORE. There's a MULTICORE SOLDER just made for the job you have in hand. Here are some of them.

SAVBIT TYPE 1 ALLOY

A specially formulated alloy to reduce the wear of soldering iron bits. Contains 5 cores of non-corrosive Ersin Flux and is ideal for all soldering purposes.

SIZE 1 CARTON 5/-

Available in three specifications.



BIB WIRE STRIPPER AND CUTTER

Strips insulation without nicking wire, cuts wire cleanly, splits extruding flx. **3/6 each**



MULTICORE SOLDERS LTD.,

MULTICORE WORKS, HEMEL HEMPSTEAD, HERTS. (BOXMOOR 3656)

“There is no Virtue without Courage — No Reward without Labour”

Not simply a school motto but at B.N.R.S. a creed and a way of life. We owe to it all we have and are. If you are prepared to make it your motto and live up to it, we can help you to get to the top. It will take time, it will take effort, it will take courage, and on top of all this you will actually be charged fees.

If we haven't succeeded in putting you off, write for details, today, to:

Mr. J. SYKES

(M.I.E.E., M. Brit. I.R.E., M.I.N.)

Principal :

BRITISH NATIONAL RADIO SCHOOL
Red Lion Court, Stalbridge, Dorset

Britain's premier Radio Correspondence School specialising in City and Guilds examinations.

*informative,
amusing
and human*

ANEW BOOK

By G. A. BRIGGS

AND 64 COLLABORATORS

Publication Date 15th November 1961

Not a “Who's Who” in Audio but reminiscences by the Editor, G. A. Briggs, and many of the interesting people he has met during some thirty years of audio activities. There are entertaining glimpses of recording studios with world-famous soloists; of triumphs and failures with prototype speakers, pickups and amplifiers. Truly a book that brings to life the heart of Audio being—as the B.B.C. critics would say — evocative, and, as the Editor ventures to say—informative and amusing.



19/6 (20/9 post paid)

344 pages with 112 photographs and illustrations. Printed on fine quality art paper and cloth bound. Available through Book Shops and Radio Dealers, or in case of difficulty direct from the Publishers.

Wharfedale
WIRELESS WORKS LTD

IDLE
BRADFORD
Yorkshire

Tel.: Idle 1235/6 Grams: Wharfedel, Idle, Bradford.

Audio Biographies

AVO METERS

MODEL 7 £12.10.0. MODEL 8 £17.10.0. Guaranteed perfect Complete with leads and batteries. Registered post and packing 5/- extra.

MULTIMETERS. 1000V/VOLT. A.C. and D.C. volts, 0-10, 50, 250, 500 & 1000 D.C. current 0-10, 100mA. Resistance 0-2K Ω and 0-200K Ω . Bakelite case, complete with test leads. BRAND NEW 59/6.

BC 221. The most accurate precision portable heterodyne frequency meter 125Kc/s to 20Mc/s. Complete with original individual calibration book. Guaranteed perfect £16.

CRYSTAL CALIBRATOR No. 10. Good condition, tested, with instruction manual. ONLY 59/6 or AS NEW with three spare valves, leads, etc. £4.10.0. P & P. 3/6.

PCR COMMUNICATIONS RECEIVER

Type PCR. Has self-contained speaker. Covers 850-2000, 200-550 and 16-50 metres. BRAND NEW CONDITION.....£9.19.8 USED (Good condition).....£7.19.8

Type PCR-2. Requires external speaker. Covers 850-2000, 200-500 and 13-50 metres. USED (Good condition).....£6.19.6

Carriage (any type) 10/6. Full details S.A.E. Any model fitted with BRAND NEW INTERNAL POWER SUPPLY, guaranteed ready for use on A.C. mains £2 extra.

Moving Coil Phones. Finest quality Canadian, with Chamois earmuffs and leather-covered headband. With lead and jack plug. Noise excluding supremely comfortable 19/6, post 1/6.

GIANT COMPONENT PARCEL. Contains 100 $\frac{1}{2}$ and 1 watt resistors, 50 Hi Stab resistors, W/W resistors, carbon and W/W pots, 100 capacitors (mica, paper, Sprague bias, variable, etc.), valveholders, tax strips, metal rectifiers, sleeving, etc. All components are unused. GUARANTEED VALUE, 25/-, plus 2/6 post.

TRANSISTOR SETS

We now stock **The Pocket 4**, a neat little job which can be made for 42/6, (**Printed Circuit Version 52/8**), and **The Good Companion** (a super job equal to the best). Easily constructed for only £9.19.8. Gladly demonstrated to callers.

CHARLES BRITAIN (RADIO) LTD.

11 Upper Saint Martins Lane, London, W.C.2

TEMPLE BAR 0645

Shop Hours 9-6 p.m. (9-1 p.m. Thursday)
Open all day Saturday.

SOUTHERN RADIO'S WIRELESS BARGAINS

PORTABLE TEST METERS. (As featured in March issue, pages 1005 to 1010) 0-5000 ohms; 0-60 mA; 0-15 v., 0-3 v., 12/6 each.

TRANSMITTER RECEIVERS. "Type 38" with 5 valves. New but untested. No guarantee, 25/- each. Post paid.

ATTACHMENTS FOR "38" TRANSMITTER-RECEIVER; Headphones 15/6; Throat Microphones, 4/6; Junction Boxes, 2/6; Aerials, No. 1, 2/9, No. 2, 5/3; Webbing, 4/-; Haversacks, 5/6; Valves—A.R.P. 12 4/6, A.T.P. 4, 3/6. Set of five valves, 19/-. Postage on each item 1/6 extra (except valves).

ATTACHMENTS FOR "18" TRANSRECEIVER. Headphones, 15/6; Microphone 4a, 12/6; Aerials, 5/-; Morse Key, 6/6; Valves—A.R.P. 12, 4/6, A.T.P. 4, 3/6, A.R. 8, 7/6; Set of six valves, 25/-. Official booklet "18" T-R Circuits, etc., 6/6 post paid. Postage extra (except valves) 1/6 each item.

QUARTZ CRYSTALS. Types F.T.241/F.T.243 2 pin $\frac{1}{2}$ in. spacing. F.T.241 20 to 38.9 Mc/s (54th and 72nd Harmonic). F.T.243 5700 to 8650 kc/s (Fundamental), 4/6 each. Lists of available frequencies on request. Crystal Holders for F.T.241/243, 1/3. F.T.241/243 Crystals. New but not guaranteed (ideal for using the case or regrinding). 12/6 per dozen. Post paid.

RECORDING BLANKS. New 13 in., 6/- each or 15 complete in Tin. £4.

BOMBSIGHT COMPUTERS. Ex-R.A.F. Wealth of gears, motors, blowers, etc. Ideal for experimenters, £3.12.6, carr. paid.

RESISTANCES. 100 Assd. Useful values, new, 12/6 per 100.

CONDENSERS. 100 Ass. Mica Elec., Tub., etc. New 15/- per 100.

MORSE PRACTICE SETS. Key with Buzzer on Base, with battery, 12/6, postage 2/-.

LUFBRA HOLE CUTTERS. Adjustable, $\frac{1}{2}$ in. to $\frac{3}{4}$ in., 7/3.

STAR IDENTIFIERS. I-AN. Covers both hemispheres, 5/6.

VISUAL INDICATORS (10Q4). Type 3 with 2 meter movements, 2 neons. New 12/-.

MAGNETS. Strong Bar, 2 in. x $\frac{1}{2}$ in. 1/6 each.

COMMAND RECEIVERS B.C. 454 3-6 Mc/s. B.C. 455 6-9 Mc/s. Complete with 6 valves, 47/6 each.

POST OR CARRIAGE EXTRA, FULL LIST OF RADIO BOOKS, ETC., 3d.

SOUTHERN RADIO SUPPLY LTD.

11 LITTLE NEWPORT ST., LONDON W.C.2. GER. 6653

FIRST-CLASS RADIO COURSES . . .

GET A CERTIFICATE!

QUALIFY AT HOME—IN SPARE TIME

After brief, intensely interesting study—undertaken at home in your spare time—YOU can secure your professional qualification or learn Servicing and Theory. Let us show you how.

FREE GUIDE

The New Free Guide contains 132 pages of information of the greatest importance to those seeking such success-compelling qualifications as A.M.Brit.I.R.E., City and Guilds Final Radio, P.M.G. Radio Amateurs' Exams., Gen. Cert. of Educ. London B.Sc. (Eng.), A.M.I.P.E., A.M.I.Mech.E., Draughtsmanship (all branches) etc., together with particulars of our remarkable Guarantee of

SUCCESS OR NO FEE

Write now for your copy of this invaluable publication. It may well prove to be the turning point in your career

FOUNDED 1885—OVER

150,000 SUCCESSSES

NATIONAL INSTITUTE OF ENGINEERING

(Dept. 461), 148 HOLBORN LONDON, E.C.1

S. Africa: P.O. Box 8417, Jo'burg.
Australia: P.O. Box 4570, Melbourne.

Just Published

RADIO CONTROL MANUAL

by E. L. Safford Jr.

25/-. Postage 9d.

TRANSISTORS—HOW TO TEST THEM. Gernsback Lib. 16/-. Postage 8d.

HANDBOOK FOR RADIO OPERATORS. G.P.O. 6/-. Postage 1/-.

REFERENCE MANUAL OF TRANSISTOR CIRCUITS. Mullard. 12/6. Postage 1/-.

RECORDS AND GRAMOPHONE EQUIPMENT. by E. N. Bradley. 8/6. Postage 6d.

TELECOMMUNICATIONS. W. T. Perkins. 21/-. Postage 9d.

THE SUPERHETERODYNE RECEIVER. A. T. Witts. 20/-. Postage 6d.

VALVE & TELETYPE MANUAL No. 9. Brimar. 6/-. Postage 1/-.

RADIO VALVE DATA. Compiled by "VWV" 7th Ed. 6/-. Postage 10d.

COMPLETE CATALOGUE 1/-.

THE MODERN BOOK CO.

BRITAIN'S LARGEST STOCKISTS of British and American Technical Books

19-21 PAED STREET LONDON, W.2

Phone: PADdington 4185
Open 6 days 9-6 p.m.

H.A.C. SHORT-WAVE EQUIPMENT

AND SHORT-WAVE KITS

Famous for over 25 years for . . . S.W. Receivers and Kits of Quality.

H.A.C. were the original suppliers of SHORT-WAVE RECEIVER KITS for the amateur constructor. Over 10,000 satisfied customers—including Technical Colleges, Hospitals, Public Schools, Hams, etc.

Improved designs with Denco coils: One-valve Kit, Model "C", Price 25/-; Two-valve Kit, Model "E", Price 50/-; New Addition: Model "K", Super sensitive "All Dry" Receiver, Special Inc. price. Complete Kit, 77/-.

All kits complete with all components, accessories and full instructions. Before ordering call and inspect a demonstration receiver, or send for descriptive catalogue and order form.

POST THIS COUPON NOW!
"H.A.C." SHORT-WAVE PRODUCTS

(Dept. TH), 44 Old Bond Street, London W.1

Please send me FREE and without obligation your 1961 literature.

NAME.....

ADDRESS.....

FIVE-TRANSISTOR POCKET RADIO

COMPLETELY PORTABLE,
NO AERIAL OR EARTH REQUIRED

- ★ Size 4½x3¼x1½ in.
- ★ Output 200m/W
- ★ 5 First quality transistors
- ★ Push-pull output
- ★ Fitted 2½ in. high-flux moving coil speaker



- ★ Medium and long wave
- ★ Internal high gain ferrox aerial
- ★ Twin coloured case in red and black
- ★ All parts available separately
- ★ Circuit-diagram 1/6. Free with kit.

PRICE ONLY **£2/19/6** plus 3/6 post and packing

RADIO & TV LTD. (Dept. 5T)
23 High Street, Acton, London, W.3.

EXPRESS ELECTRONICS ROSEDALE LABORATORIES KINGSWOOD WAY, SELSDON, SURREY

VALVES NEW TESTED AND GUARANTEED FOR THREE MONTHS

1C1	7/8 6BA5	6/8 8D8	4/8 DF96	8/8 EF41	9/8 PCL84	7/8
1C3	8/8 6BE6	7/8 12AH8	10/8 DH76	7/8 EF80	8/8 PL81	12/8
1F1	8/8 6BA6	5/8 12AT7	8/8 DH77	6/8 EF86	9/8 PL82	7/8
1F3	7/8 6BJ6	5/8 12AU7	5/8 DH142	8/8 EF89	4/8 PL 3	7/8
1FD1	8/8 6BR7	8/8 12AX7	6/8 DH130	10/8 EF92	5/8 PY81	6/8
1FD9	7/8 6BS7	10/8 12BE6	8/8 DK91	7/8 EL41	8/8 PY82	7/8
1L4	6/8 6BW6	7/8 12BH7	10/8 DK92	7/8 EL84	7/8 PY83	7/8
1P1	8/8 6BW7	7/8 12K8GT11	8/8 DK96	8/8 EM84	10/8 R19	11/8
1P10	7/8 6C10	9/8 12Q7GT	7/8 DL92	7/8 EM85	10/8 U28	8/8
1P11	7/8 6C12	4/8 16A5	9/8 DL94	6/8 EY51	7/8 U52	7/8
1R3	6/8 6F12	4/8 25A8G	8/8 DL96	8/8 EY81	10/8 U76	7/8
1R5	6/8 6H6GT	2/8 26L6GT	7/8 EB91	4/8 EZ40	7/8 U78	5/8
1T4	7/8 6J7GT	7/8 26Z4G	9/8 EBC41	10/8 EZ80	8/8 UBC41	8/8
1U5	5/8 6K7G	5/8 30C1	6/8 EBF80	8/8 E281	6/8 UGH42	9/8
3Q4	8/8 6K9G	6/8 30L1	7/8 ECC81	6/8 KT30	6/8 UF41	8/8
3B4	7/8 6L7G	6/8 35L6GT	9/8 ECC82	5/8 KT68	11/8 UL41	8/8
3V4	6/8 6SL7GT	6/8 35W4	8/8 ECC83	6/8 N17	7/8 UX41	7/8
5U4G	7/8 6SN7GT	6/8 35Z4GT	8/8 ECC84	7/8 N18	8/8 W76	6/8
5Y3GT	5/8 6V8G	7/8 63KU	10/8 ECF80	8/8 N19	7/8 W142	8/8
Z4G	9/8 6X4	5/8 5763	7/8 ECF82	8/8 N709	7/8 X17	7/8
8AKG	9/8 6X3G	5/8 59	6/8 ECH42	9/8 PCF84	6/8 X142	8/8
8AL5	4/8 6X3GT	8/8 DAF91	7/8 ECH81	10/8 PCF80	6/8 X150	9/8
8AM8	4/8 7B7	7/8 DAF96	8/8 ECL80	8/8 PCF82	7/8 Z77	4/8
JAT6	6/8 787	9/8 DFN1	7/8 ECL82	8/8 PCL82	8/8 ZL17	7/8

High Stability Resistors 1W 5% 50 Ω to 1M, 9d. Midget Ceramics 500 v, 9d. Coax. Super quality ¼ in. 6d. ½ in. Plugs 9c. Sockets 9d. Silicon H.T. Rects. 250v. 300 MA 1in. x ½ in. 17/6. Constat Cooled 250v. 50 MA 6/6 85 MA 8/6.

VOLUME CONTROLS MIDGET SIZE LONG SPINDLES. D. P. switch 4/8. Less switch 2/6. Values 10K to 2M. B9A. BTG v. holders 9d., Screens 9d.

VALVES MATCHED IN PAIRS

EL84 17/- N709 17/- 6V6G 17/- 6BW6 18/- per pair. Push Pull O.P. Transformers for above 3-15 Ω 14/6, P. & F. 1/6. 12in. P.M. Speakers 3 Ω 24/6. Baker's "Selhurst" 12in. 15 Ω 15W. 50/- 12in. Stereo Model. 27/7.0.

SETS OF VALVES

DK91, DF91, DAF91, DL92 or DL941. 19/6
 DK96, DF96, DAF96, DL96..... 27/6
 1C3, 1F1, 1FD1, 1P1..... 27/6
 1R5, 1T4, 1R5, 3S4, or 3V4..... 19/6
 Postage and packing 6d. Over 21 post free. C.O.D. 2/6.

an absolute practical minimum

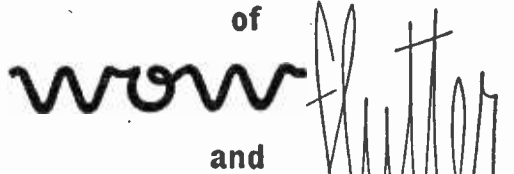

That has been one of our main objectives since we started making tape decks and recorders and we feel that we have achieved this (along with many other notable features) in our present range of recorders. By the use of high quality components and fastidious precision assembly these "wow and flutter" figures are maintained:—

Below .05% at 15 i.p.s. | Below .15% at 3½ i.p.s.
 Below .1% at 7½ i.p.s. | Below .25% at 1½ i.p.s.

The Brenell Mark 5 deck at 28 gns. has greater precision and dependability than you are ever likely to find elsewhere at anywhere near the price.

IT'S A HEART THAT IS AS SOUND AS SOUND CAN BE

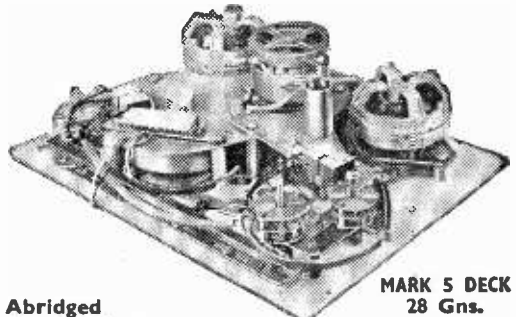

MARK 5 DECK
28 Gns.

Abridged Specification

- 3 INDEPENDENT MOTORS (Capstan motor —hysteresis synchronous)
- 4 RECORDING AND PLAYBACK SPEEDS 1½, 3½, 7½ and 15 ips.
- FAST REWIND (1,200ft. rewound in either direction in 45 secs.)
- ACCEPTS 8in. reels
- PAUSE CONTROL, INTER-LOCKED CONTROLS.
- DIGITAL REV. COUNTER.
- PROVISION FOR EXTRA HEADS (Mono or Stereo)



MARK 5
Type 'M' 88 Gns.

TAPE RECORDERS:

MARK 5: 64 Gns. MARK 5 STEREO: £99.12.0. 3 STAR: 58 Gns. 3 STAR STEREO: 89 Gns.



Full details and the address of your nearest stockist from the sole manufacturers:

BRENELL ENGINEERING CO. LTD.,
 1A DOUGHTY STREET, LONDON, W.C.1.
 Tel: Chancery 5809 Holborn 7358.

FREE TO AMBITIOUS ENGINEERS

— THE LATEST EDITION OF ENGINEERING OPPORTUNITIES

Have you sent for your copy?
ENGINEERING OPPORTUNITIES is a highly informative 156-page guide to the best paid engineering posts. It tells you how you can quickly prepare at home for a recognised engineering qualification and outlines a wonderful range of modern Home Study Courses in all branches of Engineering. This unique book also gives full details of the Practical Radio & Electronics Courses, administered by our Specialist Electronics Training Division—the *B.I.E.T. School of Electronics*, explains the benefits of our Employment Dept. and shows you how to qualify for five years promotion in one year.

We definitely Guarantee
“NO PASS—NO FEE”

Whatever your age or experience, you cannot afford to miss reading this famous book. If you are earning less than £25 a week, send for your copy of “ENGINEERING OPPORTUNITIES” today—FREE.

BRITISH INSTITUTE OF ENGINEERING TECHNOLOGY (Incorporating E.M.I. Institutes)
 (Dept. SE/21), 29 Wright's Lane, London, W.8

WHICH IS YOUR PET SUBJECT?

- Mechanical Eng.,
- Electrical Eng.,
- Civil Engineering,
- Radio Engineering,
- Automobile Eng.,
- Aeronautical Eng.,
- Production Eng.,
- Building, Plastics,
- Draughtsmanship,
- Television, etc.

GET SOME LETTERS AFTER YOUR NAME!

- A.M.I.Mech.E.
- A.M.I.C.E.
- A.M.I.Prod.E.
- A.M.I.M.I.
- A.I.O.B.
- A.F.R.Ae.S.
- B.Sc.
- A.M.Brit.I.R.E.
- City & Guilds
- Gen. Cert. of Education
- Etc., etc.

PRACTICAL EQUIPMENT

Basic Practical and Theoretic Courses for beginners in Radio, T.V., Electronics, Etc., A.M.Brit.I.R.E. City & Guilds Radio Amateurs' Exam. R.T.E.B. Certificate P.M.G. Certificate Practical Radio Radio & Television Servicing Practical Electronics Electronics Engineering Automation

INCLUDING TOOLS!

The specialist Electronics Division of *B.I.E.T. (Incorporating E.M.I. Institutes)* NOW offers you a real laboratory training at home with practical equipment. Ask for details.

B.I.E.T. SCHOOL OF ELECTRONICS



POST COUPON NOW!

Please send me your FREE 156-page “ENGINEERING OPPORTUNITIES”
 (Write if you prefer not to cut page)

NAME _____

ADDRESS _____

SUBJECT OR EXAM THAT INTERESTS ME _____ (SE/21)

THE B.I.E.T. IS THE LEADING ORGANISATION OF ITS KIND IN THE WORLD

KEEP IT COOL...



with this inexpensive
Axial Flow Cooling Fan

Only 4 1/2 in. overall dia., 2 1/2 in. overall depth, ideal for reliable, efficient ventilation of all radio and electronic equipment. Easily mounted in any position for air intake or extraction. Designed for quiet, continuous running

Leaflet available from Mfrs.:

JONES & STEVENS (PW) LTD.,

P.O. Box 35, Eastern By-pass, Littlemore, Oxford.

ONLY **27/6**

P. & P. 1/6.
 (Special prices for quantities).

NEW MODIFIED VERSION!

★ ‘PW’ 6-TRANSISTOR ★

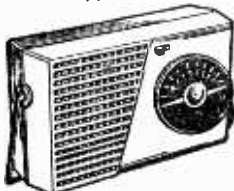

MEDIUM AND LONG WAVE
 POCKET SUPERHET

The latest version of this fine performer incorporates improvements giving even greater sensitivity and all round performance.

- 150 mW Push-Pull Output on 2 1/2 in. P.M. Speaker.
- Guaranteed first grade Matched Transistors.
- High Q Internal Ferrite Rod Aerial.
- Printed Circuit and full instructions

All parts required

£8.19.6

★ All parts sold separately. Send for illustrated building plans, 1/6 plus post. (Free with kit).

Every item down to the last nut and bolt is supplied together with easy to follow, step by step instructions—no extras to buy.

NORCOL LTD., Castle Road, Camberley, Surrey.
 Phone: Camberley 22760.

GZAK: This Month's Bargains

SCREENED CABLES

Screened Microphone Cable, 1st Grade, 9d. yd. 12-Core Screened Cable, 2/- yd. 10-Core (5 Pairs) Screened Cable, 1/8 yd. All plus 2/- P. & P.

AERIAL EQUIPMENT

TWIN FEEDER. 300 ohm twin ribbon feeder, similar K25. 6d. per yard. K35B Telcon (round) 1/6 per yard. Post on above feeder and cable 1/6 each 1/6 length.

COPPER WIRE. 14 G, H/D 140ft. 17/-; 70ft. 8/6. P. & P. 2/-.

Other lengths pro rata.

RIBBED GLASS. 3in. aerial insulators, 1/9 each. P. & P. 1/6. up to 12.

CERAMIC FEEDER SPREADERS. 6in. type F.S. 10d, each P. & P. 2/-.

CERAMIC “T” PIECES. Type A.T. for centre of dipoles, 1/6 each. P. & P. 1/-.

2 METRE BEAM 5 ELEMENT W.S. YAGI. Complete in box with 1 x 25in. mast head bracket. PRICE 49/-, P. & P. 3/6.

SUPER AERAXIAL CABLE. 75 ohm, 300 watts, very low loss, 1/8 per yard. P. & P. 2/-.

50 ohm, 300 watt coax, very low loss, 1/9 yd. P. & P. 2/-.

ABSORPTION WAVEMETERS. 3.00 to 35.00 Mc/s in 3 switched bands, 3.5, 7, 14, 21 and 28 Mc/s, Ham Bands marked on scale. Complete with indicator bulb. A MUST for any Ham shack, 22/6 post free.

VARIABLE CONDENSERS. All brass with ceramic end plates and ball race bearings. 50 pF, 5/9, 100 pF, 6/6, 160 pF, 7/6, 240 pF, 8/6, and 300 pF, 9/6. All fitted with rear extension for ganging. P. & P. 1/-. Also Flexible Couplers, 1/- each. B.I. 8 MFD, 1,200 v. D.C. Wkg. Capacitors, 12/6 each. P. & P. 2/-.

CHAS. H. YOUNG LTD.

THE COMPONENT SPECIALISTS

Dept. “P”, 110 Dale End, Birmingham 4. (CEN 1635)
 (No C.O.D. under £1 please.) (By return service.)

D.C. SUPPLY KIT. 12 v. 1 a. consisting of a partially drilled metal case, mains trans., F.W. Bridge Rectifier, 2 fuseholders and fuses. Change Direction Switch, Variable Speed regulator and circuit. For 200-250 v. A.C. mains. Suitable for Electric Trains. Limited number available at 33/9.

SELENIUM RECTIFIERS

F.W. BRIDGE	H.T. Types H.W.
6/12v. 1 a. 3/11	150 v. 40 m.A. 3/9
6/12v. 2 a. 6/11	250 v. 50 m.A. 3/11
6/12v. 3 a. 9/9	250 v. 60 m.A. 4/11
6/12v. 4 a. 12/3	250 v. 80 m.A. 5/11
6/12v. 6 a. 15/3	250 v. 250 m.A. 11/9
6/12v. 10 a. 23/9	
6/12v. 15 a. 33/9	
24 v. 2 a. 14/9	

B.S.R. MONARDECK TAPEDECKS. Speed 3 1/2 in. per sec. High quality recording heads, £6.19.6. Carr. 5/-. Suitable polished veneered walnut carrying case for above 39/6. (Space for amplifier).

EX. GOVT. CASES. Size 14-10 in. high. Well ventilated. Metal case finished, undrilled cover. IDEAL FOR ELECTRIC CHARGER OR INSTRUMENT CASE OR COVER COULD BE USED FOR AMPLIFIER. Only 9/9, plus 2/- postage.

LINEAR TREMOLO/PRE-AMP UNIT Type TP1/1, with 3 controls, volume, amplitude and frequency. Inputs for guitar and microphone. Requires power supply of 250 v. 10 m.A. and 8.3 v. 1 a. available from any R.S.C. or LINEAR amplifier. The unit is merely connected to normal input socket of hi-fi amplifier or Guitar amplifier. Only 5 gns.

MICRO-AMMETERS. 3 in. diam. 0-50 micro-amps. 33/9.

R.S.C. GRAM AMPLIFIER KIT. 3 watts output. Negative feedback. Controls Vol., Tone and Switch. Mains operation 230-250 v. A.C. Fully isolated chassis. Circuit etc. supplied. Only 39/9, Carr. 3/9.

HI-FI 10 WATT AMPLIFIERS
Brand new. Manufacturer's discontinued line. Fitted latest Mullard valves. Dual inputs for 'mike' and gram., etc. Bass and Treble Controls. High sensitivity and quality. Output for 8 ohm or 15 ohm speaker. For 230-250 v. A.C. £7.19.6 Carriage 7/6.

PORTABLE TRANSISTOR RADIO DESIGN with 7 x 4 in. loudspeaker and Car Aerial Socket. Attractively designed and covered cabinet size 8 x 10 x 3 in. Gold dials with revolving perspex covers. M. and L. wavebands. Six first grade Brimar Transistors and Printed circuit. Easy to follow instructions and diagrams, 2/6. Total cost of parts only £9.19.6, carr. 3/9. Demonstration models at all branches.

PRACTICAL WIRELESS SUPER SIX **DIAGRAM PORTABLE RADIO DESIGN** Diagrams etc., 1/6 or All parts including printed circuit and first grade transistors £8.19.6.

MULTI-METERS.
CABY A10. Basic Meter sensitivity 155 micro-amps. A.C. and D.C. ranges £4.17.6.
CABY B20. Sensitivity up to 10,000 ohms per volt, A.C. and D.C. £6.10.0.
S.A.E. will bring leaflets on A10 or B20.

RELAYS. Carpenters' Type, Polarised 2 times 9,500 turns at 1,085 ohms, 13/9. Miniature Type G.E.C. 670 Sealed, wire ends, 4 covers, platinum M1095, 12/9.

SPECIAL OFFER EX. GOVERNMENT SELENIUM RECTIFIERS. 12 v. 15 amp. with large square cooling fins. 19/9 each.

EX. GOVT. SMOOTHING CHOKES. 200 mA. 3-5 H., 50 ohms. Parmeko 8/9; 100 mA., 5 H., 100 ohms 3/11; 150 mA., 10 H., 50 ohms 9/9; 80 mA., 20 H., 900 ohms 5/9; 120 mA., 12 H., 100 ohms 8/9; 50 mA., 30 H., 1,000 ohms 6/9; 100 mA., 10 H., 100 ohms 6/9; 60 mA., 5-10 H., 250 ohms 2/11.

EX. GOVT. MAINS TRANSFORMERS
Primaries 200-250 v. 50 c.p.s. A.C.
250v. 60mA 6.3v. 2a. 11/9
250-0-250v. 60mA 6.3v. 2a. 12/9
250-0-250v. 30mA 6.3v. 3a., 6.3v. 1a. 17/9
5v. 3a. Parmeko Potted 12/9
270-0-275v. 100mA 6.3v. 7a. 5v. 3a. 22/9
300-0-300v. 60mA 6.3v. 2a. 12/11
300-0-300v. 100mA 6.3v. 2a. 5v. 2a. 18/9
5v. 10a. Parmeko 11/9
0-35-40-45-50v. 300mA 6.3v. 3a. 17/9

2 VOLT ACCUMULATORS
Varleys small size 4 x 3 x 1 1/2 in. 2 v. 14 A.H., brand new. 6/9 ea., 3 for 15/6.

FIELD TELEPHONES

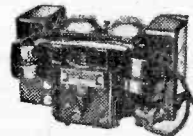

With bell. Require only small battery. Suitable for office, factory, warehouse or outdoor communication. 5/9/6 each.

TERMS: C.W.O. or C.O.D. No C.O.D. under £1. Post 1/6 extra under £2, 3/3 extra under £5. Open 8 to 6. Weds. until 1 p.m., except Manchester open all week. Trade supplied. S.A.E. with all enquiries.

Mail Orders to 29-31 Moorfield Road, Leeds 12.
Personal Shoppers to: 5 and 7 County (Mecca) Arcade, Briggate, Leeds 1.
8-10 Brown Street (Market Street), Manchester 2.
56 Morley Street (next to Majestic Ballroom), Bradford.
73 Dale Street, Liverpool 2.

R.S.C. LIVERPOOL BRADFORD MANCHESTER and LEEDS
(Manchester) Ltd.

BENSON'S BETTER BARGAINS

RECEIVERS, PRC, L, M and Short wavebands; good condition, 27 (rall 10/-). WAVEMETER Class "D" No. 1, Mk. 2, new condition, 65/- (rall 5/-). M.W., "Command RX8", with 6 valves; store soiled condition, 65/- (post 3/6). Resistors, high stability, 4 and 1w. 2/6 each, each. CONDENSERS: Block paper 8 mfd. 1 kVw 10/-; 8/600 v. 8/8; 8/400 v. 5/-; 8/250 v. 4/-; 4/2 kVw 7/6; 4/1 kVw 4/6. SWITCHES: Wafer: 2 pole, 4 way, 4 bank 1P6W3B, 4P2W2B, 1P7W3B, 1P11W2B, 4P2W3B, 3/6 each. Ceramic 2P4W1B, 1P3W3B, 1P11W, 4P2W2B, 4P3W1B, 3/6. STUD, 1P24W2B, 1P8W2B, 1P19W2B, 5/6; 1P40W3B in brass case, 12/6.

MORSE KEY with buzzer on board, wired for 4 1/2 v. battery, 3/6 (p.p. 1/6). METERS (10Q/4) with two movements, 600 and 400uA, 5/6.

TRANSFORMERS. Input 200/250 v. outputs 300-0-300 v. Tapped 250 v., 150 mA. 6-3 v., 5 A. and 5 v., 3 A (p.p. 4/-). 25V. MONITOR 56, with triggered oscilloscope, 230 v. A.C. input, with cables and circuit. Cathode probe unit extra. 17/6. 28.10.0 (Rall 15/-). NEW M.C. METERS. 3 1/2 in. round flush, 50uA 70/-; 200uA centre zero, 50/-; 1 mA. centre zero, 45/-; 1 mA. 55/-; 2 1/2 in. 100 mA 8/6; 2 in. 300 mA, each 8/6.

VIBRATORS, Mallory 0294C 12 v. 4 pin, 7/6; 12 v. 7 pin U.K., 7/6; 12 v. 7 pin reversible, 12/6; 6 v. 5 pin reversible, 7/6. DRIVES: slow motion Admiralty 200 : 1 ratio, scaled 0-100 5/6. R155 S.H. "N" type, new 10/6. VIBRAPAK, 6 v. D.C. 6 v. 25/-, DYNA-CASED, 25/8 (p.p. 4/-) or 12 v. 25/-.

MOTORS (post 4/-). 12 v. to 250 v. 60 mA. 11/6. 8 v. to 250 v. 60 mA. 11/6. CHOKES. LF 10H, 200 mA. 9/6; 10H, 250 mA. 12/6; 30H, 50 mA. 7/6; 20H, 100 mA. 9/6; 8H, 180 mA. 9/6; 15H, 150 mA. 9/6. TRANSISTORS V301, 10P, 10/-; GERM. RECTIFIERS G15M, (300 P.I.V., 550 mA), 10/-; RELAYS (LONDEX) co.-as., small 12/24 v., 7/6.

LIST AND ENQUIRIES S.A.E. please Terms. C.W.O. Postage extra. Imm. despatch. Post: W. A. BENSON (P.W.), 138 Rathbone Road, Liverpool 15, SE.F. 883. Callers: SUPERADIO (Whitechapel), Ltd., 116 Whitechapel, Liverpool, ROY 1130

CABINETS & HI-FI EQUIPMENT
We can supply any Cabinet to your own specification

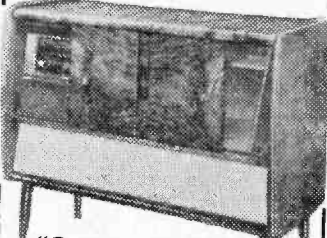

"Grosvenor" £22.1.0

This is only one example taken from our extensive range of stock cabinets. Write for our NEW 24 page fully illustrated catalogue on:

THE LARGEST RANGE OF CABINETS IN THE COUNTRY

Equipment is also our speciality and we now offer in a novel book form: **A NEW EQUIPMENT COMPARATOR** illustrating our range of radio chassis, speakers, tape decks, single players and autochangers.

SEND TODAY for a copy of these two books, which are absolutely FREE.

LEWIS radio
100 (P11) Chase Side, Southgate, London, N.14. Pal 3733/9666

2 METRES!

The thrills of 144 Mc/s can now be yours for only 39/6, complete kit! Tunable range 150-100 Mc/s, simplified construction, etc., write today for descriptive literature, also if a newcomer-beginner to Amateur Radio, ask for free copy of the world-famous "Globe-King" kits and receivers—stamp to cover postage costs appreciated. Write now to makers:

JOHNSONS (Radio)
St. Martins Gate, Worcester

GENUINE BRITISH TRANSISTORS
RED SPOT. 3/-; WHITE SPOT. 3/-; GREEN/YELLOW. 3/-; OC44, 11/-; OC45, 10/-; OC70, 6/-; OC71, 6/-; OC72, 8/- (16/- p.n.); all other types at list price.

Circuit Diodes Still Only 1/-
Resistors: All Values 10% WATT. 6d. ea.

ELECTROLYTICS.—GUARANTEED
8-8 mfd. 450 v. 100 mA. 1 1/2 x 1 1/2; 2/9.
8-16 mfd. 450 v. 100 mA. 1 1/2 x 1 1/2; 3/9.
50 mfd. 50 v. 2/-, 25 mfd. 25 v. 1/6.

New Reprodo JOURNEYMAN "6"
the kit without snags, Long and M.W. fully tunable, large PRINTED CIRCUIT (no cramped components) uses 7" x 4" speaker. Pre-aligned I.F.'s. Car aerial socket, everything supplied, including battery and solder, all you need is a soldering iron. SWITCH ON AND IT WORKS. Circuit and plans 1/7. KIT £9.15.0. Send S.A.E. for full details and parts list.

OKAFIELD RADIO
121 MACCLESFIELD ROAD, HAZEL GROVE, STOCKPORT, CHESHIRE

MAIL ORDER ONLY

EDDY'S (NOTTM) LTD.

172 Alfreton Road
Nottingham

New or Surplus VALVES

Guaranteed and Tested by Return Post.

1D5	7/6	6SN7GT	4/3	ECC82	5/11
1L4	3/6	6V6G	4/9	ECC83	6/6
1R5	5/6	6V6GT	6/-	ECC85	6/11
1S5	4/9	6V6M	8/6	ECH42	7/9
1T4	3/6	6X4	5/-	ECL80	7/-
2D21	8/6	6X5G	5/6	ECL82	9/-
3A4	6/-	6X5GT	6/6	EF36	3/-
5U4G	4/9	7C5	7/6	EF41	7/6
5Y3GT	5/11	10F1	6/6	EF42	7/6
5Z4G	7/6	12A6	5/-	EF50	1/9
6AC7	4/-	12AH7	5/-	EF80	5/-
6AG5	3/11	12K7	5/3	EF86	9/6
6BB8	2/11	12Q7	5/3	EF91	3/6
6C4	3/6	20D1	8/6	EF92	4/6
6CH6	8/-	20P1	9/6	EL41	7/6
6C5	4/9	25L6GT	8/6	EL42	7/6
6F1	6/6	30F5	6/11	EL85	10/3
6F13	6/11	35L6GT	8/6	EL91	4/6
6F15	8/6	35W4	6/9	GTIC	16/11
6F33	6/6	35Z4	5/3	KT33C	6/6
6I5G	2/9	50L6GT	10/6	MU14	7/-
6J5GT	3/9	80	6/11	OZ4	5/11
6J5M	4/3	90AY	4/6	PCC85	9/6
6L6	4/-	95A	1/6	PCL82	7/6
6I7G	5/-	955	3/6	PCL84	12/6
6K7G	1/11	956	2/6	PZ30	9/6
6K8G	5/6	AC2/		PEN36C	8/-
6K25	15/6	PENDD	7/6	PEN46	5/11
6P25	9/11	CY31	9/6	SP61	2/6
6Q7G	5/11	DM70	7/6	TDD4	7/6
6SA7M	5/9	EB34	1/6	U25	12/6
6SG7M	4/9	EBF80	8/-	UCH42	7/6
6S17M	5/9	ECC35	6/9	UY41	6/3
6SL7G	6/6	ECC81	5/3	VP23	6/3

**Build your own
CAR RADIO**

- 7 Transistor ● Long and Medium Wave ● Two Watts Output ● R.F. Stage and Automatic Gain Control



10 1/2 Gns.
P & P
5/6 extra

6 or 12 volts (state which)
Supplied with full instructions
Size 7 1/2 x 7 1/2 x 2 1/2 in.
SPEAKER, extra 17/11

POCKET RADIO. 2 Transistor with miniature speaker. Complete with all parts, wiring diagram and full instructions, 27/6. Batteries, 1/-, P. & P. 2/-.

NIFE ACCUMULATORS. 1.25 v. size 3 x 2 1/2 x 1/2 in. 7 amp. hrs., weight 13ozs., 2/6 each, P. & P. 2/-, one only add 9d. per cell.

THROAT MIKES, 2/- ea., P. 10d. Could be used for electrifying musical inst. etc.

CRYSTAL SETS. Complete 2 wave bands high gain, good quality, 19/11, also with transistor amplifier extra, 9/11, P. & P. 2/6.

HEADPHONES. High res. to suit above crystal sets, 13/11 pr., P. & P. 2/-.

All Above are New and Guaranteed.

Any parcel insured against damage in transit for only 6d. extra per order. All uninsured parcels at customer's risk. Post and Packing 6d. per valve extra. C.W.O. or C.O.D. only. C.O.D. charge 3/- extra. S.A.E. with enquiries.

**3-TRANSISTOR
POCKET RADIO**

WITH MINIATURE LOUDSPEAKER
ABSOLUTELY NO SOLDERING REQUIRED

UNIQUE DESIGN



39/6 Superb appearance. Simple instructions. Built in an evening. No drilling. No soldering. Complete in every detail. Receives entire broadcast band. Aerial required in certain areas. Pocket size 4 1/2 x 2 1/2 x 1 1/2 in.

Or the more powerful **SAVOY 55/6** SUPER 3. 3 transistors and 2 diodes in a 5 stage reflex circuit. Dimensions as above. No aerial required.

ALL PARTS SOLD SEPARATELY

Battery 1/- extra. P. & P. 2/-.

SAVOY ELECTRONICS LTD.

15 Maiden Lane, Strand, London W.C.2.
(Back of Adelphi Theatre)

BBC - ITV - F.M. AERIALS



B.B.C. (BAND 1). Tele-scopic loft, 19/6. External, S/D, 26/3.

I.T.V. (BAND 3). 3 Element loft array, 24/-, 5 Element, 39/6. Wall mounting, 3 Element, 33/6. 5 Element, 41/3.

COMBINED B.B.C. + I.T.V. Loft 1+3 Element, 41/3. 1+5 Element, 49/6. Wall mounting, 1+3 Element, 56/3. 1+5 Element, 63/9. Chimney and mast mounting units also available.

F.M. (BAND 2). Loft "H", 28/-, 3 Element loft, 52/6. S/D loft, 12/6. External S/D, 26/3. State channel when ordering. C.W.O. or C.O.D. P.P. 2/6. Coaxial cable, 8d. yd. Coaxial plugs, 1/3. Send 6d. stamps for illustrated lists.

K.V.A. ELECTRONICS (Dept.P.W.)
3B, Godstone Road, Kenley, Surrey.

**SURPLUS RADIO
SUPPLIES**

2 LAING'S CORNER,
MITCHAM, SURREY
AN INEXPENSIVE
H.T. UNIT

Suitable for working almost any battery set.

WILL SAVE ITS COST IN 9 MONTHS

Circuit & Instructions	1/-
Mains Transformer	5/6
Contact Rectifier	7/6
16+16 Condenser	3/-
2.7 Resistor (2W)	6d.
10k Resistor (2W)	6d.

Postage and packing 1/6.
Send 1/6 for catalogue

**COYNE'S NEW
PIN-POINT TV
TROUBLES**

TAKES HEADACHES OUT OF ALL SERVICING PROBLEMS



Your most useful on-the-job "tool!" Quickly and easily pin-points the exact trouble in any TV set. Covers 70 symptoms, 700 trouble spots. Over 340 cross-indexed pages; 50 time-saving Check-Charts; 290 diagrams and photos; explanation of circuits and designs.

SIMPLE CHECK-CHART SYSTEM SAVES TIME!

This amazingly practical handbook shows you how to find the trouble in any TV circuit FAST! Simple cross-index tells you in what section you'll find cause of trouble. Handy Check-Charts then help you accurately locate the EXACT trouble spot. Cut waste time, eliminate hours of aggravation, get right to the heart of the trouble in minutes.

USE THIS BOOK RIGHT ON THE JOB—NO NEED TO MEMORIZE!

This Pin-Point Book was designed especially for on-the-job trouble-shooting. You simply turn to the indexed section, locate the circuit description and Check-Chart, and in minutes you have the trouble spot located and ready for repair. No complicated theory or mathematics. Down-to-earth practical circuit shooting techniques. Published by the famous Coyne Electrical School and approved by leading authorities in the field.

J. E. C. Grover of Streatham says:
"Immediately I glanced through this book I was convinced that your claims concerning the merits of this work were justified, for it is, without a doubt, the finest book of its kind that I have ever come across. It is not only unique in its presentation but it is also superbly produced."

G. Axam of London S.E.9. says:
"I have spent nearly £50 on technical books over the past 5 years all of which I feel has now been wasted as your book is the best I have yet had the pleasure of examining. It is practical, to the point, with just the right amount of technical information needed, covering almost every aspect of TV servicing."

SEND NO MONEY

Just mail coupon for free trial. After 7 days send only low price or return book and pay nothing!

FREE TRIAL OFFER!

Mail Coupon NOW!

Mail Order Division, SIM-TECH BOOK COMPANY, Dept. A5 Gater's Mill, West End, Southampton, Hants.

RUSH TV Troubles 31/6d. plus 1/9d. postage for 7 day FREE TRIAL as per offer.

Tick here in enclosing full price, we pay postage! Same 7 day money back guarantee

Name _____
Address _____
City _____ County _____



AVO MULTI-METERS

AVO MODEL 7
COMPLETE WITH INSTRUCTIONS
LEADS AND BATTERIES
(List £19.10.0) Reg. Post 5/-
£12.10.0

AVO MODEL 8
COMPLETE WITH LEADS
BATTERIES AND INSTRUCTIONS
(List £24.10.0) Reg. Post 5/-
£17.10.0

BOTH TYPES ARE FULLY GUARANTEED

- ★ Miniature $\frac{1}{2}$ in. diam. x $\frac{1}{4}$ in. edge volume controls and switch; 5k and 10k, 7/6 each; 5k, 7/6; 50k, 8/6; printed circuit.
- ★ Speakers: 3 ohm, 3in. 15/-; 25 ohm, 22/6; 5in., 3 ohm, 15/-; 1/- P.P.
- ★ Ferrite Rod — 1st Grade: 4 x $\frac{1}{2}$ in., 1/6; 5 x $\frac{1}{2}$ in., 1/6; 8 x $\frac{1}{2}$ in., 3/6; 8 x $\frac{3}{4}$ in., 3/6; 4 x $1\frac{1}{2}$ in. slab, 2/-, P.P. 6d.
- ★ 1000 ohm Personal Phone with Leads and Jack Plug and Socket, suitable for most Commercial Transistor Radios. 15/6.
- ★ 9,065 Mc/s 3rd Over-tone Crystal for all 27 Mc/s Model Control Transmitters. 12/6.
- ★ 7 section chromed Telescopic Aerials, 38in. with fixing bracket, 12/6. P.P. 1/6. 64in. Version, 17/6. P.P. 1/6.
- ★ ACOS Crystal Mic inserts, 2in., 12/6; 1 $\frac{1}{2}$ in., 7/6. $\frac{1}{2}$ in. round or square, 3/6. P.P. 6d.
- ★ Submin. Condensers. All low voltage: 0.1, 0.25, 0.5, 1, 2, 4, 6, 8, 10, 16, 25, 30, 50, 100 mfd. All types, 2/- each.
- ★ Standard Miniature: 1, 2, 4, 8, 10, 25, 30, 50, 100, 200, 250, 500 mfd. All types 1/6 each.
- ★ Sub-miniature Jack Plug and Socket, 3/6 complete. P.P. 6d.
- ★ Set of 4 L.F. and Osc. Coils. U.S.A. Sub-miniature type, 21/-.
- ★ 2-Gang 1 inch square Poly Tuner for above, 17/6.
- ★ 1 watt Push-Pull Transformers for OC81's 21/- pair. P.P. 1/-.
- ★ 7 x 4in. 25 ohm Speaker, 22/6; 7 x 4in., or high quality 3 ohm Speaker, 20/-.
- ★ Pocket Iron, 220/250V A.C./D.C. 30 watts, complete with mains plug, case, etc. Handle unscrews to cover element to enable iron to be carried in pocket. Only 18/6. P.P. 1/-.
- ★ 208+176PF '00' tuner, with screw 8/6. P.P. 9d.

TIME SAVER
OFFICE OR HOME TELEPHONE PICK-UP AMPLIFIER

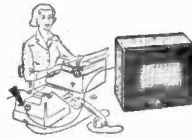

No more "Holding Up" wasting time for your call to come through. When it does the amplifier can be switched off if required. No connections, just Sellotape the pick-up coil to back of phone as above.
3 months' battery life, 400mW output with 5in. Speaker.
BUILT, TESTED, READY TO USE.

Also 'BABY ALARM' £5/10, p.p. 2/6 **£5.10.0** P.P. 2/6

TRANSISTORS

We Stock a Transistor or Component for Every Purpose. Enquiries Welcomed



SEND FOR LATEST PRICE LIST

1st GRADE—FULLY GUARANTEED

- ★ Miniature Light Weight, $\frac{1}{2}$ to 5V, 8mA Relay, 24/-.
- ★ Sub-miniature Presets, 5k, 10k, 50k, 100k, 250k, 500k, 1 meg, 2 meg, 2/- each.
- ★ 2 $\frac{1}{2}$ in. square 3 ohm Speaker, 17/6.
- ★ 2 $\frac{1}{2}$ in. 80 ohm Speaker, excellent quality, 15/6.

COMPLETE SET OF PARTS FOR "P.W." MINI-AMP AS PER NOV. EDITION OF "PRACTICAL WIRELESS" **65/-** P.P. 1/6

★ Suitable Battery Record Player 79/6 P.P. 1/6.

- ★ Quartz Crystals ★ Over 600 types in stock for all purposes — fully guaranteed. Free List on request.
- ★ 600 ohm Personal Car Phone with jack and socket, 10/6, P.P. 9d.
- ★ 208 + 208 + 176PF 3-gang 12/6.
- ★ 1k ohm HI-FI Dynamic Microphone, with lead, etc. 49/6.

- ★ Personal Earphones used with RANGER 2 and 3. British made, 10/6.
- ★ 2 $\frac{1}{2}$ inch round $\frac{1}{2}$ inch deep 3 ohm speaker, 15/-.
- ★ Push-Pull Transformers for OC72s or similar. 3 ohm 9/6 pair.
- ★ Telescopic Car Aerial. Window or Gutter mounting, 32/6.
- ★ Standard Volume Controls, $\frac{1}{2}$ in. dia., 3in. spindle: 5k, 10k, 25k, 50k, 100k, 250k, 500k, 1 meg, 2 meg, 3/6, less switch; 4/6 with switch.
- ★ Low impedance Magnetic mikes $\frac{1}{2}$ x $\frac{1}{2}$ x $\frac{1}{2}$ in.; $\frac{1}{2}$ in. dia. x $\frac{1}{2}$ in. deep; 1 $\frac{1}{2}$ in. dia. x 1 in. deep round; $\frac{3}{4}$ x $\frac{3}{4}$ x $\frac{1}{2}$ in. Ideal for amplifiers, H. Aids, 15/- each.
- ★ 5in. 25 ohm Speaker, 25/-.
- ★ Transistor Holders, 9d. each, 8/- dozen.

POCKET TESTER MODEL 200H



Volt-Ohm-Milliameter. ★ Size $\frac{1}{2}$ x $\frac{3}{4}$ x $\frac{1}{2}$ in. Over 20 Stars.

20,000 Ohms/Volt!

Price, inclusive of Test Prods, Battery and Instructions **£6.19.6** P.P. 1/6

Top Quality Meter — Fully Guaranteed.



CRYSTAL LAPEL MICROPHONE
Ideal for portable tape recording, etc. 18/6. P.P. 1/-.

6 Mullard Transistors and Diode
1—OC44 ONLY
2—OC45
1—OC71
2—OC72
1—OAB1 PER SET
50/-
Other MATCHED SETS IN STOCK SEND FOR LIST

CRYSTAL MICROPHONES

- ★ Fully Guaranteed ACOS 39-1. Stick Microphone with screened cable and stand (list 5 gns.), 39/6, P.P. 1/6.
- ★ ACOS 40 Desk Microphone with screened cable and built-in stand (list 50/-), 19/6, P.P. 1/6.
- ★ ACOS 45 Hand Microphone with screened lead, very sensitive, 29/6, P.P. 1/6.
- ★ 100 C Stick Microphone with muting switch and screened cable, detachable desk, stand, etc. 39/6, P.P. 1/6.



MERCURY BATTERIES

1.3V, 2200mA/H, $\frac{5}{8}$ x 1 in. dia., 2/6; 1.3V, 5000mA/H, 2 x $\frac{1}{2}$ in. dia., 2/6; 1.3V, 500mA/H, $\frac{5}{8}$ x $\frac{1}{2}$ in. dia., 1/3; 1.3V, 14000mA/H, 2 $\frac{1}{2}$ x 1 $\frac{1}{2}$ in. dia., 5/-.

PRACTICAL TRANSISTOR CIRCUITS 3/6

Post Free. Contains 40 easy to follow plans of all transistor units, including lightoperated switches, amplifiers, transmitters, receivers, test oscillators, signal tracers, hearing aids, radio control, etc. All parts available separately. **EXTENSION SPEAKER UNIT** for use with any Transistor **57/6**
Big set volume from the smallest radio.

- ★ Lightweight 4000 ohm Headphones, 12/6.
- ★ 2 $\frac{1}{2}$ in. square High Performance 8/10 ohm Speaker, 16/6.
- ★ Driver and Output Transformer (matched to 8/10 ohms), 12/6 pair.
- ★ Telephone Pick-up Coil with Cable. Rubber Sucker to back of phone. Ideal for recording, 14/-.
- ★ 4.7 volt 1 watt Zener Diode, 15/- each.
- ★ 2 $\frac{1}{2}$ in. 10 ohm Speaker, 15/6.
- ★ 3-Section Telescopic Car Radio Aerial. One hole fixing. Complete with lead and plug, 19/6. P. & P. 1/6.
- ★ Diodes: OA5, 6/-; GD3, 2/-; OA79, 3/-; OA70, 3/-; OA91, 3/6; OAB1, 3/-; OA85, 3/-; OA10, 8/-; G17M, 4/-.

VALVES

WE STOCK OVER 800 TYPES OF VALVES AND TUBES AT REALLY COMPETITIVE PRICES. Free List on Request

Henry's Radio Ltd

5 HARROW ROAD - LONDON W.2
SEND 6d. STAMP for Latest Catalogues.

Opposite Edgware Road Tube Station
OPEN MON. to SAT. 9-6, THURS. 1 o'clock
Telephone: PADdington 1008/9.

SEE BACK PAGE

OUR SPECIALITIES
Transistors, Valves, Quartz, Crystals, Components at Competitive Prices. Let us quote for your circuit.

Practical Wireless

BLUEPRINT

SERVICE

ALL OF these blueprints are drawn full-size and although the issues containing descriptions of these sets are now out of print, constructional details are available free with each blueprint except for the PW Monophonic Electronic Organ and the PW Roadfarer.

The Index letters which precede the Blueprint Number indicate the periodical in which the description appeared. Thus PW refers to PRACTICAL WIRELESS; AW to *Amateur Wireless* and WM to *Wireless Magazine*.

Send (preferably) a postal order to cover the cost of the Blueprint (stamps over 6d. unacceptable) to

PRACTICAL WIRELESS, Blueprint Dept., George Newnes, Ltd., Tower House, Southampton Street, London, W.C.2

SPECIAL NOTE

THE following blueprints include some pre-war designs and are kept in circulation for those constructors who wish to make use of old components which they may have in their spares box. The majority of the components for these receivers are no longer stocked by retailers.

Title	Number	Price
-------	--------	-------

CRYSTAL SETS

Junior Crystal Set	PW94	2/-
Dual-wave Crystal Diode	PW95	2/6

STRAIGHT SETS

Battery Operated

Modern One-valver	PW96	2/6
All-dry Three	PW97	3/6
Modern Two-valver	PW98	3/6

SUPERHETS

A.C. Band-pass Three	PW99	4/-
A.C. Coronet-4	PW100	4/-
A.C./D.C. Coronet	PW101	4/-
The PW Pocket Superhet	—	5/-

MISCELLANEOUS

The PW 3-speed Autogram	—	8/-
The PW Monophonic Electronic Organ	—	8/-
<i>(No constructional details are available with this blueprint)</i>		
The PW Roadfarer	—	5/-
<i>(No constructional details are available with this blueprint)</i>		

TELEVISION

The PT Band III converter	—	1/6
-----------------------------------	---	-----

Title	Number	Price
A.C. Fury Four	PW20	2/6
Experimenter's Short Wave	PW30a	2/6
Midget Short Wave Two	PW38a	2/6
Band-Spread Three (Battery)	PW68	2/6
Crystal Receiver	PW71	2/-
Signet Two (Battery)	PW76	2/6
Simple S.W. One-valver	PW88	2/6
Pyramid One-valver	PW93	2/6

BBC Special One-valver	AW387	2/6
Short-Wave Two	AW429	2/6
Short-Wave World Beater	AW436	3/6

Standard Four Valve S.W.	WM383	3/6
Enthusiast's Power Amplifier	WM387	3/6
Standard Four Valve	WM391	3/6
Listener's 5-Watt Amplifier	WM392	3/6

QUERY COUPON

This coupon is available until 7th December, 1961, and must accompany all queries in accordance with the notice on our "Letters to the Editor" page.

PRACTICAL WIRELESS, DECEMBER, 1961

REMEMBER!

All our Units are covered by After Sales Service and Guarantee
 ● Only New Components are Supplied ● No Technical Knowledge Required ●



Size $8\frac{1}{2} \times 6\frac{1}{2} \times 3\frac{1}{2}$ in.
 ● Full coverage on Medium and Long wavebands. Excellent quality with full station separation. Car aerial socket.

"TRANSFIVE" PORTABLE MEDIUM AND LONG WAVE PORTABLE RADIO

- 325 mW Push-Pull Output on 5-inch Speaker.
- Pictorial Building Plans.
- Easy to Build Printed Circuit.
- 5 Carded Components.
- Mullard Transistors.

AFTER SALES SERVICE and FULLY GUARANTEED

TOTAL COST OF ALL PARTS
£6.19.6 P.P. 2/6
 NO EXTRAS TO BUY

"QUINTET" MEDIUM AND LONG WAVE POCKET LOUDSPEAKER RADIO

- 250mW Push-Pull Output.
- Plainly marked Printed Circuit Board and Carded Components.
- 5 Mullard Transistors.
- Illustrated Plans.

A new printed circuit design fully tunable on both wavebands. Guaranteed reception of Continental and local stations including Luxembourg, anywhere with full station separation. Fitted Car Aerial and Earpiece Sockets.



Size $5\frac{1}{2} \times 3 \times 1\frac{1}{2}$ in.

TOTAL COST OF ALL PARTS
£5.10.0 P.P. 2/-
 NO EXTRAS TO BUY

VERY EASY TO BUILD AND USE.
 After Sales Service and Guarantee
 All Parts Sold Separately

● BUILDING PLANS & PRICES FREE ON REQUEST ●

● Illustrated Instructions FREE ON REQUEST ●

★ **RANGER 3** ★
 NO EXTERNAL AERIAL OR EARTH—3-TRANSISTOR and 2 DIODES

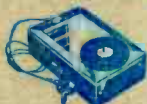

Size $4\frac{1}{2} \times 3 \times 1\frac{1}{2}$ in.

All Components
79/6 P.P. 1/6

Everything Supplied

Personal Pocket Radio with 5 stages giving clear reception on medium wave, amateur top band and shipping.

- Easy to follow instructions with pictorial layout.
- Reception of Radio Luxembourg guaranteed (most areas)

Free Instructions and Price List on request.

★ **1 WATT 4 TRANSISTOR AMPLIFIER** ★

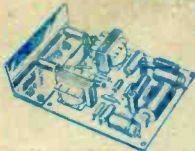

- 1 watt peak output.

± 3 db 70c/s to 12 kc/s.

Output to 3 ohm speaker
 9 volt operated.

Details on request

Built and Tested

69/6 P. & P. 1/6

A printed circuit high gain amplifier size $4 \times 2\frac{1}{2} \times \frac{1}{2}$ in. using Mullard OC71/OC81D and 2-OC81 Transistors. Ideal for Intercomm., Record Player, Tuner Amplifier or any application requiring a quality and reliable amplifier.

★ **3-TRANSISTOR AND DIODE PERSONAL POCKET RADIO** ★



ALL PARTS
37/6 P.P. 1/6

Quality Output on Personal Earphone
 A simple to build local station with personal earphone output. Built-in Ferrite Aerial and Battery lasting 9 months.
 Size $4\frac{1}{2} \times 3 \times 1\frac{1}{2}$ in.

● **CONTESSA** ●

6 TRANSISTOR MEDIUM AND LONG WAVE SUPERHET



COMBINED PORTABLE AND CAR RADIO

- High "Q" Internal Ferrite Aerial.
- Car Radio Adaptation and AVC.
- "Hi-Fi" Quality Speaker.
- Slow Motion Fingertip Tuning with Station names clearly marked.
- 425mW Push-Pull Output.
- 6 "Top-Grade" Ediswan Transistors.
- New Type Printed Circuit with all components marked.
- Full Medium and Long Wave Tuning.

TOTAL COST OF ALL PARTS
\$10.19.6 P.P. 3/6
 ● NO EXTRAS TO BUY ●

● Attractive Rexine Covered Cabinet Red/White or Blue/White, $10 \times 7\frac{1}{2} \times 3\frac{1}{2}$ in.

UNBEATABLE IN PERFORMANCE AND APPEARANCE

1 WATT TRANSISTOR AMPLIFIER

- EMI 4-Transistor Amplifier with speaker, tone and volume controls. Ready assembled for use with crystal pick-ups. $7\frac{1}{2}$ to 9 volt operated. 89/6 P.P. 1/6.

BATTERY RECORD PLAYER
 ● 6— $7\frac{1}{2}$ volt Garrard Turntable with crystal pickup. Plays 45 r.p.m. Ideal for above amplifier. 79/6 P.P. 1/6.

★ **RANGER 2** ★



All Parts
59/6
 P.P. 1/6

PERSONAL POCKET RADIO

- Two Transistor Two Diode fully tunable over medium waves. Good reception of Radio Luxembourg. Size $4\frac{1}{2} \times 3 \times 1\frac{1}{2}$ in. No extras to buy.
- PICTORIAL PLANS AND DETAILS FREE ON REQUEST

Transistor 2-Way Intercomm

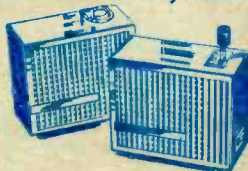

10 gns.

Unit Sizes $3\frac{1}{2} \times 1\frac{1}{2} \times 3\frac{1}{2}$ in. (Approx.)

- Internal Buzzing System.
 - Push-Pull Speaker Output.
 - Long Life Battery.
- Supplied complete with Battery, 60ft. Wire in Presentation box. Guaranteed and ready to use.

TRANSISTOR PORTABLE TAPE RECORDER

Size $6 \times 8\frac{1}{2} \times 2\frac{1}{2}$ in.



● Quality Reproduction

SUPPLIED COMPLETE WITH MICROPHONE, BATTERIES, PERSONAL PHONE AND TAPE.

● Built-in Speaker. 12 Gns.
 ● Play/Record, FULLY GUARANTEED

PLEASE

TURN PAGE

Henry's Radio Ltd 5 HARROW ROAD, LONDON W2

Opposite Edgware Road Tube Station, PADdington 1008/9.
 Open Monday to Saturday, 9-6, Thursday 1 o'clock.
 SEND 6d. STAMP FOR DETAILS & PRICES OF COMPLETE RANGE.