

OCTOBER  
1961

# Practical <sup>2</sup>/<sub>1</sub> WIRELESS

**FREE**  
INSIDE

The "TUTOR"  
**BLUEPRINT**  
4 EASY TO BUILD  
**RECEIVERS**

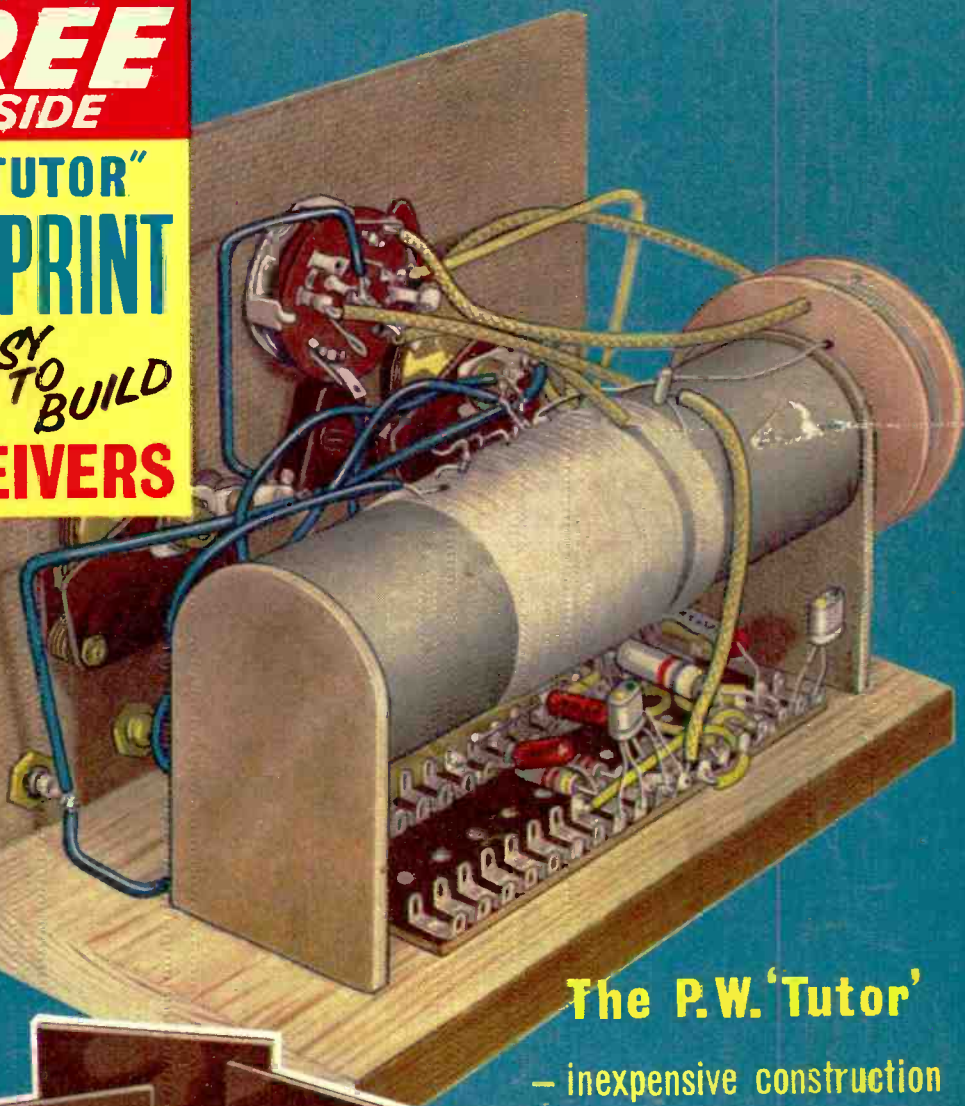

## The P.W. 'Tutor'

- inexpensive construction
- readily available parts
- L.W. and M.W. reception





# Stentorian

**Outstanding Success at the Radio Show**

This range of Stentorian loudspeakers, incorporating the patented cambric cone, was developed to provide reproduction that takes full advantage of the television and V.H.F. sound transmissions and high fidelity recordings now available. The cone of the loudspeaker is made from uncured cambric and bonded pulp, the whole being completely cured together and made into one composite cone.



Type	Flux Density	Price	Type	Flux Density	Price
8" H.F.816*	16,000 gauss	£7.0.9	T.816	16,000 gauss	£6.13.3
8" H.F.812*	12,000 gauss	£4.5.0	T.12 tweeter	16,000 gauss	£13.4.6
8" H.F.810	10,000 gauss	£3.3.6	T.10 tweeter	14,000 gauss	£4.8.3
6" H.F.610	10,000 gauss	£2.12.9 Steel £2.15.0 diecast	T.359 tweeter	9,000 gauss	£1.15.9

**MODEL H.F. 1016**

10" Unit H.F. 1016. 16,000 gauss. Instantaneous matching at 3, 7.5 and 15 ohms. Handling capacity 10 watts. Frequency response 30 c.p.s. to 15,000 c.p.s. Bass resonance, 35 c.p.s.

**Price £8.4.0 (inc. P.T.)**

\* Incorporates a universal impedance speech coil.

**WHITLEY ELECTRICAL RADIO CO. LTD. MANSFIELD, NOTTS**

Telephone: MANSFIELD 1762-5

London Office: 109 Kingsway, London, W.C.2

WA3

## JACKSON

the big name in **PRECISION** components

Precision built radio components are an important contribution to the radio and communications industry.

Be sure of the best and buy Jackson Precision Built Components.

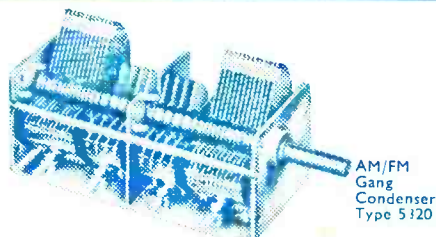

AM/FM Gang Condenser Type 5120

**JACKSON BROS. (LONDON) LTD.**

KINGSWAY-WADDON, SURREY

Phone: Croydon 2754-5 Grams: Walfico, Souphone, London

## SPECIAL FOR THE "HAMS" RADIO STATION

*Illustrated*

¼ inch detachable bit soldering instrument  
**List No. 70**

Combined Protective Unit with Wiper Abrasion Pad and Solder Reel  
**List No. 700**

Apply **SALES & SERVICE**

**ADCOLA**  
(Regd. Trade Mark)

**GAUDEN ROAD  
CLAPHAM HIGH ST.  
LONDON, S.W.4**

Telephones: MACaulay 3272-3101

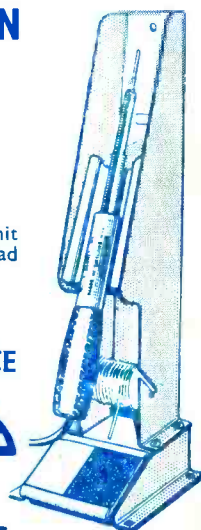

British & Foreign Patents, Registered Designs, etc.

Telegrams: "SOLJOINT. LONDON"

Tel: Mitcham 6201  
Open Daily to Callers

# R S T

All Valves Brand New  
and Fully Guaranteed

211 STREATHAM ROAD, MITCHAM, SURREY

Special 24 Hour Express Mail Order Service

OZ4	5/9	6CH6	12/-	10C2	27/10	32	13/6	CCH35	21/-	ECL83	12/6	H23DD	PEN44	17/6	U282	22/-	
IA5	6/-	6E5GT	10/-	10F1	26/2	35A5	15/6	CL4	12/6	EF9	21/-	10/6	PEN84	17/6	U301	22/6	
IA7	14/6	6F1	15/6	10F3	17/6	35L6GT	10/6	CL33	18/6	EF22	17/6	HL41	12/6	PEN4DD	U329	17/6	
ID5	14/-	6F6	6/9	10F9	12/6	35W4	8/-	CY1	15/9	EF36	7/6	HL41DD	22/6	PL33	18/6	U339	19/-
ID6	10/-	6F12	4/-	10LD3	12/6	35Z4	7/6	CY31	15/9	EF37	8/6	13/6	PL38	23/9	U403	11/6	
IH5	10/6	6F13	17/6	10LD11	15/-	35Z5	9/6	D41	12/6	EF37A	8/6	HL42DD	PL81	14/9	U404	10/-	
IL4	6/-	6F14	17/6	10P13	21/-	40SUA	15/-	D42	12/6	EF39	4/-	IW90	PL82	8/-	U409	29/-	
ILNS	4/6	6F15	14/9	10P14	20/-	41STH	23/6	D63	3/6	EF40	15/-	13/6	PL83	10/6	U420	15/6	
INS	10/6	6F17	12/-	11D3	17/6	42	15/-	D77	5/6	EF41	9/3	IW4/350	PL83	10/6	U420	15/6	
IR5	9/-	6F33	5/6	11D5	17/6	43	15/-	D152	6/-	EF42	10/6	IW4/500	PL82	8/-	U420	15/6	
IS4	8/6	6H6	2/6	12A6	6/6	50C5	15/-	DAC32	10/6	EF50(E)	3/6	KBC32	PL83	10/6	U420	15/6	
ISS	9/-	6J5GT	4/6	12AH3	10/-	50CD6G		DAF91	7/6	EF50(A)	4/-	KF35	PL82	8/-	U420	15/6	
IT4	4/-	6J7GT	9/6	12AT6	9/-	50L6GT	32/-	DF33	10/6	EF80	5/-	KLL32	PL83	10/6	U420	15/6	
IU5	10/-	6K7G	3/-	12AT7	6/-	61B1	17/6	DF91	4/-	EF85	5/6	KL35	PL82	8/-	U420	15/6	
2D21	8/6	6K8GT	10/6	12AX7	9/6	61SPT	17/6	DF92	7/-	EF86	11/-	KL35	PL82	8/-	U420	15/6	
2X2	5/-	6K8GT	12/6	12BA6	9/6	75	12/6	DF96	9/6	EF89	10/-	KT2	PM24M	13/6	U3850	5/6	
3D6	14/6	6K25	19/6	12BE6	9/6	77	12/6	DF97	9/6	EF91	4/-	KT32	PM24M	21/6	U3F89	7/6	
3Q4	8/-	6L1	7/6	12E1	17/6	77	12/6	DF97	9/6	EF91	4/-	KT32	PM202	16/-	UCC85	10/-	
3Q5	10/6	6L18	12/6	12J7GT	9/6	80	10/-	DF97	9/6	EF92	5/-	KT33C	PM202	16/-	UCC82	8/6	
3S4	8/-	6L19	21/-	12K8GT	12/6	85A2	12/6	DF97	9/6	EF92	5/-	KT33C	PM202	16/-	UCC81	8/6	
3V4	9/-	6L34	10/-	12Q7GT	8/6	150B2	12/6	DF97	9/6	EF92	5/-	KT33C	PM202	16/-	UCC82	8/6	
5U4G	4/6	6D30	10/6	12SC7	8/-	150B3	15/-	DF97	9/6	EF92	5/-	KT33C	PM202	16/-	UCC83	13/6	
5V4	8/-	6LD20	15/6	12SG7	8/-	185BT	32/-	DF97	9/6	EF92	5/-	KT33C	PM202	16/-	UCC82	8/6	
5Y3GT	8/6	6N7GT	7/6	12SJ7	4/-	304	7/6	DF97	9/6	EF92	5/-	KT33C	PM202	16/-	UCC82	8/6	
5Z3	10/-	6M1	10/6	12SK7	8/-	305	7/6	DF97	9/6	EF92	5/-	KT33C	PM202	16/-	UCC82	8/6	
5Z4G	10/-	6M2	10/6	12SQ7	11/6	328	7/6	DF97	9/6	EF92	5/-	KT33C	PM202	16/-	UCC82	8/6	
6A7	18/6	6P1	17/6	12SN7	17/6	329	7/6	DF97	9/6	EF92	5/-	KT33C	PM202	16/-	UCC82	8/6	
6A8	10/-	6P25	19/6	12Z3	15/-	807	7/6	DF97	9/6	EF92	5/-	KT33C	PM202	16/-	UCC82	8/6	
6A8B	9/-	6P28	26/-	13D3	12/6	955	4/-	DF97	9/6	EF92	5/-	KT33C	PM202	16/-	UCC82	8/6	
6A8B	9/6	6Q7GT	10/6	14H7	12/6	5763	17/6	DF97	9/6	EF92	5/-	KT33C	PM202	16/-	UCC82	8/6	
6AK5	8/-	6SA7GT	7/6	14R7	12/6	9002	7/6	DF97	9/6	EF92	5/-	KT33C	PM202	16/-	UCC82	8/6	
6AK8	7/6	6S7G	7/6	14S7	21/-	9003	7/6	DF97	9/6	EF92	5/-	KT33C	PM202	16/-	UCC82	8/6	
6AL5	6/-	6SH7	6/6	15A2	17/6	AC4/PEN	25/-	DF97	9/6	EF92	5/-	KT33C	PM202	16/-	UCC82	8/6	
6AM5	5/-	6S17	5/6	15D2	23/9	AC5/PEN	25/-	DF97	9/6	EF92	5/-	KT33C	PM202	16/-	UCC82	8/6	
6AM6	4/-	6SK7	7/6	19AQ5	10/6	AC5/PEN	25/-	DF97	9/6	EF92	5/-	KT33C	PM202	16/-	UCC82	8/6	
6AN5	7/6	6SL7GT	5/6	19B6GG		AC5/PEN	25/-	DF97	9/6	EF92	5/-	KT33C	PM202	16/-	UCC82	8/6	
6AQ5	8/3	6SN7GT	5/6	24A4	AC6	21/6		DF97	9/6	EF92	5/-	KT33C	PM202	16/-	UCC82	8/6	
6AQ8	9/3	6U4GT	11/6	20D1	12/6	ACTP	32/-	DF97	9/6	EF92	5/-	KT33C	PM202	16/-	UCC82	8/6	
6AT6	8/3	6U5	7/6	20D2	23/-	ACHL	12/6	DF97	9/6	EF92	5/-	KT33C	PM202	16/-	UCC82	8/6	
6AU6	10/-	6U7	7/6	20F2	26/6	AC/PEN		DF97	9/6	EF92	5/-	KT33C	PM202	16/-	UCC82	8/6	
6B7	10/-	6V6G	5/-	20L1	26/6	AC/PEN		DF97	9/6	EF92	5/-	KT33C	PM202	16/-	UCC82	8/6	
6B8	4/-	6V6GT	8/-	20P1	26/-	ACTH1	34/9	DF97	9/6	EF92	5/-	KT33C	PM202	16/-	UCC82	8/6	
6BA6	7/6	6X4	5/-	20P3	23/-	ACVP1	17/6	DF97	9/6	EF92	5/-	KT33C	PM202	16/-	UCC82	8/6	
6BE6	7/6	6X5GT	5/-	20P5	22/6	ACVP2	17/6	DF97	9/6	EF92	5/-	KT33C	PM202	16/-	UCC82	8/6	
6BG6G	21/-	7B7	8/-	25L6GT	9/6	AC2/PEN	21/-	DF97	9/6	EF92	5/-	KT33C	PM202	16/-	UCC82	8/6	
6B16	7/6	7C5	8/-	25Y5	10/-	AC2		DF97	9/6	EF92	5/-	KT33C	PM202	16/-	UCC82	8/6	
6BW6	7/-	7C6	8/-	25Z4	9/6	AC2		DF97	9/6	EF92	5/-	KT33C	PM202	16/-	UCC82	8/6	
6BW7	5/-	7D5	15/-	25Z5	9/6	PENDD21/-		DF97	9/6	EF92	5/-	KT33C	PM202	16/-	UCC82	8/6	
6BX6	6/-	7D6	15/-	25Z6	10/6	AC2		DF97	9/6	EF92	5/-	KT33C	PM202	16/-	UCC82	8/6	
6BY7	5/6	7D8	15/-	27SU	17/6	AZ31	10/6	DF97	9/6	EF92	5/-	KT33C	PM202	16/-	UCC82	8/6	
6C4	6/6	7H7	8/-	30	13/6	B36	21/-	DF97	9/6	EF92	5/-	KT33C	PM202	16/-	UCC82	8/6	
6CSGT	8/-	7K7	10/6	30C1	12/6	B65	8/6	DF97	9/6	EF92	5/-	KT33C	PM202	16/-	UCC82	8/6	
6C5	6/6	7Q7	11/6	30F5	11/6	B152	8/6	DF97	9/6	EF92	5/-	KT33C	PM202	16/-	UCC82	8/6	
6C9	12/6	7R7	12/-	30FL1	10/6	B309	9/6	DF97	9/6	EF92	5/-	KT33C	PM202	16/-	UCC82	8/6	
6C10	12/6	7S7	10/6	30L1	11/6	B329	9/6	DF97	9/6	EF92	5/-	KT33C	PM202	16/-	UCC82	8/6	
6CD6G	27/6	7Y4	7/6	30P1	22/-	B339	9/6	DF97	9/6	EF92	5/-	KT33C	PM202	16/-	UCC82	8/6	
6D1	8/-	8D3	4/-	30P12	11/6	B719	9/6	DF97	9/6	EF92	5/-	KT33C	PM202	16/-	UCC82	8/6	
6D2	5/-	9BW6	14/9	30P16	10/-	CBL1	17/6	DF97	9/6	EF92	5/-	KT33C	PM202	16/-	UCC82	8/6	
6D3	15/-	10C1	18/-	30P11	15/-	CBL31	21/-	DF97	9/6	EF92	5/-	KT33C	PM202	16/-	UCC82	8/6	

METAL RECTIFIERS

RM1	6/-	18RA 1-1-8-1	4/6	16RE 2-1-8-1	8/6
RM2	8/-	18RA 1-1-16-1	6/6	18RA 1-2-8-1	11/-
RM3	9/-	16RA 1-1-16-1	8/6	14A86	17/-
RM4	16/6	14RA 1-2-8-2	18/-	14A97	23/6
RMS	22/-	14RA 1-2-8-2	21/-	14A100	24/-

SPECIAL OFFER

IT4 4/-, 5U4G 4/6, 6K7G 3/-, 6K8 8/-,  
6V6G 5/-, 6X4 4/6, EBC33 4/-, EF39 4/-,  
EF80 5/-, EF85 5/6, EF91 4/-, EL84 7/-,

TERMS OF BUSINESS C.W.O. or C.O.D.  
2/9 PACKING CHARGE ON ALL C.O.D.  
ORDERS. POSTAGE 3d. PER VALVE

OBsolete VALVES A SPECIALITY.  
QUOTATIONS GIVEN ON ANY TYPE  
NOT LISTED

## R.S.C. HI-FI TAPE RECORDER KIT

**REALISM AT INCREDIBLY LOW COST, CAN BE ASSEMBLED IN HALF AN HOUR**  
 The Recorder Incorporates the Latest Collaro Studio Tape Transcriber. The Linear LT45X High Quality Tape Amplifier listed at 12.00 High Flux P.M. Speaker listed 30/-, empty Tape Spool, a Reel of Quality Tape Amplifier listed at 12.00. High Flux P.M. Speaker listed 30/-, empty Tape Spool, a Reel of Best quality Tape listed 22/8, and a Handsome Portable carrying Cabinet with latest attractive two-tone polychrome finish, size 18 x 13 x 9 in. high, listed 44.10.0, and circuit. Total cost if purchased individually approximately 240. Performance equal to units in the 260-280 class. S.A.E. for leaflet.

## HIGH FIDELITY 12-14 WATT AMPLIFIER TYPE A11

**PUSH-PULL ULTRA LINEAR  
 OUTPUT "BUILT-IN" TONE  
 CONTROL PRE-AMP STAGES**

Two input sockets with associated controls allow mixing of "mike" and gram, as in A10. High sensitivity. Includes 5 valves, ECC83, ECC83, EL84, EL84, 5Y3. High Quality sectionally wound output transformer specially designed for Ultra Linear operation, and reliable small condensers of current manufacture. **INDIVIDUAL CONTROLS FOR BASS AND TREBLE**, "Lift" and "Cut". Frequency response  $\pm$  3 D.B. 30-30,000 c/s. Six negative feedback loops. Hum level 80 D.B. down. **ONLY 23 millivolts INPUT** required for **FULL OUTPUT**. Suitable for use with all makes and types of pick-ups and microphones. Comparable with the very best designs. For **STANDARD or LONG PLAYING RECORDS** For **MUSICAL INSTRUMENTS** such as **STRING BASS, GUITARS, etc.** **OUTPUT SOCKET** with plug provides 300 v. 30 mA. and 6.3 v. 1.5 a. For supply of a **RADIO FEEDER UNIT**. Size approx. 12-9-7in. For A.C. mains 200-250 v. 50 c.p.s. Output for 3 and 15 ohms speakers. Kit is complete to last nut. Chassis is fully punched. Full instructions and point-to-point wiring diagrams supplied. **Only 8 Gns.** Carr. 10/-

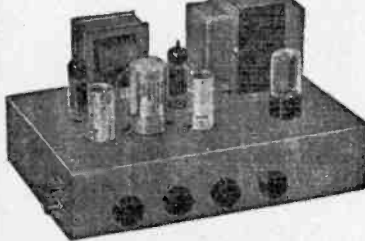

If required louvred metal cover with 2 carrying handles can be supplied for 18/9. **TERMS ON ASSEMBLED UNITS. DEPOSIT 24/9, and 3 monthly payments of 24/9** Send S.A.E. for illustrated leaflet detailing Ready-to-assemble Cabinets, Speakers, Microphones, etc., with cash and credit terms.

## R.S.C. STEREO/TEN HIGH QUALITY AMPLIFIER

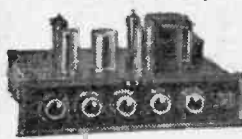

A complete set of parts for the construction of a stereophonic amplifier giving 6 watts high quality output on each channel (total 10 watts). Sensitivity is 50 millivolts suitable for all crystal stereo heads. Gained for Bass and Treble Controls give equal variation of "lift" and "cut". Provision is made for use as straight (monaural) 10 watt amplifier. Valve line-up ECC83, ECC83, EL84, EZ81. Outputs for 2-3 ohm speakers. Point-to-Point wiring diagrams and instructions supplied. Send S.A.E. for leaflet. **8 Gns.** Carr. 10/- Full constructional details and price list 2/6.



**25 1/2 GNS.**  
 Carr. 17/6

**H.F. TERMS. Deposit 25.7.6 and 12 monthly payments of 2 gns. Cash price if settled in 3 months.**

**TELEVISION RECTIFIERS 250 v. 20 mA.** small size. Only 6/8 each.  
**COLLARO CONQUEST 1-SPEED AUTO-CHANGER**, with high fidelity Studio pick-up. Latest model. For 200-250 v. 50 c.p.s. A.C. mains. Our price 22.19.6. Carr. 5/6.

**COLLARO RC 47 4 SPEED MIXER AUTO-CHANGERS**. Turnover Studio Pick-up change, for 200-250 v. A.C. 27.19.6. Carr. 4/6.

**THE SKYFOUR T.R.F. RECEIVER**  
 A design of a 3-valve long and Medium wave 200-250 v. A.C. Mains receiver with selenium rectifier. High gain H.F. stage and low distortion detector. Valve line-up 6K7, 5F6L, 6V6G. Selectivity and quality excellent. Simple to construct. Point-to-Point wiring diagrams, instructions and parts list, 1/6. maximum building costs 24.19.6, inc. attractive Walnut veneered wood cabinet 12 x 6 1/2 x 5 1/2 in.

**GL3A MINIATURE 2-3 WATT GRAM AMPLIFIER**. For use with any single or auto-change unit. Output for 2-3 ohm speaker. For 200-250 v. A.C. mains. Size 1 1/2 x 2 1/2 x 2 1/2 in. Controls: Vol. and Tone with switch. Only 59/6.

## R.S.C. BATTERY CHARGING EQUIPMENT

All for A.C. Mains 200-250v., 50 cca. Guaranteed 12 months.

**HEAVY DUTY CHARGER KIT**  
 6/12 v. 6 amps. variable output. Consisting of Mains Transformer 0-200-230-250 v.; F.W. (Bridge) Selenium Rectifier; Ammeter. Variable Charge Rate Selector Panels. Plugs. Fuses. Fuseholder and circuit. 59/6. Carr. 4/6.



**Assembled 6 v. or 12 v. 4 amps.**

Fitted Ammeter and variable charge rate selector. Also selector plug for 6 v. or 12 v. charging. Louvred steel case with stoved blue hammer finished. Fused 69/6 and ready for use with Carr. 5/- mains and output leads. Terms: Deposit 13/3 and 5 monthly payments 13/3.

**ASSEMBLED CHARGER 6 v. or 12 v. 2 amps.**

Fitted Ammeter and selector plug for 6 v. or 12 v. Louvred metal case finished attractive blue. Ready for use with mains and output leads. Double Fused. **Only 49/9** Carr. 3/9.

**BATTERY CHARGER KITS**  
 Consisting of Mains Transformer, F.W. Bridge, Metal Rectifier, well ventilated steel case. Fuses, Fuse-holders, Grommets, panels and circuit. Carr. 3/6 extra.  
 6v. or 12 v. 1 amp. .... 24/9  
 As above, with Ammeter ..... 32/9  
 6 v. 2 amps. .... 25/9  
 6 v. or 12 v. 2 amps. .... 31/6  
 6 v. or 12 v. 2 amps. inclusive of Ammeter ..... 42/9  
 6v. or 12 v. 4amps. .... 53/6  
 6 v. or 12 v. 4 amps. with Ammeter and variable charge rate selector ..... 59/9  
**CHARGE RATE AMMETERS**, 0-1.5 a., 0-3 a., 0-4 a., 0-7 a., 0-25 a., 0-80 a. 8/9.

**DEAF AID EARPIECES.** Low Impedance with lead. 8/9. High Impedance Crystal 8/9.

**MICROPHONE INSERTS.** Crystal type 8/9.

## R.S.C. MAINS TRANSFORMERS (FULLY GUARANTEED)

Interleaved and Impregnated. Primaries 200-230-250 v. 50 c/s. Screened **TOP SHROUDED DROP THROUGH**  
 250-0-250 v. 70 mA. 6.3 v. 2 a., 5 v. 2 a. 17/9  
 350-0-350 v. 80 mA. 6.3 v. 2 a., 5 v. 2 a. 18/9  
 250-0-250 v. 100 mA. 6.3 v. 2 a., 5 v. 2 a. 19/9  
 250-0-250 v. 100 mA. 6.3 v. 3.5 a., C.T. 19/9  
 250-0-250 v. 100 mA. 6.3 v. 4 a., 5 v. 3 a. 25/9  
 300-0-300 v. 130 mA. 6.3 v. 4 a., 6.3 v. 1 a. for Mullard 510 Amplifier ... 29/9  
 300-0-300 v. 100 mA. 6.3 v. 4 a., 5 v. 3 a. 25/9  
 350-0-350 v. 100 mA. 6.3 v. 4 a., 5 v. 3 a. 25/9  
 350-0-350 v. 100 mA. 6.3 v. 4 v. 4 a., C.T. 0-4-5 v. 3 a. .... 26/9  
 350-0-350 v. 150 mA. 6.3 v. 4 a., 5 v. 3 a. 29/9  
**FULLY SHROUDED UPRIGHT**  
 250-250 v. 60 mA. 6.3 v. 2 a., 5 v. 2 a. Midget type 24-33in. .... 17/11  
 250-0-250 v. 100 mA. 6.3 v. 4 a., 5 v. 3 a. 27/9  
 300-0-300 v. 100 mA. 6.3 v. 4 a., 5 v. 3 a. 27/9  
 350-0-350 v. 100 mA. 6.3 v. 4 a., 5 v. 3 a. 27/9  
 350-0-350 v. 150 mA. 6.3 v. 4 a., 5 v. 3 a. 35/9  
 425-0-425 v. 200 mA. 6.3 v. 4 a., C.T. 6.3 v. 4 a., C.T., 5 v. 3 a. .... 49/9

**FILAMENT TRANSFORMERS**  
 All with 200-250 v. 50 c/s. primaries 6.3 v. 1.5 a. 5/9; 6.3 v. 2 a. 7/9; 0-4-6.3 v. 2 a. 7/9; 12 v. 1 a. 7/11; 6.3 v. 3 a. 8/11; 6.3 v. 6 a. 17/8; 12 v. 1.5 a. twice 17/8.  
**OUTPUT TRANSFORMERS**  
 Midget Battery Pentode 68:1 for 3S4, etc. .... 3/9  
 Small Pentode, 5000 $\Omega$  to 3 $\Omega$  ... 3/9  
 Small Pentode 78,000 $\Omega$  to 3 $\Omega$  ... 3/9  
 Standard Pentode 5,000 $\Omega$  to 3 $\Omega$  ... 5/9  
 Standard Pentode 78,000 $\Omega$  to 3 $\Omega$  ... 5/9  
 10,000 $\Omega$  to 3 $\Omega$  ... 5/9  
 Push-Pull 8 watts, EL84, or 6V6 to 3 $\Omega$  ... 9/9  
 Push-Pull 10-12 watts 6V6 or EL84 to 3 $\Omega$  or 15 $\Omega$  ... 18/9  
 Push-Pull 10-12 watts to match 6V6 or EL84 to 3-5-8 or 15 $\Omega$  ... 19/9  
 Push-Pull 15-18 watts, 6L6, KT66 ... 22/9  
 Push-Pull for Mullard 510 Ultra Linear ... 29/9  
 Push-Pull 20 watts, sectionally wound, 6L6, KT68 etc., to 3 to 15 $\Omega$ . 49/9

**MIDGET MAINS**  
 Primaries 200-250 v. 50 c/s.  
 250 v. 60 mA. 6.3 v. 2 a. .... 11/9  
 250-0-250 v. 60 mA. 6.3 v. 2 a. .... 12/9  
 Both above size 21 x 2 1/2 x 2 1/2 in.

**SMOOTHING CHOKES**  
 150 mA. 7-10H 250 ohms. .... 11/9  
 100 mA. 10 H 200 ohms. .... 8/9  
 80 mA. 10 H 350 ohms. .... 5/9  
 60 mA. 10 H 400 ohms. .... 4/11

**CHARGER TRANSFORMERS**  
 All with 200-230-250 v. 50 c/s Primaries:  
 0-9-15 v. 1 1/2 a., 11/9; 0-9-15 v. 2 a., 14/9; 0-9-15 v. 3 a., 18/9; 0-9-15 v. 5 a., 19/9; 0-9-15 v. 6 a., 23/9; 0-9-15 v. 8 a., 28/9.

**AUTO (Step up/Step down) TRANS**  
 0-110-120-230/250 v. 50-80 watts. 13/9;  
 1-110-120-230/230/250 v. 150 watts. 27/9.

**MICROPHONE TRANSFORMERS**  
 120:1 High grade, clamped, 6/9; 120:1 Potted, Mu-metal screened, 9/9.

# R.S.C. (Manchester) Ltd. LIVERPOOL, LEEDS, BRADFORD, MANCHESTER

## R.S.C. A12 STEREOPHONIC AMPLIFIER KIT

A complete set of parts to construct a Stereo amplifier with an undistorted output total 6 watts. For A.C. mains input of 200-250 v. Outputs for matched 2-3 ohm speakers. Sensitivity 130 m.v. Ganged Vol. and Tone Controls. Preset balance control. Full instructions and point-to-point wiring diagrams supplied. Only good quality components and latest high grade valves used. Exceptionally realistic reproduction can be obtained at ample volume for the home, as can be demonstrated in typical surroundings at our County Arcade premises. A really sensational offer.

### 4 Gns.

Carr. and pkg. 5/-  
 Output for 2-3 ohm speakers. The miniature Mullard valves used. Size of unit only 7-5-5 1/2 in. Guaranteed for 12 months. Only £4.19.6. Send S.A.E. for illustrated leaflet. Terms: Deposit 22/6 and 5 monthly payments of 22/6.

**STEREO EQUIPMENT OFFER-**  
 Comprising A12 Kit, 2 matched 8Ω L/ Speakers, and Acos T10 Stereo head suitable most pickups. **£6.19.6** Carr. 7/6.

**PICK-UP ARMS** complete with Hi-Fi turntable crystals and Acos GP54. Limited number brand new, perfect at approx. half price. Only 29/11.

**ACOS CRYSTAL MICROPHONES.** Mic40 stand or desk. Listed 45/-. Only 27/9. 39-1 Stick type. Listed 5 gns. Only 39/6.

## R.S.C. 30 WATT ULTRA LINEAR HIGH FIDELITY AMPLIFIER A10

A highly sensitive Push-Pull high output unit with self-contained Pre-amp. Tone Control Stages. Certified performance figures compare equally with most expensive amplifiers available. Hum level 70 db. down. Frequency response—3 db. 30-30,000 c/s. A specially designed sectionally wound ultra linear output transformer is used with 807 output valves. All components are chosen for reliability. Six valves are used EF86, EF86, ECC83, 807, 807, GZ33. Separate Bass and Treble Controls are provided. Minimum input required for full output is only 13 millivolts so that ANY KIND OF MICROPHONE OR PICK-UP IS SUITABLE. The unit is designed for CLUBS, SCHOOLS, THEATRES, DANCE HALLS or OUTDOOR FUNCTIONS, etc. For use with Electronic ORGAN, GUITAR, STRING BASS etc. For standard or long-playing records. OUTPUT SOCKET PROVIDES L.T. and H.T. for a RADIO FEEDER UNIT

An extra input with associated vol. control is provided so that two separate inputs such as Gram. and 'Mike' can be mixed. Amplifier operates on 200-250 v. 50 c/s. A.C. Mains and has output for 3 and 15 ohm speakers. Complete kit of parts with fully punched chassis and point-to-point wiring diagrams and instructions. If required cover as for A11 can be supplied for 18/9. The amplifier can be supplied, factory built with EL34 output valves and 12 months guarantee, for 14 Gns. TERMS: DEPOSIT 33/9 and 9 monthly payments of 35/9.

**11 Gns.** Carr. 10/-  
**FULL RANGE OF LINEAR AMPLIFIERS ALWAYS IN STOCK.**

**COLLARO JUNIOR** 4-speed single player units and Hi-Fi crystal pick-up with turn-over head. £3.19.6.

**B.S.R. UA5 4-SPEED AUTO-CHANGERS** with Hi-Fi turnover pick-up head. £6.19.6. Carr. 5/-.

## R.S.C. BATTERY TO MAINS CONVERSION UNITS

Type BM1. An all-dry battery eliminator. Size 5 1/4 x 4 1/2 in. approx. Completely replaces battery supplying 1.4 v. and 90 c/s. where A.C. mains 200-250 v. 50 c/s is available. Suitable for all battery portable receivers requiring 1.4 v. and 90 c/s. This includes latest low consumption types. Complete kit with diagrams, 39/9, or ready to use. 46/9.



Type BM2. Size 8 x 5 1/4 x 2 1/2 in. Supplies 120 v. 90 v. and 60 v., 40 mA. and 2 v. 0.4 a. to 1 amp. fully smoothed. Thereby completely replacing both H.T. batteries and L.T. 2 v. accumulators when connected to A.C. mains supply 200-250 v. 50 c/s. **SUITABLE FOR ALL BATTERY RECEIVERS** normally using 2 v. accumulator. Complete kit of parts with diagrams and instructions. 49/9, or ready for use. 59/6.

**LINEAR L45 MINIATURE 45 WATT QUALITY AMPLIFIER.** Suitable for use with any record playing unit, and most microphones. Negative feedback 12db. Separate Bass and Treble Controls. For A.C. mains input of 200-250 v. 50 c/s. Output for 2-3 ohm speakers. The miniature Mullard valves used. Size of unit only 7-5-5 1/2 in. Guaranteed for 12 months. Only £5.19.6. Send S.A.E. for illustrated leaflet. Terms: Deposit 22/6 and 5 monthly payments of 22/6.

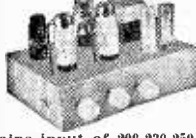

mains input of 200-230-350 v. 50 c/s. Output for 2-3 ohm speaker. Chassis is not alive. Kit is complete in every detail and includes fully punched chassis (with baseplate) with Blue hammer finish and point-to-point wiring diagrams and instructions. Exceptional value at only £4.15.0, or assembled ready for use 25/- extra. plus 3/6 carr.; or Deposit 22/6 and 5 monthly payments of 22/6 for assembled unit.

## R.S.C. 45 WATT A5 HIGH-GAIN AMPLIFIER



A highly-sensitive 4-valve quality amplifier for the home, small club, etc. Only 50 millivolts input is required for full output so that it is suitable for use with the latest high fidelity pick-up heads, in addition to all other types of pick-ups and practically all 'mikes'. Separate Bass and Treble Controls are provided. This gives full long-playing record equalisation. Hum level is negligible being 71db. down 15db. of Negative feedback is used. H.T. or 300 v. 25 mA. and L.T. or 6.3 v. 1.5 a. is available for the supply of a Radio Feeder Unit, or Tape-Deck pre-amplifier. For A.C. v. 50 c/s. Output for 2-3 ohm speaker. Chassis is not alive. Terms: Deposit 17/9 and 9 monthly payments of 17/9. Only £7.19.6. Carr. 8/6.

**12in. 10 WATT HIGH QUALITY LOUD-SPEAKER IN POLISHED WALNUT FINISHED CABINET**  
 Gauss 12,000 lines. Speech coil 3 ohms or 15 ohms. Only £4.19.6. Carr. 5/-. Terms: Deposit 11/3 and 8 monthly payments of 11/3.  
**12in. 20 WATT HI-FI LOUD-SPEAKERS IN CABINETS.** Size 18 x 18 x 10in. Finish as above. Terms: Deposit 17/9 and 9 monthly payments of 17/9. Only £7.19.6. Carr. 8/6.

## R.S.C. PORTABLE GUITAR AMPLIFIERS

**Junior 5 watts High Quality output.** Separate Bass and Treble "Cut" and "Boost" controls. Sensitivity 15 m.v. Twin inputs. High Flux 8in. Loudspeaker "built-in". Handsome, strongly made Cabinet (size approx. 14 x 14 x 7in.) finished in attractive and durable polycrome, and fitted with carrying handle. H.P. Terms. **£8.19.6** Deposit £1 and 9 monthly payments of £1 Carr. 7/6

**Senior 10 watts High Fidelity output.** Separate Bass and Treble "Cut" and "Boost" controls. Twin separately controlled high gain inputs so that two instruments such as Guitar and String Bass can be used at the same time. Two loudspeakers are incorporated, a high Flux 12in. for Bass notes and a 7 x 4 in. elliptical for Treble. Cabinet is well made and finished as Junior model. Size approx. 18 x 18 x 18in. H.P. Terms. Deposit 34/9 and 9 monthly payments of 34/9. Both models for 200-250 v. Carr. 10/- A.C. mains.

Above model fitted Linear Tremolo Unit 5 gns. extra. Or Deposit 11/6 and 9 monthly payments 11/6.

**R.S.C. BASS REFLEX CABINETS, JUNIOR MODEL.** Specially designed for W.B. HF1012 Speaker, but suitable for any good quality 10in. speaker. Acoustically lined and ported. Polished walnut veneer finish. Size 18 x 12 in. Handsome appearance. Ensure superb reproduction (or only £3.19.6.

**STANDARD MODEL.** As above but for 12in. speakers. Size 20 x 15 x 13in. Especially recommended for Plessey Dual Concentric Speaker. £5.19.6. Suitable legs with brass ferrules. 25/- per set of 4. **PLESSEY DUAL CONCENTRIC 12in. 15 ohms HIGH FIDELITY SPEAKER** (2,000 lines) with built-in tweeter (completely separate elliptical speaker with choke, condensers, etc.) providing extraordinarily realistic reproduction when used with our A11 or similar amplifier. Rated 10 watts. Price only £5.19.6.

**P.M. SPEAKERS.** 2-3 ohm. 2in. Perdio 21/9. 5in. 17/9. 6in. 16/9. 8in. 19/9. 8 x 5in. 25/9. 10in. 26/9. 10 x 6in. 29/9. 12in. 29/11. 10in. W.3. 19/9. 12in. 3 or 15 ohms type HF1012 10 watts. High fidelity type. Recommended for use with our A11 Amplifier. £4.10.9. 12in. R.A. 3 ohms 10 watts (12,000 lines). 59/6.

**TWEETERS.** Plessey 3in 19/9. 15Ω 25/9. **HI-FI CRYSTAL PICK-UP HEADS.** (Turnover type with sapphire stylus.) Acos. Standard replacement for Garrard and B.S.R. B.S.R. Ful-B. Garrard GC2. 19/9. B.S.R. Stereo-Monaural 39/11.

**R.S.C. EQUIPMENT CABINET.** Dimensions and outer appearance identical with Standard Bass Reflex Cabinet. Top hinged. Bass board adjustable. **Deck or Player Unit, and Amplifier plus F.M. or A.M./P.M. Unit.** Only 6 gns. **SUPERHET FEEDER UNIT.** Design of a high quality Radio Tuner Unit (specially suitable for use with any of our Amplifiers). Delayed A/V/C Controls are Tuning, W/Ch. and Vol. Only 250 v. 15 mA. H.T. and L.T. of 6.3 v. 1 amp. required from amplifier. Size of unit approx. 9-6-7in. High, simple alignment procedure. Point-to-point wiring diagrams, instructions and priced parts list with illustration. 2/6. Total building cost £4.15.9. For leaflet send S.A.E.

TERMS: C.W.O. or C.O.D. No C.O.D. under £1. Post 1/9 extra under £2. 3/8 extra under £5. Open 9 to 6. Weds. until 1 p.m. except Manchester open all week. Trade supplied. S.A.E. with all enquiries.

**R.S.C.** (Manchester) Ltd.

Mail Orders to 29-31 Moorfield Road, Leeds 12.  
 Personal shoppers to any of branches below—  
 73 Dale Street, Liverpool 2  
 5-7 County (Mecca) Arcade, Briggate, Leeds 1  
 8-10 Brown St. (Market St.), Manchester 2  
 56 Morley Street, (Above Alhambra Theatre), Bradford

# BENTLEY ACOUSTIC CORPORATION LTD.

38 CHALCOT ROAD, CHALK FARM, LONDON, N.W.1.

Telephone: PRIMROSE 9090

EXPRESS POSTAL SERVICE. ALL ORDERS DESPATCHED SAME DAY AS RECEIVED. TELEPHONE AND TELEGRAM ORDERS FOR CASH ON DELIVERY SERVICE ACCEPTED UP TO 3.30 P.M.

OA2	17/6	6F6G	7/1	12AC6	15/8	77	8/1	DL66	17/6	EF50(A)	7/1	HVR2A	6/1	PY31	17/1	UBF80	9/1	Z66	17/6
OB2	17/6	6F12	4/6	12AD6	17/8	78	6/1	DL68	15/1	EF50(E)	5/1	KF35	8/6	PY32	12/6	UBF89	9/1	Z77	4/6
OZ4	5/1	6F13	11/6	12AE6	14/3	80	9/1	DL72	15/1	EF54	5/1	KL35	8/6	PY80	7/6	UCL21	23/10	Transistors	
IA5	6/1	6F23	10/6	12AH7	8/1	83	15/1	DL92	7/1	EF73	10/6	KL32	25/2	PY81	8/6	UCC84	14/11	and diodes	
IA7GT	12/1	6F24	12/6	12AH8	12/6	85A2	16/1	DL94	7/6	EF80	6/1	KT2	5/1	PY82	7/1	UCC85	9/1	CG1C	3/1
IC5	12/6	6F32	10/6	12AT6	7/6	90AG	6/1	DL96	8/6	EF85	6/1	KT33C	10/1	PY83	8/6	UCH20	17/1	CG4E	3/1
ID6	10/6	6F33	7/6	12AT7	6/1	90AV	6/1	DM70	7/6	EF86	10/6	KT36	30/7	PY88	13/7	UCH213/10	10/1	CG6E	3/1
IF5GT	17/6	6H6	3/1	12AU7	6/6	90C1	16/1	E80F	30/1	EF39	9/1	KT41	23/10	PZ30	20/5	UCH42	9/6	CG7E	7/6
IL4	10/6	6J5	5/1	12AX7	7/6	90CG	37/6	E83F	30/1	EF91	4/6	KT44	12/6	PQ21	7/1	UCH81	9/6	CG10E	3/1
ILD5	5/1	6J7G	5/1	12BA6	8/1	101	13/6	EA50	2/1	EF92	4/6	KT61	12/6	PQ25	14/6	UCL82	11/6	CG12E	3/1
ILN5	5/1	6J7GT	10/6	12BE6	9/1	150B2	18/1	EA76	9/6	EF97	13/7	KT63	7/1	QS150/15	10/1	UCL83	19/9	GD3	4, 5,
INSGT	10/6	6K7G	5/1	12SH7	21/9	185BT	34/1	EABC80	9/1	EF98	13/7	KT66	15/1	UF41	9/1	UF42	12/6	OA70	3/1
IR5	6/6	6K7GT	6/1	12J7GT	9/6	305	10/6	EAC91	4/6	EF183	19/1	KT88	24/1	R12	9/1	UF80	10/6	OA73	3/1
IS4	9/1	6K8GT	10/6	12K5	18/4	807	7/6	EAF42	2/6	EF184	12/6	KTW61	6/6	R19	20/5	UF85	9/1	OA79	3/1
ISS	4/1	6K8G	6/6	12K7GT	9/6	956	3/1	EB41	8/6	EB32	5/1	KTW63	6/6	RG1/240A	10/1	UF86	18/4	OA81	3/1
IT4	3/6	6K25	20/5	12K8GT	14/1	1821	17/1	EB91	4/1	EL33	12/6	KTZ41	8/1	TK34	5/4	UF89	9/1	OA86	4/1
IU5	6/1	6L1	23/10	12QGT	5/1	4033L	12/6	EB33	23/10	EL34	15/1	KTZ63	7/1	RK34	7/6	UL41	9/1	OA91	3/6
2P	27/2	6L6G	8/1	12SA7	8/6	5763	12/6	EB33	5/1	EL38	27/2	L63	6/1	SP47	14/6	UL44	27/2	OA95	3/6
3A4	6/1	6L6M	9/6	12SC7	8/6	7193	5/1	EB41	8/6	EL41	9/1	MHL4	7/6	SP41	3/6	UL46	14/6	OA210	11/1
3A5	10/6	6L7GT	7/1	12SG7	7/1	7475	7/6	EB81	8/1	EL42	10/6	MHL6D	12/6	SP42	12/6	UL84	8/6	OA11	20/1
3B7	12/6	6L18	13/1	12SH7	8/6	90C2	5/6	EBF80	9/1	EL81	17/1	M4	8/6	SP61	3/6	UM4	17/8	OC16	48/1
3D6	5/1	6LD20	16/4	12SJ7	8/6	AC/PEN	10/6	EBF83	14/3	EL83	20/5	M54B	23/10	SU25	27/2	UM34	17/8	OC19	48/1
3Q4	7/6	6N7	8/1	12SK7	8/1	5-pin 23/10	10/6	EBF89	9/6	EL84	7/6	MU21/14	8/1	T41	9/1	UM80	15/8	OC22	28/1
3Q5GT	9/6	6P28	27/2	12SQ7	11/6	7-pin 15/1	10/6	E81	30/6	EL85	14/3	N37	23/10	TD4	12/6	URIC	19/1	OC23	87/1
3S4	7/6	6Q7G	16/6	12SR	8/6	AC/PEN	10/6	E82	10/6	EL86	17/8	N78	20/5	TH41	27/2	UU6	20/5	OC26	25/1
3V4	7/6	6Q7GT	11/1	12Y4	10/6	DD	12/6	E813	23/10	EL91	5/1	N108	23/10	TP22	15/1	UU8	27/2	OC28	25/1
5R4G	17/6	6R7G	10/1	19AQ5	10/6	AC/PEN	7/6	E852	5/6	EL95	10/6	N308	21/1	TP25	15/1	UY1N	19/1	OC35	25/6
SU4G	6/6	6SA7GT	8/6	19A10	10/6	AC/TP	34/1	E854	6/1	EL820	19/1	N339	15/1	TY26	30/1	UY21	17/1	OC44	11/1
SU4G	6/6	6S7G	8/1	20F1	15/8	ATP4	5/1	E870	12/6	EL822	25/1	P61	3/6	TY867	13/7	UY41	7/6	OC45	10/1
SY3	6/1	6S7GT	8/1	20F2	27/2	AZ1	19/1	E92	13/7	EM34	9/6	PABC80	14/3	U12/14	8/6	UY85	7/1	OC65	22/6
SZ3	20/5	6S7GT	8/1	20F1	27/2	AZ1	19/1	E92	13/7	EM34	9/6	PABC80	14/3	U12/14	8/6	UY85	7/1	OC65	22/6
SZ4G	9/1	6S7GT	8/1	20P1	27/2	AZ1	19/1	E92	13/7	EM34	9/6	PABC80	14/3	U12/14	8/6	UY85	7/1	OC65	22/6
6A7	10/6	6S7GT	6/1	20P3	23/10	B36	14/3	ECC33	8/6	EM80	9/1	PCC85	8/6	U16	10/1	VMP4G	15/1	OC66	25/1
6A8	9/1	6S7GT	6/6	20P4	27/2	BL63	12/6	ECC34	25/2	EM81	9/1	PCC88	11/6	U19	36/1	VP2	12/6	OC71	6/6
6AC7	4/1	6S7GT	5/6	20P5	23/10	C1C	12/6	ECC40	23/10	EM85	17/8	PCC89	11/6	U22	8/1	VP4	15/1	OC72	8/1
6AG5	5/6	6S7GT	9/1	25A6G	10/6	C8L1	27/2	ECC81	6/1	EN31	53/1	PCF82	10/6	U24	30/1	VP28	14/6	OC73	16/1
6AG7	5/6	6S7GT	8/1	25L6GT	10/6	CBL31	23/10	ECC82	6/6	EY51	9/1	PCF84	17/6	U25	18/4	VP4B	23/10	OC75	8/1
6AK5	8/1	6U4GT	12/6	25Y5G	10/6	CCH35	10/6	ECC83	7/6	EY83	17/1	PCF86	15/1	U31	9/6	VP3C	7/1	OC77	15/1
6AL5	4/1	6U5G	7/6	25Z4G	9/1	CC506	6/6	ECC84	9/1	EY84	14/1	PCL82	10/1	U33	27/2	VP41	6/1	OC81	8/1
6AM6	4/6	6U6G	8/6	25Z5	9/6	CL33	19/1	ECC85	8/6	EY86	9/1	PCL83	10/6	U35	27/2	VR105	8/1	OC139	24/1
6AQ5	7/6	6V7G	7/1	25Z6G	10/6	CV63	10/6	ECC88	18/1	EZ35	6/1	PCL84	12/6	U37	27/2	VR150	7/6	OC170	13/6
6AT6	7/1	6V6GTG	8/1	27S1	20/5	CY1	11/1	ECC91	5/6	EZ40	7/1	PCL85	17/1	U45	13/6	VT61A	5/1	OC171	11/6
6AU6	10/1	6X4	5/1	28D7	7/1	CY31	19/1	ECF80	10/6	EZ41	7/1	PCL86	17/1	U50	6/6	VT501	5/1	OC200	14/6
6B8	5/1	6XS7G	6/1	30C1	8/1	D15	10/6	ECF82	10/6	EZ80	7/1	PENA423/10	10/6	U52	6/6	W76	5/6	OC203	24/1
6BA6	7/6	6/30L2	10/1	30F5	6/1	D77	4/1	ECF86	20/5	E281	7/1	PENA433	10/6	U54	20/5	W81M	6/1	OC271	29/6
6BE6	6/1	7B7	8/6	30FL1	10/1	DAC32	10/6	ECH3	27/2	FC4	15/1	U76	27/2	U76	6/1	W107	19/1	TJ1	40/1
6BGG6/23/10	7/6	7C5	8/1	30L1	8/1	DAF91	6/6	ECH21	23/10	FW4/500	8/6	PEN25	4/6	U78	5/1	W729	20/5	TJ2	45/1
6BH6	8/1	7C6	8/1	30L15	11/6	DAF96	8/6	ECH35	6/6	FW4/800	8/6	PEN45	19/6	U201	17/1	X41	15/1	TJ3	50/1
6B16	6/1	7H7	8/1	30P4	12/1	DD41	14/3	ECH42	9/1	GU50	27/6	PEN46	7/6	U251	14/1	X61(C)	12/6	TP1	40/1
6BQ7A	15/1	7B7	12/6	30P12	7/6	DET25	7/6	ECH81	9/1	GZ30	9/1	PEN383	20/5	U281	20/5	X63	9/1	TP2	40/1
6BR7	12/6	757	9/6	30P13	16/6	DF33	10/6	ECH83	14/3	GZ32	10/1	PEN/DD	23/10	U282	23/2	X65	12/6	TP1	10/1
6BW6	8/6	7V7	8/6	30R13	16/6	D666	15/1	ECL80	9/1	GZ33	20/5	PEN/DD	30/1	U301	23/10	X66	12/6	TS2	12/6
6BW7	6/1	7Y4	7/6	35A5	21/9	DF91	3/6	ECL82	10/6	GZ34	14/1	4020	34/1	U329	14/1	X76M	14/1	TS3	15/1
6C4	5/1	8D2	3/6	35L6GT	9/6	DF96	8/6	FCL83	19/9	GZ37	20/5	PL33	19/1	U339	17/1	X78	23/10	TS4	24/1
6C5	6/6	9BW6	15/8	35W4	7/6	DF97	9/1	ECL86	17/1	HABC80	17/1	PL36	12/1	U403	17/1	X79	23/10	V30/10P	28/6
6C6	6/6	9D2	4/1	35Z23	10/6	DH63	6/6	EF9	23/10	HL2	13/6	PL38	27/2	U404	8/1	X109	17/8	XA101	9/1
6C9	13/6	10C1	13/1	35Z4GT	6/1	DH76	5/1	EF22	14/1	HL2	7/6	PL81	10/6	U801	30/7	XD(1.5)	6/6	XA102	10/1
6C10	9/1	10C2	27/2	35Z5GT	9/1	DH77	7/1	EF36	4/1	HL23	15/8	PL82	7/6	U4020	18/7	XFG1	15/8	XA103	15/1
6CDE6G	37/5	10F1	27/2	43	10/1	DK32	12/1	EF37A	8/1	HL23DD	7/6	PL83	9/1	UABC80	9/1	XFY12	9/6	XA104	18/1
6CH6	9/1	10LD11	16/4	50C5	10/1	DK91	6/6	EF39	5/6	HL42DD	16/6	PL84	13/1	UAF42	9/6	XFY34	18/1	XB102	6/1
6D6	6/6	10P13	15/1	50CD6G	37/5	DK92	9/1	EF40	15/1	19/9	PL820	19/1	UB41	12/1	XH(1.5)	6/6	XB103	6/6	
6E5	12/6	10P14	19/9	37/5	DK96	8/6	EF41	9/1	HN309	25/2	PM84	17/8	UBC41	8/6	XSG(1.5)	6/6	XB104	7/1	
6F1	27/2	12A6	5/1	50L6GT	9/6	DL33	9/6	EF42	10/6	HVR2	20/1	PX4	10/6	UBC81	11/6	Y63	7/6	XC101	6/6

ALL GOODS BRAND NEW AND SUBJECT TO FULL MAKERS' GUARANTEE. PLEASE NOTE THAT WE DO NOT SELL SECONDHAND GOODS OR MANUFACTURERS' REJECTS.

Standard tubular condensers	MIDGET TUBULAR CERAMIC CONDENSERS	LOW VOLTAGE BIAS CONDENSERS	RESISTORS
.001/1000 v.....9d. .1/500 v.....9d.	ANY SIZE 9d.	ANY SIZE 1/6d.	1 watt 4d. 1/2 watt 5d. 1 watt 6d.
.01/500 v.....9d. .25/500 v.....1/3d.			Close tolerance types
.02/500 v.....9d. .5/350 v.....1/3d.			1/2, 1 and 1 watt all 1/- each.
.05/500 v.....9d.			

VOLUME CONTROLS		METAL RECTIFIERS	
All with long spindles. Less switch 3/-. Double-pole switch 4/6.	DRM1B 13/- RM-1 5/3 DRM2B 15/6 RM-2 7/6 DRM3B 15/6 RM-3 7/9 LW7 21/- RM-4 14/- 10 kg. 25 K. 50 K. 100 K. 1/4 mg. 1/2 mg. 1 meg. 2 meg. RM-0 7/11 RM-5 19/6	1A4B6 17/6 14B180 35/- 1A4A97 25/- 14B261 11/6 14A100 27/- 14A1-2-8-2 17/6 14A124 28/- (FC101) 14A163 38/- 16RC 1-1-16-1 8/6	Full List with ratings free for S.A.E. 14RA 1-2-8-3 21/- (FC31) 16RD 2-2-8-1 12/- 16RE 2-1-8-1 8/6 18RA 1-1-8-1 4/6

The decision is YOURS. To be a success in your chosen career; to qualify for the highest paid job . . . to control a profitable business of your own. ICS home-study courses put your plans on a practical basis; teach you theory and practice; give you the knowledge and experience to take you, at your own pace, to the top.

Choose the RIGHT course

RADIO & TELEVISION ENGINEERING  
INDUSTRIAL TELEVISION

RADIO & TELEVISION SERVICING  
RADIO SERVICE AND SALES

VHF/FM ENGINEERING : ELECTRONIC  
COMPUTERS & PROGRAMMING

ICS provides thorough coaching  
for professional examinations:

Brit. I.R.E., City and Guilds Tele-  
communication Technicians, C. & G.  
Radio & TV Servicing (R.T.E.B.);  
C. & G. Radio Amateurs.

### LEARN AS YOU BUILD

*Practical Radio Courses*

Gain a sound up-to-professional-standards knowledge of Radio and Television as you build YOUR OWN 4-valve T.R.F. and 5-valve superhet radio receiver, Signal Generator and High-quality Multi-meter. At the end of the course you have three pieces of permanent and practical equipment and a fund of personal knowledge and skill. ICS Practical Radio courses open a new world to the keen Radio amateur.

# Technical Training in Radio, Television and Electronics Engineering with

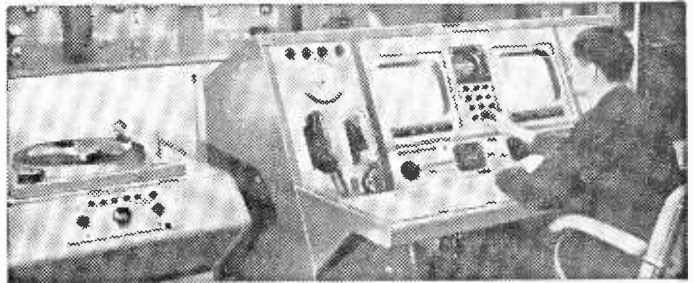

**THERE ARE ICS COURSES TO MEET YOUR NEEDS AT EVERY STAGE OF YOUR CAREER. FILL IN AND POST THIS COUPON TODAY.**

You will receive the FREE 60 page ICS Prospectus listing examinations and ICS technical courses in radio, television and electronics PLUS details of over 150 specialised subjects.

Other ICS courses include: MECHANICAL, MOTOR, FIRE, ELECTRICAL & CHEMICAL ENGINEERING. FARMING, GARDENING. ARCHITECTURE & WOODWORKING. SELLING & MANAGEMENT. ART. PHOTOGRAPHY, etc., etc.

**PLEASE STATE ON COUPON SUBJECT YOU ARE INTERESTED IN . .**

**INTERNATIONAL CORRESPONDENCE SCHOOLS**  
 (DEPT. 170) INTERTEXT HOUSE, PARKGATE RD., LONDON, SW11  
 PLEASE SEND FREE BOOK ON.....  
 NAME .....  
 ADDRESS .....  
 .....  
 OCCUPATION..... AGE.....  
 10.61

# PORTABLE RADIOPHONES MODEL MK II

Brand New British Army Portable Transmitter Receivers

Designed for reliable voice intercommunication operating up to 10 miles depending upon obstructions and elevation. The combined Transmitter Receiver covers the whole frequency range between 7.4-9 Mc/s. and is fully tunable on both Transmitter and Receiver. Simple and a delight to operate as all controls are mounted on the front panel of the set and clearly marked. Operates from standard dry batteries 3 v. L.T. and 120 v. H.T. Incorporates 5 valves: R.F. Amplifier, I.F. Amplifier, Second Detector, Output and Power Amplifier.

All sets are supplied complete with all accessories comprising dynamic sound powered headphones, electro magnet super-sensitive microphone, 4ft. aerial, junction box, battery connection details and full circuit diagram.

PRICES:  
80/- EACH (F. & P. 4/-).  
TWO FOR 28.00 (Post Free).  
Batteries 20/- per set.

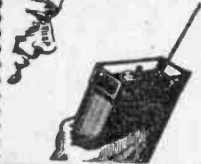

**P.217A. MINIATURE 2 1/2 in. SPEAKER**  
A miniature Hi-Fi speaker that out-performs all others. Designed to meet today's requirements for transmitters, miniature and sub-miniature applications. Size 2 1/2 in. sq. x 1 in. deep. Voice coil impedance: 8 ohms. Freq. range: 150-5000 c/s. Power: 200mW. 16/8. P. & P. 1/-.

**HOOVER ROTARY TRANSFORMERS**  
12 v. input, 500 v. output at 65 r.p.m. or 8v. input, 250 output at 75 m.a.  
Only 10/8 each. P. & P. 2/-

**SPARE VALVE SET**  
Here's a gift for all 38 and 18 Set owners! Case containing 4 ARP12 & 1 A.T.P.4 valves.  
Only 10/- P. & P. 2/6.

**SLIM RADIO PLUGS**  
A.N.D. SOCKETS. Two-way, black bakelite, solder terminal PLUG and STURDY standard SOCKET, 5/6 per pair. Post Paid. Panel mounting, neat finish.

**HI-FI HEADPHONES**  
These miniature Hi-Fi phones use high quality permanent magnetic speakers with regulated voice coil. The soft rubber ear moulds give correct spacing for optimum acoustic load. Each unit has a built-in miniature Hi-Fi transformer to ensure the finest music and voice reproduction. Supplied free is a small transformer unit which steps impedance up to 4000 ohms. Only 15/- P. & P. 2/6.

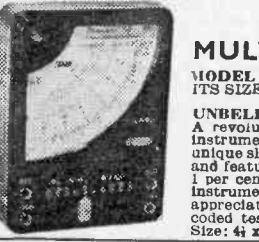

## BC-221 HETERODYNE CRYSTAL CONTROLLED FREQUENCY METERS

Frequency range: 125 Kc/s to 20 Mc/s. Calibration. Individual Calibration Books and numerous Crystal Check Points. Accuracy: 0.01% or 25 cycles. Power supplies: 6 v. and 135 v. batteries. Size 1 1/2 x 10 1/2 x 9 1/2 in. Weight 4 1/2 lbs.

Offered for the first time at the ridiculous price of only **£16 CARR. PAID.**



**NEW DYNAMIC MICROPHONE**  
**MODEL DM-175** Beautifully designed and attractively finished, lightweight dynamic microphone complete with stand. Output impedance 1K ohm, frequency response 150-9000 c.p.s. ± 3db. Sensitivity -73db. Perfect for almost all applications and offered at only 49/6, complete post and packing 2/6d.

**A.R. 88D RECEIVERS**  
Frequency coverage 550 kc/s to 32 Mc/s supplied fully reconditioned and in perfect working order. **ONLY £39.10.0** Carr. 30/-

**MINIATURE CLEAR PLASTIC PANEL METERS**  
"S" METER MODEL SR. 2P. Standard "Ham" Signal strength indicator. Calibrated in "S" units from 0-9 with scale terminating in + 10 to + 30 db calibrations. Additional full scale calibrations of 0-5 + 0-10 in linear scale divisions. A "must" for radio amateurs for conversion of any Communication Receivers with A.V.C. action to give calibrated signal strength action. 35/-



**VU METER MODEL VR. 1P.** Calibrated and damped in accordance with standard VU Meter Practice. Upper scale reads -20 to +3VU. Lower scale 0-100% modulation. Uses precision carbon film multiplier resistor and full wave rectifier. 49/8

**DC MICROAMMETERS** Model MR.25 0 to 50 uA 39/8  
Model MR.250 0 to 500 uA 38/8  
**DC MILLIAMMETER** Model MR.21 0 to 1mA. 27/8  
All Models Individually Boxed and Fully Guaranteed. P. & P. 2/6 each.



**MINIATURE EARPHONE**  
A really sensitive dynamic earphone of exceptionally fine quality. Provides clear reproduction of music as well as speech. Fully Guaranteed and complete with transparent ear insert, 3 feet cord, sub-miniature plug and socket.  
CR-5 High Imp. crystal 8/- Each  
MR-4 Low Imp. magnetic 8/- Post 1/-

## RH-30 RADIO HEADPHONES

Hi-Fi in performance. 2,000 ohms-general use headset. Black and Ivory plastic cased electro-magnetic units with adjustable head-band for comfortable fit. Individual listening for all types of applications. Individually packed, with flexible cord attached. 14/8. Post paid.



**ACCUMULATORS.** 2 volts 16 A.H. (unsplittable). Ideal for 8 and 12 volts supply, etc. Brand new. Original cartons. Size 4 1/2 in. x 7 1/2 in. x 2 1/2 in. 5/8 each. P. & P. 1/6. 3 for 15/- P. & P. 3/8. 6 for 27/6. P. & P. 5/-.

## AERIAL VARIOMETERS

These magnificent instruments will enable you to receive maximum signal strength on all S.W. receivers. Precision calibrated control. 12/8. P. & P. 2/6.



## MINIATURE DUBILIER CONDENSER SPECIAL!

Miniature lots of one dozen from these assorted values: .002; .04; .01; .005; .001; all at 100 volts A.C. and 300 volts D.C. Recent Manufacture ONLY 5/- per dozen. P. & P. 6d. (Please state values required).

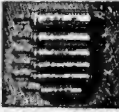

## PS.35. SUB-MINIATURE PLUG AND SOCKET

Two-way bakelite barrel Jack plug only 1 in. long. Socket only 1 in. long. 3/6 per pair. Post paid.

**FULL SCALE RANGES:**  
D.C. VOLTAGE: 0-6-30-120-600-1200v. (10,000 o.p.v.).  
A.C. VOLTAGE: 0-6-30-120-600-1200v. (10,000 o.p.v.).  
D.C. CURRENT: 0-120 uA 0-12-300mA.  
RESISTANCE: 0-20K, 0-2 Meg. (150 ohm, 15K at centre scale).  
CAPACITANCE: 0.005 to 0.15 uF. (at A.C. 3V).  
DECIBELS: -20 to +63db. (600 ohm, 1mW, 0dbm-0.755 v.).  
ACCURACY: D.C. Voltage and Current +2% i.s. A.C. Voltage ±4% i.s. Resistance ±3% of total scale length.

## NEW! 10,000 O.P.V.

**MULTI-TESTER ON BOTH AC & DC**  
**MODEL EP-10K OUTPERFORMS INSTRUMENTS MANY TIMES ITS SIZE AND PRICE!**

**UNBELIEVABLE BARGAIN!**  
A revolutionary new Multi-Tester. A complete wired and tested instrument (not a kit) incorporating extra large 3 1/2 in. meter face and unique slide range switch. Can be conveniently carried in the pocket and features unusually sensitive 10,000 ohms per volt AC-DC meter. 1 per cent precision resistors, and largest meter ever placed on an instrument this size. Simple, easy to use range selector switch, can be appreciated by the novice and engineer alike. Complete with colour coded test leads and battery.  
Size: 4 1/2 x 3 1/2 x 1 in. Model EP-10K ONLY **£5.19.6** P. & P. 3/6.

MAIL ORDERS TO  
DEPT. P.J. 22a COPTIC STREET,  
LONDON, W.C.1



CALLERS WELCOME AT  
87 TOTTENHAM COURT ROAD,  
LONDON, W.1 MUSH806



# HARVERSON SURPLUS CO. LTD.

PLEASE TURN OVER FOR ADDRESS AND MORE BARGAINS

## 2 BAND SUPERHET CHASSIS with Speaker

**ONLY £5.17.6**

Plus 6/6 Post & Packing.

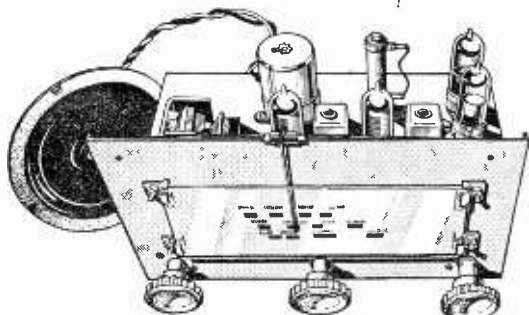

A quality 4 valve AC/DC superhet chassis made by a world famous manufacturer. Long and Medium wave coverage. Fitted with a cord and drum reduction tuning drive and attractive illuminated glass dial (size 6½ x 2½ in.). Controls: Volume on/off, tuning and wave change. The receiver is self-powered, employing a mains dropper and a valve rectifier. Chassis dimensions 6½ x 9 x 5½ in. high. Supplied complete with a good quality 5-inch loudspeaker, valves (UCH42, UAF42, UL41, UY41), AC/DC mains input lead, ivory knobs, etc.

**DON'T HESITATE, ORDER NOW!** This unbeatable bargain is bound to sell out quickly at only £5.17.6, plus 6/6 post and packing.

## 4 STATION PRESET CHASSIS with Speaker

**ONLY £4.17.6**

Plus 6/6 P. & P.

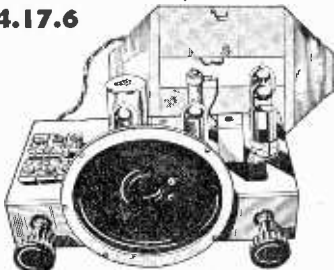

A compact, 4 station preset mains transportable receiver for operation from AC/DC mains. Two simple controls, volume on/off and 4 position station selector. The latter is set to Light Programme (Long Wave), Third Programme, Home Service and Light Programme (Medium Wave), but may of course be adjusted to alternative selections if required. A frame aerial with throw-out extension is supplied, making this receiver ideal as a general purpose transportable set for the home. A fully smoothed power supply is provided from AC/DC mains input by a mains dropper and a valve rectifier. The good tonal qualities are assisted by the provision of a quality 5in. speaker, which is ready-mounted on the chassis (this is easily detachable if alternative positioning is required). Valve line up: UCH, UAF42, UL41, UV41. This chassis (size 9 x 6½ x 5½ in. high) is supplied complete with valves, knobs, mains lead, aerial, etc. It is beautifully made by a famous maker, and is a first-class buy at the rock bottom price of only £4.17.6, plus 6/6 post and packing.

## A.M. RADIOGRAM CHASSIS

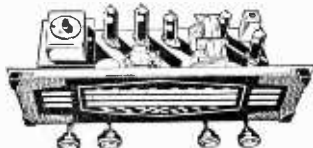

A chassis of distinction, by a famous maker. Covering Long, Med. and Short Waves, plus gram position, this chassis (size 15½ x 7 x 6½ in. high) incorporates the latest circuitry, using fully delayed A.V.C., and negative feedback. Controls: Tone, Vol. On/Off, W/Change (L.M.S. and Gram), Tuning, Tapped input (200-250 v. A.C. only). An attractive brown and gold illuminated dial with matching knobs, make this one of the most handsome, in addition to being one of the best performing chassis yet offered. Complete with valves (ECH81, EF89, EBC81, EL84, EZ81), knobs, output transformer, leads, etc. **OUR PRICE ONLY £9.19.6** plus 4/6 post & packing.

## THE WORLD FAMOUS E.M.I. ANGEL TRANSCRIPTION P.U. (Model 17A)

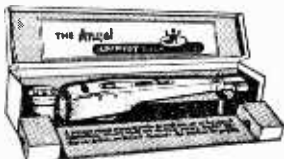

A Pick-up for the connoisseur originally priced at £17.10.0. The last remaining few offered at £5.15.0, plus P. & P. 5/-.

## HARVERSON'S F.M. TUNER KIT

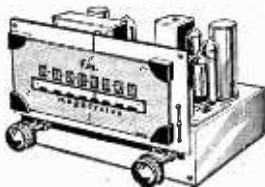

At last a quality F.M. Tuner Kit at a price you can afford. Just look at these fine features, which are usually associated with equipment at twice the price.

- ★ F.M. Tuning Head by famous maker.
- ★ Guaranteed Non-drift.
- ★ Permeability Tuning.
- ★ Frequency coverage 88-100 Mc/s.
- ★ OAB1 Balanced Diode Output.
- ★ Two I.F. Stages and Discriminator.
- ★ Attractive maroon and gold dial (7 x 3 in. glass).
- ★ Self powered, using a good quality mains transformer and valve rectifier.
- ★ Valves used ECC85, two EF80's, and EZ80 (rectifier).
- ★ Fully drilled chassis.
- ★ Everything supplied, down to the last nut and bolt.
- ★ Size of completed tuner 8 x 6 x 5½ in.
- ★ All parts sold separately.

**£4.19.6** Plus 8/6 P.P. & Ins.

Circuit diagram and illustrations, 1/6, post free.

## OUTPUT STAGE & SPEAKER FOR F.M. TUNER UNIT

All parts, including speaker, ECL82 valve, and simple instructions to make two-stage output unit for converting F.M. tuner into F.M. receiver. **ONLY 45/6**, plus 4/6 P. & P.

## E.M.I. 4-speed Player and P.U.

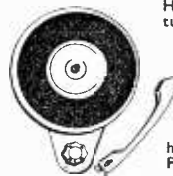

Heavy 8½ in. metal turntable. Low flutter performance 200/250V shaded motor with tap at 80V for amplifier valve filament if required. Turnover LP/78 head. Price 89/6. Plus 4/6 P. & P.

## SUPER STEREO KIT MK. II

A kit of ready-built units only requiring interconnection. Comprising two midgeet 3W amplifiers, push button switch, transformer, control unit (bass, treble and vol.), power pack, two speakers, indicator light, valves (ECL82, EZ80 range), and comprehensive instructions.

**£3.19.6** Plus 6/6 P. & P.

## F.M. TUNER HEAD

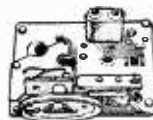

A permeability tuned tuner head by a famous maker, supplied without valve (ECC85) 18/6 plus 1/9 P. & P. Valve 8/6 extra.

# HARVERSON SURPLUS CO. LTD.

## Introducing HARVERSON'S Monaural Amplifier Kit

**39/6**

In response to numerous requests from delighted purchasers of our "SUPER STEREO KIT" we have produced a "MONAURAL AMPLIFIER" on similar lines.

★ A UCL 82 valve provides a triode amplifying stage, and a pentode output stage (3 watts), enabling good amplification and sparkling reproduction to be combined with physical compactness (amplifier size, 7 x 3½ x 8½ in. high).

★ Modern circuitry design, good quality O.P. transformer (to match ★30) keep hum and distortion to a low level.

★ The controls, volume on/off, and tone, are complete with attractive cream and gold knobs.

★ The amplifier has a built-in fully smoothed power supply, using a good quality mains transformer (A.C. mains only) and metal rectifier.

★ All you need is supplied including easy to follow instructions which guarantee good results for the beginner and expert. All components, leads, chassis, valve, knobs, etc., are first grade items by prominent manufacturers.

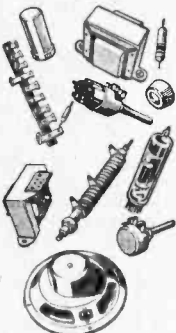
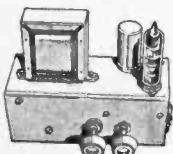

**OUR PRICE** Plus 4/6 Post and Packing. **39/6**

5in. LOUDSPEAKER TO SUIT 14/6 EXTRA ALL PARTS SOLD SEPARATELY

### CHILD'S NURSERY LAMP

A child's night light of unusual design. Contemporary styled lampholder of robust construction finished in either red or yellow. Entirely safe (bulb socket shielded from "prying fingers"), complete with flex and a push-button switch. 200/250 volts A.C. only. The low-consumption bulb element is made in the shape of either flowers or angel fish, and when switched on, glows in fluorescent colours (the flowers pink with green leaves, or the fish green with purple weed). Made by a famous manufacturer and originally priced at 29/6. Please state lampholder colour preference, and whether fish or flower element is required.

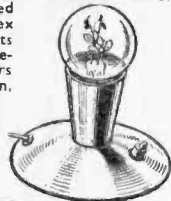

**OUR BARGAIN PRICE** only plus 9d, post and packing. **10/9**

### SUPERHET CHASSIS—less Valves & Cabinet

Modern AC/DC chassis with printed circuit and ferrite rod aerial. Although not completely built, the main components are mounted. L & M. wave coverage. 4 valves (UBF89, UCL83, UCH81, UY85). Everything supplied except valves and cabinet. With speaker and simple instructions. **£3.6.6** plus 3/6 P. & P.

### TRANSISTOR AMPLIFIER KIT

A complete kit of parts to build a compact 4-transistor amplifier, with volume control and printed cct. board. Two GT3 driver transistors, transformer coupled. 1 watt output from matched pair GT15. Supplied with output transformer and 2½ in. 3 ohm speaker. Ideal for record player, etc. **59/6** plus 4/6 P. & P.

### CONDENSER/RESISTOR PARCEL

50 mixed P.F. Condensers and 50 mixed Resistors. An assortment of useful values. All popular sizes—all new—a must for the serviceman and constructor **ONLY 10/-** P. & P. 1/-

AT ½ PRICE WHILE THEY LAST!  
**GOLDRING MU-METAL CASED CARTRIDGES**  
Sapphire styli. Brand new and boxed  
**Our Price £2.15.0** P & P 1/6 including Ins.

### BARGAIN MONTH FOR TRANSISTORS

POWER			
OC36 ... ..	10/-	GET102... ..	7/6
OC44 ... ..	9/-	XA103 ... ..	8/6
OC45 ... ..	8/-	PXA101 ... ..	9/6
OC71 ... ..	5/-	PXA102 ... ..	9/6
OC75 ... ..	6/6	<b>AMERICAN</b>	
OC76 ... ..	6/6	2N388 ... ..	6/6
OC78 ... ..	6/6	2N1485 ... ..	6/6
OC78D ... ..	6/6	2S712 ... ..	7/6
GET15 ... ..	9/-	<b>DIODE</b>	
GET15 (matched pr.) ...	16/6	OAB1 ... ..	3/-

Please add 6d. postage for each transistor.

### TRANSISTOR SPEAKER

Weston Electric 3Ω speaker. Size 2½ x 1½ in. deep. 12/6 p.p. 1/-

## THE HARVERSON COMPLETE F.M./V.H.F. RECEIVER KIT £6.19.6

AT LAST—A COMPLETE F.M. RECEIVER IN KIT FORM!

Specially designed with the home constructor in mind, this kit enables the construction of a completely self-contained V.H.F. receiver, at fraction of the normal cost of comparable equipment. This is basically a quality self-powered F.M. tuner plus 2 separate audio amplifier stages, and output transformer and speaker.

- ★ F.M. Tuning Head by famous maker.
- ★ Guaranteed Non-drift.
- ★ Permeability Tuning.
- ★ Frequency coverage 88-100 Mc/s.
- ★ ★ A81 Balanced Diode Output.
- ★ Two I.F. Stage and Discriminator.
- ★ Self powered using a good quality mains transformer and valve rectifier.
- ★ Valves used ECC85, two EF80's, ECL82 and EZ80 (rectifier).
- ★ Fully drilled chassis.
- ★ Good quality speaker.
- ★ Well designed output transformer.
- ★ Attractive maroon and gold glass dial.
- ★ Two output stages (using ECL82).
- ★ Everything supplied, down to the last nut and bolt.
- ★ Compact size.
- ★ All parts sold separately.

**OUR PRICE £6.19.6** Plus 4/6 P. & P.

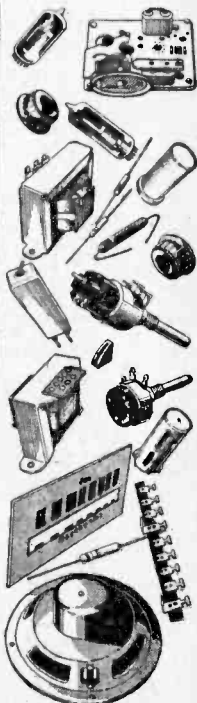

# 83 HIGH ST., MERTON, S.W.19

CHerrywood  
3985/6

## ★HARVERSON'S UNEQUALLED VALVE SERVICE★

OA2	17/6	6F6G	7/1	10D2	12/	53W4	7/6	DK32	12/	EF50(A)	7/1	KF35	8/6	PM2B	12/6	U4020	16/7	XFY12	9/6
OB2	17/6	6F11	17/3	10F1	26/6	35Z3	10/6	DK91	6/6	EF50(E)	5/1	KL35	8/6	PM84	17/3	U4BC80	9/1	XFY34	17/6
OZ4	5/1	6F12	4/6	10F9	11/6	35Z4GT	6/1	DK92	9/1	EF54	5/1	KLL32	24/7	PX4	10/6	U4F42	9/6	XH(1.5)	6/6
IA5	6/1	6F13	11/6	10LD3	8/6	35Z5GT	9/1	DK96	8/6	EF73	10/6	KT2	10/1	PY32	12/6	UBC41	8/6	Y63	7/6
IA7GT	12/1	6F15	15/3	10LD11	4/3	50C	10/1	DL33	9/6	EF80	6/1	KT33C	10/1	PY80	12/6	UBC81	11/4	Z63	7/6
IC5	12/6	6F23	10/6		15/11	50C5	10/1	DL66	17/6	EF85	6/1	KT36	29/10	PY80	6/1	UBC81	9/1	Z66	17/6
ID6	10/6	6F32	10/6	10P13	15/1	50CD6G		DL68	15/1	EF86	10/6	KT41	23/3	PY81	8/6	UBF80	9/6	Z77	4/6
IC6	17/6	6F33	7/6	10P14	19/3		36/6	DL72	15/1	EF89	9/1	KT44	12/6	PY82	7/1	UBF89	9/6	Z719	6/1
IH5GT	10/6	6G6	6/6	12A6	5/1	50L6GT	9/6	DL92	7/1	EF91	4/6	KT61	12/6	PY83	8/6	UBL21	23/3		
IL4	3/6	6H6	3/6	12AC6	15/3	53KU	19/11	DL94	7/6	EF92	4/6	KT63	7/1	PY88	13/3	UCC84	14/7		
ILD5	5/1	6J5	5/1	12AD6	17/3	77	8/1	DL96	8/6	EF97	7/6	KT66	15/1	PZ30	19/11	UCC85	9/1	Transistors	
ILN5	5/1	6J6	5/6	12AE6	13/11	78	9/1	DM70	9/1	EF98	13/3	KT68	24/1	QP21	7/1	UCC80	16/7	and diodes	
IN5GT	10/6	6J7G	6/6	12AH7	8/1	80	9/1	EB0F	20/1	EF183	18/7	KTW61	6/6	QP25	14/6	UCH20	23/3	CG1C	7/6
IR5	6/6	6J7GT	10/6	12AH8	12/6	83	25/1	EB3F	37/6	EF184	18/7	KTW62	7/6	QS150/15	10/6	UCH42	9/6	CG4E	7/6
IS4	9/1	6K7G	5/1	12AT6	7/6	85A2		EA50	2/1	EK32	8/6	KTW63	6/6		10/6	UCH81	9/6	CG6E	7/6
IS5	15/1	6K7GT	6/1	12A7E	6/1	150B2	12/1	EA76	9/6	EL32	5/1	KTZ41	8/1	R12	9/1	UCL82	11/6	CG7E	7/6
IT4	3/6	6K8GT	10/6	12AU6	23/3	161	10/6	EAB30	9/1	EL33	12/6	KTZ63	7/6	R18	14/1	UCL83	19/3	CG10E	7/6
IU5	6/1	6K8G	6/6	12AV6	12/6	185B	33/2	EAC91	4/6	EL34	15/1	L63	6/1	R19	19/11	UF41	9/1	CG12E	7/6
2P	26/6	6K25	19/11	12AV6	12/6	304	10/6	EAF42	9/1	EL38	26/6	MHL4	7/6	RG1/240A	45/1	UF80	10/6	GD3, 4, 5,	
2X2	4/6	6L1	23/3	12AX7	7/6	305	10/6	EB34	2/6	EL41	9/1	MHL4	12/6		45/1	UF80	10/6	6, 8	4/1
3A4	6/1	6L6G	8/1	12BA6	8/1	807	7/6	EB41	8/6	EL42	10/6	ML4	8/6	RK34	7/6	UF85	9/1	OA70	4/1
3A5	10/6	6L6M	9/6	12BE6	9/1	956	3/1	EB91	4/1	EL81	16/7	MS4B	23/3	S130	22/6	UF86	17/11	OA73	4/1
3D6	12/6	6L7GT	7/6	12BH7	21/3	1821	16/7	EB93	23/3	EL83	19/11	MU12/14	8/1	SP4(7)	14/6	UF89	9/1	OA79	4/1
3Q4	5/1	6L18	13/1	12E1	30/1	4033L	12/6	EB93	5/1	EL84	7/6	N37	23/3	SP41	3/6	UL41	9/1	OA81	4/1
3Q5GT	7/6	6L19	23/3	12J5GT	4/6	5763	12/6	EB81	8/6	EL85	13/11	N78	19/11	SP42	12/6	UL44	26/6	OA86	5/1
3Q5GT	9/6	6L23	8/6	12J7G	9/6	7193	5/1	EB81	8/1	EL86	17/3	N108	23/3	SP61	3/6	UL46	14/6	OA91	4/1
3S4	7/1	6LD20	15/11	12K5	17/11	7475	7/6	EBF80	9/1	EL91	5/1	N308	20/7	SU25	26/6	UL84	9/6	OA95	5/1
3V4	7/6	6N7	8/1	12K7GT	5/6	9002	5/6	EBF83	13/11	EL95	10/6	N339	15/1	SU61	9/1	UM4	17/3	OA211	40/1
5R4GY	17/6	6P25	12/6	12K8GT	14/1	AC/PEN		EBF89	9/6	EL820	18/7	P61	3/6	T41	4/1	UM30	15/3	OC16	54/1
5U4G	6/6	6P26	19/11	12Q7GT	5/1	5-pin	23/3	EBL21	23/3	EL822	25/1	PABC80			12/6	UR1C	18/7	OC19	54/1
5V4G	10/1	6P28	26/6	12A7E	8/6	7-pin	15/1	EBL31	23/3	EM34	9/6		13/11	TH41	26/6	UR1C	18/7	OC23	87/1
5Y3	6/6	6Q7G	6/6	12C5T	7/6	AC2/PEN		EC52	5/6	EM71	23/3	PC88	8/1	TH2321	20/1	UJ7	16/7	OC26	44/1
5Z3	12/6	6Q7GT	11/1	12C5G	7/1	DD	12/6	EC54	6/1	EM80	9/1	PC88	9/6	TH22	15/1	UJ8	26/6	OC28	25/1
5Z4G	9/1	6R7G	10/1	12C5H	7/6	AC6/PEN	7/6	EC70	12/6	EM81	9/1	PC88	11/6	TP25	15/1	UJ9	7/6	OC35	48/1
6A7	10/6	6SA7GT	8/6	12C5T	8/6	AC/TP	33/2	EC92	13/3	EM84	10/6	PCF80	8/1	TP2620	33/2	UY1N	18/7	OC44	26/1
6A8	9/1	6S7C	7/6	12C5K	7/6	ATP4	5/1	EC93	5/6	EM85	10/6	PCF80	8/1	TP2620	33/2	UY1N	18/7	OC45	23/1
6AC7	4/1	6S7GT	8/1	12C5Q	11/6	AZ31	18/1	ECC32	8/6	EN51	37/1	PCF82	10/6	TY86F	13/3	UY21	16/7	OC45	23/1
6AG5	5/6	6S7GT	8/1	12C5R	7/6	AZ41	13/11	ECC33	24/7	EN51	37/1	PCF84	16/7	UI2/14	8/6	UY41	7/6	OC65	22/6
6AG7	7/6	6S7GT	8/1	12C5T	10/6	B36	15/1	ECC40	8/6	EY84	16/7	PCF86	15/1	U16	10/1	UY85	7/6	OC66	25/1
6AK5	8/1	6S7GT	6/1	14S7	27/10	B63	10/6	ECC35	8/6	EY83	14/1	PCL82	10/1	U18/20	8/6	VMP43	15/1	OC70	14/1
6AL3	4/1	6S17GT	6/6	19A05	10/1	BL63	7/6	ECC81	6/1	EY86	9/1	PCL83	10/6	U19	36/1	VMS4B	15/1	OC71	14/1
6AM6	4/6	6SN7GT	5/6	19H1	10/1	C1	12/6	ECC82	6/6	EZ35	6/1	PCL84	12/6	U22	8/1	VP2	12/6	OC72	17/1
6AQ5	7/6	6SQ7GT	9/1	20D1	15/3	C1C	12/6	ECC83	7/6	EZ40	7/1	PCL85	16/7	U24	29/10	VP4	15/1	OC73	20/1
6AT6	7/1	6SS7GT	8/1	20F2	26/6	BL61	26/6	ECC84	9/1	EZ41	7/1	PENA4	23/3	U25	17/11	VP2B	14/6	OC75	15/1
6AU6	10/6	6U4GT	12/6	20L1	26/6	BL31	23/3	ECC85	8/6	EZ80	7/1	PENB4	26/6	U26	10/1	VP4B	23/3	OC77	21/1
6AV6	12/6	6U5G	7/6	20P1	26/6	CKH35	23/3	ECC88	18/1	EZ81	7/1	PEN4DD	U31	9/6	VP13C	7/1	OC78	17/1	
6B8	5/1	6U7G	8/6	20P3	23/3	CK506	6/6	ECC91	5/6	FC4	15/1		26/6	U33	26/6	VP13	6/1	OC170	35/1
6BA6	7/6	6V6G	7/1	20P4	26/6	CL33	19/3	ECF80	10/6	FW4/500	8/6	PEN25	4/6	U35	26/6	VP105	8/1	OC200	54/1
6BE6	6/1	6V6GTG	8/1	20P5	23/3	CV63	10/6	ECF82	10/6	FW4/800	8/6	PEN40DD	U37	26/6	VP150	7/6	OC203	58/1	
6BG6G	23/3	6X4	5/1	25A6G	10/6	CY1	18/7	ECF86	19/11	GU50	27/6		U45	9/1	VT61A	5/1	TJ1	40/1	
6BH6	8/1	6X5GT	6/1	25L6GT	10/1	CY31	11/1	ECH3	26/6	GZ30	9/1	PEN44	26/6	U50	6/6	VT501	5/1	TJ2	45/1
6BJ6	6/1	6/30L2	10/1	25Y5G	10/1	D1	3/1	ECH21	23/3	GZ32	9/1	PEN45	19/6	U52	6/6	W76	5/6	TJ3	50/1
6BQ7A	15/1	7A7	12/6	25Z4G	9/6	D15	10/6	ECH35	6/6	GZ33	19/11	PEN45DD	U52	6/6	W76	5/6	TJ3	50/1	
6BR7	23/3	7B6	21/3	25Z5	9/6	D63	5/1	ECH42	9/1	GZ34	14/1		26/6	U54	19/11	W81M	6/1	TP1	40/1
6B57	25/1	7B7	8/6	25Z6G	10/1	D77	4/1	ECH81	9/1	GZ37	19/11	PEN46	7/6	U56	6/1	W107	18/7	TP2	40/1
6BW6	8/6	7C5	8/1	27S0	19/11	DA3C2	10/6	ECH83	13/11	H63	12/6	PEN383	23/3	U78	5/1	W279	19/11	TS1	10/1
6BW7	6/1	7C6	8/1	28D7	7/1	DAF91	6/1	ECL80	9/1	HABC80		PEN453DD	U07	16/7	X24M	24/7	TS2	12/6	
6BX6	6/1	7H7	8/1	30C1	8/1	DAF96	6/6	ECL82	10/6		13/6		33/2	U91	16/7	X41	15/1	TS4	24/1
6C4	5/1	7R7	12/6	30F5	6/1	DD41	13/11	ECL83	19/3	HL2	7/6	PEN/DD	U201	16/7	X61(C)	12/6	TS4	24/1	
6C5	6/6	7R7	8/6	30FL1	10/1	DET25	7/6	ECL86	16/7	HL23	15/3		4020	33/2	U251	14/1	X63	9/1	
6C6	6/6	7R7	8/6	30L1	8/1	DF33	10/6	EF9	23/3	HL23DD	7/6	PL33	19/3	U281	19/11	X65	12/6	XA101	23/1
6C6	13/6	7Y4	7/6	30L15	11/6	DF66	15/1	EF22	14/1	HL41DD		PL36	12/1	U282	22/7	X66	12/6	XA102	26/1
6C9	9/1	8D2	3/6	30P4	12/6	DF91	3/6	EF36	4/1		19/3	PL38	26/6	U301	23/3	X76M	14/1	XA103	15/1
6CD6G	36/6	8D3	4/6	30P12	7/6	DF96	8/6	EF37A	8/1	HL42DD		PL81	10/6	U329	14/1	X78	23/3	XA104	18/1
6CH6	9/1	9BW6	15/3	30P1L	10/6	DF97	9/1	EF39	5/6		19/3	PL82	7/6	U339	16/7	X79	23/3	XB102	10/1
6D6	6/6	9D2	4/1	30PL13	16/6	DH63	6/6	EF40	15/1	HN309	24/7	PL83	9/1	U403	16/7	X109	17/3	XB103	14/1
6E5	12/6	10C1	13/1	35A5	21/3	DH76	5/1	EF41	9/1	HVR2	20/1	PL84	12/6	U404	8/6	XD(1.5)	6/6	XB104	10/1
6F1	26/6	10C2	26/6	35L6GT	9/6	DH77	7/1	EF42	10/6	HVR2A	6/1	PL820	18/7	U801	29/10	XFG1	18/1	XC101	16/1

For one month only the above prices less 10%. This list supersedes all previous issues

WE SPECIALISE IN OBSOLETE VALVES—IF YOU DON'T SEE IT ABOVE WRITE AND ASK

**SPECIAL OFFER! ONE DOZEN 6K7G £1, plus 2/6 P. & P.**

### Transistorised Stethoscope

Trace signal right through: Radio, TV, Tape amplifier, Hi-Fi, etc.—simplest way to fault-find—carry it like a fountain pen—all parts including transistor barrel crystal, everything except battery, 12/6 plus 1/6, data included or separately 1/6. Or complete with dear aid type earphone, 20/-.



### Speaker Bargain



12in. Hi-fidelity loudspeaker. High flux permanent magnet type with standard 3 ohm speech coil. Will handle up to 12 watts. Brand new by famous maker. Price 32/6, plus 3/6 post and insurance.

### Hi-Fi Snip Infinite Wall Baffle



Nicely veneered and polished. Corner fitting (attaches to picture rail). Takes up no floor space. Gives really fantastic results with only low-priced 8in. speaker fitted to tweeter. Only 45/- each, carriage and insurance 3/6.

### Smallest Possible 2-gang

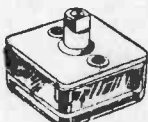

With built-in trimmers, polystyrene case, size only 1 x 1 x 7/16in., price 17/6. Smallest IF and oscillator to match. 21/- P.P. input and P.P. output transformers, 12/6. Circuit diagram free with any of above.

### Building A Scope?



3in. oscilloscope tube, American made type No. 3FP7, 6.3 v. 0.6 amp. heater, electrostatic deflection, brand new and guaranteed with circuit diagram of scope. 15/- each, plus 1/6 post and insurance.

### Transistor Set Cabinet

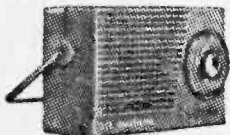

Very modern cream cabinet, size 5 1/2 x 3 x 1 1/2in. with chrome handle, tuning knob and scale. Price 7/6, plus 1/6 postage and packing.

### BATTERY CHARGER BARGAIN

Components Would Cost More

Car Battery Charger—ready-made high output battery charger in stove enamelled sheet steel louvered case. New, complete and ready to work. Rated at 12 v. 5 amps. and variable rate selector for trickle charging, also a meter to show charging rate. Suitable for 230/250 A.C. mains. Special snip price of 65/-, plus 3/6 post and ins.



### MOTOR SNIP

Miniature motor 2 1/2in. long x 1 1/2in. diameter, laminated poles and armature, separate winding for reversing. Operates off 20-30 v. D.C. or off A.C. mains through stepdown transformer. Original cost at least £3 each. Snip price for one month only 8/6, plus 1/6 postage and insurance.



### INFRA-RED HEATERS

Make up one of these latest type heaters ideal for bathroom, kitchen, bedroom etc. They are simple to make from our easy to follow instructions—uses silica enclosed elements designed for the correct infra-red wavelength (3 microns). Price for 750 watt element and instructions 15/6, plus 2/6 post and insurance.



### CHARGING SWITCHBOARDS

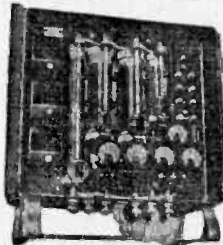

Type A. 550 w. 18 v.—contains three reverse current relays, one voltmeter rated 25 v. f.s.d., one main ammeter rated 40 amps. f.s.d., one secondary ammeter rated 15 amps. f.s.d. and two secondary meters rated 20 amps. f.s.d., one 2 ohm variable resistor, one 11 ohm variable resistor and two 1.2 ohm variable resistors. Complete in metal case 2ft. 6in. x 2ft. 8in. approx. Price 22-15-0, carriage and ins. 15/-.

Type B. 1250 w. 50 v., 0.12 amps.—contains one 14 ohm variable resistor and four 1 ohm variable resistors, one main ammeter rated at 40 amps. f.s.d., four secondary meters rated at 20 amps. f.s.d. and one voltmeter rated at 50 volts, and two reverse current relays. Complete in metal case—size approximately 2ft. 6 in. x 2ft. 8 in. Price 24-15-0, carriage 15/-.

Connectix Leads for these switchboards, with Nifam plus 30/- each.

### FLUORESCENT LIGHT BARGAIN

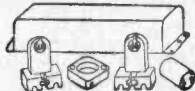

Kit of Parts comprising: choke, two lamp holders, starter holder and starter, 40 watt. 19/6; 80 watt. 23/6. Plus 2/- post and insurance.

### THIS MONTH'S SNIP

A fully-built, tested and ready to work pocket radio using six semi-conductors and tuning over the long and medium wave bands. An excellent performer and a real bargain at £5/15/- post free.

Seven days approval. Send for one today. If you are not 100% pleased then return it within seven days and your money will be refunded.

### Miniature Earphones

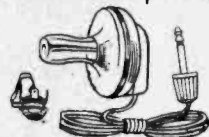

For Transistor Circuits or Beat A Id Very lightweight and easy to wear, cord almost invisible, good quality production of music and voice, complete with miniature plug and socket, ready to use—correct impedance OK for red spot and silicon transistors, Crystal and Magnetic, 6/- Post and Insurance 1/-.

### Morganite Potentiometers

Single and 2-gang types available standard size with good length spindle, all new and boxed.

Single types, 1/- each, values available: 5K, 10K, 25K, 50K, 100K, 250K, 1 meg., 2 meg.

2-gang type 3/- each, values available: 5K±5K, 10K±10K, 1 meg. ±1 meg., 2 meg. ±2 meg.

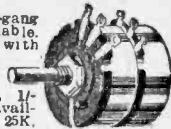

### The Taylor Meter Model 127A



A pocket size meter but with a big scale and a sensitivity of 20,000 ohms per volt D.C., therefore an ideal unit for television servicing—robustly made and complete with leads and prods—20 ranges as follows: D.C. current 50 microamps. to 1 amp. D.C. voltages—0-1,000 volt in seven ranges (25 kv) with external probe, optional extra. Volts A.C.—0-2,500 in six ranges. Ohms—0-20 meg. ohm in three ranges (self-controlled). Self-contained, 3 1/2" movement. Price £10 or 10/- deposit and 23 fortnightly payments of 10/-. Non-callers add 6/- carriage and insurance.

### "Dim and Full" Switch

Particularly useful for controlling photoflood lamps which have only a short life at full brilliance. This switch has three positions; the first position puts two lamps in series at full brilliance or setting up, the second position is off and the third position full brilliance for the operation shots. Also useful for controlling night lights, heaters, etc., etc. Price 3/9 each, post 9d. Circuit diagram included. Ditto but without the off position, i.e. d.p.d.t., 10 amp. 2/9.

### Miniature Microphone

American made, Dynamic type, real bargain at 2/6, plus 8d. postage.



### Transistor Amplifiers

2 x CX71's direct coupled cascade drive to 2 precision matched OC74's in Class B push-pull provide up to 1 W undistorted output from 5 mV. In at 1.5 K-ohm frequency response, 60-16,000 c/s ± dB. Overall size 3 x 2.2 x 1.2in. 92/6. Post and ins. 2/6. 750 M/WATT AMPLIFIER, Similar specification. 22-2-6

**SUB-MINIATURE COMPONENTS**

1. Ferrite aerial with Long and Medium Wave Coils. 4in. long, for pocket superhet., complete with circuit showing component values, etc., 7/6.
2. Ferrite aerial, as above, but 1in. diameter, 8in. long, for table model receiver or portable. 10/6.
3. Three I.F. Transformers with oscillator coil and circuit details to work with item 1. 19/6.
4. Three I.F. Coils and oscillator to work with item 2. 23/6.
5. Smallest possible electrolytics. 1MFD, 2MFD, 4MFD, 6MFD, 8MFD, 10MFD, 20MFD, 30MFD, 50MFD, 100MFD, 200MFD, all 1/8 each.
6. Smallest ½ watt resistors, all 10 per cent values. 5d. each.
7. Miniature condensers, .1, 1/5, .05, .04, .02, .01, all 8d values, below this 7d.
8. Miniature slide switch double pole change over. 2/6.
9. Edgewise volume controls, 2K, 5K, 10K and 20K. 2/6 each.
10. Small edgewise controls with switch, 2K, 5K, 10K and 20K, 4/9 each.
11. Red Spot Transistors, tested and suitable all A.P. applications. 2/6.
12. White Spot Transistors tested and suitable as I.F. or mixer. 3/6.
13. Set of six Mullard transistors for superhet in original packets, fully guaranteed, comprising OC44, OC45, OC81D and matched pair OC81. £2 the set.
14. Special 500 sub-miniature diodes, 1/6 each.
15. Surface Barrier transistors, 5-10 Mc/s, 6/6 each; 10-15 Mc/s, 8/- each; 20-30 Mc/s, 9/- each; 40-50 Mc/s, 15/- each.
16. Push-Pull Driver and Push-Pull output transformers for pocket superhets, 150 mW, 10/- pair; 400 mW, 15/- pair; 750 mW (driver only, no o.t. needed), 8/6, all complete with circuit details.
17. Smallest Tuning Condenser, size approx. 1in sq, 16pF and 85pF, with trimmers, 17/6 each.
18. Oscillator coil to suit the above. 6/-.
19. Three I.F.s, 455 kc sub-miniature to suit items 17 and 18. 18/- the set.
20. Jackson 00 2-gang tuning condensers, 208pF plus 176 pm. spindle tapped 65A, with trimmers, 10/6, less trimmers 9/6.
21. Tuning condensers for items 1 and 3. 9/6.
22. Tuning condensers for items 2 and 4. 10/6.
23. Printed circuit for items 1 and 3. 6/6.
24. Printed circuit for items 2 and 4. 7/6.
25. 2in. speaker, 3 ohm, 19/6; 80 ohm, 18/6.
26. 3in. speaker, 3 ohm, 18/6; 80 ohm, 18/6.
27. 5in. speaker, 3 ohm, 18/6; 35 ohm Hi flux, 19/6; 35 ohm Super Hi flux, 22/6.
28. Elliptical speaker, 7 x 4. 3 ohm, 19/6; 35 ohm, 19/6.
29. Battery connectors, large, 1/- pair; miniature, 1/- pair.

**NOW THE MARK IV Pocket '5' Transistor Radio**

**Read these Testimonials**

**D. A. Hilton, Leigh, Lancs.**  
 "I received Pocket 4 on Christmas Day. I made it up on Boxing Day and I am very pleased with the results. It brings in local stations and many foreign stations including Luxembourg at good strength. I am 13 years old!"

**Mr. J. Bell, Wolverhampton.**  
 "I am writing to express my satisfaction at the standard of your kit for your Pocket 4 Transistor set and also to state that it has come up to my expectations in regard to performance."

**Mr. K. Bell, Newcastle-on-Tyne.**  
 "I have built your Pocket 4 Transistor set. I am very pleased with it."

**Mr. F. Jackson, Ickenham, Middx.**  
 "I have built the Pocket 4 and am more than pleased with the results."

**Mr. G. Bamford, Ransgate.**  
 "I find this set even better than you claim it to be and most certainly up to your usual standard of quality. I feel that nobody could fail to build it and get results. Even the first-time-ever novice, as your circuit diagrams and instructions are so clear and precise."

**Mr. A. J. Simmonds, Welling, Kent.**  
 "I purchased from you a week ago the Pocket 4 Transistor Kit. I put it together last night in 1½ hours, on switching on the set I was right on Radio Luxembourg! I must say thank you because not only has the set a very attractive appearance, it also behaves fantastically!"

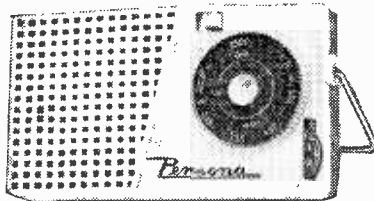

Our famous Pocket "4" which is doing yeoman service all over the country has been modified and improved to make it an even better receiver. The new features include:—

- New elegant dial graduated for Long and Medium Waves.
- Switched Long and Medium Waves.
- Slide switch on/off control.
- Printed circuit.
- Ferrite Rod Aerial.
- Improved reaction circuit.
- Positive spindle coupling to tuner.
- Battery containers.

The Pocket "5" of course retains its original r.f. circuit which means still no aerial or earth needed. The Pocket "5" Mark IV uses 4 transistors, crystal diode, miniature loud speaker and has all the above refinements, complete in case as illustrated (less motif) 52/6, battery 10d., post and insurance 2/6. Motif 2/-.

Pocket "6" as Pocket "5", but with Moving Coil Speaker and Q.P.P. output stage 95/-.

Seven days approval.

Order in confidence. We allow you seven days to decide whether or not to make the set, you may return the parcel as received within this time and your money will be refunded in full.

Read some of the testimonials, over 1,000 of which have been received about our Pocket Receivers.

**NOW THE "GOOD COMPANION" CAR RADIO AND PORTABLE**

Largely due to the helpful criticisms and suggestions received from purchasers of our previous set "The Real Companion" we have improved and now supersede this with a new set, which we call "The Good Companion". We feel confident that this new set is one of the finest of its kind available. The design is the combined efforts of our technicians and of those of several of the leading manufacturers in the country, and the resulting set has a performance as good as if not superior to those selling at £20 and more. It has the eight transistor set performance.

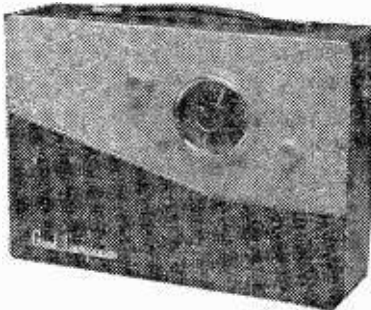

Features include American Philco R.F. transistors and Mullard A.F. transistors—Q.P.P. output giving 750 mW—full coverage on Medium and Long—very fine tuning arrangement—excellent reception of difficult stations like 208—variable feed-back control—full tonal qualities—really superior looking cabinet size 11 x 8 x 3in. approximately—or aerial attachment—several months operation from battery costing only 3/6.

Circuit employs six transistors and two diodes, it incorporates all latest refinements, and oscillator I.F. Transformer are pre-aligned so no instruments are necessary. Anyone who can solder competently can make this set. The instructions are fully comprehensive with plenty of illustrations. Service is available in the unlikely event of your getting into difficulties. All components fully guaranteed.

Price of all components and cabinet to make set as illustrated £9.19.6. Post and insurance 5/-. Battery 3/6 extra.

**AGENTS REQUIRED**  
 to make up this receiver

**ELECTRONIC PRECISION EQUIPMENT LTD.**

post orders are dealt with from Eastbourne, so for prompt attention please post your orders to 66 Grove Road, Eastbourne, marked Department 7. Callers may use any one of the Companies below.

- |   |   |  |  |  |
|---|---|--|--|--|
| 286 London Road,<br>Croydon.<br>Phone: CRO 8558<br>Half day Wednesday | 29 Stroud Green Rd.,<br>Finsbury Park, N.4.<br>Phone: ARO 1049<br>Half day Thursday | 520 High Street North<br>Minor Park, E.12.<br>Phone: ILF 1011<br>Half day Thursday | 42-46 Windmill Hill,<br>Ruislip, Middx.<br>Phone: RUISlip 5780<br>Half day Wednesday | 246 High Street,<br>Harrowden, N.W.10.<br>Phone: ELGAR 4444<br>Half day Thursday |
|---|---|--|--|--|

FURTHER HUGE PURCHASES DIRECT FROM SOURCE

# 13 CHANNEL TVs

TABLE MODELS, FAMOUS MAKERS. Complete with all valves and tubes. Unequaled in value. They are untested and not guaranteed to be in working order.

AMAZINGLY POPULAR-IDEAL SECOND SETS

12" - £2.19.0

p. & p. 12/6

14" - £4.19.0

p. & p. 15/-

12" 5 CHANNEL TVs 39/-

(p. & p. 12/6)

14" 5 CHANNEL TVs 59/-

(p. & p. 12/6)

TVs and Tubes are only sent to U.K. and N. Ireland

## LOUDSPEAKERS

TOP MAKES - MANUFACTURER

2 1/2in. 18/-; 3in. 18/-; 4 1/2in. 18/-; 5in. 16/-; 6 1/2in. 18/-; 8in. 19/-; 10in. 23/6; 7 x 4in. elliptical 13/-; 9 x 4in. elliptical 22/6; 10 x 6in. elliptical 23/6; 8 x 13in. Speakers 29/-.

PM SPEAKERS Surplus 3 ohm

Tested, top makes, performance guaranteed. 6 1/2in. 9/- 8in. 11/- 10in. 13/-

## TRANSISTORS

Yellow Spot, 2/6; Green Spot, 2/6; Red Spot, 3/6; White Spot, 3/6. Ediswan X310A, 2/6; XA103 (4 Me), 10/-; XA104 (6/8 Me), 12/-; O.C. 4/15/6, O.C. 4/15/-; O.C. 7/0, 14/-; O.C. 71, 8/-; O.C. 72, 12/-; (Matched Pairs 23/-); V15101P (10 watt power), 14/-; Yellow/Green, 5/-.

DIODES. SILICONE 125 v. 500 M.A. 2 in series make upper replacement for R.M.4 and R.M.5. 8/- each.

EY51 SHORT 4/6 U25 SHORT 8/- ENDS

# TUBES

DIRECT FROM OUR FACTORY

Due to the increasing demand for our wide range of CRTs and our efficient handling methods we offer unbeatable value.

TOP QUALITY GUARANTEED	6 MONTHS	12 MONTHS	18 MONTHS	BRAND NEW TYPES
Carriage and Insurance 12/6 CRM92. MW22-7, MW22-14, MW22-14C. MW22-17 MW22-18	£1-10	£3		MW31/74 £4
12KPA. 1.21K. C12B. CRM121. CRM121A CRM121B. CRM122. CRM123. MW31-14C. MW31/16. MW31/18. MW31/74	£1-15	£3-10		MW36/44 MW36/24 £5
141K. 7801A. C14FM. CRM141. CRM142. CRM143. MW36-24. MW36-44	£2	£4		CRM172 MW43/64 £6
171K. C17FM. CRM171. CRM172. MW43-64 MW43-69	£2-15	£4-15		
7401A. AW43-80. C14BM. C17BM. CRM151. CRM152A. CRM157B. CRM153. CRM173. MW43-80. MW43-1. 17ASP4	£3-15	£5-15		
AW53-80. CRM212. MW53-20. MW53-80				

PLEASE NOTE: Many other types not listed available. S.A.E. enquiries

## SUPER STEREO KIT

Kit of ready built units comprising two midgezt 3W amplifiers, push button switch, transformer, control unit (bass, treble, and v.l.), power pack, one speaker (2nd speaker 7/6 extra), indicator light. Valves and instructions, 59/6, P. & P. 3/-.

## 4-SPD. RECORD PLAYERS

Latest B.S.E. TU9 Turntable, together with light-weight Star Galaxy dual sapphire crystal turnover pick-up head. Truly amazing value.

£3.10.0

## UA8 Stereo Changers

B.S.R. famous Monarch autochangers, fitted with quality stereo cartridge. Truly amazing value. £6.19.0

RENEW YOUR PICK-UP. Cartridges only. Acos 22/6; Sotomote 17/-; Steig and Reuter 15/-; Power Plan 17/-. Complete with tone arm, 3/- extra.

CO-AX standard and low loss, 28 yds. 12/8. 50 yds. 22/6. 100 yds. 42/8. Co-ax. Plus 1/3. Wall outlet boxes 3/6.

## TEST SETS TYPE 74A

A service scope easily convertible for standard use, 300/250 v.a.c., all valves, E.C.R.30 tube, excellent case worth £10. Our Price. £4-10-0

## Audiotape

3in. Plastic 150 ft., 6/-; 4in. 300 ft., 10/6. 5in. 600 ft. 18/-; 9in. 850 ft., 24/8. 7in. 1,200 ft., 30/-.

## METERS

UNIVERSAL VOLT OHM MULTIMETER Reads A.C. and D.C. volts to 1000. 5 ranges at 1000 ohms per volt resistance reading to 200K in 2 ranges. Complete with prods. 59/6. P. & P. 1/6. EAGLE model EP-10K multimeter. 1000 ohms per volt. D.C. and A.C. £5.19.6. P. & P. 1/6.

100 RESISTORS 6/6  
100 CONDENSERS 10/-

Miniature Ceramic and Silver Mica Condensers 3 pF to 10,000 pF. LIST VALUE OVER £5.

## MAINS AMPLIFIERS

3 valve (10F3, 10P14, U9), 3 watt, 8in. loudspeaker, in two tone cases with controls. Ideal for record players, 19/6 P.P. 6/-

# ★ VALVES BY RETURN OF POST ★

The most competitive, comprehensive Valve list in the country

10% DISCOUNT SPECIAL OFFER TO PURCHASERS of any SIX VALVES marked in black type (15% in dozen). Post: 1 valve, 6d., 2-11, 1/-.

## NEW LOW PRICES GUARANTEED 3 MONTHS

024 5/- 6AG7 7/9 4/7 7/8	61V6 5/8 35L8GT 9/8	D152 2/9	5CC34 9/-	E141 8/-	MU1A 8/-	SP61 2/6	UCL83 13/6
1A5GT 5/- 6AK5 6/6 6J7G 7/8	12BR7 10/9 35W1 6/9	DA30 12/6	6CC35 6/-	E142 9/-	N37 11/-	SU2150A 8/6	UP41 8/6
147GT 11/3 6AL5 3/6 6J7GT 7/8	6E3 12/8 9/8 35Z6GT 5/3	DA90 2/6	6C40 19/6	E143 9/-	N78 15/-	U1 4/6	UF43 5/6
1C5GT 9/8 6AM9 3/- 6J8 8/6	6E4 12/8 16/8 35Z6GT 7/8	DA92 3/9	6C41 5/6	E144 7/-	N108 18/-	T41 4/6	UF44 5/6
1D5 8/6 6AQ5 6/- 6E6G 5/-	6E5 12/8 17/8 35Z6GT 7/8	DA93 3/9	6C42 5/6	E145 7/-	N152 8/9	TD4 7/6	UF45 8/6
1E0 9/8 6AT6 6/- 6E6GT 6/6	6E6 12/8 18/8 35Z6GT 7/8	DA94 3/9	6C43 5/6	E146 7/-	N152 8/9	TD4 7/6	UF46 8/6
1E5GT 9/8 6AU6 7/8	6E7 12/8 19/8 35Z6GT 7/8	DA95 3/9	6C44 5/6	E147 7/-	N152 8/9	TD4 7/6	UF47 8/6
1L4 3/6 6B7 8/6	6E8 12/8 20/8 35Z6GT 7/8	DA96 3/9	6C45 5/6	E148 7/-	N152 8/9	TD4 7/6	UF48 8/6
1L5 3/6 6B8 8/6	6E9 12/8 21/8 35Z6GT 7/8	DA97 3/9	6C46 5/6	E149 7/-	N152 8/9	TD4 7/6	UF49 8/6
1L6 3/6 6B9 8/6	6E10 12/8 22/8 35Z6GT 7/8	DA98 3/9	6C47 5/6	E150 7/-	N152 8/9	TD4 7/6	UF50 8/6
1L7 3/6 6C0 8/6	6E11 12/8 23/8 35Z6GT 7/8	DA99 3/9	6C48 5/6	E151 7/-	N152 8/9	TD4 7/6	UF51 8/6
1L8 3/6 6C1 8/6	6E12 12/8 24/8 35Z6GT 7/8	DA100 3/9	6C49 5/6	E152 7/-	N152 8/9	TD4 7/6	UF52 8/6
1L9 3/6 6C2 8/6	6E13 12/8 25/8 35Z6GT 7/8	DA101 3/9	6C50 5/6	E153 7/-	N152 8/9	TD4 7/6	UF53 8/6
1L10 3/6 6C3 8/6	6E14 12/8 26/8 35Z6GT 7/8	DA102 3/9	6C51 5/6	E154 7/-	N152 8/9	TD4 7/6	UF54 8/6
1L11 3/6 6C4 8/6	6E15 12/8 27/8 35Z6GT 7/8	DA103 3/9	6C52 5/6	E155 7/-	N152 8/9	TD4 7/6	UF55 8/6
1L12 3/6 6C5 8/6	6E16 12/8 28/8 35Z6GT 7/8	DA104 3/9	6C53 5/6	E156 7/-	N152 8/9	TD4 7/6	UF56 8/6
1L13 3/6 6C6 8/6	6E17 12/8 29/8 35Z6GT 7/8	DA105 3/9	6C54 5/6	E157 7/-	N152 8/9	TD4 7/6	UF57 8/6
1L14 3/6 6C7 8/6	6E18 12/8 30/8 35Z6GT 7/8	DA106 3/9	6C55 5/6	E158 7/-	N152 8/9	TD4 7/6	UF58 8/6
1L15 3/6 6C8 8/6	6E19 12/8 31/8 35Z6GT 7/8	DA107 3/9	6C56 5/6	E159 7/-	N152 8/9	TD4 7/6	UF59 8/6
1L16 3/6 6C9 8/6	6E20 12/8 32/8 35Z6GT 7/8	DA108 3/9	6C57 5/6	E160 7/-	N152 8/9	TD4 7/6	UF60 8/6
1L17 3/6 6C10 8/6	6E21 12/8 33/8 35Z6GT 7/8	DA109 3/9	6C58 5/6	E161 7/-	N152 8/9	TD4 7/6	UF61 8/6
1L18 3/6 6C11 8/6	6E22 12/8 34/8 35Z6GT 7/8	DA110 3/9	6C59 5/6	E162 7/-	N152 8/9	TD4 7/6	UF62 8/6
1L19 3/6 6C12 8/6	6E23 12/8 35/8 35Z6GT 7/8	DA111 3/9	6C60 5/6	E163 7/-	N152 8/9	TD4 7/6	UF63 8/6
1L20 3/6 6C13 8/6	6E24 12/8 36/8 35Z6GT 7/8	DA112 3/9	6C61 5/6	E164 7/-	N152 8/9	TD4 7/6	UF64 8/6
1L21 3/6 6C14 8/6	6E25 12/8 37/8 35Z6GT 7/8	DA113 3/9	6C62 5/6	E165 7/-	N152 8/9	TD4 7/6	UF65 8/6
1L22 3/6 6C15 8/6	6E26 12/8 38/8 35Z6GT 7/8	DA114 3/9	6C63 5/6	E166 7/-	N152 8/9	TD4 7/6	UF66 8/6
1L23 3/6 6C16 8/6	6E27 12/8 39/8 35Z6GT 7/8	DA115 3/9	6C64 5/6	E167 7/-	N152 8/9	TD4 7/6	UF67 8/6
1L24 3/6 6C17 8/6	6E28 12/8 40/8 35Z6GT 7/8	DA116 3/9	6C65 5/6	E168 7/-	N152 8/9	TD4 7/6	UF68 8/6
1L25 3/6 6C18 8/6	6E29 12/8 41/8 35Z6GT 7/8	DA117 3/9	6C66 5/6	E169 7/-	N152 8/9	TD4 7/6	UF69 8/6
1L26 3/6 6C19 8/6	6E30 12/8 42/8 35Z6GT 7/8	DA118 3/9	6C67 5/6	E170 7/-	N152 8/9	TD4 7/6	UF70 8/6
1L27 3/6 6C20 8/6	6E31 12/8 43/8 35Z6GT 7/8	DA119 3/9	6C68 5/6	E171 7/-	N152 8/9	TD4 7/6	UF71 8/6
1L28 3/6 6C21 8/6	6E32 12/8 44/8 35Z6GT 7/8	DA120 3/9	6C69 5/6	E172 7/-	N152 8/9	TD4 7/6	UF72 8/6
1L29 3/6 6C22 8/6	6E33 12/8 45/8 35Z6GT 7/8	DA121 3/9	6C70 5/6	E173 7/-	N152 8/9	TD4 7/6	UF73 8/6
1L30 3/6 6C23 8/6	6E34 12/8 46/8 35Z6GT 7/8	DA122 3/9	6C71 5/6	E174 7/-	N152 8/9	TD4 7/6	UF74 8/6
1L31 3/6 6C24 8/6	6E35 12/8 47/8 35Z6GT 7/8	DA123 3/9	6C72 5/6	E175 7/-	N152 8/9	TD4 7/6	UF75 8/6
1L32 3/6 6C25 8/6	6E36 12/8 48/8 35Z6GT 7/8	DA124 3/9	6C73 5/6	E176 7/-	N152 8/9	TD4 7/6	UF76 8/6
1L33 3/6 6C26 8/6	6E37 12/8 49/8 35Z6GT 7/8	DA125 3/9	6C74 5/6	E177 7/-	N152 8/9	TD4 7/6	UF77 8/6
1L34 3/6 6C27 8/6	6E38 12/8 50/8 35Z6GT 7/8	DA126 3/9	6C75 5/6	E178 7/-	N152 8/9	TD4 7/6	UF78 8/6
1L35 3/6 6C28 8/6	6E39 12/8 51/8 35Z6GT 7/8	DA127 3/9	6C76 5/6	E179 7/-	N152 8/9	TD4 7/6	UF79 8/6
1L36 3/6 6C29 8/6	6E40 12/8 52/8 35Z6GT 7/8	DA128 3/9	6C77 5/6	E180 7/-	N152 8/9	TD4 7/6	UF80 8/6
1L37 3/6 6C30 8/6	6E41 12/8 53/8 35Z6GT 7/8	DA129 3/9	6C78 5/6	E181 7/-	N152 8/9	TD4 7/6	UF81 8/6
1L38 3/6 6C31 8/6	6E42 12/8 54/8 35Z6GT 7/8	DA130 3/9	6C79 5/6	E182 7/-	N152 8/9	TD4 7/6	UF82 8/6
1L39 3/6 6C32 8/6	6E43 12/8 55/8 35Z6GT 7/8	DA131 3/9	6C80 5/6	E183 7/-	N152 8/9	TD4 7/6	UF83 8/6
1L40 3/6 6C33 8/6	6E44 12/8 56/8 35Z6GT 7/8	DA132 3/9	6C81 5/6	E184 7/-	N152 8/9	TD4 7/6	UF84 8/6
1L41 3/6 6C34 8/6	6E45 12/8 57/8 35Z6GT 7/8	DA133 3/9	6C82 5/6	E185 7/-	N152 8/9	TD4 7/6	UF85 8/6
1L42 3/6 6C35 8/6	6E46 12/8 58/8 35Z6GT 7/8	DA134 3/9	6C83 5/6	E186 7/-	N152 8/9	TD4 7/6	UF86 8/6
1L43 3/6 6C36 8/6	6E47 12/8 59/8 35Z6GT 7/8	DA135 3/9	6C84 5/6	E187 7/-	N152 8/9	TD4 7/6	UF87 8/6
1L44 3/6 6C37 8/6	6E48 12/8 60/8 35Z6GT 7/8	DA136 3/9	6C85 5/6	E188 7/-	N152 8/9	TD4 7/6	UF88 8/6
1L45 3/6 6C38 8/6	6E49 12/8 61/8 35Z6GT 7/8	DA137 3/9	6C86 5/6	E189 7/-	N152 8/9	TD4 7/6	UF89 8/6
1L46 3/6 6C39 8/6	6E50 12/8 62/8 35Z6GT 7/8	DA138 3/9	6C87 5/6	E190 7/-	N152 8/9	TD4 7/6	UF90 8/6
1L47 3/6 6C40 8/6	6E51 12/8 63/8 35Z6GT 7/8	DA139 3/9	6C88 5/6	E191 7/-	N152 8/9	TD4 7/6	UF91 8/6
1L48 3/6 6C41 8/6	6E52 12/8 64/8 35Z6GT 7/8	DA140 3/9	6C89 5/6	E192 7/-	N152 8/9	TD4 7/6	UF92 8/6
1L49 3/6 6C42 8/6	6E53 12/8 65/8 35Z6GT 7/8	DA141 3/9	6C90 5/6	E193 7/-	N152 8/9	TD4 7/6	UF93 8/6
1L50 3/6 6C43 8/6	6E54 12/8 66/8 35Z6GT 7/8	DA142 3/9	6C91 5/6	E194 7/-	N152 8/9	TD4 7/6	UF94 8/6
1L51 3/6 6C44 8/6	6E55 12/8 67/8 35Z6GT 7/8	DA143 3/9	6C92 5/6	E195 7/-	N152 8/9	TD4 7/6	UF95 8/6
1L52 3/6 6C45 8/6	6E56 12/8 68/8 35Z6GT 7/8	DA144 3/9	6C93 5/6	E196 7/-	N152 8/9	TD4 7/6	UF96 8/6
1L53 3/6 6C46 8/6	6E57 12/8 69/8 35Z6GT 7/8	DA145 3/9	6C94 5/6	E197 7/-	N152 8/9	TD4 7/6	UF97 8/6
1L54 3/6 6C47 8/6	6E58 12/8 70/8 35Z6GT 7/8	DA146 3/9	6C95 5/6	E198 7/-	N152 8/9	TD4 7/6	UF98 8/6
1L55 3/6 6C48 8/6	6E59 12/8 71/8 35Z6GT 7/8	DA147 3/9	6C96 5/6	E199 7/-	N152 8/9	TD4 7/6	UF99 8/6
1L56 3/6 6C49 8/6	6E60 12/8 72/8 35Z6GT 7/8	DA148 3/9	6C97 5/6	E200 7/-	N152 8/9	TD4 7/6	UF100 8/6
1L57 3/6 6C50 8/6	6E61 12/8 73/8 35Z6GT 7/8	DA149 3/9	6C98 5/6	E201 7/-	N152 8/9	TD4 7/6	UF101 8/6
1L58 3/6 6C51 8/6	6E62 12/8 74/8 35Z6GT 7/8						



# Stern's "fidelity" TAPE RECORDERS

There are no better value-for-money Tape Recorders on the market—if you can't call and hear them send S.A.E. for fully descriptive leaflet.

## For truly "Hi-Fi" Recordings

**MODEL CR3/S** Incorporates the COLLARO "STUDIO" TWIN TRACK 3-speed Deck, operating at 1 1/2in., 3 1/2in. and 7 1/2in. speeds ..... **£39.10.0**  
H.P. Terms: Deposit £7.18.0 and 12 months of £2.17.11.

**MODEL TR3/Mk.V1** Incorporates the New TRUVOX Mk. VI TWIN TRACK 2-speed Tape Deck operating at 3 1/2in. and 7 1/2in. speeds ..... **£49.10.0**  
H.P. Terms: Deposit £9.18 and 12 months of £3.12.7

The **MODEL HFG/2R** PORTABLE TAPE RECORDER (Original Price £33.0.0) **FOR ONLY 22 gns**

H.P. Dep. £4.14.0. 12 months £1.13.9. (Carr. & Ins. 10/- extra) Incorporates THE LATEST GARRARD "MAGAZINE" TAPE DECK and a HIGH QUALITY AMPLIFIER which is entirely based on the very successful MULLARD TYPE "A" DESIGN and specifically developed to operate the GARRARD DECK. Price INCLUDES SUPPLY OF THE GARRARD TAPE MAGAZINE and 4in. SPOOL OF DOUBLE PLAY TAPE, Comprises a Twin Track Recorder operating at 3 1/2in/sec. speed and providing up to 1 hour 10 mins. playing time. Truly "Portable", weighs only 22 lbs. Outstanding features are excellent performance and simplicity of operation.

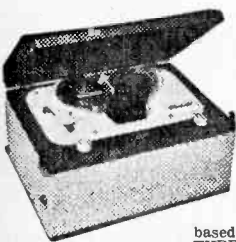

developed to operate the GARRARD DECK. Price INCLUDES SUPPLY OF THE GARRARD TAPE MAGAZINE and 4in. SPOOL OF DOUBLE PLAY TAPE, Comprises a Twin Track Recorder operating at 3 1/2in/sec. speed and providing up to 1 hour 10 mins. playing time. Truly "Portable", weighs only 22 lbs. Outstanding features are excellent performance and simplicity of operation.

FULLY DESCRIPTIVE LEAFLETS ON ALL OF ABOVE ARE AVAILABLE—BUT PLEASE ENCLOSE S.A.E. AND STATE WHICH LEAFLET IS REQUIRED.

EACH MODEL INCORPORATES THE MODEL HFTR3 MK. II TAPE AMPLIFIER (described overleaf)

Each price quoted provide for the COMPLETE RECORDER including CRYSTAL MICROPHONE and 1,200ft. Spool of Tape.

## THE 'ADD-A-DECK'

Incorporating GARRARD "MAGAZINE" TAPE and the MATCHED MODEL HF/G2P 'PRE-AMPLIFIER' Supplied on ONE CHASSIS (as illustrated) READY 18 Gns. FOR USE (Carr. & Ins. 10/- extra).

Price includes Garrard Magazine and a 4in. Spool Double Play Tape H.P. Deposit £3.16.0. and 12 months of £1.7.8. Provides complete tape recording facilities and designed to operate through the pick-up sockets of the standard type of RADIO RECEIVER, or an AMPLIFIER, from which really first class reproduction is obtained. It consists of a Twin Track Deck connected to the Pre-amplifier and operates at 3 1/2in/sec. speed providing up to 1 hr. 10 mins. playing time.



**STERN RADIO LTD.**  
Dept. P.W. 109 FLEET ST., LONDON, E.C.4  
Telephone: FLEET STREET 5812/3/4

# FREE TO AMBITIOUS ENGINEERS

— THE LATEST EDITION OF ENGINEERING OPPORTUNITIES

**Have you sent for your copy?** ENGINEERING OPPORTUNITIES is a highly informative 156-page guide to the best paid engineering posts. It tells you how you can quickly prepare at home for a recognised engineering qualification and outlines a wonderful range of modern Home Study Courses in all branches of Engineering. This unique book also gives full details of the Practical Radio & Electronics Courses, administered by our Specialist Electronics Training Division—the B.I.E.T. School of Electronics, explains the benefits of our Employment Dept. and shows you how to qualify for five years promotion in one year.

**We definitely Guarantee "NO PASS — NO FEE"**

Whatever your age or experience, you cannot afford to miss reading this famous book. If you are earning less than £25 a week, send for your copy of "ENGINEERING OPPORTUNITIES" today—FREE.

**WHICH IS YOUR PET SUBJECT?**

- Mechanical Eng.,
- Electrical Eng.,
- Civil Engineering,
- Radio Engineering,
- Automobile Eng.,
- Aeronautical Eng.,
- Production Eng.,
- Building, Plastics,
- Draughtsmanship,
- Television, etc.

**GET SOME LETTERS AFTER YOUR NAME!**

- A.M.I. Mech. E.
- A.M.I.C.E.
- A.M.I. Prod. E.
- A.M.I.M.I.
- A.I.O.S.
- A.F.R. Ac. S.
- B.Sc.
- A.M. Brit. I. R. E.
- City & Guilds
- Gen. Cert. of Education
- etc., etc.

**PRACTICAL EQUIPMENT**

Basic Practical and Theoretical Courses for beginners in Radio, T.V., Electronics, Etc., A.M. Brit. I.R.E. City & Guilds Radio Amateurs' Exam. R.T.E.B. Certificate P.M.G. Certificate Practical Radio Radio & Television Servicing Practical Electronics Electronics Engineering Automation

**INCLUDING TOOLS!**

The specialist Electronics Division of B.I.E.T. (incorporating E.M.I. Institutes) NOW offers you a real laboratory training at home with practical equipment. Ask for details.

**B.I.E.T. SCHOOL OF ELECTRONICS**



**POST COUPON NOW!**

Please send me your FREE 156-page "ENGINEERING OPPORTUNITIES" (Write if you prefer not to cut page)

NAME .....

ADDRESS .....

SUBJECT OR EXAM THAT INTERESTS ME ..... (SE/21)

**BRITISH INSTITUTE OF ENGINEERING TECHNOLOGY (Incorporating E.M.I. Institutes)**  
(Dept. SE/21), 29 Wright's Lane, London, W.8

**THE B.I.E.T. IS THE LEADING ORGANISATION OF ITS KIND IN THE WORLD**

# STERN'S MULLARD DESIGNS

Designed by MULLARD—presented by STERN'S strictly to specification

## COMPLETE KIT OF PARTS MULLARD "5-10" MAIN AMPLIFIER

For use with the MULLARD 2-valve pre-amplifier with which undistorted power output of up to 10 watts is obtained. We supply SPECIFIED COMPONENTS and new MULLARD VALVES, including PARMEKO MAINS TRANSFORMER and choice of the latest Ultra-Linear PARMEKO or the PARTRIDGE Output Transformer. COMPLETE KIT OF PARTS £10.00 Alternatively we supply ASSEMBLED and TESTED £11.00

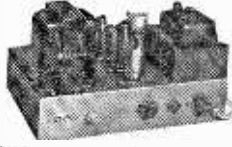

INCORPORATING PARTRIDGE OUTPUT TRANSFORMER, £1.60 EXTRA.

## MULLARD'S PRE-AMPLIFIER TONE CONTROL UNIT

Employing two EF86 valves, and designed to operate with the MULLARD MAIN AMPLIFIERS, but also perfectly suitable for other makes. PRICE COMPLETE KITS OF PARTS £6.60



ASSEMBLED AND TESTED £8.00

- Equalisation for the latest R.I.A.A. characteristics.
- Input for Crystal Pick-ups, and variable reluctance magnetic types.
- Input (a) Direct from High Imp. Tape Head. (b) From a Tape Amplifier or Pre-amplifier.
- Sensitive Microphone Channel. ● Wide range BASS and TREBLE Controls.

## COMPLETE MULLARD "5-10" AMPLIFIER

The popular and very successful complete "5-10" incorporating Control Unit providing up to 10 watts high quality reproduction. Only Specified Components and new MULLARD VALVES are supplied including PARMEKO MAINS TRANSFORMERS and choice of the latest PARMEKO or PARTRIDGE ULTRA-Linear Output Transformers.

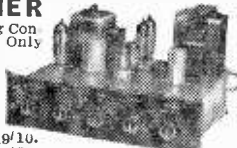

KIT OF PARTS £11.00 OR ASSEMBLED AND TESTED £13.00

H.P. (Assembled Amp. only). DEPOSIT £2.14.012 months at 19/10. ABOVE incorporating PARTRIDGE OUTPUT TRANS. £1.60 extra.

## PRICE REDUCTIONS

- (a) The KIT OF PARTS to build both the "5-10" Main Amplifier and the 2-valve PRE-AMP CONTROL UNIT. £15.15.0
- (b) The "5-10" and the 2-stage PRE-AMP both ASSEMBLED and TESTED H.P. Dep. £3.16.0 and 12 months of £1.7.8. £18.18.0
- (c) The KIT OF PARTS to build the DUAL-CHANNEL "3-3" AMPLIFIER and the DUAL-CHANNEL PRE-AMPLIFIER CONTROL UNIT. £21.10.0
- (d) The DUAL-CHANNEL "3-3" AMPLIFIER and the DUAL-CHANNEL PRE-AMPLIFIER CONTROL UNIT BOTH ASSEMBLED and TESTED. £25.0.0
- H.P. Terms: Deposit £5 and 12 months of £1.16.6.
- (e) The KIT OF PARTS to build one "5-10" MAIN CHANNEL and the DUAL-CHANNEL PRE-AMP CONTROL UNIT (f) ONE "5-10" AMPLIFIER and the DUAL-CHANNEL PRE-AMPLIFIER both ASSEMBLED and TESTED. £31.0.0
- H.P. Terms: Deposit £5, 12 months of £1.18.8.
- (g) KIT OF PARTS to build two "5-10" MAIN AMPLIFIERS (incorporating Parmeko Output Transformers) and the DUAL-CHANNEL PRE-AMPLIFIER CONTROL UNIT. £31.0.0
- (h) TWO "5-10" AMPLIFIERS and the DUAL-CHANNEL PRE-AMPLIFIER CONTROL UNIT BOTH ASSEMBLED & TESTED £36.0.0
- H.P. Terms: Deposit £7.4.0, 12 months £2.12.0.
- Carriage and Insurance 7/6 extra. Prices quoted are subject to £1.60 extra for Partridge Transformer.

## COMPLETE MULLARD "3-3"

THE IDEAL AMPLIFIER FOR A SMALL HIGH QUALITY INSTALLATION PROVIDING EXCELLENT REPRODUCTION OF UP TO 3 WATTS OUTPUT. COMPLETE KIT £7.10.0 OR ASSEMBLED £8.19.6 (plus 6/6 carriage and insurance) H.P. Terms: Deposit £2.0.0 and 8 Months at £1.0.0. Complete to MULLARD'S SPECIFICATION including Mullard valves and a PARMEKO OUTPUT TRANSFORMER.



## STEREO PRE-AMPLIFIER

This model incorporates two Mullard 2-valve Pre-Amplifiers combined into a Single unit enabling it to be used for both STEREO-PHONIC or MONAURAL operation. It is designed primarily to operate with our MULLARD MAIN AMPLIFIERS but will also operate equally well with any make of Amplifiers requiring an input of 250m/volts.



COMPLETE KIT OF PARTS £12.10.0 ASSEMBLED AND TESTED £15.0.0 H.P. £3 Dep. and 12 mths. at £1.2.0

## MULLARD FOUR CHANNEL MIXER UNIT

Self powered with Cathode follower output. Incorporates two inputs for MICROPHONES and One for CRYSTAL PICK UP and a fourth for RADIO or TAPE Complete Kit of Parts £8.8.0 Assembled and Tested £10.0.0



TERMS: Deposit £2 and 12 months at 15/-. MODEL LL one microphone input matched for moving coil or Ribbon Mike. £11.7.0 extra.

## RECORD PLAYERS THE LATEST MODELS ARE IN STOCK, SEND S.A.E. FOR ILLUSTRATED LEAFLET

- B.S.R. MONARCH UAS 4-speed mixer Autochanger with Crystal Pick-up. £6.19.6
- The NEW COLLARO MODEL RP594 4-speed Single Record Player, Studio Cartridge. £9.18.9
- The NEW COLLARO C80 4-speed Autochanger unit with Studio "O" Pick-up. £7.19.6
- The E.M.I. 4-speed Single Record Player with crystal Pick-up. £6.9.6
- B.S.R. MODELS UA12 and UA14. Each a 4-speed mixer autochanger with Crystal Pick-up. £7.19.6
- Both available incorporating the B.S.R. STEREO Pick-up, plays LP, and 78 Records. £8.13.10
- GARRARD MODEL TA/MK11 4-speed Player fitted high output Crystal Pick-up. £8.10.0
- GARRARD MODEL RC/209 Autochanger 4-speeds. High output. Crystal Pick-up. £8.19.6
- Carriage and Insurance on each above, 5/- extra.

Incorporates the latest circuitry, the design is based on the popular Mullard "Type O" Unit and employs a sensitive meter for accurately setting record level.

# STERN RADIO LTD.

## SPECIAL CASH OFFER

This very attractive PORTABLE AMPLIFIER CASE, together with a good quality GRAM AMPLIFIER and a matched P.M. SPEAKER. ALL FOR ONLY £8.7.6 (Plus 7/6 Carr. & Ins.)



The Amplifier consists of a 2-stage design incorporating 3 modern V.V.A. valves and has separate BASS and TREBLE CONTROLS.

The Portable Case will also accommodate almost any make of Autochanger and is attractively finished in Mushroom Grey Rexine. WE ALSO SUPPLY SEPARATELY—

- (a) The 2-stage (plus Rectifier) AMPLIFIER £4.2.6
- (b) THE PORTABLE CARRYING CASE £3.17.6
- (c) 6 1/2 in. P.M. SPEAKER 18/9 Carriage and Insurance 4/- extra.

## STERN'S INTER-COMM or BABY ALARM

A small versatile Unit employing the new MULLARD ECL86 valve and designed to provide two (or three) way conversation up to extreme distances. Operates from A.C. mains 200 to 250 Volts.

PRICES... MASTER UNIT and ONE EXTENSION



KIT OF PARTS £6.17.6 ASSEMBLED AND TESTED £8.0.0

Consists of a MASTER UNIT, size only 8 1/2 x 5 1/2 x 6 in. and ONE EXTENSION (a second extension may be added to any time). The Master Unit incorporates switching and power supply and with the chassis completely isolated from the mains is operated in absolute safety. Cases covered in quality leatherette.

## PRE-ANNOUNCEMENT TO STEREO ENTHUSIASTS

In response to the growing demand for Stereophonic equipment we have completed the design of a

## HIGH FIDELITY STEREO TAPE PRE-AMPLIFIER



# Stern's "fidelity" TAPE EQUIPMENT

ADD "HI-FI" TAPE RECORDING TO YOUR EXISTING AUDIO INSTALLATION WITH

MULLARD TYPE "C" TAPE PRE-AMPLIFIER—ERASE UNIT



The "HI-FI" link to add full tape recording facilities to High Fidelity home installations. Incorporates FEROXUCUBE POT CORE PUSH FULL OSCILLATOR and 3-speed treble equalisation by FEROXUCUBE POT CORE INDUCTOR FOR WEARITE-PAPELAMP and POWER UNIT ASSEMBLED KIT OF PARTS. Includes separate power Supply Unit. OR ASSEMBLED KIT OF PARTS

**£14.00** H.P. £23.8.0 Deposit and 12 months £14.11  
**£17.00** (Including power unit £11.5.0 and £14.10.0 respectively).

### SPECIAL "COMBINED ORDER" PRICES

- (a) The COLLARO "Studio" Deck with the Model "C" Preamplifier and POWER SUPPLY UNIT ASSEMBLED AND TESTED ..... **£29.10.0**
- (b) As above but the TYPE "C" Unit and POWER UNIT supplied as COMPLETE KIT OF PARTS. Deposit £5.8.0. 12 monthly payments of £1.18.10 ..... **£26.10.0**
- (c) The TRUVOX Mk.VI Deck (incorporating Pause Control and Rev. Counter) with the Model "C" PREAMPLIFIER and POWER UNIT ASSEMBLED AND TESTED. .... **£40.0.0**
- (d) As above but the Model "C" PREAMPLIFIER and POWER UNIT supplied as a COMPLETE KIT OF PARTS ..... **£36.10.0**
- (e) The BRENELL Mk.V Deck with the Model "C" PREAMPLIFIER and POWER UNIT. ASSEMBLED AND TESTED. .... **£46.0.0**
- (f) As above but the Model "C" PREAMPLIFIER and POWER UNIT supplied as a COMPLETE KIT OF PARTS ..... **£43.0.0**
- (g) Deposit £3.12.0. 12 monthly payments of £3.3.1 The WEARITE MODEL "4" DECK with ASSEMBLED AND TESTED Model "C" PREAMPLIFIER and POWER UNIT incorporating WEARITE HEADLIFT TRANSFORMER, Etc. .... **£56.0.0**  
 (Carriage and Insurance on above is 10/- extra)

### A NEW DESIGN!!!

MULLARD'S STEREO-PHONIC POWER AMPLIFIER

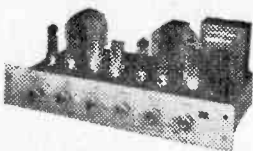

A high fidelity design based on the famous Mullard "5-10". Provides up to 10 watts (per channel) Superb reproduction. Frequency response flat to within 3 db from 3c/s. To 80 Kc/s at 50Mw. Total Harmonic Distortion at 10 watts 0.1%.

(a) ASSEMBLED COMPLETE AMPLIFIER. including CONTROL UNIT (as illustrated) ..... **PRICE: £21.0.0**

(b) A complete KIT OF PARTS will be available in OCTOBER for ..... **£18.10.0**

Built to the very highest technical standards and presented strictly to MULLARD'S specification. Incorporates complete Mullard valve line-up including two of the new valves, type ECL86, in each channel. Two specially designed GILSON OUTPUT TRANSFORMERS with 20% taps are used for ultra linear operation.

The matching CONTROL UNIT is designed to be either attached to the Amplifier (as illustrated) or can be detached for separate mounting on a Cabinet panel. Provides inputs for CRYSTAL PICK UPS, RADIO TUNING UNIT, and also for replaying from our STEREO TAPE PRE-AMPLIFIER (Briefly mentioned opposite).

AS AUDIO SPECIALISTS WE CONFIDENTLY RECOMMEND THIS DESIGN IT IS A MUST TO THE serious minded sound enthusiast. We can also supply the assembled MAIN AMPLIFIER only (excludes control unit) for operation with our DUAL CHANNEL PRE-AMPLIFIER, this provides for a more versatile or elaborate installation and would be essential if a low output Magnetic Pick Up, such as the Decca, is to be used.

- (a) THE ASSEMBLED MAIN AMPLIFIER with the ASSEMBLED DUAL CHANNEL PRE-AMPLIFIER ..... **PRICE: £30.0.0**  
 Deposit £6.0.0. 12 months of £2.4.0.
- (b) A complete KIT OF PARTS for both Units will be available in October for ..... **£26.0.0**

# HOME CONSTRUCTORS BUILD A HIGH FIDELITY TAPE RECORDER LIKE THIS



for £35.0.0

Deposit £7.0.0, 12 months at £2.11.4.

### FOR THIS WE SUPPLY

- Complete Kit of Parts to Build the HF/TR3 Tape Amplifier.
- The New Collaro "Studio" Tape Deck.
- Portable Carrying Case (as illustrated).
- Rola/Celestion 10 x 6in. p.m. Loudspeaker.
- ACOS Crystal Microphone and 1.200ft. Spool E.M.I. Tape.

Alternatively for those who prefer another make of Tape Deck—we will supply precisely as above—but in place of the Collaro "Studio" Deck, We will include: **£45.0.0**

- The New Truvox Mk. VI Deck. Deposit £9.0.0, 12 months at £3.6.0.
- For Constructors with their own cabinet—WE OFFER—
- (a) COMPLETE KIT to build the HF/TR3 Mk.II Amplifier together with the COLLARO "STUDIO" DECK. Deposit £5.4.0. 12 monthly payments of £1.18.2 ..... **£26.0.0**
- (b) As above but with the HF/TR3 Mk.II supplied ASSEMBLED AND TESTED. .... **£29.10.0**
- (c) Deposit £5.18.0. 12 monthly payments of £2.3.4. COMPLETE KIT to build the HF/TR3 Mk.II together with the TRUVOX Mk. VI TAPE DECK ..... **£36.10.0**
- (d) Deposit £7.8.0. 12 monthly payments of £2.13.6. As above but with HF/TR3 Mk.II supplied ASSEMBLED AND TESTED ..... **£40.0.0**
- (e) Deposit £9.0.0. 12 monthly payments of £2.18.8. COMPLETE KIT to build the HF/TR3 Mk.II AMPLIFIER with the BRENELL Mk.V TAPE DECK. Deposit £8.8.0 12 monthly payments of £3.1.7. As above but with HF/TR3 Mk.II supplied, ASSEMBLED AND TESTED ..... **£42.0.0**
- (f) As above but with HF/TR3 Mk.II supplied, ASSEMBLED AND TESTED ..... **£45.10.0**
- (g) Deposit £9.2.0. 12 monthly payments of £3.6.9. THE ASSEMBLED AND TESTED HF/TR3 Mk.II AMPLIFIER with the WEARITE MODEL 4A DECK, incorporates Wearite Head Lift Transformer etc. .... **£56.0.0**  
 Deposit £11.0.0. 12 monthly payments of £4.0.8. (Carriage and Insurance on each above is 10/- extra)

### MODEL HF/TR3 MK.II TAPE AMPLIFIER

(Mullard Type "A" design) A very high quality Amplifier incorporating 3-speed treble equalisation, by the latest FEROXUCUBE POT CORE INDUCTOR, FOR COLLAROTRUVOX Mk. VI TAPE DECK WEARITE Tape Decks, has GILSON Output Transformer. Includes separate Power Supply Unit.



KIT OF PARTS **£13.13.0** OR ASSEMBLED **£17.0.0**  
 H.P. Deposit £3.8.0 and 12 months at £1.4.11

### STEREOPHONIC RECORD PLAYER FOR SIMPLE UNIT ASSEMBLY

A most compact portable design consisting of TWIN CHANNEL AMPLIFIER based on the latest design by MULLARD LTD., incorporating top grade Output Transformers, and the new audio Triode-Pentode Valves Mullard E.C.L.86. Separate Bass and Treble controls. Suitable for use with Crystal Pick Ups, and capable of genuine high quality reproduction up to 3 watts per channel. An attractive and contemporary portable Case in two tone colours. The unique feature of the design is the loudspeaker mounting. Two 8 x 5in. p.m. elliptical loudspeakers are separately baffled and mounted in the lid, which is detachable, allowing for each speaker to be individually positioned in any part of the listening area. We offer a very versatile stereo arrangement tested and guaranteed which can be assembled in the minimum of time, at a comparatively Very Low Cost.

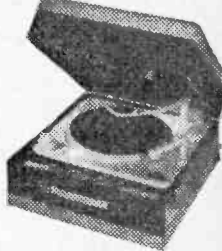

- PRICE for the ASSEMBLED AMPLIFIER, Two 8 x 5in. ROLA SPEAKERS and PORTABLE CASE ..... **£14.0.0**
- Deposit £2.18.0. 12 months of £1.0.6 ..... **£7.15.0**
- ASSEMBLED AMPLIFIER, supplied for ..... **£1.1.0**
- 8 x 5in. ROLA LOUSPEAKERS (3 ohms) each. .... **£5.0.0**
- PORTABLE CASE ..... **£5.0.0**

A CHOICE OF SINGLE RECORD PLAYERS and AUTOCHANGERS are available from Stock (Send S.A.E. for details)

Dept. P.W. 109 FLEET ST., LONDON, E.C.4

Telephone: FLEET STREET 5812/3/4



**DELUXE RECORDER**

**CABINET**  
**79/6**



Beautifully styled rexine covered cabinet in Red or Beige. Size 14½ x 13 x 9½ in. Storage comp. in lid for tapes and mike. Easily adapted to Record Player Cabinet. Ins., Carr. 4/6.

**TAPE RECORDER AMPLIFIER**

**£7.19.6**



Compact, well designed 5 valve amplifier. Output 3.5W. Input for Microphone, Radio and Gram. Size 8½ x 3 x 4½ in. Ins., carr. 4/6. 12 months' guarantee. Terms available. Extras: Dial plate, including sockets and superimpose switch, 3/6. Knobs 2/6.

**TAPE RECORDER AMPLIFIER £9.15.6**

By famous manufacturer. Superb 4 valve amplifier. Two controls and superimpose switch. Sockets for Mike and Gram. Size 11 x 4 x 6 in. Ins., Carr. 4/6. Drawings FREE with Order.

**SCOTCH BOY TAPES**

**19/9** 5½ in. **7 inch. 25/-**  
Limited quantity. POST FREE.

**MINIATURE SPEAKERS**

**16/9** Brand new 2½ and 3 in. P. & P. 1/.

**ELLIPTICAL SPEAKERS**

**15/9** Brand new slot type. 8 x 3 in. and 7 x 4 in. P. & P. 2/9.

**EXTENSION SPEAKERS**  
**19/9**



8 in. P.M. Speaker fitted into polished cabinet. Complete. Switch and flex included. P. & P. 3/9.

REPLACEMENT REBUILD

**TV TUBES**



**12**  
Months' Guarantee  
HP Terms available

21in. ... ..	99/6
17in. ... ..	90/-
15, 14, 12in. ... ..	70/-

Ins., Carr. 15/6

£1 extra without old bowl, refundable if same received within 14 days.

**14in. TV TUBES 35/-**

14KP4 and 36/24. Due to purchase of Rental replacement stocks. Carriage 5/-.

**COMPLETE 17in. TV**

**£11.10.0**

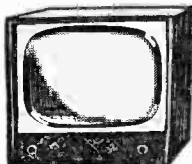

An excellent Ex-Rental Table Model. Famous manufacturer. Tuned ITA/BBC. Guaranteed 12 months. Terms available. Personal collection advised. Special delivery rate by arrangement up to 50 miles, or despatched in 3 parcels for easy assembly. Cart. & Ins. 25/-.

**COMPLETE 14in. TV**

**£7.10.0**

ITA/BBC. As above. Ideal for Caravans—Chalets—Weekend Bungalows etc. Carriage and Insurance 20/-.

**VALVES**

Salvage Guaranteed

2/9d. each **30/- Dozen**  
ECC31, ECC34, ECC81, ECC82, ECC85, ECC91, ECH42, EF80, EF92, EL32, EL36, EY51, KT36, L63, N18, N37, PL33, U22, U31, U35, U151, U281, U282, 6L18, 6U4GT, 10D1, 10F1, 12A7, 275U,

5/9d. each **60/- Dozen**  
EBC33, EBF80, ECF80, ECL80, EL33, EL38, EL41, EY85, GZ32, KT63, LNI52, LNI309, PCC84, PCF80, PCF82, PL81, PL82, PL83, PY80, PY81, 6F6, 6K8, 6Q7, 6V6, 7AN7, 9BW6.

POSTAGE

1 Valve—7d. 6 Valves—1/6. 12 Valves—2/6.

**DUKE & CO.**

(LONDON) LTD.  
621/3 Romford Road,  
MANOR PARK, E.12.

ILF 6001/3

9 a.m.—6 p.m.  
Half Day Thursday

STAMPS FREE  
CATALOGUE

**RECORD PLAYER CABINET**

**69/6**



Luxury cabinet in two tone coffee colour. Size 15½ x 17 x 9½ in. Takes all popular record player units and amplifiers. Position for 8 in. Speaker. Detachable lid for Stereo conversion. P. & P. 4/6.

**"ARGOSY" RECORD PLAYER CABINET 19/6**

Exceptional offer. A lightweight portable player Cabinet by famous manufacturer. Size 14½ x 11½ x 6 in. Takes our single player; 2 control Amplifier; 5 in. Speaker. Post, packing and Insurance, 5/6.

**TAPE RECORDER AMPLIFIER**

12 months' guarantee **MK. D.2**

**79/6**



Latest design incorporating negative feedback, giving 4 watts undistorted output. Valves: ECL82, and metal rectifier. Tone and volume control panel on flying leads. P. & P. 3/6.

**TRANSISTORS**

Complete Set **47/6**

POST FREE

**MULLARD**  
1—OC81D 6/9 2—OC81 6/9  
1—OC44 9/9 2—OC45 8/9  
1—Diode 1/9

**EDISWAN**  
XC121 8/9 XB113 8/9

**G.E.C.**  
114 6/9 873 8/9  
2—874 9/9

**SOLO SOLDERING TOOL**

ONLY

**12/6**



110 v., 6 v. or 12 v. (special) adaptor for 200/250 v., 10/- (extra). Automatic solder feed including reel solder and spare parts. It is a tool for electronic soldering or car wiring. Revolutionary in design. Cannot burn. In light metal case with full instructions for use. Post 3/6.

**ARMSTRONG AF208 AM/FM RADIOGRAM CHASSIS**

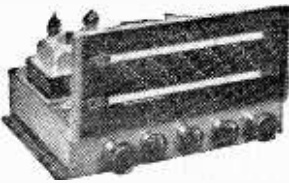

★ Full VHF Band (87-108 Mc/s and Medium Band, 187-570M) ★ 7 Valves ★ 5 Watts Output ★ 15db Negative Feedback ★ Separate wide range Bass and Treble Controls ★ 2 Compensated Pick-up Inputs ★ Frequency Response 30-22,000 c.p.s. ±2db ★ Tape Record and Playback Facilities ★ Continental Reception of Good Programme Value ★ For 3, 7 and 15 ohm speakers. Send S.A.E. for leaflet.

**PRICE 22 GUINEAS Carr. Free**

**LATEST "E.M.I." 4 SPEED SINGLE RECORD PLAYER**

Acos Hi-Fi Pick-up for LP, and/or 78, 7, 10 and 12in. records. Silent motor, heavy turntable, auto stop.

Special offer **£6.5.0** post free. Stereo/Monaural **£19.6.**

**BUILD THIS REPRODUCER BARGAIN**

**SPECIAL SINGLE PLAYER KIT**  
 B.S.R. TU9 4-speed Gram-Pick-up Unit  
 Handsome portable case, 13 1/2 x 15 x 8 1/2 in. ... **£4.5.0**  
 Ready-built 3-watt, printed circuit, amplifier with two valves and speaker ... **£2.9.6**  
**or £9.9.0 complete kit, post free.**

**L.F. TRANSFORMERS 7/6 pair**

465 kc/s slug tuning miniature can 1 1/2 x 1 x 1/2 in. High Q and good band width. Data sheet supplied.

**New Boxed VALVES 90-day Guarantee**

1R5	7/6 EK9G	7/6 EA50	1/6 EZ90	7/6
1R5	7/6 EK9G	10/6 EA8C80	8/6 K1148	1/6
1T4	6/- 6N7M	6/6 EB91	6/- HAB30	6/6
2X3	3/6 6Q7G	8/6 EB33	8/6	12/6
2R4	7/6 6A7	6/- EB41	8/6 HVR2A	6/6
3V4	7/6 6B7M	6/6 EB90	10/- MU14	9/6
5U4	7/6 6BN7	6/6 EC34	9/6 PG1	3/6
5Y3	7/6 6V6G	6/6 EC90	9/6 PC34	9/6
5Z4	6/6 6X4	7/6 EC142	10/6 PCP80	9/6
6AM6	5/- 6X5	7/6 EC180	10/6 PCL82	11/6
6B8	5/- 12A6	6/6 EB20	10/6 PEN25	6/6
6BE5	7/6 12AT7	8/- EP39	5/6 PLK1	12/6
6BE6	9/6 12AU7	8/- EP41	5/6 PLK2	10/6
6BW6	9/6 12AX7	8/- EP50	5/6 PY80	7/6
6D6	6/- 12BE6	6/6 EP80	8/- PY81	9/6
6F9	7/6 12K7	8/6 EP86	12/6 PY82	7/6
6H6	3/6	6/6 EP92	5/6 SP61	3/6
6J5	5/6 35L6	6/6 EP41	9/6 UC41	9/6
6J6	5/6 35Z4	7/6 EL11	9/6 UC42	9/6
6J7G	6/6 30	9/6 EL34	8/6 UF41	9/6
6KEGT	6/6 807	5/6 EY51	9/6 UL41	9/6
6K7G	5/- 954	1/6 EZ40	7/6 UY41	8/-

DK96, DP96, DAF96, DL96, 8/6 each or 80/- set.

NEW ELECTROLYTICS TUBULAR		FAMOUS MAKES TUBULAR		CAN TYPES	
1/350V	2/- 50/350V	5/6	18/45V	5/6	-
2/350V	2/3 100/25V	3/-	32/350V	5/6	-
4/450V	2/3 250/25V	2/-	100/270V	5/6	-
8/450V	2/3 500/12V	3/-	2,500/2V	5/6	-
8/500V	2/3 8+8/450V	3/6	5,000/8V	5/6	-
16/450V	3/- 8+8/500V	3/6	32+32/350V	5/6	-
16/500V	4/- 8+16/450V	3/6	32+32/450V	6/-	-
32/450V	3/9 8+16/500V	5/6	32+32+32/350V	7/-	-
25/25V	1/9 16+16/450V	4/3	50+50/350V	7/-	-
50/25V	2/- 16+16/500V	6/-	64+120/350V	11/6	-
50/50V	2/- 32+32/350V	4/6	100+200/275V	12/6	-

**C.R.T. BOOSTER TRANSFORMERS**

For Cathode Ray Tubes having heater cathode short circuit and for C.R. Tubes with falling emission, full instructions supplied.

Type A. Optional 25% and 50% Boost. 2V or 4V or 6.3V or 10.8V or 13.3V. Mains input. **12/6**

Type A2. High quality, low capacity. 10/15PF. Optional boost 25%, 50%, 75%. Mains input. **16/6**

Type B. Mains input. Low capacity. Multi output 2, 4, 6.3, 10 and 13V. Boost 25% and 50%. This transformer is suitable for all TV tubes. 21/- each.

**QMAX CHASSIS CUTTER**

The cutter consists of three parts: a die, a punch and an Allen screw.

Sizes	Prices	Key
1/4 in. ...	12/9	1/-
1/2 in. ...	13/9	1/-
3/4 in. ...	13/9	1/-
1 in. ...	13/9	1/-
1 1/4 in. ...	16/-	1/6
1 1/2 in. ...	16/-	1/6
1 3/4 in. ...	16/-	1/6
2 in. ...	18/-	1/6
2 1/4 in. ...	18/-	1/6
2 1/2 in. ...	20/-	2/3
2 3/4 in. ...	33/6	2/3
3 in. ...	36/6	2/3
3 1/2 in. ...	20/-	1/6

lin. square hole ... 20/-  
 O.P. TRANSFORMERS. Heavy Duty 50 mA. 4/6. Multitap, push-pull, 7/6. Ditto, 10 w. 15/6. Miniature, 3s4, etc., 4/6. L.F. CHOKES 15/10 H. 60/65 mA. 5/-; 10 H. 85 mA. 10/6; 10 H., 150 mA. 14/-

MAINS TRANSFORMERS 200/250 v. A.C. STANDARD.	
250-0-250, 80 mA, 6.3 v. 3.5 a. tapped 4 v. 4 a. Revider 6.3 v. 1 a. 5 v. 2 a. or 4 v. 2 a. ditto, 350-0-350	22/6
MINIATURE 200 v. 20 mA, 6.3 v. 1 a.	10/6
MIDGET 220 v. 45 mA, 6.3 v. 2 a.	15/6
SMALL 220-0-220, 50 mA, 6.3 v. 2 a.	17/6
STD. 250-0-250, 65 mA, 6.3 v. 3.6 a.	17/6
HEATER TRANS. 6.3 v. 1 1/2 amp.	7/6
Ditto, tapped sec. 2, 4, 6.3 v., 1 1/2 amp.	8/6
Ditto, sec. 6.3 v. 3 amp.	10/6
GENERAL PURPOSE LOW VOLTAGE, 2a.	
3, 4, 5, 6, 8, 9, 10, 12, 15, 18, 24, 30 v.	22/6
AUTO TRANS. 110-240 v. 150 w.	22/6
Ditto, 500 w.	32/6

**TELEVISION REPLACEMENT Line Output Transformers**

from 45/- each, New Stock and other timebase components. Most makes available. S.A.E. with all enquiries.

FULL WAVE BRIDGE SELENIUM RECTIFIER: 2.5 or 12 v. 1 1/2 amp., 8/9; 2 a., 11/3; 4 a., 17/6. CHARGER TRANSFORMERS. Tapped input 200/250 v. for charging at 2, 6 or 12 v., 1 1/2 amps., 15/6. 2 amps., 17/6; 4 amps., 22/6. Circuit included. 4 AMP CAR BATTERY CHARGER with amp meter Leads, Fuse Case, etc., for 6 or 12 v., 69/6.

**BOOKS**

40 Circuits for Germanium Diodes 3/-. "W.V." Radio Valve Data, 6/-. High Fidelity speaker Enclosures, 5/- Valve and TV Tube Equivalents, 9/6. TV Fault Finding, 5/-. Quality Amplifiers, 4/6. Radio Valve Guide. Books 1, 2, 3 or 4, 5/- each. Transistor Superhet Receivers, 7/6.

**CRYSTAL MIKE INSERT**

by Acos 8/6 Precision engineered. Size only 1 1/2 in. dia x 1 in. ACOS CRYSTAL MIKE 40 .. 25/- DE LUXE STICK MIKE .. 35/-

LOUDSPEAKER P.M. 3 OEM. 5in. Rols, 17/6; 8in. Plessey, 19/6. 7in. x 4in. Plessey, 18/-; 6in. Rols, 18/6. 10 x 6in. 27/6. 10in. Rols, 30/-; 6in. Tweeter 25/-; 13in. R.A., 30/-; 14 x 8in. 45/-; STENTORIAN HP1012. 10in. 3 to 15 ohms, 10 w., 86/-

**BAKER SELHURST LOUDSPEAKERS**



12in. Baker 15w. Stalwart, 3 or 15 ohms ... 90/-  
 12in. Baker ditto, foam suspension, 15 ohms ... 26  
 12in. Baker Ultra Twelve, 20 c.p.s. to 25 kcs £17.10  
 15in. Auditorium, 35 w., £16

CRYSTAL DIODE G.E.C. 2/- GEX34, 4/- HIGH RESISTANCE PHONES, 4,000 ohms, 15/- pr. MIKE TRANSF. 50 : 1, 3/9 ea.; 100 : 1, Potted, 10/6. SWITCH CLEANER, Fluid squirt spout, 4/3 tin. TWIN GANG TUNING CONDENSERS, 365 pF miniature lin. x 1 1/4 in. x 1 1/2 in., 10/-, 500pF Standard with trimmers, 9/-; midjet, 7/6; with trimmers, 9/- SINGLE 50 pF, 2/6; 75 pF, 100 pF, 160 pF, 6/6. Solid dielectric 100, 300, 500 pF, 8/6.

CONDENSERS. New stock, 0.001 mfd. 7 kv; T.C.C. 5/6; Ditto, 20 kv, 9/6; 0.1 mfd., 7 kv, 9/6. Tubular 500 v. 0.001 to 0.05 mfd., 9d., 0.1/1/-; 0.25, 1/6; 0.5/500 v., 1/8; 0.1/350 v., 9d.; 0.01/2,000 v. 0.1/1,000 v., 1/9; 0.1 mfd., 2,000 volts, 3/6. CERAMIC COND. 500 v., 0.3 pF to 0.01 mfd., 9d. SILVER MICRA CONDENSERS, 10% 5 pF to 500 pF, 1/-; 500 pF to 3,000 pF, 1/3. Close tolerance. (All pF) 1.5 pF to 47 pF, 1/8. Ditto 1% 50 pF to 815 pF, 1/8; 1,000 pF to 5,000 pF, 2/-

465 kc/s SIGNAL GENERATOR. Total cost 15/- Uses B.F.O. Unit ZA 30038 ready made. POCKET SIZE 2 1/2 x 4 1/2 in. Slight modifications required, full instructions supplied. Battery 7/6 extra 69V+1 1/2V. Details S.A.E.

Wavechange Switches, 2 p. 2-way, 3 p. 2-way, short spindle, 2/6; 6 p. 4-way 2 water, long spindle, 6/6; 2 p. 6-way, 4 p. 2-way, 4 p. 3-way, long spindle, 3/6; 3 p. 4-way, 1 p. 2-way, long spindle, 3/6;

Wavechange "MAKITS". Wafers available: 1 p. 12 water, 2 p. 6 wafer, 3 p. 4 wafer, 4 p. 3 wafer, 5 p. 2 wafer, 8 wafer, 8/6; 2 wafer, 12/6; 3 wafer, 18/-; additional waters up to 14, 3/6 each extra.

Toggle Switches, s.d., 2/-; d.p., 3/6; d.p.d.t., 4/-

JASON FM TUNER COIL SET, 29/- H.F. coil, aerial coil, oscillator coil, two i.f. transformers 10.7 Mc/s, detector transformer and heater choke. Circuit and component book using four 6AM6, 2/6. Complete Jason FM Kit, Jason chassis with calibrated dial, components and 4 valves, £6.5.0.

Valveholders, Pax. int. oct., 4d. EA50, 6d. BLA, CRT, 1/3. Eng. and Amer. 4, 5, 6 and 7 pin 1/6. MOULDED Mazda and int. oct., 6d.; BTG, BGA, B8C, B6A, 9d. BTG with can, 1/6. BGA with can, 1/6. Ceramic, EF50, 1/8; B9A, int. oct., 1/-; BTG, B9A cans, 1/- each.

**THE ORIGINAL RADIO COMPONENT**

Our written guarantee with every purchase. Bus 133 or 68 pass door S.R. Station Selhurst.

**Volume Controls 80 ohm COAX**

Long spindles. Midget 5K ohms to 2 Meg. No. 8w. D.P. 5w. 3/-  
Linear or Log Tracks. Fringe Quality 11- yd.

**COAX PLUG** .. 1/- **LEAD SOCKET** .. 2/-  
**PANEL SOCKETS** 1/- **OUTLET BOXES** .. 4/6  
**BALANCED TWIN FEEDER** yd. 6d. 80 or 300 ohms  
DITTO SCREENED per yd. 1/6. 80 ohms only  
**WIRE-WOUND POTS**, 3 WATT. Pre-set Min. TV Type. All values 10 ohms to 25 K., 3/- ca. 30 K., 30 K., 4/- (Carbon 30 K., to 2 meg., 3/-).  
**WIRE-WOUND 4 WATT Pot.** Long spindle. Values, 50 ohms to 50 K., 9/6; 100 K., 7/6.

**TRIMMERS**, Ceramic. 30, 50, 70 pF., 8d.; 100 pF., 150 pF., 1/3; 250 pF., 1/8; 500 pF., 750 pF., 1/9.  
**RESISTORS**, Preferred values. 10 ohms to 10 meg., -w., 4d.; 1 w., 4d.; 1 w., 6d.; 1 w., 8d.; 2 w., 1/-.  
**HIGH STABILITY**, 1 w., 1%, 2/- Preferred values. 100 to 10 meg. Dkto. 5%, 100 to 5 meg., 9d. 5 watt... **WIRE-WOUND RESISTORS** .. 1/8  
10 watt... 25 ohms—10,000 ohms .. 1/-  
15 watt... .. 2/6  
12.5K to 50K 10 w .. .. 3/-

**AMERICAN "BRAND FIVE" PLASTIC RECORDING TAPE**

Double Play	7in. reel, 2,400ft	80/-	Spare Plastic
	5in. reel, 1,900ft	37/6	Reels
Long Play	7in. reel, 1,900ft	35/-	3in. 1/6
	5in. reel, 1,200ft	23/6	4in. 2/-
	5in. reel, 900ft	18/6	5in. 2/-
Standard	7in. reel, 1,200ft	25/-	5 1/2 in. 2/-
	5in. reel, 600ft	16/-	7in. 2/6

"Instant" Bulk Tape Eraser and Head Defuser, 2000 yd. A.C., 27/6. Leaflet, S.A.E.

Neon Mains Tester Screwdriver, 5/-  
Solder Radiograde, 4d. yd., 1lb 5/-, 1lb 9/-  
Black Crackle Paint. Air drying, 3/- tin.

**HIGH GAIN TV PRE-AMPLIFIERS BAND I B.B.C.**

Tunable channels 1 to 5. Gain 18db. ECC84 valve. Kit price 29/6 or 49/6 with power pack. Details 6d. (PC804 valves if preferred).  
**BAND III I.T.A.**—Same prices. Tunable channels 8 to 13. Gain 17db.

Paxolin Panels, 10 x 8in., 1/6.  
Miniature Contact Cooled Rectifiers, 250V 60mA, 7/6; 250V 60mA, 8/6; 250V 85mA, 9/6; 200mA, 21/-; 300mA, 27/6.

Selenium Rect. 300V 85mA, 7/6.  
Coils. Wearite "P" type, 3/- each. Osmor Midget "Q" type, adj. dust core, from 4/- each. All ranges.

Teletron D.W.R. L. and Med. T.R.F. with reaction, 3/6.  
Ferrite Rod Aerials. M.W., 8/9; M. and L., 12/6.

Osmor Ferrite Rod Aerials. L. and M. for transistor circuits, 10/- each.

Ferrite Rods, 8 x tin., 2/6.  
H.F. Chokes, 2/6.

T.R.F. Coils, A/HF, 7/- pair; HAX, 3/-, DRR2, 4/-.

Aluminium Chassis. 18 s.w.g. Plain, undrilled, 4 sides, riveted corners, lattice fixing holes, 2 1/2in. sides, 7 x 4in., 4/6; 9 x 7in., 5/6; 11 x 7in., 6/9; 13 x 9in., 8/6; 14 x 11in., 10/6; 15 x 14in., 12/6; 18 x 16 x 3in., 16/6.  
Aluminium Panels, 18 s.w.g., 12 x 12in., 4/6; 14 x 8in., 4/-; 12 x 8in., 3/-; 10 x 7in., 2/6.

**AUTOCHANGER ACCESSORIES**

Suitable player cabinets (except 4 H.F.) .. 49/6  
Amplifier player cabinets (except 4 H.F.) .. 63/-  
2-valve amplifier and 6 1/2in. speaker 79/6  
3-valve amplifier and 6 1/2in. speaker 95/-  
Wired and tested ready for use with above.

**QUALITY 2-STAGE HI-FI AMPLIFIER**

A.C. only, 200-250V. Valves ECL82 and E280. 3 watt quality output. Mullard tone circuits, bass boost, treble and volume controls. Separate engraved Perspex front-panel with de luxe finish. Heavy duty output transformer 3 ohm. Shrouded mains transformer. Stove enamelled chassis size 8 x 5 x 3in. Bargain price £4.10. Circuit supplied.

Wirewound Ext. Speaker Control, 100. 3/-.

**ALADDIN FORMERS** and cores. 1in., 8d.; 1 1/2in., 10d.

0.3in. FORMERS 5937 or 8 and cans TV1 or 2, 1in. sq. x 2 1/2in. or 1 1/2in. sq. x 1 1/2in., 2/- with cores.

**SLOW MOTION DRIVES**, Epicyclic ratio 6-1, 2-3.

**SOLENOID IRON**, 25W, 200V or 230V, 24/-.  
**MAINS DROPPER**, 3 x 1 1/2in. With adjustable sliders, 0.5A, 1,000 ohms, 4/3; 0.2A, 1,000 ohms, 4/3.

**LINE CORD**, 0.3A 60 ohms per foot, 0.2A 100 ohms per foot, 2-way, 1/- per foot; 3-way, 1/- per foot.

**MIKE TRANS.** 50-1, 3/9; 100:1, potted, 10/6  
**P.V.C. Conn. Wire**, 8 colours, single or stranded, 2d. yd. Sleeving, 1.2mm, 2d.; 4mm, 3d.; 6mm, 5d. yd.

**Speaker Fret**, Gold cloth, 17 x 25in., 5/-; 25 x 35in., 10/-; Tygan, 52in. wide, 10/-; 26in. wide, 5/- ft. Samples, S.A.E. Expanded Metal, Gold, 12 x 12in., 6/-.

**"REGENT" 4 VALVE**



"96" RANGE VALVES  
KIT PRICE £6.6.0.  
carr. 4/-

**PRINTED CIRCUIT BATTERY PORTABLE KIT**

Medium and long wave. Powerful 7 x 4in. high Flux Speaker. T.C.C. Printed Circuit and condensers. Components of finest quality clearly identified with assembly instructions. Osmor Ferrite Aerial Coils. Kexine covered attaché case cabinet, Size 12in. x 8in. x 4in. Batteries used B126 (L5512) and A138 (L5040), 10/- extra. Instructions 9d. (free with kit). Mains Unit ready made for above 39/6. Sold separately. Details free.

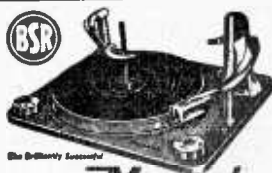

with **CABINET, AMPLIFIER and SPEAKER**  
**£12.10.0 Carr. 5/-**

**RECORD PLAYER BARGAINS**

4 Speed Autochangers:  
BSR, U.A.14 .. .. £7.10.0  
Collaro Autochanger .. .. £7.18.6  
Garrard RC25 .. .. £9.9.0  
Garrard RC 210 .. .. £10.10.0  
4 speed Single Players:  
Garrard TA Mk. II .. .. £8.0.0  
Model 4SP .. .. £8.17.6  
Garrard 4 HF Transcription £17.19.6  
Garrard Stereo Heads £2 extra.  
All Sapphire Stylus available from 6/-.

**ARDENTE TRANSISTOR TRANSFORMERS**

Type D3035, 7.3 CT: Push Pull to 3 ohms for OC72, etc., 1 x 1 x 1in., 9/6.  
Type D3034, 1.75: 1 CT. Push Pull Driver for OC72, etc., 1 x 1 x 1in., 9/6.  
Type D3068, 11.5: Output to 3 ohms for OC72, etc., 1 x 1 x 1in., 9/6.  
Type D167, 18.2: Output to 3 ohms for OC72, etc., 1 x 1 x 1in., 12/-.  
Type D238, 4.5:1 Driver Transformer, 1 x 1 x 1in., 10/-.  
Type D240, 8.5:1 Driver Transformer, 1 x 1 x 1in., 10/-.

**ARDENTE TRANSISTOR VOLUME CONTROLS**

Type VC1545, 5K with switch, dia. 0.8in., 8/-  
Type VC1760, 5K with switch, dia. 0.7in., 10/6

**WEYRAD**

**COILS AND TRANSFORMERS FOR A 2-WAVE TRANSISTOR SUPERHET WITH PRINTED CIRCUIT AND FERRITE ROD AERIAL**  
Long and Medium Wave Aerial—RA2W. On 6in. rod, 7/16in. diameter, 208pF tuning, 12/6.  
Oscillator Coil P50/1AC, Medium wave. For 176pF tuning, 5/4.  
1st and 2nd I.F. Transformers—P50/2CC, 470 kc/s, 11/16in. diameter by 1in. high, 5/7.  
3rd I.F. Transformer—P50/3CC, to feed diode detector, 6/-.  
Driver Transformer—LFD2T, 1 5/16 x 1 x 1 1/2in., 9/6.  
Printed Circuit—PCAL, Size 2 1/2 x 8 1/2in. Ready drilled and printed with component positions, 9/6.  
1 x 4in., 35 ohm Speaker, 25/-.  
These components are approved by transistor makers and performance is guaranteed.  
Constructor's Booklet 2/-.

**NEW MULLARD TRANSISTORS**

Audio OCT1 6/- R.F. OC44 10/6  
OC72 8/8 OC45 9/6  
Sub-miniature Electrolytics (15V). 1uF, 2uF, 4uF, 5uF, 6uF, 25uF, 50uF, 100uF, 2/6.

B.B.C. Pocket 2 Transistor, M.W. and L.W. Radio Kit, 39/6. Phones 7/6 or deaf aid earpiece, 12/6.

**"PW" ROADFARER AM/FM RADIO KIT**

Transistorised throughout. Advanced design, operated from internal batteries or direct from mains. Four Sections all on printed circuit. AM Tuner, FM Tuner, Audio Amplifier, Mains Supply Unit.  
Attractive Plastic Cabinet, Ferrite Rod Aerial for AM, Telescopic Aerial for FM. Order now. Lowest price £15.

"PW" Pocket 6, Transistor kit, All parts, printed circuit, all cabinet. Osmor designed kit, £8.15.0.

**COMPONENT SHOP SPECIALISTS**

**337 WHITEHORSE ROAD WEST CROYDON**

Telephone: THO 1665

P. and P. charge 1/-, over £2 post free. C.O.D. 1/6. (Export welcome. Send remittance and extra postage)

**NOW**

# YOU can MASTER ELECTRONICS!

## BRITAIN'S MOST COMPREHENSIVE PRACTICAL COURSE IN RADIO • ELECTRONICS TELEVISION!

**THESE SPECIAL TRAINING KITS—YOURS TO KEEP**

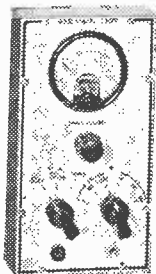

Multi-Range TEST METER

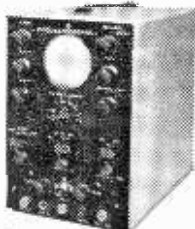

CATHODE RAY OSCILLOSCOPE

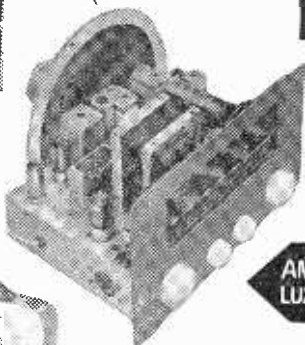

AM and VHF/FM LUXURY RECEIVER



SIGNAL GENERATOR



Complete set of Picture Way books and Experimental Manuals

**LEARN BY BUILDING NOW for your CAREER • HOBBY OWN BUSINESS**

**YOU RECEIVE**

- Complete kits of equipment as illustrated.
- Complete set of experimental manuals.
- Complete set of "picture-way" theory books.
- Modern test-yourself examination sheets.
- Study programme.
- Unlimited consultation with Tutors.



**FREE BROCHURE NOW**

### RADIOSTRUCTOR

TO RADIOSTRUCTOR (DEPT. M.82) READING, BERKS.

Name \_\_\_\_\_ BLOCK

Address \_\_\_\_\_ CAPS

PLEASE

(We do not employ representatives) 10/61

# Practical Wireless

VOL. XXXVII No. 656 OCTOBER, 1961

Editorial and Advertisement  
Offices:

**PRACTICAL WIRELESS**

George Newnes, Ltd., Tower House,  
Southampton Street, W.C.2.

© George Newnes Ltd., 1961

Phone: Temple Bar 4363  
Telegrams: Newnes, Rand, London,  
Registered at the G.P.O. for trans-  
mission by Canadian Magazine Post.

**SUBSCRIPTION RATES**  
including postage for one year

Inland - - - - £1.9.0 per annum  
Abroad - - - - £1.7.6 per annum  
Canada - - - - £1.5.0 per annum

## Contents

	Page
Editorial ... ..	477
Round the World of Wireless ... ..	480
Remote Control Unit ... ..	484
Trouble in the Local Oscillator ... ..	487
About Loudspeakers ... ..	491
On Your Wavelegth ... ..	492
Transistorised VHF Superhet ... ..	499
An Earthed Grid R.F. Amplifier ... ..	499
A Compact Power Supply ... ..	500
Calculating $\pi$ -Networks ... ..	503
How to keep Radio Equipment Cool ... ..	504
The P.W. "Tutor" ... ..	510
A Recording-level Meter ... ..	513
The P.W. Signal Generator ... ..	510
A Wobbulator for F.M. I.F. Alignment ... ..	521
Trade News ... ..	525
Short-wave Section ... ..	529
Short-wave Listeners' Log ... ..	534
Club News ... ..	537
Letters to the Editor ... ..	538

The Editor will be pleased to consider articles of a practical nature. Such articles should be written on one side of the paper only, and should contain the name and address of the sender. Whilst the Editor does not hold himself responsible for manuscripts, every effort will be made to return them if a stamped and addressed envelope is enclosed. All correspondence intended for the Editor should be addressed to The Editor, PRACTICAL WIRELESS, George Newnes, Ltd., Tower House, Southampton Street, London, W.C.2. Owing to the rapid progress in the designs of wireless apparatus and to our efforts to keep readers in touch with the latest developments, we give no warranty that apparatus described in our columns is not the subject of letters patent.

Copyright in all drawings, photographs and articles published in PRACTICAL WIRELESS is specifically reserved throughout the countries signatory to the Berne Convention and the U.S.A. Reproductions or imitations of any of these are therefore expressly forbidden. PRACTICAL WIRELESS incorporates "Amateur Wireless."

## The "Tutor" Blueprint

WITH each copy of this issue of PRACTICAL WIRELESS, we are giving away another blueprint: the "P.W. Tutor", as it is called, has been designed for absolute beginners to radio construction, those who are, perhaps, new readers of this magazine, or those who have for some time wished to know more of the basic principles from which many of the more advanced designs appearing in these pages obtain their origin. This blueprint then does not only constitute details of simple radio receivers which anyone can build, confident that successful sets will result from their efforts, but it has also been designed by our experts—leaders in the field of technical journalism—to provide also a foundation of the principles of radio reception and receiver construction. This surely is the only way to begin a satisfactory association with this hobby—from a sound knowledge of the absolute fundamentals.

The article relating to the "Tutor", on pages 504 to 509, shows, by easy stages, how four simple radio receivers may be built by anyone who is prepared to follow the step-by-step instructions, learn the meaning of the various circuit symbols (page 508), and spend a few minutes reading and practising the "Hints on Soldering" given on page 509.

The components used in all the sets are inexpensive and readily obtainable and most of them are mounted on a group-board which greatly simplifies the construction.

The first receiver is a crystal set. This type of circuit has long been recognised as the ideal introductory circuit for the newcomer to the ranks of the amateur radio enthusiasts. It is for this reason that we feel justified in describing, in detail, the construction of a simple crystal set as the starting point for the beginner.

Three other sets follow this first receiver, each being progressively more advanced than the one before, and incorporating long and medium waveband coverage, transistor amplifying stages, as well as regeneration to improve volume and selectivity. The construction of a simple cabinet is also described which will be suitable for any of the four sets, and will give the final receiver a professional appearance.

Many of the more experienced readers of PRACTICAL WIRELESS may feel that in publishing this blueprint for the beginner, we have neglected our responsibility to those who have already established themselves as radio enthusiasts. We can but hope that any such readers will be patient, for this blueprint is the first of three; the other two are to be published in the November and December issues. The November blueprint will be of a transistorised amplifier, using the group-board method of construction, which will be capable of operating a loudspeaker from a battery record player or radio tuner. The December blueprint will give details of a superhet receiver, again built on a group-board, and designed to operate with the amplifier of the November issue, to form a complete radio set which the experienced constructor and the beginner alike will find to be a useful domestic receiver with an excellent performance.

Our next issue, dated November, will be published on October 6th.

# Round the World of Wireless

## POTENTIAL AND CURRENT NEWS

### Broadcast Receiving Licences

THE following statement shows the approximate number of Broadcast Receiving Licences in force at the end of June, 1961, in respect of wireless receiving stations situated within the various Postal Regions of England, Wales, Scotland and Northern Ireland. The numbers include Licences issued to blind persons without payment.

Region	Total
London .. .. .	688,067
Home Counties .. .. .	648,049
Midland .. .. .	469,169
North Eastern .. .. .	508,102
North Western .. .. .	437,436
South Western .. .. .	387,442
Wales and Border Counties .. .. .	225,973
<b>Total England and Wales .. .. .</b>	<b>3,364,237</b>
Scotland .. .. .	375,848
Northern Ireland .. .. .	118,799
<b>Grand Total .. .. .</b>	<b>3,856,884</b>

### International Trade Fair

THIS year's Pacific International Trade Fair is to be held in Lima, Peru, during October.

The British pavilion will be of modern design and will be one of the main attractions for visitors. The Board of Trade and the British delegation, in designing the pavilion, have ensured that British products will be exhibited to best advantage. Exhibitors' and general trade 16mm films will be shown to visitors in a fully equipped cinema, with projection equipment from the RCA Great range.

### President Nkrumah Visits New Broadcasting Station

PRESIDENT Nkrumah recently visited the new external broadcasting station at Tema, near Accra, Ghana, which is being constructed by Marconi's Wireless Telegraph Co. Ltd. This station will give Ghana a modern high-power short-wave broadcasting system.

Under the contract Marconi's have designed and erected the transmitting station buildings and supplied and installed four 100kW high frequency radio transmitters. Marconi's will also supply technical staff for the supervision and maintenance of the station

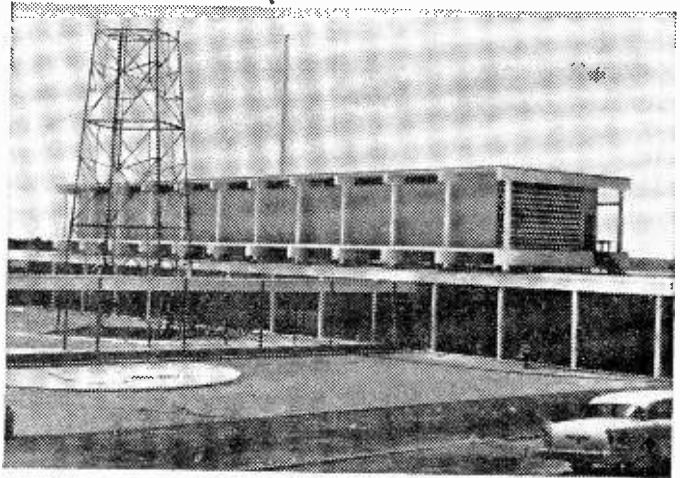

The transmitter hall and partially completed tower of a new broadcasting station at Tema, Ghana, which is being constructed by Marconi's Wireless and Telegraph Co. Ltd.

(Picture by courtesy of "Radio Review and TV Times", Ghana.)

for a period for four years and train personnel of the Ghana Broadcasting System.

### New BBC VHF Sound Broadcasting Station

THE BBC's new VHF sound broadcasting station on the site of the Air Ministry radio station on the cliffs some 400ft above Dover, was brought into service on 8th August.

The Home Service is transmitted on 94.4Mc/s, the Light Programme on 90.0Mc/s, and the Third Programme with Network Three on 92.4Mc/s, each with a mean effective radiated power of 3.5kW. A large number of listeners in South-East Kent, including Deal, Ramsgate, Broadstairs and Margate, Dover and Folkestone, are now able to receive greatly improved BBC sound broadcasting services.

The new station is of the translator type and will operate unattended. It will receive its programmes from the Wrotham VHF sound station by radio and make a direct frequency change on each without demodulation.

### Weather Ship Improvements

FOLLOWING the completion of an Air Ministry contract for the supply and installation of new radio communication and

automatic direction finding equipment, and the modernisation of the radar on two ocean weather ships the Marconi Company has been awarded a similar contract for a third ship. The Marconi equipment at present being installed includes four 1kW independent side band transmitters, eight receivers, a medium frequency direction finder and a VHF automatic direction finder and displays.

### Ionising Radiations in Industry

A SAFETY code for workers exposed to ionising radiations in industry is laid down in the Ionising Radiations (Sealed Sources) Regulations, 1961, made by the Minister of Labour, Mr. John Harcourt, and presented to Parliament on 3rd August.

The regulations impose requirements for safeguarding the health and safety of persons employed in factories and other places to which the Factories Acts apply, who may be exposed to ionising radiations from sealed radio-active substance, and from certain machines, such as X-Ray apparatus. They require the restriction of the exposure of workers to such radiations, the adequate shielding of sources of ionising radiations and instructions for workers likely to be



exposed to them, about the hazards involved and the precautions to be taken.

Maximum permissible doses of radiation are laid down, and the regulations include requirements for the medical supervision of workers, and for the wearing of film badges to measure personal doses received.

#### Valve Manufacturers' Interests Merge

ON the 1st August this year, Thorn-AEI Radio Valves and Tubes Ltd. began trading.

It was announced on 16th June that Associated Electrical Industries Ltd., were to merge their respective interests in the manufacture and sale of cathode ray tubes and radio valves. The productive capacities of both companies in this field have been pooled and include factories at Sunderland, Harlow, Rochester and Foots-cray.

AEI and TEI are both represented on the board and have equal shareholdings. TEI is responsible for management.

From 1st August all AEI's interests in radio valves and cathode ray tubes for the entertainment industry were transferred to Thorn-AEI Radio Valves and Tubes Ltd., but AEI is continuing to manufacture valves and cathode ray tubes for industrial purposes.

#### Radio Equipment for New Aircraft

THE "Sixty Series" of airborne radio equipments and navigation aids, made by Marconi's, has been specified by British European Airways for use in their fleet of de Havilland Trident.

The principal design aim in the "Sixty Series" has been for greatly improved reliability through new concepts of mechanical and circuit design. The units are transistorised, are very small and light and have an extremely low power consumption.

The equipment will include VHF communication equipment, VHF navigation and approach guidance equipment, automatic direction finder or radio compass and an aircraft selective calling system.

The "Sixty Series" has also been specified by BOAC for their fleet of Vickers VC 10's.

#### The Centre of Sound

IN June this year, the Centre of Sound was opened in London and established as the national headquarters of the British Recording Club. The Centre also aims at promoting the growth of the audio industry in this country and on the ground floor is housed a permanent exhibition of audio equipment. This exhibition is open to the public every day except Sunday, from 9.30 a.m. to 11.00 p.m.

Also for the benefit of the general public there is an Information Bureau on the ground floor which will give advice on all audio problems. It is staffed by a team of experts and is open every day from 9.30 a.m. to 5.30 p.m. For the benefit of evening visitors a skeleton staff is employed from 5.30 p.m. to 11.00 p.m.

Full club members of the Centre of Sound automatically become members of the British Recording Club. Facilities for members include a small theatre with a bar, a cinema, a library, a restaurant and television lounges.

The Centre of Sound is in Archer Street, Piccadilly, London W1.

#### Engineering Division Appointments

THE BBC recently announced the appointment of Mr. J. A. G. Mitchell as Scottish engineer. He succeeds the late Mr. F. W. Endicott and becomes responsible for the engineering services of the BBC's sound and television studios and outside broadcast units in Scotland.

#### Audio Avenue at the Radio Show

AN extensive display tracing the history of sound recording from 1888 to 1961 was a feature of the Audio Avenue at the Radio Show this year. Occupying some 500 sq. ft. this feature, "Milestones in Recording", was presented in conjunction with the E.M.I. group of companies.

Among the many vintage instruments featured in this display was one of the earliest weight-driven acoustic recording machines, an Edison phonograph and the microphones used exclusively by the Royal Family from 1924 to 1945. The modern era of recording was represented by the latest type of studio tape recorders, stereo mixer consoles and other high-fidelity equipment.



The Centre of Sound; headquarters of the British Recording Club.

# Remote Control Unit

THIS INSTRUMENT WAS DESIGNED TO OPERATE AN AUTOMATIC MECHANISM OVER A SHORT RANGE

By V. E. Holley

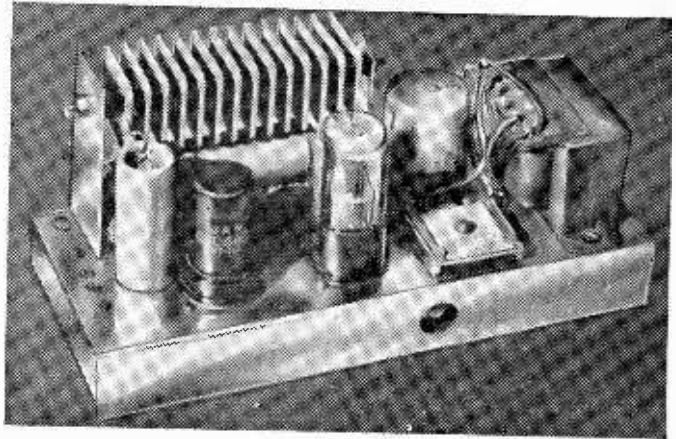

**T**HIS apparatus was designed so that the door of a garage could be made to open automatically on receipt of a command signal from the driver of an approaching vehicle. It is, of course, suitable for any other control service where only a short range is required. While the mechanical part of the installation is rather outside the scope of these pages, it must be said briefly in explanation that the controlled door is of the roller shutter type which, when the retaining bolt is withdrawn, rises

under the influence of springs incorporated in the roller. The bolt is in fact the armature of a solenoid which the apparatus here described is designed to energise. It requires a current of 0.25A at around 240V D.C.

### Command Signal

The more obvious methods of control by photoelectric circuits, contact pads laid in the approach road, etc., suffer from the defect that they can be operated by unauthorised persons. They were therefore rejected in favour of the following arrange-

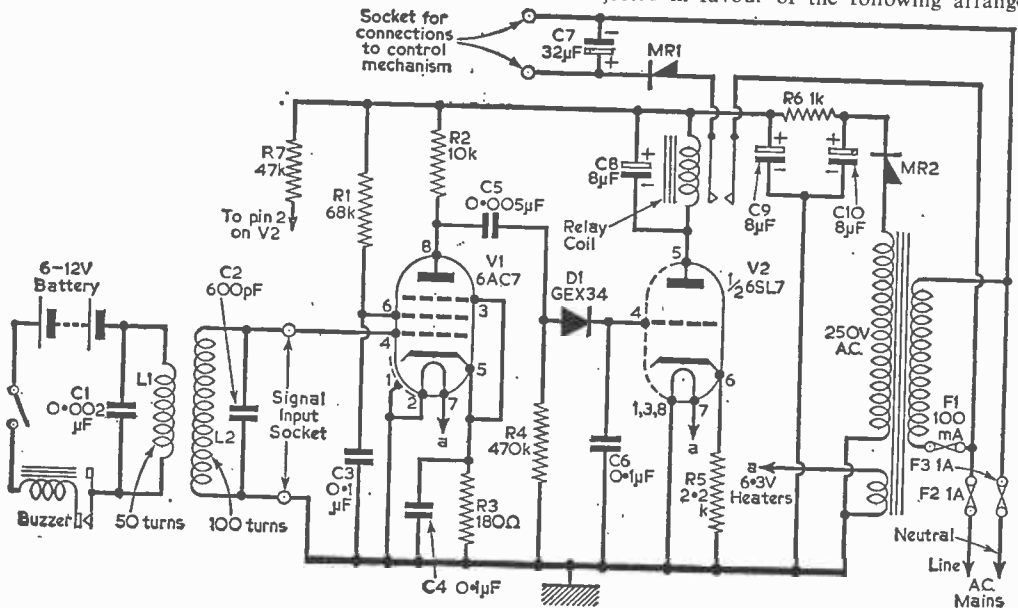

Fig. 1.—The circuit of the instrument.

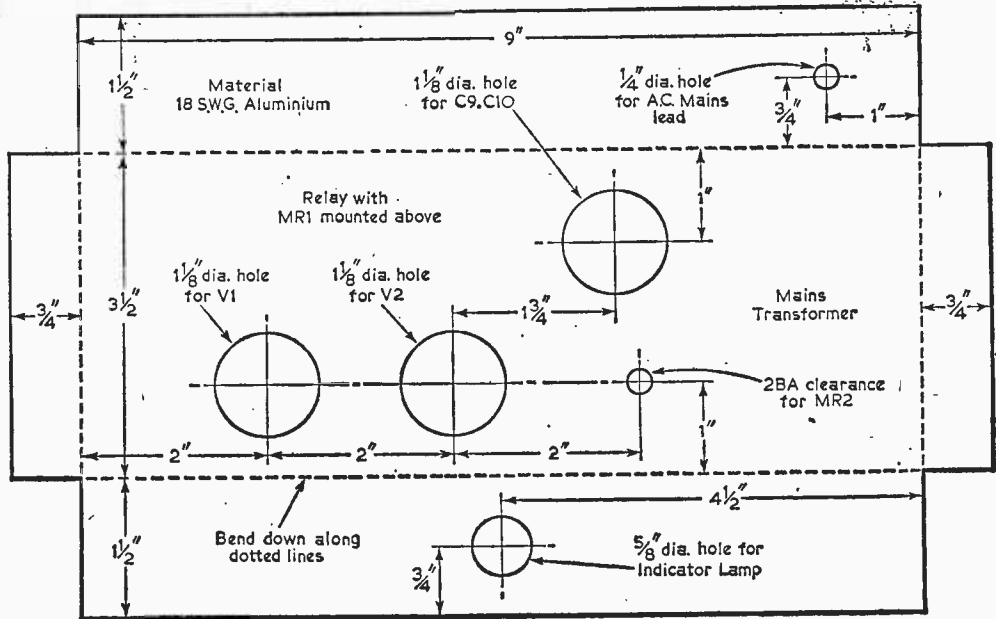

Fig. 2.—The drilling dimensions of the aluminium chassis.

ment which depends upon a secret signal given by the driver of the car. Referring to Fig. 1, the tuned circuit L1/C1, is carried on a bracket beneath the car and the buzzer and switch or bell-push in some convenient operating position inside. The second tuned circuit L2/C2 is buried several inches below the surface of the approach road in such a position that the car must pass over it to enter the garage. Operation of the buzzer energises L1 at its resonant frequency and the signal is transferred inductively to L2; the two coils may in fact be regarded as the two windings of an R.F. transformer with a step-up ratio of 1:2. With the circuit shown, sufficient signal transference is obtained with the coils three or four feet apart and, as the service operating distance is less than 18in., there is sufficient sensitivity in hand. It is not necessary that L1 should pass exactly over L2; satisfactory operation is obtainable with a divergence of up to 18in. either side.

**Signal Amplification**

The signal induced in L2 is taken by underground cable into the garage and presented to the grid of the valve V1. This is a high-gain pentode, 6AC7, arranged as an R.F. amplifier. An inductive load in the anode circuit would no doubt increase the gain considerably but the 10k resistor R2 is adequate provided the screen and cathode resistors are efficiently bypassed. The amplified signal is transferred via C5 to the diode, D1, where it is rectified and the resultant voltage is applied to the grid of the valve V2. Any other high-gain R.F. pentode can be used for V1, the values of the associated components being adjusted as necessary.

**Output Stage**

The function of V2 is to operate the relay and both valve and relay must be selected for compati-

**COMPONENTS LIST**

Resistors 1/2 W (unless otherwise stated)

- R1 68k
- R2 10k
- R3 180 Ω
- R4 470k
- R5 2.2k
- R6 1k, 1W

Capacitors 350VW (unless otherwise stated)

- C1 0.002 μF
- C2 600pF
- C3 0.1 μF
- C4 0.1 μF
- C5 0.005 μF, 1000VW
- C6 0.1 μF
- C7 32 μF (electrolytic)
- C8 8 μF (electrolytic)
- C9 8 μF (electrolytic)
- C10 8 μF (electrolytic)

Valves

- V1 6AC7 (octal base)
- V2 6SL7 (octal base)

Diode

- GEX34

Relay

See text

Rectifiers

- MR1 RM4, 250V, 300mA
- MR2 Contact-cooled, 250V, 20mA (minimum)

Mains Transformer

- 250V, 20mA, half-wave;
- 6.3V, 1A

Fuses

- F1 100mA
- F2 1A
- F3 1A

Sockets

- Two (dissimilar) for external circuits
- Buzzer and bell push
- Any type

bility. The relay in the original equipment is of a simple type which is obtainable for a few shillings; the energising coil has a D.C. resistance of 4k and the operating current is 3mA. This fits in well with a high- $\mu$  triode valve and the prototype uses one half of a double triode, 6SL7. In the quiescent condition, the valve is biased by the resistor R5 so that the anode current is 2mA. Diode D1 is connected so that the arrival of a signal produces a positive voltage on the grid of the valve which

(Note that R7 is used to feed H.T. to the spare, or unused, half of the 6SL7 to prevent cathode poisoning.)

**Power Supply**

The H.T. requirement is about 15mA at 250-300V, while the heaters and indicator lamp need a little under 1A at 6.3V. This is supplied by a miniature mains transformer of the type used in television converters. The 250V half-wave secondary feeds a contact-cooled rectifier and smoothing is provided by R6 in conjunction with the 8 $\mu$ F-capacitors C9 and C10. No mains switch is included as it is convenient to control the supply to the prototype from the mains outlet to which it is connected.

**Controlled Circuit**

The direct current for operating the door control mechanism is produced by the rectifier MR1 and its associated reservoir capacitor, C7. The supply is taken direct from the mains and the relay contacts are included in the A.C. portion of the circuit. The

connection to the mains should be made as in Fig. 1 so that, in the quiescent condition, line voltage is present in the controlled circuit only as far as the relay contact. The three fuses are a necessary precaution since the equipment will be switched on for long periods unattended and they should not be omitted. In the prototype, F2 and F3 are at the mains connection and F1 is on the chassis.

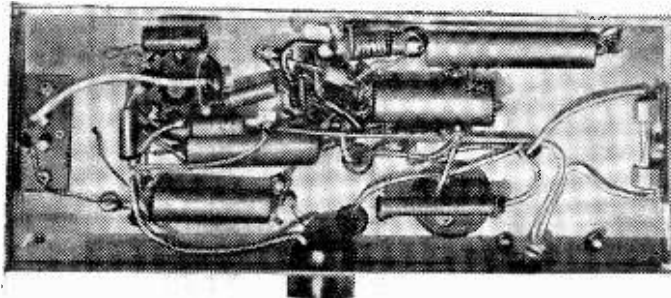

An underchassis view of the unit.

increases the anode current and operates the relay. The capacitor C6 acts as a reservoir and removes any R.F. which might otherwise be present on the grid. The anode of V2 is decoupled by the 8 $\mu$ F capacitor C8 to ensure clean make and break. Note that the decoupling is to H.T. +, since if it were taken to chassis, the flow of charging current into C8 would operate the relay when the equipment is switched on.

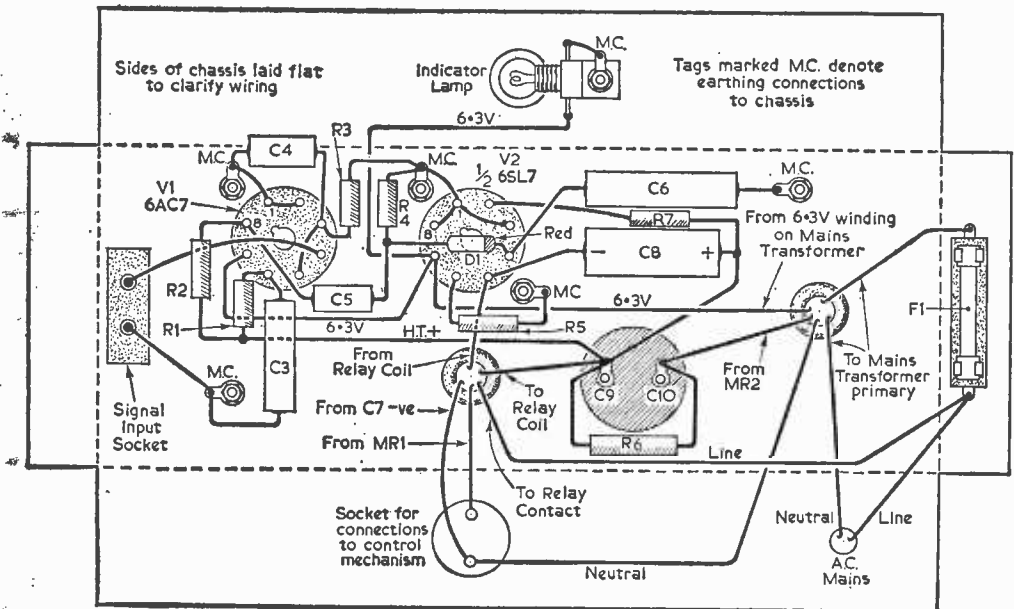

Fig. 3.—The underchassis wiring diagram.

**Construction**

The unit may be constructed in any desired form. A chassis about 9in. x 3½in. x 1½in. of 18s.w.g. sheet aluminium is convenient with the drilling dimensions given in Fig. 2. A point-to-point wiring diagram with the wiring and components opened out for clarity, is given in Fig. 3.

**Coils**

The coils L1 and L2 are wound with enamelled copper wire of 30s.w.g. on identical formers made from three layers of ¼in. plywood glued together as a "sandwich". The centre layer is 6in. x 6in. and the outers 6½in. x 6½in. so as to form a slot ¼in. deep all round in which the winding can be laid; the corners of the centre layer should be rounded off. The ends of the windings are brought through holes in the cheeks and soldered to two small wood screws which serve also to anchor the tuning capacitor. The details are shown in Fig. 4. Fifty turns are required for L1 and 100 for L2, giving a step-up ratio of 1:2.

When the construction is complete and the unit is operating satisfactorily, the coils should be thoroughly dried out and immersed in molten pitch or bitumastic paint to make them impervious to moisture. If pitch is used it should be heated very slowly to a temperature at which it is just sufficiently viscous to coat the coils thoroughly and the immersion should not be prolonged unduly. Waxed paper capacitors do not take kindly to this treatment and ceramics should be used for C1 and C2. The bracket for securing L1 beneath the car should of course be fitted before immersion.

**Other Components**

The relay must suit the valve as already mentioned and the contacts must be capable of carrying the current of the controlled circuit. Nothing is required of the buzzer except that it should buzz healthily and any type will do; the prototype uses an electric door bell with the gong removed. The diode should be suitable for low radio frequency operation and a GEX34 performs very well. The resistors may be half watt except R6 (1 watt) and the capacitors 350V.V except C5 for which a

1000VW component is advisable because breakdown or leakage here would cause the relay to operate. Sockets are required for connection of the signal circuit. L2/C2, and the circuit to be controlled. They should be dissimilar to avoid accidental wrong connection.

**Testing**

The completed unit should be set up on the bench with the coils L1 and L2 facing each other and about 3ft apart. If consistent and reliable operation is obtained at this range, it can be assumed that the equipment will be satisfactory in service. A range of 5ft was obtained with the prototype by tuning L2 accurately to the signal and capacitors of values between 500pF and

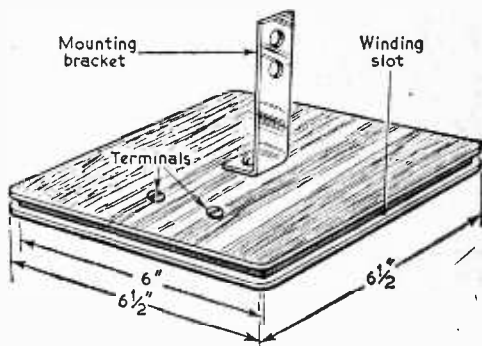

Fig. 4.—The constructional details of the former for L1.

1000pF can be tried across the coil for optimum results if maximum range is required.

A 9V grid bias battery is suitable for operating the buzzer, or power can be taken from the car battery. The original equipment is designed for operation from a 12V car system but satisfactory operation will be obtained from a 6V system provided that the buzzer does not require too much current.

**MULTIRANGE INSTRUMENT PROTECTION DEVICE**

By J. B. Ayer

The protection system described here approaches the ideal; it consists of a relay (6V to 28V D.C.), two switch banks ("break before make" types), a lamp (6V to 28V D.C.), and a D.C. supply.

One switch bank is ganged with the range selector switch of the instrument and the other ganged with the function selector switch.

The protection system provides the following facilities.

- (i) The instrument will be switched on only if the range selector switch is on the top range position initially.
- (ii) It will disconnect the instrument instantaneously if the function selector switch is operated without previously setting the range selector switch on top range.

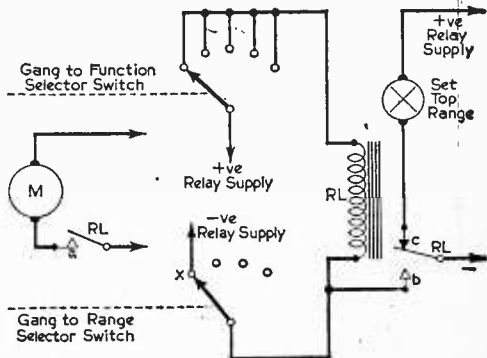

Note: X is position of Range Selector Switch on top range  
Fig. 1.—The circuit of the unit. Relay contact (a) is wired in series with the meter leads.

# TROUBLE in the LOCAL OSCILLATOR

RECOGNISING AND CURING SOME  
FAULTS TO BE FOUND IN SUPERHET  
RECEIVERS

By G. J. King

**I**N a superheterodyne receiver the local oscillator section of the frequency changer stage often gives trouble and results either in complete failure of the receiver, lack of sensitivity or apparent misalignment. In effect, the local oscillator is the heart of a superhet receiver. If the frequency is incorrect or the heterodyne signal voltage too high or too low, then the performance is impaired.

## Operation

In spite of its importance, the local oscillator is probably the section of the receiver which is most taken for granted. Should the oscillator fail to produce a heterodyne signal of any kind, the receiver will not tune signals since the operation of a superhet depends on the mixing of a locally generated signal with the incoming signal to produce an intermediate-frequency signal in the anode circuit of the mixer section of the frequency changer valve, this being subsequently amplified to the required degree before being applied to the detector stage.

The difference between the frequency of the incoming signal and that of the local oscillator gives the intermediate frequency, a common value nowadays being 470kc/s. The oscillator frequency may be 470kc/s (or whatever the I.F. is) above or below the incoming signal frequency, depending on the design of the receiver or, sometimes, on the waveband to which the receiver is adjusted.

## I.F. Pick-up

It is clear that if the local oscillator fails, no I.F. signal will be produced. Nevertheless, the receiver may not be totally dead. The receiver will not tune stations, of course, but it may pick up odd morse signals or even a Continental station. The reason for this is that the I.F. stages are still operative and sensitive and if any signal appears on the aerial at a frequency within the I.F. passband, and if the signal is strong enough, it may well break through the first stages of the receiver and undergo amplification in the I.F.

channel, where it will be detected in the normal way and give a signal from the loudspeaker.

If the tuning is operated, the station will occur over the entire tuning range, though it may be slightly stronger when the tuning is set to one extreme end of its range. This is because at one end of the range the first tuned circuits are brought closer to the intermediate-frequency and the attenuation which they offer at the I.F. is progressively reduced. If the receiver features an I.F. trap in the aerial circuit, then this may afford sufficient attenuation to prevent such I.F. pick-up.

What usually happens, however, is that when a receiver fails the experimenter or service technician endeavours to locate the faulty section by removing the aerial lead from the aerial socket and applying it to various internal points around the frequency changer stage. If the local oscillator is responsible for the failure, when the aerial lead is connected to the signal grid of the mixer or to an associated lead or component (point A in Fig. 1), I.F. pick-up may occur loud and clear. This is because the signal (or signals) in the range of the I.F. is applied direct to the I.F. amplifier stage, which then acts as a fixed-tuned TRF section.

## Partial Failure

In some cases the oscillator may not fail completely over the whole of the tuning range, but may suddenly burst into life at certain critical points on the dial, while at other points the symptoms already described may occur. This is typical local oscillator trouble, but which may occur only on some bands and not on others.

Low sensitivity of the receiver, if not due to any other cause, may be the result of low heterodyne voltage. This would point either to coil trouble or to alteration in value of an associated oscillator component. Sometimes in old sets, the oscillator coil or coils lose their "goodness"—their Q-value probably diminishes—and this results either in intermittent operation or complete failure.

On the other hand, if the oscillator is operating too strongly, as may be caused by a feed resistor decreasing in value, the sensitivity may in some cases also be reduced. In addition, harmonics of the oscillator fundamental frequency may be generated, and these may well cause spurious I.F. signals which could possibly cause disconcerting



the connection from the anode feed resistor (R1 in Fig. 1) to the H.T. line, inserting a milliammeter in circuit, as shown, making a note of the current reading and then purposely making the oscillator inactive. One way to do this is to put a short-circuit across the oscillator tuning capacitor section of the gang or, preferably, to swamp the oscillator tuner circuit by a large value capacitor. This latter method is shown in Fig. 1 by the 0.1 $\mu$ F capacitor Cs. A change in oscillator anode current should be observed; if it is not, then one can be almost certain that the oscillator was not working before the short or swamp was applied.

The oscillator current may fall or rise, depending on the characteristics of the oscillator circuit. The main factor to observe, however, is a change in current, and this should be very marked when a healthy oscillator is temporarily put out of action.

### Voltage Method

Another method is to put a voltmeter across the oscillator anode load resistor, R1, as shown. This will avoid having to break the oscillator feed circuit, but the voltmeter should be of the high resistance type to prevent the normal circuit conditions from being appreciably disturbed. When this method is adopted the change in current will be reflected as a change in voltage across the load resistor.

It should be noted that the oscillator voltage rarely remains constant over a waveband as the tuning capacitor is swung from one end of its travel to the other. There may also be a difference in voltage between wavebands. In an endeavour to keep the heterodyne voltage reasonably constant, the design engineer may find it necessary to damp the feedback on one band relative to the other bands. This is often achieved by switching a resistor in the oscillator circuit of the band requiring damping, this action being accommodated by a separate switch section on the wavechange switch.

The primary elements of the oscillator circuit given in Fig. 1 are C1 the oscillator grid coupling capacitor; R2 the oscillator grid resistor; R1 the oscillator anode load resistor; C3 the oscillator anode coupling capacitor; C2 the oscillator tuning section of the gang; L3 the L.W. oscillator coil; L4 the M.W. oscillator coil; S3 and S4 (which are ganged to S1 and S2); C4 the L.W. padding capacitor. C5 the M.W. padding capacitor; TC3 the L.W. oscillator trimmer, and TC4 the M.W. oscillator trimmer.

The components most likely to break down and cause oscillator failure are C1, C3 and R1. For weak oscillation, or oscillation which cuts off at certain points on the band, C1 should be checked by substitution, for this may have gone high in value. R1 should also be checked if necessary. Across C3 and the padding capacitors, C4 and C5 an appreciable R.F. voltage exists and this sometimes causes one or more of these components to go intermittent or noisy.

A noisy component in the oscillator circuit will give rise to background crackles which may be weak but progressively build up to quite a loud noise, and may then suddenly go weak again.

Should this occur on only one waveband, the associated padding capacitor should be an immediate suspect. Poor insulation on the associated oscillator coil is another frequent cause of this symptom. Should the trouble be present on all wavebands, C3, C1 or R1 are likely suspects and each should be checked by substitution in turn.

It should be noted that similar crackling effects sometimes originate in the I.F. amplifier stages owing to a noisy capacitor across one of the I.F. transformer windings. To prove this, the oscillator should be made inactive temporarily as already described, and if the crackling ceases, then the oscillator section is almost certainly to blame.

### Frequency Change

If one of the padding capacitors alters in value, not only will the oscillator voltage change from optimum, but the frequency of oscillation will also change. The local programme will no longer tune in at the correct point on the dial, but if the frequency change is not too great, will occur at a point somewhere on the dial, depending upon the extent of capacitance change. For example, if the trouble occurred on the L.W. band of the receiver in Fig. 1, the fault would either be in L3 or in C4. Coils which contain dust-iron cores in their formers should also be checked to ensure that the cores have not shifted.

The valve itself should not be overlooked, of course, and if there is any doubt a substitution test will prove the matter conclusively. The triode section of the valve in this circuit works as the local oscillator, while the hexode section constitutes the mixer, the valve as a whole being known as a frequency changer. ■

## Thermal Tests on Transistor Miniatures

**I**NTERMITTENT performance on transistor portables in the form of increasing distortion with time, cessation of local oscillator and cone warping of speaker, can often be due to heat action. This accounts for trouble on a hot beach, and fade-outs in the hot dash pockets of motor vehicles. The thermal lag between exposure to heat and the slow heating of the components can cause the radio to work in the car, but to remain dead for an hour or so after the removal from the hot surroundings. This is due to a period of time elapsing while the circuit cools down again—although the case exterior seems cool enough. Tests made in normal air temperatures fail to show the fault condition.

To avoid the favourite dodge of using a hot hair dryer (450W), it has been found that gentle heat radiated from the bench lamp (75W) on an exposed printed circuit of a transistor portable, the lamp being placed within 3-6in. of the open back of the radio, brings on the fault after a short period without the risk of overheating.



# ABOUT

# L O U D S P E A K E R S

## CURING ELECTRICAL AND MECHANICAL FAULTS

By P. J. Good

Loudspeaker faults can be divided into two primary classes, mechanical and electrical. An electrical fault usually causes either complete failure or intermittent operation, while a mechanical fault can produce a diversity of symptoms. Some of which may not immediately be associated with the loudspeaker, but may be put down to distortion in the A.F. stages of the receiver.

### Electrical Faults

Electrical faults are few, as a modern loudspeaker simply comprises a coil of wire, called the speech coil, which is arranged to move in a magnetic field. The output transformer is sometimes included on the loudspeaker chassis, and for this reason the transformer will be considered as part of the loudspeaker in this article. It should be noted, however, that the output transformer may not, in fact, be on the loudspeaker itself, but on the chassis of the receiver.

The transformer serves to match the impedance of the speech coil to the output valve, and thus has two windings; a low resistance winding which is connected across the loudspeaker's speech coil, and a high resistance winding which is connected to the anode circuit of the output valve. The transformer has a step-down ratio from the output valve to the speech coil, and this ratio is computed in relation to the impedances of the anode circuit and the speech coil.

In Fig. 1 is given the basic loudspeaker circuit, and it is fairly obvious that there are four main possibilities of failure. These are a break in the speech coil winding, a break on one of the windings of the transformer, a disconnected or broken wire in the loudspeaker circuit and, possibly less obvious, shorting turns in the output transformer.

### Complete Failure

The first hint that the loudspeaker may be responsible for the failure of a receiver is complete absence of the residual mains hum which is normally detected on any receiver by holding an ear close to the loudspeaker. In this event, the speaker should be unplugged from the transformer

and the speech coil connected across a 1.5V battery in series with a resistor of about 100Ω. The resulting 15mA of current in the speech coil should produce quite loud clicks and crackles as the battery connection is scraped (see Fig. 2). If this happens, then the speaker can safely be said to be electrically sound. The resistor is included to limit the current, for without it, a relatively high current can flow in low resistance speech coils and damage the winding on low-power units.

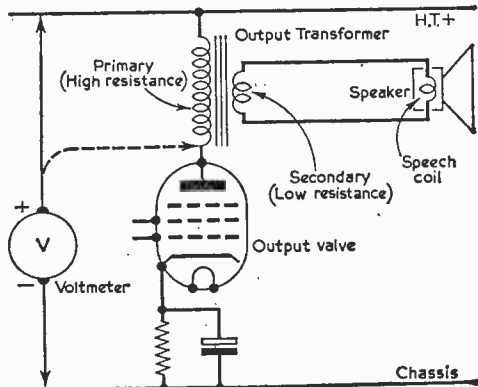

Fig. 1.—A typical output stage of a receiver, showing the loudspeaker circuit.

If the speaker remains dead, then there is a break somewhere in the speech coil circuit. Very flexible wire is used to connect the speaker terminals to the speech coil and a break sometimes occurs at one of the terminations, which can usually be mended by skilful soldering. If these wires are in order, a check should be made of the soldered connections or small wire tags in the centre of the cone which anchor the ends of the speech coil. Although these wires are held by cement, they can be traced to the soldered blobs

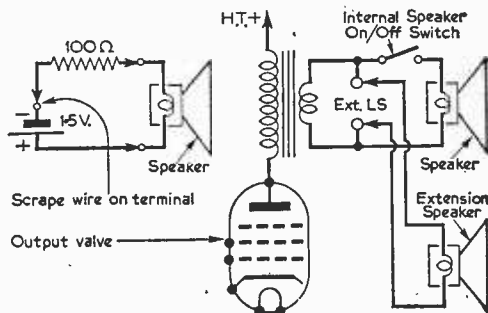

Fig. 2 (left).—A method of checking loudspeakers.

Fig. 3 (right).—Here, an extension speaker is used and an on/off switch is incorporated in the circuit.

with a pin or pointed tweezers. If the break is located, the wire should be freed from the cement, cleaned of enamel, resoldered and finally re-cemented in position to avoid vibration. If there is no break at these points, the trouble lies in the

speech coil winding and, apart from replacing the cone and speech coil assembly complete, there is little that can usually be done.

If the test given in Fig. 2 produced crackles, the wires connecting the loudspeaker unit to the secondary of the output transformer should be checked for continuity. On some sets a switch is incorporated in the speech coil circuit to switch on and off the internal speaker if an extension speaker is connected, as shown in Fig. 3. The switch may simply be a plug and socket arrangement or something more elaborate, but in either case it should be checked for continuity.

### Output Transformer Test

There are two methods of checking the output transformer complete with speaker. One is to connect a voltmeter between the anode of the output valve and the chassis of the set, after first checking that H.T. voltage is in fact present on the H.T. line, as shown in Fig. 1. If the primary of the transformer is in order, a voltage slightly lower than the H.T. line voltage will be registered at the anode of the valve (assuming that the anode circuit is taking current). If the speaker circuit is normal, slight crackles should be heard from the

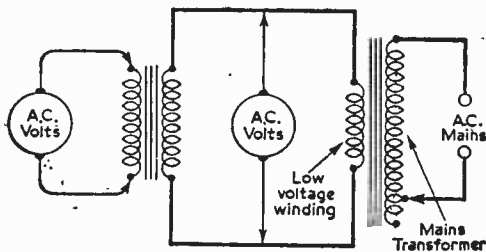

Fig. 4.—A method of determining the turns ratio of an output transformer.

loudspeaker as the voltmeter test probe is scraped on the anode tag. An alternative method is to disconnect the primary of the transformer from the valve anode and H.T. line and connect the winding across a 1.5V battery. If all is in order, crackles should again be heard from the loudspeaker as the battery connection is scraped.

### Transformer Turns Ratio

The turns ratio of the output transformer is governed by the "optimum load" of the output valve and the impedance of the speech coil, both in ohms. Optimum load values are given in valve data booklets and the speech coil impedance is sometimes marked on the loudspeaker chassis. It should be noted that the impedance is generally taken at 1,000c/s, and is, therefore, slightly higher numerically than the D.C. resistance of the speech coil. As a rough guide, the impedance is a little over twice the D.C. resistance value.

The turns ratio is equal to the square root of the optimum load divided by the speech coil impedance which, put in mathematical terms is:—

$$Tr = \sqrt{(Lo/Zs)}$$

where Tr is the turns ratio, Lo the optimum load and Zs the speech coil impedance. The expression may be altered to find Lo or Zs.

For example,

$$Lo = Tr^2 \times Zs,$$

$$\text{and } Zs = Lo/Tr^2.$$

Thus, given any two factors, the third or unknown can always be found.

If, for instance, the optimum load were 2,000Ω and the speech coil impedance 5Ω, then 5 divided by 2,000 is 400, and the square-root of 400 is 20. The required transformer in that case would have a turns ratio of 20:1, which is a fairly common value.

The same reasoning applies to any loudspeaker matching problem. Some transformers have tapped primaries or secondaries or both to enable the best match to be obtained from any optimum load to any speech coil impedance. Tapped transformers of a similar nature are also available to match a low impedance loudspeaker into a low impedance source. For example, a matching transformer would be required to match, say, a 15Ω loudspeaker to a 3Ω extension loudspeaker socket on a radio or radiogram, or vice versa.

### Checking the Turns Ratio

An approximate idea of the turns ratio of an output transformer can be obtained by applying low voltage A.C. across the secondary winding (low resistance winding) and measuring the voltage appearing across the primary winding, as shown in Fig. 4. About 2V A.C. should be used, and this can be obtained from a step-down mains transformer. It should be measured as accurately as possible on an A.C. voltmeter, as also should the voltage across the primary winding. The ratio of the two voltages is approximately equal to the turns ratio of the transformer. For example, if 2V were applied and 60V appeared across the primary winding, then the turns ratio would be 60:2, or 30:1.

### Shorting Turns

An output transformer with shorting turns may not cause total failure of the set or amplifier, but will most certainly cause low volume and distortion, with loss of bass frequencies. By using the set-up shown in Fig. 4, shorting turns will give an obviously low output voltage and the transformer will quickly heat up.

### Mechanical Faults

Mechanical faults rarely cause total failure of the set, but they produce noises, such as buzzes, rattles and distorted reproduction. A distinct buzz may be caused by the speech coil being out of centre and touching the magnet pole pieces, or by a damaged or broken centring device, a split or tear in the cone, loose turns of wire on the speech coil, loose mounting bolts, holding the loudspeaker in the cabinet, vibrating connecting leads, etc.

Such faults can usually be located by operating the set with the loudspeaker in its normal position and touching the various parts of the loudspeaker in an endeavour to pin-point the source of the noise. If the speech coil is out of centre, lightly pressing a finger at a certain point on the cone will often either clear the effect or, at least modify it.

Eventually, it will be necessary to remove the loudspeaker from the cabinet in order to effect a

(Continued on page 502)

# A GOOD 'SCOPE

*from every point of view!*



**ELECTRONIC  
EQUIPMENT  
MANUFACTURERS**

**MODEL 381.** Vertical amplifier bandwidth DC—9 mc/s ( $-3\text{dB}$ ) with rise time of  $.06 \mu\text{Sec.}$ , and overshoot of less than 1%. Calibrated nine stage frequency compensated input attenuator. In addition all the facilities of a high class 3" general purpose oscilloscope. Unique mechanical construction with all panels removable for ease of maintenance. Convection cooled.

### SEND FOR FULL TECHNICAL DETAILS

At its price the best value obtainable in this country—perhaps in the world.

**£36** carriage paid

**Dartronic**  
LIMITED

3-7, WINDMILL LANE, LONDON, E.15

Telephone: MARYland 6247

# COMPACT HI-FI

by *Armstrong*

**STEREO 55 £33.15.0**

(Illustrated)

## TUNER-AMPLIFIER CHASSIS

An outstanding new Armstrong chassis combining AM and FM Tuners, a Stereo Control Unit and two High Fidelity 5 watt Amplifiers in one compact unit. In all its functions the Stereo 55 is designed for mono as well as stereo use so that up to 10 watts output is always available.

Full VHF and medium bands. ● Inputs for tape recording and playback. ● Alternative pick-up inputs. ● Booster unit available for low output pick-ups. ● Input for possible future stereo radio. ● Separate bass and treble controls and dual volume control for ease of balancing. ● Free instruction booklet with every model.

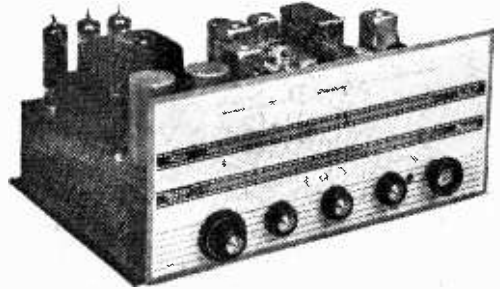

**STEREO 12 Mk. 2 £44.15.0**

A new and improved version of the famous Stereo-Twelve. A total of 16 watts output is available from the two 8 watts push-pull amplifiers. VHF, with automatic frequency control, and medium and long bands. Inputs for recording and playback and for stereo radio if required in the future. Booster unit available for low output pick-ups, both mono and stereo.

The name *ARMSTRONG* is the registered trade mark of **ARMSTRONG WIRELESS & TELEVISION Co. Ltd.** WALTERS ROAD, LONDON N.7. Tel.: NOR 3213

Post this coupon or write for free catalogue, or call at our Showroom for full demonstration and professional advice on your installation. Open 9-5 including Saturdays.

NAME \_\_\_\_\_  
 ADDRESS \_\_\_\_\_  
 PSS \_\_\_\_\_

### DE-LUXE TAPE CABINET 19/9



Exclusive design. Two-tone rexine. Detachable lid. Can be adapted to R/ Player cabinet. Size 14½ x 13 x 9½ ins. & Carr. 5/-.

### RECORD CABINET 29/9

Portable player, smart, colourful two-tone of Red and Silver Grey. Takes 4 speed single player. Plays all size records. Size 12 x 10½ x 6 ins. Ins. & Carr. 5/-.



### TRANSISTORS

G.E.C. Only 42/6 per set.  
 or 1-114 at 5/9 each.  
 1-873 at 7/9 each.

Ediswan XC121 and XB113 at 8/9 each. Post 7d. on each.

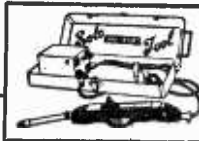

### SOLO SOLDERING TOOL 12/6

BRAND NEW. A.C. 110 v. or Car Battery. Adaptor 250 v. 10/- extra. Auto/lead and cannot burn. Carr. 4/-.

2-874 at 8/9 each.  
 1-Diode at 1/9 each.

### VALVES—BRAND NEW

8/9 each. EL91, EL42, EZ90, EZ40, EF86 I, ECC81, EF81, EF91, 6V6, ECC33, H141.

11/9 each. ECC40, EL34, EL38, EL37.

### Salvage guaranteed.

9d each. C2C, CV66, D1, D152, EA50, EB91, EF50, HL41DD, HL42DD, LD210, P61, PM202, SP41, SP61, T41, TDD13C, VR106, VR107, VR109, VR137, VR201, VR501, 4D1, 6D1, 6D2, 9D2, 12Y4, 15D2, 78, 210VPT, 2050, 1/9 each D77, EB41, EF91, N142, PEN45, PEN46, W148, Z77, 6F1, 6F12, 6F13, 6F15, 6K7, 6P25, 6P28, 7C5, 8D3.

### SPEAKER BARGAINS 8/9 each

5in, 6in, 8in, & 7 x 4in. Ex Manufacturers' Salvage. Money back guaranteed. P. & P. 3/3.



Speakers 15/9. NEW, slot type. Sizes 7 x 4ins. and 8 x 3ins. Ideal for our record cabinets. P. & P. 3/3.

### ODDMENT SALE

TV TUBES 35/-. 14in. Mullard 36/24 Perfect spares. Salvage guaranteed. Carr. & Ins. 5/6. Bakelite Cabinets 2/9. Brown Ideal for small receivers. Size 12 x 7 x 5½ in. P. & P. 4/-. Rectifiers 2/9. 250 v. 100 m.a. ½ wave, salvage guaranteed. P. & P. 1/3.

Post  
 7d.—1 6—1/6. 12—2/6.

Stamp for Free List

**REMEMBER**  
 **COMPONENTS LTD.**  
 of 219 ILFORD LANE, ILFORD, ESSEX

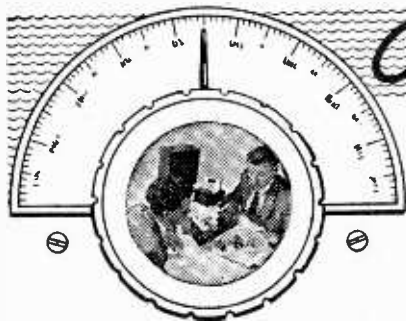

# On Your Wavelength

BY THERMION

## Transistorised Organ

**I**N the August issue I commented on the apparent absence of a commercial transistorised organ, and I must thank the many readers who sent me letters and details of one such instrument which is on sale in South Africa. Mr. Marks of Johannesburg sent me a brochure of this very interesting instrument which, he tells me, is completely transistorised and delivers an output in the region of 25W. According to the literature this is a most fascinating instrument and shows that the transistor can be used to give results probably better than the valve. Of course, there is also the point that the overall weight becomes so very much less. Apart from the interesting circuitry, the case for this instrument has the back enclosed with timber so that it can be pushed out into the middle of a room, if desired (the back is actually hand-rubbed satin finish), and this prevents any tampering with the essential adjustments. In addition to the normal organ features, this instrument includes chimes, built-in reverberation which is adjustable, and percussion. It appears to be a very noteworthy development of the application of the transistor and I hope to have an opportunity of hearing one some time. Incidentally, it is apparently manufactured in S. Africa under licence from an American company.

## Constructor Difficulties

I know that the constructor often experiences difficulties and disappointment in his hobby, but I recently heard from a reader who has, apparently, met all the troubles in the world. He contends that the amateur cannot possibly build a satisfactory transistor superhet unless he has the most expensive test gear. He says that he has spent over £200 during the past two years and has built thirty-four of these sets, not one of which has worked satisfactorily—if at all. He also says that many of his workmates experience similar difficulties, but I do feel that this is a very exceptional case. It is true that a superhet, even of the valve type, needs some care in aligning and it is always an advantage to have a signal generator. But I do know of many amateurs, even those who have never built a set before, who have attempted these modern pocket type receivers, and have been most successful. Perhaps the new Beginner's series which begins in this issue will offer some assistance to any others who find difficulty in building transistor sets.

## A Recording Problem

I have not yet got round to owning one of the modern tape recorders—mainly because I feel that I have no need for one. I have a very good record reproducing installation and this fills all my requirements so far as “mechanical” music is concerned. But I recently heard of a recording problem which seems to be rather mysterious, and perhaps one of my readers may be able to offer a suitable suggestion as to the cause and, perhaps the cure. An enthusiast had a recorder of well-known make and one day purchased a used spool of tape, but successfully made a recording of his own over the existing recording. When played back this was perfectly satisfactory (it included many of his own remarks and he was able to recognise his voice perfectly). The record was put away with others, but next time he played it, his voice had dropped several tones. The speed was correct but his voice was definitely much lower, although the speed was correct, and he wonders whether the molecular structure of the tape deposit could have altered in some way to produce this variation in reproduction. If so, of course, then tape will require special care if it is saved, as it may give a false impression when played at a later date. I suggest that there must have been some magnetic material near the tape where it was stored, and that he was lucky that the recording was not completely erased. Has anyone any other opinions?

## Revenge!

I recently commented on the increasing outdoor use of transistor portables and, apart from many letters agreeing with my dislike of this form of abuse, and the many boroughs and districts which have so far enforced a ban on their use, one reader has suggested a neat form of counter-attack. I am afraid the Post Office would not look kindly on his suggestion, but I feel that this is something which needs thinking about. He suggests the use of a low power R.F. oscillator, switched on when the offending receiver is audible. If the oscillator were tuned to the same frequency, the R.F. would tend to swamp the AVC and reduce the output. Failing that, modulation of the R.F. at 1kc/s would effectively jam the receiver. Two transistors would do the job, tuned over the medium waveband or operating at  $465\text{kc/s} \pm 10\text{kc/s}$  to cause I.F. break-through. The range required, the reader says, would be about 20ft. He adds, in rather a sarcastic vein, “Keep clear of G.P.O. detector vans.” I would be interested to know whether such a device would be contrary to the Post Office regulations, and if not, what steps could be taken by anyone with an offending portable who might be annoyed at the “interference”?

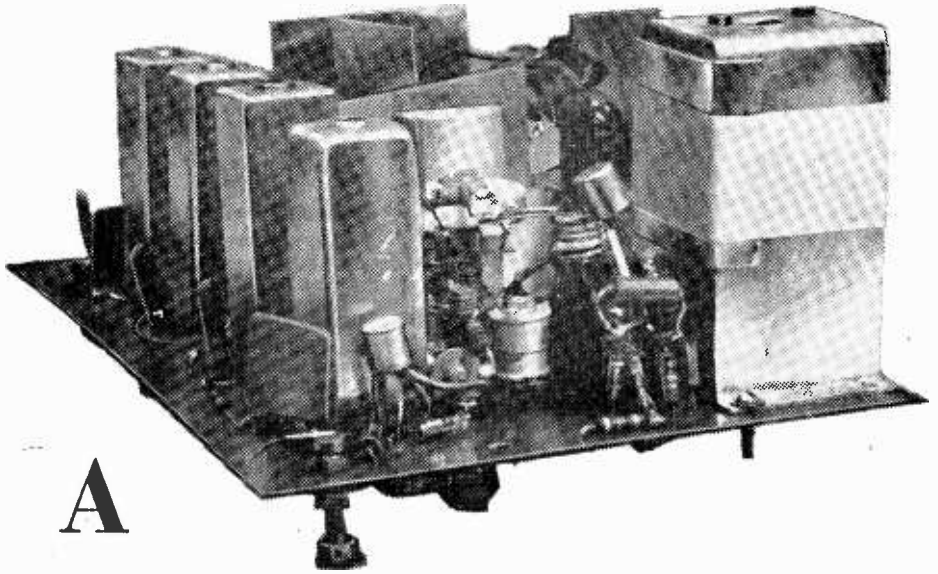

# A Transistorised VHF Superhet

HEAT SINKS, I.F. TRANSFORMERS AND  
COILS

By D. R. Bowman

(Continued from page 397 of the September issue)

**M**ENTION was made last month of the very thorough decoupling which was found to be necessary in the audio section of the receiver. However, layout is not at all critical and no difficulty should be experienced with instability.

### Negative Feedback

With the transformers specified, leakage inductance is low enough for quite a large amount of negative feedback to be applied if desired. Here however, a moderate amount only is used, approximately 6dB.

### Overall Gain

Moderate amounts of gain per stage have been designed for, in the interests of stability, except in the R.F. stage where the maximum feasible has been required. The R.F. stage gives about 15dB, the frequency changer 10dB, the I.F. stages 25dB

each, and the audio amplifier about 70dB. The total is thus 170dB, from which has to be deducted approximately 8dB per stage (as far as the detector) as transformer insertion loss, and about 20dB for loss in the detector stage. This, with 6dB negative feedback in the audio section, gives a total of approximately 112dB overall gain.

### Power Supplies

A 9V supply is required. The DT9 is a convenient battery, and will last a reasonable time—about a month or six weeks if the receiver is used

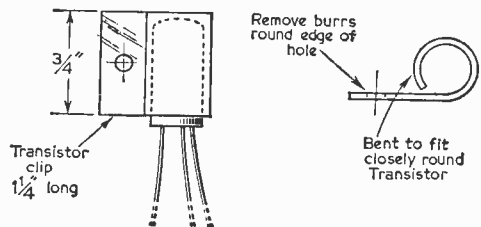

Fig. 2.—The construction of the clips for the output transistors—these clips are used to fasten the transistors to their heat sinks (which are described in the text).

**COIL WINDING DATA**

All formers are bakelite 0.27in. diameter  
 Screening cans required for transformers T2,  
 T3, T4 and T5 are  $\frac{1}{2}$ in. x  $\frac{1}{2}$ in. x  $2\frac{3}{8}$ in. All dust  
 cores are VHF (purple-coded) type

L1  $3\frac{1}{2}$  turns 18s.w.g. bare, spaced 0.3in.  
 outside length. Unscreened; one core  
 required

T1 Primary—6 turns 18s.w.g. bare, spaced  
 0.6in. outside length  
 Secondary— $1\frac{1}{2}$  turns PVC-covered connect-  
 ing wire interleaved each side of last  
 (H.T.) end of primary; one core is  
 required

All the following coils are wound in the same  
 direction. The primary and secondary would  
 thus form a winding of continuous direction  
 but for the interruption at the "middle"

T2 Primary—28 turns 28s.w.g. enamelled,  
 close-wound  
 Secondary—12 turns 24s.w.g. enamelled,  
 close-wound

Spacing:  $\frac{1}{2}$ in. between winding ends  
 (Note: The secondary is tapped 3 turns  
 from the earth end of the winding; this  
 tapping is the base connection to V3.)  
 Two cores are required

T3 } Primary—12 turns 24s.w.g. enamelled,  
 close-wound, tapped 3 turns from "inner"  
 T4 } end

Secondary—12 turns 24s.w.g. enamelled,  
 close-wound, tapped 9 turns from "inner"  
 end of winding

Spacing 0.4in. between ends of winding  
 Two cores are required for each trans-  
 former

T5 Primary—28 turns 28s.w.g. enamelled,  
 close-wound, tapped 7 turns from "outer"  
 end

Secondary—8+8 turns 24s.w.g., close-  
 wound, bifilar; Spacing 0.3in. between  
 ends of winding

Tertiary— $9\frac{1}{2}$  turns 28s.w.g. enamelled,  
 close-wound, wound over 10 turns of  
 primary nearest the tap. 1 turn Sellotape  
 as insulation

Three cores are required

much reduced output quality, down to a battery  
 voltage of 4. The oscillator section continues to  
 operate down to 2.6V with the particular trans-  
 istor used, though, of course, overall receiver  
 gain at this voltage is negligible.

**Heat Sinks**

Before fixing, the driver and output transistor  
 heat sinks should be prepared as follows. Three  
 pieces of sheet aluminium, 16s.w.g., measuring 3in.  
 x  $2\frac{1}{2}$ in. are sawn out of a flat sheet. Snipping with  
 tin-snips causes curvatures which must be  
 avoided. A  $\frac{1}{4}$ in. flange is turned over on one short  
 side. Then a flat is filed, very lightly, on the middle  
 side of the sheet. It is most important to see that this  
 flat is really accurate. A  $\frac{1}{4}$ in. hole is now drilled  
 in the flat portion and burrs carefully removed.  
 Three pieces of 22s.w.g. aluminium,  $\frac{1}{2}$ in. x  $1\frac{1}{2}$ in.  
 are sawn out of a flat sheet and bent round over  
 the shank of a  $\frac{3}{8}$ in. drill. The final curvature has  
 to be  $\frac{3}{8}$ in. to accommodate the OC81 transistors,  
 and the natural springiness of soft aluminium  
 sheet, with a very little force, will enable the trans-  
 istors to be inserted firmly and closed into these  
 cooling clips. Fig. 2 shows the arrangement. The  
 assembly should be inspected against a strong light  
 to ensure that no gaps occur between the trans-  
 istors and the cooling clip. If small gaps appear,  
 silicone grease—a smear only—may be used to  
 assist dissipation of heat, but gaps should be  
 avoided even if it means making six clips to get  
 three good ones. Before assembly, the tuning con-  
 denser should be inspected. If the bearings carry  
 an appreciable amount of grease it should be  
 wiped away, and if at all slack the bearings should  
 be tightened up. This precaution is mentioned here  
 because in the prototype receiver some consider-  
 able trouble was found in obtaining electrical con-  
 tact of the required effectiveness; the capacitor  
 tuned very noisily through stations. This instability  
 was removed partly by tightening up, partly by  
 soldering to a side pillar of the capacitor an  
 additional phosphor-bronze leaf-spring contact  
 which was arranged to press heavily on the spindle

for about 4 hours daily. The receiver gives good  
 output even when the battery voltage has dropped  
 to 6, and continues to provide a useful signal, at

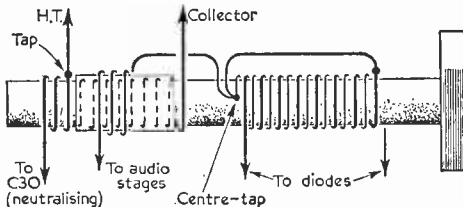

Fig. 3.—The discriminator transformer windings (T5  
 in the circuit). The method of winding the bifilar  
 secondary has been shown by using thick and thin  
 lines to represent the two halves, but, of course, the  
 same gauge of wire is used for both.

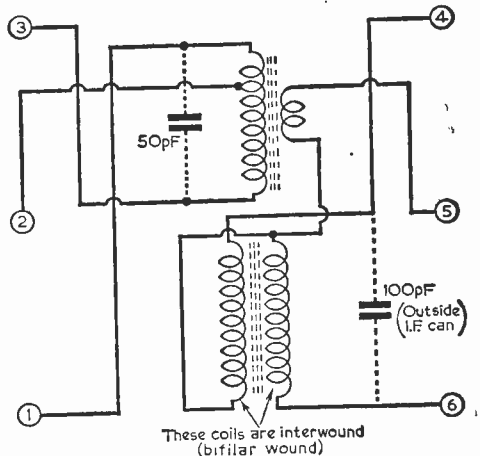

Fig. 4.—The connections of the windings of the  
 discriminator transformer—the numbers refer to the  
 coil base connections given in Fig. 6 overleaf.

between R.F. and F.C. sections. This spring was connected to chassis through a short length of copper braid. The capacitor had seen previous service, and it is not expected that a new component would cause trouble.

**The R.F. and F.C. Stages (see table, page 493)**

The coils for R.F. collector and oscillator are wound on 0.3in. bakelite formers, and the direction of winding is immaterial. The wire is 18s.w.g. bare and, preferably silver-plated, for the collector and oscillator coils; these coils are first wound on

a 1/16in. drill shank and then slipped, with some force, on to the former. The F.C. emitter winding, of 22s.w.g. copper wire, in thin sleeving (or PVC-covered connecting wire) is added between the "earthy" turns of the R.F. collector winding. The spacing is adjusted to the specified value, and then the whole windings are covered with contact adhesive (clear) and allowed to dry thoroughly. The properties of this adhesive have not been measured but appear to be not markedly inferior to polystyrene cement, and the job is much more reliable than when polystyrene cement is used with thick wire.

**The I.F. and Discriminator Transformers (see Figs. 3, 4, 5, 6 and 7).**

The I.F. transformers could be constructed in the normal way, and for mounting, the lugs of the

Slot cut in securing lugs

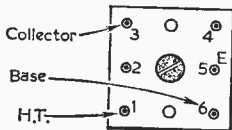
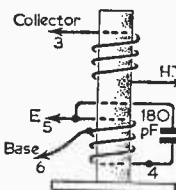
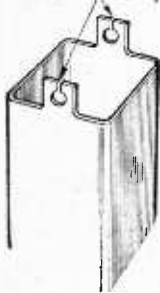

Fig. 5.—The mounting lugs of the transformers are cut as shown to enable them to be passed over the fixing bolts (see text).

Fig. 6.—The I.F. transformer windings and the numbering of the base connections.

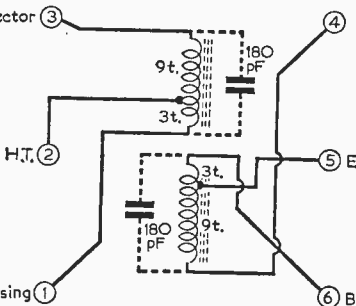

Fig. 7.—The connections of the I.F. transformer windings.

**LIST OF COMPONENTS**

Capacitors and resistors are as shown in the circuit diagram.

All resistors are of 1/2W rating and of 10 per cent tolerance, except as shown below:

R38 5 per cent

R37 5 per cent

R39 3 x 10Ω 10 per cent, in parallel

Volume control: 10k with D.P.D.T. switch, log or semi-log

Capacitors: All 180pF capacitors are 5 per cent silver-mica types

C5, C10 are type N750K (Erie)

Capacitors C2, C3, C4, C8, C11, C14, C15, C19, C20, C21, C23, C25, C28, C29, C31, C40 are of the ceramic miniature type (Erie)

CC1 and CC2 are 10pF ± 10 per cent silver-mica

C37, C39, C43 are 8μF electrolytic 6VW sub-miniature types

C38, C45 are Plessey type CE 7037

C42 is Plessey type CE205

C46 is 0.25μF tubular (TCC)

C41, C44 are TCC type CE100DE

The tuning capacitor is Jackson Bros. type C808 (catalogue number 5103)

Transformers (Gilson):

Driver transformer: type WO.1806

Output transformer: type WO.929/6v (3Ω)

Speaker: 7in. x 4in. elliptical, 3Ω

Battery: DT9 or equivalent

can slipped through slots in the printed circuit board ready for bolting down. However, cutting neat slots in the laminated board is not a simple matter, and in the prototype the following method of canning the I.F. transformers was adopted.

When the transformers have been wound, all cement is thoroughly dry and all exposed metallic surfaces are covered with Sellotape, the 1/16in. 6B.A. bolts are screwed through the fixing holes from the "inside" and are tightened up. The can is then slipped over the assembly. The lugs are then snipped through so that, on bending over, the halves can be worked round the 6B.A. bolts and flattened against the underside of the bakelite former. A brass washer is placed over the bent-over lugs and then a brass nut is screwed down firmly. Nearly 1/16in. of bolt will stand proud for insertion through holes in the laminated board, and when these in turn are screwed down, with washer and nut, against the copper surface of the printed circuit board a good electrical earth to the can is achieved.

(To be continued)

**JOIN THE PRACTICAL GROUP**

PRACTICAL TELEVISION ... .. 1/6  
Every Month

PRACTICAL MECHANICS ... .. 1/6  
Every Month

Devoted to Mechanics, Science and Invention  
PRACTICAL MOTORIST ... .. 1/6  
Every Month

PRACTICAL HOUSEHOLDER ... .. 1/3  
Every Month



# An Earthed Grid R.F. Amplifier

By E. A. Parker

*ATMOSPHERICS* and other interference generated outside the receiver limit its useful sensitivity on the communications bands below about 20Mc/s, but at higher frequencies they are much less intense and interference (except that generated by motor car ignition systems, of course) is virtually non-existent. At these high frequencies, then, receiver noise is very important, and the noise level of the receiver and the associated aerial will set the level below which signals will be inaudible. Since noise generated in the earlier stages of a receiver will undergo far more amplification than that generated in the later stages, any effort made to reduce receiver noise must be concentrated on the first R.F. stage, and to a progressively lesser degree on any subsequent R.F. or frequency changing stages.

In the case of an average communications receiver using one R.F. stage, the addition of a low noise pre-amplifier will give a most marked improvement in the signal-to-noise ratio. The existing R.F. stage has now been moved one stage away from the aerial, and the noise which it generates receives less amplification than before for a given signal output at the speaker or 'phones. The writer modified his R208 receiver in this way, using the grounded grid triode unit to be described. It was also found that the replacements of the original octal based R.F. valve — an EF39 — with an EF50 or the more recent EF91 or EF80 miniature valves again improved the performance of the set. Octal-based valves are unsuitable for use above 40-50Mc/s owing to their inherent noise and the fact that their gain tends to fall off fairly rapidly above this frequency range.

## Valves

Triode valves are much less noisy than pentodes or tetrodes, but they cannot be used in normal amplifying circuits at radio frequencies owing to their high anode-grid capacitance, which permits positive feedback at R.F. and so causes instability and oscillation. In the early days of wireless, this problem was overcome by introducing a further electrode—a grid was placed between the control grid and anode and maintained at earth potential with respect to the R.F. signal. This shielded the input to the valve from the output and prevented

positive feedback. Thus was born the tetrode valve, but, the extra electrode increased the inherent noise of the valve. However, methods were found where by the triode could be used as an amplifier at R.F. The most important of these was to earth the grid and apply the R.F. signal between cathode and earth. The amplified signal was in effect taken from anode and earth, as indicated in Fig. 1.

The cathode impedance should have a value of about  $150\Omega$  at D.C. and the voltage drop across it provides bias for the valve. At R.F., the cathode impedance is conveniently provided by an R.F. choke, and a glance at Fig. 2 will indicate that in the actual unit, a choke and resistor are used in series. The anode impedance may be an R.F. choke or a tuned circuit.

## Screening

The earthed grid mode of operation thus provides shielding of output from input in the form of an earthed grid, and the arrangement functions well with remarkably high signal-to-noise ratio. Valves designed for earthed grid operation differ from normal triodes in that care is taken to ensure that the grid extends along the whole length of the cathode, thereby totally screening it from the anode. Examples of such valves are types CV66, EC91 and 6C4. Any of these valves will work well in the circuit of Fig. 2—the circuit used by the writer. To lessen the effects of lead inductance, the grid is brought out to four pins each of which is then separately earthed; the anode is brought out to two pins for the same reason. (The inductance of inductors in parallel is less than the smallest.)

Yet another advantage of the addition of this unit was the fact that the aerial damping was removed from the first tuned circuit of the receiver, enabling the associated trimmers to be peaked sharply. This in itself resulted in an increase in gain. In addition, the input impedance of the circuit was low and matching the aerial to the receiver no longer presented any problems. Matching was far from critical. It will be noted that the circuit is aperiodic—untuned or non-

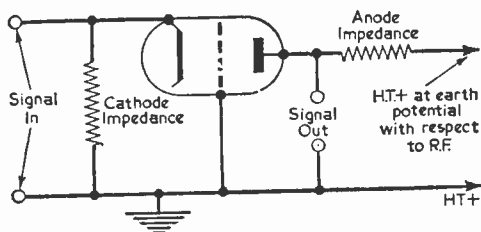
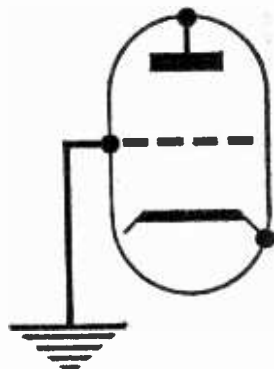

Fig. 1.—The effective circuit of an earthed grid triode.

resonant—which has the advantage that no extra gang is demanded on the main tuning capacitor.

### Constructional Details

Turn again to Fig. 2; the radio frequency choke in the aerial circuit is best made by winding in one layer a length of fine wire [about 40s.w.g.] (equal in length to one third of the wavelength of the lowest frequency to be received) on to a glass or ceramic former, so that the length of the solenoid is about twice its diameter. However, the writer had several radio frequency chokes of miscellaneous design in his junk box, and these

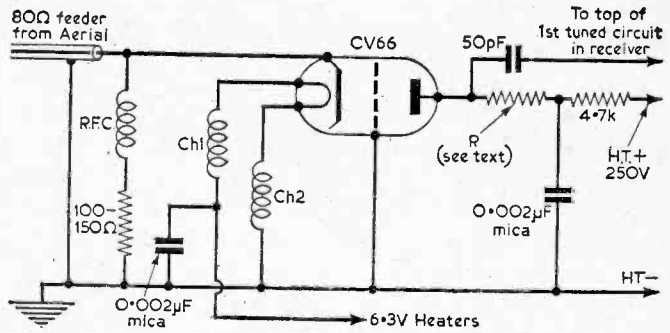

Fig. 2.—The circuit diagram of the unit.

circuit form a filter which eliminates mains-borne noise, and the chokes tend to isolate the heater and cathode from earth at radio frequencies. (The heater-cathode capacitance may be great enough to bypass to earth the signal applied to the cathode in the absence of the chokes.)

### Anode Load

A point of interest is that the anode impedance (R) was derived from a 3W wire-wound resistor of D.C. resistance 4.7k—the D.C. resistance of R limited the anode voltage of the triode to within safe bounds, and the inductance of the component presented an additional impedance to R.F. signals which increased with frequency. This tended to offset the effects of stray capacitance elsewhere in the receiver, and sensitivity at all frequencies was much greater than expected.

Fig. 3 indicates the arrangement of components used by the writer. The unit was built on a sub-chassis made from aluminium and measuring 2in. x 3½in. x 1½in. Although the layout was not found to be very critical (a welcome point at high frequencies), all leads should be kept as short as possible. Most components can be wired directly to the valveholder. The chassis should first be drilled to take the valveholder (ceramic)—a 1½in. hole if a CV66 type valve is used (B9G base)—which should then be bolted in position. The tinfoil screen should be soldered firmly to the valveholder as shown in Fig. 3, and the various components may then be mounted. "Tin" boxes provide a convenient source of tinfoil—which is very easily soldered. Any paint should be removed for appearance's sake.

When the unit has been completed it should preferably be bolted securely inside the communications receiver as near as possible to the first tuned circuit. In many receivers it will be possible to mount it so that the anode pin of the earthed grid triode lies fairly close to the top of the first gang on the main tuning capacitor. The output lead may then be kept very short.

The unit consumes very little power, and may be run without trouble from the existing power supplies of most communications receivers.

**FREE MULTIMETER BLUEPRINT**  
(value 5/-) in the October issue of  
"Practical Television." Order YOUR  
copy now!

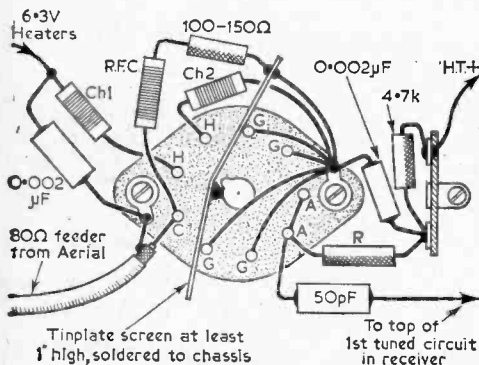

Fig. 3.—The layout of the R.F. preamplifier.

were found to function equally as well as that specified above. The value of the resistor in series with this choke should be adjusted so that the D.C. resistance of the combination is 150Ω approximately—the value required will be found to lie between 100 and 150Ω. The chokes in the heater leads are not very critical and it was found that 40 turns of 26s.w.g. wire on a ½in. diameter paxolin former was all that was required for satisfactory operation between 10 and 60Mc/s. It has been found that this circuit will function readily at all frequencies up to 400Mc/s; and the inductance and consequently the number of turns required on the choke decreases with increasing frequency. At frequencies above 100Mc/s, however, ceramic or glass formers are essential. The chokes and capacitor in the heater

### COMPONENTS LIST

Earthed grid triode valve, e.g. CV66 or EC91  
Ceramic valveholder to suit

Resistors (see text)

100-150Ω ½W; 4.7k, 3W w.w.; 4.7k, ½W

Capacitors

50pF, two 0.002μF, mica.

Single layer R.F. choke, or 40s.w.g. wire to wind and former

Two heater chokes, 26s.w.g. wire to wind and formers

**BRAND NEW AM/FM (V.H.F.) RADIOGRAM CHASSIS AT £14 (Carriage Paid)**

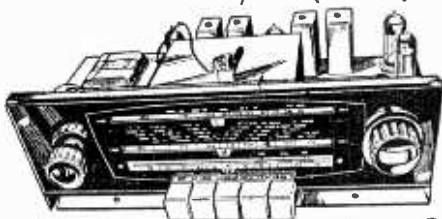

Tapped input 200-225 v. and 226-250 v. A.C. ONLY. Chassis size 15 x 6 1/2 x 5 1/2 in. high. New manufacture, 12 mths. guarantee. Dial 14 1/2 x 4 in. in black and gold. Pick-up. Extension Speaker. Ae. E., hd Dipole Sockets. Five "piano" push buttons—OFF L.W., M.W., F.M. and Gram. Aligned and tested. With all valves and O.P. Transformer. Tone Control Fitted. Covers 1,000—1,800 M.; 200-500 M.; 88-98 Mc/s. Valves E280 rect., ECH81, EF91, EABC80, EL84, ECC85. Speaker and Cabinet to fit chassis (table model), 47/6 (post 3/6). 10 x 6 in. ELLIPTICAL SPEAKER. 20/-, to purchasers of this chassis. **TERMS:**—(Chassis) £5 down and 5 Monthly Payments of £2, or with Cabinet and Speaker £5.10.0 down and 6 Monthly Payments of £2. This chassis is an ideal partner for the radiogram cabinet appearing on this page.

**THE "CABY" TEST METERS**

Prices include Test Prods., Batteries, Instruction Book. Also measure dB. Accuracy: A.C., 3 per cent. D.C., 2 per cent.

A-10 **£4.17.6** B-20 **£6.10.0**

A.10—2K ohms/v. on A.C. and D.C. volts (10, 50, 250, 500 and 1000 v.); 10K and 1M ohms; 1 mA, 25 mA and 250 mA. D.C. Size; 5 1/2 x 3 1/2 x 1 1/2 in. Weight 17 oz.

B.20—10K ohms/v. on 0.5 v. and 2.5 v.; 4K ohms/v. on 10, 50, 250, 500 and 1000 v.; A.C. and D.C. Resistance, 2K, 20K, 2M and 20M ohms; D.C. current, 100 microA. 2.5 mA, 25 mA, 250 mA. Size: 5 1/2 x 3 1/2 x 2 1/2 in. Weight 24 oz.



**TAPE RECORDER FOR ONLY £17.17.0 (10/- carr.)**

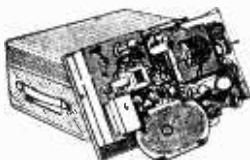

A QUALITY ARTICLE. Valves E280, ECC83, ECL82, DM70. Acos Crystal "mike", 850ft. Tape and extra spool. 3 1/2 in./sec. Mike and Radio inputs; Vol. on/off tone, Ext. L.S. and Monitor. Fast forward and reverse. Cannot be accidentally erased. Magic Eye Indicator. 6 x 4 in. Speaker. Cabinet 14 x 1 1/2 x 7 1/2 in. Supplied completely built in cabinet.

B.S.R. "MONARDECK" TAPE DECK SINGLE SPEED. Our price only £7.2.6 (5/6 carr.). 850 ft. first grade tape 5 1/2 in. plastic spool. 16/-, post 1/-.

4-VALVE AMPLIFIER (INC. RECT.). 4 watts. EF86, ECC83, EL84, and E280. Controls, volume, bass and treble. On/off switch. Overall size 13 x 4 x 5 in. over valves. Mains and O.P. trans and 6 1/2 x 4 1/2 in. Celestion speaker. Suitable for microphone input. A.C. only. Socket provided for Tape Recorder application.



**SUPERB CONTEMPORARY CABINET**

Fitted with 3 sliding doors providing room for Radio, Autochanger, 4 speakers, and record storage.

PRICE 15 Gns.

Free delivery in London area. 35/- carriage elsewhere.



SAVE 10/- Swiss made Unic Shaver operating from 1.5 v. battery, usual price 59/8. Our price 50/- with battery. Takes U2 battery. Not a toy, but a shaver (carr. paid).

COLLARO STUDIO TAPE TRANSCRIBER. 3 MOTORS, 3 SPEED. Push Buttons. £10.17.6 (10/- carr.) incl. spool.



**LISTEN WITHOUT INTERFERENCE**  
Fully built V.H.F./F.M. Set for £8.12.0 (carr. pd.). Covers 89/96 Mc/sec. Wired, aligned and tested. Muillard permeability tuner and 4 valves (ECC85, ECL82 and two EF91), 2 diodes. Cheap room dipole, 10/-, 300 ohm twin feeder, or co-axial cable. 6d. yd.

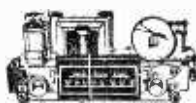

**SELF-POWERED VHF TUNER CHASSIS.** Covering 88-95 Mc/s. Muillard permeability Tuner. Dims. 10 1/2 x 4 1/2 x 5 1/2 in. high. ECC85, EF91, EF91 and 2 diodes. Metal Rectifier. Mains transformer. Fully wired and tested. Only £7.14.0 (carr. pd.). Room dipole 10/-, 300 ohm twin feeder. 6d. yd. Tuner without power pack £6.14.0 (carr. pd.).

**STEREO AMPLIFIER £4.15.0 (4/- p. & p.)**

Brand new. 200-250 A.C. Tone and volume controls each channel. E280; ECC83; and 2—EL84; giving 2 x 4W. Size 12 x 3 1/2 x 3 1/2 ins. O.P. Trans. for 2-3Ω speaker. Separate on/off switch to allow balancing to remain set. Monoaural push/pull amplifier giving 8W same price.

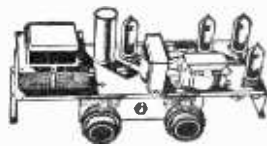

**BATTERY ELIMINATOR.** For 4 Low Consumption Valves (86 range), 90 v. 15 mA, and 1.4 v. 125 mA. £2/6 (2/6 post). 200-250 v. A.C. Size 5 1/2 x 3 1/2 x 2 in. Also for 250 mA. 1.4 v. and 90 v. 15 mA at same price.

**AUTOMATIC RECORD CHANGERS.** ALL 4-SPEED WITH TURN-OVER CRYSTAL CARTRIDGE (carr. 5/- extra). B.S.R. UA8, £6.10.0; UA8 stereo, £7.5.0; latest UA14, £7.10.0. Motor board to fit changer 3/6.

**COMPLETE V.H.F./A.M. RADIO FOR £12.10.0 (carr. paid)**

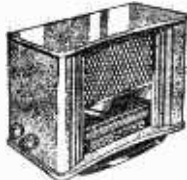

Brand new set, in superb walnut cabinet (size 19 x 9 1/2 x 14 1/2 in. high). Covering 80-100 Mc/s. 16-49 M.v. and 200-500 M. Mains trans. 200-250 v. with 2 tapplings. Ferrite rod aerial for A.M. Controls: volume on/off, tone, tuning, w/change. Gram and ext. speaker position provided. Valves 12AT7, 12AH8, 6B6, EABC80, 6BW6 and metal rectifier. Fully guaranteed. Today's Value £20.

**GRAMOPHONE AMPLIFIER**

With 5 in. SPEAKER. Baffle 12 1/2 x 6 in. E240 and EL1. Tone and Volume. On/Off switch. Two Knobs. Ready to play. Useful for Stereo. ONLY 57/-, post 3/-.



**GERMAN MADE F.M. FRONT END** with ECC85 valve. Capacity tuned with reduction gear. Covers 88-96 Mc/s. 4 1/2 x 3 x 3 1/2 in. over valve. New. price 22/6 (2/6 post). Circuit 2/6.

"Fidelity" 6-transistor "Coronet" Radio. Pocket Radio 4 1/2 x 2 1/2 x 1 1/2 in. for M.W. and L.W. 12 months guarantee. 59 gns. inc. battery carr. paid.

**CONSTRUCTORS' Bargain parcel for 20/- (3/- post)**  
Electrolytics, tubulars, resistors, ceramics, valveholders, etc. Every parcel worth £4 at current prices.

Send 6d. (stamps will do) for 20 p. illustrated catalogue. All New Goods. Delivered by return. Terms:—One third down and balance plus 12/6 in four equal monthly payments. Postage with down payment (C.O.D. 2/- extra).

SEE SPECIAL TERMS FOR AM/FM CHASSIS.  
ALL ITEMS GUARANTEED 12 MONTHS—  
B.V.A. VALVES 3 MONTHS

**GLADSTONE RADIO "SCALA," CAMP ROAD, FARNBOROUGH, HANTS.**

Also at 247 New Road, Portsmouth, Hants, and 56 Stokes Croft, Bristol 1. Tel. 27809

Farnborough closed Saturday. Portsmouth and Bristol closed Wednesday.

Posted orders to Farnborough Please.

See additional advert, page 532.

# WEYRAD

IMPROVED COMPONENTS FOR THE 6-TRANSISTOR  
2-WAVE SUPERHET RECEIVER

NEW ROD AERIAL AND DRIVER TRANSFORMER FOR SIMPLER ASSEMBLY  
AND HIGHER PERFORMANCE

- ROD AERIAL—RA2W  
6 in. long, 3/8 in. diameter, connections to tags  
on Coils. For 208 pF tuning capacity ... .. 12/6
- Car Aerial coupling Coil ... .. 1/-
- OSCILLATOR COIL—P50/1AC  
M.W. covered with 176 pF tuning capacity.  
L.W. by extra padder ... .. 5/4
- I.F. TRANSFORMERS  
1st and 2nd Stage—P50/2CC ... .. 5/7  
(2 Required)
- 3rd Stage—P50/3CC ... .. 6/-
- DRIVER TRANSFORMER—LFD T4  
Redesigned to reduce size and improve perform-  
ance. Six spills for mounting and connections 9/6

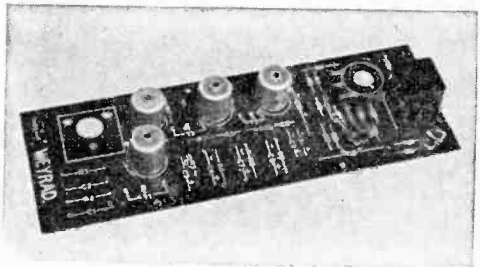

PRINTED CIRCUIT—PCAI

Size 2 3/4 in. x 8 1/4 in. Ready drilled and printed with component positions ... .. 9/6

WE CAN NOW OFFER A CIRCULAR TUNING SCALE PRINTED IN BLACK ON GOLD FOIL,  
CALIBRATED WITH WAVE-LENGTHS AND STATION NAMES ... .. PRICE 6d.

CONSTRUCTOR'S BOOKLET WITH FULL DETAILS AND FREE SCALE ... .. 2/-

**WEYMOUTH RADIO MANUFACTURING CO., LTD.**  
REGENT FACTORY, SCHOOL STREET,  
WEYMOUTH, DORSET

## KINGSMERE SUPPLIES LIMITED

Insured Post 1/-, over £2 Free (Export extra).  
Single valves, post 6d.

MAIL ORDER HOUSE

TERMS: Remit with Order or C.O.D.  
Cash refund guarantee

Built to the highest specifications,  
these chassis offer  
the finest valve  
to the en-  
thusiast.

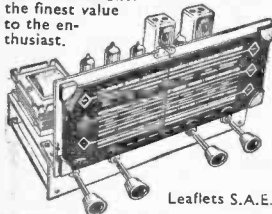

Leaflets S.A.E.

**ALL BRITISH RADIOGRAM  
CHASSIS, 3 WAVEBANDS  
5 MULLARD VALVES**  
ECH81, EF89, EBC81, EL84, EZ80  
Brand new and guar. A.C. 200/250v.  
Short - Medium - Long Gram. P.U.  
High Q dust core coils - Latest  
circuit technique. AVC and neg-  
feedback. 4 watts. Chassis size  
13 1/2 x 6 x 7 in. Aligned and  
calibrated ready for use. Quality  
at Low Cost. Chassis isolated.  
H.P. Dep. £5 and five monthly of £1.

OUR PRICE **£9.9.0**

Matched Speakers, 5in., 6 1/2in., 8in., 17 1/2 ea. 10in. 25/-, 12in. 30/-.

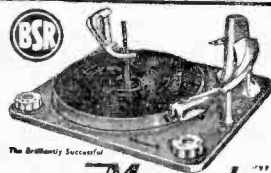

**BRAND NEW  
AND BOXED**

4 SPEED  
MODEL UA14

**£7.9.6**

FOR L.P. and 78  
R.P.M. RECORDS  
7", 10", 12"

**GARRARD 4-SPEED HIGH FIDELITY UNITS**

Autochanger RC210 £9.19.6  
Single Player TAMk. II £7.19.6  
Transcription 4HF £16.19.6

Price inc. plug-in normal  
heads. Stereo hds. £2 ex.

### BRAND NEW VALVES

1R5	6/-	6X5G	6/-	EF41	9/-
1S5	6/-	12AT7	6/-	EF80	7/-
1T4	5/-	12AU7	6/-	EF91	4/-
354	7/6	12AX7	6/-	EL41	9/-
3V4	7/6	12K7GT	6/6	EL84	8/6
5U4	6/-	12Q7GT	6/6	EY51	7/6
5Z4G	9/6	35L6	9/6	EY86	7/6
6J5	5/6	35Z4	6/6	EZ40	7/-
6I6	5/6	954	1/6	EZ80	7/6
6I7G	6/6	DAF9.3	8/-	MU14	7/6
6K6GT	5/-	DF96	8/-	PCF84	8/-
6K7G	5/-	DK96	8/-	PCC80	7/6
6K7M	7/6	DL96	8/-	SP61	3/6
6K8G	6/-	EB31	4/-	UL41	8/6
6Q7G	7/6	EBC41	8/-	UY41	7/-
6SN7GT	6/6	EBF80	10/-	U22	8/-
6V6G	5/-	ECC84	8/-		

### COMPLETE RADIO

**£4.19.6**



4 Mullard valves, 5in. speakers, frame  
aerial, 4 pre-set stations, 1 long, 3  
med. wave, Superhet Circuit.  
Size 9 x 6 x 5 1/2 in. high. Tested ready for  
use. 200/250 v. A.C.—D.C. Mains.

### Syncrotape

**RECORDING TAPE "BRAND FIVE"**  
5in. 600ft. ... 13/6  
5in. 900ft. ... 18/6  
5 1/2 in. 1,200ft. ... 20/6  
7in. 1,200ft. ... 20/6  
7in. 1,800ft. ... 32/6  
Spare Reels, 3in. 1/6, 4, 5, 5 1/2 in. 2/-, 7in. 2/6.

### Recording Tape

"BRAND FIVE"  
MYLAR DUPONT  
Super High Fidelity  
Double Play  
5in. 1,200ft. ... 37/6  
7in. 2,400ft. ... 60/-  
7in. 2,400ft. ... 60/-

"Instant" Bulk Tape Eraser and Head De-  
fluxer, 200/250 v. A.C., 27/6. Leaflet, S.A.E.

4 amp Car Battery Charger with amp meter  
Leads, Fuse Case etc., for 6 v. or 12 v. 69/6.

### SETS OF VALVES

19/6 1R5, 1T4, 1S5, 354 or 3V4.  
27/6 6K8, 6K7, 6Q7, 6V6, 5Z4 or 6X5.  
37/6 ECH42, EF41, EBC41, EL41, EZ40.  
39/6 ECH81, EF89, EBC81, EL84, EZ80.  
35/- 12K8, 12K7, 12Q7, 35L6, 35Z4.

**25 FOAMCOURT WAY, FERRING, WORTHING, SUSSEX**

# A Compact Power Supply

By  
J. C. Flind

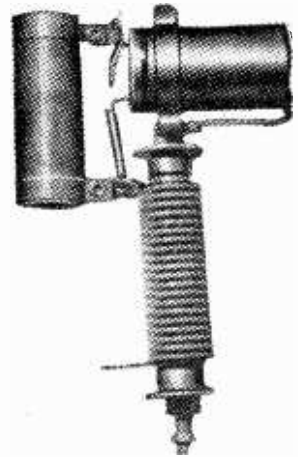

Above—The completed unit.

**A** PROBLEM which frequently confronts the constructor is the provision of power supplies to equipment which has been built up on a chassis which "happened to be handy"—all too often, after a series of modifications and improvements there is insufficient space left for the rectifier and associated smoothing components. The rather neat assembly described here was evolved to meet just such an emergency which arose when a battery receiver had to be converted to mains operation, and the idea is offered in the hope that it will help other constructors who may come up against the same difficulty.

### Layout

The unit requires only a single  $\frac{1}{4}$ in. hole for fixing to the chassis, and the space taken up at chassis level is no more than the diameter of the metal rectifier—say one square inch at the most. The smoothing components are carried some inches above the chassis where there is usually some spare space and where risks of overheating are reduced.

The diagrams are almost self-explanatory; the main feature of the design is the familiar Westing-house-type air-cooled metal rectifier, obtainable from surplus dealers for a few shillings. The screwed rod which forms the "backbone" of the rectifier is used to carry a Terry spring tool-clip, which in turn holds a metal-cased twin electrolytic smoothing condenser of suitable capacity and rating; the case of the condenser, forming the negative pole, is effectively earthed through the metal rod, the other end of which is passed through the fixing hole in the chassis and secured by a nut. (In the illustration at the top of the page the capacitor employed had a polythene covering—hence the earthing wire which is visible, running to a solder-tag just under the Terry clip.)

### Construction

Soldered to the red or positive terminal of the rectifier is a suitable dropper resistor, chosen according to the current demands of the equipment; a useful value for general purposes is a wire-wound  $2,000\Omega$  10W resistor, with a ceramic former and having substantial lugs. One of the "positive" wire leads from the condenser is also connected to this terminal of the rectifier, and the other end of the resistor goes to the second positive tag of the condenser, the thick wire lead giving adequate mechanical strength. This is point B (see Fig. 2), the output lead, and the unit is now ready to be connected up.

The simple circuit is shown in Fig. 1. A small eliminator-type transformer, having a single H.T. winding, is employed, thus isolating the chassis from mains and increasing safety.

This power pack can be made up in a few minutes, usually from odd components which can be found in the spares-box, and one or two kept ready-built will be found invaluable when power supplies are wanted in a hurry during experiments.

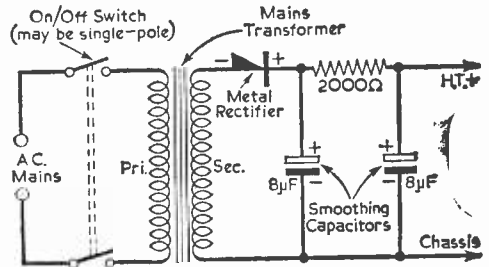
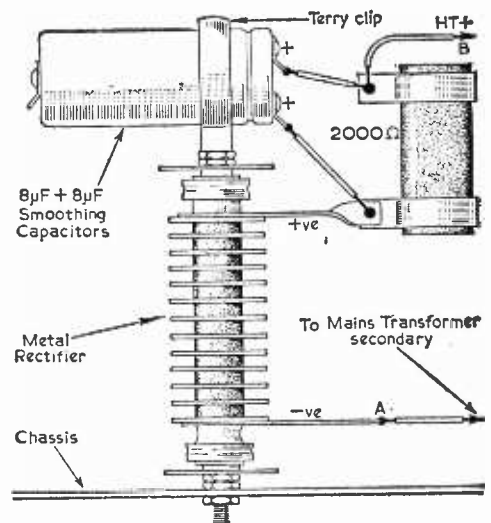

Fig. 1 (above).—The simple circuit of the unit.

Fig. 2 (below).—The straightforward construction of the power pack.



# CALCULATING $\pi$ -NETWORKS

## DETERMINING COMPONENT VALUES FOR THESE COUPLING CIRCUITS

By G3OGR

THE common use of a  $\pi$ -network is to couple a transmitter to the line feeding the aerial. In these circumstances, the network is nearly always required to provide an impedance transformation from a fairly high impedance to a much lower impedance. When it cannot do this satisfactorily, various difficulties in tuning and loading arise and it is hoped that means of arriving at suitable values may be useful, together with ways of overcoming the troubles which can arise when values are not suitable.

With circuits of reliable design, difficulties of this nature may not be encountered, unless an attempt is made to operate outside the conditions originally intended (e.g., with a very high impedance aerial). But, with converted or home-built equipment, or the pressing into service of unsuitable components which may be to hand, trouble may be experienced.

A typical  $\pi$ -network is shown in Fig. 1. The amplifier will probably be working Class C, which means it is provided with bias beyond cut-off, and anode current flows for only about 120° to 150° of the excitation. In these circumstances, the anode voltage can be expected to reach about twice the H.T. voltage. If a 600V supply were used, the isolating condenser should thus be rated at 1200V or higher. A 2kVW or 3kVW condenser would serve. If anode modulation drives the anode voltage from zero to 1200V, the isolating condenser should be for at least twice this figure—2400V. A 4kVW or 5kVW condenser would probably be used. As the capacity is not large, a component of adequate rating can easily be fitted. The choke is usually 1mH or larger, and needs to withstand the R.F. voltage developed. A receiver type choke is only suitable for low power.

The  $\pi$ -network consists of C1, L1 and C2. For a low output impedance, C2 is large. The anode or plate load R1 for the Class C amplifier can be found by dividing the plate resistance by 2. The plate resistance can be taken as E/I. If the valve is loaded to 100mA at 600V, this is 600/0.1=6,000 $\Omega$ . One half of this is 3,000 $\Omega$ .

It would be usual to employ a minimum Q of about 12, for such purposes. The capacitive reactance Xc of C1 is given by:

$$Xc = \frac{\text{Plate load}}{Q} = 250\Omega$$

Assume the circuit is to be used for 3.6Mc/s. The capacitor reactance  $Xc = 1/2\pi fC$ . From the above, Q may be expressed as  $R1/Xc$ . The coil reactance may be expressed by:

$$\frac{Q \cdot R1 + (R1 \cdot R2 / Xc2)}{Q^2 + 1}$$

Approximate values are suitable, because both C1 and C2 will be variable, for tuning and load adjustment. This gives approximately 170pF for C1, 12.5 $\mu$ H for L1, and 1,000pF for C2, where R2 is to be about 70 $\Omega$ .

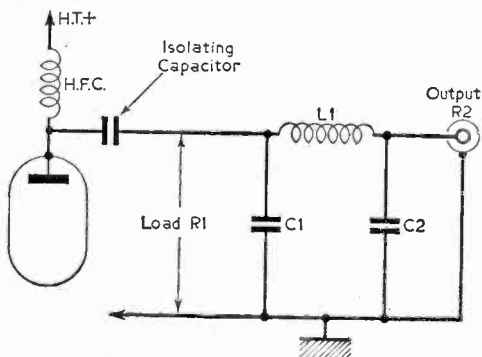
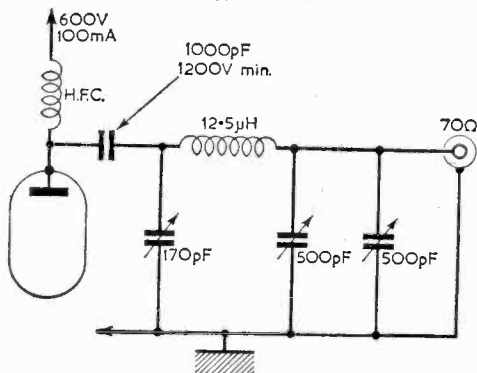

Fig. 1 (above).—A typical  $\pi$ -network output circuit.

Fig. 2 (below).—The values of components determined for a typical circuit.



### Practical Circuit

These values are inserted in Fig. 2. A 2-gang 500pF condenser is used for C2, with sections in parallel. If an output impedance higher than about 70 $\Omega$  is to be matched, C2 has to be reduced in value. This is readily carried out by adjusting it as necessary. If a very high impedance is wanted, it may be found that C1 is too small, or L1 too low, for resonance.

A symptom of this fault is that C1 is nearly closed, while C2 is still at too high a capacity. As

C2 is opened further, C1 has to be closed, and reaches maximum capacity, with loading still insufficient. This indicates that the network was not designed to operate into so high an impedance, on that frequency. If so, one solution is to use an impedance matching circuit in such a way as to allow the  $\pi$ -network to operate into a lower impedance. This is preferable when the  $\pi$ -network is already correctly arranged. But if it has been made on an experimental basis, it may merely indicate that the condenser actually in the C1 position is too small, or the coil inductance is too low.

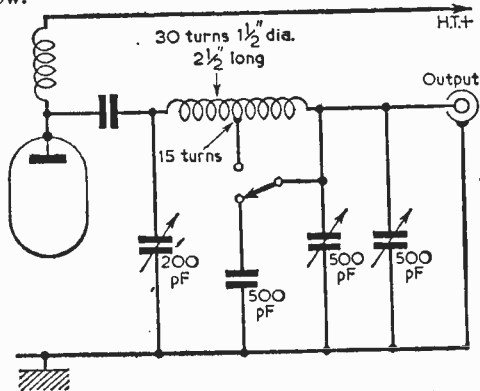

Fig. 3.—A  $\pi$ -network output circuit for 2-band operation.

When obtaining an output of very low impedance, it will be seen that C2 requires to be larger, if C1 and L1 remain unchanged. An indication of this type of fault arises when it is impossible to load up correctly into a low impedance circuit, even with C2 fully closed. The solution is to increase the value of C2 (e.g., employ a 3-gang condenser with all sections in parallel) or wire additional fixed capacity across it.

In Fig. 2, C1 is the approximate total capacity. The valve capacity, etc., will be in parallel with this, but can be neglected in the example given, because C1 is variable, and can be opened slightly to secure resonance.

**Coil Windings**

When an approximately suitable inductance has been found, a satisfactory number of turns may be calculated, so that the network coil L1 can be wound. A formula suitable for this purpose is:

$$N = \frac{5L}{na^2} \left\{ 1 + \sqrt{1 + \frac{0.36n^2 a^3}{L}} \right\}$$

where "a" is the radius of coil in inches, "n" is the number of turns per inch, "L" is the required inductance in  $\mu$ H, and the result (N) is the number of turns. A typical coil could thus have 30 turns on a 1 1/2 in. diameter former 2 1/2 in. long, for the 3.5Mc/s to 3.8Mc/s band.

It will be apparent that other values of C1 and L1 could give resonance, but that these values would not also provide the correct impedance match or Q. The fact that C1 and C2 are adjustable allows the network to perform effectively over the band required.

For 2-band operation, it is usual to tap a coil, so that a lower inductance is available for one

band. This can be arranged by fitting a switch. If additional capacity is required to obtain a sufficiently low impedance output on the lower frequency band, a 2-way switch may be used to introduce this as well, as in Fig. 3.

The 170pF condenser used for C1 can readily be adjusted to the value shown in Fig. 2. For 7Mc/s, all values will be approximately one half those given for 3.6Mc/s. Resonance will thus be obtained with C1 at approximately 100pF (including circuit capacity) and C2 at 500pF. For lower

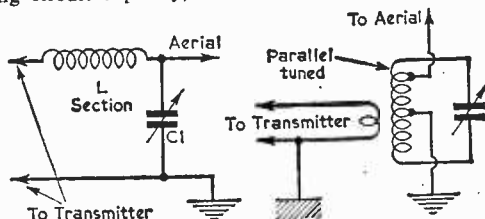

Fig. 4.—Two methods of impedance matching.

impedance transformation (e.g., higher impedance output) C1 will be increased, and C2 reduced. For higher impedance transformation (e.g., lower impedance output) C1 will be reduced in value, and C2 increased. It will thus be possible to load into low-impedance circuits with the 2x500pF capacity at C2, and the extra fixed condenser, switched in for the lower frequency band, is not required on the 7Mc/s band.

**Impedance Matching**

When the  $\pi$ -network is correctly built, but it is impossible to load up the transmitter correctly, the impedance being fed is outside the range for which the network was designed. A frequent example of this arises with a high impedance aerial, such as an end-fed half-wave type. In these circumstances, no adjustment of C1 and C2 will give adequate loading. In addition, the voltage across C2 may become too high, and the spacing of the condenser used here is not intended for the high voltage swing in a circuit of high impedance. If so, both the inability to load sufficiently, and the

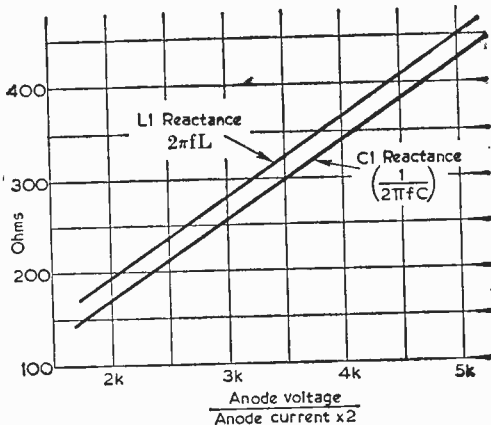

Fig. 5a.—Values for reactance of C1 and L1 for a Q of approximately 12

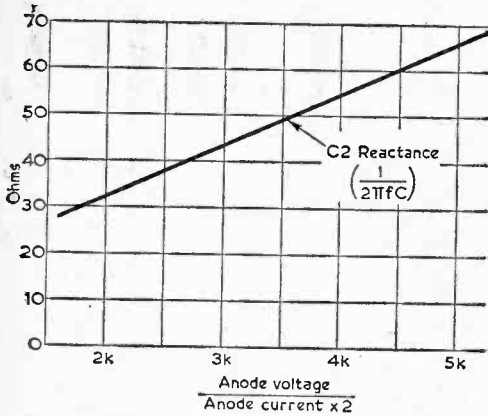

Fig. 5b.—Values for outputs in the region of 50Ω

flash-over, may be avoided by an impedance matching circuit such as those in Fig. 4.

The L-section circuit allows the transmitter condenser C2 to be adjusted for a low impedance output, while C1 in Fig. 4 is of small capacity and wide spacing, for the high impedance aerial. C1 may easily be chosen by using a component of similar spacing and capacity to C1 in Fig. 3.

The parallel tuner produces a similar result, but in this case the coil is parallel tuned by a condenser of about 150pF to 200pF, and with adequate spacing. The coil can resemble that in the transmitter. Only a few turns are required for the link, and loading can be adjusted by modifying the link

coupling, and the tapping of the aerial on the coil, as well as by adjusting the  $\pi$ -network output condenser.

In the case of a commercially made transmitter which cannot be loaded into an end-fed aerial, one of the circuits in Fig. 4 will provide a solution. The parallel tuned circuit may also be used to feed twin high impedance lines.

#### Chart Values

To simplify working, the figures required may be taken from Fig. 5, which is for a Q of approximately 12. The load is found as already explained, for the anode voltage and anode current required.

It will be more convenient to express values directly in Mc/s,  $\mu$ H, and pF, to simplify calculation. For example, if the frequency is expressed in Mc/s, inductance will automatically be obtained in  $\mu$ H, which is more convenient than employing cycles per second and Henries.

With C2, the actual reactance required for a 50Ω output would be lower than for a 75Ω output, so that the condenser values would be greater for 50Ω, than 75Ω. However, except for the cases previously described, this can be accommodated by the adjustment of the condenser.

For a given load and frequency, lower reactances may be used for C1, L1 and C2, when a higher Q is required. It would normally be satisfactory to take a Q of 12 as near the lowest to be used. In some circuits it will be possible to plan the  $\pi$ -network for a Q of 15, or even 20, but when the load R1 is fairly low, it will be found rather impracticable to provide the values of capacity needed, because they will become so large.

## ABOUT LOUDSPEAKERS

(Continued from page 488)

permanent repair. If the fault is due to the speech coil being out of centre and the centring device has not shifted, the centring "spider" may have come loose from the cone or the speech coil former may have warped. A centring device which has cracked or parted from the cone can usually be repaired without difficulty, and repairs have been carried out successfully when the speech coil has actually broken away from the centre of the cone. The cone and speech coil assembly should be removed from the loudspeaker chassis and a cellulose cement should be applied between the coil former and the cone and allowed to set hard before reassembling. Loose turns on the speech coil can also be locked with a similar cement applied in a very thin layer.

If the speech coil former has warped, there is usually little that can be done, for even if the former is squeezed back to approximate its original shape, it very often warps again as soon as it warms up in the set. This trouble, in fact, often happens in small mains-type radio receivers, which become very hot inside and use a small loudspeaker. When the set is first switched on the reproduction may be normal, but after a warm-up period loudspeaker distortion becomes apparent, owing to warping of the speech coil. The only cure here is to replace the loudspeaker.

#### Speaker Centring

To re-centre a loudspeaker, the retaining screw or screws of the centring device should be slackened. Pressure should then be applied to the cone as required and the retaining screw or cones tightened. The process may have to be repeated several times in order to achieve the best results. The speech coil must, of course, operate within the magnet gap without touching the pole pieces.

Gauges for pushing between the coil former and the magnet to hold the former in the correct position while tightening the centring screws are available, but if these are used care should be taken to avoid using too much pressure, otherwise the former may spring out of centre when the gauges are removed. One way of checking whether the speech coil is correctly centred is to apply about 2V A.C. via a 100Ω current limiting resistor, to the speech coil terminals on the loudspeaker chassis. If all is well, the cone will vibrate freely without harshness or obvious fouling. The correct centring position can be established, if necessary, by adjusting the centring device with the loudspeaker connected to the A.C. supply, but the speech coil should not be allowed to rub on the pole pieces for any length of time, otherwise the coil winding may be damaged.

Metallic particles of a ferrous nature, or even rust, sometimes reduce the magnetic gap or stick to the pole pieces. These can be removed by pressing a piece of Plasticine or soft wax on the pole pieces and magnet assembly.



# HOW TO KEEP RADIO EQUIPMENT

# COOL

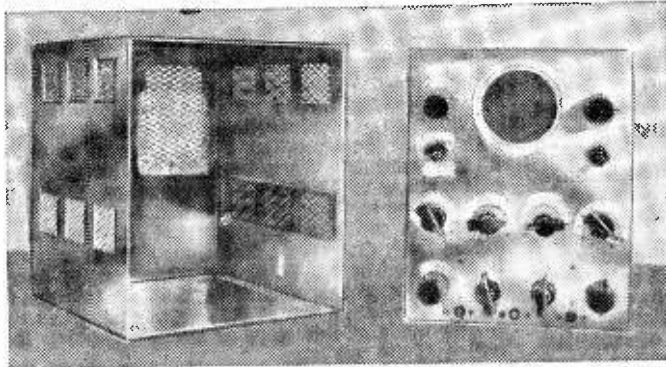

VENTILATING HOME-CONSTRUCTED INSTRUMENTS PRONE TO OVERHEATING

By W. Cleland

Left.—Expanded aluminium was used in this oscilloscope for ventilation.

ONE factor that can be overlooked in home-constructed equipment is the necessity of adequate ventilation. The problem hardly arises with transistors except in output stages handling heavy currents, but in valve equipment (some valve heaters dissipate as much as 4W each) it can make the difference between a successful or an unsatisfactory design

### Temperature Stability

For example, in an A.F. oscillator of the phase-shift, Wien Bridge, or similar type, the calibration may be unreliable owing to frequency drift with heating. Similarly, in an R.F. signal generator where the oscillator has to be well screened, it is still necessary to provide ventilation, with suitable precautions against R.F. radiation through the openings. Lack of sufficient ventilation would cause the frequency to drift for a lengthy period before reaching a steady value. Radio receivers are normally well ventilated by openings at the rear, and this enables the local oscillator rapidly to settle down to a steady condition. The use of components of low temperature coefficient may prove necessary especially at VHF.

Local "hot spots" also require careful consideration. A wire-wound resistor that is too hot to touch should not be situated in close proximity to carbon resistors, as the latter would be liable to become faulty. Nor should capacitors be placed close to hot components, as capacitors of the waxed type would melt, and their electrical characteristics would be impaired at such high temperatures. Metal-cased capacitors can be used up to the temperature of boiling water, but their voltage rating is reduced by some 30% under these conditions.

Electrolytic capacitors should not be used at all above 70°C (158°F), and above 60°C (140°F), their working voltage rating has to be taken as 50VW less than at lower temperatures. Metal rectifiers require still lower ambient temperatures to work in, and their current ratings are decreased by 25per cent or more at 55°C (131°F).

### Equilibrium

Usually electrical apparatus should be capable of continuous working. Laboratory equipment is sometimes kept switched on permanently to maintain steady conditions. This means that thermal equilibrium must be reached at a reasonable temperature. Cooling only begins to take effect as the temperature rises sufficiently above that of the surrounding air. Heat loss then increases rapidly until it balances heat production, and a steady temperature level above ambient is then maintained.

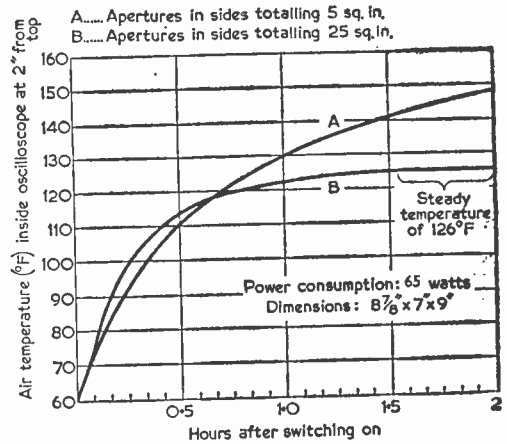

Fig. 1.—The curve "A" represents the result of inadequate ventilation, curve "B" with more ventilation.

Provision of ample ventilation not only ensures a lower ultimate temperature, it also considerably shortens the heating up period, and allows the heat to be distributed evenly in a shorter time. When numbers of valves are involved with an appreciable wattage dissipation in a confined space,

(Continued on page 534)

# Practical Wireless

# T U T O R

WITH each copy of this issue is included a PRACTICAL WIRELESS "Tutor" blueprint. This blueprint has been designed to give the complete beginner to radio construction a graded course to introduce him to the techniques and theory of wireless. The "Tutor" describes four simple receivers, each complete in itself, which can be built by the complete beginner with certainty of good results. The instructions for building the first receiver are more detailed than those for the remaining three as the constructor will gain proficiency and will need less guidance as he works his way through the course. The main difficulty which the beginner will encounter is the art of soldering. A second difficulty will be in recognising circuit symbols. Both of these difficulties will, however, be overcome by a study of pages 508 and 509 where circuit symbols are given together with illustrations of the components concerned. Details of the soldering process are also given together with illustrations.

## The First Receiver

The first receiver consists of a crystal set using the modern equivalent of the old "crystal and cat's whisker" of the early days of radio. The results from this set are very good, particularly if a good aerial and earth are used. The results obtained will encourage the constructor to build the second and subsequent receivers.

## Construction

The set is built on a wooden baseboard and this is the first part to be made. The baseboard is cut from inexpensive timber and is 7in. long and about

3½in. wide—the nearest stock width of wood is quite suitable although it is better to err on the larger side. A hardwood front panel is then cut 7in. x 5½in. and drilled with the holes required for the first set (see blueprint)—the other holes can be made at the same time if it is intended to build all four receivers. When the panel has been drilled, it is screwed to the front of the baseboard. A case can then be made as shown in Fig. 1 on page 507, but if the width of the timber of the baseboard differs from that given, then some dimensions will have to be altered. When the wood for the baseboard is bought, it should be possible to have it cut to the width given at little extra cost. The case is best made at this stage to avoid disturbing the wiring of the sets later.

The case may be given a coat of varnish or paint and the baseboard a coat of clear varnish before starting construction.

## Construction

First, the components concerned are mounted on the front panel: four terminals and the tuning condenser (C1). Then the coil must be made. The former for the coil is made from a 5½in. length of cardboard tube about 1½in. in diameter. Pierce a small hole (with a sewing needle) at a point 1½in. from one end and pass the end of the 34s.w.g. DCC (double cotton covered) wire through it. The wire may be passed through another hole to anchor it securely as shown on the blueprint. Now wind on ten turns of the wire side by side in the direction shown on the blueprint. Now, double the wire back on itself for about 2in. and twist the doubled-back portion together quite tightly so that does not come untwisted when it is pulled gently.

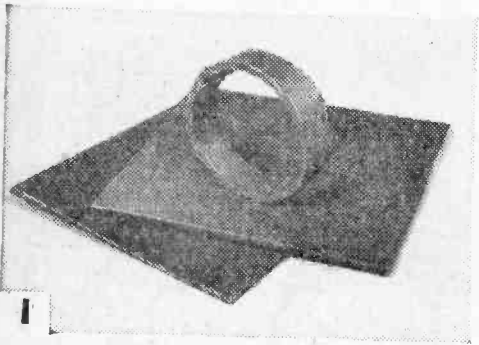

1 Making the Long Wave coil for the Stage 2 Receiver—two square pieces of cardboard are required together with a ½in. length cut from the cardboard tube used to make the Medium Wave coil, and a tube of Balsa Cement. The cardboard ring is glued to one of the cardboard squares and when the cement has set, the excess cardboard is cut away to within a ½in. of the ring—see 2. The remaining square of cardboard is then glued to the other side of the ring. These two pieces of cardboard eventually form the cheeks of the former. The corners of this square are bent (3) so that the 36s.w.g. wire may be wound on to the former more easily. When winding the coil, pin holes are made in one cheek of the former and

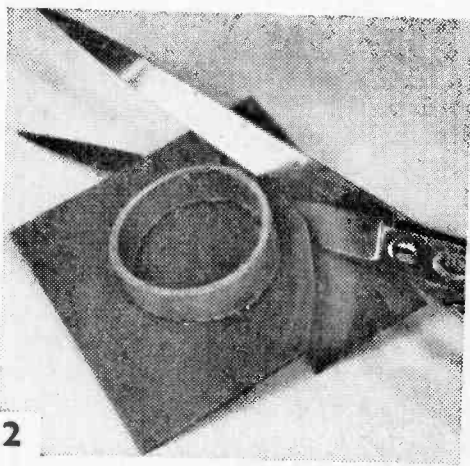

2 the wire passed through to anchor it. Balsa Cement may be applied where the wire passes through the cheek. When the coil has been completed, the remaining square of cardboard is cut to leave a circle of the same diameter as the first.

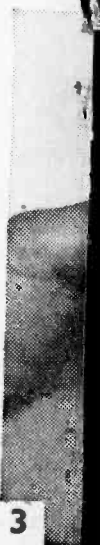

# R

By R. E. F. Street

Wind on another ten turns and again double the wire back on itself for about 2 in. and twist it as before. Arrange the twisted portion so that it is in line with the first as indicated on the blueprint. Wind on another ten turns and make another twist. Carry on winding, ten turns at a time and twisting until 90 turns have been wound on altogether. Then, pierce another small hole at the "finishing" end of the winding, and wedge the wire in it, using a piece of wood—a sharpened match-stick is ideal. The wire does not pass through the hole, but is only anchored there. Cut the wire to leave about 6 in.

Balsa cement can now be used to fix the wire to the former securely. Spread it liberally around the twists of wire and the two end wires of the coil. Allow the cement to dry and cut the wire at each twisted loop. Two ends will thus be formed at each twist. Unravel the cotton covering at each of these ends or remove it by scraping gently with a knife. Twist each pair of bare wires together and in such a way as to form a small "bunch" of copper wire at each twist or "tap". These taps can now be tinned with solder—apply the soldering iron to each in turn together with the solder and leave a small blob of solder at each tap.

The supports for the coil are next to be made.

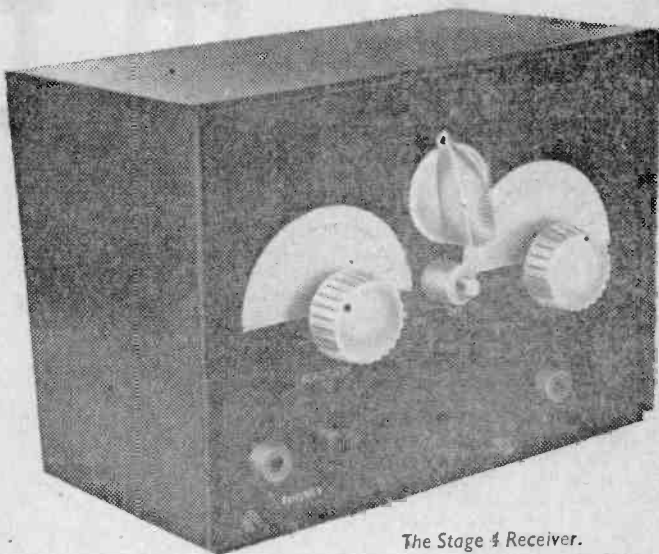

*The Stage 4 Receiver.*

Cut two pieces of hardboard 2½ in. long and as wide as the diameter of the cardboard tube. Place the tube at one end of each and mark a semicircle to be cut away so that the supports are circular at one end. One of the supports may now be cemented to the tube on which the coil is wound (so that the taps on the coil will be in the position shown on the blueprint). When the cement is dry, the other support may be glued in place—the two supports must, of course, be parallel.

The group-board may now be mounted and components C2 and D1 soldered in position. These are the only ones to be mounted on the group-board in this receiver. Note the position of the red, or positive, end of the diode D1. When soldering, remember not to overheat the compo-

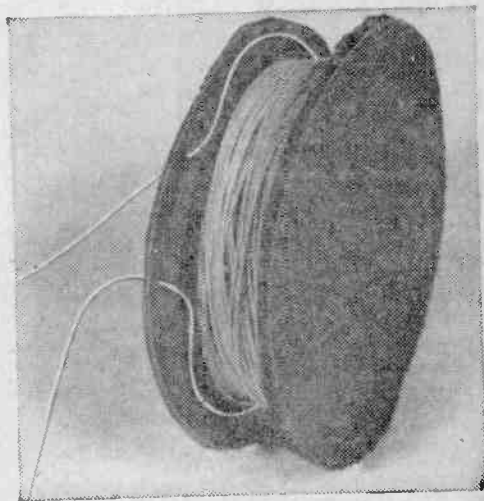
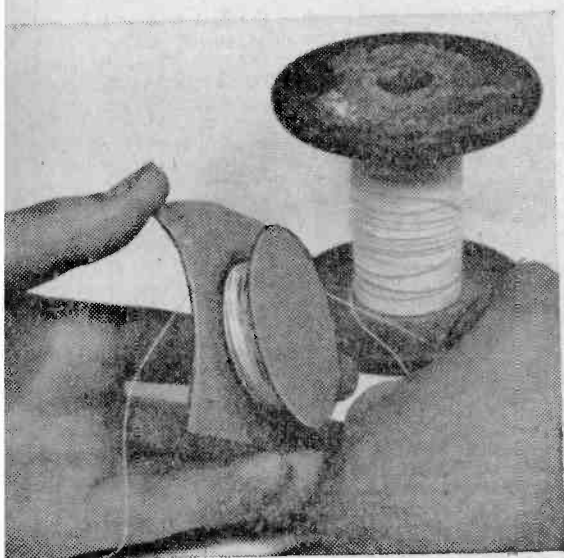

*The completed L.W. coil.*

nents, especially the diode. Leave the leads of the diode long—do not cut them at all—and conduct the heat away when soldering with a damp cloth or with pliers as shown on page 509.

Solder in the two wire links on the group-board which are shown on the blueprint. Connect the earth terminal to the moving plates connection of the variable condenser C1 (M) and take a wire from there to C2. Keep this wire near to the baseboard—the battery will be fixed over this wire in the three other stages. Connect the fixed plates of the condenser (F) to D1. Connect the headphone terminals to the tags indicated on the group-board. Two pieces of thin plastic-covered flex will now be required: one of these is connected to the aerial socket and the other to the fixed plates connection of the variable condenser.

Mount the coil—the end at which winding was begun should be on the left (viewed as shown on the blueprint). Connect the right hand end of the coil (6in. of wire was left) to the moving plates connection of the condenser. Connect the flex lead from the aerial terminal to the third tap from the right on the coil, and the one from the fixed plates to the first tap from the left. The end wire of the coil is, of course, not used.

Connect the aerial and the headphones, rotate the variable condenser (C1) and at least one programme should be heard. If not, check the connections and if still no results can be obtained, connect the aerial to the same tap as the wire from the fixed plates to the condenser. The signal should now be heard. If a programme was

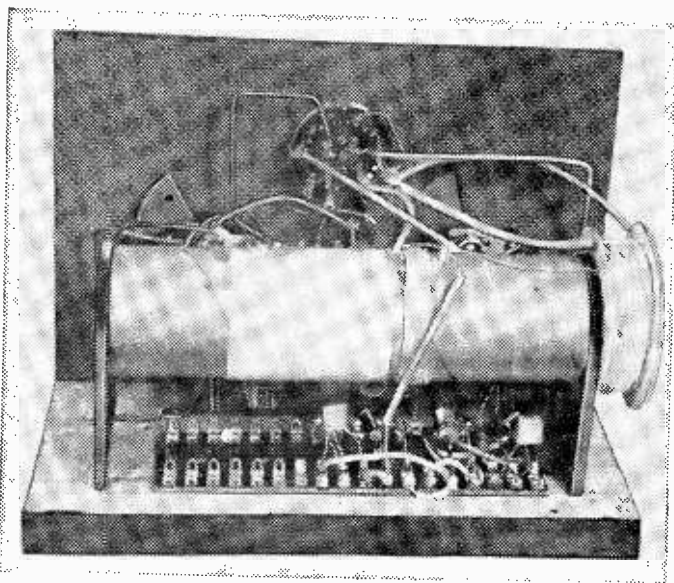

*The Stage 4 Receiver.*

obtained before the aerial tap was moved, then it will be noticed that although the signal is louder, it spreads over the full range of the condenser C1. The set is now not so selective—it does not tune so sharply—but it is more sensitive—the signal is louder.

Note that a good aerial and earth are essential for a crystal set of this type and poor results will often be due to insufficient signal reaching the set.

The tapping of the aerial on the coil can be altered to improve results and the best position will soon be found.

#### **The Stage 2 Receiver**

Disconnect and remove the coil so that it is not damaged when the new parts are being added. Mount one of the Terry clips as shown to hold the battery. Cut off one "arm" from each of two Terry clips (to leave the holes for mounting). Each clip is then screwed to the baseboard to contact the two ends of the battery when it is in position. Use ½in. brass screws to mount the clips for ease of soldering later. Connect the left hand—positive—battery terminal to the earth socket, and the right hand—negative—battery terminal to one side of the on/off switch (S2). Connect the other side of S2 to the left hand headphone terminal. At the same time, remove the wire already there, shorten it and solder it to the tag marked b on the group-board of the Stage 2 receiver. Join tag e to C2 as shown. Remove the wire linking the other headphone terminal to the group-board and connect this terminal to tag c.

Now make the Long Wave coil as shown in the illustrations (pages 504 and 505). 250 turns of the 36s.w.g. wire are needed. Note that both ends of the wire should be anchored through holes in the same cheek—the left hand one, and the direction of winding should be the same as for the M.W. coil, i.e. as shown on the blueprint.

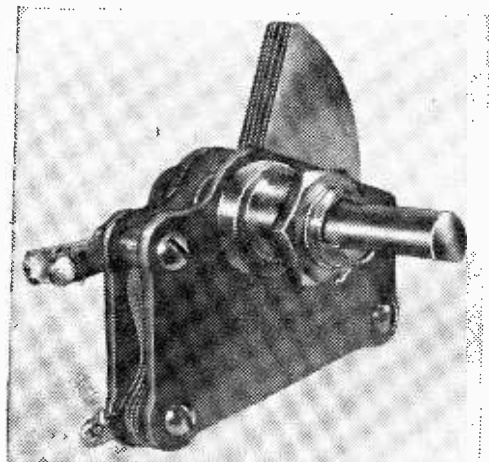

*A variable condenser of the type used in all four 'Tutor' receivers. (The fixed plates connection is the lower of the two soldering tags.)*

Now join one of the inner tags of the wave-change switch S1 to the moving plates connection of the variable condenser C1.

Solder the transistor to tags e, b and c, with the emitter to tag e, base to b and collector to c. Do not cut the wire short and use pliers or a piece of wet cloth to conduct away the heat when soldering the leads. The procedure is described and illustrated on page 509. Make sure that the transistor is soldered in the correct way round. A diagram is given on page 508. Great care should be taken where transistors are concerned or these expensive components will be ruined.

Remount the coil, and connect the M.W. winding as before, except that the right hand wire goes to an outer tag of S1—corresponding to the inner tag used. To this outer tag is also connected the inner end (or starting end) of the L.W. coil—the other end goes to the inner tag in use on S1.

Replace the battery and switch on. Turn C1 with S1 in the M.W. position. The same stations as in the Stage 1 Receiver should be heard, but much louder and the aerial may be moved more to the right to reduce volume and improve selectivity. Several programmes should be audible, particularly at night.

Move S1 to the L.W. position and the Light Programme should be received. To improve results the tappings on the M.W. coil may be altered as required.

By now, even the complete beginner should have an idea of the meaning of the circuit diagrams and how they constitute a short way of describing receivers. It is a useful exercise to compare the circuit of the set just completed with its actual physical layout.

**The Stage 3 Receiver**

Remove the battery and then disconnect and remove the coil. Mount components C4, R1, R2, C5, D2 as shown on the blueprint. Note the position of the red, or positive, end of D2. Wire in the associated links on the group-board and mount C3, the other variable condenser, on the front panel, moving S1 to the new fixing hole.

**Coil alterations**

An  $\frac{1}{4}$ in. to the right of where the M.W. coil finishes, pierce a small hole and anchor the end of the 34s.w.g. wire, leaving a 6in. end. Wind on 30 turns in the same direction as the M.W. coil over a length of about  $\frac{1}{4}$ in. Pierce another hole and anchor the wire and leave a 6in. end. Now remove 100 turns from the L.W. coil (leaving 150 as shown on the blueprint) and rewind 40 turns on top of the 150 turn coil as a separate coil. The ends of this coil are passed through the right hand cheek.

Solder in transistor Tr2—take great care not to damage it by incorrect connections or by excessive heat. Connect the wave-change switch to C3

and C1 as indicated, and also wire in the link shown (the one which joins two of the outside tags). Now remount the coil and connect it as shown. Note that if the windings have been made exactly as given on the blueprint, the letters on the diagrams can be used to assist wiring in of the coil.

Finally, insert the battery and switch on with S1 in the M.W. position. Stations should be heard, and if C3 is rotated, should become louder until an oscillation is heard. Adjust C3 so that it is just short of the point at which oscillation begins and it should be found that selectivity is much greater than with the Stage 2 Receiver.

If it is found that closing C3 makes results worse, reverse the connections to the M.W. reaction coil. When results are satisfactory on M.W., try L.W. If reaction cannot be obtained, reverse the connections to the L.W. reaction coil. It should be noted once again that if the blueprint is followed exactly, the reaction will be obtained on both wavebands from the start.

**The Stage 4 Receiver**

The Stage 4 Receiver is the circuit of the Stage 3 Receiver with an extra transistor amplifier added to increase volume.

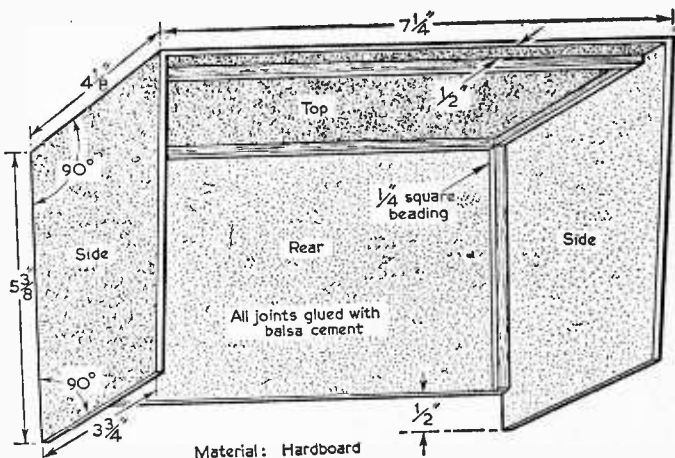
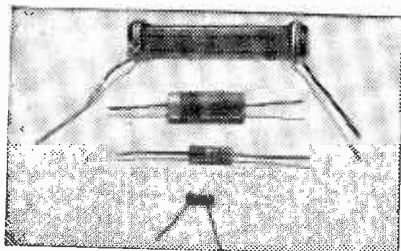

Fig. 1.—The dimensions of a suitable cabinet for any of the receivers.

Remove the coil and add the extra components to the group-board, adjusting the wiring accordingly. Add R3, R4, R5, C6 and C7. Note that with C6 the red end or the end which has a rubber washer (which may be black) is connected to b (Tr3) and the other end—plain metal—is connected to c on Tr1.

Finally, connect Tr3, taking the usual precautions. Remount the coil as it was for Stage 3, and replace the battery and switch on. The signal should now be much louder and may be too loud. If this is so, add a condenser in series with the aerial lead—a value of 20pF to 200pF will be suitable. Alternatively, it may be necessary to try using an indoor aerial or to alter the tappings of the aerial on the coil.

# to help the beginner build the 'Tutor'



Fixed resistors.

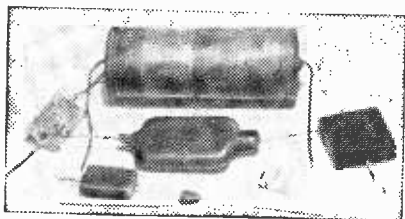

Capacitors (condensers).



Headphones.

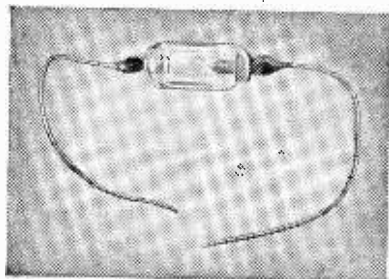

Crystal diode.



## CIRCUIT SYMBOLS

The four 'Tutor' receivers described in this issue were designed especially for the absolute beginner to radio construction. It is therefore probable, that to some readers intending to build these sets, the circuits diagrams relating to them (on the Blueprint) appear too complicated for them to comprehend. These circuits are, in fact, very simple and with the help of the diagrams, illustrations, and hints on soldering given in these two pages, even those with no previous knowledge of radio should be able to build any or all of the four sets satisfactorily.

The diagrams on this page of the various circuit symbols, and the accompanying photographs of actual components, are, on the whole, self-explanatory. For instance, no one would mistake the symbol for a pair of headphones, but the sign for a tuning condenser (bottom left of this page) might prove confusing until it was pointed out that in circuit diagrams, a component crossed with an arrow usually means it is variable, e.g. variable resistors and condensers. The circuit symbol for a battery is given, without an illustration as it is felt that of all the components used in making these receivers, this, at least, is likely to be recognised by those unfamiliar with radio construction. Similarly, no photograph is given of a switch but the physical appearance of the two types used in the 'Tutor' may be seen from the Blueprint. The dimensions and construction of the tuning coil may be obtained from the article on the receivers and from the Blueprint.



Tuning coil.

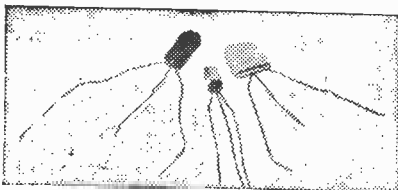

Tuning condenser—the type used in the 'Tutor' is shown on page 506.

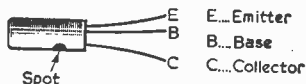
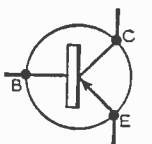

Transistor

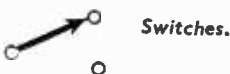

Switches.



Battery.

**HINTS ON SOLDERING**

It is essential in radio construction to be able to make good soldered joints. If poor joints are made, then the receiver or other apparatus may not work at all or may work for only a short period. The beginner may think that good soldering is difficult: it is not. Soldering consists of coating the parts to be joined with a thin layer of molten solder and allowing it to solidify over the join.

**THE TEMPERATURE OF THE IRON**

The first essential is that the soldering iron should be at the correct temperature—if the iron is electric, then it will automatically be at the correct heat, but if it has to be heated in the gas or in a fire, then it may easily be too hot or too cold. The correct heat is shown when the iron causes a green coloration to the flame of the source of heat.

The second essential is that the iron should be clean and tinned—if a new iron is bought, then before it is used for the first time, it should be heated to the correct temperature, cleaned with a file or sandpaper, and solder applied to the tip. This action will give a coating of solder on the tip or bit of the iron. **Note that this is the only time that solder is applied direct to the iron.**

**THE CORRECT SOLDER**

The third essential is that cored solder should always be used—preferably "Multicore Savbit" which contains a non-corrosive flux and also prevents erosion of the copper bit of the iron.

When soldering, heat the surfaces to be joined and apply the solder direct rather than carry it to the joint on the tip of the iron. This procedure is clearly illustrated on the right. If the solder is not applied direct to the parts to be joined, then the flux which is included in the solder to make good joints easier serves no purpose and dry joints, which can be pulled apart easily, will result.

Transistors and diodes need very careful soldering if the heat of the operation is not to ruin them. The best method of conducting the heat away from transistors and diodes is shown in the illustration on the right. A pair of long-nosed pliers is used to hold the lead to be soldered and provided that the joint is made quickly, the pliers will conduct the heat away from the transistor. This procedure will also be found useful for other parts. Note that if the soldering iron is not sufficiently hot, it will take a long time to make joints, and the parts being soldered will become very hot.

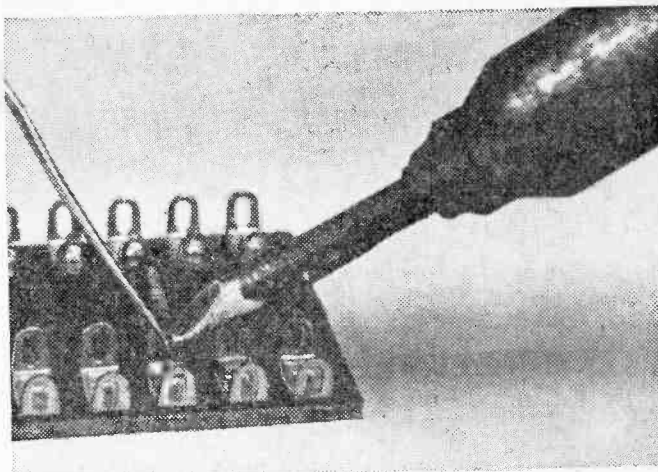

(Above) Soldering a resistor to a tag-board, and (below) using pliers as a heat shunt when soldering transistor leads.

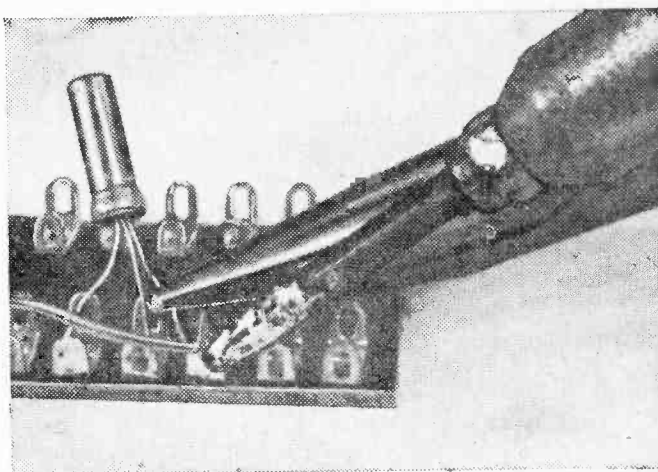

**RESISTOR COLOUR CODE**

- |          |           |          |          |
|----------|-----------|----------|----------|
| 0. Black | 3. Orange | 6. Blue  | 9. White |
| 1. Brown | 4. Yellow | 7. Mauve |          |
| 2. Red   | 5. Green  | 8. Grey  |          |

First Number—Body or Band 1 } Yellow = 4  
 Second Number—Tip or Band 2 } Mauve = 7 } 47,000 Ω (47k)  
 Number of Noughts—Spot or Band 3 } Orange = 3

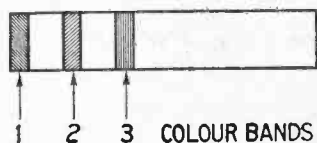
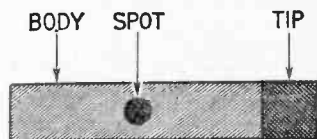

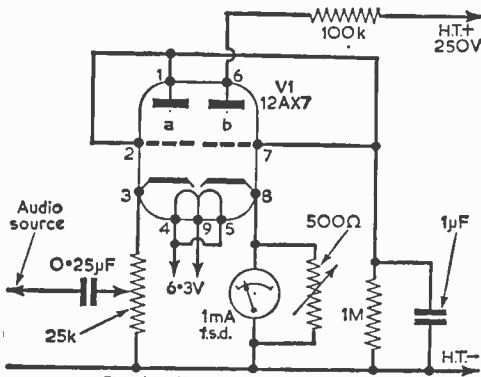

Fig. 1.—The circuit of the meter.

## A Recording-level Meter

By R. Dowling

A USEFUL ADDITION TO ANY TAPE RECORDERS

**T**APE RECORDERS are at present enjoying an unprecedented popularity owing to their versatility and ease of use. This has made it possible to produce tape recorders at prices much below those of a few years ago. Despite the high sales, however, manufacturers have to make one or two economies in order to produce machines at the lowest possible price. For example, some decks have only one motor (with ingenious pulley switching to carry out the various functions); most decks have a combined record/playback head; and very few of the cheaper tape recorders have anything other than a simple "magic-eye" in order to estimate the optimum recording-level.

The purpose of this article is to describe a single-valve recording-level meter constructed in such a way that it makes an easy "add-on" unit to any tape recorder. It will be found that the mean recording-level may be determined with much greater accuracy than the average "magic-eye", resulting in a much improved signal-to-noise ratio on the recordings made.

### General Circuit Description

The circuit of the unit is quite straightforward, and is shown in Fig. 1. The valve used is a 12AX7 double-triode, one half of which is strapped as a diode. The audio signal from the tape recorder is fed to the cathode of V1a through an isolating capacitor (0.25µF) and the "set-level" potentiometer (25k). The rectified output of V1b is then fed to the grid of V1b. Between this point and earth is connected a CR combination (1µF and 1M) giving a one-second time constant. This prevents the meter from trying to follow the audio signal peaks too closely, and accordingly gives a better measure of mean audio level. It should be noted, however, that if a milliammeter is used which is inherently rather sluggish, better results will be obtained with a rather smaller time constant (say, 0.5µF and 1M).

The indicating milliammeter is connected in the cathode circuit of V1b. It should have a f.s.d. of

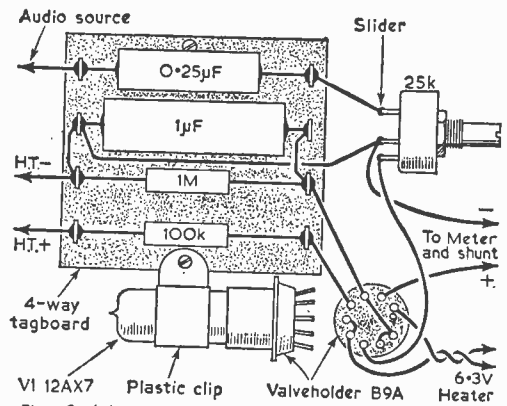
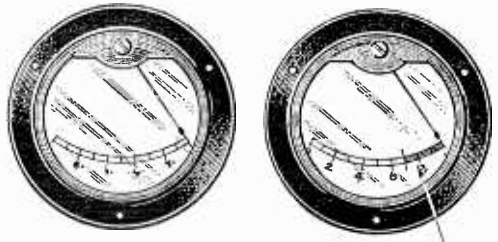

Fig. 2 (above).—The component layout: the 25k potentiometer may be mounted on any small bracket. Fig. 3 (below).—A method of modifying the milliammeter scale; left, the original scale; right, the modified scale.



1mA, and is shunted by the "set-zero" potentiometer (500Ω<sub>ww</sub>).

The power supply required for the unit is only about 1mA at 250V and 0.3A and 6.3V. The tape recorder will itself usually be able to provide this light extra load with no difficulty. The whole unit may be built up on a small tag-board as suggested in Fig. 2.

### Calibrating the Meter

In the zero-signal condition, the meter will read full scale deflection: this is the reason why the milliammeter is shown mounted upside-down in Fig. 3. It is seen that the face of the meter is renumbered from 0 to 10, the portion from 7 to 10 being painted in red. A good plan is to unscrew the original meter dial and paint over the back with white paint. Then a new scale may be easily marked out, using ink-compasses and Indian ink.

The meter is set to the new zero by means of the set-zero potentiometer, and a signal (preferably a continuous tone) applied to the input of the tape recorder. The recording-level control on the machine is then slowly advanced in the normal way until the correct level is indicated on the "magic-eye". The set-level potentiometer is now adjusted until the needle of the meter reads about 7, and thus the 7 to 10 portion in red will indicate over-modulation.

Finally, a word about the actual audio take-off point in the tape recorder. A satisfactory point on most small machines is the "magic-eye" grid; in the unlikely event of the signal voltage level at this point being too low, one may alternatively take off a signal at the grid of the output valve. ■



# CLYNE RADIO LTD



18 TOTTENHAM COURT ROAD, W.1  
162 HOLLOWAY ROAD, LONDON N.7  
9 CAMBERWELL CHURCH STREET S.E.5

MUSEum 5929/0095  
NORth 6295/6/7  
RODney 2875

All post orders and correspondence to 162 HOLLOWAY ROAD, LONDON N.7

## THE COMPONENT SPECIALISTS

OPEN: Tottenham Court Rd., 9 a.m. to 6 p.m. Mon. to Fri., Sat. 1 p.m. Holloway Rd. and Camberwell; 9 a.m. to 6 p.m. daily. Thurs. 1 p.m. Sat. 5.30 p.m. Our Advantageous H.P. and Credit Sale Terms are available on any single item over £5. Your enquiries invited. Please print your name and address.

### THE "CITIZEN"

Our sensitive 5 S. age (4 transistor plus diode) pocket transistor receiver—for full medium wave reception—with the following outstanding features:

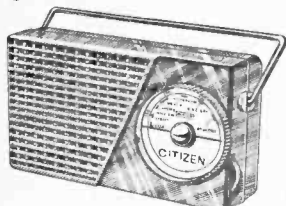

Only **95/-**  
Plus **2/6**  
P & P

★ Completely self-contained—No external aerial or earth required. ★ Genuine 2 1/2" High Flux P.M. Speaker. ★ Push-pull output 250 milliwatts. ★ Genuine Edison transistors. ★ Socket provided for personal listening. ★ Socket provided for connection to Car Aerial. ★ Volume Control with on/off switch—Condenser tuning. ★ Easy assembly on colour coded pre-tagged circuit board. ★ Attractive red polystyrene cabinet measures 5 1/2 x 3 x 1 1/4 in., chrome handle, attractive dial. All required components including full instructions, solder, etc. and battery at special inclusive price of only 95/- (Yes! Ninety-Five shillings only) Plus 2/6 P. & P. Nothing more to spend. Suitable crystal deat-aid type miniature earpiece fitted with miniature jack plus 7/8 extra only if reqd. All parts available separately—Itemised list and full assembly instructions, sent for 1/6 post free. Hear this amazing little receiver working, at any of our branches.

**LIGHT-WEIGHT HIGH RESISTANCE HEADPHONES.** 4,000 ohms, adjustable headband, brand new. Limited quantity at 13/6 per pair, plus 1/- P. & P.

**SMALL SOLDERING IRON.** Complete with vinyl carrying case, mains lead and 2 pin plug. A.C. 230 v. Handle unscrews and becomes protective cover for the bit. Only 18/6 plus 1/- P. & P. Spares available. Bit 1/3. Element 4/6.

**CRYSTAL MICROPHONE (Hisu).** Sensitive Miniature Lapel-type. Complete with clip and screened lead. Brand new 17/6, plus 6d. P. & P.



### OUTSTANDING METER IMPORT!

20,000 ohms per volt!

MODEL 200H. Volt-ohm-Milliammeter



Hanks: A.C. Voltage: 10, 50, 170, 500, and 1,000 volts. 10,000 ohms per volt. D.C. Voltage: 5-25, 50, 250, 500, and 2,5k. 30,000 ohms per volt. D.C. Current: 0-50 microamps. 0-2.5 ma. 0-250 ma. Resistance: 0-6k, 0-6 meg. (300 ohm and 30k at centre scale). Capacitance: 10 pF to 301 mfd., 300 mfd. to 1 mfd Decibels: -1 mid to +22 dB.

A truly guaranteed pocket size meter, (actual size: 4 1/4 x 3 1/2") knife edge pointer, top quality supplied complete with test prods and full operating instructions at £8.19.6 ONLY. Plus 2/6 P. & P. Optional extra, attractive carrying case 13/6 only. (Bona-fide trade enquiries invited). Leaflet available

### "PAGEBOY" 2-TRANSISTOR "POCKET PORTABLE"

Completely portable—No external Aerial or Earth Reqd.

An amazing little receiver with built in aerial and small enough to be held in the palm of the hand. Medium wave reception at wonderful volume. No fiddly tuning! Condenser tuned.



Supplied with drilled chassis and colour coded components. Easily assembled with the aid of the easy-to-follow assembly instructions provided. Total cost of all necessary components, including transistors, wiring, etc. and even solder. ONLY 32/6, plus 1/6 P. & P. Battery 3/- extra. Ardent type deat-aid earpiece complete with cord and plus 12/6 extra. Parts price list and Easy Lay-out Plans 1/6 post free. Demonstrated at all our branches.

### RADIO JACK

Covers local medium wave stations variably tuned. Compact self contained unit requiring only connection to aerial (no power supplies reqd.) for let class reception when used in conjunction with your tape recorder or high gain amplifier. All necessary parts available at a special inclusive price of ONLY 19/6. P. & P. 1/6.

### LOUDSPEAKERS, EX. CHASSIS

As new guaranteed perfect, by leading manufacturers. 5in. 9/6; 6 1/2in. 10/6; 7in. x 4in. 10/6; 8in. 15/6; also 10in. with O/P transformer (5,000 ohms), 17/6. All 3 ohm speech coil, also 8in. available, in attractive cloth covered cabinet, ideal for extension speaker 22/6. Each item plus 1/6 P. & P. Large selection of Brand New Speakers. Full list on request.

### NEW!

## "POPULAR FOUR"

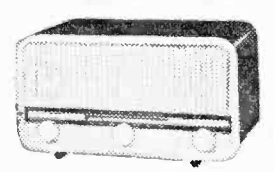

### IMPROVED APPEARANCE AND PERFORMANCE

A new three valve plus miniature contact-cooled rectifier, mains T.R.F. Receiver is now available. New De Luxe Cabinet polished walnut finish, cream trim, attractive horizontal dial (as illustrated). Quality 5in. P.M. speaker. Specially wound high gain super-sensitive Denco coils. Medium and Long Wavebands. Excellent Continental reception! Overall dimensions: 12in. x 6in. x 5in. A.C. 200/250 v. Simple construction with guaranteed results. Easy to follow practical and theoretical diagrams supplied. All necessary components, down to the last nut and bolt, are offered at a SPECIAL INCLUSIVE PRICE of £5.5.0. plus 3/6 p. & p. Instruction book available separately 1/6, post free. ALL PARTS AVAILABLE SEPARATELY.

### THE "WAVEMASTER" 7-TRANSISTOR LUXURY PORTABLE

400 Milliwatt Output

To build yourself! Medium and Long Waves—Push-Pull Superhet A. V. C. Perfect Car Radio reception. Size 10in. x 6 1/2in. x 4 1/4in. at base tapering to 4in. at top.



Very attractive two-tone grey vinyl covered cabinet with black and gold printed escutcheon plate, cream and gold knobs, handle and cabinet fittings ★ Weight—complete with long-life 7 1/2 volt battery—4 1/2 lb. ★ Mazda high-grade transistors throughout. ★ High-Flux 7in. x 4in. Elliptical Speaker. ★ Slow motion tuning. ★ Co-axial socket at rear for direct connection to Car Radio Aerial ★ Improved reception by use of seven-section plated telescopic aerial disappearing into Cabinet when closed. 3 1/2in. above cabinet when fully extended. Construction simplified by Bakelite chassis board with the following components already mounted: I.F. Transformers (3), Oscillator Coil, Trimmer Bank, Output Transformer, Interstage Transformer, Aerial Brackets and Earth Bar. SPECIAL INCLUSIVE PRICE for all required components, full assembly instructions—nothing more to buy—is £10.19.6 plus 3/6 P. & P. Alignment service available. Full assembly instructions and individually priced parts list, all of which are available separately, 2/6, post free.

### "PRACTICAL WIRELESS CIRCUITS" "ROADFARER"

All required components at £16.19.6.

### "TUTOR"

Send stamp for details

### 1 VALVE SHORT-WAVE RADIO

World-wide coverage at most reasonable cost. Covers 40-100 metres with the coil supplied. Can be extended to cover 10-100 metres. Provision is also made for the addition of two extra valve stages. Employs the famous Acorn-type 964

vaive. All necessary components can be supplied complete with full assembly instructions for ONLY 35/- plus 2/- p. & p. Send 2/- for point-to-point wiring diagram and Price list.

Have you tried the famous American Ferrodynamics

### "BRAND FIVE"

Recording Tape. An enthusiast's must! High Quality Accutone Base: 5' 300ft., 18/-; 5' 900ft., 18/6; 5 1/2' 1,200ft., 23/6; 7' 1,200ft., 25/-; 7' 1,800ft. 35/-; Extra Quality Mylar Dupont: 3' 300ft., 13/6; 5' 900ft., 18/6; 7' 1,800ft., 23/6; 7' 2,400ft., 30/-; Each on plastic spool. All post free.

BRAND NEW—NOT SUB-STANDARD PLASTIC TAPE SPOOLS—Best quality 3in. 1/8in. 5in. 2 1/2in. 2 1/2in. 7in. 2 1/2in. PLASTIC SPOOL CONTAINERS for spool sizes 5in. 1/8in. 5in. 2 1/2in. 2 1/2in. Any single item plus 6d. P. & P. Total over £1. Post free.



**"P.W." 6 TRANSISOR PERSONAL RECEIVER**

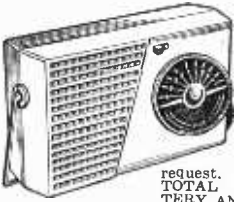

Designed by the technical staff of *Practical Wireless*; easy to build, using printed circuit, and 1st Grade Matched Transistors and Diode. Full Medium and Long Wave coverage to internal speakers. All parts sold separately (new components only) enabling you to buy as required, and full detailed price list will be sent on request. Constructional details 1/6. **TOTAL COST INCLUDING BATTERY AND CABINET £8.19.6.**

**"POCKET 4" TRANSISTOR RECEIVER**

Attractive cabinet as illustrated above for "P.W.6". Uses miniature speaker, proper tuning condenser, and volume control. Built-in aerial makes unit efficient and portable. Ideal for the beginner. Full medium wave coverage. All components for only 42/6 (p. & p. 2/6). Ten-page constructional book free with parts or separately 1/6. S.A.E. for parts price list.

**SUMMER SPECIAL**

**"GOOD COMPANION" 6 TRANSISTOR COMBINED PORTABLE & CAR RADIO.** ★ 750 mW output. ★ 6 transistors and 2 diodes. ★ Full Medium and Long Wave coverage. ★ Quality speaker. ★ Pre-aligned I.F.T.'s ★ Brilliantly styled 2 tone cabinet, size 11 x 8 x 3ins. ★ Very fine tuning with calibrated dial. ★ Latest printed circuit. ★ Internal high gain aerial with car aerial socket. ★ Easy to follow construction data (available separately 3/6).

All parts sold separately and full illustrated details will be sent on request.  
**Total cost - £9.19.6** plus 5/- post and Ins. (Battery 3/6 extra.)

**UNIVERSAL AVO METERS.** In first-class condition, thoroughly overhauled and guaranteed perfect. In the well-known AVO styling with 5in. hand calibrated Mirror Scale. Complete with leads and internal batteries. The 50 RANGE MODEL, 7 ONLY £12.10.0, and the SUPERLATIVE 20,000 OHMS PER VOLT MODEL, 8 ONLY, £17.10.0. (Regd. P. & P. 5/- on either). S.A.E. for full details.

**H.R.O. SENIOR COMMUNICATIONS RECEIVERS.** With all 9 coils, giving coverage of 50 kc/s-30 Mc/s. Checked and in perfect working order. Rack mounting type 13 gns., Standard Table Model 21 gns. (Carr., etc. 22/- either type).

**H.R.O. MAINS POWER UNITS.** A.C. input 115/230 v. output D.C. (fully smoothed) 230 v. 75 mA. and 6.3 v. 3.5 A. Complete in black crackle case. ONLY 59/6.

**POCKET VOLTMETERS,** Read 0-15 volts and 0-300 volts A.C. or D.C. BRAND NEW and UNUSED. ONLY 18/6.

**R.C. 221 FREQUENCY METERS.** The famous American crystal controlled, portable frequency measuring standard. Coverage 125 kc/s-20 Mc/s. With original numbered calibration book. Perfect order. Illustrated details on request. ONLY 21/6.

**UNIVERSAL VOLT-OHM-MILLIAMETER.** Reads A.C. and D.C. Volts up to 1,000 in 5 ranges, at 1,000 ohms per volt. current (3 ranges) to 500 mA. Resistance readings to 200 K ohms in 2 ranges. Basic movement 300µA sensitivity. Easily read open scale, beautifully made and fully guaranteed. Limited number available under import quota. Complete with leads, probes, and internal battery. ONLY 59/6.

**ACOS TYPE 39-1 STICK MICROPHONE.** With screened lead and stand 39/6, plus 1/6 p. & p.

**CRYSTAL DESK MICROPHONE.** With screened lead and built-in stand. 16/6, plus 1/6 p. & p.

**HARRIS ELECTRONICS**  
 (LONDON) LTD.

138 Gray's Inn Road, London, W.C.1.  
 (Phone: TERminus 7937)

Please include carriage costs on all items  
 (Open until 1 p.m. Saturdays) We are 2 mins. from High Holborn  
 (Chancery Lane Station) and 5 mins. by bus from King's Cross.

**TECHNICAL TRAINING in radio television and electronics**

Whether you plan to have your own business, to become an electronics engineer, to take up a career in industry, or to brush-up your knowledge and study new developments, transistors, etc., an I.C.S. Course will help you to success. You learn at home in your own time, under expert tuition. Moderate fees include all books.

**EXAMINATION COURSES FOR:-**

**C. & G. Radio and TV Servicing Certificate**  
 (R.T.E.B.)

**C. & G. Radio Amateurs' Exam.**  
 (Amateurs' Transmitting Licence)

British Institution of Radio Engineers, etc.  
 C. & G. Telecom. Technician's Cert.

**LEARN AS YOU BUILD**

**Practical Radio Servicing Course**

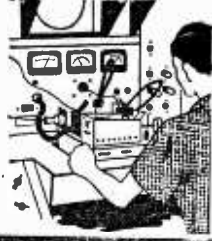

A basic course in radio electronic and electrical theory backed by thorough practical training. You build radio receivers, signal generator and multimeter.

**Post this Coupon TODAY!** for FREE book on careers in Radio, and full details of other I.C.S. Courses

**INTERNATIONAL CORRESPONDENCE SCHOOLS**  
 (Dept. 171), Intertext House, Parkgate Road, London, S.W.11.

Please send book on \_\_\_\_\_

Name \_\_\_\_\_ Age \_\_\_\_\_  
 (Block Letters Please)

Address \_\_\_\_\_

Occupation \_\_\_\_\_ 10.61

**INTERNATIONAL CORRESPONDENCE SCHOOLS**

THE CABINET,  
POWER OUTPUT METER  
AND DUMMY AERIAL

By E. V. King

(Continued from page 391 of  
the September issue)

# THE P.W. SIGNAL GENERATOR

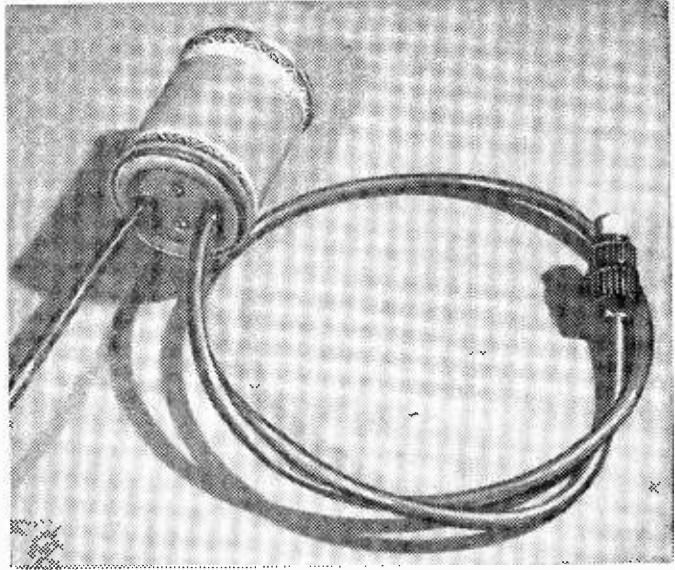

A dummy aerial unit.

LAST month, Chassis No. 4 was constructed. This unit was the crystal check oscillator, and if the construction was completed and the multivibrator set on 10kc/s as described, the unit should give marker, or check frequencies at intervals of 100kc/s or 10kc/s according to whether switch S11 is on or off. The complete circuit of Chassis No. 4 is given in Fig. 32a on this page so that the constructor will have a diagram of the unit as a whole if a fault should develop and repairs become necessary.

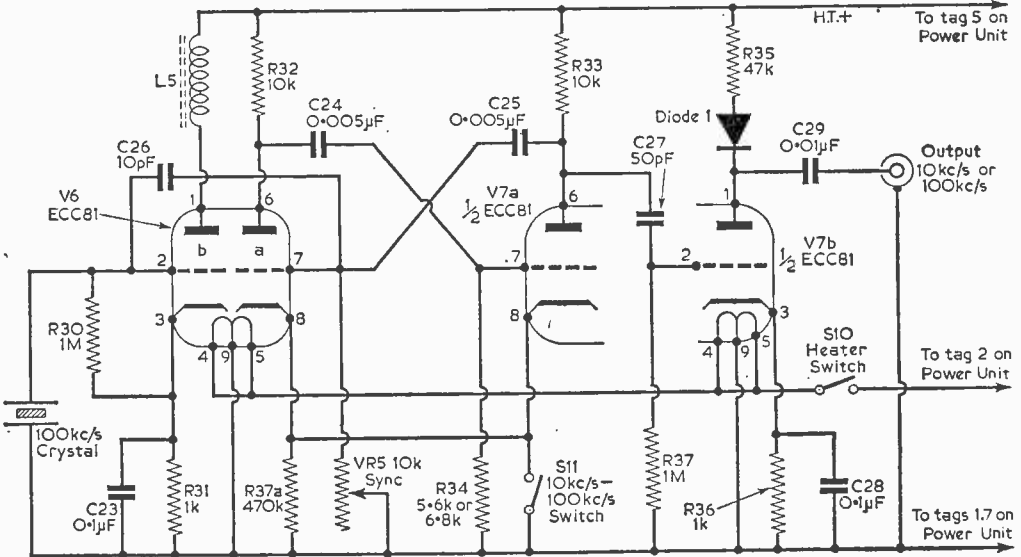
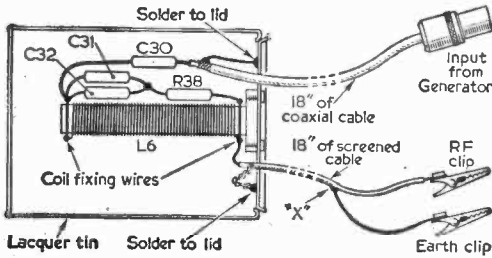
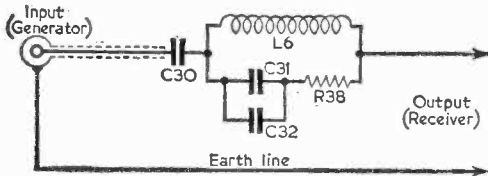

Fig. 32a.—The complete circuit of Chassis No. 4—the crystal check oscillator.



Figs. 33 and 34.—The circuit and construction of the dummy aerial unit.

**The Dummy Aerial**

When an R.F. signal generator is connected to a receiver instead of the ordinary aerial, it is best, though not absolutely essential, to connect it through a device which has approximately the same characteristics as the original aerial. This is particularly necessary when dealing with radio frequency amplifiers as in TRF receivers.

A special lead is therefore made which plugs in to the R.F. output socket of Chassis No. 2. It passes through a small can containing the  
(Continued on page 517)

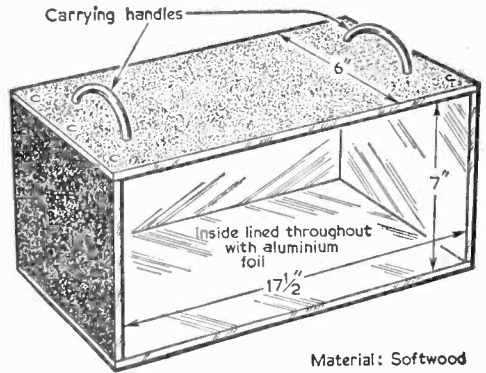
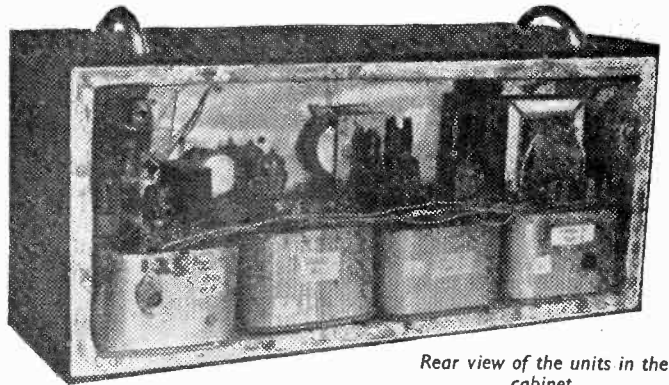

Fig. 35.—The construction of the cabinet of the generator.



Rear view of the units in the cabinet.

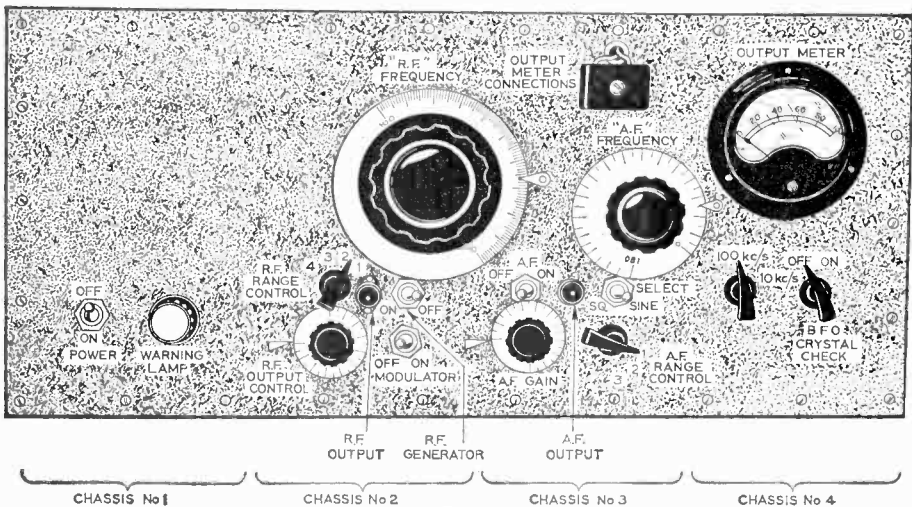

Fig. 36.—The front panel of the completed signal generator.

Easy to build kit sets of



highest quality at lowest cost

**AMATEUR TRANSMITTER Model DX-100U**  
Covers all amateur bands from 160-10 metres. 150 watts D.C. input. Self contained including Power Supply Modulator V.F.O. **£81.10.0**

**AMATEUR TRANSMITTER Model DX-40U**  
From 80-10 m. Power input 75 w. C.W., 60 w. peak C.C. phone. Output 40 w. to aerial. Compact and self-contained. Prov. for V.F.O. **£32.10.0**

**VAR. FREQ. OSCILLATOR VF-1U**  
From 160-10 m. ideal for our DX-40U and similar transmitters. Price less valves **£8.19.6** **£11.2.0**

**R.F. SIGNAL GENERATOR Model RF-1U**  
Up to 100 Mc/s fundamental and 200 Mc/s. on harmonics and up to 100mV. output on all bands. **£11.18.0**

**AUDIO SIGNAL GENERATOR Model AG-9U**  
10 c/s to 100 kc/s. switch selected. Distortion less than 0.1% 10 v. sine wave output metered in volts and dB's. **£19.19.6**

**VALVE VOLTMETER Model V-7A**  
Measures volts to 1,500 (D.C. and R.M.S.) and 4,000 pk. to pk. Res. 0.1  $\Omega$  to 1,000 M  $\Omega$ . D.C. input impeded. 11M $\Omega$ . Complete with test prods leads and standardising battery. **£13.0.0**

Portable 2 3/4 in. **SERVICE 'Scope Model OS-1**  
Compact portable scope ideal for servicing and general work. Y amplifier sensitivity 10 mV/cm; response  $\pm 3$  dB 10 c/s-2.5 Mc/s. Time base 15 c/s-150 kc/s. Printed circuit. Case 7 1/2 x 4 1/2 x 1 1/2 in. long Wt. only 10 1/2 lb. **£19.10.0**

5 in. **OSCILLOSCOPE Model O-12U**  
Has wide-band amplifiers, essential for TV servicing. F.M. alignment, etc. Vertical freq. response 3 c/s. to over 5 Mc/s. without extra switching. T/B covers 10 c/s to 500 kc/s. in 5 ranges **£36.10.0**

**RES.-CAP. BRIDGE Model C-3U**  
Measures resistance 100 $\Omega$  to 5M $\Omega$ , capacity 10pF to 1000 $\mu$ F, and power factor. Test voltages 5-450 v. with automatic safety switch. **£8.6.6**

**SINGLE CHANNEL AMPLIFIER, MA-12**  
10-12 watt Hi-Fi amplifier. Extremely low distortion and wide frequency range. **£10.19.6**

**HI-FI EQUIPMENT CABINETS**  
Range of cabinets available with at least one to suit your particular needs. From small to large, housing Tape Deck, Record Player and full equipment. In the white for finishing to personal taste. **From £11.5.6 to £17.18.6**

**GRID DIP METER Model GD-1U**  
Coverage from 2 Mc/s. to 250 Mc/s. Complete set of plug-in coils provided. **£10.9.6**

**TAPE RECORDING/PLAYBACK AMPLIFIER Model TA-1**  
Monaural (TA-1M) **£18.2.6**. Conversion unit to Stereo **£6.10.0**. Stereo (TA-1S) **£23.6.0**

**'PACKAGED DEALS' of Hi-Fi**  
Equipment including TAPE DECKS RECORD PLAYERS and DECCA ffs PICK-UPS.

Write in to see how these deals save you further money:



F.M. TUNER



S.33



S.88



DX-40



UXR-1



OS-1



SSU-1

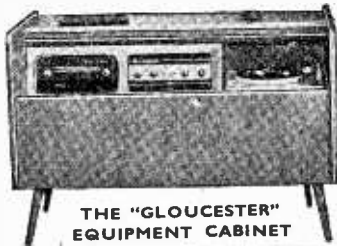

THE "GLOUCESTER" EQUIPMENT CABINET

**THE "MOHICAN" GENERAL COVERAGE RECEIVER Model GC-1U**  
Fully transistorised, including 4 piezo-electric transmitters. The very latest and an excellent portable or Fixed Station receiver for the Ham and short-wave listener. **£38.15.0**

**SHORT-WAVE TRANSISTOR PORTABLE Model RSW-1**  
Extending aerial leather case, four band (2 short-wave bands Trawler and Medium). **£22.10.0**

**6-TRANSISTOR PORTABLE Model UXR-1**  
Pre-aligned I.F. transformers, printed circuit, 7 x 4 in. high-flux speaker. Real hide case. **£14.18.6**

**DUAL-WAVE TRANSISTOR RADIO UJR-1**  
This sensitive headphone set is a fine introduction to electronics for any youngster. **£2.16.6**

**HI-FI F.M. TUNER**  
Tuning range 88-108 Mc/s. For your convenience this is available in two units sold separately as follows: Tuner Unit (FMT-4U) with 10.7 Mc/s. I.F. output  $\pm 3.5.0$  (inc. P.T.). I.F. Amplifier (FMA-4U) complete with cabinet and valves (11.11.0). **£14.16.0**

**HI-FI 16W STEREO AMPLIFIER Model S-88**  
20mV. basic sensitivity (4 mV. available, 7/6 extra). Ganged controls. Stereo-Monaural gram. radio and tape recorder input. Push-button selection. Two-tone grey metal cabinet. **£26.12.6**

**6W STEREO AMPLIFIER Model S-33**  
3 watts per channel, 0.3% distortion at 25 w/ch 20dB N.F.B. Inputs for Radio (or Tape) and Gram. Stereo or Monaural, ganged controls. Sensitivity 200 mV. **£12.8.6**

**TRANSCRIPTION RECORD PLAYER, GL-58**  
Goldring—Lenco four speed unit. G.60 pick-up arm and infinitely variable speed adjustment between 33 1/2 and 80 r.p.m. with fixed speed at 16 r.p.m. Balanced turntable (3 1/2 lb.). Stereo. **£20.12.2**

**HI-FI SPEAKER SYSTEM Model SSU-1**  
Ducted-port bass reflex cabinet "in the white" Twin speakers. With legs **£11.18.6** **£10.17.6**

**"COTSWOLD" HI-FI SPEAKER SYSTEM KIT.**  
Acoustically designed enclosure "in the white", 26 x 23 x 15 1/2 in., housing a 12 in. bass speaker with 2 in. speech coil, elliptical middle speaker and pressure unit to cover the full frequency range of 30-20,000 c/s Complete with speakers, cross-over unit, level control, etc. **£21.19.0**

**COMPLETE MATCHED STEREO OUTFIT**  
includes record player, amplifier and twin speaker systems (pedestal speaker legs optional **£2.2.0** extra). **£44.9.4**

**STEREO CONTROL UNIT USC-1**  
Luxury model with press-button inputs to suit any pick-up or tuner and most tape-heads. Output 1.3 v. R.M.S. per channel. Printed circuit construction. **£18.18.6**

**STEREO HEAD BOOSTER USP-1**  
Ideal for boosting tape-head output and low output pick-ups (e.g. Decca ffs). **£6.17.6**

Prices include free delivery UK  
Deferred Terms  
available on orders over £10

Please send me FREE CATALOGUE (Yes/No) \_\_\_\_\_

Full details of model(s) \_\_\_\_\_

NAME \_\_\_\_\_

ADDRESS \_\_\_\_\_

PW10

**DAYSTROM LTD.**

Dept. P.W.10, GLOUCESTER, ENGLAND

A member of the Daystrom Group, manufacturers of the WORLD'S LARGEST-SELLING ELECTRONIC KITS

# CIRCUITS FOR AUDIO AMPLIFIERS

-a book every enthusiast will want!

This new Mullard publication is a practical manual for every audio enthusiast. In addition to describing twelve of the most popular Mullard circuits, it has introductory chapters on many of the theoretical and practical aspects of high quality sound reproduction.

Whether you are interested in disc or tape, monaural or stereo, you will find that "Circuits for Audio Amplifiers" gives just the sort of information you need.

This informative book costs only 8/6. The demand for it is high, so get your copy now from your local radio dealer.

## Mullard

MULLARD LIMITED • MULLARD HOUSE • TORRINGTON PLACE

LONDON W.C.1  
MVM423A



## CODAR "CLIPPER" ALL BAND RECEIVERS 10-2000 METRES

LISTEN TO AMATEURS, AIRCRAFT, SHIPPING, SHORT, MEDIUM, LONG WAVE BROADCAST STATIONS THROUGHOUT THE WORLD.

### THE MINI-CLIPPER

39/6

The miniature valve radio with the BIG SET features. Covers all Short, Medium, Long waves 10-2000 metres (5 coils). Smart all satin silver all. front panel with engraved dials, etc. Ball bearing, air spaced variables. Size only 6½ x 3½ x 4in. Battery lasts months. No drilling. Total building cost including punched chassis, valve, front panel, one coil for 20-60 metres, nuts, bolts, wire, Step-by-step pictorial plans, 39/6. P. & P. 2/-. Additional coils and electrical bandspread optional extras. Parts sold separately. Full plans, parts list, 2/-.



### THE SUPER CLIPPER 88/6

This world-famous hybrid receiver has achieved remarkable success. Tremendous performance with Hi-gain valve detector PLUS two Ediswan transistor amplifiers which are supplied assembled, only 3 wires to connect. Large precision dial, 7 x 4in., with 2 pointers, bandset and bandspread, dual slow-motion drives, air spaced variables. Punched chassis 8 x 5½in. Batteries last months. Covers 10-2000 metres (5 coils). Total building cost including chassis, valve, 2 transistor stages, 2 coils 20-60 and 55-190 metres. Step-by-step pictorial plans, nuts, bolts, wire 88/6. P. & P. 2/6.

**THE CLIPPER.** As above but one transistor stage, 79/6. P. & P. 2/6. Optional Front Panel, Silver Hammer finish, all holes, 6/9.



### THE CLIPPER CR 45

£6.17.6



This A.C. Mains receiver is the latest model in the famous CLIPPER Series and combines really top performance with superb professional finish. It is the finest ALL BAND receiver at the price with a new high gain circuit using ECC81 double triode, EL84 output, EZ80 full wave rectifier. Power output 3½ watts for 2/3 ohm speaker. Covers 10-2000 metres (5 coils). World-wide reception. Outstanding features include 3 planetary slow motion drives, separate electrical bandspread, air spaced low loss variables, satin silver dials, silver hammer front panel. Total building cost, including 10 x 5½in. punched chassis, valves, front panel, 2 coils 20-60 and 55-190 metres, nuts, bolts, wire, etc., 10 pages pictorial plans, £6.17.6. P. & P. 3/6. Optional extra. Modern styled Cabinet, rear panel, silver hammer finish, 27/6. Parts sold separately. Full plans, parts list, 10 pages, 3/6 post free.

No technical knowledge is required to build these fine receivers. Only new guaranteed components are supplied. Send 3d. stamp for illustrated leaflets, testimonials. Suppliers to Educational Authorities, Government Departments, etc. Coming shortly, The Clipper CR 66 A.C. Superhet Communication Receiver.

**CODAR RADIO COMPANY, COLEBROOK ROAD, SOUTHWICK, SUSSEX**

(continued from page 514)  
components of Fig. 33 and passes out to the receiver under test.

### Making the Dummy Aerial

Obtain a suitable "tin" can of 1½ in. diameter or more, and 2½ in. or more long. The lid may be clipped on or screwed on. The prototype uses a tin which contained Chinese Lacquer.

Refer to Figs. 33 and 34. Make L6 by winding 32s.w.g. enamelled copper wire on the 2½ in. former in a single layer for 100 turns. Apply cellulose cement and let it set. Fix the coil in the centre of the lid and remove any dust cores from the former. Fix one band of wire (about 26s.w.g.) at each end by twisting and soldering and solder the ends of the coil to these "bands" (Fig. 34).

Drill two ¼ in. holes in the lid to take the two screened cables, and if necessary file away a little of the base of the coil former. Prepare the screened cable so that it can be fixed on the inside of the can by soldering the metal braiding to the can. Use rubber grommets to protect the cable where they pass through the can.

Connect the centre lead of one of the cables to the bottom of the coil, and attach crocodile clips to the ends of this lead as shown. The best method is to cut off the outer plastic covering for a few inches and twist the copper braiding into a "pigtail" and solder a length of single flex to it as shown. The joint can then be bound with insulating tape so that the lead does not break off with use.

The coaxial lead is taken through C30 to the top coil connection. Between the top and bottom of the coil attach R38, C31 and C32 as shown (Fig. 34). A single condenser of 400pF may be used instead of C31 and C32. The other end of this second coaxial lead is taken to a plug for the R.F. socket. Be careful to connect this plug correctly. Check with a battery and bulb that the braiding and centre conductor are not shorting.

### Testing the Dummy Aerial

Connect the unit between the generator and any type of receiver. Switch on R.F. (modulated) for the correct waveband, and tune the receiver or generator until a note is heard. Even with com-

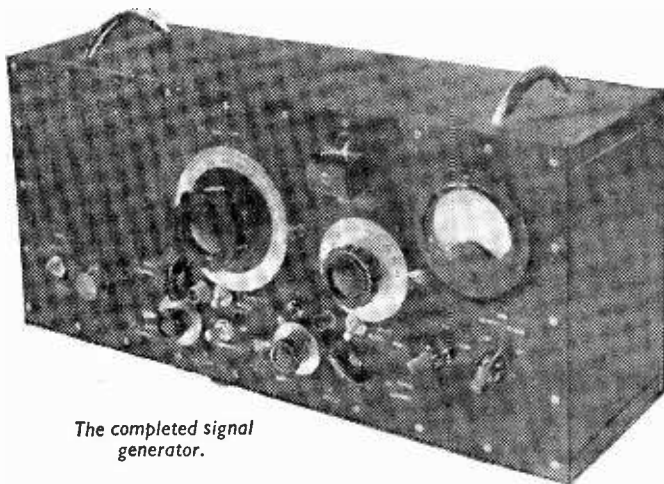

The completed signal generator.

paratively simple receivers, the dial positions for certain "wavelengths" should still be about the same as when used with the normal aerial.

### Making the Cabinet

The three units are placed side by side with the power unit (Chassis No. 1) on the left and finishing with No. 4 (Crystal Check) on the right. The necessary wires are connected at the back, keeping to definite colours for the various connections in case servicing is required later. Verify that all the units still work as they did when tested separately. Note that all units must not be switched on at once or the mains transformer will be overloaded. When the crystal check unit is switched on, then the R.F. unit may also operate, but not the audio oscillator as well.

Four square-cut pieces of planed soft wood are purchased and assembled as shown in Fig. 35. Verify that the units will all fit in it and then cut out a piece of aluminium sheet from which to make the front panel. Another may be used, with ventilation holes for the back. Fix this aluminium sheet to the front of the case.

Place the four units inside the cabinet shell, and put a little Vaseline on the tip of each control spindle and switch. Offer the aluminium sheet

### COMPONENTS LIST FOR THE DUMMY AERIAL

1yd of coaxial cable; about 1ft of single flex  
One coaxial plug (Belling-Lee)  
Two crocodile clips  
1½ in. x ½ in. diameter coil former (no cores are required)  
A few yards of 32s.w.g. enamelled copper wire  
Three 220pF condensers—mica or ceramic  
One resistor—390 Ω ½ W

### COMPONENTS LIST FOR THE POWER OUTPUT METER

1mA moving coil meter—the prototype used a meter having a 2½ in scale, but a smaller type would be suitable. The internal resistance is immaterial  
Four diodes—'surplus' types are suitable  
R39 about 8.2k—see text  
R40 Any physically large, high-valued, resistor wound with one yard of 26s.w.g. Eureka wire (see Fig 38)  
Two pole terminal block for fixing to the front panel of the completed generator  
Nuts and bolts, soldering tags, Perspex etc.

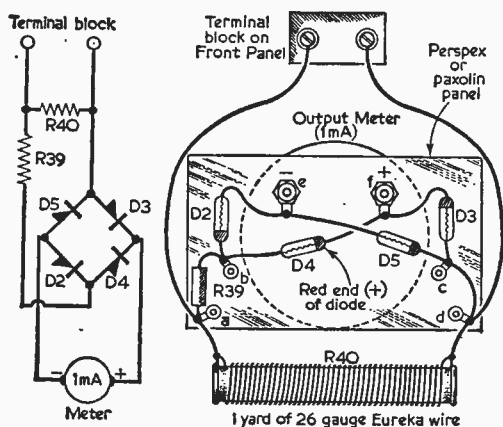

Figs. 37 and 38.—The circuit and construction of the power output meter.

carefully to the cabinet shell. The longest control knob will leave a Vaseline mark on the panel. This point is then drilled to take the spindle or switch concerned. The sheet is then offered up again with *that spindle* hole only cut. Another mark will then appear; this is then drilled out. The remaining holes are drilled in the same manner. A round file will be necessary and the actual switch holes must be sufficiently large so that the threaded portion of the switch may project right through the panel to receive a nut on the outside. This connects the panel (electrically) with the four chassis.

Remove the drilled panel.

### Screening

All of the inside of the cabinet is now screened with aluminium foil as is used for cooking purposes and obtainable from household stores. A few drawing pins will hold it in position. Bend it over so that when the panel is fixed, it will clamp the aluminium screen in place. Likewise the back will also clamp it and make the screen continuous.

The back may be of hardboard covered with aluminium foil, but be careful that it does not touch the terminal strips on each unit. Aluminium sheet (18s.w.g.) will also be suitable, and in either case ventilation holes will be necessary—four or five lin. holes along the bottom *and* top. For good screening, these will have to be covered with wire gauze as is obtainable, for petrol filters, from a garage.

### Marking the Panel

The units are placed in position and extra nuts are then put on to hold the units in place. The assembly is tested.

The panel now has to be marked in some way. First roughen the surface of the panel with sandpaper and then give it a coat of cellulose or lacquer. When the paint is dry, mark the panel. The following methods may be used:—

1. white paper, paste and Indian ink. Cover each piece with Sellotape.

2. white ink and cover the lettering with clear spirit varnish (*not* cellulose varnish) afterwards.
3. transfers obtainable from most radio shops.

Control knobs of any type may be used, but the diagrams show types which are very suitable. The following Bulgín types are suggested:

Main R.F. Frequency, 1/K403

Main A.F. Frequency, 2/K402 (this has to be modified as explained later).

R.F. Output Control, 4/K400

A.F. Output Control, 4/K400.

All other controls use types 38.

It must be stressed that large diameter knobs are essential for the two frequency controls.

### The Power Output Meter

It will be very useful to have a power output meter in the completed generator so that receivers may be tested and aligned without disturbing other members of the household. Various possibilities will occur to readers, but in this design a  $3\Omega$  dummy load is used with a meter fitted with a bridge rectifier working as a voltmeter. The meter is arranged to read directly up to 10V, but it could be calibrated easily in Watts. "Wattage" is equal to the voltage multiplied by itself (i.e. squared) and divided by 3. For instance, if the dummy load were connected to a receiver instead of its  $3\Omega$  loudspeaker and the reading was 6V, the wattage or power would be  $(6 \times 6)/3 = 12W$ . Readers will note that the meter is not *very* sensitive, but this is purely in the interests of safety and R39 (Figs. 37 and 38) may be reduced. However, if the amplifier under test overloads the meter it will burn out, or the rectifiers will be ruined or both. The meter will not give a true power reading on a  $15\Omega$  loudspeaker, but will still be useful as an indicator when trimming receivers.

### Making the Output Meter Assembly

Refer to Fig. 38. A small sheet of Perspex or paxolin is drilled to take the meter terminals (e and f). Four other holes are also drilled at a, b, c and d. Soldering tags are bolted at each of these four holes and the panel is then fixed to the meter as shown.

Take the output leads from a and d, make up the resistor R40 and solder it to a and d—if R40 burns out or is open-circuited in any way the meter will be ruined. Solder R39 ( $\frac{1}{4}W$ ) from a to b.

Now, wire in the diodes: hold the wires in cold pliers when soldering so that the diodes are not heated. The red or positive ends must be wired as shown in Fig. 38. Tag e has a diode wired to c and one to b, and f has one wired to c and one to b. Check that tag e has two uncoloured ends connected to it and that f has two red ends connected to it. If the meter used has the positive terminal on the right, reverse all the diodes and check the wiring against Fig. 37. Fix the unit to the front panel and wire the leads from d and a through a grommet to the terminal block.

Next month the calibration of the R.F. and A.F. oscillators will be explained in detail so that the frequencies corresponding to various settings of the dial are known quite accurately.

(To be continued)



★ **POST HASTE** ★

**TRANSISTORS REDUCED PRICES**  
**MULLARD HAVE REDUCED THE PRICE OF MANY**  
**TRANSISTORS To**

OC44 11/-	OC71 6/6	OC76 8/-
OC45 10/-	OC72 8/-	OC78 8/-
OC70 6/6	OC75 8/-	OC81 8/-

**THESE ARE THEIR NEW LIST PRICES**  
**WHY BUY SURPLUS?**

**MATCHED PAIRS** of the above listed transistors, Mullard match only the OC72 at 16/- pair.

**"PRACTICAL WIRELESS"**  
**POCKET SUPERHET**

OSMOR printed circuit version. Osmor Rod Aerial 10/-, I.F.T.s and Osc: Coils, 22/6. Osmor Driver, 11/6. Osmor Output, 10/6. Set MULLARD transistors, 53/6. OA81 Diode, 3/-, J.B. Gang, 11/-, Trimmers, 2/8 pr. Set Condensers, 15/-, Set Resistors, 6/6. Ardente Vol. Control, 8/-, Ardente W/C, 3/6. Speaker, 19/10. Hardware, 4/6. Printed Circuit, 9/-, Case and Knob, 7/6, Dial, 6d. Battery PP4, 2/-, Leaflet giving full illustrated details, 1/9. **All the above components if purchased at one time £9.9.0.** OSMOR undertake to align this receiver for a charge of 10/-.

**"WEYRAD"**

WEYMOUTH RADIO 6 Transistor Superhet using the P50 coils, as they advertise in this journal.  
 P50/IAC Osc: Coil, 5/4, P50/2CC 1st and 2nd I.F.T.s, 5/7 ea. P50/3CC 3rd I.F.T., 6/-, RA2W Rod Aerial, 12/6. LFDT2 Driver, 9/6, PCAI Printed Circuit, 9/6, Instruction Book, 2/-, Set Resistors, 7/6, Vol. Control D.P., 5/6, Set Condensers, 20/-, J.B. Gang, 11/-, Beehive Trimmers, 1/3 ea. W/C, 3/6, Dial and Knob, 3/6, Battery PP11, 5/6, OA81, 3/-, Set MULLARD transistors, 53/6. 35 ohm 5in. round L/S, 15/-.

**JASON F.M. TUNER KITS**

We are the Authorised Jason Dealer and the whole kit is as supplied by them. You can therefore safely return to Jason for alignment without them rejecting it for non-standard components. We can also align for the standard charge.

- FMT1** Is the standard variable tuner for cabinet mounting, unpowered. Supplied complete with four EF91 valves ..... £6.17.6  
 Hire purchase deposit £1.7.6 and 6 monthly ..... £1.1.8
- FMT1** Power pack ready drilled chassis complete... £2.12.6  
 is a new tuner in a modern case, green, which can be used for shelf or cabinet mounting, and has the space for power supplies if required.
- FMT2** Supplied complete with four EF80 valves..... £7.17.6  
 Hire purchase deposit £1.11.6 and 6 monthly ..... £1.4.4
- FMT2** With power. Complete kit ..... £9.15.0  
 Hire purchase deposit £1.19.0 and 6 monthly ..... £1.9.4
- FMT3** Is the fringe version and should be used when farther than 70 miles from the transmitter. Supplied complete with 6 valves ..... £9.12.6  
 Hire purchase deposit £1.18.6 and 6 monthly ..... £1.9.0
- FMT3** With power. Complete kit ..... £12. 0.0  
 Hire purchase deposit £2.8.0 and 8 monthly... £1.6.6
- The instruction book is included in all kits, but otherwise 2/6.

**JASON SWITCHED TUNERS**

The JTV/2 and Mercury 2 are both of the pre-set station type with the addition of BBC and ITA sound. They use the latest "Fireball" current and the A.F.C. ensures freedom from drift. The Mercury 2 is for cabinet mounting with external power, the JTV/2 has the same tuning heart, with power supplies mounted in a case, and can be used for shelf or cabinet.

- JTV/2** Complete with valves and book..... £14.15.0  
 Hire purchase deposit £3.0.0 and 12 monthly ..... £1.1.6
- Mercury 2** Complete with valves and book ..... £10.15.0  
 Hire purchase deposit £2.3.0 and 8 monthly... £1.4.0  
 Power pack kit for Mercury 2 ready drilled chassis ..... £2.12.6

Instruction book for switched tuners 4/-  
**REQUIRED CHANNELS MUST BE SPECIFIED FOR SWITCHED TUNERS**

A more detailed list can be sent upon request.

↑ **ALL JASON TUNERS ARE ON DEMONSTRATION, AND ALWAYS IN STOCK.**

★ **POST FREE** ★

**MARTIN RECORDAKITS**

We are able to offer for the first time, a proprietary range of Recorders in kit or assembled form. This enables you to take advantage of mass production techniques and prices, should you wish to assemble yourself. The components used are the finest available, with BVA valves, and the decks are the latest having all the improvements B.S.R. and Collaro make from time to time, Heads etc.

The amplifiers are packed in special cartons with instructions which enable anyone to build. We are confident you will find these Recorders very good value, they have been built up to a standard and not down to a price.

**B.S.R. TD3 Monardeck, latest model 5 1/2in. spools**

- CASH £9. 9.0  
 Hire purchase deposit £1.19.0 and 6 monthly ..... £1. 8.4
- Tape Amplifier** for B.S.R. deck, printed circuit ready wired, with ECC83, ECL82, EM85 and EZ81. Complete with all plugs, sockets, panels, knobs, etc. The whole amplifier mounts on to the deck, making a self contained unit.

- CASH PRICE £8. 8.0  
 Hire purchase deposit £1.14.0 and 6 monthly ..... £1. 5.8  
**Cabinet** for above including 7 x 4in. speaker ..... £4. 4.0  
 Total kit as above. CASH £22. 0.0  
 Hire purchase deposit £4.10.0 and 12 monthly ..... £1.12.1

The above recorder can be supplied complete with Mic: tape assembled and tested for CASH PRICE £25. 0.0

- Hire purchase deposit £5.0.0 and 12 monthly ..... £1.16.8  
**Collaro Studio Deck**, Very latest model 3 speeds... £12.10.0  
 Hire purchase deposit £2.10.0 and 8 monthly ..... £1. 7.6

**Tape Amplifier** for Studio deck, with ready wired printed circuit, control and input panels, mains and output trans., complete with knobs, plans screws etc., EF86, ECC83, EF84, OA81 and 2 EL84, 3 watts output. Magic eye, Radio and Mic. inputs, Superimposing facilities, EX L/S socket. Low level output, tone control. Can be used as an amplifier.

- COMPLETE CASH £11.11.0  
 Hire purchase deposit £2.7.0 and 8 monthly... £1. 5. 6  
**Cabinet** for above including 9 x 5in. speaker ..... £5. 5.0  
 Total kit as above. CASH £29. 0.0  
 Hire purchase deposit £6.0.0 and 12 monthly ..... £2. 2. 2

We can supply the above recorder, complete with tape and Mic., in a DE LUXE cabinet, assembled for ..... £35. 0.0

**THIS MACHINE IS LISTED £41.0.0 BY MAKERS AND IS A VERY GOOD BUY.**

Hire purchase deposit £7.0.0 and 12 monthly ..... £2.11.4  
**Microphone** for the above recorders, Acos MIC 40, 25/-, 5/C plug, 4/6.

**Synchrotape** 5in. 600ft. 15/- 5in. 900ft. 19/6  
 Finest 5 1/2in. 850ft. 19/6 5 1/2in. 1200ft. 22/6  
 Boxed 7in. 1200ft. 22/6 7in. 1800ft. 32/6

**Tape Recorder** Speaker Cabinet, corner, 20 x 10in. High class finish in two-tone Grey 'Vynair'... £2.15.0  
 With 9 x 5in. High flux speaker ..... £4. 0.0

**F.M. Tuner** Aligned and assembled, using Philips tuning head with ECC85, EF85, EF85, EZ81 and EM81, with 2 diodes. SELF POWERED. UNREPEATABLE BARGAIN. CASH £7.19.6

**Loudspeakers**  
 Elac 4in. tweeter, 28/6. T.S.L. LPH65, 37/8.

**Goodmans**  
 Axiom 110 10in., £5.0.0. Axiette 8in., £6.12.1.  
 Axiom 112 10in., £8.10.0. Deposit 34/- and 6 mthy. 26/-  
 Trebas 5K/20XL, £7.0.0. Deposit 28/- and 6 mthy. 22/-  
 Axiom 300 12in., £11.5.9. Deposit 45/9 and 8 mthy. 25/-  
 Triaxiette 8in., £13.10.0. Deposit 54/- and 12 mthy. 21/4  
 Cross overs X05000, 39/-, ARU172, £3.5.6.

**Whiteley**  
 HF812 8in., £4.3.6. HF1012, £5.0.0.  
 CX3000, £1.11.6. CX1500, £1.7.3.

**Wharfedale**  
 Super 8/FS/AL, £6.19.11. 8/145, £6.19.11.

**WE PAY ALL POSTAGE AND INSURANCE**  
**ALL ORDERS DESPATCHED SAME DAY**  
**MONEY WILL BE REFUNDED IF REQUESTED**

**SURBITON PARK RADIO**

(Established over 30 years)

**48 SURBITON ROAD,**  
**KINGSTON UPON THAMES, SURREY**

Telephone: KIN 5549

Hours: 9 a.m. to 6 p.m. 1 p.m. Wed

We do not close for lunch.

Open all day Saturday

**CORNER**

# CONSTRUCTORS

OUR NEW 5 STAGE SUPER SENSITIVE TRANSISTOR PORTABLE

## The "BOBETTE"

- Simple to Build.
- All first grade components.

A truly portable transistor radio giving full medium wave reception.

Incorporates 5in. High Flux Speaker, push pull output, first grade transistors, High-Q ferrite aerial, socket for car aerial, pre-tagged circuit board for easy construction. Attractive two tone case.

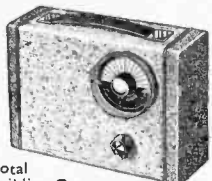

Total Building Costs **£5.2.6** No Extras to Buy

All parts sold separately. Send 1/6 for itemised price list and full assembly instructions. (Free with order).

## EASY TO BUILD TWO STAGE TRANSISTOR SET The "BIJOU"

The set that looks like a Radio Set.

- Attractive Case.
- Mini .0005 Tuner.
- High Q Litz Coil.
- Works for months off No. 8 Battery.
- Simple to construct in 15 min.

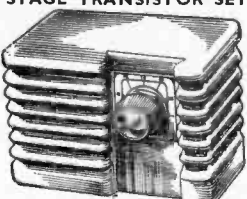

Total Building Costs **25/-** P. & P. 1/6

You can't go wrong. We guarantee good results. Components Price List, Layout Plans 1/6 (free with order)

## EXPLORE THE WORLD ON THIS 1-VALVE SHORTWAVE RADIO

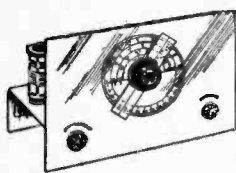

- Receives speech and music from all over the world.
- Construction price includes valve and one coil covering 40-100 metres.
- Can be extended to cover 10-100 metres.
- Can be converted to 2 or 3 valve.

Total Building Costs Only **35/-** P. & P. 1/6

Send 2/- for wiring diagram and components price list

## IDEAL FOR THE BEGINNER

### CRYSTAL RECEIVER

Covering Medium Wave Band

Easily converted to 1-transistor or 2-stage transistor receiver. Send 1/6 for construction details and component price list.

All components including case for only **12/6** P. & P. 1/6

## PUR YOUR FAVOURITE PROGRAMME ON TAPE TAPE IT WITH THE R.C.S. TAPE TUNER



Will operate on all types of Recorder. High impedance output. variable Medium wave tuning. Triple wound Super Hi-Q coil. Chassis and components colour coded. Easily constructed from full instruction data and layout diagrams. Size 3 3/4 x 1 1/2 x 1 in.

Total Building Costs Only **30/-** P. & P. 1/6

Send 1/6 for wiring diagram and components price list.

**"Ensure success with R.C.S."**  
**R.C.S. PRODUCTS (RADIO) LTD.**  
 11, OLIVER ROAD, LONDON, E.17  
 Mail Order only. Trade Enquiries welcomed.

# SOLDERING EQUIPMENT

by **LITESOLD**  
 PRECISION SOLDERING for the **ELECTRONICS INDUSTRY**



Comprehensive range-Robust & Reliable - Light weight - Rapid heating - Bit sizes 3/32in. to 3/8in. - 'Permatit' or Copper bits - All voltage ranges 6/7v. to 230/250v. - Prices from 19/6.

- Also
- Plastic Cable Strippers
  - Miniature Solder Pots
  - Heat Guards
  - Long Life Bits

Illustrated is the 25w. 3/16in. replaceable bit model with safety shield.

**ADAMIN**—the new range of precision micro-soldering instruments—Have you had details?

Brochure No. S10 sent free on request. Sole proprietors and manufacturers: **LIGHT SOLDERING DEVELOPMENTS LTD.** 28 Sydenham Road, Croydon, Surrey Phone: CR0ydon 8589 Grams: Litesold Croydon

## EXPRESS ELECTRONICS ROSEDENE LABORATORIES KINGSWOOD WAY, SELSDON, SURREY

### VALVES NEW TESTED AND GUARANTEED FOR THREE MONTHS

101	7/6	6BA6	7/-	787	9/6	DF91	7/8	ECL82	9/8	PCL82	7/-
103	8/-	6BE6	7/-	8D3	4/-	DF96	8/-	EP41	9/-	PCL84	7/-
1F1	8/-	6BH6	6/8	12AH8	10/-	DH76	7/8	EP80	8/-	PL81	12/6
1F3	7/6	6B18	5/9	12AT7	6/-	DH77	6/-	EP86	8/-	PL82	7/-
1FD1	8/-	6BR7	8/9	12AU7	5/6	DH142	8/0	EP91	4/-	PY81	6/9
1FD9	7/8	6BS7	10/6	12AX7	6/-	DH150	10/-	EP92	5/6	PY82	7/8
1L4	6/9	61W6	7/8	12BE6	8/8	DK91	7/6	EL41	9/8	PY83	7/8
1P1	8/-	6BW7	7/-	12BH7	10/6	DK92	7/6	EL84	7/-	R19	11/6
1P10	7/8	6C10	9/-	12K8GT	11/-	DK98	8/-	EP94	10/-	U26	9/8
1P11	7/8	6D2	4/-	12Q7GT	7/8	DL92	7/8	EM85	10/-	U32	7/8
1K5	6/-	6F12	4/-	16A5	5/-	DL94	6/6	EP91	7/8	U76	7/8
1K5	6/-	6HG7	2/-	26AG6	8/8	DL96	8/-	EY81	10/-	U78	5/8
1L4	7/8	6J7GT	7/8	25L6GT	7/8	EB91	4/-	E240	7/8	UBC41	8/8
1U5	6/-	6K72	5/6	25Z4G	9/-	EB41	10/-	E280	5/6	UCH42	9/8
3Q4	8/-	6K8G	6/-	30C1	6/9	EBF80	8/6	E281	6/9	U41	8/8
384	7/6	6Q7G	5/8	30L1	7/-	PCC81	6/-	KT33C	9/8	U41	8/8
3V4	6/6	6L7GT	6/-	36L6GT	9/-	PCC82	5/8	KT66	11/8	UY41	7/8
5U4G	7/8	6SN7GT	6/-	39W4	8/6	ECC83	6/-	N17	7/8	W76	7/6
5Y30T	5/-	6V6G	7/6	35Z4GT	8/-	ECC84	7/8	N18	5/-	W142	9/8
5Z4G	9/8	6X4	5/-	58K10	10/8	ECP80	8/6	N19	7/8	X17	7/8
6AK6	6/6	6X5G	5/-	5768	7/8	ECP82	6/9	N37	10/6	X142	9/8
6AL5	4/-	6X5GT	8/-	80	6/-	ECH42	6/-	PCC84	6/9	X150	9/8
6AM6	4/-	7B7	7/8	DAF91	7/8	ECH81	10/-	PCF80	6/8	Z77	4/-
6AT6	6/-	7C5	7/8	DAF96	8/-	ECL80	8/6	PCF82	7/-	ZD17	7/6

High Stability Resistors 4W 5% 50Ω to 1M, 9d. Midset Ceramics 500 v. 1M. Coax. Super quality 1in., 6d., 8d., 12d., 16d., 20d., 25d., 30d., 35d., 40d., 45d., 50d., 55d., 60d., 65d., 70d., 75d., 80d., 85d., 90d., 95d., 100d., 105d., 110d., 115d., 120d., 125d., 130d., 135d., 140d., 145d., 150d., 155d., 160d., 165d., 170d., 175d., 180d., 185d., 190d., 195d., 200d., 205d., 210d., 215d., 220d., 225d., 230d., 235d., 240d., 245d., 250d., 255d., 260d., 265d., 270d., 275d., 280d., 285d., 290d., 295d., 300d., 305d., 310d., 315d., 320d., 325d., 330d., 335d., 340d., 345d., 350d., 355d., 360d., 365d., 370d., 375d., 380d., 385d., 390d., 395d., 400d., 405d., 410d., 415d., 420d., 425d., 430d., 435d., 440d., 445d., 450d., 455d., 460d., 465d., 470d., 475d., 480d., 485d., 490d., 495d., 500d., 505d., 510d., 515d., 520d., 525d., 530d., 535d., 540d., 545d., 550d., 555d., 560d., 565d., 570d., 575d., 580d., 585d., 590d., 595d., 600d., 605d., 610d., 615d., 620d., 625d., 630d., 635d., 640d., 645d., 650d., 655d., 660d., 665d., 670d., 675d., 680d., 685d., 690d., 695d., 700d., 705d., 710d., 715d., 720d., 725d., 730d., 735d., 740d., 745d., 750d., 755d., 760d., 765d., 770d., 775d., 780d., 785d., 790d., 795d., 800d., 805d., 810d., 815d., 820d., 825d., 830d., 835d., 840d., 845d., 850d., 855d., 860d., 865d., 870d., 875d., 880d., 885d., 890d., 895d., 900d., 905d., 910d., 915d., 920d., 925d., 930d., 935d., 940d., 945d., 950d., 955d., 960d., 965d., 970d., 975d., 980d., 985d., 990d., 995d., 1000d.

VOLUME CONTROLS MIDGET SIZE LONG SPINDLES. D.P. switch 4/- Less switch, 2/8. Values 10K to 2M, B9A, BTG v. Holders 9d., Screens 9d., Contact Cooled Rectifiers 250v. 50 mA, 6/8, 85mA, 3/8.

**MATCHED PAIRS**  
 EL94 17/-, 6V6G 17/-, 6BW6 18/-, per pair. Push Pull O.P. Transformers for above 3-15 Q 14/8, P. & P. 1/6. 12in. P.M. Speakers 3 Q 24/6, Baker's "Selburn" 12in. 15 Q 15W, 90/-, P. & P. 2/6, 12in. Stereo Model 27.7.0.

**SETS OF VALVES**  
 DK91, DF91, DAF91, DL92 or DL941, 19/8 ECH42, EP41, EBC41, DK96, DF96, DAF96, DL96, 27/8 EL41, E240, 37/8 IC8, 1P1, 1FD1, 1P1, 27/8 UCH42, UF41, UBC41, 1R5, 1T4, 185, 384, or 3V4, 19/8 UL41, UY41, 35/- Postage and packing 6d. Over 41 post free. C.O.D. 2/6.

VISUAL DISPLAY OF  
I.F. AMPLIFIER AND  
DISCRIMINATOR  
CHARACTERISTICS

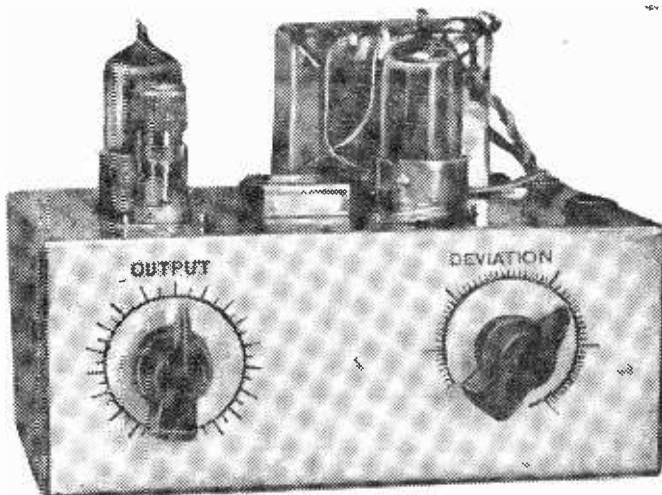

# A WOBBLULATOR

## for F.M. I.F. Alignment

(Continued from page 430 of the September issue)

As mentioned last month, the centre frequency of 10.7Mc/s is set by moving a dust core in the former of L1. This method, of setting the centre frequency ensures that the ratio of inductance-to-capacity in the oscillator tuned circuit is as high as possible—the only capacity in the oscillator tuned circuit consists of “strays” and

that contributed by the valve. (It is advantageous to have a high L/C ratio so that the variations in the capacity of the diode have maximum effect on the frequency of operation of the oscillator.)

The second half of V2 functions as another cathode-follower and enables the output of the unit to be controlled by the variable control VR2.

Layout of the unit is not unduly critical, apart from that of the R.F. oscillator section where the aim should be to keep leads as short as possible—the layout shown in Fig. 3 should be followed carefully.

### Using the Unit

In use, the unit and the F.M. set to be aligned are switched on and allowed to reach their final operating temperature. A lead is connected from the X-deflecting plate of the oscilloscope to the input terminal provided. This lead can be of coaxial cable but at the oscilloscope end the outer sheath may be left unconnected: the earth connection will be made by way of the cable from the receiver to the oscilloscope. Coaxial cable will also be needed for the lead from the unit to the receiver. At the receiver end, the braiding of the coaxial cable is twisted together and soldered to a crocodile clip which is used to connect it to the chassis of the set under test. Another length of coaxial cable is needed for the input lead to the oscilloscope. One end is terminated with plugs suitable for the oscilloscope and the other end with a crocodile clip to form the chassis connection from the outer of the coaxial cable. At the receiver end, the inner of the cable is terminated

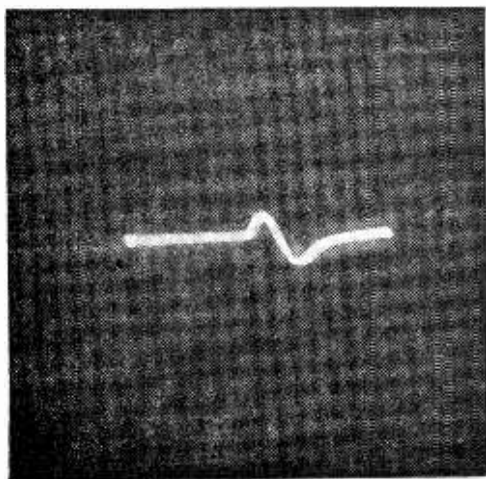

Discriminator response of an F.M. receiver.

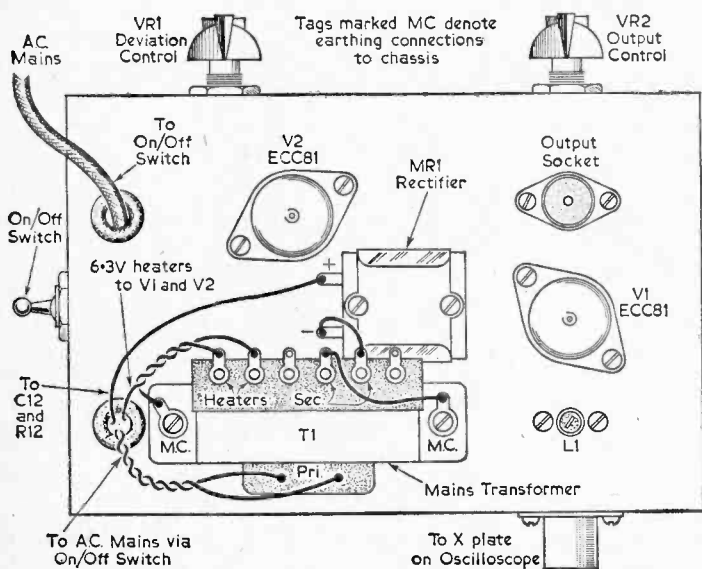

Fig. 4.—The above chassis view, showing the layout of components.

with a resistor of about 10k, to act as a stopper to prevent instability. This resistor should be soldered as near to the point where the inner leaves the outer as possible. In use the other end of the resistor is soldered to the desired point in the receiver. This lead is connected between earth on the scope and the Y-amplifier input—if one of these connections has to be long, be sure that it is the "earthy" one and keep as much of the inner wire screened as possible.

For the alignment, the oscillator valve of the set is removed or the oscillator is prevented from working—methods of doing this can be determined from the circuit diagram. The output from the unit is fed into the grid of the mixer—a stopper resistor may be required to avoid instability and may have a value of 33 to 470Ω, the exact value being determined by experiment.

During alignment, it is an advantage if the output of the set can be heard, and this should be fed to an audio amplifier. The oscilloscope is switched to a low sweep speed—10 to 20 per second—and the voltage at the grid of the limiter valve, of the receiver, fed to the Y-amplifier of the oscilloscope. The deviation control on the unit is set to maximum and a hum may be heard from the loudspeaker. If not, the setting of the dust core in L1 is altered until a hum is heard and a trace is obtained on the screen. When some evidence of the response is seen, the various controls on the unit and the oscilloscope may be altered for best results, bearing in mind that the input to the set should be kept as low as possible.

#### Marker Signals

The shape of the trace may be altered to give the optimum characteristic by altering the cores on the I.F. transformers. If another signal generator is available, a signal may be injected in parallel with the main signal and this will give a

marker on the trace which will enable the I.F. to be set correctly. Note that when once the unit has been set to give a centre output frequency of 10.7Mc/s, the open, underside, of the chassis may be fitted with a metal bottom plate to prevent unwanted radiation from the oscillator circuit—the core of the oscillator coil will still be accessible from the top of the chassis. If further screening is thought, or found, necessary, then the unit as a whole may be fitted into a perforated metal case. Radiation from the oscillator should then take place only from the centre conductor of the output coaxial socket.

If the trace is observed to pulsate at a definite frequency, the effect is probably due to hum voltages from the mains and it may be removed by using the sync control on the oscilloscope to lock the sweep to a submultiple of the internal (mains) sync frequency—say 12½c/s, which is also a good sweep frequency.

When the I.F. amplifier has been aligned satisfactorily, the output to the oscilloscope may be taken from the audio take-off point, but before the capacitor which feeds the audio to the output socket of the tuner or the A.F. stages of the receiver. This is essential if a distorted trace is not to result.

The deviation control should be set so that the response curve occupies the centre of the trace; in this way, the non-linearity of the frequency-sweep circuit may be ignored for most purposes.

Of necessity, an outline only has been given of the method of using the unit and for a more detailed explanation, the reader is referred to the article by R. Brown in the September 1960 issue of *Practical Television* entitled "Using the Wobulator", and to "Semi-conductor Diodes as Variable Capacitors" by R. B. Archer in the November 1960 issue of *Practical Television*. ■

## Another Pye Installation

**T**HE Airfield at Bahrein in the Persian Gulf has been fitted with a Pye Instrument Landing System.

This internationally specified approach aid incorporates a directional localiser and is now being used at over 100 airfields throughout the world. It gives accurate and safe guidance to airliners in their approach to landing, especially under conditions of low visibility.

The excellent quality of the information provided by the Pye system enables the "aid" to be coupled to the Auto Pilot which gives automatic approach to landing, thus relieving the pilot of much of the manual and mental effort of safely bringing in a plane.

# RETURN-OF-POST SERVICE

We offer a really efficient Mail Order Service on all items stocked. All cash orders are dealt with on the day of receipt. Hire purchase orders are subject to slight delay but this is kept to the absolute minimum

## ● STEREO COMPONENTS

Morganite ganged potentiometers as specified for the Mullard circuits. Log/Anti-Log, 500k, 1 meg., 2 meg. Log/LoE, 50k, 250k, 1 meg., 2 meg. Lin/Lin, 500 k, 1 meg. All 10/6 each. Denco Chassis for the Mullard circuits. All drilled with printed front panel. Three Valve Stereo Amplifier Chassis, 22/-. Seven watt Stereo Amplifier Chassis, 24/6. Stereo Pre-Amplifier Chassis, 24/6. Set of switches for Pre-Amp, 34/8. Pick-up cartridges. B.S.R. TC95 £2.4.11. Ronette DC294. £3.19.6. Both are turn-overs for Stereo. L.P. and 78 records. List of all components for Mullard Stereo Designs is available.

## ● GRAMOPHONE EQUIPMENT

**ALL LATEST MODELS** Hire Purchase  
**ALL POST FREE** Cash Price Deposit Mthly/Pmts.

**RECORD CHANGERS**

GARRARD RC210 (GC8 PU)	£10. 6.0	£2. 2.0	12 of 15/4
B.S.R. UA14 (TC8 PU)	£7.15.0	£1.11.0	12 of 12/-
B.S.R. UA14 Monarch (TC85 Stereo/EP78)	£8.18.0	£1.16.0	12 of 13/6

**SINGLE RECORD PLAYERS**

GARRARD TA (GC8 PU)	£8.10.0	£1.14.0	12 of 13/-
B.S.R. TU9 (TC8 PU)	£4.10.0	£1. 5.0	3 of £15.0
E.M.I. (Acos Stereo/Mono PU)	£6.15.0	£1. 7.0	12 of 10.8

**TRANSCRIPTION UNITS**

GARRARD 4HF (GC8 PU)	£18.18.0	£3.16.0	12 of £1.7.8
PHILLIPS AG2009	£10.10.0	£2. 2.0	12 of 15/8

Many of the above can be supplied for stereo working. See our Gramophone Equipment List for details.

★ "P.W. TUTOR". Send for fully detailed list! ★

## ● LOUDSPEAKERS

GOODMANS: Axiom 110 10in. £5.2.0; Axiom 112 10in. £8.14.0; Axiote 8in. £6.15.0; Axiom 300 12in. £11.5.9; Axiom 400 12in. £16.1.0; Audiom 60 Bass, 12in. £9.12.9; Trebas Tweeter £6.4.0; CX 500 Cross-over unit £1.18.0.

WHITELEY: HF 1016 10in. £8.0.0; HF 1012 10in. £5.2.0; HF816 8in. £6.17.3; F816 8in. £6.10.0; T10 Tweeter £4.8.3; T359 Tweeter £1.15.0; CX3000 Cross-over unit £1.11.6; CX1500 Cross-over unit £2.0.6. H.P. Terms available.

## ● LATEST TEST METERS

AVO Model 8	£24. 0.0	£4.16.0	12 of £1.15. 8
AVO Model 8 with leather carrying case	£27.18.0	£5.12.0	12 of £2. 0.11
AVO Model 7	£21. 0.0	£4. 0.0	12 of £1.10.11
AVO Model 7 with leather carrying case	£24.18.0	£5. 0.0	12 of £1.16. 6
AVO Multiminor	£29.10.0	£1.18.0	12 of 14.4
AVO Multiminor with leather carrying case	£11. 8.0	£2. 5.0	12 of 17/-
TAYLOR Model 127A	£10. 0.0	£2. 0.0	12 of 15/-
CABY A-10	£4.17.6	£1. 7.6	3 of £1. 6. 8
CABY B20	£6.10.0	£2. 0.0	3 of £1.13. 4

Full details of any of the above supplied free on request.

## ● AMPLIFIER KITS

We have full stocks of all components for the Mullard 510, Mullard 3-3, Mullard 2 and 3 Valve Pre-amp, Mullard Stereo, Mullard Mixer, GEC 912 Plus. Fully detailed list on any of these sent upon request.

Instruction Manuals: All Mullard Audio Circuits in "Circuits or Audio Amplifiers", 9/5. GEC 912, 4/6. All post free.

## ● "BRAND FIVE" RECORDING TAPE

Standard Play: 600ft (5") 16/-; 1,200ft (7") 25/-; Long Play: 900ft (5"), 18/6; 1200ft (5"), 23/6; 1800ft (7"), 35/-; Double Play: 1200ft (5"), 37/6; 2400ft (7"), 60/- (All Post Free!)

## ● TAPE DECKS

All carriage free	Cash Price	Deposit Mthly/Pmts.	
B.S.R. TD2	£8.19.6	£1.18.6	12 of 13/7
COLLARO STUDIO	£12.18.6	£2.12.6	12 of 19/-

ARMSTRONG PAB03 Tape Pre-amp £16.16.0 £3. 8.0 12 of £14.7

All components in stock for the Mullard Tape "C" Pre-Amplifier Kit. Fully detailed list available.

## ● OUTPUT TRANSFORMERS

GILSON: W0696A, W0696B, 50/6, post 2/-; W0710, W0710/8K, 55/6, post 2/-; W0892, 62/3, post free; W0767, 27/-, post 1/6. PARTRIDGE: P9667, 52/6, post 2/-; P4014, 99/6, post free; P4131, 80/-, post free; P3551A, 99/-, post free; P5202, P5203, 95/-, post free. PARMEKO: P2641, 28/-, post 1/6.

## ● TERMS OF BUSINESS

Cash with order or C.O.D. We charge C.O.D. orders as follows. Up to £3, minimum of 2/8. Over £3 and under £5, 1/8. Over £5 and under £10, 1/8. Over £10, no charge. Postage extra on CASH orders under £3 except where stated. Postage extra on Overseas orders irrespective of price.

## ● JASON FM TUNER KITS

We supply kits for the Jason FMT1, FMT2 and FMT3 (Fringe) Tuners with variable tuning also the JTV2 and Mercury 2 Switched Tuners with TV Sound. We take great care in the making up of these kits to ensure that every item needed is included and we can confidently claim that our kits are the best and most complete available. We are continually receiving compliments on the quality and above all the completeness of our kits. Prices: Standard Tuners: FMT1, complete kit, £8.19.6; Power Pack kit, £2.12.6; FMT2, complete kit, less power supply, £8.9.6; Kit with power supply, £10.9.6. Fringe Tuner: FMT3, kit less power supply, £10.9.6; Kit with power supply, £12.7.6. FM/TV Switched Tuners: JTV2, complete kit, £15.17.6; Mercury 2, complete kit, £11.7.6. (Important. When ordering JTV2 and Mercury 2 kits it is essential to give TV Channel and FM Stations required on Tuner). All kits are supplied complete with valves and instructions manual. Hire Purchase terms available. Fully detailed lists are available free upon request. Instruction manuals available as follows. Data Booklet for FMT1, FMT2 and FMT3, 2/10. JTV2, 3/10. Mercury 2, 3/10. All post free.

## ● MULLARD CATHODE RAY TUBES

ALL AT THE NEW REDUCED PRICES

We supply both Mullard Radiant Screen (Brand new factory fresh) and Mullard Lumener (Re-builds by Mullard with re-claimed bulbs—all other parts brand new). List of types available with prices and hire purchase terms available.

## ● ILLUSTRATED LISTS

Illustrated lists are available on LOUDSPEAKERS, TAPE DECKS, TEST & RECORDING TAPES, GRAMOPHONE EQUIPMENT. Any will be sent free upon request.

## ● TRANSITOR PORTABLE

DANSETTE RT222. We can particularly recommend this Transistor Portable for sensitivity and quality of reproduction. Ready-built not a kit. First class results guaranteed. Fully descriptive leaflets available. Price £165.0. Hire Purchase Terms—Deposit £35.0 and 12 monthly payments of £13.10.

## ● MAINS TRANSFORMERS

GILSON: W0741AB, 63/-, post free; W0839, 48/9, post 2/3; PARTRIDGE: P3001/10, 79/-, post free; P4132, 78/6, post free; P3877, 85.2.0, post free; P4013, 80/-, post free. ELSTONE: MT/MU, 45/-, post 2/9; MT/3M, 35/-, post 2/6. PARMEKO: P2631, 32/3, post 2/3.

## ● COMPONENTS

BULGIN. GROUP BOARDS. C120, 1/3; C125 2/3; C109, 2/3; C14, 4/-; BULGIN. PLUGS AND SOCKETS. P340, 4/-; P350, 3/9; P360, 4/-; P195, 5/6. BULGIN JACK PLUGS. P38, 3/-; Igranick Jack Sockets P71, 3/4; P72, 3/10. BULGIN: LE1, L604S, 1/2; L734S, 1/-; L734P, 1/3. VALVE HOLDERS. B5A Ceramic. Latest type. 9d. each. 7/6 per doz. COIL FORMERS—send for list.

## ● B.A.S.F. RECORDING TAPE

Long Play: 210ft. (3"), 9/-; 900ft (5"), 28/-; 1200ft (5"), 35/-; 1800ft (7") 50/-; Double Play: 300ft (3"), 14/-; 600ft (4"), 25/-; 1,200ft (5"), 42/-; 1,800ft (5"), 58/-; 2,400ft (7"), 77/6. All post free.

## ● TAPE ACCESSORIES

WEARTE DEFLUXER. For the regular de-magnetising of Tape Heads. 50/-, post of. BIR TAPE SPLICER, 18/6, post ad. EMU TAPE ACCESSORY KIT, 37/6, post 1/- SCOTCH BRAND TEST TAPE. Tones from 40 cycles to 10 Kcs. Recorded at 7 1/2 inches per second. 49/6, postage ad.

## ● TRANSISTORS

MULLARD. All at greatly reduced prices. Please note that these are the makers' first grade current production types. They are not rejects. All in makers' boxes. OC44, 11/-; OC45, 10/-; OC70 and OC71, 8/6; OC72, 8/-; OC72 Matched Pairs 16/-; OC78, 9/-; OC81, 8/-; OC170, 13/6; OC171, 14/6. Postage 3d on each transistor.

## ● HIRE PURCHASE TERMS

are available on any item. Payments may be spread over 3, 6 or 12 months. Details as follows: Three months: Deposit 6/- in the £. Service charge 5 per cent but minimum charge of 10/-; Six and Twelve months: Deposit 4/- in the £. Service charge 10 per cent, but minimum charge 20/-.

**WATTS RADIO**  
(MAIL ORDER) LTD.

54 CHURCH STREET, WEYBRIDGE, SURREY  
Telephone: Weybridge 4556  
Please note: Postal business only from this address

# LASKY'S RADIO

## The "CLARION" Transistor Battery Tape Recorder

Capstan drive, push-button controls. Speed 3! i.p.s., uses 3in. spools. High impact plastic case with transparent upper. Size: 9½ x 3 x 3½in.

LIST 25 Gns. LASKY'S PRICE, with Mike and Tape. **16½ Gns.** Carr. 7/8.

## 'SUPER 60' 6-TRANSISTOR S/HET TRANSPORTABLE

CAN BE BUILT FOR

**£9.15.0**

Post 4/6.

Uses 6 Mullard matched transistors including two OC81 in push-pull, plus 1 diode, 1-watt undistorted output. I.F. 470 Kc/s. Med/long wave. Ferrite rod aerial, high flux 7 x 4in. Speaker. Walnut veneer finish Cabinet, 18 x 18½ x 5in. Circuit diagram and full data supplied.

## LASKY'S CAR RADIO

12 v. operation. Transistor output. Medium and long waves. CAN BE BUILT COMPLETE WITH SPEAKER FOR £9.19.6, post 3/6. Booklet 2/6 (refunded if you order).

# TELEFUNKEN STEREO HI-FI AMPLIFIER AT BIG REDUCTION!

A complete stereo amplifier of unsurpassed quality, with inputs for radio, tape recorder, F.M. tuner etc., either monaural or stereo. For A.C. mains 110, 125, 150, 220, 240 v. Freq. response: 30 c/s to 40 Kc/s. Output: 5 watts (2½ each channel), but actual power fed to speakers equals a normal 10-watt amplifier. Bass and treble controls, etc. Size: 12 x 9 x 2½in. Green/grey hammered enamel with gold trim. New in maker's cartons, guaranteed.



LISTED AT 18 GNS. LASKY'S PRICE **£9.19.6** Post 5/-

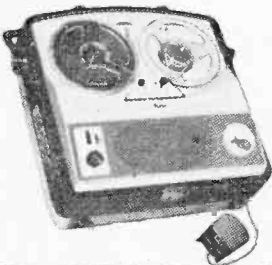

## THE 'WALTER' MAINS/BATTERY FULLY TRANSISTORISED TAPE RECORDER

Uses 7 transistors and operates anywhere, either on three PP9 batteries or mains 100/250 v. 50 cycles. Twin track, uses 5½in. reels, giving 3 hours playing time on double play tape. 2½ watts output. 2 inputs for extension speaker and external amplifier. Single master control, magic eye level indicator, superimposing and mixing facilities, rev. counter, etc. Full size: 14 x 13½ x 5½in. overall. Smart black/grey finish, detachable lid, carrying handle. New in maker's cartons. Fully guaranteed. Limited number only.

LISTED AT £57.15.0. LASKY'S PRICE INCLUDING MIKE, REEL OF TAPE AND EMPTY SPOOL **27 GNS.** Carr. & Ins., 15/-, Batteries extra, 3/- each.

207 EDGWARE ROAD, LONDON, W.2.

Near Praed St. PADDINGTON 3271/2

33 TOTTENHAM COURT ROAD, W.1.

Nearest Stn. Goodle St. MUSEUM 2605

BOTH OPEN ALL DAY SAT. Early Closing Thurs. Mail Orders to Dept. P.W., Edgware Road.

# NEW!

## DO-IT-YOURSELF TRAINING TECHNIQUE in RADIO & ELECTRONICS

You LEARN while you BUILD...

SIMPLE... PRACTICAL... FASCINATING... 1st stage receiver

ANNOUNCING—after many years of highly successful operation in the U.S.A. and in Europe—the latest system in home training in electronics is now introduced by an entirely new British training organisation. AT LAST—a comprehensive and simple way of learning—by practical means—the basic principles of radio and electronics, with a minimum of theory. YOU LEARN BY BUILDING actual equipment with the components and parts which we send you. You advance by simple steps using high quality equipment and performing a whole series of interesting and instructive experiments. No mathematics! INSTRUCTION MANUALS and our teaching staff employ the latest techniques for showing clearly how radio works in a practical and interesting manner. You really have fun whilst learning! And you end by possessing a first rate piece of home equipment with the full knowledge of how it operates and—very important—how to service and maintain it afterwards. A full library of magnificent illustrated textbooks are included with the Courses. IN FACT for the 'Do-it-Yourself' enthusiast, the hobbyist, or those wanting help with their radio career training, or to set up their own full or part-time servicing business—then this new and exciting instructional system is exactly what is needed and it can all be provided at a remarkably low cost. Easy payments available. Post the coupon now, for full details. There is no obligation.



BUILD YOUR OWN • RADIO EQUIPMENT • TEST GEAR • HI-FI INSTALLATION—AND LEARN AS YOU DO IT

# RADIOSTRUCTOR

BRITAIN'S LEADING RADIO TRAINING ORGANISATION

FREE-POST TODAY

To: RADIOSTRUCTOR (Dept. G107), Reading, Berks.

Name .....  
Address .....

BLOCK CAPS PLEASE

(821) We do not employ representatives 10-61

# T rade N ews

## L.F. SIGNAL GENERATOR

THE Airmec L.F. signal generator, type 252 is designed for the generation of pure and highly stable sinewave signals in the frequency ranges 30c/s to 300kc/s.

The oscillator consists of a Wien Bridge network with thermistor feedback amplitude control, followed by a negative feedback push-pull amplifier; tuning is by means of a variable capacitor and covers the frequency band in four decade ranges.

A screened and balanced output transformer provides either balanced or unbalanced outputs at an impedance of 600Ω; circuit design is such that the output impedance remains constant regardless of frequency and attenuator setting, and the output is monitored by a crystal diode voltmeter.

An output control provides smooth variation of output over the meter range; in conjunction with a step attenuator, it enables the output level to be

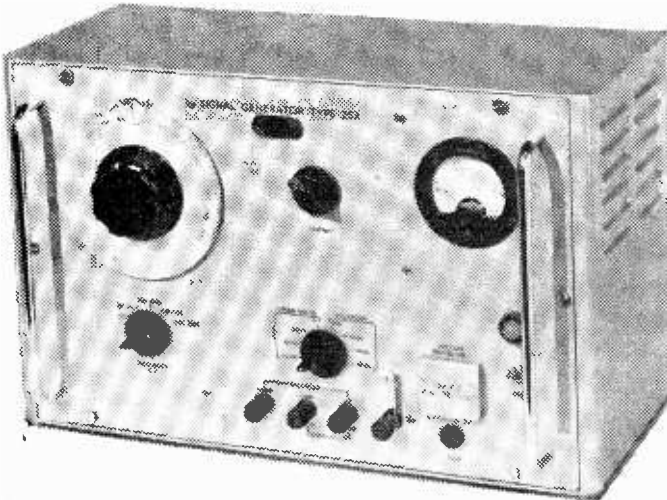

An L.F. signal generator made by Airmec Limited.

Right.—The EM87 valve; a new voltage level indicator for tape recorders. It is manufactured by Mullard Ltd.

set to any value from less than 1mV to 15V open circuit.

This signal generator is made by Airmec Limited, High Wycombe, Buckinghamshire.

## VOLTAGE LEVEL INDICATOR

THE EM87 is a new Mullard voltage indicator valve primarily intended for use as a recording level indicator in tape recorders.

In many recorders the A.F. voltage appearing at the anode of the recording output stage is about 10V, which is insufficient to close the display of currently available level indicators. The EM87 has a grid base of only 10V and in addition it has a high sensitivity in the initial region of the control characteristic ( $V_g = 0V$ ).

Over modulation of the tape is immediately apparent, since A.F. signals greater than 10V in amplitude cause the luminous areas to overlap, giving a brighter centre portion to the display.

Maximum ratings are: anode voltage 300V, anode dissipation 600mW, cathode current 5mA, and deflection electrode voltage 300V. The heater draws a current of 300mA at 6.3V.

The EM87 has the same overall physical dimensions (72.8mm overall length, 22.2mm diameter) and the same pin connections as the EM84. The fluorescent strip is 32.6mm in length by 4mm in width. This new valve is made by Mullard Limited, Mullard House, Torrington Place, London, W.C.1.

## 2-BAND POCKET PORTABLE RECEIVER

THE Ajax TR-220 de luxe portable receiver is now available in this country for £13 17s. 6d., which includes the battery (9V), leather carrying case and magnetic earpiece for personal listening. This receiver covers the long and

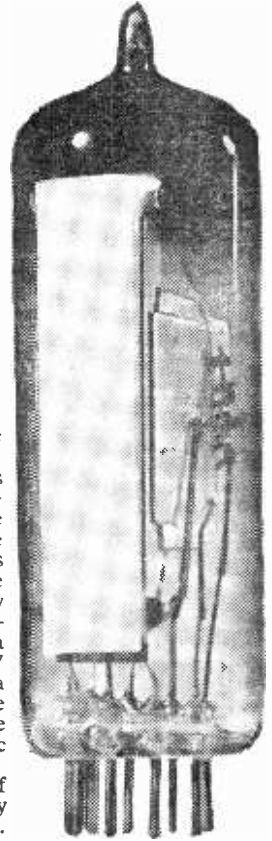

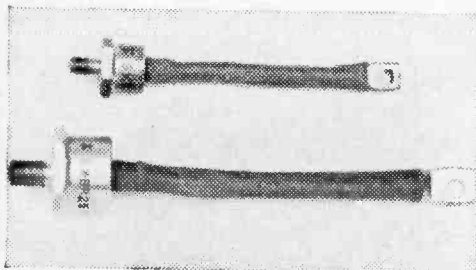

The two new silicon diodes now available from Westinghouse Brake and Signal Co. Ltd.

medium wavebands and supplies a 2½ in. loudspeaker with a 200mW output. The TR-220 is housed in a plastic case, measuring only 4½ in. x 2½ in. x 1½ in.

Six transistors are employed in the circuit which uses a ferrite rod aerial. The Ajax TR-220 is distributed in this country by *Acme Electric Co. (Finsbury) Ltd.*, 63 Great Eastern Street, London, E.C.2.

#### DOMESTIC RADIOS AT EARLS COURT

A COMPLETE range of radio, television, record players, etc. were on show at the Pam stand at the Radio Show this year.

The model 222 portable transistor radio, which was shown, incorporates a printed circuit chassis and is presented in a cabinet of cream and royal blue. It costs 13 guineas.

Model TB.77 is a fully transistorised table radio. It covers four wavebands and operates from an internal aerial. It is finished in a high gloss walnut veneer and costs 28 guineas.

Two car radios were shown this year; one of them, the model CR.40, is operated from a 12V D.C. supply. It covers two wavebands and will fit any make of car. It costs 18½ guineas.

A stereophonic radiogram (model RG.630) was also on show. This instrument includes a two waveband VHF receiver and a four-speed autochange for monaural or stereo record reproduction. The loudspeakers are fixed into swing doors for better stereo reproduction. This model, which costs 69 guineas, and the three other radios mentioned are all made by *Pam Radio and Television Ltd.*, 295 Regent Street, London, W.1.

#### MEDIUM POWER SILICON DIODES

TWO new ranges of high voltage, medium power silicon diodes are available from Westinghouse Brake and Signal Co. Ltd. The SxBR8 is rated at 18A and may be used at case temperatures up to 140°C, whilst the SxBR25 is rated at 30A and may be used at similar case temperatures. Both ranges are available in voltage ratings of 100 to 1500V peak, with ten intermediate voltages.

The diodes are hermetically sealed, using glass/metal seals and the latest press seal techniques. Mounting is by means of a stud base which also serves as the anode connection. The cathode connection is made by means of an insulated flexible lead through the glass/metal seal. These diodes are manufactured by *Westinghouse Brake and Signal Co. Ltd.*, 82 York Way, King's Cross, London N.1.

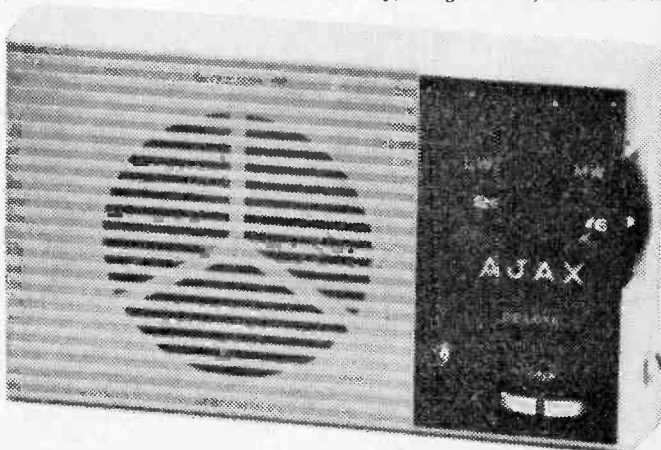

(Above).—The Ajax portable receiver, distributed in this country by Acme Electric Co. (Finsbury) Ltd.

(Below).—A stereophonic radiogram by Pam Radio and Television Ltd.

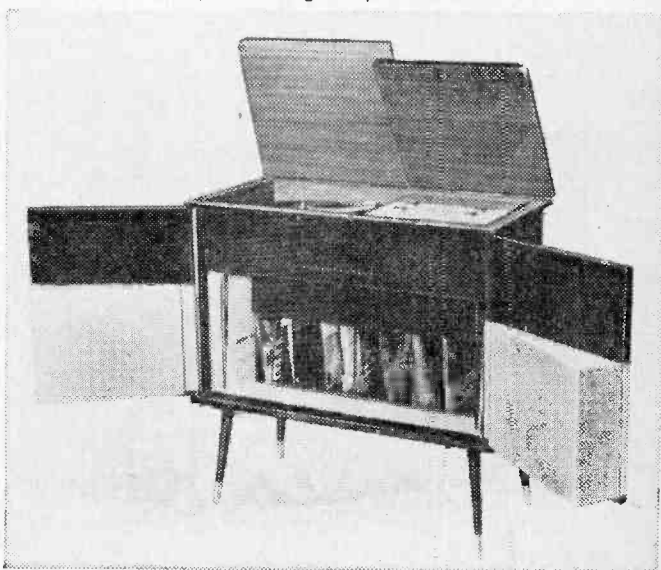



# PORTABLE RADIO OR CAR RADIO

## PUSH-PULL SIX

(6 Ediswan Transistors plus 2 Diodes)

MEDIUM, LONG WAVE AND TRAWLER BAND EXTENDING TO 80 METRES WITHOUT COIL CHANGING



350 Mw XC101's push-pull output Transistors. Powerful magnet 3in. high grade speaker. Miniature push-pull transformers. This is a top performing receiver. Nearly 30 stations listed in one evening including Luxembourg loud and clear. A pleasure to listen to. **FERRITE ROD AERIAL.** All parts sold separately, including pale blue gleaming poly-

styrene case with duo-diffusion grilles in red. Uses 9 volt battery. Sockets for car aerial.

Total building cost **£6.19.6** Size 6½ x 4½ x 1½in.

"Agreeably surprised with Trawler Band reception. Luxembourg as loud as local. Your easy build diagram helped a lot... my first attempt."—H.S., Penzance, Cornwall (poor reception area). "Super car radio."—L.B.V., Liverpool.

**ALL PARTS SOLD SEPARATELY**

## TRANSONA-4

(4 Ediswan Transistors, plus 2 Diodes)

Miniature speaker. **FERRITE ROD AERIAL.** MW/LW and Trawler Band coverage down to 80 metres On test tuned in nearly 30 stations inc. Luxembourg. This sensational new radio is simple to build with our easy-build plans. Handsome pocket case.

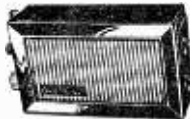

May be built for **65/-** P.P. 2/6

## NEW!

## POCKET RADIO

(5 Ediswan Transistors and 2 Diodes)

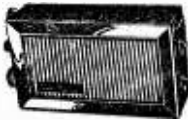

MEDIUM, LONG WAVE AND TRAWLER BAND TO 80 METRES. Designed round super sensitive ferrite rod aerial and 3in. speaker. Attractive 2-tone pocket size case in gleaming polystyrene. No aerial required. On test Home, Light Radio Lux. and many others. Easy-build plans for beginners. Powered by 4½ volt battery.

Easy-build plans for beginners.

Total cost of parts required. **£4.19.6** P.P. 2/6

**ALL PARTS SOLD SEPARATELY**

## NEW PUSH-PULL FIVE

(MW/LW and TRAWLER BAND)  
(5 Ediswan Transistors)

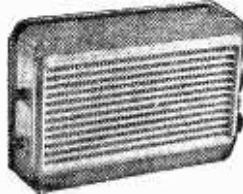

Now greatly improved. Sensitive **FERRITE ROD AERIAL.** Pale blue polystyrene case with speaker grilles in red. Volume/sensitivity control. Miniature push-pull transformers. 350 Mw XC101's in push-pull. Sensitivity R.F. stage for station selection.

Total building cost **£5.7.6** P.P. 2/6.  
**ALL PARTS SOLD SEPARATELY**

## Push-Pull Pocket Six

MEDIUM AND LONG WAVES AND 400 TO 750 METRES WITHOUT COIL CHANGING.

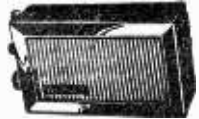

Sensitivity of a superhet, tonal quality of a TRF. Volume control. Tuning condenser. Latest type switches. Handsome two tone-pocket case. Ferrite rod aerial. 3in. quality speaker. Easy build diagrams. 6 Transistors (including Ediswan and Semiconductors) plus 2 diodes.

Total cost of all parts **£5.19.6** P.P. 2/6  
**ALL PARTS SOLD SEPARATELY**

## NEW!

## Easy Build Three Radio

(3 Ediswan Transistors plus 2 Diodes)

Easy to build, easy to operate. This transistor radio operates over the M.W. and L.W. extending down to 80 metres without coil changing. Ferrite rod aerial, volume-sensitivity control. Sonotone high fidelity miniature earpiece.



May be built for **49/6** P.P. 2/6

Ferrite Rod Aerial, M/L wave (7in.)	8/6
Ferrite Rod Aerial, M/W (4in.)	5/-
Transformers: 300 ohms primary, 5 ohms secondary	
Brand new boxed	3/6
High Fidelity Headphones with miniature earpieces and transformer with lead and jack plug for high or low impedance, matching. Brand new.	
Boxed	25/-
Sensitive balanced Armature Headphones. Boxed.	
Brand new	pair 9/-
Sensitive 2½in. Speakers. Only ¾in. deep, 3 ohm	16/6

**DATA SHEETS AND PARTS PRICE LIST FOR THE ABOVE 1/3 EACH**  
ALL PARTS SOLD SEPARATELY  
**AFTER SALES SERVICE YOUR PROTECTION**

# RADIO EXCHANGE COMPANY

27 HARPUR STREET, BEDFORD

PHONE 2367

(Opposite Co-op)

CLOSE 1 p.m. SAT.

# Note

for less...



## 19 Ranges

<b>D.C. Voltage</b>	<b>A.C. Voltage</b>
0—100mV.	0—10 V.
0—2.5 V.	0—25 V.
0—10 V.	0—100 V.
0—25 V.	0—250 V.
0—100 V.	0—1000 V.
0—250 V.	
0—1000 V.	

<b>Resistance</b>
0—20,000 Ω
0—2M Ω

<b>D.C. Current</b>
0—100μA
0—1mA
0—10mA
0—100mA
0—1 A

List Price: **£9:10s.**

complete with Test Leads and Crocodile Clips

Leather Case if required 39/-

Size: 5½ x 3½ x 1½ in.  
Weight: 1 lb. approx.

Designed to offer the widest possible range of accurate and reliable measurements at the lowest possible price, the versatility and usefulness of the Multiminor are now further extended by specially designed leads. These new leads, available at no extra cost, will accept crocodile clips or PRODClips.

The Multiminor takes full advantage of the possibilities of printed circuit techniques to achieve outstanding compactness and economy of weight. The scale is clear and open. The fine red colour pointer and effectively damped movement facilitate easy and rapid reading.

For use in Radio, TV, Electronics, Motor Vehicles, domestic appliances, workshop equipment, you'll find the Multiminor a great little meter!

Use PRODClips with the MULTIMINOR (Pat No. 748811)

These cleverly designed spring-loaded insulated prods are the complete answer to a long-standing problem. Press the trigger to open, release to grip. Keep your hands free no matter how difficult of access your test points may be.

15/- per pair

...with the

# MULTIMINOR

Write now for illustrated literature to:—

**AVO LTD**

**AVOCET HOUSE - 92-96 VAUXHALL BRIDGE ROAD  
LONDON - S.W.1**

Victoria 3404 (12 lines)



A MEMBER OF THE METAL INDUSTRIES GROUP OF COMPANIES

## HOME RADIO OF MITCHAM

(Dept. P), 187 London Road, Mitcham, Surrey.

MIT 3282

Shop hours 9 a.m. to 6.30 p.m. Wed. 9 a.m. to 1 p.m.

### Dark Evenings Ahead—Have Fun With The "GLOBE KING" Short Waver

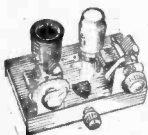

Short wave radio operates 24 hours a day. You can explore the world from the comfort of your own armchair and enjoy perfect relaxation from a day's work. Start now with this amazing little one-valver which gives really long distance reception at a minimum cost. Extra stage can be added later.

Learn morse and listen in to shipping etc. 100/A kit with three matched coils covering 10 to 100 metres. PRICE £3.19.6, plus 1/- post. Send S.A.E. for leaflet.

### MINIATURE SPEAKER BARGAIN

Brand new miniature 2½ in. permanent magnet loudspeakers. 3 ohms impedance. Ideal for portable sets etc. Size 2½ x 2½ in. ONLY 12/6, post 6d.

### WE ARE ACTUAL STOCKISTS for HEATHKITS

### MODEL ELECTRIC MOTOR



ideal for operating toys, models, etc. Works from 4½-volt dry battery or 6-volt transformer. Size 2 x 2 x 2 in. New and boxed. PRICE 4/6, post 6d.

### SUPER NEW 128 PAGE ILLUSTRATED CATALOGUE

2/- Plus 9d. Postage

### HEADPHONES



The famous "Royal" lightweight headphones. 4000 ohms high impedance and very sensitive. Ideal for crystal sets, transistor sets, short-wave receivers etc. Brand new and boxed.

Still only 15/-, post 1/-. Also S.G. BROWN type 'F', 37/6, post 1/-.

### ARMSTRONG CHASSIS

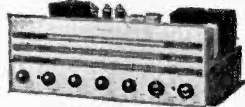

Stereo 12 Mk. II The most complete Hi-Fi radio and amplifier chassis ever produced. Everything you require on one compact precision-engineered streamlined chassis. Full details on request. PRICE 42 gns. All other Armstrong models in stock. AF208 22 gns. JUBILEE 29 gns. STEREO 55.32 gns.

**BETTER SHORT-WAVE RECEPTION**  
For the serious short-wave listener the MOSLEY SWL-7 dipole kit covers the 11, 13, 16, 19, 25, 31, 49 metre bands. Complete kit with patent trap assemblies. PRICE £7.

### NEW BOOKS

STEREO HANDBOOK, by Briggs, 146 pages ... .. 10/6  
EXTRA EQUIPMENT FOR TAPE RECORDERS ... .. 6/-

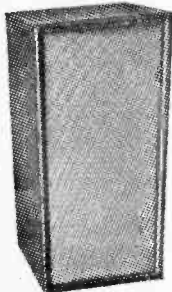

### NEW W.B. "CLUMBER" SPEAKER

An entirely new Hi-Fi loudspeaker system incorporating special 9 in. unit in patented cabinet with acoustic filters to give smooth clean bass. Very solid compact cabinet beautifully finished in dark walnut. Can be used horizontally or vertically. Size 25 x 11 x 11½ in. PRICE £14.14.0 part carriage 5/-.

# SHORT-WAVE SECTION

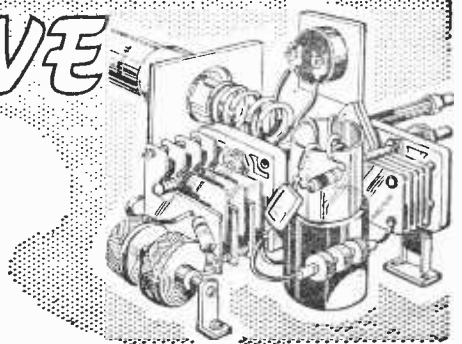

## MAKING A TUNED DOUBLET

An All-band Aerial for Receiving and Transmitting

By "Amateur Transmitter"

**J**HE use of a tuned doublet for transmitting purposes is quite well known, but the efficiency of this type of aerial for receiving can be overlooked by short-wave listeners who have not yet used anything except the simplest form of aerial. An ordinary dipole with coaxial feeder has the advantage that no tuning is required, but such aerials only work effectively on frequencies which give a fairly accurate impedance match to the feeder. As a result they are usually cut for one band only, and not used on other bands. The tuned doublet requires a tuned circuit (which may be regarded as part of the system) but this is

B and C, each one quarter-wave, make up the centre half-wave, and D is the final half-wave. If the portions B and C are brought down to make a feeder, parts A and D will form the flat top, and this part of the aerial will consist of two half-waves in phase.

When a station is received, the current flow in parts B and C will be in opposite directions, and thus provide a signal at the tuning coil connected

Fig. 1.—A doublet with two half-waves in phase.

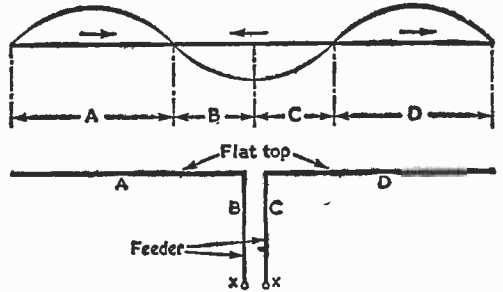

easily arranged, and the aerial will work effectively over a very wide range of frequencies. A single aerial may thus be used for harmonically related bands, such as 80m, 40m, 20m etc., and also for 49m, 31m, 25m, 19m and other short-wave broadcast bands. On all bands it is tuned to resonance, a coil and condenser being used for this purpose. This tuning can compensate for modifications in the length of the aerial top, or feeder, and so exact dimensions are not necessary for these items.

to the feeder ends X. A static impulse will, however, flow down B and C in the same direction, and thus cancel out at the tuning coil. This explains the reduction in static interference. Cancellation will not in fact be complete, owing to lack of exact balance, but will usually be worthwhile.

When the aerial is used on other frequencies, A and D will not be a half-wave each, but this has little effect on results. In the same way, the

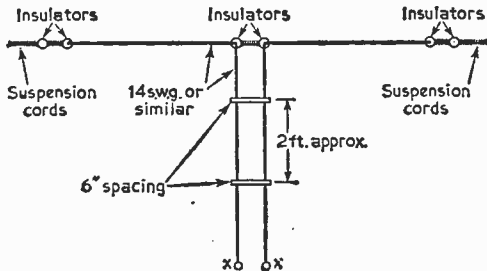

Fig. 2.—Practical construction of the aerial.

feeders B and C will no longer be a quarter-wave each, but this is unimportant because of the tuned circuit attached to the ends X. It is thus possible to use a wide range of lengths, for both the flat top, and the feeder. For the same reasons, one aerial will work over a wide range of frequencies.

### Doublet Construction

Fig. 2 shows how the doublet, with tuned feeder, can be made. Single 14s.w.g. copper wire is often used for aerials, but other types of aerial wire can be employed instead. Hard-drawn wire is satisfactory for the flat top, but soft-drawn or stranded wire will be more convenient for the feeder.

A balanced aerial can also give a considerable reduction in static and similar noise, compared with a single wire or end-fed or end-coupled aerial. This reduction in noise is somewhat similar to that achieved with a coaxial feeder.

Fig. 1 shows the approximate current distribution in an aerial wire which is three half-waves long at operating frequency. Section A is one half-wave;

Each end of the flat top has one or two aerial insulators, and suspension cords or wires are taken to suitable supports. The leads forming the feeder are roughly 6in. apart, and spacers can be obtained for this purpose, or made. The spacers will be needed at about 2ft intervals: A pair of insulators in the flat top enables each feeder to be attached as shown. At this point the feeders should either be parallel, or fan out slightly. They should not run closer, as might be so if only one short insulator were used. If the top and feeders are not made with single lengths of uncut wire, joints should be soldered to avoid noises in the receiver.

The top of the aerial should be as high and in the clear as possible, and especially removed from local interference. Long distance results may easily be achieved with an indoor aerial, but when space is available outside, indoor erection is pointless, and reduces signal strength.

If the top of the aerial slopes, because the supports are of unequal height, this will modify the directional pattern. The latter also depends on the aerial length. However, the position of the aerial usually depends on the available supports, so there is little point in being too concerned about directional effects.

#### Top and Feeder Lengths

When the system is operating as in Fig. 1, and the feeder is just short of an odd number of quarter-waves, parallel tuning is needed at the ends X. When the feeder is just short of an even number of quarter-waves, series tuning is necessary. For all-band operation, it is thus necessary that the tuner condenser can be placed either in parallel, or series with, the coil.

It will be noted that parallel tuning can be used with anything up to one quarter-wave; that is, with very short feeders. Approximate quarter-wave lengths for 160m, 80m, 40m and 20m are 132ft, 66ft, 33ft and 16ft. Some typical top and feeder lengths, with the tuning to be expected, are given in Table I

TABLE I			
Top	Feeder	Frequency	Tuning
66ft	66ft	7 and 21 Mc/s	Series
		3.5, 14 and 28 Mc/s	Parallel
106ft	82ft	3.5, 7 and 14 Mc/s	Parallel
67ft	42ft	3.5 Mc/s	Series
		7 and 28 Mc/s	Parallel
134ft	70ft	3.5, 7, 14 and 28 Mc/s	Parallel

The top is the total overall length. Except when the aerial is very high, or a long way from the receiver or transmitter, the feeder will often be shorter than the examples.

A suitable aerial for reception can be an aerial with a 66ft top (A and D each 33ft) and a feeder of any length. The type of open feeder described may, if desired, be replaced by 300Ω twin flat ribbon. This is slightly less efficient than the 600Ω open-wire line, but the losses are not particularly great if the feeder from flat top to receiver is not too long.

If it is desired to find out the particular top and feeder lengths for special bands, this can be found

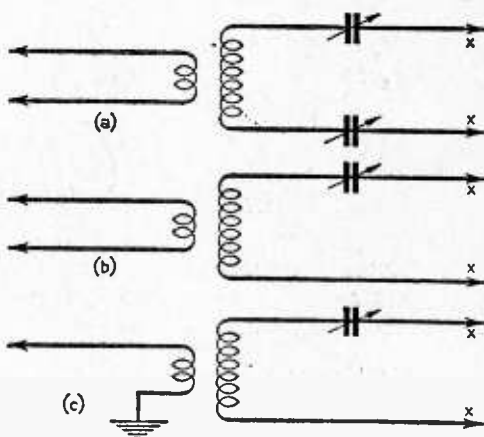

Fig. 3.—Series tuning of the feeder.

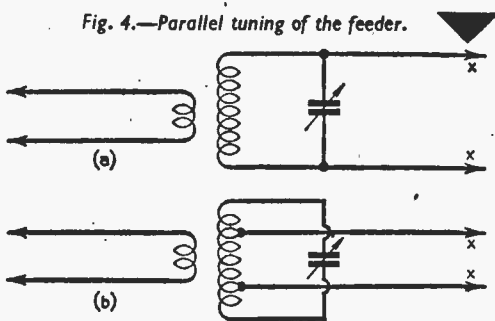

Fig. 4.—Parallel tuning of the feeder.

directly in feet, for a half-wave, from:—

$$\frac{468}{\text{frequency in Mc/s}}$$

It will have been seen that the tuning varies from band to band. When the system of tuning for a band has been found, it should be noted down, so that it can be returned to at once, when necessary.

#### Feeder Tuning

Circuits for this purpose are shown in Fig. 3. At "a" one variable condenser has been included in each feeder. In practice, one condenser is sufficient, if near the coil, and this can be included as at "b". In both "a" and "b" a coupling loop is taken to the dipole input of the receiver. When the receiver has no dipole input, but only a single aerial terminal, the coupling loop is connected to aerial terminal and earth, as at "c".

For parallel tuning, the condenser is placed across the coil, as shown at "a" in Fig. 4. Either of the receiver coupling methods shown in Fig. 3 may be used.

When the aerial is used for transmitting, it may be necessary to tap the feeders in an equal number of turns from each end, as at "b" in Fig. 4, to secure proper loading. In some cases where the impedance is improved by this, tapping in the feeders can also give improved reception.

(Continued on page 533)

# CHECK with these

# BARGAINS

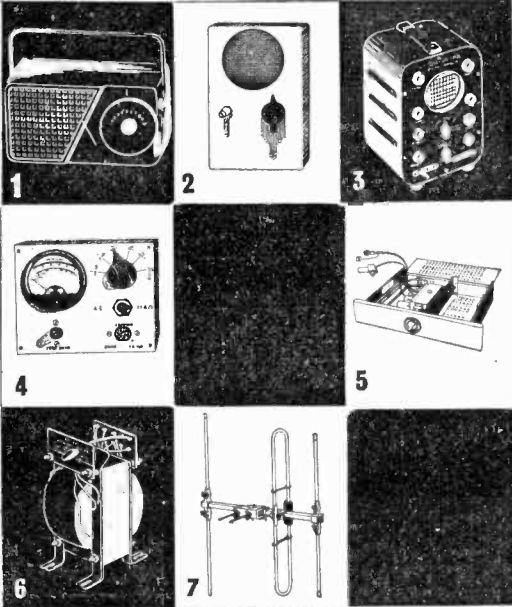

1. **3-TRANSISTOR POCKET RADIO** with MINIATURE SPEAKER, FERRITE ROD, and 2 GERMANIUM DIODES. The only 3 transistor radio available at the price. Build it in 1 evening! Tunable over M/L waves. Complete with easy-to-follow instructions and all components (less batteries obtainable anywhere 1/3). 27/6. P. & P. 2/-. (All parts available separately.)
2. **3-TRANSISTOR SUPER POCKET RADIO** with MINIATURE SPEAKER. Plus Germanium Diode and Printed Circuit. Size 3 1/2 x 4 x 1 1/2 in. Ferrite Rod Aerial. Two Surface Barrier Transistors and one Audio. Tunable over medium and long waves. To build yourself 39/6. P. & P. 1/6. Circuit diagram 1/6, free with kit. All parts of items 1 and 2 sold separately.
3. **OSCILLOSCOPE** for D.C. and A.C. APPLICATIONS. A high gain, extremely stable differential Y-amplifier (30 mv/C.M.). Provide ample sensitivity with A.C. or D.C. inputs. Especially suitable for measurements of transistor operating conditions where maintenance of D.C. levels is of paramount importance. Push-pull X amplifier, Fly-back suppression; Internal Time-base Scan Waveform available for external use; pulse output available for checking TV line O/P Transformers, etc. Provision for external—1/P and CRT Brightness Modulation. A.C. mains 200/250 v. £15.15.0. P. & P. 7/6 or 30/- deposit, plus P. & P. 7/6 and 12 monthly payments of 25/6. FULL 12 MONTHS GUARANTEE INCLUDING VALVES and TUBE.
4. **A.C./D.C. POCKET MULTI-METER KIT.** 2 1/2 in. moving coil meter, scale calibrated in A.C./D.C. volts, ohms and milliamps. Voltage range A.C./D.C. 0-50, 0-100, 0-250, 0-500. Milliamps 0-10, 0-100. Ohms range 0-10,000. Front panel, range switch, wirewound pot (for ohms zero setting), toggle switch, resistor and rectifier. 19/6. P. & P. 1/6. Wiring diagram 1/-, free with kit.
5. **CHANNEL TUNER.** Will tune to all Band I and Band III stations. Complete with P.C.F.84 and P.C.F.80 valves (in series) I.F. 16-19 or 33-38. Can be modified as an aerial converter (instructions supplied). 32/6, plus 3/6 P. & P. **HEATER TRANSFORMER** to suit above, 200-250 v., 6/-, plus 1/8 P. & P.
6. **MAINS TRANSFORMERS.** All with tapped primaries, 200-250 volts, 0-160 180, 200 v., 90 mA. 6.3 v. 2 amps, 10/6. 350-0-350 v., 70 mA. 6.3 v. 1 amp, 6.3 v. 2 amp, 10/6. 250-250 v. 2 amp, 6.3 v. 2 amp, 10/6. P. & P. 3/-. 280-0-280V 70mA 6.3v. 2A. 6.3v. 1A 10/6 p. & p. 3/-. 280-0-280 120mA 6.3v. 2A, 6.3v. 3A 17/6 p. & p. 3/-.  
- 7. **WOLSEY 3-ELEMENT FOLDED DIPOLE.** I.T.V. Aerial less mounting bracket for external use, complete with 12 yds. of coaxial cable, 16/-, P. & P. 3/6.
- 8. **SIGNAL GENERATORS.** Cash £6.19.6 or 25/- deposit and 6 monthly payments of 21/6. P. & P. 5/-. Coverage 120 kc/s to 84 Mc/s. Case 10 x 6 1/2 x 4 1/2 in. Size of scale 6 1/2 x 3 1/2 in. 2 valves and rectifier. A.C. mains 230-250 v. Internal modulation of 400 c.p.s. to a depth of 30 per cent, modulated or unmodulated R.F. output continuously variable 100 millivolts. C.W. and mod. switch variable A.F. output and moving coil output meter. Accuracy ± 2 per cent.
- 9. **BATTERY RECORD PLAYER AND AMPLIFIER.** 45 r.p.m. "Star" motor "Acme" crystal pick-up, 3 transistor push-pull amplifier complete with transistors. Output 500 milliwatts, 49/6. P. & P. 3/8.
- 10. **3-watt PUSH-PULL 5 VALVE AMPLIFIER.** A.C. mains 200-250 v. Size 10 1/2 x 6 1/2 x 2 1/2 in. 5 valves. For use with all makes and type of pick-up and mike. Negative feedback. Two inputs, mike and gram, and controls for same. Separate controls for Bass and Treble lift. Response flat from 30 cycles to 15 kc/s, ± 2 db; 4 db down to 20 kc/s. Output 5 watts at 5 per cent total distortion. Noise level 40 db down all burn. Output transformer tapped for 3 and 15 ohms speech coils. For use with 8Ω, or L.P. records, musical instruments such as guitars, etc. Suitable for small halls, £8.19.6. P. & P. 6/-. Crystal mike to suit 15/-, P. & P. 1/6. 8in. P.M. Speaker to suit 12/6. P. & P. 1/6.
- 11. **B.S.R. MONARCH WAS WITH FUL-PI HEAD.** 4-speed, plays 10 records, 12in., 10in., or 7in. at 18, 33, 45 or 78 r.p.m. Internixes 7in., 10in., and 12in. records of the same speed. Has manual play position: colour, brown. Dimensions: 12 1/2 x 10 1/2 in. Space required above baseboard 4 1/2 in., below baseboard 2 1/2 in. Fitted with Ful-Pi turnover crystal head. £6.19.6. P. & P. 5/-. With Stereo Head £7.19.6. P. & P. 5/-.  
- 12. **TRANSISTOR TESTER.** For both P.N.P. and N.P.N. transistors incorporating moving coil meter. In metal case, size 4 1/2 x 3 1/2 x 1 1/2 in. Scale marked in gain and leakage. 19/6. P. & P. 2/6.
- 13. **PUSH-PULL OUTPUT STAGE** inclusive of transistors with input and output transformers to match 3 ohm speech coil, suitable for use with the POCKET RADIO. Kit of parts, including transistors. 19/6. P. & P. 1/6. Wiring diagram 1/6, free with kit.
- 14. **PORTABLE AMPLIFIER.** On printed circuit for A.C. Mains 200/250 v. Size 4 x 3 in. with tone and volume control. Valves: ECL52 and EZ90. 38/6. P. & P. 2/6.

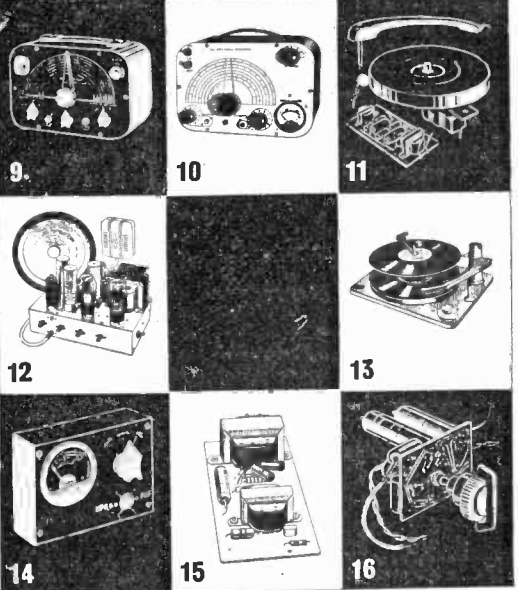

## RADIO & T.V. COMPONENTS (Acton) LTD.

23B HIGH STREET, ACTON, LONDON, W.3.  
 ALL ENQUIRIES S.A.E.  
 GOODS NOT DISPATCHED OUTSIDE U.K.

### SUPERIOR GRAMOPHONE AMPLIFIER

3 valves, 4 watt

13 1/2 x 7 1/2 in. (2 1/2 in. front to back). 3 front controls, bass, treble, vol./on-off. 6 1/2 in. circ. or 8 x 5 1/2 in. speaker; UY85, UF86 and UL84. Mains trans. 200-240ac; "gold" fret front. ONLY 70/- (p.p. 3/6).



### BUILD YOUR OWN RECORD PLAYER FOR £11.10.0

2v. amp. 57/-; B.S.R. 4-sp. auto-changer £6.10.; case 17 x 15 x 8 1/2 in. 45/-; carr. 7/6 on any two items or the lot for £11.10—carr. paid. Assembled in 15 mins.

### The "CANTATA" 6-transistor and diode Portable Kit

400mW push-pull output; Ferrite rod aerial; M.W. and L.W.; operates on two 4.5 v cells; full working instructions; printed circuit board size 8 1/2 x 2 1/2 in. with all holes drilled; booklet of full assembly and alignment instructions; all parts sold separately. Write for list; 6 x 4 in. speaker included for the price of £6.19.6 (post 3/6). Cabinet 20/- extra.

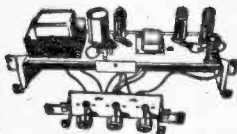

### PUSH-PULL AMPLIFIER £4.15.0

Brand new 200-240 A.C. mains. Bass, treble and vol. controls with valves EZ80, ECC83 and 2-E184 giving full 8 w. Chassis 12 x 3 1/2 x 3 1/2 in. With o.p. trans. for 3-2 ohm speaker.

Front panel (normally screwed to chassis) may be removed and used as "flying panel".

### NEW LOUDSPEAKER BARGAINS. Good Makes.

2-3 ohm. 13 x 8 1/2 in. 35/- (4/-); 7 x 4 in. 14/6 (2/-); 6 1/2 x 4 1/2 in. 12/6 (2/-); 10 x 8 in. 25/- (3/-); 5 in. 12/- (2/-); 4 in. tweeter 7/6 (2/-); 7 x 5 in. 17/6 (2/-); 8 x 6 in. 22/- (2/6). *Postal charges bracketed.*

### "READY TO USE" ITA CONVERTER

Direct switching ITA to BBC. metal rectifier, co-axial plug. Can be fitted in 5-10 mins., and needs no alteration to your set. ALL AREAS. ALL SETS. ALL CHANNELS. 12 months' guarantee (3 months on valves).

Separate gain controls. Valves PCF80 and PC84. Switch positions OFF—ITA—BBC. Bakelite moulded cabinet. 8 1/2 x 4 x 6 in. 70/- (3/- P. & F.).

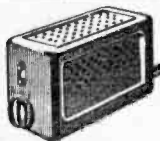

### PANEL OF 7 POTS.

10 x 1 1/2 in.—4 x 1M & 3 x 2M. 4/- (post 1/-).



6 DIFFERENT PRE-SET POTS, 2K to 500K 3/- (post 1/3).

MAINS TRANSFORMER. 6.3v 14A and 200v. 30mA. 7/- (post 1/6).

### 3-VALVE AMPLIFIER (INC. RECT.).

4 watts. Valves ECC83, EL84 and EZ80. Controls, volume, bass and treble. On/off switch. (Chassis size 6 1/2 x 3 x 2 1/2 in.) 6 1/2 in. round or 7 x 4 in. elliptical speaker. Not suitable for microphones input. A.C. only. 67/- P. & F. 3/-.

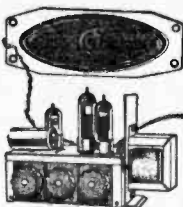

### BERIC BATTERY RADIO IN MAKER'S CARTON.

Valves DK96, DF96, DAF96, DL86. Two Short Wavebands 2.5 to 7 Mc/s and 6.5 to 17 Mc/s. Cabinet 12 x 7 1/2 x 6 in. ONLY £5 (2/6 p. & p.); MW and SW £5.4.0 (plus 2/6 p. & p.).

## GLADSTONE RADIO

See additional advert. and address on page 497

Take the trouble OUT of trouble-shooting with the NEW

## Lab-Craft

### TRANSISTOR SIGNAL INJECTION PROBE

Price

# 99/6

### QUICKLY CHECKS:

Radio, T.V. Sound.  
All forms of Audio Ccts.  
Printed Wiring.

Complete with  
long life  
MERCURY  
BATTERY

- ★ Self contained.
- ★ Completely safe.
- ★ Light in weight.
- ★ Wide frequency range.

Used for rapid signal injection—Functions as a Wide-Band Modulated Signal Generator emitting a signal rich in AF, IF and RF components. Useful range 2 Kc/s to 25 Mc/s.

1/2 Actual Size



### LAB-CRAFT LTD.

83 ILFORD LANE, ILFORD, ESSEX. Tel. 2576

It may cost a bit more at the B.N.R.S. and you will be required to work a bit harder, but **OH BOY!** the results are worth it.

With a career at stake only the best will do.

Write today, to:

**Mr. J. SYKES**

(M.I.E.E., M. Brit. I.R.E., M.I.N.)

Principal:

**BRITISH NATIONAL RADIO SCHOOL**

Red Lion Court, Stalbridge, Dorset

Britain's premier Radio Correspondence School specialising in City and Guilds and Brit. I.R.E. examinations.

(Continued from page 530)

With parallel tuning, the effect of taking an earth connection to a centre-tap on the coil can be tried, as this can further reduce static interference.

A suitable tuning coil is shown in Fig. 5. If this is wound with 20s.w.g. or similar wire on a ceramic former, it will do for both receiving and transmitting purposes. When the aerial is to be used for receiving only, the ribbed former is still convenient, as clips can easily be attached to the coil turns. There is, however, no need that the coil be of the dimensions given, provided it has a number of turns which allow it to be tuned to resonance on the bands required. Tinned copper wire will allow easy tapping, and tags or leads can be soldered on when the tapping points are found. Adjoining turns must not be shorted.

The loop consists of 2 or 3 turns of well insulated wire wound round the centre of the coil. The number of turns has to be a compromise for all bands, and more turns may well be used if the higher frequency bands are not of much interest.

For receiving purposes, almost any air-spaced tuning condenser will be satisfactory. A value of about 200pF will generally be convenient. Smaller condensers may be used, but it will be necessary

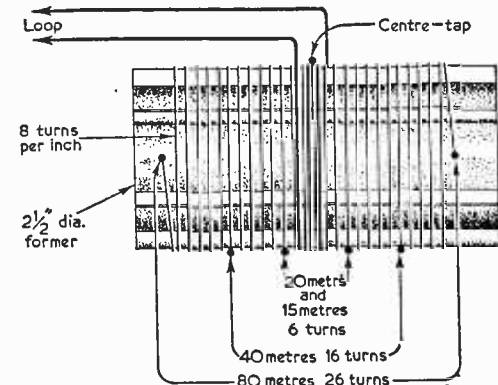

Fig. 5.—Details of the tuning coil for the feeder.

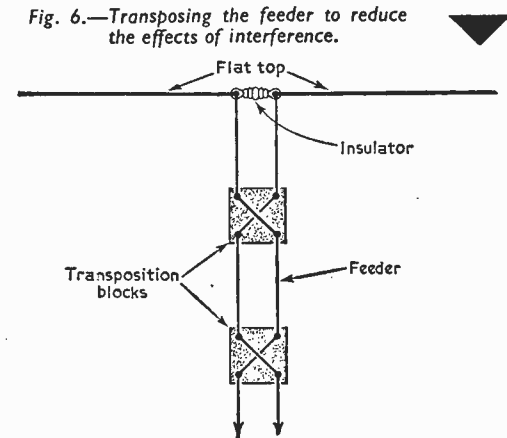

Fig. 6.—Transposing the feeder to reduce the effects of interference.

to move tappings on the coil more frequently. A receiver type condenser will be suitable. For transmitting, a condenser with wide spacing may be required, except for low power.

If the feeder is taken to terminals equipped with short lengths of flex, and clips, this will allow easy adjustment. The condenser may also have flexible leads and clips, so that it can be placed in series or parallel with the coil, as required, and to permit changing the number of turns.

**Tuning Method**

If the receiver has a signal strength meter, the tuning condenser is simply rotated to obtain best signal strength on the required band. The correct tuning point should show an improvement of several times in signal strength, but is not very critical as the circuit tunes flatly. If the condenser cannot be adjusted to give a definite peak in results, the number of turns in circuit may need adjusting. If results improve with the condenser fully open, too many turns are in use. On the other hand, if results are improved when the condenser is fully closed, more turns are required in circuit.

Once tapping points, method of tuning, and tuning condenser settings have been noted, they can be returned to easily.

When the receiver has no tuning meter or indicator, weak transmissions should be tuned in, and the aerial tuner adjusted for best results. Settings should then be noted, for future reference.

For transmitting purposes, the aerial can be tuned up roughly on the receiver, by noting the signal strength meter. The loop can be coupled by a short length of coaxial cable to the  $\pi$ -output of a transmitter, the coaxial sheath and one end of the loop being earthed as at "C" in Fig. 3. Meters may be included in one or both feeders, to show feeder current. Current will be fairly large for series tuning (low impedance), and fairly small with parallel tuning (high impedance).

**Transposed Line**

When the aerial is used for receiving, the line may be transposed, as in Fig. 6, as a further aid to reducing interference. For reception in such circumstances, there is no need for the spacers to be so long, and the feeder leads can thus be closer together. The wires cross at each transposition block. The blocks may be cut from perspex or other insulating materials. To avoid contact between the leads where they cross, one lead can be each side of the block.

Local interference is less likely to cause trouble with a transposed feeder, because the interference strength will be more nearly equal in each wire, and will thus cancel out better at the ends of the feeder. The aerial may be used untuned by taking its feeders directly to a receiver dipole input, or by omitting the tuning condenser, so that the coil merely acts as a coupler.

**PRACTICAL WIRELESS CIRCUITS**

17th Edition

By F. J. CAMM 17/6 by post 18/7

from

**GEORGE NEWNES, LTD.,**

Tower House, Southampton Street, London W.C.2.

# Short-wave Listeners' Log

**M**OST Dx reception of amateur stations is usually on the 20m and 15m bands, these bands being from 14.00Mc/s to 14.35Mc/s and 21.00Mc/s to 21.45Mc/s respectively. Circumstances may make it difficult for some S.W. listeners to erect an extremely efficient or high aerial. Fortunately, however, a half-wave aerial for either the 20m or 15m band does not have to be particularly long. The actual lengths are 33ft for the 20m band, and 22ft for the 15m band. In very many cases it should be possible to erect an aerial of this length.

Tests with a simple dipole of this kind show that it can give excellent reception. Good results are obtainable even if the aerial is not at all high. A few listening periods with such an aerial, at a height of about 12ft to 15ft above ground, enabled many Amateur stations to be logged.

For a centre-fed dipole, the length of aerial wire mentioned is cut in half, a few inches extra being allowed to attach to the insulators. A low impedance feeder of any length is then taken from the centre. This feeder may be of 75Ω twin

flat lead, or of twin twisted flex, or may be a co-axial cable. In the case of the 15m aerial, for example, the aerial itself would have two sections, each 11ft long, with the feeder descending from the centre, so that the whole resembles the letter "T".

## Confined Spaces

If space is limited, it is in order to turn down vertically a few feet at each end, to accommodate the correct length. It is interesting to note, in this, that the HP9 station (Panama) was heard on two days at very good strength. As a transmitter was available, this station was called, and when describing his equipment he said that space was so limited that he was using a 20m indoor dipole, with both ends turned down in the way explained.

It is not necessary that the dipole top should be horizontal, so supports of unequal height may be used. The slope does, however, change the directive pattern. This is not usually of much importance, unless the best possible reception is wanted from one area, or unless experiments are to be made with directivity. ■

## How to Keep Radio Equipment Cool

(Continued from page 503)

it may be difficult to make the heating-up period take less than an hour, and quite often the apparatus may be in use for a shorter time, so it is desirable that it should have a stable performance as independent of temperature changes as possible.

### Curve

The heating-up curve is easily plotted if an accurate mercury thermometer is inserted to measure the air temperature inside the case, an inch or two from the top. The thermometer can be inserted through a hole with a rubber grommet for protection. If it is of the total immersion type, the stem can be covered to avoid cooling of the projecting part of the thermometer. The thermometer must of course have a sufficient range, e.g., up to 240°F, to ensure that it will read up to the maximum temperature reached without breaking. Over the first part of the curve, readings can be taken at intervals of five minutes. After half an hour, less frequent readings would suffice. All that is really important, however, is to check that a steady and not excessive temperature is reached in a reasonable time. If 140°F is exceeded, the test should be discontinued before any damage to components can occur, and the ventilation arrangements will require improvement.

This was well-illustrated by a small home-made oscilloscope contained in an aluminium case measuring 8½ in. x 7 in. x 9 in. The case had not been painted black, and this was an additional factor in retaining the heat, as unpainted alumin-

ium will not radiate heat so well. Reliance was placed on convection via 24 small louvres pressed in the sides. These provided apertures only ¼ in. wide, and the total area of the openings was only 5sq in. The louvres proved to be ornamental rather than efficient.

### 65W Dissipation

The oscilloscope contained seven valves and a cathode ray tube, and there was a total dissipation of 65W inside the cabinet. The heating-up curve (A) shows no sign of a steady temperature being reached even after two hours (see Fig. 1 on page 503). It was obvious that worked for long periods under these conditions, the oscilloscope would soon break down, and the only way to avoid this was to provide larger apertures. Experiments however were first made in separating the top and bottom of the case from the sides by ¼ in. spacers, but such a small gap had a quite negligible effect, and the original louvres had to be replaced by rectangular openings measuring 1½ in. x 1¼ in., covered with expanded aluminium material of the type used for loudspeaker grilles—which reduced the effective area of the openings by about 50% (see the illustration on page 503).

Six of these openings were made in each side, and two at the back of the case, giving a total estimated area of aperture of roughly 25sq in., or about five times the previous amount.

The ventilation now proved to be reasonably effective (Curve B) and the final working temperature did not quite reach 130°F in a room temperature of 60°F. ■





# Valves by return post

AZI 10/-	ECF80 12/6	EF183 15/-	KT61 10/-	TH30C 5/-	VP23 5/-	5Z4G 9/-	6K7G 3/6	7C6 8/-	25L6GT 10/-
AZ31 10/-	ECF82 10/6	EF184 15/-	KTW61 6/6	TP22 8/-	VR105/308/ 6A7	6A7 10/-	6K7M 6/9	7H7 8/-	25Z4 9/6
DAF96 8/-	ECH42 9/-	EK32 7/-	MX40 12/6	U10 9/6	VR150/307/6 6A8G	6A8G 9/6	6K8G 6/6	757 9/6	25Z5 7/-
DF96 8/-	ECH81 9/6	EL32 10/-	OZ4 4/6	U25 13/6	VU39 (MU 6AK5	6AK5 5/6	6K7GT 5/9	7Y4 6/6	25Z6 10/-
DK96 8/-	ECL80 9/6	EL41 9/-	PCC84 12/-	U26 12/-	(12/14) 8/9 6AL5	6AL5 4/6	6K8GT 10/-	10F1 12/6	30FL1 10/6
DL96 8/-	ECL82 10/-	EL84 9/-	PCC85 8/6	U50 8/-	Y63 7/6	6AM5 7/6	6L6G 8/-	10P13 22/3	30P15 23/3
EABC80 9/-	ECL83 15/-	EL91 4/6	PCF80 8/9	UABC80 9/-	1A7GT 13/6	6AM6 4/6	6L6M 9/6	12A6 5/-	30P4 15/-
EAF42 9/6	EF36 3/6	EM34 9/-	PCF82 11/6	UAF42 9/6	IC2 11/6	6AQ5 5/6	6L18 11/6	12AH8 12/-	30P12 12/6
EB91 4/6	EF41 9/6	EM80 9/6	PCL83 13/6	UBC41 8/6	ICSGT 12/6	6AT6 8/6	6N7GT 7/6	12AT7 7/6	30P11 12/6
EBC3 5/-	EF50 5/-	EM81 10/6	PCL84 10/-	UBC81 11/4	1HSGT 9/-	6BA6 7/6	6Q7G 7/6	12AU7 8/-	35L6GT 10/-
EBCC33 6/9	EF50SL 7/-	EY51 9/6	PL36 13/6	UBF80 9/-	IN5 10/6	6BE6 7/6	6Q7GT 9/6	12AX7 8/-	25Y5 9/-
EBC41 8/9	EF80 7/-	EY86 10/-	PL81 11/-	UCC8410/11 1R5	1R5 7/6	6BH6 9/-	6SK7 6/-	12BA6 9/-	35Z4GT 8/-
EBF80 9/9	EF85 7/6	EZ40 7/6	PL82 8/6	UCC85 9/6	1S5 6/6	6BJ6 9/6	6SL7GT 8/-	12BE6 9/-	42 8/-
EBF89 9/6	EF86 12/6	EZ41 7/6	PL83 9/6	UCH42 9/6	1T4 5/6	6BV6 9/6	6SN7GT 7/6	12C8 7/-	35Z5GT 9/6
ECC81 8/9	EF89 8/6	EZ80 7/0	PL84 9/6	UCH81 9/6	3D6 5/-	6C4 6/6	6S7 9/3	12J7GT 10/6	50L6GT 8/6
ECC82 7/6	EF91 5/9	EZ81 7/6	PX25 12/6	UCL82 11/6	3Q4 7/6	6CS5GT 6/6	6U4GT 12/-	12K7G 6/6	75 10/6
ECC83 9/6	EF91(BVA) 7/-	FC13 5/6	PY80 7/6	UCL83 13/6	3Q5GT 9/6	6C6 5/6	6V6G 5/-	12K8GT13/6 80	8/6
ECC84 10/-	EF92 7/6	FW4/500 PY81	8/6	UF85 9/-	354 7/6	6D6 5/6	6V6GT 7/6	12K8M 13/-	142B7 3/6
ECC85 9/6	EF92 6/6	10/- PY82	7/6	UF89 9/-	3V4 8/-	6CH6 7/6	6X4 7/6	12Q7GT 6/6	210DDT 4/6
		GZ32 11/6	PY83 8/6	UL41 9/-	4D1 3/-	6F6G 7/6	6X5G 7/6	12SK7 6/-	210VPT 3/6
		HL23DD 8/6	PEN4VA 10/-	UL84 9/-	5R4GT 9/6	6F6M 7/6	6X5GT 7/6	12SL7 8/-	
		HL42DD 10/-	10/-	UU6 19/3	5U4G 5/-	6J5GT 5/6	6/30L2 12/6	12SN7GT 10/-	
		10/-	PEN25 5/6	UY11 12/6	5V4 11/6	6J5M 4/6	7B6 10/6		
		KT2 5/-	PEN45 8/6	UY41 6/6	5Y3G 8/-	6J6 4/6	7B7 8/6	15D2 7/9	
		KT33C 6/-	SP4 5/-	UY85 7/-	5Y3GT 7/6	6J7G 6/6	7C5 8/-	15DA6 8/-	

**MULLARD TRANSISTORS**  
 OC19 48/- OC77 10/-  
 OC35 25/6 OC78 8/-  
 OC44 11/- OC78D 8/-  
 OC45 10/- OC81 8/-  
 OC70 6/6 OC84 11/-  
 OC71 6/6 OC170 13/6  
 OC72 8/- OC171 14/6  
 OC72pr 16/- OC201 12/6  
 OC73 16/- OC202 36/-  
 OC75 8/-

**A SPECIAL OFFER OF SIX MULLARD TRANSISTORS**  
 1 OC44, 2 OC45, 1 OC81D, 2 OC81. Only 37/6 set.  
**EDISWAN TRANSISTORS**  
 XA104 12/-, XA103 10/-, XB102 6/6 ea.

**RECORDING TAPE**  
 Special Offer of Top quality recording tape, 3 1/2 in. spool 200ft, 5/3, 5 in. spool 600ft, 13/9, 5 1/2 in. spool 850ft, 18/6, 7 in. spool 1200ft, 23/-. Extra-play tape, 3 1/2 in. spool 300ft, 7/-, 5 in. spool 900ft, 21/-, 5 1/2 in. spool 1275ft, 26/6, 7 in. spool 1800ft, 37/6. Empty spools, 3 1/2 in., 1/6, 5 in., 2/-, 7 in., 3/-.

**RECTIFIERS**  
 RM1-5/3, RM2 6/9, RM3 7/6, RM4 13/6, RM5 19/6, 14A86 19/6, 14A97 19/6, 14A100 19/6, LW7 17/6, 18RA 1-1-16-1 6/-, FC31 (14RA 1-2-8-3) 22/6, FC101 (14RA 1-2-8-2) 16/6.

Hi-Fi Transistor FM Tuner for the Home Constructor, complete kit £18.18.0. Fully illustrated booklet with diagrams, full shopping list etc., 3/6.

**LOUDSPEAKER UNITS**  
 All brand new  
 2 1/2 in. square Rola C25 ..... 26/10  
 2 1/2 in. square EMI ..... 18/6  
 4 in. square Elac Tweeter ..... 12/6  
 5 in. round Plessey with O.P.T. .... 16/6  
 6 1/2 in. round Celestion ..... 17/6  
 8 in. round Richard Allen ..... 18/6  
 10 in. round Elac ... 25/6  
 12 in. round Plessey 29/6  
 7 in. x 4 in. Plessey ... 19/6  
 7 in. x 4 in. Plessey ... 19/6  
 8 in. x 4 in. Celestion and Richard Allen 19/11  
 10 in. x 6 in. Celestion and Plessey 21/6

**LOUDSPEAKER CABINETS**  
 Type suitable for an 8 in. unit ..... 21/-  
 Type suitable for a 10 in. unit ..... 25/6  
 Type suitable for a 7 x 4 in. unit ..... 17/6

**CRYSTAL CALIBRATOR No. 10**  
 Crystal controlled. Directly calibrated. Functions: Crystal, controlled oscillator providing fixed frequency signals of 500kc/s and all harmonics of 500kc/s up to 30mc/s variable oscillator from 250kc/s to 500kc/s enabling all intermediate frequencies between 250 kc/s to 500kc/s to be produced and modulated. Complete in carrying case/bag with all valves, leads and instruction book. £4.10.0 ea.

**MICROPHONES**

★ **Acos Mic., 39/1.** Crystal stick microphone for use as a hand, desk or floor stand unit. Listed at 3 gns. OUR PRICE 37/6. Table Stand 7/6 extra. Floor stand adaptor, 12/6 extra.  
 ★ **Acos Mic. 40,** as supplied with modern tape recorders with a folding rest and 8fc. lead. Listed at £1.15.0. OUR PRICE 19/6.  
 ★ **GBC Microphone,** pencil stick type fitted with muting switch, 42/-.  
 ★ **T.S.L. Crystal "Stick" Microphone,** Model MX3, for general purpose use, complete with table stand, 45/-.

★ **T.S.L. Moving Coil Microphone,** for high or low impedance. Brown and cream plastic case with a fold-in table rest, 6ft. cable and a standard 3-way connecting Continental plug, £4.4.0.  
 ★ **Acos Mic. 45,** dual purpose, designed to fit into the hand, has built-in stand for desk use, die-cast case for a variety of applications from music to dictation, with lead, 25/- each.

**CAR RADIO KIT**  
 Can be built absolutely complete for £11.19.6. (Post 3/6).

★ Small size. Will fit any car. ★ 12 volt operation. ★ New Hybrid circuit. ★ Transistor output. ★ New Type Brimar valves. ★ No Vibrator, 12 volt H.T. and L.T. ★ T.C.C. Printed Circuit and Condensers. ★ Tuned R.F. stage. ★ Medium and long waves. ★ Permeability tuning. ★ 7 x 4 in. elliptical speaker. Instruction Booklet giving full details, illustrations, dimensions, circuit diagram and shopping list, 2/6.

**SPECIAL OFFERS**  
 Paxolin sheet, 1/4 in. thick, 6 x 6 in., 1/-; 12 x 6 in., 2/-; 12 x 12 in. 4/- each  
 Set of Mullard Transistors, comprising 1 OC44, 2 OC45, 1 OC81D, 2 OC81 ... .. 37/6 set  
 Special Purchase, ex-Government Rectifiers, 250v., 45mA ... .. 3/9 each

**TELEFUNKEN: STEREO HIGH FIDELITY AMPLIFIER**  
 Five watts total output (2 1/2 watts each channel), size 12 in. wide x 9 in. deep 2 in. high, weight 9 lbs. Hammered enamel finish in green/grey with gold trim, control and press buttons in cream with black, blue and red lettering. Provision made to feed the amplifier from radio, tape recorder, FM tuner, etc. Listed at £16.16.0. **£12.12.0**  
 Special Alpha Offer.

**CATALOGUE**  
 OUR 1962 CATALOGUE IS NOW AVAILABLE. PLEASE SEND 1-IN STAMPS FOR YOUR COPY. TRADE CATALOGUE ALSO AVAILABLE. FOR WHICH PLEASE ATTACH YOUR BUSINESS LETTER HEADING.

**TERMS:** Cash with order or C.O.D. Postage and Packing charges extra; as follows: Orders value 10/-, add 1/-; 20/- add 1/9; 40/- add 2/6; £5 add 3/6. Minimum C.O.D. fee & postage 3/-. For full terms of business see inside cover of our catalogue. Personal Shoppers 9 a.m. to 5 p.m. Mon. to Friday; Saturday 10 a.m. to 1 p.m.



103 LEEDS TERRACE  
 WINTOUN STREET  
 LEEDS 7

THE WORD **MAXI-Q** IS THE REGISTERED TRADE MARK  
 OF DENCO (CLACTON) LIMITED  
 IT IS ALSO A GUARANTEE OF  
 WORKMANSHIP & TECHNICAL PERFORMANCE

OUR RANGE OF PRODUCTS IS SO GREAT THAT WE NOW HAVE TO REQUEST THE AMOUNT OF 1/4d. FOR OUR GENERAL CATALOGUE AND TO SAVE YOU POSTAL ORDER POUNDAGE CHARGE WE REQUEST SEND 1/4d. IN STAMPS.

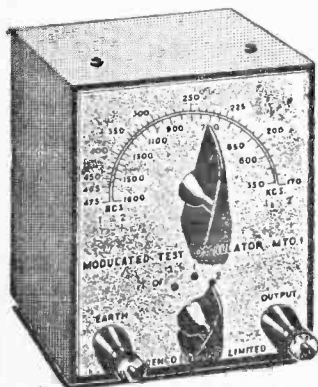

### MODULATED TEST OSCILLATOR MTO. 1

- ★ Provides a modulated signal suitable for I.F. alignment, also trimming and tracking R.F. circuits.
- ★ Frequency is continuously variable from 170-475 kc/s and 550-1,600 kc/s.
- ★ Suitable for the alignment of transistor receivers.
- ★ Operates from a single 9-volt grid-bias battery (not supplied) which is housed within the unit.
- ★ The case is manufactured from steel and is finished in silver hammer. The front panel is gloss black bearing white lettering. Dimensions are 5 1/16in. x 4 1/16in. x 3in.
- ★ Supplied with full operating instructions.

PRICE £3/17/6

PLEASE SEND S.A.E. WITH ALL ENQUIRIES

**DENCO (CLACTON) LTD.**

(DEPT. P.W.)

357/9 OLD ROAD, CLACTON-ON-SEA, ESSEX

STOP PRESS:  
**MULLARD "TWIN THREE-THREE" STEREO AMPLIFIER.** Punched Aluminium Chassis and Hammered Gold printed Front Panel, 25/9d.

# Premier RADIO

23 TOTTENHAM COURT ROAD, LONDON W.1  
 and at 309 EDGWARE ROAD, LONDON W.2

Tel: MUSEUM 3451/2  
 Tel: PADDINGTON 6963

## THE TELEFUNKEN STEREO HI-FI AMPLIFIER



Original Price 16 gns.

NOW ONLY

**£9.19.6**

P. & P. 5/-.

At last perfection is now within the reach of all. This unique Amplifier has been designed to revolutionary Standards, both in appearance and technical design and backed by the full technical resources of Telefunken.

#### Brief Specifications:

- ★ Power Output 5 watts total (2½ watts per channel).
- ★ Total harmonic distortion less than 1% at 1 watt output.
- ★ Frequency Response: 30 c/s to 40 Kc/s 2dB. 45 c/s to 30 Kc/s 1dB.
- ★ Sensitivity sufficient for all normal inputs from Tape Recorders, Pick-ups, Microphones, Radios.
- ★ Specially designed output transformers have been used having an extremely high transfer efficiency therefore delivering a far greater output to the speakers.
- ★ Power Requirements 110, 125, 150, 220, 240 volts A.C.
- ★ Piano key selecting.
- ★ Presettable tone control.
- ★ Size: 12in. wide x 9in. deep x 2in. high.
- ★ Weighs 9lbs.
- ★ Finish: Hammered enamel in grey/green with gold trimmings. Controls and press buttons in cream with black, blue and red lettering.

## The SUPER 60 6-Transistor Battery Receiver May be Built for

**£9.15.0**

Plus 5/- P. & P.  
 Ever-Ready P.P10  
 Battery Extra 11/-

#### STAR FEATURES:—

- ★ Six 1st grade Mullard Transistors and one Diode.
  - ★ Internal Ferrite Rod Aerial.
  - ★ 7in. x 4in. Elliptical Speaker.
  - ★ Printed Circuit.
  - ★ 500 mW Push-Pull Output.
  - ★ Full medium and long waveband coverage.
  - ★ Calibrated Direct Drive Dial Drive Assembly.
  - ★ Full point-to-point instructions supplied.
  - ★ Dimensions 18in. x 7in. x 5½in.
- The Receiver is housed in an attractive contemporary mahogany finished cabinet trimmed with gilt, supported by gilt stands.  
 The receiver will operate for months on one 9-volt long-life battery.  
 Instruction Book separately at 2/6 p.p.

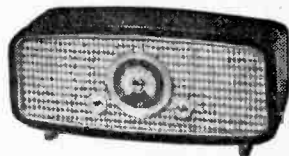

## HI-FI BARGAIN G.E.C. BCS 1851 8" METAL CONE LOUDSPEAKER

Usual Price £9.10.0 ONLY **£5.19.6** P. & P. 3/-

- ★ Flux Density 13,500 Gauss.
- ★ Frequency Response 20—20,000 c/s.
- ★ Speech Coil Impedance 4 ohms.
- ★ Power Rating 12 watts.
- ★ Matching G.E.C. Presence Unit RCS 1852, complete with Condenser and Mounting Components 29/6 (Usual Price £3.19.6) P. & P. 2/-.

# Club News

## REPORTS OF CURRENT ACTIVITIES

### AMATEUR RADIO MOBILE SOCIETY

Hon. Sec.: G3FPK, 79 Murchison Road, London E.10.

At the Longleat Mobile Rally many A.R.M.S. members were present to enjoy the many attractions of this event, held in this local beauty spot. There were five notable rallies during August; the Derby Mobile Rally and Hamfest, held as part of this Society's Golden Jubilee Year celebrations; the Hetton Show and Mobile Rally, which included show jumping in its attractions; the Stamford Rally Fest; the Luton Mobile Rally and the South Manchester and Stockport Amateur Radio Rally, the main event of which, was a navigation and mobile contest.

#### Future Events:

September 10th—National Mobile Rally.

September 17th—Lincoln Hamfest and Mobile Rally.

### BLACKWOOD AMATEUR RADIO SOCIETY

Hon. Sec.: P. M. Fulton, GW3MMU, 36 Sunnybank Road, Blackwood, Monmouthshire, Wales.

For the past three months members have been helping to transform an old cottage into new headquarters for the society. Both inside and outside the cottage have been subjected to alterations and it is hoped that it will be officially opened quite soon. New members are still wanted urgently.

### BURSLAM AMATEUR RADIO CLUB

Hon. Sec.: W. Luscott, 36 Rothsay Avenue, Sneyd Green, Hanley, Stoke-on-Trent.

Meetings are held at Burslem Town Hall on the third Wednesday of each month and start at 7.30 p.m. A Morse class is included at each meeting.

A series of lectures and demonstrations have been planned for the winter months—commencing in September. New members are always welcome.

### DUDLEY AMATEUR RADIO CLUB

Hon. Sec.: D. H. W. Pratt, G3MHS, 23 Kent Street, Upper Gornal, Dudley, Worcestershire.

This newly formed club held its first general meeting on the 18th August. Until a headquarters can be found all meetings will be held at 23 Kent Street, Upper Gornal, Dudley, Worcestershire.

### GUILDFORD AND DISTRICT RADIO SOCIETY

Hon. Sec.: J. R. Barker, 35 Banders Rise, Merrow, Guildford, Surrey.

The July meeting was designed to give younger members experience in setting up a portable station. On the 28th July, Ken Orford gave a talk on "Propagation—Past, Present and Future."

#### Future Event:

October 1st—A Car Treasure Hunt.

### LEEDS AMATEUR RADIO SOCIETY

Hon. Sec.: D. Dinsdale, 69 Spen Lane, Leeds 16, Yorkshire.

This society will soon begin a new programme of activities, starting on September 20th with an informal exhibition of members' equipment.

#### Future Events:

September 27th—Demonstration of 4m equipment.

October 4th—Spares Sale.

### MITCHAM AND DISTRICT RADIO SOCIETY

Hon. Sec.: M. Pharaoh, G3LCH 1 Madeira Road, Mitcham.

G3NFA/P was at Hindhead during the 2-metre field day and made quite a good score. The number of contacts made by G3NFA (assisted by G3LSP and G3LCH) was 195 with several contacts with stations other than English. G3LAR, who was operating from the Norfolk area during the contest, made about 72 contacts.

### NEWBURY AND DISTRICT AMATEUR RADIO SOCIETY

Hon. Sec.: G. T. Allen, G3JTK, 83 Huntsmoor Road, Tadley, Hampshire.

At the August meeting, members brought/items of test equipment etc., to the headquarters and explained their various uses.

#### Future Events:

September 29th—"On understanding radio"; a short talk by G3LLK.

October 1st—The Southern Regional Meeting.

October 27th—Constructional Competition.

### NORTHERN HEIGHTS AMATEUR RADIO SOCIETY

Hon. Sec.: A. Robinson, G3MDW, Candy Cabin, Ogdan, Halifax, Yorkshire.

Recent activities have included a talk by G2SU on his "50 Years of Radio," and a visit to a local television factory. The subject of the meeting on September 6th was Radio Astronomy.

#### Future Event:

September 20th—An informal meeting.

### PETERBOROUGH RADIO SOCIETY

Hon. Sec.: D. Byrne, G3KPO, Jersey House, Eye, Peterborough.

A barbecue has been planned for September 10th at the Society's riverside site at Alwalton. Autumn and winter meetings will be held at the Peterborough Technical College at 7.15 p.m. on the first Friday in each month.

#### Future Events:

October 6th—"Aerials".

November 3rd—The Annual General Meeting.

### READING AMATEUR RADIO CLUB

Hon. Sec.: R. G. Nash, G3EJA, 9 Holybrook Road, Reading, Berkshire.

From August 25th, Friday evenings have been taken up by slow Morse classes given by G5XB or G6WO, starting at 7 o'clock. On August 25th D. Keable discussed the method of aligning superhet receivers.

#### Future Event:

September 30th—G5TP will demonstrate and discuss the G2DAF SSB transmitter.

### SLADE RADIO SOCIETY

Hon. Sec.: C. N. Smart, 110 Woolmore Road, Erdington, Birmingham 23.

On August 25th members visited an electrical control manufacturer's factory for a demonstration of automatic control equipment.

Thursday evening meetings include informal discussions, operation of the club transmitter, and instruction in Morse. Slow Morse transmissions are radiated each Monday evening from G3AYJ on 1.9Mc/s from 8 p.m. to 8.30 p.m.

#### Future Events:

September 8th—Exhibition of members' equipment.

September 16th—Annual dinner.

September 22nd—A lecture called "How far can radio waves be heard?"

### WANSTEAD, WOODFORD AND DISTRICT RADIO CLUB

Hon. Sec.: J. R. Seaman, 67 Beattysville Gardens, Ilford, Essex.

During August the club held its field-day. Members operated on 1.8, 14 and 144Mc/s for most of the time.

Members for the junior section is continuing to grow.

## COURSES OF INSTRUCTION

### BATTERSEA MEN'S INSTITUTE

Latchmere Road, Lavender Hill, Battersea, London S.W.11.

The radio course, in preparation for the City and Guilds Examination in May 1962, has been extended, and now takes place on Monday and Thursday evenings, from 7.30 to 9.30 p.m., at the Spencer Park School, Trinity Road, London S.W.11. The course covers the entire syllabus of the examination and no prior knowledge of radio is required.

There are also two classes—beginners and advanced—in general radio and television at the Battersea Institute.

Classes commence on the 25th September and the schools will be open for enrolment during the week 18th to 22nd September. Fees: one class £1 0s. 0d., two classes £1 2s. 6d.

### ILFORD LITERARY INSTITUTE

High School for Girls, Cranbrook Road, Ilford.

Classes for the eight month RAE course will be held on Wednesdays at 7.15 to 9.15 p.m. Classes of the six month Morse course will be held on Mondays from 7.30 to 9.30 p.m.

Fees for those living in the Essex County Council area are: 30s. for the RAE course and 20s. for the Morse course.

Classes commence September 18th. Those interested should apply to, Mr. C. H. L. Edwards, 28 Morgan Crescent, Theydon Bois, Epping, Essex.

### STREATHAM AND TOOTING L.C.C. INSTITUTE

J. Caley, 6 Farnan Road, Streatham, London S.W.16.

Radio and television classes at Durraven, Penwortham and Hillcroft schools will be held on Mondays, Wednesdays and Fridays at 7.30 p.m.

For the benefit of new students instruction will be given on basic principles assisted by practical demonstration and test equipment.

Classes commence on September 25th.

### WEMBLEY EVENING INSTITUTE

99 Watford Road, Wembley, Middlesex.

Radio Amateur's Examination classes will be held on Mondays at the Wembley Evening Institute, Copland School, High Road, Wembley. Morse practice will be held from 7 to 8 p.m., and radio theory from 8 to 10 p.m. Persons wishing to enrol may do so from 11th September to 14th September, and classes start the following week.

# Letters to the Editor

The Editor does not necessarily agree with the opinions expressed by his correspondents.

Whilst we are always pleased to assist readers with their technical difficulties, we regret that we are unable to supply diagrams or provide instructions for modifying commercial or surplus equipment. We cannot supply alternative details for receivers described in these pages. **WE CANNOT UNDERTAKE TO ANSWER QUERIES OVER THE TELEPHONE.** If a postal reply is required a stamped and addressed envelope must be enclosed with the coupon from page III of the cover.

## YOUNG ENTHUSIASTS

**SIR,**—I made my first radio (a crystal set) when I was 12½. Since then I have made a transistor set and a few one-valve receivers (some of the designs were taken from issues of P.W. dated 1930 to 1940). I also made a morse oscillator.

I would be pleased if anyone could supply information about a station received on Sunday, 23rd July, at 10.15 p.m. The transmissions were repeated alternately in English and Italian and as far as I could make out were as follows: "This is Rome Radio, Maritime Radio Telephone Service. This is a test transmission for receiver . . ." I could not ascertain the wavelength but it was on the lower part of the S.W. band. — **D. HILL** (Edinburgh).

## LIGHT PROGRAMME AMPLIFIER

**SIR,**—I read with interest Mr. Joyce's letter in the August issue, concerning reception of the Light Programme on his amplifier without a tuner. This occurrence is common among audio amplifiers and is caused by rectification taking place in one of the circuits. Most probably the input wires to the amplifier form a tuned circuit which resonates at one of the Light Programme frequencies. Rectification in the amplifier is often caused by a grid bias resistor "going high", making the valve operate nearly at cut off, thereby producing anode bend rectification.

Mr. Joyce could, with advantage, connect a tuning capacitor across the input terminals to his amplifier, thus enabling another station to be tuned in.—**S. H. NANKIVELL** (New Mills, Derbyshire).

## PHONETIC ALPHABET

**SIR,**—I thoroughly agree with Mr. P. A. Ellis's plea (August) for an official phonetic alphabet. The situation is made worse by those gentlemen who use geographical names in their transmissions, so that one is likely to hear something like: "Glasgow, Fife, Cardiff".

The I.C.A.O. alphabet is not ideal, but if everyone used this there would at least be some uniformity.—**F. DORMAN BYERS** (London, S.E.19).

## LIGHT PROGRAMME VOLUME

**SIR,**—I have noticed, while listening to the Light Programme on medium waves, that a marked increase in volume occurred immediately the television receiver was switched on in the next room. The two aerial systems are quite independent and

the mains supply for one is from a power point, while the other is connected to the lighting circuit.

The receiver is a conventional four-valve TRF. I wonder if any reader can explain this occurrence? —**T. F. WALL** (Preston).

## CORRESPONDENTS WANTED

**SIR,**—I would very much like to correspond with anyone interested in Short-wave reception, transmitting and radio construction in general. I will answer all letters received.—**R. CHIPPERFIELD** (4 Bayston Road, Stoke Newington, London N.16).

## TRANSISTOR RESULTS

**SIR,**—I have built a number of transistor receivers over the past year or so and have been very intrigued with the ferrite type of aerials. So far I have not seen a single article, either in your magazine or in any other, which gives characteristics or calculations for such an aerial. In examining some commercial sets I find that there are single rods, flat slabs and, in some cases, two or three rods bound together. I have experimented with these types of aerial and cannot find any basis upon which I could draw up my own data. Using the same winding, placed upon slabs and doubled-up rods, the performance is distinctly different, and I was unable to find the optimum arrangement; single wires, Litz, silk and cotton covered, of all gauges seeming to give quite unrelated results. I do not own any reliable test apparatus, so I could not make quantitative measurements, but I should like to see some definite data, preferably issued by one of the better firms, on this important aspect of the modern portable receiver.—**G. HUTCHEON** (Derby).

## TRANSMITTER LICENCES

**SIR,**—Recent correspondence in your magazine about the possibility of a novice licence, brings to mind my own wish of a couple of years ago, when I was all for such a scheme. Now, however, after passing the RAE and the GPO morse test, I realise that such a licence would do more harm than good, particularly as it is evidently those people who do not have the necessary knowledge to pass the examinations who want low-power transmitter licences.

I do not consider it so difficult to learn what is required for the RAE and to learn the C.W. code.—**C. R. MORLEY** (Reigate).

## CORRECTION

Will readers please note that the advertisement for Messrs. Stern Radio Ltd., in both issues dated August and September, for the "special offer of tape" should have read 1,200ft on 7in. Spool 21/-, 1,800ft on 7in. Spool 32/6, and not vice-versa as printed.

# BUILD A BETTER RECORDER

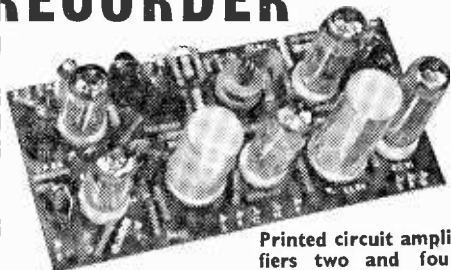

Printed circuit amplifiers two and four track models

Here are professionally designed amplifiers mounted on printed circuit boards complete with transformers and valves for building with Collaro or BSR Decks. Everything included down to the last piece of measured wire. Available as separate amplifier or with cases, speakers and decks. When built you will possess an instrument of high professional standard at truly popular prices.

Descriptive Literature on request.

Kit 'A' (4TR) amp. for Monar-deck. 9 gns.

Kit 'B' (2 TR) amp. for Monar-deck. 8 gns.

Kit 'C' for Collaro Studio Deck. 11 gns.

Cases and speaker assemblies available with or without decks.

**WITH A MARTIN RECORDAKIT**

**MARTIN ELECTRONICS LTD**  
155 HIGH ST., BRENTFORD, M'SEX.

## Become a Television expert this easy way

The Bennett College offers you a complete course

THE Bennett College offers you personal tuition in a course that's non-mathematical and particularly easy to follow. It contains clear diagrams which cover everything you want to know from beginning to end (and even includes the basic principles of sound radio if you wish).

The complete home-study course covers everything: Production of the signal, scanning and reproduction of picture from signals. Aerials, types and purpose. The cathode-ray tube. Time-base oscillators, and output circuits. Synchronisation. Video frequency amplifiers. The TV tuner, turret incremental, etc. Television test gear. Television faults.

For more details, please fill in the coupon below. Your studies cost very little and the book you need is included in the cost.

To THE BENNETT COLLEGE (Dept. 1 104NTV, Sheffield)  
Please send me details of the new  
TELEVISION SERVICING COURSE

NAME \_\_\_\_\_

ADDRESS \_\_\_\_\_

AGE \_\_\_\_\_

IN THE HOME, IN THE CAR,  
BY THE SEA, IN FIELDS AFAR

# THE CONTESSA

IS VOTED BEST OF ALL

A really remarkable

## 2 BAND 6 TRANSISTOR SUPERHET KIT

(As displayed at the Radio Hobbies Exhibition)

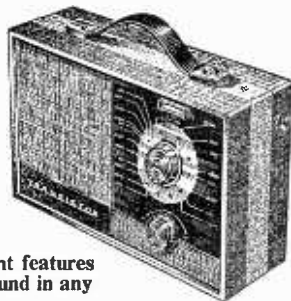

The CONTESSA is the professional looking set with the professional performance.

Study these brilliant features which cannot be found in any other kit . . .

- Waveband Coverage of 530 k/cs to 1620 k/cs and 160 k/cs to 270 k/cs.
- Assured reception of at least a dozen stations in daylight!
- Large clearly-calibrated station-named dial.
- Internal high-gain FerroX Aerial.
- 5:1 ratio slow motion tuning.
- Fitted with the latest 12000 line high-flux loudspeaker.
- Power of 410 milliwatts from the single-ended push pull final stage.
- Specially designed aerial matching coil for use in a CAR.
- Only first grade fully guaranteed Mazda matched transistors and diodes are used.
- Double tuned IF transformers for maximum gain and knife-edged selectivity.
- Fully drilled printed circuit panel marked with component numbers.
- The two colour case measures 10 x 7½ x 3½ in. and weighs approx. 4 lbs.
- Battery lasts 4 months with normal usage.
- Book supplied with detailed assembly instructions, diagrams and circuitry.
- Anyone can build this set—everything supplied just a soldering iron required.

Inclusive price for all associated components, cabinet and battery, complete in every detail. **£10.19.6**  
Plus 3/6 Regd. P.P.  
Or our BUY AS YOU BUILD SCHEME any parts sold separately. Send for comprehensive descriptive manual and parts list, 3/6 post free.

See and hear a working model at:—

**RADIO CLEARANCE LTD.**  
27 Tottenham Court Road, London W.1  
Telephone: Museum 9188

**RECEIVERS & COMPONENTS**

"HEATHKITS" can now be seen in London and purchased on easy terms. Free brochure DIRECT TV REPLACEMENTS LTD., Dept. PW/7/3, 138 Lewisham Way, S.E.14. Tideway 6666.

**COMPONENTS, VALVES**, Tubes, etc. Write or phone for free list. ARION TELEVISION, 4 Maxted Road, Peckham, S.E.15 (New X 7152).

**SPEAKER REPAIRS**. Cones/Fields fitted. Clock Coils Wound. L. S. REPAIRS, Pluckley, Ashford, Kent.

**"WEYRAD" TRANSISTOR RECEIVER**

LONG & MEDIUM WAVE, P.P. O/P. ALL COMPONENTS AVAILABLE TOTAL COST £8.5.6. CONSTRUCTOR'S BOOKLET 2/- CABINET TO SUIT 17/6. TRANSISTOR AM FEEDER UNIT. Size 4 1/2 x 3 x 1 1/2 in. TOTAL COST OF COMPONENTS £4.10.0. CONSTRUCTOR'S BOOKLET, 1/6. Send S.A.E. for Shopping Lists. 35 OHM ALLAN SPEAKERS, 27/1. JACKSON "00" GANG (with Trimmers), 10/6.

**WESTHAM RADIO SUPPLIES**  
 Rear of 176 Abbotbury Road  
**WEYMOUTH, DORSET**

**KITS BUILT**, tested, supplied. S.A.E. details: — J.A.K., 6 Hooker Road, Hearsease, Norwich. NFK NOR 25.

**SPEAKERS BRAND NEW** 2in. 75 ohms 18/6, 3in. 25 ohms 20/6, 5in. 35 ohms 22/-. OC81D, OC81 match pr 30/-. Diodes 1/- mln cap. 2/3 each, RM5 10/6, SM5 11/6. TAPE: Stand: 5 1/2 in. 850ft 16/6, 7in. 1.200ft 20/-. 7in L.P. 1.800ft 25/6. Postage paid by CHAPPELLE RADIO, 107 Neasden Lane, N.W.10.

**DENBY'S ELECTRONICS**

**CAPACITORS**

32µF, 500 v. 1 1/2 in. diam., 4 1/2 in. long, 3/-. 8µF, 500 v. 1 in. diam., 4 1/2 in. long, 1/9.

**WIRE ENDED PAPER CAPACITORS**  
 .1µF, 400 v. Moulded, 3/4 x 1 1/2 in., 4 for 2/-. .02µF, 800 v. Moulded, 3/4 x 1 1/2 in., 4 for 2/-. .025µF, 350 v. Moulded 3/4 x 1 1/2 in., 5 for 2/-. T.C.C. Metalclite .1, .05, .02, .01, .005, .002, .001µF, 350 v., 4 for 2/3. 2.250pF, 2.5kv, Moulded Mica, 1 1/2 x 1 1/2 x 1/8 in., 1/-.  
**RELAYS**. 300 ohm, D.P. c/o, 1/2 x 1 1/2 x 1 1/2 in., 4/-. 5k ohms, 3 watt, W.W. Colvern pots, 1/2 in. shaft, 1/3.  
**TRANSISTORS**  
 Red Spot, 3/3, Yellow/Red Spot, 4/-. OC71, 5/-. OC72, 6/6.

**Precision W.W. Pots**. 3k ohm. ± 1%, 1 1/2 in. diam., 1/2 in. shaft, 4/9. Spare track and wiper (with silver slip ring), 2/6. C.O.D. or cash with order. Orders below 5/- post 9d extra.

"HILLSIDE", COLDSHAW,  
 HAWORTH, KEIGHLEY, Yorks.

**RATES: 6/6 per line or part thereof, average five words to line, minimum 2 lines, Box No. 1/- extra. Advertisements must be prepaid and addressed to Advertisement Manager, "Practical Wireless" Tower House, Southampton St., London, W.C.2.**

**In Scotland . . . . .**  
**RENVUE**  
**for Better Value**

**COMPLETELY REPROCESSED TUBE (NEW GUN, RESCREENED, ALUMINISED)**

- 12.6v and 6.3v, 0.3 amp., 17 and 15in. Types ... .. £6.10.0
- 12.6v and 6.3v, 0.3 amp., 14in. Types ... .. £6. 0.0
- 12v, 15in. Types ... .. £7. 0.0
- 2v, 12 and 15in. Types ... .. £6. 0.0
- Electrostatic 90 degree and 110 degree tubes 10/- extra. Carr. paid.

17in. BBC and STV Receivers ... £19.0.0  
**COMPLETELY OVERHAULED AND FITTED WITH PROCESSED TUBE**  
 STV and BBC 14in. Receivers ... £2.10.0  
**COMPLETE WITH VALVES AND TUBE. CALLERS ONLY. CARRIAGE EXTRA.**  
 OPEN SATURDAY AFTERNOONS

**Renfrew Electronics Ltd.**  
**Anderson Drive**  
**Renfrew : Scotland**  
 Tel.: Renfrew 2642

8in. Dia. (yes—six inch) Millimeters 9/11 ft. round Ernest Turner 78/- (3/6). 2 1/2 in. Dia. Voltmeters 0/90 ft. round Weston 1000 ohms per volt. 47/6 (2/6). Special Valves 4/250A 28.10.0: QY3/125 26.10.0: 4212 £4. Simpson Model 443 Volt-ohmmeters 24 in. meter in case 23.10.0 (5/-). Metal Rectifiers 24 v. 12A 20/- (3/6).

**40 PAGE LIST OF OVER 1,000 ITEMS IN STOCK AVAILABLE—KEEP ONE BY YOU.**

**Wide Band Aerial Amplifiers**. ten separate outlets from one aerial rack mounting 28.10.0. (7/6) Pocket Radioactive Dosimeters, quartz fibre fountain pen type 25/- (1/-), reduction for quantities. 5 Foot P.O. Racks 19in. wide drilled and tapped 65/- (10/-). Elliott 0/4 volt moving coil Voltmeters 2000 ohms per volt, 2 1/2 in. dia: Ideal as basic meter 25/- (2/6). Mains Filter Units. laboratory precision type totally enclosed 24 amps. 10/- (2/6). Sierra 10/000 ohms SPDT Relays 12/6 (1/6). Metal Rectifiers 24 x 12A 20/- (3/6). AVO Geiger Counters 29.10.0 (5/-). Bendix 611, enclosed Transmitter Cabinet, 15in. wide 25 (20/-). P.O. Racks 19in. wide, 3it. high 22 (10/-). Metal Rectifiers 12 v. 1 amp 5/- (1/6). 20 Foot Super Lightweight Aluminium Tripod self supporting 1 1/2 in. dia. Masts, complete 7 lbs. weight £10.10.0 (30/-).

**We have large quantities of "bits and pieces" we cannot list—and invite your enquiries—we can probably help—every one answered.**

Amounts in brackets are carriage England and Wales.  
**P. BARRIS, ORGANFORD, DORSET.**

**RECEIVERS & COMPONENTS**  
 (continued)

**NEW AND Surplus Valves**, fully guaranteed. S.A.E. for List. A.50 Reclaimed Valves, perfect 5/- maximum. Genuine bargains, valves bought.—LEWIS, 46 Woodford Avenue, Ilford, Essex.

**TUBES! NEW 12in. 75/-**. Most rebuilds 75/-, new guns, guaranteed. Seconds 30/-. Finest value—3 Park Avenue, New Barnet. BAR 1934.

**LEADER RADIO**

**THE NEW REPANCO JOURNEYMAN—6**  
 A highly sensitive medium and long wave six transistor superbet circuit with overcollared coils and transformers. 5in. high flux speaker and car aerial socket. Complete kit less battery. .... £10.10.0

**REPANCO MIN-7**  
 The amazing New Transistor set for the home constructor. Seven Transistors, superbet circuit, fully tunable over long and medium waves. Equal to any manufactured set. Kit complete with instruction data (excluding battery) .... £10.0.0

**REPANCO MIN-4**  
 The popular pocket four transistor superbet. Size 5 1/2 x 3 1/2 x 1 1/2 in. with prealigned coils and transformers. 2 1/2 in. high flux speaker, ferrite slab aerial. Easy to build. Kit complete with instruction data, less battery. .... £8.19.6  
**REPANCO OSMOB, TELETRON, T.S.L.** coils, transformers, etc., for transistor radios, S.A.E. for lists.

**TELETRON** transistorised tapejack, medium and long wave 59.9.0. Carr. 3/-.  
**COLLARO STUDIO TAPE DECK**. 3 motors, 3 speed, only £11.10.0. S.A.E. with enquiries, 73 VISTA WAY, KENTON, HARROW, MIDDIX. Phone: WOR 4512.

**A.1. BARGAINS**. Miniature silicone rectifiers 125V, 300mA 10/-, 250V, 300mA 20/6. Sub-miniature electrolytics 15V 1 to 1,000mf 2/9 each. 25k or 50k wire-wound pots. S.P. switch 5/3. Speakers 5in., 6 1/2 in., 7in. x 4in. 10/6; 10in. Light 19/-. Heavy with exponential cone 28/- 10 1/2 in. x 6 1/2 in. 35/- all 3 ohm. New and post free. C.W.O.—A.I. RADIO COMPONENTS, 14 The Borough, Canterbury, Kent.

**RESISTORS—100 new**, wire ended, assorted, all types, 7/6 box, post free. COOK'S OF BEDFORD, 29 St. Mary's Street, Bedford.

**KINGSLAND**  
**ELECTRONIC COMPONENTS**

**Stupendous Offers**

**1558 ELECTRONIC COMPONENTS FINED**

Potentiometers in banks of four fixed on grey stove enamelled plate 1 1/2 x 6 1/2 inches easily detachable. 4/6, p. & p. 1/8.

1 1/2 in. cartridge fuse holders screw cap type mounted on grey stove enamelled plate approx. 1 1/2 in. wide perspex cover in banks of three, four and five, 3/6, 4/6, 5/6, p. & p. 1/8.

Try our surprise pack of accessories, if not satisfied return within seven days and money will be refunded. 7/6, p. & p. 2/6.

6 assorted voltage droppers, 5/-, p. & p. 1/8. 100 assorted condensers, 8/-, p. & p. 1/8. Instrument Rectifier with circuits, 5/6. 6 volt or 12 volt vibrators, 3/6 each, p. & p. 1/8. Mike and pick-up transformers ideal for baby alarms, 4/6, p. & p. 1/-.

6 assorted potentiometers, 5/-, p. & p. 1/8. 50 assorted resistances and condensers, 6 miniature valve holders, 2 tag strips, 40 separate contacts each 3/8, p. & p. 1/8.

**182 KINGSLAND RD., SHOREDITCH.**  
 E.2. Tel: SHO 6572. Sorry! U.R. only.

**RECEIVERS & COMPONENTS**

(continued)

**TUBES - AERIALS - VALVES**

Regunned tubes, guaranteed one year, full range of aerials and fittings, 1 T.V. boosters, valves, braihead tuners, TV sets, transistor radios and all electrical appliances. Co-axial cables and house wiring cables, fluorescent fittings. All quotations without obligation. Special terms to the trade, and Home Engineers. S.A.E. for Catalogue.

**G. A. STRANGE**

**BROADFIELD, NORTH WRAXHALL, NR. Chippenham, Wilts, Tel. Marshfield 236**

**STOCK SALE.** Lists 2d. Mail only.—98 Greenway Avenue, E.17.

**TRANSISTOR BARGAINS**

Red Spot, 3/- White, 3/9; Yellow (6 volt), 2/3; Green, 3/-; Red/Yellow, 3/-; STC/TSL (OC71), 4/3; TS17 (OC72), 6/- each Diodes 1/- P. & P. 6d.

**EDISVAN**

XA101, 102, 103, XB102, 103, 104, 8/- each. XC101, 10/- P. & P. 6d.

**NEWMARKET**

NKT152A (OC44), 9/-; 153A (OC45), 8/6. 252A (OC71), 5/6; 253A (OC74), 6/9; P. & P. 6d. each, or complete set of six transistors with diode for 43/-, P. & P. 9d.

**MULLARD**

OC16, 15/-; OC170 (up to 100 Mc/s.), 13/6. OC31D 6/-; OC81 7/- P. & P. 6d. Condensers. Sub-Miniature, 1, 2, 4, 8, 10, 16, 30 and 50 mids. at 2/3 each, 100 mid 2/9. P. & P. 3d.

**TRANSISTOR TRANSFORMERS**

1: 1 C.T. Sec. Driver, 10/-; 6.6: 1 C.T. Prim Output, 9/-; 3.6: 1 plus 1 Split Sec. Driver, 11/6; 9.2: 1 Output, 8/- P. & P. 6d.

Headphones for Crystal Sets, 12/6 (light weight). P. & P. 1/-.

Sub-Miniature.—Jack Plugs and Sockets 3/6 pair. Slider Wave Change Switch, 2/6. Transistor Holders, 1/- P. & P. 3d.

24in. speakers 15, 35, and 60 ohm. at 19/6. Elliptical 7 x 4, 35 ohm, 25/- Engraved 24in. round dials, Med. long 4/- Telescopic Chrome Aerials 7/6. P. & P. 6d.

**SOUND VISION**

**137 MOULSHAM STREET CHELMSFORD - ESSEX**

**SOUND RECORDINGS**

**TELEFUNKEN TAPE** Recording Heads. Record and Erase 60 to 20kc/s 30" the pair Twin Track. Rectifiers 12/24 volt 5 amp 15/- Elapsed Hour Meters. Sangamo movement. New! Suitable clock conversion, etc. 19/6 each. All post paid. — A. FANTHORPE LTD., 6-8 Hepworth's Arcade, Hull, Yorks.

**RECORDING TAPE**, save up to 30% send for list; also 50 second-hand recorders in stock.—E. C. KINGSLEY AND CO., 132 Tottenham Court Road, London, W.1. EUS 6500.

**PRIVATE GRAMOPHONE** Records made from your own recorded tape. Weddings, Choirs, Greetings records, etc. LP's from 17/6. S.A.E. SOUND SERVICES (Dept. 2), 28 Viewforth Terrace, Sunderland. Tel.: 57032.

**TAPE/DISC TRANSFER.** Fine US tapes now, 1.800£ 29/-. Unmixer units for quality work. SOUND NEWS, 10 Clifford Street, W.1. REGent 2745.

**LINE OUTPUT TRANSFORMERS SCAN COILS SPECIALISTS**

Makes	Models	Prices
ACE:	Spares available.	
ALBA:	T301, T304, T394, T484, T494, etc.	89/6
AMBASSADOR:	Spares supplied.	
AROSY:	Most models available.	
ARMSTRONG:	Spares supplied.	
BAIRD, BANNER, BEETHOVEN:	Spares supplied.	
BUSH:	TV11A, 11B, 12A, 12B, TVG12A, 12B, TRG12A, 12B, TVG29, TV32, TV33, TVG34, TVG34A, TV35, TVG36, TVG39, TV93, VTG36C, TV45, TV43, TV56, T67, TV67, TVG58, TV62, TV63, TV66, only TV67, etc.	45/- 89/6 69/6
COSSOR:	930 & T, 931, 933-4-5, 937, 938A & F, 939 & A & F, 943T, 940-946, 945, 945B, 949	69/6 69/6
CHAMPION, COLUMBIA:	Spares supplied.	
DECCA:	D17 & C, 1M11, 2M2C, D23, DM44C, DM5, DM1, DM17, 444, 655, TR1453, TR1753	89/6 65/- 85/- 69/6
DEFIANT:	Spares supplied.	
DYNATRON:	Spares supplied.	
EKCO:	TR93, TC8102, TS105, TS114, TRC134, TC138, TR188, TR189, TRC139, TC140, T141, TV142, T161, TC162, T164, T166, etc. TC298, TV209, T231, T221, T231F, T248, T283, T284, T293, etc.	55/- 47/6 47/6 45/- 45/- 45/- 45/- 45/-
ENGLISH ELECTRIC/ELECTRONIC:	Spares supplied.	
FERGUSON:	103T, 105T, 113T, 135T, 145T, 941T-953T inclusive, 951T-997T inclusive, 203T-246T inclusive, 306T, 308T	66/6 69/6 69/6 65/- 45/- 45/- 45/- 45/-
FERRANTI:	14T3, 14T3F, 14T4, 17K3 & F, 17T3 & F, 17K4 & F, 178K4 & F, 17T4 & F, 14T5, 178K5, 17K6	45/- 49/6 49/6 49/6 49/6 and 89/6
G.E.C.:	BT1261, BT1262, BT1746, BT1745, BT4743, BT4843, BT5147, BT5246-48, BT5348-BT5643R inclusive	49/6 49/6 49/6 and 89/6
H.M.V.:	1824 & A to 1831 inclusive, 1840, 1841, 1842-1848	87/6 87/6 66/-
INVICTA:	7118, T119, T120, etc.	
K.B.:	All other models available, LFT50, LVT50, LFT60, MV60	107/6
MARCONI:	All models available, etc.	
MASTERADIO:	All models available.	
McMICHAEL:	All models available.	
MURPHY:	V390, V292C, V290, V295B	57/6 85/-
P.A.M. PETO SCOTT, PHILCO:	All models available	
PHILIPS:	1768U, 2168U, etc.	105/-
PILOT:	All models available.	
PORTADYNE:	All models available.	
PYE:	CTM4, FV4C, FV4C0L, V4, VT4, V7, VT7, LV30, FV1, FV10, CB17, CTM17F, CW17, CW17C, CW17CF, CW17P, etc.	55/- 55/- 69/6 69/6 69/6
RAYMOND:	All models available.	
REGENTONE:	All models available.	
R.G.D.:	801T, 701F, 634, etc.	59/6
SOBELL:	TS17, T346	65/-
STELLA:	ST3791U, ST8617U, ST8621U, ST8917U	108/- 105/- 105/-
STRAD, TELEVOICE, TRUVIEW:	Available.	
ULTRA:	86 series, 815 series, with U25 etc., complete	79/6
VALRADIO:	Spares available.	
VIDOR:	CN4217-CN4281 inclusive	65/-
WESTMINSTER:	Spares available.	
WHITE-IBOTSON:	Spares available.	

Beacoulis, Oso. and Outout Tel. for all above makes available. C.O.D. 3/- extra.

Post and Packing 2/6. All Enquiries S.A.E.

**WYNDSOR TELEVISION**

Dept. P.W. St. ALBAN ROAD, BARNET, HERTS

WAB 1769

**FOR SALE**

**100 BAYS** of Brand New Adjustable Steel Shelving 72in. high x 34in. wide x 12in. deep; stove enamelled dark green, sent unassembled. Six shelf bay £3 15s. Sample delivered free. Quantity discounts. N. C. BROWN LTD., Eagle Steelworks, Heywood, Lancs. Tel: 69018.

**VHF UNIT.** Ready built Front End F.M. unit. Coverage 85-100Mc/s. I.F. 10.7Mc/s. Single valve (ECC85). Price, including circuit and data but without valve £2-12.3, plus 2/- postage. **VHF TUNER UNIT.** Ready built without dial and valves. Price, including circuit and data, £6-16-0, plus 3/6 postage. Delivery ex stock. (DEPARTMENT E/2)

**ROTOPONS LIMITED**  
54 BEDDINGTON LANE, CROYDON, SURREY.

**ASK your dealer for American Ferro-dynamics.** "Brand Five" Recording Tapes—the best tape value!

GARRARD R.C. 210 ... .. £9. 8. 6

B.S.R. UA14 ... .. £7.15.0

Makers' Sealed Cartons.

B.S.R. TU9 ... .. £4. 2. 6

B.S.R. TAPE DECK ... .. £7.10.0

Transistors (Famous Make)

Seven Transistors ... .. 32/6

Diode. Driver. Matched Pair.

Mixer. 1st I.F. 2nd I.F.

Standard Goods

**AUTUMN LIST NOW READY**

**H. F. JAMES**

21 Claremont Road, Twickenham, Middlesex.

Tel. POPegrove 3579.

**EDUCATIONAL**

**Radio Television & Electronics**

Learn at home with the world's largest home study organisation, Brit.I.R.E.; City & Guilds; R.T.E.B., etc. Also Practical Courses with equipment. No books to buy.

Write for FREE prospectus stating subject to

**I.C.S.**  
(Dept. 541), Intertext House, Parkgate Road, London, S.W.11

"HOW AND WHY" of Radio and Electronics made easy by a new, non-maths practical way. Postal instruction based on hosts of experiments and equipment building carried out at home. New courses bring enjoyment as well as knowledge of this fascinating subject. FREE brochure from: Dept. F.W., 12 RADIOSTRUCTOR, Reading.

(Continued on next page)

**EDUCATIONAL**

(continued)

**FREE FROM THE I.P.R.E.** Syllabus of famous radio and TV courses. Membership Conditions booklet 1/-. Sample copy The Prac. Radio Engineer, 2/- post free. Secretary, 20 Fairfield Road, London N.8.

★ **LEARN** ★  
**RADIO & TV**  
**SERVICING**  
for your **OWN**  
**BUSINESS/HOBBY**

● by a new exciting no maths system, using practical equipment recently introduced to this country.

FREE Brochure from:—

**RADIOSTRUCTOR**

DEPT. G77, READING, BERKS. 10/61.

**WIRELESS.** See the world as a Radio Officer in the Merchant Navy; short training period; low fees; scholarships, etc. available. Boarding and Day students. Stamp for prospectus. **WIRELESS COLLEGE,** Colwyn Bay.

**LEARN RADIO AND ELECTRONICS** the new practical way! Hosts of absorbing experiments carried out at home under expert guidance to teach you Radio in a new, enjoyable and interesting way. Construction, servicing and fault-finding on equipment made easy for the first time! No previous experience needed. No mathematics used. Free brochure from: Dept. 11, F.W., **RADIO-STRUCTOR,** Reading.

$$X = \frac{-b \pm \sqrt{b^2 - 4ac}}{2a}$$

**DON'T FUMBLE** with Formulae. Master Mathematics quickly and easily the Understandable Way. First lesson and details free from:



**UNDERSTANDABLE MATHEMATICS**

11F Dryden Chambers, Oxford St. London, W.1.

Name \_\_\_\_\_  
Address \_\_\_\_\_  
\_\_\_\_\_

**BOOKS & PUBLICATIONS**

**FIND TV SET TROUBLES IN MINUTES** from the great book "The Principles of TV Receiver Servicing." 10/6 all book houses and radio wholesalers. If not in stock, from Secretary, I.P.R.E., 20 Fairfield Road, London, N.8.

**MISCELLANEOUS**

**DIAMOND** **STYLI**

**DASCO**

**FOR DIAMONDS**

Manufacturer's offer to users—send us your old stylus arm and we will retip with finest Transcription quality Diamond. To ensure best production every Diamond is inspected for finish and radius with 500 magnification.

**FOR £1.0.0 ONLY**

Or we will supply complete with any stylus arm for £1 5s. 0d. Tax Paid and will despatch within 48 hours of receipt, post free.

**All Diamonds are Guaranteed for One Year**  
(Sapphires also supplied 4/6 Tax Paid)

Mail Orders to:—Daseco, Frith Park, Tadworth, Surrey.

**MISCELLANEOUS**

(continued)

**ELECTRONIC MUSIC ?**

Then how about making yourself an electric organ? Constructional data available—full circuits, drawings and notes. It has 5 octaves, 2 manuals and pedals with 24 stops—uses 41 valves. With its variable attack you can play Classics and Swing.

Write **NOW** for free leaflet and further details to C. & S., 20 Maude Street, Darlington, Durham.

**SITUATIONS VACANT**

**TV AND RADIO, A.M.Brit.I.R.E., City and Guilds, R.T.E.B. Cert., etc., on "No pass—no fee" terms. Over 95% successes. For details of exams and courses (including practical apparatus) in all branches of Radio, TV and Electronics, write for 148-page handbook, free, B.I.E.T. (Dept. 242G), 29 Wright's Lane, London, W.3.**

**HANDICRAFTS**

**JEWELLERY** Simply made, Brooches, Rings, Marcasites. List Free. **WEBBS,** 46 Burnway, Hornchurch, Essex.

**SITUATIONS VACANT**

(continued)

**A.M.I.Mech. E., A.M.Brit.I.R.E., City and Guilds, G.C.E., etc., brings high pay and security. "No pass—no pay" terms. Over 95% successes. For details of exams and courses in all branches of Engineering, Building, Electronics, etc., write for 148-page handbook, free, B.I.E.T. (Dept. 242B), London, W.8.**

**CITY AND GUILDS (Electrical, etc.) on "No pass—no fee" terms. Over 95% successes. For details of Electrical Engineering, Applied Electronics, Automation, etc., send for our 148-page handbook, free and post free, B.I.E.T. (Dept. 242A), 29 Wright's Lane, London, W.8.**



**TRAINING TO BE COMPUTER ENGINEERS**

We have the following vacancies:

1. Staff to maintain the electronic equipment of our computers. We require both Junior and fully qualified engineers. Applicants for junior posts should have G.C.E. "A" level in Physics and Mathematics and an active interest in electronics.
2. Staff to maintain the electro-mechanical equipments linked to large scale computers installations. The equipments range from simple punch card and paper tape devices to the more complex magnetic tape transports. Applicants should have a good basic engineering knowledge with some experience of electro-mechanical equipments. Some electronic knowledge would be advantageous.

For all posts full training will be given and there are excellent prospects for advancement.

Details of experience, qualifications, age and present salary should be sent to:

**Personnel Manager, LEO Computers Ltd., Hartree House, Queensway, London W.2.**





# Fly as an Air Electronics Officer in the R.A.F.

The domain of the Air Electronics Officer is the whole range of electrical and electronics equipments in an operational aircraft. This covers high frequency long range communication equipment (both voice and wireless telegraphy), VHF communications (short range radio telephone), ASV (air to surface vessel) radar, and the 'black boxes' for the electronic defence of the aircraft.

Having completed your highly-specialised training courses—during which you do about 123 hours flying, including two flights abroad—you fly in the V-bombers of Bomber Command or on Coastal Command reconnaissance.

You are a key man doing a key job—where success depends entirely on your own skill, training and flexibility. There is nothing run-of-the-mill about it. You have a career you can be proud of—and there lies satisfaction.

You are well paid from the very beginning—you earn £950 as a Flying Officer of 21. At 25 as a Flight Lieutenant, drawing full allowances, you could earn over £1,750. You travel the world, meeting old friends on almost every airfield, making new friends wherever you go. You live well in the Officers Mess, and have the opportunity of taking part in almost any sport you can name.

If you are under 26, fit, and hold or expect to gain, G.C.E. at 'O' level (or equivalent) in 5 acceptable subjects including mathematics and English language, you are eligible for a Direct Entry commission. Write for further details, giving date of birth and educational qualifications to Group Captain J. A. Crockett, R.A.F., Air Ministry (PW 841) Adastral House, London, W.C.1.

THE FUTURE IS WITH THE R.A.F.

The Royal Air Force

## SERVICE SHEETS

**SERVICE SHEETS**, Radio, TV, 5,000 models. List 1/-. S.A.E. enquiries: TELRAY, 11 Maudland Bk., Preston.

**FAULTFINDER FILES**, showing common faults that each receiver is prone to and other useful servicing information. 2/- ea. List 9d., plus postage. S.P. DISTRIBUTORS, 44 Old Bond Street, London, W.1.

**SERVICE SHEETS**. We have the largest stock of Radio and TV Service Sheets in the country for sale at 4/- each. Why tolerate delay in obtaining your supplies when we will dispatch by return? Service Sheet List 1/-. Also Manufacturer's Manuals for sale and hire. 1961 List now available, 1/-. S.A.E. please. Mail orders only to S.P. DISTRIBUTORS, 44 Old Bond Street, London, W.1.

**SERVICE SHEETS**. Radio and TV 4/- each. List 1/-. All orders despatched on day received. Also manuals for sale and hire. S.A.E. please. SULTAN RADIO, 29 Church Road, Tunbridge Wells, Kent.

## 38 SET WALKIE TALKIE CIRCUIT INFORMATION

Alignment Procedure. Typical faults in Ex W.D. Sets. Components location diagram. Circuit diagram. Complete Circuit description. Instructions for use, etc. P.O. 5/-. Address in block capitals please.

### CAMPBELL

Laundry Lane, Hungerford, Berks.

**SERVICE SHEETS**; also Current and Obsolete Valves for sale. JOHN GILBERT RADIO, 20 Extension, Shepherd's Bush Market, London W.12 (Phone: SHE 3052).

**SERVICE SHEETS** (1930-1961) from 1/- with free Fault Finding Guide. Catalogue 6,000 models. 1/-, 125 Radio/TV Sheets covering 370 popular models 20/-. S.A.E. enquiries, HAMILTON RADIO, Western Road, St. Leonards, Sussex.

## WANTED

**A PROMPT CASH OFFER** for your surplus Brand New Valves, Speakers, Components Test Instruments, etc. R.H.S., Beverley House, Manville Terrace, Bradford 7.

**NEW VALVES** bought, state price. A. D. A. MANUFACTURING CO., 172 Alfreton Road, Nottingham.

## NEW VALVES WANTED

Any type, any quantity

### CASH PAID

R.S.T. 211 Streatham Road,

Mitcham, Surrey.

Telephone: MITCHAM 6201

**WANTED: Service Sheets**. No quantity too large. Highest prices paid. SULTAN RADIO, 29 Church Road, Tunbridge Wells, Kent.

# THE LINEAR L1/10

A 10-WATT HIGH FIDELITY ULTRA LINEAR AMPLIFIER WITH INTEGRAL PRE-AMP

Full advantage has been taken of latest component miniaturisation developments to produce a 10-watt Hi-Fi push-pull amplifier incorporating tone control preamplifier stages within the measurements of 9 x 7 x 5ins. In addition two high impedance input sockets are provided for microphone and gram., etc. With selector switch and vol. control, five B.V.A. valves are employed ECC83, ECC83, EL84, EL84, EZ81, H.T. and L.T. power supply point is included for a radio tuner.

**FREQUENCY RESPONSE**  
± 1 d.b., 30-20,000 c.p.s.

**MAXIMUM POWER OUTPUT**  
in excess of 14 watts.

**SENSITIVITY**

L.P. 220 m.v. for 10 watts. 78 r.p.m. 220 m.v. for 10 watts. Radio/Microphone 40 m.v. for 10 watts.

**TREBLE LIFT CONTROL**

+ 10 d.b. to -22 d.b. at 12,000 c.p.s.

**BASS CONTROL**

+ 14 d.b. to -10 d.b. at 50 c.p.s.

**HUM LEVEL**

Referred to maximum output and including integral pre-amp.—70 d.b.

**NEGATIVE FEEDBACK**

21 d.b. in main loop.



**HARMONIC DISTORTION** Less than 0.1% measured at 8 watts at 1000 c.p.s. Weight 10 lbs. Power consumption 90 watts. For 200-230-250 v. 50 c.p.s. A.C. mains. Outputs for 3-and 15-ohm speakers. Chassis finish stoved Gold hammer.

**HIGHEST QUALITY** Retail Price  
**MAXIMUM RELIABILITY**  
**AT A PRICE YOU CAN AFFORD** **13 GNS.**

Send S.A.E. for descriptive literature

**TRADE ENQUIRIES to**

Also Available—THE L.45.A compact High Quality 4-5 watt amplifier. Size approx. 7-5-3½in. high. Sensitivity is 28 millivolts so that the input socket can be used for either microphone or gram., tape, radio tuner etc. B.V.A. valves used are ECC83 EL84, EZ80. Controls are: Vol. Treble and Bass with mains switch. The Tone controls provide full compensation for long playing records. Output matching for 3 ohm loudspeaker. Retail price £5.19.6.

**THE LT45 TAPE DECK AMPLIFIER.** A complete unit (power pack and oscillator incorporated) ready for connection to A.C. mains. 3 ohm loudspeaker and practically any make of deck. Negative feedback equalisation adjustment by multi-position switch for 1½, 3½ and 7½in. per second. Retail price 12 gns.

**DIATONIC 10-14 WATT.** High Fidelity amplifier with integral pre-amplifier. Retail 12 gns.

**CONCHORD 30 WATT.** Hi-Fi amplifier with two separately controlled inputs. Retail 16 gns.

**L50 50 WATT AMPLIFIER.** Size approximately 14 x 10 x 8in. Sensitivity 25 mV. Output for 3 and 15 Ω speakers. Retail price 22 gns.

**L5/5 STEREO AMPLIFIER** 5 + 5 watt 12 gns.

**LINEAR PRODUCTS LTD.**

**ELECTRON WORKS, ARMLEY LEEDS**

## VALVES SAME DAY SERVICE NEW! TESTED! GUARANTEED!

<b>SETS</b>	IR5, IS5, IT4, 3S4, 3V4, DAF91, DF91, DK91, DL92, DL94 ..	Set 4 for 18/6
	DAF96, DF96, DK96, DL96	4 for 27/6
	6K7G, 6K8G, 6Q7G, 6V6G, 6X5G, or 5Y3G .. .. .	5 for 24/6

1A7GT 11/6	6P1 13/6	35A5 14/-	UC22 6/3	EZ81 7/-	U94 17/6
1D5 8/-	6P25 9/-	35L8GT 9/-	ECC83 7/-	PW4/500 8/-	U95 15/-
1HG5T 10/-	6Q7G 6/-	35Z4GT 6/9	ECC84 8/9	GZ30 8/6	U96 10/-
1NSGT 10/-	6Q7GT 9/6	35Z6GT 8/6	ECC85 8/3	GZ32 9/6	U97 6/-
1R5 6/-	68L7GT 6/3	50L8GT 8/9	ECP80 8/6	KT33C 7/6	U98 4/9
1S4 8/-	6SN7GT 4/9	AC/TH1 18/9	ECP82 8/6	KT41 11/6	U99 4/9
1S5 5/3	6U4GT 11/-	AZ31 9/6	ECH21 13/6	KT44 5/9	UABC80 9/6
1T4 3/6	6V6G 5/-	B96 8/6	ECH35 6/3	KT61 10/-	UAF42 5/-
1U5 5/9	6V6GT 6/6	CL33 12/3	ECH42 8/9	KT63 6/6	UB41 8/6
3A5 9/-	6X4 4/9	DAC32 10/-	ECH81 8/-	MU14 8/6	UBC41 7/9
3Q4 7/-	6X5GT 5/-	DAF91 5/3	ECL30 7/6	MX40 9/6	UBP80 8/9
3S4 6/-	7B6 8/-	DAF96 7/6	ECL82 9/6	N18 7/-	UBP89 8/9
3V4 7/-	7B7 7/6	DCC90 9/-	EPF39 4/6	PC95 10/-	UC92 12/6
5U4G 4/6	7C5 7/6	DF33 10/-	EP40 12/6	PC84 7/6	UCC84 12/9
5V4G 8/-	7C8 7/6	DF91 3/6	EP41 8/3	PCC89 11/-	UC86 7/6
5Y3GT 7/9	7E7 7/6	DF92 7/6	EP42 9/6	PCL84 7/6	UCF80 14/-
6AL5 3/9	7Y4 7/-	DH76 4/9	EP80 5/6	PCF82 8/-	UCH21 13/6
6AM6 3/6	10C2 17/6	DH77 6/9	EP85 5/6	PCF86 14/-	UCH42 8/-
6AQ5 6/6	10P13 14/6	DK32 11/6	EP86 9/9	PCL82 9/-	UCH81 8/-
6AT6 6/9	12A7B 7/6	DK91 6/-	EP89 7/9	PCL83 11/6	UCL82 10/9
6BA6 6/-	12A7 7/-	DK92 7/6	EP91 3/6	PCL84 7/6	UCL83 13/3
6BE6 5/9	12A7T 5/3	DK96 7/6	EP92 4/3	PCL85 13/6	UP41 8/9
6BH6 5/9	12AUT 6/9	DL33 9/-	EP183 14/-	PEN44 11/-	UP42 5/6
6BU6 5/9	12AX7 7/-	DL35 9/6	EL33 10/-	PEN36C 8/-	UP85 8/6
6BW6 8/-	12K7GT 5/3	DL92 6/-	EL41 8/6	PE38 11/6	UP89 7/-
6CD8G 28/9	12K8GT 11/6	DL94 7/-	EL42 9/-	PL81 8/6	UL41 8/-
6F1 11/6	12Z3 7/6	DL96 7/6	EL84 7/-	PL82 8/6	UL84 7/6
6F6G 6/6	12Z3 7/6	EABC80 7/6	ELM34 6/9	PL83 7/6	URIC 8/-
6F13 11/6	14S7 18/6	EAF42 8/6	EM80 8/6	PL84 10/-	UU6 13/6
6F14 16/6	20F2 17/6	EB91 3/9	EM81 8/6	PY32 11/-	UY21 13/6
6K7G 2/6	20L1 17/6	EB93 5/6	EM84 10/-	PY30 7/6	UY41 6/6
6K7GT 5/-	25A6G 8/-	ERC41 8/-	EY51 7/6	PY81 6/9	UY85 6/6
6K8G 6/3	25L6GT 7/9	EPF80 8/-	EY84 10/-	PY82 6/6	VP4B 9/6
6K8GT 9/3	25Z4G 7/6	EPF89 8/9	EY86 7/9	PY83 7/9	VP41 5/6
6L8 18/6	25Z6GT 9/6	E8L21 18/9	EZ40 9/6	PZ30 17/-	W76 5/3
6LD20 10/3	30L15 11/-	ECC40 15/-	EZ41 7/-	T41 9/6	W77 4/6
	30P12 7/-	ECC81 5/-	EZ80 6/3	U22 7/3	Z77 3/6

**READERS RADIO**  
24, COLBERG PLACE STAMFORD HILL,  
LONDON N.16 STA 4587

## HANDBOOK FOR RADIO OPERATORS

G.P.O. Working Installations. 6/-. Postage 10d.

**THE RADIO AMATEUR'S HANDBOOK, 1961 ed.** by A.R.R.L., 32/6. Postage 2/-.

**PRACTICAL WIRELESS SERVICE MANUAL,** by F. J. Camm., 21/-. Postage 9d.

**AN ELECTRONIC ORGAN FOR THE HOME CONSTRUCTOR,** by A. Douglas, 15/-. Postage 9d.

**A BEGINNER'S GUIDE TO RADIO,** by F. J. Camm., 7/6. Postage 6d.

**A TO Z IN AUDIO,** by G. A. Briggs., 15/6. Postage 1/-.

**INTERNATIONAL TRANSISTOR SUBSTITUTION GUIDE BOOK** by K. A. Pullen., 12/-. Postage 6d.

**RADIO VALVE DATA** Compiled "WWW", 7th ed., 6/-. Postage 10d.

**COMPLETE CATALOGUE, 1/-.**

**THE MODERN BOOK CO.**  
BRITAIN'S LARGEST STOCKISTS  
of British and American Technical Books

**19-21 PRAED STREET LONDON, W.2**  
Phone: PAddington 4185  
Open 6 days 9-6 p.m.

Post 6d. per valve extra.  
Any Parcel insured Against Damage in Transit 6d. extra.  
Any C.O.D. Parcel 3/- extra.

## Well paid to see the world

A really interesting and worthwhile job as a **Radio Officer in the Merchant Navy** awaits you if you are the holder of a current P.M.G. certificate. Salary and allowances are good from the start, rising by regular increments to well over the four figure mark with all found. Your job can take you all over the world, and you get generous annual leave besides off-duty time in foreign ports. Sea service offers ample opportunity to study for further technical qualifications and many well-paid shore appointments are open to you later on.

## A tradition second to none

Marconi Marine Radio Officers have a long and proud tradition of service extending back to the early years of this century. Among them are to be found names hallowed in the history of the sea. Moreover, many men in the highest public and administrative positions today began their careers as Radio Officers in the Marconi Marine Company.

Write for particulars to: **F. E. ASH, Esq.**

## THE MARCONI INTERNATIONAL MARINE COMMUNICATION CO. LTD.,

English Electric House, Strand, London, W.C.2

## FREE TO CONSTRUCTORS OF

## "PRACTICAL WIRELESS" TRANSISTORISED-PRINTED BOARD POCKET SHEET

Simple Modifications to Boost and Improve this set

## A-Z CONSTRUCTIONAL BOOKLET 1/6 EACH

including "BLOWN-UP" DRGM and full particulars of Boost Modifications

## Price List from your usual Dealer or Direct from OSMOR RADIO PRODUCTS LTD.

418 BRIGHTON ROAD, S. CROYDON GRO 5148

## "6 plus 1" TRANSISTOR RADIO KIT — UNBEATABLE VALUE —

Mrs. Current Production Offer—A fortunate bulk purchase enables us to offer one of the season's most outstanding bargains in Portable Transistor Radio Kits. This kit is a modern, sensitive quality circuit Receiver Unit with all the latest features. Six B.V.A. Transistors and 1 Diode, Printed Circuit, Med. and Long Waves, Ferrite Aerial, Car Radio Input, 4w Push-Pull output into 3 ohm Speaker, Calibrated Dial and Slow Motion Tuning, etc. Size: approx. 8 1/2 x 2 1/2 in.



**COMPONENT KIT 5 Gns.** (p. & d. 2/6)  
**SET OF 6 TRANSISTORS and 1 DIODE 45/-**  
 Complete Kit (less speaker) Bargain Price **£6.19.6** carr. 2/6  
 3d. stamp, full details. Circuit and instra. **1/6**

NEW VALVES GUARANTEED		ALL TRANSISTOR BARGAINS!	
		BRAND	NEW—BVA 1st Grade
1F4	8/-	EF86	12/8
1L5, 185	7/6	EL84	5/6
354, 3V4	7/6	EY51	9/6
DAF08	8/-	EY88	10/-
DP96	9/-	EZ80/81	7/6
DL96	9/-	POC84	9/6
DL98	9/-	PCF90	9/6
ECL80	10/6	PCL83	12/6
ECL82	10/6	PL81	12/6
EP90	8/-	U25	12/6
		OC44	10/8 874 9/8
		OC45	9/8 873 8/6
		OC81D	7/8 GET114 6/6
		2/OC81	15/8 OC72 7/6
		XA109	10/- OC70 5/6
		XA101	9/8 OC71 5/6
		XB109	7/8 GEX54 2/8
		XC101	8/8 OA79 2/8
		SB305	9/8 OA81 2/8

**SPEAKER FRET** Expanded Bronze anodised metal 8 x 8 in. 2/3; 12 x 8 in. 3/-; 12x12 in. 4/8; 12x18 in. 8/-, etc.  
**TYGAN FRET** (Contemp. pattern) 12 x 12 in. 2/-; 12 x 18 in. 3/-, etc.  
**SPEAKERS P.M.** 3 ohms 2 1/2 in. Eiac. 17/8. 3 1/2 in. Goodmans. 18/8. 6 in. Rola. 17/8. 6 in. Eiac. 18/6. 7 x 4 in. Goodmans. 18/8. 8 in. Rola. 20/-, 9 x 6 in. Goodmans. 25/- EMI Tweeter. 25/8.

**CONDENSERS—Silver Mica.** All values, 2 pF to 1,000 pF., 6d. each. Ditto, ceramics 9d. Tub. 450 v. T.C.O., etc., .001 mfd., .01 and 1/350 v., 9d.; .02, 1/500 v., 1/-; .25 Hunte 1/8. 5 T.C.C. 1/8, etc., etc.  
**RESISTORS—FULL RANGE** 10 ohms—10 megohms 20% 1 w. and 1 w., 3d.; 1 w., 5d.; (Midjet type modern rating), 1 w., 6d.; 1 w., 8d.; 10% Hi-Stab., 1 w., 5d.; 1 w., 7d.; 5% 1 w., 9d., 1% Hi-Stab., 1 w., 1/6.  
**W/W RESISTORS.** 25 ohms to 10K, 5 w., 1/3; 10 w., 1/8; 15 w., 2/-.  
**PRE-SET TV POT.** Full range 25 ohms—2 meg., 3/-.  
**VOLUME CONTROLS—5K—9 Megohms, 3 in. SPINDLES MORGANTH MIDGET TYPE.** 1 in. diam. Guar. 1 year. LOG or LIN ratios less 8w., 3/-; D.P. Sw., 4/6. Twin Stereo less 8w., 6/8. D.P. Sw., 8/-.

**Electrolytics All Types New Stock**

TUBULAR	CAN TYPES
25/25v. 50/12v.	8+8/45v. 4/8
	32+32/275v. 4/8
50/50v. 100/25v.	50+50/850v. 6/8
	60+250/275v. 18/6
8/450v. 4/350v.	100+200/275v. 12/6
18+16/450v. 5/8	32+32/450v. 8/8
32+32/450v. 8/8	Transistor Midget Types—all values 1 mfd. to 100 mfd. 1/8 ea. 5v/12v.

### RECORDING TAPE—Special Offer

American COLUMBIA (C.B.S.) 1st Grade P.V.C. TAPE. Fitted leader and auto stop folk. Brand New, Boxed, and fully guaranteed.

Standard	Long Play
5in., 900ft. ... 15/-	900ft. ... 19/6
5 1/2 in., 900ft. ... 18/8	1,200ft. ... 22/8
7 in., 1,200ft. ... 21/-	1,800ft. ... 22/8

P. & P. per reel 1/-, 6d. on ea. additional reel.  
**SPECIAL BARGAIN** 3in. mfrs. Tape 225ft. 5/8. P. & P. 6d.  
 Plastic Tape Reels ... 3in. 2/6. 5in. 3/-. 5 1/2 in. 3/8. 7in. 3/8

### TAPE RECORDER KIT ONLY £16 10s.

Latest 5-valve circuit based on Mullard's design. Magic eye and tone controls. Printed circuit already wired. A sensitive quality recorder. B.S.R. Amp Kit 95/-. B.S.R. Tape Deck £8.10.0. Collaro Amp Kit £8.5.0. Collaro Tape Deck £12.10.0. Set of 5 valves 45/-. Special Unit Kit Prices—Send stamp for detailed list. Handbook (full details) 2/6.

Jason Tuners—Approved Kits—comprehensive range in stock. Model PM11 5 gns. etc., 48-hour Alignment Service. Send for complete bargain list.

## TRS RADIO COMPONENT SPECIALISTS

70 BRIGSTOCK ROAD, THORNTON HEATH, SURREY Est. 1946. Telephone THO 2188  
 Terms C.F.O. or C.O.D. Post and Packing up to 4 lb., 7d., 1 lb., 3/1, 3 lb., 1/6, 5 lb., 2/-, 10 lb., 2/6. Hours: 9 a.m.—5 p.m., 1 p.m. Weds.

**D.C. SUPPLY KIT.** 12 v. 1 a. consisting of a partially drilled metal case, mains trans., F.W. Bridge Rectifier, 2 fuseholders and fuses, Change Direction switch, variable Speed regulator and circuit. For 200-250 v. A.C. mains. Suitable for Electric Trains. Limited number available at 35/9.

**SELENIUM RECTIFIERS**

F.W. BRIDGE	H.T. Types H.W.
6/12v. 1 a. .3/11	150 v. 100 m.a. . . 3/29
6/12v. 2 a. .6/11	250 v. 50 m.a. . .3/11
6/12v. 3 a. .9/9	250 v. 60 m.a. . .4/11
6/12v. 4 a. .12/3	250 v. 80 m.a. . .5/11
6/12v. 6 a. .15/3	250 v. 250 m.a. . .11/9
6/12v. 10 a. .25/9	250 v. 80 m.a. H.W.
6/12v. 15 a. .35/9	6/11, 250 v. 50 m.a.
24 v. 2 a. .14/9	F.W. (Bridge) 8/11

**B.S.E. MONARDECK TAPEDECKS.** Speed 31 in. per sec. High quality recording heads. 7 gms. Carr. 5/-  
Suitable polished veneered walnut carrying case for above 39/6. (Space for amplifier.)

**EX. GOVT. CASES.** Size 14-10in. high. Well ventilated, black chrome finished undrilled cover. IDEAL FOR BATTERY CHARGER OR INSTRUMENT CASE OR COVER COULD BE USED FOR AMPLIFIER. Only 9/6 plus 2/- postage

**LINEAR TREMOLO/PRE-AMP UNIT** Type TPU/1, with 3 controls, volume, amplitude and frequency. Inputs for guitar and microphone. Requires power supply of 250 v. 10 m.a. and 6.3 v. 1 a., available from any R.S.C. or LINEAR amplifier. The unit is merely connected to normal input socket of hi-fi amplifier or guitar amplifier. Only 5/6s.

**MICRO-AMMETERS.** 3in. diam. 0-50 micro-amps. 33/9.

**R.S.C. GRAM AMPLIFIER KIT.** 3 watts output. Negative feedback. Controls Vol. Tone and Switch. Mains operation 200-250 v. A.C. Fully isolated chassis. Circuit etc. supplied. Only 39/9. Carr. 3/6.

**HI-FI 10 WATT AMPLIFIERS**

Brand new. Manufacturer's discontinued line. Fitted Mullard valves. Dual inputs for "mike" and gram., etc. Bass and Treble Controls. High sensitivity and quality. Output for 3 ohm or 15 ohm speaker. For 230-250 v. A.C. **£6.19.6** Carriage 7/6.

**PORTABLE TRANSISTOR RADIO DESIGN** with 7 x 4in. loudspeaker and Car Aerial Socket. Attractively designed and covered cabinet size 3 x 10 x 3in. Gold dials with revolving perspex covers. M. and L. wavebands. Six first grade Brimar Transistors and Printed circuit. Easy to follow instructions and diagrams. 3/6. Total cost of parts only £9.19.6. carr. 3/6. Demonstration models at all branches.

**PRACTICAL WIRELESS SUPER SIX POCKET PORTABLE RADIO DESIGN** Diagrams etc., 1/9 or All parts including printed circuit and first grade transistors **£8.19.6.**

**MULTI-METERS.** Ferranti Universal A.C./D.C. 59/6.

**CABY A10.** Basic Meter sensitivity 155 micro-amps. A.C. and D.C. ranges £4.17.6.  
**CABY B20.** Sensitivity up to 10,000 ohms per volt. A.C. and D.C. **£6.19.0.**  
S.A.E. will bring leaflets on A10 or B20.

**RELAYS.** Carpenters' Type, Polarised 2 times 5,000 turns at 1,685 ohms, 13/9. Miniature Type G.E.C. 6/0 Sealed, wire ends. 4 covers. platinum M105. 12/6.

TERMS: C.W.O. or C.O.D. No C.O.D. under £1. Post 1/9 extra under £2. 2/9 extra under £5. Open 9 to 6 Weds. until 1 p.m., except Manchester open all week. Trade supplied. S.A.E. with all enquiries.

Mail Orders to 29-31 Moorfield Road, Leeds 12.

Personal Shoppers to: 5 and 7 County (Metca) Arcade, Briggate, Leeds 1.  
64-69 Brown Street (Market Street), Manchester 2.  
56 Morlie Street (next to Majestic Ballroom), Bradford.  
73 Dale Street, Liverpool 2.

**SPECIAL OFFER EX. GOVERNMENT SELENIUM RECTIFIERS.** 12 v. 15 amp. with large square cooling fins. 19/9 each.

**EX. GOVT. SMOOTHING CHOKES.** 200 mA., 3-5 H., 50 ohms, Parmeko 8/9; 100 mA., 5 H., 100 ohms 3/11; 150 mA., 10 H., 50 ohms 9/9; 90 mA., 20 H., 300 ohms 5/9; 120 mA., 12 H., 100 ohms 8/9; 50 mA., 50 H., 1,000 ohms 6/9; 100 mA., 10 H., 100 ohms 6/9; 60 mA., 5-10 H., 250 ohms 2/11.

**EX. GOVT. MAINS TRANSFORMERS** Primaries 200-250 v. 50 c.p.s. A.C.  
250v. 60mA 6.3v. 2a . . . . . 11/9  
250-0-250v. 60mA 6.3v. 2a. . . . . 12/9  
250-0-250v. 30mA 6.3v. 3a. . . . . 17/9  
5v. 3a. Parmeko Potted . . . . . 21/9  
270-0-275v. 100mA 6.3v. 7a. 5v. 3a . . . . . 12/11  
300-0-300v. 60mA 6.3v. 2a. . . . . 18/9  
300-0-300v. 100mA 6.3v. 2a. 5v. 2a. . . . . 18/9  
350-0-350v. 90mA 6.3v. 3a., 6.3v. 1a. Parmeko Potted . . . . . 19/9  
5v. 10a. Parmeko. . . . . 11/9  
0-35-40-45-50v., 300mA 6.3v. 3a. . . . . 17/9

**2 VOLT ACUMULATORS** Varleys small size 4 x 3 x 1 1/2. 2 v. 14 A.H., brand new, 6/9 ea., 3 for 15/6.

**FIELD TELEPHONES**

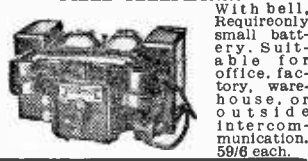

**R.S.C. LIVERPOOL BRADFORD MANCHESTER and LEEDS**  
(Manchester) Ltd.

**AVO METERS**

**MODEL 7 £12.10.0. MODEL 8 £17.10.0.** Guaranteed perfect. Complete with leads and batteries. Registered post and packing 5/- extra.

**MULTIMETERS.** 1000 Ω/volt. A.C. and D.C. volts. 0-10, 50, 250, 500 & 1000. D.C. current 0-10, 100mA. Resistance 0-2k Ω and 0-200k Ω. Bakelite case, complete with test leads. BRAND NEW 59/6.

**BC 221.** The most accurate precision portable heterodyne frequency meter 125Kc/s to 20 Mc/s. Complete with original individual calibration book. Guaranteed perfect £16.

**CRYSTAL CALIBRATOR No. 10.** Good condition, tested, with instruction manual, ONLY 59/6 or AS NEW with three spare valves. leads, etc. £4.10.0. P. & P. 3/6.

**CR100 COMMUNICATION RECEIVERS** 60 Kc/s—30 Mc/s in 6 bands. 11 valves, 2RF and 3 I.F. stages. Crystal gate BFO etc. Input 200-250 v. A.C. mains. 2W output for 3Ω spkr. In superb condition £25. Carr. 30/- S.A.E. for illustrated details.

**GRAM MOTORS.** Garrard AC6. 78 r.p.m. NEW 19/6, post 2/6.

**DEAF AID—MEDRESCO TYPE** (3 min. batt. valves). Complete with min. xtal earphone carps and leather case. Brand New 35/- with batteries £25 post free.

**R-1155-B,** with latest drive, first class condition. £9.19.6. Mains Power Pack, £6.10.0. Data Book, 1/3 post paid. Moving Coil Phones. Finest quality Canadian 4th Chamot's ear-muffs and leather-covered headband. With lead and jack plug. Noise excluding, supremely comfortable, 19/6, post 1/6.

**GIANT COMPONENT PARCEL.** Contains 100+ and 1 watt resistors, 50 Ht Stub resistors, W/W resistors, carbon and W/W pots, 100 capacitors (mica, paper, Sprague, bias, variable, etc.), valveholders, tag strips, metal rectifiers, sleeving, etc. All components are unused. **GUARANTEED VALUE, 25/-, plus 2/6 post.**

**TRANSISTOR SETS**

We now stock The Pocket 4 (a neat little job which can be made for 42/6) and The Good Companion (A super job equal to the best). Easily constructed for only £9.19.6. Gladly demonstrated to callers.

**CHARLES BRITAIN (RADIO) LTD.**

11 Upper Saint Martins Lane, London, W.C.2.

TEmple Bar 0545

Shop Hours 9-6 p.m. (9-1 p.m. Thursday.)  
Open all day Saturday.

**GAZAK: This Month's Bargains**

**SCREENED CABLES**

Screened Microphone Cable, 1st. Grade, 9d. yd. or 6/- per doz. yds. 12-Core Screened Cable, 2/- yd. 10-Core (5 Pairs) Screened Cable, 1/8 yd. All plus 1/6 P. & P.

**AERIAL EQUIPMENT**

**TWIN FEEDER.** 300 ohm twin ribbon feeder, similar K25, 6d. per yard. K35B Telcon (round) 1/6 per yard. Post on above feeder and cable 1/6 any length.

**COPPER WIRE.** 14 G., H/D 140ft. 17/-; 70ft. 8/6. P. & P. 2/-. Other lengths pro rata.

**RIBBED GLASS.** 3in. aerial insulators, 1/9 each. P. & P. 1/6.  
**CERAMIC FEEDER SPREADERS.** 6in. type F.S. 10d. each or 9/- dozen. P. & P. 2/-.  
**CERAMIC "T" PIECES.** Type A.T. for centre of dipoles, 1/6 each. P. & P. 1/6.

**2 METRE BEAM 5 ELEMENT W.S. YAGI.** Complete in box with 1 x 25in. mast head bracket. PRICE 49/-. P. & P. 3/6.

**SUPER AERIAL CABLE.** 75 ohm, 300 watts, very low loss, 1/8 per yard P. & P. 1/6. 50 ohm, 300 watt coax, very low loss, 1/6 yd. or 20 yds. 27/6. P. & P. 1/9.

**ABSORPTION WAVEMETERS.** 3.00 to 35.00 Mc/s. in 3 switched bands. 3.5, 7, 14, 21 and 28 Mc/s. Ham Bands marked on scale. Complete with indicator bulb. A MUST for any Ham shack. 22/6 post free.

**VARIABLE CONDENSERS.** All brass with ceramic end plates and ball race bearings. 50 pF, 5/9. 100 pF, 6/6. 160 pF, 7/6. 240 pF, 8/6, and 300 pF, 9/6. All fitted with rear extension for ganging. P. & P. 1/-. Also Flexible Couplers 1/- each. B.1. 8 MFD. 1,200 v. D.C. Wkg. Capacitors, 12/6 each. P. & P. 2/-.

**CHAS. H. YOUNG LTD.**

THE COMPONENT SPECIALISTS

Dept. "P", 110 Dale End, Birmingham 4. (CEN 1635)  
(No C.O.D. under £1 please.) (By return service)

# SENSATIONAL NEW 1961 DESIGNS—BY CONCORD

## LOW PRICES ★ PICTORIAL STEP-BY-STEP PLANS ★ EASY AS A.B.C.

### THE NEW "LISBON" TRANSISTOR SET

This is a pocket 2-stage transistor set not much larger than a matchbox. Excellent clear reception covering all medium waves, works for months off a tiny 1½ or 3 volt battery costing only 3d. Easy to build and an excellent introduction to transistor circuitry. Everything can be supplied down to the last nut and bolt incl. **PRICE 19/6**

**SIMPLE PICTORIAL STEP-BY-STEP PLANS FOR ONLY 19/6**, plus post and packing 1/6. (C.O.D. 2/- extra). Parts sold separately, priced parts list 1/-.



### THE NEW "FLORIDA" VALVE RADIO

This sensational "FLORIDA" model is one of our most sensitive valve radios. It is a highly compact, self-contained miniature push button base, valve pocket radio at absolutely rock bottom building cost. Covers all medium waves with very latest circuitry bringing in stations from all over Europe without fuse. Size only 4½ x 2½ x 1½ in. A fascinating pocket radio. We can supply all the parts including beautiful 2-tone case and **PRICE OF 27/6**, plus post and packing 1/6 (C.O.D. 2/- extra). Parts sold separately, priced parts list 1/-.

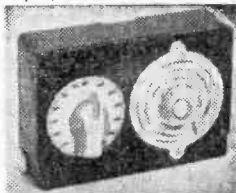

### OUR NEW 4 STAGE "MINUETTE"

Build this newly-designed "MINUETTE" 4-STAGE transistor set in very strong ready drilled **ULTRA-MODERN CASE**, size only 6 x 3½ x 1½ in. Uses three transistors and diode and **PRICE 39/6**

**CONTAINED LOUD SPEAKER**. Very sensitive, ideal for office, bedroom, holidays, etc. Months and months of listening off an 8d. battery. Can be built **FOR ONLY 39/6**, including **PROPER CASE**, miniature speaker, etc. **SIMPLE AS A.B.C. PICTORIAL STEP-BY-STEP PLANS** etc., plus post and packing 1/6 (C.O.D. 2/- extra). Parts sold separately, priced parts list 1/-.



### THE NEW "SAN REMO" VALVE RADIO

This All Transistor Speaker Radio—the "San Remo"—covers all medium waves including "Home," "Light," etc. Reliable and lightweight—slips easily into the Pocket or Handbag—size only 4½ x 2½ x 1½ in. Works for months off 8d. Battery! Ideal for holidays, Camping, Bedroom, etc. Anyone can assemble it in an hour or two with our simple-as-A.B.C. PLAN! Complete set of parts including miniature speaker—everything—only **PRICE 27/6**, plus 2/6 P. & P. (C.O.D. 2/- extra). Parts can be bought separately.



**CONCORD ELECTRONICS Dept. PW35**  
210, Church Road, Hove, Sussex

Cheques accepted. Cash on delivery 2/- extra. Please print name and address in block letters. Suppliers to Schools, Universities, Government and Research Establishments. Complete range of components and values stocked. Export no C.O.D. abroad. **DEMONSTRATIONS DAILY AT WORKS.**

## THE PUNCH YOU NEED!

### HOLE PUNCHES

Instant Type			
1 1/2" diameter	...	...	5/6 ea.
"	...	...	6/4 "
Screw-up Type			
1 1/2" diameter	...	...	6/8 ea.
"	B7G	...	7/2 "
"	B8A, B9A	...	7/8 "
"	...	...	8/3 "
"	...	...	8/7 "
"	...	...	9/6 "
Postage and packing 1/-			
1 1/2" diameter Int. Octal	...	...	10/11 ea.
"	...	...	13/3 "
"	...	...	15/6 "
"	B9G	...	17/11 "
"	...	...	20/4 "
2 3/4" "	Meter	...	27/8 "
Postage and packing 2/3			

Complete set including postage and packing £8.

**OLIVER & RANDALL LTD**  
Dept. 7.  
40 Perry Hill, London, S.E.6  
Tel.: BEckenham 8262

### RADIO VALVE DATA

- by W.W. new 7th Ed. 6/-. Postage 9d.
  - Radio Amateur Examination Manual by R.S.G.B. 5/-. Postage 9d.
  - Amateur Radio Call Book by R.S.G.B. 4/-. Postage 6d.
  - Mullard Circuits for Audio Amplifiers. 3/8, postage 10d.
  - Extra Equipment for your Tape Recorder by Rashied. 6/-. postage 9d.
  - Coil design and construction Manual RF, and AF coils, and transformers. 5/-. postage 6d.
  - The Radio Amateurs Handbook by A.R.R.L. 32/8, postage 2/3d.
  - High Fidelity Loudspeaker Enclosures by Babani. 5/- postage 6d.
  - Newnes Electrical Pocket Book by Reeves. 10/6, postage 1/-.
  - Short Wave Receivers for the Beginner by Data. 6/-. postage 6d.
- UNIVERSAL BOOK CO.**  
12 Little Newport Street, London, W.C.2  
(adjoining Lisie Street)

**WANTED!**

A BETTER, BRIGHTER, CLEARER PICTURE PATENTED

It can be done if you plug this on your TV Tube

Important! State Make, Model No. Name and Address in Block Letters Please.

STANDARD MODEL .. 22/6  
DE LUXE MODEL .. 30/-  
Postage 2/6 either model.

**SINCLAIR ELECTRONICS Dept. P.W.2**  
18 Newport Court Charing X Rd. WC2  
Terms: C.W.O., C.O.D.

## CABINETS & HI-FI EQUIPMENT

We can supply any Cabinet to your own specification

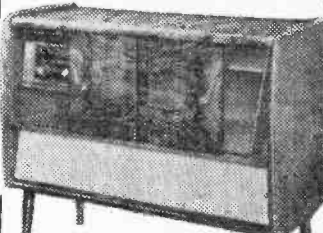

"Grosvenor" £22.1.0

This is only one example taken from our extensive range of stock cabinets. Write for our NEW 24 page fully illustrated catalogue on:

**THE LARGEST RANGE OF CABINETS IN THE COUNTRY**

Equipment is also our speciality and we now offer, in a novel book form: **A NEW EQUIPMENT COMPARATOR** illustrating our range of radio chassis, speakers, tape decks, single players and autochangers.

SEND TODAY for a copy of these two books, which are absolutely FREE.

**LEWIS radio**

100' (P101) Chase Side, Southgate, London, N.14. Pal 3733/9666

**EDDY'S (NOTTM) LTD.**  
172 Alfreton Road  
Nottingham

**Build your own  
CAR RADIO**

- ★ 7 Transistor ● Long and Medium Wave ● Two Watts Output ● R.F. Stage and Automatic Gain Control



**10 1/2 Gns.**  
P & P  
5/- extra

6 or 12 volts (state which)  
Supplied with full instructions  
Size 7 1/2 x 7 1/2 x 2 1/2 in.  
SPEAKER, extra 17/11

**GUITAR PICK-UPS.** Super Hi-Fi non-accoustical universal fitting. High output complete with lead and plug. Full and easy instructions, 49/11. P. & P. 2/6.  
**NIFE ACCUMULATORS.** 1.25 v. size 3 x 2 1/2 x 1/2 in. 7 amp. hrs. weight 13 ozs., 1/11 each. P. & P. 2/-, one only add 9d. per cell.  
**THROAT MIKES.** 2/- each, P. 8d., could be used for electrifying musical inst. etc.  
**VIBRATORS.** 12 volt 4 pin, 4/11. Post 1/6.  
**POCKET RADIO.** 2 Transistor with miniature speaker. Complete with all parts. Wiring diagram and full instructions, 27/6. Batteries 1/-, P. & P. 2/-.  
**CRYSTAL SETS.** Complete 2 wave bands high gain good quality, 19/11, also with transistor amplifier extra, 9/11, P. & P. 2/6.  
**HEADPHONES.** High res. to suit above crystal sets. Good quality, 13/11 pr. P. & P. 1/6.  
**LUXEMBOURG AERIALS.** Easy to fit No technical knowledge required. 3/11. Post 6d.

All above are new and guaranteed. New or Surplus valves guaranteed and tested by return post.

1D5	7/6	10F1	6/6	EF86	9/6
1L4	3/6	12A6	5/3	EF91	3/6
1R5	5/6	12AT6	7/6	EF92	4/6
1S5	4/6	20D1	8/6	EL41	7/3
1T4	3/11	20P1	9/6	EL84	6/6
3A4	6/-	30F5	6/11	EL85	10/3
3S4	5/11	35L6GT	8/11	EL91	4/6
3V4	6/9	35W4	6/9	EY51	7/11
5U4G	4/9	35Z4	5/3	EY86	7/9
5Y3GT	6/6	954	1/6	EZ40	6/3
5Z4G	7/6	955	3/6	EZ41	7/-
6B8G	2/11	956	2/6	EZ80	6/3
6C4	3/6	AC2/		KT33C	6/6
6C6	4/6	PEN/DD		MU14	7/-
6F1	6/11			OZ4	5/11
6F13	8/11	CY31	7/6	PCC84	7/6
6F15	9/6	DAF91	9/6	PCF80	7/6
6F33	6/6	DAF96	4/11	PCL85	12/6
6J5G	2/9	DF91	3/11	PEN36C	8/-
6J5GT	3/9	DF96	6/11	PEN46	6/11
6J5M	4/3	DL96	6/11	PEN4A	12/6
6J7G	5/7	DM70	6/11	PL33	8/3
6K7G	1/11	ECC81	5/3	PL36	10/9
6K8G	5/3	ECC82	5/11	PL81	9/-
6Q7G	5/9	ECC83	6/6	PY80	7/-
6SG7M	4/9	ECC85	6/11	PY81	6/6
6SN7GT	4/3	ECH42	7/9	PY82	6/9
6V6G	4/9	ECL80	7/9	PZ30	9/6
6V6GT	6/-	ECL82	9/-	SP61	2/6
6X4	5/-	EF36	3/6	TDD4	7/6
6X5G	5/6	EF41	7/6	UBC41	7/6
6X5GT	6/6	EF42	7/6	UCH42	7/6
7C5	7/6	EF50	1/9	UL41	7/6
7Y4	6/11	EF80	5/-	VP23	6/6
				Z77	3/6

Any parcel insured against damage in transit for only 6d. extra per order. All uninsured parcels at customers risk. Post and Packing 6d. per valve extra. C.W.O. or C.O.D. only C.O.D. charge 3/- extra. S.A.E. with enquiries.

**RADIO BOOKS**

**NEW PICTORIAL APPROACH TO LEARNING BASIC ELECTRICITY, 5 parts. BASIC ELECTRONICS, 6 parts.** The Complete Set sent on payment of first instalment.

**LEARN WHILE YOU PAY FOR ONLY 2/6 PER WEEK** Write for FREE Illustrated Prospectus giving details of instalment plan!

**TRANSISTOR CIRCUITS** for Radio Controlled models. Howard Boys. 8/-.  
**SUPER SENSITIVE TRANSISTORISED POCKET RADIO 4/-.**

**INTERNATIONAL RADIO STATION LIST 4/-.**

**TRANSISTOR CIRCUITS Nos. 1, 2, 3, 4, 3/- each.** Each book gives instruction for building ten different Transistor Units.

**COIL DESIGN AND CONSTRUCTION MANUAL 5/6.**

**HIGH FIDELITY TAPE RECORDER FOR THE HOME CONSTRUCTOR 3/-.**  
**ONE VALVE RECEIVERS, TWO VALVE RECEIVERS, THREE VALVE RECEIVERS, FOUR VALVE RECEIVERS, 1/9d. each.** Each book gives full comprehensive instructions, diagrams, etc.

**BOY'S BOOK OF CRYSTAL SETS, 12 different circuits fully illustrated 3/-.**

**PRACTICAL RADIO FOR THE BEGINNER.** Fully illustrated with diagrams, etc. 64 pages. 4/-.

**HIGH FIDELITY LOUDSPEAKER ENCLOSURES 5/6.**

**TRANSISTOR SUPERHET RECEIVERS 8/-.** Includes circuit diagrams of 50 different Receivers.

**40 CIRCUITS USING GERMANIUM DIODES 3/6.**

**RADIO VALVE DATA (Wireless World) 7th edition. 7/-.**

**GUIDE TO BROADCASTING STATIONS (Wireless World) 12th edition. 4/-.**

**BRIMAR VALVE MANUAL No. 8. 7/-.**

**MULLARD REFERENCE MANUAL OF TRANSISTOR CIRCUITS. 13/6.**

**ELECTRONIC NOVELTIES. Bradley 5/6.**

**ELECTRONIC GADGETS. Bradley 4/-.**

**SERVICING TRANSISTOR RECEIVERS Pettit. 6/6.**

**USING AN OSCILLOSCOPE. Easterling. 7/-.**

**BEGINNERS GUIDE TO RADIO. Camm, New and Revised Edition. 8/6.**

**DICTIONARY OF MATHEMATICAL DATA 2/3.**

**RADIO TEST EQUIPMENT MANUAL 3/-.**

**HIGH FIDELITY STEREO GRAMOPHONE FOR HOME CONSTRUCTOR. Easterling 5/6.**

**PORTABLE TRANSISTOR RADIO AND GRAMOPHONE 3/-.**

All above titles include postage.

SEND STAMP FOR LISTS

**SELRAY BOOK CO.**

60 HAYES HILL, HAYES, BROMLEY  
KENT. Tel. HURStway 1818

**MICROAMMETER.** 0-50uA, 3 x 2 1/2 in., new, scaled 0-3 with FREE 25 range 18,000 o.p.v. AC/DC multimeter scale, circuit, wiring diag. 22/8 post 1/3. Circuit, scale 9d.

**High Stability Resistors.** Surplus 1W 1% 9d. each. Stamp for list 1-2W, 1% -5%. 2W Resistors. 4d. each. 30 assorted 5/- post 1/-. Small Battery 6 valve TX chassis. 65 parts inc. mike tran., less valves 2/6, post 1/6.

**Wirewound Pots.** 1K, 2K, 5K, 10K, 50K, 20K each, min 500, min. carbon 200K, 1/8 each. 34 in. cam corrected (super linear) 50K 8/8; 34in. precision twin-gang 5K 8/8. All spindle.

**Condensers. Elec. 25uF/25v. 9d. 80/100v 1/-, 16/150 1/-, 16/275 1/3; 1/600 Block 9d. tubs. 0.5/250, 0.1/1500, 0.02/350 6d. ea., 0.05/350 4d., 0.3/500 8d. Silver Mica 2% 0.01. 100PF 1/- each. 1uF 2% Block 3/6.**

S.A.E. with enquiries postage extra.

**PLANET INSTRUMENT CO.**

25 DOMINION AVE., LEEDS, 7,

**FIRST-CLASS  
RADIO COURSES . . .**

**GET A CERTIFICATE!**

**QUALIFY AT HOME—IN SPARE TIME**

After brief, intensely interesting study—undertaken at home in your spare time—YOU can secure your professional qualification or learn Servicing and Theory. Let us show you how.

**FREE GUIDE**

The New Free Guide contains 132 pages of information of the greatest importance to those seeking such success-compelling qualifications as A.M.Brit.I.R.E., City and Guilds Final Radio, P.M.G. Radio Amateurs' Exams., Gen. Cert. of Educ. London B.Sc. (Eng.), A.M.I.P.E., A.M.I.Mech.E., Draughtsmanship (all branches) etc., together with particulars of our remarkable Guarantee of SUCCESS OR NO FEE

Write now for your copy of this invaluable publication. It may well prove to be the turning point in your career.

**FOUNDED 1885—OVER 150,000 SUCCESSSES.**

**NATIONAL INSTITUTE OF ENGINEERING**  
(Dept. 461), 148 HOLBORN LONDON, E.C.1

S. Africa: P.O. Box 8417, Jo'burg.  
Australia: P.O. Box 4570, Melbourne.

**H.A.C. SHORT-WAVE EQUIPMENT AND SHORT-WAVE KITS**

Famous for over 25 years for S.W. Receivers and Kits of Quality.

H.A.C. were the original suppliers of SHORT-WAVE RECEIVER KITS for the amateur constructor. Over 10,000 satisfied customers—including Technical Colleges, Hospitals, Public Schools, Hams, etc.

Improved designs with Denco coils: One-valve Kit, Model "C", Price 25/-. Two-valve Kit, Model "E", Price 50/-. New Addition, Model "K", Super sensitive "All Dry" Receiver. Special incit. price. Complete Kit, 77/-.

All kits complete with all components, accessories and full instructions. Before ordering call and inspect a demonstration receiver, or send for descriptive catalogue and order form.

**POST THIS COUPON NOW!**

"H.A.C." SHORT-WAVE PRODUCTS  
(Dept. TB), 44 Old Bond Street, London W.1

Please send me FREE and without obligation your 1961 literature.

NAME .....

ADDRESS .....

## SOUTHERN RADIO'S WIRELESS BARGAINS

**PORTABLE TEST METERS.** (As featured in March issue, pages 1005 to 1010) 0-5000 ohms; 0-60 mA; 0-15 v., 0-3 v. 12/6 each.

**TRANSMITTER RECEIVERS.** "Type 38" with 5 valves. New but untested. No guarantee. 25/- each. Post paid.

**ATTACHMENTS FOR "38" TRANSMITTER-RECEIVER;** Headphones 15/6; Throat Microphones, 4/6; Junction Boxes, 2/6; Aerials, No. 1, 2/9, No. 2, 5/3; Webbing, 4/-; Haversacks, 5/6; Valves—A.R.P.12 4/6, A.T.P.4, 3/6, A.R.8 7/6; Set of five valves, 19/-; Postage on each item 1/6 extra (except valves).

**ATTACHMENTS FOR "18" TRANSRECEIVER.** Headphones, 15/6; Microphone 4s, 12/6; Aerials, 5/-; Morse Key, 6/6; Valves—A.R.P.12, 4/6, A.T.P.4, 3/6, A.R.8 7/6; Set of six valves, 25/-; Official booklet "18" T-R Circuits, etc., 6/6 post paid. Postage extra (except valves) 1/6 each item.

**QUARTZ CRYSTALS.** Types F.T.241/F.T.243 2-pin  $\frac{1}{2}$ " spacing. F.T.241 20 to 38.9 Mc/s (54th and 72nd Harmonic). F.T.243 5700 to 8650 kc/s (Fundamental), 4/6 each. Lists of available frequencies on request. Crystal Holders for F.T.241/243, 1/3. F.T.241/243 Crystals. New but not guaranteed (ideal for using the case or regrinding). 12/6 per dozen, post paid.

**RECORDING BLANKS.** New 13in., 6/- each or 15 complete in Tin, 64.

**BOBSIGHT COMPUTERS.** Ex-R.A.F. Wealth of gears, motors, blowers, etc. Ideal for experimenters. £3.12.6, carr. paid.

**RESISTANCES.** 100 Assd. Useful values, new. 12/6 per 100.

**CONDENSERS.** 100 Assd. Mica, Elec., Tub., etc. New 15/- per 100.

**MORSE PRACTICE SETS.** Key with Buzzer on Base, with battery. 12/6, postage 2/-.

**LUBRA HOLE CUTTERS.** Adjustable.  $\frac{1}{2}$ " to  $3\frac{1}{2}$ ". 7/3.

**STAR IDENTIFIERS.** 1-AN. Covers both hemispheres, 5/6.

**VISUAL INDICATORS (10Q4).** Type 3 with 2 meter movements, 2 neons. New 12/-.

**MAGNETS.** Strong Bar, 2" x  $\frac{1}{2}$ " 1/6 each.

**COMMAND RECEIVERS B.C.** 454 3-6 Mc/s. B.C. 455 6-9 Mc/s. Complete with 6 valves, 47/6 each.

POST OR CARRIAGE EXTRA, FULL LIST OF RADIO BOOKS, ETC., 3d.

## SOUTHERN RADIO SUPPLY LTD.

11 LITTLE NEWPORT ST., LONDON W.C.2. GER. 6653

## Surplus Radio Supplies

2 LAING'S CORNER, MITCHAM  
SURREY

OFFER THE FOLLOWING

## F.M. KIT.

Consisting of 1 Discriminator. 2 I.F.'s. 1 F.M. Gang. 2 Diodes. Price 12/6.

2 $\frac{1}{2}$ in. Speaker, 3 ohm, 12/6. 2 $\frac{1}{2}$ in. Speaker, 15 ohm, 14/6. 500 Microamp Meter, 14/6. Postage and Packing 1/6 per Parcel.

Send for Catalogue, 1/6 post paid.

## REPANCO

HIGH GAIN COILS & TRANSFORMERS  
for

THE HOME CONSTRUCTOR

Send 6d. stamp for comprehensive List of  
REPANCO COMPONENTS  
and Easy-to-build Receivers

RADIO EXPERIMENTAL  
PRODUCTS LTD

33 Much Park Street, Coventry

Tel.: 27114

## Electronics FLEET ST. Ltd

Dept. B

152-153 Fleet St., London, E.C.4. Tel. Flc 2833  
Business Hours; Weekdays, 9-6, Saturdays 9-1

Stockists for  
AMPLIFIERS V.H.F. TUNERS, HI-FI SPEAKERS BY ALL  
THE LEADING MANUFACTURERS

The Transistor Set you "THE FLEET SIX"  
have been waiting for!



The "Fleet 6" a wow of a transistor set that really gets the stations. New design 6 transistor superhet pocket receiver, using 6 guaranteed first grade, transistors plus sensitive diode, push pull output medium and long wave bands, new type

printed circuit, high Q internal ferrite rod aerial, 2 $\frac{1}{2}$ in. high flux speaker, provision for car aerial, overall size 7 $\frac{1}{2}$  x 4 $\frac{1}{2}$  x 2 $\frac{1}{2}$ . Simple to follow instructions. All components guaranteed, service after sales. This is equal to many manufactured sets at double the price. All components including cabinets, transistors, speaker, circuit, etc., only £8/19/6 complete, post and pkg. 2/6. PP4 Battery 2/- extra. All components sold separately. Send S.A.E. for details. Circuit and Instructions 2/- post free.

## THE FLEET 6 PORTABLE TRANSISTOR RECEIVER

Using 6 guaranteed first grade transistors, sensitive diode, p/pull output, medium and long wave bands, printed circuit, high Q ferrite rod aerial, 6 x 4 high flux speaker. Provision for car aerial. Attractive 2 tone cabinet overall size 10 $\frac{1}{2}$  x 8 x 3 $\frac{1}{2}$ in. Easy to follow instructions, all components including cabinet, transistors, speaker, circuit etc. £9. 19. 6d. complete P. & Pkg. 3/6. Battery extra. All components guaranteed and sold separately. Send S.A.E. for details. Circuit and Instructions 2/6 post free.



## STOP PRESS

Brand new in sealed carton at  
BARGAIN PRICE, the famous  
G.E.C. 8" METAL CONE LOUDSPEAKER

Specification. Frequency range 30-20000 c/s maximum power rating 12 watts, speech coil impedance 3-6 ohms. at 30-3000 cycles, rising to 12 ohms. at 10000 cycles. flux density 13,500 gauss lines, overall depth 4 $\frac{1}{2}$ " weight 3lb. 6ozs.  
Makers Price £9. 7s. 0d. OUR PRICE £5.19s. 6d. Post and packing 5/-.

## THE POPULAR "VERDIK QUALITY TEN"

10 watt push-pull ultra linear Hi-Fi amplifier with pre-amp control unit. Amplifier Valves EF86, ECC83, 2-EL84, EZ81. Sensitivity 40 M/V for 10 watts, output impedance, 4, 8 and 16 ohms, spare supply for tuner, 200/250 v., A.C. Pre-Amp valve EF86.  
INPUTS Radio 100M/V., tape 100 M/V.  
GRAM LP 50 M/V. 78 60 M/V.

MIC 10 M/V., output socket for recording direct to tape recorder. Treble between—10db and + 12db at 10 kc/s. BASS between—10db and + 12 db at 20 c/s. Finished in grey, green, stone enamel, control panel in gold lettering, fully guaranteed. Original price 20 gns., OUR PRICE £14. 19s. 6d. P. & P. 7/6.

## WIRECOMP ELECTRONICS

378 HARROW ROAD, LONDON, W.9  
TEL: CUNNINGHAM 9530

Hours of business: 9 a.m. to 6 p.m. Open all day Saturday. Opposite Paddington General Hospital. Buses 18B and 36 pass the door.

### SPECIAL OFFER G.E.C. BCS 1851

METAL CONE LOUDSPEAKER  
OUR PRICE

List Price £9.10 **£5.19.6** P. & P. 2/6

Outstanding performance. Frequency response from 30 c/s to 20,000 c/s. Exceptional Bass reproduction. Maximum power rating (single unit) 12 watts. Overall dia. 8in. Accessories available include: Power Bracket—for unequalled Bass reproduction; Presence Unit—which gives a musical illusion of actually being among the instruments.



JUST ARRIVED!!! FOR USE WITH THE G.E.C. METAL CONE SPEAKER. G.E.C. HIGH QUALITY 12 WATT AUDIO AMPLIFIER AND PRE-AMPLIFIER. ALSO RANGE OF G.E.C. PERIFONIC SPEAKER CABINETS. ALL AT GREATLY REDUCED PRICES. SEND S.A.E. FOR FULL DETAILS.

### THE NEW "COMPANION"

TRANSISTORISED POCKET RADIO **£8.19.6** COMPLETE KIT OF PARTS

Uses 6 first-grade transistors covering Long and Medium wavebands. High Q internal ferrite rod aerial, with socket for car aerial. Size 6½ x 4½ x 1½ ins. Latest printed circuit. Two tone case. Complete with instructions. All parts sold separately. Battery extra. P. & P. 3/6.

SEND S.A.E. FOR FREE PRICE LIST OR PAY US A PERSONAL CALL

### "SONIC SIXTY" TRANSISTOR KIT



6 Mullard Transistors. 1 Diode. Internal Ferrite Rod Aerial. 7 x 4in. high quality Speaker. 500 mW push-pull out put. MW and LW. Calibrated Direct Drive Assembly. Modern Walnut Cabinet 17 x 7½ x 5in

COMPLETE KIT READY TO BUILD **£9.15.0** P. & P. 4/6

ALL PARTS SOLD SEPARATELY

### COMPLETE V.H.F./A.M. RADIO FOR

**£12.12.0**

Brand new set, in superb walnut cabinet (size 19 x 8½ x 14 in. High). Covering 80-100 Mc/s. 16-49 M., 200-500 M. and 1,200-2,000 M. Mains trans. 200-250 v. with 3 tappings. Ferrite rod aerials for A.N. Controls: volume on/off tone, turning, w/change, Gram. and ext. speaker position provided. Fully guaranteed. Post and packing 5/- extra.



## LOOK! PRICES DOWN

MULLARD TRANSISTOR PRICES DOWN. OC71, 6/6; OC72, 8/-; OC78, 8/-; OC81, 8/-; OC45, 10/-; OC44, 11/-; OC170, 13/6; OC171, 14/6.

RED SPOT TRANSISTORS 3/- each, 3 for only 8/6.

WHITE SPOT TRANSISTORS 3/- each. YELLOW SPOT A.F. 6 volt Transistor 2/6.

BLUE SPOT R.F. Type 4/9 each. YELLOW/GREEN TRANSISTORS 3/3 each, 3 for 9/-.

RED/YELLOW TRANSISTORS 5/- each. SURFACE BARRIER SB305 9/- each. GERMANIUM DIODES 1/- each, 3 for 2/6.

MULLARD OA70, OA79 or OA81 3/- each.

MULLARD OA91 or OA95 Miniature Diodes 3/6.

TRANSISTOR HOLDERS 1/3 each, 3 for 3/6.

MINIATURE SLIDE SWITCHES DP/DT 2/9 each.

CRYSTAL SET COILS. M & L 2/6. SUB-MINIATURE TRANSISTOR TRANSFORMERS. P-P Driver 4.5:1 & P.P. Output 20:1. Boxed with Spec. 9/6 pr.

CRYSTAL EARPIECES with lead 8/6. LOW IMP. EARPIECES with lead 8/6. REACTION CONDENSERS. .0001 3/-, .0003 3/9, .0005 4/-, Miniature .0005 4/-.

ALL SENT POST FREE IN U.K. by

## PETHERICK'S RADIO SUPPLIES

22 High Street, Bideford, N. Devon  
Tel: Bideford 1217

S.A.E. WITH INQUIRIES PLEASE

## NEW VALUES!

Guaranteed Set Tested  
24 HOUR SERVICE

1R5, 1S5, 1T4, 3S4, 3V4, DAF91, DF91, DK91, DL92, DL94, SET of 4, 18/8.

DAF96, DF96, DK96, DL96, SET of 4 26/-

1D5 7/- DL92 5/11 PCP80 6/9

1R5 6/- DL94 6/9 PCP82 7/6

1S5 4/6 DL93 6/9 PCL82 8/3

1T4 3/3 EB91 3/- PCL83 11/6

3S4 5/11 EBC41 7/6 PCL84 7/6

3V4 6/9 EBF80 7/9 PL36 10/9

5U4G 4/3 EBL21 12/6 PL81 8/6

5Y3GT 5/6 ECC40 14/6 PL82 6/6

5Z4G 7/3 ECC81 4/9 PL83 6/6

6AM6 2/9 ECC82 5/9 PL84 9/6

6KT6 1/9 ECC83 6/3 PY32 10/3

6K9G 4/9 ECC84 8/- PY33 7/-

6GT6 5/6 ECC85 7/9 PY81 8/-

6V6G 4/9 ECF80 2/3 PY82 6/-

6V6GT 6/6 ECF82 8/3 PY83 7/3

6X5GT 4/9 ECH21 12/6 U25 12/-

12K7GT 4/9 ECH42 7/9 UAB30 7/6

12K8GT 11/- ECL80 6/9 UAF42 7/6

12Q7GT 4/6 EF40 12/3 UBC41 7/-

35L6GT 9/6 EF41 7/6 UBF80 8/6

3Z4GT 5/9 EF80 4/9 UCC85 7/-

AZ31 9/9 EF85 5/- UC821 12/6

CL33 11/9 EF86 8/9 UCH42 7/6

DAC32 9/6 EF89 6/9 UCH81 8/-

DAF91 4/6 EF91 2/9 UCL82 10/-

DAF96 6/9 EL41 7/- UCL83 13/-

DF93 9/6 EL94 6/3 UF41 7/9

DF91 8/3 EY31 7/3 UF85 8/-

DF96 6/9 EY86 7/6 UF89 6/6

DH77 6/- EZ40 6/- UL41 7/-

DK32 11/- EZ41 6/9 UL84 7/-

DK91 6/- EZ280 5/9 UY21 13/-

DK92 7/3 EZ31 6/6 UY41 5/6

DK96 6/9 MU14 6/- UY85 6/3

DL33 8/6 PCP84 6/9 VP4B 8/6

DL35 9/6 PCP89 10/- Z77 2/9

Postage 6d. per valve extra. Any Parcel Insured Against Damage in Transit 6d. extra

ANY C.O.D. Parcel 3/- extra. Office address, no callers.

### GERALD BERNARD

(Note new address—formerly of Leeds)  
83 OSBALDESTON, ROAD,  
STOKE NEWINGTON, LONDON, N.16.

## BENSON'S BETTER BARGAINS

CONDENSERS: Block paper 8 mfd. 1 kVv 10/-; 8/800 v. 6/6; 8/400 v. 5/-; 8/250 v. 4/-; 4/2 kVv 7/8; 4/1 kVv. 4/6. SWITCHES: Wafer: 2 pole, 4 way, 4 bank 1P6W3B, 4P2W2B, 1P7W3B, 1P11W2B, 4P2W3B, 3/8 each. Ceramic 2P4W1B, 1P5W3B, 1P11W, 3P3W2B, 4P3W1B, 3/8. STUD. 1P24W2B, 1P8W2B, 3/8; 1P19W2B, 5/8; 1P40W3B in brass case, 12/6. MORSE KEY with buzzer on board, wired for 4½ v. battery, 8/8 (p.p. 1/6).

METERS (10Q/4) with two movements, 600 and 400µA. 8/8. TRANSFORMERS. Mains, for R1139/RL392, 25/-; (P. 3/6).

MONITOR 56, triggered oscilloscope, 280 v. A.C. input, with cables and circuit. Cathode probe unit extra, 17/6. £8.10.0. (Rail 15/-). CR100 Noise Limiter assemblies with valve, 3/8. NEW M.C. METERS, 34in. round flush, 50µA 70/-; 200µA centre zero, 50/-; 1 mA. centre zero, 45/-; 1 mA, 55/-; 100 mA, 8/8; 3in. 300 mA, each 8/6; VIBRATORS, Mallory G634C 12 v. 4-pin, 7/6; 6 v. 5-pin reversible, 7/8. DRIVES: slow motion Admiralty 200 : 1 ratio, scaled 0-100, 5/8; £115 S.M. "C" 10H, 250 mA, 12/6; VIB-PAK, 8 v. D.C. to 250 v., 60mA smoothed case, 22/6 (p.p. 3/6), or 12 v. 25/-; DYNAMOTORS (post 3/6), 12 v. to 250 v., 60 mA, 11/8, 5 v. to 250 v., 60 mA, 11/8. CHOKES, LF 10H, 200 mA, 8/6; "C" 10H, 250 mA, 12/6; 5H, 400 mA, 10/8; 30H, 50 mA, 7/6; 10H, 500 mA, "C" 22/6; 20H, 100 mA, 9/8; 8H, 190 mA, 8/6; 16H, 150 mA, 9/8. TRANSISTORS V20110/P, 10/-; GERM. RECTIFIERS GJ5M, (300P1.V., 550 mA), 10/-; RELAYS (LONDEX) co-ax, small 12/24 v., 7/8; 12/24 v. DP/CO, 5/8; 24 v. DP/CO plus 1M (Two on Base) 8/6. Valveholders: B7G W/Skit, 5/- dozen L.O. Ceramic, 1/- each. CALIBRATOR T.B. UNITS. Input 115/250 v. A.C. Outputs—D.C. 330 v., 120 mA and A.C. 6.3 x 2. with 15 valves: new, 35/- (rail 7/6). Test set 263, 9280/9480 mcs, with waveguides and 50µA and 1 mA Meters; new £5.10 (rail 7/6).

LIST AND ENQUIRIES S.A.E. please. Terms, C.W.O. Postage extra. Imm. despatch, Callers and post.

W. A. BENSON (P.W.), 136 Rathbone Road, Liverpool, 15. SEP 8853. Callers: SUPERADIO (Whitechapel), Ltd., 118 Whitechapel, Liverpool 1.

ROY 1130



**PADGETTS RADIO STORE**

40 MEADOW LANE, LEEDS 11  
Phone: Cleckheaton 2866.

**Rush TV 24c.** BBC-ITV Television Set, complete and in perfect working order. 13 channels, £4.10., carriage and insurance 17/-.

**Rush 24c.** 5 channels 55/- carriage 17/- Tested OK.

**New Bomblight Computers.** Type X15A full of gears and motors, 42/-, carriage 10/-.

**Brand New Boxed CRT Tubes.** Types 5FP7, 3/6. VCR517C, 5/-, VCR112, 3/6. CV429 12in., 5/-. Carriage and insurance on any tube 6/6.

**Brand New, U.S.A. amplifier type A684.** Double blower motor takes JAHAE/27, valves, etc. Less valves, 17/-, carriage 8/6.

**P.M. Speakers.** Removed from TV sets. All guaranteed perfect working order. sound comes 8in. and 7 x 4, 5/-, post 2/-.

**TV Tubes. Requined.** 12 months' guarantee, 14in. and 17in. all at £3.15.0, carriage and insurance 7/6.

**NEW VALVES, Ex-units. All post free.**

6K7	2/-	EL91	1/9	1S4	2/-
8X9	3/6	EB91	1/9	5U4	4/6
6X5	4/-	EF50	1/8	EA50	6d.
6V8GT	4/-	EF50 red	2/-	VR37	6d.
6A4	3/6	E19	4/-	U12	5/-
6C4	2/-	6X30033	1/8	DL810	1/4
KT88	6/6	E1S24	2/-	9001	9d.
KT63	4/-	2C26A	2/-	964	1/8
EF91	1/9	VR150/30	4/-		

Valves removed from TV sets. All tested on a Mullard Valve Tester, are 100% as new. They carry a 3 months' unconditional guarantee. All valves Post Free.

**Grade 2** 2/- 6F14 5/- U801 3/6  
6d. 6SN7 2/9 U25 5/-  
ECL20 4/6 6G6 2/6 U261 5/-  
ECC82 5/6 6Y8 2/6 U229 5/-  
EL38 4/6 6Y8 2/6 KT38 5/-  
EY51 4/- 6LD20 5/- PL81 5/-  
EBF80 4/6 10C2 3/- PY81 4/6  
EB91 1/- 10E1 2/6 PL82 5/-  
EP91 1/- 10P14 1/8 PY80 5/-  
EL91 1/10 10P13 5/- PL33 5/-  
6P25 4/- 20D1 3/- PZ30 5/-  
6P28 5/- 20P1 5/- B36 4/6  
6P25 5/- 20L1 5/- N37 5/-  
6P1 2/- 20P4 5/- L63 3/-  
6P13 2/- 185BT 8/6

**TV Spares.** Cydon tuners, less knobs and valves, 2/6, post 2/-.

**Reclaimed TV Tubes.** Not booted, six months' guarantee. 12in. Mullard 17/-, 12in. Mazda 25/-, 14in. Mullard 30/-. Carriage insurance 7/6.

**Complete TV Chassis for Spares.** Less valves, 12in. four for 10/-, carriage 5/-, 14in. chassis four for 15/-, carriage 7/6.

★★★ Special bargain offer-Complete Kit P.W. Superhet including genuine Ediswan Transistors, £7.15.0-a bargain not to be missed ★★ Red Spot Transistors, 2/9, White Spots, 2/9; Yell./Gr., 3/3; Ediswan XA102, 9/-; XA104, 8/-; XA103, 8/-; XA101, 8/-; XB103, 7/6; XB104, 6/6; XC101, 8/6; Special bargain set for P.W. Superhet 6 Transistors (1-XA102, 2-XA101, 1-XB103, 2-XC101), plus Diode, 42/6; Newmarket V15/10 P, 15/-; Diodes, 1/-; 2/-; 3/-; Transistor holders, 1/-; Ardent Trans. D239, 8/6; D240, 8/6; D.131, 10/-; D.132, 10/-; Sub. Min. Electrolytics 2, 4, 8, 10, 16, 32 mfd. 2/-; 50, 100, 2/9. M.C. Earpiece (used as speaker), 5/-; Balance Inserts (as earpiece or speaker), 3/6. Silicon Rectifier bargain 70 p.i.v. 1/2 amp., 3/3; Westalite Contact Rectifier 250 v., 60 mA, 7/6; Transformer 250.0-250 v., 6v. and 5v., 15/-; Packard Bell Amplifiers, new 12/6; Garrard Portable Record Player, cabinet, battery runtable 45 r.p.m. and pick-up; takes transistor amplifier, £3/10/0, plus carr. 3/3. Real bargain. Limited quantity. TERMS.—Cash with order. Post extra, excess refunded. Our Reflex Rx. best 2-transistor Receiver. Send 8d. stamps for notes.

**MOORES EXPERIMENTAL SUPPLIES**  
8 & 10 Granville Street, Sheffield 2  
Tel.: 27461

**3-TRANSISTOR POCKET RADIO**

With Miniature Loudspeaker  
ABSOLUTELY NO SOLDERING  
REQUIRED



Unique Design  
**39/6**

Superb appearance. Simple instructions.

Build in an evening. No drilling. Complete in every detail. Full medium wave coverage. Aerial required in certain areas. Pocket size 4 1/2 x 2 1/2 x 1 1/2 ins.

**OR THE MORE POWERFUL SAVOY SUPER 3 55/6**  
No Aerials required P. & P. 2/-  
Battery 1/- extra ALL PARTS SOLD SEPARATELY.

**SAVOY BARGAINS**

- High gain audio transistors, 4/6, P. & P. 3d.
- Ferrite rod 4 x 3/4 in., 1/6, P. & P. 6d.
- Solid dielectric tuning condensers: 0.0003 mfd. 4/-; 0.0005 mfd. 4/3; P. & P. 6d.
- Miniature dynamic speakers. Resistance 30 or 70 ohms, 4/6, P. & P. 8d.
- 5 ft. phone cord with No. 9 jack plug, 2/-, P. & P. 6d.

**SAVOY ELECTRONICS LTD.**

15 Malden Lane, Strand, London WC2  
(Back of Adelphi Theatre)

**2 METRES!**

The thrills of 144 Mc/s can now be yours for only 39/6, complete kit! Tuneable range 150-160 Mc/s, simplified construction, etc., write today for descriptive literature, also if a newcomer-beginner to Amateur Radio, asks for free copy of the world-famous "Globe-King" kits and receivers—stamp to cover postage costs appreciated. Write now to makers:

**JOHNSONS (Radio)**  
St. Martins Gate, Worcester

**JAMES H. MARTIN & CO.**

Radio & Television Component Service  
Finthwaite, Newby Bridge  
Ulverston, Lancs.

Lists available. Inland 3d. stamp only  
Overseas, airmail 5/- refundable.

**RES/CAP. BRIDGE 38/-**

p. & p. 2/6  
Checks all types of resistors, condensers  
6 RANGES  
Built in 1 hour. Direct reading  
**READY CALIBRATED**  
Stamp for details of this and other kits.  
**RADIO MAIL (Dept. QP)**  
Raleigh Mews, Raleigh Street, Nottingham

**COYNE'S NEW PIN-POINT TV TROUBLES**

TAKES HEADACHES OUT OF ALL SERVICING PROBLEMS

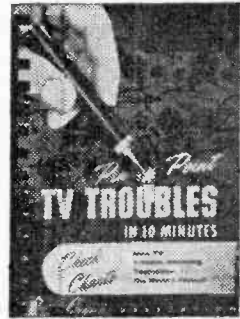

Your most get-on-the-job "tool"! Quickly and easily pin-points the exact trouble in any TV set. Covers 70 symptoms, 700 trouble spots. Over 340 cross-indexed pages; 50 time-saving Check-Charts; 290 diagrams. It is practical; explanation of circuits and designs.

**SIMPLE CHECK-CHART SYSTEM SAVES TIME!**

This amazingly practical handbook shows you how to find the trouble in any TV circuit FAST! Simple cross-index tells you in what section you'll find cause of trouble. Handy Check-Charts then help you accurately locate the EXACT trouble spot. Cut waste time, eliminate hours of aggravation, get right to the heart of the trouble in minutes.

**USE THIS BOOK RIGHT ON THE JOB—NO NEED TO MEMORIZE!**

This Pin-Point Book was designed especially for on-the-job trouble-shooting. You simply turn to the indexed section, locate the circuit description and Check-Chart, and in minutes you have the trouble spot located and ready for repair. No complicated theory or mathematics. Down-to-earth, practical circuit description, service methods and trouble-shooting techniques. Published by the famous Coyne Electrical School and approved by leading authorities in the field.

J. E. C. Grewer of Stratham says: "Immediately I glanced through this book I was convinced that your claims concerning the merits of this work were justified, for it is, without a doubt, the finest book of its kind that I have ever come across. It is not only unique in its presentation but it is also superbly produced."

G. Axam of London S.E.8, says: "I have spent nearly £50 on technical books over the past 6 years all of which I feel has now been wasted as your book is the best I have yet had the pleasure of examining. It is practical, to the point, with just the right amount of technical information needed, covering almost every aspect of TV servicing."

**SEND NO MONEY!**  
Just mail coupon for free trial. After 7 days send only low price or return book and pay nothing!

**FREE TRIAL OFFER!**

Mail Coupon NOW!

Mail Order Division, B1M-TECH BOOK COMPANY, Dept. AS, Gater's Mill, West End, Southampton, Hants.

RUSH TV Troubles 31/6d. plus 1/6d. postage; for 7 day FREE TRIAL as per offer.

Tick here if enclosing full price, we pay postage; Same 7 day money back guarantee

Name.....  
Address.....  
City..... County.....

★ Miniature 3/4 in. diam. x 3/4 in. edge volume controls with switch; 5k and 10k, 7/6 each; 5k, 7/6; 50k, 8/6; printed circuit.  
 ★ Speakers: 3 ohm, 3 in., 15/-; 25 ohm, 22/6; 5 in., 3 ohm, 15/-, 1/- P/P.  
 ★ Ferrite Rod - 1st grade 4 x 1/2 in., 1/6; 5 x 3/4 in., 1/6; 8 x 1/2 in., 3/6; 8 x 3/4 in., 3/6; 4 x 1 1/2 in. slab, 2/-, P/P 6d.

★ 1000 ohm Personal Phone with Leads and Jack Plug and Socket, suitable for most Commercial Transistor Radios. 15/6.

★ 9.065 Mc/s 3rd Overtone Crystal for all 27 Mc/s Model Control Transmitters. 12/6.

★ 7 section chromed Telescopic Aerials, 38 in. with fixing bracket, 12/6. P.P. 1/6. 64in. Version, 17/6. P.P. 1/6.

★ ACOS Crystal Mic inserts. 2in., 12/6; 1 1/2 in., 7/6. 3/4 in. round or square 3/6. P/P 6d.

★ Submin. Condensers. All low voltage; 0.1, 0.25, 0.5, 1, 2, 4, 6, 8, 10, 16, 25, 30, 50, 100 mfd. All types, 2/- each.

★ Standard Miniature: 1, 2, 4, 8, 10, 25, 30, 50, 100, 200, 250, 500 mfd. All types 1/6 each.

★ Sub-miniature Jack Plug and Socket, 3/6 complete. P/P 6d.

★ Set of 4 I.F. and Osc. Coils. U.S.A. Sub-miniature type, 21/-.

★ 2-Gang 1 inch Square Poly Tuner for above. 17/6.

★ 1 watt Push-Pull Transformers for OC81's 21/- pair. P/P 1/-.

★ 7 x 4in. 25 ohm Speaker, 22/6; 7x 4in., or high quality 3 ohm Speaker, 20/-.

★ Pocket Iron, 220/250V A.C./D.C. 30 watts, complete with mains plug, case, etc. Handle unscrews to cover element enabling iron to be carried in pocket. Only 18/6. P.P. 1/-.

★ 208 + 176 pF 00'tuner, with screw 8/6. P/P 9d.

★ Sub-miniature 27 Mc/s 3rd Overtone Xtal for model control 30/-.

★ Personal Earphones used with RANGER 2 and 3. British made, 12/6

★ 2 1/2 inch round 1/2 inch deep 3 ohm speaker, 17/6

All Transistor Medium Long and Short Wave Pre-built Units in Stock. Fully illustrated Booklet showing uses. 2/6.

### TYPE 38 TRANSMITTER/RECEIVER

complete with 5-valves, in new condition sold without guarantee but are generally workable.

- Coverage 7 to 9 Mc/s variable tuning.
- Requires 120 to 150 volt and 1 1/2 volt batteries.
- Range 3 to 5 miles. 22/6 p.p. 2/6

HEADPHONES with JACK PLUG 6/- pair  
 JUNCTION BOX 2/6  
 THROAT MIKE with JACK PLUG 4/6  
 5 ft AERIAL ROD 2/6  
 (POSTAGE ON ABOVE 1/- PER ITEM)

### MINIATURE COMPONENTS CHASSIS

- including
- 1in. square crystal microphone
  - Sub-miniature volume control with switch.
  - Sub-miniature output transformer
  - Sub-miniature 1 pole 4-way switch
  - Earphone socket
  - Miniature jack socket
- Sub-miniature resistors and condensers and chassis 7/6. P.P. 9d.

★ Standard Volume Controls, 3/4 in. dia., 3in. spindle: 5k, 10k, 25k, 50k, 100k, 250k, 500k, 1 meg, 2 meg, 3/6, less switch; 4/6 with switch.

★ Low impedance Magnetic mikes (no matching required) 1/2 x 1/2 x 1 1/2 in. 10/-; 3/4 in. dia. x 3/4 in. deep 15/-; 1 1/2 in. dia. x 3/4 in. deep round 15/-, 3/4 x 3/4 x 3/4 in. 12/6. Ideal for amplifiers H. Aids.

★ 5in. 25 ohm Speaker, 25/-.

★ Miniature Light Weight, 4 1/2 to 5V, 8mA Relay, 24/-.

★ Lightweight 4000 ohm Headphones, 12/6.

★ Driver and Output Transformer (matched to 8/10 ohms), 12/6 pair.

★ Siemens High Speed Sealed Miniature Relay, 1700-1700 ohms. 15/-ea.

★ 4.7 volt 1 watt Zener Diode. 19/6 ea.

★ 2 1/2 in. 10 ohm Speaker, 17/6.

★ ACOS 39-1 Stick Mic. with lead and stand, 39/6. P.P. 1/6.

★ Acos 45 Hand Mic. 29/6. P.P. 1/6.

★ Crystal Lapel Microphone, ideal for portable tape recording, 18/6. P.P. 1/-.

★ Diodes: GD3, 2/-; OA79, 3/-; OA70, 3/-; OA91, 3/6; OA10, 3/-; OA85, 3/-; OA10, 8/-; G37M, 4/-.

★ Sub-miniature Pre-sets. 5k, 10k, 50k, 100k, 250k, 500k, 1 meg, 2 meg, 2/- each.

★ 2 1/2 in. 8/10 ohm Speaker U.S.A. Type. 17/6.

★ 365pF 3/4 in. square U.S.A. Type Tuner, 8/6.

★ 2 1/2 in. 80 ohm Speaker, excellent quality, 17/6.

★ 600 ohm Personal Car Phone with jack and socket, 10/6, P.P. 9d.

★ Acos 40 Desk Mic. 19/6, P.P. 1/6.

● 6 Mullard Transistors and Diode  
 1-OC44 ONLY  
 2-OC45 50/-  
 1-OC71 PER SET  
 2-OC72  
 1-OC81

Other matched sets in stock send for list.

All COMPONENTS in STOCK for "WEYRAD" 6-Transistor Superhet. Booklet 1/3 post free. Leaflet on request.

★ Quartz Crystals ★ Over 600 types in stock for all purposes—fully guaranteed. Free List on Request.

### 3-TRANSISTOR AND DIODE PERSONAL POCKET RADIO



**SUPER 3**

QUALITY OUTPUT ON PERSONAL EARPHONE

A simple to build local station radio with personal earphone output. Built-in Ferrite Aerial and Battery lasting 9 months.

ALL PARTS 37/6 P.P. 1/6  
 ● NO EXTRAS TO BUY Size 4 1/2 x 3 x 1 1/2 in.

★ IDEAL for BEGINNERS



### TRANSISTORS

MORE THAN 50% PRICE REDUCTIONS

● MULLARD AND EDISWAN →



SEND FOR LATEST PRICE LIST

### RANGER 2

### PERSONAL POCKET RADIO

● Two Transistor Two Diode version of "Ranger-3". See back page. Ideal pocket receiver.

All Parts 59/6 P.P. 1/6.

● PICTORIAL PLANS AND DETAILS FREE ON REQUEST.



ALL TRANSISTOR ● TIME SAVER ● OFFICE OR HOME TELEPHONE PICK-UP AMPLIFIER

● No more "Holding Up" wasting time waiting for your call to come through. When it does the amplifier can be switched off if required. No connections, just Sellotape the pick-up coil to back of phone as above.

BUILT, TESTED, READY TO USE

£5.10.0 P.P. 2/6

● 5-inch speaker; 3 months' battery life. Now with 400mW output.

ALSO 'BABY ALARM' £5.10.0 p.p. 2/6.

### PRACTICAL TRANSISTOR CIRCUITS

3/6 Post Free.

Contains easy to follow plans of 40 all transistor units, including light operated switches, amplifiers, transmitters, receivers, test oscillators, signal tracers, hearing aids, radio control, etc. All parts available separately. ★ Designed for the Home Constructor.

### VALVES

WE STOCK OVER 800 TYPES OF VALVES AND TUBES AT REALLY COMPETITIVE PRICES. Free List on Request

**Henry's Radio Ltd**  
 DEPT. B10  
 5 HARROW ROAD . LONDON W.2

Opposite Edgware Road Tube Station  
 OPEN MON. to SAT. 9-6, THURS. 1 o'clock  
 Telephone: PADDINGTON 1008/9.

SEE BACK PAGE

OUR SPECIALITIES  
 Transistors, Valves,  
 Quartz Crystals, Components at Competitive Prices

# Practical Wireless

## BLUEPRINT

## SERVICE

ALL OF these blueprints are drawn full-size and although the issues containing descriptions of these sets are now out of print, constructional details are available free with each blueprint except for the PW Monophonic Electronic Organ.

The index letters which precede the Blueprint Number indicate the periodical in which the description appeared. Thus PW refers to PRACTICAL WIRELESS; AW to *Amateur Wireless* and WM to *Wireless Magazine*.

Send (preferably) a postal order to cover the cost of the Blueprint (stamps over 6d. unacceptable) to

PRACTICAL WIRELESS, Blueprint Dept., George Newnes, Ltd., Tower House, Southampton Street, London, W.C.2.

### SPECIAL NOTE

THE following blueprints include some pre-war designs and are kept in circulation for those constructors who wish to make use of old components which they may have in their spares box. The majority of the components for these receivers are no longer stocked by retailers.

Title	Number	Price
<b>CRYSTAL SETS</b>		
Junior Crystal Set .. .. .	PW94	2/-
Dual-wave Crystal Diode .. .. .	PW95	2/6

<b>STRAIGHT SETS</b>		
<b>Battery Operated</b>		
Modern One-valver .. .. .	PW96	2/6
All-dry Three .. .. .	PW97	3/6
Modern Two-valver .. .. .	PW98	3/6
The PW Pocket Superhet .. .. .	—	5/-

<b>SUPERHETS</b>		
<b>Mains Operated</b>		
A.C. Band-pass Three .. .. .	PW99	4/-
A.C. Coronet-4 .. .. .	PW100	4/-
A.C./D.C. Coronet .. .. .	PW101	4/-

<b>MISCELLANEOUS</b>		
The PW 3-speed Autogram .. .. .	—	8/-
The PW Monophonic Electronic Organ .. .. .	—	8/-
<i>(No constructional details are available with this blueprint)</i>		
The PW Roadfarer .. .. .	—	5/-
<i>(No constructional details are available with this blueprint)</i>		

<b>TELEVISION</b>		
The PT band III converter .. .. .	—	1/6

Title	Number	Price
A.C. Fury Four .. .. .	PW20	2/6
Experimenter's Short Wave .. .. .	PW30a	2/6
Midget Short Wave Two .. .. .	PW38a	2/6
Band-Spread Three (Battery) .. .. .	PW68	2/6
Crystal Receiver .. .. .	PW71	2/-
Signet Two (Battery) .. .. .	PW76	2/6
Simple S.W. One-valver .. .. .	PW88	2/6
Pyramid One-valver .. .. .	PW93	2/6

BBC Special One-valver .. .. .	AW387	2/6
Short-Wave Two .. .. .	AW429	2/6
Short-Wave World Beater .. .. .	AW436	3/6

Standard Four Valve S.W. .. .. .	WM383	3/6
Enthusiast's Power Amplifier .. .. .	WM387	3/6
Standard Four Valve .. .. .	WM391	3/6
Listener's 5-Watt Amplifier .. .. .	WM392	3/6

### QUERY COUPON

This coupon is available until 6th October, 1961, and must accompany all queries in accordance with the notice on our "Letters to the Editor" page.

PRACTICAL WIRELESS, OCTOBER, 1961

**POCKET TESTMETER****20,000  
OHMS PER VOLT !****£6.19.6** P.P. 1/6.WITH TEST PRODS, BATTERY  
AND INSTRUCTIONS.A new pocket meter of exceptional  
sensitivity easy to use and read.

- ★ **TOP QUALITY.**
- ★ **OVER 20 SCALES.**

Size  $4\frac{1}{2} \times 3\frac{1}{2} \times \frac{1}{8}$  in.  
Fully GuaranteedSize  $4\frac{1}{2} \times 3 \times 1\frac{1}{2}$  in.

ALL COMPONENTS  
**79/6** P.P. 1/6  
NO EXTRAS TO BUY  
Everything supplied.

- **AFTER SALES SERVICE, GUARANTEED SUCCESS**

★ **RANGER 3** ★  
NO EXTERNAL AERIAL OR EARTH  
**3-TRANSISTOR and 2-DIODES**  
PERSONAL POCKET RADIO with 5  
stages giving clear reception on medium  
wave, amateur top band and shipping.  
**FULL STATION SEPARATION**

Only first grade components used  
throughout. As described in March RC.  
● Easy to follow instructions  
with pictorial layout.  
● Reception of Radio Luxemburg  
guaranteed (most  
areas).

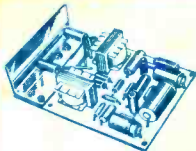
Free Instructions and Price  
List on request. Easy to build● **AFTER SALES SERVICE, GUARANTEED SUCCESS** **$\frac{3}{4}$ -WATT  
4 TRANSISTOR  
AMPLIFIER**

- 1 watt peak output.
- $\pm 3$ db 70c/s to 12 kc/s.
- Output to 3 ohm speaker.
- 9 volt operated.

Built and Tested  
**69/6** P. & P. 1/6

A printed circuit high gain amplifier, size  $4 \times 2\frac{1}{2} \times \frac{1}{2}$  in., using Mullard OC71/OC81D and 2-OC81 Transistors. Ideal for Intercomm., Record Player, Tuner Amplifier or any application requiring a quality and reliable amplifier.

- **FULL DETAILS AND USES ON REQUEST**

Size  $8\frac{1}{2} \times 6\frac{1}{2} \times 3\frac{1}{2}$  in.

● Full coverage on  
Medium and Long wave-  
bands. Excellent quality  
with full station separation.

- **BUILDING PLANS & PRICES FREE ON REQUEST**
- **ALL PARTS IN STOCK FOR "P.W. POCKET 6"**  
As previously advertised, at £8.19.6.  
LEAFLET ON REQUEST

**"TRANSFIVE" PORTABLE  
MEDIUM AND LONG WAVE  
PORTABLE RADIO**

- 325 mW Push-Pull Output on  
5-inch Speaker.
- Fully Illustrated Plans.
- Easy to Build Printed Circuit.
- Carded Components.
- 5 "Top Grade" Transistors.

**AFTER SALES SERVICE  
and  
FULLY GUARANTEED**

TOTAL COST OF ALL PARTS  
**£6.19.6** P.P. 2/6  
NO EXTRAS TO BUY

**COMBINED  
PORTABLE AND  
CAR RADIO**  
**"CONTESSA"**  
**6 TRANSISTOR  
MEDIUM & LONG  
WAVE SUPERHET**  
TERRIFIC SENSITIVITY  
UNBEATABLE IN  
PERFORMANCE AND  
APPEARANCE

- Specification:**
- 425mW Push-Pull Output.
  - 6 "Top-Grade" Ediswan Transistors.
  - New Type Printed Circuit with all Components marked.
  - Full Medium & Long Wave Tuning.
  - High "Q" Internal Ferrite Aerial.
  - Car Radio Adaptation and AVC.
  - "Hi-Fi" Quality Speaker
  - Slow Motion Fingertip Tuning with Station names clearly marked.



● Attractive Rexine Covered Cabinet. Red/white or Blue/white. Fully illustrated building plans and packaged components enable the "Conessa" to be built without any technical knowledge.  
● All parts sold separately.  
● Descriptive leaflet on request.

TOTAL COST OF ALL PARTS

**£10.19.6** P.P. 3/6

- **NO EXTRAS TO BUY**

**6-TRANSISTOR FIDELITY "CORONET"  
MEDIUM AND LONG WAVE  
POCKET RADIO**

- Size  $2\frac{1}{2} \times 4\frac{1}{2} \times 1\frac{1}{2}$  in.
- Quality Push-Pull Speaker Output.
- Guaranteed for 12 months.
- Phone and Tape Sockets.

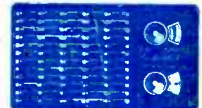

**9 1/2 gns** Reg. Post  
2/6  
(INCL. BATTERY)

**ALL BRITISH DESIGN AND  
CONSTRUCTION**

**"QUINTET"  
MEDIUM AND LONG WAVE  
POCKET LOUDSPEAKER  
RADIO**

- 250mW Push-Pull Output.
- Plainly marked Printed Circuit Board.
- 5 "Top Grade" Transistors.
- Carded Components.

Size  $5\frac{1}{2} \times 3 \times 1\frac{1}{2}$  in.

A new design. Fully tunable on both wavebands. Guaranteed reception of Continental and local stations, including Luxembourg, anywhere with full station separation. Fitted Car Aerial and Earpiece Sockets.

- **Illustrated Instructions FREE ON REQUEST**

TOTAL COST OF ALL PARTS  
**£5.10.0** P.P. 2/-  
NO EXTRAS TO BUY

VERY EASY TO BUILD AND USE.  
Fitted Car Aerial and Earpiece Sockets.

All Parts Sold Separately

- **Illustrated Instructions FREE ON REQUEST**

**AVO MULTI-METERS**

● **AVO MODEL 7** ●  
COMPLETE WITH INSTRUCTIONS  
LEADS AND BATTERIES  
(List £19.10.0)

OUR PRICE **£12.10.0** Reg. Post 5/-

● **AVO MODEL 8** ●  
COMPLETE WITH LEADS  
BATTERIES AND INSTRUCTIONS  
(List £24.10.0)

OUR PRICE **£17.10.0** Reg. Post 5/-



BOTH TYPES ARE FULLY GUARANTEED

PLEASE

TURN  
PAGE**Henry's Radio Ltd 5 HARROW RD., LONDON, W2**

Opposite Edgware Road Tube Station. PADDINGTON 1008/9. Open Monday to Sat. 9-6, Thurs. 1 o'clock

★ Let us have your Enquiries for Components, Miniature and Standard ★  
NOT ALL OUR UNITS ARE ADVERTISED ABOVE, SEND FOR DETAILS OF OUR RANGE