

SEPTEMBER
1961

Practical 1/6 **WIRELESS**

**A WOBBULATOR
FOR F.M. I.F.
ALIGNMENT**



Transistorised VHF Superhet **An Intercom Amplifier**

POWER MEGAPHONE MODEL PM.242

HAND-HELD PORTABLE SOUND BROADCASTER WEIGHING ONLY 4lbs.

A lightweight new megaphone notable for its extreme economy in battery power despite its high sound volume output. Incorporates a patented non-linear current-limiting device to give maximum possible battery life. Just pick it up, aim, press the pistol grip switch, and talk. The reflexed air column in the horn, plus its special shape serve to concentrate and direct the amplified sound and throw it for a considerable distance. Sturdy construction throughout with lightweight spun aluminium rubber ribbed horn. Microphone is removable from instrument to give the added feature of remote operation. Especially recommended for use on Loading Platforms, Police and Fire Departments, Railway Yards, Sports Events, Coaching, Holiday Resorts, Ship to Ship and Ship to Shore Voice Communication, etc.

Size: 14in. long.
Horn dia. 9in.
Wgt.: 4lb. Supplied complete with batteries and wrist and shoulder straps.

ONLY
£14.10.0
Post Paid



PM 242

LAPEL MICROPHONE MODEL 178

Precision engineered Crystal Microphone for lapel or hand use. Only 1 1/2 in. diameter. Exceptionally sensitive. Chrome plated case and clip includes 5ft. shielded cable. Only 17/6. P. & P. 1/-

RH-20 RADIO HEADPHONES

Hi-impedance 2,000 ohms-general use headset. Black and Ivory plastic cased electro-magnetic units with adjustable head-band for comfortable fit. Individual listening for all types of applications. Individually packed, with flexible cord attached. 14/6. post paid.

WIRELESS SET No. 19



Incorporates TX/RX covering 2-10 Mc/s (37.5-150 metres), and intercom, amplifier, 500 microamp check and tuning meter, circuit and instruction book.

ONLY 65/-, Carr. 10/-

TELEPHONE PICK-UP COILS



MODEL FC-8 Induction Pick-up coils enabling conversations to be picked up without tapping of wires or special telephone circuits. Brand new complete with 5ft. shielded cable, 16/- plus 1/6 P. & P.



S.L.I.M. RADIO PLUGS A N D SOCKETS.

Two-way, black bakelite, solder terminal PLUG and STURDY standard SOCKET. 5/6 per pair. Post Paid. Panel mounting, neat finish.



DM 175

MINIATURE CLEAR PLASTIC PANEL METERS

"S" METER MODEL SR. 2P. Standard "Head" signal strength indicator. Calibrated in "S" units from 0-0 with scale terminating in - 10 to + 30 db calibrations. Additional full scale calibrations of 0-5 - 0-10 in linear scale divisions. A "most" for radio amateurs for conversion of any Communication Receivers with A.V.C action to give calibrated signal strength action. 35/-

VU METER MODEL VR. 1P. Calibrated and damped in accordance with standard VU Meter Practice. Upper scale reads -20 to +3VU. Lower scale 0-100% modulation. Uses precision carbon film multiplier resistor and full wave rectifier. 42/6.

DC MICROAMMETERS Model MR.25 0 to 50 uA. 39/6.
Model MR.250 0 to 500 uA. 32/6.
Model MR.21 0 to 1mA. 27/6.
All Models Individually Boxed and Fully Guaranteed. P. & P. 2/6 each.



MINIATURE EARPHONE

A really sensitive dynamic earphone of exceptionally fine quality. Provides clear reproduction of music as well as speech. Fully Guaranteed and complete with transparent ear insert 3 feet cord, sub-miniature plug and socket.
CR-5 High Imp. crystal 8/- Each
MR-1 Low Imp. magnetic 12/- Post 1/-

3-WAY SLIM CRYSTAL MICROPHONE

- May be hand held, stand mounted or suspended by Lavalier Cord
- Response 60-10,000 Cps
- Built in on/off switch.

Revolutionary new crystal microphone with all the features of "Mikes" three times the price. Output level—52db Omni-directional head. Clips on or off standard stand adaptor, permitting linking for multi-angle use. Satin chrome finished complete with 7ft. shielded cable, stand adaptor and Lavalier Cord.



MODEL 100C

ONLY
39/6
P. & P. 2/6

NEW! 10,000 O.P.V.

MULTI-TESTER ON BOTH AC & DC

MODEL EP-10K OUTPERFORMS INSTRUMENTS MANY TIMES ITS SIZE AND PRICE!

UNBELIEVABLE BARGAIN!

A revolutionary new Multi-Tester. A complete wired and tested instrument (not a kit) incorporating extra large 3 1/2 in. meter face and unique slide range switch. Can be conveniently carried in the pocket and features unusually sensitive 10,000 ohms per volt AC-DC meter 1 per cent precision resistors, and largest meter ever placed on an instrument of this size. Simple, easy to use range selector switch, can be appreciated by the novice and engineer alike. Complete with colour coded test leads and battery.
Size: 4 1/2 x 3 1/2 x 1 1/2 in. Model EP-10K ONLY **£5.19.6** P. & P. 3/6.



MAINS PORTABLE SOLDERING IRON



Model SPL Precision Built. 30 Watts. Only 18/9. P. & P. 1/3.

HI-FI HEADPHONES
Uses high-quality permanent magnetic speakers with regular voice coil. The padded chamois ear muffs give correct spacing for optimum acoustic load, giving finest music and voice reproduction. Each unit has a built-in Hi-Fi 500 trans. total 1000Ω. Only 25/- P. & P. 1/6.

ACCUMULATORS 2 volts 16 A.H. (unsplittable). Ideal for 6 and 12 volts supply etc. Brand new. Original cartons. Size 4in. x 7in. x 2in. 5/6 each. P. & P. 1/6. 3 for 15/- P. & P. 3/6. 6 for 27/6 P. & P. 5/-

AERIAL VARIOMETERS

These magnificent instruments will enable you to receive maximum signal strength on all S.W. receivers. Precision controlled control 12/6. P. & P. 2/6.

MINIATURE DUBILIER CONDENSER SPECIAL!

Millions of one dozen from these assorted values: .002; .004; .01; .005; .01; .001; all at 100 volts A.C. and 300 volts D.C. Recent Manufacture ONLY 5/- per dozen. P. & P. 6d. (Please state values required.)

FULL SCALE RANGES:
D.C. VOLTAGE: 0-6-30-120-600-1200v. (10,000 o.p.v.)
A.C. VOLTAGE: 0-6-30-120-600-1200v. (10,000 o.p.v.)
D.C. CURRENT: 0-120 uA. 0-12 300mA.
RESISTANCE: 0-20K. 0-2 Meg (150 ohm, 15K at centre scale).
CAPACITANCE: 0.005 to 0.15 uF (at A.C. Res.)
DECIBELS: -20 to -63db (600 ohm, 1mW, 0.03m-0.755 v.)
ACCURACY: D.C. Voltage and Current ± 2%. I.S. A.C. Voltage ± 4%. I.S. Resistance ± 3% of total scale length



MAIL ORDERS TO
DEPT. P., 32a COPTIC STREET,
LONDON, W.C.1



CALLERS WELCOME AT
87 TOTTENHAM COURT ROAD,
LONDON, W.1 MUS 9606

Tel: Mitcham 6201
Open Daily to Callers

R S T

All Valves Brand New
and Fully Guaranteed

211 STREATHAM ROAD, MITCHAM, SURREY

Special 24 Hour Express Mail Order Service

| | | | | | | | | | | | | | | | | | |
|--------|------|--------|------|--------|-------|-----------|------|-------|------|---------|------|---------|--------|--------|------|--------|-------|
| OZ4 | 5/9 | 6CH6 | 12/- | 10C2 | 27/10 | 32 | 13/6 | CCH35 | 21/- | ECL83 | 12/6 | H23DD | PENA4 | 17/6 | U282 | 22/- | |
| IA5 | 6/- | 6E5GT | 10/- | 10F1 | 26/2 | 35A5 | 15/- | CL4 | 12/6 | EF9 | 21/- | HL41 | 10/6 | PENB4 | 17/6 | U301 | 22/6 |
| IA7 | 14/6 | 6F1 | 15/6 | 10F3 | 17/6 | 35L6GT | 10/6 | CL33 | 18/6 | EF22 | 17/6 | HL41DD | 12/6 | PEN4DD | | U329 | 17/6 |
| ID5 | 10/- | 6F6 | 6/9 | 10F9 | 12/6 | 35W4 | 8/- | CY1 | 15/9 | EF36 | 7/6 | | | | 22/6 | U339 | 19/- |
| ID6 | 14/- | 6F7 | 15/- | 10LD3 | 12/6 | 35Z4 | 7/6 | CY31 | 15/9 | EF37 | 8/6 | | | | 13/6 | U403 | 11/6 |
| IHS | 10/6 | 6F12 | 4/- | 10LD11 | 15/- | 35Z5 | 9/6 | D41 | 12/6 | EF37A | 8/6 | HL42DD | | | 13/6 | U404 | 10/- |
| IL4 | 4/6 | 6F14 | 17/6 | 10P13 | 21/- | 40SUA | 15/- | D42 | 12/6 | EF39 | 4/- | | | | 13/6 | U801 | 29/- |
| ILN5 | 4/6 | 6F15 | 14/9 | 10P14 | 20/- | 41STH | 23/6 | D63 | 3/6 | EF40 | 15/- | HY90 | 8/- | PL82 | 8/- | U40C20 | 15/6 |
| IN5 | 10/6 | 6F17 | 12/- | 11D3 | 17/6 | 42 | 15/- | D77 | 5/6 | EF41 | 9/3 | IW4/350 | 10/6 | PL83 | 10/6 | U4BC80 | 7/- |
| IR5 | 9/- | 6F33 | 5/6 | 11D5 | 17/6 | 43 | 15/- | D152 | 6/- | EF42 | 10/6 | IW4/500 | 10/6 | PL820 | 21/- | UAF42 | 9/6 |
| ISS | 5/6 | 6H6 | 2/6 | 12A6 | 6/6 | 50C5 | 15/- | DAC32 | 10/6 | EF50(E) | 3/6 | KBC32 | 9/6 | PM2A | 12/6 | UB41 | 9/- |
| IS4 | 8/6 | 6H8GT | 4/6 | 12AH3 | 10/- | 50CD6G | | DAF91 | 7/6 | EF50(A) | 4/- | KF35 | 8/6 | PM2HL | 13/6 | UBC41 | 9/6 |
| IT4 | 4/- | 6J7GT | 9/6 | 12AT7 | 6/- | 50L6GT | 9/- | DF33 | 10/6 | EF80 | 5/- | KLL32 | 11/6 | PM2M | 13/6 | UBF80 | 7/6 |
| IU5 | 10/6 | 6K7G | 3/- | 12AU7 | 9/- | 61BT | 17/6 | DF91 | 4/- | EF85 | 5/6 | KL35 | 9/6 | PM202 | 16/- | UCB85 | 10/- |
| 2D21 | 8/6 | 6K7GT | 10/6 | 12AX7 | 9/6 | 61SPT | 17/6 | DF92 | 7/- | EF86 | 11/6 | KT2 | 7/6 | PY31 | 16/6 | UCH42 | 8/6 |
| 2X2 | 5/- | 6K8GT | 12/6 | 12BA6 | 9/6 | 62BT | 17/6 | DF97 | 9/6 | EF91 | 4/- | KT32 | 10/- | PY32 | 15/6 | UCH81 | 8/6 |
| 3D6 | 14/6 | 6K25 | 15/6 | 12BE6 | 9/6 | 75 | 12/6 | DH63 | 10/6 | EF92 | 5/- | KT33C | 10/- | PY80 | 8/- | UCL82 | 12/6 |
| 3Q4 | 8/6 | 6L1 | 19/6 | 12E1 | 17/6 | 77 | 12/6 | DH76 | 7/6 | EF93 | 7/6 | KT36 | 22/6 | PY81 | 7/6 | UCL83 | 13/6 |
| 3Q5 | 10/6 | 6L6 | 7/6 | 12I7GT | 9/6 | 78 | 12/6 | EF95 | 15/- | KT41 | 8/6 | KT44 | 13/6 | PY82 | 8/6 | UF41 | 9/- |
| 3S4 | 8/6 | 6L18 | 12/6 | 12K7GT | 8/6 | 80 | 10/- | DH107 | 13/6 | EL31 | 12/6 | KT45 | 12/6 | PY83 | 8/6 | UF42 | 11/6 |
| 3V4 | 9/- | 6L19 | 21/- | 12K8GT | 12/6 | 85A2 | 12/6 | DH719 | 7/6 | EL32 | 5/- | KT55 | 22/6 | PZ30 | 18/6 | UF80 | 9/- |
| SU4G | 4/6 | 6L34 | 10/- | 12Q7GT | 8/6 | 150B2 | 12/6 | DK91 | 9/- | EL33 | 12/6 | KT61 | 18/6 | QP25 | 14/6 | UF85 | 9/- |
| SV4 | 8/6 | 6/30L2 | 10/- | 12SC7 | 8/- | 150B3 | 15/- | DK92 | 9/6 | EL35 | 12/6 | KT63 | 8/6 | QP230 | 17/6 | UF89 | 8/- |
| 5Y3GT | 8/6 | 6LD3 | 9/6 | 12SG7 | 8/- | 185BT | 32/- | DK96 | 10/- | EL37 | 18/6 | KT66 | 17/6 | QP21 | 12/6 | UL41 | 9/- |
| SZ3 | 10/6 | 6LD20 | 15/6 | 12SH7 | 4/- | 303 | 7/6 | DL35 | 12/6 | EL41 | 10/6 | KT74 | 12/6 | R19 | 19/6 | UL44 | 24/6 |
| SZ4G | 10/6 | 6N7GT | 7/6 | 12SJ7 | 4/- | 304 | 7/6 | DL92 | 8/6 | EL42 | 10/6 | KT76 | 12/6 | SD6 | 8/6 | UL84 | 7/6 |
| 6A7 | 18/6 | 6M1 | 10/6 | 12SK7 | 8/- | 305 | 7/6 | DL94 | 9/- | EL81 | 14/9 | KT101 | 25/- | 5P4 | 14/6 | U06 | 20/11 |
| 6A8 | 10/6 | 6M2 | 10/6 | 12SQ7 | 11/6 | 328 | 7/6 | DL96 | 9/6 | EL84 | 7/- | KTW63 | 7/6 | 5P41 | 3/6 | U07 | 15/- |
| 6A8B | 9/- | 6P1 | 17/6 | 12SN7 | 17/6 | 329 | 7/6 | EAS0 | 2/- | EL85 | 10/6 | KTZ41 | 8/- | 5P42 | 12/6 | U08 | 26/- |
| 6A8B | 9/- | 6P25 | 19/6 | 12Z3 | 15/- | 807 | 7/6 | EAB80 | 7/6 | EL90 | 8/6 | KTZ63 | 10/- | 5P61 | 3/6 | U21 | 15/6 |
| 6A8B | 9/- | 6P28 | 26/- | 13D3 | 12/6 | 955 | 4/- | EAC91 | 7/6 | FL91 | 5/- | L63 | 4/9 | T41 | 22/6 | U41 | 7/6 |
| 6A8B | 9/6 | 6Q7GT | 10/6 | 14H7 | 12/6 | 5763 | 17/6 | EAF42 | 10/6 | EM80 | 10/- | LN309 | 15/- | TDD4 | 17/6 | U85 | 6/6 |
| 6AK5 | 7/6 | 6SA7GT | 7/6 | 14R7 | 12/6 | 9002 | 7/6 | EB41 | 7/6 | EM81 | 10/- | LZ319 | 12/6 | TDD13C | | VP2B | 17/6 |
| 6AK8 | 7/6 | 6SG7 | 7/6 | 14S7 | 21/- | 9003 | 7/6 | EB41 | 5/- | EM81 | 10/- | MH4 | 8/6 | | 17/6 | VP4B | 17/6 |
| 6ALS | 6/- | 6SH7 | 6/6 | 15A2 | 17/6 | AC4/PEN | | EY51 | 8/6 | EM81 | 10/- | MHL | 17/6 | TH41 | 23/9 | W17 | 8/6 |
| 6AM5 | 5/- | 6S17 | 5/6 | 15D2 | 23/9 | AC5/PEN | 25/- | EBF80 | 9/6 | EY84 | 10/6 | MHL | 10/- | TP22 | 17/6 | W76 | 7/6 |
| 6AM6 | 4/- | 6SK7 | 7/6 | 19AQ5 | 10/6 | AC5/PEN | 22/6 | EBF89 | 7/6 | EY86 | 9/6 | MKT4 | 5(7/2) | TP25 | 17/6 | W77 | 5/- |
| 6AN5 | 7/6 | 6SL7GT | 6/6 | 19BG6G | | AC6 | 21/6 | EBL21 | 22/- | EY91 | 9/- | MS4B | 17/6 | U14 | 15/9 | W81 | 6/- |
| 6AQ5 | 8/3 | 6SN7GT | 5/6 | | 24/4 | ACTP | 32/- | EBL31 | 21/6 | EZ35 | 7/6 | MSP4 | 17/6 | U16 | 10/- | W142 | 9/- |
| 6AQ8 | 9/3 | 6U4GT | 11/6 | 20D1 | 12/6 | ACHL | 12/6 | EC90 | 9/6 | EZ40 | 7/6 | MUI4 | 9/- | U18/20 | 10/- | W719 | 7/6 |
| 6AT6 | 8/3 | 6U5 | 7/6 | 20D2 | 23/- | AC/PEN | | EC91 | 9/6 | EZ41 | 7/6 | MX40 | 17/6 | U24 | 29/6 | W727 | 7/6 |
| 6AU6 | 10/- | 6U7 | 7/6 | 20F2 | 26/6 | ACTH1 | 34/9 | ECC31 | 10/- | EZ80 | 7/6 | N18 | 8/- | U25 | 14/- | X18 | 11/6 |
| 6B7 | 10/6 | 6V6G | 5/- | 20L1 | 26/6 | ACVPI | 17/6 | ECC32 | 10/- | EZ81 | 7/6 | N19 | 8/- | U26 | 12/6 | X65 | 23/9 |
| 6B8 | 4/- | 6V6GT | 8/- | 20P1 | 26/- | ACVPI | 17/6 | ECC33 | 5/- | EZ90 | 7/6 | N37 | 18/6 | U31 | 9/6 | X66 | 21/- |
| 6BA6 | 7/6 | 6X4 | 5/- | 20P3 | 23/- | ACVPI | 17/6 | ECC34 | 15/- | FC2 | 21/- | N78 | 17/6 | U33 | 21/- | X78 | 21/- |
| 6BE6 | 7/6 | 6X5GT | 5/- | 20P5 | 22/6 | AC2/PEN | | ECC35 | 8/- | FC13 | 17/6 | N108 | 18/- | U35 | 21/- | X79 | 21/- |
| 6BG6G | 21/- | 7B7 | 8/- | 25L6GT | 9/6 | AC2/PEN | 21/- | ECC40 | 21/- | FW4,500 | | N142 | 9/6 | U37 | 25/- | Y61 | 10/6 |
| 6B16 | 7/6 | 7C5 | 8/- | 25Y5 | 10/- | AC2 | | ECC81 | 6/- | FW4,800 | | N147 | 18/6 | U45 | 21/- | Y63 | 9/- |
| 6BW6 | 7/6 | 7C6 | 8/- | 25Z4 | 9/6 | PENDD21/- | | ECC82 | 9/6 | | | N150 | 10/- | U47 | 21/- | Z21 | 12/6 |
| 6BW7 | 5/- | 7D5 | 15/- | 25Z5 | 9/6 | AZ1 | 15/6 | ECC83 | 9/6 | | | N153 | 10/6 | U50 | 8/6 | Z63 | 7/6 |
| 6BX6 | 6/- | 7D6 | 15/- | 25Z6 | 10/6 | AZ1 | 10/6 | ECC84 | 9/6 | | | N309 | 11/6 | U52 | 7/6 | Z66 | 19/6 |
| 6B7 | 5/- | 7D8 | 15/- | 27SU | 17/6 | B36 | 21/- | ECC85 | 8/- | | | N329 | 10/6 | U76 | 7/6 | Z73 | 4/9 |
| 6C4 | 6/6 | 7H7 | 8/- | 30 | 13/6 | B65 | 8/6 | ECC91 | 5/6 | | | N727 | 7/6 | U78 | 7/6 | Z153 | 8/6 |
| 6CS5GT | 8/- | 7K7 | 10/6 | 30C1 | 12/6 | B152 | 8/6 | ECF80 | 12/6 | | | N729 | 8/- | U142 | 8/- | Z19 | 7/9 |
| 6C6 | 6/6 | 7O7 | 11/6 | 30F5 | 11/6 | B305 | 9/6 | ECF82 | 12/6 | | | H63 | 9/6 | U145 | 15/- | ZD152 | 9/6 |
| 6C9 | 12/6 | 7R7 | 12/6 | 30FL1 | 10/6 | B329 | 9/6 | ECF81 | 22/- | | | HBC90 | 9/6 | U153 | 9/6 | | |
| 6CD10 | 12/6 | 7S7 | 10/6 | 30L1 | 11/6 | B339 | 9/6 | ECF85 | 21/- | | | HL92 | 6/6 | U191 | 20/- | | |
| 6CD6G | 27/6 | 7Y4 | 7/6 | 30P4 | 22/- | B719 | 9/7 | ECF82 | 10/6 | | | HL133DD | | U251 | 17/6 | | |
| 6D1 | 8/- | 8D3 | 4/- | 30P12 | 11/6 | B811 | 17/6 | ECF81 | 9/6 | | | | | U251 | 17/6 | | |
| 6D2 | 5/- | 9BW6 | 14/9 | 30P16 | 10/6 | CBLL1 | 17/6 | ECH83 | 12/6 | | | | | U281 | 20/- | | |
| 6D3 | 15/- | 10C1 | 18/- | 30PL1 | 15/- | CBL31 | 21/- | ECL80 | 9/- | | | | | | | | |

METAL RECTIFIERS

| | | | | | |
|-----|------|---------------|------|--------------|------|
| RM1 | 6/- | 1BRA 1-1-8-1 | 4/6 | 16RE 2-1-8-1 | 8/6 |
| RM2 | 8/- | 1BRA 1-1-16-1 | 6/6 | 1BRA 1-2-8-1 | 11/- |
| RM3 | 9/- | 16RA 1-1-16-1 | 8/6 | 14A86 | 17/- |
| RM4 | 16/6 | 14RA 1-2-8-2 | 18/- | 14A97 | 23/6 |
| RM5 | 22/- | 14RA 1-2-8-2 | 21/- | 14A100 | 24/- |

SPECIAL OFFER

IT4 4/-, SU4G 4/6, 6K7G 3/-, 6K8 8/-, 6V6G 5/-, 6X4 4/6, EBC33 4/-, EF39 4/-, EF80 5/-, EF85 5/6, EF91 4/-, EL84 7/-,

TERMS OF BUSINESS C.W.O. or C.O.D.
2/9 PACKING CHARGE ON ALL C.O.D.
ORDERS. POSTAGE 3d. PER VALVE

OBsolete VALVES A SPECIALITY.
QUOTATIONS GIVEN ON ANY TYPE
NOT LISTED



Stern's "fidelity" TAPE RECORDERS

**BEFORE YOU BUY
—YOU SHOULD
HEAR THESE**

RECORDERS. THEY ARE COMPARABLE TO THE MUCH HIGHER-PRICED MODELS

There are no better value-for-money Tape Recorders on the market—if you can't call and hear them send S.A.E. for fully descriptive leaflets.

MODEL CR3/S Incorporates the COLLARO "STUDIO" TWIN TRACK 3-speed Deck, operating at 1 $\frac{1}{2}$, 3 $\frac{1}{2}$ and 7 $\frac{1}{2}$ speeds. **£39.10.0**
H.P. Terms: Deposit £7.18.0 and 12 months of £2.17.11.

All prices quoted provide for the COMPLETE RECORDER including CRYSTAL MICROPHONE and 1,200 ft. Spool of Tape.

Each Model incorporates the highly successful HF/TR3 Amplifier (described below) thus ensuring truly "HI-FI" record and playback facilities.

MODEL TR3/Mk.V1 Incorporates the New TRUVOX Mk. VI TWIN TRACK 2-speed Tape Deck operating at 2 $\frac{1}{2}$ and 7 $\frac{1}{2}$ speeds. **£49.10.0**
H.P. Terms: Deposit £9.18 and 12 months of £3.12.7

TAPE AMPLIFIERS and PRE-AMPLIFIERS PRESENTED FROM MULLARD DESIGNS

MODEL HF/TR3 TAPE AMPLIFIER
(Mullard Type "A" design) A very high quality Amplifier incorporating 3-speed treble equalisation, by the latest FERROXCUBE POT CORE INDUCTOR FOR COLLARO-TRUVOX or BRENNELL WEARITE Tape Decks, has GILSEN Output Transformer. Includes separate Power Supply Unit.

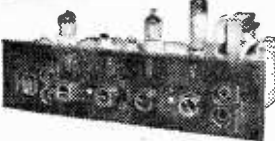

MULLARD TYPE "C" TAPE PRE-AMPLIFIER—ERASE UNIT



The "HI-FI" link to add full tape recording facilities to High Fidelity home installations. Incorporates FERROXCUBE POT CORE PUSH PULL OSCILLATOR and 3-speed treble equalisation by FERROXCUBE POT CORE INDUCTOR FOR WEARITE-COLLARO-TRUVOX OR BRENNELL TAPE DECKS. Includes separate power Supply Unit.

OR ASSEMBLED **£17.0.0**
KIT OF PARTS **£13.13.0** H.P. Deposit £3.8.0 and 12 months at £1.4.11.

OR ASSEMBLED **£17.0.0**
KIT OF PARTS **£14.0.0** H.P. £3.8.0 Deposit and 12 months £1.4.11 (Excluding power unit £11.15.0 and £14.10.0 respectively).

FOR THE HOME CONSTRUCTOR SPECIAL 'COMBINED ORDER' PRICES

- (a) The COLLARO "STUDIO" TAPE DECK and our Mullard Type "C" PRE-AMPLIFIER and POWER Unit Assembled and Tested. **£29.10.0**
H.P. Deposit £4.18.0 and 12 months £2.3.5.
- (b) As above but TYPE "C" PRE-AMPLIFIER supplied as complete KIT OF PARTS. **£26.10.0**
- (c) The TRUVOX Mk. VI DECK and the assembled Type "C" Pre-amplifier and Power Unit. **£40.0.0**
H.P. Deposit £8.0.0, and 12 months £2.18.5.
- (d) As above but Type "C" as complete KIT OF PARTS. **£36.10.0**
- (e) The BRENNELL Mk. V DECK and the assembled Type "C" PRE-AMPLIFIER and POWER UNIT. **£46.0.0**
H.P. Deposit £9.4.0, and 12 months £3.7.6.
- (f) As (e) but Tape "C" as complete KIT OF PARTS. **£43.0.0**
- (g) THE WEARITE 4A DECK with TYPE "C" assembled and tested. **£56.0.0**
H.P. Deposit £11.4.0 and 12 months £4.2.1.

- (a) COMPLETE KIT to build the HF/TR3 Amplifier, together with the COLLARO "STUDIO" DECK. **£26.0.0**
- (b) As above but with HF/TR3 supplied ASSEMBLED and TESTED. **£29.10.0**
H.P. Deposit £5.18.0 and 12 months £2.3.3.
- (c) COMPLETE KIT to build the HF/TR3, together with the NEW TRUVOX Mk. VI TAPE DECK. **£36.10.0**
- (d) As above but HF/TR3 supplied ASSEMBLED and TESTED. **£40.0.0**
H.P. Deposit £8.0.0, and 12 months £2.18.3.
- (e) COMPLETE KIT to build the HF/TR3 AMPLIFIER with the BRENNELL Mk. V TAPE DECK. **£42.0.0**
- (f) As above but HF/TR3 supplied ASSEMBLED and TESTED. **£45.10.0**
H.P. Deposit £9.2.0, and 12 months £3.5.9.
- (g) THE WEARITE 4A DECK with assembled and tested HF/TR3 Amplifier including WEARITE Head Lift Transformer. **£55.0.0**
H.P. Deposit £11.0.0, and 12 months £4.0.0.

(Carriage and Insurance on above quotes 10/- extra). EACH OF THE ABOVE CAN BE SUPPLIED IN A PORTABLE CASE FOR £5.10.0 EXTRA, THUS FORMING A COMPLETE PORTABLE PRE-AMPLIFIER. FULL DETAILS ON REQUEST.

Carriage and insurance on each above is 10/- extra. Attractive PORTABLE CASE is available to accommodate the TRUVOX or COLLARO TAPE DECKS and we offer it, together with ROLA/CELESTION 10 x 6in. LOUDSPEAKER—ACOS CRYSTAL MICROPHONE—and 1,200 ft. SPOOL E.M.I. TAPE—ALL FOR £9.0.0. Carriage and Insurance 5/- extra.

SPECIAL OFFER OF TAPE spools. New, boxed and guaranteed.
225ft. on 3in. Spool..... **5/9**
900ft. on 5in. Spool..... **18/6**

P.V.C. base on latest type plastic
1,200ft. on 5in. Spool..... **21/-**
1,800ft. on 7in. Spool..... **21/-**
1,200ft. on 7in. Spool..... **32/6**

TAPE ACCESSORY KITS

- (a) E.M.I. Includes 3 reels leader tape, splicer, jointing tape and stop foil. **37/6**
- (b) SCOTCHBOY includes 3 reels leader tape, splicer, and jointing tape. **29/6**

A LARGE PURCHASE OF BRAND NEW AND FULLY GUARANTEED GARRARD TAPE EQUIPMENT



ENABLES THESE OUTSTANDING PRICE REDUCTIONS
The "MODEL HFG/2R" PORTABLE TAPE RECORDER (Original Price £33.0.0) **FOR ONLY 22 gns.**

H.P. Dep. £4.14.0. 12 months £11.3.9. (Carr. & ins. 10/- extra). Incorporates THE LATEST GARRARD "MAGAZINE" TAPE DECK and a HIGH QUALITY AMPLIFIER which is entirely based on the very successful MULLARD TYPE "A" DESIGN and specifically designed to operate the GARRARD DECK. Price INCLUDES SUPPLY OF THE GARRARD TAPE MAGAZINE and 4in. SPOOL OF DOUBLE PLAY TAPE. Comprises a Twin Track Recorder operating at 3in/sec. speed and providing up to 1 hour 10 mins. playing time. Truly "Portable", weighs only 22 lbs. Outstanding features are excellent performance and simplicity of operation.

THE "ADD-A-DECK"

Incorporating GARRARD "MAGAZINE" TAPE and the MATCHED MODEL HF/G3P PRE-AMPLIFIER

Supplied on ONE CHASSIS (as illustrated) **18 Gns.** READY FOR USE (Carr. & ins. 10/- extra). Price includes Garrard Magazine and a 4in. Spool Double Play Tape H.P. Deposit £3.16.0, and 12 months of £1.7.8. Provides complete tape recording facilities and designed to operate through the pick-up sockets of the standard type of RADIO RECEIVER, or an AMPLIFIER, from which really first class reproduction is obtained. It consists of a Twin Track Deck connected to the Pre-amplifier and operates at 3in/sec. speed providing up to 1 hr. 10 mins. playing time.



FULLY DESCRIPTIVE LEAFLETS ON ALL OF ABOVE ARE AVAILABLE—BUT PLEASE ENCLOSE S.A.E. AND STATE WHICH LEAFLET IS REQUIRED.

STERN RADIO LTD.

STERN'S MULLARD DESIGNS

Designed by MULLARD—presented by STERN'S strictly to specification

COMPLETE KIT OF PARTS

MULLARD "5-10" MAIN AMPLIFIER

For use with the MULLARD 2-valve pre-amplifier with which undistorted power output of up to 10 watts is obtained. We supply SPECIFIED COMPONENTS AND NEW MULLARD VALVES, including PARMKO MAINS TRANSFORMER and choice of the latest Ultra-Linear PARMKO or the PARTRIDGE Output Transformer. COMPLETE KIT OF PARTS (PARMEKO Output Trans.) **£10.00**



Alternatively we supply ASSEMBLED AND TESTED. **£11.10** INCORPORATING PARTRIDGE OUTPUT TRANSFORMER, £1.60 EXTRA.

MULLARD'S PRE-AMPLIFIER

TONE CONTROL UNIT

Employing two EF86 valves, and designed to operate with the MULLARD MAIN AMPLIFIERS, but also perfectly suitable for other makes.



PRICE COMPLETE KIT OF PARTS **£6.60** ASSEMBLED AND TESTED **£8.00**

- Supplied strictly to MULLARD'S SPECIFICATION and incorporating:
- Equalisation for the latest R.I.A.A. characteristics.
 - Input for Crystal Pick-ups, and variable reluctance magnetic types.
 - Input (a) Direct from High Imp. Tape Head. (b) From a Tape Amplifier or Pre-amplifier.
 - Sensitive Microphone Channel. ● Wide range BASS and TREBLE Controls.

COMPLETE MULLARD "5-10" AMPLIFIER

The popular and very successful complete "5-10" incorporating Control Unit providing up to 10 watts high quality reproduction. Only Specified Components and new MULLARD VALVES are supplied including PARMKO MAINS TRANSFORMERS and choice of the latest PARMKO or PARTRIDGE ULTRA-Linear Output Transformers.

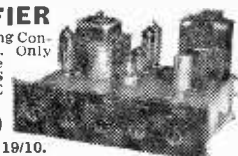

KIT OF PARTS **£11.10** OR ASSEMBLED AND TESTED **£13.10**

H.P. (Assembled Amp. only). DEPOSIT £2.14.0 12 months at 19/10. ABOVE incorporating PARTRIDGE OUTPUT TRANS. £1.6 extra.

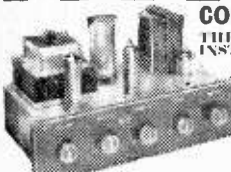

COMPLETE MULLARD "3-3"

THE IDEAL AMPLIFIER FOR A SMALL HIGH QUALITY INSTALLATION PROVIDING EXCELLENT REPRODUCTION OF UP TO 3 WATTS OUTPUT. COMPLETE KIT OF PARTS **£7.10** OR ASSEMBLED AND TESTED **£8.19.6** (plus 6/6 carriage and insurance) H.P. Terms: Deposit £2.0 8 and 8 Months at £1.0. Complete to MULLARD'S SPECIFICATION including Mullard valves and a PARMKO OUTPUT TRANSFORMER.

A SPECIAL CASH OFFER!!

This very attractive PORTABLE AMPLIFIER CASE together with a good quality GRAM AMPLIFIER and a matched P.M. SPEAKER. ALL for ONLY **£8.7.6** (Plus 7/6 Carr. & Ins.)



The Amplifier consists of a 2-stage design incorporating 3 modern B.V.A. valves and has separate BASS and TREBLE CONTROLS.

The Portable Case will also accommodate almost any make of Autochanger and is attractively finished in Mushroom Grey Rexine. WE ALSO SUPPLY SEPARATELY—

- (a) The 2-stage (plus Rectifier) AMPLIFIER **£4.2.6**
- (b) The PORTABLE CARRYING CASE **£3.17.6**
- (c) 6in. P.M. SPEAKER 18/9 Carriage and Insurance 4/- extra.

RECORD PLAYERS THE LATEST MODELS ARE IN STOCK, MANY AT REDUCED PRICES

- SEND S.A.E. FOR ILLUSTRATED LEAFLET
 - B.S.R. MONARCH UA8 4-speed mixer Autochanger with Crystal Pick-up. **£6.19.6**
 - THE NEW COLLARO MODEL RP594 4-speed Single Record Player. Studio Cartridge. **£9.18.9**
 - THE NEW COLLARO C60 4-speed Autochanger unit with Studio "C" Pick-up. **£7.19.6**
 - The E. M. L. 4-speed Single Record Player with crystal Pick-up. **£6.9.6**
 - B.S.R. MODELS UA12 and UA14. Each a 4-speed mixer autochanger with Crystal Pick-up. **£7.19.6**
 - Both available incorporating the B.S.R. STEREO Pick-up, plays L.P. and 78 Records. **£10.10.0**
 - GARRARD MODEL TA/MkII 4-speed Player fitted high output Crystal Pick-up. **£8.10.0**
 - GARRARD MODEL HG4 Autochanger 4-speeds. High output. Crystal Pick-up. **£8.19.6**
- Carriage and Insurance on each above, 5/- extra.

Dept. P.W. 109 FLEET ST. LONDON E.C.4
Telephone: FLEET STREET 5812/3/4

PRICE REDUCTIONS

- (a) THE KIT OF PARTS to build both the "5-10" Main Amplifier and the 2-valve PRE-AMP CONTROL UNIT. **£15.15.0**
 - (b) The "5-10" and the 2-stage PRE-AMP both ASSEMBLED and TESTED H.P. Dep. £3.16.0 and 12 months of £1.7.8. **£18.18.0**
 - (c) THE KIT OF PARTS to build the DUAL-CHANNEL "3-3" AMPLIFIER and the DUAL-CHANNEL PRE-AMPLIFIER CONTROL UNIT. **£21.10.0**
 - (d) THE DUAL-CHANNEL "3-3" AMPLIFIER and the DUAL-CHANNEL PRE-AMPLIFIER CONTROL UNIT BOTH ASSEMBLED and TESTED. H.P. Terms: Deposit £5 and 12 months of £1.18.8. **£25.0.0**
 - (e) THE KIT OF PARTS to build one "5-10" MAIN CHANNEL and the DUAL-CHANNEL PRE-AMPLIFIER CONTROL UNIT. **£21.10.0**
 - (f) ONE "5-10" AMPLIFIER and the DUAL-CHANNEL PRE-AMPLIFIER both ASSEMBLED and TESTED. H.P. Terms: Deposit £5, 12 months of £1.18.8. **£25.0.0**
 - (g) KIT OF PARTS to build Two "5-10" MAIN AMPLIFIERS (incorporating Parmeko Output Transformers) and the DUAL-CHANNEL PRE-AMPLIFIER CONTROL UNIT. **£31.0.0**
 - (h) TWO "5-10" AMPLIFIERS and the DUAL-CHANNEL PRE-AMPLIFIER CONTROL UNIT BOTH ASSEMBLED & TESTED. H.P. Terms: Deposit £7.4.0. 12 months £2.12.0. **£36.0.0**
- Carriage and Insurance 7/6 extra. Prices quoted are subject to £1.6.0 extra for Partridge Transformer.

STEREO PRE-AMPLIFIER

This model incorporates two Mullard 2-valve Pre-Amplifiers combined into a single unit enabling it to be used for both STEREO PHONIC or MONAURAL operation. It is designed primarily to operate with our range of MULLARD MAIN AMPLIFIERS but will also operate equally well with any make of Amplifiers requiring an input of 100 ohms.



COMPLETE KIT OF PARTS **£12.10.0** ASSEMBLED AND TESTED **£15.0.0**

H.P. £3 Dep. and 12 mths. at £1.2.0

MULLARD FOUR CHANNEL MIXER UNIT

Self powered with Cathode follower output. Incorporates Two inputs for MICROPHONES. One for CRYSTAL PICK UP and a fourth for RADIO or TAPE Complete Kit of Parts **£8.8.0**

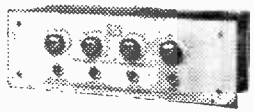

Assembled and Tested **£10.0.0**

TERMS: Deposit £2 and 12 months at 15/-

MODEL I.L. one microphone Inp.it matched for moving coil or Ribbon Mike. £1.17.0 extra.

STEREO PRE-ANNOUNCEMENT

To meet the increasing demand for stereophonic sound equipment our Design Engineers are producing.

MINIFLUX and COLLARO for operation with the latest MINIFLUX and COLLARO track tape heads.

The Unit incorporates the latest circuitry, the design being based on the very popular MULLARD TYPE "C" Unit, and employs a sensitive meter for accurately setting the record level. High-grade Tape Decks incorporating the MINIFLUX Heads will be available and in keeping with our normal practice will be offered with the Pre-amplifier. Full details and the assembled Pre-amplifier will be available in September.

STERN'S INTER-COMM or BABY ALARM

A small versatile Unit employing the new MULLARD ECL86 valve and designed to provide two (or three) way conversation up to extreme distances. Operates from A.C. Mains 200 to 250 Volts and as in all our designs only new high grade and guaranteed components are incorporated.

PRICES... MASTER UNIT and ONE EXTENSION KIT OF PARTS **£6.17.6** ASSEMBLED AND TESTED **£8.0.0**

The equipment consists of a MASTER UNIT, size only 8 1/2 x 5 1/2 x 6 in. and ONE EXTENSION (a second extension may be added at any time). The Master Unit incorporates switching and power supply and with the chassis completely isolated from the mains is operated in absolute safety. Attractively presented in Cases covered in quality leatherette.

BENTLEY ACOUSTIC CORPORATION LTD.

38 CHALCOT ROAD, CHALK FARM, LONDON, N.W.1.

Telephone: PRIMROSE 9090

EXPRESS POSTAL SERVICE. ALL ORDERS DESPATCHED SAME DAY AS RECEIVED. TELEPHONE AND TELEGRAM ORDERS FOR CASH ON DELIVERY SERVICE ACCEPTED UP TO 3.30 P.M.

| | | | | | | | | | | | | | | | | | | | |
|--------|-------|--------|-------|--------|-------|---------|-------|--------|-------|---------|-------|----------|-------|----------|-------|----------|-------|-------------|------|
| OA2 | 17/6 | 6F6G | 7/1 | 10F1 | 26/6 | 35Z4GT | 6/1 | DH76 | 5/1 | EF40 | 15/1 | HN309 | 24/7 | PL84 | 12/8 | UABC80 | 9/1 | XFY34 | 17/6 |
| OB2 | 17/6 | 6F11 | 17/3 | 10F9 | 11/6 | 35Z5GT | 9/1 | DH77 | 7/1 | EF41 | 9/1 | HVR2 | 20/7 | PL820 | 18/8 | UAF42 | 9/6 | XH(1.5) | 6/6 |
| OZ4 | 5/1 | 6F12 | 4/6 | 10LD11 | 15/11 | 43 | 10/1 | DK32 | 12/1 | EF42 | 10/6 | HVR2A | 6/1 | PM84 | 17/7 | UB41 | 12/1 | YSG(1.5) | 6/6 |
| IA5 | 6/1 | 6F13 | 1/6 | 10P13 | 15/1 | 50C5 | 10/1 | DK91 | 6/1 | EF50(A) | 7/1 | KF35 | 8/6 | PX4 | 4/6 | UBC41 | 8/6 | Y63 | 7/6 |
| IA7GT | 12/1 | 6F15 | 15/3 | 10P14 | 19/3 | 50C6DG | 6/1 | DK92 | 9/1 | EF50(E) | 5/1 | KL35 | 8/6 | PY31 | 16/7 | UBC81 | 11/4 | Z63 | 7/6 |
| IC5 | 12/6 | 6F23 | 10/6 | 12A6 | 5/1 | | | DK96 | 8/6 | EF54 | 5/1 | KLL32 | 24/7 | PY32 | 12/6 | UBF80 | 9/1 | Z66 | 17/6 |
| ID6 | 10/6 | 6F24 | 12/6 | 12AC6 | 15/3 | 50L6GT | 9/6 | DL33 | 9/6 | EF73 | 10/6 | KT2 | 5/1 | PY80 | 7/6 | UBF89 | 9/6 | Z77 | 4/6 |
| IG6 | 17/6 | 6F32 | 10/6 | 12AD6 | 17/3 | 53KU | 19/11 | DL66 | 17/6 | EF80 | 6/1 | KT33C | 10/1 | PY81 | 8/6 | UBL21 | 23/3 | Z719 | 6/1 |
| IHS5GT | 10/6 | 6F33 | 7/6 | 12AE6 | 13/11 | 77 | 8/1 | DL68 | 15/1 | EF85 | 6/1 | KT36 | 29/10 | PY82 | 7/1 | UCC84 | 14/7 | | |
| IL4 | 3/6 | 6G6 | 6/6 | 12AH7 | 8/1 | 78 | 6/6 | DL72 | 15/1 | EF86 | 10/6 | KT41 | 23/3 | PY83 | 8/6 | UC85 | 9/1 | Transistors | |
| ILDS | 5/1 | 6H6 | 3/1 | 12AH8 | 12/6 | 80 | 9/1 | DL92 | 7/1 | EF89 | 9/1 | KT44 | 12/6 | PY88 | 13/3 | UCF80 | 16/3 | and diodes | |
| ILNS | 5/1 | 6J5 | 3/1 | 12AT6 | 7/6 | 83 | 15/1 | DL94 | 7/6 | EF91 | 4/6 | KT61 | 12/6 | PZ30 | 19/11 | UCH21 | 23/3 | CG1C | 7/6 |
| IN5GT | 10/6 | 6J6 | 5/6 | 12AT7 | 6/1 | 85A2 | 16/1 | DL96 | 8/6 | EF92 | 4/6 | KT63 | 7/1 | Q21 | 7/1 | UCH42 | 9/6 | CG4E | 7/6 |
| IR5 | 6/1 | 6J7G | 6/1 | 12AU7 | 23/3 | 90AC | 6/1 | DM70 | 7/6 | EF97 | 13/3 | KT66 | 15/1 | QP25 | 14/6 | UCH81 | 9/6 | CG6E | 7/6 |
| IS4 | 9/1 | 6J7GT | 10/6 | 12AU7 | 6/6 | 90AY | 6/1 | EB0F | 30/1 | EF98 | 13/3 | KT88 | 24/7 | QS150/15 | | UCHL2 | 11/6 | CG7E | 7/6 |
| IS5 | 6/1 | 6K7G | 5/1 | 12AV6 | 12/8 | 90C1 | 16/1 | EB3F | 30/1 | EF183 | 12/7 | KTW61 | 6/6 | | | UCL83 | 19/3 | CG10E | 7/6 |
| IT4 | 3/6 | 6K7GT | 6/1 | 12AX7 | 7/6 | 90CG | 37/6 | EA50 | 2/1 | EF184 | 18/6 | KTW62 | 7/6 | R12 | 9/1 | UF41 | 9/1 | GD3, 4, 5 | |
| IU5 | 6/1 | 6K8BG | 10/6 | 12BA6 | 8/1 | 101 | 13/6 | EA76 | 9/6 | EK32 | 8/6 | KTW63 | 6/6 | R18 | 14/1 | UF42 | 12/6 | 6, 8 | 4/1 |
| 2D21 | 15/1 | 6K8G | 6/6 | 12BE6 | 9/1 | 150B2 | 18/1 | EABC80 | 9/1 | EL32 | 5/1 | KTZ41 | 8/1 | R19 | 19/11 | UF80 | 10/6 | OA70 | 3/1 |
| 2P | 26/6 | 6K25 | 19/11 | 12BH7 | 21/3 | 161 | 10/6 | EAC91 | 4/6 | EL33 | 12/6 | KTZ63 | 7/6 | RG1/240A | | UF85 | 9/1 | OA73 | 3/1 |
| 2X | 4/6 | 6L1 | 23/3 | 12E1 | 30/1 | 185B7 | 33/2 | EAF42 | 9/1 | EL34 | 15/1 | L63 | 6/1 | | 54/1 | UF86 | 17/11 | OA79 | 3/1 |
| 3A4 | 6/1 | 6L6G | 8/1 | 12J5GT | 4/6 | 304 | 10/6 | EB34 | 2/6 | EL38 | 26/6 | MHL4 | 7/6 | RK34 | 7/6 | UF89 | 9/1 | OA81 | 3/1 |
| 3A5 | 10/6 | 6L6M | 9/6 | 12J7GT | 9/6 | 305 | 10/6 | EB41 | 8/6 | EL41 | 9/1 | MHL2 | 12/6 | S130 | 22/6 | UL41 | 9/1 | OA86 | 4/1 |
| 3B7 | 12/6 | 6L7GT | 7/6 | 12K5 | 17/11 | 807 | 7/6 | EB91 | 4/1 | EL42 | 10/6 | ML4 | 8/6 | SP4(7) | 14/6 | UL44 | 24/6 | OA91 | 3/6 |
| 3D6 | 5/1 | 6L18 | 13/1 | 12K7GT | 5/6 | 956 | 3/1 | EC33 | 23/3 | EL81 | 16/7 | MS4B | 23/3 | SP41 | 3/6 | UL46 | 16/6 | OA95 | 3/6 |
| 3Q4 | 7/6 | 6L19 | 23/3 | 12K8GT | 14/1 | 1821 | 16/7 | EBC33 | 5/1 | EL83 | 19/11 | MU12/14 | 8/1 | SP42 | 12/6 | UL84 | 8/6 | OA210 | 11/1 |
| 3Q5GT | 9/6 | 6LD20 | 15/11 | 12Q7GT | 5/1 | 4033L | 12/6 | EBC41 | 8/6 | EL84 | 7/6 | N37 | 23/3 | SP61 | 3/6 | UM4 | 17/6 | OA211 | 20/1 |
| 3S4 | 7/1 | 6N7 | 8/1 | 12SA7 | 8/6 | 5763 | 12/6 | EBC81 | 8/1 | EL85 | 13/11 | N78 | 19/11 | SU25 | 26/6 | UM34 | 17/3 | OC16 | 48/1 |
| 3V4 | 7/6 | 6P26 | 19/11 | 12SC7 | 8/6 | 7193 | 5/1 | EBF80 | 9/1 | EL86 | 17/3 | N108 | 23/3 | T41 | 9/1 | UM80 | 15/3 | OC19 | 48/1 |
| 5R4GY | 17/6 | 6P28 | 26/6 | 12SG7 | 7/1 | 7475 | 7/6 | EBF83 | 13/11 | EL91 | 5/1 | N308 | 20/7 | TDD4 | 12/6 | UR1C | 18/7 | OC23 | 87/1 |
| 5U4G | 6/6 | 6Q7G | 6/6 | 12SH7 | 8/6 | 9002 | 5/6 | EBF89 | 9/6 | EL95 | 10/6 | N339 | 15/1 | TH41 | 19/6 | UR1E | 19/11 | OC26 | 25/1 |
| 5V4G | 10/6 | 6Q7GT | 11/1 | 12SJ7 | 8/6 | AC/PEN | | EBL1 | 2/6 | EL92 | 18/7 | P61 | 3/6 | TH23 | 33/3 | U07 | 16/7 | OC28 | 25/1 |
| 5Y3 | 6/1 | 6R7G | 8/1 | 12SK7 | 6/1 | 7-pin | 23/3 | EBL2 | 19/11 | EL93 | 10/6 | PABC80 | | TP22 | 15/1 | U08 | 26/6 | OC35 | 25/6 |
| 5Z3 | 19/11 | 6SA7GT | 11/6 | 12SQ7 | 11/6 | AC/PEN/ | | EBL31 | 23/3 | EM34 | 9/6 | 13/11 | TP25 | 15/1 | U09 | 7/6 | OC44 | 11/1 | |
| 5Z4G | 9/1 | 6S7G | 7/6 | 12SR7 | 8/6 | AC/PEN/ | | EC52 | 5/6 | EM71 | 23/3 | PCC84 | 8/1 | TP220 | 33/2 | UY1N | 18/7 | OC45 | 10/6 |
| 6A7 | 10/6 | 6S7GT | 8/1 | 12TA | 10/6 | DD | 12/6 | EC54 | 6/1 | EM80 | 9/1 | PCC85 | 9/1 | TY86F | 13/3 | UY21 | 16/7 | OC65 | 22/6 |
| 6A8 | 9/1 | 6S7GT | 8/1 | 1457 | 27/10 | AC/PEN | 7/6 | EC70 | 12/6 | EM81 | 9/1 | PCC88 | 18/1 | U12/14 | 8/6 | UY41 | 7/6 | OC66 | 25/1 |
| 6AC7 | 4/1 | 6S7GT | 8/1 | 19A05 | 10/6 | AC/TP | 33/2 | EC92 | 13/6 | EM84 | 10/6 | PCC89 | 11/6 | U16 | 10/6 | UY85 | 7/1 | OC70 | 6/6 |
| 6AG5 | 5/6 | 6SK7G | 6/1 | 19H1 | 10/1 | ATP4 | 5/1 | ECC32 | 5/6 | EM85 | 17/3 | PCF80 | 8/1 | U18/20 | 8/6 | VMP4G | 15/1 | OC71 | 6/6 |
| 6AG7 | 7/6 | 6S7GT | 6/6 | 20D1 | 15/3 | AZ1 | 18/7 | ECC33 | 8/6 | EN31 | 53/1 | PCF82 | 10/6 | U19 | 36/1 | VMS4B | 15/1 | OC72 | 8/1 |
| 6AK5 | 8/1 | 6SN7GT | 5/6 | 20F2 | 26/6 | AZ31 | 10/1 | ECC34 | 24/7 | EY51 | 9/1 | PCF84 | 16/7 | U22 | 8/1 | VP2 | 12/6 | OC73 | 16/1 |
| 6AL5 | 4/1 | 6SQ7GT | 9/1 | 20L1 | 26/6 | AZ41 | 13/11 | ECC35 | 8/6 | EY83 | 16/7 | PCF86 | 15/1 | U24 | 29/10 | VP4 | 15/1 | OC75 | 8/1 |
| 6AM6 | 4/6 | 6SS7G | 8/1 | 20P1 | 26/6 | B36 | 15/1 | ECC40 | 23/3 | EY84 | 14/1 | PCL82 | 10/1 | U25 | 17/11 | VP2B | 14/6 | OC77 | 15/1 |
| 6AQ5 | 7/6 | 6U4GT | 12/6 | 20P3 | 23/3 | BL63 | 7/6 | ECC81 | 6/1 | EY86 | 9/1 | PCL83 | 10/6 | U26 | 10/1 | VP4B | 23/3 | OC78 | 8/1 |
| 6AT6 | 7/1 | 6U5G | 7/6 | 20P4 | 26/6 | CI | 12/6 | ECC82 | 6/6 | EZ35 | 6/1 | PCL84 | 12/6 | U31 | 9/6 | VP13C | 7/1 | OC81 | 8/1 |
| 6AU6 | 10/1 | 6U7G | 8/6 | 20P5 | 23/3 | C1C | 12/6 | ECC83 | 7/6 | EZ40 | 7/1 | PCL85 | 16/7 | U33 | 26/6 | VP23 | 6/6 | OC170 | 13/6 |
| 6AV6 | 12/8 | 6V6G | 7/1 | 25A6G | 10/6 | CB1L | 26/6 | ECC84 | 9/1 | EZ41 | 7/1 | PCL86 | 16/7 | U35 | 26/6 | VP41 | 6/1 | OC171 | 14/6 |
| 6B8 | 5/1 | 6V6GTG | 8/1 | 25L6GT | 10/6 | CB131 | 23/3 | ECC85 | 8/6 | EZ80 | 7/1 | PEN4A | 23/3 | U37 | 26/6 | VR105 | 8/1 | OC200 | 16/6 |
| 6BA6 | 7/6 | 6X4 | 5/1 | 25Y5G | 10/6 | CCH35 | 23/3 | ECC88 | 10/6 | EZ81 | 7/1 | PEN4B | 26/6 | U43 | 9/1 | VR150 | 7/6 | OC203 | 9/6 |
| 6BE6 | 6/1 | 6X5GT | 6/1 | 25Z4G | 9/1 | CK506 | 6/6 | ECC91 | 5/6 | FC4 | 15/1 | PEN4DD | | U45 | 9/1 | VT61A | 5/1 | OC271 | 29/6 |
| 6BGGG | 23/3 | 630L2 | 10/1 | 25Z5 | 9/1 | CL33 | 19/3 | ECF80 | 10/6 | FW4/500 | 8/6 | PEN25 | 6/6 | U52 | 6/6 | W76 | 5/1 | TJ1 | 40/1 |
| 6BH6 | 8/1 | 7A7 | 12/6 | 25Z6G | 10/1 | CV63 | 10/6 | ECF82 | 10/6 | FW4/800 | 8/6 | PEN40D | | U54 | 19/11 | W81M | 6/1 | TJ3 | 45/1 |
| 6B16 | 6/1 | 7B6 | 17/3 | 27S4 | 10/1 | CV1 | 18/7 | ECF86 | 19/11 | GUS0 | 27/6 | | | U57 | 25/1 | U76 | 6/1 | TJ4 | 40/1 |
| 6BQ7A | 15/1 | 7B7 | 8/1 | 28D7 | 7/1 | CY31 | 11/1 | ECH3 | 26/6 | GZ30 | 9/1 | | | U58 | 6/1 | W107 | 18/7 | TP1 | 40/1 |
| 6BR7 | 12/6 | 7C5 | 8/1 | 30C1 | 8/1 | D1 | 3/1 | ECH21 | 23/3 | GZ32 | 10/1 | PEN44 | 26/6 | U78 | 5/1 | W729 | 19/11 | TP2 | 40/1 |
| 6BS7 | 25/1 | 7C6 | 8/1 | 30F5 | 6/1 | D15 | 10/6 | ECH35 | 6/6 | GZ33 | 19/11 | PEN45 | 19/6 | U107 | 16/7 | X24M | 24/7 | TS1 | 10/6 |
| 6BW6 | 8/6 | 7H7 | 8/1 | 30FL1 | 40/1 | D77 | 4/1 | ECH42 | 9/1 | GZ34 | 14/1 | PEN46 | 7/6 | U191 | 16/7 | X41 | 15/1 | TS2 | 12/6 |
| 6BW7 | 6/1 | 7R7 | 12/6 | 30L1 | 8/1 | DAC32 | 10/6 | ECH81 | 9/1 | GZ37 | 19/11 | PEN383 | 23/3 | U201 | 16/7 | X61(C) | 12/6 | TS3 | 15/1 |
| 6C4 | 5/1 | 757 | 9/6 | 30L15 | 11/6 | DAF91 | 6/1 | ECH83 | 13/11 | H63 | 12/6 | PEN453DD | | U251 | 14/1 | X63 | 9/1 | TS4 | 24/1 |
| 6C5 | 6/6 | 7V7 | 8/6 | 30P4 | 12/1 | DAF96 | 8/6 | ECL80 | 9/1 | HABC80 | | | | U281 | 19/11 | X65 | 12/6 | V30/10P | 28/6 |
| 6C6 | 6/6 | 7Y4 | 7/6 | 30P12 | 7/6 | DD41 | 13/11 | ECL82 | 10/6 | | | | | U282 | 22/7 | X66 | 12/6 | XA101 | 23/1 |
| 6C9 | 13/6 | 8D2 | 3/6 | 30P19 | 12/1 | DET25 | 7/6 | ECL83 | 19/3 | HL2 | 7/6 | 4020 | 33/2 | U301 | 23/3 | X76M | 14/1 | XA102 | 26/1 |
| 6C10 | 9/1 | 8D3 | 4/6 | 30PL1 | 10/6 | DF33 | 10/6 | ECL86 | 16/7 | HL23 | 15/3 | PL33 | 19/3 | U329 | 14/1 | X78 | 23/3 | XA103 | 15/1 |
| 6CD6G | 36/6 | 9BV6 | 15/3 | 30PL13 | 16/6 | DF66 | 15/1 | EF9 | 23/3 | HL23DD | 7/6 | PL36 | 12/1 | U339 | 16/7 | X79 | 23/3 | XA104 | 18/1 |
| 6CH6 | 9/1 | 9D2 | 4/1 | 35A5 | 21/3 | DF91 | 3/6 | EF22 | 14/1 | HL41DD | | PL38 | 26/6 | U403 | 16/7 | X109 | 17/3 | XB102 | 10/6 |
| 6D6 | 6/6 | 10C1 | 13/1 | 35L6GT | 9/6 | DF96 | 9/6 | EF36 | 4/1 | | | PL81 | 10/6 | U404 | 8/6 | XDI(1.5) | 6/6 | XB103 | 14/1 |
| 6E5 | 12/6 | 10C2 | 26/6 | 35W4 | 7/6 | DF97 | 9/1 | EF37A | 8/1 | HL42DD | | PL82 | 7/6 | U401 | 29/10 | XFG1 | 18/1 | XB104 | 10/6 |
| 6F1 | 26/6 | 10D2 | 12/1 | 35Z3 | 10/6 | DH63 | 6/6 | EF39 | 5/6 | | | PL83 | 9/1 | U4020 | 16/7 | XFY12 | 9/6 | XC101 | 16/1 |

ALL GOODS BRAND NEW AND SUBJECT TO FULL MAKERS' GUARANTEE. PLEASE NOTE THAT WE DO NOT SELL SECONDHAND GOODS OR MANUFACTURERS' REJECTS.

VOLUME CONTROLS

All with

CHECK with these

BARGAINS

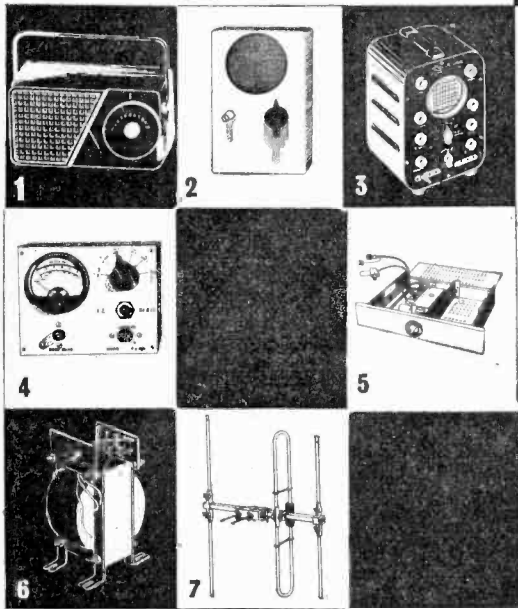

- 3-TRANSISTOR POCKET RADIO** with MINIATURE SPEAKER, FERRITE ROD and 2 GERMANIUM DIODES. The only 3 transistor radio available at the price. Build it in 1 evening! Tunable over M/L waves. Complete with easy-to-follow instructions and all components (less batteries obtainable anywhere 1/9). 27/6. P. & P. 2/-. (All parts available separately.)
- 3-TRANSISTOR SUPER POCKET RADIO** with MINIATURE SPEAKER. Plus Germanium Diode and Printed Circuit. Size 3½ x 4 x ¾ in. Ferrite Rod Aerial. Two Surface Barrier Transistors and one Audio. Tunable over medium and long waves. To build yourself 39/6. P. & P. 1/6. Circuit diagram 1/6, free with kit. All parts of items 1 and 2 sold separately.
- OSCILLOSCOPE** for D.C. and A.C. APPLICATIONS. A high gain, extremely stable differential V-amplifier (30 mV/C.M.). Provide ample sensitivity with A.C. or D.C. inputs. Especially suitable for measurements of transistor operating conditions where maintenance of D.C. levels is of paramount importance. Push-pull X amplifier; Fly-back suppression; Internal Time-base Scan Waveform available for external use; pulse output available for checking TV line O/P Transformers, etc. Provision for external-1/E and CRT Brightness Modulation. A.C. mains 200/250 v. £15.15.0. P. & P. 7/6 or 30/- deposit, plus P. & P. 7/6 and 12 monthly payments of 26/6. FULL 12 MONTHS GUARANTEE INCLUDING VALVES and TUBE.
- A.C./D.C. POCKET MULTI-METER KIT**. 2in. moving coil meter, scale calibrated in A.C./D.C. volts, ohms and milliamperes. Voltage range A.C./D.C. 0-50, 0-100, 0-250, 0-500. Milliamperes 0-10, 0-100. Ohms range 0-10,000. Front panel, range switch, wirewound pot (for ohms zero setting), toggle switch, resistor and rectifier. 19/6. P. & P. 3/6. Wiring diagram 1/-, free with kit.
- CHANNEL TUNER**. Will tune to all Band I and Band III stations. Complete with P.C.C84 and P.C.F.80 valves (in series) I.F. 16-19 or 33-38. Can be modified as an aerial converter (instructions supplied). 32/6, plus 3/6 P. & P.
- HEATER TRANSFORMERS** to suit above. 200-250 v. 6/-, plus 1/6 P. & P.
- MAINS TRANSFORMERS**. All with tapped primaries. 200-250 volts, 0-100 180. 200 v., 60 mA, 6.3 v. 2 amps, 10/8. 300-350 v., 70 mA, 6.3 v. 1 amp, 6.3 v. 2 amp, 10/8. 250-260 v. 70 mA, 6.3 v. 2 amp, 10/8. P. & P. 3/-, 280-0-280v. 70mA 6.3v. 2A. 6.3v. 1A 10/6 p. & p. 3/-. 280-0-280 120mA 6.3v. 2A. 6.3v. 3A 17/6 p. & p. 3/6.
- WOLSEY 3-ELEMENT FOLDED DIPOLE**. I.T.V. Aerial less mounting bracket for external use, complete with 12 yds. of coaxial cable, 15/-, P. & P. 3/6.
- SIGNAL GENERATORS**. Cash £4.19.8 or 25/- deposit and 4 monthly payments of 21/6. P. & P. 6/-. Coverage 100 kc/s to 84 Mc/s. Case 10 x 6½ x 4½ in. Size of scale 6½ x 3½ in. 2 valves and rectifier. A.C. mains 200-250 v. Internal modulation of 400 c.p.s. to a depth of 30 per cent, modulated or unmodulated R.F. output continuously variable 100 millivolts. C.W. and mod. switch variable A.F. output and moving coil output meter. Accuracy ± 2 per cent.
- BATTERY RECORD PLAYER AND AMPLIFIER**. 45 r.p.m. "Star" motor "Acos" crystal pick-up. 3 transistor push-pull amplifier complete with transistors. Output 500 milli watts, 49/6. P. & P. 3/6.
- 8-watt PUSH-PULL 5 VALVE AMPLIFIER**. A.C. mains 200-250 v. Size 10½ x 6½ x 2½ in. 5 valves. For use with all makes and type of pick-up and mike. Negative feed back. Two inputs, mike and gram, and controls for same. Separate controls for Bass and Treble lift. Response flat from 40 cycles to 15 kc/s, ± 2 db; 4 db down to 30 kc/s. Output 8 watts at 5 per cent total distortion. Noise level 40 db down all hum. Output transformer tapped for 3 and 15 ohms speech coils. For use with Std. or I.P. records, musical instruments such as guitars, etc. Suitable for small halls. £3.19.6. P. & P. 6/8. Crystal mike to suit 15/-, P. & P. 1/6. 8in. P.M. Speaker to suit 12/6. P. & P. 1/6.
- B.S.R. MONARCH U48 WITH FUL-FI HEAD**. 4-speed, plays 10 records, 12in., 10in., or 7in. at 16, 33, 45 or 78 r.p.m. Intermixes 7in., 10in. and 12in. records of the same speed. Has manual play position; colour, brown. Dimensions: 12½ x 10½ in. Space required above baseboard 4½ in. below baseboard 2½ in. Fitted with Ful-Fi turnover crystal head. £6.19.6. P. & P. 6/-. With Stereo Head £7.19.6. P. & P. 6/-.
- TRANSISTOR TESTER**. For both P.N.P. and N.P.N. transistors incorporating moving coil meter. In metal case, size 4½ x 3½ x 1½ in. Scale marked in gain and leakage. 19/6. P. & P. 2/6.
- PUSH-PULL OUTPUT STAGE** inclusive of transistors with input and output transformers to match 3 ohms speech coil, suitable for use with the POCKET RADIO. Kit of parts, including transistors. 19/6. P. & P. 1/6. Wiring diagram 1/6, free with kit.
- PORTABLE AMPLIFIER**. On printed circuit for A.C. Mains 200/250 v. Size 4 x 3 in. with tone and volume control. Valves: ECL82 and EZ80. 39/6. P. & P. 2/6.

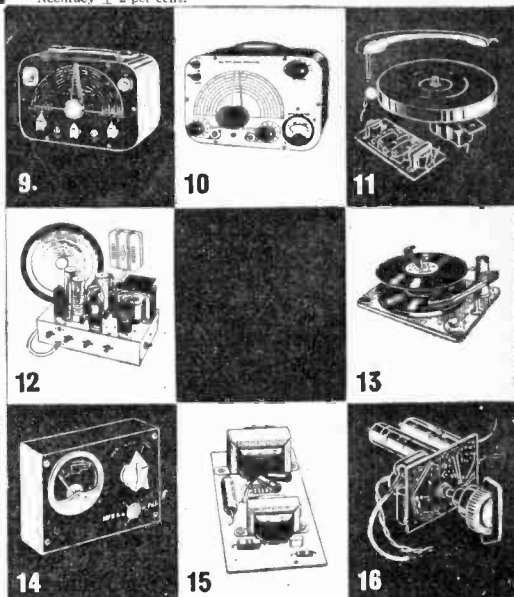

RADIO & T.V. COMPONENTS

(Acton) LTD.

23B HIGH STREET, ACTON, LONDON, W.3.

ALL ENQUIRIES S.A.E.
GOODS NOT DISPATCHED OUTSIDE U.K.

R.S.C. HI-FI TAPE RECORDER KIT

REALISM AT INCREDIBLY LOW COST, CAN BE ASSEMBLED IN HALF AN HOUR. The Recorder incorporates the Latest Collaro Studio Tape Transistor. The Linear LT45X High Quality Tape Amplifier listed \$12.12.0 High Flux P.M. Speaker listed 30/-, empty Tape Spool, a Reel of Best quality Tape listed 22/6, and a Handsome Portable carrying Cabinet with latest attractive two-tone polychrome finish, size 18 x 13 x 9 in. high, listed \$4.10.0, and circuit. Total cost if purchased individually approximately \$40. Performance equal to units in the \$30-\$80 class. S.A.E. for leaflet.

HIGH FIDELITY 12-14 WATT AMPLIFIER TYPE A11

PUSH-PULL ULTRA LINEAR OUTPUT "BUILT-IN" TONE CONTROL PRE-AMP STAGES

Two input sockets with associated controls allow mixing of "mike" and gram, as in A10. High sensitivity, includes 5 valves, ECC83, ECC83, EL24, EL24, 5Y3. High Quality sectionally wound output transformer specially designed for Ultra Linear operation, and reliable small condensers of current manufacture. INDIVIDUAL CONTROLS FOR BASS AND TREBLE "Lift" and "Cut". Frequency response ± 3 D.B. 30,000 c/s. Six negative feedback loops. Hum level 60 D.B. down, ONLY 23 millivolts INPUT required for FULL OUTPUT. Suitable for use with all makes and types of pick-ups and microphones. Comparable with the very best designs. For STANDARD or LONG PLAYING RECORDS FOR MUSICAL INSTRUMENTS such as STRING BASS, GUITARS, etc., OUTPUT SOCKET with plug provides 300 v. 30 mA. and 6.3 v. 1.5 a. For supply of a RADIO FEEDER UNIT. Size approx. 12-9-7 in. For A.C. mains 200-250 v. 50 c.p.s. Output for 8 and 15 ohm speakers. Kit is complete to last nut. Chassis is fully punched. Full instructions and point-to-point wiring diagrams supplied. Only **8 Gns.** Carr. (Or factory built \$1/- extra).

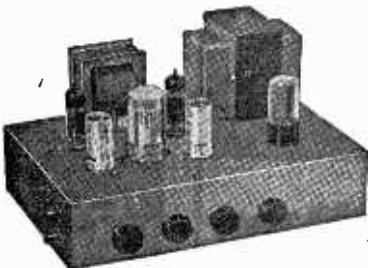

25 1/2
GNS.

Carr. 17/6



H.P. TERMS. Deposit \$5.76 and 12 monthly payments of 2 gns. Cash price if settled in 3 months.

TELEVISION RECTIFIERS 250 v. 300 mA. small size. Only 6/9 each.

COLLARO CONQUEST 4-SPEED AUTO-CHANGER, with high fidelity Studio Pick-up. Latest model. For 200-250 v. 50 c.p.s. A.C. mains. Our price \$8.19.6. Carr. 5/6.

COLLARO RC 457 4 SPEED MIXER AUTO-CHANGERS. Turnover Studio Pick-up head. For 200-250 v. A.C. \$7.19.6. Carr. 4/6.

THE SKYFOUR T.R.F. RECEIVER A design of a 3-valve long and Medium wave 200-250 v. A.C. Mains receiver with selenium rectifier. High gain H.F. stage and low distortion detector. Valve line-up 6K7, 6P61, 6V6G. Selectivity and quality excellent. Simple to construct. Point-to-Point wiring diagrams, instructions and parts list. 1/8. maximum building costs \$4.19.6, inc. attractive Walnut veneered wood cabinet 12 x 8 1/2 x 5 1/2 in.

D.C. SUPPLY KIT, 12 v. 1 a. consisting of a partially drilled metal case, mains trans. F.W. Bridge Rectifier, 2 fuseholders and fuses. Change Direction switch, variable Speed regulator and circuit. For 200-250 v. A.C. mains. Suitable for Electric Trains. Limited number available at 33/9.

If required louvered metal cover with 2 carrying handles can be supplied for 18/9. TERMS ON ASSEMBLED UNITS. DEPOSIT \$4/9, and 8 monthly payments of 24/9. Send S.A.E. for illustrated leaflet detailing Ready-to-assemble Cabinets, Speakers, Microphones, etc., with cash and credit terms.

R.S.C. STEREO/TEN HIGH QUALITY AMPLIFIER



A complete set of parts for the construction of a stereophonic amplifier giving 5 watts high quality output on each channel (total 10 watts). Sensitivity is 50 millivolts, suitable for all crystal stereo heads. Ganged Bass and Treble Controls give equal variation of "Lift" and "cut". Provision is made for use as straight (monaural) 10 watt amplifier. Valve line-up ECC83, ECC83, EL24, E221. Outputs for 2-5 ohm speakers. Point-to-Point wiring diagrams and instructions supplied. Send S.A.E. for leaflet. **8 Gns.** Full constructional details and price list 2/6. Carr. 10/9.

R.S.C. BATTERY CHARGING EQUIPMENT

HEAVY DUTY CHARGER KIT 6/12 v. 6 amps. variable output. Consisting of Mains Transformer 0-200-250 v. F.W. Bridge Selenium Rectifier, Ammeter. Variable Charge Rate Selector Panels, Plugs, Fuses, Fuseholder and circuit. 59/9. Carr. 4/6.



Assembled 6 v. or 12 v. 4 amps.

Fitted Ammeter and variable charge rate selector. Also selector plug for 6 v. or 12 v. charging. Louvered steel case with stoved blue hammer finished. Fused and ready for 69/6 use with Carr. 5/- mains and output leads. Double Fused. Terms: Deposit 13/3 and 5 monthly payments 13/3.

ASSEMBLED CHARGER 6 v. or 12 v. 2 amps.

Fitted Ammeter and selector plug for 6 v. or 12 v. Louvered metal case finished attractive hammer blue. Ready for use With mains and output leads. Double Fused. Carr. 3/9. **49/9**

All for A.C. Mains 200-250v., 50 ccs. Guaranteed 12 months.

BATTERY CHARGER KITS Consisting of Mains Transformer, F.W. Bridge, Metal Rectifier, well ventilated steel case, Fuses, Fuseholders, Grommets, panels and circuit. Carr. 3/6 extra.
6 v. or 12 v. 1 amp. 24/9
As above, with Ammeter. 32/9
6 v. or 12 v. 2 amps. 25/9
6 v. or 12 v. 2 amps. 31/6
6 v. or 12 v. 2 amps. inclusive of Ammeter 42/9
6 v. or 12 v. 4 amps. 53/9
6 v. or 12 v. 4 amps. with Ammeter and variable charge rate selector 69/9
CHARGER AMMETERS, 0-1.5 a., 0-3 a., 0-4 a., 0-7 a., 0-25 a., 0-60 a. 8/9.

DEAF AID EARPIECES. Low Impedance with lead. 8/9. High Impedance Crystal 8/9.

MICROPHONE INSERTS. Crystal type 8/9.

R.S.C. MAINS TRANSFORMERS

Interleaved and impregnated. Primaries 200-230-250 v. 50 c/s. screened TOP SHROUDED DRA THROUGH
250-0-250 v. 10 mA. 6.3 v. 2 a. 5 v. 2 a. 17/9
350-0-350 v. 100 mA. 6.3 v. 2 a. 5 v. 3 a. 27/6
250-0-250 v. 100 mA. 6.3 v. 2 a. 8 v. 1 a. 18/9
250-0-250 v. 100 mA. 6.3 v. 3.5 a. C.T. ... 19/9
250-0-250 v. 100 mA. 6.3 v. 4 a. 5 v. 3 a. 25/9
300-0-300 v. 130 mA. 6.3 v. 4 a. 5 v. 3 a. 29/9
for Mullard 510 amplifier
300-0-300 v. 100 mA. 6.3 v. 4 a. 5 v. 3 a. 26/1
350-0-350 v. 100 mA. 6.3 v. 4 a. 5 v. 3 a. 28/9
350-0-350 v. 100 mA. 6.3 v. 4 v. 4 a. C.T. ... 24/6
350-0-350 v. 150 mA. 6.3 v. 4 a. 5 v. 3 a. 29/9
FULLY SHROUDED UPRIGHT
250-250 v. 80 mA. 6.3 v. 2 a. 5 v. 2 a. Mid. type 24-3-3in. 17/11
250-0-250 v. 100 mA. 6.3 v. 4 a. 5 v. 3 a. 27/9
300-0-300 v. 130 mA. 6.3 v. 4 a. 5 v. 3 a. 27/9
350-0-350 v. 100 mA. 6.3 v. 4 a. 5 v. 3 a. 27/6
350-0-350 v. 100 mA. 6.3 v. 4 a. 5 v. 3 a. 25/9
425-0-425 v. 200 mA. 6.3 v. 4 a. C.T. ... 46/9
6.3 v. 4 a. C.T. 5 v. 3 a. 49/9

(FULLY GUARANTEED)

FILAMENT TRANSFORMERS All with 200-250 v. 50 c/s. primaries 6.3 v. 1.5 a. 5/9; 6.3 v. 2 a. 7/6; 0-4 6.3 v. 2 a. 7/6; 12 v. 1 a. 7/11; 6.3 v. 3 a. 8/11; 6.3 v. 6 a. 17/6; 12 v. 1.5 a. twice, 17/6.

OUTPUT TRANSFORMERS Midget Battery Pentode 68:1 for 384 etc. 3/9
Small Pentode. 5000 to 30 .. 3/9
Small Pentode 70,000 to 30 .. 3/9
Standard Pentode 5,000 to 30 .. 5/6
Standard Pentode 70,000 to 30 .. 5/6
10,000 to 30 .. 5/6
Push-Pull 10-12 watts 6V6 to 3n or 15n .. 13/9
Push-Pull 10-12 watts to match 6V6 to 3-5-8 or 15n .. 12/9
Push-Pull EL24 to 3 or 15n .. 18/9
Push-Pull 15-18 watts. 6L6, KT66 .. 22/9
Push-Pull for Mullard 510 Ultra Linear .. 29/9
Push-Pull 20 watts, sectionally wound 6L6, KT66 etc. to 3 to 15n .. 49/9

ELIMINATOR TRANSFORMERS Primaries 200-250 v. 50 c/s.
120 v. 40 mA. 6-0-5 v. 1 a. 15/9
90 v. 15 mA. 4-0-4 v. 500 mA. 9/9

SMOOTHING CHOKES 150 mA. 7-10 H 250 ohms. 11/9
100 mA. 10 H 200 ohms. 8/9
80 mA. 10 H 350 ohms. 5/9
80 mA. 10 H 400 ohms. 4/11

CHARGER TRANSFORMERS All with 200-230-250 v. 50 c/s Primaries:
0-9-15 v. 1 a. 11/9; 0-9-15 v. 2 a. 14/9; 0-9-15 v. 3 a. 16/9; 0-9-15 v. 5 a. 19/9; 0-9-15 v. 8 a. 23/9; 0-9-15 v. 8 a. 28/9.

AUTO (Step up/Step down) TRANS. 0-110-120-230/250 v. 50-80 watts 13/9; 1-110/120-230/250 v. 150 watts 27/6.

MICROPHONE TRANSFORMERS 120:1 high grade, clamped, 6/9; 120:1 Potted. Mu-metal screened, 9/9.

R.S.C. (Manchester) Ltd. LIVERPOOL, LEEDS, BRADFORD, MANCHESTER

R.S.C. A12 STEREOPHONIC AMPLIFIER KIT

A complete set of parts to construct a Stereo amplifier with an undistorted output total of 4 watts. For A.C. mains input of 200-250 v. Outputs for matched 2-ohm speakers. Sensitivity 130 m.v. Ganged Vol. and Tone Controls. Preset balance control. Full instructions and point-to-point wiring diagrams supplied. Only good quality components and latest high grade valves used. Exceptionally realistic reproduction can be obtained at ample volume for the home, as can be demonstrated in typical surroundings at our County Arcade premises. A really sensational offer.

4 Gns.

Carr. and pkg. 5/-

STEREO EQUIPMENT OFFER.
Completing A12 Kit, 2 matched 8in. Speakers and Acos T70 Stereo head suitable most pickups. **£6.19.6** Carr. 7/6.

PICK-UP ARMS complete with Hi-F1 turnover crystal head, Acos GP54. Limited number brand new, perfect at approx. half price. Only 33/6. Designed sectionally sound ultra linear output transformer is used with 807 output valves. All components are chosen for reliability. Six valves are used EP86, 6X8, ECC83, 6X7, 6Z53. Separate Bass and Treble Controls are provided. Minimum input required for full output is only 12 millivolts so that ANY KIND OF MICROPHONE OR PICK-UP IS SUITABLE. This unit is designed for CLUBS, SCHOOLS, THEATRES, DANCE HALLS or OUTDOOR FUNCTIONS, etc. For use with Electronic ORGAN, GUITAR, STRING BASS etc. For standard or long-playing records. OUTPUT SOCKET PROVIDES L.T. and H.T. for a RADIO FEEDER UNIT. An extra input with associated vol. control is provided so that two separate inputs such as Gram. and 'Mikes' can be mixed. Amplifier operates on 200-250 v. 50 c/c.s. A.C. Mains and has output for 3 and 15 ohm speakers. Complete kit of parts with fully punched chassis and point-to-point wiring diagrams and instructions. If required Carr. 10/- cover as for A11 can be supplied for 18/9. The amplifier can be supplied factory built with EL34 output valves and 12 months' guarantee. For 14 Gns. TERMS: DEPOSIT 33/6 and 9 monthly payments/33/6.

ACOS CRYSTAL MICROPHONES. M1040 stand or desk. Listed 45/-. Only 27/9. 39-1 Stick type. Listed 5 gns. Only 39/6.

R.S.C. 30 WATT ULTRA LINEAR HIGH FIDELITY AMPLIFIER A10

A highly sensitive Push-Pull high output unit with self-contained Pre-amp, Tone Control Stages. Certified performance figures compare equally with most expensive amplifiers available. Hum level 70 db. down. Frequency response—3 db. 20-30,000 c/s. specially designed sectionally sound ultra linear output transformer is used with 807 output valves. All components are chosen for reliability. Six valves are used EP86, 6X8, ECC83, 6X7, 6Z53. Separate Bass and Treble Controls are provided. Minimum input required for full output is only 12 millivolts so that ANY KIND OF MICROPHONE OR PICK-UP IS SUITABLE. This unit is designed for CLUBS, SCHOOLS, THEATRES, DANCE HALLS or OUTDOOR FUNCTIONS, etc. For use with Electronic ORGAN, GUITAR, STRING BASS etc. For standard or long-playing records. OUTPUT SOCKET PROVIDES L.T. and H.T. for a RADIO FEEDER UNIT. An extra input with associated vol. control is provided so that two separate inputs such as Gram. and 'Mikes' can be mixed. Amplifier operates on 200-250 v. 50 c/c.s. A.C. Mains and has output for 3 and 15 ohm speakers. Complete kit of parts with fully punched chassis and point-to-point wiring diagrams and instructions. If required Carr. 10/- cover as for A11 can be supplied for 18/9. The amplifier can be supplied factory built with EL34 output valves and 12 months' guarantee. For 14 Gns. TERMS: DEPOSIT 33/6 and 9 monthly payments/33/6.

£8 Gns. wiring diagrams and instructions. If required Carr. 10/- cover as for A11 can be supplied for 18/9. The amplifier can be supplied factory built with EL34 output valves and 12 months' guarantee. For 14 Gns. TERMS: DEPOSIT 33/6 and 9 monthly payments/33/6.

FULL RANGE OF LINEAR AMPLIFIERS ALWAYS IN STOCK.
COLLARO JUNIOR 4-speed single player units and Hi-F1 crystal pick-up with turn-over head, £3.19.6.
B.S.R. UAS 4-SPEED AUTO-CHANGERS with Hi-F1 turnover pick-up head, £6.19.6. Carr. 6/-.

R.S.C. BATTERY TO MAINS CONVERSION UNITS

Type BM1. An all-dry battery eliminator. Size 5 1/2 x 4 1/2 in. Approx. Completely replaces battery supplying 1.4 v. and 90 v. where A.C. mains 200-250 v. 50 c/s is available, suitable for all battery portable receivers requiring 1.4 v. and 90 v. This includes latest low consumption types. Complete kit with diagrams. 39/6, or ready to use, 46/9.



Type BM2. Size 8 x 5 1/2 x 2 1/2 in. Supplies 120 v. 80 v. and 60 v., 40 mA. and 0.5 a. to 10 amp. fully smoothed. Thereby completely replacing both H.T. batteries and L.T. accumulators when connected to A.C. mains supply 200-250 v. 50 c/s. **SUITABLE FOR ALL BATTERY RECEIVERS** normally using 2 v. accumulator. Complete kit of parts with diagrams and instructions. 49/6, or ready for use, 59/6.

LINEAR TAPE PRE-AMPLIFIER Type LP71. Switched Negative feedback equalisation. Positions for Record lin. 3in., 7in., and Playback. EM84 Recording Level Indicator. Designed primarily as the link between a Collaro Tape Recorder and a high fidelity amplifier, but suitable for almost any Tape Deck. Only 9 gns. S.A.E. for leaflet.

LINEAR L45 MINIATURE 45 WATT QUALITY AMPLIFIER. Suitable for use with any record playing unit, and most microphones. Negative feedback 12db. Separate Bass and Treble Controls. For A.C. mains input of 200-250 v. 50 c/c.s. Output for 2-ohm speaker. Three miniature Mullard valves used. Size of unit only 7-5 1/2 in. high. Guaranteed for 12 months. Only £5.19.6. Send S.A.E. for illustrated leaflet. Terms: Deposit 22/6 and 5 monthly payments of 22/6.

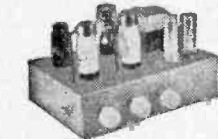

A highly sensitive 4-valve quality amplifier for the home, small club, etc. Only 50 millivolts input is required for full output so that it is suitable for use with the latest high fidelity pick-up heads, in addition to all other types of pick-ups and practically all 'mikes'. Separate Bass and Treble Controls are provided. These give full long-playing record equalisation. Hum level is negligible being 70db. down. 15db. of Negative feedback is used. H.T. or 300 v. 25 mA. and L.T. or 6.3 v. 1.5 a. is available for the supply of a Radio Feeder Unit, or Tape-Deck pre-amplifier. For A.C. mains input of 200-250 v. 50 c/c.s. Output for 2-3 ohm speaker. Chassis is not alive. Kit is complete in every detail and includes fully punched chassis (with baseplate) with Blue hammer finish and point-to-point wiring diagrams and instructions. Exceptional value at only £4.15.0, or assembled ready for use 25/- extra, plus 3/6 carr.; or Deposit 22/6 and 5 monthly payments of 22/6 for assembled unit.

R.S.C. PORTABLE GUITAR AMPLIFIERS

Junior 5 watts High Quality output. Separate Bass and Treble "Cut" and "Boost" controls. Sensitivity 15 m.v. Twin inputs. High Flux 8in. Loudspeaker "built-in". Handsome, strongly finished in attractive and durable polycrome, and fitted carrying handle. H.P. Terms. Deposit £1 and 9 monthly payments of £1. Carr. 7/6

£8.19.6

Senior 10 watts High Fidelity output. Separate Bass and Treble "Cut" and "Boost" controls. Twin separately controlled high gain inputs so that two instruments such as Guitar and String Bass can be used at the same time. Two loudspeakers are incorporated. A high Flux 12in. for Bass notes and a 7 x 4 in. elliptical for Treble. Cabinet is well made and finished as Junior model. Size approx. 18 x 18 x 18in. H.P. Terms. Deposit 34/9 and 9 monthly payments of 34/9. Both models for 200-250 v. Carr. 10/- A.C. mains. Above model fitted Linear Tremolo Unit 2 gns. extra. Or Deposit 11/6 and 9 monthly payments 11/6.

15 Gns.

12in. 10 WATT HIGH QUALITY LOUD-SPEAKER IN POLISHED WALNUT FINISHED CABINET

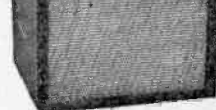

Gauss 12,000 lines. Speech coil 3 ohms or 15 ohms. Only £4.19.6 Carr. 5/- Terms: Deposit 11/3 and 8 monthly payments of 11/3. **HI-FI SPEAKERS IN CABINETS.** Size 18 x 18 x 10in. Finish as above. Terms: Deposit 17/9 and 9 monthly payments of 17/9. Only £7.19.6. Carr. 8/6.

R.S.C. 45 WATT A5 HIGH-GAIN AMPLIFIER

A highly sensitive 4-valve quality amplifier for the home, small club, etc. Only 50 millivolts input is required for full output so that it is suitable for use with the latest high fidelity pick-up heads, in addition to all other types of pick-ups and practically all 'mikes'. Separate Bass and Treble Controls are provided. These give full long-playing record equalisation. Hum level is negligible being 70db. down. 15db. of Negative feedback is used. H.T. or 300 v. 25 mA. and L.T. or 6.3 v. 1.5 a. is available for the supply of a Radio Feeder Unit, or Tape-Deck pre-amplifier. For A.C. mains input of 200-250 v. 50 c/c.s. Output for 2-3 ohm speaker. Chassis is not alive. Kit is complete in every detail and includes fully punched chassis (with baseplate) with Blue hammer finish and point-to-point wiring diagrams and instructions. Exceptional value at only £4.15.0, or assembled ready for use 25/- extra, plus 3/6 carr.; or Deposit 22/6 and 5 monthly payments of 22/6 for assembled unit.

R.S.C. BASS REFLEX CABINETS, JUNIOR MODEL. Specially designed for W.B. HF1012 Speaker, but suitable for any good quality 10in. speaker. Acoustically lined and ported. Polished walnut veneer finish. Size 18 x 12 x 10in. Handsome appearance. Ensure superb reproduction for only £3.19.6.

STANDARD MODEL. As above but for 12in. speakers. Size 20 x 15 x 13in. Especially recommended for Plessey Dual Concentric Speaker, £5.19.6. Suitable legs with brass ferrules, 25/- per set of 4. **PLESSEY DUAL CONCENTRIC 12in. 15 ohms HIGH FIDELITY SPEAKER** (12,000 lines) with built-in tweeter (completely separate elliptical speaker with choke, condensers, etc.) providing extraordinarily realistic reproduction when used with our A11 or similar amplifier. Rated 10 watts. Price only £5.19.6.

P.M. SPEAKERS. 2-3 ohm, 2 1/2in. Perdio 21/9. 5in., 17/9. 6 1/2in., 16/9. 8in., 10/9. 8 x 5in., 25/6. 10in., 26/9. 10 x 8in., 29/9. 12in., 29/11. 10in. W.B. 3 or 15 ohms type HF1012 10 watts, hi-fidelity type. Recommended for use with our A11 Amplifier, £5.19.6, 12in. R.A. 3 ohms 10 watts (12,000 lines), 59/6.

TWEETERS. Plessey 30 19/9, 150 25/9. **HI-FI CRYSTAL PICK-UP HEADS.** (Turnover type with sapphire stylus).

Acos. Standard replacement for Garrard and B.S.B. B.S.R. Full-R. Garrard GC2. 19/9. B.S.R. Stereo-Monaural 39/11. **GLA MINIATURE 2-3 WATT GRAM AMPLIFIER.** For use with any single or auto-change unit. Output for 2-3 ohm speaker. For 200-250 v. A.C. mains. Size 1 1/2 x 2 1/2 x 2 1/2 in. Controls: Vol. and Tone with switch. Only 59/6. **SUPERHET FEEDER UNIT.** Design of a high quality Radio Tuner Unit (specially suitable for use with any of our Amplifiers). Delayed A.V.C. Controls are Tuning, W/C.H. and Vol. Only 250 v. 15 mA. H.T. and L.T. of 6.3 v. 1 amp. required from amplifier. Size of unit approx. 9-5/8 in. high. Simple adjustment procedure. Point-to-point wiring diagrams, instructions and priced parts list with illustration. 2/6. Total building cost £4.15.6. For leaflet send S.A.E.

TERMS: C.W.O. or C.O.D. No. O.O.D. under £1. Post 1/9 extra under £2. 2/9 extra under £5. Open 9 to 5. Weis. until 1 p.m. Trade supplied S.A.E. with all enquiries.

R.S.C. (Manchester) Ltd.

Mail Orders to 29-31 Moorfield Road, Leeds 12. Personal shoppers to any of branches below—
73 Dale Street, Liverpool 2
5-7 County (Mecca) Arcade, Briggate, Leeds 1
8-10 Brown St. (Market St.), Manchester 2
56 Morley Street, (Above Alhambra Theatre), Bradford

CONSTRUCTORS

ORNER

OUR NEW 5 STAGE SUPER SENSITIVE TRANSISTOR PORTABLE

The "BOBETTE"

- Simple to Build.
- All first grade components.

A truly portable transistor radio giving full medium wave reception.

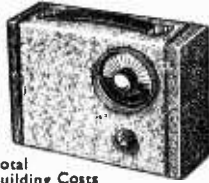

Total Building Costs

£5.26

No Extras to Buy

Incorporates Sin. High Flux Speaker, push pull output, first grade transistors, High-Q ferrite aerial, socket for car aerial, pre-tagged circuit board for easy construction. Attractive two tone case.

All parts sold separately. Send 1/6 for itemised price list and full assembly instructions. (Free with order).

EASY TO BUILD TWO STAGE TRANSISTOR SET The "BIJOU"

The set that looks like a Radio Set.

- Attractive Case.
- Mini .0005 Tuner.
- High Q Litz Coil.
- Works for months off No. 8 Battery.
- Simple to construct in 15 min.

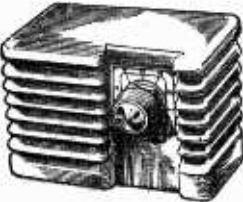

Total Building Costs **25/** P. & P. 1/6. You can't go wrong. We guarantee good results. Components Price List, Layout Plans 1/6 (free with order)

EXPLORE THE WORLD ON THIS 1-VALVE SHORTWAVE RADIO

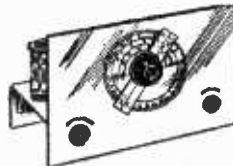

- Receives speech and music from all over the world.
- Construction price includes valve and one coil covering 40-100 metres.
- Can be extended to cover 10-100 metres.
- Can be converted to 2 or 3 valve.

Total Building Costs Only **35/** P. & P. 1/6

Send 2/- for wiring diagram and components price list

IDEAL FOR THE BEGINNER

CRYSTAL RECEIVER
Covering Medium Wave Band

All components including case for only **12/6** P. & P. 1/6

Easily converted to 1-transistor or 2-stage transistor receiver. Send 1/6 for construction details and component price list.

PUT YOUR FAVOURITE PROGRAMME ON TAPE IT WITH THE R.C.S. TAPE TUNER



Will operate on all types of Recorder. High impedance output, variable Medium wave tuning. Triple wound Super Hi-Q coil. Chassis and components colour coded. Easily constructed from full instruction data and layout diagrams. Size 3 1/2 x 1 1/2 x 1 in.

Total Building Costs Only **30/** P. & P. 1/6

Send 1/6 for wiring diagram and components price list.

"Ensure success with R.C.S."
R.C.S. PRODUCTS (RADIO) LTD.
11, OLIVER ROAD, LONDON, E17
Mail Order only. Trade Enquiries welcomed.

For Safety's Sake
use
AVO Prodclips

Pat. No. 748811

with Trigger-Action Spring-Loaded Clips

PRESS TRIGGER TO OPEN
RELEASE TO GRIP

Safety first every time with these patented spring-loaded AVO Prodclips.

Cleverly designed for use as insulated prods, they are invaluable for reaching and holding test points which are difficult of access.

Suitable for use with AvoMeter, Multimeter and Avo Electronic Test Meter Leads.

Post Free **15/-** per pair.

AVO LTD • AVOCET HOUSE,
92-96 VAUXHALL BRIDGE ROAD, LONDON, S.W.1.
VICtoria 3404 (12 lines)
A MEMBER OF THE METAL INDUSTRIES GROUP OF COMPANIES

Become a Television expert this easy way

The Bennett College offers you a complete course

THE Bennett College offers you personal tuition in a course that's non-mathematical and particularly easy to follow. It contains clear diagrams which cover everything you want to know from beginning to end (and even includes the basic principles of sound radio if you wish).

The complete home-study course covers everything: Production of the signal, scanning and reproduction of picture from signals. Aerials, types and purpose. The cathode-ray tube. Time-base oscillators, and output circuits. Synchronisation. Video frequency amplifiers. The TV tuner, turret incremental, etc. Television test gear. Television faults.

For more details, please fill in the coupon below. Your studies cost very little and the book you need is included in the cost.

To THE BENNETT COLLEGE (Dept. I 104NTV, Sheffield)
Please send me details of the new
TELEVISION SERVICING COURSE

NAME _____

ADDRESS _____

AGE _____

TV TUBES

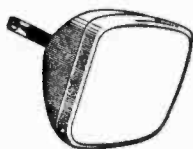

12 Months' Guarantee

HP Terms available

Ins., Carr. 15/6

21in..... 99/6
17in..... 90/-
15, 14, 12in. 70/-
£1 extra without old bowl, refundable if same received within 14 days.

VALVES

9d. Each 7/6 Dozen
4D1, 6D1, 6D2, 6J5, 6J7, 9D2, 12Y4, 2050, 2151, 7193, CV66, EF50, HL41DD, HL42DD, P61, SP41, SP61, TDD13C, VR35, VR37, VR106, VR107.

1/9 Each 17/6 Dozen
6AT6, 6F1, 6F12, 6F13, 6F14, 6F15, 6F25, 6F28, 7C5, 7Q7, 7Y4, 8D3, DH77, EB41, EF91, PEN45, PEN46, Z77.

2/9 Each 30/- Dozen
6BX6, 6L18, 6U4GT, 10P13, B36, ECC81, ECC82, ECH42, EY51, KT36, L63, PL33, U24, U31, U35, U281, U282.

5/9 Each 60/- Dozen
6AB8, 20F2, 20L1, 20P1, 30FL1, EB80, ECL80, EL41, EY85, KT33C, LN152, PCC84, PCF82, PL38, PL81, PL82, PL83, PY80, PY81.
Post on one 7d., on six 1/6, on twelve 2/6.

COMPLETE 17in. TV

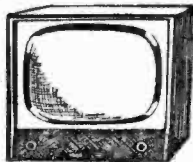

£11-10-0

An excellent Ex-Rental Table Model. Famous manufacturer. Tuned ITA/BBC. Guaranteed 12 months. Terms available. Personal collection advised. Special delivery rate by arrangement up to 50 miles, or despatched in 3 parcels for easy assembly, 25/-.

Coax Cable, 6d. per yd. Good quality, cut to any length. 45/- per 100 yds. Post 3/6.

Insulating Tape, 1/6 per roll. Finest quality in metal container. 75ft. x 3/8in. wide. Post 9d.

Scanning Coils, 1/- each. 35mm and 38mm. at 70° and 90°, low imp. P. & P. 1/3.

Focus Magnets, 1/- each. 35mm and 38mm. New. P. & P. 1/9.

Chassis 1/-. 6 or 8 valve. Latest magnet valve type. New, cadmium plated. Size 12 1/2 x 7 1/2 x 2 1/2in. P. & P. 1/9.

Compass, 5/-. Ex. A.M. Types. P.10 and O2A. Ideal for Boats, cars, etc., transit case incl. Requires refilling with oil or meth. Ins. carr. 3/6.

14in. TUBES 35/-

36/24 and 14KP4. Due to purchase of Renters Replacement stocks. Carr 5/-

REPLACEMENT

REBUILD

TRANSISTORS

6 Mullard and 1 Diode
1—OC81D 6/9
2—OC81 6/9
1—OC44 9/9
2—OC45 8/9
1—Diode 1/9 Per Set

47/6

G.E.C. types available, also Ediswan—XC121 and XB113 both at 8/9 each. Post Free

EXTENSION SPEAKERS

19/9



8in. P.M. Speaker fitted into polished cabinet. Complete. Switch and flex included. P. & P. 3/9.

MINIATURE SPEAKERS 16/9

Brand new 2 1/2 and 3in. P. & P. 1/-.

ELLIPTICAL SPEAKERS 15/9

Brand new slot type. 8 x 3in. and 7 x 4in. P. & P. 2/9.

SOLO SOLDERING TOOL

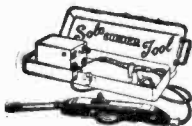

ONLY 12/6

110 v., 6 v. or 12 v. (special) adaptor for 200/250 v., 10/- (extra). Automatic solder feed including reel solder and spare parts. It is a tool for electronic soldering or car wiring. Revolutionary in design. Cannot burn. In light metal case with full instructions for use. Post 3/6.

SCOTCH BOY TAPES

19/9

Limited quantity of these 5 1/2in. tapes. Post Free.

DUKE & CO.

(LONDON) LTD.
621/3 Romford Road,
MANOR PARK, E.12.

ILF 6001/3

9 a.m.—6 p.m.
Half Day Thursday

STAMPS FREE
CATALOGUE



DELUXE RECORDER CABINET

79/6

Beautifully styled rexine covered cabinet in Red or Beige. Size 14 1/2 x 13 x 9 1/2in. Storage comp. in lid for tapes and mike. Easily adapted to Record Player Cabinet. Ins., Carr. 4/6.

"ARGOSY" RECORD PLAYER CABINET 19/6

Exceptional offer. A lightweight portable Player Cabinet by famous manufacturer. Size 14 1/2 x 11 1/2 x 6in. Takes our single player; 2 control Amplifier; 5in. Speaker. Post, packing and Insurance, 5/6.

RECORD PLAYER CABINET 69/6

Luxury cabinet in two tone coffee colour. Size 15 1/2 x 17 x 9 1/2in. Takes all popular record player units and amplifiers. Position for 8in. Speaker. Detachable lid for Stereo conversion. P. & P. 4/6.



TAPE RECORDER AMPLIFIER

£7.19.6

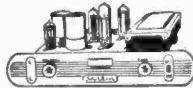

Compact, well designed 5 valve amplifier. Output 3.5W. Input for

Microphone, Radio and Gram. Size 8 1/2 x 3 x 4 1/2in. ins., carr. 4/6. 12 months' guarantee. Terms available. Extras: Dial plate, including sockets and superimpose switch, 3/6. Knobs 2/6.

TAPE RECORDER AMPLIFIER

£9.15.6 By famous manufacturer. Superb 4-valve amplifier. Two controls and superimpose switch. Sockets for Mike and Gram. Size 11 x 4 x 6in. Ins., Carr. 4/6. Drawings FREE with Order.

RECORD PLAYER AMPLIFIER

12 months' guarantee MK. D.2

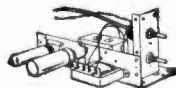

79/6

Latest design incorporating negative feedback, giving 4 watts undistorted output. Valves: ECL82, and metal rectifier. Tone and volume control panel on flying leads. P. & P. 3/6.

HOME RADIO OF MITCHAM

(Dept. P), 187 London Road, Mitcham, Surrey.
MIT 3282
Shop hours 9 a.m. to 6.30 p.m. Wed. 9 a.m. to 1 p.m.

DARK EVENINGS AHEAD HAVE FUN WITH THE "GLOBE KING" SHORT WAVE



Short wave radio operates 24 hours a day. You can explore the world from the comfort of your own armchair and enjoy perfect relaxation from a day's work. Start now with this amazing little one-valver which gives really long distance reception at a minimum cost. Extra stage can be added later.

Learn morse and listen in to shipping etc. 100/A kit with three matched coils covering 10 to 100 metres. PRICE £3.19.6, plus 1/- post. Send S.A.E. for leaflet.

ENTIRELY NEW VALVE DATA MANUAL

156 pages and giving characteristics of 4,800 valves, transistors, rectifiers and cathode ray tubes. Also base connections and equivalents. Latest issue and right up-to-date. Essential to all engineers. PRICE 6/-, post 9d.

WE ARE ACTUAL STOCKISTS FOR HEATHKITS

JASON TUNER KITS



Enjoy crystal clear Hi-Fi reception with a JASON FM/VHF tuner unit. Still the best and most popular kits available. Full constructional data and prices 3/6, post 6d. Standard versions as illustrated FM12 £11.7.6, with power supply. Other models including TV sound available.

TRANSISTORS SENSATIONAL PRICE REDUCTIONS BY MULLARDS

OC26 25/-, OC44 11/-, OC45 10/-, OC70 6/6, OC71 6/6, OC72 8/-, OC76 8/-, OC78 8/-, OC81 8/-, OC170 13/6, OC171 14/6. Matched pairs available. All available from stock.

SUB MINIATURE RESISTORS

We now stock the full range of LAB type LX resistors, only 1in. long and 1/10in. dia. All preferred values 10% tolerance at 8d. each. Ideal for medal control and transistor sets.

ANTEX "PRECISION" SOLDERING IRON



A wonderful miniature iron for the constructor. Five different sizes of interchangeable bits are available, also practical bench stand and solder holder. All voltages from 6 to 240 in stock. Send for illustrated leaflet. Iron as shown 2/6 post paid. (Please state voltage).

NEW HI FI SPEAKER UNIT

The W.B. Stentorian 'Gumber' 912C speaker and cabinet assembly mark a new advance in quality reproduction. Available from stock. PRICE 14 gns. (Plus 5/- part carriage). Leaflet on request.

MAKE YOUR OWN HIGH GRADE CERAMIC WAFER SWITCHES

Really compact high quality switches that you can assemble to your own particular requirements.

Complete shaft assembly 4/3 Separate wafers 4/- each Spacers (if required) 9d. doz.

Wafers are available in the following combinations and up to eight can be assembled on to one shaft assembly. 1 pole 12 way, 2 pole 6 way, 3 pole 4 way, 4 pole 3 way, 6 pole 2 way. If desired D.P. mains on/off switch can be added to above 5/-.

"ROADFARER" AND "TRANSISTOR SIX"

Constructional data and all parts in stock for these two sets. Price list on request. Complete set of guaranteed and specified parts for "Transistor 6" 9 gns. and "Roadfarer" £17.10.0.

SUPER 128 PAGE ILLUSTRATED CATALOGUE 2/- Plus 9d. Postage

SENSATIONAL NEW 1961 DESIGNS—BY CONCORD LOW PRICES ★ PICTORIAL STEP-BY-STEP PLANS ★ EASY AS A.B.C.

THE NEW "LISBON" TRANSISTOR SET

This is a pocket 2-stage transistor set not much larger than a matchbox. Excellent clear reception covering all medium waves, works for months off a tiny 1 1/2 or 3 volt battery costing only 3/4d. Easy to build and an excellent introduction to transistor circuitry. Everything can be supplied down to the last nut and bolt including PICTORIAL STEP-BY-STEP PLANS FOR ONLY 19/6, plus post and packing 1/6. (C.O.D. 3/- extra). Parts sold separately, priced parts list 1/-.

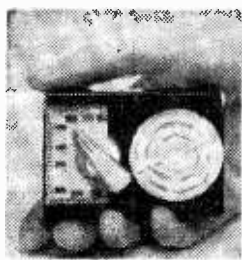

THE NEW "FLORIDA" VALVE RADIO

This sensational "FLORIDA" model is one of our most sensitive valve radios. It is a highly compact, self-contained miniature push button base, valve pocket radio at absolutely rock bottom building cost. Covers all medium waves with very latest circuitry bringing in stations from all over Europe without fuss. Size only 4 1/2 x 2 1/2 x 1 1/2 in. A fascinating pocket radio. We can supply all the parts including beautiful 2-tone case and SIMPLE AS A.B.C. PICTORIAL STEP-BY-STEP PLANS, screws, wire, etc. Can be built for the exceptionally LOW PRICE OF 27/6, plus post and packing 1/6 (C.O.D. 2/- extra). Parts sold separately, priced parts list 1/-.



OUR NEW 4 STAGE "MINUETTE"

Build this newly-designed "MINUETTE" 4-STAGE transistor set in very strong ready drilled ULTRA-MODERN CASE, size only 6 x 3 1/2 x 1 1/2 in. Uses three transistors and diode and SELF-CONTAINED LOUD SPEAKER. Very sensitive, ideal for office, bedroom, holidays, etc. Months and months of listening of an 8d. battery. Can be built FOR ONLY 39/6, including PROPER CASE, miniature speaker, etc. SIMPLE AS A.B.C. PICTORIAL STEP-BY-STEP PLANS etc., plus post and packing 1/6 (C.O.D. 2/- extra). Parts sold separately, priced parts list 1/-.



THE NEW "SAN REMO"

This All Transistor Speaker Radio—the "San Remo"—covers all medium waves including "Home," "Light," etc. Reliable and lightweight—slips easily into the Pocket or Handbag—size only 4 1/2 x 3 1/2 x 1 1/2 in. Works for Months off 8d. Battery! Ideal for holidays, Camping, Bedroom, etc. Anyone can assemble it in an hour or two with our simple-as-ABC Plan! Complete set of parts including miniature speaker—everything—only 27/6, plus 2/6 P. & P. (C.O.D. 2/- extra). Parts can be bought separately.



CONCORD ELECTRONICS Dept. PW34 210, Church Road, Hove, Sussex

Orders accepted. Cash on delivery 2/- extra. Please print name and address in block letters. Suppliers to Schools, Universities, Government and Research Establishments. Complete range of components and valves stocked. Reply to C.O.D. abroad. DEMONSTRATIONS DAILY AT WORKS.



"MINITEST" Model 127A

20,000 o.p.v. POCKET SIZE!

Performance equal to a high priced instrument

OUTSTANDING FEATURES:

- ★ Sensitivity 20,000 o.p.v. D.C. 1,000 o.p.v. A.C.
- ★ 20 Ranges.
- ★ D.C. Current 50μA, to 1 Amp.
- ★ D.C. Volts 0.3 v. to 1,000 v. (25 kV by probe).
- ★ A.C. Volts 10 v. to 1,000 v.
- ★ 3 Resistance Ranges from 0-20 megohms (self-contained).
- ★ Meter 40μA 3½ in. arc.
- ★ Accuracy D.C. 3%, A.C. 4%.
- ★ Dimensions 5½ x 3½ x 1½ in.

PRICE: £10.0.0

Credit Sale Terms available

9 monthly instalments of
£1.44

Complete with instruction Manual and interchangeable test prods and clips. High quality leather case, if required, £25.0.
H.V. Probe for 25 kV ... £5.5.0

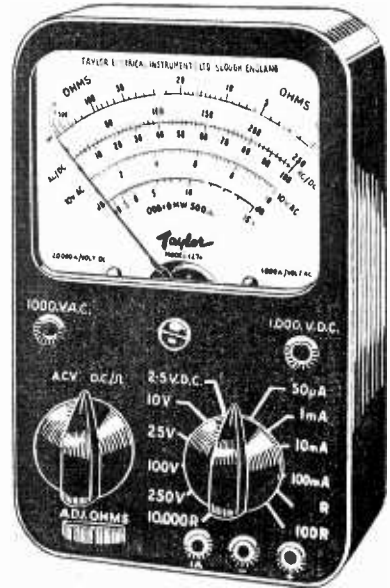

Write for
fullest
details to:

TAYLOR ELECTRICAL INSTRUMENTS LIMITED
Montrose Avenue, Slough, Bucks. Tel: Slough 21381 Cables: Taylins Slough

Member of the METAL INDUSTRIES GROUP OF COMPANIES

CODAR "CLIPPER" ALL BAND RECEIVERS 10-2000 METRES

LISTEN TO AMATEURS, AIRCRAFT, SHIPPING, SHORT, MEDIUM, LONG WAVE BROADCAST STATIONS THROUGHOUT THE WORLD

THE MINI-CLIPPER

The miniature valve radio with the BIG SET features! Covers all Short, Medium, Long waves 10-2000 metres (5 coils). Smart all satin silver all front panel with engraved dials, etc. Ball bearing, air spaced variables. Size only 6½ x 3½ x 4 in. Battery lasts months. No drilling. Total building cost including punched chassis, valve, front panel, one coil for 20-60 metres, nuts, bolts, wire, Step-by-step pictorial plans, 39/6. P. & P. 2/-.



39/6

Additional coils and electrical bandspread optional extras. Parts sold separately. Full plans, parts list, 2/-.

THE SUPER CLIPPER 88/6

This world-famous hybrid receiver has achieved remarkable success. Tremendous performance with Hi-gain valve detector PLUS two Ediswan transistor amplifiers which are supplied assembled, only 3 wires to connect! Large precision dial, 7 x 4 in. with 2 pointers, bandset and bandspread, dual slow-motion drives, air spaced variables. Punched chassis 8 x 5½ in. Batteries last months. Covers 10-2000 metres (5 coils). Total building cost including chassis, valve, 2 transistor stages, 2 coils 20-60 and 55-190 metres. Step-by-step pictorial plans, nuts, bolts, wire 88/6. P. & P. 2/6.



THE CLIPPER. As above but one transistor stage, 79/6. P. & P. 2/6. Optional Front Panel, Silver Hammer finish, all holes, 6/9-

THE CLIPPER CR 45

£6.17.6



This A.C. Mains receiver is the latest model in the famous CLIPPER Series and combines really top performance with superb professional finish. It is the finest ALL BAND receiver at the price with a new high gain circuit using ECC81 double triode, EL84 output, EZ80 full wave rectifier. Power output 3½ watts for 2/3 ohm speaker. Covers 10-2000 metres (5 coils). World-wide reception. Outstanding features include 3 planetary slow motion drives, separate electrical bandspread, air spaced low loss variables, satin silver dials, silver hammer front panel. Total building cost, including 10 x 5½ in. punched chassis, valves, front panel, 2 coils 20-60 and 55-190 metres, nuts, bolts, wire, etc., 10 pages pictorial plans, £6.17.6. P. & P. 3/6. Optional extra. Modern styled Cabinet, rear panel, silver hammer finish, 27/6. Parts sold separately. Full plans, parts list, 10 pages, 3/6 post free.

No technical knowledge is required to build these fine receivers. Only new guaranteed components are supplied. Send 3d. stamp for illustrated leaflets, testimonials. Suppliers to Educational Authorities, Government Departments, etc.

CODAR RADIO COMPANY, COLEBROOK ROAD, SOUTHWICK, SUSSEX

Radio & TV Engineers' Reference Book

FREE
 to every keen radio man
FOR A WEEK
 WITHOUT
 OBLIGATION
 TO BUY

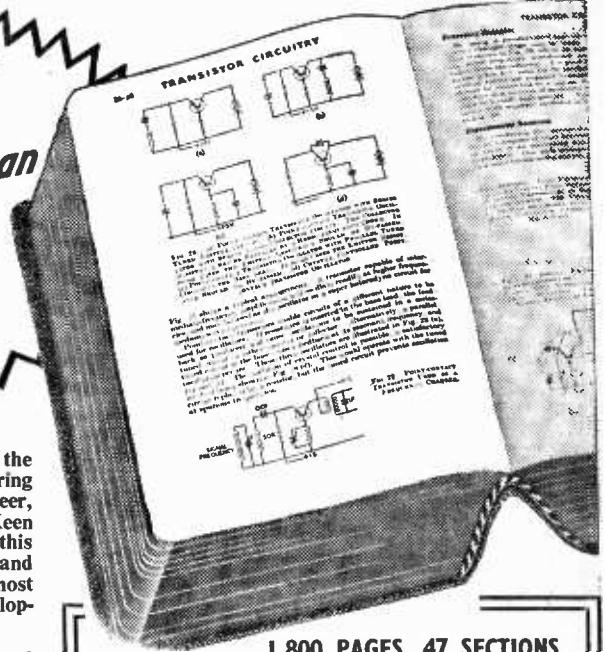

Now you can have for 7 days' free examination the revised 3rd Edition of this very practical engineering and servicing work. If you are a Radio Engineer, Technician, Mechanic, Instructor, Student, Keen Amateur, or engaged in the electronics field, this great wealth of data in all branches of radio and television will prove invaluable. It covers a most comprehensive range of subjects, new developments and techniques.

**BROADCASTING • COMMUNICATIONS
 SERVICING • NAVIGATION**

**High Fidelity Recording
 and Reproduction. Components**

Written for you by nearly 50 Specialists

Including L. S. Allard, B.S.C., A.INST.P. (G.E.C. Cathode-ray Tube Group); S. W. Amos, B.S.C.(HONS.), A.M.I.E.E. (B.B.C. Tech. Instructions Section); E. S. Bacon, M.S.C.(LOND.), A.R.I.C. (Chief Supervisor Elec. Labs. Ever Ready Co. (G.B.) Ltd.); W. T. Blackband, M.S.C., A.M.I.E.E. (Aerials Research. R.A.E., Farnborough); R. H. Burdick, A.G.C.I., A.M.I.E.E. (Marconi's); L. Driscoll, B.S.C., A.M.I.E.E., A.M.BRIT.I.R.E. (Murphy Radio); E. A. Fielding, B.S.C.TECH.(HONS.), A.M.C.T., M.I.E.E., A.I.R.E. (Salford Electrical Instruments Ltd.); D. H. Fisher, A.M.I.E.E. (Regenone); L. S. Foskett (E.M.I.); R. C. Glass, M.A., B.S.C., A.M.I.E.E. (Lecturer Applied Physics, Northampton Coll. Adv. Technology, London); F. J. Grimm, A.M.BRIT.I.R.E. (Pye); P. Jones (Aerialite Ltd.); J. M. Kirk, M.B.E., B.S.C.(HONS.), D.I.C., A.C.G.I., M.I.E.E. (Standard Telephones and Cables Ltd.); L. A. Moxon, B.S.C.(ENG.), A.M.I.E.E. (R.N. Scientific Service); D. F. Urquhart (Erie Resistor Ltd.); V. Valchera (Valradio Ltd.); A. H. B. Walker, B.S.C.(ENG.), D.I.C., A.C.G.I., M.I.E.E. (Westinghouse Research Lab.).

1,800 PAGES, 47 SECTIONS

Includes:—Formulae, Calculations, Communication Theory, Electron Optics, Colour TV, Materials, Studio Equipment, Transmitter Power Plant, Broadcasting and Communications Transmitters, V.H.F. Equipment, Amateur Radio Equipment, TV Transmitters and Aerials, Radio-Frequency Transmission Lines, Waveguides, Broadcasting Receivers, TV Receiver Design, Commercial H.F. Radio Links, Broad-band Systems, Radio Navigation and Radar, Aero Radio and Radar, Radio Astronomy and Satellite Communication Aerials, Valves, Tubes, A.C. Rectification and Ripple Filters, Transistors, Diodes, Resistors, Capacitors, Inductors, Transformers, Gramophone Pick-ups, Speakers, Interference, Recording, Batteries and Conversion Equipment, H.F. Reproduction, Measuring and Test Equipment, R/TV Installation and Servicing, Noise Projection TV, Oscillators, Industrial TV, Units and Symbols, Progress & Developments, etc
2000 DIAGRAMS AND TABLES

**POST NOW
 7-DAY
 FREE
 TEST**

GEORGE NEWNES LTD., 15-17 LONG ACRE, LONDON, W.C.2.

Please send me Newnes RADIO AND TELEVISION ENGINEERS' REFERENCE BOOK without obligation to purchase. I will either return the work within eight days or I will send the first payments of 5/- eight days after delivery, then ten monthly subscriptions of 10/- until the sum of £5 5s. has been paid. Cash price within eight days is £5.

Name _____

Address _____

Occupation _____

Your Signature _____
 (Or your Parent signs if you are under 21)

Tick (✓) where applicable

| | |
|--------------------------|---------------------|
| <input type="checkbox"/> | HouseOWNER |
| <input type="checkbox"/> | Householder |
| <input type="checkbox"/> | Living with Parents |
| <input type="checkbox"/> | Lodging Address |

RB2V

HARVERSON SURPLUS CO. LTD.

83 HIGH STREET, MERTON,

GRAM AND TAPE EQUIPMENT BARGAINS

MONAURAL AMPLIFIER KIT

This comprises a complete kit of parts (including UCL82 valve) to build a quality 3W amplifier, size 7 x 3 1/4 x 6 1/2 in. Efficient Circuit with volume and tone controls. Everything supplied including mains and O.P. transformers, metal rect., knobs, etc. and comprehensive instructions.

ONLY 39/6 Post and packing 4/6 extra.

Sin. loudspeaker (3Ω) to suit, 14/6 extra. All parts sold separately.

A.M. RADIOGRAM CHASSIS

A modern chassis by a famous maker. Size 15 1/2 x 7 x 6 1/2 in. high, incorporating fully delayed AVC and neg-feed back. Valves ECH81, EF89, EBC81, EL84, EZ81. Attractive brown and gold dial with matching knobs. Controls—w/change (L.M.S. and gram), tone, tuning and vol. on/off. Complete with O.P. trans, valves, knobs, etc.

£9.19.6 plus 4/6 P. & P.

F.M. TUNER HEAD

Made by famous manufacturer, 88-100 Mc/s. Non-drift. Uses ECC85 valve. (PRICE) **18/6** plus 1/6 P. & P. (less valve) ECC85 valve 8/6 extra.

2 BAND SUPERHET CHASSIS with Speaker

A quality AC/DC chassis, size 6 1/2 x 9 x 5 1/2 in. Long & Medium wave coverage. Fitted with attractive illuminated glass dial and reduction tuning drive. Controls: Vol. on/off, w/change, and tuning. Complete with valves (UCH42, UAF42, UL41, UY41), knobs, etc.

ONLY £5.17.6, plus 6/6 P. & P.

4 STATION PRESET SUPERHET CHASSIS WITH SPEAKER

A compact A.C./D.C. receiver, size 9 x 6 1/2 x 5 1/2 in. 2 controls: vol. on/off, and station selector. Fitted with frame aerial and quality 5in. speaker. Complete with valves (UCH42, UAF42, UL41, UY41), knobs, etc.

ONLY £4.17.6, plus 6/6 P. & P.

TAPE DECKS

LATEST B.S.R. MONARDECK (single speed) 3 1/2 in. per sec., simple control, uses 5 1/2 in. spools

£7. 5. 0 plus 5/6 carr. & ins. (tapes extra). TRUVOX MARK III TAPE DECK. New and Boxed. **£10.6. 6** Plus 6/- carr. and ins. (tapes extra)

CONDENSER/RESISTOR PARCEL

50 mixed P.F. Condensers and 50 mixed Resistors. An assortment of useful values. All popular sizes—all new—a must for the serviceman and constructor. P. & P. 1/-.

ONLY 10/-

1/6 H.P. MOTOR

140 watts (approx. 1/6 H.P.). Series wound, 220/250 volt 50 cycle motor. Off load 14,000 rev/min. on load 8,500 rev/min. Ideal small saw, sewing machine, etc., post free.

30/-

HI/FI STEREO/MONAURAL AMPLIFIER

A 5 valve HI/FI amplifier with switched stereo/monaural operation. Output 3 watts per channel, provision for bass and treble speakers on each. Volume and tone controls fitted both channels. All housed in stylish blue/grey metal case, with gold finished knobs **£9.19.6** plus 4/6 P. & P. and trimmings.

READY BUILT AMPLIFIER

A 3-valve amplifier (ex-relay unit). Comprising 10F3 RF amp, 10P14 Audio amp (3W) and U404 rect. Inputs for AC/DC mains, 6 preset channels and crystal P.U. Complete in attractive brown and cream bakelite case, with 8in. 15Ω speaker fitted. Ideal gram, guitar, amplifier, etc. **ONLY 21/-** plus 6/6 P. & P.

THE WORLD FAMOUS E.M.I. ANGEL TRANSCRIPTION P.U. (Model 17A)

A Pick-up for the connoisseur originally priced at £17.10.0. The last remaining few offered at **£4.10.0** Plus 5/- P. & P.

E.M.I. 4-SPEED RECORD TURNTABLE AND PICK-UP

Heavy 8 1/2 in. metal turntable. Low flutter performance, 200/250 v. shaded motor with tap at 80 v. for amplifier valve filament if required. Turnover LP/78 head.

89/6 COMPLETE Plus 4/6 P. & P.

E.M.I. 4-SPEED STEREO PLAYER

To suit our stereo amplifiers **£6.12.6** Plus 5/- carr.

T.S.L. STICK MICROPHONE

A top grade stick mike, originally priced at 45/-. Ideal for Tape Recorder, etc. **OUR PRICE 25/-** Plus 1/6 P. & P.

MIDGET I.F. TRANSFORMERS & COILS

A pair of midget 465 kc/s I.F. transformers, plus LW and MW coils. PRICE 10/- per set. P. & P. 1/9. Set of I.F. transformers for transistor superhet. 12/6. P. & P. 1/9.

COSSOR C.R.T. SNIP

108K 10-inch. New and boxed. 15/-, plus 6/- P. & P. 75K 10-inch. New and boxed. 15/-, plus 6/- P. & P.

ION TRAP MAGNETS

To suit the above, 2/9 each. P. & P. 3d.

MAZDA CRM 172—Not a Regun. Picture tested—12 months' Guarantee. **£3.17.6.** 12/6 P. & P.

CYLDON 12 CHANNEL TURET TUNERS

New purchase offered at still lower price I.F. 33-38 Mc/s. Complete with PCC84 and PCF80 valves and 8 sets of Coils for 5 Band I Channels and 8, 9, 10 Band III. New and unused. Value over £7.

OUR PRICE, 32/6

PAIR OF MOTORS

Two miniature motors (each 3 1/2 x 3 x 1 1/2 in.). Can be run in parallel from 115 v. A.C. or in series from 200/250 v. A.C. Ideal tape motors, models, etc.

15/6 per pair, plus 2/9 p. & p.

FOR FULL DETAILS AND ILLUSTRATIONS OF THE ITEMS IN THIS ADVERTISEMENT, SEE MAY ISSUE, PAGES 3, 4, 5 and 6.

SUPER STEREO KIT

A kit of ready-built units only requiring interconnection. Comprising two medium 3W amplifiers, push-button switch, transformer, control unit (bass, treble and vol.), power pack, one speaker (second speaker 14/6 extra), indicator light, valves (ECL82, EZ80 range), and comprehensive instructions. **59/6** plus 6/6 P. & P.

SUPERHET CHASSIS

Modern AC/DC chassis with printed cct. and ferrite rod aerial. Although not completely built, the main components are mounted. L. & M. wave coverage. 4 valves (UBF89, UCL83, UCH81, UY85). Everything supplied including dial knobs, etc., and simple **£4.19.6** plus 3/6 instructions. P. & P.

F.M. TUNER

At last a quality F.M. Tuner Kit at a price you can afford. Just look at these fine features, which are usually associated with equipment at twice the price!

- ★ F.M. Tuning Head by famous maker.
- ★ Guaranteed Non-drift.
- ★ Permeability Tuning.
- ★ Frequency coverage 88-100 Mc/s.
- ★ OAB1 Balanced Diode Output.
- ★ Two I.F. Stages and Discriminator.
- ★ E.M.84 Magic Eye.
- ★ Self powered, using a good quality mains transformer and valve rectifier.
- ★ Valves used ECC85, two EF80's, EM84 (Magic Eye) and EZ80 (rectifier).
- ★ Fully drilled chassis.
- ★ Everything supplied, down to the last nut and bolt.
- ★ Size of completed tuner 8 x 6 x 5 1/2 in.

£4.19.6 Plus 8/6 P.P. & Ins.

Circuit diagram and illustrations, 1/6, post free.

STEREOPHONIC AMPLIFIER

Complete with 2 Speakers

A compact amplifier embodying the latest features, giving good reproduction and ample volume. Complete with valves (ECL82, ECL82, EZ80), panel, knobs, etc. and two 3Ω matched speakers.

£510.0. Plus 4/6 P. & P.

TRANSISTOR BARGAINS

ALL FIRST GRADE

| | |
|-------------------------|------|
| OC71 | 8/- |
| OC72 | 12/- |
| OC72 Matched Pair | 25/- |
| OC45 Green Spot | 15/- |
| OC45 Blue Spot | 15/- |
| OC44 | 15/6 |
| OA41 Diode | 3/6 |

Postage on all above 6d.

SPECIAL OFFER

DON'T MISS THIS
MULLARD O.C.76 10/6
MATCHED PAIR £1.0.0
Post and packing 6d.

G.E.C. FIRST GRADE TRANSISTORS

Set comprising one 874 mixer, two 873 I.F.'s, one GET114 driver, two GET113 matched output and one diode.

£1.18.6 post 1/-

**CHerrywood 3985/6
LONDON, S.W. 19**

VALVE BARGAINS

★ **NEW AND BOXED**
★ **PROMPT DESPATCH**
★ **POST 6d. PER VALVE EXTRA**

| | | | |
|-----------------|---------------|---------------|------------|
| 470B 12/6 | EL35 12/6 | PY83 8/6 | 1L4 8/6 |
| AC/PEN 17/6 | EL38 18/6 | R10 17/- | 1LN5 5/- |
| AC8/PEN/DD 12/6 | EL42 10/- | R16 18/6 | 1R5 6/6 |
| AC8/PEN 17/6 | EL84 8/6 | S216/UM 7/9 | 1S4 9/- |
| AC8/PEN 7/6 | EL91 5/- | 8D6 8/- | 1S5 6/6 |
| ATP4 5/- | EM4 10/- | 8D81 2/5 | 2D130 6/3 |
| AZ1 15/6 | EM80 9/6 | 8T7 11/6 | 2X2 4/6 |
| AZ2 12/6 | EM91 9/6 | 8P4 11/6 | 3D6 5/- |
| AZ31 10/- | EM84 9/6 | 8P13 8/3 | 3Q7 9/6 |
| B36 15/- | EY51 9/6 | 8P41 3/3 | 4THA 6/9 |
| B65 8/6 | EY96 9/3 | 8P42 12/- | 5U4Q 6/9 |
| C1 12/6 | EZ40 7/3 | 8P61 9/3 | 5Z39 12/6 |
| C1C 12/6 | EZ41 7/3 | 8U25 19/6 | 5Z49 12/6 |
| CBL1 19/6 | EZ80 7/- | SU2150 7/9 | 6A45 2/9 |
| CL4 12/6 | EZ81 7/3 | T41 9/- | 6A45 2/9 |
| CY1 18/7 | EZ90 7/3 | TH2821 18/- | 6A45 2/9 |
| CY1C 17/6 | KT18 18/6 | TP22 15/- | 6B56G 17/6 |
| CY81 16/7 | PC74 18/6 | TP2820 15/- | 6B16 6/6 |
| D41M 12/6 | FW 4500 9/6 | T8E4 8/6 | 6C5GT 6/- |
| D12 12/6 | GT1C 10/- | T8P4 7/9 | 6D1 4/- |
| D43 5/- | GZ32 11/3 | U10 9/9 | 6P7 9/9 |
| DAF96 8/6 | E80 5/- | U17 11/9 | 6P8 9/9 |
| DF96 8/6 | KT49DD 12/- | U21 17/9 | 6F11 11/6 |
| DH101 19/6 | HL13C 7/9 | U35 17/9 | 6F15 11/6 |
| DK96 8/6 | HL41DD 16/- | U87 19/9 | 6F32 9/6 |
| DL33 8/6 | HL139DD 10/- | U60 7/8 | 6H6 8/- |
| DL63 9/6 | KT33 12/6 | U62 6/9 | 6I7G 6/- |
| DL65 16/6 | KT48 12/6 | U74 10/- | 6K7G&M 5/- |
| DL68 14/- | KT55 18/6 | U81 12/6 | 6K25 12/6 |
| DL74 3/3 | KT66 17/- | U101 12/6 | 6N7 8/- |
| DL82 8/6 | KT70B 11/6 | U191 17/6 | 6P25 12/6 |
| DL96 8/6 | KT71 9/- | U389 12/6 | 6P28 23/6 |
| DM96 9/6 | KT74 12/- | U403 15/6 | 6R7GT 10/- |
| DW 4/500 13/6 | KT76 12/- | U404 10/6 | 6R7G 10/- |
| EA50 1/6 | KTW63 7/- | UABC80 9/6 | 6S7G 7/6 |
| EA8080 8/6 | KT741 8/- | UBF80 8/- | 6SF7 7/6 |
| EB34 2/6 | KT783 8/6 | UC84 12/6 | 6S87 8/- |
| EB41 8/- | L63 5/6 | UC85 10/6 | 6SK7M 6/6 |
| EB3 21/- | M14 8/3 | UCF80 16/- | 6U7G 8/6 |
| EB38 6/3 | MH4/150 7/9 | UCH42 9/9 | 6V6G 7/6 |
| EBF80 9/- | MH41 7/8 | UCH81 9/9 | 6Z5 8/3 |
| EBF89 9/6 | MKT4 18/- | UCL82 9/- | 7B5 11/- |
| EBL1 15/- | M14 8/6 | UCL83 14/9 | 7C5 8/- |
| EBL21 22/- | MS/PEN 6/- | UF85 9/- | 7C8 8/- |
| EBL31 22/- | MSP4 17/- | UF89 8/6 | 7E7 12/6 |
| ECC31 10/- | MSP41 13/6 | UCL41 9/6 | 7Q7 13/6 |
| ECC32 9/6 | MU14 5/6 | ULM4 9/- | 8A1 7/6 |
| ECC34 19/9 | N16 9/- | UR1C 12/6 | 9 4/6 |
| ECC81 8/- | N108 19/6 | UR3C 10/- | 9A1 7/6 |
| ECC83 9/6 | BO2 7/9 | U6 17/6 | 9D2 4/- |
| ECC84 9/6 | OC3 7/6 | U07 13/- | 10P1 10/9 |
| ECC86 9/6 | OD3 5/6 | U08 19/9 | 10P6 8/6 |
| ECC90 12/6 | OM1 12/6 | U060/260 11/3 | 10P3 12/6 |
| ECC92 12/6 | OZ4 5/6 | UY41 7/8 | 10P14 18/- |
| ECH42 9/6 | P14 7/6 | UY85 7/6 | 11D5 5/9 |
| ECH81 9/6 | P16 9/- | V94 6/9 | 12T7 9/9 |
| ECL20 9/3 | PCC85 9/3 | VM4AB 12/6 | 12T8A7 9/6 |
| ECL84 10/3 | PCF40 9/6 | VP2B 10/6 | 12S7 7/- |
| EF9 8/6 | PCF82 11/6 | VP4 15/- | 12S7K7 6/- |
| EF36 9/6 | PCF82 11/6 | VP13A 7/6 | 12L7 6/9 |
| EF37 14/- | PCL82 11/6 | VP41 6/- | 12R7 8/6 |
| EF39 5/6 | PCL83 13/6 | VPT4 7/6 | 12T7 8/6 |
| EF40 14/6 | PEN40DD 19/9 | VK505 6/9 | 18 17/9 |
| EF42 19/3 | PEN46 19/9 | V8L631 7/- | 19A05 10/6 |
| EF30 4/6 | PEN83 15/6 | VUJ11 10/- | 19X3 10/6 |
| EF51 7/9 | PEN468DD 19/9 | W61 10/6 | 21P2 19/9 |
| EF54 5/- | PL33 18/6 | W24 19/9 | 20P1 15/9 |
| EF80 7/- | PL36 14/6 | X41 15/- | 25L6 10/6 |
| EF86 7/6 | PL81 11/6 | X79 17/9 | 25Y6 10/- |
| EF89 9/- | PL92 3/0 | X109 15/9 | 25Y7 9/6 |
| EP91 5/- | PM12M 7/8 | X13 17/6 | 35L6 9/6 |
| EK2 8/6 | PL36 14/6 | Z14 10/6 | 35Z4 6/- |
| EL2 11/3 | PL81 11/6 | Z63 7/8 | 35Z5 9/- |
| EL3 11/3 | PL81 11/6 | Z66 17/6 | 41-TH 11/- |
| EL32 3/- | PY81 9/3 | Z85 10/6 | 45 10/- |
| EL33 13/- | PY82 7/- | 1AGT 6/9 | 45U1 10/- |
| | | 1AGT 12/- | 77 8/- |
| | | 1D6 10/6 | 807 7/8 |

SPECIAL OFFER 12-6K7G 35/-

MANY MORE VALVES THAN THE ABOVE IN STOCK, PLEASE ENQUIRE FOR TYPES NOT LISTED

100 ASSORTED TAG STRIPS
I way up to—9 way
15/- per 100

WIRE WOUND POTS
12 Wire Wound Colvern
Pots—all different
values. P. & P. 9d. **10/9**

TECHNICAL TRAINING
in radio television and electronics

Whether you plan to have your own business, to become an electronics engineer, to take up a career in industry, or to brush-up your knowledge and study new developments, transistors, etc., an I.C.S. Course will help you to succeed. You learn at home in your own time, under expert tuition. Moderate fees include all books.

EXAMINATION COURSES FOR:—

C. & G. Radio and TV Servicing Certificate
(R.T.E.B.)

C. & G. Radio Amateurs' Exam.
(Amateurs' Transmitting Licence)

British Institution of Radio Engineers, etc. C. & G. Telecom. Technician's Cert.

LEARN AS YOU BUILD

Practical Radio Servicing Course

A basic course in radio electronic and electrical theory backed by thorough practical training. You build radio receivers, signal generator and multimeter.

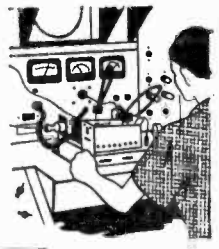

Post this Coupon TODAY! FREE book on career in radio and on details of other I.C.S. Courses

INTERNATIONAL CORRESPONDENCE SCHOOLS
(Dept. 171), Intertext House, Parkgate Road, London, S.W.11.

Please send book on _____

Name _____ Age _____
(Block Letters Please)

Address _____

Occupation _____ 9.61

INTERNATIONAL CORRESPONDENCE SCHOOLS

CIRCUITS FOR AUDIO AMPLIFIERS

-a book every enthusiast will want!

This new Mullard publication is a practical manual for every audio enthusiast. In addition to describing twelve of the most popular Mullard circuits, it has introductory chapters on many of the theoretical and practical aspects of high quality sound reproduction.

Whether you are interested in disc or tape, monaural or stereo, you will find that "Circuits for Audio Amplifiers" gives just the sort of information you need.

This informative book costs only 8/6. The demand for it is high, so get your copy now from your local radio dealer.



Mullard

MULLARD LIMITED • MULLARD HOUSE • TORRINGTON PLACE

LONDON W.C.1
MVM423A

Premier RADIO

23 TOTTENHAM COURT ROAD, LONDON W.1
and at 309 EDGWARE ROAD, LONDON W.2

Tel: MUSEUM 3451/2
Tel: PADDINGTON 6963

THE TELEFUNKEN STEREO HI-FI AMPLIFIER

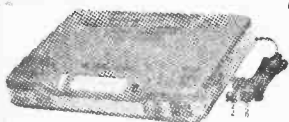

Original Price 16 gns.

NOW ONLY

£9.19.6

P. & P. 5/-

At last perfection is now within the reach of all. This unique Amplifier has been designed to revolutionary Standards, both in appearance and technical design and backed by the full technical resources of Telefunken.

Brief Specifications:

- ★ Power Output 5 watts total (2½ watts per channel).
- ★ Total harmonic distortion less than 1% at 1 watt output.
- ★ Frequency Response: 30 c/s to 40 Kc/s 2dB, 45 c/s to 30 Kc/s 1dB.
- ★ Sensitivity sufficient for all normal inputs from Tape Recorders, Pick-ups, Microphones, Radios.
- ★ Power Requirements 110, 125, 150, 220, 240 volts A.C.
- ★ Piano key selecting.
- ★ Preset/selected tone control.
- ★ Size: 12in. wide x 9in. deep x 2in. high.
- ★ Weighs 9lbs.
- ★ Finish: Hammered enamel in grey/cream with gold trimmings. Controls and press buttons in cream with black, blue and red lettering.

Specially designed output transformers have been used having an extremely high transfer efficiency therefore delivering a far greater output to the speakers.

The SUPER 60

6-Transistor
Battery Receiver

Use by Built for
£9.15.0

Plus 4/6 P. & P.
Beer-Ready P.P10
Battery Extra 11/-



STAR FEATURES:—

- ★ Six 1st grade Mullard Transistors and one Diode.
 - ★ Internal Ferrite Rod Aerial.
 - ★ 7in. x 4in. Elliptical Speaker.
 - ★ Printed Circuit.
 - ★ 500 mW Push-Pull Output.
 - ★ Full medium and long waveband coverage.
 - ★ Calibrated Direct Drive Dial Drive Assembly.
 - ★ Full point-to-point instructions supplied.
 - ★ Dimensions 18in. x 7in. x 5in.
- The Receiver is housed in an attractive contemporary mahogany finished cabinet trimmed with gilt, supported by gilt stands. The receiver will operate for months on one 9-volt long-life battery. Instruction Book separately at 2/6 p.p.

Why not convert your battery portable to mains operation with the **COSSOR MUJ BATTERY ELIMINATOR?**

This Eliminator is completely assembled and supplied with 4ft of Mains Lead and Torpedo Type of On/Off Switch. It is housed in 2 Metal Containers approximately the same size as the AD35 and B126 Batteries, and suitable for receivers using DK96 range valves for use on 200-250V A.C. mains. Size: L.T. Unit 3in. x 2½in. x 1½in. H.T. Unit 4in. x 2½in. x 2in. Original price 3 gns. plus 2/- P. & P.

OUR PRICE for a limited period only. 39/6

| REDUCTIONS IN MULLARD TRANSISTORS | | |
|-----------------------------------|-------------|------------|
| OC19 48/- | OC72 8/- | OC78D 8/- |
| OC35 25/6 | OC72pr 16/- | OC81 8/- |
| OC44 11/- | OC73 16/- | OC84 11/- |
| OC45 10/- | OC75 8/- | OC170 13/6 |
| OC70 6/6 | OC77 10/- | OC171 14/6 |
| OC71 6/6 | OC78 8/- | OC201 12/6 |
| | | OC202 36/- |

A SPECIAL OFFER OF SIX MULLARD TRANSISTORS
1 OC44, 2 OC45, 1 OC81D, 2 OC81.
Only 37/6 set.

EDISWAN TRANSISTORS
XA104 12/-, XA103 10/-, XB102 6/6 ea.

P.W. TRANSISTOR SIX PRINTED CIRCUIT VERSION
All components available from stock
Complete kit £9.15.0.

| | |
|--|-------|
| Full detailed shopping list, point to point wiring diagram, fully illustrated..... | 1/6 |
| Coil Set (Osc. and 3 I.F.T.s)..... | 22/6 |
| Driver Transformer..... | 10/6 |
| Output Transformer..... | 10/- |
| Ferrite Rod Aerial..... | 10/- |
| Printed Circuits..... | 9/- |
| OO Gang Condensers..... | 11/- |
| Volume Control V.C. 1545..... | 10/6 |
| Switch..... | 3/6 |
| Hardware Kit..... | 4/6 |
| Transistors (set of 6 plus crystal diode GD9)..... | 70/- |
| Speaker..... | 19/10 |
| Case..... | 7/6 |
| Complete Kit of Condensers..... | 15/- |
| Complete Set of Resistances..... | 6/6 |
| Trimmers (2)..... | 2/8 |

All above components are brand new and are fully guaranteed.

TAPE DECKS

Collaro Studio Tape Transcriber 3 motors, 3 speeds, 17, 33, 74 i.p.s., take 7in. spool. Push-button control. Price £12.12.0. Tape extra. Carr. & Ins. 5/6. Latest B.S.R. "Monardeck"
Single Speed
3 1/2 i.p.s. takes 5 1/2in. spools. Simple controls. £7.7.0. Tapes extra. Carr. and Ins. 5/6.

MICROPHONES

- ★ **Acos Mic.** 39/1. Crystal stick microphone for use as a hand, desk or floor stand unit. Listed at 3 gns. **OUR PRICE 37/6.** Table Stand 7/6 extra. Floor stand adaptor, 12/6 extra.
- ★ **Acos Mic.** 40, as supplied with modern tape recorders with a folding rest and 8ft. lead. Listed at £115.0. **OUR PRICE 19/6.**
- ★ **GBS Microphone**, pencil stick type fitted with muting switch, 42/-.
- ★ **T.S.L. Crystal "Stick" Microphone**, Model MX3, for general purpose use, complete with table stand, 45/-.
- ★ **T.S.L. Moving Coil Microphone**, for high or low impedance. Brown and cream plastic case with a fold-in cable rest, 6ft. cable and a standard 3-way connecting continental plug, £4.4.0.
- ★ **Acos Mic.** 45, dual purpose, designed to fit into the hand, has built-in stand for desk use, die-cast case for a variety of applications from music to dictation, with lead, 25/- each.

TELEVISION TUBES RE-GUNNED

Super screen TV tubes with a 12 months' guarantee.

Tubes all types 12in. to 14in. ... £4.5.0 Tubes all types 15in. to 17in. ... £4.15.0
Carriage and insurance 10/- extra. Allowance against the return of old tube.

AUTOMATIC RECORD PLAYER UNITS

| | |
|---|---------|
| B.S.R. Monarch UAB, 4 speed unit, fitted the B.S.R. Full/Fi cartridge..... | £6.15.0 |
| B.S.R. Monarch UAB, as above but fitted with B.S.R. Full/Fi Stereo cartridge..... | £6.19.6 |
| B.S.R. Monarch UA14, 4 speed unit in two-tone grey..... | £7.19.6 |

| | |
|--|----------|
| Garrard 210, 4 speed unit, arm wired for stereo, fitted with GC8 monaural cartridge..... | £10.19.6 |
| Garrard 209, 4 speed unit, fitted with GC8 cartridge..... | £10.10.0 |
| Garrard Laboratory Series Auto turnable type A, can be supplied with or without base, and cartridges to your specification, prices from..... | £21.1.5 |
| Collaro, the latest Collaro Studio automatic record changer, 4-speed unit, finished in cream, fitted with turnover cartridge..... | £7.19.6 |



VALVES BY RETURN POST

| | | | |
|---------------|--------------|-----------------|-------------|
| AZ1 10/- | FW4/500 10/- | VP23 5/- | 607GT 9/6 |
| AZ31 10/- | 10/- | VR105/308/- | 6SK7 6/6 |
| DAF96 8/- | GZ32 11/6 | VR150/307/6 | 6SL7GT 8/- |
| DF96 8/- | HL23DD 8/6 | VU39 (MU 12/14) | 6SN7GT 7/6 |
| DK96 8/- | HL42DD 10/- | | 6SQ7 9/3 |
| DL96 8/- | 10/- | | 6U4GT 12/- |
| EABC80 9/6 | KT2 7/6 | IA7GT 13/6 | 6V6G 5/9 |
| EAF42 9/6 | KT33C 6/- | IC2 11/6 | 6V6GT 7/6 |
| EB91 4/6 | KT61 10/- | IC5GT 12/6 | 6X4 7/6 |
| EB33 5/6 | KTW61 6/6 | IR5 5/6 | 6X5G 7/- |
| EBC35 6/9 | MX40 12/6 | IN5 10/6 | 6XSGT 7/- |
| EBC41 8/9 | OZ4 4/6 | IR5 7/6 | 6/30L2 12/6 |
| EBF80 9/9 | PCC84 12/- | IS5 6/6 | 7B6 10/6 |
| EBF89 9/6 | PCC85 8/6 | IT4 5/6 | 7B7 8/6 |
| ECC81 8/6 | PCF90 8/9 | JA5 5/6 | 7C5 8/- |
| ECC82 7/6 | PCF82 11/6 | IR5 7/6 | 7C6 8/- |
| ECC83 9/6 | PLC83 13/6 | IN5 7/6 | 7H7 8/- |
| ECC84 10/- | PL36 13/6 | IS5 6/6 | 7Y4 6/6 |
| ECC85 9/6 | PL81 11/- | IS4 5/6 | 10F1 12/6 |
| ECF80 12/- | PL82 8/6 | IS4 5/6 | 10P13 22/3 |
| ECF82 10/6 | PL83 9/6 | IS4 5/6 | 12A6 5/- |
| ECH42 9/6 | PL83 9/6 | IS4 5/6 | 12A8H 12/- |
| ECH81 9/6 | PX25 12/6 | IS4 5/6 | 12A77 7/6 |
| ECL80 9/6 | PY80 7/6 | IS4 5/6 | 12AU7 8/- |
| ECL82 10/6 | PY81 8/6 | IS4 5/6 | 12AX7 8/- |
| ECL83 15/- | PY82 7/6 | IS4 5/6 | 12B6 9/- |
| EF6 5/- | PY83 8/6 | IS4 5/6 | 12C6 7/6 |
| EF36 3/6 | PEN4VA 10/- | IS4 5/6 | 12J7GT 10/6 |
| EF41 5/6 | PEN25 5/6 | IS4 5/6 | 12K7GT 6/6 |
| EF49 5/6 | PEN45 8/6 | IS4 5/6 | 12K8GT 13/6 |
| EF50SYL 7/6 | SP4 5/6 | IS4 5/6 | 12K18M 13/- |
| EF85 7/6 | TH30C 5/6 | IS4 5/6 | 12Q7GT 6/6 |
| EF86 12/6 | TP22 8/6 | IS4 5/6 | 12SK7 6/- |
| EF89 8/9 | U10 9/6 | IS4 5/6 | 12SL7 8/- |
| EF91 5/9 | U25 13/6 | IS4 5/6 | 12SN7GT 8/- |
| EF91(BVA) 7/6 | U26 10/- | IS4 5/6 | 15D2 7/9 |
| EF92 6/- | UAB80 9/6 | IS4 5/6 | 25A6G 8/- |
| EF183 15/- | UAF42 9/6 | IS4 5/6 | 25L6GT 10/- |
| EF184 15/- | UBC41 8/6 | IS4 5/6 | 25Z4 9/6 |
| EK32 7/6 | UBC81 11/4 | IS4 5/6 | 25Z5 7/- |
| EL32 4/6 | UBF90 9/6 | IS4 5/6 | 25Z6 10/- |
| EL33 10/- | UCC84/10/11 | IS4 5/6 | 30F1 10/6 |
| EL41 9/6 | UCC85 9/6 | IS4 5/6 | 30P15 23/3 |
| EL84 9/6 | UCH42 9/6 | IS4 5/6 | 30P1 15/- |
| EL91 4/6 | UCH81 9/6 | IS4 5/6 | 30P12 12/6 |
| EM34 9/6 | UCL82 11/6 | IS4 5/6 | 30P11 12/6 |
| EM80 9/6 | UCL83 13/6 | IS4 5/6 | 35L6GT 10/6 |
| EM81 10/6 | UFB8 9/6 | IS4 5/6 | 35Y5 9/9 |
| EM82 10/6 | UFB9 9/6 | IS4 5/6 | 35Z4GT 8/- |
| EM86 10/- | UL41 9/6 | IS4 5/6 | 42 8/- |
| EZ40 7/6 | UL84 9/6 | IS4 5/6 | 35Z5GT 9/- |
| EZ41 7/6 | UU6 19/3 | IS4 5/6 | 50L6GT 8/6 |
| EZ80 7/6 | UYIN 12/6 | IS4 5/6 | 6L8 7/5 |
| EZ81 7/6 | UY41 6/6 | IS4 5/6 | 6L6G 8/6 |
| FC13 5/- | UY85 7/6 | IS4 5/6 | 6L8 7/5 |
| | | IS4 5/6 | 6N7GT 7/6 |
| | | IS4 5/6 | 210DDT 4/6 |
| | | IS4 5/6 | 210VPT 3/6 |

LOUDSPEAKER UNITS

All brand new

| | |
|--|-------|
| 2 1/2in. square Rola C25..... | 26/10 |
| 2 1/2in. square EMI..... | 18/6 |
| 4in. square Elac Tweeter..... | 12/6 |
| 5in. round Plessey with O.P.T..... | 16/6 |
| 6in. round Celestion..... | 17/6 |
| 8in. round Richard Allen..... | 18/6 |
| 10in. round Elac..... | 25/- |
| 12in. round Plessey..... | 27/6 |
| 6in. x 4in. Plessey..... | 19/6 |
| 7in. x 4in. Plessey..... | 19/6 |
| Collaro, x 4in. Celestion and Richard Allen..... | 19/11 |
| 10in. x 6in. Celestion and Plessey..... | 21/6 |

RECORDING TAPE

Special Offer of Top quality recording tape, 3 1/2in. spool 200ft., 5/3, 5in. spool 600ft., 13/9, 5 1/2in. spool 850ft., 18/6, 7in. spool 1200ft., 23/-. Extra-play tape, 3 1/2in. spool 300ft., 7/-. 5in. spool 900ft., 21/-, 5 1/2in. spool 1275ft., 26/6, 7in. spool 1800ft., 37/6.
Empty spools, 3 1/2in., 1/6, 5in., 2 1/2, 7in., 3/-.

RECTIFIERS

RM1 5/3, RM2 6/9, RM3 7/6, RM4 13/6, RM5 19/6, 14A86 19/6, 14A97 19/6, 14A100 19/6, LW7 17/6, 18RA 1-1-16-1 6/-, FC31 (14RA 1-2-8-3) 22/6, FC101 (14RA 1-2-8-2) 16/6.

LIGHTWEIGHT SOLDERING IRON

Latest design, for use on 200/250 volts, with detachable handle, can be carried quite comfortably in pocket, 18/9 each.

HENLEY SOLON SOLDERING IRONS

65 watt, with oval bit, 29/- each; 65 watt, with pencil bit, 30/8 each; 25 watt, instrument model, 24/- each. All spares available from stock.

CATALOGUE

OUR 1962 CATALOGUE IS NOW AVAILABLE. PLEASE SEND 1/- IN STAMPS FOR YOUR COPY. TRADE CATALOGUE ALSO AVAILABLE. FOR WHICH PLEASE ATTACH YOUR BUSINESS LETTER HEAD.

TERMS: Cash with order or C.O.D. Postage and Packing charges extra; as follows: Orders value 10/- add 1/-; 20/- add 1/9; 40/- add 2/6; £5 add 3/6. Minimum C.O.D. fee & postage 3/-. For full terms of business see inside cover of our catalogue. Personal Shoppers 9 a.m. to 5 p.m. Mon. to Friday; Saturday 10 a.m. to 1 p.m.



103 LEEDS TERRACE
WINTOWN STREET
LEEDS 7

SUMMER SALE Last Month! SUMMER SALE

Most of the items advertised last month are still available and these, together with the new ones listed this month, may be purchased at the Special SUMMER SALE PRICE LIST until September 15th.

- **Transistor output transformer**, to match OC81 into 3 ohm. 4/6.
- **Small Bakelite cabinet**, suit table radio of any type 6/6, plus 2/- postage and insurance.
- **Potmeters long spindle**, no switch, following values available all 1/6. Each 25K 1 meg. 50K 1 meg. 100K 2 meg. Ditto with SP switch, 2/- each.
- **Crystals**, American make two pin plug-in type, 10/- doz. our assortment.
- **Fortiphone transformer**, type N23, for transistor circuits, 5/-.
- **3 valve amplifier** for portable record player, £2-10-0 complete.
- **Potmeters wire wound**, standard size, following values—1K, 5K, 25K, 100 ohm, 220 ohm, 50 ohm. all 2/- each.
- **Rubber grommets**, our assortment, 5/- for 50.
- **Electrolytic condensers**, standard size, 1000 MFD 6 v. 3/3, 100 MFD 20 v. 2/6, 250 MFD 200 v. 2/6, 32 MFD 350 v. 1/10, 16 MFD 350 v. 1/8, 8 MFD 350 v. 1/3, 8 MFD 150 v. 1/-, 4 MFD 150 v. 1/-, 12 MFD 50 v. 9d, 50 MFD 6 v. 9d, 25 MFD 25 v. 9d, 100 + 200 MFD 250 v. 3/3, 9 + 18 MFD 350 v. 2/6, 32 + 32 MFD 375 v. 3/3.
- **Transistors**, set of 8 all Mullard, in maker's packs. OC44, OC45 (2) OC81D, OC81 matched pair 2/2.
- **Transistors**, 6 first grade unbranded, are replacements for the above Mullard range, 17/6.
- **Ferrite Aerial Rods**, 8 x 3/4 in. diameter, 4/6, 8 x 5/16 in. diameter, 2/6, 6 x 3/4 in. diameter, 3/6, 4 x 5/16 in. diameter, 2/3.
- **4 in. Ferrite Rod** complete with Long and Medium Wave coils and circuit diagram. 7/6.
- **8 in. Ferrite Rod**, complete with Long and Medium Wave coils, plus cat aerial coil and circuit, 8/6.
- **2K Heavy duty wire wound pot meters**, normally 15/-, Sale price 5/-.
- **TV Pattern eliminators**, 10/- each.
- **Complete Radio chassis** by Reethoven, few only £4-10-0. Each 5/6. Post and insurance.
- **Flat TRS cable** for electric wiring, 3/029 3 core, 1/-, 3/029 twin with earth, 9d., 3/029 twin, 8d., 3/029 single 4d, 7/029 twin, 1/-, 7/029 3 core, 1/3 7/036, twin, 2/-, 7/036 3 core, 2/6, 7/044 2 core, 2/6. All prices are per yard.
- **Thermistors**, type No. not known, 6/- per doz.
- **Moving Coil Meter**, 2 1/2 in. flush 5 amp for battery charger etc., 15/-.
- **Wander plug connector** for extending leads, 6/- per doz.
- **Moving Coil Meter**, flush 2 in. 0-350 R.F. 6/6.
- **Set of coils** for Long and Medium Wave radio with circuit, 5/6.
- **1 in. spindle connectors**, metal with grub screws, 4/6 per doz.
- **Knobs Instrument type**, medium size 9d. each.
- **Slow Motion Drive**, epicyclic 1/6.
- **Resistors**, 1/2 watt 100 assorted comprise two each of 50 values covers 600 range up to 2 meg., 10/-.
- **TCC metal pack condensers**, 1 MFD 500 v. 3/-, .5 MFD 500 v. 2/-, .25 MFD 500 v. 1/8, .25 MFD 350 v. 1/8, .1 MFD 100 v. 1/8, .01 MFD 1000 v. 1/-, .005 MFD 1000 v. 1/3, .002 500 v. 1/-.
- **Indicators**, Solenoid operated winking eye type, 6/6 each.
- **Base with MU metal shield** for VCR 13R etc., 8/6.
- **Corner brackets** for mounting glass panels, 1/- set of four.
- **Carbon pile regulators**, 9/- each.
- **ES Lamp holders**, panel mounting 1/6 each.
- **Pyrex glass, aerial insulators** with metal fixing flange, 1/8.
- **Twin gang Tuning condensers**, .0004 pF, each section. 4/- each.
- **Toggle type switch**, 3 positions one permanently on, one permanently off the other spring return on/off, 3/6 each.
- **Knobs** for push buttons, 2/- per doz.
- **Rectifier type**, J50 high voltage, 5/- each.
- **Rectifier type**, 4 tubular type, 2/6 each.
- **Chrome handles** for instruments etc., size 7/16, 6/- pair.
- **Thermal delay switch** 6.3 v. operated, 6/6 vacuum type, 2/8 open type.
- **Heater Transformer**, 6.3 v. 3/4 amps, unused but soiled, 6/- each.
- **Waterproof Heater wire**, 9/- per element or 7d. yd. 16 ohm per foot.
- **Cold Cathode Valve**, CV413 voltage regulator on trigger switch unused but ex-equipment, 2/- each.
- **Car Charger Rectifier**, for 6 or 12 volt at 5 amps, 10/- each plus 1/6 postage.

£100 WORTH OF EQUIPMENT 19/6

The famous R1154—unused but slightly soiled and not tested. Covers 200-500 kc/s. 3-5.5 Mc/s and 5.5-10 Mc/s. Has unique "click stop" mechanism (7 stops) and permits selected frequency to be held, returned to, etc. Hartley oscillator, power amplifier, keying and speech. Wonderful breakdown value—meters, relays switches. Less valves—real bargain at 19/6, plus 10/- carriage.

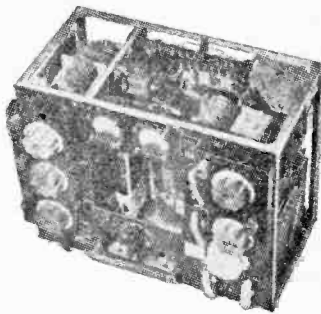

- **8 in. Ferrite Rod**, complete with Long and Medium Wave coils, plus cat aerial coil and circuit, 8/6.
- **2K Heavy duty wire wound pot meters**, normally 15/-, Sale price 5/-.
- **TV Pattern eliminators**, 10/- each.
- **Complete Radio chassis** by Reethoven, few only £4-10-0. Each 5/6. Post and insurance.
- **Flat TRS cable** for electric wiring, 3/029 3 core, 1/-, 3/029 twin with earth, 9d., 3/029 twin, 8d., 3/029 single 4d, 7/029 twin, 1/-, 7/029 3 core, 1/3 7/036, twin, 2/-, 7/036 3 core, 2/6, 7/044 2 core, 2/6. All prices are per yard.
- **Thermistors**, type No. not known, 6/- per doz.
- **Moving Coil Meter**, 2 1/2 in. flush 5 amp for battery charger etc., 15/-.
- **Wander plug connector** for extending leads, 6/- per doz.
- **Moving Coil Meter**, flush 2 in. 0-350 R.F. 6/6.
- **Set of coils** for Long and Medium Wave radio with circuit, 5/6.
- **1 in. spindle connectors**, metal with grub screws, 4/6 per doz.
- **Knobs Instrument type**, medium size 9d. each.
- **Slow Motion Drive**, epicyclic 1/6.
- **Midget coils**, double tuned with dust cores, frequency not known, useful for rewinding, 6/- per doz.
- **Bakelite case** for deal aid, 3/6 each.
- **VCR 139 A**, cathode ray tube, 19/6 each. Plus 2/- post and insurance.
- **465 KC miniature I.F. transformers**, potted 5/- a pair.
- **Wander plugs** lockable types, 6/- per doz.
- **Spun Aluminium lamp reflectors**, 5 1/2 in. diameter 5 in. deep. 3/3 each.
- **High to low** headphone adapters, 2/6 each.
- **Stand off insulator** porcelain with brass insets, threaded 2 BA, 1/6.
- **Cabinet safety switch**, cuts current when door opens, 6/- each.
- **Battery charger clips**, 25 amps 1/3 each.
- **Spring return toggle switches**, heavy duty, 2/6.
- **Set of Superhet coils**, LM & S, 8/6 each, with diagram.
- **High voltage tubular condensers**, .1 MFD 2500 v. Bakelite cased 2/6.
- **Ceiling Rose**, 2 Plate Bakelite, 9d. each.
- **Twin leads** as fitted to deal aids 2/- each. 20/- per doz.
- **3 gang tuning condensers**, .0005 approx. 6/6 each. 2 gang ditto 5/6. 2 gang ditto with trimmers 6/6.
- **Midget 2 gang tuning condensers** fitted dust covers 370 pf each section, 7/6 each.
- **Double Trimmers**, 100 + 100, 250 + 250, 820 + 250, 1/3 each, 12/- per doz.
- **Electrolytics** small, but not miniature 50 v. 5 MFD, 15/- per doz.
- **Push Switches** for table lamps etc. 9d. each.
- **Pole switch** for lighting with screw-in type 30 amp fuses, 5/- each.
- **Rotary Switch by Arrow**, carry 15 amp. A.C. 4 positions hot, off, cold, off. Suitable half driver, air-conditioning plant etc., 3/6, post 1/-.
- **Rotary Switch by Santon**, suitable 30 amp. A.C. single pole on/off. 3/6.
- **Silicon crystal diodes**, 6/- per doz.
- **Sapphire gramophone needles** miniature or standard 78 r.p.m. type. 12/- doz. 1/6 each.

Please include enough for postage and request "Summer sale list" for details of many other items.

"Dim and Full" Switch

Particularly useful for controlling photoflood lamps which have only a short life at full brilliance. This switch has three positions; the first position puts two lamps in series at half brilliance or setting up, the second position is off and the third position full brilliance or the operation shots. Also useful for controlling night lights, heaters, etc., etc. Price 3/9 each, post 9d. Circuit diagram included.

Ditto but without the off position i.e. d.p.d.t., 10 amp 2/9.

A.C./D.C. Multimeter Kit

Ranges: D.C. volts 0-5, 0-50, 0-100, 0-500, 0-1,000 A.C. volts 0-5, 0-50, 0-100, 0-500, 0-1,000 D.C. milliamperes 0-5, 0-100, 0-500. Ohms 0-50,000 with internal battery or 0-500,000 with external batteries Measures A.C./D.C. volts, D.C. current up to 1000mA. All the essential parts including metal case, 2in. moving coil meter, selected resistors, wire for shunts, range selector switches, calibrated scale and full instructions. Price 19/6, plus 2/6 post and insurance.



Speaker Bargain



12in. Hi-fidelity loudspeaker. High flux, permanent magnet type with standard 3 ohm speech coil. Will handle up to 12 watts. Brand new by famous maker. Price 32/6, plus 3/6 post and insurance.

The Taylor Meter Model 127A



A pocket size meter but with a big scale and a sensitivity of 20,000 Ohms per volt D.C., therefore an ideal unit for television servicing—robustly made and complete with leads and probes—20 ranges as follows: D.C. current 50 microamps to 1 Amp. D.C. voltages—0-1,000 volts in seven ranges (25 KV.) with external probe, optional extra. Volts A.C.—0-2,500 in six ranges. Ohms—0-20 meg Ohm in three ranges (self-controlled). Self-contained, 3in. movement. Price £10 or 10/- deposit and 23 fortnightly payments of 10/-, Non-callers add 5/- carriage and insurance.

NOW THE MARK IV Pocket '4' Transistor Radio

Read these Testimonials

D. A. Hilton, Leigh, Lancs. "I received 'Pocket' 4 on Christmas Day. I made it up on Boxing Day and I am very pleased with the results. It brings in local stations and many foreign stations including Luxembourg at good strength. I am 13 years old!"

Mr. J. Bell, Wolverhampton. "I am writing to express my satisfaction at the standard of your kit for your Pocket 4 Transistor set and also to state that it has come up to my expectations in regard to performance."

Mr. K. Helt, Newcastle-on-Tyne. "I have built your Pocket 5 Transistor set. I am very pleased with it."

Mr. F. Jackson, Ickenham, Middx. "I have built the Pocket 4 and am more than pleased with the results!"

Mr. G. Bamford, Ramsgate. "I find this set even better than you claim it to be and most certainly up to your usual standard of quality. I feel that nobody could fail to build it and get results. Even the first-time-ever novice, as your circuit diagrams and instructions are so clear and precise."

Mr. A. J. Simmonds, Welling, Kent. "I purchased from you a week ago the Pocket 4 Transistor Kit. I put it together last night in 14 hours. On switching on the set, I was right on Radio Luxembourg. I must say thank you because not only has the set a very attractive appearance, it also behaves fantastically!"

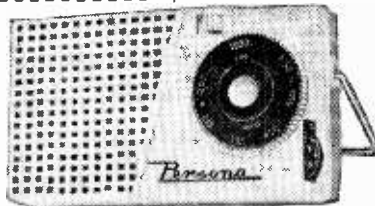

Our famous Pocket "4" which is doing yeoman service all over the country has been modified and improved to make it an even better receiver. The new features include—

- New elegant dial graduated for Long and Medium Waves.
- Switched Long and Medium Waves.
- Slide switch on/off control.
- Printed circuit.
- Ferrite Rod Aerial.
- Improved reaction circuit.
- Positive spindle coupling to tuner.
- Battery containers.

The Pocket "4" of course retains its original r.f. circuit which means still no aerial or earth needed. The Pocket "4" Mark IV uses 3 transistors, crystal diode, miniature loud speaker and has all the above refinements, complete in case as illustrated (less mott) 52/6, battery 10d., post and insurance 2/8. Mott 2/-.

Pocket "6" as Pocket "4", but with Moving Coil Speaker and Q.P.P. output stage, 95/-.

Seven days approval. Order in confidence. We allow you seven days to decide whether or not to make the set, you may return the parcel as received within this time and your money will be refunded in full. Read some of the testimonials, over 1,000 of which have been received about our Pocket Receivers.

NOW THE "GOOD COMPANION" CAR RADIO AND PORTABLE

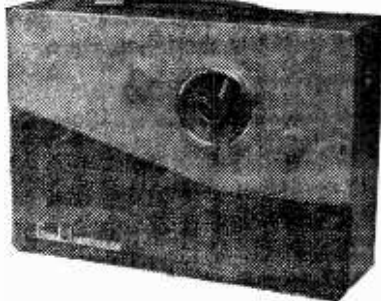

Largely due to the helpful criticisms and suggestions received from purchasers of our previous set "The Real Companion" we have improved and now supersede this with a new set which we call "The Good Companion". We feel confident that this new set is one of the finest of its kind available. The design is the combined efforts of our technicians and of those of several of the leading manufacturers in the country, and the resulting set has a performance as good as if not superior to those selling at £20 and more. It has the eight transistor set performance. Features include American Philco R.F. transistors and Mullard A.F. transistors—Q.P.P. output giving 750 mW—full coverage on Medium and Long—very fine tuning arrangement—excellent reception of difficult stations like 208—variable feed-back control—full tonal qualities—really superior looking cabinet size 11 x 8 x 3in. approximately—car aerial attachment—several months operation from battery costing only 3/6.

Circuit employs six transistors and two diodes, it incorporates all latest refinements, and oscillator i.f. Transformer are pre-aligned so no instruments are necessary. Anyone who can solder competently can make this set. The instructions are fully comprehensive with plenty of illustrations. Service is available in the unlikely event of your getting into difficulties. All components fully guaranteed.

Price of all components and cabinet to make set as illustrated £9.19.6. Post and insurance 5/-. Battery 3/6 extra.

AGENTS REQUIRED
to make up this receiver

ELECTRONIC PRECISION EQUIPMENT LTD.

post orders are dealt with from Eastbourne, so for prompt attention please post your orders to 66 Grove Road, Eastbourne, marked Department 7. Callers may use any one of the Companies below.

266 London Road, Croydon. Phone: C30 8558 Half day Wednesday

29 Strand Green Rd., Emsbury Park, N.4. Phone: ARChway 1049 Half day Thursday

520 High Street North Manor Park, E.12. Phone: ILFord 1011 Half day Thursday

42-48 Windmill Hill, Ruislip, Middx. Phone: RUISlip 5780 Half day Wednesday

246 High Street, Harlesden, N.W.10. Phone: ELGar 4444 Half day Thursday

See the whole range at our

Heathkit
DAYSTROM

STAND III, RADIO SHOW

AMATEUR TRANSMITTER Model DX-100U
Covers all amateur bands from 160-10 metres. 150 watts D.C. input. Self contained including Power Supply Modulator V.F.O. £81.10.0

AMATEUR TRANSMITTER Model DX-40U
From 80-10 m. Power input 75 w. C.W., 60 w. peak C.C. phone. Output 40 w. to aerial. Compact and self-contained. Prov. for V.F.O. £32.10.0

VAR. FREQ. OSCILLATOR VF-1U
From 160-10 m. Ideal for our DX-40U and similar transmitters. Price less valves £8.19.6 £11.2.0

R.F. SIGNAL GENERATOR Model RF-1U
Up to 100 Mc/s fundamental and 200 Mc/s. on harmonics and up to 100mV. output on all bands. £11.18.0

AUDIO SIGNAL GENERATOR Model AG-9U
10 c/s to 100 kc/s. switch selected. Distortion less than 0.1%. 10 v. sine wave output metered in volts and dB's. £19.19.6

VALVE VOLTMETER Model V-7A
Measures volts to 1,500 (D.C. and R.M.S.) and 4,000 pk. to pk. Res. 0.1Ω to 1,000 MΩ. D.C. input impeded, 11MΩ. Complete with test prods leads and standardising battery. £13.0.0

Portable 2 3/4 in. SERVICE 'Scope Model OS-1
Compact portable scope ideal for servicing and general work. Y amplifier sensitivity 10 mV/cm; response ±3 dB 10 c/s-2.5 Mc/s. Time base 15 c/s-150 kc/s. Printed circuit. Case 7 1/2 x 4 1/2 x 12 1/2 in. long £19.10.0 Wt. only 10 1/2 lb.

5 in. OSCILLOSCOPE Model O-12U
Has wide-band amplifiers, essential for TV servicing. F.M. alignment, etc. Vertical freq. response 3 c/s. to over 5 Mc/s. without extra switching. T/B covers 10 c/s to 500 kc/s. in 5 ranges. £36.10.0

RES.-CAP. BRIDGE Model C-3U
Measures capacity 10μF to 1,000μF resistance 100Ω to 5MΩ and power factor 5-450 v. test voltages. With safety switch. £8.6.6

SINGLE CHANNEL AMPLIFIER, MA-12
10-12 watt Hi-Fi amplifier. Extremely low distortion and wide frequency range. £10.19.6

HI-FI EQUIPMENT CABINETS

Range of cabinets available with at least one to suit your particular needs. From small to large, housing Tape Deck, Record Player and full equipment. In the white for finishing to personal taste.

From £11.5.6 to £17.18.6

GRID DIP METER Model GD-1U
Coverage from 2 Mc/s. to 250 Mc/s. Complete set of plug-in coils provided. £10.9.6

TAPE RECORDING/TAPBACK AMPLIFIER Model TA-1
Monaural (TA-1M) £18.2.6. Conversion unit to Stereo £6.10.0. Stereo £23.6.0 (TA-1S).

'PACKAGED DEALS' of Hi-Fi
Equipment including TAPE DECKS
RECORD PLAYERS and DECCA ffs
PICK-UPS.

Write in to see how these deals save you further money!



F.M. TUNER



S.33



S.88



DX-40



UXR-1



OS-1

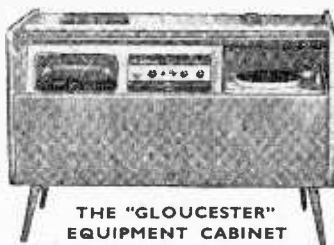

SSU-1

THE "GLOUCESTER"
EQUIPMENT CABINET**THE "MOHICAN" GENERAL COVERAGE RECEIVER, Model GC-1U**

Fully transistorised, including 4 piezo-electric transmitters. The very latest and an excellent portable or Fixed Station receiver for the Ham and short-wave listener. £38.15.0

SHORT-WAVE TRANSISTOR PORTABLE Model RSW-1

Extending aerial leather case, four band (2 short-wave bands Trawler and Medium). £21.18.6

6-TRANSISTOR PORTABLE Model UXR-1

Pre-aligned I.F. transformers, printed circuit, 7 x 4 in. high-flux speaker. Real hide case. £14.18.6

DUAL-WAVE TRANSISTOR RADIO UJR-1

This sensitive headphone set is a fine introduction to electronics for any youngster. £2.16.6

HI-FI F.M. TUNER

Tuning range 88-108 Mc/s. For your convenience this is available in two units sold separately as follows: Tuner Unit (FMT-4U) with 10.7 Mc/s. I.F. output £3.2.0 inc. P.T.). I.F. Amplifier (FMA-4U) complete with cabinet and valves (11.11.6). £14.13.0

HI-FI 16W STEREO AMPLIFIER Model S-88

20mV. basic sensitivity (4 mV. available, 7/6 extra). Ganged controls. Stereo-Monaural gram. radio and tape recorder input. Push-button selection. Two-tone grey metal cabinet. £26.12.6

6W STEREO AMPLIFIER Model S-33

3 watts per channel, 0.3% distortion at 2.5 w/ch 20dB N.F.B. Inputs for Radio (or Tape) and Gram. Stereo or Monaural, ganged controls. £12.8.6 Sensitivity 200 mV.

TRANSCRIPTION RECORD PLAYER RP-1U

4-speed A.C. motor Ronette Stereo/Mono pick-up. Complete with plinth. Only limited number available. £12.10.0

HI-FI SPEAKER SYSTEM Model SSU-1

Ducted-port bass reflex cabinet "in the white" Twin speakers. With legs £11.16.6. £10.15.6

"COTSWOLD" HI-FI SPEAKER SYSTEM KIT

Acoustically designed enclosure "in the white" 26 x 23 x 15 1/2 in., housing a 12 in. bass speaker with 2 in. speech coil, elliptical middle speaker and pressure unit to cover the full frequency range of 30-20,000 c/s Complete with speakers, cross-over unit, £21.19.0 level control, etc.

COMPLETE MATCHED STEREO OUTFIT

includes record player, amplifier and twin speaker systems (pedestal speaker legs optional £2.2.0 extra). £43.19.0

STEREO CONTROL UNIT USC-1

Luxury model with press-button inputs to suit any pick-up or tuner or most tape-heads. Output 1.3 v. R.M.S. per channel. Printed circuit construction. £18.18.6

STEREO HEAD BOOSTER USP-1

Ideal for boosting tape-head output and low output pick-ups (e.g. £6.17.6 Decca ffs).

Prices include free delivery UK
Deferred Terms
available on orders over £10

Please send me FREE CATALOGUE (Yes/No) _____

Full details of model(s) _____

NAME _____

ADDRESS _____

PW9

DAYSTROM LTD.

DEPT. P.W.9, GLOUCESTER, ENGLAND

A member of the Daystrom Group, manufacturers of the
WORLD'S LARGEST-SELLING ELECTRONIC KITS

Practical Wireless

VOL. XXXVII No. 655 SEPTEMBER, 1961

Editorial and Advertisement
Offices:

PRACTICAL WIRELESS

George Newnes, Ltd., Tower House,
Southampton Street, W.C.2

© George Newnes Ltd., 1961

Phone: Temple Bar 4363
Telegrams: Newnes, Rand, London,
Registered at the G.P.O. for trans-
mission by Canadian Magazine Post.

SUBSCRIPTION RATES

including postage for one year

Inland - - - - £1.3.0 per annum
Abroad - - - - £1.1.6 per annum
Canada - - - - 19s. per annum

Contents

| | Page |
|--|------|
| Editorial | 381 |
| Round the World of Wireless | 382 |
| Wide-range Audio Oscillator | 384 |
| The P.W. Signal Generator | 388 |
| On Your Wavelength | 392 |
| A Transistorised VHF Superhet | 395 |
| A Pre-Wired Valveholder Ex- tension | 398 |
| Record-player and Radiogram Faults | 399 |
| An Intercom Amplifier | 403 |
| Ferrite Rod Aerial Conversion | 406 |
| A Wobbulator for F.M. I.F. Alignment | 408 |
| Adding Communications Features | 411 |
| Club News | 414 |
| Signal Generator Outputs | 417 |
| Recording from the Radio | 421 |
| Converting the TRF Transistor Four to L.W. Tuning | 425 |
| Letters to the Editor | 429 |
| A Crystal Frequency Marker | 433 |
| Trade News | 438 |
| A Sensitive Multimeter | 441 |

The Editor will be pleased to consider articles of a practical nature. Such articles should be written on one side of the paper only, and should contain the name and address of the sender. Whilst the Editor does not hold himself responsible for manuscripts, every effort will be made to return them if a stamped and addressed envelope is enclosed. All correspondence intended for the Editor should be addressed: The Editor PRACTICAL WIRELESS, George Newnes, Ltd., Tower House, Southampton Street, London, W.C.2. Owing to the rapid progress in the designs of wireless apparatus and to our efforts to keep our readers in touch with the latest developments, we give no warranty that apparatus described in our columns is not the subject of letters patent.

Copyright in all drawings, photographs and articles published in PRACTICAL WIRELESS is specifically reserved throughout the countries signatory to the Berne Convention and the U.S.A. Reproductions or imitations of any of these are therefore expressly forbidden. PRACTICAL WIRELESS incorporates "Amateur Wireless."

MORE FREE BLUEPRINTS

INCLUDED with each copy of our next issue, will be a blueprint for our new receiver—the P.W. Tutor. As its name implies, it is designed essentially for the beginner, although it will also be found instructive for those who have not built a radio set for some time. The great success of our previous series for the beginner—The Beginner's Constructional Course and others—shows that there is a real need for this type of apparatus. Young people are continually leaving school and entering the radio field, and wish to add to any knowledge they may have gained at school, with practical work, which at the same time, will introduce them to new aspects of construction.

It is natural that the beginner will need to start from the very simplest point which means the crystal receiver, but the transistor must also be employed as this is becoming more and more to be accepted in place of the valve. Printed circuits are, of course, very widely used to-day, but it was felt that it would be rather too involved to try and use these in a receiver of the progressive kind, so the technique of utilising standard tag-boards has been adopted, and the receiver is built on these. The constructor goes from stage to stage, gradually adding parts and so advancing the design of each set.

NOVEMBER AND DECEMBER BLUEPRINTS

In the November and December issues, further free blueprints will enable more additions to be made to the preceding receivers. Included in the second and third blueprints will be a transistor battery superhet tuner together with its amplifier, which will also be suitable for a battery operated record player.

The blueprints will be such that the stages of construction are complete in themselves and each reader will be able to choose a design to suit his pocket and requirements.

INCREASED PRICE

The steadily increasing costs of production, paper, and other materials have made it necessary to increase the price of this magazine from the October issue—or to reduce it in size. We know that the latter procedure would not meet with approval and that most readers would rather pay an increased price than buy a smaller edition of PRACTICAL WIRELESS.

We shall, of course, keep up the same high standard of articles and endeavour to make each issue appeal to the widest possible circle of readers—catering both for the absolute beginner, as in the blueprint mentioned in the above paragraphs, as well as the advanced constructor and amateur transmitter. Blueprints in later issues will be designed for more experienced readers and we shall continue to provide the maximum service not only to individuals, but also to clubs and societies. From the October issue, therefore, the price of PRACTICAL WIRELESS will be increased to 2/-.

The October issue of PRACTICAL WIRELESS is published on September 7th—order your copy now and be sure of obtaining the first of the free blueprints.

Our next issue, dated October, will be published on September 7th.

Round the World of Wireless

POTENTIAL AND CURRENT NEWS

Broadcast Receiving Licences

THE following statement shows the approximate number of Broadcast Receiving Licences in force at the end of May, 1961, in respect of wireless receiving stations situated within the various Postal Regions of England, Wales, Scotland and Northern Ireland. The numbers include Licences issued to blind persons without payment.

| Region | Total |
|--|------------------|
| London Postal | 687,207 |
| Home Counties.. .. . | 649,332 |
| Midland | 460,189 |
| North Eastern | 511,984 |
| North Western | 439,846 |
| South Western | 388,260 |
| Wales and Border Counties | 227,571 |
| Total England and Wales | 3,372,460 |
| Scotland | 376,595 |
| Northern Ireland | 117,560 |
| Grand Total | 3,866,625 |

Tape Recorder Company Interests Change Hands

A WHOLLY-OWNED subsidiary of Multicore Solders Limited, Multimusic Limited, announces that it has disposed of all its interests in Reflectograph Tape Recorders to Pamphonic Reproducers Limited, a Pye Group Company. Pamphonic are now responsible for all service of Reflectograph recorders. Enquiries from the public concerning Reflectograph recorders should now be directed to Pamphonic Reproducers Limited at 17 Stratton Street, London, W.1.

Expansion at Valve and Capacitor Factory

A FURTHER expansion programme for the production and marketing of new and present types of valves and capacitors has recently been started by Standard Telephones and Cables Limited.

Manufacture of both these product lines is at the modern S.T.C. factory in Paignton, Devon. In the Valve Division plant, the principal products are valves for use in telecommunication systems, such as microwave radio links and transoceanic telephone cables.

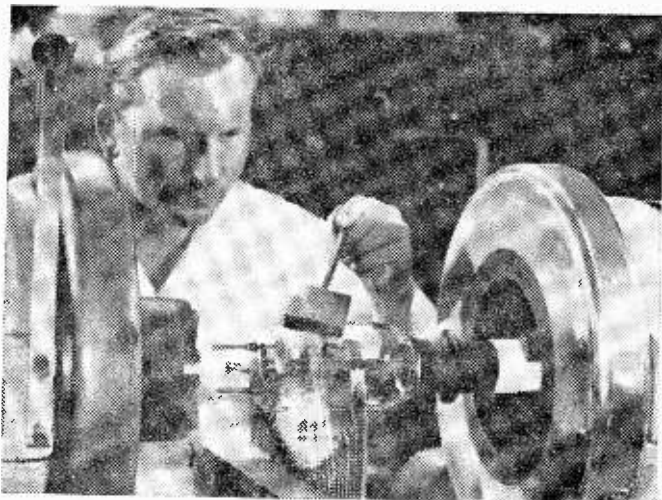

Sealing the glass envelope of a water-cooled power triode, at the S.T.C. factory at Paignton, Devon.

Expansion is envisaged in the production and application of many types of valve.

Capacitors, like valves, have been key products of S.T.C. for many years and were formerly made mainly at North Woolwich, London, with a satellite plant at Treforest in Wales. The success of the Valve Division operations led to the building of a second factory for the manufacture of capacitors.

Multi-channel Radio Telephone System for British Railways

AS part of the British Railways modernisation programme, its north-eastern region is to be equipped with a high-frequency multi-channel radio telephone system between York and Newcastle, via Darlington—a distance of 78 miles. This will be the first such installation to be used by British Railways.

The radio equipment is to be supplied and installed by Marconi's Wireless Telegraph Co. Ltd., and the carrier equipment by Automatic Telephone and Electric Co. Ltd. The system is designed for a maximum capacity of 300 telephone channels, but initially 180 will be in operation. It will handle the telephone traffic between the regional centres, with full facilities for through subscriber trunk dialling.

The installation is duplicated to operate on a main-standby basis, with automatic changeover in the event of failure. In this connection, particular features of the equipment are the relatively low number of valves used and the simplicity of the R.F. transmission circuits, which employ one microwave klystron per unit equipment, both factors which greatly reduce the probability of equipment failure. The telephone channelling equipment is of the latest design, using transistors throughout and printed wiring cards for mounting all components.

Radio and Television Exhibition

THE Radio and Television Exhibition of France will be held this year from September 14th to 26th in Paris—Porte de Versailles. It will be situated in the Parc des Expositions—Halls 101 to 110. This exhibition is undertaken by the Radiodiffusion Télévision Française and by the Fédération Nationale des Industries Electroniques.

The exhibition, which covers all fields of radio and television, is open to all foreign visitors but is for French exhibitors only. The utilization of the "Palais des Sports" enables the organizers to receive the largest audience in conditions of comfort. A studio

with 1,000 seats for broadcasting lyrical and dramatic programmes, and high fidelity demonstrations will be included in the exhibition.

Minicabs Radiotelephone System

WITH the opening of the London minicab scheme, Pye Telecommunications put into operation, for Welbeck Motors, a radiotelephone system which operates 200 radiotaxis initially, expanding to 800 by the end of the year.

The system with six-channel radiotelephone equipment is installed under the dashboard of each car and gives communication over a radius of 20 to 25 miles of Piccadilly Circus. A special control room has a conveyor-belt message system designed to handle calls at the rate of one every two seconds.

V.H.F. Unit for Lifeboat

THE President of the Dieppe Lifeboat Committee has been presented with a Pye International marine radiotelephone by the French National Railway.

This is the first French national lifeboat to be equipped with V.H.F. radio. It will work into the Dieppe railway radio station and the local public correspondence scheme. The lifeboat will thus be able to communicate with cross-channel steamers, with local fishing boats, which have the requisite equipment, and with the Boulogne Sur Mer Radio Station.

Mobile Microwave System

THE United States Government has recently placed a contract with Marconi's Wireless Telegraph Co. Ltd., for the supply of a mobile microwave telephone and telegraph communication system to link many of the United States Air Force bases in the U.K. Marconi's and the Automatic Telephone and Electric Co. Ltd., who are also involved in the contract, are currently fulfilling this three-and-a-half million dollar agreement.

The Marconi radio equipment and the Automatic Telephone and Electric telephone carrier equipment is housed in semi-trailer air-conditioned vehicles. Inside these large vehicles the transmitter, receiver and supervisory equipment are each contained in racks arranged for easy accessibility by the operators.

Naval Plotting System

MOST of the Western nations were represented at a recent demonstration of a new naval automatic plotting system—developed by E.M.I. Electronics Ltd.—given on board H.M.S. Rhyl, one of Britain's latest anti-submarine frigates. The system constitutes a big advance in plotting the positions of other craft in the vicinity, and is of particular use when hunting fast submarines. It is also of great value for coastal navigation.

In ships fitted with this system, the former method of manual plotting and the reporting of bearings and ranges over an intercom network has been replaced by E.M.I.'s electronic equipment, which produces much quicker and more accurate results.

Radio Paging System

PHILLIP W. HOLLAND, M.P. for Acton Constituency, visited the Ultra Electronics factory at Western Avenue, Acton, recently to inspect their radio paging system.

He became interested in this equipment when he saw it at the Crime Prevention Exhibition organised recently at Acton Town Hall, by the local police authorities.

Mr. Holland has a question tabled to the Secretary of State regarding the use of such equip-

ment by the policeman on the beat.

Moscow Exhibition

THE Council of the Scientific Instrument Manufacturers' Association of Great Britain states that its 19 members who took part in the combined stand at the recent British Industries Fair in Moscow are very well pleased with the results.

Firm contracts have been signed for 75 per cent. of their exhibits. Preliminary contracts for a considerable additional quantity of equipment to be exported immediately or in the near future have also been placed.

Cable Across The Thames

A £100,000 contract from the South Eastern Electricity Board to reinforce the electricity distribution system between substations at West Weybridge in Surrey, and Laleham in Middlesex, has been awarded to Associated Electrical Industries Limited.

The project will involve laying four miles of 33kV oil-filled cable and associated pilot cables. They will be taken across the River Thames in buried pipes. Two canal crossings are also involved.

The work will be carried out by AEI Construction (Cables and Lines) Division and will begin in July. The cable will be of AEI manufacture, from AEI Cable Division's Gravesend factory.

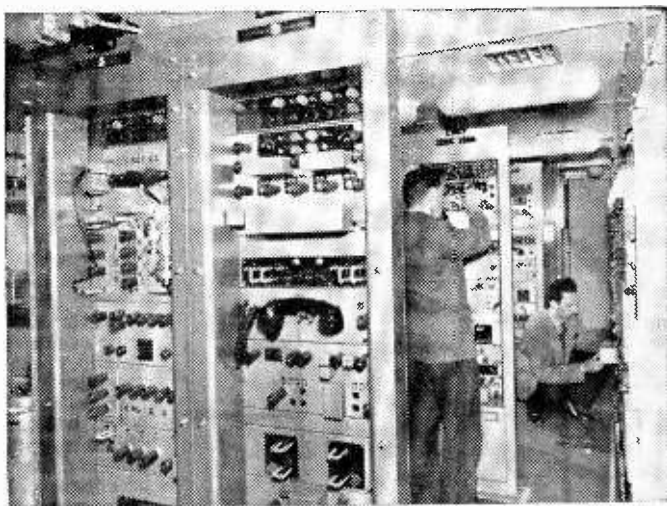

The interior of one of the vehicles which Marconi are supplying to the U.S. Air Force. The rack on the extreme left houses the transmitter, the middle rack the receiver, and the right-hand rack contains the supervisory equipment.

20c/s TO 200kc/s ON FUNDAMENTALS WITH LOW DISTORTION AND STABLE OUTPUT LEVEL

HERE are four problems involved in the design of a variable low frequency signal generator: stability, waveform, frequency range, and output level characteristics. Of the three main audio oscillator circuits, the beat-frequency oscillator is suitable for general purpose applications, especially where a wide frequency range is required with a single tuning control. It has, however, several serious drawbacks, including lack of stability, bad waveform at low frequencies, and R.F. in the output. These disadvantages may all be overcome by careful design, but the resulting instrument is very large and very expensive.

The conventional L-C oscillator is ideal for single frequency operation but requires an impossibly large tuning capacitor to produce the lowest ranges of a variable oscillator. In addition to this, it is difficult to obtain a frequency coverage greater than 3 : 1 in each band, which means that 7 ranges are necessary to cover the audio spectrum of 20-20,000c/s.

The R-C oscillator, however, easily achieves a coverage of 10 : 1, reducing the number of ranges to three. It has the further advantage that the basic circuit satisfies the four design problems set out above. The R-C circuit has therefore been chosen for this design.

The R-C circuit

The basic circuit is shown in Fig. 1. It consists of an amplifier back-coupled through a Wein bridge. The bridge is made up of the resistors

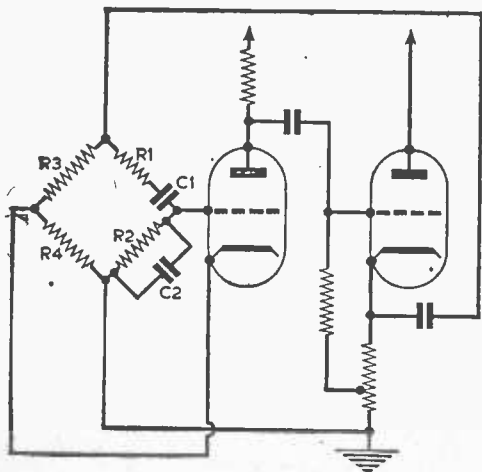
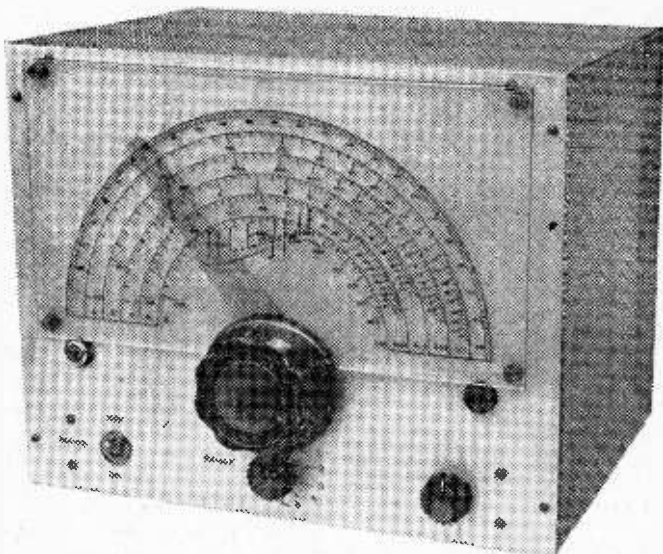

Fig. 1. The basic circuit.



WIDE-RANGE AUDIO OSCILLATOR

By R. C. Englefield

R1-R4 and the capacitors C1-C2, with the input and output of the amplifier connected to the diagonal points. By this means, both positive and negative feedback are applied to the amplifier. The circuit oscillates at the balance frequency of the bridge. The negative feedback, through R1C1 and R2C2 determines the frequency, given by

$$f = \frac{1}{2\pi \sqrt{(C1 \cdot C2 \cdot R1 \cdot R2)}}$$

The positive feedback, through R3 and R4, stabilises the level of the oscillation.

Since the input and output impedances of the amplifier are not directly connected across the arms of the frequency discriminating network, the amplifier characteristics have no effect on the oscillator frequency.

In order to stabilise the amplitude of the oscillation with change of frequency, the attenuation of the negative feedback network must be kept constant, that is, the ratios R1/R2 and C1/C2 must be constant. The frequency of the oscillation may be adjusted by alteration of either pair of these components, and in this design, continuous frequency variation is achieved by varying the capacitances, different ranges being selected by variation of the resistances. A much higher degree

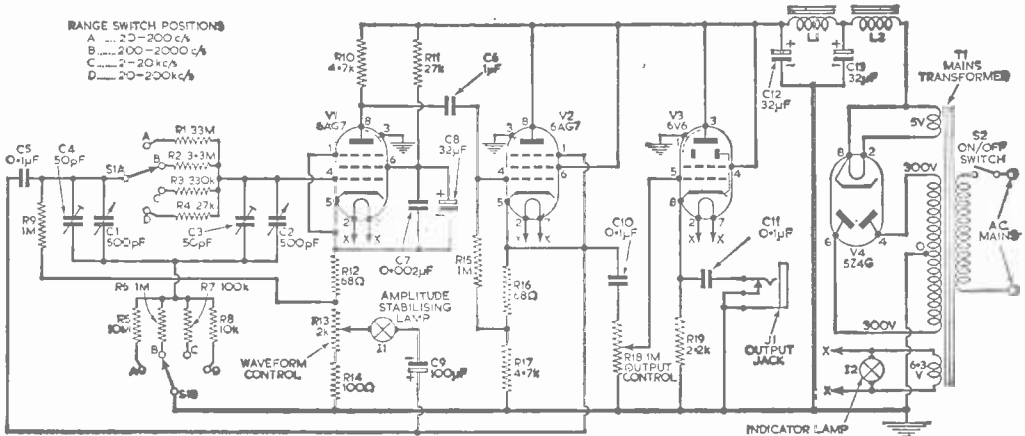

Fig. 2.—The complete practical circuit diagram.

of amplitude stability can be obtained by substituting a metal filament lamp for the resistor R3. Thus when the amplitude of the oscillation falls, the positive feedback current decreases, so reducing the resistance of the lamp—this in turn increases the positive feedback and compensates for the original drop in amplitude.

The practical circuit

A complete bridge-stabilised circuit is shown in Fig. 2. The first two stages are based on the circuit of Fig. 1, with the addition of the 15W 240V lamp, L1, and range switching. The tuning capacitor is a standard two-gang capacitor with trimmers, and the resistors R1-R8 are low temperature-coefficient types, though ordinary resis-

tors should prove satisfactory in use. The range resistors are best mounted on a ceramic switch.

The output of the oscillator is fed to the grid of a cathode follower, and the output from the unit is taken from a shorting-type microphone jack. If the oscillator is required to work into load impedances lower than 20k, it will be necessary to substitute a 25µF capacitor in place of C11, if excessive loss of voltage is to be avoided at very low frequencies.

The power section is a conventional full-wave circuit, and generous smoothing arrangements are used, with the result that the hum level of the output is less than 0.2per cent of the maximum output voltage. Screened wire should be used for the wiring of the heaters and panel lamp.

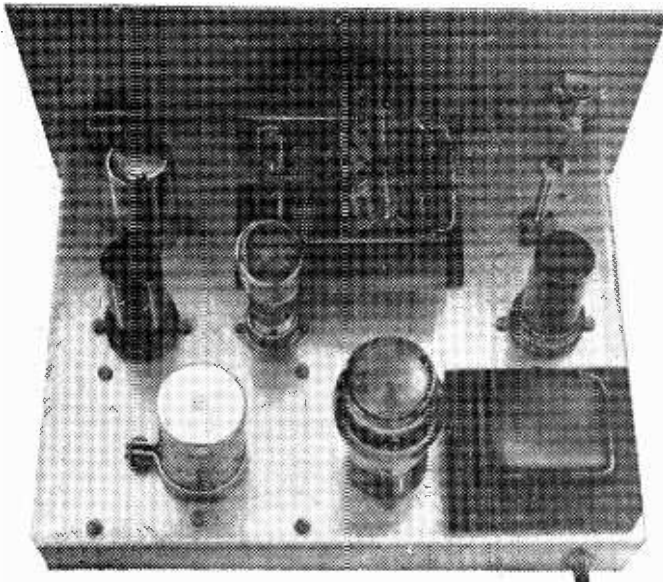

Rear view of the oscillator.

Construction

Construction is simple and straightforward. The tuning capacitor is insulated from the chassis with a sheet of Paxolin, and carries the pointer; slow motion tuning is employed, a simple frictional drive being easy to make and perfectly satisfactory. The range switch is mounted beneath the tuning control, and selects the following ranges: 20 to 200c/s (A) 200 to 2000c/s (B) 2 to 20kc/s (C) 20 to 200kc/s (D). The range can be extended up to 1Mc/s if necessary by using a 2.2k resistor and a 680Ω resistor, mounted on a fifth pole of the range switch. A continuously variable output control, the output socket, the main switch, and the indicator lamp complete the panel items.

The scale is made from Perspex sheet, mounted in front of the pointer; the calibrations are drawn in Indian ink on the back of the Perspex, this type of scale being very durable, and has the advantage that errors can be corrected without trace by removing the ink with

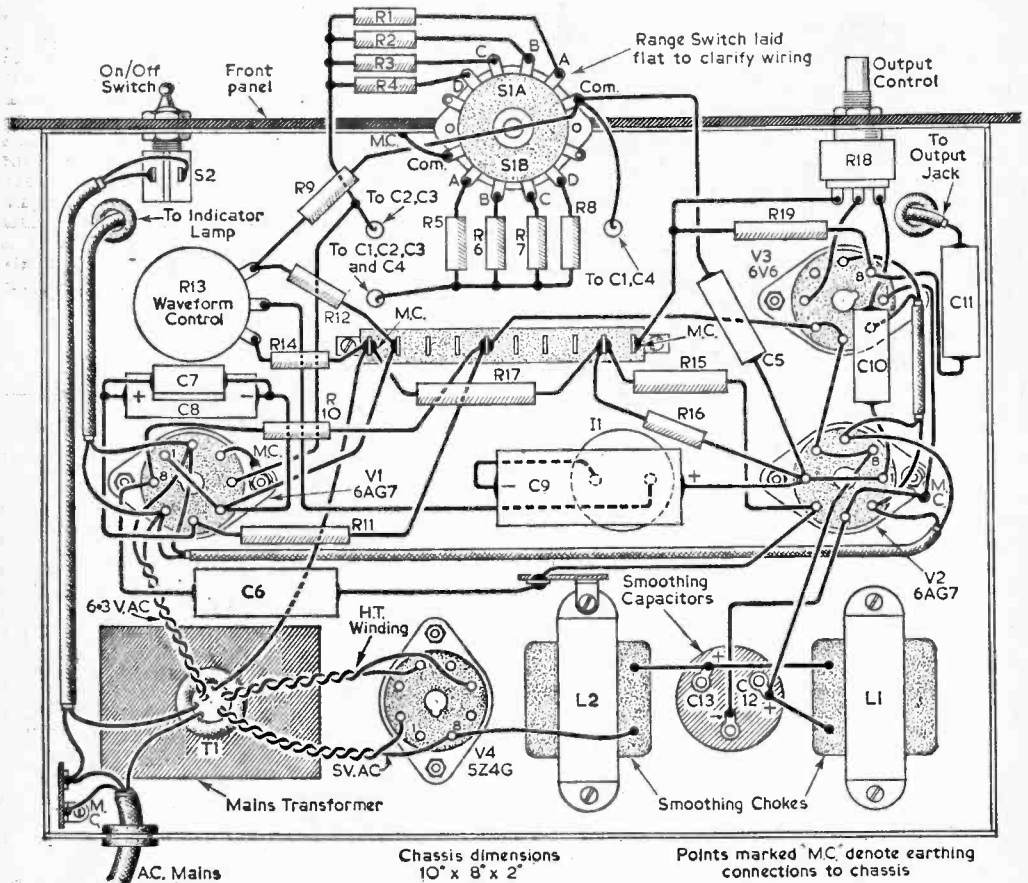

Fig. 3.—The under-chassis wiring diagram.

the finger-nail. The whole unit is contained in a case made from perforated zinc.

Calibration

An oscilloscope is essential for the accurate calibration of the instrument. Two preliminary adjustments are necessary: first, feed the output of the oscillator into the 'scope, and adjust R13 until a good sine-wave is obtained—this circuit gives an exceptionally low distortion, less than 0.5 per cent at all frequencies. Second, set the trimmers C3 and C4 to maximum capacity, and find the 200c/s point in range A, using the 50c/s mains supply as standard; then adjust the trimmers a

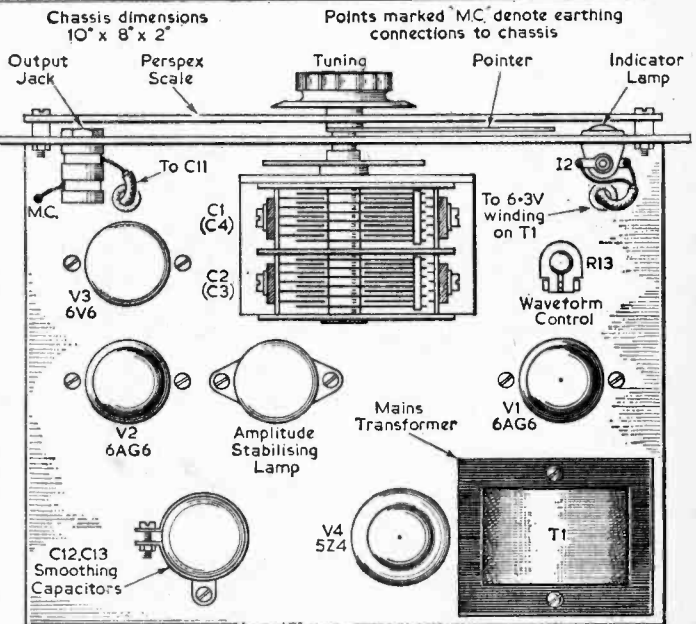
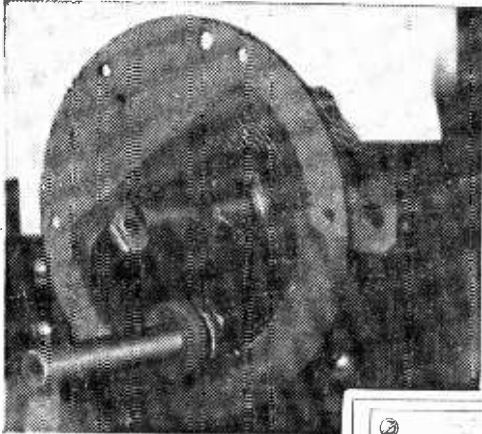

Fig. 4.—The above-chassis layout.



The tuning drive mechanism.

little at a time, keeping their capacities about equal, until the 200c/s point is just at the end of the range. This sets the high end of all four ranges.

Before commencing the calibration proper, remove the Perspex dial and construct a logging scale on the surface nearest to the pointer; this scale should have as large a radius as the length of the pointer will allow. A large protractor will simplify the division of the circumference into 180 parts, but if this is not available, then a scale of divisions (say 256) may be constructed by continuous bisection of a 360°—this is best drawn out on paper first, and then transferred to the Perspex.

Fig. 5.—The front panel.

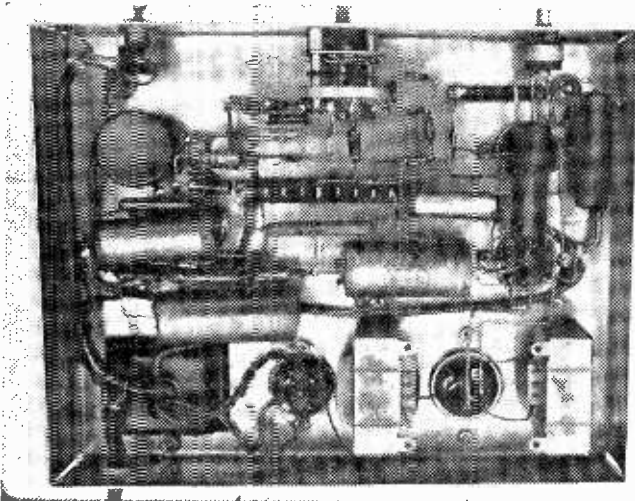
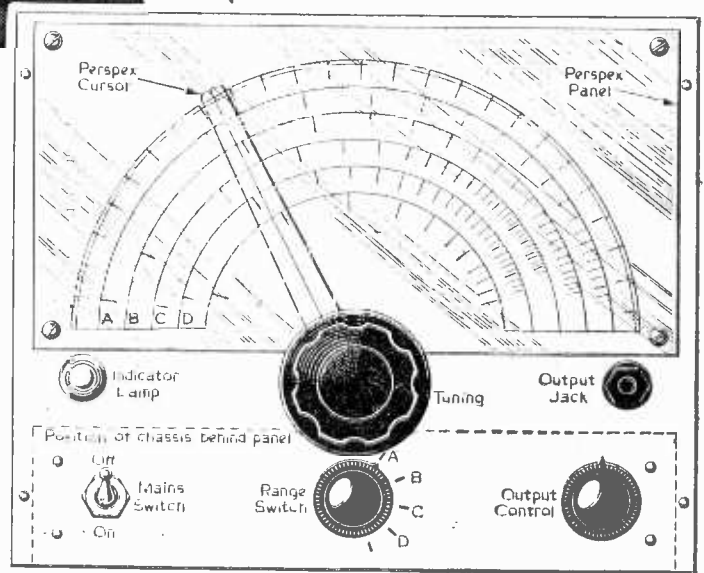

An underchassis view.

By connecting the 'scope to display Lissajous figures, using 50c/s mains as standard, ranges A and B can now be calibrated; points should be logged every 5c/s in range A, and every 50c/s in range B. To calibrate range C, set the internal timebase of the 'scope to 500c/s, again using the mains as standard, and log points every 500c/s throughout the range—it is recommended that the sweep frequency be checked directly after each calibration is taken. Lissajous figures may again be used to calibrate range D if a 100kc/s quartz crystal standard or other ultra-stable oscillator is available, but if not, points can be accurately obtained by beating the harmonics of the oscil-

lator against the carrier waves of broadcasting stations, especially in the Long-wave band.

The scale may now be removed, and the dial calibrated directly in terms of frequency; further points may be obtained if necessary by graphical means; if any marks are misplaced, they can easily be corrected as explained.

The overall performance of this instrument is more than adequate for ordinary testing; the output is inherently stable in frequency and level, and the hum level and distortion are especially low. These advantages more than offset the slight disadvantage that range-switching is necessary to cover the audio spectrum.

MANY amateurs have made up an R.F. generator and then found that the greatest difficulty, often insuperable, has been accurate calibration.

Details will be given of methods of calibration using broadcast stations as standards, but it is so simple to build a standard crystal oscillator that it is proposed to deal with the construction of a simple unit as part of this instrument.

The author housed the crystal check unit in the same case as the other chassis, but it could be kept separate and only plugged in or connected when required. Valves from the variable audio oscillator could be "borrowed" for this, but it is better to have two kept for use in the unit alone.

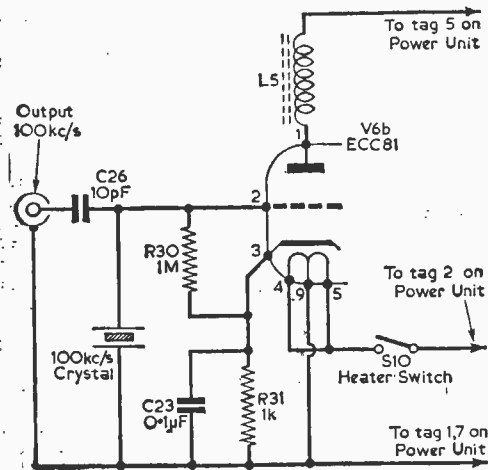

Fig. 27.—The crystal oscillator circuit.

BUILDING CHASSIS No. 4— THE CRYSTAL CHECK OSCILLATOR

(Continued from page 306 of the
August issue)

By E. V. King

THE P.W. SIGNAL GENERATOR

How it works

The valve oscillator V6b (Fig. 27) functions on a frequency of 100kc/s owing to the inductance and self capacitance of L5 and the quartz crystal. This latter is not "tuned", but will be accurate enough at all temperatures for this purpose.

Valves V6a and V7a (Fig. 28) function as another oscillator, a multi-vibrator (working at 10kc/s), but the frequency is very unstable and therefore a synchronising signal is fed from the crystal controlled oscillator.

The actual frequency of 10kc/s is set by using the pre-set variable resistance VR5 which corrects for slight variations in component values. Switch S11 is used to control this 10kc/s oscillator—when S11 is "open", the oscillator is switched off. The resistor R37a, which is wired across the switch, is to ensure that some H.T. current is always

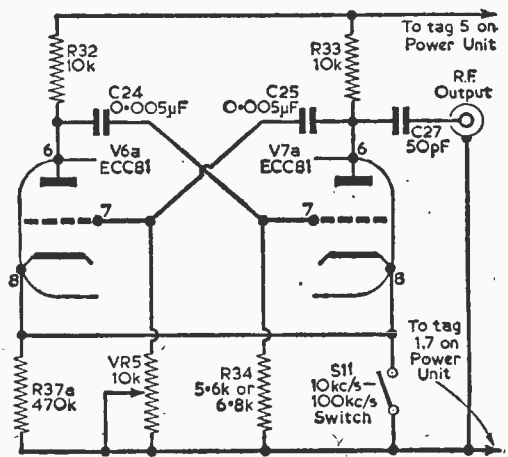

Fig. 28.—The circuit of the multivibrator.

passing through the valves V6a and V6b—if the valves were operated for long periods without H.T., the cathodes would become "poisoned" and the circuit would no longer operate.

Switch S10 is used to switch on or off the complete crystal check oscillator—Chassis 4. When S10 is on, the 100kc/s oscillator will function.

The signals obtained are fed to V7b, a harmonic-producing amplifier (Fig. 30); the diode, helps in this respect, too. If S11 is on, 10kc/s signals and harmonics are thus fed to the output socket. When S11 is off, the 100kc/s signal from V6b goes through C26, C25 and C27 and is thus amplified in the same way. The 100kc/s signal will thus be fed through to V7b in addition to the 10kc/s signal from the multi-vibrator (V6a and V7a).

Mounting the Components

There is plenty of room in the chassis and the layout is in no way critical. Fig. 29 shows the wiring for the 100kc/s crystal oscillator.

Rotary toggle switches are used so that the fact that Chassis 4 is a check unit is apparent from the front, all other switches being of the lever toggle type. Likewise the output socket is at the back so that it cannot be used in error for the R.F. or audio socket.

Make sure the tag strip does not short to earth and that the valveholders are correctly positioned as in Fig. 29.

Inductance L5

This has an inductance (measured) of 11.5mH, but is not critical.

A length of ferrite rod (see the Components List and Fig. 29) is covered with a layer of Sellotape and then 400 turns of 32s.w.g. enamelled copper wire are wound on approximately to the dimensions of Fig. 29 where distances "a" are $\frac{1}{2}$ in. and "b" are $\frac{1}{4}$ in. Wind-

Note that tag 5 of the power unit is also used for the audio oscillator, but this does not matter as the two units will not be used at the same time.

Take one side of the crystal to earth and the other side to pin 2 of V6. Join pin 2 to pin 3 via R30 and connect C26 from pin 2 to the output socket (temporarily only). From pin 3 take R31 to earth and C23 also to earth. Note there are now three wires on pin 3.

Testing the Crystal Oscillator

Connect it to the power unit. Put a milliammeter in the H.T. lead to tag 5. The current taken will be about 2mA if the unit is oscillating and 8mA if it is not oscillating.

While the unit is connected, withdraw the crystal and the H.F. current should alter from the approximate value of 2mA to about 8mA. If difficulty is experienced and wiring is correct, try another valve or suspect the wrong inductance for L5—try putting small condensers across it, starting with 100pF. If the crystal recommended is used there will be no trouble.

Now put the oscillator near the long wave crystal transistor or another receiver (page 27, May issue). A high pitched whistle or hiss (which may be hum-modulated) should be heard. It should also be possible to tune it slightly. If necessary, join the output terminal to the receiver's aerial terminal through a small condenser (say, 50pF).

If a good mains receiver is available for long waves put the crystal oscillator near to it, with 6in. of wire connected to the output socket. On tuning the long waves, a whistle, hiss,

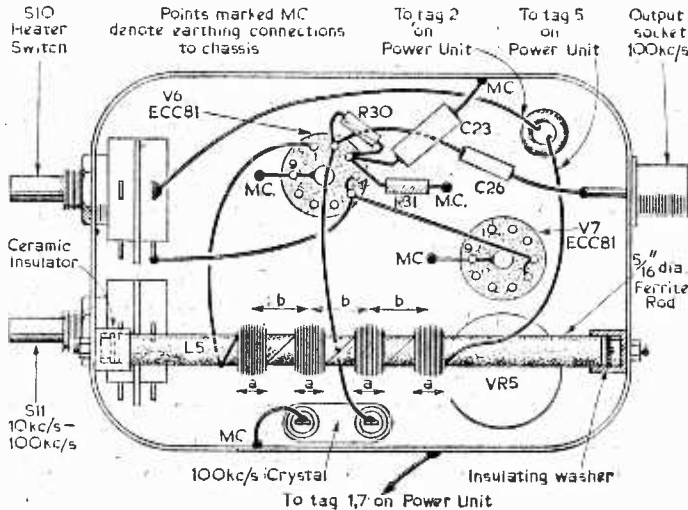

Fig. 29.—The underchassis wiring of the crystal oscillator.

ings are pile-wound and *must* all be in the same direction. Balsa cement may be used to keep the windings in place. Check that the windings do not short to earth when mounted.

The rod may be mounted in any convenient manner. The author preferred to insulate it from the chassis at the ends, but it worked quite satisfactorily uninsulated.

Wiring the Crystal Oscillator (V6b)

The circuit is shown in Fig. 27 and the layout and wiring in Fig. 29. Proceed as follows: take pin 1 and the centre spigot of each valve to earth. Join pins 4 and 5 of each valve and wire them via S10 to a tag (2) of the tag strip which is on top of the chassis. This tag strip is fixed in a similar position to the strips on the other three chassis—see Fig. 23 last month for example. Connect the unit to the power pack tags 1 (or 2) and 7. Plug in the valves and observe that all heaters light correctly.

Now take one end of the coil to pin 1 of V6 and the other end to a tag (5) of the tag strip.

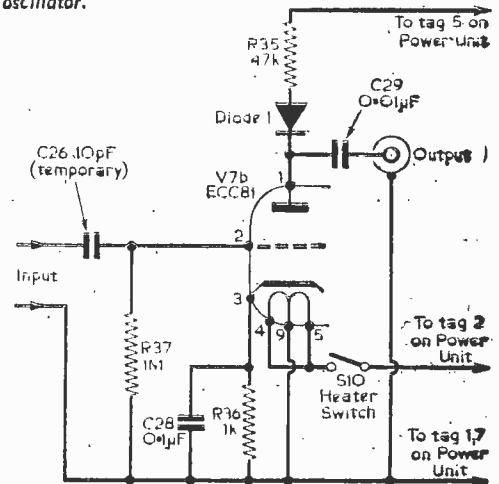

Fig. 30.—The distorter amplifier or harmonic producer.

or hum, should be heard at the 200kc/s mark (Light Programme) and also at 300kc/s and 400kc/s. If the receiver will tune to 100kc/s, a stronger signal will be heard there. If the output is connected via a condenser to the aerial terminal, strong signals will be heard as the receiver is tuned through the 100kc/s, 200kc/s, 300kc/s and 400kc/s points.

The 100kc/s point is the fundamental. It is now proposed to increase the number of strong harmonics so that the receiver may pick them up even on 25Mc/s. As it is now, the crystal oscillator will check receiver calibrations on the Long Wave band and part of the Medium Wave band.

The Harmonic-producing Amplifier

The circuit is shown in Fig. 30 and the layout and wiring in Fig. 31.

Proceed as follows: remove C26 from the output socket and solder it to pin 2 of the other valve (V7), and then wire pin 2 to earth via R37. From pin 3 of this valve take R36 and C28 to earth. To pin 1 connect the diode (do not shorten the leads too much or allow them to become hot), and wire the other end of the diode through R35 to tag 5 on the tag strip (for H.T. from the power unit). Note that the red (+) end of the diode is connected to pin 1 of V7b and the black (-) end to R35. From pin 1 take C29 to the output socket. From the H.T. end of R35, wire R32 to pin 6 of V6.

Testing the Amplifier

Connect 'phones to the output socket. Remove V6 from its holder, plug in, switch on, etc., and touch pin 2 of V7. A humming should be heard in the 'phones. Replace V6 and repeat the previously described tests with receivers. Calibration points will be found every 100kc/s up to at least

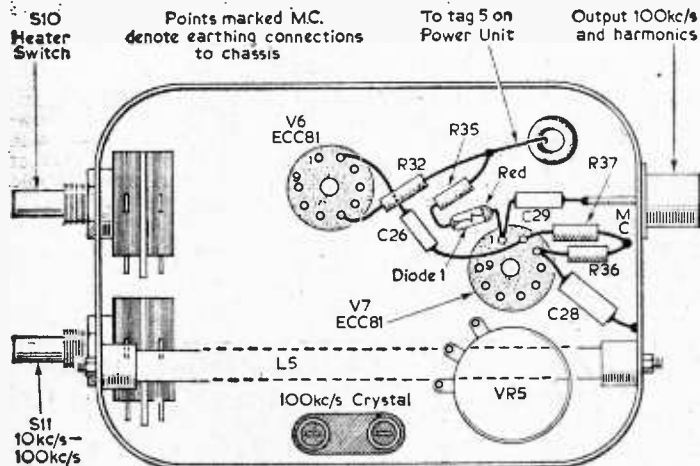

Fig. 31.—The wiring of the harmonic-producing amplifier.

25Mc/s (i.e., even on the 16m band which is considered adequate for this instrument). Note that most ordinary receivers are only approximately aligned to the scale on the short-wave bands.

**COMPONENTS LIST
FOR CRYSTAL CHECK UNIT**

Baking Tin (as for the other chassis)

Resistors:

| | |
|----------------------------------|---------------------------|
| R30 1M $\frac{1}{2}$ W | R35 47k $\frac{1}{2}$ W |
| R31 1k $\frac{1}{2}$ W | R36 1k $\frac{1}{2}$ W |
| R32 and R33 10k $\frac{1}{2}$ W | R37 1M $\frac{1}{2}$ W |
| R34 5.6k or 6.8k $\frac{1}{2}$ W | R37a 470k $\frac{1}{2}$ W |

Condensers:

C23 0.1 μ F 200VW
C24 and C25 0.005 μ F (5000pF) Mica
(No other value is suitable—parallel wiring of say 1000pF and 4000pF condensers will give the required value)

C26 10pF, mica or ceramic
C27 50pF, mica or ceramic
C28 0.1 μ F 200VW
C29 0.01 μ F 350VW

Valve V6 and V7 Mullard ECC81
Switch S11 Rotary toggle type
Switch S10 Rotary toggle type
Diode Any germanium or silicon diode (surplus)

Inductance L5 About 1oz of 32s.w.g. enamelled copper wire and a $\frac{1}{2}$ in. diameter ferrite rod 5 $\frac{1}{2}$ or 5 $\frac{1}{2}$ in. long is required

Quartz Crystal Any 100kc/s crystal will suit, the prototype uses a rather large surplus type available from Henry's Radio. A holder is available also

Output Socket Normal co-axial type
4 or 4-way tag strip—two tags being earthed by fixing

Variable Resistor VR5 10k, any type will suit.
A surplus locking ring is useful to prevent this control from moving once it is set

Nuts, bolts, grommets, etc

Building the 10kc/s Multivibrator

The valve heaters for this part of the circuit are already wired and tested. The circuit can be seen in Fig. 28 and the wiring, which has to be added to that already carried out (Figs. 29 and 31), can be seen in Fig. 32.

Unsolder C26 from its temporary connection on pin 2 of V7. Join pins 8 of both valves together. Connect pin 8 of V6 to one side of S11 and the other side of S11 to earth. Take pin 8 of V6 temporarily direct to earth. Take pin 7 of V6 to one outer tag of VR5 and also through C25 (which must be of the correct value) to pin 6 of V7. Take pin 7 of V7 to earth via R34 (this must also be of the correct value). It will probably be easiest to earth pin 7 of V7 to the centre spigot or to pin 9. Join pin 7 of V7 also to pin 6 of V6 via C24 (again, this must be of the correct value). From pin 6 of V6, join R32 (positioned upright) to a similar

resistor R33 (also upright) and the junction of these two (R32 and R33) is joined to R35 where it leads off to tag 5 (H.T.). The wire joining the three resistors is left "in the air". The other end of R33 is connected to pin 6 of V7.

Testing the Multivibrator

Connect up to the power pack with a milliammeter in the H.T. lead to tag 5. The current should be about 10 to 12mA with both the amplifier and crystal oscillator working.

Connect to the aerial socket of a receiver via a small condenser (10pf) (and via C27) to pin 6 of V7. Loud and numerous "swishes" will be heard in many places on any waveband, the number of swishes being controlled partly by VR5 which must not be turned to the completely "off" (i.e., shorting) position.

Synchronising the Multivibrator

Condenser C26 has already been connected to pin 2 of V6 and is now not connected at the other end; solder this end to pin 7 of V6. The 100kc/s signal will now synchronise the multivibrator.

Connect up as before to a receiver set to long waves. Notice exactly where the 100kc/s points were (they will be the loudest "whistles" or "swishes") and verify that "swishes", previously non-existent, are now heard in between the 100kc/s points. Verify that the number can be altered by means of VR5.

Setting the Multivibrator on 10kc/s

Connect the unconnected end of C27 to pin 2 of V7. Disconnect the earth lead from pin 8 of V6. The circuit is now as shown in Fig. 28.

It is vital that VR5 control is correctly set—guess-work is not good enough. Place the unit near to a selective receiver, and connect it to the aerial socket via a low value condenser (only if it proves necessary). Disconnect the normal aerial. Switch to Long waves and tune in the Light Programme. Switch S10 on and S11 off. Note very carefully (a piece of gummed paper on the dial will help) the crystal calibrator point at 200kc/s and tune in the next one at 300kc/s and mark it accurately. Now switch on S11 so that the multi-vibrator functions. Count very carefully the "swishes" between the two points already marked. There should be nine (i.e. eleven counting the two main points). If the number is not correct, move VR5 slowly until you hear it lock to another frequency (in the receiver, or, if your hearing is good, from the vibrating valve electrodes in the vibrator). Repeat this until you are sure. Near the actual 100kc/s points, the hiss or whistle may be so loud that it spreads over some of the dial and masks what might be another "swish" or "whistle".

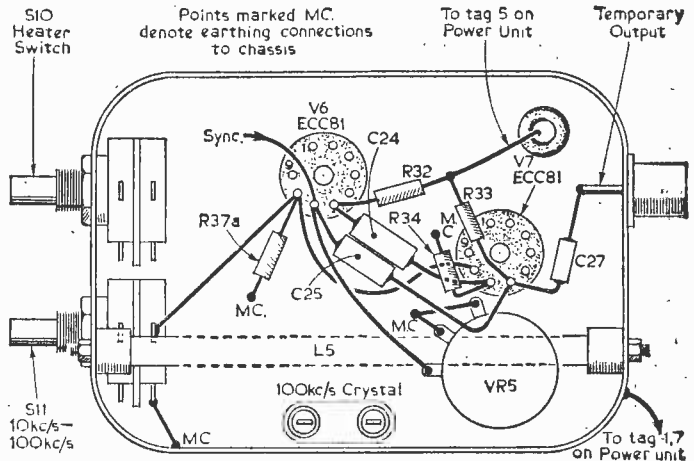

Fig. 32.—The wiring of the multivibrator.

The remedy is to move the generator farther away from the receiver so that the "swishes" are not so loud.

Finally, when VR5 has been correctly set, there should be nine smaller "swishes" between the two larger "swishes". If the receiver used is not sufficiently selective, then only seven smaller "swishes" may be heard. The two which are nearest the two larger "swishes" may be hidden by them. However, it should be obvious that two are being hidden because the spacing between the seven smaller "swishes" will be regular, while the spacing between the final smaller "swishes" and the two larger "swishes" will be noticeably greater: it will be obvious that there is space for the two "swishes" which are masked.

When VR5 is correctly set it is sealed; sealing wax is suitable.

Checking Receiver Dials

The receiver dial may now be checked; approximately, using the 100kc/s points (these are, however, exactly accurate), and then in detail with the 10kc/s points throughout the whole range of most ordinary receivers. The beginner should experiment in this direction to gain experience.

(To be continued)

| | | | |
|---|-----|-----|-----|
| JOIN THE PRACTICAL GROUP | | | |
| PRACTICAL TELEVISION | ... | ... | 1/6 |
| Every Month | | | |
| PRACTICAL MECHANICS | ... | ... | 1/6 |
| Every Month | | | |
| Devoted to Mechanics, Science and Invention | | | |
| PRACTICAL MOTORIST | ... | ... | 1/6 |
| Every Month | | | |
| PRACTICAL HOUSEHOLDER | ... | ... | 1/3 |
| Every Month | | | |

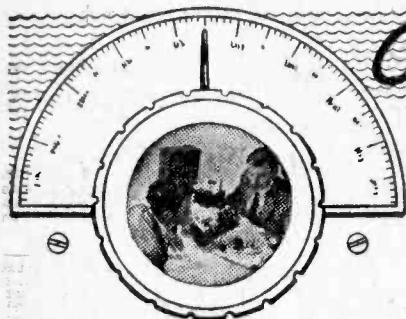

On Your Wavelength

BY THERMION

Those Portables

SOME time ago I mentioned the annoyance which was being caused by the transistor type of portable and suggested that perhaps legislation would have to be introduced to limit the use of this latest weapon. Since then, I was very relieved to see that a number of authorities have taken steps to preserve the rights of the majority of us who prefer quiet and peace. At Lord's cricket ground the use of the portable has been banned, as well as on the sun-deck of the pier at Southend. At least one other seaside resort has a bye-law preventing the playing of radio in the streets after a certain hour and one visitor who was walking along with his radio playing was fined.

These little sets are wonderful, if properly used, but now one sees them, in my view, being abused. On an underground train recently, one gentleman was tinkering with one and when he got out at my local station (which was above ground) he slipped it in a small cloth shopping bag, still playing, and his taste in music was inflicted on all the passengers, and presumably also on the pedestrians in every street through which he passed. The recent spate of cricket and tennis relays has brought untold misery to many and I do feel very strongly about these receivers, and think that the type with a plug-in earpiece deserves wider use, as then others do not have to listen. It is surely a very selfish attitude to use these loudspeaker portables in such a way that others can hear them, and I feel sure that their continued use to the annoyance of others will cause so many complaints that eventually they will be banned from public places, or at least a limit will be put on the volume of sound which may be used. This, of course, brings in the problem of our old friend the decibel. When a standard such as this is adopted, some measuring device must be employed and users of road breaking apparatus and others who may fall foul of the law may plead that the volume was not excessive whilst those who object contradict this, so without a reliable yardstick, legal actions will not be possible. Perhaps the Noise Abatement people will produce some instrument which may be legalised as a measurer of noise, and receive police sanction, so that those who wish to complain will be able to do so with every chance of being upheld in their complaint.

Speed Detectors

The talk of noise measurers, brings to mind the speeding car detector, and it seems that our lives

are being rather filled with modern scientific apparatus to the exclusion of our own senses and abilities. The modern calculating machine, the instant photo copier and similar devices are now commonplace, and whilst there is little doubt that they do improve efficiency by speeding up the result, the human endeavour is ousted and I wonder whether this is all to the good. We shall not need the clever mathematician in future years, as the calculator will take his place, and the efficient typist will be pushed out by the electrical typewriter, complete with automatic gadgets, whilst the skilled photographer who is now called upon to make accurate copies of documents, etc., will be replaced by the "copier".

Amateur Satisfaction

My postbag contains letters on a multitude of subjects, but it is surprising how many deal with the radio of earlier days. As one who saw radio commence its entry into the world, I do agree with a correspondent who wonders whether the modern amateur gets as much satisfaction from modern equipment. He sends me a neat pile of leaflets which he found amongst some gear at home and sends them for my inspection. He says

"From my point of view, the list of the Northampton Plating Co. was of particular interest, as I remember that it was one of those sources of components at a price low enough for me to afford, being a schoolboy at that time. Their S.L.F. variable condensers at 3s 11d were well made and smooth in use, one of them was surviving until some ten years ago when it was passed on to some local Scouts with other items for further use. It was still quite free of wear or shake. Incidentally S.L.F. type single condensers do not seem to be very easily obtainable nowadays, which is a pity in view of the number of circuits appearing for small receivers and alignment oscillators in amateur publications. Most condensers offered at "popular" prices seem to be either S.L.C. or law types, and twin gang at that.

"The dull emitter valves advertised by the Plating Co. were also quite good for their time, although the two I purchased had a greater tendency to microphony than the Mullard and Cosor products.

"Still, one sometimes wonders whether the present day schoolboy, with a range of components available at relatively low price, gets quite the same gratification as my generation did at receiving Schenectady on a crystal and cats-whisker."

Yes, I wonder whether the same degree of satisfaction is experienced, especially by those who received tuition in radio at school and therefore regard it not so much as a mystery but as an accepted thing—like the essential services to be found in the home?

BRAND NEW AM/FM (V.H.F.) RADIOGRAM CHASSIS AT £14 (Carriage Paid)

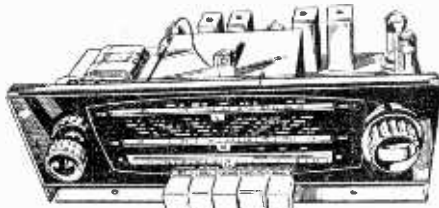

Tapped input 200-225 v. and 226-250 v. A.C. ONLY. Chassis size 15 x 6 1/2 x 5 1/2 in. high. New manufacture, 12 mths. guarantee. Dial 1 1/2 x 4 in. in black and gold. Pick-up. Extension Speaker. Ae., E., Hd Dipole Sockets. Five "piano" push buttons—OFF L.W., M.W., F.M. and Gram. Aligned and tested. With all valves and O.P. Transformer. Tone Control Fitted. Covers 1,000-300 Mc/s. 200-500 M.; 38-98 Mc/s. Valves E280 rect. EC81, EF89, EABC80, EL84, ECC85. Speaker and Cabinet to fit chassis (table model). 47/6 (post 3/6). 10 x 6 in. ELLIPTICAL SPEAKER. 20/-, to purchasers of this chassis. TERMS:—(Chassis) £5 down and 5 Monthly Payments of £2, or with Cabinet and Speaker £5.10.0 down and 6 Monthly Payments of £2. This chassis is an ideal partner for the radiogram cabinet appearing on this page.

THE "CABY" TEST METERS

Prices include Test Prods. Batteries. Instruction Book. Also measure d.B. Accuracy: A.C., 3 per cent, D.C., 2 per cent. A-10 **£4.17.6** B-20 **£6.10.0**
A.10—2K ohms/v. on A.C. and D.C. Volt (10, 50, 250, 500 and 1000 v.); 10K and 1M ohms; 1 mA, 25 mA and 250 mA. D.C. Size; 5 1/2 x 3 1/2 x 1 1/2 in. Weight 17 oz.
B-20—10K ohms/v. on 0.5 v. and 2.5 v.; 4K ohms/v. or 10, 50, 250, 500 and 1000 v.; A.C. and D.C. Resistance, 2K, 20K, 2 M and 20M ohms; D.C. current, 100 microA, 2.5 mA, 25 mA, 250 mA. Size: 5 1/2 x 3 1/2 x 2 1/2 in. Weight 24 oz.



SELF-POWERED VHF TUNER

4 CHASSIS. Covering 88-95 Mc/s. Mullard permeability Tuner. Dims. 10 1/2 x 4 1/2 x 5 1/2 in. high. ECC85, EF91, EF91 and 2 diodes. Metal Rectifier. Mains transformer. Fully wired and tested. Only £7.14.0 (carr. pd.). Room dipole. 100 ohm twin feeder. 6d. yd. Tuner without power pack **£6.14.0** (carr. pa.).

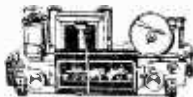

TAPE RECORDER FOR ONLY £17.10 (10/- carr.)

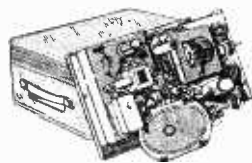

A QUALITY ARTICLE. Valves E280, ECC83, ECL82, DM70. Acos Crystal "mike", 850ft. Tape and extra spool. 3 1/2 in./sec. Mike and Radio inputs; Vol. on/off tune, Ext. L.S. and Monitor. Fast forward and reverse. Cannot be accidentally erased. Magic Eye Indicator. 6 x 4 in. Speaker. Cabinet 14 x 1 1/2 x 7 1/2 in. Supplied completely built and in cabinet.

B.S.R. "MONARDECK" TAPE DECK SINGLE SPEED. Our price only **£7.2.6** (5/6 carr.). 8 1/2 in. first grade tape 5 1/2 in. plastic spool, 16/-, post 1/-.

3-VALVE AMPLIFIER (INC. RECT.) 4 watts. Valves ECC83, EL84, and E280; Controls, volume, bass and treble. On/off switch. Overall size 10 1/2 x 4 x 5 1/2 in. over valve. Mains and O.P. trans. and 7 x 4 in. elliptical speaker. Not suitable for microphone input. A.C. only



62/- P. & P. 3/-.

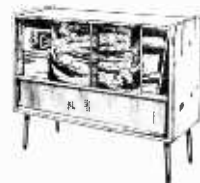

SUPERB CONTEMPORARY CABINET

Fitted with 3 sliding doors providing room for Radio, Autochanger, 4 speakers, and record storage.

Takes our AM/FM (V.H.F.) radiogram chassis at £14.

PRICE 15 Gns.

Free delivery in London area.

SAVE 10/-. Swiss made Uno Shaver operating from 1.5 v. battery, usual price 5/8. Our price 50/- with battery. Takes U2 battery. Not a toy, but a shaver (carr. paid).

COLLAR TUBE TAPE TRANSCRIPTOR. 3 MOTORS, 3 SPEED. Push Buttons. **£10.17.6** (10/- carr.) incl. spool.



LISTEN WITHOUT INTERFERENCE. Fully built V.H.F./F.M. Set for **£8.12.0** (carr. pd.) Covers 88/95 Mc/sec. Wired, aligned and tested. Mullard permeability tuner and 4 valves (ECC85, ECL82 and two EF91). 2 diodes. Cheap room dipole. 100-300 ohm twin feeder, or co-axial cable, 6d. yd.

STEREO AMPLIFIER £4.15.0 (3/- p. & p.)

Brand new. 200-250 A.C. Tune and volume controls each channel. HZ80; ECC83; and 2-EL84; giving 2 x 4W. Size 12 x 3 1/2 x 3 1/2 ins. O.P. Trans. for 2-30 speaker. Separate on/off switch to allow balancing to remain set. Monaural push/pull amplifier giving 8W same price.

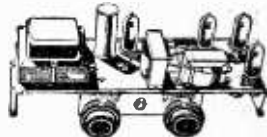

Write for details of printed circuit 6-transistor chassis, new, working order. 8 x 2 1/2 in. with ferrite aerial, dial and 6 x 4 in. speaker. M. and L.W. ONLY **£7.10.0** (3/- post).

BATTERY ELIMINATOR. For 4 Low Consumption Valves (80 range), 90 v. 15 mA, and 1.4 v. 125 mA. A2/6 (2/6 post). 200-250 v. A.C. Size 8 1/2 x 3 1/2 x 2 1/2 in. Also for 250 mA, 1.4 v. and 90 v. 15 mA at same price.

AUTOMATIC RECORD CHANGERS. ALL 4-SPEED WITH TURN-OVER CRYSTAL CARTRIDGE (carr. 5/- extra). B.S.R. UA8, £8.10.0; UA8 stereo, £7.5.0; latest UA14, £7.10.0. Motor board to fit changer 3/6.

COMPLETE V.H.F./A.M. RADIO FOR £12.10.0 (carr. paid)



Brand new set, in superb walnut cabinet (size 19 x 8 x 14 1/2 in. high). Covering 80-100 Mc/s. 16-49 M., and 200-500 M., Mains trans. 200-250 v. with 2 tappings. Ferrite rod aerial for A.M. Controls: volume on/off, tone, tuning, w/change. Gram and ext. speaker position provided. Valves 12A17, 12AB8, 6B6, EABC80, 6B8B and metal rectifier. Fully guaranteed. Today's Value £20.

GRAMOPHONE AMPLIFIER With 5 in. SPEAKER. Baffle 12 x 6 in. (2/6 post). EL41. Tone and Volume. On/Off switch. Two Knobs. Ready to play. Useful for Stereo. ONLY **67/-**, post 3/-.



TWO-TONE BROWN RECORD PLAYER CABINET (with Motor Board for Autochanger) and Gramophone Amplifier to fit Cabinet for **£5.5.0** (3/- carr.). Size 17 x 15 x 3 1/2 in. Brand New. B.S.R. UA8 autochanger to fit. **£6.10.0** (extra carriage 2/6)

GERMAN MADE F.M. FRONT END with ECC85 Valve. Capacity tuned with reduction gear. Covers 88-98 Mc/s. 4 1/2 x 3 x 3 1/2 in. over valve. New, price **£2/6** (2/6 post). Circuit 2/6.

Send 6d. (stamps will do) for 20 p. illustrated catalogue. All New Goods. Delivered by return. Terms:—One third down and balance plus 12/6 in four equal monthly payments. Postage with down payment (C.O.D. 2/- extra).

ALL ITEMS GUARANTEED 12 MONTHS—B.V.A. VALVES 3 MONTHS—SEE SPECIAL TERMS FOR A.M./F.M. CHASSIS.

GLADSTONE RADIO CAMP ROAD, FARNBOROUGH, HANTS. Tel.

Also at 247 New Road, Portsmouth, Hants., and 56 Stokes Croft, Bristol G. Tel. 78509
Farnborough closed Saturday. Portsmouth and Bristol closed Wednesday.

Posted Orders to Farnborough Please

MAXI-Q I.F. TRANSFORMERS

REGD.

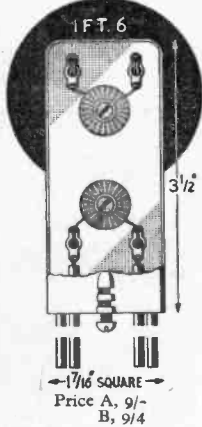

IFT. 11/465 Kc/s and 1.6 Mc/s.
 Miniature IF Transformers for 465 Kc/s or 1.6 Mc/s giving excellent performance at low cost. Coils are litz wound and permeability tuned with high-grade iron dust cores and silver mica condensers. Screening can 1 1/2 in. x 1 1/2 in. sq. PRICE 6/6.

IFT. 11/10.7 Mc/s.
 Nominal frequency 10.7 Mc/s. For IF stages of F.M. receivers and converters. The Q of each winding is 90 and the coupling critical. Construction and dimensions as above. PRICE 6/6.

IFT. 11/10.7 L.
 As above but with secondary tap for limiter input circuits. PRICE 6/6.

IFT. 6A and B 465 Kc/s or 1.6 Mc/s.

A superior IF Transformer for use in high quality receivers and tuners. Permeability tuned, litz wound coils, high-grade iron dust cores and silver mica condensers. Termination is made by four coloured flexible leads. Coupling is optimum at 465 Kc/s and slightly sub-optimum for increased selectivity at 1.6 Mc/s. IFT. 6A has all leads brought out at the bottom while IFT. 6B has a top screened grid lead. Screening can 3 in. x 1 1/2 in. square.

PRICE: TYPE 'A', 9/- . PRICE: TYPE 'B', 9/4.

IFT. 12/85 Kc/s.

A narrow band 85 Kc/s IF Transformer for use in double superhet communications receivers. The overall response of one transformer is approx. 3.5 Kc/s at - 6db. Dynamic resistance 500,000 ohms. Wound on a polystyrene former with iron dust core tuning and silver mica condensers. Screening can 2 1/2 in. x 1 1/2 in. square.

PRICE 16/-.

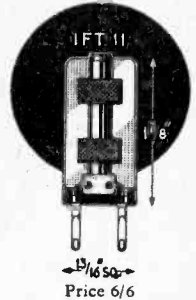

ALL IF. TRANSFORMERS ARE ALIGNED BEFORE LEAVING THE WORKS

GENERAL CATALOGUE covering full range of components, send 1/4 in stamps. PLEASE SEND S.A.E. WITH ALL ENQUIRIES.

DENCO (CLACTON) LTD. Dept. (P.W.) 357/9 Old Rd., Clacton-on-Sea, Essex

Stop Press: MULLARD "TWIN THREE-THREE" STEREO AMPLIFIER. Punched Aluminium Chassis and Hammered Gold printed front Panel 25/9d.

EXPRESS ELECTRONICS

ROSEDENE LABORATORIES

KINGSWOOD WAY, SELSDON, SURREY

VALVES NEW TESTED AND GUARANTEED FOR THREE MONTHS

| | | | | | | | | | | | |
|-------|-----|--------|------|----------|------|-------|------|-------|------|-------|------|
| 1C1 | 7/8 | 6BA6 | 7/- | 787 | 9/6 | DF91 | 7/8 | ECL82 | 9/6 | PCL82 | 7/- |
| 1D1 | 8/- | 6BE6 | 7/- | 8D9 | 4/- | DF96 | 8/- | EF41 | 9/- | PCL84 | 7/- |
| 1E1 | 8/- | 6BE8 | 6/6 | 12A8 | 10/- | DH75 | 7/8 | EF80 | 3/- | PL81 | 12/6 |
| 1F8 | 7/8 | 6BJ6 | 5/8 | 12AT7 | 6/- | DH77 | 6/- | EF86 | 9/- | PL82 | 7/- |
| 1FD1 | 8/- | 6BK7 | 8/9 | 12AU7 | 5/- | DH142 | 8/8 | EF91 | 4/- | PY81 | 6/9 |
| 1FDJ | 7/8 | 6BS7 | 10/6 | 12AX7 | 7/8 | DH150 | 10/- | EF92 | 5/6 | PY82 | 7/8 |
| 1L4 | 8/9 | 6BW6 | 7/8 | 12BE6 | 8/6 | DK92 | 7/8 | EL41 | 9/8 | PY83 | 7/8 |
| 1P1 | 8/- | 6BW7 | 7/- | 12BH7 | 10/6 | DK92 | 7/8 | EL84 | 7/- | R19 | 11/8 |
| 1P10 | 7/8 | 6D10 | 9/- | 12K8GT11 | - | DK96 | 8/- | EM84 | 10/- | U26 | 9/8 |
| 1P11 | 7/8 | 6D2 | 4/- | 12Q7GT | 7/8 | DL92 | 7/8 | EM85 | 10/- | U82 | 7/8 |
| 1R5 | 8/- | 6F12 | 4/- | 16A5 | 9/- | DL94 | 7/8 | EY61 | 7/8 | U76 | 7/8 |
| 1R5 | 8/- | 6F6GT | 8/- | 25A8G | 8/6 | DL96 | 3/- | EY81 | 10/- | U78 | 8/- |
| 1T3 | 7/8 | 6I7GT | 7/8 | 2B18GT | 7/8 | EB91 | 4/- | EZ40 | 7/8 | UBC41 | 8/6 |
| 1U5 | 4/- | 6K7G | 5/6 | 2E24G | 9/- | EBC41 | 10/- | EZ30 | 6/6 | UCH42 | 8/6 |
| 1Q4 | 8/- | 6K8G | 8/- | 30C1 | 6/9 | EBF80 | 8/8 | EZ81 | 8/9 | UF41 | 8/8 |
| 384 | 7/8 | 6Q7GT | 8/6 | 30L1 | 7/- | ROC81 | 8/- | KT38C | 9/8 | UL41 | 8/8 |
| 3V4 | 7/8 | 6S18GT | 8/- | 35L6GT | 9/- | ECC42 | 8/- | KT96 | 11/6 | UY41 | 7/8 |
| 514G | 7/8 | 6S18GT | 8/- | 35W4 | 8/6 | ECC83 | 7/8 | N17 | 7/8 | W76 | 6/6 |
| 6Y8GT | 4/8 | 6V6G | 7/8 | 35Z4GT | 8/- | ECC84 | 7/8 | N18 | 8/- | W142 | 8/8 |
| 6Z1G | 9/8 | 6X4 | 5/- | 58K U | 10/6 | ECF80 | 8/8 | N19 | 7/6 | X17 | 7/8 |
| 6AK6 | 8/8 | 6X5G | 5/- | 57B3 | 7/8 | ECF82 | 8/8 | N87 | 10/6 | X142 | 9/- |
| 6AL5 | 4/- | 6X5GT | 8/- | 50 | 6/- | ECH42 | 8/- | PCCR4 | 8/9 | X150 | 9/- |
| 6AM3 | 4/- | 7B7 | 8/- | DAF91 | 7/8 | ECH81 | 10/- | PCF80 | 8/9 | Z77 | 4/- |
| 6AT6 | 6/- | 7C5 | 7/6 | DAF96 | 8/- | ECL80 | 8/8 | PCF82 | 7/- | ZD17 | 7/8 |

Coax. Super quality 4in., 6d. yd. Plugs, 9d. Sockets, 6d.

VOLUME CONTROLS MIDGET SIZE LONG SPINDLES. D.P. switch 4/-, Loss switch, 2/6. Valves 10K to 2M, B9A, B7G v. Holders 9d., Screens 9d., Contact Coated Rectifiers 250v. 50 mA. 8/8, 85mA. 8/8.

MATCHED PAIRS

EL84 17/-, 6V6G 17/-, 6BW6 18/- per pair. Push Pull O.P. Transformers for above 3-15Ω 14/6. P. & P. 1/6. 12in. P.M. Speakers 3Ω 24/6. Baker's "Selhurst" 12in. 15Ω 15W. 90/- . P. & P. 2/6. 13in. Stereo Model 27.7.0.

SETS OF VALVES

DK91, DF91, DAF91, DL92 or DL941. 19/6
 DK96, DF96, DAF96, DL96. 27/8
 1C3, 1P1, 1FD1, 1P1. 27/8
 1R5, 1T4, 1R5, 384, or 3V4. 19/6
 Postage and packing 6d. Over £1 post free. C.O.D. 2/6.

SPECIAL FOR THE "HAMS" RADIO STATION

Illustrated

1/8 inch detachable bit soldering instrument
 List No. 70

Combined Protective Unit with Wiper/Abrasion Pad and Solder Reel
 List No. 700

Apply SALES & SERVICE

ADCOLA

(Regd. Trade Mark)

GAUDEN ROAD
 CLAPHAM HIGH ST.
 LONDON, S.W.4

Telephones: MAcaulay 3272-3101

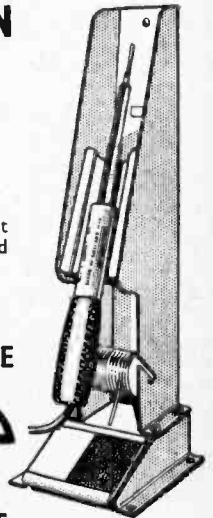

British & Foreign Patents, Registered Designs, etc.

Telegrams: "SOJJOINT, LONDON"

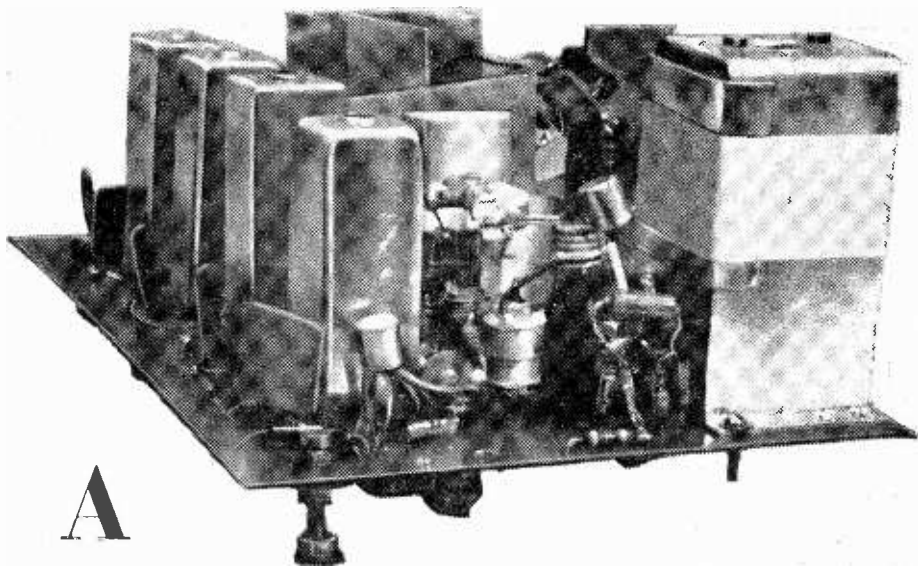

A Transistorised VHF Superhet

AN
ALL TRANSISTOR PORTABLE RECEIVER

Designed by D. R. Bowman

THE design of the receiver described here is admittedly a by-product in the development of a fully-transistorised television receiver. Before the latter can be presented, a number of serious problems remain to be solved; but the radio-frequency and intermediate-frequency stages proved very amenable to normal transistor design procedure, and it was therefore decided to make the few necessary modifications to offer a fully transistorised VHF receiver. Work with this will afford valuable experience to the constructor, as it did to the writer.

It was realised from the outset that the production of a receiver of the too-usual miniature type would result in the also too-usual "tinny" reception, and this would do far less than justice both to the excellent and interference-free VHF transmissions and to the present-day high quality transistors. Provision has therefore been made for class AB audio output up to 1W, and for reasonable reproduction of bass frequencies, a minimum

size of cabinet had to be specified. The receiver is certainly quite portable, as it weighs only a few pounds, but is not in the vest-pocket class.

Sensitivity is of the same order as the usual kind of domestic F.M. mains-operated receiver. An aerial signal of $5\mu\text{V}$ gives a power output of 50mW with the prototype receiver. The normal spread of transistor parameters may cause this to vary appreciably—perhaps from 3 to $20\mu\text{V}$ —but this will be found quite adequate in practice. Signals of 200mV can be handled, but where such a strong signal is obtainable, a very sketchy aerial can be used, and doubtless will be used, by many constructors. An outside aerial, 20ft high, consisting of a plain dipole, will ensure reception at distances of 100 miles or more from the transmitter.

In the prototype receiver, printed-circuit construction has been employed. The circuit will be found readily adaptable however for those who wish to use a normal chassis, but the use of copper-clad laminate is recommended for its ease of working and its good electrical properties—no difficulty will be experienced in the etching process.

Fig. 1 shows the circuit diagram. This, it will be seen, denotes a "line-up" of nine transistors; an R.F. amplifying stage, self-oscillating frequency-changer, three I.F. stages, ratio detector, audio pre-amplifier, driver and push-pull output stages.

The R.F. Stage

The R.F. stage consists of a Mullard OC171, operating in the grounded-base configuration. The real part of the emitter input impedance under the conditions of the circuit, is about 120Ω . The aerial is therefore connected direct to the emitter through the usual coaxial cable of nominal impedance 80Ω . This provides a very reasonable match. If, however, a length of wire is used for portable operation, best results are obtained by plugging a 42in. length into the centre connection of the coaxial input socket. It will be remembered that a single 33in. length will present an impedance of about 40Ω to the emitter, and the extra length is required for a better match.

The input is of course not aperiodic, as might be supposed: the input tuned circuit is in fact the aerial. As long as its Q is about 12 or less, the sensitivity drop at the edges of the VHF band will be less than 6dB. The aerial should therefore ideally consist of a dipole using copper or aluminium tubing of $\frac{1}{2}$ in. diameter. However, the writer uses a picture-rail aerial consisting of two 33in. lengths of 14s.w.g. copper wire, with good reception of the "local" station (56 miles away).

The R.F. OC171 operates at a collector current of about 1.4mA. A higher current gives negligible increase of gain and a noticeable rise in noise-level. A capacitor connected between emitter and base, of value 20pF, may require some comment. The purpose of this is to bring the collector feed-back current more into phase with the aerial current, and results in a measure of positive feedback, increasing R.F. gain by 3 to 4dB. It may be pos-

sible to increase this capacitor to a value of 25pF, but in the prototype receiver such an increase caused the R.F. stage to oscillate when the collector circuit was tuned to 95Mc/s or higher frequency. By the same token, with certain transistors, it may be necessary to reduce its value to 15pF or even 10pF.

The Frequency-Changer

The frequency-changer, another OC171, is also operated in the grounded-base configuration, current from the R.F. stage being introduced by including the secondary of the inter-stage transformer in the emitter circuit. As this is a self-oscillating frequency-changer, and feedback from the collector is arranged by capacitive coupling, it is necessary to include a resistor of about 100Ω in the emitter circuit also. This causes some reduction in the signal injected, but the effect is small. The oscillating circuit is tuned partly by a pre-set capacitor, and partly by a variable capacitor ganged with the R.F. inter-stage tuning capacitor. Both are in series with a fixed capacitor of negative temperature coefficient which also does duty as the fixed capacitor of the I.F. transformer in the collector circuit.

The use of negative temperature coefficient capacitors in the R.F. and F.C. circuits is not—as with valve operated equipment—to correct for warming-up drift. In the transistor receiver their function is to correct for changes in ambient temperature, and conditions are much less critical. If the user does not object to re-tuning as the room temperature changes, silver-mica capacitors can be used instead.

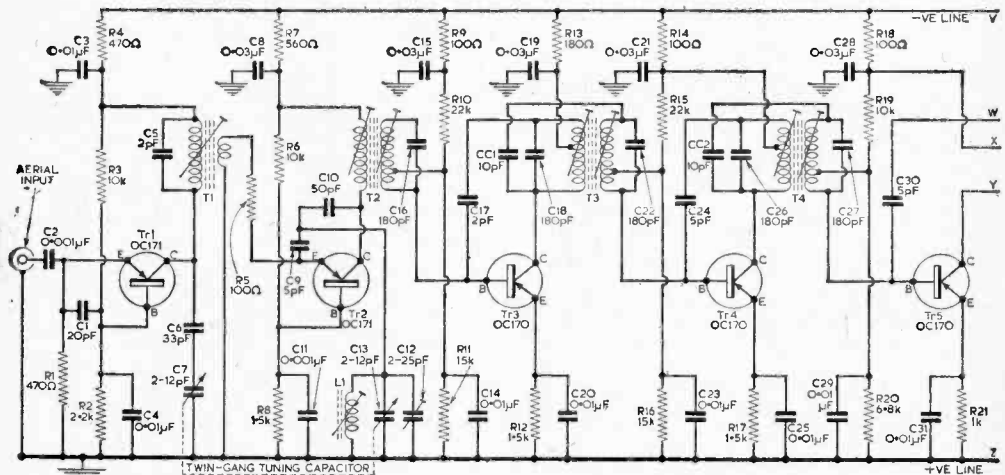

Fig. 1a.—The input and I.F. stages of the circuit.

The Intermediate-Frequency Amplifier

It was realised that many constructors would be unwilling to undertake the construction of a receiver in which the setting-up and alignment would require a valve voltmeter or oscilloscope. In this circuit, adjustable coupling has been avoided wherever possible, and the I.F. transformers have

been arranged for fixed capacitive coupling between primary and secondary, with non-critical spacing between windings. The only variable coupling is in the collector circuit of the last I.F. stage, where a simple drill enables the precise conditions to be reached, using a meter, or "near-enough" conditions by ear.

Mullard transistors, type OC170, are employed in the I.F. stages. Two pairs of coupled circuits are used between the first and second I.F. stages and between the second and third. Coupling is "critical", and the dynamic impedance of primary and secondary have been calculated to give the bandwidth needed. For exact bandwidth the transformers should be tuned by 160pF capacitors; but 180 pF capacitors are here specified because the inevitable slight inaccuracies in practical alignment, result in a very slightly "stagger-tuned" amplifier, which still has the correct bandwidth.

The last I.F. stage, which drives the ratio detector, requires tighter coupling than critical, and coupling of approximately 1.5 critical is used. The intermediate frequency is 10.7Mc/s nominally, though the constructor may prefer to vary this a little one way or the other to avoid a powerful local short-wave transmitter.

The Ratio Detector

The use of a ratio detector was decided upon because of its simplicity and its ability to deal with small signals effectively. Because of this latter consideration, AGC has not been provided and its absence has not been acutely felt. The

Neutralisation

As the transistor may be regarded for some purposes as a triode with the grid operated in the positive region, it will be understood that at the intermediate frequency concerned, 10.7Mc/s, neutralisation of the collector-base feedback will be needed. By suitable design of the I.F. transformers, fixed non-critical capacitive neutralisation can be achieved. In fact, this circuit possesses very slight over-neutralisation, and with certain transistors the 5pF neutralising capacitors may need reduction to 3.3pF if I.F. instability is experienced. If desired, the addition of small resistors (about 47Ω) in series with the neutralising capacitors will improve stability and gain. This process, known as unilateralisation, enables wanted and unwanted feedback to cancel each other out exactly in magnitude and phase. However, this is a refinement found not to be necessary in practice,—although the purist may prefer to include it in his receiver.

The Audio Amplifier

No claim is made that the audio amplifier is original. In fact it is almost identical with the Mullard 1W amplifier, described in "Reference Manual of Transistor Circuits" (first edition, 1960). There seemed to be no point in gilding the lily. However, with the transformers specified, crossover distortion at low signal levels was more noticeable than might be desired, and a slight increase in output quiescent current has been arranged to overcome this.

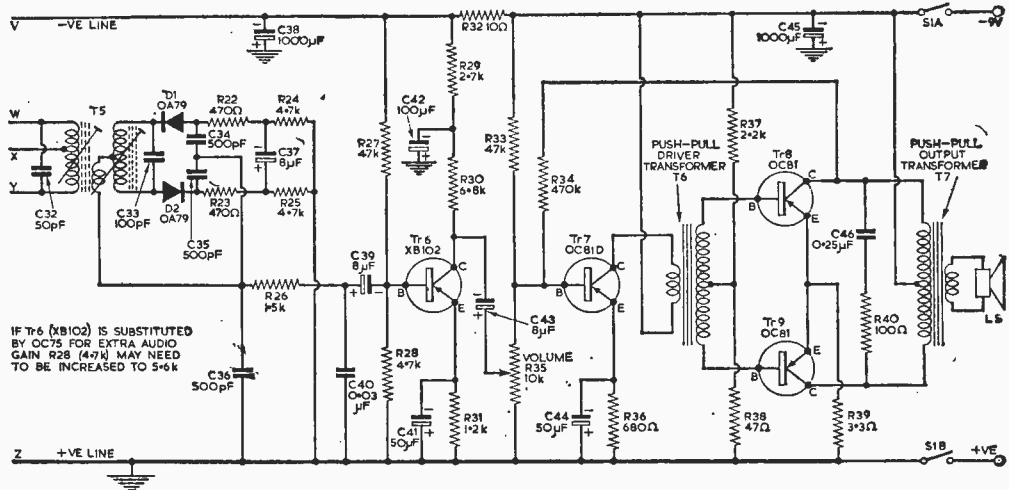

Fig. 1b.—The detector and audio stages of the circuit.

ratio detector is of conventional design. Diodes supplied in a matched pair (OA79) avoid the need for adjustable resistances in series. Amplitude limiting is improved by the stabilisation of only about 90per cent of the developed voltage, and this is arrived at by the inclusion of small fixed resistors in series with the diodes. The normal de-emphasis (in this case, 45μsec) is provided.

Very thorough decoupling has been found essential in the audio section of the receiver. This is hardly surprising, since approximately 70dB audio gain is obtained. Layout however is not critical. The inevitable increase in battery resistance during discharge causes no instability, and as much as 300Ω has been put in series with the battery without causing trouble.

(To be continued)

A Pre-wired Valveholder Extension

A SPACE SAVING MODIFICATION

By D. J. Gill

A READER'S letter in the February issue, on the subject "Extension of Valveholders," tempts me to submit this simple and effective solution, which I adopted some years ago.

This simple method not only eliminates the cumbersome tagboard, thus enabling the amateur to reduce the overall size of the unit under construction, or take advantage of the space saved to accommodate better his other components, but it has the added advantage of allowing each valveholder and its associated components to be wired and checked as a separate sub-unit before the valveholders are mounted on the chassis, as will be seen. Added to this is the advantage of being able to wire all valveholders while they are on a clear bench with every component readily accessible, as opposed to having to probe into

The extension pillar, Fig. 2, can be made from brass, dural, or one of the many thin rods or tubing easily obtained. For those whose kit does not include taps or dies, this pillar can be made equally well from a 0B.A. 1 1/2 in. long screw, in the case of a nine pin valveholder. For a seven pin valveholder, the procedure is the same but the screw is 2B.A.

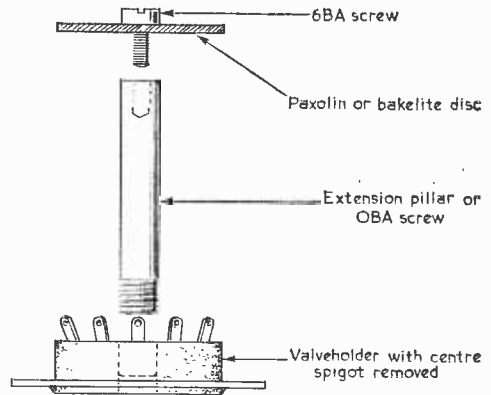

Fig. 3.—The simple construction of the extension.

The head of the screw is removed and a 6B.A. or 4B.A. nut soldered on one end of the screw. The thread is then filed off about a 1/4 in. at the other end. This will leave the screw a tight push-fit into the centre of the valveholder.

Fig. 3 shows the unit ready for assembly, and needs no explanation further than to say that the

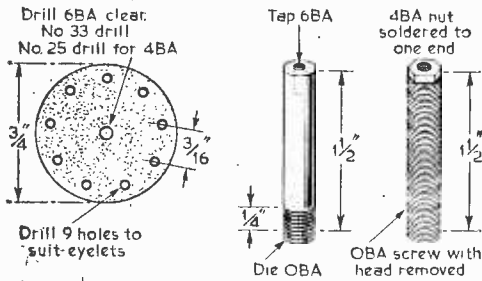

Fig. 1. (left)—The dimensions of the Paxolin disc.

Fig. 2. (right)—Two suitable extension pillars.

hidden corners with a soldering iron, sometimes at the expense of wiring, or other components, only to finish up with a doubtful connection.

Reference to the diagrams will show that the only tools required are a couple of taps and dies, but even these are not absolutely necessary. Fig. 1 shows the type of disc used by the writer, but the shape is optional, and end cheeks from discarded coil formers, or any other thin Paxolin or Bakelite will serve equally well. The dimensions for Fig. 1 can also be left to the reader, though those shown have been found to be more than adequate to accommodate all the components associated with any valve. When the size and shape has been decided, they can be drilled in batches of about six at a time as shown.

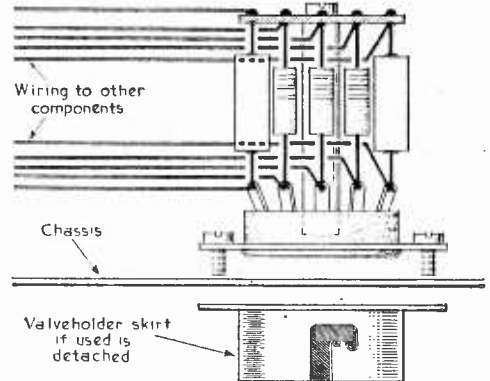

Fig. 4.—The valveholder extension in use.

top disc can be left off until all the components have been soldered to the valveholder pins.

When all components have been soldered to the valveholders, the free ends are slipped through the eyelets and the outgoing leads with them, the disc having been screwed in position. The reason for putting the outgoing wires in at this stage is that it is easier to put two or three wires if necessary through an eyelet before soldering, although there is nothing against making small loops in the component wires after they have been passed through the eyelets, and taking the wiring from these.

Record-player and Radiogram Faults

CAUSES AND CURES OF NOISE DISTORTION, WRONG SPEED, ETC.

By
L. E. Higgs

RADIOGRAMS can suffer from a number of troubles in addition to the usual radio receiver faults with symptoms peculiar to themselves. These defects are generally either pick-up faults or turntable faults.

Pick-up Faults—Hum

Hum is more pronounced on radiograms, when present because of the larger speakers fitted and the extra attention given to the audio circuit by the designer to increase bass response. The larger baffle area for the speaker also accentuates this. Never attempt to clear hum troubles on a gram chassis without the accompanying speaker connected and fitted in its cabinet. If this is not possible, then make sure that the bench speaker used is well baffled, because a low-level hum which is tolerable on a small speaker turns out to be overpowering when the chassis is fitted back in its cabinet.

Hum that occurs when the gram is switched to records, and is unaffected by the volume control, is residual and is introduced in the circuit after the volume control. Deteriorating smoothing capacitors and partial heater to cathode leaks in following audio valves are the most likely reasons.

Variation in hum level when the pick-up or motor board are handled denotes incorrect earthing. Check the earth connections under the board but do not add extra earths to chassis in the case of A.C./D.C. grams or the motor board might become live to mains. Some A.C./D.C. grams give less hum with the mains plug a certain way round in the supply socket (taking the chassis to neutral).

Pick-up Faults (Fig. 1)

Distortion on gram only, can be caused by the stylus or by the pick-up crystal itself. The stylus can be checked on rotating cartridges by reversing to the other stylus; if this gives undistorted results (on the correct speed record), then the other stylus is proved defective. In any case, it pays to replace worn styli before evidence of wear is audible. See that the stylus is properly located on the crystal transmission pad. Too often, through mishandling and heavy set-down on auto-changers, the stylus becomes dislodged and is found jammed between the cartridge side and pad (see Fig. 1). Debris picked up as dust should be cleaned periodically from the stylus.

Cracked Crystals

Good reproduction on radio but weak distorted

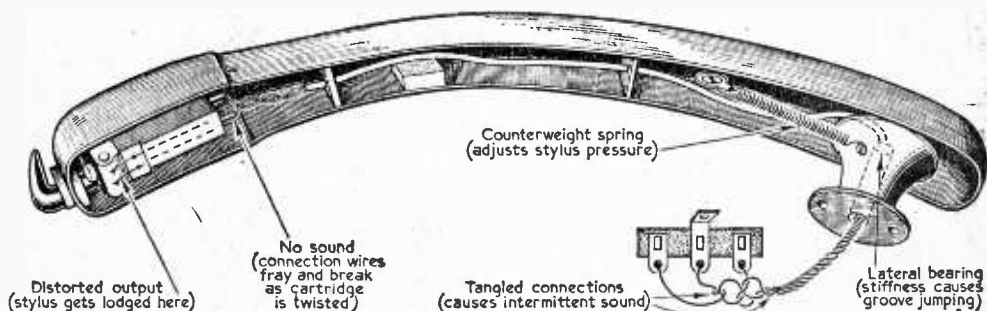

Fig. 1.—Typical faults which may develop in the pick-up arm.

Hum which reduces with the volume control setting on "gram" only nearly always originates from the pick-up. This can be checked by unplugging the pick-up leads from the chassis when the hum drops to a tolerable level. Check that the pick-up leads are not reversed—the screen should be earthed or connected to the chassis—this is a common trouble as many grams are not provided with polarised sockets and the plugs can be fitted the wrong way round by a novice without affecting the sound but causing hum.

sound from records is often due to a cracked crystal. This can be checked by unplugging the pick-up plugs from the chassis and fitting a crystal microphone or a substitute crystal pick-up from a portable record player. Good results from any of these shows the original crystal to be at fault. Crystal cartridges are fragile and can be fractured by careless handling—it is not generally known however that they are prone to failure with high temperature and portable mains radiograms with upper vents discharging heat into the space under

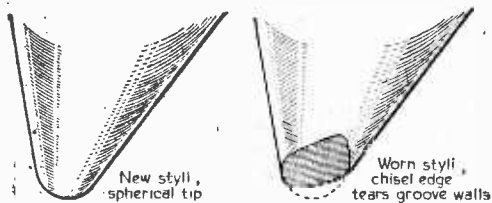
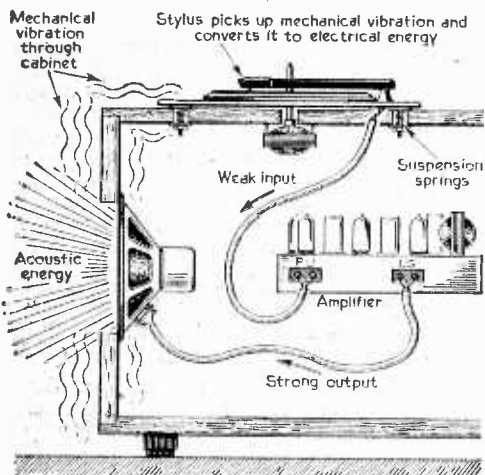

Fig. 2 (above).—The styli may become worn if the balance of the arm is maladjusted.

Fig. 3 (below).—Howling is caused by mechanical vibration being picked up and circulated by the acoustic feedback loop.



Microphony

Howling which commences when the volume is increased above a certain minimum (similar to amplifier acoustic feedback in a hall) is due to the cabinet conducting vibrations from the loudspeaker to the turntable and record where they are picked up by the stylus, amplified, and sent round the feedback loop again (see Fig. 3). This is usually a fault with home constructed equipment where the motor board is un sprung or badly fitted. A rigid cabinet with baffle bracing reduces mechanical vibration and raises volume at which the threshold of howl is reached. On manufacturers equipment this trouble is more often due to tight, unslackened, turntable transit screws.

Turntable Speed

The usual fault causing wow, slurring, and slowing of the record is not the turntable at all but the record slipping and skidding on its label with the one in contact with it (Fig. 4). This loss of friction can cause a warbling noticed on sustained high notes or severe slowing and at times stopping of the top record while the underside pile continue to rotate normally. The upper record when examined will be found to be saucer-shaped or to possess a small eruption on the label lifting the upper record clear of the main friction plane. A greasy or polished rim on the jockey wheel can cause the same effects but this time the turntable will be found to be turning slowly (Fig. 5). Check the pressure spring pulling the jockey wheel on to the pulley for reduced tension.

Permanent steady slow speed is most usually caused by engagement of the wrong pulley. The pulley bush can slip down the motor spindle if the grub screws loosen accidentally and with little flywheel momentum, wow or flutter may be present to iron it out.

(Continued on page 407)

the lid "cook" pick-ups if the gram is operated for an hour or two with the lid down.

One of the commonest troubles with turnover pick-up cartridges is the breaking off of the fine wire leads at the terminals on the cartridge due to the constant flexing with rotation. Do not solder direct to the terminals but remove the clips first and solder to them otherwise the heat may damage the crystal. This trouble is sometimes intermittent if the broken lead makes and breaks with vibration.

Insufficient pick-up weight can also cause cutting out of the sound owing to the stylus tip being held clear of the bottom of the groove. An adjustable lowering stop at the base of the pick-up can allow the stylus to drop lower, or if the arm is almost weightless, the counter balance spring also situated under the arm at the base can be slackened off one hole. Too much weight however causes excessive wear of records and styli (see Fig. 2).

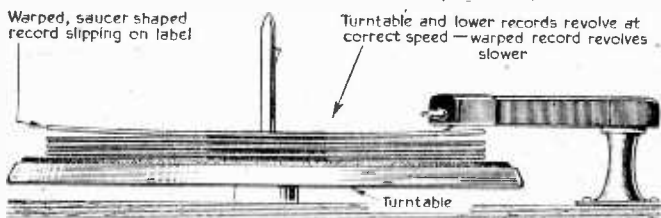
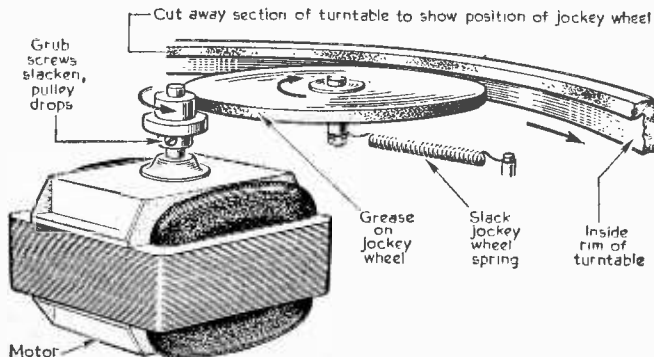

Fig. 4 (above).—Slow speed, slurring and wow, is usually caused by a warped record.

Fig. 5 (below).—Some of the causes of permanent slow speed.



LEARN ELECTRONICS! NOW!

RADIOSTRUCTOR and TECHNICAL PRESS

combine the **PRACTICAL WAY** with the
PICTURE BOOK WAY
for a complete answer to a real understanding
of this exciting subject!

INCLUDING

Radio : Electronics : Electricity : Television : Audio Eng. : Test Instruments
Transistors : Synchros & Servo Mechs : Radar.

THE EQUIPMENT comprises a full set of radio components and apparatus including a COMPLETE 8-VALVE MAINS AM and FM/VHF LUXURY RECEIVER on which all the practical work and servicing is carried out. A MULTI-RANGE TEST METER; SIGNAL GENERATOR and CATHODE RAY OSCILLOSCOPE are provided for use during the Course. Students advance step-by-step performing a whole series of experiments—with no complicated mathematics. Practical Manuals are provided showing in clear and simple language how each experiment is to be carried out.

THE MANUALS are radically different from anything hitherto published. The visual aid system is employed in such a manner as to make one's journey through the cartoon-type illustrated pages an exciting passage of easily assimilated steps of knowledge. The average scholar, the older student or the enthusiastic home-worker will find here the study of electricity and electronics a smooth and logical process; founded on the substantial basis of a thorough grasp of the electron theory.

RADIOTEC incorporating TECHNICAL PRESS LTD. & RADIOSTRUCTOR

**FREE
PROSPECTUS**



POST COUPON NOW!

TO
RADIOTEC (DEPT. R.T.3), 40 RUSSELL ST., READING, BERKS.

Please send full details of your Programme.

I AM INTERESTED IN: **THE BOOKS OF THEORY ONLY**
PRACTICAL EQUIPMENT ONLY
THE COMPLETE COURSE

(Please tick in space shown)

NAME _____

ADDRESS _____

DATE _____

LASKY'S RADIO

REBUILDING SALE!

SAVE ON COMPONENTS !!!

We shall shortly be moving from 42 Tottenham Court Road to larger premises at No. 33 (ten doors away). To speed up the work of transferring stocks we are now holding a Special Sale of hundreds of Components, Transformers, Speakers, Cabinets, etc., etc., at clearance prices. **CALLERS ONLY.** Come and get some fine bargains!

TRANSISTOR RECORD PLAYER

CAN BE BUILT FOR **£9.19.6** Carr. free

5 v. operation. For all L.P. and standard records. All components available separately.

AMPLIFIER. 300 milliwatts push-pull output, using two OC71 and two OC72 transistors. Fully assembled. 79/6. Knobs, 3/6 extra.

LOUDSPEAKER. 30 ohms, 7 x 4 in. elliptical, matched to Amplifier, 25/-, 3-SPEED TURNABLE. 8 v., complete with t.o. crystal cartridge and two saddle wire, 79/6.

CARRYING CASE, smart two-tone finish. 17 x 14 x 5 1/2 in. High. 49/6. Batteries extra.

GREAT HALF-PRICE OFFER!



THE "WALTER" MAINS/BATTERY FULLY TRANSISTORISED TAPE RECORDER

Uses 7 transistors and operates anywhere, either on three PP9 batteries or mains 100/250-V. 50 cycles. Twin track, uses 5 1/2 in. reels, giving 3 hours playing time on double play tape. 24 watts output. 2 inputs for extension speaker and external amplifier. Single master control, magic eye level indicator, etc., etc. Full size: 14 x 13 1/2 x 5 1/2 in. overall. Smart black/grey finish, detachable H.d. carrying handle. New in maker's cartons. Fully guaranteed.

LISTED AT £57.15.0

LASKY'S PRICE

INCLUDING MIKE, REEL OF TAPE AND EMPTY SPOOL

27 GNS.

Carr. & Ins., 15/-. Batteries extra, 3/- each.

"SUPER 60" 6-TRANSISTOR S/H/T TRANSPORTABLE

CAN BE BUILT FOR **£9.15.0** Post 4/6.

Uses 6 Mullard matched transistors, including two OC31 in push-pull. Plus 1 diode, 1-watt undistorted output. I.F. 470 Kcs. Medium waves. Ferrite rod aerial, high flux 2 x 4 in. Speaker, Walnut veneer finish Cabinet. 18 x 13 1/2 x 5 in. Circuit diagram and full data supplied.

LASKY'S CAR RADIO 12 v. operation. Transistor output, Medium and long waves. Can be built complete with Speaker for **£9.18.6**, post 3/6. Booklet 2/6 (refunded if you order).

207 EDGWARE ROAD, LONDON, W.2.
Near Praed St. PADDINGTON 3271/2

The "CLARION" Transistor Battery Tape Recorder. Capstan drive, push-button controls. Speed 3 I.P.s., uses 3 in. spools. High impact plastic case with transparent upper. Size: 9 1/2 x 5 x 5 1/2 in. List 25 Gns.
LASKY'S PRICE, with Mike and Tape. Carr. 7/6. 16 1/2 Gns.

THE "SHERWIN SIX" TRANSISTOR POCKET SUPERNET

Uses 6 matched top-grade S.T.C. transistors and germanium diode. Push-pull output. 3 in. P.M. Speaker. Covers med/long waves. Size: 6 1/2 x 4 1/2 in. Full details on request.

CAN BE BUILT FOR **£8.19.6**
Circuit etc., 2/6. (Refunded if you order.)

33 TOTTENHAM COURT ROAD, W.1.
Nearest Stn. Goodge St. MUSEUM 6667

BOTH OPEN ALL DAY SAT. Early Closing Thurs. Mail Orders in D-plt. P.W., Edgware Road.

VALVES SAME DAY SERVICE!

SETS IR5, IS5, IT4, 3S4, 3V4, DAF91, DF91, DE91, DL92, DL64 .. Set 4 for 19/6
DAF96, DF96, DE96, DL66 .. 4 for 27/6
6K7G, 6K8G, 6Q7G, 6V6G, 6X5G, 6Y3G .. 5 for 24/6

| | | | | | |
|------------|-------------|-------------|------------|------------|------------|
| 1A7GT 11/8 | 6P1 13/6 | 35A5 14/- | ECC82 6/3 | EZ81 7/- | U24 17/6 |
| 1D5 18/- | 6P25 9/- | 35L6GT 9/- | ECC83 7/- | FW4500 8/- | U25 13/- |
| 1R8GT 10/- | 6Q7G 6/- | 35Z4GT 8/6 | ECC84 8/6 | G233 8/6 | U26 10/- |
| 1NSGT 10/- | 6Q7GT 9/6 | 35Z5GT 8/6 | ECC85 8/3 | G232 9/6 | U50 6/- |
| 1R5 5/6 | 6SL7GT 6/3 | 50L6GT 8/9 | ECC86 8/6 | KT38C 7/- | U52 4/6 |
| 1S4 8/- | 6SN7GT 4/9 | AC/TH1 18/9 | ECC82 8/6 | KT41 11/6 | U78 4/6 |
| 1S5 5/3 | 6U9GT 11/- | A231 9/6 | ECH21 13/6 | KT44 8/6 | UABC80 7/9 |
| 1T4 3/6 | 6V6G 5/- | B36 8/6 | ECH35 6/3 | KT81 8/6 | UAF42 9/- |
| 1U5 5/3 | 6V8GT 6/6 | CL33 12/3 | ECH42 8/9 | KT83 8/6 | UB41 6/6 |
| 3A5 9/- | 6X4 4/9 | DAC32 10/0 | ECH81 8/- | MU14 7/6 | UBC41 7/6 |
| 3Q4 7/6 | 6X5GT 5/0 | DAF91 5/3 | ECL20 7/6 | MX40 9/6 | UBF90 8/9 |
| 3S4 6/- | 7B5 9/- | DAF96 7/6 | ECL52 9/6 | N15 7/- | UBF99 8/- |
| 3V4 7/- | 7B7 7/6 | DC90 9/- | EF39 3/6 | PC35 10/- | UC2 12/6 |
| 5U4G 4/6 | 7C3 7/6 | DF31 9/6 | EF40 12/6 | PC84 7/6 | UCC84 12/6 |
| 5V4G 8/- | 7C6 7/6 | DF91 3/6 | EF41 8/3 | PC89 11/- | UCC85 7/6 |
| 5Y3GT 6/- | 7H7 7/6 | DE96 7/6 | EF42 9/6 | PCF80 7/9 | UCF80 14/- |
| 5Z4G 7/6 | 7S7 9/- | DH75 4/9 | EF80 5/6 | PCF82 8/- | UCH21 13/6 |
| 6A5 3/6 | 7A 7/4 | DE96 6/9 | EF85 5/6 | PCF88 14/- | UCH42 8/9 |
| 6AM5 7/6 | 10C2 17/6 | DK32 11/8 | EF86 9/9 | PCL82 9/- | UF85 8/6 |
| 6AQ5 3/6 | 10P13 14/6 | DK91 5/6 | EF89 7/- | PCL83 11/6 | UCL82 10/0 |
| 6AT5 6/9 | 12AT6 7/6 | DK92 7/6 | BF91 3/6 | PLC84 7/6 | UCL83 13/3 |
| 6BA5 6/9 | 12AT7 5/- | DK96 7/6 | EF92 4/3 | PEN44 13/6 | UF41 8/6 |
| 6BE5 6/9 | 12AU7 6/3 | DL33 9/- | EF133 14/- | PEN45 11/6 | UF42 5/9 |
| 6BH6 5/9 | 12AX7 7/- | DL35 9/6 | EL33 10/- | PEN36C 8/- | UF85 8/6 |
| 6BJ6 5/9 | 12K7GT 5/3 | DL92 6/- | EL41 8/6 | PL36 11/6 | UF89 7/- |
| 6BW6 8/- | 12K8GT 11/6 | DL94 7/- | EL42 9/- | PLd1 9/6 | UL41 4/6 |
| 6CD6G 26/9 | 12Q7GT 4/9 | DL96 6/9 | EL84 7/- | PL32 7/- | UL44 7/6 |
| 6F1 13/6 | 12Z3 7/6 | EABC90 7/6 | EM34 6/9 | PL33 7/6 | UR10 8/- |
| 6F6G 6/6 | 14S7 18/6 | EAF42 8/6 | EM80 8/6 | PL41 10/- | UR11 8/- |
| 6F13 11/- | 20F2 17/6 | EB91 3/9 | EM81 8/6 | PY32 11/- | UY21 13/6 |
| 6F14 18/6 | 20L1 17/6 | EBC33 5/- | EM84 10/- | PY80 7/6 | UY41 6/6 |
| 6E7G 2/6 | 25A6 8/- | EBC41 8/- | EY1 7/6 | PY81 6/9 | UY85 6/6 |
| 6E7GT 6/6 | 25L6GT 7/9 | EBF90 8/6 | EY94 10/- | PY82 6/6 | VF4B 9/6 |
| 6K8G 6/3 | 25Z4G 7/6 | EF89 8/9 | EY86 7/9 | PY83 7/9 | VP41 5/- |
| 6K8GT 9/3 | 25Z6GT 9/6 | EL21 13/6 | EZ40 6/9 | PZ30 17/- | W76 5/6 |
| 6L8 10/3 | 30L15 11/- | ECC40 15/- | EZ41 7/- | T41 9/6 | W77 4/3 |
| 6LD20 8/- | 30P12 7/- | ECC81 5/- | EZ80 8/3 | U22 7/6 | Z77 3/6 |

READERS RADIO
24 COLBERG PLACE, STAMFORD HILL,
LONDON, N.16. STA. 4587

7th NEW EDITION RADIO VALVE DATA

Characteristics of 4,800 valves & transistors, rectifiers & cathode ray tubes.
Compiled by staff of "V.W.V."
6/- Postage 10d.

- THE RADIO AMATEUR'S HANDBOOK, by A.R.K.L. 1961. 32/6. Postage 2/-.
- TELECOMMUNICATIONS. Principles & Practice, by W. T. Perkins. 21/-. Postage 9d.
- SHORT WAVE RECEIVER FOR THE BEGINNER. Data Pub: 6/- Postage 6d.
- PRACTICAL AUTO RADIO, SERVICE & INSTALLATION. By J. Greenfield. 23/-. Postage 9d.
- RADIO-CONTROLLED MODELS. by F. J. Camm. 12/6. Postage 9d.
- BASIC MATHEMATICS FOR THE RADIO & ELECTRONICS, by F. M. Colebrook. 17/6. Postage 9d.
- BEGINNER'S GUIDE TO RADIO by F. J. Camm. 7/6. Postage 6d.
- COMPLETE CATALOGUE. 1/-. Postage 6d.

THE MODERN BOOK CO.
BRITAIN'S LARGEST STOCKISTS
of British and American Technical Books
19-21 PRAED STREET
LONDON, W.2
Phone: PADDington 4185
Open 6 days 9-6 p.m.

An Intercom Amplifier

By V. E. Holley

THIS AMPLIFIER WILL GIVE RELIABLE SERVICE AS A GENERAL COMMUNICATIONS UNIT.

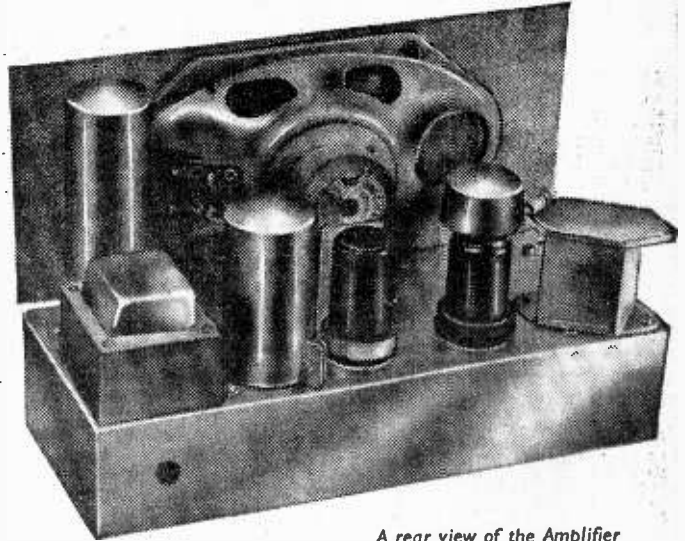

A rear view of the Amplifier

THIS amplifier is designed for the reproduction of speech and it will give long and reliable service as an intercom, baby alarm, etc. Power consumption and heat generation are both very low and it is therefore especially suitable for continuous duty over long periods. The prototype has been in service for more than 3000 hours without valve replacement or deterioration in performance.

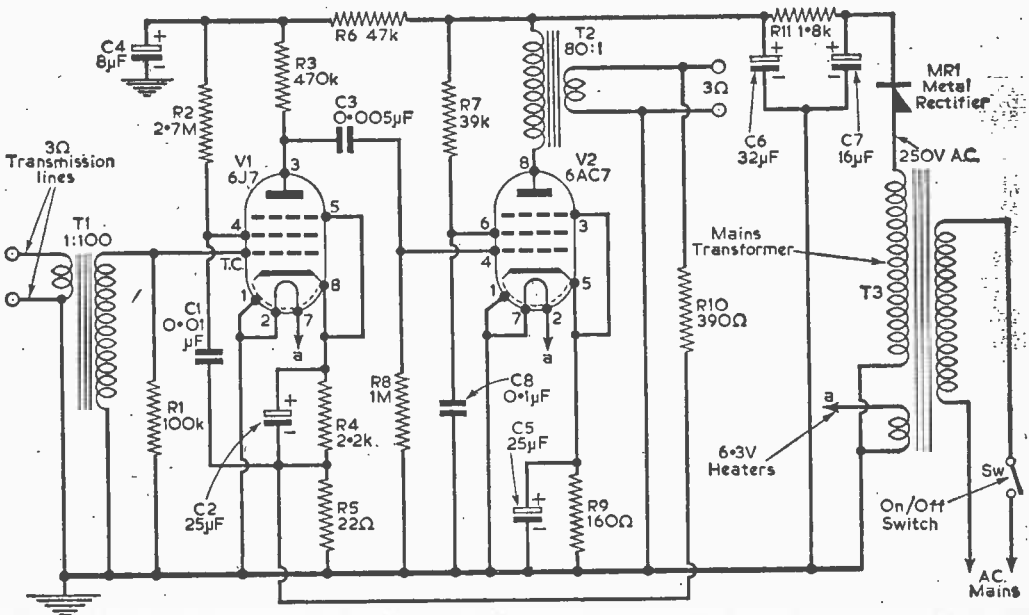

Fig. 1. The circuit diagram.

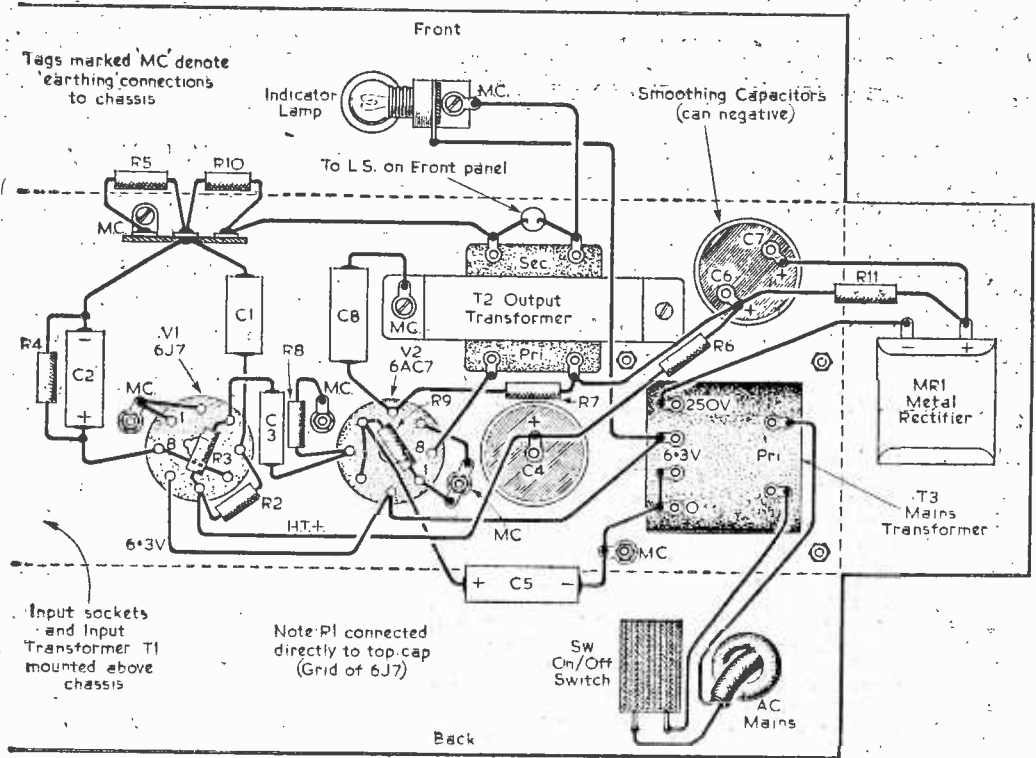

Fig. 2.—Details of the underchassis wiring.

Output Stage

This stage uses a high gain pentode, 6AC7, in the circuit given in Fig. 1. Though not properly an output valve, the 6AC7 performs that function very well, with an output approaching one watt for a signal of about 2V peak on the grid. The output transformer in the anode circuit should have a ratio of 80 or 90:1 for a 3Ω loudspeaker. Both cathode and screen resistors are bypassed for maximum gain.

Voltage Amplifier

The signal required by the output stage is derived from the anode circuit of V1, a resistance

coupled A.F. pentode (6J7). The coupling capacitor, C3, is given a value of 0.005μF to introduce some attenuation of the lower audio frequencies which is desirable for clean crisp speech. With anode and screen loads of 470k and 2.7M respectively, and a cathode bias resistor of 2.2k the gain of the stage is 180 and the upper frequency limit is around 5000c/s. In the grid circuit is a microphone transformer, T1, having a step-up ratio of 1:100, so that the external lines can be at low impedance and therefore less susceptible to hum pick-up. The screen of V1 is decoupled to the junction of R4 and R5. This avoids degeneration and loss of gain which R5 would introduce if the decoupling were to chassis.

Negative Feedback

The overall gain of the two stages is more than is required and is reduced by negative feedback taken from the output transformer secondary to the junction of R4 and R5 in the cathode circuit of V1. The feedback, and, therefore, the gain, can be adjusted as necessary by varying the value of R10, in the range 220 to 1000Ω and if the gain cannot be reduced to the desired working level, a further reduction can be effected by removing C5.

With equipment of this sort it is found that if the gain is fixed and constant, the user rapidly becomes accustomed to it so that the results are always consistent; it might be compared in this respect with a telephone. No external gain control is therefore provided.

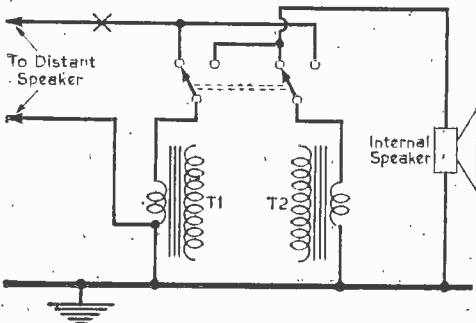

Fig. 3.—The "talk-listen" switch circuit.

Power Supply

The H.T. required is 14mA at 250-300V and the total heater current including the indicator lamp, is a little less than 1A. A miniature mains transformer of the instrument of television convertor type is used, together with a half-wave, contact-cooled, rectifier. The power consumption from 240V mains is less than 15W.

The resistor R11, and the capacitors C6 and C7, provide the main smoothing, supplemented by R6 and C4 for the supply to V1. It must be mentioned that the elimination of hum requires rather special attention. A background hum which would pass unnoticed in a domestic radio receiver can be prominent and objectionable in apparatus where the sound output is normally zero, especially in quiet surroundings. In this amplifier, adequate smoothing and negative feedback give a silent background.

Construction

Fig. 4 gives a plan of the chassis on which the prototype was built. It is not essential to adhere to this, but, whatever layout is adopted, it must be arranged that there is a distance of not less than about 6in. between the mains and input transformers and that the magnetic axes of the mains and output transformers are at right angles. The output transformer also, must not be less than about 4in. from the input transformer and the latter should not be bolted to the chassis until after it has been wired up and orientated to the position of minimum hum pick-up—this position is usually quite critical. A wiring diagram is

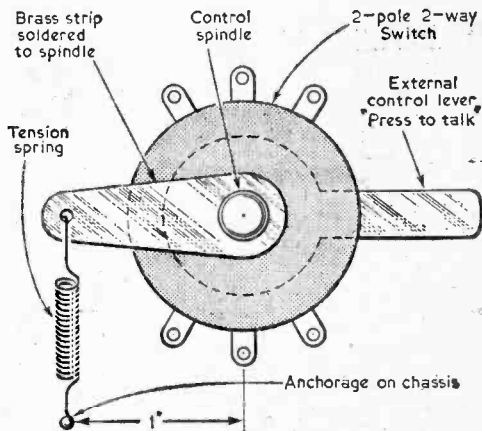

Fig. 5.—The construction of the "talk-listen" switch.

ner in two places and the speaker is supported at the rear by a light aluminium bracket.

Components

All the capacitors except C2 and C5 should be 350VW as they have to withstand the full H.T. voltage from the rectifier while the valve cathodes are warming up. The resistors can all be 1/2W except R11, which should be 1W. R9, which has a non-standard value of 160Ω is easily found by

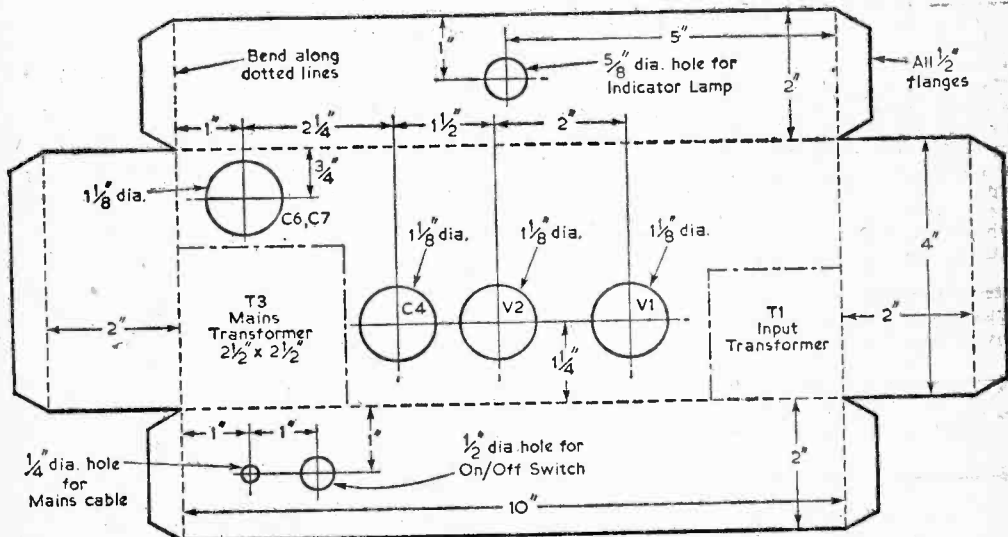

Fig. 4.—The drilling dimensions for the chassis.

given in Fig. 2. It is convenient to omit the connection between the output transformer and R10 until the test stage is reached.

The speaker in the prototype is a 7in. x 4in. elliptical unit mounted on a piece of hardboard 10in. x 6 1/2in. in which a suitable aperture has been cut. The board is bolted to the chassis run-

measurement from a batch of 150Ω components of usual tolerance. V1 may be a 6J7, 6K7, 6SJ7, 6SK7, or any direct equivalent, without alteration of component values and with very little difference in performance, though the use of a valve with a top grid cap and a metal body is recommended.

(Continued on page 414)

Ferrite Rod Aerial Conversion

By C. Fletcher

CONVERTING A TRF SET TO A RECEIVER USING A FERRITE AERIAL AND ONE STAGE OF TUNING

THIS article describes a method of converting a simple TRF receiver using a tuned R.F. stage with air-cored coils, to a receiver with a ferrite rod aerial and only one stage of tuning.

The conversion was carried out on a miniature three valve mains receiver during the course of a complete overhaul, the valve line-up being three Z77's used as the R.F. stage, the A.F. amplifier and the output valves (plus a crystal diode detector). The main advantage of the conversion was the elimination of the inconvenience of having to

ventional and the valve drew an anode current of about 9mA. The values of inductance against the secondaries of the coils refer to the medium-wave sections of the windings only.

Choice of New Circuit

On looking at Fig. 1 it might be thought that the simplest thing to do would be to wind a coil on a ferrite rod, with inductances the same as for the air-cored secondaries, and wire it in the grid circuit, leaving the rest of the circuit unaltered. However, such a solution is neither necessary nor practical. It is not necessary since with two similar cascaded tuned circuits, as are present in Fig. 1, the effective Q of the combination is approximately double that of the Q of one circuit considered separately; hence with a Q of 60 for each circuit the overall Q is about 120. With a ferrite rod aerial it is quite easy to construct a coil with a medium wave Q of several hundreds — in fact the aerial constructed by the writer had a measured Q of 300 at 1.5Mc/s. Hence, it is

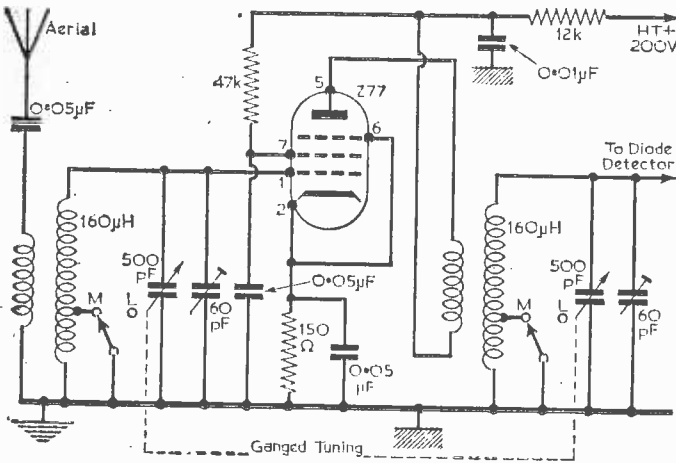

Fig. 1.—The R.F. stage of the receiver.

provide even a short length of aerial wire when the set was transported from room to room. A further, although not so obvious, advantage was the elimination of the anode tuning of the R.F. stage. This meant a very simple alignment procedure. This second advantage was gained because of the extremely high unloaded "Q" of the Ferrite rod aerial.

The circuit of the R.F. stage of the receiver was as shown in Fig. 1. The circuit was quite con-

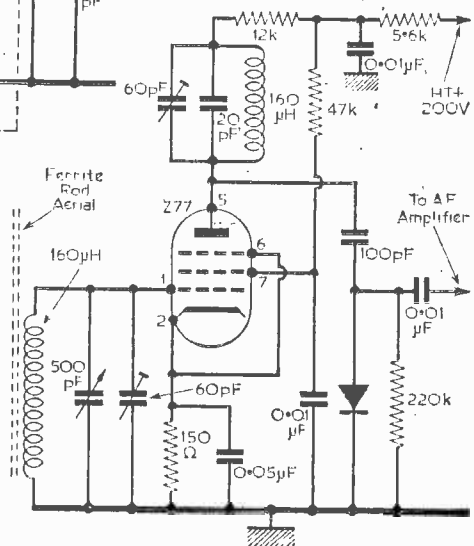
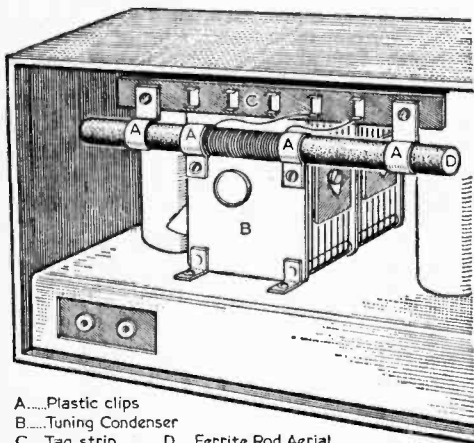

Fig. 2.—The circuit of Fig. 1 with the alterations necessary for the use of a ferrite aerial; the resistor previously used for anode decoupling is now employed as the anode load.

unnecessary to increase the effective Q of the R.F. stage by employing anode tuning.

It is not practical to tune the anode of the R.F. stage since, with most double-tuned TRF receivers, the anode and grid coils are not separately screened, but merely screened from one another by being placed one above and one below the chassis. With a high Q grid coil it is extremely difficult, without special precautions in layout and screening, to ensure that positive, uncontrolled, feedback does not take place. Since this was a conversion, the layout had been already fixed and the slight increase in selectivity which would be obtained did not justify extensive modifications to the existing layout.

The circuit so far described is an R.F. stage with grid tuning only. A further simplification made in the writer's set was to restrict the tuning to medium-waves only. This was decided since the set was mainly intended for domestic listening and the only station normally required on long waves was the BBC Light Programme. Since this is easily obtainable, in the writer's location, on medium waves, the inclusion of long waves was not considered justified. In order to use all the control positions of the set, the hole previously used by the wave-change switch was used for the "on-off" switch and a volume control without a switch was employed.



A.....Plastic clips
B.....Tuning Condenser
C.....Tag strip D.....Ferrite Rod Aerial

Fig. 3.—A suitable method of mounting the aerial.

A difficulty which arises on medium waves (without a tuned anode circuit), particularly at the high frequency end of the band, is due to the stray capacities appearing across the anode load of the R.F. stage. The effect of such capacities is to shunt the anode load and so reduce the gain of the stage. This is unfortunate, particularly if it is required to receive Radio Luxembourg since this station is fairly elusive anyway. However, the difficulty can be easily overcome by employing the anode coil (previously tuned by the variable condenser) in series with a resistive anode load, and peaking this coil on about 1.5Mc/s by means of its trimmer. Hence, instead of the gain falling at the H.F. end of the band, it can be made to rise and then fall away sharply. No difficulty was experienced with unwanted feedback since the

fixed anode tuned circuit is quite isolated from the variable grid tuned circuit, and no long grid and anode leads need to be adjacent. With a coil inductance of $160\mu\text{H}$, to tune to 1.5Mc/s, the preset tuning condenser must have a value of at least 60pF; this assumes a stray capacity of 10pF. In order to be sure of satisfying this condition a fixed condenser of 20pF was added in parallel with the 60pF trimmer already available. The circuit arrived at from the above considerations is shown at Fig. 2. It can be seen that the resistor previously used for anode decoupling is now employed as the anode load.

The aerial coil was wound on a piece of $\frac{1}{4}$ in. \times $6\frac{1}{2}$ in. ferrite rod, 52 turns being required for an inductance of $160\mu\text{H}$. In order to achieve the high Q necessary the coil was wound with Litz wire. A suggested method of mounting the aerial is indicated by Fig. 3.

Since the coil was wound with Litz wire, care had to be taken to be certain that each strand of wire was soldered on to the tags. An extremely satisfactory way of cleaning the ends of the Litz wire is given as follows. A small tin lid is filled with "meths" and the "meths" is ignited: the end of the Litz wire is first placed in the blue flame. The wire is held here for a few seconds allowing the cotton to burn off, and the copper to become red hot. The wire is then plunged into the "meths" and then immediately withdrawn over the side of the tin lid. If the method has been carried out correctly, each strand of the Litz wire will be perfectly clean and show the characteristic pink colour of un-oxidised copper. As soon as the wire has been withdrawn from the "meths" it should be tinned.

The receiver should first be tuned to a station at the L.F. end of the dial, and the aerial trimmer and tuning condenser adjusted until the station coincides with its marked position on the dial. The set is then tuned to the required H.F. station at which the anode tuned circuit is to be peaked (e.g. Radio Luxembourg) and the anode trimmer adjusted for maximum volume.

Record-player and Radiogram Faults

(Continued from page 400)

Generally quiet passages or sustained notes show up this effect which is heard as a flutter or gnawing sound. It may be due to a fault in the rotor causing uneven pull, or to a flat on the drive pulley.

Groove Jumping

Microgroove records in good condition that exhibit this trouble at any random place across the record point to excessive lateral stiffness of the pick-up arm. See that the pick-up screened wire is flexing freely without resistance and that the central bearing holding the arm is lightly lubricated.

Groove jumping that takes place always near the end of the record is often caused by the trip mechanism becoming stiff. When examining this small, lightly riveted pawl, under the turntable do not oil it. Clean it and exercise it with a few twists with the fingers to clear any chemical corrosion that can increase friction but to oil it will only attract the dirt and dust and cause the same trouble later.

A WOB

for

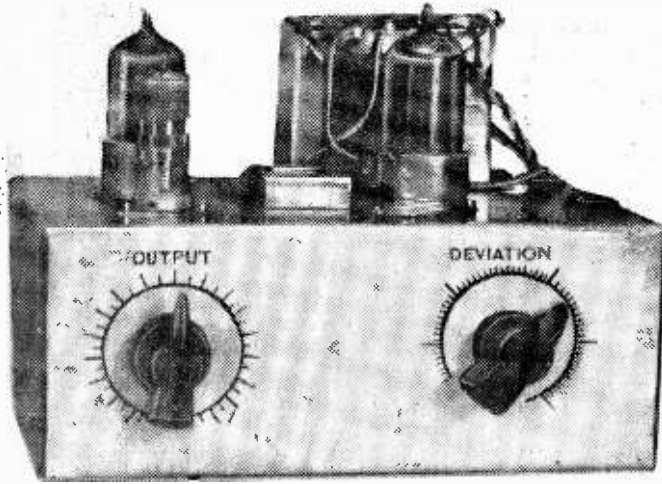

Of course, the characteristic of an I.F. amplifier may be plotted on graph paper by using an accurately calibrated signal generator in conjunction with a meter. Unmodulated signals are fed into the I.F. amplifier at various frequencies, and the output voltages are noted for each. A curve may then be drawn showing output voltage against frequency; a similar procedure may be adopted with the discriminator. However, should the curves have the wrong shape, then when steps have been taken to correct them, another set of curves must be drawn. This alignment procedure is obviously not one to be recommended for the amateur.

What is needed is a visual display of the various characteristics without the necessity of drawing graphs. The instrument for this display is the oscilloscope—as in the graphs which may be drawn, the x-axis is used to represent frequency and the y-axis to represent the output voltages. In

RECEIVERS for the BBC's F.M. service have always presented difficulties of alignment for the amateur. The usual methods employ an A.M. signal generator and a sensitive voltmeter. In such a method, the generator is connected between the chassis and the input of the receiver's I.F. amplifier, and the meter between the chassis and the grid of the limiter valve. The cores of the I.F. transformers are adjusted for maximum readings on the meter. The meter is then moved to the discriminator stage and the alignment completed.

use, a frequency-modulated signal is applied to the I.F. amplifier and the output of the amplifier is fed to the Y-plates of the oscilloscope to deflect the spot vertically. Horizontal deflection of the spot is obtained in the usual way by using the internal timebase of the oscilloscope. If the frequency modulation of the input signal is synchronised with the timebase of the oscilloscope, then a trace will

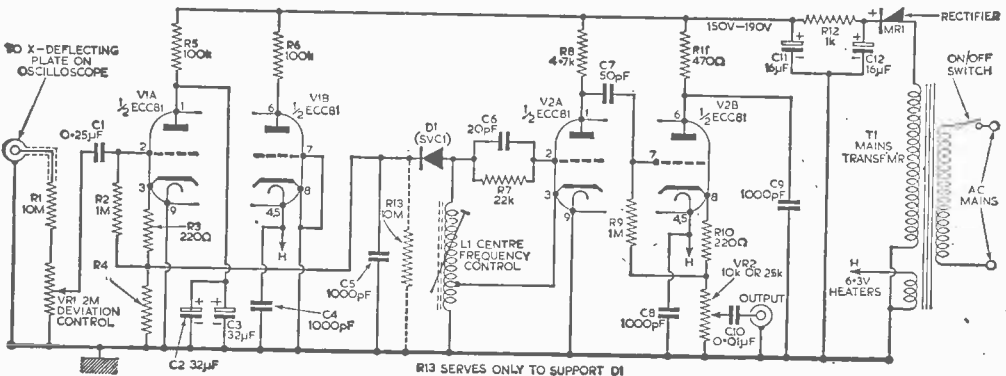

Fig. 1.—The circuit of the wobulator. Note: the value of the resistor R4 is 6-8k.

Whilst this procedure is satisfactory for approximate alignment, it is not always good enough, as I.F. amplifiers in F.M. receivers need to have a certain bandwidth if the signal from the transmitter is to retain its high fidelity. The discriminator especially needs to be aligned accurately so that its characteristic is linear if distortion is not to be heard in the output of the receiver.

use, a frequency-modulated signal is applied to the I.F. amplifier and the output of the amplifier is fed to the Y-plates of the oscilloscope to deflect the spot vertically. Horizontal deflection of the spot is obtained in the usual way by using the internal timebase of the oscilloscope. If the frequency modulation of the input signal is synchronised with the timebase of the oscilloscope, then a trace will

BULATOR

V.M. I.F. Alignment

VISUAL DISPLAY OF I.F. AMPLIFIER AND
DISCRIMINATOR CHARACTERISTICS

By R. E. F. Street

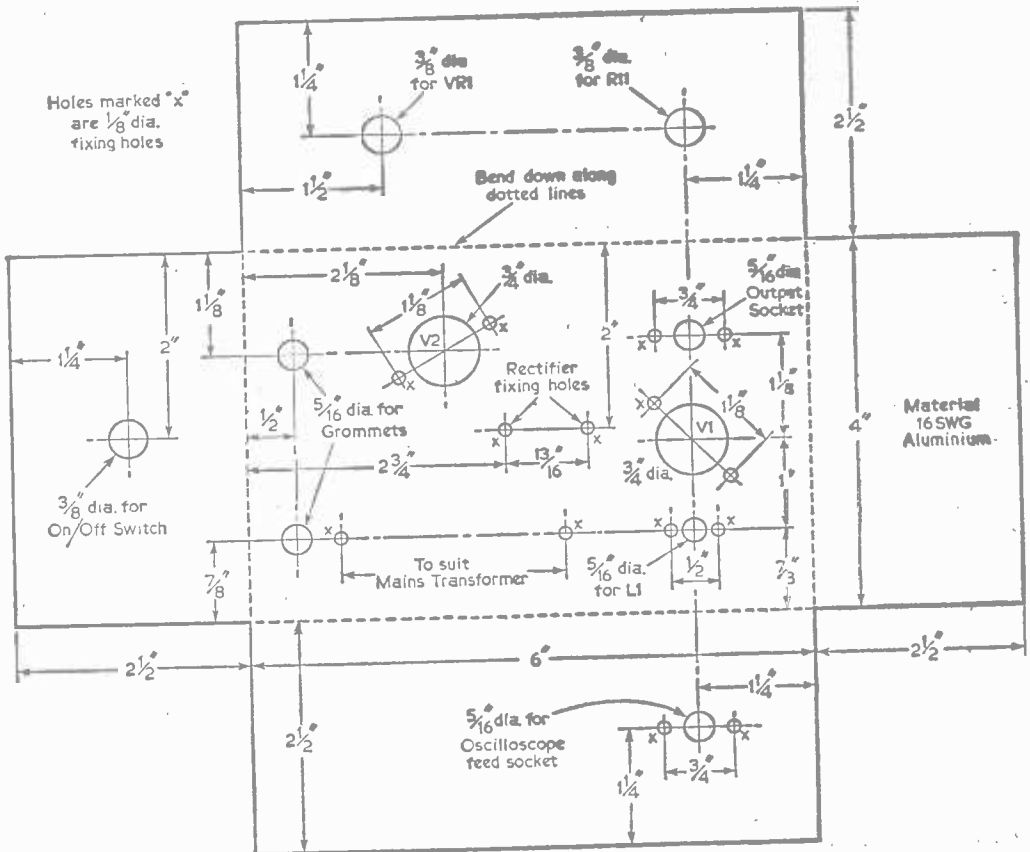
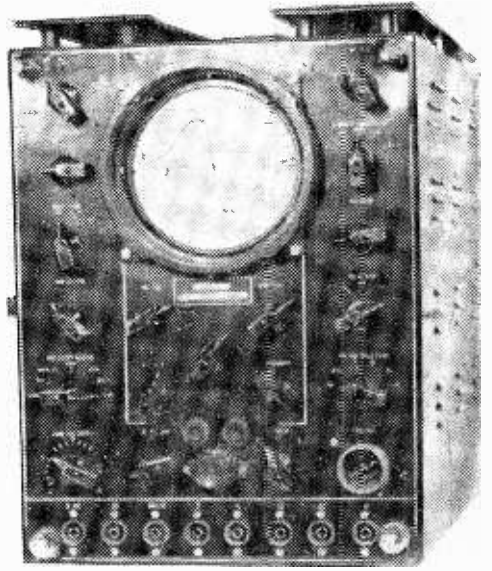

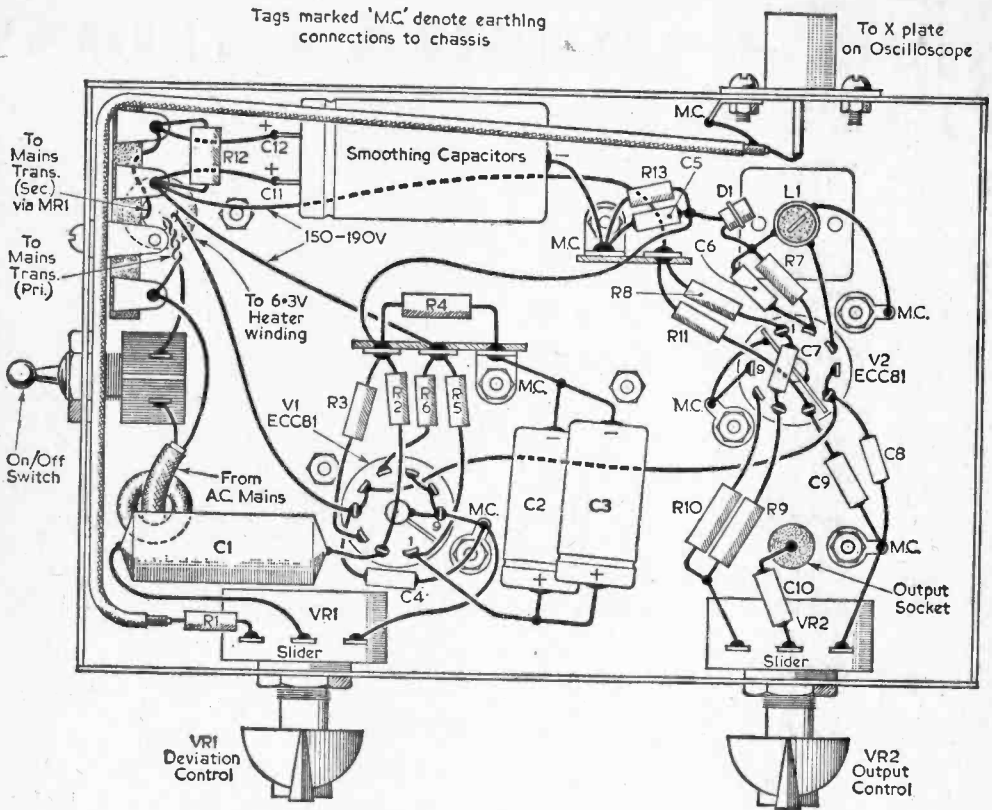

Fig. 3.—The underchassis wiring and component layout.

be formed on the face of the tube which represents the amplifier characteristic.

The Principle of Operation

In this instrument, a signal is generated at a frequency of 10.7Mc/s—the optimum F.M. I.F.—and this signal is frequency-modulated by a signal derived from the timebase of the oscilloscope. Early methods of obtaining frequency-modulation employed variation of the inductance of the oscillator producing the 10.7Mc/s signal, or the use of a reactance valve circuit, which acted as a voltage-dependent capacitor across the tuned circuit of the oscillator. However, the circuit used in this unit employs a silicon-junction diode as a voltage-dependent capacitor. When such a diode is biased in its reverse direction, a “depletion” layer is formed which acts as a dielectric of a capacitor formed by the two halves of the diode. The width of this layer, and thus the capacity of the junction, may be varied by altering the reverse bias across the diode. This is the principle of operation of the unit described.

It might be thought that the use of the 50c/s mains voltage as a modulating source would make for a simple instrument, but using such a high sweep frequency would give a misleading set of curves—the tuned circuits would not have time to respond to the rapidly changing frequency of the input signal.

(Continued on page 430)

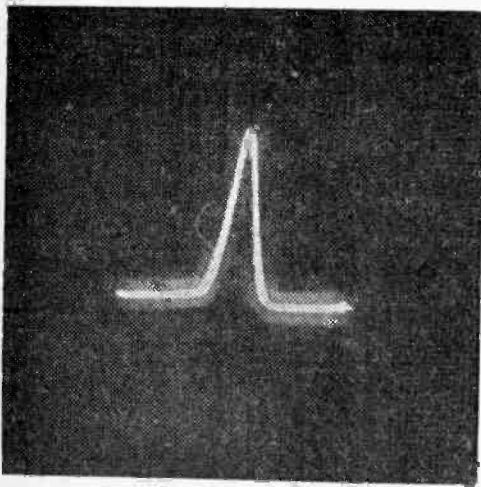

I.F. response of an F.M. receiver at limiter grid.

ADDING COMMUNICATIONS FEATURES

(Continued from page 342 of the August issue)

By F. G. Rayer

GOOD results can be obtained with the older type of valve, such as those with octal bases, and many highly valued communications receivers have such valves. But when a receiver is being modified, or stages are to be added, it may be worth while using modern miniature valves, which will save space, and in some cases may give improved results.

Value of Modifications

If octal valves are to hand, or already fitted, it will not be worth while to replace these by miniature valves, in some stages. This particularly applies to audio amplifiers. Even in earlier stages, an anticipated improvement from substituting an old type valve by one with higher gain may scarcely be realised. This is because gain will almost always be reduced to some extent by the AVC circuit, so that the extra gain of the newer valve is not used.

It is in the early stage or stages in particular (e.g. R.F. amplifiers, and mixer or frequency changer) that modern valves with a lower noise level can best be used. Even here, it must be remembered that the noise level referred to is that

CHOICE OF VALVES AND STAGES

such as the 6K7 (or equivalents CV1941, CV1943, FF39, OM6, W63 etc.) in R.F. and I.F. stages. That such receivers are still in regular use indicates that these valves can give good results. With them will often be found the 6K8, 6Q7, 6H6, 6V6, and similar octal valves.

Receivers of later design tend to use more modern valves, such as the 6SG7, 6BA6, UAF42, 6BJ6, etc., in R.F. and I.F. stages. Frequency-changers, converters, mixers and oscillators are also of more modern type, such as 6U8, UCH42, 6A18, 6A1H6, 6C4, etc.

In later stages, miniature valves are also generally used, but some of these are equivalents of octal types, and are only fitted to save space and give uniformity. For example, a 6BW6 may be used instead of a 6V6, and except for being a miniature, is identical, for audio purposes.

To obtain best results with the modern valve types, some resistor values may require changing. The circuits given here, and in other articles in this series, may be used with either octal or miniature valves. When adapting and improving a receiver, it should be remembered that a double valve can often be introduced, to perform more than one function. For example, a twin triode may act as A.F. amplifier and BFO. Or such a valve could be used for a 100kc/s crystal marker, and audio or other purposes.

R.F. Stage

Suitable values for a 6BJ6 are shown in Fig. 1. C1 and C2 are sections of the usual gang tuning condenser. This valve is economical, and can give very good results. A 6K7 may be used if the bias resistor is changed to about 220Ω. The high slope 6BA6 is also employed in this stage in high quality receivers, and should have a 33k screen grid resistor, and 68Ω bias resistor. Its heater current is twice that of the 6BJ6, but its gain is higher.

The usual popular type of super-het has no R.F. gain control, and one should certainly be introduced when improving the receiver. One method of doing this is shown in Fig. 13, where the 25k potentiometer is panel mounted, and acts as R.F. gain control. The most suitable value depends to some extent on the valve and H.T. voltage, and may be from about

5k to 50k. If the value is too small, volume will be too great, even at minimum setting. But a very large value will give abrupt control of volume. A value of about 20k can thus often be fitted. The fixed resistor from cathode to H.T. positive (100k in Fig. 13) helps to give more uniform control.

If a receiver of fairly simple type is in view, quite good results are possible on the lower

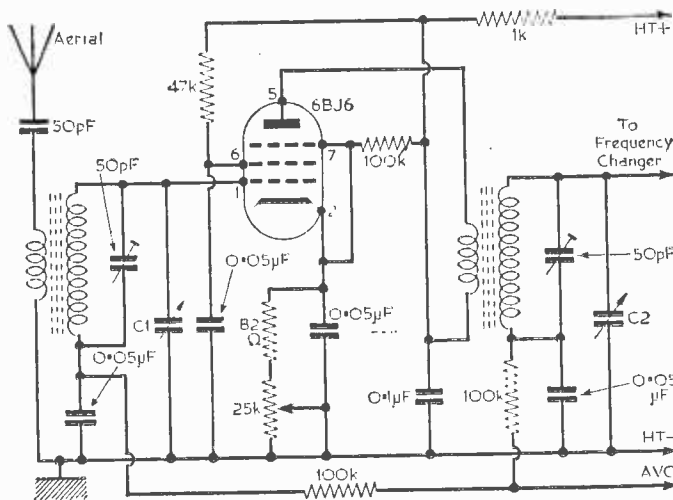

Fig. 13.—This circuit shows a 6BJ6 R.F. stage.

generated inside the set, and not that picked up by the aerial from external sources, which will often predominate.

The valve types favoured in commercially built communications receivers are a good guide to those which may be used when adapting or building a receiver. Many reputable communications receivers of older type, still in use, employ valves

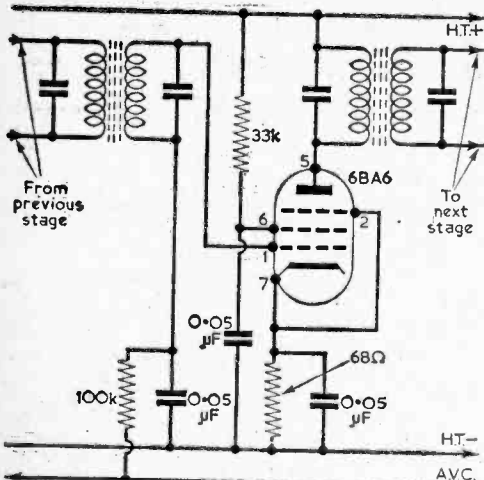
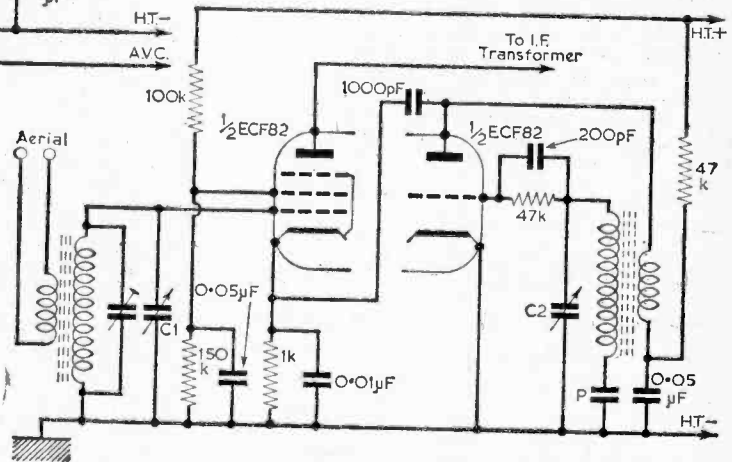

Fig. 14 (above).—A 6BA6 valve in an I.F. stage.

Fig. 15 (right).—An E6F82 mixer-oscillator stage.



frequency amateur and S.W. bands, without the use of an R.F. stage. It is usual, however, to have at least one R.F. stage, as this reduces second channel interference, and improves sensitivity and signal-to-noise ratio.

I.F. Stages

When an ordinary type of superhet is being improved, it is usually fairly easy to add an I.F. stage. This will give considerable increase in selectivity and sensitivity. Such a stage is particularly easy to add in a receiver originally having only one I.F. stage. If the receiver already has two intermediate frequency stages, much more care is necessary to avoid instability. Complete screening, and decoupling of AVC and H.T. feed circuits, will be required.

A typical I.F. stage is shown in Fig. 14, using a high slope valve. Valves such as the 6K7 may be used, with a 220Ω bias resistor, and 47k screen grid resistor. The additional I.F. transformer must, of course, be for the same frequency as those already fitted.

If the I.F. amplifier has

more than one valve it is useful to fit an I.F. gain control, which can be arranged in a similar manner to that in Fig. 13.

A crystal filter may be incorporated in an I.F. stage, and this will be dealt with later. A simple way of securing additional selectivity is to use two I.F. transformers in the coupling between I.F. stages. The secondary of the first transformer is connected to the primary of the second transformer through a very small capacity.

Frequency-Changer or Mixer

Many popular sets have a triode-hexode frequency changer, such as an octal 6K8, or miniature 12AH8. Older communications receivers often have a valve such as the 6K8 operating as mixer only, with a separate oscillator valve. These methods can work well in general coverage receivers.

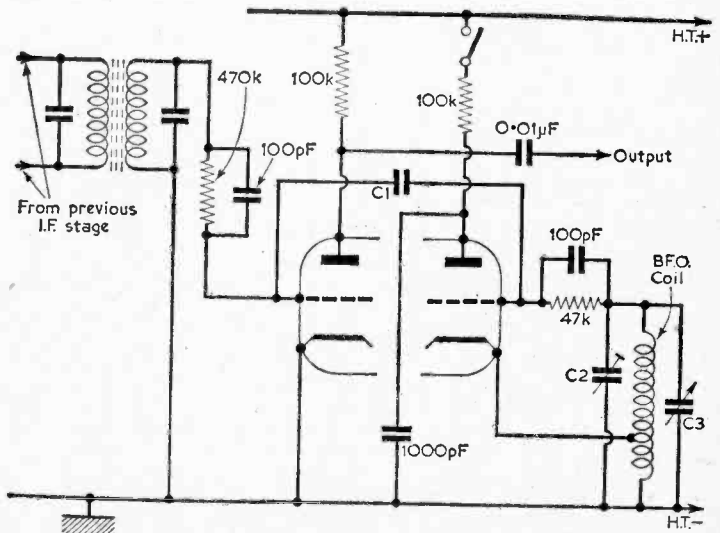

Fig. 16.—A double triode used in a detector and BFO circuit.

A mixer-oscillator stage using an ECF82 is shown in Fig. 15. A similar circuit may be used with a separate oscillator valve, and a 6C5, 6C4, 6AM6, or similar valve may then be used as oscillator.

Fig. 15 also shows connections for a dipole aerial—the coil primary is not earthed, but twin sockets or terminals are provided, for the twin feeder. Such an aerial will usually give better results, especially in reducing untunable background noise from external sources.

Good results can be achieved by using the ECF82 as the first stage, and this has the merit of simplicity. In a larger or more ambitious receiver, a 6BA6 R.F. stage, followed by the ECF82 stage, will allow of a very good performance.

C1 and C2 are sections of the usual gang condenser. The padder condenser P should be of the correct value for the band in use. Several wavebands will normally be provided, as already explained.

Combined Valves

When high sensitivity is required from a superhet with few stages, a grid detector may be used, instead of the more usual diode. Such a detector may be easily overloaded, but can give a very good output with weak signals.

Fig. 18.—This output stage could use any of a number of valves; 6V6, 6B6W6, 6AQ5, etc.

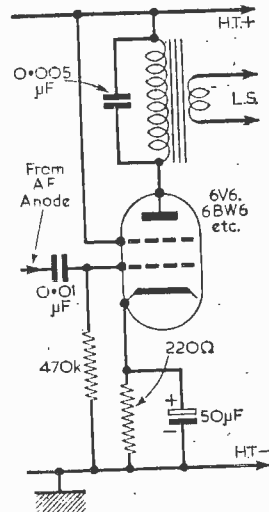

valves, such as the 12A17, are equally suitable.

If a BFO is not wanted, or is already available, a twin triode may be used as grid detector and A.F. amplifier. Alternatively, one triode section can furnish a 100kc/s marker signal, as previously explained in an earlier article. Some receivers employ a twin triode for BFO and audio amplifier.

Fig. 17 shows suitable values for a 6AT6, employed for detection, A.F. amplification, and automatic volume control. If a miniature valve is not wanted, a 6Q7 octal type may be used instead. An AVC line/out switch may be wired from the AVC line to chassis, to permit manual control in R.F. and I.F. stages, and prevent the automatic volume control circuit trying to follow morse. A double-diode-triode stage of this kind is very popular indeed. The H.T. positive feed may be decoupled by means of a 33k resistor and 8µF or similar condenser. This will slightly reduce hum, if H.T. smoothing is a little inadequate, and is generally worth while.

When phone reception is in view, the output of the triode will often be adequate. Alternatively, a second small triode can be used. Or a 6H6 or other double-diode may be fitted, for detection and AVC and a double-triode to provide two stages, of A.F. amplification.

Output and Rectifier

Very many communications receivers, including modern sets of high quality, employ a single beam tetrode or similar valve, such as the 6BW6 or 6AQ5. These are miniatures, and similar, except that the 6AQ5 is intended for up to 250V only, and has a miniature 7-pin base, compared with the 9-pin of the 6BW6. If octal valves are preferred, a 6V6 may be employed, with no change in values or performance. Suitable values for any of these valves are shown in Fig. 18. Other valves may, of course, be used instead. If so, the bias resistor should be chosen to suit.

The existing power supply circuit of the receiver can probably remain unchanged, especially if transformer and rectifier are of fairly generous rating. If the H.T. rating of the transformer is rather small, it may be necessary to replace the output valve by a more economical type, for example, a 6BW6 might be replaced by a 6AM5, and this would save roughly 30mA of H.T. current, which would be available for extra I.F. or other stages. The 6AM5 requires a 680Ω bias resistor.

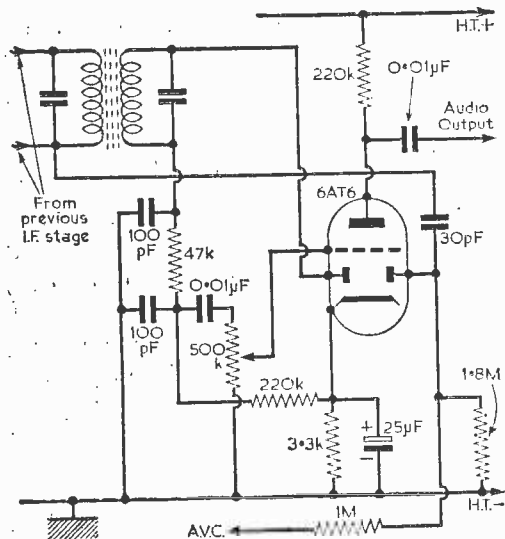

Fig. 17.—An AVC, detection and audio amplification circuit using a 6AT6.

A detector of this kind is shown in Fig. 16. Here, a double-triode has been used, and the second triode section is employed as BFO. The coupling condenser C1 is of very small capacity, such as can be made from twisting together insulated connecting wire for a short distance. Octal valves such as the 6SL7 or 6SN7 may be usefully employed. Full details of BFO oscillators have been given. The BFO circuit is tunable 1kc/s or so either side the intermediate frequency, C3 being used for adjustment. It renders CW morse audible, and is switched off for voice reception. Miniature

Club News

REPORTS OF CURRENT ACTIVITIES

BRADFORD RADIO SOCIETY

Hon. Sec.: M. T. Powell, G3NNO, 28 Gledhow Avenue, Roundhay, Leeds 8.

At the Annual General Meeting it was decided to change the name of the society from "Bradford Amateur Radio Society" to "Bradford Radio Society". On May 23rd members visited the Granada TV studios in Manchester, and on June 6th they visited the Leeds and Bradford Airport. G3LZW gave a talk on "Audio Amplifier Design and Construction" on July 25th.

All meetings commence at 7.30 p.m. Slow Morse classes, if previously arranged, are held before meetings.

Future Events:

September 12th—The first meeting of the new session.

DERBY AND DISTRICT AMATEUR RADIO SOCIETY

Hon. Sec.: F. C. Ward, G2CVV, 5 Uplands Avenue, Littleover, Derby.

The Society's Golden Jubilee Year celebrations are continuing, and on July 2nd the second Two Metre Field Day was held. A Surplus Sale was held on July 5th and on the 12th a Direction Finding Practice Run.

Future Events:

August 5th—"Fifty Years of Radio"—an exhibition at the Derby Art Gallery—will be held for three weeks until August 26th.

August 13th—A Mobile Rally at Rykneid School.

LICHFIELD AMATEUR RADIO SOCIETY

Hon. Sec.: T. L. Painter, G3NEO, Lyndhurst, 98 Gaia Lane, Lichfield.

The Society meets on the first Monday and third Tuesday of every month, at the King's Head, Lichfield.

LLANELLY AND DISTRICT AMATEUR RADIO CLUB

Hon. Sec.: H. J. Hughes, 4 Pen-y-morfa, New Dock, Llanelly.

Lectures for the RAE were continued each Thursday up to the end of May. A highly successful "Ladies' Night" was held on May 18th.

During Technical Training Week, commencing May 30th, a club transmitter, under the call sign GW3LL U/A, was set up at the Drill Hall, Llanelly.

LUTON AND DISTRICT RADIO SOCIETY

Hon. Sec.: D. Barister, 70 Crawley Green Road, Luton, Bedfordshire.

The Society is organising a Mobile Rally for August 20th at Stockwood Park, Luton.

Meetings are still held at Surrey Street School every Monday night at 8 p.m.

MITCHAM AND DISTRICT RADIO SOCIETY

Hon. Sec.: M. Pharaoh, G3LCH, 1 Madeira Road, Mitcham.

Recent meetings included one where various members brought along a piece of equipment and gave a short-descriptive talk about it. On Friday, June 30th, there was a discussion on Club affairs and outside activities.

On July 22nd members operated an exhibition station at the Mitcham Horticultural Show. The Society operated a similar station at the Show last year.

NORTHERN HEIGHTS AMATEUR RADIO SOCIETY

Hon. Sec.: A. Robinson, G3MDW, Candy Cabin, Ogden, Halifax, Yorkshire.

On July 26th the Society held an informal meeting.

Future Events:

August 9th—A discussion on the Scout-Jamboree-On-The-Air.

NORTHERN MOBILE RADIO RALLY

Hon. Sec.: J. Charlesworth, G3JJC, 23 Craven Lane, Gomersal, Leeds.

The Rally was held in fine weather and attracted approximately 900 visitors of which 80 were mobiles, which with 160 non-mobiles, made a total of 240 cars. The majority operated on 160m, although a few 2m and All-band operators were present.

PADDINGTON AND DISTRICT AMATEUR RADIO SOCIETY

Hon. Sec.: N. A. Lambert, G3LVK, Beauchamp Lodge Settlement, 2 Warwick Cresceat, London, W.2.

The Society continues to meet on Wednesday evenings at 7.30. Recent activities have included a sale of surplus equipment and talks by Mr. Alban (G3JEA), and Mr. Legge (G3KNL). Mr. Kippin, G8PL, brought along a large number of pre-war QSL cards and certificates to show the members.

On June 24th the Society was active on G3PAD and also had an exhibition of home-made equipment.

SHEFFIELD AMATEUR RADIO CLUB

Hon. Sec.: D. R. A. Hill, 16 Tynley Road, Sheffield 2.

The two technical lectures will be held during October and December at the Dog and Partridge Hotel, Trippett Lane, Sheffield 1. They are to be held on the second Wednesday of each month.

The October lecture will be on High Power Transmitters and will be given by Dr. Kaiser, Department of Physics, Sheffield University; and the December lecture will be given by Mr. Lyon, and is entitled "New Receiver".

SOUTH YORKSHIRE AMATEUR RADIO SOCIETY

Hon. Sec.: E. Brailsford, G3PAF, 15 Ayrnme Walk, Cantley 4, Doncaster.

The Society continues to increase its membership, and is now on the air as G30WK. Members recently saw two Mullard films at the Club room.

An Intercom Amplifier

(Continued from page 405)

Pin 1 on each valve base should be earthed to chassis.

Testing

When construction is complete and the wiring has been checked against the diagram, test with a meter between C7 and chassis that there are no shorts in the H.T. circuits. If all is well, apply power and check that the proper voltages appear at the valve electrodes. R10 can then be connected to the output transformer and if this causes oscillation, the connections to either the primary or secondary of the output transformer should be reversed to make the feedback negative. Orientate T1 to the position of minimum hum and bolt it to the chassis; hum should then be inaudible 6in. from the speaker when the primary of the input transformer is short circuited.

Operation

The external lines should be unshielded and if an earth connection is used, and it is not essential, it should be to the amplifier chassis only. In this way, interference which may be present is picked up on both transmission lines equally and is cancelled out in the primary of T1. Ordinary lighting flex is very satisfactory for distances up to about 50ft but for longer runs, a cable of lower D.C. resistance is desirable. The signal source may be a moving coil microphone but a small moving coil speaker is equally satisfactory and much cheaper.

Talk-back Facilities

For intercom service, talk-back facilities will be required and may be arranged quite simply with the circuit of Fig. 3. The switch should be a double-pole change-over component preferably of the key type, but, if this is not obtainable, an ordinary rotary switch can be modified by removal of the locating device and the addition of a spring-loaded arm as shown in Fig. 5, so that it will automatically return to the "Listen" position after use. Communication to any number of distant points can of course be established by including a multi-way switch in the transmission line at point X in Fig. 3.

PORTABLE RADIO OR CAR RADIO

PUSH-PULL SIX

(6 Ediswan Transistors plus 2 Diodes)

MEDIUM, LONG WAVE AND TRAWLER BAND EXTENDING TO 80 METRES WITHOUT COIL CHANGING

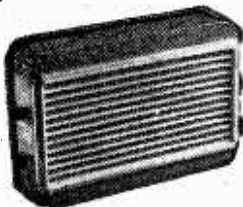

350 Mw XC101's push-pull output Transistors. Powerful magnet 3in. high grade speaker. Miniature push-pull transformers. This is a top performing receiver. Nearly 30 stations listed in one evening including Luxembourg loud and clear. A pleasure to listen to. **FERRITE ROD AERIAL.** All parts sold separately, including pale blue gleaming poly-styrene case with duo-diffusion grilles in red. Uses 9 volt battery. Sockets for car aerial.

styrene case with duo-diffusion grilles in red. Uses 9 volt battery. Sockets for car aerial.

Total building cost **£6.19.6** P.P. 2/6. Size 6½ x 4½ x 1½in. "Agreeably surprised with Trawler Band reception, Luxembourg as loud as local. Your easy build diagram helped a lot... my first attempt."—H.S., Penzance, Cornwall (poor reception area). "Super car radio."—L.B.V., Liverpool.

ALL PARTS SOLD SEPARATELY

TRANSONA-4

(4 Ediswan Transistors, plus 2 Diodes)

Miniature speaker. **FERRITE ROD AERIAL.** MW/LW and Trawler Band coverage down to 80 metres. On test tuned in many stations. This sensational new radio is simple to build with our easy-build plans. Handsome pocket case.

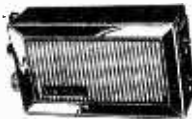

May be built for **65/-** P.P.-2/6

NEW!

POCKET RADIO

(5 Ediswan Transistors and 2 Diodes)

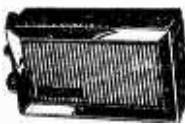

MEDIUM, LONG, WAVE AND TRAWLER BAND TO 80 METRES. Designed round super sensitive ferrite rod aerial and 3in. speaker. Home and Continental stations at your finger tips. Attractive 2-cone pocket size case in gleaming polystyrene. No aerial required.

Many stations listed test receiver. Easy-build plans for beginners. Powered by 4½ volt battery.

Total cost of parts required. **£4.19.6** P.P. 2/6

ALL PARTS SOLD SEPARATELY

NEW PUSH-PULL FIVE

(MW/LW and TRAWLER BAND)
(5 Ediswan Transistors)

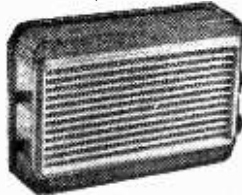

Now greatly improved. Sensitive **FERRITE ROD AERIAL.** Pale blue polystyrene case with speaker grilles in red. Volume/sensitivity control. Miniature push-pull transformers. 350 Mw XC101's in push-pull. Sensitivity R.F. stage for station selection.

Total building cost **£5.7.6** P.P. 2/6
ALL PARTS SOLD SEPARATELY

Push-Pull Pocket Six

MEDIUM AND LONG WAVES AND 400 TO 750 METRES WITHOUT COIL CHANGING.

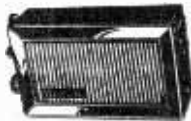

Sensitivity of a superhet, tonal quality of a TRF. Volume control. Tuning condenser. Latest type switches. Handsome two tone-pocket case. Ferrite rod aerial, 3in. quality speaker. Easy build diagrams. 6 Transistors (including Ediswan and Semiconductors) plus 2 diodes.

All parts cost **£5.19.6** P.P. 2/6
ALL PARTS SOLD SEPARATELY

New!

Easy Build Three Radio

(3 Ediswan Transistors plus 2 Diodes)

Easy to build, easy to operate. This transistor radio operates over the M.W. and L.W. extending down to 80 metres without coil changing. Ferrite rod aerial, volume-sensitivity control. Sonotone high fidelity miniature earpiece or miniature speaker.



May be built for **49/6** P.P. 2/6

| | |
|---|----------|
| Ferrite Rod Aerial, M/L wave (7in.) | 8/6 |
| Ferrite Rod Aerial, M/W (4in.) | 5/- |
| Transformers: 300 ohms primary, 5 ohms secondary | |
| Brand new boxed | 3/6 |
| High Fidelity Headphones with miniature earpieces and transformer with lead and jack plug for high or low impedance, matching. Brand new. | |
| Boxed | 25/- |
| Sensitive balanced Armature Headphones. Boxed. brand new | pair 9/- |
| Sensitive 2½in. Speakers. Only ½in. deep, 3 ohm | 16/6 |

DATA SHEETS AND PARTS PRICE LIST FOR THE ABOVE 1/3 EACH

ALL PARTS SOLD SEPARATELY
AFTER SALES SERVICE

RADIO EXCHANGE COMPANY

27 HARPUR STREET, BEDFORD

PHONE 2367

(Opposite Co-op)

CLOSE 1 p.m. SAT.

KINGSMERE SUPPLIES LIMITED

Insured Post 1/-, over £2 Free (Export extra).
Single valves, post 6d.

MAIL ORDER HOUSE

TERMS: Remit with Order or C.O.D.
Cash refund guarantee

Build to the highest specifications, these chassis offer the finest value to the enthusiast.

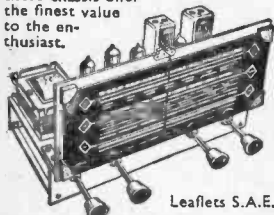

Leaflets S.A.E.

ALL BRITISH RADIOGRAM CHASSIS, 3 WAVEBANDS 5 MULLARD VALVES
ECH81, EF89, EBC81, EL84, EZ80

Brand new and guar. A.C. 200/250v. Short - Medium - Long Gram. P.U. High Q dust core coils. Latest circuit technique. AVC and neg. feedback. 4 watts. Chassis size 13½ x 6 x 7in. Aligned and calibrated ready for use. Quality at Low Cost. Chassis isolated. H.P. Dep. £5 and five monthly of £1.

OUR PRICE £9.9.0

Matched Speakers, 5in., 6½in., 8in., 17½ ea. 10in. 25/-, 12in. 30/-.



Maranch

BRAND NEW AND BOXED

with Template
4 SPEED
MODEL UA8

£6.15.0

STANDARD OR
STEREO PICK-UP

GARRARD 4-SPEED HIGH FIDELITY UNITS

Autochanger RC210 £9.19.6
Single Player TA Mk. II £7.19.6
Transcription 4HF £16.19.6

Price inc. plug-in norma. heads. Stereo hds. £2 ex!

BRAND NEW VALVES

| | | | | | |
|--------|-----|--------|------|-------|-----|
| 1RS | 6/- | 6X5G | 6/- | EF41 | 9/- |
| 1S5 | 6/- | 12A7 | 6/- | EF80 | 7/- |
| 1T4 | 5/- | 12AU7 | 6/- | EF91 | 4/- |
| 3S4 | 7/6 | 12AX7 | 6/- | EL41 | 9/- |
| 3V4 | 7/6 | 12K7GT | 6/6 | EL84 | 8/6 |
| 5U4 | 6/- | 12Q7GT | 6/6 | EY51 | 7/6 |
| 5Z4G | 9/6 | 35L6 | 9/6 | EY86 | 7/- |
| 6J5 | 5/6 | 35Z4 | 6/6 | EZ40 | 7/- |
| 6J6 | 5/6 | 954 | 1/6 | EZ80 | 7/- |
| 6J7G | 6/6 | DAF96 | 8/- | MU14 | 7/6 |
| 6K6GT | 5/- | DF96 | 8/- | PCC84 | 8/- |
| 6K7G | 5/- | DK96 | 8/- | PCF80 | 7/6 |
| 6K7M | 7/6 | DL96 | 8/- | SP61 | 3/6 |
| 6K8G | 6/6 | EB91 | 4/- | UL41 | 8/6 |
| 6Q7G | 7/6 | EBC41 | 8/- | UL41 | 8/6 |
| 6SN7GT | 6/6 | EBF80 | 10/- | UY41 | 7/- |
| 6V6G | 5/- | ECC84 | 8/- | U22 | 8/- |

COMPLETE RADIO

£4.19.6

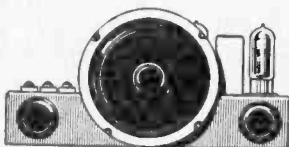

4 Mullard valves, 5in. speaker, frame aerial. 4 pre-set stations. 1 long, 3 med. wave. Superhet Circuit. Size 9 x 6 x 5½in. high. Tested ready for use. 200/250 v. A.C.—D.C. Mains.

RECORDING TAPE

Synrocotape
5in. 600ft. ... 13/6
5in. 900ft. ... 15/6
5½in. 1,200ft. ... 20/-
7in. 1,200ft. ... 20/-
7in. 1,800ft. ... 32/6
Spare Reels, 3in. 1/6, 4, 5, 5½in. 2/-, 7in. 2/6.
"Instant" Bulk Tape Eraser and Head Defluxer, 200/250 v. A.C., 27/6. Leaflet, S.A.E.
4 amp Car Battery Charger with amp meter Leads, Fuse Case etc., for 6v. or 12v. 6/9/6.

Recording Tape "BRAND FIVE"

MYLAR DUPONT
Super High Fidelity
Double Play
5in. 1,200ft. ... 37/6
7in. 2,400ft. ... 60/-
Spare Reels, 3in. 1/6, 4, 5, 5½in. 2/-, 7in. 2/6.
"Instant" Bulk Tape Eraser and Head Defluxer, 200/250 v. A.C., 27/6. Leaflet, S.A.E.
4 amp Car Battery Charger with amp meter Leads, Fuse Case etc., for 6v. or 12v. 6/9/6.

SETS OF VALVES

17/6 1RS, 1T4, 1S5, 354 or 3V4.
27/6 6K8, 6K7, 6Q7, 6V6, 5Z4 or 6X5.
37/6 ECH42, EF41, EBC41, EL41, EZ40.
39/6 ECH81, EF89, EBC81, EL84, EZ80.
35/- 12K8, 12K7, 12Q7, 35L6, 35Z4.

25 FOAMCOURT WAY, FERRING, WORTHING, SUSSEX

SOLDERING EQUIPMENT

by



PRECISION SOLDERING for the ELECTRONICS INDUSTRY

Comprehensive range—Robust & Reliable - Light weight - Rapid heating - Bit sizes 3/32in. to 3/8in. - "Permatbit" or Copper bits - All voltage ranges 67v. to 230/250v. - Prices from 19/6.

- Plastic Cable Strippers
- Miniature Solder Pots
- Heat Guards
- Long Life Bits

Illustrated is the 25w. 3/16in. replaceable bit model with safety shield.

ADAMIN—the new range of precision micro-soldering instruments—Have you had details?

Brochure No. S10 sent free on request.
Sole proprietors and manufacturers:
LIGHT SOLDERING DEVELOPMENTS LTD.
28 Sydenham Road, Croydon, Surrey
Phone: CROYdon 8589 Grams: Litesold Croydon



AVO METERS

MODEL 7 £12.10.0. MODEL 8 £17.10.0. Guaranteed perfect. Complete with leads and batteries. Registered post and Packing 5/- extra.

MULTIMETERS. 1000 Ω/volt. A.C. and D.C. volts, 0-10, 50, 250, 500 & 1000. D.C. current 0-10, 100mA. Resistance 0-2k Ω and 0-200k Ω. Bakelite case, complete with test leads. **BRAND NEW 59/6.**

BC 221. The most accurate precision portable heterodyne frequency meter 125Kc/s to 20 Mc/s. Complete with original individual calibration book. **Guaranteed perfect £16.**

CRYSTAL CALIBRATOR No. 10. Good condition, tested, with instruction manual. **ONLY 59/6 or AS NEW** with three spare valves, leads, etc. **£4.10.0. P. & P. 3/6.**

CR100 COMMUNICATION RECEIVERS 80 Kc/s—30 Mc/s in 6 bands. 11 valves, 2RF and 3 LF. stages. Crystal gate BFO etc. Input 200-250 v. A.C. mains. 21W output for 3 Ω spkr. In superb condition **£25.** Carr. 30/- S.A.E. for illustrated details.

GRAM. MOTORS. Garrard AC6, 78 r.p.m. **NEW 19/6, post 2/6.**

DEAF AID—MEDRESCO TYPE (3 min. batt. valves). Complete with min. xtal earphone earplugs and leather case. **Brand New 35/- or with batteries £2 post free.**

R-1155-B, with latest drive, first class condition. **£9.19.6.** Mains Power Pack, **£6.10.0.** Data Book, 1/3 post paid. Moving Coil Phones. Finest quality Canadian, with Chamolite ear-muffs and leather-covered headband. With lead and jack plug. Noise excluding, supremely comfortable. **19/6, post 1/6.**

GIANT COMPONENT PARCEL. Contains 100 ½ and 1 watt resistors, 50 Hi Stab resistors, W/W resistors, carbon and W/W pots, 100 capacitors (mica, paper, Sprague, bias, variable, etc.), valveholders, tag strips, metal rectifiers, sieving, etc. All components are unused. **GUARANTEED VALUE, 25/-, plus 2/6 post.**

TRANSISTOR SETS
We now stock The Pocket 4 (A neat little job which can be made for 42/6) and The Good Companion (A super job equal to the best). Easily constructed for only **£9.19.6.** Gladly demonstrated to callers.

CHARLES BRITAIN (RADIO) LTD.
11 Upper Saint Martins Lane, London, W.C.2.
TEmple Bar 0545 Shop Hours 9-6 p.m. (9-1 p.m. Thursdays).
Open all day Saturdays.

SIGNAL GENERATOR OUTPUTS

(Continued from page 315 of the August issue)

By R. Brown

THE output impedance of a signal generator can be changed, quite easily, with the aid of external impedances.

Supposing the required output impedance is greater than the actual signal generator

impedance, the signal generator output impedance can be increased to the new value by connecting a resistance R_B in series with the output lead. R_B must have a value such that $R_B + R_A$ is equal to the required output impedance. Under these

| OUTPUT CONNECTIONS | REQUIRED OUTPUT IMPEDANCE R_O or Z_O | VALUE OF EXTRA RESISTOR R_B | NEW SOURCE EMF | VOLTAGE DEVELOPED ACROSS LOAD R |
|--|---|-----------------------------------|---------------------------------|---|
| <p style="text-align: center;">$R_O = R_A + R_B$</p> | Resistive $R_O > R_A$ | $R_O - R_A$ | E | $\frac{R}{R_A + R_B + R} \cdot E$ |
| <p style="text-align: center;">$R_O = \frac{R_A R_B}{R_A + R_B}$</p> | Resistive $R_O < R_A$ | $\frac{R_O \cdot R_A}{R_A - R_O}$ | $\frac{R_B}{R_A + R_B} \cdot E$ | $\frac{R \cdot R_B}{R \cdot R_B + R_A \cdot R_B + R \cdot R_A} \cdot E$ |
| <p style="text-align: center;">$R_O = R_A + R_B$ $Z_O = \sqrt{(R_A + R_B)^2 + X^2}$</p> | Resistive and reactive ($R_O + jX$) $R_O > R_A$ | $R_O - R_A$ | E | $\frac{R}{\sqrt{(R_A + R_B + R)^2 + X^2}} \cdot E$ |
| <p style="text-align: center;">$R_O = \frac{R_A R_B}{R_A + R_B}$ $Z_O = \sqrt{\left(\frac{R_A R_B}{R_A + R_B}\right)^2 + X^2}$</p> | Resistive and reactive ($R_O + jX$) $R_O < R_A$ | $\frac{R_O \cdot R_A}{R_A - R_O}$ | $\frac{R_B}{R_A + R_B} \cdot E$ | $\frac{R}{\sqrt{\left(R + \frac{R_A R_B}{R_A + R_B}\right)^2 + X^2}} \cdot E$ |
| <p style="text-align: center;">$R_O = R_A$</p> | Resistive $R_O = R_A$ | — | E | $\frac{R}{R_A + R} \cdot E$ |

The connecting cable X-X should have a characteristic impedance equal to R_A . Y-Y should have a characteristic impedance equal to R_O . (or Z_O).

Fig. 4.—Altering the signal generator output impedance. For convenience X may be connected at load end of Y-Y, which should then have a characteristic impedance equal to R_O .

conditions the source EMF will have the same value, E , as before; but the voltage developed across a load, R , will now equal:

$$ER \quad RA + RB + R \quad (1)$$

A reduction in the signal generator output impedance can be achieved by connecting a suitable value resistor, RB , directly across the signal generator output. The value of RB is chosen so that the parallel combination of R , and RA ,

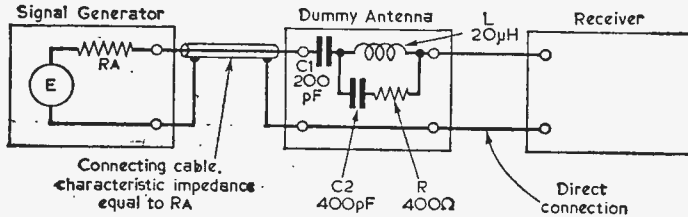

Fig. 5.—Connecting a signal generator to a broadcast band receiver.

$R = RB \cdot RA / (RB + RA)$ is equal to the desired output impedance. The source EMF is now given by:

$$E = \frac{RB}{RB + RA} \cdot E \quad (2)$$

The voltage developed across a load, R , will be given by:

$$e = \frac{RB \cdot R}{RB + R} \times \left(\frac{RB + R}{RB \cdot R} + R \right) \times E$$

$$e = \frac{R \cdot RB}{R \cdot RB + RA \cdot RB + R \cdot RA} \cdot E \quad (3)$$

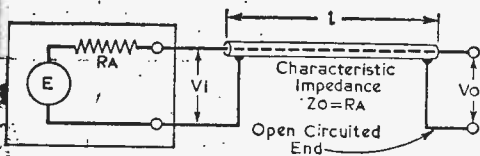

Fig. 6.—The effect of connecting cable. Here the cable has a characteristic impedance equal to RA , and its far end is open circuited (see text).

If the required output impedance is to be reactive and resistive then a suitable reactive component may be connected in series with the output. These results are summarised in the chart Fig. 4. The connections marked X—X and Y—Y are usually coaxial cables, and the correct value for their characteristic impedance will be discussed later.

Connecting the Signal Generator to Low Frequency Receivers

As has already been mentioned, low frequency receivers usually operate from non-resonant aerials; aerials which present an impedance which has a resistive and a reactive component. This type of aerial can be effectively simulated by

connecting the signal generator to the receiver via a network which has an impedance equivalent to the aerial impedance. A standard network, called a dummy aerial, is shown in Fig. 5. This, with the output impedance of the signal generator, effectively simulates a broadcast band aerial.

The Connecting Cable

The signal generator is usually connected to the receiver with a length of coaxial cable. This cable does not need to be terminated in a resistance equal to its characteristic impedance. It must, however, have a characteristic impedance equal to the signal generator output impedance.

That this is so can perhaps best be seen with the aid of Fig. 6. This shows a signal generator, to the output of which is connected a length 'l' of coaxial cable. The far end of this cable is open circuited. It has a characteristic impedance equal to RA . Now, it can be shown, that if such a cable is "loss-less", then the voltage Vi developed across the input end will be given by:

$$Vi = E \cos \beta l \quad (5)$$

where β is the phase constant ($2\pi/\lambda$) of the cable. It can also be shown that the voltage Vo at the end of such an open-circuited line is given by:

$$Vo = Vi / \cos \beta l = E \cos \beta l / \cos \beta l$$

Therefore, $Vo = E$ (6)

In other words the source EMF is still E volts even though the cable is unterminated.

If we now look back along the cable from the far end we see a line of characteristic impedance Zo terminated in a resistance RA . But $RA = Zo$. So we are looking at a cable which is correctly terminated. The impedance we see looking back from the far end of the cable is therefore RA .

Thus provided the cable does have the correct characteristic impedance, the receiver, or other

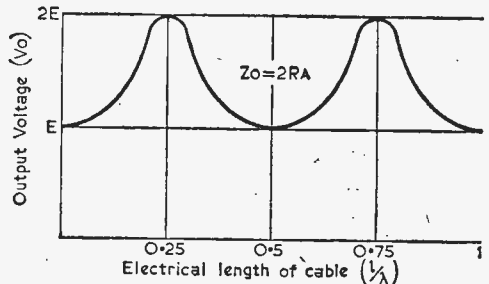

Fig. 7.—The cable output voltage for an open circuited cable which has a characteristic impedance equal to $2RA$.

equipment, to which the signal generator is connected, will still see a generator of E volts in series with a resistance RA .

(Continued on page 422)

FOR READERS OF "PRACTICAL WIRELESS" AT REMARKABLY LOW COST!

RADIO, TELEVISION & ELECTRICAL REPAIRS



AMAZING 'KNOW HOW' BOOK Saves You Pounds

Here is just the practical, at-a-glance guidance YOU need, whether you wish to know how to service radio and TV sets, install lighting points, or repair any domestic appliance, from a bell or an iron to a vacuum cleaner or washing machine. Explains basic principles and working of modern radio and TV sets and electrical appliances. Shows how to test for faults, carry out maintenance and repairs by the most modern methods. Special section on the operation and servicing of frequency modulated receivers. 480 pages. Over 400 illustrations. Amazing VALUE—Standard Edition, 21/-; De Luxe, leathercloth, 23/-. Or on easy terms: 5/- down and 3 monthly instalments. (Total credit prices: Standard, 22/-; De Luxe, 24/-)

ALL THIS—AND MORE IN ONE GREAT VOLUME!

Comprehensive Contents include:

Current, Voltage and Resistance. Coils, Capacitors and Valves. Basic Radio-receiver Circuits. Preliminary Tests. Instruments for Set Testing. Locating Faults. Dynamic Testing. Tuned Circuit Alignment. Noises, Interference, Distortion and Instability. Components. Loudspeakers. Pick-ups. Gramophone Motors. Frequency Modulation. Television Circuits and Test Gear. Television Faults, Symptoms and Cures. Aerials and Pre-Amplifiers. Maintenance of Domestic Electric Wiring. Small Appliances. Fires and Space Heaters. Vacuum Cleaners and Polishers. Rewinding Small Motors. Cookers and Boiling Plates. Washing Machines. Refrigerators. Electric Water Heaters. Battery Charging. Testing and Repairs, etc.

ESSENTIAL TO EVERY SERVICE ENGINEER, ENTHUSIAST AND HANDYMAN!

Getting the best from RADIO AND TV SETS

Here is expert advice that will enable you to make the necessary adjustments or repairs in order to get the best possible performance from any radio or TV set.

All you need to know about DOMESTIC WIRING

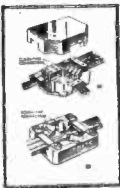

Learn from these helpful pages how to carry out all kinds of installations and extensions—with efficiency and safety! Complete guidance on conductors, insulation, safety regulations, conduits, cables, earthing, practical work, fuses, flexible cords, etc.

BASIC RADIO CIRCUITS

All you want to know about circuits, so that you can find your way around modern sets without hesitation. How components form various types of set: gives circuits for 1-valve receiver, 3-valve receiver, battery TRF receiver 4-valve superhet, Universal sets, etc.

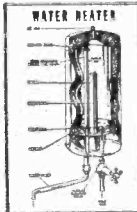

FIRES & SPACE HEATERS

Full, easy-to-follow instructions for servicing small domestic fires—whether of the radiant, reflector or convector type.

WATER HEATING

All you should know about the various types of electric water-heaters and how to install them and keep them in perfect working order. Advice that will save you POUNDS!

TRACKING DOWN TROUBLE

This grand book is invaluable for tracing faults in radio and TV sets. Tells you all you want to know—from how to carry out Preliminary Tests how to align R.F. and I.F. circuits. Shows how to carry out Dynamic Testing. Also shows how to trace the causes of Noises, Distortion and Instability and deal with the trouble. Gives detailed information on Components and Loud-speakers and how to deal with any faults that may develop.

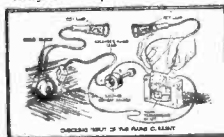

See how to maintain Vacuum Cleaners and Floor Polishers, Refrigerators, Cookers and Boiling Plates, Washing Machines, etc. Do your own BATTERY CHARGING

Here are clear, complete instructions

DO THIS NOW!

Simply complete form, indicating Edition preferred, and post in a 2d. stamped, unsealed envelope to Dept. E.B.35, Odhams Press Ltd., Basted, Sevenoaks, Kent. Offer applies in the U.K. and Eire only, closes September 30th.

FULL SATISFACTION GUARANTEE

SEND NO MONEY NOW!

To: Dept. E.B.35, Odhams Press Ltd., Basted, Sevenoaks, Kent.

WITHOUT OBLIGATION reserve me "Radio, Television and Electrical Repairs" and send Special Invoice with "100% Satisfaction or No Charge" Guarantee.

Cross out edition NOT required: STANDARD/DE LUXE
BLOCK LETTERS BELOW

NAME _____
Full Postal ADDRESS _____

E.B.35/Sept. '61.



another NEW instrument
from Salford, the
minitest
POCKET-SIZED MULTIRANGE TEST SET

A new compact instrument suitable for the measurement of D.C. voltages and currents, A.C. voltages and ohms. Its high sensitivity renders it suitable for testing and fault location in all types of electrical and electronic circuits. It is well built to ensure long and satisfactory service. The instrument is economically priced and supplied with test leads with plug connections at one end. (Leather carrying case available as an extra).

RANGES: A.C. Volts. 2.5, 10, 25, 100, 250, 1000.
D.C. Volts. 2.5, 10, 25, 100, 250, 1000.
D.C. Amps. 50 μ A, 1mA, 10mA, 100mA, 1A.
Ohms. 2000, 200,000, 20 M Ω .

ACCURACY: D.C. Volts & Amps. $\pm 2\%$ of full scale deflection
A.C. Volts $\pm 3\%$ of full scale deflection
 $\pm 5\%$ at centre scale.

Send for leaflet MIN/6009/PW

neat and compact with age instrument performance

SALFORD ELECTRICAL INSTRUMENTS LIMITED
Peal Works · Silk Street · Salford 3 · Lancs. Tel: Blackfriars 6688
London Sales Office: Magnet House, Kingsway, W.C.2. Tel: Temple Bar 4668
A Subsidiary of THE GENERAL ELECTRIC CO. LTD. OF ENGLAND

SET

FOR BARGAINS

M.S. RADIOPOST CO.
MAIL ORDER SPECIALISTS

Please quote Dept. M.O.P.W.

Wanstead 1534

Rear of 19 HARPENDEN ROAD, WANSTEAD PARK, LONDON, E.12.



CARBON HAND MICROPHONES. New in original cartons. On/Off switch in handle. Bakelite construction with lead & plug Type: 5A-With No. 10 Jack plug 6/-. Type 4A-With 4-pin Skt. 6/8d. Type: 49-With P.O. Jack plug 20/1. 7/6d.

TAPE RECORDER MOTOR

(Not Ex-Govt.)
Removed from
Transistor
Tape Recor-
ders and in
perfect con-
dition, 9 to
12 volts.



Only
9/6 each

Dual spindle fully reversible, protected bearings. Approximately 3/4000 r.p.m. Size: 2 1/2 in. long x 1 in. wide. Spindle: 1/4 in. x 1/32 in.

3ft. WHIP AERIALS. 8 x 1ft. sections.

For model radio control, etc. 7/6 com.

TERMS: C.W.O. or 7 days approved accounts.

All our goods are guaranteed new or in working order. Money refunded in full if not absolutely satisfied.

Orders despatched same day. NO POSTAL OR PACKING CHARGES. C.O.D.

3/- extra. Carriage extra Eire and N. Ireland and countries outside U.K.

MINIATURE DYNAMIC SPEAKERS
A must for all Build-it-yourself-Hams. As supplied with all current transistor Kits. Can also be adapted for home phones or intercom. 2in. diameter. Resistance 70 ohms. ONLY 6/-.
SENSITIVE RELAY. Miniature type 250 ohms. D.P.D.T. 12 v. D.C. Overall size 1 x 1 1/4 x 1 in. Adjustable armature tension spring. Will operate on less than 1 m/s. Suitable all model radio control. Brand new, 15/6 each.

MORSE KEYS. Metal shrouded and with built-in D.P. toggle switch. NEW. 6/- each. **SUB-MINIATURE JACK PLUGS AND SOCKETS.** As used on all transistor sets. Two-way type, 3/8 pair.
30 FOOT AERIAL MASTS. Complete assembly consists of 10-3ft. x 1/4 in. dia. steel mast sections, mtg. base, guys, ropes, peg bag and pegs, insulators, stay plates and necessary fitting equipment. Comes to you complete with Hammer and Canvas carrying bag. NEW Only 24/15/-.

AIRBORNE TRANSMITTER RECEIVER. TYPE 1888. A mobile 10-channel crystal controlled V.H.F. Tx/Rx. covering 124.5/156 Mo/s. I.F. Bandwidth 23 kc/s. Complete (less external attachments) in metal case, with all valves and 34 v. rotary power unit. Used, but in first-class condition. Only 28/10/-.

All our goods are guaranteed new or in working order. Money refunded in full if not absolutely satisfied.

Orders despatched same day. NO POSTAL OR PACKING CHARGES. C.O.D.

3/- extra. Carriage extra Eire and N. Ireland and countries outside U.K.

Build these four up-to-the-minute
REPANCO designs

1-THE "JOURNEYMAN". A SIX TRANSISTOR PORTABLE RECEIVER

- ★ MEDIUM AND LONG WAVEBANDS
- ★ POSITION FOR CAR RADIO AERIAL
- ★ PRINTED CIRCUIT WITH COMPONENT NUMBERS MARKED
- ★ PUSH-PULL OUTPUT
- ★ FERRITE SLAB AERIAL

Step by step instructions. 1/6, post 3d.

2-MINI-4. A REMARKABLE FOUR TRANSISTOR SUPER-HET POCKET RECEIVER

- ★ MEDIUM AND LONG WAVEBANDS
- ★ SIZE OF CASE 5 1/2 x 3 1/2 x 1 1/4 in.
- ★ AUTOMATIC GAIN CONTROL
- ★ 2 1/2 in. LOUDSPEAKER
- ★ 3rd IFT REFLEXED AS AUDIO DRIVER

Easy Wiring Plans and Step-by-Step Instructions. 1/6, post 3d.

3-THE "TWINETTE" A TWO TRANSISTOR LOCAL STATION PORTABLE RECEIVER

- ★ LOUDSPEAKER RECEPTION
- ★ MEDIUM AND LONG WAVEBANDS
- ★ REFLEX CIRCUIT

Step by step instructions. 1/3, post 3d.

4-FULLY TRANSISTORISED CAR RADIO

- ★ 7 TRANSISTORS
- ★ 2 WATTS OUTPUT
- ★ MEDIUM AND LONG WAVEBANDS
- ★ A.G.C. AND AUXILIARY A.G.C. CIRCUITS
- ★ SUPER PERFORMANCE

Step by step instructions, 2/6, post 3d.

Mail Order and Trade:
RADIO EXPERIMENTAL PRODUCTS LTD.
33 Much Park Street,
COVENTRY
Tel.: 27114

Wholesale Inquiries and Export:
REPANCO LTD.
O'Brien's Buildings,
203-269 Foleshill Rd.
COVENTRY
Tel.: 24224

By J. B. Dance

RECORDING FROM THE RADIO

AVOIDING HUM AND DISTORTION

JAPE recorders do not normally have built-in radio receivers. When one wishes to record a radio programme, it is, therefore, necessary to feed a signal from a receiver into the input of the tape recorder through a length of cable which may have to be fairly long. It is preferable to use coaxial cable.

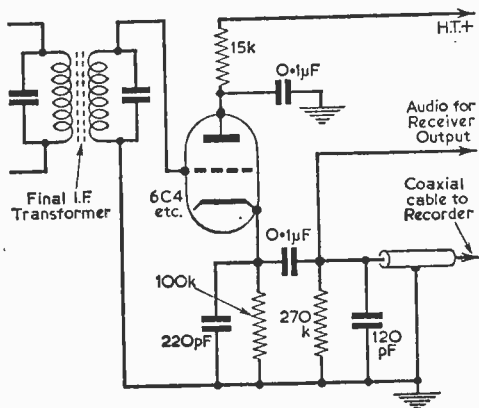

Fig. 1.—The cathode follower detector.

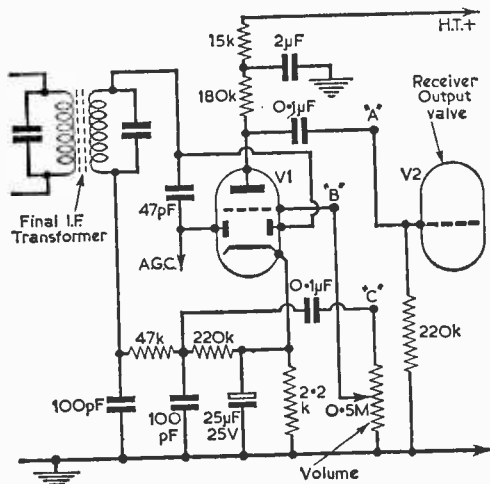

Fig. 2.—The circuit on the right is a cathode follower audio stage which may be added to a receiver the existing circuit of which is shown in the left-hand diagram. Point "X" should be connected to one of the points "A", "B" or "C".

Signal Supply Point

It is common practice to take the signal from the external speaker terminals of the radio receiver or (if no such terminals are fitted) the signal may be taken from the output side of the speaker transformer. Although a low impedance output is conveniently obtained by this method, it necessarily means that any distortion in the receiver output valve or in the speaker transformer will be present in the recording. Most radio receiver distortion usually occurs in the output stage unless the receiver is an expensive one.

On the other hand, it is not wise to connect a length of coaxial cable to the detector output or to the anode of an audio amplifier which is in the radio receiver (via a D.C. blocking condenser), because the capacity of the cable will severely affect the high frequency response.

Cathode Follower Detector

If a radio receiver is being constructed so that it can be used to feed a tape recorder, a cathode follower detector may conveniently be used. This circuit, which is shown in Fig. 1, has a low output impedance and can be used to feed a tape recorder through a long length of coaxial cable without high audio frequency attenuation. The circuit

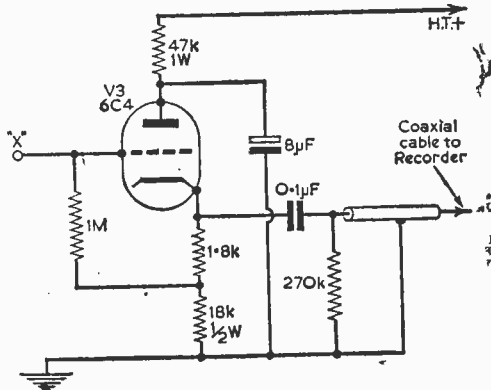

has the additional advantages that it does not appreciably load the previous tuned circuit and maximum selectivity and gain are therefore obtained. The distortion given by the cathode follower detector is very low. Almost any small triode or triode connected pentode, e.g. the 6C4 triode, can be used as the detector valve in the Fig. 1 circuit.

Cathode Follower Stage

If it is required to feed a tape recorder from an existing receiver, the substitution of a cathode follower detector for the common diode detector would involve re-alignment of the receiver. This can be avoided by the use of an additional cathode follower audio stage in the receiver.

Assuming a diode detector is used in the usual double diode triode circuit shown in Fig. 2, the audio output may be taken from one of the points marked A, B and C in the circuit and fed into the point marked X. The component values shown in the left-hand circuit of Fig. 2 are typical, but will vary slightly from receiver to receiver.

If the point X is connected to the point A, considerably more amplification will be obtained than if it is connected to the point B or point C. The receiver volume control will affect the tape recorder input if the connection is made to point A or B, but it is probably more convenient to connect point X to point C so that the receiver volume control does not affect the recording level.

Double Triode Circuit

Those readers wishing to use the double triode ECC82 (or the 6SN7 or 12AU7) may find the Fig. 3 circuit convenient. The first triode is an ordinary amplifying stage which is directly coupled to the grid of the second stage. The positive voltage applied to this grid (about 100) is counteracted by a slightly greater positive voltage on the cathode owing to the flow of the anode current through the large cathode resistor. The difference

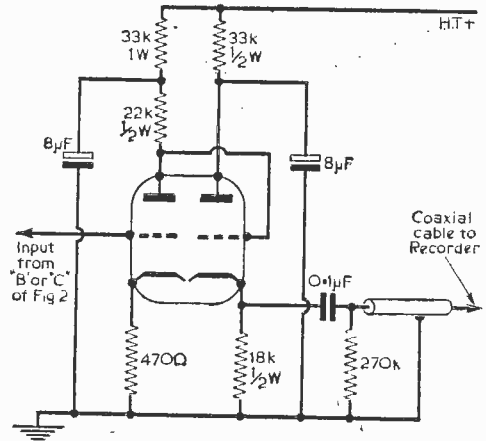

Fig. 3.—A double triode as amplifier and cathode follower.

between these voltages provides the bias for the second triode. The input can be taken from points B or C of Fig. 2. The audio voltage at point A is too large for connection to the input of the Fig. 3 circuit.

With the circuits shown, the signal can be fed into a very long length of coaxial cable, and hence to the recorder, without the high frequency response being noticeably affected. The circuits must be placed in the radio receiver and not in the tape recorder. When the circuit of Fig. 2 or Fig. 3 is used; the lead from the audio take-off point (A, B or C) to the additional valve circuit should not be more than about three inches long—shorter if possible. Care should be taken to ensure that there is only one earth connection between the receiver and recorder; this is the outer connection of the coaxial cable.

IMPORTANT NOTE

COPYRIGHT AND PERFORMERS' RIGHTS

BBC Sound and TV Programmes:

It is an infringement of the rights of the BBC, under the Copyright Act, 1956, to do any of the following things without first obtaining permission from the BBC.

- (1) To make a record of a sound broadcast or of the sound part of a television broadcast otherwise than for private purposes.
- (2) To make a film of any sequence of images in a television broadcast sufficient to be seen as a moving picture, otherwise than for private purposes.
- (3) To show a television broadcast in public to a paying audience.

Copyright, Musical and Literary Material:

The permission of the owners of the copyright in musical and literary material used in BBC sound or television broadcasts must be obtained under the Copyright Act, 1956, before such material is recorded or filmed, (otherwise than for research or private study) or before its performance in public (whether the audience pays or not).

Gramophone Records:

Gramophone records are already covered by a separate copyright protection under the Copyright Act, 1956, and any unauthorised re-recording of gramophone records either directly or from a broadcast (including re-recording on to tape, whether for private purposes or otherwise) is an infringement of the copyright in the gramophone record which is normally controlled by the issuing record company.

Performers' Rights:

The permission of any dramatic or musical performers taking part in a broadcast must be obtained under the Dramatic and Musical Performance Protection Act, 1952, for the recording or filming of their performances, otherwise than for private or domestic use.

BBC Schools Broadcasts:

The recording of BBC Schools Broadcasts may be made by schools without obtaining the above permissions, provided that the records are only used for instructional purposes in class, and that they are destroyed at the end of the school term.

SIGNAL GENERATOR OUTPUTS

(Continued from page 418)

There will, of course, be standing waves on the cable (except when the load equals R_A), but provided the cable introduces negligible losses, this will not cause any error. The cable will not normally introduce losses, for the signal generator will be close to the equipment under test, and the cable will be very short.

Incorrect Cable Impedance

The incorrect reading of the signal generator attenuator, and an incorrect connection to the equipment under test can certainly result in errors in measurements. The cause of these errors is often difficult to find. A graph is shown in Fig. 7 giving the variations in the cable output voltage with length, when the cable has a characteristic impedance equal to $2R_A$. The output impedance seen by the equipment under test will also be wrong with this condition, and it does not need much imagination to picture the completely incorrect and probably baffling results which could be achieved. Provided reasonable care is taken, however, one can usually be sure what output voltage the signal generator is giving, and what its output impedance is.

Wharfedale TRANSFORMERS

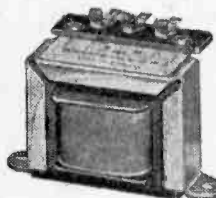

OP3 (3 ratios)

Small output transformer for battery and portable sets or mains set up to 3 watts output. Ratios 30, 60 and 90 to 1. Max. D.C. 30mA. Inductance at 4v 50c/s. 26H with zero D.C. 3.8H with 30mA D.C. Width 2 1/2 in. by height 1 1/2 in. Weight 6 oz. Max. watts. 3. Price 7/6

TYPE P (4 ratios)

The ideal replacement transformer for sets up to 5 watts output. Ratios 30, 45, 60 and 90 to 1 (90:1 centre tapped) Max. D.C. 50 mA. Inductance at 4v 50c/s. 28H with zero D.C. 6.5H with 30mA D.C. 4.0H with 50mA D.C. Width 2 1/2 in. Height 2 in. Weight 12 1/2 oz. Max. watts. 5. Price 9/-

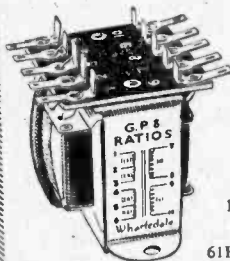
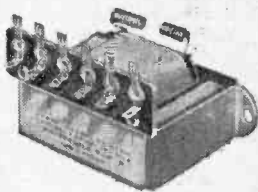

GP8 (8 ratios) General purpose output transformer with two centre-tapped primary windings and two secondaries. Matches practically all output conditions to speakers of 1 to 15 ohms impedance. Suitable for use up to 5 watts output. Ratios 12, 18, 24, 30, 36, 48, 60 and 72 to 1 (ratios 36, 48 and 72 to 1 are centre-tapped). Max. D.C. 50mA. Inductance at 10v 50c/s (each primary winding, 22.5H with zero D.C. 5.0H with 30mA D.C. Width 2 1/2 in. Height 2 1/2 in. Weight 12 1/2 oz. Max. watts 5. Price 12/6

W12 (3 ratios—all centre tapped)

A high quality transformer for undistorted output up to 10 watts with speakers up to 15 ohms impedance. Ratios: 15:1, 22:1, 45:1. D.C. resistance of primary 460 ohms. Max. D.C. 80mA Inductance at 4v 50c/s. 61H with zero D.C. Leakage inductance 20mH Width 4 1/2 in. Height 3 in. Weight 2 lb. Max. watts 10. Price 26/- Special ratios to order 30/-

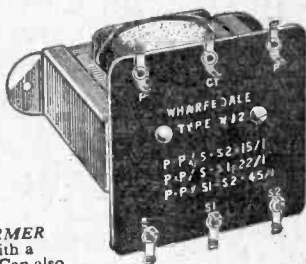

SM1 STEREO MIXER TRANSFORMER
Enables stereo systems to be operated with a single bass unit and two treble speakers. Can also be used to add a centre speaker to "fill in the middle" where existing speakers are too widely spaced. Existing full range speakers can also be converted to stereo using the SM1 and an additional treble unit. Size 4 x 2 1/2 in. Weight 2 lb. Input 15 watts Max. Price 30/-

WMT1 MATCHING TRANSFORMER

Auto transformer for matching with 10-15 ohm or 7-9 ohm speakers to sets with 2-5 ohms output or vice versa. Frequency response within 1dB from 20c/s to 15kc/s. Power handling capacity 15 watts. Can be used to match loudspeakers of different impedances to cross-over unit in high-quality two or three speaker systems. Width 2 1/2 in. Height 2 1/2 in. Weight 12 1/2 oz. Max. watts 15. Price 13/6

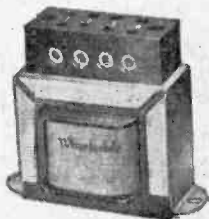

AIR CORED INDUCTORS

High grade air bored inductors wound with 17 s.w.g. aluminium wire can be supplied to order within the range 0.1 to 8.0mH. Suitable for use in cross-over networks and filter circuits. Prices on application.



IDLE BRADFORD YORKSHIRE | Tel: Idle 1235/6
Grams: "Wharfedale" Bradford

CLYNE RADIO LTD.

18 TOTTENHAM COURT ROAD, W.1
 MUSeum 5929/0095
 162 HOLLOWAY ROAD LONDON N.7
 NORch 6295/6/7
 9 CAMBERWELL CHURCH STREET, S.E.5
 RODney 2875

All post orders and correspondence to
 162 HOLLOWAY ROAD, LONDON N.7

THE "CITIZEN"

Introducing our new Sensitive 5-Stage (4 transistor plus diode) pocket transistor receiver—for full medium wave reception—with the following outstanding features ★ Completely self-contained—No external aerial or earth required. ★ Genuine 41in. High Flux P.M. Speaker. ★ Push-pull output. ★ Genuine Ediswan transistors. ★ Socket provided for personal listening. ★ Socket provided for connection to Car Aerial. ★ Volume Control with on/off switch. ★ Condenser tuning. ★ Easy assembly. ★ colour coded pre-tagged circuit board. ★ Attractive red poly-styrene cabinet measures 5 1/2 x 3 1/2 in. chrome handle, attractive dial. All required components including full instructions, solder, etc. and battery at special inclusive price of only 95/- (Yes, Ninety-Five Shillings only) Plus 2/6 P. & P. Nothing more to spend. Suitable crystal deck & type miniature earpiece fitted with miniature jack plug at 7/6 extra only! If req. All parts available separately—Itemised list and full assembly instructions sent for 1/6 post free. Hear this amazing little receiver working, at any of our branches.

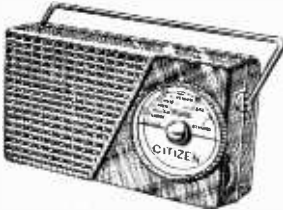

ONLY 95/- Plus P. & P. 2/6.

"WAVEMASTER" 7-TRANSISTOR LUXURY PORTABLE

ONLY £10.19.6 P. & P. 3/6.

400 milliwatt Output To build yourself, Medium and Long Waves—Push-Pull Superhet A. V. C. Perfect Car Radio reception, Size 6 1/2 x 4 1/2 in. x 4 1/2 in. at base tapering to 4 1/2 in. at top. Very attractive two-tone grey Vynide covered cabinet with black and gold printed escutcheon plate, cream and gold knobs, handle and cabinet fittings. ★ Weight—complete with long-life 71 volt battery—4 1/2 lb. ★ Mazda high-grade transistors throughout. ★ High-Flux 7in. x 4in. Elliptical Speaker. ★ Slow motion tuning. ★ Co-aerial socket at rear for direct connection to Car Radio Aerial ★ Improved reception by use of seven-section plated telescopic aerial disappearing into Cabinet when closed. 34in. above Cabinet when fully extended. Construction simplified by Bakelite chassis board with the following components already mounted: I.F. Transformers (3), Oscillator Coll., Trimmer Bank, Output Transformer, interstage Transformer, Aerial Brackets and Earth Bar. SPECIAL INCLUSIVE PRICE for all required components. Full assembly instructions—nothing more to buy—is £10.19.6 plus 3/6 P. & P. Alignment service available. Full assembly instructions and individually priced parts list, all of which are available separately, 2/6, post free.

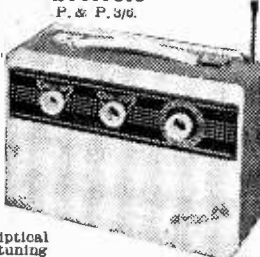

F.W. "ROADFARER" Now available the "Osmor" version at special inclusive price of £16.19.6. P. & P. 2/6.

CRYSTAL MICROPHONE (illus). Sensitive Miniature Lapel-type. Complete with clip and screened lead. Brand new. 17/6. Post 6d. MINIATURE 2P. 2 WAY SLIDER SWITCH as used in F.W. pocket superhet and "Roadfarer". 2/6 each, plus 3d. P. & P. LIGHTWEIGHT HIGH RESISTANCE HEADPHONES, 4,000 ohms, adjustable headband, brand new. Limited quantity at 13/6 per pair, plus 1/6 P. & P.

SMALL SOLDERING IRON. Complete with vinyl carrying case, mains lead and 2-pin plug. A.C. 230 v. Handle unscrews and becomes protective cover for the bit. Only 18/9, plus 1/6 P. & P. Spares available. Bit 1/3. Element 4/6.



TUBES

HIGHEST QUALITY—NEW LOW PRICES
 Carr. 12/6
GUARANTEED

| | | | | | |
|--|--|---|---|------------------------|---|
| MOST MULLARD MAZDA COSSOR, EMITRON, EMI- SON, BRIMAR, FERRANTI TYPES, PROCESSED IN OUR OWN FAC- TORY. | 9/10in. 12in. 14in. 16/17in. 21in. | 21-10-0 23- 0-0 25-10-0 25- 0-0 28-15-0 | 23- 0-0 25- 0-0 25- 0-0 25-15-0 25-15-0 | 12 Months NEW TYPES | MW 31/74. 24-0-0 MW 36/44. MW 36/24. 25-0-0 CRM 172. MW 43/84. 26-0-0 |
|--|--|---|---|------------------------|---|

RENEW YOUR PICK-UP Cartridges only. Acos 22/8; Monotone 17/-; Steig and Reuter 15/-; Power Point 17/-. Complete with tone arm, 3/- extra.

TRANSISTORS. Yellow Spot, 2/8. White Spot, 3/8. Keel Spot, 2/8. DIODES. General purpose, Famous makes, 8d each, 8/- doz. RECTIFIERS for chargers. 4 amps, 7/9. Transformers to match 6-12 v. 19/-.

TAPE RECORDEES. Cases at Bargain Prices, Rexine covered. 10 x 14 x 5 1/2 in. 15/-; 10 x 12 x 7 1/2 in. 14/-; 11 x 5 1/2 in. 14/-; 11 x 9 x 5 in., 11/8. Various colours. (P. & P. 2/-).

4 SPEED RECORD PLAYERS. Latest B.S.K. TU9 Turntable together with Lightweight dual Sapphire Crystal Pick-up head. Amazing value, £8.10.0, Carr. 3/-.

LOUDSPEAKERS. Manufacturer fresh. 2 1/2 in. 13/-; 3 in. 19/-; 10 in. 22/8; 6 x 4 in. 15/-; 6 x 3 in. 19/8; 8 x 4 in. 21/-; 7 x 4 in. 18/-; 3 in. 16/-; 8 x 1 1/2 in. 35/- (P. & P. 1/6).

PM SPEAKERS 3 Ohms. Performance Guaranteed. 3in. 5in. 10in. 6 1/2 8/- 7 x 4 in. 11/- 10 x 4 in. 18/- (P. & P. 2/-).

TEST SETS. Type 74A. Brand new worth £10. Our price £4.10.0.

VALVES

10% DISCOUNT SPECIAL OFFER TO PURCHASERS OF ANY SIX VALVES marked in black type (15/- in dozens). Post: 1 valve 6d.; 2-11. 1/- FREE TRANSIT INSURANCE. All valves are factory guaranteed ex-Government origin. Satisfaction or Money Back Guarantee on goods if returned unused within 14 days.

| | | | | | | | | | | |
|-------|------|-------|------|--------|------|-------|------|---------|------|------|
| 02A | 5/- | 6L1 | 12/8 | 20P8 | 12/8 | EB91 | 3/8 | 14L4ADD | U74 | 5/8 |
| 14GT | 11/6 | 6L6G | 9/8 | 20P4 | 17/6 | EB83 | 3/8 | HVR2 | U78 | 6/8 |
| 16GT | 9/8 | 6L7G | 8/6 | 25A6G | 15/6 | EB83C | 7/8 | HR22 | U78 | 6/8 |
| 114 | 3/8 | 6L13 | 8/8 | 25L6G | 6/8 | EBF80 | 7/8 | K788 | U78 | 7/- |
| 1N6GT | 9/8 | 6L19 | 12/8 | 35F5 | 9/8 | EBF69 | 8/8 | K744 | U78 | 11/- |
| 154 | 3/8 | 6P15 | 8/8 | 35Z4G | 7/8 | EBL21 | 12/8 | K745 | 8/8 | U119 |
| 154 | 3/8 | 6P25 | 8/8 | 37 | 8/8 | EBL21 | 12/8 | K761 | 8/8 | U142 |
| 155 | 4/8 | 6P28 | 12/8 | 39F5 | 6/8 | EBL21 | 12/8 | K762 | 8/8 | U145 |
| 174 | 3/8 | 6Q7G | 6/3 | 30F1 | 9/8 | ECC31 | 8/8 | K766 | 8/8 | U145 |
| 2A3 | 3/8 | 6Q7GT | 8/8 | 30P4 | 12/8 | ECC32 | 4/- | K761 | 5/8 | U147 |
| 2121 | 4/8 | 6B7 | 4/8 | 30P12 | 8/8 | ECC33 | 4/8 | K762 | 5/8 | U149 |
| 3A4 | 4/8 | 6B7 | 4/8 | 30P11 | 10/8 | ECC34 | 8/8 | K763 | 5/8 | U150 |
| 3Q4 | 7/- | 6B47 | 4/8 | 35L6GT | 6/8 | ECC35 | 8/8 | K764 | 5/8 | U151 |
| 3Q4 | 6/- | 6E37 | 4/8 | 35W4 | 6/8 | ECC36 | 8/8 | M114 | 5/8 | U152 |
| 5V4 | 8/8 | 6B87 | 5/8 | 35Z4GT | 6/8 | ECC32 | 8/8 | N18 | 7/8 | U155 |
| 6A4 | 9/8 | 6B1GT | 6/8 | 50D6G | 6/8 | ECC33 | 8/8 | N37 | 11/- | U154 |
| 6V4 | 4/8 | 6B7GT | 4/8 | 50D6 | 6/8 | ECC34 | 8/8 | N78 | 15/- | U151 |
| 6V4 | 8/8 | 6B87 | 4/8 | 50L6GT | 16/- | ECC35 | 8/8 | PC24 | 18/- | U241 |
| 6V4 | 8/8 | 6B87 | 4/8 | 50L6 | 16/- | ECC36 | 8/8 | PC25 | 18/- | U242 |
| 6V4 | 8/8 | 6B87 | 4/8 | 50L6 | 16/- | ECC37 | 8/8 | PC26 | 18/- | U243 |
| 6V4 | 8/8 | 6B87 | 4/8 | 50L6 | 16/- | ECC38 | 8/8 | PC27 | 18/- | U244 |
| 6V4 | 8/8 | 6B87 | 4/8 | 50L6 | 16/- | ECC39 | 8/8 | PC28 | 18/- | U245 |
| 6V4 | 8/8 | 6B87 | 4/8 | 50L6 | 16/- | ECC40 | 8/8 | PC29 | 18/- | U246 |
| 6V4 | 8/8 | 6B87 | 4/8 | 50L6 | 16/- | ECC41 | 8/8 | PC30 | 18/- | U247 |
| 6V4 | 8/8 | 6B87 | 4/8 | 50L6 | 16/- | ECC42 | 8/8 | PC31 | 18/- | U248 |
| 6V4 | 8/8 | 6B87 | 4/8 | 50L6 | 16/- | ECC43 | 8/8 | PC32 | 18/- | U249 |
| 6V4 | 8/8 | 6B87 | 4/8 | 50L6 | 16/- | ECC44 | 8/8 | PC33 | 18/- | U250 |
| 6V4 | 8/8 | 6B87 | 4/8 | 50L6 | 16/- | ECC45 | 8/8 | PC34 | 18/- | U251 |
| 6V4 | 8/8 | 6B87 | 4/8 | 50L6 | 16/- | ECC46 | 8/8 | PC35 | 18/- | U252 |
| 6V4 | 8/8 | 6B87 | 4/8 | 50L6 | 16/- | ECC47 | 8/8 | PC36 | 18/- | U253 |
| 6V4 | 8/8 | 6B87 | 4/8 | 50L6 | 16/- | ECC48 | 8/8 | PC37 | 18/- | U254 |
| 6V4 | 8/8 | 6B87 | 4/8 | 50L6 | 16/- | ECC49 | 8/8 | PC38 | 18/- | U255 |
| 6V4 | 8/8 | 6B87 | 4/8 | 50L6 | 16/- | ECC50 | 8/8 | PC39 | 18/- | U256 |
| 6V4 | 8/8 | 6B87 | 4/8 | 50L6 | 16/- | ECC51 | 8/8 | PC40 | 18/- | U257 |
| 6V4 | 8/8 | 6B87 | 4/8 | 50L6 | 16/- | ECC52 | 8/8 | PC41 | 18/- | U258 |
| 6V4 | 8/8 | 6B87 | 4/8 | 50L6 | 16/- | ECC53 | 8/8 | PC42 | 18/- | U259 |
| 6V4 | 8/8 | 6B87 | 4/8 | 50L6 | 16/- | ECC54 | 8/8 | PC43 | 18/- | U260 |
| 6V4 | 8/8 | 6B87 | 4/8 | 50L6 | 16/- | ECC55 | 8/8 | PC44 | 18/- | U261 |
| 6V4 | 8/8 | 6B87 | 4/8 | 50L6 | 16/- | ECC56 | 8/8 | PC45 | 18/- | U262 |
| 6V4 | 8/8 | 6B87 | 4/8 | 50L6 | 16/- | ECC57 | 8/8 | PC46 | 18/- | U263 |
| 6V4 | 8/8 | 6B87 | 4/8 | 50L6 | 16/- | ECC58 | 8/8 | PC47 | 18/- | U264 |
| 6V4 | 8/8 | 6B87 | 4/8 | 50L6 | 16/- | ECC59 | 8/8 | PC48 | 18/- | U265 |
| 6V4 | 8/8 | 6B87 | 4/8 | 50L6 | 16/- | ECC60 | 8/8 | PC49 | 18/- | U266 |
| 6V4 | 8/8 | 6B87 | 4/8 | 50L6 | 16/- | ECC61 | 8/8 | PC50 | 18/- | U267 |
| 6V4 | 8/8 | 6B87 | 4/8 | 50L6 | 16/- | ECC62 | 8/8 | PC51 | 18/- | U268 |
| 6V4 | 8/8 | 6B87 | 4/8 | 50L6 | 16/- | ECC63 | 8/8 | PC52 | 18/- | U269 |
| 6V4 | 8/8 | 6B87 | 4/8 | 50L6 | 16/- | ECC64 | 8/8 | PC53 | 18/- | U270 |
| 6V4 | 8/8 | 6B87 | 4/8 | 50L6 | 16/- | ECC65 | 8/8 | PC54 | 18/- | U271 |
| 6V4 | 8/8 | 6B87 | 4/8 | 50L6 | 16/- | ECC66 | 8/8 | PC55 | 18/- | U272 |
| 6V4 | 8/8 | 6B87 | 4/8 | 50L6 | 16/- | ECC67 | 8/8 | PC56 | 18/- | U273 |
| 6V4 | 8/8 | 6B87 | 4/8 | 50L6 | 16/- | ECC68 | 8/8 | PC57 | 18/- | U274 |
| 6V4 | 8/8 | 6B87 | 4/8 | 50L6 | 16/- | ECC69 | 8/8 | PC58 | 18/- | U275 |
| 6V4 | 8/8 | 6B87 | 4/8 | 50L6 | 16/- | ECC70 | 8/8 | PC59 | 18/- | U276 |
| 6V4 | 8/8 | 6B87 | 4/8 | 50L6 | 16/- | ECC71 | 8/8 | PC60 | 18/- | U277 |
| 6V4 | 8/8 | 6B87 | 4/8 | 50L6 | 16/- | ECC72 | 8/8 | PC61 | 18/- | U278 |
| 6V4 | 8/8 | 6B87 | 4/8 | 50L6 | 16/- | ECC73 | 8/8 | PC62 | 18/- | U279 |
| 6V4 | 8/8 | 6B87 | 4/8 | 50L6 | 16/- | ECC74 | 8/8 | PC63 | 18/- | U280 |
| 6V4 | 8/8 | 6B87 | 4/8 | 50L6 | 16/- | ECC75 | 8/8 | PC64 | 18/- | U281 |
| 6V4 | 8/8 | 6B87 | 4/8 | 50L6 | 16/- | ECC76 | 8/8 | PC65 | 18/- | U282 |
| 6V4 | 8/8 | 6B87 | 4/8 | 50L6 | 16/- | ECC77 | 8/8 | PC66 | 18/- | U283 |
| 6V4 | 8/8 | 6B87 | 4/8 | 50L6 | 16/- | ECC78 | 8/8 | PC67 | 18/- | U284 |
| 6V4 | 8/8 | 6B87 | 4/8 | 50L6 | 16/- | ECC79 | 8/8 | PC68 | 18/- | U285 |
| 6V4 | 8/8 | 6B87 | 4/8 | 50L6 | 16/- | ECC80 | 8/8 | PC69 | 18/- | U286 |
| 6V4 | 8/8 | 6B87 | 4/8 | 50L6 | 16/- | ECC81 | 8/8 | PC70 | 18/- | U287 |
| 6V4 | 8/8 | 6B87 | 4/8 | 50L6 | 16/- | ECC82 | 8/8 | PC71 | 18/- | U288 |
| 6V4 | 8/8 | 6B87 | 4/8 | 50L6 | 16/- | ECC83 | 8/8 | PC72 | 18/- | U289 |
| 6V4 | 8/8 | 6B87 | 4/8 | 50L6 | 16/- | ECC84 | 8/8 | PC73 | 18/- | U290 |
| 6V4 | 8/8 | 6B87 | 4/8 | 50L6 | 16/- | ECC85 | 8/8 | PC74 | 18/- | U291 |
| 6V4 | 8/8 | 6B87 | 4/8 | 50L6 | 16/- | ECC86 | 8/8 | PC75 | 18/- | U292 |
| 6V4 | 8/8 | 6B87 | 4/8 | 50L6 | 16/- | ECC87 | 8/8 | PC76 | 18/- | U293 |
| 6V4 | 8/8 | 6B87 | 4/8 | 50L6 | 16/- | ECC88 | 8/8 | PC77 | 18/- | U294 |
| 6V4 | 8/8 | 6B87 | 4/8 | 50L6 | 16/- | ECC89 | 8/8 | PC78 | 18/- | U295 |
| 6V4 | 8/8 | 6B87 | 4/8 | 50L6 | 16/- | ECC90 | 8/8 | PC79 | 18/- | U296 |
| 6V4 | 8/8 | 6B87 | 4/8 | 50L6 | 16/- | ECC91 | 8/8 | PC80 | 18/- | U297 |
| 6V4 | 8/8 | 6B87 | 4/8 | 50L6 | 16/- | ECC92 | 8/8 | PC81 | 18/- | U298 |
| 6V4 | 8/8 | 6B87 | 4/8 | 50L6 | 16/- | ECC93 | 8/8 | PC82 | 18/- | U299 |
| 6V4 | 8/8 | 6B87 | 4/8 | 50L6 | 16/- | ECC94 | 8/8 | PC83 | 18/- | U300 |

The most competitive comprehensive value list in the country.
TECHNICAL TRADING CO.
 350/352 FRATTON ROAD, PORTSMOUTH

Converting the TRF Transistor Four to L.W. Tuning

By D. SAULL

A SIMPLE MODIFICATION TO THIS P.W. SET TO ALLOW RECEPTION ON THE LONG WAVE BAND.

THE four transistor TRF receiver featured in the June 1960 issue of PRACTICAL WIRELESS was described as simple to construct and therefore particularly suitable to the newcomer to transistor circuits. For simplicity, medium waveband tuning only was included, and this arrangement is entirely satisfactory for readers living equidistant from the transmitters covering the Light and the Home programmes on the medium waveband. However, in areas where it is the usual practice to receive the Light programme on the long waveband, medium waveband tuning only restricts the usefulness of the receiver, and details are given here of how best to modify the original design, in order to accommodate both wavebands. The modification necessitates introducing a four-pole, two-way, switch into the circuit, which may be the circular type (1½ in. in diameter) and also an additional L.W. R.F. transformer.

In the first method, where both coils are wound on the same ferrite rod, the medium-wave coil forms part of the winding of the long-wave coil. When the wave-change switch is turned to the medium-wave position, the long-wave section of the coil is left floating. This section of the coil has an inductance of about 2.2mH and requires only a 10pF parallel capacitance to resonate at 1.2Mc/s, which is the wavelength of the Light programme on the medium waveband. Should this section of the coil, when not in circuit, so resonate—being tightly coupled through the ferrite rod to the medium-wave tuning section of the coil—it will result in heavily loading the medium-wave coil and will render the 1.2Mc/s tuning section inoperative. The self capacity of the wave-change switch will be about 3pF, and the single-layer wound aerial coil will also possess a little self capacity—hence the stray capacity of the wiring in the circuit must be kept to an absolute minimum if trouble is to be avoided. This may be achieved by keeping the connecting lead from the top end of the long-wave coil to the switch as short as possible. To achieve this, the wave-change switch should be mounted directly beneath the ferrite rod—the switch control spindle may then extend to the rear of the receiver cabinet.

The Method of Winding the M.W. and L.W. Coils on the same Ferrite Rod

The dual-wave coil consists of 150 turns of 34s.w.g. double silk covered wire, close wound in a single layer on the former that should be a sliding fit, on the two ferrite rods; the coil is tapped as shown in Fig. 2. The former is made by winding a strip of thick paper, two inches wide, three times round the ferrite rods, adhesive having first been applied to the surfaces in contact. A piece of similar paper wrapped round the ferrite rods beforehand

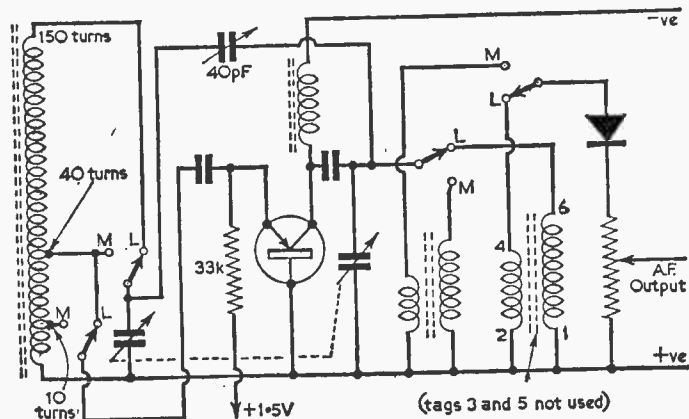

Fig. 1.—The arrangement of the second tuned circuit. The L.W. Coil used is a Teletron HLX.

The Construction of the Aerial Coils

There are three methods of constructing the aerial coils: winding the coils for both wavebands on the same ferrite rod; winding the medium-wave coil on the ferrite rod and winding a separate frame aerial to cover the long-wave tuning; or winding the long-wave coil on the ferrite rod and winding a separate frame aerial to cover medium-wave tuning. If either of the last two methods is used, the choice between them is determined by the weakest signal strength in a particular area—a frame aerial has greater sensitivity to weaker signal strengths.

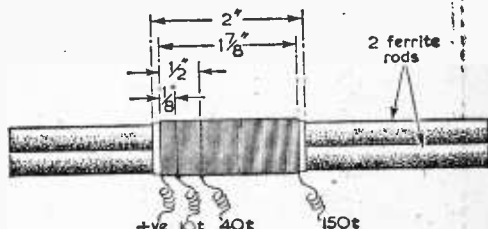
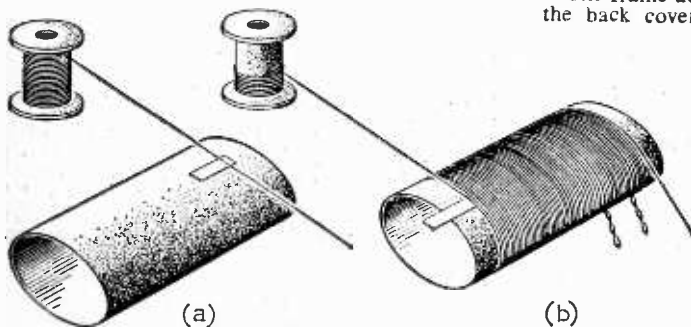

Fig. 2.—The winding details of the dual-wave coil.

will ensure a little clearance, so that the finished former is free to slide on the ferrite rod when the under piece is removed.

The gauge of wire is not critical, and it is not important that double silk covered wire is used—enamel covered wire would function electrically. However, the best conditions prevail if the given specifications are adhered to—and the guide to the physical measurements, in Fig. 2, may then be followed.



The frame aerial may be wound on the inside of the back cover of the receiver cabinet; the size should be about 7 $\frac{1}{8}$ in. x 10 $\frac{3}{8}$ in. The coil is wound round four blocks, $\frac{3}{4}$ in. square, cut from hardboard and cemented to the inside of the back cover of the receiver; four larger blocks, $\frac{7}{8}$ in square, also cut from hardboard, are cemented on top of the former blocks, to prevent the wire from sliding off (Fig. 4).

Fig. 3. (left)—The method of winding the coil on its former.

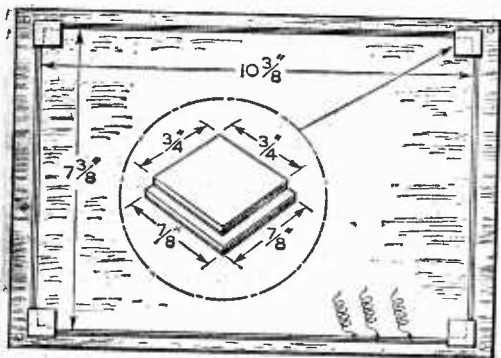

Fig. 4.—This shows the way in which the frame aerial is wound on to the inside of the back of the receiver.

The taps on the coil are formed by making a loop in the wire and twisting together the pair thus formed; then carry on winding.

A convenient method to wind the coil is to cut a narrow piece of Sellotape to a size about $\frac{1}{2}$ in. x $\frac{1}{2}$ in. to form an anchoring tab. Then wrap the extreme end of the tape round the wire and attach the wire to the former (Fig. 3a) by means of the remaining length of adhesive tape. Successive turns of the winding will hold the tape firmly in position. Likewise, slip a piece of tape, the same size as before, underneath the wire (adhesive side uppermost) about 15 turns from the completion of the winding (Fig. 3b). When the final turn has been wound on, pull the extruding length of tape upwards and back over the top of the winding. A coating of varnish over the entire winding will hold it secure, but first remove the former from the ferrite rods, otherwise it may stick to the rods. The ferrite rod aerial may then be connected, and the position of the coil on the

rods adjusted to give the best results. This position will most likely be in the centre.

Winding the M.W. and L.W. Coils Separately—One on a Ferrite Rod—the Other as a Frame Aerial

If the L.W. coil is to be wound as a frame aerial, the existing M.W. winding on the ferrite rods need not be disturbed. If the L.W. coil is to be on the ferrite rod, then wind the coil as in the first method, omitting the 10-turn tap.

The frame aerial may be wound on the inside of

the back cover of the receiver cabinet; the size should be about 7 $\frac{1}{8}$ in. x 10 $\frac{3}{8}$ in. The coil is wound round four blocks, $\frac{3}{4}$ in. square, cut from hardboard and cemented to the inside of the back cover of the receiver; four larger blocks, $\frac{7}{8}$ in square, also cut from hardboard, are cemented on top of the former blocks, to prevent the wire from sliding off (Fig. 4).

Fig. 3. (left)—The method of winding the coil on its former.

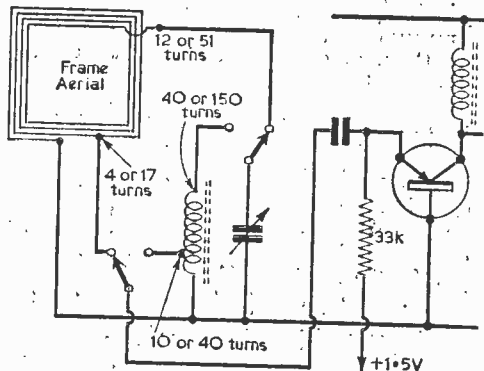

Fig. 5.—This shows the method of connecting the frame aerial in circuit.

For medium-wave tuning, the frame aerial consists of 12 turns of 34s.w.g., d.s.c., wire tapped at 4 turns; for long-wave tuning, 51 turns of the same type wire is tapped at 17 turns, connected as in Fig. 5.

The Second Tuned Circuit

The arrangement of the second tuned circuit remains identical for the three methods; and is shown in Fig. 1.

The L.W. coil used is a Teletron H.L.X.

Ascertain that connecting wires in the first and second tuned circuits of the receiver are not in close proximity, which would result in instability.

The method of aligning the receiver is the same as that described in the June 1960 issue, but in the first instance make sure that the 40pF reaction capacitor is fully out and then slowly turn in to increase the positive feed-back until the best results are obtained once the required signal is heard.

The decision is YOURS. To be a success in your chosen career; to qualify for the highest paid job . . . to control a profitable business of your own. ICS home-study courses put your plans on a practical basis; teach you theory and practice; give you the knowledge and experience to take you, at your own pace, to the top.

Choose the RIGHT course :

RADIO & TELEVISION ENGINEERING
INDUSTRIAL TELEVISION

RADIO & TELEVISION SERVICING
RADIO SERVICE AND SALES

VHF/FM ENGINEERING : ELECTRONIC
COMPUTERS & PROGRAMMING

ICS provides thorough coaching
for professional examinations:

Brit. I.R.E., City and Guilds Tele-
communication Technicians, C. & G.
Radio & TV Servicing (R.T.S.B.);
C. & G. Radio Amateurs.

LEARN AS YOU BUILD

Practical Radio Courses

Gain a sound up-to-professional-standards knowledge of Radio and Television as you build YOUR OWN 4-valve T.R.F. and 5-valve superhet radio receiver, Signal Generator and High-quality Multi-meter. At the end of the course you have three pieces of permanent and practical equipment and a fund of personal knowledge and skill. ICS Practical Radio courses open a new world to the keen Radio amateur.

Technical Training in Radio, Television and Electronics Engineering with

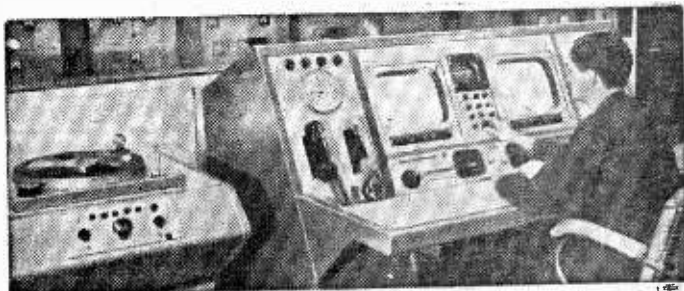

THERE ARE ICS COURSES TO MEET YOUR NEEDS AT EVERY STAGE OF YOUR CAREER. FILL IN AND POST THIS COUPON TODAY.

You will receive the FREE 60 page ICS Prospectus listing examinations and ICS technical courses in radio, television and electronics PLUS details of over 150 specialised subjects.

Other ICS courses include:
MECHANICAL, MOTOR,
FIRE, ELECTRICAL &
CHEMICAL ENGINEERING.
FARMING, GARDENING.
ARCHITECTURE &
WOODWORKING.
SELLING & MANAGEMENT.
ART. PHOTOGRAPHY,
etc., etc.

**PLEASE STATE ON COUPON
SUBJECT YOU ARE
INTERESTED IN . .**

INTERNATIONAL CORRESPONDENCE SCHOOLS
(DEPT. 170), INTERTEXT HOUSE, PARKGATE RD., LONDON, SW11
PLEASE SEND FREE BOOK ON.....
NAME
ADDRESS
.....
OCCUPATION..... AGE.....
9-81

Electronics (FLEET ST.) Ltd

Dept. B

152-153 Fleet St., London, E.C.4. Tel. Fle 2833

Business Hours; Weekdays, 9-6, Saturdays 9-1

Stockists for

AMPLIFIERS V.H.F. TUNERS, HI-FI SPEAKERS BY ALL THE LEADING MANUFACTURERS

The Transistor Set you have been waiting for!

"THE FLEET SIX"



The "Fleet 6," a wow of a transistor set that really gets the stations. New design 6 transistor superhet pocket receiver, using 6 guaranteed first grade, transistors plus sensitive diode, push pull output medium and long wave bands, new type

printed circuit, high Q internal ferrite rod aerial, 2 1/2 in. high flux speaker, provision for car aerial, overall size 6 1/2 x 4 1/2 x 1 1/2. Simple to follow instructions. All components guaranteed, service after sales. This is equal to many manufactured sets at double the price. All components including cabinets, transistors, speaker, circuit, etc., only £8/19/6 complete, post and pkg. 2/6. PP4 Battery 2/- extra. All components sold separately. Send S.A.E. for details. Circuit and Instructions 2/6 post free.

THE FLEET 6 PORTABLE TRANSISTOR RECEIVER

Using 6 guaranteed first grade transistors, sensitive diode, p/pull output, medium and long wave bands, printed circuit, high Q ferrite rod aerial, 6 x 4 high flux speaker. Provision for car aerial. Attractive 2 tone cabinet, overall size 10 1/2 x 8 x 3 1/2 in. Easy to follow instructions, all components including cabinet, transistors, speaker, circuit etc. £9.19.6d. complete P. & Pkg. 3/6. Battery extra. All components guaranteed and sold separately. Send S.A.E. for details. Circuit and Instructions 2/6 post free.



LAST FEW LEFT!

ANOTHER FAMOUS MANUFACTURER'S BARGAIN

COSSOR 4 VALVE SUPERHET PORTABLE

Long and Medium wave bands, 5in. speaker, built-in frame aerial using Ever-Ready B126 90 volt H.T. and AD35 1 1/2 volt Batteries. Attractive 2-tone finish, dimensions 9in. x 8 1/2in. x 4 1/2in. Original Price 15 gns. Our Price £8/19/6. P. & P. 3/-.

Batts. 10/- extra.

Suitable mains unit to fit in place of batteries. Original Price 63/-. Our Price 39/6 P. & P. 2/-. This Cossor Battery eliminator will replace any 90v. HT & 1 1/2v. LT, providing the set uses 96 series valves.



★ Installing hi-fi?



★ The 'Multigram' Senior houses it handsomely!

It's the newest in our wide range of handsome hi-fi furniture. Takes tape deck or turntable; pre-amp, amplifier and tuner, plus 100 records. Adapts for tape deck. 48" long, 18 1/2" deep, 14" high, 9" legs. Superbly hand-finished walnut or mahogany. Costs less than making your own—23 gns.

Write today for details of full range and name of nearest stockist.

RECORD HOUSING

DEPT. PW961

BROOK ROAD, LONDON N22

Please state location of convenient shopping centres

SOUTHERN RADIO'S WIRELESS BARGAINS

PORTABLE TEST METERS. (As featured in March issue, pages 1005 to 1010) 0-5000 ohms; 0-60 mA; 0-15 v.; 0-3 v. 12/6 each.

METERS. 30-0-30 and 3-0-3 volts, with leads. 15/-

ATTACHMENTS FOR "38" TRANSMITTER-RECEIVER;

Headphones 15/6; Throat Microphones, 4/6; Junction

Boxes, 2/6; Aerials, No. 1, 2/9, No. 2, 5/3; Webbing, 4/-;

Haversacks, 5/6; Valves—A.R.P.12 4/6, A.T.P.4, 3/6. Set

of five valves, 19/- Postage on each item 1/6 extra (except valves).

ATTACHMENTS FOR "18" TRANSRECEIVER. Head-

phones, 15/6; Microphone 4s, 12/6; Aerials, 5/-; Morse

Key, 6/6; Valves—A.R.P.12, 4/6, A.T.P.4, 3/6, A.R.8 7/6; Set

of six valves, 25/- Official booklet "18" T-R Circuits, etc., 6/6

post paid. Postage extra (except valves) 1/6 each item.

QUARTZ CRYSTALS. Types F.T.241/F.T.243 2-pin 1/2" spacing.

F.T.241 20 to 38.9 Mc/s (54th and 72nd Harmonic). F.T.243 5700

to 8650 kc/s (Fundamental), 4/6 each. Lists of available frequencies

on request. Crystal Holders for F.T.241/243, 1/3. F.T.241/243

Crystals. New but not guaranteed (ideal for using the case or

regrinding). 12/6 per dozen, post paid.

RECORDING BLANKS. New 13in., 6/- each or 15 complete

in Tin, 64.

BOMBSIGHT COMPUTERS. Ex-R.A.F. Wealth of gears,

motors, blowers, etc. Ideal for experimenters. £3.12.6, carr. paid.

RESISTANCES. 100 Assd. Useful values, new wire-ends,

12/6 per 100.

CONDENSERS. 100 Assd. Mica, Elec., Tubular, etc. New

15/- per 100.

MORSE PRACTICE SETS, Key with Buzzer on Base, with

battery. 12/6, postage 2/-.

LUFBRA HOLE CUTTERS. Adjustable. 3" to 3 1/2". 7/3.

STAR IDENTIFIERS. I-AN. Covers both hemispheres, 5/6.

VISUAL INDICATORS (10 Q4). Type 3 with 2 meter move-

ments, 2 neons. New 12/-.

MAGNETS. Strong Bar, 2" x 1/2" 1/6 each.

COMMAND RECEIVERS B.C. 454 3-6 Mc/s. B.C. 455 6-9 Mc/s.

Complete with 6 valves, new condition, 47/6 each.

POST OR CARRIAGE EXTRA, FULL LIST OF RADIO BOOKS, ETC., 3d.

SOUTHERN RADIO SUPPLY LTD.

11 LITTLE NEWPORT ST., LONDON W.C.2. GER. 6653

Letters to the Editor

The Editor does not necessarily agree with the opinions expressed by his correspondents

Whilst we are always pleased to assist readers with their technical difficulties, we regret that we are unable to supply diagrams or provide instructions for modifying commercial or surplus equipment. We cannot supply alternative details for receivers described in these pages. **WE CANNOT UNDERTAKE TO ANSWER QUERIES OVER THE TELEPHONE.** If a postal reply is required a stamped and addressed envelope must be enclosed with the coupon from page 111 of the cover.

TRANSMITTER LICENCES

SIR,—Surely we have not started that stupid business about low-power transmitter licences again? Mr. Dick's letter in the July issue seems to point to this. To own a "ham" transmitter licence is a privilege, not a right, and it seems only fair that one should earn this privilege by taking the G.P.O. examination. As for saying that only a simple test, if any, would be required, is ridiculous; the present test does not seem all that difficult.

Regarding his wish to abolish the morse test for inputs of under one watt, I should have thought that morse was the only way to achieve a reasonable range with this type of equipment. Moreover, if this test were abolished, there would be dozens of irresponsible people using ex-government transceivers, which, among other things, are by no means TVI-proof.—M. J. REDMAN (Brighton).

SIR,—I have read with interest the great deal of correspondence which you have published recently on the subject of novice licences.

It has been my ambition for the last three years to obtain an amateur transmitting licence, and at last I have taken the Radio Amateurs Examination, and am now striving to attain the morse sending speed necessary for the G.P.O. test. If, and when, I finally obtain my licence, I shall feel justified in using the frequency bands allocated to amateurs. I have been asked by many people studying science subjects what justification amateurs have in using parts of the precious frequency spectrum for their own pleasure. I then proceed to tell them that at least the amateur has a knowledge of morse, which might be valuable in an emergency.

If novice licences or special concessions to "phone-only" operators were permitted in this country, the people who have to defend the amateur's cause would have no argument for the continued existence of amateur bands.

It takes three years as an SWL to become really familiar with amateur procedure, and anyone who cannot accumulate enough knowledge in that time to pass the RAE cannot be really interested in amateur radio.—D. A. PARK (Bagshot).

ITV SOUND

SIR,—The reception of TV sound on a radio receiver, as described by B. Quest (July issue) can sometimes be caused by the sound channel of a local TV station interacting with part of the lower vision side-band to form an intermediate frequency; similar to the I.F. generated in a frequency changer.

Reception of such a signal can only be on a sensitive TRF receiver; not with a superhet. This effect disappears below 1Mc/s—750kc/s, this being the separation between the furthest sound and vision signals, and it should disappear altogether when the vision carrier is not modulated.—C. BARNES (Cheshire).

VINTAGE MODELS

SIR,—I was not surprised to read in the July issue of P.W. a letter from Mr. A. V. Newman expressing his pleasure on hearing a friend's 1934 radio.

The pleasant tone of these vintage sets is a phenomenon not met in these days of "high fidelity".

I would not care to open any discussion on the merits or demerits of high fidelity in these columns—it would rage on indefinitely—but the pleasure derived from listening to music on the old faithfuls is almost entirely due to the absence of the more irritating top frequencies and the presence of a measure of "woofiness" from the larger cabinets with their uncontrolled resonances.—W. J. HUNTINGFORD (Guildford).

CORRESPONDENTS WANTED

SIR,—I am 15 years old and I am very interested in radio and TV construction and theory. I would therefore like to correspond with any other readers of the same age.—H. JOHNSTONE (2 Fox Hill, Distington, Cumberland).

DISHEARTENED SWL

SIR,—Being one of the "younger SWL's set", and after reading in several books that local hams are always ready to help SWLs, I decided to visit a nearby operator.

The books could not have been more wrong! He considered that SWLs were maniacs, forgetting that he was once one himself.

I can only hope that not all amateur radio enthusiasts hold similar opinions.—E. L. W. (Cheshire).

THREE FREE BLUEPRINTS

WITH the October, November and December issues we are presenting free blueprints intended to teach the beginner the fundamentals of practical radio construction and also to enable him to build useful receivers for his own use. The final design will be a transistorised superhet tuner unit with an amplifier which may also be used with a battery-operated record player.

EACH DESIGN WILL INCORPORATE

- inexpensive construction
- readily available components
- long and medium wave reception

NEXT MONTH—The first blueprint (The P.W. Tutor) deals with a crystal set suitable for the absolute beginner which is then modified in four simple stages by adding parts to make progressively more advanced sets. Each set gives greater amplification than the preceding model, and the final receiver is a selective, reflexed, regenerative circuit.

A Wobbulator for F.M. I.F. Alignment

(Continued from page 410)

The circuit of the instrument is shown in Fig. 1. A signal derived from the X-detecting plates of the oscilloscope is fed to VIA which is arranged in a cathode-follower circuit. The silicon-junction diode is connected from the cathode load of this valve to the tuned circuit of the oscillator, which is set to give a centre (unmodulated) frequency of 10.7Mc/s. The voltage across the cathode resistor (R4) also provides the reverse bias necessary for the diode. The decoupling condensers C2 and C3 are given large values to ensure that the timebase

waveform suffers negligible distortion in passing through VIA.

Although the second half of V1 is not used in the circuit, it is given a feed from the H.T. so that a current passes through it all the time that the unit is switched on; this avoids "cathode poisoning" or loss of emission in V1B.

The 10.7Mc/s oscillator is provided by V2A and the circuit values are so arranged that the frequency of operation is 10.7Mc/s when there is no input to VIA. This centre frequency is set by altering the setting of a dust core in the former of coil L1.

(To be continued)

COMPONENTS LIST

Resistors:

| | | | | |
|---------|---------|---------|----------|----------------|
| R1 10M | R4 6.8k | R7 22k | R10 220Ω | R13 10M |
| R2 1M | R5 100k | R8 4.7k | R11 470Ω | VR1 2M |
| R3 220Ω | R6 100k | R9 1M | R12 1k | VR2 10k or 25k |

Capacitors:

| | |
|-----------------------------|---|
| C1 0.25μF 350VW Paper | C7 50pF Ceramic |
| C2 32μF 350VW—Daly W3 13-10 | C8 1000pF Ceramic |
| C3 32μF 350VW—Daly W3 13-10 | C9 1000pF Ceramic |
| C4 1000pF Ceramic | C10 0.01μF Paper 250VW |
| C5 1000pF Ceramic | C11, C12 16, 16μF 350VW— Daly W2/39/10 |
| C6 20pF Ceramic | |

Valves: VIA and V1B ECC81

V2A and V2B ECC81

Diode: DI 5VC1 GEC Semiconductor Division, School Street, Hazel Grove, Stockport, Cheshire

Chassis: 6in × 4in. × 2½in., approximately

Coil: This is wound on a ½in. internally threaded coil former and details are given in Fig. 4. A dust core is required.

Sundries: Two B9A valveholders, tag strips, mains switch, wire, etc.

Transformer: Mains primary, 180V to 250V H.T. secondary, 6.3V 1A winding for heaters. (A "converter" transformer is very suitable.)

Rectifier: Miniature contact-cooled type—200-250V, 40mA

Note that the value of R12 may require to be altered to ensure that the H.T. line voltage does not exceed 190.

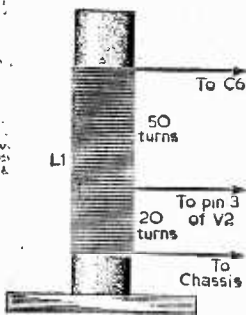

Fig. 4.—Details of the coil windings (on ½in. former with dust core).

465 Kc/s. SIGNAL GENERATOR. Total cost 15/-. Uses B.F.O. Unit ZA 30038 ready made. **POCKET SIZE** 2 1/2 x 4 1/2 x 1 1/2. Slight modifications required, full instructions supplied. Battery 7/6 extra 60 v. + 1 1/2 v.

TRIMMERS. Ceramic, 30, 50, 70 pF., 9d.; 100 pF., 150 pF., 1/3; 250 pF., 1/6; 500 pF., 750 pF., 1/8. **RESISTORS.** Preferred values. 10 ohms to 10 meg., 1/4 w. 4d.; 1 w. 4d.; 1 w., 6d.; 1 1/2 w., 9d.; 2 w., 1/1-; **HIGH STABILITY.** 1/4 w., 1%, 2/1-. Preferred values. 10Ω to 10 meg. Ditto, 5%, 100Ω to 5 meg., 9d. 5 watt 1/8
10 watt 25 ohms-10,000 ohms 2/1-
16 watt 25 ohms-10,000 ohms 3/1-
12.5K to 50K 10 ... 2/1-

AMERICAN "BRAND FIVE" PLASTIC RECORDING TAPE

| | | | |
|-------------|--------------------|------|-----------|
| Double Play | 7in. reel, 2,400ft | 80/- | Spare |
| | 5in. reel, 1,200ft | 37/6 | Plastic |
| Long Play | 7in. reel, 1,800ft | 35/- | Reels |
| | 5in. reel, 1,200ft | 23/- | 3in. 1/6 |
| | 5in. reel, 900ft | 18/6 | 4in. 2/- |
| | | | 5in. 2/- |
| Standard | 7in. reel, 1,200ft | 25/- | 5in. 2/1- |
| | 5in. reel, 600ft | 13/6 | 7in. 2/6 |

"Instant" Bulk Tape Eraser and Head De-auser, 300/250 v. A.C., 27/6. Leadset, S.A.E.

O.P. TRANSFORMERS. Heavy Duty 60 mA, 4/6. Inductance, 334, etc., 5/8. Multitap push-pull, 7/6. Push-Pull 10 w., 15/6. 10 to 20 w., 6K. P.F., 30/1-. **L.F. CHOKES** 15/10 H. 60/65 mA. 6/-; 10 H. 85 mA, 10/6; 10 H. 120 mA, 12/6; 10 H. 150 mA, 14/1-

MAINS TRANSFORMERS: 200/250 v. A.C. STANDARD, 250-0-250, 80 mA. 6.3 v. 3.5 a. 5/-
tapped 4 v. 2a. Rectifier 6.3 v. 1 a. 5/-
2 a. or 4 v. 2 a. ditto, 500-0-500 ... 22/6
MINIATURE, 200 v. 20 mA, 6.3 v. 1 a. ... 10/8
MIDGET, 250 v. 45 mA, 6.3 v. 2 a. ... 15/6
SMALL, 220-0-220, 60 mA, 6.3 v. 3.5 a. ... 17/6
STD., 250-0-250, 65 mA, 6.3 v. 3.5 a. ... 17/8
HEATER TRANS. 6.3 v. 1 1/4 7/6 3A ... 10/6
Ditto 1.4, 2.3, 4.5, 6.3 v. 1 1/4 ... 8/6
Ditto Tapped, 6.3 to 20 v., 2 a. ... 22/6
AUTO TRANS. 110-240 v. 150 w. ... 22/6
Ditto 600 w. ... 32/6

ALADDIN FORMERS and core, 8in., 8d.; 1in., 10d. 3 in. FORMERS 5937/8 and Cans T/2. 7in. sq., 1in. x 2 1/2in. and 1in. sq. 1 1/2in., 2/- ea., with cores.
SOLOIN Midget Iron 200/10v. or 230/40v. 25w. 24/-
MAINS DROPPER, 3in. x 1 1/2in. ad. 5/6. 8/6.
LINE COIL, 0.3 amp., 60 ohms per ft., 0.3 amp., 100 ohms per ft., 2-way, 1/1-. per ft., 3-way, 1/1-. per ft.
LOUDSPEAKER F.M. 3 ORN. 5in. Roia. 17/6. 8in. Piesley, 19/6. 7in. x 4in. Piesley, 18/-, 6/10. Roia. 18/6. 10 x 6in. 27/6. 10in. Roia. 30/-.
4in. Tweeter, 25/- 12in. B.A. 30/-, 14 x 8in. 45/-
STENTORIAN HP1012, 10in. 3 to 15 ohms 10 w., 95/-
12in. Baker 15 watt 3 ohms or 15 ohms, 90/-
12in. BAKER FOAM SPHONEX, 15 ohms, 85/-
CRYSTAL DIODES: 8/-, 6HX34, 4/-
HIGH RESISTANCE PHONES: 1,000 ohms, 15/-
LOW RESISTANCE PHONES (BA6), 7/6 pr.
MIKE TRANSF. 50-1, 3/9 ea.; 100:1, Potted, 10/6.
SWITCH CLEANER. Fluid squirt sprout, 4/3 1/2.
TWIN GANG TUNING CONDENSERS: 100 pF. Standard with trimmers, 9/-; midget, 7/6 with trimmers.
SINGLE. 50 pF., 80 pF., 100 pF., 160 pF., 5/6. Solid dielectric 100, 300, 500, pF. 3/6.
SPEAKER FRET GOLD CLOTH. 17in. x 25in., 5/-; 25in. x 39in., 10/-; Pyran, 62in. wide, 10/- ft.; 26in. wide, 5/- ft. Send for samples S.A.E.

New and Boxed **VALVES** 90-day Guarantee.

| | | | | | | | |
|-------|-----|-------|------|--------|------|-------|------|
| 1R5 | 7/6 | 6K89 | 7/8 | EAB080 | 8/6 | HVR2A | 6/6 |
| 1R5 | 7/6 | 6L6G | 10/8 | EB91 | 9/6 | MU14 | 9/- |
| 1T4 | 8/- | 6CT6 | 7/6 | EB33 | 8/6 | PC084 | 9/6 |
| 384 | 7/6 | 6937M | 6/6 | EB41 | 3/6 | PCP80 | 9/6 |
| 3V4 | 7/6 | 69N7 | 6/6 | EBF90 | 10/- | POL82 | 11/6 |
| 5U4 | 7/6 | 6Y6G | 6/6 | EO084 | 9/6 | PL92 | 10/6 |
| 5Y3 | 7/6 | 6X4 | 7/8 | ECF90 | 9/6 | PY60 | 7/6 |
| 5Z4 | 9/6 | 6X5 | 6/6 | ECL82 | 10/6 | PY81 | 9/6 |
| 6A5 | 5/- | 12AT7 | 8/- | ECL82 | 10/6 | PY89 | 7/6 |
| 6B8 | 5/6 | 12AU7 | 3/- | EF41 | 9/6 | 8P11 | 3/6 |
| 6B8 | 5/6 | 12AX7 | 3/- | EF60 | 5/6 | UB041 | 3/6 |
| 6D6 | 4/- | 12K7 | 6/6 | EF80 | 3/- | UB42 | 3/6 |
| 6F6G | 7/6 | 12Q7 | 6/6 | EL82 | 5/6 | UL41 | 9/6 |
| 6H6 | 3/6 | 15L6 | 6/6 | EL82 | 5/6 | UL41 | 9/6 |
| 6J5 | 6/6 | 6X324 | 7/- | EL84 | 3/6 | UY41 | 8/- |
| 6J6 | 5/6 | 80 | 9/6 | EZ40 | 7/6 | UY85 | 8/6 |
| 6J7G | 6/6 | 80 | 5/6 | EZ80 | 7/6 | U23 | 8/- |
| 6K6GT | 6/6 | 954 | 1/6 | EV81 | 9/6 | VB105 | 8/6 |
| 6K7G | 5/- | EA50 | 10/6 | EV86 | 10/- | VR150 | 9/6 |

DK96, DAF96, DF90, DL96 8/6 ea. 30/- set.

"REGENT" 4 VALVE



PRINTED CIRCUIT BATTERY PORTABLE KIT

Medium and long wave. Powerful 7 x 4in. Speaker. T.O.C. Printed Circuit and condenser. Components clearly identified with assembly instructions. Oscon Ferrite Aerial Coils. Resin covered cabinet. 12in. x 8in. x 4in. Batteries B12E (L5512) and AD35 (L6040), 10/- extra. Instructions 9d. (free with kit). Mains Unit ready made for above 39/6. Sold separately. Details free.

ARMSTRONG AF 208 AM/FM RADIOGRAM CHASSIS

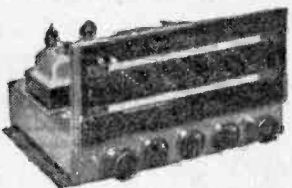

★ Full VHF Band (87-108 Mc/s) and Medium Band, 187-570M. ★ 7 Valves ★ 5 Watts output ★ 10dB Negative Feedback ★ Separate wide range Bass and Treble Controls ★ Frequency Compensated Pick-up Inputs ★ Frequency Response 30-22,000 c.p.s. ± 2dB ★ Tape Record and Playback Facilities ★ Continental Reception of Good Programme Value ★ For 3 1/2 and 15 ohm speakers. 12 Month Guarantee ★ Installation and Service Manual Supplied. Leaflet free.

Price **22 Guineas** Carr. Free
RECOMMENDED SPEAKER 12in. BAKER STALWART, £4.10.0.



4 Speed Autochangers, B.R.R., U.A.S. £6.15.0
4 Speed Autochangers, U.A.S. Stereo £2.10.0
Garrard RC131-GCS Head ... £8.15.0
Garrard Model 210, G.C.S. Head ... £10.10.0
4 Speed Single Players, E.M.I. ... £6. 5. 0
Garrard TA Mk. 11 G.C.S. Head ... £8. 0. 0
Garrard 4 HF Transcription G.C.S. £17.19.6
Garrard Stereo Heads ... £2. 0. 0
All Sapphire 87yll available from 6/-

Volume Controls 80 ohm COAX

Thin spindles. Midget 5K ohms to 2 Meg. 0.18 Sw. D.P. 3w. 4/6
Linear or Log Tracks.
COAX PLUGS 1/-
PANEL SOCKETS 1/-
LEAD SOCKET ... 2/6
OUTLET BOXES ... 4/6
DATTED TWIN FEEDER yd. 6d. 80 or 300 ohms.
BALANCED SCREENED per yd. 1/8. 80 ohms only.
WIRE-WOUND POTS, 3 WATT. Pre-cut Min. T/Type. All values 10 ohms to 25 k, 31- ea.
ALUMINIUM PANELS. 12 x 12ins. 4/6; 14 x 9in., 4/1-; 12 x 12ins. 4/6; 14 x 9in., 4/1-; 12 x 12ins. 3/1-; 10 x 7in., 2/6.

ALUMINIUM CHASSIS. 15 s.w.g. undrilled. With 4 sides, riveted corners and lattice fixing holes, 2 1/2in. sides, 7 x 4in., 4/8; 9 x 7in., 5/9; 11 x 7in., 6/8; 13 x 9in., 8/6; 14 x 11in., 10/6; 15 x 14in., 12/6; 18 x 15 x 3in., 15/6; Aluminum Panels, 12 x 12ins. 4/6; 14 x 9in., 4/1-; 12 x 12ins. 3/1-; 10 x 7in., 2/6.

CONDENSERS. 1000 pF. 7 kV. T.C.C. 5/8. 500 1,000 pF. 20 v. 9/8, 0.1 mfd. 7 kV. 9/8. Tubular 600 v. 0.001 to 0.05 mfd., 9d. 0.1, 1/1- 0.25, 1/8; 0.5/500 v. 1/8; 0.1/350 v., 9d.; 0.1/1000 v. 1/9; 0.01/2,000 v. 1/9; 0.1 rfd., 2,500 volta, 3/6.
CERAMIC COND. 500 v., 0.3 pF. to 0.01 mfd., 9d.
SILVER MICA CONDENSERS. 100 v. 5 pF to 0.01 mfd., 9d. (±1 pF) 2 pF to 47 pF, 1/8. Ditto 1% 10 pF to 815 pF, 1/8; 1,000 pF to 5,000 pF, 2/1-

I.F. TRANSFORMERS 7/6 pair
465 Kc/s Slur Tuning Miniature Can. 1 1/2in. x 1in. Height. High Q and good bandwidth. Data sheet supplied.

NEW ELECTROLYTIC. FAMOUS MAKES

| TUBULAR | TUBULAR | CAN TYPES | 9/- |
|---------------|------------------|---------------------|------|
| 1/350v. 2/- | 50/350v. 5/8 | 8/600v. | 9/- |
| 2/350v. 2/3 | 100/25v. 2/8 | 16/450v. | 5/6 |
| 4/450v. 2/3 | 250/25v. 2/8 | 32/250v. | 4/1- |
| 8/450v. 2/3 | 500/12v. 3/1 | 100/270v. | 5/6 |
| 8/500v. 2/3 | 8/5450v. 3/8 | 2,500/3v. 5/1- | 4/1- |
| 16/450v. 3/1- | 8+16/450v. 3/8 | 22+32/350v. 4/1- | 6/1- |
| 16/600v. 4/1- | 8+16/500v. 4/8 | 52+32/450v. 3/1- | 5/1- |
| 32/450v. 3/9 | 16+16/450v. 4/8 | 80+50/350v. 7/1- | 2/1- |
| 50/25v. 1/9 | 16+16/500v. 5/1- | 84+120/350v. 1/1- | 2/1- |
| 20/50v. 2/1- | 32+32/350v. 4/8 | 100+200/270v. 12/1- | 2/1- |

H.I.-GAIN BAND 3 I.T.A. PRE-AMP KIT.
Cascaded circuit with valve EC004 or PC008. Price 29/6. With Power Pack 49/6. Plans only 6d. Band I.B.C. version, same prices.

SELENIUM RECTIFIER. 300 v., 85 mA., 7/8.
CONTACT COILED. 250 v. 50 mA., 7/6; 60 mA., 8/6; 85 mA., 9/6; 200 v., 21/-, FC31, 300 mA., 27/6.
COILS Weirite. P type 3/- each, Oscon Midget "Q" type ad. dust cover from 4/1-. All ratings.
TELETRON. 250 v., 1.5 w., T.B. 200 v. reaction, 3/6.
FERRITE ROD AERIALS. M.W., 8/9; M. & L. 12/6. Ditto for transistor circuits. M. & L. 10/-.
FERRITE ROD. 3in. x 1/2in. dia., 3/6.
T.R.F. COILS, A/H/F. 7/6 pair. **H.F. CHOKES** 2/6

JASON F.M. TUNER COIL SET. 29/-
H.F. coil, aerial coil, Oscillator coil, two I.F. trans. 10.7 Mc/s. Ratio Detector and heater choke. Circuit book using four 6A8/6, 2/6.
COMPLETE JASON F.M. KIT F/ML with set of 4 valves, 26.5.0. Details S.A.E.

FULL WAVE BRIDGE SELENIUM RECTIFIERS. 2, 6 or 12 v., 11 amp., 8/9; 2 a., 11/8; 4 a., 17/6
CHARGER TRANSFORMERS. Tapped input 200/250 v. for charging at 2, 6 or 12 v., 11 amps, 15/6; 2 amps., 17/6; 4 amps., 22/6. Circuit included.
VALVE and TV TUBE equivalent books, 9/6.
VALVE DATA. Vol. 1, 2, 3 or 4, 5/- each.
TOGGLE SWITCHES. S.P. 2/-, D.P. 3/6. D.P. 4/1-
WAVECHANCE SWITCHES
5 p. 4-wave 2 waier-10n spindles ... 6/8
2 p. 2-way, or 3 p. 2-way short spindles ... 2/8
3 p. 4-way, 4 p. 2-way, 4 p. 3-way long spindle 3/8
3 p. 4-way, or 1 p. 12-way long spindle ... 3/6
VALVE HOLDERS. Pax Int. Oct. ad. EF50, EA60, 6d. B12A, CRT. 1/3. Eng. and Amer. 4, 6, 8, and 7 pin, 1/4. MOULDED MAZDA and Ins. Oct. 6d. E70, B8A, B89, B9A, 8d. BYG with can, 1/8. B94, 1/4c. can, 1/8. CERAMIC EF50, B70, B9A. Int. Oct. 1/-, 5/Cans. B7G, B9A, 1/-.

NEW MULLARD TRANSISTORS

| | | | |
|------------|-----|---------|------|
| Audio OC72 | 8/8 | EP OC44 | 10/6 |
| OC75 | 8/8 | OC45 | 9/6 |

Sub Miniature Electrolytics, 15 volt.
1, 2, 4, 5, 8, 25, 50, 100 mfd. 2/each.
"P.W." Pocket 6 Transistor Kit. All parts Printed Circuit and Cabinet. ... £8.15.0

RADIO COMPONENTS SPECIALISTS

Postal Service 1/4, over £2 free C.O.D. 1/6 (Export Post Extra. Nō C.O.D.) (Wed. 1 p.m.) THO 1665. Buses 133 or 68

WEYRAD

COILS AND TRANSFORMERS FOR A 2-WAVE TRANSISTOR SUPERHET WITH PRINTED CIRCUIT AND FERRITE ROD AERIAL

LONG AND MEDIUM WAVE AERIAL—RA2W
On 6 in. rod, $\frac{1}{8}$ in. diameter, connections to 6-Tag Ring, 208 pF tuning 12/8

OSCILLATOR COIL P50/1AC
Medium wave in screening can. For 176pF tuning condenser 5/4

1st AND 2nd I.F. TRANSFORMERS—P50/2CC
470 Kc/s operation with 250 pF tuning in cans. $\frac{1}{2}$ in diameter by $\frac{3}{4}$ in. high 5/7
(2 REQUIRED)

3rd I.F. TRANSFORMERS—P50/3CC
Last stage transformers to feed diode detector. Size at P50/2 6/-

DRIVER TRANSFORMER—LFDT2
Upright mounting with six connecting tags— $1\frac{1}{2}$ in. x $\frac{7}{8}$ in. x $1\frac{3}{4}$ in. 9/8

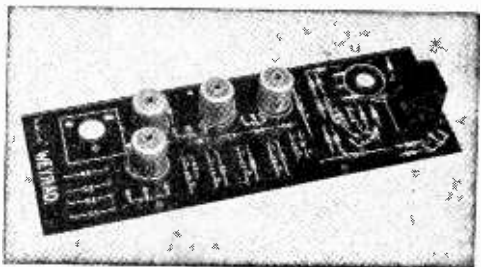

PRINTED CIRCUIT—PCAI

Size: $2\frac{1}{4}$ in. x $8\frac{1}{4}$ in. Ready drilled and printed with component positions 9/8

THESE COMPONENTS ARE APPROVED BY TRANSISTOR MAKERS AND PERFORMANCE IS GUARANTEED.

Constructor's Booklet with full details, 2/-.

WEYMOUTH RADIO MANUFACTURING CO., LTD.
CRESCENT STREET, WEYMOUTH, DORSET

SELENIUM RECTIFIERS

| | | |
|---------------------|------------------------|----------------------|
| F.W. BRIDGE | H.T. Types H.W. | |
| 6/12v. 1 a. ..3/11 | 150 v. 40 m.a. .. 3/9 | |
| 6/12v. 2 a. ..8/11 | 250 v. 60 m.a. ..3/11 | |
| 6/12v. 3 a. ..9/9 | 250 v. 60 m.a. ..4/11 | |
| 6/12v. 4 a. ..15/3 | 250 v. 80 m.a. ..5/11 | |
| 6/12v. 6 a. ..15/3 | 250 v. 250 m.a. ..11/9 | |
| 6/12v. 10 a. ..25/9 | CONTACT-COOLED | |
| 6/12v. 15 a. ..35/9 | 250 v. 80 m.a. H.W. | 6/11. 250 v. 50 m.a. |
| 24 v. 2 a. ..14/9 | F.W. | (Bridge) 8/11 |

B.S.R. MONARDECK TAPEDECKS.

Speed 3 1/2 in. per sec. High quality recording heads. 7 gms. Carr. 5/-.
Suitable polished veneered walnut carrying case for above 39/8. (Space for amplifier.)

EX-GOVT. CASES. Size 14-10 1/2 in. high. Well ventilated, black crackle finished, undrilled cover. IDEAL FOR BATTERY CHARGER OR INSTRUMENT CASE OR COVER COULD BE USED FOR AMPLIFIER. Only 9/8, plus 2/- postage.

LINEAR TREMOLO/PRE-AMP UNIT

Type TPU/1, with 3 controls, volume, amplitude and frequency. Inputs for guitar and microphone. Requires power supply of 250 v. 10 m.a. and 6.3 v. 1 a., available from any R.S.C. or LINEAR amplifier. The unit is merely connected to normal input socket of hi-fi amplifier or guitar amplifier. Only 5 gns.

MICRO-AMMETERS. 3 in. diam. 0-50 micro-amps. 33/9.

R.S.C. GRAM AMPLIFIER KIT. 3 watts output. Negative feedback. Controls Vol. Tone and Switch. Mains operation 200-250 v. A.C. Fully isolated chassis. Circuit etc. supplied. Only 39/8. Carr. 3/6.

HI-FI WATT AMPLIFIERS

Brand new. Manufacturer's discontinued line. Fitted Mullard valves. Dual inputs for "mike" and gram., etc. Bass and Treble Controls. High sensitivity and quality. For 200-250 v. A.C. **£6.19.6**

POCKET PORTABLE 3 TRANSISTOR RADIO DESIGN. Handsome plastic cabinet. "Built-in" ferrite rod aerial, and Miniature loudspeaker unit. Regenerative circuit using 2 Brimar R.F. transistors. 1 output transistor and crystal diode. Point-to-point wiring diagrams and instructions 12d. Total cost of all necessary parts only 49/8.

PRACTICAL WIRELESS SUPER SIX POCKET PORTABLE RADIO DESIGN
Diagrams etc., 1/9 or All parts including printed circuit and first grade transistors 28/19.6.

MULTI-METERS, Ferranti Universal A.C./D.C. 59/6.

CABY A10. Basic Meter sensitivity 155 micro-amps. A.C. and D.C. ranges 24.17 d.

CABY B20. Sensitivity up to 10,000 ohms per volt, A.C. and D.C., 26.10.0.
S.A.E. will bring leaflets on A10 or B20.

RELAYS. Carpenters' Type, Polarised 2 times 9,500 turns at 1,625 ohms, 13/9.
Miniature Type G.E.C. 670 Sealed, wire ends, 4 c/overs, platinum M1056, 12/9.

SPECIAL OFFER EX-GOVERNMENT SELENIUM RECTIFIERS. 12 v. 15 amp. with large square cooling fins. 19/8 each.

EX. GOVT. SMOOTHING CHOKES. 200 mA., 3-5 H., 50 ohms, Parmeko 8/9; 100 mA., 5 H., 100 ohms 9/11; 150 mA., 10 H., 50 ohms 9/8; 80 mA., 20 H., 500 ohms 5/9; 120 mA., 12 H., 100 ohms 6/9; 50 mA., 50 H., 1,000 ohms 6/9; 100 mA., 10 H., 100 ohms 6/9; 60 mA., 5-10 H., 250 ohms 2/11.

EX. GOVT. MAINS TRANSFORMERS
Primaries 200-250 v. 50 c.p.s. A.C.
250v. 60 m.a. 6.3v. 2a. 11/9
250 v. 0-250v. 60 m.a. 6.3v. 2a. 12/8
270-0-275v. 100 m.a. 6.3v. 7a. 5v. 3a.1. 21/9
300-0-300v. 60 m.a. 6.3v. 2a. 12/11
300-0-300v. 100 m.a. 6.3v. 2a. 5v. 2a. ... 18/9
350-0-350v. 160 m.a. 6.3v. 5a. 5v. 3a. ... 27/9
5v. 10a. Parmeko 11/9
400-0-400v. 200 m.a. 17/9
0-35-40-45-50v., 300 m.a. 6.3v. 3a. ... 17/9
450-0-450v. 100 m.a. 6.3v. 1.5a. 4v. 3.5a. 5v. 2.5a. 22/9

2 VOLT ACCUMULATORS
Varleys small size 4 x 3 1/2 x 4 1/2 in., 2 v. 14 A.H., brand new 6/9 ea. 3 for 15/6.

FIELD TELEPHONES



With bell. Require only small battery. Suitable for office, factory, warehouse, or outside intercommunication. 59/8 each.

TERMS: C.W.O. or C.O.D. No. C.O.D. under 21. Post 1/9 extra under 22. 2/9 extra under 25. Open 9 to 6, Weds. until 1 p.m. Trade supplied, S.A.E. with all enquiries.

Mail Orders to 29-31 Moorfield Road, Leeds 12.

Personal Shoppers to: 5 and 7 County (Mecca) Arcade, Briggate, Leeds 1.
8-10 Brown Street (Market Street), Manchester 2.
56 Morley Street (next to Majestic Ballroom), Bradford.
73 Dale Street, Liverpool 2.

R.S.C.
(Manchester)
Ltd.

**LIVERPOOL
BRADFORD
MANCHESTER
and LEEDS**

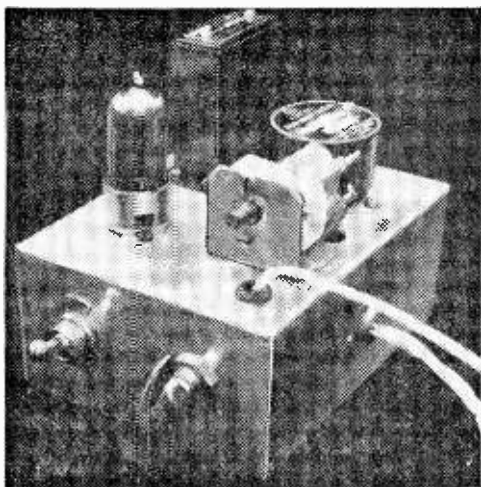

A crystal frequency marker

By J. Longwood

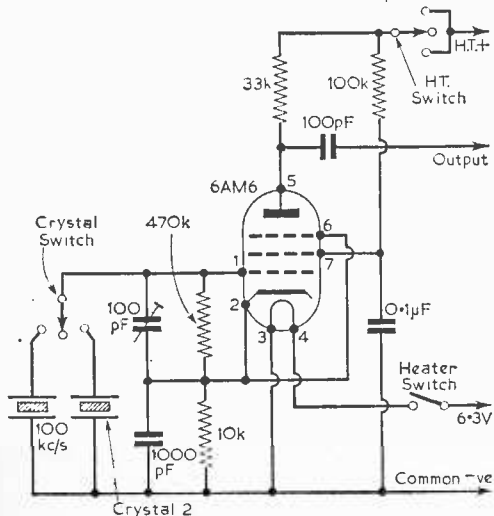

Fig. 1.—The circuit of the unit.

CRYSTAL frequency markers are intended to give frequency check points over a wide range, so that receivers or signal generators may be accurately calibrated. The marker described here has a useful coverage of 100kc/s (3,000m) up to about 15Mc/s (20m) or more, the maximum frequency depending on the sensitivity of the receiver.

The Circuit

The circuit is shown in Fig. 1, and any high slope, R.F. type pentode may be used instead of the 6AM6. With some valves pin connections will of course be different, while octal valves will require an octal holder instead of the miniature holder. Two crystals are provided for, but it is perfectly in order to use a single crystal only, as will be explained. The current required by the valve may usually be drawn from the receiver. The marker may be permanently connected—the heater switch being opened when it is not required. In addition to the heater switch, the 3-way rotary switch, which allows either crystal to be selected, has a central "off" position which interrupts the H.T. circuit. This allows the marker to be turned off and on again without waiting for the heater to reach working temperature. It also allows the marker signal to be interrupted at any time, so that it can be easily distinguished from other carriers which may be heard on crowded S.W. bands.

Operating Details

Constructors who have not used a crystal marker will probably find details of the method of operation useful. When the 100kc/s crystal is in circuit, the output from the marker is at 100kc/s and multiples of 100kc/s. As example, its signal will be heard at 200kc/s (1500m), 300kc/s (1000m) and so on. In terms of wavelength, the marker signals are widely spaced on long waves, but much closer together on medium waves, and closer still on short waves. As 100kc/s is the same as 0.1Mc/s, the signal will be heard at 0.1Mc/s intervals throughout M.W. and S.W. bands. For example, on the M.W. band of about 600kc/s to 1500kc/s, the marker signal will be present at 600, 700, 800, 900 and 1000kc/s, and 1.1Mc/s (1,100kc/s), etc., up to 1.5Mc/s (1,500kc/s). The same result is obtained on S.W. bands. Harmonics become weaker, and this sets the upper limit at which the marker signal can be heard. With a highly sensitive receiver, harmonics may be heard up to 30Mc/s (10m).

Receiver Calibration

For receiver calibration, the appropriate marker harmonics are tuned in, and the receiver scale is drawn up to agree, or the dial readings are noted down. For example, marker signals at 3.5, 3.6, 3.7 and 3.8Mc/s will accurately set the limits of the "80m" amateur band. Medium wave tuning scales, or commercial S.W. bands, can be calibrated in the same way.

In the unit shown, crystal 2 was a 1750kc/s crystal. When in circuit, this gives marker signals at 3.5Mc/s, 7Mc/s, etc., in addition to the fundamental (1750kc/s), for easy identification of

amateur bands, with any receiver. Almost any crystal which may be in hand can be used for a somewhat similar purpose. It is also quite usual to have a 1Mc/s crystal, to give tuning points at 1Mc/s intervals, the 100kc/s crystal then being used to fill in the 0.1Mc/s tuning points between those obtained with the 1Mc/s crystal.

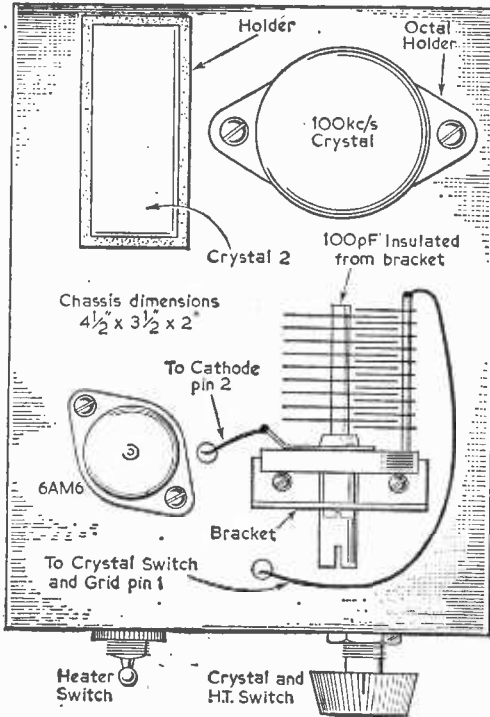

Fig. 2 (above).—Above chassis view of the marker.

It is perfectly in order to omit the second crystal and change-over switch. This will not in any way influence the accuracy of calibration at 100kc/s intervals, but will mean that the 100kc/s marker signals will have to be counted off fairly carefully; or known stations or bands will have to be tuned in, to identify the particular harmonic.

Unit Construction

Dimensions and layout are of little importance, but a small chassis about 3½ in. x 4½ in. x 2 in. deep will be convenient. Fig. 2 shows a suitable layout. The 100pF variable condenser, which is used for exact frequency setting of the 100kc/s crystal, must be insulated from the chassis. This can be done by having a clearance hole in the bracket, and using insulating washers. Some surplus condensers have mounting bushes isolated from the moving plates—if this is the case, insulating washers are

unnecessary. The spindle is slotted to receive a screwdriver blade.

Fig. 3 shows underchassis wiring, the 3-way switch actually being mounted on the chassis runner. An octal holder is shown, for an octal based 100kc/s crystal, but the holder should of course suit the crystal to be used. The second holder was for surplus ¼ in. spacing crystals.

A small tagboard provides anchorage for power supply leads, and some of the components. Power requirements are 6.3V, 0.3A for heater, and approximately 5mA at 200V to 300V for H.T. Wiring should be reasonably short and direct, and well insulated.

If the second crystal is not to be used, wire the 100kc/s crystal holder directly to the 100pF condenser fixed plates, and tag 1 of the B7G valve-holder. A second toggle switch in the H.T. circuit will then allow the marker to be switched off, with heater running.

If a separate power pack is required, this can use a small converter or eliminator transformer, and metal rectifier. Two 8μF or similar smoothing condensers will be adequate, and the usual smoothing choke may be omitted, a 2k resistor being employed instead. In addition to about 250V for H.T., the transformer must have a 6.3V heater secondary.

When drawing power from the receiver, any convenient means of connecting the leads may be employed. It may be feasible to mount a socket on the receiver chassis, and to fit the marker leads with a plug to suit.

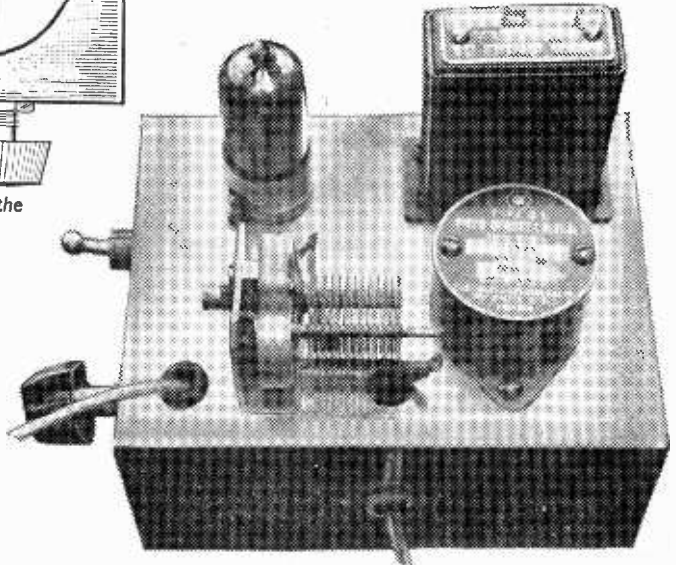

The Prototype Marker Unit

Frequency Adjustment

Crystal No. 2 is used for quick location of bands, with an entirely uncalibrated receiver, as described, and no attempt is made to adjust its frequency, as the 100kc/s crystal is used for actual, exact calibration. With the 100kc/s crystal, the 100pF pre-set condenser permits a very small shift in
(Continued on page 437)

NOW!

YOU can MASTER ELECTRONICS!

BRITAIN'S MOST COMPREHENSIVE PRACTICAL COURSE IN RADIO • ELECTRONICS TELEVISION!

THESE SPECIAL TRAINING KITS — YOURS TO KEEP



Multi-Range TEST METER

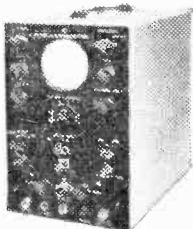

CATHODE RAY OSCILLOSCOPE

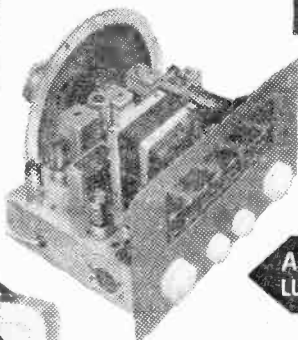

AM and VHF/FM LUXURY RECEIVER



SIGNAL GENERATOR



Complete set of Picture Waybooks and Experimental Manuals

LEARN BY BUILDING NOW for your CAREER • HOBBY OWN BUSINESS

YOU RECEIVE

- 1 Complete kits of equipment as illustrated.
- 2 Complete set of experimental manuals.
- 3 Complete set of "picture-way" theory books.
- 4 Modern test-yourself examination sheets.
- 5 Study programme.
- 6 Unlimited consultation with Tutors.

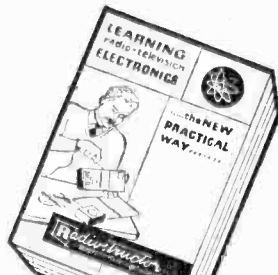

FREE BROCHURE

POST NOW

RADIOSTRUCTOR

TO RADIOSTRUCTOR (DEPT. M.82) READING, BERKS.

Name _____ **BLOCK**

Address _____ **CAPS**

PLEASE

(We do not employ representatives)

9/61

"6 plus 1" TRANSISTOR RADIO KIT
— UNBEATABLE VALUE —

Mrs. Current Production Offer—A fortunate bulk purchase enables us to offer one of the season's most outstanding bargains in Portable Transistor Radio Kits. This kit is a modern, sensitive quality circuit Receiver Unit with all the latest features. Six B.V.A. Transistors and 1 Diode, Printed Circuit, Mod. and Long Waves, Ferrite Aerial, Car Radio Input, $\frac{1}{2}$ w. Push-Pull output into 3 ohm Speaker. Calibrated Dial and Slow Motion Tuning, etc. Size approx. 9 $\frac{1}{2}$ x 2 $\frac{1}{2}$ in.



COMPONENT 5 Gns. KIT

7 x 3 $\frac{1}{2}$ in. speaker 15/6 carr. 1/6.
Cabinets 25/- extra.
Sd. stamp, full details.

SET OF 6 TRANSISTORS and 1 DIODE 45/-

Complete Kit—less speaker
Bargain Price **£6.19.6** carr. 9/6.
Circuit and Instrs. 1/6

| NEW VALVES | ALL GUARANTEED | TRANSISTOR BARGAINS! |
|------------|----------------|--------------------------------|
| 1T4 | 6/- EF86 | 12/6 |
| 1R5, 1R5 | 7/6 EL84 | 8/6 |
| 2R4, 3V4 | 7/6 EY61 | 9/6 |
| DAF96 | 9/- EY86 | 10/- |
| DF96 | 9/- E220/81 | 7/6 |
| DK96 | 9/- POC84 | 9/6 |
| DL96 | 9/- PCP80 | 9/6 |
| ECL90 | 10/6 PCL83 | 12/6 |
| ECL92 | 10/6 PL81 | 12/6 |
| EF90 | 8/- U25 | 12/6 |
| | | BRAND NEW—BVA 1st Grade |
| | | OC44 10/6 874 9/6 |
| | | OC43 9/6 873 9/- |
| | | OC81 7/6 GE114 6/6 |
| | | 2/OC81 15/6 OC72 7/6 |
| | | XA102 10/- OC70 5/6 |
| | | XA101 9/6 OCT1 6/- |
| | | XB103 7/6 GEX34 2/9 |
| | | XC101 8/6 OA70 2/9 |
| | | SB305 9/6 OA×1 2/9 |

SPEAKER FRET. Expanded Bronze anodised metal 8 x 8 in. 2/3; 12 x 8 in. 3/-; 12x12 in. 4/6; 12x16 in. 6/-, etc.
TYGAN FRET (Contemp. pattern) 12 x 12 in. 2/-; 12 x 18 in. 3/-, etc.
SPEAKERS P.M. 3 ohm 2 $\frac{1}{2}$ in. Elasc. 17/8. 3 $\frac{1}{2}$ in. Goodmans, 18/8. 5 in. Rols. 17/8. 8 in. Elasc. 18/8. 7 x 4 in. Goodmans, 18/8. 8 in. Rols. 20/- 9 x 6 in. Goodmans, 25/- EMI Tweeter, 29/8.

CONDENSERS—Silver Mica. All values, 2 pF to 1,000 pF., 6d. each. Diato, ceramics 9d. Tub. 450 v. T.C.C., etc. .001 mfd., .01 and .1/350 v., .9d.; .02-1/800 v., 1/-; .25 Hunts 1/8; .5 T.C.C. 1/9, etc., etc.
RESISTORS—FULL RANGE 10 ohms-10 megohms 20% $\frac{1}{2}$ w. and $\frac{1}{4}$ w. 8d.; $\frac{1}{2}$ w. 5d.; (Midjet type modern rating), 1 w., 6d.; 2 w., 9d.; 10% Hi-Stab. $\frac{1}{2}$ w., 5d.; $\frac{1}{4}$ w., 7d.; 5% $\frac{1}{2}$ w., 9d.; 1% Hi-Stab. $\frac{1}{2}$ w., 1/6.

W/W RESISTORS. 25 ohms to 10K, 5 w., 1/3; 10 w., 1/6; 15 w., 2/-.
PRE-SET T/V POTS. Full range 25 ohms-2 meg. 3/-.

VOLUME CONTROLS—5K-2 Meg. ohms, 3 in. SPINDLES MORGANITE MIDGET TYPE, 1 $\frac{1}{2}$ in. diam. Guar. 1 year. LOG or LIN ratios less Sw., 3/-. D.P. Sw., 4/8. Twin Stereo less Sw., 6/6. D.P. Sw., 8/-.

Electrolytics All Types New Stock

| TUBULAR | CAN TYPES |
|------------------------------------|------------------------------------|
| 25/25v. 50/12v. | 8+8/45v. 4/6 |
| 50/50v., 100/25v. | 32+32/275v. 4/6 |
| 8/450v. 4/350v. | 50+50/350v. 6/6 |
| | 60+250/275v. 12/6 |
| | 100+200/275v. 12/6 |
| 16+16/450v. 5/6 | 32+32/450v. 6/6 |
| 32+32/450v. 6/6 | Transistor Midget Types—all values |
| 1 mfd. to 100 mfd. 1/9 ea. 6v/12v. | |

RECORDING TAPE—Special Offer

American COLUMBIA (G.B.S.) 1st Grade P.V.C. TAPE. Fitted leader and auto stop foils. Brand New, Boxed, and fully guaranteed.

| Standard | Long Play |
|--|---------------------|
| 5in., 600ft. 15/- | 900ft. 19/6 |
| 5 $\frac{1}{2}$ in., 900ft. 19/6 | 1,200ft. 22/6 |
| 7in., 1,200ft. 21/- | 1,800ft. 32/- |

P. & P. per reel 1/-. 6d. on ea. additional reel.
SPECIAL BARGAIN 3in. mfra. Tape 226ft. 5/6. P. & P. 8d.
Plastic Tape Reels 3in. 2/6, 5in. 3/-, 8 $\frac{1}{2}$ in. 3/3, 7in. 3/6.

TAPE RECORDER KIT ONLY £16 10s.

Latest 5-valve circuit based on Mullard's design. Magic eye and tone controls. Printed circuit already wired. A sensitive quality recorder. B.S.R. Amp Kit 94/-. B.S.R. Tape Deck £8.10.0. Collaro Amp Kit £8.6.0. Collaro Tape Deck £12.10.0. Set of 5 valves 45/-.
Special Unit Kit Prices—send stamp for detailed list. Handbook (full details) 2/6.



Jason Tuners—Approved Kits—comprehensive range in stock. Model PMT1 5 gns. etc. 48-hour Alignment Service. Send for complete bargain list.



RADIO COMPONENT SPECIALISTS

70 BRIGSTOCK ROAD, THORNTON HEATH, SURREY
Est. 1946. Telephone THO 3146

Terms C.F.O. or O.O.D. Post and Packing up to $\frac{1}{2}$ lb., rd., 1lb. 11s. 15s., 1/6, 5 lb., 2/-, 10 lb., 2/9. Hours: 9 a.m.—6 p.m.; 1 p.m. Weds.

Two new books for the serious HI-FI enthusiast and engineer . . .

INTRODUCTION TO HI-FI

Clement Brown

A clear introduction to what we can and cannot do in the world of hi-fi, what is and is not important, which items of equipment can be bought cheaply, and for which this would be false economy. 85 illustrations.



21s. net

HIGH FIDELITY SOUND ENGINEERING

Norman H. Crowhurst
50s. net

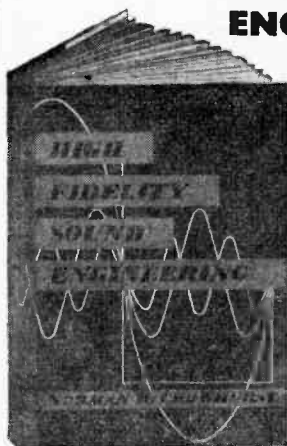

From all booksellers or in case of difficulty use the order form below. A fully descriptive leaflet is available from the publishers.

A complete ready reference for active design work, assuming only a knowledge of electrical fundamentals. The presentation aims at convenience as a text book, working from simple circuits or circuit elements to more complicated ones. 336 pages. 262 illustrations.

ORDER HERE

To George Newnes Ltd., Tower House, Southampton Street, London, W.C.2.

Please supply _____ copy/copies
Introduction to Hi-Fi (21s. net, 22s. by post)
and _____ copy/copies
High Fidelity Sound Engineering (50s. net, 51s. 6d. by post)
(Please cross out items which do not apply)

Name _____
Address _____

I enclose remittance of _____ PW/9.61

NEWNES

(Continued from page 434)

frequency. The exact setting of this condenser can be found by beating the marker against the BBC 200kc/s (1500m) Light Programme, or against the National Physical Laboratory signal radiated on 2.5Mc/s. By this means, an extremely high degree of accuracy indeed can be reached.

If a new 100kc/s crystal is purchased and used with the parallel capacity setting specified by the maker, the standard of accuracy will be high enough for all practical purposes. But it is quite easy to check against one of the standards mentioned, so this is in any case worth while.

To set the 100kc/s crystal against the BBC 200kc/s transmitter (the frequency of which is maintained to high standards) it is necessary to arrange that the Light Programme signal and marker signal are of roughly the same strength. This can be done by removing the receiver aerial, or using a short piece of wire for aerial, and also by modifying the coupling between marker output lead and receiver aerial lead. An exact balance between signal strengths is in no way necessary, but adjustment will be difficult if one signal almost completely swamps the other.

With the receiver tuned to the Light Programme, and the marker working, a very low-pitched audio tone, or flutter, may be heard. This is the difference between crystal harmonic and BBC frequencies, and the 100pF trimmer is adjusted with an insulated blade so that the tone or flutter falls in frequency, and ceases.

If the receiver has a tuning eye or tuning meter, this will show fluctuations in signal strength when the marker tuning is almost exactly correct (say within 1c/s). If there is no eye or meter, a rise or fall in background noise or volume will be apparent. A higher standard of accuracy would be quite pointless for all normal purposes.

Receiver Calibration

The method of using harmonics has been described. Through the L.W. and M.W. bands, the marker signals will be very strong, and only loose coupling between marker output lead and receiver aerial input will be necessary.

For higher frequencies, the marker signal will be weaker, and tighter coupling will be required. It will be necessary to bring the marker output lead near the receiver aerial lead, or to twist it

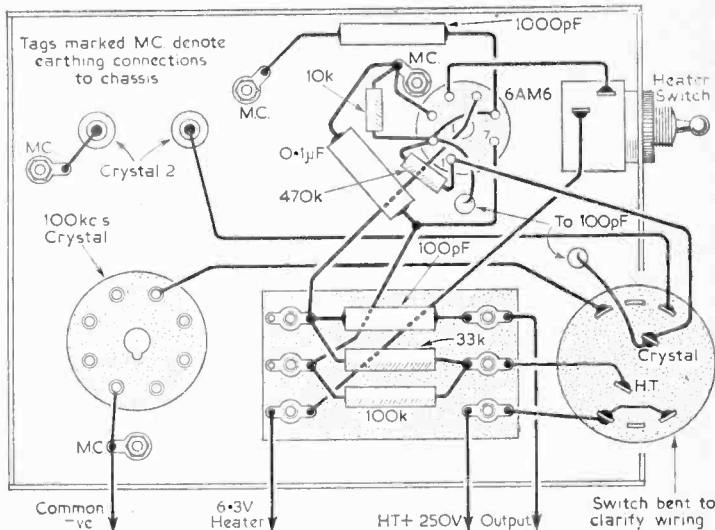
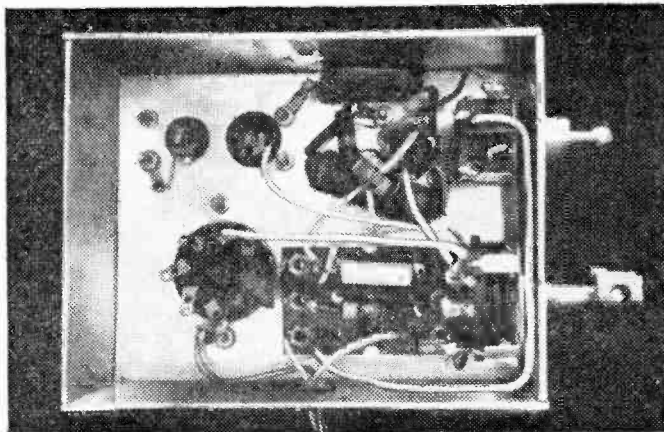

Fig. 3.—The wiring diagram of the crystal marker.

round a short insulated wire inserted in the receiver aerial socket. The receiver aerial may then be temporarily detached.

Tuning Indication

If the receiver has a tuning eye or meter, this will show fluctuations when the marker signal is tuned in. The marker signal is unmodulated. That is, it consists of a radio frequency carrier only, with no audible tone. With TRF receivers, the signals can be located by advancing reaction until the detector is just oscillating. The marker harmonics



An under-chassis view of the unit.

can then be tuned in at 100kc/s intervals, in the same way as broadcasting stations. A receiver with BFO (beat frequency oscillator) will make the harmonics audible in a similar manner.

T rade N ews

NEW PORTABLE RECEIVER

FOUR wavebands are covered by the "Courier" receiver, which is made by Pam Radio and Television Ltd. It employs eight transistors and printed circuit chassis. Apart from the internal ferrite aerial for long and medium wavebands, a telescopic rod aerial is included.

Provision is made for connecting this set to a car aerial for use in a car.

700mW output is achieved from this

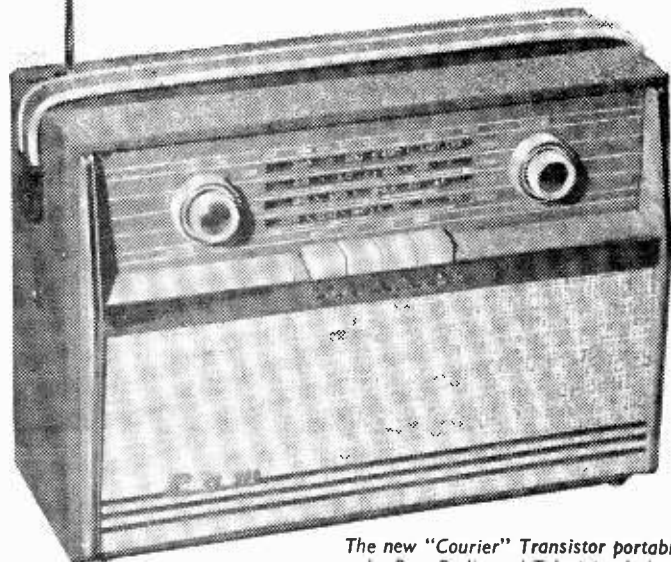

The new "Courier" Transistor portable by Pam Radio and Television Ltd.

receiver which weighs only 6lb 13oz. The price of the "Courier" is 25 guineas and it is made by Pam Radio and Television Ltd., 295 Regent Street, London, W.1.

TRANSISTOR RADIO FOR STANDBY NAVIGATION

A PORTABLE transistor receiver, called the "Navigator" is now being marketed in this country by the Zenith Radio Corporation. This set, as well as receiving normal broadcasting stations, is suitable for standby navigation purposes by private pilots and yachtsmen, as it covers weather stations and L.F. directional beacons.

The "Navigator", which covers the 550-1600kc/s and 150-400kc/s bands, is an 8 transistor set with 500mW output. It weighs only 5lb.

The "Navigator" is fitted with an accurate and easily read azimuth scale for taking cross-bearings and has precision vernier tuning on the main control. The price of this receiver in this country is £69 6s. 11d. The agents for the Zenith Radio

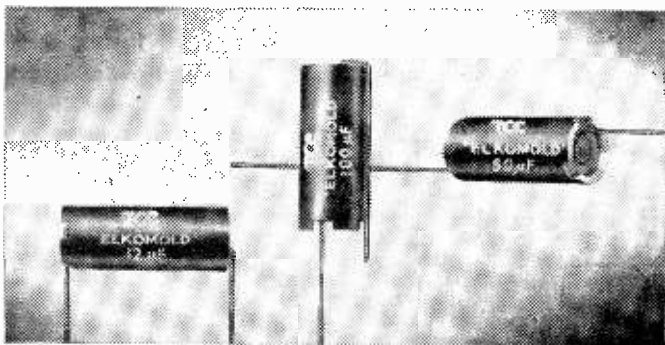

These TCC "Elkomold" electrolytic capacitors will be on show at the Radio Show.

Corporation in this country are United Mercantile Company Ltd., Sovereign House, Queen Street, Mayfair, London, W.1.

CAPACITORS AT THE RADIO SHOW

AT this year's National Radio Show TCC will be exhibiting many ranges of capacitors.

Sub-miniature electrolytics for potted assemblies and transistor circuitry will be on show along with Tantalum electrolytics—entirely new ranges of wet and dry solid sintered capacitors for wide ranges of temperature.

Miniature components will be well represented—Elkomold electrolytic and sub-miniature paper tubulars.

Printed circuits will also be featured on the TCC stand as will "Flexistrip", a new cable having hair-thin copper tape conductors embedded in transparent polyester. The Telegraph Condenser Co. Ltd., North Acton, London, W.3.

THE BEST YET IN RECORDER KITS

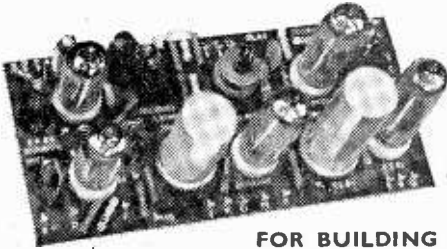

FOR BUILDING TWO AND FOUR TRACK MODELS USING LATEST BSR AND COLLARO DECKS

- KIT 'A' (4-TRACK) for BSR Monadeck. Assembled ready for building in. 9 gns.
- KIT 'B' (TWO TRACK) for BSR Monadeck Assembled for building in. 8 gns.
- Two-tone covered wooden case with speaker for above. 4 gns.
- KIT 'A' with Deck, Case and Speaker. 24 gns.
- KIT 'B' with Deck, Case and Speaker. 21 gns.
- KIT 'C' or Collaro Studio Deck (illustrated above). 11 gns.
- Case and Speaker for above. 5 gns.
- KIT 'C' with Case, Speaker and Deck (as illustrated). 28½ gns.

▼ All amplifiers supplied assembled on printed circuit boards with valves.

MARTIN RECORDAKITS

Leaflet free on request. Set of full instructions for any one model 2/6d. post free. (Allowable on purchasing kit).

COUPON BRINGS DETAILS →

- Hi-fi quality printed-circuit, amplifiers, individually checked
- Complete with valves, transformers and everything down to wire cut to length

Produced by the makers of amplifiers for some of today's best known recorders, the specially designed kits offered here set entirely new standards of performance and finish for the home constructor. Amplifiers, case and speaker assemblies and kits complete with decks are available. Well presented instructions are included. All equipment complete and guaranteed.

From radio dealers, or in cases of difficulty please write direct



MODEL C

MARTIN ELECTRONICS LIMITED, 155 HIGH ST., BRENTFORD, M'SEX.

Leaflet on Martin Recordakits please.

NAME _____

ADDRESS _____

(In Block Letters.)

THE PEMBRIDGE COLLEGE OF ELECTRONICS
offers training in
RADIO TELEVISION AND ELECTRONICS

ATTENDING COURSE

Full-time One Year Course in Radio and Television, College course in basic principles for prospective servicing engineers.

Next course commences 5th September, 1961.

This course is recognised by the Radio Trades Examination Board (R.T.E.B.) for the new Servicing Certificate examinations.

HOME STUDY COURSES

A. Radio and Television Servicing.

- (1) Introductory course.
- (2) Basic course covering R.T.E.B. Intermediate Radio and Television Servicing Certificate examination.

B. Courses in Radio, Telecommunications and Mathematics up to City and Guilds Telecommunication Technicians' Final Certificate.

For details, write to:

The Principal, P.10
THE PEMBRIDGE COLLEGE OF ELECTRONICS

34a Hereford Road, London, W.2

| TESTED AND GUARANTEED VALVES | | | New Valve Price List Available | | | | | | |
|------------------------------|------|------|--------------------------------|----------|------|-------|------|-----------|------|
| OA2 | 8/- | | EP91 | 4/- | | | | | |
| OA3 | 10/- | | EP92 | 3/6 | | | | | |
| OB2 | 6/- | | EL34 | 7/- | | | | | |
| OB3 | 3/6 | | EL91 | 4/6 | | | | | |
| OC3 | 5/6 | | EY51 | 9/- | | | | | |
| OD3 | 5/6 | | EY48 | 8/- | | | | | |
| 02A4 | 5/6 | | EY91 | 3/6 | | | | | |
| 1L4 | 2/6 | OC5 | 8/- | 12SA7 | 7/6 | AW2 | 3/6 | EZ90 | 6/- |
| 1LD5 | 6/- | OC6H | 6/6 | 12SH7 | 3/6 | AW3 | 4/- | FC13 | 15/- |
| 1LN5 | 5/6 | OC6 | 6/6 | 12K7 | 5/6 | AW6 | 5/6 | K78 | 27/6 |
| 1R4 | 6/- | OC6 | 5/6 | 12L7GT/6 | 6/- | C3L | 7/6 | K76 | 12/6 |
| 1R5 | 6/- | OC6 | 5/6 | 12N7GT | 6/- | DAF91 | 6/- | K791 | 17/6 |
| 1R4 | 6/- | OC6 | 5/6 | 12P7 | 10/- | DAF98 | 7/6 | M4 | 4/6 |
| 1R5 | 6/- | OC6 | 5/6 | 12R7 | 5/6 | DC90 | 5/6 | M16 | 6/6 |
| 1T4 | 4/- | OC6 | 5/6 | 12Y4 | 2/6 | DF91 | 6/- | NGT1 | 3/6 |
| 1U5 | 6/- | OC6 | 5/6 | 13D1 | 6/- | DF92 | 3/6 | PC84 | 8/- |
| 1V | 4/- | OC6 | 5/6 | 26L6GT/6 | 6/- | DF96 | 7/6 | PC82 | 10/6 |
| 2C9A | 5/6 | OC6 | 5/6 | 25N7GT/5 | 6/- | DK63 | 6/- | PC153 | 10/6 |
| 2C34 | 4/6 | OC6 | 5/6 | 39A4 | 3/6 | DK92 | 9/- | PC290 | 9/6 |
| 2D21 | 6/- | OC6 | 5/6 | 42 | 5/6 | DK96 | 7/6 | PI39 | 11/6 |
| 2X3 | 4/- | OC6 | 5/6 | 48 | 7/6 | DL33 | 7/6 | PI31 | 10/6 |
| 2A4 | 5/6 | OC6 | 5/6 | 58A7 | 7/6 | DL92 | 5/6 | PI82 | 8/6 |
| 2A5 | 5/6 | OC6 | 5/6 | 68H7 | 8/6 | DL93 | 5/6 | PI15 | 10/6 |
| 2D6 | 4/6 | OC6 | 5/6 | 68J7 | 8/6 | DL94 | 6/6 | PI81 | 7/6 |
| 304 | 7/6 | OC6 | 5/6 | 68K7 | 5/6 | DL95 | 7/6 | PI82 | 7/6 |
| 323 | 5/6 | OC6 | 5/6 | 68L7GT/6 | 10/6 | DL96 | 7/6 | PI33 | 10/6 |
| 3V4 | 6/6 | OC6 | 5/6 | 68N7GT/4 | 7/6 | DL97 | 4/6 | PI82 | 10/6 |
| 5U4G | 6/- | OC6 | 5/6 | 68P7 | 8/6 | EA73 | 7/6 | QV47-12/6 | 6/6 |
| 5V4G | 10/- | OC6 | 5/6 | 68VGT/6 | 5/6 | 815 | 4/6 | EABCS9 | 8/6 |
| 5Y3GT | 6/- | OC6 | 5/6 | 68X4 | 5/6 | 832 | 15/6 | EAC91 | 4/6 |
| 5Z3 | 6/- | OC6 | 5/6 | 68Y3GT | 5/6 | 865A | 10/6 | EC99 | 2/6 |
| 6Z4 | 8/6 | OC6 | 5/6 | 6Y6G | 8/6 | 935 | 5/6 | EC91 | 3/6 |
| 6Z4G | 7/6 | OC6 | 5/6 | 6Z4 | 6/6 | 963A | 5/6 | EC92 | 4/6 |
| 6A67 | 6/- | OC6 | 5/6 | 7A7 | 5/6 | 2051 | 7/6 | ECU81 | 6/6 |
| 6AG5 | 6/- | OC6 | 5/6 | 7N7 | 5/6 | 3870 | 10/6 | EC92 | 8/6 |
| 6AG7 | 7/6 | OC6 | 5/6 | 7N7 | 5/6 | 5678 | 8/6 | EC93 | 7/6 |
| 6AK5 | 6/- | OC6 | 5/6 | 7Z4 | 4/6 | 5763 | 10/6 | EC93 | 8/6 |
| 6AK6 | 7/6 | OC6 | 5/6 | 11E3 | 17/6 | 6005 | 10/6 | EC91 | 3/6 |
| 6AL6 | 4/6 | OC6 | 5/6 | 12A6 | 8/6 | 7193 | 2/6 | EC98 | 10/6 |
| 6AM5 | 4/6 | OC6 | 5/6 | 12A7GT/6 | 7/6 | 7475 | 4/6 | EC93 | 10/6 |
| 6AM6 | 4/6 | OC6 | 5/6 | 12A7 | 6/6 | 9020 | 10/6 | EC185 | 8/6 |
| 6AQ5 | 7/6 | OC6 | 5/6 | 12A7 | 6/6 | 9002 | 5/6 | EL90 | 10/6 |
| 6AT6 | 5/6 | OC6 | 5/6 | 12A7 | 6/6 | 9003 | 6/6 | EP22 | 10/6 |
| 6AU7 | 6/- | OC6 | 5/6 | 12A7 | 7/6 | 9004 | 2/6 | EF37A | 4/6 |
| 6B4G | 10/- | OC6 | 5/6 | 12AY7 | 10/6 | 9006 | 2/6 | EF49 | 10/6 |
| 6B8 | 8/6 | OC6 | 5/6 | 12C3 | 8/6 | AC/EL | 5/6 | EF50 | 1/6 |
| 6BA0 | 6/- | OC6 | 5/6 | 12B6 | 2/6 | ARP12 | 9/6 | EF55 | 5/6 |
| 6B26 | 6/- | OC6 | 5/6 | 12J6GT/6 | 8/6 | ARTH2 | 7/6 | EF89 | 6/6 |
| 6C4 | 2/6 | OC6 | 5/6 | 12K9 | 8/6 | ATP4 | 6/6 | EF86 | 7/6 |

We Buy Special Valves and Tubes, Klystrons, Magnetrons, etc., and High-class Test Equipment and Communication Receivers.

Z & I AERO SERVICES LTD
 Retail Shop: 85 TOTTENHAM CT. ROAD, W.1.
 Tel. LANGHAM 8403
 Head Office and Warehouse: 14 SOUTH WHARF ROAD, W.2. Tel. AMB 0151/2, 0677.
 Please send all correspondence and Mail Orders to the Head Office.

Modelmakers' Motors
 Reversible 12V miniature motors; output 6 watts at 7000 r.p.m. Dimensions 1 1/2 in. long x 1 1/2 in. dia. shaft 0.077 in. dia. x 4 in. long. Centre-off reversing switch integral with the motor. Self-lubricating. Inking slotted bronze bearings. **15/6 Post free.**

VENNER TIMES WITCHES
 Eight-day clockwork type. One make and one break every 24 hours. 1 amp, 250V contacts. Dial graduated in hours. Second hand, guaranteed, complete **27/6 p. & p. with key.**

RELAYS
 Second hand, guaranteed

S.T.C. MIDGET RELAYS:
 1 R. Contact at 5A, 250V Coil. Operating 40mA. Release 15mA. 6/6
 2 C.O. Bifurcated Contacts at 300mA, 700V Coil; operating 10mA; release 5mA. 7/6
SIGMA TYPE 401 or ALLIED TYPE 4G
 1 C.O. contact, 5000V coil; current 4mA ± 5mA. Will operate with change of current of 0.2mA. 5/6
CITIZENS HIGH SPEED, SEALED
 1 C.O. contact at 500mA. Twin coil 2 x 140Ω; operating 15mA with coils in series, 30 mA with coils parallel. 5/6
POST OFFICE RELAYS
 Type 600, 500V coil, 2 C.O. contacts 6/6
 Type 8000, 500V coil, 2 C.O. contacts 7/6
 Type 3000, 100V coil, 4M-4B contacts, break before make. Operating 55mA. Release 20mA. 5/6
AL08917 MIDGET RELAY
 1M 3 Amps, 12V 75Ω coil, dim. 1 1/2 x 1 x 1 1/2 in. 1/6
D16416 WESTINGHOUSE POLARIZED RELAY
 1 C.O.; twin 1450Ω coil and soaking winding of 90Ω. Speed of operation 500 or more per second. Complete with nine-pin base. 20/-
 Post and packing 9d. per relay.

HEADSETS
 DLR-5... 10/-
 DR-30D... 15/-
 Post and packing 1/6 per headset.

MAINS ENERGISED LOUSPEAKERS (new)
 6in., 1000Ω Pd., 3Ω Sp. Coll. 8/6
 6in., 68Ω Pd., 5Ω Sp. Coll. 8/6
 10in., 68Ω Pd., 5Ω Sp. Coll. 12/6
 Packing and postage 2/6 per speaker.

MAINS TRANSFORMERS
 Input 120V, output 6.3V at 5A, 7.5A and 0.5A, new 12/6
 Input 120V, output 6.3V at 10A, 0.5A and 0.3A and 6V at 4A, new 16/6
 Input 100/250V, output 275-0-275V at 80mA, 0.3V at 2.5A, and 0.6A 15/6
 Input 200-250V, Gardner or Parmeko, output 350-0-350V at 70mA D.C., and 6.3V at 2X1A and 2X3A, new 25/6
 Postage and packing 3/6 per transformer.

AVOMETER MODEL 7
 Fully overhauled and guaranteed **£12.10.0**
 Leads, per pair 15/-
 Packing and postage, 10/-

RECTIFIERS
 T38EHT46 Tubular, screw terminals, 1200V rms at 2mA, new 7/6
 38EHT46, as above, but solder tag terminals 5/6
 Germanium Power Rectifier GJ5M, 300 p.i.v. at 550mA D.C. 10/6
 Postage and packing 9d. per rectifier.

★ **POST HASTE** ★
JASON F.M. TUNER KITS

We are the authorised Jason dealer and the whole kit is as supplied by them.

| | | |
|-----------|---|----------|
| FMT1 | Standard variable tuner, complete with valves | £6.17.6 |
| | Hire purchase deposit £1.7.6 and 6 monthly... | £1. 1.8 |
| FMT2 | Power pack ready drilled chassis, complete... | £2.12.6 |
| | Hire purchase deposit £1.1.6 and 6 monthly... | £1. 4.4 |
| FMT2 | Shelf mounting, less power supplies, complete | £1.4.4 |
| | Hire purchase deposit £1.1.6 and 6 monthly... | £1. 9.4 |
| FMT3 | Fringe model, less power supplies, complete | £9.12.6 |
| | Hire purchase deposit £1.18.6 and 6 monthly... | £1. 9.0 |
| FMT3 | As above, with power supplies, complete... | £12. 0.0 |
| | Hire purchase deposit £2.8.0 and 8 monthly... | £1. 6.6 |
| Mercury 2 | Switched tuner with A.F.C. TV sound ... | £10.15.0 |
| | Hire purchase deposit £2.3.0 and 8 monthly... | £1. 4.0 |
| JTV/2 | As above, but shelf mounting and powered... | £14.15.0 |
| | Hire purchase deposit £2.15.0 and 12 monthly... | £1. 2.0 |

The Instruction Book is included in all kits.

REQUIRED CHANNELS MUST BE SPECIFIED FOR SWITCHED TUNERS

Instruction Book for FMT1, FMT2, and FMT3, 2/6. Mercury 2 and JTV/2, 3/6.

A more detailed list can be sent upon request.

ALL JASON TUNERS ARE ON DEMONSTRATION ALL THE ABOVE TUNERS ARE ALWAYS IN STOCK

SURBITON PARK RADIO
 (Established over 30 years)
 48 SURBITON ROAD,
 KINGSTON UPON THAMES, SURREY

★ **POST FREE** ★

TRANSISTORS REDUCED PRICES MULLARD HAVE REDUCED THE PRICE OF MANY TRANSISTORS TO

| | | | | | |
|------|------|------|-----|------|-----|
| OC44 | 11/- | OC71 | 6/6 | OC76 | 8/6 |
| OC45 | 10/- | OC72 | 8/6 | OC78 | 8/6 |
| OC70 | 6/6 | OC75 | 8/6 | OC81 | 8/6 |

THESE ARE THEIR NEW LIST PRICES WHY BUY SURPLUS

MATCHED PAIRS of the above listed transistors, Mullard match only the OC72 at 16/- pair.

"PRACTICAL WIRELESS" POCKET SUPERHET

Osrom printed circuit version. Osrom Rod Aerial 10/-, I.F.T.s and Osc. Coils, 22/6. Osrom Driver, 11/6. Osrom Output, 10/6. Set Mullard Transistors, 53/6. OA81 Diode, 3/-. J.B. Gang, 11/-. Trimmers, 2/8 pr. Set Condensers, 15/-. Set Resistors, 6/6. Ardente Vol. Control, 8/-. Ardente W/C, 3/6. Speaker, 19/10. Hardware, 4/6. Printed Circuit, 9/-. Case and Knob, 7/6. Dial, 6d. Battery, PP4, 2/-. Leaflet giving full illustrated details, 1/9. All the above components if purchased at one time **£9.9.0**. Osrom undertake to align this receiver for a charge of 10/- **COLLARO STUDIO DECK**. List price £17.10.0. OUR PRICE £11.19.9. Hire purchase deposit £2.8.0 and 8 monthly £1.6.6.

TAPE AMPLIFIER for Studio Deck. Printed Circuit ready wired. 6 Valves including Power Supplies. £11.11.0. Hire Purchase deposit £2.7.0 and 8 monthly £1.5.6.

WE PAY ALL POSTAGE AND INSURANCE ALL ORDERS DESPATCHED SAME DAY MONEY WILL BE REFUNDED IF REQUESTED

Telephone: KIN 5549

Hours: 9 a.m. to 6 p.m. 1 p.m. Wed

We do not close for lunch.

Open all day Saturday

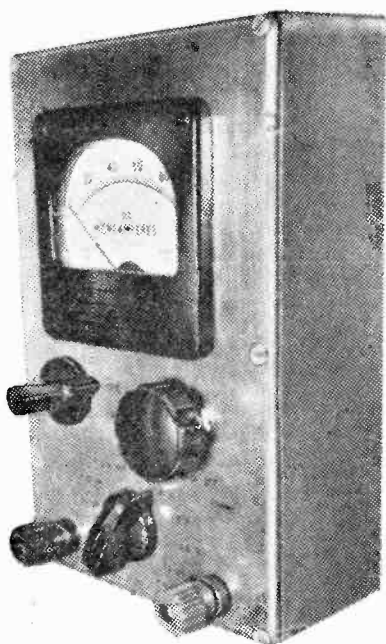

A Sensitive Multimeter

A 10,000Ω/V INSTRUMENT

(Continued from page 296 of the August issue)

By R. Murray-Shelley

THE figures, given in Table 1 (page 296 of the August issue) should only be used as a guide, the exact lengths being found by a process of trial and error, using another meter of known accuracy in the circuits of Fig. 2. The additional components required for the construction of the shunts are, a 3V dry battery, a 1k potentiometer (pre-set, linear), a 2.2k resistor and a 50Ω resistor. The principle of this method of construction is to vary the length of wire in the shunt until the readings of the two meters are the same for a given current (e.g. for the 10mA shunt, the multimeter reads full scale when the check meter reads 10mA).

Somewhat lower accuracy can be tolerated for the 1A range, and thus the shunt should be adjusted so that while the check meter reads 100mA, the reading of the multimeter is 10, assuming that the meter is calibrated from 0 to 100, i.e. 0.1 of the full scale deflection. The reason for this is that a normal dry cell battery cannot supply 1A for even a short period and thus calibra-

tion must be achieved using a lower current.

When the correct lengths of wire have been obtained, they should be wound either on a small choke former or a 2 or 3W resistor of at least 5,000Ω resistance. The purpose of this is merely to act as a carrier for the wire. Resistance wire is occasionally difficult to obtain, and in the prototype, wire removed from a 50Ω 5W resistor was used very satisfactorily. Insulated copper wire (40s.w.g.) was used for the 100mA shunt, and 28s.w.g. for the 1A shunt. The formula for calculating shunt values is:

$$R = \frac{I_m \times R_m}{I - I_m}$$

where I is the maximum current which the meter is to measure in amps, and I_m and R_m are as in the August issue.

The shunt for the 1mA range has a value of over 100Ω. This is most easily made by using a 100Ω close tolerance high-stability resistor in series with a wire-wound resistor made as described above.

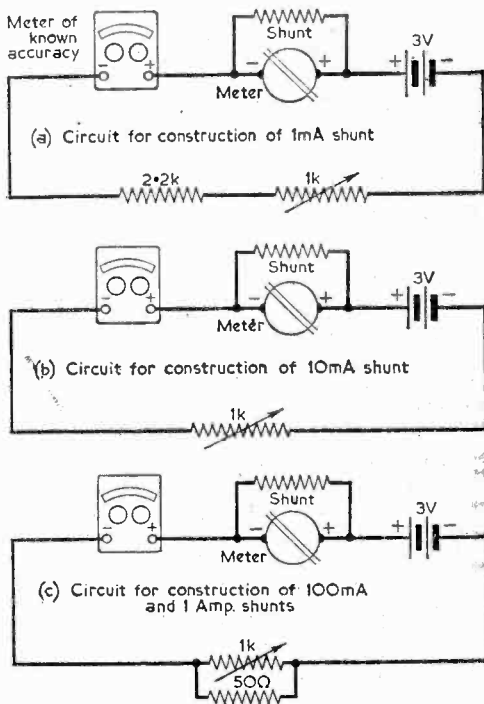

Fig. 2.—These circuits illustrate the use of a meter of known accuracy to calibrate the multimeter under construction.

Tolerance

The resistors used for the multipliers should be high-stability components of 1per cent or 2per cent tolerance. The exact calculated values are not always obtainable, since only preferred values are usually stocked. In the component list, therefore, when a resistor is not a preferred value, a pair of preferred resistances has been suggested, which when connected in series or parallel, depending on

the resistance in question, will give the required value of the multiplier.

Resistance

This instrument has provision for measuring resistances to 1M in two ranges. The circuit used is quite conventional, and although it is by no means the most accurate method which may be employed, nevertheless, it is adequate for general purposes.

The principle of this method depends on measuring the current flowing in a circuit, the potential across which is known, and thus obtaining the resistance of the circuit from Ohm's Law. If the unknown resistance is a part of that circuit, then, assuming the resistance of the rest of the circuit is known, the unknown resistance may be found by subtraction. The basic circuit measuring to 1M is shown in Fig. 3.

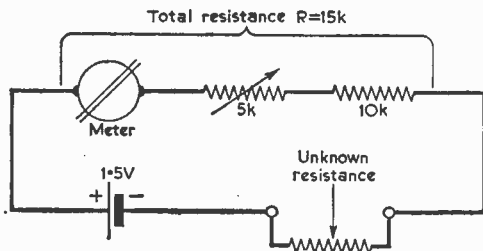

Fig. 3.—The basic ohms circuit, measuring up to 1M.

Calibration

In use the meter terminals are first shorted together, and the variable resistor is adjusted until the meter reads full scale. The unknown resistance is then connected across the meter terminals, when the reading of the meter will drop. The new reading is noted and the resistance is calculated using formula:

$$R_x = \frac{R(1 - D)}{D}$$

where D is the fraction of the full scale current, and R is the resistance of the rest of the circuit (in this case 15k). This method of calculating the resistance can be rather tedious, and the most accurate alternative method is to draw a graph between resistance and meter readings for various resistances. (Two graphs will be required, one for each range.) Another method of achieving the same result is to add a resistance scale to the meter itself, though this is not so accurate, since the current does not vary directly as the unknown resistance.

It is a good idea to wire the resistance ranges before wiring the voltage ranges, since, then, the precision resistors which are to be used for the multipliers can be used to calibrate these ranges.

The resistance R_{14} is used as a range multiplier to achieve a resistance range of up to 10k. The value of this resistance is given by the formula:

$$R_{14} = \frac{R}{(N - 1)}$$

where R , as before, is the resistance of the meter circuit, and N is the ratio of the resistance ranges. In this case:

$$N = \frac{1M}{10k} = 100.$$

For meters not having the specified characteristics, the value of R is given by (battery E.M.F. \div 1m) where the battery E.M.F. is the voltage of the cell used—in this case a 1.5V penlight cell, or a larger U10 cell is recommended. 1m is the meter full-scale deflection as before (in amps).

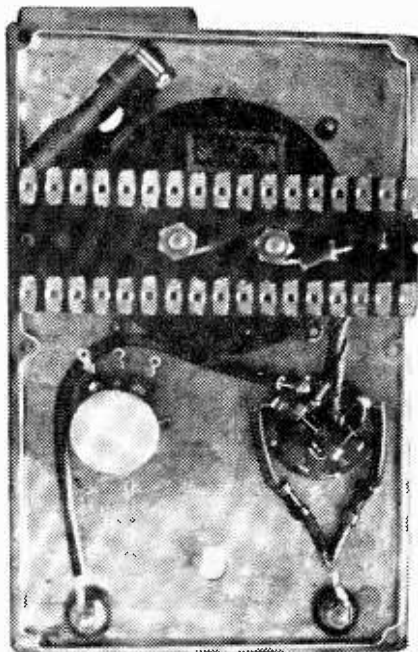

A view of the meter components, before the wiring is completed.

The resistance ranges are also useful for testing continuity, at the same time giving some idea of the resistance of the circuit under test.

Construction

The prototype instrument was housed in a metal box, size 7½in. x 4½in. x 2in. deep. This box was of very stout construction, being diecast, and made of zinc alloy. Ranges of meter boxes are available, and the exact size used will depend entirely upon the size of the basic meter movement. There is no real objection to the use of a steel box since the meter used is of the moving coil type, and is not easily affected by external magnetic fields as a moving iron meter might be.

The layout is in no way critical. In the original instrument the multipliers and shunts were carried on a group board attached to the rear of the meter movement.

Connection should be made with stout (16 to 20s.w.g.) tinned copper wire, insulated where necessary with insulating sleeving. The rectifier elements can be wired directly to the range switch and to the A.C./D.C. switch. The range switch has three wafers, each being 1-pole, 12-way, giving a composite 3-pole, 12-way switch. If this is difficult to obtain, a 3-pole, 11-way switch could be used

(Continued on page 445)

A Sound QUINTET

OF BOOKS by G. A. BRIGGS
All readable and entertaining

- ★ **A to Z in AUDIO**
224 Pages 160 illustrations 15/6 (16/6 post free).
 - ★ **STEREO HAND BOOK**
146 Pages 88 illustrations 10/6 (11/6 post free).
 - ★ **LOUDSPEAKERS 5th Ed.**
336 Pages 230 illustrations 19/6 (20/9 post free).
 - SOUND REPRODUCTION 3rd Ed.**
368 Pages 315 illustrations 17/6 (18/6 post free).
 - PIANOS, PIANISTS & SONICS**
190 Pages 102 illustrations 10/6 (11/6 post free)
- ★ With R. E. COOKE, B.Sc. (Eng.) as Technical Editor.
The above books are sold by many radio dealers and bookshops.
In case of difficulty direct from

Wharfedale

WIRELESS WORKS LTD

**IDLE
BRADFORD
YORKSHIRE**

Telephone
Idle 1235/18
Grams: 'Wharfedale'
Idle, Bradford

*There is no virtue without courage—
no reward without labour*

BRITISH NATIONAL RADIO SCHOOL

PRINCIPAL:
Mr. J. SYKES, M.I.E.E., M.Brit.I.R.E.

Britain's only Privately Owned and
Conducted Radio Correspondence School
(Est. 1940)

*Our speciality is coaching candidates to
sit and pass City & Guilds Telecommunication
Technicians' Certificate Examinations
and the Radio Amateurs' Exam.*

R.A.E. fully worked exam papers.
20/- per set of 8 (post paid)
or 30/- by airmail.

Also Morse Code Record 12" L.P. reduced to 30/-
Transistor audio oscillator 35/-

B.N.R.S.,
RED LION COURT, STALBRIDGE, Dorset
Tel.: Stalbridge 498

IN THE HOME, IN THE CAR, BY THE SEA, IN FIELDS AFAR

THE CONTESSA

IS VOTED BEST OF ALL

A really remarkable

2 BAND 6 TRANSISTOR SUPERHET KIT

(As displayed at the Radio Hobbies Exhibition)



The CONTESSA is the professional looking set with the professional performance.

Study these brilliant features which cannot be found in any other kit

- Waveband Coverage of 530 k/cs to 1620 k/cs and 160 k/cs to 270 k/cs.
- Assured reception of at least a dozen stations in daylight!
- Large clearly-calibrated station-named dial.
- Internal high-gain Ferrox Aerial.
- 5.1 ratio slow motion tuning.
- Fitted with the latest 12000 line high-flux loudspeaker.
- Power of 410 milliwatts from the single-ended push pull final stage.
- Specially designed aerial matching coil for use in a CAR.
- Only first grade fully guaranteed Mazda matched transistors and diodes are used.
- Double tuned IF transformers for maximum gain and knife-edged selectivity.
- Fully drilled printed circuit panel marked with component numbers.
- The two colour case measures 10 x 7½ x 3½ in. and weighs approx. 4 lbs.
- Battery lasts 4 months with normal usage.
- Book supplied with detailed assembly instructions, diagrams and circuitry.
- Anyone can build this set—everything supplied just a soldering iron required.

Inclusive price for all associated components,
cabinet and battery, complete in every detail. **£10.19.6**
Plus 3/6 Regd. P.P.
Or our BUY AS YOU BUILD SCHEME any parts sold
separately. Send for comprehensive descriptive manual
and parts list, 3/6 post free.

See and hear a working model at:—
RADIO CLEARANCE LTD.
27 Tottenham Court Road, London W.1
Telephone: Museum 9188

"P.W." 6 TRANSISTOR PERSONAL RECEIVER

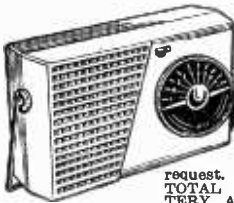

Designed by the technical staff of *Practical Wireless*: easy to build, using printed circuit, and 1st Grade Matched Transistors and Diode. Full Medium and Long Wave coverage to internal speakers. All parts sold separately (new components only) enabling you to buy as required, and full detailed price list will be sent on request. Constructional details 1/6. TOTAL COST INCLUDING BATTERY AND CABINET 28.19.6.

"POCKET 4" TRANSISTOR RECEIVER

Attractive cabinet as illustrated above for "P.W.6". Uses miniature speaker, proper tuning condenser, and volume control. Built-in aerial makes unit efficient and portable. Ideal for the beginner. Full medium wave coverage. All components for only 42/6 (p. & p. 2/6). Ten-page constructional book free with parts or separately 1/6. S.A.E. for parts price list.

SUMMER SPECIAL

"GOOD COMPANION" 6 TRANSISTOR COMBINED PORTABLE & CAR RADIO. ★ 750 mW output ★ 6 transistors and 2 diodes. ★ Full Medium and Long Wave coverage. ★ Quality speaker. ★ Pre-aligned I.F.T.'s. ★ Brilliantly styled 2 tone cabinet, size 11 x 8 x 3 ins. ★ Very fine tuning with calibrated dial. ★ Latest printed circuit. ★ Internal high gain aerial, with car aerial socket. ★ Easy to follow construction data (available separately 3/6).

All parts sold separately and full illustrated details will be sent on request.

Total cost **£9.19.6** plus 5/- post and ins. (Battery 3/6 extra.)

UNIVERSAL AVO METERS. In first-class condition, thoroughly overhauled and guaranteed perfect. In the well-known AVO styling with 5in. hand calibrated Mirror Scale. Complete with leads and internal batteries. The 50 RANGE MODEL 7 ONLY, £12.10.0, and the SUPERLATIVE 20,000 OHMS PER VOLT MODEL 8 ONLY, £17.10.0. (Read. P. & P. 5/- on either). S.A.E. for full details.

H.R.O. SENIOR COMMUNICATIONS RECEIVERS. With all 8 coils, giving coverage of 60 kc/s—30 Mc/s. Checked and in perfect working order. Rack mounting type 18 gns., Standard Table Model 21 gns. (Carr., etc. 22/- either type).

H.R.O. MAINS POWER UNITS. A.C. input 115/230 v. output D.C. (fully smoothed) 230 v. 75 mA, and 6.3 v. 3.5 A. Complete in black crackle case. ONLY 59/6.

POCKET VOLTMETERS. Read 0-15 volts and 0-300 volts A.C. or D.C. BRAND NEW and UNUSED. ONLY 18/6.

R.C. 221 FREQUENCY METERS. The famous American crystal controlled, portable frequency measuring standard. Coverage 125 kc/s—20 Mc/s. With original numbered calibration book. Perfect order. Illustrated details on request. ONLY £18.

UNIVERSAL VOLT-OHM-MILLIAMMETER. Reads A.C. and D.C. Volts up to 1,000 in 5 ranges, at 1,000 ohms per volt, current (3 ranges) to 500 mA. Resistance readings to 200 K ohms in 3 ranges. Basic movement 30µA sensitivity. Easily read open scale, beautifully made and fully guaranteed. Limited number available under import quota. Complete with leads, prods, and internal battery. ONLY 59/6.

ACOS TYPE 39-1 STICK MICROPHONE. With screened lead and stand 39/6, plus 1/6 p. & p.

CRYSTAL DESK MICROPHONE. With screened lead and built-in stand. 16/6, plus 1/6 p. & p.

HARRIS ELECTRONICS

(LONDON) LTD.

138 Gray's Inn Road, London, W.C.1.

(Phone: TERminus 7937)

Please include carriage costs on All items.

(Open until 1 p.m. Saturdays). We are 2 mins. from High Holborn (Chancery Lane Station) and 5 mins. by bus from King's Cross.

ERSIN MULTICORE SOLDERS

for a first class joint every time

Ersin Multicore contains 5 cores of extra-active, non-corrosive Ersin Flux. Prevents oxidation and cleans surface oxides.

SIZE 1 CARTON

5/-

HANDYMAN'S CARTON

Suitable for 200 average joints. **6d.**



Wherever precision soldering is essential, manufacturers, engineers and handymen rely on MULTICORE. There's a MULTICORE SOLDER just made for the job you have in hand. Here are some of them.

SAVBIT TYPE 1 ALLOY

A specially formulated alloy to reduce the wear of soldering iron bits. Contains 5 cores of non-corrosive Ersin Flux and is ideal for all soldering purposes.



SIZE 1 CARTON 5/-

Available in three specifications.

HOME CONSTRUCTORS 2/6 PACK

In addition to the well-known Home Constructors Pack (containing 16ft. of 18 s.w.g. 60/40 alloys) a similar pack is now available containing 35ft. of 22 s.w.g. 60/40 alloy especially suitable for printed circuits.



BIB WIRE STRIPPER AND CUTTER

Strips insulation without nicking wire, cuts wire cleanly, splits extruding flex. 3/6 each



MULTICORE SOLDERS LTD.,

MULTICORE WORKS, HEMEL HEMPSTEAD, HERTS. (BOXMOOR 3656)

Well paid to see the world

A really interesting and worthwhile job as a Radio Officer in the Merchant Navy awaits you if you are the holder of a current P.M.G. certificate. Salary and allowances are good from the start, rising by regular increments to well over the four figure mark with all found. Your job can take you all over the world, and you get generous annual leave besides off-duty time in foreign ports. Sea service offers ample opportunity to study for further technical qualifications and many well-paid shore appointments are open to you later on.

A tradition second to none

Marconi Marine Radio Officers have a long and proud tradition of service extending back to the early years of this century. Among them are to be found names hallowed in the history of the sea. Moreover, many men in the highest public and administrative positions today began their careers as Radio Officers in the Marconi Marine Company.

Write for particulars to: F. E. ASH, Esq.

THE MARCONI INTERNATIONAL MARINE COMMUNICATION CO. LTD.,

English Electric House, Strand, London, W.C.2

(Continued from page 442)

in its place, though one, or possibly two ranges would now have to be omitted (e.g. 1,000 volts A.C. and D.C., or the 1A range of the 10k range). The purpose of the third wafer of the range switch, S2c, is to avoid any possibility of damaging the meter movement on the higher current ranges. This might well happen if the positive terminal of the instrument were to be connected directly to the pole of the wafer, S2b, and a faulty contact were to develop on S2b. The result would then be that the shunt would be removed from the circuit, and the full current in the circuit under test would be applied to the meter movement, in most cases causing it to burn out.

It is important when wiring the range switch to note carefully which position of the switch corresponds to which range.

All connections to the multimeter are made using only two terminals, and these terminals should be of the type which are totally insulated from the panel. The cell is conveniently held with a Terry clip. Connections to the cell may be soldered, since its life is many months.

Resistor Ratings

The resistors used for the multipliers need only be of $\frac{1}{2}W$ rating, since they will only be called upon to carry a very small current. In the case of an instrument using a 1mA meter, however, the resistors should be rated at 1W, at least for the 300V and 1,000V ranges.

The power dissipated by a resistor is given by the formula: Power (watts) = $(I_r)^2 \times R$,

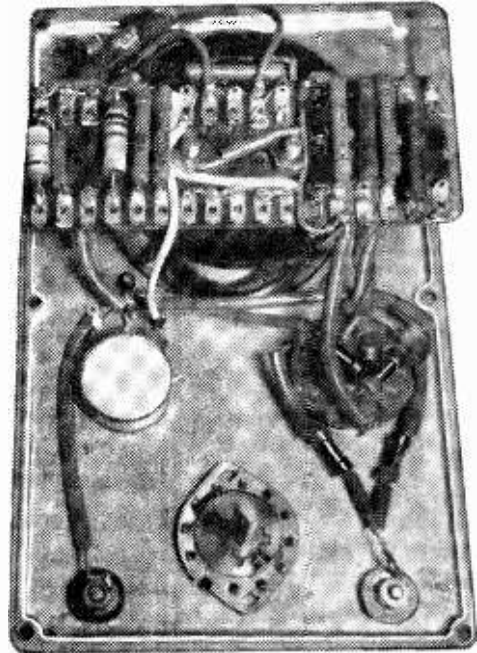

The underchassis view with the wiring complete.

where I_r is the current in the resistor in amps, and R is its resistance.

The current in the resistor will be the same as that in the meter, and thus the maximum current which a multiplier will be called upon to carry is equal to the full scale deflection of the meter. Using this relationship the ratings of the resistors required for any meter movement can be calculated.

Soldering

It is particularly important when constructing equipment of this kind that all soldered joints should be of low resistance, and not of the "dry" type. Cored solder should always be used, and the iron should be clean, and sufficiently hot that the solder flows easily. The components to be soldered should be cleaned carefully, particularly the switches, if these are of the "surplus" type. In this case, the switch contacts themselves should be cleaned, first by scraping them, and then by using a proprietary switch cleaner, preferably one which contains switch lubricant.

Taking Readings

When using the completed instrument, always start with a high range, working down to the lower current and voltage ranges. This avoids any possibility of damaging the meter movement. The instrument should be disconnected from the apparatus when changing ranges. The test leads can be about 3ft long, and they should terminate in a pair of test prods, if possible of the retractable type.

This meter will be found to be invaluable for all types of servicing and experimental work where a comprehensive accurate instrument is required. ■

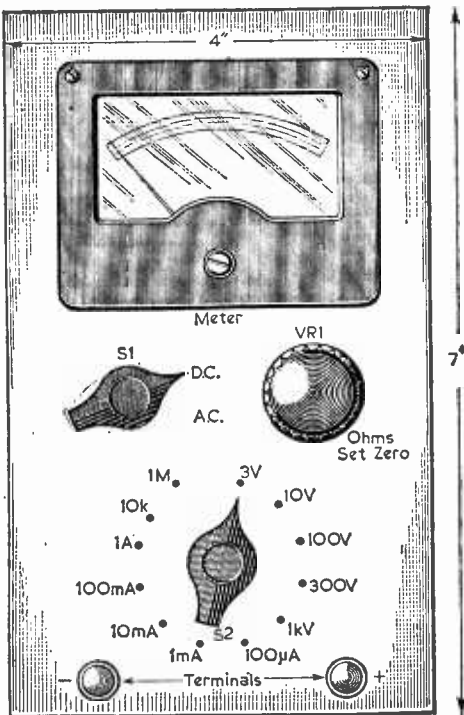

Fig. 4.—The layout of controls on the front panel.

RECEIVERS & COMPONENTS

GUARANTEED VALVES from 1/- Radio, TV components. Transistor set Kits from 10/-. S.W. Kit 22/6. List 3d. HAMILTON RADIO (W), 13 Western Rd., St Leonards, Sussex.

RESISTORS—100 new, wire ended, assorted, all types, 7/6 box, post free. COOK'S OF BEDFORD, 29 St. Mary's Street, Bedford.

STOCK SALE. Lists 2d. Mail only.—98 Greenway Avenue, E.17.

"WEYRAD" TRANSISTOR RECEIVER

LONG & MEDIUM WAVE, P.P. OP. ALL COMPONENTS AVAILABLE TOTAL COST £5.5d. CONSTRUCTOR'S BOOKLET 2/-.

TRANSISTOR AM FEEDER UNIT, SUPERHER AVAILABLE NOW. Size 4 1/2 x 3 x 1 1/2in. TOTAL COST OF COMPONENTS £5.10. CONSTRUCTOR'S BOOKLET, 1/9. Send S.A.E. for Shopping Lists. 35 OHM ALLAN SPEAKERS, 27/1. JACKSON "OO" GANG (with Trimmers), 10/6.

WESTHAM RADIO SUPPLIES
Rear of 176 Abbotsbury Road
WEYMOUTH, DORSET

TRANSISTORS OC44, OC45 1st & 2nd IF, OC81D, OC81mat. pair. Complete set of 6 50/-. Newmarket set of 6 & 1 diode 42/-. XA102 10/- XA101 9/- XB103 7/-. White spot 4/-. Red spot 3/3. R&Y 5/6, G&Y 4/6; GEX34 3/9. OA71 2/9, OA81 3/-. Postage paid by CHAPPEL RADIO, 107, Neasden Lane, N.W.10.

RECLAIMED VALVES. Tested, perfect. One price. 5/- plus 6d. postage. Also surplus and new valves, guaranteed. S.A.E. for list. LEWIS, 46 Woodfield Avenue, Ilford, Essex.

KINGSLAND ELECTRONIC COMPONENTS
Stupendous Offers

1958 ELECTRONIC COMPONENTS

Potentiometers in banks of four fixed on grey stove enamelled plate 1 1/2 x 6 1/2 inches easily detachable, 4/6, p. & p. 1/9.

1 1/2in. cartridge fuse holders screw cap type mounted on grey stove enamelled plate approx. 1 1/2in. wide perspex cover in banks of three, four and five. 3/6, 4/6, 5/6, p. & p. 1/9.

Try our surprise pack of accessories, if not satisfied return within seven days and money will be refunded, 7/6, p. & p. 2/6.

6 assorted voltage droppers, 5/-, p. & p. 1/6. 100 assorted condensers, 6/-, p. & p. 1/9. Instrument Rectifier with circuits, 5/6. 6volt or 12 volt vibrators, 3/6 each p. & p. 1/6. Mike and pick-up transformers ideal for baby alarms, 4/6, p. & p. 1/-.
6 assorted potentiometers, 5/-, p. & p. 1/9. 50 assorted resistances and condensers, 6 miniature valve holders, 2 tag strips, 40 separate contacts each 3/9, p. & p. 1/9.

182 KINGSLAND RD., SHOREDITCH.
E.2. Tel: SHO 6572. Sorry! U.K. only.

RATES: 6/6 per line or part thereof, average five words to line, minimum 2 lines, Box No. 1/- extra. Advertisements must be prepaid and addressed to Advertisement Manager, "Practical Wireless", Tower House, Southampton St., London W.C.2.

In Scotland
RENEWUE
for Better Value

COMPLETELY REPROCESSED TUBE (NEW GUN, RESCREENED, ALUMINISED)

- 12-6v and 6-5v, 0-3 amp., 17 and 15in. Types £6.10.0
- 12-6v and 6-5v, 0-3 amp., 14in. Types £6. 0. 0
- 12v, 15in. Types £7. 0. 0
- 2v, 12 and 15in. Types £6. 0. 0

Electrostatic 90 degree and 110 degree tubes 10/- extra. Carr. paid.

10/- ALLOWED ON OLD TUBE
Terms arranged.

FERGUSON
14in. BBC and STV Consoles . . . £12.10.0
14in. BBC and STV Receivers . . . £10.10.0
17in. BBC and STV Receivers . . . £19. 0. 0

COMPLETELY OVERHAULED AND FITTED WITH COMPLETELY

*** REBUILT TUBE with One Year's Guarantee**

£5 Deposit. Terms on Balance

Renrew Electronics Ltd.
Anderson Drive
Renrew : Scotland
Tel.: Renfrew 2642

RECEIVERS & COMPONENTS
(continued)

Guaranteed Perfect, Ex-equipment TUBES—VALVES—SPARES

TUBES 6 mon. Guar. FITTED FREE! 9-10-12in. 30/-, 14in. 40/-, 17in. 50/- VALVES, 50,000 in stock, 1,000 types. All set tested before despatch. Examples:

| | | |
|-----------|------------|-----------|
| ID5 5/- | 27SU 10/- | N37 4/6 |
| 5U4 4/6 | 5/ 5/ | N108 12/6 |
| 6BG6 12/6 | 195BT 12/6 | PCF84 4/6 |
| 6BW6 6/- | AZ31 7/6 | PCF80 4/6 |
| 6C5 2/- | B36 4/6 | PL82 4/6 |
| 6C9 6/- | EABC80 6/6 | PL33 4/6 |
| 6F1 2/- | EB34 2/- | PL38 10/- |
| 6F13 6/- | EB41 2/- | PL8 4/6 |
| 6F14 4/6 | EB91 2/6 | PL82 4/6 |
| 6F15 4/6 | EBG91 4/6 | PL83 4/6 |
| 6K25 6/6 | EBF80 6/6 | PY31 4/6 |
| 6P1 6/6 | EB41 2/6 | PY80 4/6 |
| 6L18 4/6 | ECC82 3/6 | PY8 4/6 |
| 6LD20 4/6 | ECH35 6/6 | PY82 4/6 |
| 6N7 4/6 | ECH42 4/6 | PZ30 4/6 |
| 6P25 4/6 | ECL80 4/6 | SP61 1/- |
| 6V6 4/6 | EP42 4/6 | U14 5/6 |
| 7B7 4/6 | EF50 1/- | U24 7/6 |
| 7C5 4/6 | EF80 2/6 | U25 12/6 |
| 7C6 4/6 | EF91 2/6 | U31 4/6 |
| 7S4 4/6 | EL33 4/6 | U35 6/6 |
| 7Y4 4/6 | EL38 4/6 | U37 12/6 |
| 10C1 6/6 | EL42 4/6 | U78 4/6 |
| 10C2 6/6 | EY51 4/6 | U281 7/6 |
| 10P1 3/6 | EY86 4/6 | U801 12/6 |
| 10P13 6/6 | KT30C 4/6 | UAF42 4/6 |
| 10P14 6/6 | KT38 4/6 | UB41 2/6 |
| 20D1 3/6 | KT81 4/6 | UC142 6/6 |
| 20P2 4/6 | KT86 10/6 | UF42 3/6 |
| 20P1 4/6 | KT88 10/6 | UL41 4/6 |

Most Pre-war 4, 5, 7 and 9 pin valves of British, European and American manufacture 5/- each. Postage and packing 6d. per valve.

NEW TRANSISTORS. Red Spot 2/6, OC45, OC72, OC76, 7/6, OC35 (1 watt power), OC201 (Silicon) 20/-. Postage 3d.

SPEAKERS: 6in. 5/-, 8in. 7 x 4in., 7/6, 10in. 12/6.

LINE OUTPUT TR., from 20/-.

CONSTRUCTOR'S PARCEL. 2lbs. assorted components from TV Sets, resistors, condensers, pots, electrolytics, etc., 7/6. Postage 2/6.

Send stamp with enquiries or for full list. **TEL. JOHN'S RADIO, 156 St. John's Hill, London S.W.11.** Phone: BA1 9838

"HEATHKITS" can now be seen in London and purchased on easy terms. Free brochure. **DIRECT TV REPLACEMENTS LTD.,** Dept. PW/7/8, 138 Leisham Way, S.E. 14. Tideway 6666.

DENBY'S ELECTRONICS

TUBES
3BP1 with base, mask, and Mu-Metal screen, as new 17/6. VCR517 C(new) 8/-, 5FP7A 6/6.
HYSTERESIS MOTORS
110v. 3 phase 400 c/s (will run on 50 c/s at reduced speed) type LK, 1 1/2in. diam. 3 1/2in. long. 1/2in. diam. shaft fitted with 4in. diam. fan. (ex-equip. as new) 8/-. Type M 2 1/2in. diam. 2 1/2in. long. 1/2in. shaft (new in sealed cartons). 4/9 each.

CONSTANT VOLTAGE TRANSFORMERS. Input 190-260 v. 50 c/s., output 230v. 150 watt max. £4 each.

MICROPHONE TRANSFORMERS
Contained in screening can 1 1/2 x 1 1/2 x 1 1/2in. Two matched primaries each giving 100:1, can be wired in series to give 50:1 or can be used for double button carbon microphone, 1/3 each, 6/6 for 6/6. 12 for 10/-.

CERAMIC TRIMMERS
5-40 pf (rotary disc type) 6d. 15pf, 50 pf (mica dielectric) 5d.

BRIDGE RECTIFIERS. 250v 60mA. 2in. dia., 3 1/2in. long 4/- each.

Orders below 5/- postage 9d. extra.

"HILLSIDE", COLDSHAW, HAWORTH, KEIGHLEY, Yorks.

6in. Dia. (yes—six inch) Millimeters 0 1/2 in. round Ernest Turner 79/- (3/6), 24in. D.I. Voltmeters 0/500 H. round Weston 1000 ohms per volt, 47/6 (2/6). Special Valves 4/250A £8.10.0; QY3/125 £8.10.0; 4212 £4. Simpson Model 443 Volt-ohmmeters 2 1/2 in. meter in case £3.10.0 (5/-). Metal Rectifiers 24 v. 12A 20/- (3/6).

40 PAGE LIST OF OVER 1,000 ITEMS IN STOCK AVAILABLE—KEEP ONE BY YOU.

Wide Band Aerial Amplifiers. ten separate outlets from one aerial rack mounting £9.10.0 (7/6). **Pocket Radioactive Dosimeters,** quartz fibre tountain pen type 25/- (1/-), reduction for quantities. 5 Foot P.O. Racks 19in. wide drilled and tapped 65/- (10/-). **Elliott 0/5 volt moving coil Voltmeters** 2000 ohms per volt, 2 1/2in. dia: Ideal as basic meter 25/- (2/6). **Mains Filter Units,** laboratory precision type totally enclosed 2 1/2 amps. 10/- (2/6). **Sigma** 10,000 ohms SPDT Relays 12/6 (1/6). **Metal Rectifiers** 24 x 12A 20/- (3/6). **AVO Geiger Counters** £9.10.0 (5/-). **Bendix** 6ft. enclosed Transmitter Cabinets, 19in. wide £5 (30/-). **P.O. Racks** 19in. wide 3ft. high £2 (10/-). **Metal Rectifiers** 12 v. 1 amp 5/- (1/6). 20 Foot Super Lightweight Aluminium Tripod self supporting 1 1/2in. dia. Masts, complete, 7 lbs. weight £10.10.0 (30/-).

We have large quantities of "bits and pieces" we cannot list—and invite your enquiries—we can probably help—every one answered.

Amounts in brackets are carriage England and Wales?
P. HARRIS, ORGANFORD, DORSET.

RECEIVERS & COMPONENTS

(continued)

COMPONENTS, VALVES, Tubes etc. Write or phone for free list. ARION TELEVISION, 4 Maxted Rd., Peckham, S.E.15. (New X 7152).

SPEAKER REPAIRS. Cones/Fields fitted Clock Coils Wound. L. S. REPAIRS, Pluckley, Ashford, Kent.

NEW AM/FM STEREO

- INPUTS FOR TAPE, 70's, etc.
- MW-LW-VHF
- PUSH-PULL OUTPUTS—16W
- SEPARATE TONE AND VOLUME
- INTEGRAL PRE-AMPLIFIER

BEL, Marlborough Yard, London N.19
Arc 5078

25% CREDIT discount scheme enables you to save considerably. Send for details and lists of hundreds of bargains in Radio and TV components at **ARTRONICS**, 6a Blackstock Road, London N.4.

SPECIAL OFFER. Used components—All items tested. 50 Resistors—assorted 4/6, 50 pF Condensers—assorted 4/6. Paper condensers .01 .02 .05 .25 3d. each. 6 Preset pots 4/8 Speakers 5 in., 6 in., 8 in. 6/9 each. Speaker Transformers 2/- each. TV H.T. Smoothing Chokes 3/4 each. **TRANSFORMERS** All post paid. J. H. GOULD, 40 Kipling Road, Sedgley, Staffs.

TRANSISTOR BARGAINS

Red Spot, 3/- White, 3/9; Yellow (6 volt), 2/3; Yellow/Green, 3/9; Red/Yellow, 4/6; ETC/TS1 (OC71), 4/3; TS17 (OC72), 6/- each Diodes 1/-, P. & P. 6d.

EDISWAN

XA101, 102, 103, 104, 9/- each. XB102, 103, 104, 8/- each. XC101, 10/-, or complete set with diode 52/6; P. & P. 6d.

NEWMARKET

NKT152A (OC44), 10/-, 153A (OC45), 8/6, 252A (OC71), 5/6, 253A (OC74), 8/9 each, or complete set with diode for 43/-, P. & P. 6d.

MULLARD

OC18, 18/-, OC10 (up to 100 Mc/s.), 13/6. OC81D, 8/9; OC81, 8/-, P. & P. 6d. Condensers. SUB-Miniature, 1, 2, 4, 5, 8, 10, 16, 30 and 50 mfd. at 2/3 each P. & P. 3d.

TRANSISTOR TRANSFORMERS

1:1 C.T. Sec. Driver, 10/-; 6:6:1 C.T. Prim Output, 9/-; 3:6:1 plus 1 Split Sec. Driver, 11/9; 9:2:1 Output, 8/-, P. & P. 6d.

Headphones for Crystal Sets, 12/6 (light weight), P. & P. 1/-.

Sub-Miniature:—Jack Plugs and Sockets 3/6 pair, Slider Wave Change Switch, 2/6. Transistor Holders, 1/-, P. & P. 3d.

SPEAKERS

2in. E.M.I., 3 ohm, 18/11, 15, 35, and 80 ohm. at 19/6. Elliptical 7 x 4, 35 ohm, 25/-, Engraved 2in. round dials, Med. long 4/-, Telescopic Chrome Aerials 7/6, P. & P. 6d.

SOUND VISION
137 MOULSHAM STREET
CHELMSFORD - ESSEX

BOOKS & PUBLICATIONS

FIND TV SET TROUBLES IN MINUTES from the great book "The Principles of TV Receiver Servicing." 10/6 all book houses and radio wholesalers. If not in stock, from Secretary, I.P.R.E., 20 Fairfield Road, London, N.8.

FOR SALE

INDEPENDENT 200/240 volt electricity supply for only £8. American Dynamotor Unit, runs Television, Electric Drills and all Universal AC/DC Mains Equipment from 12 volt car battery. Cost £40, our price £8. — S.A.E., full details, Scientific Products, P., Cleveleys, Lancs

100 BAYS of Brand New Adjustable Steel Shelving 72in. high x 34in. wide x 12in. deep, stove enamelled dark green, sent unassembled. Six shelf bay £3 15s. Sample delivered free. Quantity discounts. N. C. BROWN LTD., Eagle Steelworks, Heywood, Lancs. Tel: 69018.

VHF UNIT. Ready built Front End F.M. unit. Coverage 85-100 Mc/s. I.F. 10.7Mc/s. Single valve (ECC85). Price, including circuit and data but without valve £2-12-3, plus 2/- postage

VHF TUNER UNIT. Ready built without dial and valves. Price, including circuit and data, £6-16-0, plus 3/6 postage. Delivery ex stock.

(DEPARTMENT E/2)

ROTOPONS LIMITED

54 BEDDINGTON LANE, CROYDON, SURREY.

ASK your dealer for American Ferro-dynamics. "Brand Five" Recording Tapes—the best tape value!

P.V.C. COVERED WIRE. Nine colours, 20ft lengths 10/-. Transistors, OC78, 72, 71, 45, 44 8/- each. Mail orders only. Postage and packing 1/6. **FRED HALL**, 21 Kirchen Road, London W.13.

AMERICAN MAGAZINES. Year's subscription "Electronics World" 43/-; "Radio Electronics" 49/6; "Audio" 35/-, Specimens 5/- each. Full catalogue free. **WILLEN LTD.** (Dept. 40), 9, Drapers Gardens, London, E.C.2.

100 MICRO-AMP METERS. 4 1/2 in. x 3 1/2 in.—350 ohms Internal Resistance. Scaled as follows:—0-30 MW, 0-1 Watts, 0-20 Watts, 0-12 Volts, 0-200 Volts, 0-100 Micro-amp. A first class instrument at 38/6. Limited supply only. 100 Micro-amp Meters 2 1/2 in. round—620 ohms Internal Resistance. Few only at 22/6. **TCC 16-24uF 450 volt 2/6 each**—can type. 60 uF 350 volt 1/6 each—can type. Mains Transformers, size 2 1/2 in. x 2 1/2 in. x 2 1/2 in. Input, 0-200-220-240 volt. Output: 250-0-250 volt 25mA. 0-6.3 volt 1 amp 8/6. Orders over £1 post free—under add 1/-. **BOLD AND BULLROWS LTD.** Verulam Road, St. Albans, Herts.

CONDENSERS—Government surplus. Value 30pf to 10,000pf. 40/- per 1,000 post free.—**D. SMITH**, 113 Burford Street, Hoddesdon, Herts.

SOUND RECORDINGS

RECORDING TAPE, save up to 30% send for list; also 50 second-hand recorders in stock.—**E. C. KINGSLEY AND CO.**, 132 Tottenham Court Road, London, W.1. EUS 6500.

PRIVATE GRAMOPHONE Records made from your own recorded tape. Weddings, Choirs, Greetings records, etc. LP's from 17/6. S.A.E. **SOUND SERVICES** (Dept. 2), 28 Viewforth Terrace, Sunderland. Tel: 57032.

TAPE/DISC transfer. Fine US tapes now. 1,800 ft. 29/-. Unimixer units for quality work. **SOUND NEWS**, 10 Clifford Street, W.1. REGENT 2745.

WANTED

A PROMPT CASH OFFER for your surplus Brand New Valves, Speakers, Components, Test Instruments, etc. R.H.S., Beverley House, Manville Terrace, Bradford 7.

NEW VALVES bought, state price. A. D. A. MANUFACTURING CO., 172 Alfreton Road, Nottingham.

NEW VALVES WANTED

Any type, any quantity

CASH PAID

R.S.T. 211, Streatham Road,
Mitcham, Surrey.

Telephone: MITCHAM 6201

WANTED: Service Sheets, No quantity too large. Highest prices paid. **SULTAN RADIO**, 29 Church Road, Tunbridge Wells, Kent.

WANTED VALVES

All types for prompt cash. Must be new. State quantity.

WILLIAM CARVIS LTD.

103 North Street, Leeds 7

SERVICE SHEETS

SERVICE SHEETS. Radio, TV, 5,000 models. List 1/-, S.A.E. enquiries; **TELRAY**, 11 Maudland Bk., Preston.

FAULTFINDER FILES, showing common faults that each receiver is prone to and other useful servicing information, 2/- ea. List 8d., plus postage. **S.P. DISTRIBUTORS**, 44 Old Bond Street, London, W.1.

SERVICE SHEETS. We have the largest stock of Radio and TV Service Sheets in the country for sale at 4/- each. Why tolerate delay in obtaining your supplies when we will dispatch by return? Service Sheet List 1/-. Also Manufacturer's Manuals for sale and hire. 1981 List now available, 1/-, S.A.E. please. Mail orders only to **S.P. DISTRIBUTORS**, 44 Old Bond Street, London, W.1.

SERVICE SHEETS. Radio and TV 4/- each. List 1/-. All orders despatched on day received. Also manuals for sale and hire. S.A.E. please. **SULTAN RADIO**, 29 Church Road, Tunbridge Wells, Kent.

38 SET WALKIE TALKIE
CIRCUIT INFORMATION

Alignment Procedure. Typical faults in Ex W.D. Sets. Components location diagrams. Circuit diagram. Complete Circuit description. Instructions for use, etc. P.O. 5/-. Address in block capitals, please.

CAMPBELL

Laundry Lane, Hungerford, Berks.

(continued on next page)

SERVICE SHEETS

(continued)

SERVICE SHEETS; also Current and Obsolete Valves for sale. **JOHN GILBERT RADIO**, 20 Extension, Shepherd's Bush, Market, London, W.12. (Phone: SHE3052).

SERVICE SHEETS (1930-1961) from 1/- with free Pault Finding Guide. Catalogue 6,000 models, 1/-, 125 Radio/TV Sheets covering 370 popular models 20/-. S.A.E. enquiries. **HAMILTON RADIO**, Western Road, St. Leonards, Sussex.

SERVICE SHEETS for TV & Radio. Loan or Sale Service. S.A.E. Enquiries. Tested Components from Dismantled Sets. Bargain Parcel 10/- Value £5. Enquiries, S.A.E. Lists & contents sample parcel. Postal service only, no callers. **GREIG**, 243 Bury Old Road, near Bury, Lancs.

PUBLIC APPOINTMENTS

MEN with knowledge of basic principles of **RADIO AND RADAR** required in the **METEOROLOGICAL OFFICE**. After short initial training, those appointed will maintain and operate radio and radar equipment, including facsimile apparatus. There are vacancies in various localities in the United Kingdom and opportunities to serve overseas. Starting salary for Radio (Meteorological) Technicians is £810 (national) at 25 or over, rising annually to £930 subject to deduction for each year below the age of 25. These rates are subject to a small deduction at certain provincial stations and to a small increase in London. Good promotion prospects and allowances for overtime, night duty, etc. Applicants must be British subjects.

Applications to Meteorological Office (M.O.10 R/M/T), London Road, Bracknell, Berks, or to any Employment Exchange, quoting order no. Bracknell 379.

MISCELLANEOUS

YOU READ MUSIC?

Then how about making yourself an electric organ? Constructional data available—full circuits, drawings and notes. It has 5 octaves, 2 manuals and pedals with 24 stops—uses 41 valves. With its variable attack you can play Classics and Swing. Write **NOW** for free leaflet and further details to **C. & S.**, 20 Maude Street, Darlington, Durham.

SITUATIONS VACANT

BOROUGH POLYTECHNIC,
Borough Road, S.E.1.

LABORATORY TECHNICIANS: Two Technicians and one Junior Technician (male or female) for Department of Electrical Engineering and Physics. Laboratory Technicians should be experienced (and preferably qualified) in Electronics, Vacuum work or glasswork. Junior Technician preferably to have interest in photography. Salary scales, dependent on age and qualifications, in range £2470—£7530 p.a. (Technician) and £230—£630 p.a. (Junior). Apply in writing, giving full particulars, to Secretary, Borough Polytechnic, Borough Road, S.E.1.

VACANCIES EXIST

ADMIRALTY SURFACE WEAPONS
ESTABLISHMENT EXTENSION

at
**ROYAL NAVAL STORES DEPOT
COPENACRE, HAWTHORN, WILTS**

for
ELECTRICIANS (RADIO)
and
ELECTRICAL FITTERS

Applicants for the former position should have at least five years experience in the trade and for the latter must have completed a recognised apprenticeship.

The Establishment is located 8 miles from Bath. The work is interesting and varied, in modern test rooms and workshops, and is mainly concerned with the testing and modification of naval radio and radar equipment.

The commencing basic rate of pay is £9 18s.2d. for a five-day 42-hour week. In addition, new entrants are assessed for a merit award after three months' service and this award is back-dated to the date of joining. The initial award may be up to 25/- per week and further awards up to a total of £3 per week may be granted. After a minimum period of service all employees are considered for establishment on permanent staff.

Admiralty employment confers certain benefits, including assisted travel, paid sick leave entitlement, paid public holidays, and a fortnight's paid annual holiday. Recreation and welfare facilities are available. Applications, in writing, should be addressed to the

**OFFICER-IN-CHARGE
ADMIRALTY SURFACE WEAPONS
ESTABLISHMENT EXTENSION,
ROYAL NAVAL STORE DEPOT,
COPENACRE, HAWTHORN,
WILTSHIRE**

UNITED KINGDOM ATOMIC
ENERGY AUTHORITY

Atomic Energy Establishment, Winfrith

Vacancies exist at A.E.E. Winfrith, Dorchester, Dorset, for

INSTRUMENT MECHANICS

(Electronic and Electro-Mechanical)

Applicants should be familiar with the construction of Electro-Mechanical experimental equipment and components; ability to read circuit diagrams and drawings, and to construct, wire and test electrically complex equipment is desirable. Duties will include the major overhaul and repair of a wide variety of electronic and electro-mechanical equipment including potentiometric recorders, moving coil instruments, pressure, vacuum and flow transducers, oscilloscopes, signal and pulse generators, all types of amplifiers and high vacuum ionisation gauges.

Housing may be available to the successful applicants, but this would be determined at the time of interview. Excellent working conditions including sick-pay and pensions schemes.

Further details of conditions of employment, rates of pay and application forms may be obtained from the Labour Department, A.E.E. Winfrith, Dorchester, Dorset, quoting Reference Number IM/PW/PT.

BRITISH COUNCIL
PAKISTAN

PUNJAB UNIVERSITY, LAHORE

Applications are invited for the post of Laboratory Technician in the English Language Unit of the Punjab University. Duties, to have charge of a small phonetics laboratory, to act as recording engineer, to devise new applications of instrumental techniques and to train Pakistani assistants, as necessary. Candidates should have a thorough electrical training, and a good knowledge of electronic sound equipment.

Salary on scale £940 x £30 to £1 060. Over sea allowance (maximum); single £525, married £995. Children's and home education allowances. Free furnished accommodation. Installation grant. Medical scheme. Fares paid, and for family (including mid-tour passages for children in U.K.), and for home leave. Employer's portion U.K. superannuation paid. Contract with British Council for two years, renewable, from 1961. Secondment from home employment may be arranged. Write, quoting N.B.R.(61) and enclosing stamped, addressed foolscap envelope, to Director, Recruitment Department, British Council, 65 Davies Street, W.1., for further particulars and application form to be returned completed within two weeks of receipt.

CITY AND GUILDS (Electrical, etc.) on "No pass—no fee" terms. Over 95% successes. For details of Electrical Engineering, Applied Electronics, Automation, etc., send for our 148-page handbook, free and post free. B.I.E.T. (Dept. 242A), 29 Wright's Lane, London, W8.

(Continued on next page)

DIAMOND



STYLI

DASCO

FOR DIAMONDS

Manufacturer's offer to users—send us your old stylius arm and we will retip with finest Transcription quality Diamond.
To ensure best reproduction every Diamond is inspected for finish and radius with 300 magnification.

FOR £1.00 ONLY

Or we will supply complete with any stylius arm for £1 5s. 0d. Tax Paid and will despatch within 48 hours of receipt, post free.

All Diamonds are Guaranteed for One Year

(Sapphires also supplied 4/6 Tax Paid)

Mail Orders to:—Dasco, Frith Park, Tadworth, Surrey.



Servicing electronic computer for Comet simulator

Make your hobby your career

In today's R.A.F. you can work on some of the most sensitive electronic equipment ever made

The man in this photograph is an instrument fitter at work. At least, it's called work, but to him it has the fascination of a hobby—a paid hobby at that. Still, he's an enthusiast; anything to do with electronics and he's not happy until he's ferreted out all the secrets. And there are plenty of secrets in the R.A.F. In fact, you don't really know what advanced equipment is until you've handled some of the R.A.F. stuff.

If you have the flair that makes the born electronics man, the R.A.F. offers you a satisfying career. You will get a skilled training that is yours for life. You get paid well, you live well—and you may travel anywhere in the world. There's no doubt about it, —the R.A.F. gives you a secure career—and an adventurous one.

THE FUTURE IS WITH THE R.A.F.



.....

Fill in this coupon and you will be sent, without obligation, a free copy of "The Man on the Ground", an illustrated booklet giving details of all R.A.F. trades.

NAME

ADDRESS

.....

DATE OF BIRTH.....

Send the completed coupon to:

R.A.F. Careers Information Centre (PW 116B),
Victory House, Kingsway, London, W.C.2.

.....

SITUATIONS VACANT *(continued)*

RADIO MECHANICS REQUIRED for equipment overhaul and aircraft maintenance at Stansted Airport. Men with sound knowledge of service or industrial radio equipment will be particularly suitable but those with a sound knowledge of TV will also be considered. N.J.C. rates of pay, sick payments, contributory superannuation scheme, paid holidays. Detailed applications to the Personnel Officer SKYWAYS LTD., 7, Berkeley St., W.1.

TV AND RADIO, A.M.Brit.I.R.E., City and Guilds, R.T.E.B. Cert., etc. on "No pass—no fee" terms. Over 95% successes. For details of exams and courses (including practical apparatus) in all branches of Radio, TV and Electronics, write for 148-page handbook, free. B.I.E.T. (Dept. 242G), 29 Wright's Lane, London, W.3.

A.M.I. Mech. E., A.M.Brit.I.R.E., City and Guilds, G.C.E., etc. brings high pay and security. "No pass—no pay" terms. Over 95% successes. For details of exams and courses in all branches of Engineering, Building, Electronics, etc., write for 148-page handbook, free. B.I.E.T. (Dept. 242B), London, W.8.

EDUCATIONAL

COUNTY OF ESSEX
SOUTH-EAST ESSEX TECHNICAL COLLEGE
Longbridge Road, Dagenham
MARINE RADIO OFFICERS' COURSES

The College offers full-time courses of one or two years duration leading to the 1st and 2nd Class P.M.G. Certificates and the M.O.T. Radar Maintenance Certificate.

Applications for enrolment should be made as soon as possible. Late enrolments may be considered up to 11th September, 1961. Officers possessing the P.M.G. 2nd Class or both 1st and 2nd Class Certificates may join the course at appropriate points to complete their qualification.

For further particulars apply to the Principal.

FREE FROM THE I.P.R.E. Syllabus of famous radio and TV courses. Membership Conditions booklet 1/-. Sample copy The Prac. Radio Engineer, 2/- post free. Secretary, 30 Fairfield Road, London, N.8.

★ LEARN ★

RADIO & T/V SERVICING
for your OWN BUSINESS/HOBBY

● by a new exciting no maths system, using practical equipment recently introduced to this country.

FREE Brochure from:—
RADIOSTRUCTOR
DEPT. G77, READING, BERKS. 9161.

(Continued on next page)

EDUCATIONAL
(continued)

**PLYMOUTH AND DEVONPORT
TECHNICAL COLLEGE**

TAVISTOCK ROAD
PLYMOUTH

Principal:
E. BAILEY, B.Sc., F.R.I.C., A.M.I.Chem.E.

RADIO OFFICERS' COURSES

FULL-TIME COURSES start in September 1961 for P.M.G. Radio and M.O.T. Radar Maintenance Certificates.

Applications, giving particulars of previous education, should be made now to the Principal.

WIRELESS. See the world as a Radio Officer in the Merchant Navy; short training period; low fees; scholarships, etc. available. Boarding and Day students. Stamp for prospectus. **WIRELESS COLLEGE,** Colwyn Bay.

**Radio
Television
& Electronics**

Learn at home with the world's largest home study organisation, Brit.I.R.E.; City & Guilds; R.T.E.B., etc. Also Practical Courses with equipment. No books to buy.

Write for **FREE** prospectus stating subject to

I.C.S.

(Dept. 541), Intertext House,
Parkgate Road, London, S.W.11

"HOW AND WHY" of Radio and Electronics made easy by a new, maths practical way. Postal instruction based on hosts of experiments and equipment building carried out at home. New courses bring enjoyment as well as knowledge of this fascinating subject. **FREE** brochure from: Dept. P.W., 12, **RADIOSTRUCTOR,** Reading.

$$X = \frac{-b \pm \sqrt{b^2 - 4ac}}{2a}$$

DON'T FUMBLE with Formulae. Master Mathematics in 6 weeks the Understandable Way. First lesson and details free from:

1st lesson
and details
FREE
from

UNDERSTANDABLE MATHEMATICS
11F Dryden Chambers, Oxford St.
London, W.1.

Name _____
Address _____

EDUCATIONAL
(continued)

LEARN RADIO AND ELECTRONICS the new practical way! Hosts of absorbing experiments carried out at home under expert guidance to teach you Radio in a new, enjoyable and interesting way. Construction, servicing and fault-finding on equipment made easy for the first time! No previous experience needed. No mathematics used. **Free** brochure from: Dept. 11, P.W., **RADIOSTRUCTOR,** Reading.

HANDICRAFTS

JEWELLERY Simply Made, Brooches, Rings, Marcasites. List Free. **WEBBS,** 46 Burnway, Hornchurch, Essex.

RES/CAP. BRIDGE 38/-
p. & p. 2/-

Checks all types of resistors, condensers 6 RANGES
Built in 1 hour. Direct reading
READY CALIBRATED
Stamp for details of this and other kits.
RADIO MAIL (Dept. PP)
Raleigh Mews, Raleigh Street, Nottingham

PADGETTS RADIO STORE
40 MEADOW LANE, LEEDS 11
Phone: Cleckheaton 2886.

Super Tube Unit. New condition, complete with 3in. tube. Type VCR138A. Also 3in. 100uA meter and full set of valves. 45/-, carriage 8/-.

Tube Unit Type 116A. New condition complete with VCR97 tube, M.U. screen and all valves. 15/-, carriage 8/-.

New Bombsight Computers. Type X15A full of gears and motors, 42/-, carriage 10/-.

Brand New Boxed CRT Tubes. Types 5P7, 3/6. VCR517C, 5/-, VCR112, 3/6. CV49 12in., 5/-. Carriage and insurance on any tube 5/6.

Brand New U.S.A. amplifier type A1894. Double blower motor takes JAHAE/27 valves etc. Less valves. 17/-, carriage 8/6.

P.M. Speakers. Removed from TV sets. All guaranteed perfect working order, sound cones 6in. and 7 x 4. 5/-, post 2/-.

TV Tubes. Returned. 12 months' guarantee, 14in. and 17in. all at £3.15.0, carriage and insurance 7/6.

NEW VALVES, Ex-units. All post free.

| | | | | | |
|-------|-----|----------|-----|-------|-----|
| 6K7 | 2/- | EL91 | 1/9 | IS4 | 2/- |
| 6K8 | 3/6 | EB91 | 1/9 | 5U4 | 4/6 |
| 6X5 | 4/- | EF50 | 1/6 | EA50 | 6d. |
| 6V8GT | 4/6 | RF50 red | 2/- | VE37 | 6d. |
| 6AQ4 | 3/6 | R10 | 4/- | U12 | 5/- |
| 6C4 | 2/- | Z530338 | 2/6 | DL510 | 1/- |
| KT68 | 6/6 | R1S24 | 2/- | 9001 | 9d. |
| KT63 | 4/- | 2C26A | 2/- | 954 | 1/8 |
| EF91 | 1/9 | VR150/30 | 4/- | | |

Valves removed from TV sets. All tested on a Mullard Valve Tester, are 100% as new. They carry a 3 months' unconditional guarantee. All valves Post Free.

| | | | | | |
|---------|-----|-------|-----|-------|-----|
| EF90 | 2/- | 6F14 | 5/- | 185BT | 8/6 |
| Grade 2 | | 6SN7 | 2/9 | U601 | 8/6 |
| EF90 | 6d. | 6BS7 | 2/- | U25 | 5/- |
| ECL80 | 4/6 | 6G6 | 2/6 | U281 | 5/- |
| EC82 | 5/- | SP61 | 1/6 | U329 | 5/- |
| EL38 | 4/6 | 6Y6 | 2/- | KT36 | 5/- |
| EY51 | 4/- | 6LD20 | 5/- | PL81 | 5/- |
| EF90 | 4/6 | 10C2 | 3/- | PY81 | 4/6 |
| EB91 | 1/- | 10F1 | 2/6 | PL82 | 5/- |
| EF91 | 1/- | 10P14 | 5/- | PY80 | 5/- |
| EL91 | 1/- | 10P13 | 5/- | PL33 | 5/- |
| 6E25 | 4/- | 20D1 | 3/- | PZ30 | 5/- |
| 6E28 | 5/- | 20P1 | 5/- | R36 | 4/6 |
| 6K25 | 5/- | 20P1 | 5/- | N37 | 5/- |
| 6F1 | 2/- | 20L1 | 5/- | L63 | 3/- |
| 6F13 | 2/- | 20P4 | 5/- | | |

TV Spares, Cylcon tuners, less knobs and valves. 2/6, post 2/-.

Reclaimed TV Tubes. Not boosted, six months' guarantee. 12in. Mullard 17/-, 12in. Mazda 25/-, 14in. Mullard 30/-. Carriage insurance 7/6.

Complete TV Chassis for Spares. Less valves. 12in. four for 10/-, carriage 5/-, 14in. chassis four for 15/-, carriage 7/6.

**COYNE'S NEW
PIN-POINT TV
TROUBLES**

**TAKES HEADACHES OUT OF
ALL SERVICING PROBLEMS!**



Your most useful on-the-job "tool"! Quickly and easily pin-points the exact trouble in any TV set. Covers 70 symptoms. 700 trouble spots. Over 340 cross-indexed pages; 50 time-saving Check-Charts; 290 diagrams and photos; explanation of circuits and designs.

SIMPLE CHECK-CHART SYSTEM SAVES TIME!

This amazingly practical handbook shows you how to find the trouble in any TV circuit FAST! Simple cross-index tells you in what section you'll find cause of trouble. Handy Check-Charts then help you accurately locate the EXACT trouble spot. Cut waste time, eliminate hours of aggravation, get right to the heart of the trouble in minutes.

USE THIS BOOK RIGHT ON THE JOB—NO NEED TO MEMORIZE!

This Pin-Point Book was designed especially for on-the-job trouble-shooting. You simply turn to the indexed section, locate the circuit description and Check-Chart, and in minutes you have the trouble spot located and ready for repair. No complicated theory or mathematics. Down-to-earth, practical circuit description, service methods and trouble-shooting techniques. Published by the famous Coyne Electrical School and approved by leading authorities in the field.

J.E.C. Grover of Streatham says:
"Immediately I glanced through this book I was convinced that your claims concerning the merits of this work were justified, for it is, without a doubt, the finest book of its kind that I have ever come across. It is not only unique in its presentation but it is also superbly produced."

G. Axam of London S.E.9, says:
"I have spent nearly £50 on technical books over the past 5 years all of which I feel has now been wasted as your book is the best I have yet had the pleasure of examining, it is practical, to the point, with just the right amount of technical information needed, covering almost every aspect of TV servicing."

SEND NO MONEY!

Just mail coupon for free trial. After 7 days send only low price or return book and pay nothing!

FREE TRIAL OFFER!
Mail Coupon NOW!

Mail Order Division, SIM-TECH BOOK COMPANY, Dept. A.2, Oster's Mill, West End, Southampton, Hants.

RUSH TV Troubles 31/6d, plus 1/6d postage for 7 day **FREE TRIAL** as per offer.

Tick here if enclosing full price, we pay postage: Same 7 day money back guarantee

Name _____
Address _____
City _____ County _____

WIRECOMP ELECTRONICS

378 HARROW ROAD, LONDON, W.9
TEL: CUNNINGHAM 9530

Hours of business: 9 a.m. to 6 p.m. Open all day
Saturday. Opposite Paddington General Hospital.
Buses 18B and 36 pass the door.

SPECIAL OFFER G.E.C. BCS 1851

METAL CONE LOUDSPEAKER
OUR PRICE **£5.19.6** P. & P. 2/6

High quality loudspeaker at special low price, usually £9 10s. Frequency response 30 c/s to 20,000 c/s. Exceptional Bass reproduction. Maximum power rating 112 watts. Overall dia. 8ins. Supplied with dimensional drawing for suitable cabinet. Also available Bass Power Bracket to suit.



THE NEW "COMPANION"

TRANSISTORISED POCKET RADIO **£8.19.6** COMPLETE KIT OF PARTS

Uses 6 first-grade transistors covering Long and Medium wavebands. High Q internal ferrite rod aerial, with socket for car aerial. Size 6 1/2 x 4 1/2 x 1 1/2 ins. Latest printed circuit. Two tone case. Complete with instructions. All parts sold separately. Battery extra. P. & P. 3/6.

MINIATURE EARPHONE FOR TRANSISTOR RADIOS

Light-weight plastic earpiece, can be worn without discomfort, provides excellent reproduction of music and speech. Fully guaranteed. Complete with 3 ft. of fine flex, plug and socket. Crystal earpiece as illustrated **8/-** P. & P. 1/-.

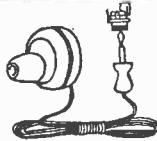

SEND S.A.E. FOR FREE PRICE LIST
OR PAY US A PERSONAL CALL

"SONIC SIXTY" TRANSISTOR KIT



6 Mullard Transistors, 1 Diode, Internal Ferrite Rod Aerial, 7 x 4in. high quality Speaker. 500 mW push-pull out put. MW and LW. Calibrated Direct Drive Assembly. Modern Walnut Cabinet 17 x 7 1/2 x 5in

COMPLETE KIT READY TO BUILD **£9.15.0** P. & P. 4/6

ALL PARTS SOLD SEPARATELY

COMPLETE V.H.F./A.M. RADIO FOR

£12.12.0

Brand new set, in superb walnut cabinet (size 19 x 8 1/2 x 14 in. high). Covering 80-100 Mc/s. 16-49 M., 200-500 M., and 1,200-2,000 M. Mains trans. 200-250 v. with 3 tapings. Ferrite rod aerials for A.N. Controls: volume on/off tone, turning, w/change, Gram, and ext. speaker position provided. Fully guaranteed. Post and packing 5/- extra.

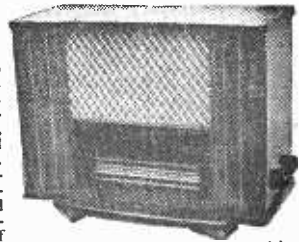

CABINETS & HI-FI EQUIPMENT

We can supply any Cabinet to your own specification



"Grosvenor" £22.1.0

This is only one example taken from our extensive range of book cabinets. Write for our NEW 24 page fully illustrated catalogue on:

THE LARGEST RANGE OF CABINETS IN THE COUNTRY

Equipment is also our speciality and we now offer, in a novel book form: A NEW EQUIPMENT COMPARATOR illustrating our range of radio chassis, speakers, tape decks, single players and autochangers.

SEND TODAY for a copy of these two books, which are absolutely FREE.

LEWIS radio

100 (PW91) Chase Side
Southgate, London, N.14. Pal 3733

FIRST-CLASS RADIO COURSES . . .

GET A CERTIFICATE!
QUALIFY AT HOME—IN SPARE TIME

After brief, intensely interesting study—undertaken at home in your spare time—YOU can secure your professional qualification or learn Servicing and Theory. Let us show you how

FREE GUIDE
The New Free Guide contains 132 pages of information of the greatest importance to those seeking such success-compelling qualifications as A.M.Brit.I.R.E., City and Guilds Final Radio, P.M.G. Radio Amateurs' Exams., Gen. Cert. of Educ. London, B.Sc. (Eng.), A.M.I.P.E., A.M.I.Mech.E., Draughtsmanship (all branches) etc., together with particulars of our remarkable Guarantee of **SUCCESS OR NO FEE**

Write now for your copy of this invaluable publication. It may well prove to be the turning point in your career

FOUNDED 1885—OVER 150,000 SUCCESSSES.

NATIONAL INSTITUTE OF ENGINEERING

(Dept. 461), 148 HOLBORN LONDON, E.C.1

S. Africa: P.O. Box 8417, Jo'burg.
Australia: P.O. Box 4570, Melbourne.

3-TRANSISTOR POCKET RADIO

With Miniature Loudspeaker
ABSOLUTELY NO SOLDERING REQUIRED

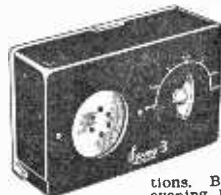

Unique Design

Superb appearance. Simple instructions.

Built in an evening. No drilling. No soldering. Complete in every detail. Receives entire broadcast band. Aerial required in certain areas. Pocket size 4 1/2 x 2 1/2 x 1 1/2 in.

ALL PARTS SOLD SEPARATELY

42/6

Battery 1/- extra P. & P. 2/-

SAVOY BARGAINS

- High gain audio transistors. 4/6. P. & P. 3d.
- Ferrite rod. 4 x 1/2 in. 1/9. P. & P. 6d.
- Solid dielectric tuning condensers: 0.0003 mfd. 4/-; 0.0005 mfd. 4/3; P. & P. 6d.
- Miniature dynamic speakers. Resistance 30 or 70 ohms. 4/6. P. & P. 6d.
- 5 ft. phone cord with No. 9 jack plug. 2/-. P. & P. 6d.

SAVOY ELECTRONICS LTD.

15 Maiden Lane, Strand, London WC2 (Back of Adelphi Theatre)

FOR THE FINEST, FASTEST SERVICE IN THE COUNTRY, CONTACT—

D. & B. TELEVISION

Phone: Cherrywood 3955

131a KINGSTON ROAD, SOUTH WIMBLEDON, S.W.19

OUR COMPREHENSIVE SERVICE INCLUDES:

12 CHANNEL TURRET TUNERS, 10, 16, 38 Mc/s. 40/-; VALVES, PCF80 and PCC84 7/- each. Cabinets, Glasses, Masks, Condensers, Resistors, Ion Traps, Speakers.

RECLAIMED C.R. TUBES (Not boosted or reactivated)

9in. and 12in. 35/-; 14in., 50/-; 17in., 60/-; All picture tested taken from stripped TVs.

REGUNDED C.R. TUBES (12 months' guarantee): 12in., 80/-; 14in., 90/-; 17in., 100/-.

EXAMPLE OF TRANSFORMER LIST

| L.O.T. SCAN COILS | | P.YE: | | L.O.T. SCAN COILS | |
|-------------------|-----------|-------|--------|-------------------|-----------|
| (New) | (Used) | (New) | (Used) | (New) | (Used) |
| 103T, 105T | 69/9 35/- | 60/- | 35/- | V4, V7, V7 | 52/8 35/- |
| 992/4/6/8 | 69/9 35/- | 60/- | 35/- | V7, CTM4. | 52/6 35/- |

These are only examples of stocks, we have many thousands more, and would be pleased to quote for any component you may require.

We pride ourselves that we can obtain and supply any TV spare.

OUR GIGANTIC STOCKS INCLUDE:

LINE OUTPUT, FRAME OUTPUT, SOUND OUTPUT, LINE AND FRAME BLOCKING, C. TRANS., AND SCAN COILS, FOR ANY MAKE OR MODEL TELEVISION. SOME OF OUR VALVES:

| | | | | | | |
|-----------|-----------|------------|-----------|------------|-----------|------------|
| AZ31 8/6 | ECF80 8/- | KT33C 6/- | PY31 7/- | U801 22/6 | 5V4 9/- | 10P13 9/- |
| B99 5/6 | ECH35 9/- | KT38 8/6 | PY32 10/- | UA F82 8/- | 5Y3 10/6 | 10P14 9/- |
| D77 3/- | ECH81 6/- | KT66 15/- | PY80 6/6 | UBC41 7/9 | 5Z4 10/- | 12AT7 5/6 |
| DH74 4/6 | ECL80 6/9 | PCC84 7/- | PY81 6/6 | UCH42 7/- | 6AL5 3/- | 12AU7 5/6 |
| DK91 5/9 | EF39 5/- | PCC89 8/6 | PY82 6/6 | UF41 8/6 | 6AM6 3/- | 20D1 8/9 |
| DK92 8/- | EF50 3/9 | PCF20 7/- | PZ30 10/- | UF42 3/9 | 6C06 27/8 | 20D2 9/9 |
| DK98 7/6 | EF80 4/6 | PCL82 7/- | U22 10/- | UL41 7/3 | 6D2 3/- | 20E2 9/9 |
| DL92 7/6 | EF91 3/- | PCL83 10/9 | U24 10/- | UL46 7/3 | 6F1 5/- | 20L1 12/8 |
| DL94 5/9 | EF92 5/- | | U25 12/- | UL44 11/6 | 6F12 3/- | 20P1 10/8 |
| DL98 7/6 | EL33 8/6 | | U29 12/- | UY41 6/6 | 6F13 7/- | 20P3 12/8 |
| EB91 3/- | EL38 14/6 | PCL84 9/6 | U31 9/8 | UU8 14/6 | 6F14 9/6 | 20P4 16/6 |
| EB33 5/- | EY51 7/9 | PL33 9/8 | U50 8/6 | U50 8/6 | 6F15 9/6 | 27BU 14/- |
| EBF80 9/6 | EY51 7/9 | PL36 10/9 | U52 7/- | SP41 2/3 | 6L1 12/6 | 30C1 7/- |
| ECC31 5/3 | EY51 7/9 | PL38 14/6 | U191 9/- | SP41 2/3 | 6V6 5/- | 30C2 14/- |
| ECC32 5/9 | EY98 7/8 | PL81 8/6 | U281 9/- | W77 5/- | 10F1 4/6 | 30L1 7/- |
| ECC84 8/- | EZ40 6/6 | PL82 6/9 | U292 20/- | Z77 3/- | 10C1 10/6 | 30P4 10/9 |
| | | PL83 7/- | U301 20/- | 5U4 5/- | 10C2 13/- | 185BT 14/- |

These are only examples of our valves: if you do not see what you require send stamped addressed envelope for special quotation.

And that's not all—WE ARE OPEN FROM 10 a.m. UNTIL MIDNIGHT.

For any information or problems you have call or Phone, we are always pleased to help.

TERMS: S.A.E. all enquiries. C.W.O. or C.O.D. 3/- extra.

Postage on Valve 6d. each. C.R.T.'s 12/6 inc. insurance.

SATISFACTION ASSURED. RETURN POST SERVICE.

H.A.C. SHORT-WAVE EQUIPMENT

SHORT-WAVE KITS

Famous for over 25 years for S.W. Receivers and Kits of Quality.

H.A.C. were the original suppliers of SHORT-WAVE RECEIVER KITS for the amateur constructor. Over 10,000 satisfied customers—including Technical Colleges, Hospitals, Public Schools, Hams, etc.

Improved designs with Denco coils: One-valve Kit, Model "C". Price 25/-. Two-valve Kit, Model "E". Price 50/-. New Addition: Model "K". Super sensitive "All Dry" Receiver. Special incl. price. Complete Kit, 77/-.
 All kits complete with all components, accessories and full instructions. Before ordering call and send a demonstration receiver, or inspect for descriptive catalogue and order form.

POST THIS COUPON NOW!

"H.A.C." SHORT-WAVE PRODUCTS
 (Dept. TB), 44 Old Bond Street, London W.1

Please send me FREE and without obligation your 1961 literature.

NAME.....

ADDRESS.....

RADIO VALVE DATA

by W.W. new 7th Ed. 6/-. Postage 9d.
 Radio Amateur Examination Manual by R.S.G.B. 5/-. postage 8d.
 Amateur Radio Call Book by R.S.G.B. 4/-. postage 6d.

Practical Transistor Receivers. Book 1 by Sinclair, 5/-. postage 6d.
 TV Fault Findings by Data, 5/-. postage 6d.
 Mullard Reference Manual of Transistor Circuits, 12/6. postage 1/-.
 All-In-One Tape Recorder Book by Lloyd, 12/6. postage 1/-.
 Beginners Guide to Radio, 5th ed. by Camm, 7/6. postage 9d.

Using an Oscilloscope by Easterling, 6/6. postage 6d.
 Radio Controlled Models by Camm, 12/6. postage 1/-.
UNIVERSAL BOOK CO.
 12 Little Newport Street, London, W.C.2 (adjoining Lisie Street)

MICROAMMETER. 0-50µA. 3 x 2 1/2in. new, sealed 0-3, with FREE multimeter scale, circuit and wiring diagram. 22/8, post 1/3. Circuit, scale 9d.
 High Stability Resistors. Surplus 1/2 1% at 9d. each. List available 1/10 to 2 watt, 1% to 5%.
 Two Watt Carbon Resistors. 4d each. 30 assorted 5/-, post 1/4.
 Transmitter Head. Small 6 valve TX chassis, approx. 7 Mc/s osc. doubling to approx. 56 Mc/s., air sp. trimmer tuning, mike tran. etc. 65 parts. less valves 2/6. Post 1/4.
 Instrument Rectifiers. New Salford 1mA, 5mA 7/6. Ex-Govt. 5-50mA 50µA-1mA 3/6.
 Instrument Case, 4 1/2 x 5 1/2 x 3 1/2in. deep, new ex-rovf. 2/- post 1/8.
 Precision Wirewound Resistors. 1 Watt 1 ohm to 1K. 1% 2/9; 1% 3/-; 0.2% 4/3 to 5K 1% 3/3; 1% 3/8; 0.2% 4/9; to 20K 1% 4/-; 1% 4/3; 0.2% 6/-; to 100K 1% 4/3; 1% 4/6; postage extra. S.A.E. enquiries please.

Pat. No. 836161
 Reg. design.
JUST P.L.G. ON TO TUBE!
 No technical knowledge required.
 Important! State Make, Model No. Name and Address in Block Letters Please.



STANDARD MODEL .. 25/-
 DE LUNE MODEL .. 35/-
 Postage 2/6 either model.

SINCLAIR ELECTRONICS Dept. P.W.1
 18 Newport Court, Charing Cross Rd. W.C.2.
 Terms: C.W.O., C.O.D. REGENT 5520

★★★ Special bargain offer—Complete Kit P.W. Superhet including genuine Ediswan Transistors, £7.19.6—a bargain not to be missed ★★★ Red Spot Transistors, 2/9, White Spots, 2/9; Yell./Gr., 3/3; Ediswan XA102, 10/-; XA104, 9/6; XA103, 9/-; XA101, 9/-; XB103, 8/6; XB104, 7/6; XC101, 9/-.
 Special bargain set for P.W. Superhet 6 Transistors (1-XA102, 2-XA101, 1-XB103, 2-XC101), plus Diode, 47/6; Newmarket V15/10 P, 15/-; Diodes, 1/-; 2/-; 3/-; Transistor holders, 1/-; Ardent Trans. D239, 8/6; D240, 8/6; D.131, 10/-; D.132, 10/-; Sub. Min. Electrolytics (15v) 2, 4, 8, 10, 25, 50, 100 mfd., 3/2 mid., 2/9. M.C. Earpiece (used as speaker), 5/-; Balance Inserts (as earpiece or speaker), 3/6. Silicon Rectifier bargain 70 p.p.v. 1/2 amp., 3/3; Westlake Contact Rectifier, 250 v., 60 mA, 7/6; Transformer 250.0-250 v., 6v. and 5v., 15/-; Packard Bell Amplifiers, new 12/6; Garrard Portable Record Player, cabinet, battery turntable 45 r.p.m. and pick-up, takes transistor amplifier, £3/10/0, plus car. 3/3. Real bargain. Limited quantity. TERMS.—Cash with order. Post extra, excess refunded. Our Reflex R, best 2-transistor Receiver. Send 8d. stamps for notes.

MOORES EXPERIMENTAL SUPPLIES
 8 & 10 Granville Street, Sheffield 2
 Tel.: 27461

FREE TO AMBITIOUS ENGINEERS

— THE LATEST EDITION OF ENGINEERING OPPORTUNITIES

Have you sent for your copy?
ENGINEERING OPPORTUNITIES is a highly informative 156-page guide to the best paid engineering posts. It tells you how you can quickly prepare at home for a recognised engineering qualification and outlines a wonderful range of modern Home Study Courses in all branches of Engineering. This unique book also gives full details of the Practical Radio & Electronics Courses, administered by our Specialist Electronics Training Division—the *B.I.E.T. School of Electronics*, explains the benefits of our Employment Dept. and shows you how to qualify for five years promotion in one year.

We definitely Guarantee
“NO PASS—NO FEE”

Whatever your age or experience, you cannot afford to miss reading this famous book. If you are earning less than £25 a week, send for your copy of “ENGINEERING OPPORTUNITIES” today—FREE.

BRITISH INSTITUTE OF ENGINEERING TECHNOLOGY (Incorporating E.M.I. Institutes)
 (Dept. SE/21), 29 Wright's Lane, London, W.8

THE B.I.E.T. IS THE LEADING ORGANISATION OF ITS KIND IN THE WORLD

WHICH IS YOUR PET SUBJECT?

Mechanical Eng.,
 Electrical Eng.,
 Civil Engineering,
 Radio Engineering,
 Automobile Eng.,
 Aeronautical Eng.,
 Production Eng.,
 Building, Plastics,
 Draughtsmanship,
 Television, etc.

GET SOME LETTERS AFTER YOUR NAME!

A.M.I.Mech.E.
 A.M.I.C.E.
 A.M.I.Prod.E.
 A.M.I.M.I.
 A.I.O.B.
 A.F.R.Ac.S.
 B.Sc.
 A.M.Brit.I.R.E.
 City & Guilds
 Gen. Cert. of Education
 Etc., etc.

PRACTICAL EQUIPMENT

Basic Practical and Theoretic Courses for beginners in Radio, T.V., Electronics, Etc., A.M.Brit.I.R.E. City & Guilds Radio Amateurs' Exam. R.T.E.B. Certificate P.M.G. Certificate Practical Radio Radio & Television Servicing Practical Electronic Electronics Engineering Automation

INCLUDING TOOLS!

The specialist Electronics Division of *B.I.E.T. (Incorporating E.M.I. Institutes)* NOW offers you a real laboratory training at home with practical equipment. Ask for details.

B.I.E.T. SCHOOL OF ELECTRONICS



POST COUPON NOW!

Please send me your FREE 156-page “ENGINEERING OPPORTUNITIES” (Write if you prefer not to cut page)

NAME _____

ADDRESS _____

SUBJECT OR EXAM THAT INTERESTS ME _____

(SE/21)

BBC - ITV - F.M. AERIALS

B.B.C. (BAND 1). Telescope loft, 19/6. External, S/D, 28/3.
I.T.V. (BAND 3). 3 Element loft array, 24/-. 5 Element, 39/6. Wall mounting, 5 Element, 39/8. 5 Element, 41/3.
COMBINED B.B.C. + I.T.V. Loft 1+3 Element, 41/3. 1+5 Element, 48/9. Wall mounting, 1+3 Element, 56/8. 1+5 Element, 68/9. Chimney and mast mounting units also available.
F.M. (BAND 2). Loft “H”, 28/-. 3 Element loft, 62/6. S/D loft, 12/6. External S/D, 26/8. Stereo channel when ordering. C.W.O. or C.O.D. P.P. 2/6. Coaxial cable, 8d. yd. Coaxial plugs, 1/3. Send 8d. stamps for illustrated lists.
K.V.A. ELECTRONICS (Dept.P.W.)
 3B, Godstone Road, Kenley, Surrey.

2 METRES!

The thrills of 144 Mc/s can now be yours for only 39/6, complete kit! Tuneable range 150-100 Mc/s, simplified construction, etc., write today for descriptive literature, also list a newcomer-beginner to Amateur Radio, ask for free copy of the world-famous “Globe-King” kits and receivers—stamp to cover postage costs appreciated. Write now to makers:

JOHNSONS (Radio)
 St. Martins Gate, Worcester

RADIO BOOKS

NEW PICTORIAL APPROACH TO LEARNING
BASIC ELECTRICITY, 5 parts.
BASIC ELECTRONICS, 8 parts.
 The Complete Set sent on payment of first instalment.
LEARN WHILE YOU PAY
 Write for FREE illustrated Prospectus giving details of instalment plan!

BOYS' BOOK OF CRYSTAL SETS AND SIMPLE CIRCUITS, 3/-
TRANSISTOR CIRCUITS Nos. 1, 2, 3, 4, 3/- each.
ELECTRONIC NOVELTIES, 5/6.
ELECTRONIC GADGETS, 4/-
SERVICING TRANSISTOR RECEIVERS, 6/6.
 Postage included in above prices. SEND STAMP FOR LISTS.
SELRAY BOOK CO.
 60 HAYES HILL, HAYES, BROMLEY, KENT. Tel. HURStway 1818.

Surplus Radio Supplies

2 LAING'S CORNER MITCHAM SURREY

OFFER THE FOLLOWING

30 2 WATT ERIE TYPE T2 RESISTORS

All different and all standard values between 22 ohms and 3.3 Meg ohms, plus the following wirewound resistors 15 and 18 ohm, 3 watt: 33, 100, 820, 3.9k, 5 watt, 70 plus 70 'anode' surge and 60 plus 75 plus 35 plus 25, 20 watt dropper. Worth 30/-. ALL FOR 5/- plus 1/- postage and packing.

BARGAIN CORNER

- GARRARD RC210 Auto Changer. List Price £13.6.5. Our Price £9.19.6.
 - COLLARO STUDIO TAPE DECK. List Price £17.10.0. Our Price £12.18.6.
 - LEAK POINT ONE PRE-AMPLIFIER. Last Price £12.12.0. Our Price £9.9.0.
 - WHITELEY Prelude Console Speaker Cabinet. List Price £10.10.0. Our Price £8.8.0.
 - WHITELEY T816 Cone Tweeter. List £8.10.0. Our Price £4.10.0.
 - PICK-UP CARTRIDGES. BSR TC8M 19/6. Collaro PX 19/6. Garrard GC2 15/6. All with fixing brackets.
 - VALVES. ISS. 5/6. EF1. 6/-. EM60. 7/6.
 - VALVE HOLDERS. B9A Ceramic. 9d. each. 7/- doz.
 - TRANSISTORS, COIL FORMERS AND TAPES—Send for lists of bargain offers.
- All items guaranteed perfect condition. All prices include postage.

WATTS RADIO 54 CHURCH ST., Weybridge, Surrey (MAIL ORDER) LTD. (Telephone: Weybridge 4656)
 Please note: Post orders only.
IMPORTANT! Closed for Holidays, AUGUST 11th to 26th.

GZAK: This Month's Bargains

SCREENED CABLES

Screened Microphone Cable, 1st Grade, 9d. yd. or 6/- per doz. yds. 12-Core Screened Cable, 2/- yd. 10-Core (5 Pairs) Screened Cable, 1/8 yd. All plus 1/6 P. & P.

AERIAL EQUIPMENT

TWIN FEEDER. 300 ohm twin ribbon feeder, similar K25, 6d. per yard. K35B Telcon (round) 1/6 per yard. Post on above feeder and cable 1/6 any length.

COPPER WIRE. 14 G., H/D 140ft. 17/-; 70ft. 8/6. P. & P. 2/-.

Other lengths *pro rata*.
RIBBED GLASS. 3in. aerial insulators, 1/9 each. P. & P. 1/6.
CERAMIC FEEDER SPREADERS. 6in. type F.S. 10d. each or 9/- dozen, P. & P. 2/-.

CERAMIC "T" PIECES. Type A.T. for centre of dipoles, 1/6 each. P. & P. 1/-.

2 METRE BEAM 5 ELEMENT W.S. YAGI. Complete in box with 1 x 2 1/2 in. mast head bracket. PRICE 49/-.

SUPER AERAXIAL CABLE. 75 ohm, 300 watts, very low loss, 1/8 per yard P. & P. 1/6. 50 ohm, 300 watt coax, very low loss, 1/6 yd. or 20 yds. 27/6. P. & P. 1/9.

ABSORPTION WAVEMETERS. 3.00 to 35.00 Mc/s. in 3 switched bands, 3.5, 7, 14, 21 and 28 Mc/s. Ham Bands marked on scale. Complete with indicator bulb. **A MUST** for any Ham shack. 22/6 post free.

VARIABLE CONDENSERS. All brass with ceramic end plates and ball race bearings. 50 pF, 5/9. 100 pF, 6/6. 160 pF, 7/6. 240 pF, 8/6, and 300 pF, 9/6. All fitted with rear extension for ganging. P. & P. 1/-.

Also Flexible Couplers 1/- each.
B.1.8 MFD. 1,200 v. D.C. Wkg. Capacitors, 12/6 each. P. & P. 2/-.

CHAS. H. YOUNG LTD.

THE COMPONENT SPECIALISTS

Dept. "P", 110 Dale End, Birmingham 4. (CEN 1635)
(No C.O.D. under £1 please.) (By return service)

P.W. POCKET SUPERHET TRANSISTORISED PRINTED BOARD

A-Z CONSTRUCTIONAL BOOKLET 1/6 including "BLOWN-UP" DIAGRAM

and list of modifications

Write for Price List and Free Information

OSMOR RADIO PRODUCTS LTD.

418 BRIGHTON ROAD SOUTH CROYDON SURREY Telephone CRO 5148/9

NEW VALVES!

Guaranteed Set Tested 24 HOUR SERVICE

1R5, 1S5, 1T4, 3B4, 3V4, DAF91, DF91, DK91, DL92, DL94, SET of 4, 18/6.
DAF96, DF96, DK96, DL96, SET of 4 26/-.

| | | | | | |
|--------|------|-------|------|--------|------|
| 1D5 | 7/- | DL92 | 5/11 | PCR80 | 6/9 |
| 1R5 | 5/8 | DL94 | 6/9 | PCR82 | 7/6 |
| 1S5 | 4/6 | DL96 | 6/9 | PCL82 | 5/3 |
| 1T4 | 3/3 | EB91 | 3/4 | PCL83 | 11/6 |
| 3B4 | 5/11 | EBC41 | 7/6 | PCL84 | 7/6 |
| 3V4 | 6/9 | EBF80 | 7/9 | PL36 | 10/9 |
| 5D4G | 4/3 | EHL21 | 12/6 | PL81 | 8/6 |
| 5Y3GT | 5/6 | ECC40 | 14/6 | PL82 | 6/6 |
| 5Z4G | 7/3 | ECC81 | 4/9 | PL83 | 6/6 |
| 6AM6 | 2/9 | ECC82 | 5/9 | PL84 | 9/6 |
| 6K7G | 1/9 | ECC83 | 6/3 | PY32 | 10/3 |
| 6K8G | 4/9 | ECC84 | 8/- | PY80 | 7/- |
| 6Q7G | 5/6 | ECC85 | 7/9 | PY81 | 6/- |
| 6V6G | 4/9 | RCF80 | 8/3 | PY82 | 6/- |
| 6V6GT | 6/6 | ECF82 | 8/3 | PY83 | 7/3 |
| 6X54GT | 4/9 | ECH21 | 12/6 | U26 | 12/- |
| 12K7GT | 4/9 | ECH42 | 7/9 | UABC80 | 7/6 |
| 12K9GT | 11/- | ECL80 | 6/9 | UA P42 | 8/6 |
| 12W7GT | 4/6 | EF40 | 12/3 | UBC41 | 7/- |
| 35L8GT | 8/6 | EF41 | 7/6 | UBP80 | 8/6 |
| 35Z4GT | 5/9 | EF90 | 4/9 | UCC85 | 7/- |
| AZ31 | 8/6 | EF95 | 5/- | UCH21 | 12/6 |
| CL83 | 11/9 | EF98 | 6/9 | UCH42 | 9/6 |
| DACS2 | 9/6 | EF99 | 6/9 | UCH81 | 11/6 |
| DAF91 | 4/6 | EF91 | 2/9 | UCL82 | 10/- |
| DAF96 | 6/9 | EL41 | 7/- | UCL83 | 13/- |
| DF33 | 9/6 | EL94 | 6/3 | UF41 | 7/9 |
| DF91 | 3/3 | EY31 | 7/3 | UR85 | 3/- |
| DF96 | 6/9 | EY86 | 7/6 | UF89 | 6/6 |
| DH77 | 6/- | EZ40 | 6/- | UL41 | 7/- |
| DK32 | 11/- | EZ41 | 6/9 | UL84 | 7/- |
| DK91 | 5/- | EZ80 | 5/9 | UY21 | 13/- |
| DK92 | 7/3 | EY81 | 6/9 | UY41 | 5/6 |
| DK96 | 6/9 | MU14 | 7/- | UY85 | 6/9 |
| DL33 | 8/6 | PCC84 | 6/9 | VP4B | 8/6 |
| DL35 | 8/6 | PCC89 | 10/- | VZ7 | 2/9 |

Postage 6d. per valve extra. Any Parcel Insured Against Damage in Transit 6d. extra. Any C.O.D. Parcel 3/- extra. Office address, no callers.

GERALD BERNARD

(Note new address, formerly of Leeds)
25 NEWBURY ROAD
HIGHAMS PARK, LONDON, E.4

THE PUNCH YOU NEED!

HOLE PUNCHES

| | | | |
|----------------------------|-----|-----------|--|
| One Minute Type | | | |
| 1 1/2" diameter | ... | 5/6 ea. | |
| 2" diameter | ... | 6/4 " | |
| Screw-up Type | | | |
| 1 1/2" diameter | ... | 6/8 ea. | |
| 2" diameter | ... | 7/2 " | |
| 2 1/2" diameter | ... | 7/8 " | |
| 3" diameter | ... | 8/3 " | |
| 3 1/2" diameter | ... | 8/7 " | |
| 4" diameter | ... | 9/6 " | |
| Postage and packing 1/- | | | |
| 1 1/8" diameter Int. Octal | ... | 10/11 ea. | |
| 1 1/4" diameter | ... | 13/3 " | |
| 1 3/8" diameter | ... | 15/6 " | |
| 1 1/2" diameter | ... | 17/11 " | |
| 1 3/4" diameter | ... | 20/4 " | |
| 2 3/8" diameter | ... | 27/8 " | |
| Postage and packing 1/9 | | | |

Complete set including postage and packing £8.

OLIVER & RANDALL LTD

Dept. 1.

40 Perry Hill, London, S.E.6

Tel.: BECKenham 8262

SOLO SOLDERING TOOL 12/6

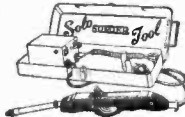

Brand New. A.C. 110v. or Car Battery. Adaptor 250v. 10/- extra. Auto/feared cannot burn. P. & P. 3/6.

TV CHASSIS 5/6

Plessey. Less valves and tube. Circuit incl. carr. 7/6.



EXPANSION SPEAKERS 19/9

8in. P.M. Speaker fitted into polished cabinet. Complete. P. & P. 2/9

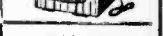

VALVES

9d. EACH. 4D1, 6AL5, 6D1, 6D2, 6SG7, 6SH7, 8D2, 9D2, 10F3, 12V4, 15L12, 75, 210VPT, 2059, 21S1, 7193, C2C, CV66, D1, D152, EA50, EB91, EF50, HL41DD, NL42DD, LD210, P61, PM202, SF41, SP61, TDD13C, VR35, VR51, VR106, VR107, VR108, VR109, VR137, VR201, VR501, Z66, and many others. Postage: 1, 7d.; 6, 1/8; 12, 2/6.

P.P. COMPONENTS, LTD.
219 ILFORD LANE, ILFORD, ESSEX
STAMP FOR FREE LIST

JAMES H. MARTIN & CO.
Radio & Television Component Service
Finsthwaite, Newby Bridge
Ulverston, Lancs.

Lists available. Inland 3d. stamp only
Overseas, airmail 5/- refundable.

Lyons Radio Ltd.

Telephone: SHEpherds Bush 1729

3 Goldhawk Road, London W.12

GUARANTEED METERS. All 2 1/2 inch dia., flush panel mtg., 100 micro-amp., magnet coil type 37/6. 25 v. A.C. resistor type 22/6. 100-0-100 v. moving coil type (1,000 ohms per 1) 27/6. Post 1/-.

TRANSFORMER BARGAINS. Type 7A. Pri. 230 v. 50 cps. Sec. 450-0-450v. at 225mA. 250-0-250v. at 75mA. 8.3v. at 5A. 5v. at 3A. twice. Ex. Govt.. PRICE ONLY 25/-, post 4/-. Tapped L.T. Types: Pri. 200/250v. 50cps. Sec. 30v. tapped at 3, 4, 5, 6, 8, 9, 10, 12, 15, 20 & 24v. Type T3. 2 Amp size 22/6. Type T3A. 4 Amp size PRICE 33/-. Post 2/-.

ROTARY TRANSFORMERS TYPE 76. Input 24v. D.C. Output 250v. D.C. twice at 150mA. Size approx. 9ins. long x 4ins. dia. In condition as new and unused. PRICE ONLY 15/-, post 3/6.

RESISTANCE WIRE. Make your own wire-wound resistors. Brand new cupro-nickel wire on 4 oz. reels. 33swg. SCC. approx. 27 ohms per yard. 31swg. SSC. approx. 6.2 ohms per yard. PRICE ONLY 3/6 per reel, post paid.

SMOOTHING CHOKES. 10H. approx. at 150mA. D.C. resistance 200 ohms. wt. 6 lbs.. fully impregnated, size 4 x 4 x 3 1/2 ins. Made to Govt. spec. PRICE ONLY 7/6. Post 2/6.

T.C.C. MANSFIELD CONDENSERS. 5mf. 500v. 40 pF. 80 deg. C. inverted mtg. type 82 I.M. PRICE 5/6. 4mf. 1,500v. wkg. at 80 deg. C. inverted mtg. type 121B PRICE 4/6. 4mf. 750v. wkg. at 80 deg. C. type 92. PRICE 4/-, Add 1/6 postage less than 6, over post free.

PLUGS & SOCKETS. We stock a large range of "Service" types and can supply the correct type for most units on the "Surplus" market (Postal enquiries, S.A.E. please.).

BENSON'S BETTER BARGAINS

CONDENSERS: Block paper 8 mfd. 1 kVv 10/-; 8/600 v. 6/8; 8/400 v. 5/-; 8/250 v. 4/-; 4/2 kVv 7/8; 4/1 kVv 4/6. **SWITCHES:** Water: 2 pole, 4 way, 4 bank 1P6W8B, 4P2W2B, 1P7W3B, 1P11W2B, 4P2W6B, 3/6 each. Ceramic 3P4W1B, 1P5W3B, 1P11W3B, 3P3W2B, 4P3W1B, 3/6. **STUD.** 1P4W2B, 1P4W2B, 3/6; 1P19W2B, 5/8; 1P40W3B in brass case, 12/6. **MORSE key** with buzzer on board, wired for 4v. battery, 8/6 (p.p. 1/6). **TELE "E"** intercom, set, good condition, pair 65/-. Post free Gr. B. **METERS** (10Q/4) with two movements, 600 and 400µA, 8/8. **TRANSFORMERS.** Mains, for R1132R1392, 25/- (P. 3/6). Input 110/240. Output 180v. 4 mA, 12/6. **MONITOR** 56 triggered oscilloscope, 220 v. A.C. input, with cables and circuit. Cathode probe unit extra, 17/6. 88.10/0. (Rail 15/-). **CR100 Noise Limiter** assemblies with valve, 3/6. **NEW M.C. METERS.** 3 1/2 in. round flush. 50µA 70/-, 200µA centre zero, 50/-; 1 mA, centre zero, 45/-; 1 mA, 65/-; 100 mA, 8/8; 2in. 800 mA, each 7/8; **VIBRATORS.** Malory G684C 12 v. 4 pin, 8/6; 6 v. 5-pin reversible, 7/8. **DRIVES:** slow motion Admiralty 200 1 r.p.m. rated 0-1/6. **ELIEM "S.B.S." "N"** type, new 10/6. **VIBRAPAK** 6 v. D.C. to 350 v. 60mA, smoothed case, 22/6 (p.p. 3/6), or 12 v. 25/-, **DYNAMOTORS** (post 3/6), 12 v. to 250 v. 60 mA, 11/8, 6 v. to 250 v. 60 mA, 11/8. **CHOKES:** P.F.101 100 v. 10/6. **ELIEM 250 mA, 12/8; 5H, 40 mA, 10/8; 30H, 50 mA, 7/8, 10H, 500 mA, "C" 22/8; 20H, 100 mA, 9/8; 4H, 190 mA, 8/6; 16H, 150 mA, 9/6. **TRANSISTORS** V30/10P, 10/-; GERM. RECTIFIERS G35M, 1300P.I.V., 530 mA, 10/-.**

CLOSED HOLIDAYS
24 JUNE - 10 JULY (inc.)

RELAYS (LONDEX) oo-ax, small 12/24 v. 7/6; 12/24 v. DP/CO, 8/8; 24 v. DP/CO plus 1M (Two on Base), 8/6. **Rectifier Unit (U.S.A.)** 11-C1 with 3/6/24, 3/6/16, 5/1R/50, 1/68/7 1/68/7, new 65/- (rail 5/-). **Valueholders:** B7W/Skirt, 6/- dozen; I.O. Ceramic, 1/- each. **LIST AND ENQUIRIES** S.A.E. please. Terms, C.W.O. Postage extra. **Imports, despatch, Callers and post:** W. A. BENSON (P.W.), 138 Bathstone Road, Liverpool, 15. **SEF** 6853. **Callers:** SUPERADIO (Whitechapel), Ltd., 116 Whitechapel, Liverpool 1. **ROY** 1130

B. W. CURSONS

78 Broad Street, Canterbury, Kent.
Phone: Canterbury 5442.

POST FREE BARGAINS

- Two Gang .0005 Condensers .. 4/6 ea.
 - 100 Condensers 2pF to 200mf... 10/-
 - 100 resistors 4Ω to 10MΩ .. 9/6
 - 12 volt vibrators 4 for 7/-
 - Xtal Mics & Car Aerials .. 17/- ea.
 - Pre-set pots 500K 4 for 4/9
 - Min. Earpieces HI or Low imp. 7/3 ea.
 - Tape Spools and Cases all sizes 2/3 ea.
 - Brand five tape 600 14/6 ea.
 - Repanco mini 4 Kit 55/18/6 ea.
 - P.W. Transistor 6 kit 28/18/6 ea.
- All types of valves 10,000 in stock 4/- each, send C.W.O. any out of stock refunded.
- Our rebuilt C.R.T.s 9in. to 17in. new guns, 18 months guarantee, dud not required, 24.7-6. 21inch 25.7-6.
- Callers large stock of components, kits, Ex Gov. equipment, etc.
- C.W.O. to

B. W. CURSONS

TRANSISTOR TOOL KIT

NO MORE HEAD-ACHES with the specially selected miniature extra small, high grade tools.

KIT COMPOSES:-
Slide Cutters, Extra Pointed Tweezers, Circuit Brush, Steel Probe, Sharp Steel Midget Screwdriver, Watchmaker's Eyeglasses, Extra Pointed Long-nosed Pliers. **IDEAL FOR EVEN TINY RADIOS.**

Any of the above tools and many others sold separately. S.A.E. with enquiries. **Order Now, Supplies Limited** Send P.O. and 1/6 to cover post. **LUBRICANT ELECTRONIC AIDS**
22 Hunton Street
Brick Lane, London E.1
Trade enquiries welcome.

LOOK! PRICES DOWN

MULLARD TRANSISTOR PRICES DOWN. OC71, 6/6; OC72, 8/-; OC78, 8/-; OC81, 8/-; OC45, 10/-; OC44, 11/-; OC170, 13/6; OC171, 14/6.

RED SPOT TRANSISTORS 3/- each, 3 for only 8/6.

WHITE SPOT TRANSISTORS 3/- each.

YELLOW SPOT A.F. 6 volt Transistor 2/6.

BLUE SPOT R.F. Type 4/9 each.

YELLOW/GREEN TRANSISTORS 3/6 each, 3 for 10/-.

RED/YELLOW TRANSISTORS 5/6 each.

SURFACE BARRIER SB305 9/- each, 3 for 2/6.

GERMANIUM DIODES 1/- each, 3 for 2/6.

MULLARD OA70, OA79 or OA81 3/- each.

MULLARD OA91 or OA95 Miniature Diodes 3/6.

TRANSISTOR HOLDERS 1/3 each, 3 for 3/6.

MINIATURE SLIDE SWITCHES DP/DT 2/9 each.

CRYSTAL SET COILS. M & L 2/6.

ALL SENT POST FREE IN U.K. by

PETHERICK'S SUPPLIES

22 High Street, Bideford, N. Devon
Tel: Bideford 1217
S.A.E. WITH INQUIRIES PLEASE

EDDY'S (NOTTM) LTD.

172 Alfreton Road
Nottingham

GUITAR PICK-UPS. Super HI-FI non-acoustical universal fitting. High output complete with lead and plug. Full and easy instructions 49/11. P. & P. 7/6.

NIFE ACCUMULATORS. 1.25 v. size 3 x 2 1/2 x 3/4 in. 7 amp. hrs. weight 13 ozs. 1/11 each. P. & P. 1/6., add 9d. per cell.

Build your own CAR RADIO

- ★ 7 Transistor ● Long and Medium Wave ● Two Watts Output ● R.F. Stage and Automatic Gain Control



10 1/2 Cns.
P & P 5/- extra

6 or 12 volts (state which)
Supplied with full instructions
Size 7 1/2 x 7 1/2 x 2 1/4 in.
SPEAKER, extra 17/11

DIMMER SWITCHES. Ideal for train speed regulators, 1/11. Post 9d.

GERMANIUM DIODES. 9d. each. 7/- Doz. Post 6d.

VIBRATORS. 12v. 4 pin 4/11. Post 1/-.

NEON MAINS TESTER/SCREW-DRIVERS. 3/11. Post 9d.

MORSE TAPPERS. Plated contacts. Adjustable gaps. Heavy duty. 3/6. Post 9d.

CRYSTAL SETS. Complete 2 wave bands, high gain, good quality. 19/11. Also with transistor amp. Extra 9/11. P. & P. 2/6.

HEADPHONES. High res. to suit above crystal set 13/11. P. & P. 1/6.

POCKET RADIO. 2 Transistor with miniature speaker complete with all parts wiring diagram and full instructions, 27/6. Batteries 1/-, P. & P. 1/6.

LUXEMBOURG AERIALS. Expanding complete and easy to fit. No technical knowledge required. 3/11. Post 6d.

V.H.F. Aerials. Expanding complete and easy to fit. No technical knowledge required. 6/11. Post 10d.

All above are new and guaranteed. New or Surplus valves guaranteed and tested by return post.

| | | | | |
|-------|--------|-------|-------|--------|
| AC2/ | EY86 | 7/9 | 6C6 | 4/9 |
| PENDD | EZ40 | 6/3 | 6F33 | 6/6 |
| | EZ41 | 7/- | 6J5G | 2/9 |
| CY31 | EZ80 | 6/11 | 6J5GT | 3/9 |
| DAF91 | EZ81 | 6/9 | 6J5M | 4/3 |
| DAF96 | HL23DD | | 6J7G | 5/- |
| DF91 | 7/11 | 6K7G | 1/11 | |
| DF96 | MU14 | 7/6 | 6K8G | 5/3 |
| DL96 | PC84 | 7/6 | 6Q7G | 5/9 |
| DL93 | 4/11 | 6P36C | 8/- | 6S47M |
| EAF42 | 8/6 | PEN44 | 12/6 | 6SG7M |
| ECC81 | 5/3 | PL36 | 10/9 | 6S17M |
| ECC82 | 5/11 | PL81 | 9/- | 6SL7GT |
| ECC85 | 6/11 | TD44 | 7/6 | 6SN7GT |
| ECL80 | 7/- | VP23 | 6/6 | 6V6G |
| ECL82 | 9/11 | ID5 | 7/6 | 6X5G |
| EF36 | 3/- | IS5 | 4/9 | 10F1 |
| EF41 | 7/6 | IT4 | 3/11 | 12A6 |
| EF42 | 7/6 | 354 | 5/11 | 12AT6 |
| EF50 | 1/9 | 3A4 | 4/11 | 30F5 |
| EF80 | 5/6 | 5Y3GT | 6/9 | 35W4 |
| EF86 | 9/6 | 5Z4G | 7/6 | 95A |
| EL41 | 7/3 | 524G | 7/6 | 95A |
| EL84 | 6/6 | 6B8G | 2/11 | 955 |
| EY51 | 7/11 | 6C4 | 3/6 | 956 |

Any parcel insured against damage in transit for only 6d. extra per order. All uninsured parcels at customers risk. Post and Packing 6d. per valve extra. C.W.O. or C.O.D. only C.O.D. charge 3/- extra. S.A.E. with enquiries.

SUNDRIES

- ★ 1000 ohm Personal Phone with Leads and Jack Plug and Socket, suitable for most Commercial Transistor Radios. 17/6.
 - ★ 9,065 Mc/s 3rd Overtone Crystal for all 27 Mc/s Model Control Transmitters. 12/6.
 - ★ 7 section chromed Telescopic Aerials, 38 in. with fixing bracket, 12/6. P.P. 1/6. 64in. Version, 17/6. P.P. 1/6.
 - ★ ACOS Crystal Mic Inserts. 2in., 12/6; 1½in., 7/6; ½ x ¾in. 7/6.
 - ★ Mercury Batteries, 1.3 v. 500MAH. ¾in. x ¾in. 1/3 ea. P.P. 3d.
 - ★ Siemens High Speed Sealed Miniature Relay, 1700-1700 ohms. 15/- ea.
 - ★ 4.7 volt 1 watt Zener Diode. 19/6 ea.
 - ★ 2½in. 10 ohm Speaker, 17/6.
 - ★ ACOS 39-1 Stick Mic. with lead and stand, 39/6. P.P. 1/6.
- ALL COMPONENTS IN STOCK for "WEY-RAD" 6-Transistor Superhet. Booklet 1/3 post free.

Leaflet on request.

BABY SITTER ALL TRANSISTOR BABY OR INVALID ALARM



NOW MORE SENSITIVE!

Battery operated, push-pull, 400mW output. Low impedance microphone enables unit to be used up to 200 yards. Output on 5in. speaker.

- GUARANTEED for 6 MONTHS and 100% SAFE.
- Microphone is placed within 6 ft. of baby; twin flex is taken to amplifier unit and placed in any room required.
- COMPLETELY BUILT AND TESTED £5.10.0 P.P. 2/6
- Used, All Night, Every Night, Battery Life 3 to 4 months.

★ Quartz Crystals ★
Over 600 types in stock for all purposes—fully guaranteed.

Free List on Request

TRANSISTOR FM TUNER

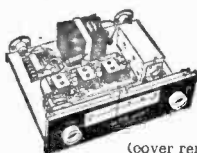

(cover removed)

- 2-OC171 and 3-OC170 Selected Transistors.
- Fully Tunable 85 to 108 Mc/s.
- 10.7 Mc/s I.F.

A new design for Hi-Fi to feed quality valve or transistor amplifiers. Noise level better than 55dB. Hammer finish case. Pre-aligned and tested units. Fully Illustrated Book 3/6. All Parts as Shown 18 gns. P.P. 3/-.
● Units Sold Separately

2 WATT POWER AMPLIFIER

● Designed to boost up the output of Portable Transistor Radios when used in a Car. Works from 6 or 12 volt (state which) Car Battery—uses power transistor. All parts 49/6 P.P. 2/-.

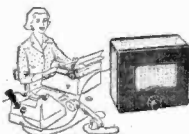

BUILT, TESTED,
READY TO USE

£5.10.0 P.P. 2/6

SUB-MINIATURE CONDENSERS (All low voltage)

1, 2, 4, 6, 8, 10, 16, 25, 30, 50, 100, 0.1, 0.25, 0.5 mfd. All 2/- each.

Type 38

TRANSMITTER/RECEIVER
Complete with 5 valves. In new condition. These sets are sold without guarantee, but are serviceable.

7 to 9 Mc/s 22/6. P.P. 2/9
Headphones, 7/6 pair. Junction Box, 2/6. Throat Mike 4/6. Aerial Rod, 2/6.

MODEL 200H

Volt-Ohm-Milliammeter

20,000 ★ Size 4½ x 3¼ x 1½in.
Ohms/Volt! Over 20 Scales

Price, inclusive of Test Prods, Battery and Instructions P.P. 1/6

Top Quality Meter—Fully Guaranteed

3-TRANSISTOR AND DIODE PERSONAL POCKET RADIO



SUPER-3

QUALITY OUTPUT ON
PERSONAL EARPHONE

A simple to build local station radio with personal earphone output. Built-in Ferrite Aerial and Battery lasting 9 months.

ALL PARTS

37/6 P.P. 1/6

- NO EXTRAS TO BUY
Size 4½ x 3 x 1½in.

★ IDEAL for BEGINNERS

ALL TRANSISTOR
MEDIUM LONG AND
SHORT WAVE PRE-
BUILT UNITS IN
STOCK. FULLY ILLU-
STRATED BOOKLET
SHOWING USES. 2/6.

ALL TRANSISTOR

TIME SAVER

OFFICE OR HOME TELEPHONE
PICK-UP AMPLIFIER

★ No more "Holding Up" wasting time waiting for your call to come through. When it does the amplifier can be switched off if required. No connections, just Sellotape the pick-up coil to back of phone as above.

● 5-inch speaker; 3 months' battery life. Now with 400mW output

REMEMBER!

WE CAN SUPPLY MOST OF
THE COMPONENTS USED
IN CIRCUITS PUBLISHED
IN THIS AND OTHER
MAGAZINES AND BOOKS
AT LOWEST EVER PRICES.
LET US QUOTE FOR YOUR
COMPONENTS.

DECCA AMPLIFIER

Portable Record Player Amplifier with tone and volume controls,

59/6 P.P. 2/-.

● Fully Guaranteed ●

ADDON AMPLIFIER

250mW push-pull stage with 3 inch speaker. Converts any ear-phone radio to full loudspeaker. All parts 59/6. P.P. 1/6.

● Diagrams Free ●

★ TSL 250 ohm Speaker. Replaces earphone, 17/6.

★ Standard Volume Controls. All Values, 3/6, with switch 4/6.

SUNDRIES

- ★ Sub-miniature Jack Plug and Socket, 3/6 complete.
- ★ Mullard LA4 Pot Core complete 12/6. LA10 complete 17/6.
- ★ 208 + 176 pf. 00 tuner 9/6.
- ★ Sub-miniature 27 Mc/s 3rd Overtone Xtal for model control 30/-.
- ★ Personal Earphones used with RANGER 2 and 3. British made, 12/6
- ★ 2½ inch round 11 deep 3 ohm speaker, 17/6
- ★ 2½in. 80 ohm Speaker, excellent quality, 17/6.
- ★ 600 ohm Personal Car Phone with jack and socket, 10/6, P.P. 9d.
- ★ Acos 40 Desk Mic. 19/6. P.P. 1/6.

★ 1 Watt Push-Pull Transformers for OC81 Transistors, 3 ohm, 25/- pair.

★ OA70, OA81 Diodes. 3/- each. OA91 3/6. Other types in stock.

★ Acos 45 Hand Mic. 29/6. P.P. 1/6.

★ Crystal Lapel Microphone, ideal for portable tape recording, 18/6. P.P. 1/-.

★ 5k and 10k Edge Volume Controls with on/off. 7/6.

★ Set of 4 IF and Osc. Coils. U.S.A. Sub-miniature type, 21/-.

★ 2-Gang 1 inch Square Poly Tuner for above. 17/6.

★ 1 watt Push-Pull Transformers for OC81's 25/- pair.

★ 100 mW Push-Pull Transformers for 8/10 ohm Speaker. 12/6 pair.

POCKET IRON

★ Pocket Iron, 220/250v A.C./D.C. 30 watts, complete with mains plug, case, etc. Handle unscrews to cover element enabling iron to be carried in pocket. Only 18/6. P.P. 1/-.

★ Sub-miniature Pre-sets. 5k, 10k, 50k, 100k, 250k, 500k, 1 meg, 2 meg. 2/- each.

★ 2½in. 8/10 ohm Speaker U.S.A. Type. 17/6.

★ 365pF ¾in. square U.S.A. Type Tuner, 8/6.

★ VALVES ★

WE STOCK OVER 800 TYPES OF VALVES AND TUBES AT REALLY COMPETITIVE PRICES.

Free List on Request

Henry's Radio Ltd
DEPT. B9
5 HARROW ROAD . LONDON W.2

Opposite Edgware Road Tube Station
OPEN MON. to SAT. 9.6. THURS. 1 o'clock
Telephone: PADdington 1008/9

SEE BACK PAGE

OUR SPECIALITIES
Transistors, Valves,
Quartz Crystals, Compon-
ents at Competitive Prices

Practical Wireless

BLUEPRINT

SERVICE

ALL OF these blueprints are drawn full-size and although the issues containing descriptions of these sets are now out of print, constructional details are available free with each blueprint except for the PW Monophonic Electronic Organ.

The index letters which precede the Blueprint Number indicate the periodical in which the description appeared. Thus PW refers to PRACTICAL WIRELESS; AW to *Amateur Wireless* and WM to *Wireless Magazine*.

Send (preferably) a postal order to cover the cost of the Blueprint (stamps over 6d. unacceptable) to

PRACTICAL WIRELESS, Blueprint Dept., George Newnes, Ltd., Tower House, Southampton Street, London, W.C.2.

SPECIAL NOTE

THE following blueprints include some pre-war designs and are kept in circulation for those constructors who wish to make use of old components which they may have in their spares box. The majority of the components for these receivers are no longer stocked by retailers.

| Title | Number | Price |
|---------------------------------|--------|-------|
| CRYSTAL SETS | | |
| Junior Crystal Set | PW94 | 2/- |
| Dual-wave Crystal Diode | PW95 | 2/6 |

| Title | Number | Price |
|--------------------------------|--------|-------|
| STRAIGHT SETS | | |
| Battery Operated | | |
| Modern One-valver | PW96 | 2/6 |
| All-dry Three | PW97 | 3/6 |
| Modern Two-valver | PW98 | 3/6 |
| The PW Pocket Superhet | — | 5/- |

| Title | Number | Price |
|------------------------------|--------|-------|
| SUPERHETS | | |
| Mains Operated | | |
| A.C. Band-pass Three | PW99 | 4/- |
| A.C. Coronet-4 | PW100 | 4/- |
| A.C./D.C. Coronet | PW101 | 4/- |

| Title | Number | Price |
|--|--------|-------|
| MISCELLANEOUS | | |
| The PW 3-speed Autogram | — | 8/- |
| The PW Monophonic Electronic Organ | — | 8/- |
| <i>(No constructional details are available with this blueprint)</i> | | |
| The PW Roadfarer | — | 5/- |
| <i>(No constructional details are available with this blueprint)</i> | | |

| Title | Number | Price |
|-----------------------------------|--------|-------|
| TELEVISION | | |
| The PT band III converter | — | 1/6 |

| Title | Number | Price |
|-------------------------------------|--------|-------|
| A.C. Fury Four | PW20 | 2/6 |
| Experimenter's Short Wave | PW30a | 2/6 |
| Midget Short Wave Two | PW38a | 2/6 |
| Band-Spread Three (Battery) | PW68 | 2/6 |
| Crystal Receiver | PW71 | 2/- |
| Signet Two (Battery) | PW76 | 2/6 |
| Simple S.W. One-valver | PW88 | 2/6 |
| Pyramid One-valver | PW93 | 2/6 |

| | | |
|---------------------------------|-------|-----|
| BBC Special One-valver | AW387 | 2/6 |
| Short-Wave Two | AW429 | 2/6 |
| Short-Wave World Beater | AW436 | 3/6 |

| | | |
|--------------------------------------|-------|-----|
| Standard Four Valve S.W. | WM383 | 3/6 |
| Enthusiast's Power Amplifier | WM387 | 3/6 |
| Standard Four Valve | WM391 | 3/6 |
| Listener's 5-Watt Amplifier | WM392 | 3/6 |

QUERY COUPON

This coupon is available until 7th September, 1961, and must accompany all queries in accordance with the notice on our "Letters to the Editor" page.

PRACTICAL WIRELESS, SEPTEMBER, 1961

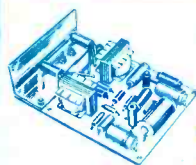

**2 WATT
4 TRANSISTOR
AMPLIFIER**

- 1 watt peak output.
- 3db 70c/s to 12 kc/s.
- Output to 3 ohm speaker.
- 9 volt operated.

**Built and Tested
6916 P. & P. 1/6**

A printed circuit high gain amplifier size 4 x 2 1/2 x 1/2 in. using Mullard OC71/OC81D and 2-OC81 Transistors. Ideal for Intercomm., Record Player, Tuner Amplifier or any application requiring a quality and reliable amplifier.

- Full Details and uses on request

PRICES DOWN! →
NOW EVEN BETTER VALUE FOR MONEY

CONTESSA
**6 TRANSISTOR MEDIUM AND
LONG WAVE SUPERHET
TERRIFIC SENSITIVITY**

UNBEATABLE IN PERFORMANCE AND APPEARANCE

SPECIFICATION

- 425mW Push-Pull Output.
- 6 "Top-Grade" Ediswan Transistors.
- New Type Printed Circuit with all Components marked.
- Full Medium & Long Wave Tuning.
- High "Q" Internal Ferrite Aerial.
- Car Radio Adaptation and AVC.
- Slow Motion Fingertip Tuning with Station Names clearly marked.
- "Hi-Fi" Quality Speaker.
- Attractive Rexine Covered Cabinet.

TOTAL COST OF ALL PARTS

£10.19.6 P.P. 3/6

- NO EXTRAS TO BUY ●

**COMBINED PORTABLE AND
CAR RADIO**



Fully illustrated building plans and packaged components enable the "Contessa" to be built without any technical knowledge.

- All parts sold separately.
- Descriptive leaflet on request.

6-TRANSISTOR FIDELITY "CORONET"
MEDIUM AND LONG WAVE
POCKET RADIO

- Size 2 1/2 x 4 1/2 x 1 1/2 in.
- Quality Push-Pull Speaker Output.
- Guaranteed for 12 months.
- Phone and Tape Sockets.



**ALL BRITISH DESIGN AND
CONSTRUCTION**

9 1/2 gns Reg. Post 2/6
(INCL. BATTERY)

★ **'PW' 6-TRANSISTOR** ★
MEDIUM AND LONG WAVE
SUPERHET

(as described November P.W.)

- A sensitive superhet with 150mW push-pull output on 2 1/2 in. speaker. Uses 6 first grade Mullard transistors and printed circuit. Moulded cabinet. Red, Blue or Cream.
- All parts sold separately. Send for list. Illustrated Building Plans, 1/6 plus post.

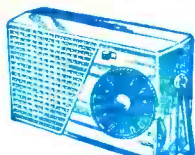

Size 5 1/2 x 3 x 1 1/2 in.

ALL PARTS REQUIRED **£8.19.6**

★ NO EXTRAS TO BUY—EVERYTHING SUPPLIED ★



AVO MULTI-METERS

- **AVO MODEL 7** ●
- COMPLETE WITH INSTRUCTIONS
LEADS AND BATTERIES
- List £19 10 0

OUR PRICE **£12.10.0** Reg. Post 5/-

- **AVO MODEL 8** ●
- COMPLETE WITH LEADS
BATTERIES AND INSTRUCTIONS
- List £24.10.0

OUR PRICE **£19.10.0** Reg. Post 5/-

**BOTH TYPES
ARE FULLY
GUARANTEED**



Size 4 1/2 x 3 x 1 1/2 in.

ALL COMPONENTS

7916 P.P. 1/6

NO EXTRAS TO BUY
Everything supplied.

★ **RANGER 3** ★
NO EXTERNAL AERIAL OR EARTH

3-TRANSISTOR and 2-DIODES
PERSONAL POCKET RADIO with 5 stages giving clear reception on medium wave, amateur top band and shipping.

FULL STATION SEPARATION
Only first grade components used throughout. As described in March R.C. Easy to follow instructions with pictorial layout.

● Reception of **Radio Luxembourg** guaranteed (most areas).

Free Instructions and Price List on request. Easy to build

● AFTER SALES SERVICE, GUARANTEED SUCCESS ●

TRANSISTORS

MORE THAN **50%**
PRICE REDUCTIONS

● MULLARD AND EDISWAN →

SEND FOR LATEST PRICE LIST

6 MULLARD TRANSISTORS & DIODE

- 1—OC44 1—OC71 AND 1—OAB1
- 2—OC45 2—OC72 PER SET ONLY

50/-

Other Matched Sets Available

PRACTICAL TRANSISTOR CIRCUITS

Contains easy-to-follow plans of 40 all-transistor units, including light-operated switches, amplifiers, transmitters, receivers, test oscillators, signal tracers, hearing aids, radio control, etc. All parts available separately. 3/6 POST FREE.

RANGER 2 ★ PERSONAL POCKET RADIO ★

- Two Transistor Two Diode version of "Ranger-3". See above. Similar in performance.

All Parts **59/6 P.P. 1/6**

● PICTORIAL PLANS AND DETAILS FREE ON REQUEST



27 Mc/s MODEL CONTROL RECEIVERS

Three new designs, all 2 1/2 x 2 x 1 in. Single Channel 59/6 p.p. 1/6. 3-Channel Reed Type 59/6 p.p. 1/6 and Single Channel Relayless 72/6 p.p. 1/6.

DIAGRAMS AND DETAILS ON REQUEST

"P.W." ROADFRER

Complete set of parts as specified. £16.19.6, P.P. 3/-. All components sold separately. List on request.

PLEASE



TURN PAGE

Henry's Radio Ltd

Dept. B.9 PADdington 1008/9
5 HARROW ROAD, LONDON W2
Open Monday to Sat. 9-6, Thurs. 1 o'clock

SEND 6d. STAMP FOR NEW ILLUSTRATED PRICE LISTS

35

718