

JULY
1961

Practical

1/6

WIRELESS

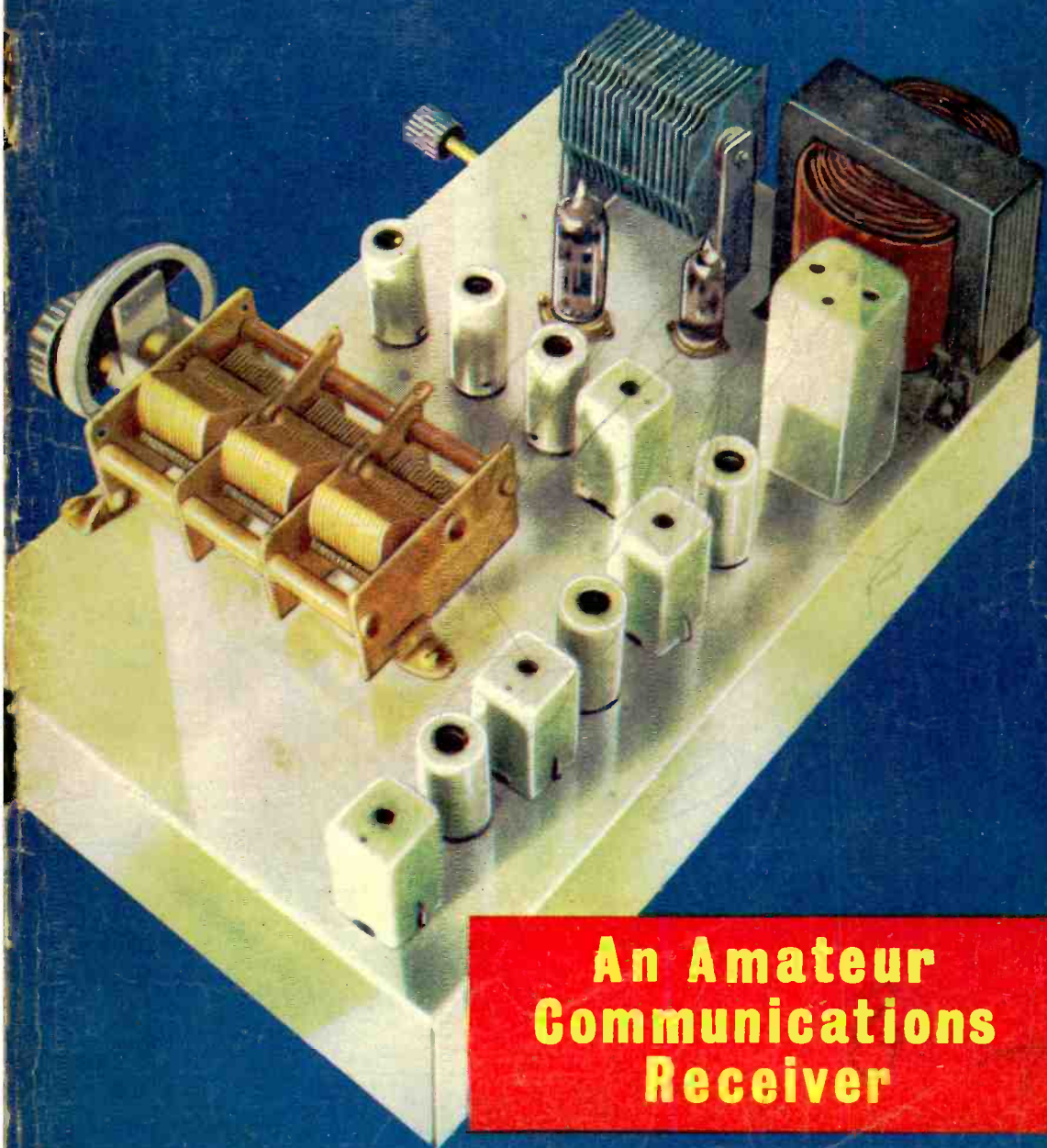

**An Amateur
Communications
Receiver**

Relda Breaks the Tape Recorder Price Barrier!

NEW! MODEL RA-11 TRANSISTORISED PORTABLE TAPE RECORDER
Size only 6 x 8 1/2 x 2 1/2 in. and weighs a mere 2 1/2 lbs. Fully transistorised, complete with mike, earphone, built-in speaker and amplifier. Powered by three inexpensive batteries. Twin track recording at 31 1/2 P.S. for maximum economy. Records and plays for over one hour on standard 3in. reel (34 minutes each track.)
The RA-11 is a precision miniature tape recorder which slips easily into a brief case or handbag. Utilises advanced transistor circuitry and built-in 2 x 3in. P.M. speaker and amplifier. Engineered for ease of operation. All controls are accessible on front panel. The magnificent two-tone plastic and metal case features a carrying handle and snap open top for fast, easy tape loading. Complete with batteries, tape and accessories.



ONLY
15 Gns.

Post Paid

WIRELESS SET No. 19

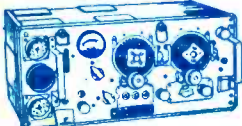

Incorporates TX/RX covering 2-8 Mc/s (37.5-150 metres), and intercom. amplifier, 500 microamp check and tuning meter, circuit and instruction book.

ONLY 65/-, Carr. 10/-

TELEPHONE PICK-UP COILS



MODEL FG-8 Induction Pick-up coils enabling conversations to be picked up without tapping of wires or special telephone circuits. Brand new complete with 5ft. shielded cable. 16/- plus 1/6 P. & P.

POCKET VOLT TEST METER
Two D.C. ranges: 0-250 v. and 0-25 v. Complete with test prods. and leather case. Very limited quantity. Only 12/6. P. & P. 1/6.



HI-FI HEADPHONES

Use high-quality permanent magnetic speakers with regular voice coil. The padded chamomile ear-muffs give correct spacing for optimum acoustic load, giving finest music and voice reproduction. Each unit has a built-in Hi-Fi 50Ω trans, total 100Ω. ONLY 25/-, P. & P. 1/6.



U.S.A. DYNAMOTOR
Manufactured by BICOR. Input 12 v., output 400 v. at 180 m.A. Size 7 x 4 x 4 1/2 in. Brand new 45/-, P. & P. 3/6.



FULL SCALE RANGES:
D.C. VOLTAGE: 0-6-30-120-600-1200 v. (10,000 o.p.v.)
A.C. VOLTAGE: 0-6-30-120-600-1200 v. (10,000 o.p.v.)
D.C. CURRENT: 0-120 uA, 0-12-300 mA
RESISTANCE: 0-20K, 0-2 Meg. (150 ohm, 15K at centre scale).
CAPACITANCE: 0.005 to 0.15 uF. (at A.C. 6 v.)
DECIBELS: —20 to +63db. (600 ohm, 1mW, 0dbm = 0.775 v.)
ACCURACY: D.C. Voltage and Current ± 2% f.s. A.C. Voltage ± 4% f.s. Resistance ± 3% of total scale length.

3-WAY SLIM CRYSTAL MICROPHONE

- May be hand held, stand mounted or suspended by Lavalier Cord
- Response 60-10,000 Cps.
- Built in on/off switch.

Revolutionary new crystal microphone with all the features of "Mikes" three times the price. Output level—5248. Omni-directional lead. Clips on or off standard stand adaptor, permitting tilting for multi-angle use. Satin chrome finish complete with 7ft. shielded cable, stand adaptor and Lavalier Cord.



MODEL 100C

ONLY
32/6

P. & P. 2/6



MINIATURE EARPHONE

A really sensitive dynamic earphone of exceptionally fine quality. Provides clear reproduction of music as well as speech. Fully Guaranteed and complete with transparent ear insert, 3 feet cord, sub-miniature plug and socket. CR-5 High imp. crystal 8/- Each MR-4 Low imp. magnetic 8/- Post 1/-

PORTABLE MAINS SOLDERING IRON MODEL SP1

30 Watts. Designed on an entirely new principle for lightweight applications. Highly stable heat characteristics ensure long life and safety in use. The removable handle may be used to cover the tip and barrel to permit the iron to be carried safely even while hot. Supplied complete with Vinyl bag, mains lead and plug. Only 18/9. P. & P. 1/3.



LAPEL MICROPHONE MODEL 178

Precision engineered Crystal Microphone—for lapel or hand use. Only 1 1/2 in. diameter. Exceptionally sensitive. Chrome plated case and clip. Includes 5ft. shielded cable. Only 17/6. P. & P. 1/-.



MORSE CODE SET WITH HEADPHONES

Complete morse code set, includes headphones, morse key, buzzer, pitch control. Internal battery. Magnificent appearance and housed in portable wooden case with carrying strap. Supplied complete and ready for immediate use.

ONLY 19/6. Carr. 4/6.



5/6 per pair Post Paid.

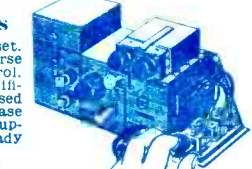

SLIM RADIO PLUGS AND SOCKETS. Two-way, black bakelite, solder terminal PLUG and STURDY standard SOCKET. Panel mounting, neat finish.

AERIAL VARIOMETERS

These magnificent instruments will enable you to receive maximum signal strength on all S.W. receivers. Precision calibrated control. 12/6. P. & P. 2/6.



ACCUMULATORS

2 volts 16 A.H. (unspillable). Ideal for 6 and 12 volts supply, etc. Brand new. Original cartons. Size 4 1/2 x 7 1/2 x 2 1/2. 5/6 each. P. & P. 1/6. 3 for 15/-, P. & P. 3/6. 6 for 27/6. P. & P. 5/6.



MINIATURE DUBILIER CONDENSER SPECIAL!

Minimum lots of one dozen from these assorted values: .002; .04; .01; .005; .001; all at 100 volts A.C. and 300 volts D.C. Recent Manufacture ONLY 5/- per dozen. P. & P. 6d. per dozen. (Please state values required.)



RII-20 RADIO HEADPHONES

Hi-Impedance—2,000 ohms—general use headset. Black and Ivory plastic cased electro-magnetic units with adjustable headband for comfortable fit. Individual listening for all types of applications. Individually packed, with flexible cord attached. 14/6. post paid.



SIGNAL GENERATOR

Model SWO-300 150 kc/s—300 Mc/s. Frequency Range: 150 kc/s-150 Mc/s on fundamentals (6 bands), 150 Mc/s, 300 Mc/s on harmonics. Calibration Accuracy within ± 1 per cent. Modulation: Internal and external. Attenuation: To —40db. Output: Facilities for high and low. Power Supply: Internal 230 v. A.C. Size: 7 x 10 x 5 1/2 in. Complete with test leads and instruction manual. ONLY 214.19.6. Carriage 5/6. Fully Guaranteed.

NEW! 10,000 O.P.V.

MULTI-TESTER ON BOTH AC & DC

MODEL EP-10K OUTPERFORMS INSTRUMENTS MANY TIMES ITS SIZE AND PRICE!
UNBELIEVABLE BARGAIN!
A revolutionary new Multi-Tester. A complete wired and tested instrument (not a kit) incorporating extra large 3 1/2 in. meter face and unique slide range switch. Can be conveniently carried in the pocket and features unusually sensitive 10,000 ohms per volt AC-DC meter, 1 per cent. precision resistors, and largest meter ever placed on an instrument of this size. Single, easy to use range selector switch, can be appreciated by the novice and engineer alike. Complete with colour coded test leads and battery.
Size: 4 1/2 x 3 1/2 x 1 1/2 in. Model EP-10K ONLY **£5.19.6** P. & P. 3/6

MAIL ORDERS TO
(DEPT. P.), 32A COPTIC STREET,
LONDON, W.C.1



CALLERS WELCOME AT
87 TOTTENHAM COURT ROAD,
LONDON, W.1 MUS 9606

Tel: Mitcham 6201
Open Daily to Callers



All Valves Brand New
and Fully Guaranteed

211 STREATHAM ROAD, MITCHAM, SURREY

Special 24 Hour Express Mail Order Service

0Z4	5/9	6CH6	12/-	10C2	27/10	32	13/6	CCH35	21/-	ECL83	12/6	H23DD		PENA4	17/6	U282	22/-
1A5	6/-	6E5GT	10/-	10F1	26/2	35A5	15/-	CL4	12/6	EF9	21/-	HL41	10/6	PENB4	17/6	U301	22/6
1A7	14/6	6F1	15/6	10F3	17/6	35L6GT	10/6	CL33	18/6	EF22	17/6	HL41DD	12/6	PEN4DD		U329	17/6
ID5	14/-	6F7	6/9	10F9	12/6	35W4	8/-	CY1	15/9	EF36	7/6				22/6	U339	19/-
ID6	10/6	6F7	15/-	10LD3	12/6	35Z4	7/6	CY31	15/9	EF37	8/6					U403	11/6
IH5	10/6	6F12	4/-	10LD11	15/-	35Z5	9/6	D41	12/6	EF37A	8/6	HL42DD	13/6			U404	10/-
IL4	4/6	6F13	17/6	10P13	21/-	40SUA	15/-	D42	12/6	EF39	4/-			PL33	18/6	U801	29/-
ILN5	4/6	6F14	17/6	10P14	20/-	41STH	23/6	D63	3/6	EF40	15/-	HW4/350	8/-	PL38	23/9	U4020	15/6
IN5	10/6	6F15	14/9	11D3	17/6	42	15/-	D77	5/6	EF41	9/3	IY4/500	10/-	PL81	14/9	UABC80	7/6
IR5	5/6	6F33	5/6	11D5	17/6	43	15/-	D152	6/-	EF42	10/6	IW4/500	10/-	PL82	8/6	UAF42	9/6
IS4	8/6	6H6	2/6	12A6	6/6	50C5	15/-	DAC32	10/6	EF50(E)	3/6			PL20	12/6	UBC41	9/6
IS5	9/6	6J5GT	4/6	12AH3	10/-	50CD6G		DAF91	7/6	EF50(A)	4/-			PL22A	14/6	UBF80	9/6
IT4	4/-	6J6	7/6	12AT6	9/-			DF91	4/-	EF85	5/6			PM24M	21/6	UBF89	7/6
IU5	10/6	6J7GT	9/6	12AT7	9/-	50L6GT	9/-	DF92	7/-	EF86	11/-			PM202	16/6	UCC85	10/-
2D21	8/6	6K7G	3/-	12AX7	9/6	61SPT	17/6	DF96	9/6	EF89	10/-	KT2	7/6	PY31	16/6	UCH42	8/6
2X2	5/-	6K7GT	10/6	12BA6	9/-	62BT	17/6	DF97	9/6	EF91	4/-	KT32	10/-	PY32	15/6	UCH81	8/6
3D6	14/6	6K25	19/6	12BE6	9/6	75	12/6	DH63	10/-	EF92	5/-	KT33C	10/-	PY80	8/6	UCL82	13/6
3Q4	8/6	6L1	15/6	12J7GT	9/6	78	12/6	DH76	7/6	EF93	7/6	K766	28/6	PY81	7/6	UCL83	12/6
3Q5	10/6	6L6	7/6	12K7GT	8/6	80	10/-	DH77	8/3	EF95	15/-	KT41	22/6	PY82	8/6	UF41	9/-
354	8/-	6L18	12/6	12K8GT	12/6	85A2	12/6	DH107	13/6	EL31	12/6	KT44	13/6	PY83	8/6	UF42	11/6
3V4	9/-	6L19	21/-	12Q7GT	8/6	150B2	12/6	DH719	7/6	EL32	5/-	KT55	22/6	PZ30	18/6	UF80	9/-
5U4G	4/6	6L34	10/-	12SC7	8/-	150B3	15/-	DK91	9/-	EL33	12/6	KT61	18/6	QP25	14/6	UF85	9/6
5V4	8/6	6/30L2	10/-	12SG7	8/6	185BT	32/-	DK92	9/6	EL35	12/6	KT63	8/6	QP210	17/6	UF89	8/-
5Y3GT	8/6	6LD3	9/6	12SH7	4/-	303	7/6	DK96	10/-	EL37	18/6	KT66	17/6	QP21	12/6	UL41	24/6
5Z3	10/-	6LD20	15/6	12S17	4/-	304	7/6	DL33	12/6	EL41	10/6	KT71	9/-	R10	21/-	UL44	21/6
5Z4G	10/-	6N7GT	7/6	12S17	4/-	305	7/6	DL35	12/6	EL42	10/6	KT76	12/6	R19	19/6	UL46	21/6
6A7	18/6	6M1	10/6	12S27	11/6	328	7/6	DL92	8/6	EL43	14/9	KT101	25/-	SD6	8/6	UL84	7/6
6A8	10/6	6M2	10/6	12S27	11/6	329	7/6	DL96	9/6	EL84	7/-	KTW63	7/6	SP4	14/6	U06	20/11
6AB8	9/-	6P1	17/6	12S27	11/6	807	7/6	EA50	21/-	EL85	10/6	KTZ41	8/-	SP41	3/6	U07	15/-
6AB8	9/-	6P25	19/6	12S3	15/-	955	4/-	EABCB0	7/6	EL90	8/6	KTZ63	10/-	SP42	12/6	U08	26/-
6AK5	9/6	6P28	26/-	13D3	12/6	965	4/-	EAC91	7/6	EL91	5/-	L63	4/9	SP61	3/6	UY21	15/6
6AK8	7/6	6Q7GT	10/6	14H7	12/6	973	17/6	EAF42	10/-	EM80	10/-	L39	15/9	T41	22/6	UY41	7/6
6AL5	6/6	6SA7GT	7/6	14R7	12/6	9002	7/6	EB41	7/6	EM81	10/-	LZ319	12/6	TD44	17/6	UY85	6/6
6AM5	5/-	6S7G	7/6	14S7	21/-	9003	7/6	EB91	5/-	EY51	8/6	MH4	8/6	TD44	17/6	VP28	17/6
6AM6	4/6	6S7H	6/6	15A2	17/6	AC4/PEN	25/-	EB91	5/-	EY51	8/6	MH4	8/6	TH41	23/9	VP48	17/6
6AN5	7/6	6S7H	6/6	15D2	23/9	AC5/PEN	22/6	EBF80	9/6	EY84	10/6	MHD4	17/6	TP22	17/6	W17	8/6
6AQ5	8/6	6S7GT	6/6	19AQ5	10/6	198G6G	12/6	EBF89	7/6	EY86	9/6	MHL	10/-	TP25	17/6	W76	7/6
6AQ8	9/3	6S7GT	5/6					EBL21	22/-	EY91	9/6	MKT4 (5/7)	17/6	TP25	17/6	W77	5/-
6AT6	8/3	6U4GT	11/6	20D1	12/6	AC6	21/-	EBL31	21/6	EZ35	7/6	M548	17/6	U14	15/9	W81	6/-
6AU6	10/-	6U5	7/6	20D2	23/6	ACTP	32/-	EA391	7/6	EZ40	7/6	MSP4	17/6	U16	10/-	W142	9/6
6B7	10/-	6U7	7/6	20D2	23/6	ACHL	12/6	EC90	9/6	EZ40	7/6	MU14	9/-	U18/20	10/-	W719	7/6
6B8	4/6	6V6G	5/-	20F2	26/6	AC/PEN	17/6	EC91	9/6	EZ41	7/6	MX40	17/6	U22	10/-	W727	7/6
6BA6	7/6	6V6GT	8/-	20L1	26/6	ACTHI	34/9	ECC31	10/-	EZ80	7/6	N18	8/-	U24	29/6	X18	11/6
6BE6	7/6	6X4	5/-	20P1	26/6	ACTH1	34/9	ECC32	10/-	EZ90	7/6	N19	8/-	U25	14/-	X61M	21/9
6BG6G	21/-	6X5GT	5/-	20P3	23/6	ACVPI	17/6	ECC33	5/-	FC2	21/-	N37	17/6	U26	14/-	X65	23/9
6BJ6	7/6	7B7	8/-	20P5	22/6	ACVP2	17/6	ECC34	15/-	FC1	17/6	N78	18/6	U31	9/6	X66	21/9
6BW6	7/-	7C6	8/-	25L6GT	9/6	AC2/PEN	21/-	ECC40	21/-	FC13C	21/-	N108	18/-	U33	21/6	X78	21/9
6BW7	5/-	7D5	15/-	25Y5	10/-	AC2	21/-	ECC81	6/-	FW4,500	10/-	N142	9/6	U35	21/6	X79	21/9
6BX6	6/-	7D6	15/-	25Z4	9/6	AC2	21/-	ECC82	9/6	FW4,800	10/-	N147	18/6	U45	21/6	Y61	10/6
6BY7	5/6	7D8	15/-	25Z5	9/6	PENDD21/-		ECC83	9/6			N150	10/-	U47	21/6	Y63	9/-
6C4	6/6	7H7	8/-	25Z6	10/6	AZ1	15/6	ECC84	9/6			N153	11/6	U50	8/6	Z63	7/6
6CSGT	8/-	7K7	10/6	25Z6	10/6	AZ31	10/6	ECC85	8/-	GZ30	10/6	N309	11/6	U52	7/6	Z66	19/6
6C6	6/6	7Q7	11/6	30	13/6	B36	21/-	ECC91	5/6	GZ32	11/6	N329	10/6	U76	7/6	Z77	4/9
6C9	12/6	7R7	12/-	30C1	12/6	B65	8/6	ECC90	12/6	GZ34	13/6	N727	7/6	U78	7/6	Z153	8/6
6C10	12/6	7S7	10/6	30F5	11/6	B309	9/6	ECH82	12/6	H30	9/6	N729	8/-	U142	8/-	Z19	7/9
6CD6G	27/6	7Y4	7/6	30FL1	10/6	B329	9/6	ECH21	22/-	H63	9/6	P2	10/-	U145	15/-	ZD152	9/6
6D1	8/-	8D3	4/-	30L1	11/6	B339	9/6	ECH35	21/-	HBC90	9/6	PCC84	9/-	U147	7/-		
6D2	5/-	9BW6	14/9	30P4	22/-	B719	9/7	ECH42	10/-	HL92	6/6	PCF80	9/6	U153	9/6		
6D3	15/-	10C1	18/-	30P16	10/-	CBL1	17/6	ECH81	9/-	HL13DD	10/-	PCF82	8/6	U191	20/6		
				30PL1	15/-	CBL31	21/-	ECH83	12/6			PCL82	10/-	U251	17/6		
								ECL80	9/-	HL23	12/6	PCL83	12/6	U281	20/-		

METAL RECTIFIERS

RM1	6/-	1B8A	1-1-8-1	4/6	16RE	2-1-8-1	8/6
RM2	8/-	1B8A	1-1-16-1	6/6	1B8A	1-2-8-1	11/-
RM3	9/-	16RA	1-1-16-1	8/6	14A86		17/-
RM4	16/6	14RA	1-2-8-2	18/-	14A97		23/6
RM5	22/-	14RA	1-2-8-2	21/-	14A100		24/-

SPECIAL OFFER

IT4 4/-, 5U4G 4/6, 6K7G 3/-, 6K8 8/-,
6V6G 5/-, 6X4 4/6, EBC33 4/-, EF39 4/-,
EF80 5/-, EF85 5/6, EF91 4/-, EL84 7/-.

TERMS OF BUSINESS C.W.O. or C.O.D.
2/9 PACKING CHARGE ON ALL C.O.D.
ORDERS. POSTAGE 3d. PER VALVE

OBsolete VALVES A SPECIALITY.
QUOTATIONS GIVEN ON ANY TYPE
NOT LISTED

SUMMER 'SALE!

STOCK OFFERED AT SENSATIONAL REDUCTIONS THIS MONTH

- **Braylock TV Turret Tuner**, for 33/38 Mc/s. I.F., normally 79/6. With valves 39/6. Less valves 19/6, plus 3/6 post and ins.
- **14in. TV Mask**, grey plastic, normally 10/-. Sale price 5/-, plus 1/6 post and ins.
- **17in. TV Mask**, grey plastic, normally 12/-. Sale price 9/-, plus 1/6 post and ins.
- **TV Rectifier**, R.M.S., equivalent, normally 25/-. Sale price 12/6.
- **14in. TV Cabinet**, modern design. Cost £4 to make. Sale price 9/6, plus 3/6 carriage.
- **Set of Four TV Parts**, scan coils, line E.H.T. frame output and width control. Normally 57/6. Sale price 39/6, plus 2/6.
- **Output Transformer**, fixed ratio for pentode, normally 6/6. Sale price 3/6, plus 1/-.
- **250-0-250 60/80 mA.** Mains Transformer, with 6.3 v. filament winding, half-shrouded droptrough, standard replacement in many receivers, made to sell at 19/6. Sale price 12/6, plus 2/6 post and ins.
- **Iditto**, but with additional 5 v. winding for separate rectifiers, made to sell at 21/-. Sale price 13/6, plus 2/6.
- **Auto Transformer**, totally enclosed primary 200-250, secondary 110-120 v. 200 v. normally 27/6. Sale price 19/6, plus 3/6.
- **I.F. Coils**, standard size by Weymouth 465 Kc/s. dust cores, normally 12/6. Sale price 6/6 per pair.
- **P.M. Speaker**, 6in., with output transformer, normally 30/-. Sale price 12/6.
- **Miniature Microphones**. Dynamic American, beautifully made. Sale price 2/-.
- **Pilot Bulbs**, 3-5 volt, 0.3 amp. 3/6 a box of 25.
- **Stick Microphone**, CosmoCORD 39/1, normally £3.3.0. Sale price 35/-.
- **Windoor Cabinet and Chassis**, comprises a veneered and polished cabinet, size 14 x 17 x 6 1/2 in., and prepared metal chassis with glass dial to fit, normally £3.15.0. Sale price 29/6, plus 5/-.
- **Push-Pull Transformers**, input and output, midget, potted. Sale price 5/- pair, plus 1/6.
- **B78 Holder**, with skirt for screening can. Normally 10d. Sale price 6d., or 5/6 doz.
- **Metal Rectifiers**, 250 v. 60-80 mA, ideal for mains set or instrument, or to replace that expensive valve. Sale price 3/6.
- **Filament Transformer**, 6.3 v. 1 1/2 amps., normally 8/6. Sale price 6/6, plus 1/- post.
- **Filament Transformer**, 6.3 v. 2 amps., normally 10/6. Sale price 6/3, plus 1/- post.
- **Charging Switchboard**, offered at about 1/20th of original cost. Ex Government, contains three reverse current relays, one voltmeter, one mains ammeter, two secondary ammeters and three variable resistors. In original cases. Sale price £3.15.0, 1,250 watt, £2.15.0, 850 watt, carriage 10/-.
- **Cine Camera**, 16 mm. motorised 24 v. for 15 frames per second. Sale price £3.19.6, plus 3/6 carriage.
- **Dinshy Mast**, tubular aluminium, extends from 15in. to 9ft. Sale price 4/6, plus 1/6 postage.
- **Magneto Generator (hand)**, as used in telephones. Sale price 7/6, plus 1/6 postage.
- **P.O. Type 3000 Relays**, 2,000 ohm coil, 6 contacts 7/6, 4 contacts 6/6, 2 contacts 5/6, plus postage 1/-.
- **Variable Rheostats**, heavy duty slider resistor rated at 25 amps. Ideal for dimmer circuits, etc. Sale price 7/6, plus 8d. postage.
- **Versatile Wire**, single strand 18 gauge, with p.v.c. covering. New 4-mile on drum. Sale price 6/6, plus 3/6 carriage.
- **Wire jointer** (welder for 28 gauge or thinner), in bakelite case with trigger switch, works off step-down transformer. Sale price 2/6, plus 9d. postage.
- **Rectifier Bargain**, selenium rectifier 25 v. 25 amp., easily rebuilt into 3 full-wave charger rectifiers, suitable 6 or 12 v. battery at 3 amps. Sale price 15/-, plus 3/6 post.
- **80 ohm Coax**, low loss expanded Polythene, normally 9d. per yard. Sale price 6d. yd.
- **Connecting Wire**, 24 gauge. Tuned copper, P.V.C. insulated. Four 100ft coils, different colours. Sale price 8/-.
- **Superhet 7 v. 5 Waveband Chassis**. Unused. Less valves and power pack. Soiled 75/-. Coil pack with twice as much. Carriage and insurance 7/6.
- **Geiger Counter Tube**, 20th Century. No. G25 with circuit of geiger counter. Sale price 27/6.
- **Twin-twisted Lighting Flex** equivalent 1436, 12/6 per 100 yd. coil. Carriage 1/6.
- **3029 Twin T.R.S.** 37/6 per 100yd. coil, carriage 9/6.
- **3029 Twin T.R.S.** 20/- per 100 yd. coil, carriage 2/6.
- **Transistor A.F.** equivalent to red spot. Sale price 2/6.
- **Bakelite Wall Switch** household type 6/- doz. one way, 8/- doz. two way.
- **Wall Switch** by Crabtree two way and off. Sale price 1/- each.
- **Double pole**, double through toggle switch heavy duty, 10 amp. 250 volts. Suitable for controlling photo flood lamps. Sale price 1/3, 18/- doz.
- **Multi-speed Motor** with gearbox, works on A.C. 3 D.C. mains, gives any speed from 1 r.p.m. Sale price 17/6, plus 2/6 postage.
- **Low Resistance Single Headphones**, good British make. Sale price 4/6, Plus 1/6.
- **Chest Microphone**, excellent American make with adjustable mouthpiece, 8/6, plus 1/6.
- **Throat Microphone**, 2/6, plus 1/6 post.
- **American Lightweight Headphones**, type HS.30. Sale price 17/6, plus 1/6 post.
- **Regulator Resistors**, slider type, 11 ohm 15/-, 3 ohm, 12/6, 1 ohm, 2/6, plus 2/- post.
- **E.H.T. Transformer**, standard mains input, 3 secondaries, heavy duty potted transformer. In cast case, normal price 20/- Sale price 15/-, plus 3/6 post.
- **Suppressor Condenser**, stops drill, etc., interfering with radio or television. Simple instructions included, normal price 1/6 each. Sale price 1/- each.
- **Ri-Metal Contact Strip** for making thermostat, 1/9.
- **Rectifier Unit**, for working D.C. instruments, motorised equipment, etc., from A.C. mains. Input 200-240 v. Output 200-240 v. 300mA amp. 35/-, carriage 7/6.
- **Sniperscope**, "Cat's Eye" for seeing in the dark. Will work burglar alarms, circuits, etc. Sale price 4/-, plus 1/- post.
- **Telephone Handset**, sound powered, just join two together with a pair of wires and you have telephonic communication. Sale price 25/-, plus 3/- post and ins.
- **12-24 v. D.C. Converter**. Sale price 32/6.
- **R.F. 25 Tuner Unit**, complete, new condition. Sale price 8/6, plus 2/6 post.
- **Stud Switch**, heavy duty, 30 amp. contacts, for dimmer, charger, regulator, etc. Sale price 7/6.
- **Powerful Blower**, with motor. 24 v. D.C., but can be operated off mains with rectifier, 15/-, post and packing 2/-.
- **Canadian Telephone Sets**, although originally intended for use with transmitters, these make excellent telephones for calling over long distances in noisy situations. Distances up to 3 or 4 miles (Using our versatile wire, 6/6 for 1 mile) can be covered using these sets, which contain hand generator, telephone bell, hand microphone, Morse key, indicator lamp, buzzer, relay, etc. Sets complete 27/6, with full instructions, complete in carrying case.
- **Ardent Hearing Aid**, normally bargain at £7.10.0. Sale price 49/6, plus 3/6 post and insurance. Need attention, ditto transistorised £3.10.0.
- **Switch for Electric Blanket**, double pole three position, 5/-.
- **Packard Bell Pre-Amp**, complete with 6SL7 and 28D7 valves, relay, leads, jacks, input and output transformers, etc., etc., 7/6, plus 2/- post, less case.
- **Centre Zero meter 3 1/2 in.** movement, flush mounting, 500-0-500 micro Amp. Sale price 30/-, plus 1/6 post.
- **Moving Coil Meter**, 2 1/2 in. movement, 0-750 micro amp. Sale price 19/6, 0-30 mA., 15/-, plus 2/-, ditto 2.500 micro amp. 15/-.
- **Unbreakable mains leads**, as fitted to electric razors etc. Makes ideal lead for test meters. Twin 6ft long 6d. per lead. 5/- doz.
- **Cold Cathode Valve CV413** voltage regulator or trigger tube. Unused, but ex equipment. 2/- each.
- **Electric brake disc type** for stopping lathe and coil winders etc. 25/-.
- **VCR517 Cathode Ray Tube** is a plug in replacement for the VCR97. 8/6 carriage and insurance 4/6.
- **10 Valve 1 1/2 metre superhet** contains 9 valves, 6 I.F. Transformers and hundreds of useful spares. Brand new 29/6. Carriage and insurance 10/-.
- **R.F. 24 Tuning units** in soiled condition, but contain valves and many useful components, 3/6, carriage 3/6.
- **3 Wave band Coil pack** for medium short, short ex equipment, but unused 8/6, plus 1/6 post.
- **Rotary Switch by Arrow**, carry 15 amp. A.C. 4 positions hot, off, cold, off. Suitable hair drier, air-conditioning plant etc., 3/6, post 1/-.
- **Rotary Switch by Santon**, suitable 30 amp. A.C. single pole on/off. 3/6.
- **Silicon crystal diodes**, 6/- per doz.
- **Sapphire gramophone needles** miniature or standard 78 r.p.m. type. 12/- doz. 1/6 each.

Please include enough for postage and request "Summer sale list", for details of many other items.

THE SOLDERLESS TRANSISTOR "3"



Ideal for Camping and Holidays as no Aerial or Earth Needed

You can easily make this set without any soldering, our special solderless terminals ensure perfect connection also remove risk of damage to transistors. This pocket set is a real radio in a proper plastic cabinet, uses proper tuning condenser, first grade transistors and other parts, it will receive Luxembourg and local stations on the Broadcast Band.

Add on units are available to increase volume and to bring in long waves, if required.

Price of the basic set, as illustrated, 37/6. Post and insurance 2/6. More details S.A.E.

NOW THE "GOOD COMPANION" CAR RADIO AND PORTABLE

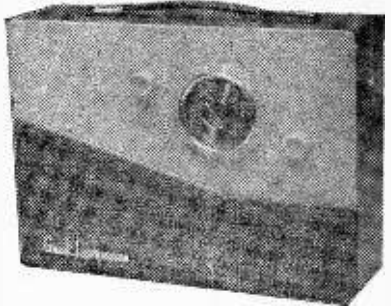

Largely due to the helpful criticisms and suggestions received from purchasers of our previous set "The Real Companion" we have improved and now supersede this with a new set which we call "The Good Companion". We feel confident that this new set is one of the finest of its kind available. The design is the combined efforts of our own technicians and of those of several of the leading manufacturers in the country, and the resulting set has a performance as good as if not superior to those selling at £20 and more. It has the eight transistor set performance.

Features include American Philco R.F. transistors and Mullard A.F. transistors—Q.P.P. output giving 750 mW—full coverage on Medium and Long—very fine tuning arrangement—excellent reception of difficult stations like 208—variable feed-back control—full tonal qualities—really superior looking cabinet size 11 x 8 x 3in. approximately—car aerial attachment—several months operation from battery costing only 3/6.

Circuit employs six transistors and two diodes, it incorporates all latest refinements, and oscillator I.F. Transformer are pre-aligned so no instruments are necessary. Anyone who can solder competently can make this set. The instructions are fully comprehensive with plenty of illustrations. Service is available in the unlikely event of your getting into difficulties. All components fully guaranteed.

Price of all components and cabinet to make set as illustrated £9.19.6. Post and insurance 5/-. Battery 3/6 extra.

AGENTS REQUIRED
to make up this receiver

SUB MINIATURE COMPONENTS FOR TRANSISTOR SETS

- ★ Push-pull o.p.t. and driver 17/9 pair (500 milliwatt). 12/6 pair (300 milliwatt).
- ★ Push-pull driver with Sep. Secondaries for transformerless output 6/6.
- ★ 3 IF transformers and oscillator and circuit 23/6.
- ★ Ferrite aerial with coils for medium and long wave with circuit for Pocket sets 7/6.
- ★ Smallest possible electrolytics 1/9 each, 1 mfd., 2 mfd., 8 mfd., 10 mfd., 20 mfd., 30 mfd., 50 mfd., 100 mfd., 200 mfd.
- ★ Smallest 1/2 watt resistors 5d. each all popular values.
- ★ Miniature 0.1 mfd., 1/- 0.05, 0.01 8d. values up to 0.005 6d. each.
- ★ Miniature slide switch 2/6.
- ★ Edgewise Volume controls. 2K., 5K., 10K., 20K., all 2/6 each.
- ★ Set of 6 transistors for superhet in original packets guaranteed, Mullard OC4., OC45., OC71 matched pair OC72 £2.0.0 the set.
- ★ 3in. Speakers 3 ohm 18/6.
- ★ 3in. Speakers 80 ohm 18/6.
- ★ 2in. Speakers 3 ohm 19/6.
- ★ Elliptical Speaker. 7" x 4", 3 ohm or 35 ohm 19/6.

POCKET LOUDSPEAKER TRANSISTOR RADIO

Available Again at 42/6

Read these Testimonials

D. A. Hilton, Leigh, Lancs.
"I received 'Pocket 4' on Christmas Day. I made it up on Boxing Day and I am very pleased with the results, it brings in local stations and many foreign stations including Luxembourg at good strength. I am 13 years old".

Mr. J. Bell, Wolverhampton.
"I am writing to express my satisfaction at the standard of your kit for your Pocket 4 Transistor set and also to state that it has come up to my expectations in regard to performance".

Mr. R. Belt, Newcastle-on-Tyne.
"I have built your Pocket 5 Transistor set. I am very pleased with it".

Mr. F. Jackson, Ickenham, Middx.
"I have built the Pocket 4 and am more than pleased with the results".

Mr. G. Bamford, Ramsgate.

"I find this set even better than you claim it to be and most certainly up to your usual standard of quality. I feel that nobody could fail to build it and get results. Even the first-time-ever novice, as your circuit diagrams and instructions are so clear and precise".

Mr. A. J. Simmonds, Welling, Kent.
"I purchased from you a week ago the Pocket 4 Transistor Kit. I put it together last night in 1 1/2 hours, on switching on the set I was right on Radio Luxembourg. I must say thank you because not only has the set a very attractive appearance, it also behaves fantastically".

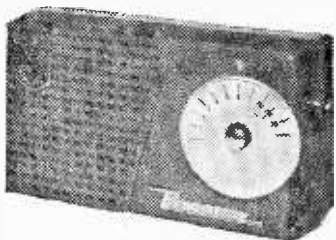

Circuit comprises 2 HF transistors reflexed to equal 4 stages. Permanent germanium diode and high gain AF output stage, fitted with miniature speaker, proper tuning condenser, volume control and in case with handle as illustrated (less monogram), completely portable. No aerial or earth required. Pocket 4 uses 3 transistors and 1 diode, price 42/6, plus 2/6 post and insurance. Pocket 5 uses 4 transistors and 1 diode and has feedback control, price 55/-, plus 2/6 post and insurance. Prices are for medium wave models, long or medium versions 8/6 extra.

GOOD RESULTS EVERYWHERE

Nothing can be more disappointing than to find that despite care in making up, your radio just will not work or needs a long high aerial and water pipe earth. We can prove good results in all areas and we guarantee all components for 12 months. Read just a few of the hundreds of testimonials we have received from constructors who have made these sets. Send in confidence. Money refunded if not up to your expectations. Plans free with parts, or separately 1/6. More details S.A.E.

ELECTRONIC PRECISION EQUIPMENT LTD.

post orders are dealt with from Eastbourne, so for prompt attention please post your orders to 66 Grove Road, Eastbourne, marked Department 7. Callers may use any one of the Companies below.

266 London Road, Croydon. Phone: CRO 6558 Half day Wednesday

29 Stroud Green Rd., Finsbury Park, N.4. Phone: ARChway 1049 Half day Thursday

520 High Street North, Manor Park, E.12. Phone: ILFord 1011 Half day Thursday

42-46 Windmill Hill, Ruislip, Middx. Phone: RUISlip 5780 Half day Wednesday

246 High Street, Harlesden, N. W.10. Phone: ELGar 4444 Half day Thursday

BENTLEY ACOUSTIC CORPORATION LTD.

38 CHALCOT ROAD, CHALK FARM, LONDON, N.W.1.

Telephone: PRIMROSE 9090

EXPRESS POSTAL SERVICE! ALL ORDERS DESPATCHED SAME DAY AS RECEIVED. TELEPHONE AND TELEGRAM ORDERS FOR CASH ON DELIVERY SERVICE ACCEPTED UP TO 3.30 P.M.

OA2	17/6	6F6G	7/-	10D2	12/-	35W4	7/6	DK32	12/-	EF50(A)	7/-	KF35	8/6	PM2B	12/6	UA020	16/7	XFY12	9/6
OB2	17/6	6F11	17/3	10F1	26/6	35Z3	10/6	DK91	6/6	EF50(E)	5/-	LK35	8/6	PM84	17/3	UAF80	9/-	XFY34	17/6
OZ4	5/-	6F12	4/6	10F9	11/6	35Z4GT	6/-	DK92	9/-	EF54	5/-	KLL32	24/7	PX4	10/6	UA4F2	9/6	XH1(5)	6/6
IA5	6/-	6F13	11/6	10LD3	8/6	35Z5GT	9/-	DK96	8/6	EF73	10/6	KT2	5/-	PY31	16/7	UB41	12/-	XSG(1.5)	6/6
IA7GT	12/-	6F15	15/3	10LD11	43		10/-	DL33	9/6	EF80	6/-	KT33C	10/-	PY32	12/6	UBC41	8/6	Y63	7/6
IC5	12/6	6F23	10/6		15/11	50C5	10/-	DL66	17/6	EF85	6/-	KT36	29/10	PY80	7/6	UBC81	11/4	Z63	7/6
ID6	10/6	6F32	10/6	10P13	15/-	50CD6G		DL68	15/6	EF86	10/6	KT41	23/3	PY81	8/6	UBF80	9/-	Z66	17/6
IG6	17/6	6F33	7/6	10P14	19/3		36/6	DL72	15/-	EF89	9/-	KT44	12/6	PY82	7/6	UBF89	9/6	Z77	4/6
IH5GT	10/6	6G6	6/6	12A6	5/-	50L6GT	9/6	DL92	7/6	EF91	4/6	KT61	12/6	PY83	8/6	UBL21	23/3	Z719	6/-
IL4	3/6	6H6	3/-	12AC6	15/3	53KU	19/11	DL94	7/6	EF92	4/6	KT63	7/1	PY88	13/3	UCC84	14/7		
ILD5	5/-	6J5	5/-	12AD6	17/3	77	8/-	DL96	8/6	EF97	13/3	KT66	15/-	PZ30	19/11	UC85	9/-	Transistors	
ILN5	5/-	6J6	5/6	12AE6	13/11	78	6/6	DM70	7/6	EF98	13/3	KT68	24/-	QP21	7/-	UCF80	16/7	and diodes	
IN5GT	10/6	6J7G	6/-	12AH7	8/-	80	9/-	EB0F	20/-	EF183	18/7	KTW61	6/6	QP25	14/6	UCH21	23/3	CG1C	7/6
IR5	6/6	6J7GT	10/6	12AH8	12/6	83	15/-	EB3F	37/6	EF184	18/7	KTW62	7/6	QP25	14/6	UCH42	9/6	CG4E	7/6
IS4	9/-	6K7G	5/-	12AT6	7/6	85A2	25/-	EA50	27/6	EK32	8/6	TW63	6/6		10/6	UCH81	9/6	CG5E	7/6
IS5	6/-	6K7GT	6/-	12AT7	6/-	150B2	15/-	EA76	9/6	EL32	5/-	KTZ41	8/-	R12	9/-	UCL82	11/6	CG7E	7/6
IT4	3/6	6K8GT	10/6	12AU6	23/3	161	10/6	EABC80	9/-	EL33	12/6	KTZ63	7/6	R18	14/-	UCL83	19/3	CG10E	7/6
IUS	6/-	6K8G	6/6	12AU7	6/6	185BT	33/2	EAC91	4/6	EL34	15/-	L63	6/-	R19	19/11	UF41	9/-	CG12E	7/6
2P	26/6	6K25	19/11	12AV6	12/6	304	10/6	EAF42	3/6	EL38	26/6	MHL4	7/6	RG1/240A		UF42	12/6	GD3, 4, 5,	
2X2	4/6	6L1	23/3	12AX7	7/6	305	10/6	EB34	2/6	EL41	9/-	MHLD6	12/6		45/-	UF80	10/6	6, 8	4/-
2A4	6/-	6L6G	8/-	12BA6	8/-	807	7/6	EB41	4/-	EL42	10/6	M4	8/6	RK34	7/6	UF85	9/-	OA70	7/6
3A5	10/6	6L6M	9/6	12BE6	5/-	956	3/-	EB91	4/-	EL81	16/7	M54B	23/3	S130	22/6	UF86	17/11	OA73	4/-
3B7	12/6	6L7GT	7/6	12BH7	21/3	1821	10/6	EB33	23/3	EL81	19/11	MJ12/14	8/-	SP47(7)	14/6	UF89	9/-	OA79	4/-
3D6	5/-	6L18	13/-	12E1	30/-	4033L	12/6	EB33	5/-	EL84	7/6	N37	23/3	SP41	3/6	UL41	9/-	OA81	4/-
3Q4	7/6	6L19	23/3	12J5GT	4/6	5763	12/6	EB41	8/6	EL85	13/11	N78	19/11	SP42	12/6	UL44	26/6	OA86	6/-
3Q5GT	9/6	6LD3	8/6	12J7GT	9/6	7193	5/-	EB81	8/-	EL86	17/3	N108	23/3	SP61	3/6	UL46	14/6	OA91	5/-
3S4	7/-	6LD20	15/11	12K5	17/11	7475	7/6	EBF80	9/-	EL91	5/-	N308	20/7	SU25	26/6	UL84	8/6	OA95	5/-
3V4	7/6	6N7	8/-	12K7GT	5/6	9002	5/6	EBF83	13/11	EL95	10/6	N339	15/-	SU61	9/-	UM4	17/3	OA210	25/-
5R4GY	17/6	6P25	12/6	12K8GT	14/-	AC/PEN		EBF89	9/6	EL820	18/7	P61	3/6	T41	9/-	UM34	17/3	OA211	40/-
5U4G	6/6	6P26	19/11	12Q7GT	5/-	5-pin 23/3		EBL21	23/3	EL822	25/-	PABC80		TD4	12/6	UM80	15/3	OC16	54/-
5V4G	10/6	6P28	26/6	12SA7	8/6	7-pin 15/-		EBL31	23/3	EM34	9/6		13/11	TH41	26/6	UR1C	18/7	OC19	54/-
5Y3	6/6	6Q7G	6/6	12SC7	8/6	AC2PEN/		EC52	5/6	EM71	23/3	PCC84	8/-	TH233	33/2	U06	19/11	OC23	87/-
5Z3	12/6	6Q7GT	11/-	12SG7	7/-	DD	12/6	EC54	6/-	EM80	9/-	PCC85	9/6	TH2321	20/-	U07	16/7	OC26	44/-
5Z4G	9/-	6R7G	10/6	12SH7	8/6	AC6PEN	7/6	EC70	12/6	EM81	9/-	PCC88	18/-	TP22	15/-	U08	26/6	OC28	25/-
6A7	10/6	6SA7GT	8/6	12SJ7	8/6	AC/TP	23/3	EC92	13/6	EM84	10/6	PCC89	11/6	TP25	15/-	U09	7/6	OC35	48/-
6A8	9/-	6SCT	7/6	12SK7	6/-	ATP4	5/-	ECC32	5/6	EM85	17/3	PCF80	8/-	TP2620	33/2	UY1N	18/7	OC44	26/-
6AC7	4/-	6SG7GT	8/-	12SQ7	11/6	AZ1	18/7	ECC33	8/6	EN31	37/-	PCF82	10/6	TY86F	13/3	UY21	16/7	OC45	23/-
6AG5	5/6	6SH7GT	8/-	12SR7	8/6	AZ31	10/-	ECC34	24/7	EY51	9/-	PCF84	16/7	UI2/14	8/6	UY41	7/6	OC56	22/6
6AG7	7/6	6SJTGT	8/-	12SY7	10/6	AZ41	13/11	ECC35	8/6	EY83	16/7	PCF86	15/-	UI6	10/-	UY85	7/1	OC66	25/-
6AK5	8/-	6SK7GT	6/-	12T4	27/10	B36	15/-	ECC40	23/3	EY84	14/-	PCLB2	10/-	UI8/20	8/6	VMP4G	15/-	OC70	14/-
6AL5	4/6	6SN7GT	6/6	19AQ5	10/6	BL63	7/6	ECC81	6/-	EY86	9/-	PCL83	10/6	UI9	36/-	VMS4B	15/-	OC71	14/-
6AM6	4/6	6SN7GT	5/6	19H1	10/-	C1	12/6	ECC82	6/6	EZ35	6/-	PCL84	12/6	U22	8/-	VP2	12/6	OC72	17/-
6AQ5	7/6	6SQ7GT	9/-	20D1	15/3	C1C	12/6	ECC83	7/6	EZ40	7/-	PCL85	16/7	U24	29/10	VP4	15/-	OC73	20/-
6AT6	7/6	6SS7GT	8/-	20F2	26/6	CB11	26/6	ECC84	9/-	EZ41	7/-	PEN4A	23/3	U25	17/11	VP2B	14/6	OC75	15/-
6AU6	10/-	6U4GT	12/6	20P1	26/6	CB13	23/3	ECC85	8/6	EZ80	7/-	PEN4B	26/6	U26	10/-	VP4B	23/3	OC77	21/-
6AV6	12/6	6U5G	7/6	20P1	26/6	CCH35	23/3	ECC88	18/-	EZ87	10/-	PEN4DD		U31	9/6	VP13C	7/1	OC78	17/-
6B6	5/-	6U7G	6/-	20P3	26/6	CK506	6/6	ECC91	5/6	FC4	15/-		26/6	U33	26/6	VP23	6/6	OC81	18/-
6BA6	7/6	6V6GT	7/-	20P4	26/6	CL33	19/3	ECF80	18/6	FW4/500	8/6	PEN25	4/6	U35	26/6	VP41	6/-	OC170	35/-
6B6G	6/6	6V6GTG	7/-	20P5	23/3	CV63	10/6	ECF82	10/6	FW4/800	8/6	PEN40DD	U37	26/6	VR105	8/6	OC200	54/-	
6B6GG	23/3	6X4	5/-	25A6G	10/6	CY1	10/6	ECF83	19/11	GV50	27/6		25/-	U43	9/-	VR150	7/6	OC203	58/-
6BH6	8/-	6XS7GT	6/-	25L6GT	10/-	CY31	11/-	ECF83	26/6	GZ30	9/-	PEN44	26/6	U45	9/-	VT61A	5/-	T11	40/-
6B16	6/-	6/30L2	10/-	25Y5G	10/-	D1	3/-	ECF81	23/3	GZ32	10/-	PEN45	19/6	U50	6/6	VT501	5/-	T12	45/-
6BQ7A	15/-	7A7	12/6	25Z4G	9/6	D15	10/6	ECH35	6/6	GZ33	19/11	PEN45DD	U52	6/6	W76	5/6	T13	50/-	
6BR7	23/3	7B6	21/3	25Z5	9/6	D63	5/-	ECH42	9/-	GZ34	14/-		26/6	U54	19/11	W81M	6/-	TP1	40/-
6B57	25/-	7B7	8/6	25Z6G	10/-	D77	4/-	ECH81	9/-	GZ37	19/11	PEN46	7/6	U76	6/-	W107	18/7	TP2	40/-
6BW6	8/6	7C5	8/-	275U	19/11	DAC32	10/6	ECH83	13/11	H63	12/6	PEN383	23/3	U78	5/-	W279	19/11	TS1	10/-
6BW7	6/-	7C6	8/-	28D7	7/6	DAF91	6/-	ECL80	9/6	HABC80		PEN453DD	U107	16/7	X24M	24/7	TS2	12/6	
6BX6	6/-	7H7	5/-	30C1	8/-	DAF96	8/6	ECL82	10/6		13/6		33/2	U191	16/7	X41	15/6	TS3	15/-
6C4	5/-	7R7	12/6	30F5	6/-	DD41	13/11	ECL83	19/3	HL2	7/6	PEN/DD	U201	16/7	X61(C)	12/6	TS4	24/-	
6C5	6/6	7S7	9/6	30FL1	10/-	DET25	7/6	ECL86	16/7	HL23	15/3		40/20	33/2	U251	14/-	X63	9/-	
6C6	6/6	7V7	8/6	30L1	8/-	DF33	10/6	EF9	23/3	HL23DD	7/6	PL33	19/3	U281	19/11	X65	12/6	XA101	23/-
6C9	13/6	7Y4	7/6	30L15	11/6	DF66	15/-	EF22	14/-	HL41DD		PL36	12/-	U282	22/7	X66	12/6	XA102	26/-
6C10	9/-	8D2	3/6	30P4	12/-	DF91	3/6	EF36	4/-		19/3	PL38	26/6	U301	23/3	X76M	14/6	XA103	15/-
6CD6G	36/6	8D3	4/6	30P12	7/6	DF96	8/6	EF37A	8/-	HL42DD		PL81	10/6	U329	14/-	X78	23/3	XA104	18/-
6CH6	9/-	9BWV6	15/3	30P1L	10/6	DF97	9/-	EF39	5/6		19/3	PL92	7/6	U339	16/7	X79	23/3	XB102	10/-
6D6	6/6	9D2	4/-	30PL13	16/6	DH63	6/6	EF40	15/-	HN309	24/7	PL83	9/-	U403	16/7	X109	17/3	XB103	14/-
6E5	12/6	10C1	13/-	35A5	21/3	DH76	5/6	EF41	9/-	HVR2	20/-	PL84	12/8	U404	8/6	XID(1.5)	6/6	XB104	10/-
6F1	26/6	10C2	26/6	35L6GT	9/6	DH77	7/-	EF42	10/6	HVR2A	6/-	PL820	18/7	U801	29/10	XFG1	18/-	XC101	16/-

Radio Books. MULLARD AMPLIFIER MANUAL 9/6d. MULLARD TRANSISTOR MANUAL 13/6d. BRIMAR VALVE MANUAL 7/- ALL POST FREE.

VOLUME CONTROLS

All with Long Spindle and Double-pole Switch, 4/6 each.

10 K 25 K 50 K 100 K

1/2 mg. 1 mg. 1 meg. 2 meg.

METAL RECTIFIERS

Full List with ratings free for S.A.E.

DRM1B	13/-	RM-1	5/3	14A86	17/6	14B130	35/-</
-------	------	------	-----	-------	------	--------	--------

CHECK with these

BARGAINS

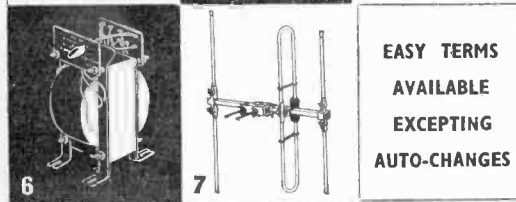
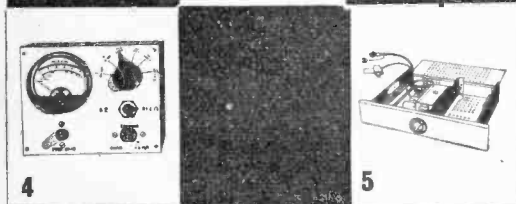
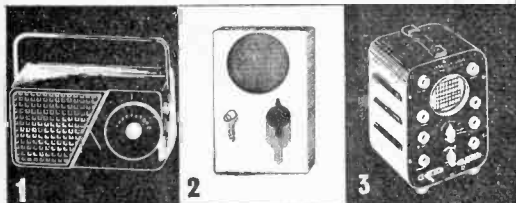

**EASY TERMS
AVAILABLE
EXCEPTING
AUTO-CHANGES**

- 3-TRANSISTOR POCKET RADIO with MINIATURE SPEAKER, FERRITE ROD, and 2 GERMANIUM DIODES.** The only 3 transistor radio available at the price. Build in 1 evening! Tunable over 30L waves. Complete with easy-to-follow instructions and all components (less batteries obtainable anywhere 10d.). 27/6. P. & P. 2/-. (All parts available separately.)
- 3-TRANSISTOR SUPER POCKET RADIO with MINIATURE SPEAKER.** Plus Germanium Diode and Printed Circuit. Size 3½ x 4 x ¾ in. Ferrite Rod Aerial. Two Surface Barrier Transistors and one Audio. Tunable over medium and long waves. To build yourself 39/6. P. & P. 1/6. Circuit diagram 1/6, free with kit. All parts of items 1 and 2 sold separately.
- OSCILLOSCOPE for D.C. and A.C. APPLICATIONS.** A high gain, extremely stable differential Y-amplifier (30 mV/C.M.). Provide ample sensitivity with A.C. or D.C. inputs. Especially suitable for measurements of transistor operating conditions where maintenance of D.C. levels is of paramount importance. Push-pull X amplifier; Fly-back suppression; Internal Time-base Scan Waveform available for external use; pulse output available for checking TV line O/P Transformers, etc. Provision for external—1/1 and CRT Brightness Modulation. A.C. mains 200/250 v. £15.15/0. P. & P. 7/6 or 30/- deposit, plus P. & P. 7/6 and 12 monthly payments of 28/6. **FULL 12 MONTHS GUARANTEE INCLUDING VALVES and TUBES.**
- A.C./D.C. POCKET MULTI-METER KIT.** 2in. moving coil meter, scale calibrated in A.C./D.C. volts, ohms and milliamperes. Voltage range A.C./D.C. 0-50, 0-100, 0-250, 0-500. Millamps 0-10, 0-100. Ohms range 0-10,000. Front panel range switch, wirewound pot (for ohms zero setting), toggle switch, resistor and rectifier. 19/6. P. & P. 1/6. Wiring diagram 1/-, free with kit.
- CHANNEL TUNER.** Will tune to all Band I and Band III stations. Complete with P.C.C.84 and P.C.F.80 valves (in series) I.F. 12-19 or 33-38. Can be modified as an aerial converter (instructions supplied) 32/6, plus 3/6 P. & P. **HEATER TRANSFORMER** to suit above, 200-250 v., 6/-, plus 1/6 P. & P.
- MAINS TRANSFORMERS.** All with tapped primaries, 200-250 volts, 0-100 180, 200 v., 60 mA, 6.3 v. 2 amps, 10/8. 350-0-350 v., 70 mA, 6.3 v. 1 amp, 6.3 v. 2 amp, 10/8. 250-250 v. 70 mA, 6.3 v. 2 amp, 10/8. P. & P. 3/-.
- WOLSEY 3-ELEMENT FOLDED DIPOLE.** I.T.V. Aerial less mounting bracket for external use, complete with 12 yds. of coaxial cable, 15/- P. & P. 3/6.
- SIGNAL GENERATORS.** Cash £6.19.6 or 25/- deposit and 6 monthly payments of 21/6. P. & P. 5/-. Coverage 100 kc/s to 100 Mc/s on fundamentals and 100 Mc/s to 200 Mc/s on harmonics. Case 10 x 6½ x 5½ in. Three miniature valves and Metal Rectifier. A.C. mains 200/250 v. Internal modulation of 400 c.p.s. to a depth of 30 per cent. Modulated or unmodulated R.F. output continuously variable 100 millivolts. C.W. and mod. switch, variable A.F. output. Magic eye as output indicator. Accuracy ± 2 per cent.

10. **SIGNAL GENERATORS.** Cash £4.19.6 or 25/- deposit and 4 monthly payments of 21/6. P. & P. 5/-. Coverage 120 kc/s to 84 Mc/s. Case 10 x 6½ x 4½ in. Size of scale 6½ x 3½ in. 2 valves and rectifier. A.C. mains 230-250 v. Internal modulation of 400 c.p.s. to a depth of 30 per cent, modulated or unmodulated R.F. output continuously variable 100 millivolts. C.W. and mod. switch variable A.F. output and moving coil output meter. Accuracy ± 2 per cent.

11. **BATTERY RECORD PLAYER AND AMPLIFIER.** 45 r.p.m. "Star" motor "Aeos" crystal pick-up, 3 transistor push-pull amplifier complete with transistors. Output 500 milliwatts, 49/6. P. & P. 3/6.

12. **8-watt PUSH-PULL 5 VALVE AMPLIFIER.** A.C. mains 200-250 v. Size 10½ x 6½ x 2½ in. 5 valves. For use with all makes and type of pick-up and mike. Negative feed back. Two inputs, mike and gram, and controls for same. Separate controls for Bass and Treble lift. Response flat from 40 cycles to 15 kc/s, ± 2 db, 4 db down to 20 kc/s. Output 8 watts at 5 per cent total distortion. Noise level 40 db down all hum. Output transformer tapped for 3 and 15 ohms speech coils. For use with Std. or L.P. records, musical instruments such as guitars, etc. Suitable for small halls, £3.19.6. P. & P. 6/5. Crystal mike to suit 15/-, P. & P. 1/6. 8in. P.M. Speaker to suit 12/6. P. & P. 1/6.

13. **B.S.R. MOMARCH UAS WITH FUL-FI HEAD.** 4-speed, plays 10 records 12in., 10in., or 7in. at 16, 33, 45 or 78 r.p.m. Intermixes 7in., 10in. and 12in. records of the same speed. Has manual play position; colour, brown. Dimensions 12½ x 10½ in. Space required above baseboard 4½ in., below baseboard 2½ in. Fitted with Ful-Fi turnover crystal head. £3.19.6. P. & P. 5/- With Stereo Head £7.19.6. P. & P. 5/-.

14. **TRANSISTOR TESTER.** For both P.N.P. and N.P.N. transistors incorporating moving coil meter. In metal case, size 4½ x 3½ x 1½ in. Scale marked in gain and leakage. 19/6. P. & P. 2/6.

15. **PUSH-PULL OUTPUT STAGE** inclusive of transistors with input and output transformers to match 3 ohms speech coil, suitable for use with the **POCKET RADIO.** Kit of parts, including transistors. 19/6. P. & P. 1/6. Wiring diagram 1/6, free with kit.

16. **PORTABLE AMPLIFIER.** On printed circuit for A.C. Mains 200/250 v. Size 4 x 3½ in. with tone and volume control. Valves: ECL82 and EZ80. 39/6. P. & P. 2/6.

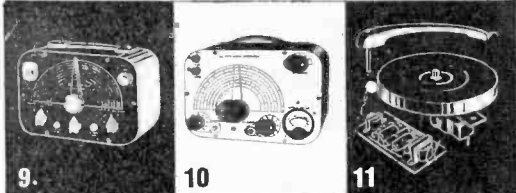

**SATISFACTION
GUARANTEED
OR
MONEY
REFUNDED**

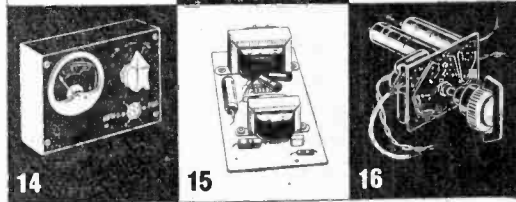

**RADIO & T.V. COMPONENTS
(Acton) LTD.**

**23B HIGH STREET, ACTON,
LONDON, W.3.**
ALL ENQUIRIES S.A.E.
GOODS NOT DISPATCHED OUTSIDE U.K.

HARVERSON SURPLUS CO. LTD.

83 HIGH STREET, MERTON,

GRAM AND TAPE EQUIPMENT BARGAINS

MONAURAL AMPLIFIER KIT

This comprises a complete kit of parts (including UCL82 valve) to build a quality 3W amplifier, size 7 x 3½ x 6½in. Efficient Circuit with volume and tone controls. Everything supplied including mains and O.P. transformers, metal rect., knobs, etc. and comprehensive instructions.
ONLY 39/6 Post and packing 4/6 extra.
 5in. loudspeaker (3Ω) to suit, 14/6 extra. All parts sold separately.

A.M. RADIOGRAM CHASSIS

A modern chassis by a famous maker. Size 15½ x 7 x 6½in. high, incorporating fully delayed AVC and neg-lead back. Valves ECH81, EF89, EBC81, EL84, EZ81. Attractive brown and gold dial with matching knobs. Controls—w/change (L.M.S. and gram), tone, tuning and vol. on/off. Complete with O.P. trans. valves, knobs, etc. **£9.19.6** plus 4/6 P. & P.

F.M. TUNER HEAD

Made by famous manufacturer. 88-100 Mc/s. Non-drift. Uses ECC85 valve (PRICE) **14/6** plus 1 6 P. & P. ECC85 valve 8/6 extra.

RECORD CHANGERS

Write for our new super list of Tape Decks and Changers.

B.S.R.

Monarch UAB 4-spd. a/changer **£6.19. 6**
 TUB 4-spd. single player less P.U. **£2.10. 0**
 UA14 Stereo Changer **£9. 5. 0**
 NOTE: Any of our Mono Players with Stereo Cartridge and Fittings, 16/- extra. Carriage and ins. on each of above 5/- extra.

TAPE DECKS

LATEST B.S.R. MONARDECK (single speed) 3½in. per sec., simple control, uses 5½in. spools **£7. 5. 0** plus 5/6 carr. and ins. (tapes extra).
 TRUVOX MARK III TAPE DECK. New and Boxed **£10.6. 6** plus 6/- carr. and ins. (tapes extra).

MIDGET I.F. TRANS ★ COILS

A Pair of midget 465 kc/s I.F. transformers, plus LW and MW coils. PRICE 10/- per set. P. & P. 1/9.
 Set of I.F. transformers for transistor superhet. 12/6. P. & P. 1/9.

CONDENSER / RESISTOR PARCEL

50 mixed P.F. Condensers and 50 mixed Resistors. An assortment of useful values. All popular sizes—all new—a must for the serviceman and constructor. P. & P. 1/-.
ONLY 10/-

1/6 H.P. MOTOR

140 watts (approx. 1/6 H.P.). Series wound, 220/250 volt 50 cycle motor. Off load 14,000 rev/min. on load 8,500 rev/min. Ideal small saw, sewing machine, etc., post free. **30/-**

HI/FI STEREO/MONAURAL AMPLIFIER

A 5 valve HI/FI amplifier with switched stereo/monaural operation. Output 3 watts per channel, provision for bass and treble speakers on each. Volume and tone controls fitted both channels. All housed in stylish blue/grey metal case, with gold finished knobs **£9.19.6** plus 4/6 P. & P.

READY BUILT AMPLIFIER

A 3-valve amplifier (ex-relay unit). Comprising 10F3 RF amp, 10P14 Audio amp (3W) and U404 rect. Inputs for AC/DC mains, 6 preset channels and crystal P.U. Complete in attractive brown and cream bakelite case, with 8in. 15Ω speaker fitted. Ideal gram, guitar, amplifier, etc. **ONLY 21/-** Plus 6/6 P. & P.

THE WORLD FAMOUS E.M.I ANGEL TRANSCRIPTION P.U. (Model 17A)

A Pick-up for the connoisseur originally priced at £17.10.0. The last remaining few offered at **£4.10.0** Plus 5/- P. & P.

E.M.I 4-SPEED RECORD TURNTABLE AND PICK-UP

Heavy 8½in. metal turntable. Low flutter performance, 200/250 v shaded motor with tap at 80 v. for amplifier valve filament if required. Turnover LP/78 head.

89/6 COMPLETE Plus 4/6 P. & P.

E.M.I 4-SPEED STEREO PLAYER

To suit our stereo amplifiers **£6.12.6** Plus 5/- carr.

SWITCHED ATTENUATOR

Audio to V.H.F. in four steps of 20 dB ± 0.02 dB up to 300 Mc/s. Cost **£5.10.0**.
OUR PRICE £2.19.6 Plus 1/- P. & P.

20,000 VALVES

in stock SEND FOR YOUR REQUIREMENTS

COSSOR C.R.T. SNIP

108K 10-inch. New and boxed. 15/-, plus 6/- P. & P.
 75K 10-inch. New and boxed. 15/-, plus 6/- P. & P.

ION TRAP MAGNETS

To suit the above, 2/9 each. P. & P. 3d.

MAZDA CRM 172—Not a Regun.

Picture tested—12 months' Guarantee. **£3.17.6.** 12/6 P. & P.

CYLDON 12 CHANNEL TURRET TUNERS

New purchase offered at still lower price I.F. 33-38 Mc/s. Complete with PCC84 and PCF80 valves and 8 sets of Coils for 5 Band I Channels and 8, 9, 10 Band 111. New and unused. Value over £7.
OUR PRICE, 32/6 post paid

WIRE WOUND POTS

12 Wire Wound Colvern Pots—all different values. P. & P. 9d. **10/9**

PAIR OF MOTORS

Two miniature motors (each 3½ x 3 x 1½in.). Can be run in parallel from 115 v. A.C. or in series from 200/250 v. A.C. Ideal tape motors, models, etc.

35/- per pair, plus 2/9 p. & p.

FOR FULL DETAILS AND ILLUSTRATIONS OF THE ITEMS IN THIS ADVERTISEMENT, SEE MAY ISSUE, PAGES 3, 4, 5 and 6

SUPER STEREO KIT

A kit of ready-built units only requiring interconnection. Comprising two midget 3W amplifiers, push button switch, transformer, control unit (bass, treble and vol.), power pack, one speaker (second speaker 14/6 extra), indicator light, valves (ECL82, EZ80 range) and comprehensive instructions. **59/6** plus 6/6 P. & P.

SUPERHET CHASSIS

Modern AC/DC chassis with printed cct. and ferrite rod aerial. Although not completely built, the main components are mounted. L. & M. wave coverage. 4 valves (UBF89, UCL83, UCH81, UY85). Everything supplied including dial knobs, etc., and simple **£4.19.6** plus 3/6 instructions. P. & P.

F.M. TUNER KIT

At last a quality F.M. Tuner Kit at a price you can afford. Just look at these fine features, which are usually associated with equipment at twice the price!

- ★ F.M. Tuning Head by famous maker.
- ★ Guaranteed Non-drift. ★ Permeability Tuning. ★ Frequency coverage 88-100 Mc/s. ★ OA81 Balanced Diode Output.
- ★ Two I.F. Stages and Discriminator.
- ★ E.M.84 Magic Eye. ★ Self powered, using a good quality mains transformer and valve rectifier. ★ Valves used ECC85, two RF80's, EM84 (Magic Eye) and EZ80 (rectifier). ★ Fully drilled chassis.
- ★ Everything supplied, down to the last nut and bolt. ★ Size of completed tuner 8 x 6 x 5½in. ★ All parts sold separately. **£4.19.6** Plus 8/6 P. & P.

Circuit diagram and illustrations, 1/6, post free.

STEREOPHONIC AMPLIFIER

Complete with 2 Speakers

A compact amplifier embodying the latest features, giving good reproduction and ample volume. Complete with valves (ECL82, ECL82, EZ80), panel, knobs, etc., and two 3Ω matched speakers. **£5.10.0** Plus 4/6 P. & P.

TRANSISTOR BARGAINS ALL FIRST GRADE

- OC71 8/-
 - OC72 12/-
 - OC72 Matched Pair 25/-
 - OC45 Green Spot 15/-
 - OC45 Blue Spot 15/-
 - OC44 15/6
 - OA41 Diode 3/6
- Postage on all above 6d.

SPECIAL OFFER

DON'T MISS THIS
MULLARD OC.76 10/6
MATCHED PAIR £10.0.0
 Post and packing 6d.

G.E.C. FIRST GRADE TRANSISTORS

Set comprising one 874 mixer, two 873 I.F.s, one GET114 driver, two GET113 matched output and one diode.

£1.18.6

post 1/-

CHerrywood 3985/6 LONDON, S.W.19

VALVE BARGAINS

NEW ★ BOXED ★ GUARANTEED ★
PROMPT DESPATCH ★ POST 6d. PER

VALVE EXTRA

ACHLDD 9/3	FW4/500/9/3	U191 10/6	6AC7 6/-	10F9 14/8
AC/P 7/-	GZ32 11/-	U339 11/6	6AG5 5/3	10L1 9/-
AC/P4 7/-	H80 4/8	U403 15/6	6AK5 6/-	10LD11 8/8
AC/PEN DD 25/9	H83 9/3	U501 26/-	6AL5 6/-	10P13 16/8
AC/PEN 6/-	HL23DD 8/-	UABC90 9/6	6AM5 11/9	10P14 18/-
ACVPI 59/3	HL22 6/-	UAF42 8/8	6AQ5 7/-	12A8 6/-
ATP4 3/3	HL41 3/3	UBC41 8/8	6AT6 8/-	12A76 10/-
AZ1 9/3	HN309 8/8	UBF80 8/9	6AU6 9/9	12AT7 7/-
AZ31 11/6	K40N 2/6	UCC84 10/6	6BA6 8/8	12A76 7/8
B36 14/-	KF35 8/-	UCF35 10/6	6BB6 7/8	12A76 7/8
CB131 22/0	KKL32 8/-	UCF80 15/6	6BB6 7/8	12A76 7/8
CCM35 22/0	KT2 4/6	UCI181 9/9	6BGG 22/-	12A76 7/8
CL4 11/9	KT24 4/6	UCL32 15/6	6BH6 8/8	12A76 7/8
CL33 18/2	KT82 9/3	UCL33 11/6	6BIB 8/8	12A76 7/8
CY31 15/0	KT33C 8/-	UCF41 8/8	6BWB 8/8	12A76 7/8
CV13 5/9	KT36 25/-	UF85 8/8	6BWB 8/8	12A76 7/8
C36A 6/-	KT35 10/3	UF89 8/8	6C4 3/9	12A76 7/8
DAF96 8/3	KT61 9/6	UL41 9/6	6CGT 6/-	12A76 7/8
DF96 8/6	KT83 7/-	UL44 25/-	6E87 11/9	12A76 7/8
DB83 11/6	KT86 18/-	UL46 25/-	6F1 13/-	12A76 7/8
DH101 11/6	KT88 21/-	UL48 8/6	6F15 13/-	12A76 7/8
DK96 8/6	KTW61 6/-	UU6 18/6	6F15 13/-	12A76 7/8
DL96 8/6	KTW63 7/-	UO8 25/-	6F15 13/-	12A76 7/8
DL145 9/3	KTZ41 8/8	UY1N 11/9	6F15 13/-	12A76 7/8
DM70 7/-	KT88 7/-	UY21 11/9	6F15 13/-	12A76 7/8
DN41 16/6	ML4 8/-	UY41 7/8	6F15 13/-	12A76 7/8
EA50 1/3	MS48 16/-	UY85 6/6	6F15 13/-	12A76 7/8
EACB80 8/6	MS45 7/7	VPI30 3/3	6F15 13/-	12A76 7/8
EAF42 9/6	MS47 7/7	VPC3 6/-	6F15 13/-	12A76 7/8
EA34 1/9	MVS/PEN	VY41 8/8	6F15 13/-	12A76 7/8
EB41 8/-	NZ8 9/3	VR133 14/-	6F15 13/-	12A76 7/8
EBC33 6/3	MX40 16/-	VR22(PM	6F15 13/-	12A76 7/8
EB41 8/6	N37 18/6	2A) 2/9	6F15 13/-	12A76 7/8
EBF80 9/-	N78 18/6	VR105/80	6F15 13/-	12A76 7/8
EBF89 9/-	N339 28/-	6G6 7/8	6F15 13/-	12A76 7/8
EB121 22/-	OZ4 5/-	VR116 3/9	6G7 6/-	12A76 7/8
EBL31 22/-	P61 3/3	VR100/30	6G7M 8/8	12A76 7/8
EC31 7/-	PCC84 8/8	W21 11/9	6K7 3/9	12A76 7/8
ECB81 7/8	PCP80 9/-	VU190A 3/3	6K7M 6/3	12A76 7/8
ECB82 7/8	PCP82 11/9	VU39(MU	6K7M 6/3	12A76 7/8
ECB83 8/6	PCL82 11/6	12/14) 8/8	6K8GT 6/8	12A76 7/8
ECC94 9/3	PCL83 13/6	VU111 2/3	6J7GT 5/8	12A76 7/8
ECC85 9/-	PL38 16/6	W21 11/9	6K8GT 6/8	12A76 7/8
ECP80 11/3	PL36 14/8	W16 7/-	6K25 18/6	12A76 7/8
ECP82 12/3	PL81 11/9	W77 8/-	6L1 14/6	12A76 7/8
ECH21 22/-	PL82 8/-	W729 9/9	6L6G 1/7	12A76 7/8
ECH42 8/6	PL83 11/9	X22 16/9	6L6M 9/-	12A76 7/8
ECH81 8/6	PX25 11/9	X41C 16/8	6L7G 7/-	12A76 7/8
EC130 9/3	PY80 7/-	X101M 9/6	6L18 10/3	12A76 7/8
EC132 9/9	PY81 8/8	6L18 10/3	6L18 10/3	12A76 7/8
EC282 8/-	PY82 6/6	Z21 11/9	6N7GT 7/-	12A76 7/8
EF36 4/6	PY83 8/-	Z309 7/-	6P28 25/-	12A76 7/8
EF37A 14/-	PZ30 18/6	Z359 7/-	6Q7G 7/-	12A76 7/8
EF59 5/3	PEN1DD	1A3 3/-	6Q7GT 9/-	12A76 7/8
EF40 13/8	PEN1E	1A3GT 5/8	6NA3GT 7/8	12A76 7/8
EF41 9/3	PEN4VA	1A7GT 11/9	68GT 7/-	12A76 7/8
EF42 10/3	14/-	IC2 11/-	68H7 5/8	12A76 7/8
EF50 3/9	PEN25 5/6	IC5GT 11/9	68J7 8/-	12A76 7/8
EF508YL	PEN45 6/6	1D5 11/9	68K7 5/8	12A76 7/8
EF54 5/6	PEN220A	1D6 11/9	68L7 5/8	12A76 7/8
EF55 9/3	3/9	114 6/-	68Q7 8/-	12A76 7/8
EF80 7/-	PEN45DD	1LD5 5/-	6T46GT 11/3	12A76 7/8
EF85 7/-	25/-	1N5 9/9	6U5/9G5	12A76 7/8
EF86 11/9	PEN44 25/-	1R5 9/9	6V5 16/-	12A76 7/8
EF91 5/6	PM12M 7/8	1S4 9/9	6V5G 18/-	12A76 7/8
EF91(BVA)	QP21 4/6	1S3 6/-	6V7G 8/-	12A76 7/8
EL32 8/6	R16 25/-	1T4 5/8	6V8G 5/8	12A76 7/8
EL33 13/-	SP41 2/8	2C26 1/3	6V8GT 7/3	12A76 7/8
EL38 24/6	SP61 2/8	2F 25/-	6V9 8/8	12A76 7/8
EL41 9/6	SP45 9/8	2X2 4/-	6X5G 6/8	12A76 7/8
EL42 9/6	SP47 9/8	3A1 6/8	6X5GT 6/8	12A76 7/8
EL51 15/8	T41 22/-	3A8GT 5/8	6/30L2 11/9	12A76 7/8
EL54 8/6	TD18C 7/-	3D6 4/8	7B6 9/9	12A76 7/8
EM80 9/3	TD233 17/6	3Q4 7/6	7B7 5/8	12A76 7/8
EM81 9/6	TP2 7/8	3Q5GT 9/-	7B8 5/8	12A76 7/8
EM82 9/3	TP25 25/-	384 7/-	7C5 7/8	12A76 7/8
EM83 9/3	U10 9/9	3V4 8/-	7C6 7/6	12A76 7/8
EM84 9/3	U14 8/-	4D1 2/9	7D6 12/6	12A76 7/8
EM85 9/3	U18 11/9	6L4GY 9/-	7E7 8/8	12A76 7/8
EZ40 7/-	U17 11/9	6U4G 6/3	7Q7 8/8	12A76 7/8
EZ41 7/-	U22 7/6	6V4 10/9	787 9/-	12A76 7/8
EZ41 7/-	U25 13/-	6Y3G 7/8	7Y4 8/-	12A76 7/8
EZ80 6/6	U26 11/9	6Y3GT 7/8	8D2 2/8	12A76 7/8
EZ81 6/6	U37 25/-	6Z4G 8/8	9D2 3/3	12A76 7/8
EZ80 7/-	U45 14/-	6Z4M 9/8	10C1 11/9	12A76 7/8
EL148 1/9	U50 7/6	6A7 10/6	10C2 16/9	12A76 7/8
FC13 6/-	U76 7/6	6A8G 8/8	10F1 14/6	12A76 7/8

MANY MORE VALVES THAN THE ABOVE IN STOCK, PLEASE ENQUIRE FOR TYPES NOT LISTED

TECHNICAL TRAINING

in radio television and electronics

Whether you plan to have your own business, to become an electronics engineer, to take up a career in industry, or to brush-up your knowledge and study new developments, transistors, etc., an I.C.S. Course will help you to success. You learn at home in your own time, under expert tuition. Moderate fees include all books.

EXAMINATION COURSES FOR:—

C. & G. Radio and TV Servicing Certificate (R.T.E.B.)

C. & G. Radio Amateurs' Exam. (Amateurs' Transmitting Licence)

British Institution of Radio Engineers, etc. C. & G. Telecom. Technician's Cert.

LEARN AS YOU BUILD

Practical Radio Servicing Course

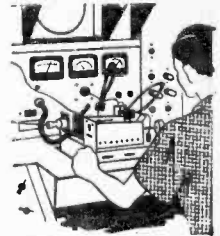

A basic course in radio electronic and electrical theory backed by thorough practical training. You build radio receivers, signal generator and multimeter.

Post this Coupon TODAY! for FREE book on careers in Radio, and full details of other I.C.S. Courses

INTERNATIONAL CORRESPONDENCE SCHOOLS

(Dept. 171), Intertext House, Parkgate Road, London S.W.11.

Please send book on _____

Name _____ Age _____
(Block Letters Please)

Address _____

Occupation _____ 7.61

INTERNATIONAL CORRESPONDENCE SCHOOLS

R.S.C. HI-FI TAPE RECORDER KIT

REALISM AT INCREDIBLY LOW COST, CAN BE ASSEMBLED IN HALF AN HOUR. The Recorder incorporates the Latest Collaro Studio Tape Transcriber. The Linear L145X High Quality Tape Amplifier listed £12.12.0 High Flux P.M. Speaker listed 40/- empty Tape Spool, a reel of Best quality Tape listed 22/6, and a Handsome Portable carrying Cabinet with latest attractive two-tone polychrome finish, size 18 x 13 x 9 1/2 in. high. Listed £4.10.0 and circuit. Total cost if purchased individually approximately £40. Performance equal to units in the £60-£80 class. S.A.E. for leaflet.

HIGH FIDELITY 12-14 WATT AMPLIFIER TYPE A11

PUSH-PULL ULTRA LINEAR OUTPUT "BUILT-IN" TONE CONTROL PRE-AMP STAGES

Two input sockets with associated controls allow mixing of "mike" and gram, as in A10. High sensitivity. Includes 5 valves, ECC83, ECC83, EL34, EL84, 5Y3. High Quality sectionally wound output transformer specially designed for Ultra Linear operation, and reliable small condensers of current manufacture. INDIVIDUAL CONTROLS FOR BASS AND TREBLE "Lift" and "Cut." Frequency response ± 3 D.B. 30-30,000 c/s. Six negative feedback loops. Hum level 60 D.B. down. ONLY 23 millivolts INPUT required for FULL OUTPUT. Suitable for use with all makes and types of pick-ups and microphones. Comparable with the very best designs. For STANDARD or LONG PLAYING RECORDS. For MUSICAL INSTRUMENTS such as STRING BASS, GUITARS, etc. OUTPUT SOCKET with plug provides 300 v. 30 mA. and 6.3 v. 1.5 a. For supply of a RADIO FEEDER UNIT. Size approx. 12-9 in. For A.C. mains 200-250 v. 50 c.p.s. Output for 3 and 15 ohm speakers. Kit is complete to last nut. Chassis is fully punched. Full instructions and point-to-point wiring diagrams supplied. Only **8 Gns.** Carr. 10/- (Or factory built 45/- extra).



If required louvred metal cover with 2 carrying handles can be supplied for 18/9. TERMS ON ASSEMBLED UNITS. DEPOSIT 25/-, and 9 monthly payments of 25/-.. Send S.A.E. for illustrated leaflet detailing Ready-to-assemble Cabinets, Speakers, Microphones, etc., with cash and credit terms.

R.S.C. STEREO/TEN HIGH QUALITY AMPLIFIER



A complete set of parts for the construction of a stereophonic amplifier giving 5 watts high quality output on each channel (total 10 watts). Sensitivity is 50 millivolts, suitable for all crystal stereo heads. Ganged Bass and Treble Controls give equal variation of "lift" and "cut." Provision is made for use as straight (monaural) 10 watt amplifier. Valve line-up ECC83, ECC83, EL84, E281. Outputs for 2 3 ohm speakers. Point-to-point wiring diagrams and instructions supplied. Send S.A.E. for leaflet. **8 Gns.** Carr. 10/- Full constructional details and price list 2/6

R.S.C. BATTERY CHARGING EQUIPMENT

HEAVY DUTY CHARGER KIT 12 v. 6 amps, variable output. Consisting of Mains Transformer 0-200-230-250 v.; F.W. (Bridge) Selenium Rectifier; Ammeter, Variable Charge Rate Selector Panels, Plugs, Fuses, Fuseholder and circuit, 59/9, Carr. 4/6.

DEAF AID EARPECS. Low Impedance with lead, 8/9. High Impedance Crystal 8/8.

MICROPHONE INSERTS. Crystal type, 8/9.



Assembled 6 v. or 12 v. 4 amps.

Fitted Ammeter and variable charge rate selector. Also selector plug for 6 v. or 12 v. charging. Louvred steel case with stoved blue hammer finished. Fused and ready for use with Car. 11/- mains and output leads. Terms: Deposit 13/3 and 5 monthly payments 13/3.

ASSEMBLED CHARGER 6 v. or 12 v. 2 amps.

Fitted Ammeter and selector plug for 6 v. or 12 v. Louvred metal case finished attractive hammer blue. Ready for use with 11/- mains and output leads. Double Fused. Carr. Only **49/9**

All for A.C. Mains 200-250 v., 50 ccs. Guaranteed 12 months.

BATTERY CHARGER KITS Consisting of Mains Transformer, F.W. Bridge, Metal Rectifier, well ventilated steel case, Fuses, Fuse-holders, Grommets, panels and circuit. Carr. 3/9 extra.
 6 v. or 12 v. 1 amp. 24/9
 As above, with Ammeter. 32/9
 6 v. 2 amps. 25/9
 6 v. or 12 v. 2 amps. 31/6
 6 v. or 12 v. 2 amps. inclusive of Ammeter. 42/9
 6 v. or 12 v. 4 amps. with Ammeter and variable charge rate selector. 59/9
CHARGER AMMETERS. 0-1.5 a., 0-3 a., 0-4 a., 0-7 a., 0-25 a., 0-60 a. 8/9.

R.S.C. MAINS TRANSFORMERS (FULLY GUARANTEED)

Interleaved and Impregnated. Primaries 200-230-250 v. 50 c/s. Screened TOP SHROUDED DROP THROUGH

250-0-250 v. 70 mA, 6.3 v. 2a, 5 v. 2a.	17/9
350-0-350 v. 60 mA, 6.3 v. 2a, 5 v. 2a.	18/9
250-0-350 v. 100 mA, 6.3 v. 2a, 6.3 v. 1a	18/9
250-0-250 v. 100 mA, 6.3 v. 3.5 a. C.T.	19/9
250-0-250 v. 100 mA, 6.3 v. 4a, 5 v. 3a.	25/9
300-0-300 v. 130 mA, 6.3 v. 4a, 6.3 v. 1a.	
for Mullard 519 Amplifier	29/9
300-0-300 v. 100 mA, 6.3 v. 4a, 5 v. 3a.	26/9
350-0-350 v. 100 mA, 6.3 v. 1a, 5 v. 3a.	26/9
350-0-350 v. 100 mA, 6.3 v. 4v. 4a, C.T.	
0-4-5 v. 3a.	28/9
350-0-350 v. 150 mA, 6.3 v. 4a, 5 v. 3a.	28/9

FULLY SHROUDED UPRIGHT

230-250 v. 60 mA, 6.3 v. 2 a, 5 v. 2 a.	17/11
Midget type 21-9 in.	
250-0-250 v. 100 mA, 6.3 v. 4a, 5 v. 3a.	27/9
300-0-300 v. 100 mA, 6.3 v. 4a, 5 v. 3a.	27/9
350-0-350 v. 100 mA, 6.3 v. 4a, 5 v. 3a.	27/9
350-0-350 v. 150 mA, 6.3 v. 4a, 5 v. 3a.	35/9
425-0-425 v. 200 mA, 6.3 v. 4a, C.T.	
6.3 v. 4a C.T., 5 v. 3a	49/9

FLUORESCENT TRANSFORMERS All with 200-250 v. 50 c/s. primaries 6.3 v. 1.5 a. 5/9; 6.3 v. 2 a. 7/8; 0-4-6.3 v. 2 a. 7/9; 12 v. 1 a. 7/11; 6.3 v. 3 a. 8/11; 6.3 v. 6 a. 17/8; 12 v. 1.5 a twice, 17/6.

OUTPUT TRANSFORMERS Midget Battery Pentode 66:1 for 3S1 etc. 3/9
 Small Pentode, 5000 Ω to 3 Ω 3/9
 Small Pentode 7/8,000 Ω to 3 Ω 3/9
 Standard Pentode 5,000 Ω to 3 Ω 5/6
 Standard Pentode 7/8,000 Ω to 3 Ω 5/6
 10,000 Ω to 3 Ω 5/6
 Push-Pull 10-12 watts 6V6 to 3 Ω or 15 Ω 18/9
 Push-Pull 10-12 watts to match 6V3 to 4-5-8 or 15 Ω 19/-
 Push-Pull EL84 to 3 or 15 Ω 25/-
 Push-Pull 15-18 watts, 6L6, KT66. 3/3
 Push-Pull for Mullard 510 Ultra Linear 29/9
 Push-Pull 20 watts sectionally wound 6L6, KT66 etc., to 3 to 15 Ω 47/9

ELIMINATOR TRANSFORMERS Philips: 200-250 v. 50 c/s. 120 v. 40 mA, 5-6-5 v. 1 a. 15/9
 90 v. 15 mA, 4-0-4 v. 500 mA 8/9

SMOOTHING CHOKES 150 mA, 7-10 H 250 ohms. 11/9
 100 mA, 10 H 350 ohms. 8/9
 60 mA, 10 H 350 ohms. 5/9
 60 mA, 10 H 400 ohms. 4/11

CHARGER TRANSFORMERS All with 200-230-250 v. 50 c/s Primaries: C-9-15 v. 11 a. 11/9; 0-1-15 v. 2 a. 14/9; 0-9-15 v. 3 a. 18/9; 0-9-15 v. 5 a. 19/9; 0-9-15 v. 6 a. 23/9; 3-9-15 v. 8 a. 28/9.

AUTO STEP UP/STEP DOWN TRANS. -11 v. 30/250 v. 50-60 watts 13/9; -11 120-200/230/250 v. 150 watts, 17/9.

MICROPHONE TRANSFORMERS 120:1 high grade, clamped, 8/9; 120:1 Fused, Mu-metal screened, 9/8.

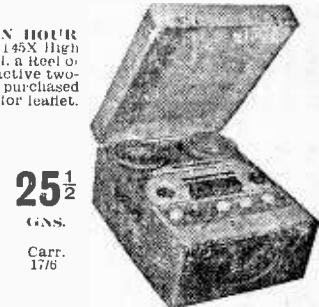

H.P. TERMS. Deposit £5.7.6 and 12 monthly payments of 25 s. Cash price if settled in 3 months.

TELEVISION RECTIFIERS 250 v. 200 mA. small size. Only 8/9 each.

COLLARO CONQUEST 4-SPEED AUTO-CHANGER with high fidelity Studio pick-up. Latest mode. For 200-250 v. 50 c.p.s. A.C. mains. Our price 28.18.6, Carr. 5/6.

COLLARO RC 47 4 SPEED MIXER AUTO-CHANGER Turnover Studio Pick-up head, for 200-250 v. A.C. £7.18.6, Carr. 4/6.

THE SKYFOUR T.R.F. RECEIVER A design of a 3-valve Long and Medium wave 200-250 v. A.C. Mains receiver with selenium rectifier. High gain H.F. stage and low distortion detector. Valve line-up 6X7, 5Y61, 6Y6G. Selectivity and quality excellent. Simple to construct. Point-to-Point wiring diagrams, instructions and parts list, 1/6. maximum building costs £4.19.6. Inc. attractive Walnut veneered wood cabinet 12 x 8 x 5 1/2 in.

D.C. SUPPLY KIT. 12 v. 1 a. consisting of a partially drilled metal case, mains transformer, F.W. Bridge Rectifier, fuses and fuses. Change Direction switch, variable Speed regulator and circuit. For 200-250 v. A.C. mains. Suitable for Electric Trains. Limited number available at 33/9.

R.S.C. (Manchester) LIVERPOOL, LEEDS, BRADFORD, MANCHESTER Ltd.

R.S.C. A12 STEREOPHONIC AMPLIFIER KIT

A complete set of parts to construct a Stereo amplifier with an undistorted output total 6 watts. For A.C. mains input of 200-250 v. Outputs for matched 2-3 ohm speakers. Sensitivity 130 m.v. Ganged Vol. and Tone Controls. Preset balance control. Full instructions and point-to-point wiring diagrams supplied. Only good quality Carr. and pkg. 5/- components and latest high grade valves used. Exceptionally realistic reproduction can be obtained at ample volume for the home, as can be demonstrated in typical surroundings at our County Arcade premises. A really sensational offer.

4 Gns.

STEREO EQUIPMENT OFFER.
Comprising A12 Kit, 2 matched 8in. L/Speakers, and Acos T10 Stereo head suitable most pick-ups. **£6.19.6** Carr. 7/6

PICK-UP ARMS complete with Hi-Fi turnover crystal head. Acos GF54. Limited number-brand new, perfect at approx. half price. Only 35/9.

ACOS CRYSTAL MICROPHONES. Mic40 stand or desk. Listed 45/-. Only 27/9. 39-1 Stick type. Listed 5 gns. Only 39/6.

R.S.C. 30 WATT ULTRA LINEAR HIGH FIDELITY AMPLIFIER A10

A highly sensitive Push-Pull high output unit with self-contained Pre-amp. Tone Control Stages. Certified performance figures compare equally with most expensive amplifiers available. Hum level 70 db. down. Frequency response—3 db. 30-30,000 c/s. A specially designed sectionally wound ultra linear output transformer is used with 807 output valves. All components are chosen for reliability. Six valves are used EF86, EF86, ECC83, 607, 807, GZ33. Separate Bass and Treble Controls are provided. Minimum input required for full output is only 12 millivolts so that ANY KIND OF MICROPHONE OR PICK-UP IS SUITABLE. The unit is designed for CLUBS, SCHOOLS, THEATRES, DANCE HALLS or OUTDOOR FUNCTIONS, etc. For use with Electronic ORGAN, GUITAR, STRING BASS, etc. For standard or long-playing records, OUTPUT SOCKET PROVIDES L.T. and H.T. for a RADIO FEEDER UNIT. An extra input with associated vol. control is provided so that two separate inputs such as Gram. and 'Mike' can be mixed. Amplifier operates on 200-250 v. 50 c/s. A.C. Mains and has output for 3 and 15 ohm speakers. Complete kit of parts with fully punched chassis and point-to-point wiring diagrams and instructions. If required cover as for A12 can be supplied for 13/9. The amplifier can be supplied, factory built with EL34 output valves and 12 months' guarantee, for 14 Gns.

11 Gns.

Carr. 10/-

TERMS: DEPOSIT 33/9 and 9 monthly payments of 35/9.

FULL RANGE OF LINEAR AMPLIFIERS ALWAYS IN STOCK.

COLLARO JUNIOR 4-speed single player units and Hi-Fi crystal pick-up with turn-over head, £3.19.6.

B.S.R. UAS 4-SPEED AUTO-CHANGERS with Hi-Fi turnover pick-up head, £6.19.6, Carr. 5/-.

R.S.C. BATTERY TO MAINS CONVERSION UNITS

Type BM1. All-dry battery eliminator. Size 5 1/2 x 4 1/2 x 2 1/2 approx. Comp. 24V. replaces battery supplying 1.4 v. and 90 v. where A.C. mains 200-250 v. 50 c/s is available. Suitable for all battery portable receivers requiring 1.4 v. and 90 v. This includes latest low consumption types.

Complete kit with diagrams. 39/9, or ready to use, 46/9.

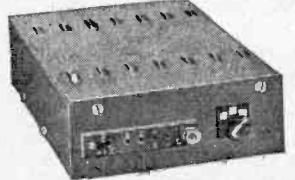

Type BM2. Size 8 x 5 1/2 x 2 1/2 in. Supplies 120 v. 90 v. and 60 v., 40 mA. and 2 v. 0.4 a. to 1 amp. fully smoothed. Thereby completely replacing both H.T. batteries and L.T. 2 v. accumulators when connected to A.C. mains supply 200-250 v. 50 c/s.

SUITABLE FOR ALL BATTERY RECEIVERS normally using 2 v. accumulators. Complete kit of parts with diagrams and instructions. 46/9, or ready to use, 59/6.

LINEAR L45 MINIATURE 4 1/2 WATT QUALITY AMPLIFIER. Suitable for use with any record playing unit, and most microphones. Negative feedback 12db. Separate Bass and Treble Controls. For A.C. mains input of 200-250 v. 50 c/s. Output for 2-3 ohm speaker. Three miniature Mullard valves used. Size of unit only 7-5-5 1/2 in. high. Guaranteed for 12 months. Only £5.19.6. Send S.A.E. for illustrated leaflet. Terms: Deposit 22/6 and 5 monthly payments of 22/6.



mains input of 200-250-250 v. 50 c/s. Unit is complete in every detail and includes fully punched chassis (with baseplate) with Blue Hammer finish and point-to-point wiring diagrams and instructions. Exceptional value at only £4.15.0, or assembled ready for use 25/- extra, plus 3/6 carr.; or Deposit 22/6 and 5 monthly payments of 22/6 for assembled unit.

R.S.C. 4.5 WATT A5 HIGH-GAIN AMPLIFIER

A highly-sensitive 4-valve quality amplifier for the home, small clubs, etc. Only 50 millivolts input is required for full output so that it is suitable for use with the latest high fidelity pick-up heads, in addition to all other types of pick-ups and practically all 'mikes'. Separate Bass and Treble Controls are provided. These give full long-playing record equalisation. Hum level is negligible being 71db. down. 15db of Negative feedback is used. H.T. or 300 v. 25 mA. and L.T. of 6.3 v. 1.5 a. is available for the supply of a Radio Feeder Unit, or Tape-Deck pre-amplifier. For A.C. mains input of 200-250 v. 50 c/s. Output for 2-3 ohm speaker. Chassis is not veneer finish. Size 18 x 12 x 10 in. Handsome appearance. Ensure superb reproduction for only £3.19.6.

R.S.C. PORTABLE GUITAR AMPLIFIERS

Junior 5 watts High Quality output. Separate Bass and Treble "Cut" and "Boost" controls. Sensitivity 15 m.v.. Twin inputs. High Flux 8in. Loudspeaker "built-in". Handsome, strongly made Cabinet (size approx. 14 x 14 x 7 1/2 in.) finished in attractive and durable pollicrome, and fitted with carrying handle. H.P. Terms. **£8.19.6** Deposit £1 and 9 monthly payments Carr. 7/6

Senior 10 watts High Fidelity output. Separate Bass and Treble "Cut" and "Boost" controls. Twin separately controlled high gain inputs so that two instruments such as Guitar and String Bass can be used at the same time. Two loudspeakers are incorporated, a high Flux 12in. for Bass notes and a 7 x 4 m. elliptical for Treble. Cabinet is well made and finished as Junior model. Size approx. 18 x 13 x 18 in. H.P. Terms. Deposit 34/9 and 15 Gns. 9 monthly payments of 34/9. Carr. 10/-

Both models for 200-250 v. Carr. 10/- A.C. mains. Above model fitted Linear Tremolo Unit 5 gns. extra. Or Deposit 11/6 and 9 monthly payments 11/6.

12in. 10 WATT HIGH QUALITY LOUD-SPEAKER IN POLISHED WALNUT FINISHED CABINET

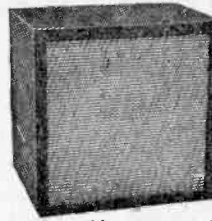

Causs 12,000 lines. Speech coil 3 ohms or 15 ohms. Only £5.19.6. Terms: Deposit 11/3 and 8 monthly payments of 11/3. **12in. 20 WATT HI-FI LOUD-SPEAKERS IN CABINETS.** Size 18 x 18 x 10in. Finish as above. Terms: Deposit 17/9 and 9 monthly payments of 17/9. Only £7.19.6, Carr. 8/6.

R.S.C. BASS REFLEX CABINETS. JUNIOR MODEL. Specially designed for W.B. HF1012 Speaker, but suitable for any good quality 10in. speaker. Acoustically lined and ported. Polished walnut veneer finish. Size 18 x 12 x 10in. Handsome appearance. Ensure superb reproduction for only £3.19.6.

STANDARD MODEL. As above but for 12in. speakers. Size 20 x 15 x 13in. Especially recommended for Plessey Dual Concentric Speaker. £5.19.6. Suitable legs with brass ferrules, 25/- per set of 4. **PLESSEY DUAL CONCENTRIC 12in. 15 ohms HIGH FIDELITY SPEAKER** (2,000 lines) with built-in tweeter (completely separate elliptical speaker with choke, condensers, etc.) providing extraordinarily realistic reproduction when used with our All or similar amplifier. Rated 10 watts. Price only £5.19.6. **P.N. SPEAKERS.** 2-3 ohm. Perdio 21/9. 5in., 17/9. 6in., 16/9. 8in., 19/9. 8 x 5in., 25/9. 10in., 26/9. 10 x 6in., 29/9. 12in., 29/11. 10in. W.B. "Stentorian" 3 or 15 ohms type HF1012 10 watts, hi-fidelity type. Recommended for use with our All Amplifier. £5.19.6. 1 2in. R.A. 3 ohms 10 watts (12,000 lines), 59/6.

TWEETERS. Plessey 3p 19/9. 15p 25/9. **HI-FI CRYSTAL PICK-UP HEADS.** Acos. Standard replacement for Garrard and B.S.R. B.S.R. Ful-f. Garrard GC2. 19/9. B.S.R. Stereo-Monaural 39/11. **GL3A MINIATURE 2-3 WATT GRAM AMPLIFIER.** For use with any single or auto-change unit. Output for 2-3 ohm speaker. For 200-250 v. A.C. mains. Size 1 1/2 x 2 1/2 x 2 1/2 in. Controls: Vol. and Tone with switch. Only 59/6.

SUPERB FEEDER UNIT. Design of a high quality Radio Tuner Unit (specially suitable for use with any of our Amplifiers). Delayed A.V.C. Controls are Tuning, W/Ch. and Vol. Only 250 v. 15 mA. H.T. and L.T. of 6.3 v. 1 amp. required from amplifier. Size of unit approx. 9-6-7 1/2 in. high. Simple alignment procedure. Point-to-point wiring diagrams, instructions and priced parts list with illustration. 2/6. Total building cost £4.15.0. For leaflet send S.A.E.

LINEAR TAPE PRE-AMPLIFIER Type LP1. Switched Negative feedback equalisation. Positions for Record (1in. 3in., 7in. and Playback. EM84 Recording Level Indicator. Designed primarily as the link between a Collaro Tape Transcriber and a high fidelity amplifier, but suitable for almost any Tape Deck. Only 9 gns. S.A.E. for leaflet.

TERMS: C.W.O. or C.O.D. No. C.O.D. under £1. Post 1/9 extra under £2. 2/9 extra under £5. Open 9 to 6. Weds. until 1 p.m. Trade supplied. S.A.E. with all enquiries.

Mail Orders to 29-31 Moorfield Road, Leeds 12. Personal shoppers to any of branches below—
R.S.C. (Manchester) Ltd. 73 Dale Street, Liverpool 2
S-7 County (Mecca) Arcade, Briggate, Leeds 1
8-10 Brown St. (Market St.), Manchester 2
56 Morley Street (Above Alhambra Theatre), Bradford

VALVES SALVAGE GUARANTEED

9d. each. 7/6 doz.
2D21, 4D1, 5AL5, 6C6, 6D2, 6L5, 6A5,
5R67, 6R67, 5D2, 6D2, 7R, 4R5, 4R10,
EB41, 6F36, D1, 6F50, 6L41D, 6F50,
K730, 8P4, 8P4, 8P4, 8P4, 8P4, 8P4,
V1107, VT201, VT501, W150, Z66.

2/9 each 30/- doz.
6AK5, 6AM6, 6C4, 6F1, 6F12, 6F13,
6F14, 6D9, 6D15, 6K7, 6K25, 6L7, 6L8,
5P25, 6L7, 6Z4, 7B7, 7Q7, 10P1, 128H7,
128J7, 128K7, 25A6, 18, 25Z5, 35Z4, 42,
43, 7B121, 6C34, 6C71, 6P30, 6P40,
6P41, 6P42, 6L32, 6Y51, 6Y51, 6Y51,
U22, U31, 6AF42, 6B11, UCH42, UF41,
CF12, UL41, UL46, UY, UC5, VP41,
VP133.

5/9 each 60/- doz.
3U4, 6P6, 6K3, 6Q7, 6V6, 6X5, 6AB5,
6AK5, 6AT8, 6AQ5, 6BW6, 6BW7,
6K3, 6L1, 6A07, 1, AT7, 12K7, 12K8,
12Q7, 20L1, 20P1, 20P1, 20P1, DCF80,
6BF80, 6CC81, 6CC81, 6CC81, 6CC82,
6CC83, 6CC84, 6CF80, 6CF82, 6CH42,
6CH42, 6CL82, 6H45, 6L80, 6P80,
6P80, 6L80, 6L41, 6CF82, 6CF83,
6CF80, 6CC84, 6BF80, 6CH80, 6CH81,
6CH83, 6CL82, 1Y45.

POSTAGE
On 1 valve 7d. On 6 valves 1/6. On 12
valves 2/6.

**DE-LUXE TAPE RECORDER
CABINET ONLY
29/9**



Beautifully made Tape Recorder Cabinet. Size: 13 x 10 1/2 x 7 1/2. Covered in two-tone coloured rexine cloth. Stylish design. Easily adapted to Record Player Cabinet. P. & P. 4/6.

B.S.R. "MONARDECK" £6.10s.0d.
3H.o.s. 5 1/2in. spools. Complete with R/playback and erase head. Simple control for R/playback and fast rewind with safety switch. Size: 13 x 8 1/2 x 2 1/2in. P. & P. 4/6.

DUKE & CO. (London) LTD
621/3 ROMFORD ROAD MANOR PARK, E.12
ILT 6001/3

Hours—
9 a.m.—6 p.m.
Half Day Thursday

Send for
LATEST FREE
CATALOGUE

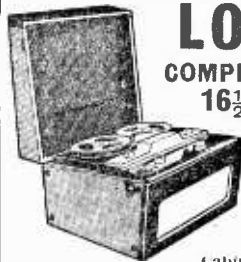

**LOOK!
COMPLETE KIT
16 1/2 Gns.**

(Sold separately).
Mike £17.6
Tape 19/9
Spools 2/9
Jack Plugs 1/9
Cabinet £2.9c
B.S.R. Deck £6.10.0
Amplifier £7.19.6
Loudspeaker 15/9
Terms available.

Amplifier Accessories:
Dial incl. sockets and
superimpose switch. 3/6
each. Knobs 2/6.

Kit 12/6	Amplifier 4/6	POSTAGE Cabinet 4/6	Deck 4/6	Speaker 2/9
----------	---------------	---------------------	----------	-------------

COMPLETELY ASSEMBLED ONLY 18 Gns.

Including MICROPHONE AND TAPE
Ins., Carr. 12/6. Credit Terms Available

SPECIAL OFFER

6 MULLARD TRANSISTORS AND DIODE

1—OC81D 6/9 each
2—OC81 6/9 each Only
1—OC44 9/9 each **47/6**
2—OC45 8/9 each
and Diode 1/9 each Per Set
G.E.C. Types Available. Post Free.

MINIATURE SPEAKERS
2 1/2 and 3 inch. Postage 1/-.

SPEAKER SALE 8/9 TO CLEAR
5in., 6in., 8in. and 7 x 4in. Ex. Manufacturers Salvage. Money back guaranteed. P. & P. 2/9.

ELLIPTICAL SPEAKERS
New slot type. 7 x 4in. and 8 x 3in. P. & P. 2/9.

FREE TO AMBITIOUS ENGINEERS
— THE LATEST EDITION OF ENGINEERING OPPORTUNITIES

Have you sent for your copy?
ENGINEERING OPPORTUNITIES is a highly informative 156-page guide to the best paid engineering posts. It tells you how you can quickly prepare at home for a recognised engineering qualification and outlines a wonderful range of modern Home Study Courses in all branches of Engineering. This unique book also gives full details of the Practical Radio & Electronics Courses, administered by our Specialist Electronics Training Division—the B.I.E.T. School of Electronics, explains the benefits of our Employment Dept. and shows you how to qualify for five years promotion in one year.

**We definitely Guarantee
"NO PASS — NO FEE"**

Whatever your age or experience, you cannot afford to miss reading this famous book. If you are earning less than £25 a week, send for your copy of "ENGINEERING OPPORTUNITIES" today—FREE.

BRITISH INSTITUTE OF ENGINEERING TECHNOLOGY (Incorporating E.M.I. Institutes)
(Dept. SE/21), 29 Wright's Lane, London, W.8

WHICH IS YOUR PET SUBJECT?

- Mechanical Eng..
- Electrical Eng..
- Civil Engineering.
- Radio Engineering.
- Automobile Eng..
- Aeronautical Eng..
- Production Eng..
- Building, Plastics, Draughtsmanship, Television, etc.

GET SOME LETTERS AFTER YOUR NAME!

- A.M.I.Mech.E.
- A.M.I.C.E.
- A.M.I.Prod.E.
- A.M.I.M.I.
- A.I.O.B.
- A.F.R.Ac.S.
- B.Sc.
- A.M.Brit.I.R.E.
- City & Guilds Gen. Cert. of Education Etc., etc.

PRACTICAL EQUIPMENT

Basic Practical and Theoretical Courses for beginners in Radio, T.V. Electronics, Etc., A.M.Brit.I.R.E. City & Guilds Radio Amateurs' Exam. R.T.E.B. Certificate P.M.G. Certificate Practical Radio Radio & Television Servicing Practical Electronics Electronics Engineering Automation

INCLUDING TOOLS!

The specialist Electronics Division of B.I.E.T. (incorporating E.M.I. Institutes) NOW offers you a real laboratory training at home with practical equipment. Ask for details.

B.I.E.T. SCHOOL OF ELECTRONICS

POST COUPON NOW!

Please send me your FREE 156-page "ENGINEERING OPPORTUNITIES"
 (Write if you prefer not to cut page)
 NAME,
 ADDRESS,

 SUBJECT OR EXAM THAT INTERESTS ME, (SE/21)



THE B.I.E.T. IS THE LEADING ORGANISATION OF ITS KIND IN THE WORLD

Brand new, individually checked and guaranteed VALVES

ACSPENDD	EAC91 1/6	EY86 8/-	PL82 8/-	VU39 6/-	6C4 3/6	6X4 5/-	8V3 12/-	Cathode
AL60 6/-	EB34 4/6	EY91 3/6	PL83 7/9	VU111 3/3	6C5 6/-	6X5GT 6/6	84 8/-	Ray Tubes
AP4 4/-	EBC21 8/-	EZ80 6/6	PT25H 7/6	VX3138 12/-	6C6G 4/3	6Y6G 6/6	89 6/-	58P1 35/-
ARB 5/-	EBC91 3/9	EZ81 6/9	PX4 19/-	W31 7/-	6C8G 5/-	6Z4 8/-	210LF 3/-	5CP1 42/6
ARDDS 2/-	EC52 3/-	GL450 6/6	PX25 9/-	Y63 5/-	6D6 4/6	6Z7 6/6	210VPT 7 pin 2/6	5FP7 45/-
ARF3 3/-	ECC81 5/6	GL450 10/-	PY80 6/9	Y66 8/-	6E5 5/-	7C7 6/6	7B7 40/-	12DP7 60/-
ARF4 3/6	ECC82 6/6	GZ32 9/-	PY81 7/-	Z31 6/-	6F6 7/-	7Q7 7/-	705A 17/6	CV1596 (OJ3) 55/-
ARF12 2/9	ECC83 7/-	HL23 6/-	PY82 8/-	IA3 3/-	6F6G 4/-	7V7 5/-	715B 97/6	VCR97 15/-
ARF21 5/6	ECC84 7/1	HL23DD 8/-	QP21 6/-	IA5G 3/-	6F8G 6/6	7Y4 6/-	717A 8/6	VCR138 30/-
ARF24 3/6	ECC85 7/9	HL41DD 8/-	QP25 5/3	IC5GT 7/6	6F12 4/6	8W2 2/6	801 6/-	VCR139A 35/-
ARF34 4/6	ECC86 7/1	HL23DD 8/-	QS75/20 6/9	ID8GT 6/-	6G6G 3/-	FD24 2/6	803 22/6	VCR258 (with scanning coil 45/-)
ARTH2 7/1	ECL80 8/-	KF35 5/-	QS95/10 6/9	IE7GT 7/6	6H6M 2/-	9D2 3/-	804 55/-	805 30/-
ATP4 2/9	EF22 7/3	KRN2A 19/-	QS108/45 6/9	IG6GT 12/-	6I5 3/6	12A6 5/-	807AMER 7/-	807BR 5/-
ATP7 5/6	EF32 5/-	KT2 4/-	R3 6/9	ILDS 3/6	6J5G 3/-	12AH7 7/-	808 80/-	Photo Tubes
AUI 5/-	EF36 3/6	KT31 8/-	R10 12/6	ILN5 4/9	6K6GT 6/6	12AT7 5/6	810 80/-	CMG8 9/-
AU4 5/-	EF37A 8/-	KT32 8/-	REL21 25/-	IR5 6/-	6K7G 2/3	12E1 22/6	813 67/6	CMG25 8/-
AW3 4/-	EF39 4/3	KT33C 4/9	RK34 2/6	IS5 5/9	6K8GT 4/9	12H6 6/6	815 40/-	GS16 12/6
AZ 8/-	EF50 2/6	KT44 6/3	RX235 10/-	IT4 4/-	6K8M 8/3	12J5GT 3/6	816 30/-	931A 50/-
BL63 6/-	EF54 3/3	KT63 6/-	SP2 4/-	2A6 7/6	6K8M 8/3	12K8M 9/-	826 10/6	Special Valves
BS4A 5/6	EF55 6/-	KT 11/-	SP4B 7/6	2A8 7/6	6L5G 6/-	12S7 4/6	829A 30/-	2J31 45/-
BT45 40/-	EF70 4/-	KTW62 7/6	SPI3C 4/6	2X2 4/-	6L6 9/-	12SH7 3/3	832 15/-	3A/1481 45/-
B703 22/6	EF73 6/-	KTW63 6/6	SP41 2/6	2X4 5/-	6L6G 6/6	12SHT 3/3	832A 35/-	723AB 45/-
BT9B 40/-	EF80 5/6	MH4 5/-	SP61 2/-	3B2 3/-	6L34 4/6	12S17 6/6	843 7/6	725A 30/-
CY31 11/6	EF85 6/9	MH41 5/-	STV280/40 12/-	3E29 3/-	6N7G 5/9	12S17 6/6	866A 12/6	726A 27/6
D41 3/3	EF86 9/-	ML4 4/-	SU2150A 4/9	T41 7/-	6N7GT 6/-	12SL7 7/6	872A 35/-	930 8/-
D77 4/3	EF89 7/10	MS/PEN 6/-	T1 15/-	TP25 15/-	6O7G 9/-	12SN7 8/-	930 8/-	954 2/6
DA30 12/6	EF91 3/6	NT37 10/-	TT11 3/-	TT11 3/-	6R7G 6/-	12SR7 6/-	954 2/6	956 2/6
DAF86 8/-	EF92 4/6	(4033A) 10/-	TZ20 16/-	U17 5/-	6R7GT 8/-	15S2 6/-	956 2/6	958A 5/-
DAF91 6/6	EF95 7/6	OD3 5/-	U17 5/-	U18 6/6	6S4 9/-	15S2 6/-	1619 5/-	1625 6/-
DE75 15/-	EL32 3/9	OD4 5/-	U27 8/-	U27 8/-	6S3 8/6	15S2 6/-	1626 4/6	1629 4/6
DE77 7/6	EL33 8/-	PCC84 7/3	U52 5/-	UL41 7/-	6S4G 8/-	15S2 6/-	1629 4/6	1629 4/6
DF91 3/3	EL35 8/3	PCC85 8/3	UL41 7/-	UL84 7/6	6B87 4/-	15S2 6/-	1629 4/6	1629 4/6
DF96 8/-	EL41 8/3	PCF80 7/-	UL84 7/6	UL85 7/6	6AC7 3/-	6S7G 5/9	1629 4/6	1629 4/6
DK96 8/-	EL42 9/-	PCF82 8/-	UL85 7/6	UL85 7/6	6AG5 3/6	6SK7 5/3	1629 4/6	1629 4/6
DL92 6/-	EL84 7/6	PCL82 8/6	UU9 5/6	UP23 3/6	6AG7 6/-	6SL7GT 6/6	1629 4/6	1629 4/6
DL94 6/-	EL85 10/-	PEN25 4/6	VP33 3/6	VP41 5/6	6A7 4/3	6SN7GT 6/6	1629 4/6	1629 4/6
DL96 8/-	EL91 7/6	PEN46 5/6	VP41 5/6	VR78 4/-	6AK5 5/-	6S07 6/-	1629 4/6	1629 4/6
DX25 9/-	EM80 8/-	PEN65 6/6	VR78 4/-	VR87 4/-	6AK7 8/-	6S7 6/6	1629 4/6	1629 4/6
E1232 5/6	EN31 22/6	PEN220A 3/-	VR99 8/-	VR99 8/-	6AM6 6/3	6S7 6/6	1629 4/6	1629 4/6
E1323 25/-	EN32 7/6	PEND/D 1360 7/6	VR105/30 7/6	VR105/30 7/6	6A66 5/-	6S7 6/6	1629 4/6	1629 4/6
E1524 6/6	ESU208 8/-	PL81 9/6	VR150/30 7/3	VR150/30 7/3	6B8 5/6	6V6G 5/6	1629 4/6	1629 4/6
EA50 1/6	EYS1 8/-	PL81 9/6	VT4C 25/-	6B8G 2/6	6V6GT 6/-	82 8/-	1629 4/6	1629 4/6

AND MANY OTHERS IN STOCK, INCLUDING CATHODE RAY TUBES AND SPECIAL VALVES. All U.K. Orders below 10/-, 1/6; P. & P. 1/- over 10/-. Orders over £2, P. & P. free. C.O.D. 2/- extra. Overseas Postage extra at cost.

FREQUENCY METER BC221 TECHNICAL MANUAL 22/6.
Field Telephone Type "L" Excellent guaranteed condition, £5.50 per pair, carriage paid.
Telephone Handset. Standard G.P.O. type, new, £1, P. & P. 1/6.
Transmitter/Receiver No. 22. 2 Mc/s to 8 Mc/s. Built almost exactly as No. 19 set but much more economical in battery consumption. Complete in fully working condition with power pack for 12 v., Headgear and Microphone assembly and Key, £9.19.6. Carriage 15/-.
Marconi SIGNAL GENERATOR. TF144G. 85 kc/s. 25 Mc/s. Made up to new standard. £70 delivered free.
U.H.F. SIGNAL GENERATOR
TYPE T.S.14. 3.200-3.370 Mc/s, power measuring range 20-200 mW, R.F. output power —20 to —100 dbm below 1 mW. Power supply 115 w A.C. Price £15. Carriage 15/-.
S.C.R. 522 Receivers (BC624) 100-156 Mc/s, without valves, 7/6. P. & P. 5/-.
H.T. Chokes made by Bendix Radio (U.S.A.), 3 Henry's 0.6000 D.C. 25 ohms D.C. resistance 18,000 v. R.M.S. 60 cycle test, £1.12.6. P. & P. 6/- Ditto 10 Henry's 250A D.C. 90 ohms resistance 1,500 v. R.M.S. 60 cycle test, 16/6. P. & P. 3/6.
Carbon Inset Microphone, G.P.O. Type 2/6. P. & P. 1/-.
Miniature Relays. Changeover 12-30 v. D.C. supply, 5 amps contacts. 5/-, P. & P. 2/-.
Pre-set Double Potentiometers. 2 x 3,000 ohms linear 4 w. 5/- P. & P. 1/6.
R109 Receivers. 1.8-8.5 Mc/s working from 6 v. D.C. Complete with all valves and built-in speaker. In excellent, guaranteed working condition. £5.50. Carriage and packing 15/-.

BRAND NEW ORIGINAL SPARE PARTS FOR AR88 RECEIVERS
I.F. Transformers. 1st, 2nd, 3rd, 4th (for type D), 12/6 each or complete set of 6, 60/-.
I.F. Transformers. Crystal Load, 12/6 each
Plates escutcheons (for D and LF), 15/- each.
Dials (for type D), 10/- each.
Logging Dia. (for D and LF), 10/- each.
Filter Chokes (for D and LF), 22/6 each.
Output Transformers (for LF), 30/- each.
Antenna Trimmers (LF and D), 2/6 each.
Filter Condenser 3 x 4μF, £2.10.0
Condensers:
3 x .25μF (D and LF), 2/6 each.
3 x .01μF (D and LF), 2/6 each.
RF Antenna Inductors (D and LF), 7/6 each.
Mains Transformers (LF), £3 each.
Small Mica Condensers, various values, 1/6 each.
Instruction Manual for AR88D, £1.
Specialty Built Power Pack for TCS Receiver. 230 v. A.C. mains, including 6X5GT valve, £3.10.0. Carriage 5/-.
Marconi CR-100 Communications Receiver. 60 kc/s-30 Mc/s with noise limiter. Completely reconditioned, £25. Carriage 25/-.
T.C.S. Receivers. Made by Collins of U.S.A. in fully guaranteed working condition. 1.5-12 Mc/s. Line up: 12SA7 (1) 12SQ7 (1), 12A6 (2), 12SK7 (3). Power requirements 12 v. L.T., 225 v. H.T. £11.10.0. Carriage 12/6.

R209 Reception Set. A 10-valve High-Grade Super Heterodyne Receiver with facilities for receiving R/T (A.M. or F.M.) and C.W. Frequency 1-20 Mc/s. Hermetically sealed. Built on miniature valves and incorporating its own vibrator power supply unit driven by a 6 v. battery (2-point connector included). The set provides for reception from rod, open-wire or dipole aerial with built-in loud-speaker or phone output. Overall measurements: Length 12in., width 8in., depth 9in. Weight 23 lbs. In as new, tested and guaranteed condition £23.10.0, including special headphone and supply leads. Carriage £1.
Supply Unit Rectifier No. 21. Fully sealed enabling all sets built for 6 v. (R209, R109, etc.) to work from A.C. mains. Input 90-260 v. A.C. (Taps at 10 v. intervals). Output excellently smoothed up to 10 amps with meter indicating exact output voltage. Measurements: 12 x 9 x 10in. Price £8. Carriage and packing 15/-.
19 Set Owners. To increase output of your set 6 to 10 times use **RF Amplifier No. 2** with built-in rotary converter for 12 v. input. Four 807 valves output. Simple connection with transmitter. Fully tested condition, £9.15.0, including necessary connectors and instructions. Carriage and packing 15/-.
Laboratory Precision Variable Condenser. Manufactured by General Radio Co., U.S.A. 50-1,500pF with micro metric drive and calibration chart. Overall dimensions of case 9 x 8 x 7in. Price £15. Carriage 15/-.
Vacuum Condenser. 32,000 v, 50pF, 12/6. P. & P. 3/-.
AR 88's. Completely rebuilt with new PVC wiring. Type "D" £75; Type "LF" £70.

P. C. RADIO LTD.
170 GOLDHAWK RD., W.12
Shepherds Bush 4946

UNUSUAL SINGLE SPEAKER SYSTEM

A CONCRETE COLUMN

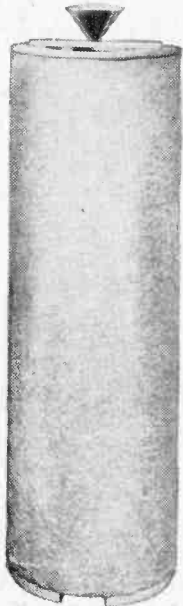

An inexpensive column speaker constructed from a concrete pipe and fitted with a good 8in. or 10in. unit has attracted much interest and admiration because of its clean open sound.

Complete kits of wooden fixtures are available including absorbent wadding and diffusing cone.

Price £3.15.0 for 8" model. Recommended 8" unit—8/145 £6.19.11 including purchase tax.

Price £4.18.0 for 10" model. Recommended 10" units—W10/FSB £12.9.10; Golden/FSB £8.6.7; 10" Bronze/FSB £5.5.11. Prices include purchase tax.

Suitable concrete pipes can be purchased from builders' merchants at about 12/6 to 17/6.

Descriptive leaflet free on request from:



IDLE, BRADFORD, YORKSHIRE
Grams: Wharfedale Idle Bradford
Phone: Idle 1235/6

TUBES

HIGHEST QUALITY—NEW LOW PRICES

Carr. & Ins. 12/6

GUARANTEED

	8 Months Seconds	12 Months REUNED	12 Months NEW TYPES MW 31/74. £4-0-0 MW 38/44 MW 38/24 £5-0-0 CRM 172 MW 43/64 £6-0-0
9/10in.	£1-10-0	£3-0-0	
12in.	£1-15-0	£3-10-0	
14in.	£2-0-0	£4-0-0	
15/17in.	£2-15-0	£4-15-0	
21in.	£3-15-0	£5-15-0	

13 Channel TV's—Absolutely Complete

These Sets are unequalled in value. They are untested and are not guaranteed to be working.

12" £3.19.0 (P.P. 12/6) 14" £5.19.0 (P.P. 15/-)

External ITV Converters with power pack

Hammered finish. Very compact. Gain and Trimming controls. OUR PRICE 39/-
Listed at £7.7s. Carriage 2/6.

U48 Stereo Changers

B.S.R. famous Monarch autochangers, fitted with quality stereo cartridge. Truly amazing value. P. & P. 3/-.

VALVES

10% DISCOUNT SPECIAL OFFER TO PURCHASERS

of any SIX VALVES marked in black type (15% in dozens). Post: 1 valve 6d., 2-11, 1/- FREE TRANSIT INSURANCE. All valves are new or fully guaranteed ex-government or ex-equipment origin. Satisfaction or Money Back Guarantee on goods if returned unused within 14 days.

BY RETURN OF POST

GUARANTEED 3 MONTHS

NEW LOW PRICES

0Z4	5/-	6L18	8/6	25L6GT	9/-	ERF89	8/6	KT44	7/6	U74	8/-
1A7GT	11/3	6L19	12/6	25Z4G	7/3	EEL21	12/6	KT45	8/6	U76	5/6
1C5GT	9/6	6LD20	8/6	27S0	18/-	EEL31	21/-	KT61	8/6	U78	5/-
1E5GT	9/6	6P25	8/6	30P5	6/9	ECC31	3/6	KT63	6/3	U82	7/-
1L4	3/6	6P28	12/6	30FL1	6/9	ECC31	9/6	KT63	6/3	U97	11/-
1N5GT	9/9	6Q76	6/3	30P4	12/6	ECC32	4/-	KT66	12/6	U118	6/6
1R5	5/6	6Q7GT	8/9	30P12	8/-	ECC33	4/6	KT66	5/9	U119	6/9
1S4	8/-	6S47	5/9	30PL1	10/6	ECC34	9/-	KT69	5/9	U142	8/6
1S5	4/6	6S27	4/9	33L6GT	8/6	ECC35	6/9	KT69	5/9	U143	8/9
1T4	3/9	6S47	4/8	38W4	6/9	ECC31	5/6	KT68	5/6	U145	6/6
2D21	4/6	6S47	4/-	38Z4GT	5/3	ECC32	6/9	MU14	8/-	U147	5/6
3A4	4/9	6S87	5/3	50CD6G		ECC33	6/9	N13	7/3	U149	7/6
3Q4	7/-	6S17GT	6/9		19/-	ECC34	8/9	N37	11/-	U150	8/6
3R4	6/9	6S7GT	4/6	50L6GT	9/-	ECC35	7/9	N78	11/6	U151	8/6
3V4	6/9	6S97	6/-	61BT	18/-	ECC40	8/6	N108	18/-	U152	7/-
5R4G	9/6	6S57	4/6	61SFT	11/-	ECC42	8/6	P41	4/6	U153	6/6
5Y4G	4/9	6L4GT	10/6	90AV	9/-	ECH21	12/6	P61	2/3	U154	6/2
5V4G	8/9	6V9G	5/6	18S2T	18/-	ECH35	9/6	PABC80		U191	11/-
5X3G	5/9	6V9GT	6/6	807(A)	5/8	ECH42	8/6			U281	9/6
5X3GT	6/-	6X4	5/-	807(B)	2/6					U284	15/-
5Z4G	8/6	6X3G	5/-	965	3/9	ECL80	17/-	PCC85	9/3	U301	11/6
5Z4GT	11/-	6X3GT	5/6	956	2/6	ECL82	9/6	PCC88	19/6	U309	7/-
6A8G	9/6	7B6	9/-	9001	4/-	ECL83	12/6	PCC89	13/6	U329	7/-
6A4C	8/6	7B7	7/9	9003	4/-	EP22	7/-	PCF80	7/6	U339	11/-
6A6G	5/8	7C5	7/8	AT24	2/8	EL24	3/3	PCF22	7/3	U343	8/6
6A9T	7/8	7D8	7/3	AZ31	9/-	EF30	4/6	PCF81	18/6	U361	17/-
6AK3	6/6	7H7	7/6	B38	8/6	EF85	6/6	PCL82	7/3	UABC80	8/6
6AL5	3/8	787	8/-	B65	4/6	EF86	9/-	PCL83	10/6	UAF42	8/6
6AM3	3/-	7V4	7/-	CHL31	21/-	EF89	6/9	PCL84	7/6	UBC41	7/6
6AQ5	6/9	11L	11/-	CH35	14/-	EF93	3/6	PCN25	4/8	UBV80	8/6
6AT8	8/-	10C2	13/6	CL33	11/8	EF95	4/6	UPN9	4/6	UB94	7/6
6AU6	7/8	10F1	5/9	CV31	9/9	EL32	12/6	PEN48	5/3	UBL21	14/6
6BBG	3/6	10LD11	14/6	D63	1/6	EL32	4/6	PL33	8/3	UCH21	12/6
6PA6	8/-	10P13	9/-	DA90	2/6	E133	3/6	PL36	10/6	UCH42	7/6
6BE8	5/9	10P14	9/-	DA32	9/9	EL35	7/-	PL38	18/6	UCH91	8/6
6R6GG	12/6	12A17	6/9	DAF91	4/9	EL37	11/8	PL91	8/9	UCL82	11/3
6HW5	7/8	12A19	9/9	DAF96	7/3	EL38	12/6	PL82	6/9	UCL83	13/6
6BW7	5/9	12A16	7/6	DF33	9/9	EL41	8/-	PL83	6/9	UF41	8/6
6C4	3/8	12A17	5/6	DF91	3/9	EL42	9/-	PL94	9/-	UF42	5/6
6C8	4/9	12A17	6/9	DF92	3/8	EL34	7/-	PV31	7/8	UF80	7/6
6C9	8/9	12A17	6/9	DF96	7/3	EL34	4/6	PC85	9/8	U86	8/9
6CD6G	21/-	12S1GT	3/6	DR77	6/-	EM34	3/6	PY80	7/-	UF86	14/6
6CH6	8/3	12K7GT	5/-	DH81	9/-	EM80	8/6	PY81	6/-	UF89	7/-
6D5	4/8	12K8GT		DK32	11/3	EM81	8/9	PY82	6/3	UL41	7/-
6F1	4/6			DK91	5/8	EM84	8/9	PY83	7/8	UL44	11/-
6F12	5/-	12Q7GT	5/-	DK93	7/6	EM85	10/6	PZ50	9/8	UL46	9/9
6F13	6/9	12S1GT	4/6	DR66	7/6	EN31	18/-	R18	11/-	UL48	7/6
6F14	9/6	12SK7GT		DL33	3/6	EY61	R19		11/-	UL80	9/6
6F15	9/6			DL35	9/6	Small	8/-	T41	7/8	U88	12/8
6H9	2/-	12SN7GT		DL91	8/-	EY86	8/-	TDD4	7/6	U87	9/6
6J5G	2/9			DL93	4/9	EZ41	5/6	U11	8/6	UY11	11/-
6J5GT	3/9	13D3	7/-	DL93	4/9	EZ41	5/6	U11	8/6	UY11	11/-
6J7G	5/-	1487	22/6	DL94	6/8	EZ80	6/-	U22	6/9	UY88	6/6
6J7GT	7/8	19BGGG		DL96	7/3	EZ91	6/6	U24	15/-	VR105/30	
6K0GT	6/8			EA30	9/9	GT10	7/-	U25	12/6		5/6
6K7G	2/8	20D1	15/-	EA30	9/9	GT10	14/6	U25	9/9	VR150/30	
6K7GT	4/9	20F2	8/6	EAF32	8/9	GZ32	8/3	U31	7/9		8/9
6K9G	5/6	20L1	18/-	EB34	1/6	HABC80	9/6	U33	14/-	X63	9/6
6K9GT	9/9	20P1	9/9	EB31	3/6	HABC80	7/6	U35	11/-	X66	11/-
46K25	7/8	20P3	12/6	EB31	3/6	HABC80	7/6	U37	26/-	X76H	12/-
6L1	12/6	20P4	17/-	EB33	4/9	HV82	9/6	U39	5/9	X78	14/6
6L6	7/3	20P5	15/-	EB34	6/9	HV82	9/6	U39	5/9	X78	14/6
6L6G	7/3	20AG6	8/-	EB38	7/9	KT33C	6/6	U70	5/6	X68	6/3
6L7C	6/-	25L6	6/9	EBP80	7/9	KT36	9/-	U71	8/-	Z63	6/6

The most competitive comprehensive valve list in the country.

TECHNICAL TRADING CO.

350/352 FRATTON ROAD, PORTSMOUTH

SENSATIONAL NEW 1961 DESIGNS—BY CONCORD

LOW PRICES ★ PICTORIAL STEP-BY-STEP PLANS ★ EASY AS A.B.C.

THE NEW "LISBON" TRANSISTOR SET

Build the miniature, highly sensitive "LISBON" design. This is a pocket 2-stage transistor set not much larger than a matchbox. Excellent clear reception covering all medium waves and working for months and months off a tiny 13 or 8 volt battery costing only 3d. A very simple set to build and an excellent introduction to transistor circuitry. Everything can be supplied down to the last nut and bolt including **SIMPLE AS A.B.C. PICTORIAL STEP-BY-STEP PLANS FOR ONLY 19/6** plus post and packing 1/6. (C.O.D. 2/- extra). Parts sold separately, priced parts list 1/-.

19/6

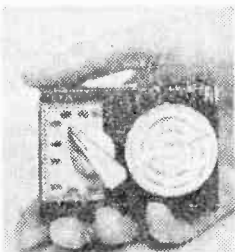

"MAJORCA" 7 TRANSISTOR RADIO

Build this 7-TRANSISTOR **£10.19.6** "MAJORCA" superb portable with Car Radio aerial attachment. An exceptional high quality design giving remarkable tone with push-pull output. Can be built for **ONLY £10.19.6**, including everything down to the last nut and bolt and **SIMPLE AS A.B.C. PICTORIAL STEP-BY-STEP PLANS**. Post and packing 3/6 (C.O.D. 3/- extra). Parts sold separately.

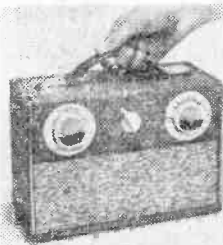

OUR NOVEL WRIST RADIO

Our engineers have designed this novel Wrist Radio using latest transistor techniques. Size only 1 1/2 x 1 x 1/2 in. "Featherweight" yet gives clear, crisp reception over all medium waves. Tiny battery lasts months and months costing only 4d. No valves—anyone can build it in an hour or two using our **SIMPLE AS A.B.C. PICTORIAL STEP-BY-STEP PLANS**. All parts can be supplied including case and strap **FOR ONLY 22/6**, plus post and packing 1/6 (C.O.D. 2/- extra). Parts sold separately, priced parts list 1/-.

22/6



THE NEW "FLORIDA" VALVE RADIO

This sensational "FLORIDA" model is one of our most sensitive valve radios. It is a highly compact, self-contained miniature push button base, valve pocket radio at absolutely rock bottom holding cost. Covers all medium waves with very latest circuitry bringing in stations from all over Europe without fuss. Size only 4 1/2 x 2 1/2 x 1 1/2 in. A fascinating pocket radio. We can supply all the parts including beautiful 2-tone case and **SIMPLE AS A.B.C. PICTORIAL STEP-BY-STEP PLANS**, screws, wire, etc. Can be built for the exceptionally **LOW PRICE OF 27/6**, plus post and packing 1/6 (C.O.D. 2/- extra). Parts sold separately, priced parts list 1/-.

27/6

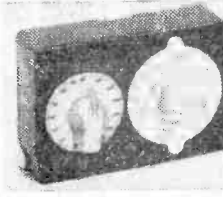

OUR NEW 4 STAGE "MINUETTE"

Build this newly-designed "MINUETTE" 4-STAGE transistor set in very strong ready drilled **ULTRA-MODERN CASE**, size only 6 x 3 1/2 x 1 in. Uses three transistors and diode and **SELF-CONTAINED LOUD SPEAKER**. Very sensitive, ideal for office, bedroom, holidays, etc. Months and months of listening off an 8d. battery. Can be built **FOR ONLY 39/6**, including **PROPER CASE** miniature speaker, etc. **SIMPLE AS A.B.C. PICTORIAL STEP-BY-STEP PLANS**, etc., plus post and packing 1/6 (C.O.D. 2/- extra). Parts sold separately, priced parts list 1/-.

39/6

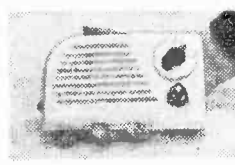

THE NEW "MONTE-CARLO" RADIO

One of our new, exciting designs, the "MONTE CARLO" is a powerful, all mains, miniature table radio with the latest trimmings, solid insert knobs, special unbreakable plastic veneer, etc. The amazing circuit covers all medium and long waves with good selectivity, fantastic tone and output. Includes ready drilled and punched chassis, standard octal base valves, etc. All the parts can be supplied including **SIMPLE AS A.B.C. PICTORIAL STEP-BY-STEP PLANS**. Everything down to the last nut and bolt **FOR ONLY £5.15.0**, plus post and packing 3/6 (C.O.D. 2/- extra). Parts sold separately, priced parts list 1/-.

£5.15.0

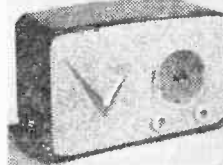

THE NEW 3-STAGE "RIO"

Our fabulous new 3-STAGE **MINIATURE LOUDSPEAKER DESIGN** THE "RIO" covers all medium waves including Home, Light, etc. Very reliable and lightweight. Works for months and months off an 8d. battery. Can be assembled in an hour or two. All parts can be supplied including miniature speaker and everything down to the last nut and bolt with **SIMPLE AS A.B.C. PICTORIAL STEP-BY-STEP PLANS** for **ONLY 29/6**, plus post and packing 1/6 (C.O.D. 2/- extra). Parts sold separately, priced parts list 1/-.

29/6



BRAND NEW RECORD CHANGERS

ONLY £8.15.0 BRAND NEW! the latest 4-speed Autochanger, B.S.R. UA14, as illustrated, few only **OUR PRICE £8.15.0. P. & P. 3/6.**

BRAND NEW! the B.S.R. 4-speed Autochanger, UA8, few only left. **OUR PRICE £8.15.0. P. & P. 3/6.**

BRAND NEW! the COLLARO Junior 4-speed record player. **OUR PRICE 75/- P. & P. 3/6.**

BRAND NEW! COLLARO "Conquest" 4-speed Autochanger. **OUR PRICE £7.15.0 P. & P. 3/6.**

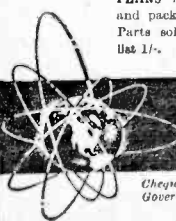
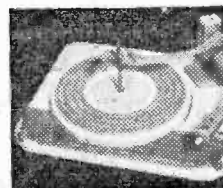

CONCORD ELECTRONICS

210, Church Road, Hove, Sussex

Dept. PW32

Cheques accepted. Cash on delivery 2/- extra. Please print name and address in block letters. Suppliers to Schools, Universities, Government and Research Establishments. Complete range of components and valves stocked. Regret no C.O.D. abroad. DEMONSTRATIONS DAILY AT WORKS



Stern's "fidelity" TAPE RECORDERS

**BEFORE YOU BUY
—YOU SHOULD
HEAR THESE**

**RECORDERS. THEY ARE COMPARABLE
TO THE MUCH HIGHER-PRICED MODELS**

There are no better value-for-money Tape Recorder on the market—if you can't call and hear them, send S.A.E. for fully descriptive leaflets.

MODEL GR3/S Incorporates the COLLARO "STUDIO" TWIN TRACK 3-speed Deck, operating at 1 1/2, 3" and 7 1/2" speeds..... **£39.10.0**
H.P. Terms: Deposit £7.18.0 and 12 months of £2.17.11.

All prices quoted provide for the COMPLETE RECORDER including CRYSTAL MICROPHONE and 1,200 ft. Spool of Tape.

Each Model incorporates the highly successful HF/TR3 Amplifier (described below) thus ensuring truly "Hi-Fi" record and playback facilities.

MODEL TR3/Mk. V1 Incorporates the New TRUVOX Mk. VI TWIN TRACK 2-speed Tape Deck operating at 3" and 7 1/2" speeds..... **£49.10.0**
H.P. Terms: Deposit £9.18.0 and 12 months of £3.12.7.

TAPE AMPLIFIERS and PRE-AMPLIFIERS PRESENTED FROM MULLARD DESIGNS

MODEL HF/TR3 TAPE AMPLIFIER
(Mullard Type "A" design) A very high quality Amplifier incorporating 3-speed treble equalisation by the latest FEROXUCUBE POT CORE INDUCTOR. FOR COLLARO-TRUVOX-BRENNELL or WEARITE Tape Decks, has GILSEN Output Transformer. Includes separate Power Supply Unit.



MULLARD TYPE "C" TAPE PRE-AMPLIFIER—ERASE UNIT

The "Hi-Fi" link to add full tape recording facilities to High Fidelity home installations. Incorporates FEROXUCUBE POT CORE PUSH PULL OSCILLATOR and 3-speed treble equalisation by FEROXUCUBE POT CORE INDUCTOR FOR WEARITE-COLLARO-TRUVOX OR BRENNELL TAPE DECKS. Includes separate power Supply Unit.



KIT OF PARTS £13.13.0 OR **ASSEMBLED £17.0.0**
H.P. Deposit £3.8.0 and 12 months at £1.4.11.

KIT OF PARTS £14.0.0 H.P. £3.8.0 Deposit and 12 months £1.4.11. **£17.0.0**
(Excluding power unit £11.15.0 and £14.10.0 respectively).

FOR THE HOME CONSTRUCTOR SPECIAL 'COMBINED ORDER' PRICES

- (a) The COLLARO "STUDIO" TAPE DECK and our Mullard Type "C" PRE-AMPLIFIER and POWER Unit Assembled and Tested..... **£29.10.0**
H.P. Deposit £4.18.0 and 12 months £2.3.3.
- (b) As above but TYPE "C" PRE-AMPLIFIER supplied as complete KIT OF PARTS..... **£26.10.0**
- (c) The TRUVOX Mk. VI DECK and the assembled Type "C" Pre-amplifier and Power Unit..... **£40.0.0**
H.P. Deposit £8.0.0, and 12 months £2.18.8.
- (d) As above but Type "C" as complete KIT OF PARTS..... **£36.10.0**
- (e) The BRENNELL Mk. V DECK and the assembled Type "C" PRE-AMPLIFIER and POWER UNIT..... **£46.0.0**
H.P. Deposit £9.4.0, and 12 months £3.7.6.
- (f) As (e) but Type "C" as complete KIT OF PARTS..... **£43.0.0**
- (g) THE WEARITE 4A DECK with TYPE "C" assembled and tested..... **£56.0.0**
H.P. Deposit £11.4.0, and 12 months £4.2.1.

- (a) COMPLETE KIT to build the HF/TR3 Amplifier, together with the COLLARO "STUDIO" DECK..... **£26.0.0**
- (b) As above but with HF/TR3 supplied ASSEMBLED and TESTED..... **£29.10.0**
H.P. Deposit £5.18.0 and 12 months £2.3.3.
- (c) COMPLETE KIT to build the HF/TR3, together with the NEW TRUVOX Mk. VI TAPE DECK..... **£36.10.0**
- (d) As above but HF/TR3 supplied ASSEMBLED and TESTED..... **£40.0.0**
H.P. Deposit £8.0.0, and 12 months £2.18.8.
- (e) COMPLETE KIT to build the HF/TR3 AMPLIFIER with the BRENNELL Mk. V TAPE DECK..... **£42.0.0**
- (f) As above but HF/TR3 supplied ASSEMBLED and TESTED..... **£45.10.0**
H.P. Deposit £9.2.0 and 12 months £3.6.9.
- (g) THE WEARITE 4A DECK with assembled and tested HF/TR3 Amplifier including WEARITE Head Lift Tape Indicator..... **£55.0.0**
H.P. Deposit £11.0.0, and 12 months £4.0.8.

(Carriage and Insurance on above quotes 10/- extra).
EACH OF THE ABOVE CAN BE SUPPLIED IN A PORTABLE CASE FOR £5.10.0 EXTRA, THUS FORMING A COMPLETE PORTABLE PRE-AMPLIFIER. FULL DETAILS ON REQUEST.

Carriage and Insurance on each above is 10/- extra. Attractive PORTABLE CASE is available to accommodate the TRUVOX or COLLARO TAPE DECKS and we offer it, together with ROLA/CELESTION 10 x 5 in. LOUDSPEAKER—ACOS CRYSTAL MICROPHONE—and 1,200ft. SPOOL E.M.I. TAPE—ALL FOR £9.0.0. Carriage and Insurance 5/- extra.

SPECIAL OFFER OF TAPE

spools. New, boxed and guaranteed.
25ft. on 3in. Spool..... **5/9**
800ft. on 5in. Spool..... **18/6**

P.V.C. base on latest type plastic
1200ft on 5 1/2 in. Spool..... **21/-**
1200ft. on 7in. Spool..... **21/-**
1800ft. on 7in. Spool..... **32/6**

TAPE ACCESSORY KITS

- (a) E.M.I. includes 3 reels leader tape, splicer, jointing tape and stop foil..... **37/6**
- (b) SCOTCHBOY, includes 3 reels leader tape, splicer, and jointing tape..... **29/6**

A LARGE PURCHASE OF BRAND NEW AND FULLY GUARANTEED TRUVOX and GARRARD TAPE EQUIPMENT

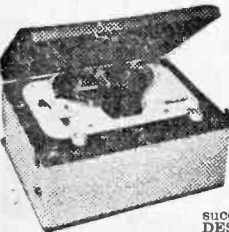

The "MODEL HFG/2R" PORTABLE TAPE RECORDER (Original Price £33.0.0)

FOR ONLY 22 gns.
H.P. Dep. £4.14.0. 12 months £1.13.8. (Carr. & ins. 10/- extra). Incorporates THE LATEST GARRARD "MAGAZINE" TAPE DECK and a HIGH QUALITY AMPLIFIER which is entirely based on the very successful MULLARD TYPE "A" DESIGN and specifically developed to operate the GARRARD DECK. Price INCLUDES SUPPLY OF THE GARRARD TAPE MAGAZINE and 4in. SPOOL OF DOUBLE PLAY TAPE. Comprises a Twin Track Recorder operating at 3 1/2 in./sec. speed and providing up to 1 hour 10 mins. playing time. Truly "Portable", weighs only 22 lbs. Outstanding features are excellent performance and simplicity of operation.

PRICE REDUCTIONS

The "MODEL TK/MkIV" PORTABLE TAPE RECORDER (Original Price £49.10.0)

FOR ONLY £36.10.0 Price includes a 7" spool of EMI tape!
H.P. Dep. £7.6.0. 12 months £2.13.6 (Carr. and ins. 10/- extra). Incorporates the Truvox MkIV Tape Deck, Rola/Celestion 9 x 5 in. Loudspeaker and the Truvox Type "K" Amplifier specifically developed by Truvox Ltd to correctly operate their MkIV Tape Deck. As a result we are able to present a highly perfected tape recorder providing sound reproduction which truly justifies the title "High Fidelity". A Twin Track Two Speed model operating at 3 1/2 and 7 1/2 in./sec. speeds and incorporating Magic Eye Indicator, Safety Button. (Prevents accidental erasure.) Ext. Speaker output, tone and volume controls.



FULLY DESCRIPTIVE LEAFLETS ON ALL OF ABOVE ARE AVAILABLE—BUT PLEASE ENCLOSE S.A.E. AND STATE WHICH LEAFLET IS REQUIRED.

STERN RADIO LTD.

STERN'S MULLARD DESIGNS

Designed by MULLARD—presented by STERN'S strictly to specification

COMPLETE KIT OF PARTS—

MULLARD "5-10" MAIN AMPLIFIER

For use with the MULLARD 2-valve pre-amplifier with which undistorted power output of up to 10 watts is obtained. We supply SPECIFIED COMPONENTS AND NEW MULLARD VALVES, including PARMEKO MAINS TRANSFORMER and choice of the latest Ultra-Linear PARMEKO or the PARTRIDGE Output Transformer. PRICE COMPLETE KIT (PARMEKO Output Trans.).

Alternatively we supply ASSEMBLED AND TESTED. **£10.00**

ABOVE INCORPORATING PARTRIDGE OUTPUT TRANSFORMER, **£1.60 EXTRA**

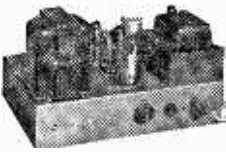

MULLARD'S PRE-AMPLIFIER TONE CONTROL UNIT

Employing two EF86 valves, and designed to operate with the MULLARD MAIN AMPLIFIERS, but also perfectly suitable for other makes.

PRICE COMPLETE **£6.60** ASSEMBLED AND TESTED **£8.00**

KIT OF PARTS Supplied strictly to MULLARD'S SPECIFICATION and incorporating:

- Equalisation for the latest R.I.A.A. characteristics.
- Input for Crystal Pick-ups, and variable reluctance magnetic types.
- Input (a) Direct from High Imp. Tape Head. (b) From a Tape Amplifier or Pre-amplifier.
- Sensitive Microphone Channel. ● Wide range BASS and TREBLE Controls.



COMPLETE MULLARD "5-10" AMPLIFIER

The popular and very successful complete "5-10" incorporating Control Unit providing up to 10 watts high quality reproduction. One Specified Components and new MULLARD VALVES are supplied including PARMEKO MAINS TRANSFORMERS and choice of the latest PARMEKO or PARTRIDGE ULTRA-Linear Output Transformers.

PRICE COMPLETE KIT OF PARTS **£11.10** OR ASSEMBLED AND TESTED **£13.10**

HIRE PURCHASE (Assembled Amp. only). DEPOSIT **£2.14.0** 12 months at **19/10**. ABOVE incorporating PARTRIDGE OUTPUT TRANS. **£1.60 extra**.



COMPLETE MULLARD "3-3"

THE IDEAL AMPLIFIER FOR A SMALL HIGH QUALITY INSTALLATION PROVIDING EXCELLENT REPRODUCTION OF UP TO 3 WATTS OUTPUT. COMPLETE KIT **£7.10.0** OR ASSEMBLED **£8.19.6** OF PARTS (plus 6/6 carriage and insurance) AND TESTED **£8.20.0** and 8 Months at **£1.0.0**. Complete to MULLARD'S SPECIFICATION including Mullard valves and a PARMEKO OUTPUT TRANSFORMER.

THE "ADD-A-DECK"

Incorporating GARRARD "MAGAZINE" TAPE and the MATCHED MODEL HF/G2P PRE-AMPLIFIER

Supplied on ONE CHASSIS (as illustrated) READY FOR USE **18 Gns.**

(Carr. & Ins. 10/- extra). Price includes Garrard Magazine and a 4in. Spool Double Play Tape H.P. Deposit **£2.16.0**, and 12 months of **£1.7.8**.

Provides complete tape recording facilities and designed to operate through the pick-up sockets of the standard type of RADIO RECEIVER, or an AMPLIFIER, from which really first class reproduction is obtained. It consists of a Twin Track Deck connected to the Pre-amplifier and operates at 3 1/2 in/sec. speed providing up to 1 hr. 10 mins. playing time.



RECORD PLAYERS THE LATEST MODELS ARE IN STOCK, MANY AT REDUCED PRICES

- SEND S.A.E. FOR ILLUSTRATED LEAFLET
- B.S.R. MONARCH II 4-speed mixer Autochanger with Crystal Pick-up. **£6.19.6**
 - The NEW COLLARO MODEL RP594 4-speed Single Record Player. Studio Cartridge. **£9.18.9**
 - The NEW COLLARO C60 4-speed Autochanger unit with Studio "O" Pick-up. **£7.19.6**
 - The E.M.I. 4-speed Single Record Player with crystal Pick-up. **£6.9.6**
 - B.S.R. MODELS UA2 and UA14. Each a 4-speed mixer autochanger with Crystal Pick-up. Both available incorporating the B.S.R. STEREO Pick-up, plays L.P. and 78 Records. **£7.19.6**
 - GARRARD MODEL TA/ARK II 4-speed Player fitted with output Crystal Pick-up. **£8.10.0**
 - GARRARD MODEL RA/209. Autochanger 4-speeds. High output. Crystal Pick-up. **£8.19.6**
- Carriage and Insurance on each above, 5/- extra.

PRICE REDUCTIONS

- (a) The KIT OF PARTS to build both the "5-10" Main Amplifier and the 2-valve PRE-AMP CON- TROL UNIT..... **£15.15.0**
- (b) The "5-10" and the 2-stage PRE-AMP both ASSEMBLED and TESTED H.P. Dep. **£3.16.0** and 12 months of **£1.7.8**..... **£18.18.0**
- (c) The KIT OF PARTS to build the DUAL-CHANNEL "3-3" AMPLIFIER and the DUAL-CHANNEL PRE-AMPLIFIER CON- TROL UNIT..... **£21.10.0**
- (d) The DUAL-CHANNEL "3-3" AMPLIFIER and the DUAL-CHANNEL PRE-AMPLIFIER CONTROL UNIT BOTH ASSEMBLED AND TESTED..... **£25.0.0**
- H.P. Terms: Deposit **£5** and 12 months of **£1.16.8**.
- (e) THE KIT OF PARTS to build one "5-10" MAIN CHANNEL, and the DUAL-CHANNEL PRE-AMP CONTROL UNIT..... **£21.10.0**
- (f) ONE "5-10" AMPLIFIER and the DUAL-CHANNEL PRE-AMPLIFIER both ASSEMBLED AND TESTED..... **£25.0.0**
- H.P. Terms: Deposit **£5**, 12 months of **£1.16.8**.
- (g) KIT OF PARTS to build Two "5-10" MAIN AMPLIFIERS (incorporating Parmeko Output Transformers) and the DUAL-CHANNEL PRE-AMPLIFIER CONTROL UNIT..... **£31.0.0**
- (h) TWO "5-10" AMPLIFIERS and the DUAL-CHANNEL PRE-AMPLIFIER CONTROL UNIT BOTH ASSEMBLED & TESTED..... **£36.0.0**
- H.P. Terms: Deposit **£7.4.0**, 12 months of **£2.12.0**.
- Carriage and Insurance 7/6 extra. Prices quoted are subject to **£1.6.0** extra for Partridge Transformer.

STEREO PRE-AMPLIFIER

This model incorporates two Mullard 2-valve Pre-Amplifiers combined into a Single Unit enabling it to be used for both STEREO PHONIC or MONAURAL operation. It is designed primarily to operate with our range of MULLARD MAIN AMPLIFIERS but will also operate equally well with any make of Amplifiers requiring an input of 250 mV/ohms.



COMPLETE KIT **£12.10.0** ASSEMBLED AND TESTED **£15.0.0** OF PARTS H.P. £3 Dep. and 12 mths. at **£1.2.0**

MULLARD FOUR CHANNEL MIXER UNIT

Self powered with Cathode follower output. Incorporates two inputs for MICROPHONES One for CRYSTAL PICK UP and a fourth for RADIO or TAPE



Complete Kit of Parts **£8.8.0** Assembled and Tested **£10.0.0**

TERMS: Deposit **£2** and 12 months at 15/-.

MODEL I.L. one microphone Input matched for moving coil or Ribbon Mike. **£1.17.0 extra**.

Mk.11 "Fidelity" FM TUNING UNIT

An attractively presented Unit incorporating MULLARD PERMEABILITY TUNING HEART and corresponding Mullard valve line up. FOR THE CONSTRUCTOR **£10.10.0** ASSEMBLED **£14.5.0**

A SPECIAL CASH OFFER!!

This very attractive PORTABLE AMPLIFIER CASE together with a good quality GRAM AMPLIFIER and a matched P.M. SPEAKER FOR ONLY **£8.7.6** (Plus 7/6 Carr. & Ins.)



The amplifier consists of a 2-stage design incorporating 3 modern B.V.A. valves and has separate BASS and TREBLE CONTROLS. The Portable Case will also accommodate almost any make of Autochanger and is attractively finished in Mushroom Grev Rexine.

- WE ALSO SUPPLY SEPARATELY—
- (a) The 2-stage (plus rectifier) AMPLIFIER **£4.2.6**
 - (b) THE PORTABLE CARRYING CASE **£3.17.8**
 - (c) 6in. P.M. SPEAKER 18/9 Carriage and Insurance 4/- extra.

Dept. P.W. 109 FLEET ST., LONDON, E.C.4
Telephone: FLEET STREET 5812/3/4

Easy-to-build kit-sets of

Heathkit

highest quality at lower cost

AMATEUR TRANSMITTER Model DX-100U
Covers all amateur bands from 160-10 metres. 150 watts D.C. input. Self contained including Power Supply Modulator V.F.O. £81.10.0

AMATEUR TRANSMITTER Model DX-40U
From 80-10 m. Power input 75 w. C.W., 60 w. peak C.C. phone. Output 40 w. to aerial. Compact and self-contained. Prov. for V.F.O. £32.10.0

VAR. FREQ. OSCILLATOR VF-1U
From 160-10 m. Ideal for our DX-40U and similar transmitters. Price less valves £8.19.6 £11.2.0

R.F. SIGNAL GENERATOR Model RF-1U
Up to 100 Mc/s. fundamental and 200 Mc/s. on harmonics and up to 100mV. output on all bands. £11.18.0

AUDIO SIGNAL GENERATOR Model AG-9U
10 c/s to 100 kc/s. switch selected. Distortion less than 0.1% 10 v. sine wave output metered in volts and dB's. £19.19.6

VALVE VOLTMETER Model V-7A
Measures volts to 1,500 (D.C. and R.M.S.) and 4,000 pk. to pk. Res. 0.1 Ω to 1,000 M Ω . D.C. input impeded. 11M Ω . Complete with test prods leads and standardising battery. £13.0.0

Portable 2 $\frac{3}{4}$ in. **SERVICE 'Scope Model OS-1**
Compact portable scope ideal for servicing and general work. Y amplifier sensitivity 10 mV/cm; response ± 3 dB 10 c/s-2.5 Mc/s. Time base 15 c/s-150 kc/s. Printed circuit. Case 7 $\frac{1}{2}$ x 4 $\frac{1}{2}$ x 12 $\frac{1}{2}$ in. long. Wt. only 10 $\frac{1}{2}$ lb. £19.10.0

5 in. **OSCILLOSCOPE Model O-12U**
Has wide-band amplifiers, essential for TV servicing. F.M. alignment, etc. Vertical freq. response 3 c/s to over 5 Mc/s. without extra switching. T.B. covers 10 c/s to 500 kc/s. in 5 ranges. £36.10.0

RES.-CAP. BRIDGE Model C-3U
Measures capacity 10pF to 1,000 μ F resistance 100 Ω to 5 M Ω and power factor 5-450 v. test voltages. With safety switch. £8.6.6

SINGLE CHANNEL AMPLIFIER, MA-12
10-12 watt Hi-Fi amplifier. Extremely low distortion and wide frequency range. £10.19.6

HI-FI EQUIPMENT CABINETS
Range of cabinets available with at least one to suit your particular needs. From small to large, housing Tape Deck, Record Player and full equipment. In the white for finishing to personal taste.
From £11.5.6 to £17.18.6

GRID DIP METER Model GD-1U
Coverage from 2 Mc/s. to 250 Mc/s. Complete set of plug-in coils provided £10.9.6

TAPE RECORDING/PLAYBACK AMPLIFIER Model TA-1
Monaural (TA-1M) £18.2.6 Conversion unit to Stereo £6.10.0. Stereo (TA-1S) £23.6.0

'PACKAGED DEALS' of Hi-Fi
Equipment including TAPE DECKS RECORD PLAYERS and DECCA ffs PICK-UPS.

Write in to see how these deals save you further money:



F.M. TUNER



S.33



S.88



DX-40



UXR-1



OS-1



SSU-1

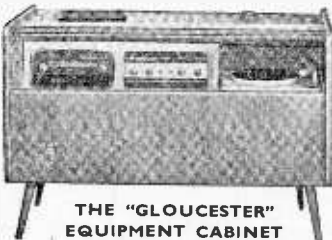

THE "GLOUCESTER" EQUIPMENT CABINET

THE "MOHICAN" GENERAL COVERAGE RECEIVER, Model GC-1U

Fully transistorised, including 4 piezo-electric transmitters. The very latest and an excellent portable or Fixed Station receiver for the Ham and short-wave listener. £38.15.0

SHORT-WAVE TRANSISTOR PORTABLE

Model RSW-1
Extending aerial, leather case, four band (2 short-wave bands Trawler and Medium). £21.18.6

6-TRANSISTOR PORTABLE Model UXR-1
Pre-aligned i.F. transformers, printed circuit, 7 x 4 in. high-flux speaker. Real hide case. £14.18.6

DUAL-WAVE TRANSISTOR RADIO UJR-1
This sensitive headphone set is a fine introduction to electronics for any youngster. £2.16.6

HI-FI F.M. TUNER
Tuning range 88-108 Mc/s. For your convenience this is available in two units sold separately as follows: Tuner Unit (FMT-4U) with 10.7 Mc/s. i.F. output (£3.2.0 inc. P.T.). I.F. Amplifier (FMA-4U) - complete with cabinet and valves (£11.11.0). £14.13.0

HI-FI 16W STEREO AMPLIFIER Model S-88
20mV. basic sensitivity (4 mV. available, 7/6 extra). Ganged controls. Stereo-Monaural gram, radio and tape recorder input. Push-button selection. Two-tone grey metal cabinet. £26.12.6

6W STEREO AMPLIFIER Model S-33
3 watts per channel, 0.3% distortion at 2.5 w/ch 20dB N.F.B. Inputs for Radio (or Tape) and Gram. Stereo or Monaural, ganged controls. Sensitivity 200 mV. £12.8.6

TRANSCRIPTION RECORD PLAYER RP-1U
4-speed A.C. motor Ronette Stereo/Mono pick-up. Complete with plinth. Only limited £12.10.0 number available.

HI-FI SPEAKER SYSTEM Model SSU-1
Ducted-port bass reflex cabinet "in the white" Twin speakers. With legs £11.16.6. £10.15.6

"COTSWOLD" HI-FI SPEAKER SYSTEM KIT
Acoustically designed enclosure "in the white" 26 x 23 x 15 $\frac{1}{2}$ in. housing a 12in. bass speaker with 2in. speech coil, elliptical middle speaker and pressure unit to cover the full frequency range of 30-20,000 c/s. Complete with speakers, cross-over unit, level control, etc. £21.19.0

COMPLETE MATCHED STEREO OUTFIT
includes record player amplifier and twin speaker systems (pedestal speaker legs optional £2.7.0 extra). £43.19.0

STEREO CONTROL UNIT USC-1
Luxury model with press-button inputs to suit any pick-up or tuner and most tape-heads. Output 1.3 v. R.M.S. per channel. Printed circuit construction. £18.18.6

STEREO HEAD BOOSTER USP-1
Ideal for boosting tape-head output and low output pick-ups (e.g. Decca ffs). £6.17.6

Prices include free delivery UK
Deferred Terms
available on orders over £10

Please send me FREE CATALOGUE (Yes/No).....

Full details of model(s).....

NAME

ADDRESS

PW7

DAYSTROM LTD.

DEPT. P.W.7, GLOUCESTER, ENGLAND

A member of the Daystrom Group, manufacturers of the
WORLD'S LARGEST-SELLING ELECTRONIC KITS

Practical Wireless

VOL. XXXVII No. 653 JULY, 1961

Editorial and Advertisement
Offices:

PRACTICAL WIRELESS

George Newnes, Ltd., Tower House,
Southampton Street, W.C.2.

© George Newnes Ltd., 1961

Phone: Temple Bar 4363.

Telegrams: Newnes, Rand, London.
Registered at the G.P.O. for trans-
mission by Canadian Magazine Post.

SUBSCRIPTION RATES

including postage for one year

Infand - - - - £1.3.0 per annum
Abroad - - - - £1.1.6 per annum
Canada - - - - 19s. per annum

Contents

	Page
Editorial	201
Round the World of Wireless	202
An Inexpensive Amplifier ...	204
Radio Construction for the Beginner	208
An Introduction to Stereo ...	211
Adding Communications Fea- tures	215
The P.W. Signal Generator ...	218
On Your Wavelength	223
A Top-Band Transistor Tx ...	224
A Valve/Transistor Short Waver	225
An Amateur Communications Receiver	228
Transistorised Signal Tracer ...	231
Designing Multimeter Circuits	232
Trade News	237
Phase Splitters and Phase Reversers	241
Letters to the Editor	249
Short Wave Listeners' Log ...	250
Transmitting Topics	253
Club News	258

The Editor will be pleased to consider articles of a practical nature. Such articles should be written on one side of the paper and addressed envelope is enclosed. All correspondence intended for the Editor should be addressed: The Editor PRACTICAL WIRELESS, George Newnes, Ltd., Tower House, Southampton Street, London, W.C.2. Owing to the rapid progress in the designs of wireless apparatus and to our efforts to keep our readers in touch with the latest developments, we give no warranty that apparatus described in our columns is not the subject of letters patent.

Copyright in all drawings, photographs and articles published in PRACTICAL WIRELESS is specifically reserved throughout the countries signatory to the Berne Convention and the U.S.A. Reproductions or imitations of any of these are therefore expressly forbidden. PRACTICAL WIRELESS incorporates "Amateur Wireless."

Modern Communications

ONE of the first uses for radio was the establishment of reliable communications between countries and continents. Now, submarine cables are used increasingly for the transmission of messages and information, but even so, electronic research is facilitating the introduction of new telephone circuits operating over larger distances than before. The main problem in installing telephone cables of great length is in finding a way of preserving the strength of the signals—the resistance of the conductor used cannot be reduced indefinitely since the weight and cost of the cable rises as well. The solution is to employ amplifiers at regular intervals along the cable, but it is only recently that this has become possible. Electronic research has permitted the introduction of reliable valves which have an extremely long life and the characteristics of which remain almost constant during their life. Amplifiers using these valves are spliced into the submarine cables in the factory and can thus be made an integral part of the cable.

At present, the conventional type of cable predominates, but cables using integral repeaters—as the submerged amplifiers are termed—will soon become much more numerous. Communications will thus become increasingly more reliable. However, one of the factors which cause interruption of messages is the breakage of cables caused by trawl fishing. In such fishing, the boat drags behind it a trawl or net and in order to hold the net open, two weighted boards are used. Although these boards will generally ride over any cables on the bed of the ocean, where there is a trough for example, it is possible for them to foul the cable and break or damage it. It is obvious that such damage will be very serious where repeater cables are concerned—these may carry as many as 80 conversations in each direction simultaneously. The interruption to services will have much more effect than if a telegraph cable were broken or damaged.

Much of the damage occurs in European coastal waters, or in the North-West Atlantic, off the Newfoundland coast, in depths of about 500 fathoms, and recently practical steps have been taken to minimise the damage. Following two years' work by an internationally constituted Cable Damage Committee, with headquarters in London, charts are to be issued to trawler owners in an effort to reduce the number of cable interruptions caused by trawlers. The charts will plot the positions of every cable in water up to 500 fathoms in depth in the North-East and North-West Atlantic.

The introduction of these charts should be an important factor in the establishment of reliable communications over long distances and should materially affect the cost of using and installing the necessary equipment. Further research—both into cables and the associated electronic components—should reduce the cost of communications still further in the future.

Our next issue, dated August, will be published on July 7th.

Round the World of Wireless

POTENTIAL AND CURRENT NEWS

Broadcast Receiving Licences

THE following statement shows the approximate number of Broadcast Receiving Licences in force at the end of March, 1961, in respect of wireless receiving stations situated within the various Postal Regions of England, Wales, Scotland and Northern Ireland. The numbers include Licences issued to blind persons without payment.

Region	Total
London Postal	632,282
Home Counties	652,843
Midland	473,911
North Eastern	518,782
North Western	448,390
South Western	381,932
Wales and Border Counties	230,117
Total England and Wales	3,408,259
Scotland	383,379
Northern Ireland	117,346
Grand Total	3,908,984

Simlac Analogue Computer

THIS computer, made by Short Brothers and Harland Ltd., was featured in Round the World of Wireless of the May issue of PRACTICAL WIRELESS. However, the illustration accompanying its description was not of the Simlac analogue computer, as stated in the caption, but was a photograph of the Short Educational Computer.

This month an artist's impression of the Simlac analogue computer is illustrated. Printed circuit detachable patch panels, push button selection of coefficients and fault detection are all features of the Simlac computer which employs components of 0.01 per cent accuracy. Design and circuiting have already been established and a prototype is being built. Production models are scheduled for next year.

German Radio, Television, and Phono Exhibition Berlin 1961.

THE German Radio, Television and Phono Exhibition Berlin 1961, to be held from 25th August to 3rd September at the Berlin radio tower, is to be the biggest exhibition event of the year. It is the first such exhibition held in Berlin for 22 years. It was first held here in 1924 and then regularly until 1939. Since

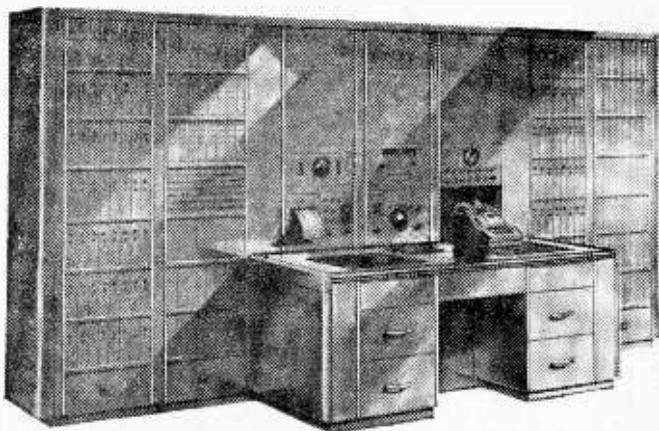

A Simlac analogue computer made by Short Brothers and Harland Ltd.

the end of the second world war it was three times held in Düsseldorf and twice in Frankfurt.

This year there will be 150 exhibitors in 13 halls and the Philips pavilion will be on West Berlin's exhibition grounds at the radio tower. German radio stations are to set up studios in two halls from which live broadcasts and television programmes can be transmitted with exhibition reports, giving visitors a view behind the scenes of radio and TV work.

R.E.C.M.F. Exhibition

FOUR types of rectifier units and diodes, namely copper-oxide, selenium, germanium and silicon, were shown on the Westinghouse stand at the Radio and Electronic Component Manufacturers' Exhibition in a variety of power, miniature and sub-miniature assemblies to meet all the requirements of the electronic industry.

Of special interest were ranges of crystal aligned selenium rectifiers in various types of assembly, capable of working at much higher current densities and giving greater service life expectancy than normal processed selenium units.

The copper-oxide display showed units specially designed for telecommunication applications together with bridge connected instrument type rectifiers in both standard and potted assemblies.

Applications of silicon controlled rectifiers included single- and three-phase A.C. power regulators, motor control and regenerative braking, and a power inverter.

C.E.G.B.'s Biggest Transformers

THE Central Electricity Generating Board Midlands Project group has placed an order with Associated Electrical Industries Limited for two 400MVA generator transformers for connection to the supergrid at the Drakelow "C" Power Station near Burton-on-Trent.

These generator transformers are the largest so far ordered by C.E.G.B. and they will connect two 375MW super critical turbine-generators to the grid system. AEI is manufacturing one of these 375MW turbine-generators.

When fully assembled each transformer will weigh 270 tons and be 38ft long, by 13ft wide, by 30ft high.

The transformers will step up the generator voltage from 90kV to 300kV at no-load. Tappings will provide voltage adjustments of plus or minus 10 per cent in eighteen equal steps arranged for local and remote electrical control.

Radar for Brussels National Airport

WITH the installation of the new 500kW Marconi 50cm

surveillance radar nearing completion, a new order has been placed with Marconi's/S.A.I.T. Electronics for the delivery and installation of 18 fixed coil radar display units, to be manufactured by the Chelmsford works of Marconi's Wireless Telegraph Co. Ltd. With this installation the Air Traffic Control at Brussels National Airport will be provided with extensive display facilities. In this way a complete coverage of a territory extending considerably beyond the frontiers of Belgium has been obtained.

The fixed coil display units, type SD 1010, to be installed in the control tower have been designed to handle and display large quantities of ancillary information between timebase sweeps. Up to 20 inter-trace markers will be employed at the Brussels Air Traffic Control Centre with joystick control to place them on any part of the display. Some of the inter-trace marks will be of the track-while-scan type; these, when positioned alongside aircraft responses, follow them automatically for permanent and positive identification. Facilities are also included for repeating the strobe information from one display to another. Superimposition of automatic direction finding traces will also be incorporated. Facilities for data handling of radar information will be progressively incorporated.

British Electronics Exhibition in Sweden

THE British Radio and Electronic Component Manufacturers' Federation is to hold an exhibition in the Marmorhallar, Stockholm, from 9th to 13th October, 1961.

This will be the fourth exhibition held in Stockholm by the British electronic component manufacturing industry, previous ones having been in 1948, 1953 and 1958. Previously timed for every five years, representations have been made from the Scandinavian countries that the exhibition should be held more frequently.

The exhibition follows the Federation's exhibition at Olympia, London, from 30th May to 2nd June. It is expected to include components for the latest electronic applications, including computers, machine tool control,

communications and other satellites, missiles and nuclear engineering.

Exports of British components last year increased by 36per cent compared with 1959.

Trans-Atlantic Talk

A TRANS-ATLANTIC meeting of audio engineers took place recently over the inter-continental broadcast telephone lines.

The conference was between the Association of Public Address Engineers at the Kings Head Hotel, Harrow-on-the-Hill, in England, and representatives of the U.S. Audio Engineers' Society in New York.

Audiences assembled in both places to hear the conversation over loudspeakers. The U.S. panel used a three-pick-up system employing Shure Brothers Inc's newest 545 Unidyne III dynamic microphones in desk stands.

Topics ranged broadly over the entire audio field, including transistorised power supplies and amplifiers, ribbon versus dynamic microphone, proper output and placement of speakers at public events, theatre sound systems, stereo pick-up of musical presentations, etc.

On both sides of the Atlantic, participating engineers pronounced the experiment a success.

Sound fidelity was of the highest quality, with good frequency response and complete freedom from fading.

Service Depot moves to New Premises

THE address of the Mullard Birmingham Service Depot is now 2,219 Coventry Road, Birmingham. These new premises will give better facilities both to dealers and to service depot staff.

It has modern equipment for handling and testing valves and picture tubes, and an improved valve tester service section.

One of the greatest benefits of the new depot is that it is sited well away from the traffic congestion of the City centre.

R.E.C.M.F. Elections

MR. ARTHUR BULGIN (A. F. Bulgin and Co. Ltd.) has been elected president of the Radio and Electronic Component Manufacturers' Federation, in succession to Mr. E. M. Lee (Belling and Lee Ltd.). Mr. Bulgin was one of the six manufacturers who met in 1932 to form the Federation.

Dr. G. A. V. Sowter (Telcon Metals Ltd.) succeeds Mr. Hector V. Slade (Garrard Engineering and Manufacturing Co. Ltd.) as chairman.

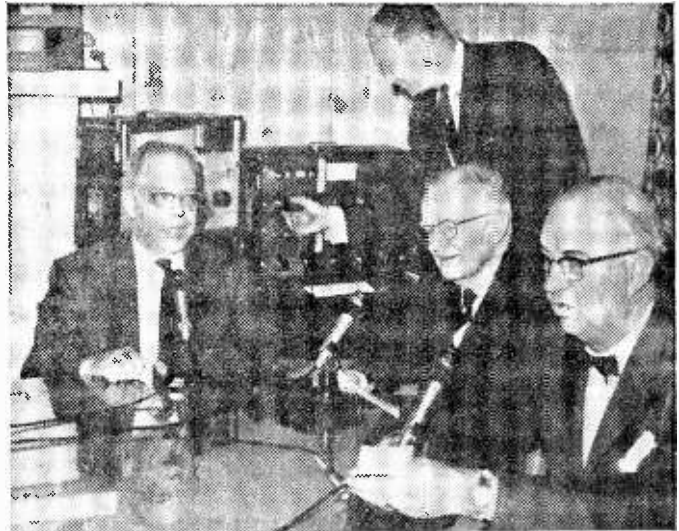

Audio engineers in England and the United States confer over inter-continental broadcast telephone lines to compare latest advances in techniques.

12AU7 2L42(2) 6X7
 61- 8/9 716

6 AMG
 312 July, 1961

166.
 17
 336

QUALITY reproduction is commonly associated with large power valves, expensive transformers, etc., but if fundamental principles are observed, excellent results can be obtained with simple circuits and inexpensive components. The amplifier described here was designed for use with a VHF tuner; it has a frequency range which is more than adequate for the purpose and a silent background which does justice to the quality of the transmissions.



An Inexpensive Amplifier

Circuit

As will be seen from Fig. 1, the output stage employs two pentodes, EL42, which in class AB1 push-pull operation will produce 7W. This is more than enough for the average listener and is unlikely to be required in full. The valves have been selected because, although they are slightly more expensive than some alternatives, they have a comparatively small current requirement which enables the power supply to be reduced in bulk, weight and cost. They are operated with 250V on anodes and screens and share a common bias resistor. This does not have to be bypassed, since the signal currents cancel out at the cathodes if the valves are reasonably well matched. A word of warning here—the amplifier must not be switched on unless *both* output valves are in place.

Output Stage

The output transformer should have a reasonably high primary inductance and, to match the anode-to-anode load, which is 15k, should provide a ratio of about 70 to 1 for a 3Ω speaker or 35

By V. E. Holley

to 1 for a 15Ω type. The primary inductance of the transformer used in the prototype is 45H with no D.C. An expensive component is not necessary; indeed the extended frequency response obtained from it may introduce phase shift leading to instability when negative feedback is applied. The circuit relies on negative feedback to make good the shortcomings of the cheaper transformer.

Inverter

The output stage requires a signal of about 35V peak grid-to-grid for full power, and this is provided by one half of the double triode valve, 12AU7, connected as a phase inverter. The circuit shown is simple but linear in the extreme, owing to heavy negative current feedback in the cathode load resistor. This feedback raises the input impedance of the stage to about ten times the value of the grid leak, i.e. 10M. Quite a small coupling capacitor from the previous stage would therefore be adequate for low frequency

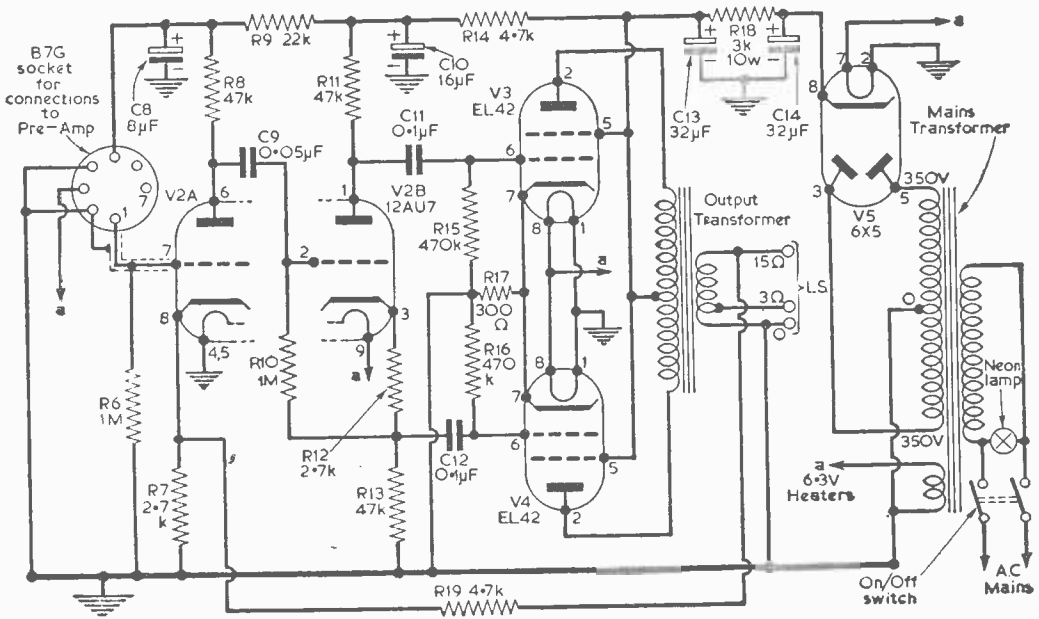

Fig. 1.—The circuit of the main amplifier.

response, but it is not advisable to reduce it below $0.05\mu\text{F}$ or the high impedance from the grid of V2B to earth will make the grid unduly susceptible to electrostatic hum pick-up. For the same reason, the anode load in the preceding stage should not be too high. The cathode bias resistor, R12 is small in relation to R13, so that there is no point in bypassing it.

A.F. Stage

The phase inverter is fed from the other half of the 12AU7, arranged as a conventional resistance coupled amplifier with an anode load of 47k. Decoupling and additional smoothing are provided by C8 and R9 and the linearity of the stage is improved by omitting the usual bypass capacitor from the cathode circuit. This omission also provides a suitable point for the injection of negative voltage feedback from the output transformer and of course, saves the cost of the capacitor. The resistors R7 and R19 are selected for two purposes; their value in parallel provides the correct bias for V2A and their relative values determine the proportion of the output voltage to be fed back to the valve cathode. The valve, of course, operates with both current and voltage feedback.

Tone Controls

Tone controls are not strictly necessary for reproduction of VHF programmes, but comprehensive controls have been provided so that the response can be adjusted for individual taste. The gain from the grid of V2A onwards is quite low and the controls are inserted at this point, so that they shall not be sensitive to hum. The values of the capacitors can be varied to taste; those

shown gave a wide range of control in the prototype and should be generally satisfactory. No special screening is necessary.

Pre-Amplifier

The pre-amplifier stage employs a resistance-coupled pentode, 6AM6 (Fig. 2). This gives the amplifier more overall gain than is necessary for radio reproduction, but makes it suitable for use

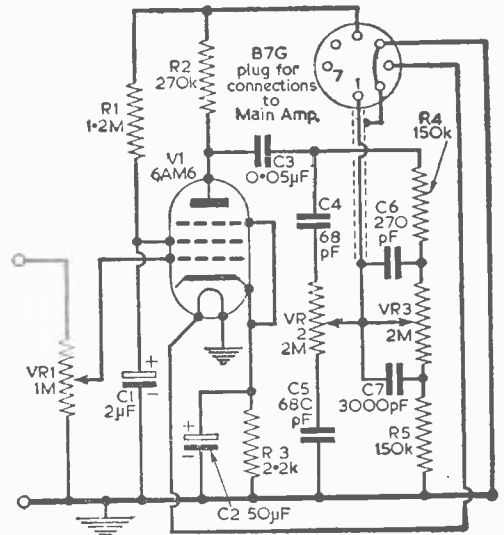

Fig. 2.—The pre-amplifier circuit.

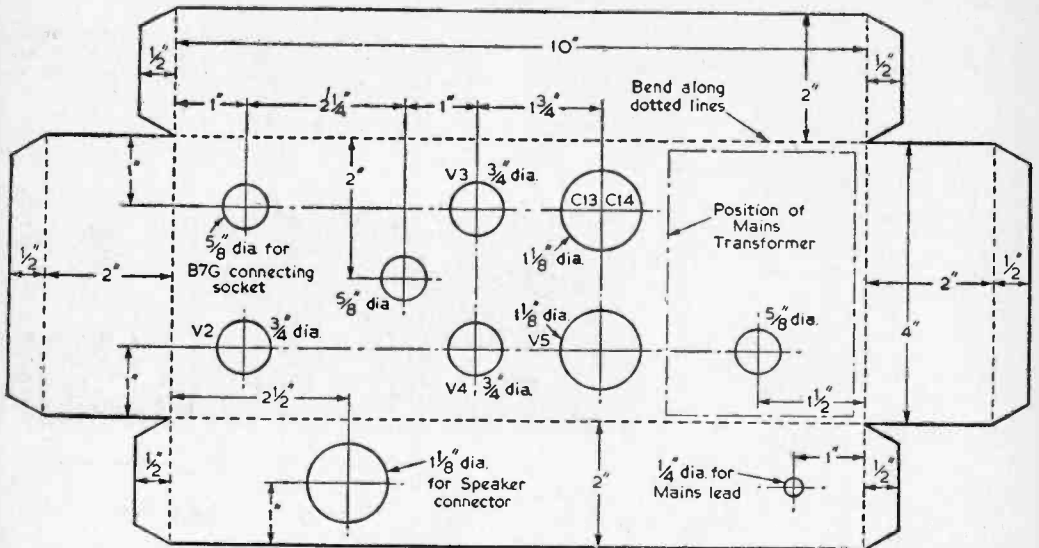

Fig. 3.—Details of the main chassis.

with other lower level inputs. The screen of this valve requires to be decoupled by not less than 0.5μF, and as a paper capacitor of this value is rather bulky, a 2μF electrolytic is used. The

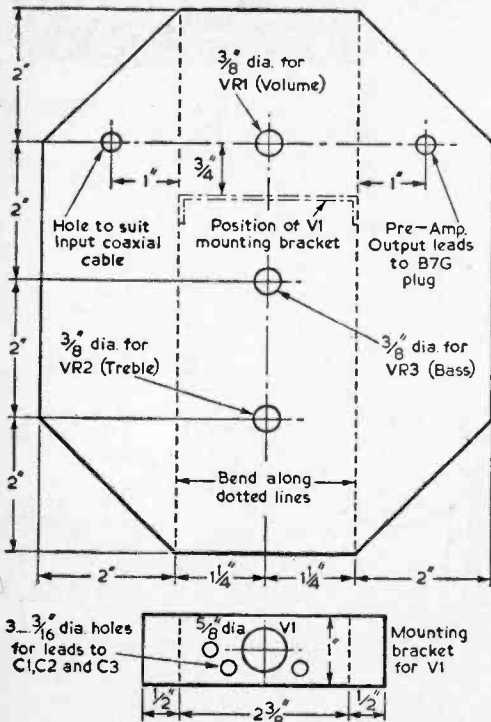

Fig. 4.—Constructional details of the pre-amplifier chassis.

COMPONENTS LIST

Resistors: ($\frac{1}{2}$ W unless otherwise stated)	Capacitors (500 VW unless otherwise stated)
R1 1.2M	C1 2μF electrolytic
R2 270k	C2 50μF 25VW electrolytic
R3 2.2k	C3 0.05μF
R4 150k	C4 68pF
R5 150k	C5 680pF
R6 1M	C6 270pF
R7 2.7k	C7 3000pF
R8 47k	C8 8μF electrolytic
R9 22k	C9 0.05μF
R10 1M	C10 16μF electrolytic
R11 47k	C11 0.1μF
R12 2.7k	C12 0.1μF
R13 47k	C13 32μF electrolytic
R14 4.7k	C14 32μF electrolytic
R15 470k	
R16 470k	
R17 300Ω, 1W	
R18 3k, 10W	
R19 4.7k	

- Valves:**
 V1—6AM6, B7G base and screen
 V2—12AU7, B9A base
 V3— } EL42, B8A base
 V4— }
 V5—6XS, octal base
- Potentiometers:**
 VR1 1M log. VR2 2M log. VR3 2M log.

- Mains transformer:**
 350-0-350V, 60mA, 6.3V, 2A
- Output transformer:**
 Push-pull ratio 70 to 1 for 3Ω speaker, 35 to 1 for 15Ω
- 1 B7G base and plug to suit
 1 Octal base and plug to suit

cathode resistor in this stage must be bypassed, not to avoid degeneration but to remove hum caused by the heater-cathode capacitance of the valve. The volume control is incorporated in the grid circuit. No decoupling is necessary between V1 and V2.

If the expense of an additional 1M potentiometer is no objection, one may be fitted in the grid circuit of V2 as the main volume control in place of R6, so that any noise voltages originating in the first stage will be reduced along with the signal. It will be necessary, however, to retain the control in the grid circuit of V1 to prevent overloading with high level inputs, but a cheaper pre-set type is suitable for this.

Power Supply

The mains transformer must have an output of 350V at 60mA and 6.3 at 2A, and the clamping must be adequate to prevent any audible buzz from the stampings. Ex-Government transformers, impregnated for tropical use, are excellent and one was used in the prototype. A 6X5 rectifier is shown in Fig. 1, but any type to suit the transformer will be satisfactory. Mains smoothing is provided by R18 in conjunction with C13 and C14; the resistor value may need slight adjustment to produce the right voltages at the valve electrodes. Generous smoothing almost completely eliminates hum and it is very difficult indeed to discover by ear whether the amplifier is switched on.

Construction

The construction is quite straightforward and the layout is in no way critical. The prototype

was built in two sections so that the main amplifier could, for physical stability, be fitted at the bottom of a floor-standing cabinet, to be described, and the pre-amplifier and controls higher up in a convenient operating position. A plan of the main chassis, which is of 16s.w.g. aluminium sheet, is given in Fig. 3. Power supplies for the pre-

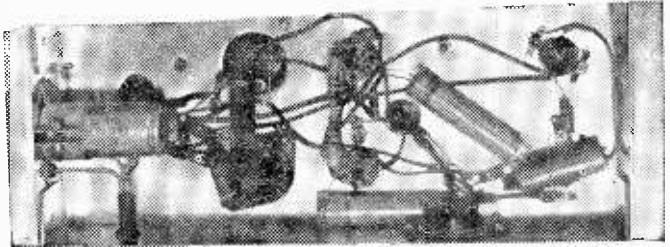

Above.—The component layout of the amplifier.

Below.—An underchassis view of the pre-amplifier.

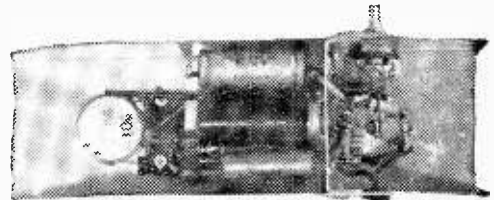

amplifier are taken from the B7G socket by way of a suitable plug and cables.

(To be continued)

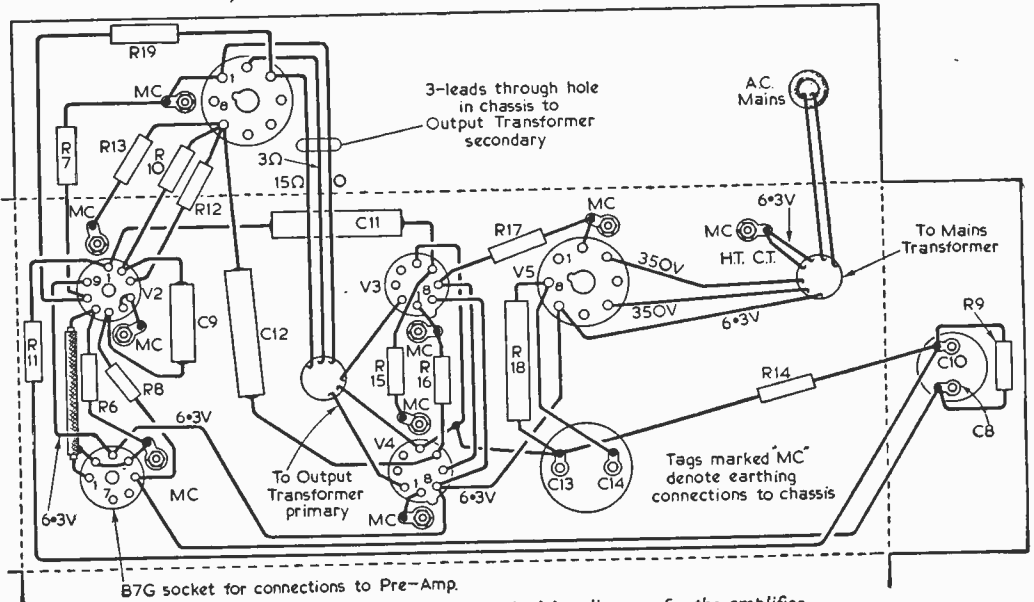

Fig. 5.—The component layout and wiring diagram for the amplifier.

Radio Construction for the Beginner

ALTHOUGH No. 5 in the series practically exhausted the possibilities of construction from photographs reproduced in half-tone, so many readers requested further circuitry on the same lines that this article has been written to round off the series.

This has been made possible by employing line-drawings only as illustrations, and it is hoped that these will enable the reader to construct quite a complicated receiver without assuming much previous knowledge.

By D. B. Kidd

The receiver last described (in the January and February 1961 issues) was a two-transistor regenerative set, and although many beginners have expressed pleasure at its performance (especially as a "Top Band" receiver) help has been asked for in almost every case to obtain additional volume or "output".

It will be assumed that the reader has built the set and that its appearance is roughly as shown in the half-tone illustration, which appeared on page 777 of the January issue. It will be found extremely helpful to compare this, and the theoretical diagram at the foot of page 776, with the illustrations in the present article.

The circuitry to be described consists of modifications and additions to the previous receiver, and a little time spent in comparing the two will save a good deal of work later, as there is no point in moving components about the board unnecessarily.

Greater volume can be obtained from the receiver in two ways. The first is to add another amplifying stage—that is, to use a third transistor. (Two methods of doing this will be described.)

The other method is by using a trick known as "reflexing", which readers have probably read about already in the pages of this magazine at some time or other.

It was pointed out in the January article (No. 4) that "ordinary" or audio-type transistors will not magnify the sort of signals (called "radio-frequency") which are emitted by the transmitter and appear at the aerial of the set. For this, a special sort of transistor (R.F. type) had to be used. Now, an R.F. transistor will amplify the "audio" (sound frequency) signals produced by the crystal detector perfectly well. For this reason, it is possible, provided certain precautions are taken, to make the R.F. transistor (T1 in the two-transistor set) carry out both functions at the same time. It thus takes over the work of T2, leaving the second transistor in the position of a third amplifier.

This means that a two-transistor set can be made to work as though it were a three-transistor receiver, thus obtaining greater volume.

To see how this is done, it is only necessary to compare Fig. 1 (below) with the theoretical circuit on page 776 of the January issue. The audio feedback loop at the foot of the new diagram is very obvious and the three extra components needed appear near the top. They are R2 (2.2k), C4 (8μF), and R3 (100k).

The total cost of these components is less than half that of a good audio transistor, so there is some saving in cost when reflexing is used.

The reader should now compare Fig. 2 (page 209) with the layout photograph in the January issue. Eighteen woodscrews and washers are required for the new circuit, not counting those of the ferrite aerial and battery assemblies, which, together with the tuning condenser, headphone sockets, and on/off switch, need not be disturbed at all. In Fig. 2 (page 209) the on/off switch has been shown as though placed on one side, but this is simply to make the illustration easier to follow.

It will also be noticed that nearly all the components near the positive line, including the two transistors, can remain where they are, though as

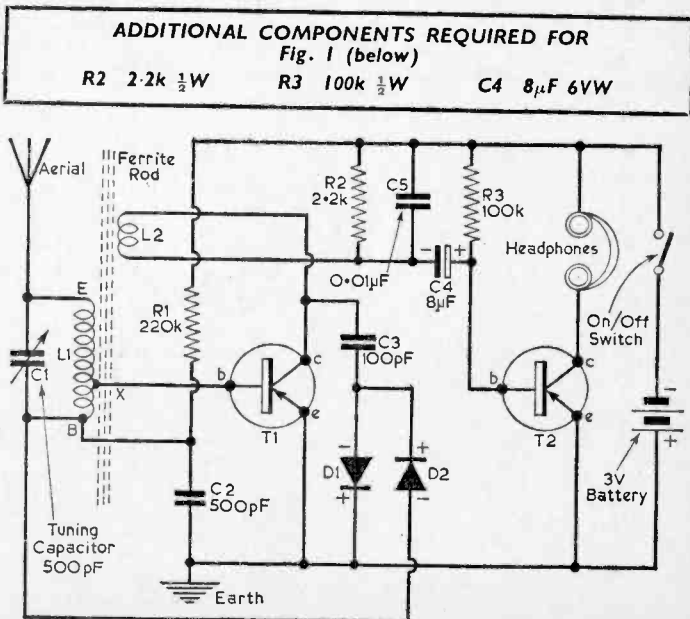

Fig. 1.—The modified circuit to give reflexed operation.

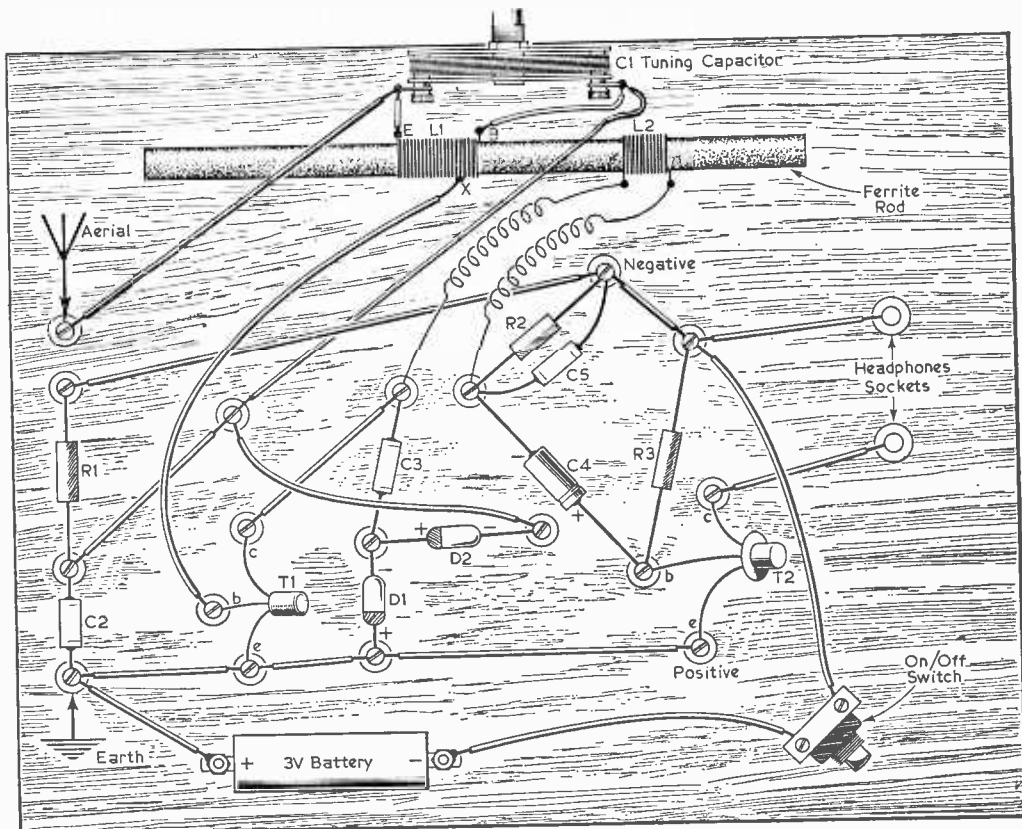

Fig. 2.—The practical layout of the new circuit.

a precaution the battery should be removed from its clips while the various changes are made.

When the new circuit pattern has been completed, the battery can be replaced and the set switched on. If the wiring has been carried out correctly, the increased volume should be apparent immediately. If not, the set should be switched off and the circuit rechecked, making sure that all connections are correct, clean, and tightly screwed up.

It is most important that the diodes should be fixed as shown. If either diode is reversed, the receiver will fail to operate. If they have been left undisturbed, this, of course, cannot happen. Although the added impedance of R2 and C5 may make an extra turn or two on L2 an advantage, the difference is most likely to be too small to matter.

The beginning and end of the tuning coil have been marked B and E on both Figs. 1 and 2, and the tapping marked X.

This modification has, incidentally, introduced a new component to the beginner. This is the electrolytic condenser, C4, and a few words about this will therefore not be out of place.

Electrolytic condensers contain a liquid or moist element. They are less robust than other types of

leads, especially the positive one, must not be bent too near to the body of the condenser, otherwise they may snap off. This is particularly true of the very small condensers.

They must always be connected **the right way round in the circuit**; reversing the polarity may damage the condenser. They must not be submitted to a voltage strain greater than that printed on them.

All this may make the beginner feel that it is best not to touch them at all in case of damage! In practice, all that is necessary is to make sure that the wire leads are treated reasonably gently and that the end marked negative on the diagram is the lead going directly to the aluminium casing. (If both ends are insulated, they will have different colours: black for negative; red for positive.)

As our battery supply is 3V, the condenser should be marked "3 volts working" (3VW). Any larger figure would do perfectly well, but a smaller figure would denote an unsuitable type. The value of electrolytics is usually very broadly assessed. For instance, C4 is quoted as $8\mu\text{F}$ when, in practice, any value between, say, $6\mu\text{F}$ and $15\mu\text{F}$ would do just as well.

The reflexed receiver works as follows. The audio (sound frequency) output, instead of passing directly to the base of T2, as previously, is led

back to the base of T1, the condenser C2 ensuring that any radio frequencies left after detection flow to earth and do not reach T1. The audio signal, after being amplified by T1, is reflected by the resistance R2 through C4 to the base of T2 for further amplification. The purpose of condenser C5 is to provide an easy path for radio frequency currents in L2. Without it, L2 would be damped too much to provide any useful amount of reaction, and the set would lose sensitivity.

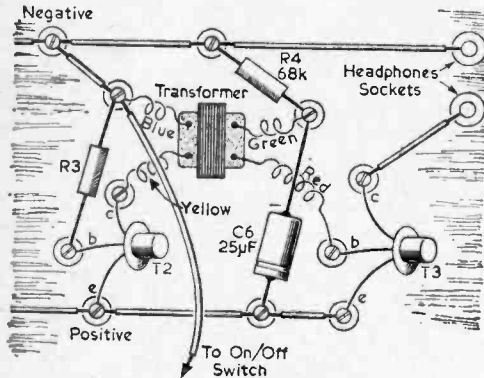
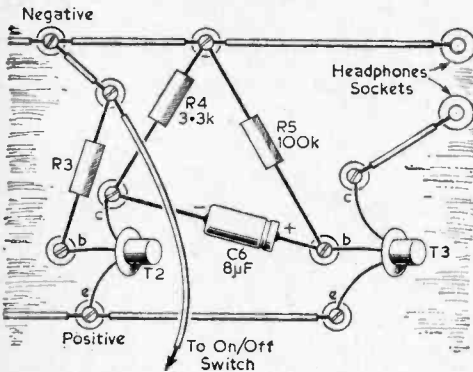

Fig. 3 (above).—An additional transformer-coupled stage.

Fig. 4 (below).—An additional resistance-capacitance coupled stage.



A Further Stage

A further stage may be added instead of, or in addition to, reflexing. This will be a matter of personal preference for most readers, but it should be pointed out that if a local station is very near (within a few miles) reflexing could overload T1 on this station.

A further stage using a third audio transistor can be achieved in several ways, of which the following two are the most commonly used. The first uses transformer coupling to the extra stage, and the second what is called "Resistance-Capacitance" (R/C) coupling. The first gives greater volume at the cost of one rather expensive component, the transformer. The second gives somewhat better tone, and is cheaper.

Figs. 3 and 4 give all the details necessary to connect the extra stage. The colours of the wires in Fig. 3 are the standard ones used by most manufacturers of transformers. If the wire-colours of the transformer used are different, the correct connections can be found by experiment; connecting them wrongly will do no harm but simply reduce the output.

The terminals "Negative" and "Positive" are repeated in Figs. 2, 3 and 4 to provide clear reference points.

The precautions already given regarding electrolytic condensers should be taken with C6 in both cases.

COMPONENTS LIST (Figs. 3 and 4)

Transformer-coupled stage (Fig. 3)

1 audio transistor (T3)

1 4½:1 transistor interstage transformer

1 resistor 68k (R4)

1 electrolytic condenser, 25µF 3VW (C6)

RC coupled stage (Fig. 4)

1 audio transistor (T3)

1 resistor, 3.3k (R4)

1 resistor, 100k (R5)

1 electrolytic condenser, 8µF 3VW (C6)

Conclusion

It is possible that the reader may wish to preserve the receiver more or less permanently, with the additional stage and perhaps an output transformer and speaker as previously described.

In this event, soldered connections may be substituted in the following simple way:—

A supply of solder tags is purchased and the "tag" of each one bent at right-angles to the "washer" portion. These are then substituted for the brass washers, one by one, the wires being soldered to the upright "tag" portion.

If the diodes and transistors are soldered into circuit, the job should be done as quickly as possible so as not to damage these components by heat conducted along the leads from the soldering-iron. A pair of pliers gripping each lead whilst soldering will help by acting as a heat-shunt, but if in doubt, it is best to avoid soldering these components at all.

When replacing the battery, care should always be taken to place it back in position the correct way round. While making any modification to the circuit, the battery should always be removed as a safety measure.

Regeneration

Those readers who experience difficulty in obtaining regeneration when using a "surplus" R.F. transistor may care to increase the supply voltage from 3V to 4½V, which is the maximum value permitted.

PRACTICAL WIRELESS CIRCUITS

17th Edition

By F. J. CAMM

1976 by post 18/7

from

GEORGE NEWNES, LTD.,

Tower House, Southampton Street, London W.C.2.

An Introduction to Stereo

THE LOUDSPEAKER SYSTEM AND POWER SUPPLY

By N. A. Walter

(Continued from page 124 of the June issue)

MOST constructors have their own ideas of what is the best arrangement of the loudspeaker system. However, it is useless to build an amplifier with low distortion and then use it on ordinary small speakers built into a small radiogram cabinet. The choice of speaker will depend upon space and finance available and it is suggested that one of two systems be used.

With a small reflex enclosure a good single full range high fidelity loudspeaker is suitable. A frequency range of 40 to 15,000c/s, 6W handling capacity and a fundamental resonance of 65c/s is typical of such a speaker.

tions can be tried, but the loudspeakers should be kept between 4 and 8ft. apart.

The Power Supply

Most enthusiasts will have various components available, and provided that the H.T. voltages given are fed to the various units, satisfactory operation will be ensured. It is essential that the H.T. fed to the units has some degree of smoothing such as choke and condenser, and that the 6.3V heater supply is centre-tapped to earth. However, for those wishing to build a new power supply, a suitable design is given in Fig. 10. Remember, always feed the unit from a 3-pin plug/socket arrangement and ensure that earthing is efficient.

A few fundamental precautions are worth listing:

- (1) all electrolytic capacitors should be adequately rated, e.g., a 325-0-325 secondary will produce a peak voltage on load of 450 volts, and without a load may well be over 500V;
- (2) an indirectly heated rectifier is better for capacitors that a directly heated rectifier;
- (3) make sure the chassis is earthed;
- (4) fit a fuse in the leads of the mains input and another in the lead from the centre-tap of the secondary H.T. winding to earth;
- (5) bleed resistors of 470k should be fitted across each electrolytic capacitor in the H.T. smoothing circuit;
- (6) keep the power supply well away from the pick-up and pre-amplifier unit;
- (7) if possible, use a separate heater winding for the rectifier valve.

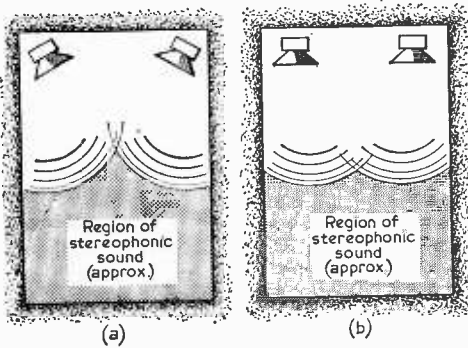

Fig. 9.—The regions of stereophonic effect obtained with different loudspeaker positions.

With a larger reflex enclosure, starting perhaps with one loudspeaker, provision for the addition later on of a mid-range and tweeter speaker is advisable.

Placing of the Loudspeakers

As a general rule the aim should be to keep the loudspeakers separate from the radiogram itself for the following reasons: (a) acoustic feedback can be very difficult to eliminate; (b) unless the radiogram cabinet is very large, and solidly built, good bass response cannot be obtained; (c) positioning of the loudspeakers for best results would be impossible.

Each room behaves differently and, in order to find the best position for maximum stereo effect, some experimenting will be necessary. As a guide, start with the loudspeakers as shown in Fig. 9(a); then try Fig. 9(b). Other posi-

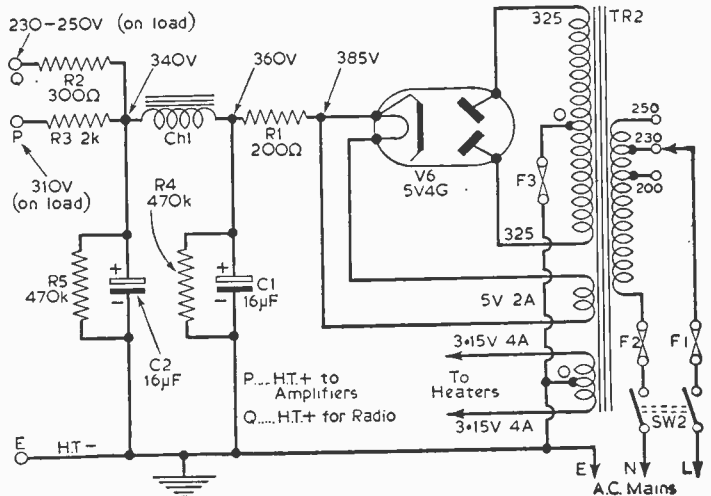

Fig. 10.—The circuit of the power supply.

Power Supply Requirements

Pre-amplifier and tone control unit

H.T. = 230 to 250V at 10mA

L.T. = 6.3V at 0.4A

Main amplifiers

H.T. = 310V at 95mA

L.T. = 6.3V at 2.0A

Radio feeder

H.T. = 230 to 280V at 40mA

L.T. = 6.3V at 2.0A (too allow for dial lamps).

The total H.T. current consumption can be taken to be about 150mA, and the L.T. as 6.3V at 4A together with a winding to suit the rectifier; e.g., 5V 2A, for a 5V4G rectifier.

Setting up the Completed Unit

Having checked the wiring, a few preliminary adjustments are necessary:

(a) Pre-amplifier

Apart from H.T. and L.T. voltage, the only precaution is to ensure that the right-hand channel lead from the pick-up goes to its appropriate grid input and that the audio output from the pre-amplifier is connected into the right-hand channel main amplifier. The same check should be made on the left-hand channel.

(b) Main Amplifiers

The only checks needed here are:—

(i) To obtain correct phasing of the feedback.

This is achieved by connecting the main amplifiers, but first disconnecting the feedback lead in, say, the left hand channel. If possible use an old loudspeaker and connect it across the loudspeaker output leads of the right hand channel. Load the loudspeaker output of the left hand channel with a 3Ω 1W resistor. Switch on H.T. and L.T., and if violent oscillation occurs, switch off. Reverse the secondary connections to the output transformer of the right hand channel, when all should be well. Switch off, remove the loudspeaker from the right hand channel output sockets to the left hand output sockets and load the right hand output sockets with the resistor. Reconnect the feedback in the left hand channel. If violent oscillations occur on switching on, reverse the secondary connections to the left hand output transformer, when again all should be well.

(ii) Switch off and connect up the correct loudspeakers to their respective channels.

(c) Loudspeaker phasing

It is essential that the loudspeakers are correctly phased, and this can be arranged as follows:

If each loudspeaker system consists of more than one loudspeaker, each loudspeaker in that system must be correctly phased. Take each loudspeaker separately and apply a 1½V battery across the speech coil, and note which way the cone moves on connecting the battery. It is worth using a convention here, and the following is suggested. If the cone moves inwards, reverse the connection to the battery so that the cone now moves outwards when the battery is connected. Mark the speech coil solder tag connected to the positive of the battery with a +. Repeat this for each loudspeaker in the system.

Correct phasing will be obtained when all + signs are connected to the same lead. Also, code the lead connecting these + signs with a red sleeve, so that it can be connected to the loudspeaker output sockets on the main amplifier in the correct way.

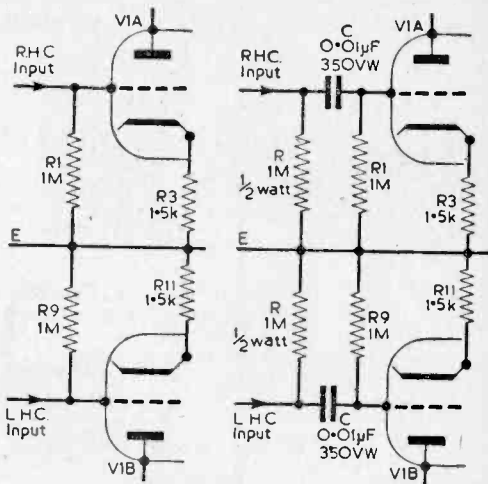

Fig. 11. (left).—The original circuit of the pre-amplifier and (right) a modified circuit to remove "rumble".

Repeat the above for the other channel loudspeaker system.

If turntable rumble is pronounced or noticeable when playing quiet passages, the input circuit of the pre-amplifier may be modified as shown in Fig. 11.

FOR POWER PACK**COMPONENTS LIST**

- TR2** Mains Transformer—
 Primary: 0-200, 230, 250V
 Secondary: 325-0-325V at 150mA
 5V 2A
 3-15-0-3-15V at 4A
- SW2** Mains on-off switch (can be fitted on volume control RV3/RV7, but a separate control on the control panel is recommended)
- F1, F2** 2A fuses and holders
F3 250mA fuse with holder
CL1 10H 150mA choke
C1, C2 16µF (or 32µF) 500VW electrolytic capacitors
R1 200Ω 10W w.w.
R2 300Ω 6W w.w.
R3 2000Ω 10W w.w.
R4, R5 500k 2W
V6 5V4G

Note: R2 and R3 can be adjusted on load to provide correct H.T.

TEST VOLTAGES

(using high resistance voltmeter)

- H.T.** 310V at 48mA
 at C2 285V
 at C1 210V
V3 anode voltage 290
 screen voltage 235 (approximate)
 cathode voltage 28
V2 anode voltage 20
 screen voltage 28

BRAND NEW AM/FM (V.H.F.) RADIOGRAM CHASSIS AT £14 (Carriage paid)

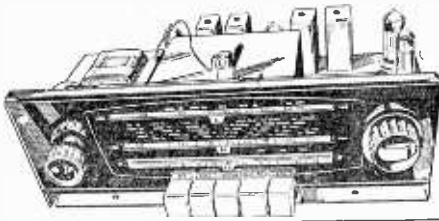

Tapped input 200-225 v. and 226-250 v. A.C. ONLY. Chassis size 15 x 6 1/2 x 5 1/2 in. high. New manufacture, 12 mths. guarantee. Dial 1 1/2 x 4 in. in black and gold. Pick-up. Extension Speaker. Ae., E., hd Dipole Sockets. Five "plano" push buttons—OFF L.W., M.W., F.M. and Gram. Aligned and tested. With all valves and O.P. Transformer. Tone Control Fitted. Covers 1,000—1,900 Mc., 200-500 M.; 88-98 Mc/s. Valves EZ80 rect., EC81, EF89, EABC80, EL84, ECC85. Speaker and Cabinet to fit chassis (table model), 47/6 (post 3/6), 10 x 6 in. ELLIPTICAL SPEAKER. 20/-, to purchasers of this chassis. **TERMS:**—(Chassis) £5.10.0 down and 6 Monthly Payments of 30/-, or with Cabinet and Speaker £5.17.0 down and 7 Monthly Payments 32/- This chassis is an ideal partner for the radiogram cabinet appearing on this page.

THE "CABY" TEST METERS

Prices include Test Prods., Batteries, Instruction Book. Also measure dB. Accuracy: A.C., 3 per cent, D.C., 2 per cent.

A-10 **£4.17.6** B-20 **£6.10.0**

A.10—2K ohms/v. on A.C. and D.C. volts (10, 50, 250, 500 and 1000 v.); 10K and 1M ohms; 1 mA, 25 mA and 250 mA. D.C. Size: 5 1/2 x 3 1/2 x 1 1/2 in. Weight 17 oz.

B-20—10K ohms/v. on 0.5 v. and 2.5 v.; 4K ohms/v. on 10, 50, 250, 500 and 1000 v. A.C. and D.C. Resistance 2K, 200K, 2 M and 20M ohms; D.C. current, 100 microA, 2.5 mA, 25 mA, 250 mA. Size: 5 1/2 x 3 1/2 x 2 1/2 in. Weight, 24 oz.



TAPE RECORDER FOR ONLY £17.17.0 (10/- carr.)

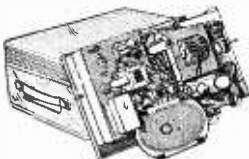

A QUALITY ARTICLE. Valves EZ80, ECC83, ECL82, DM70. Acos Crystal "mike", 850Hz. Tape and extra spool; 3in./sec. Mike and Radio inputs; Vol. on/off tone, Ext. L.S. and Monitor. Fast forward and reverse. Cannot be accidentally erased. Magic Eye Indicator. 6 x 4 in. Speaker. Cabinet 14 x 11 1/2 x 7 in. Supplied completely built and in cabinet.

B.S.R. "MONARDECK" TAPE DECK SINGLE SPEED. Our price only £7.2.6 (5/6 carr.). 850 ft. first grade tape 5 1/2 in. plastic spool. 16/-, post 1/-.

ELECTROLYTICS. ALL 275 v. 100+200mF, 5/-; 100-100mF, 7/6; 100-400-32mF, 8/6; 200-200-300mF, 9/-; 32-32mF, 3/-; 60-250mF, 5/-, Please add Postage 9d. for 1; 1/6 for 3; 6 post free.

NEW WAXED TUBULARS. 350 v. or above, 0.001, 0.002, 0.0005, 0.01, 0.02, 0.05, 0.1, 0.25, 0.5 mF. Total 21 for 4/6, post 9d.

TWO-TONE BROWN RECORD PLAYER CABINET (with Motor Board for Autochanger) and Gramophone Amplifier to fit Cabinet for £5.5.0 (3/- carr.) Size 17 x 15 x 8 1/2 in. Brand New. BSR UA8 autochanger to fit £6.10.0 (extra carriage 2/6).

SAVE 10/- Swiss made Uni Shaver operating from 1.5 v. battery, usual price 50/6. Our price, 40/6. Long Life Battery, 2/-. Not a toy, but a shaver (carr. paid).

COLLARO STUDIO TAPE TRANSCRIPTORS. 3 MOTORS, 3 SPEED. Push Button Controls. £12 (10/- carr.).

3-VALVE AMPLIFIER (INC. RECT.). 4 watts. Valves ECC83, EL84, and EZ80. Controls, volume, bass and treble. On/off switch. (Chassis size 6 1/2 x 3 x 2 1/2 in.) 6 1/2 in. round or 7 x 4 in. elliptical speaker. Not suitable for microphone input. A.C. only.

67/- (3/- p. & p.)

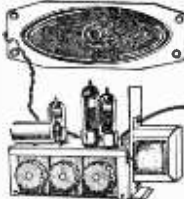

LISTEN WITHOUT INTERFERENCE

Fully built V.H.F./F.M. Set for £8.12.0 (carr. pd.) Covers 88-95 Mc/sec. Wired, aligned and tested. Mullard permeability tuner and 4 valves (ECC85, ECL82 and two EF91), + 2 diodes. Cheap room dipole, 10/-, 300 ohm twin feeder. 6d. yd.

SELF-POWERED VHF TUNER CHASSIS.

Covering 88-95 Mc/s Mullard permeability Tuner, Dims. 10 1/2 x 4 x 5 1/2 in. high. ECC85, EF91, EF91 and 2 diodes. Metal Rectifier. Mains transformer. Fully wired and tested. Only £27.14.0 (carr. pd.). Room dipole 10/-, 300 ohm twin feeder 6d. yd. Tuner without power pack £6.14.0 (carr. pd.).

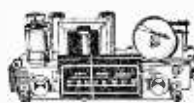

STEREO AMPLIFIER £4.15.0 (3/- p. & p.)

Brand new, 200-250 A.C. Tone and volume controls each channel, EZ80; ECC83; and 2—EL84; giving 2 x 4W. Size 12 x 3 1/2 x 3 1/2 in. O.P. Trans. for 2 x 3 in. speaker. Separate on-off switch to allow balancing to remain set. Monaural push/pull amplifier giving 8W same price.



NEW VALVES (add 9d. post for 1; 1/3 for 2 or 3; 1/6 for 4 or more). 2/- ea., RF50, HL4, Barretter 306, VU120, AR8; 2/6 ea., 6AL7, 6BT1, CV54, VP41, HL41DD, P41, HL42DD, D341; 4/- ea., VR86, ME41, HL133DD, AC/P4, 6K7, 6AT5, 6AU6, 6F33, EF91, EB91, EA/C91, ECC91, U76/624, W77, TH41, 1LD5, TH2321, U06, 50C5, 12SC7; 5/- ea., 7193, VP4B, N78, AC2HL, EC31, 354V, 2P, MH41, AC/P; 7/6 ea., PP351, PA20, AC4/PEN, X79, V503, VP1322, FX4, AC2/PENDD, FC4, KT55, ECC34, DA30, PP5/400.

BATTERY ELIMINATOR. For 4 Low Consumption Valves (96 range), 90 v. 15 mA, and 1.4 v. 125 mA, 42/6 (2/6 post). 200-250 v. A.C. Size 5 1/2 x 3 1/2 x 2 1/2 in. Also for 250 mA, 1.4 v. and 90 v. 15 mA at same price.

AUTOMATIC RECORD CHANGERS. ALL 4-SPEED WITH TURN-OVER CRYSTAL CARTRIDGE (carr. 5/- extra). B.S.R. UA8. £6.10.0; UA8 stereo, £7.5.0; latest UA14, £7.10.0.

COMPLETE V.H.F./A.M. RADIO FOR £13.10.0 (carr. paid)

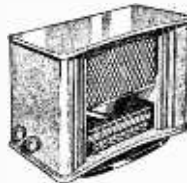

Brand new set, in superb walnut cabinet (size 19 x 8 1/2 x 14 1/2 in. high). Covering 80-100 Mc/s, 16-45 M., trans. 200-250 v. with 3 tappings. Ferrite rod aerial for A.M. Controls: volume on/off, tone, tuning, w/ change. Gram and ext. speaker position provided. Valves 12AT7, 12AH3, 6B/6, EABC80, 6B/6 and metal rectifier. Fully guaranteed. Today's Value, £20.

SUPERB CONTEMPORARY CABINET

Fitted with sliding doors providing room for Radio, Tape Recorder, Autochanger, 4 speakers, and record storage.

PRICE 15 Gns.

Free delivery in London area.



Send 6d. (stamps will do) for 20 p. illustrated catalogue. All New Goods. Delivered by return. Terms:—One-third down and balance plus 7/6 in four equal monthly payments. Postage with down payment (C.O.D. 2/- extra). SEE SPECIAL TERMS FOR A.M./F.M. CHASSIS.

Posted Orders to Camberley Please ALL ITEMS GUARANTEED 12 MONTHS—B.V.A. VALVES 3 MONTHS

GLADSTONE RADIO 58A HIGH STREET, CAMBERLEY, SURREY Tel. 22791

Also at 247 New Road, Portsmouth, Hants, and 56 Stokes Croft, Bristol 1
Camberley closed Saturday. Portsmouth and Bristol closed Wednesday.

CIRCUITS FOR AUDIO AMPLIFIERS

-a book every enthusiast will want!

This new Mullard publication is a practical manual for every audio enthusiast. In addition to describing twelve of the most popular Mullard circuits, it has introductory chapters on many of the theoretical and practical aspects of high quality sound reproduction.

Whether you are interested in disc or tape, monaural or stereo, you will find that "Circuits for Audio Amplifiers" gives just the sort of information you need.

This informative book costs only 8/6. The demand for it is high, so get your copy now from your local radio dealer.

Mullard

MULLARD LIMITED • MULLARD HOUSE • TORRINGTON PLACE

LONDON W.C.1
MVM423A



P.W. POCKET SUPERHET

TRANSISTORISED PRINTED BOARD

A-Z CONSTRUCTIONAL BOOKLET 1/6
including "BLOWN-UP" DIAGRAM

P.W. ROADFARER AM/FM

TRANSISTORISED-PRINTED
BOARD and BATTERY/MAINS
INCLUDING

SPECIALIST-DESIGNED CABINET

A-Z CONSTRUCTIONAL BOOKLET 1/6

Write for Price List
and Free Information

GSMOR RADIO PRODUCTS LTD.

418 BRIGHTON ROAD SOUTH CROYDON
SURREY Telephone CRO 5148/9

SPECIAL FOR THE "HAMS" RADIO STATION

Illustrated

$\frac{1}{8}$ inch detachable bit
soldering instrument
List No. 70

Combined Protective Unit
with Wiper/Abrasion Pad
and Solder Reel
List No. 700

Apply SALES & SERVICE

ADCOLA

(Regd. Trade Mark)

GAUDEN ROAD
CLAPHAM HIGH ST.
LONDON, S.W.4

Telephones:
MACaulay 4272-3101

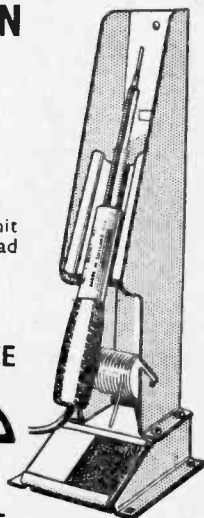

British & Foreign
Patents, Registered
Designs, etc.

Telegrams:
"SOJJOINT, LONDON"

ADDING COMMUNICATIONS FEATURES

TUNING INDICATOR CIRCUITS

(Continued from page 132 of the June issue)

By F. G. Rayer

THE circuit of the BFO stage was given last month. The frequency of oscillation may be varied by means of a 25pF variable condenser. Modification to the value of C1 may be tried if results seem unsatisfactory. The BFO signal at the diode must not be too strong, or weak C.W. signals may be lost.

When interference is troublesome, the BFO may be tuned above or below the I.F., as necessary, for best reception. For SSB reception, adjust the BFO frequency for maximum intelligibility. If the

speech sounds "inverted", the BFO signal is on the wrong side of the SSB signal, so the 25pF condenser must be readjusted. It is also necessary to secure a correct balance between the strength of the SSB signal and the BFO signal. The 50k potentiometer in Fig. 3 will aid in this direction. If no means of adjusting the BFO output is provided, a somewhat similar effect can be achieved by turning back the R.F. gain control. Such a control can be fitted and will be described later.

For battery operated receivers, a similar circuit may be used. The BFO valve filament is switched, to conserve battery supplies. A 1S5, 1T4, or similar valve will be suitable. An anode coupling winding or reaction circuit can be used to obtain oscillation, as a separate cathode will not be available.

When other additions are to be made, it will be convenient to fit a 5-way rotary switch, to control the BFO. Other switch positions can then furnish standby and AVC in/out operation.

Tuning Indicators

A signal strength or tuning indicator is extremely useful. In addition to performing its usual function of showing the signal strength of a station, it also allows receiver adjustments to be made more easily. The meter type of indicator is particularly sensitive, and is usually preferable.

If a station is tuned in, and trimming or alignment of R.F., F.C. or I.F. stages is adjusted, the meter will show if results are being improved. This is an extremely useful function. In addition, if changes to the aerial or earth improve signal strength, this will immediately be shown by the meter. It is thus easy to compare one aerial with another or to test the effect of directional aeri-als.

Meter indicators are frequently controlled by an I.F. stage. The anode current of such a stage is at maximum with no signal, and falls by several milliamperes when a signal is tuned in, owing to the AVC action. Two simple ways of connecting the meter are shown in Fig. 4.

The meter may be included in the anode circuit, as indicated, with a bypass condenser to chassis, or it may be included in series with the usual fixed cathode bias resistor. The current drawn by the valve passes through the meter, which is equipped with a variable shunt. This forms the zero adjuster, and its value is modified until the meter reads full scale, with no station tuned in. The correct tuning point for a station, and the strength of the signal, will then be indicated by the extent to which the meter pointer falls back.

A 1mA, 2mA or 5mA instrument will be satisfactory with most mains valves, with a low value wire-wound shunt of such resistance that the meter reads full scale with normal anode or cathode current (about 7mA to 10mA). If the meter pointer tends to go off the scale, the zero adjuster resistance is simply reduced in value, until the proper full-scale reading is achieved.

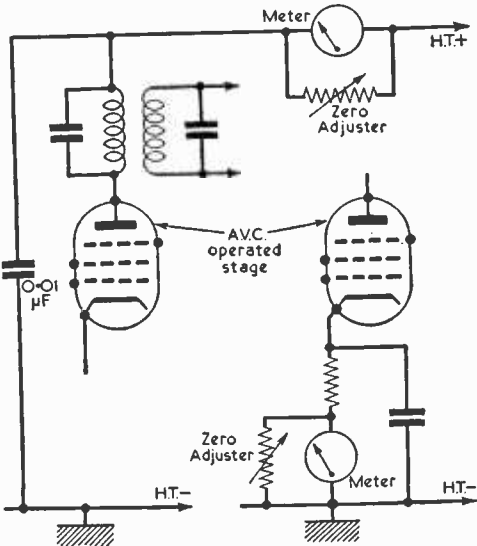

Fig. 4.—Two simple tuning indicator circuits.

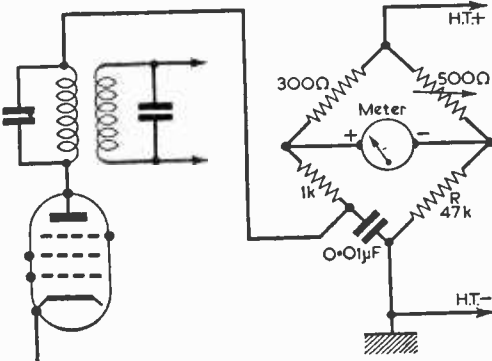

Fig. 5.—A bridge signal strength meter circuit.

Circuits like those in Fig. 4 are particularly suitable for a receiver with a strong AVC action. With the usual type of meter, the pointer will move towards the left, as signal strength increases. If a movement from left to right is preferred, with these circuits, the meter may be mounted upside down, and the scale drawn to suit.

A further signal strength and tuning meter circuit is shown in Fig. 5. With no signal, the bridge is so balanced that no current passes through the meter. When the AVC voltage is applied to the I.F. stage, its anode current falls. This unbalances the bridge, so that the pointer moves in proportion to the signal strength.

The 1k resistor and 0.01μF condenser merely serve to keep I.F. currents out of the meter circuit. The values of the 300Ω and 500Ω resistors are not at all critical, provided the bridge can be balanced (zero current through the meter) with no signal tuned in. If balance cannot be achieved, the resistor, R, should be changed in value. If the meter is too sensitive, it can be so shunted that it reads full scale only with an S9-plus signal.

Such circuits may be employed in battery operated receivers, provided the meter is of fairly sensitive type. A 1mA or 2mA instrument will usually be satisfactory, though this depends on the valve types and battery voltage.

Magic Eye

A magic eye may be used as a tuning indicator, though it is less exact in its indications than a meter, and is not very suitable for signal strength readings. It does, however, require only a small panel area.

A suitable circuit is shown in Fig. 6, and may be used with a 6U5G or similar valve. With this indicator, sensitivity can be adjusted to some extent by modifying the target voltage. With the

values shown and a 250V supply, a grid voltage of about -22V will shadow angle. If the AVC circuit does not provide this, with a strong signal, the sensitivity of the eye can be increased by reducing the supply voltage. This can be achieved with a resistor dropping network. With a 100V supply, and the 1M resistor reduced to 500k, zero shadow angle will be reached with about -8V.

Adding Extra Bands

When improving an ordinary set so that it can be used as a communications receiver, it will almost certainly be necessary to add other wave bands. Many ordinary receivers have only one S.W. range, in addition to L.W. and M.W. coverage. The S.W. band will often cover about 19m to 50m. Even if two S.W. bands are provided, it is not likely these will include the 80m and 160m Amateur frequencies. Some surplus receivers also have a rather restricted frequency coverage.

When modifying the set it is a good plan to provide continuous coverage from about 200m to 10m if possible. The usual M.W. band of about 550m to 200m can prove useful occasionally, but it may be decided to omit the L.W. band.

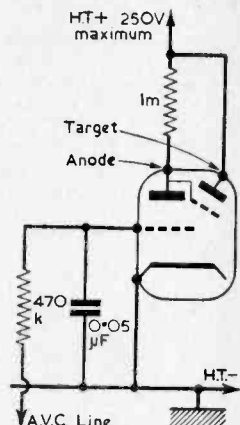

Fig. 6.—A circuit for a "magic eye" tuning indicator.

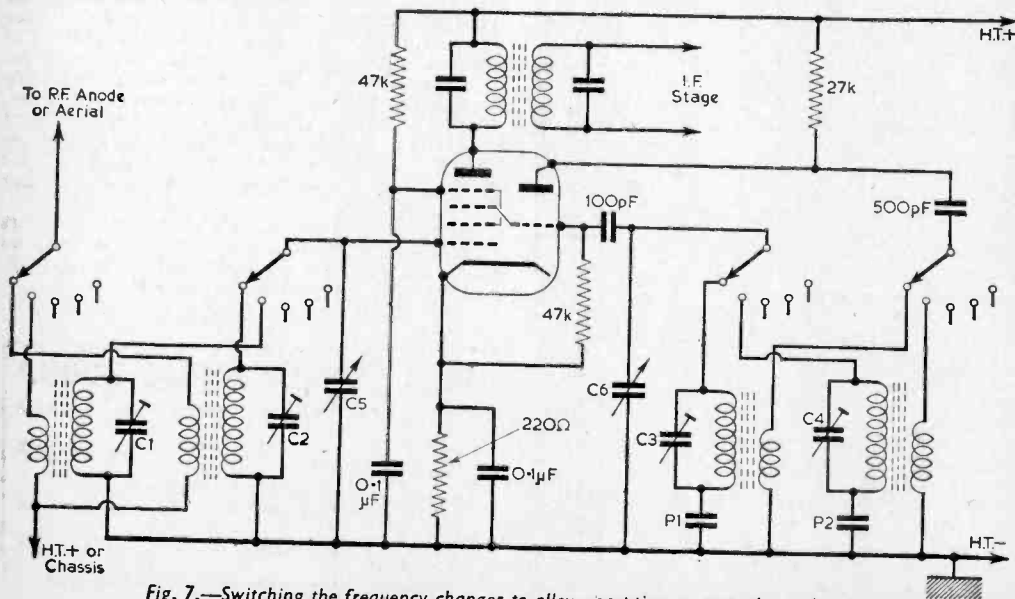

Fig. 7.—Switching the frequency-changer to allow reception on several wavebands.

Switching Circuit

An efficient and convenient way of obtaining the required wave-bands is to use a separate set of coils for each band, as in Fig. 7. This has the advantage that each set of coils is independent of the others. The switch should be a long type with separate wafers, and have as many positions as there will be wavebands. It is wise to use a switch with a fairly large number of positions, as it will then be easy to add further coils later.

In Fig. 7, only two bands are shown. C1 and C2 are trimmers for the signal frequency coils, and C3 and C4 are oscillator coil trimmers. Small 50pF or similar trimmers will be satisfactory. Each set of coils has its own trimmers, so that each band can be adjusted individually.

P1 and P2 are the oscillator coil padders. Unit coils of this type can be obtained from many manufacturers, and each oscillator coil must have the padder capacity specified for it. C5 and C6 are sections of the usual gang tuning condenser.

The values given in Fig. 7 are average for many popular valves, and can be followed when constructing such a receiver. But when an existing receiver is to be adapted, resistors and condensers already present can usually be retained. The tuning coils may also be returned to the AVC line, though results will generally be better on the S.W. bands with no AVC bias applied to the frequency changer.

If a tuning indicator has been provided, as described earlier, this will greatly simplify accurate alignment. Each band is dealt with separately. The appropriate trimmers are adjusted at a fairly low wavelength in the band, and the coil cores are adjusted at a high wavelength. Adjustment will be for maximum reading on the tuning indicator, which will reveal changes indistinguishable to the ear.

Image Frequencies

When reception will be on high frequencies, the effect of image frequency interference must be kept in mind. This is likely to be troublesome on short wave bands, but not on higher wavelengths. Fig. 8 shows how image frequency reception arises, with a typical M.W. and S.W. set. It is assumed that the receiver has an intermediate frequency of 465kc/s. If the receiver is tuned to 500m or 600kc/s, the oscillator will be operating at 1065kc/s. Stations 465kc/s higher in frequency than the oscillator frequency would also be converted to intermediate frequency in the F.C. stage. That is, a station at 1530kc/s (approximately 200m) might be heard together with the station at 600kc/s. However, even a single tuned circuit of average efficiency can distinguish sufficiently between the 500m and 200m signals to reject the latter. Because of this, image frequency reception is unlikely on the M.W. band.

On the S.W. band it is assumed that a station is tuned in at 20m or 15Mc/s. This is 15,000kc/s, and the oscillator will be operating at 15,465kc/s. The image frequency thus falls at 15,930kc/s or approximately 19m. A single tuned circuit will not distinguish strongly between signals so near in wavelength, and thus a station near 19m may easily come in on top of the required 20m signal.

Image frequency reception is at twice the receiver intermediate frequency, e.g., 930kc/s

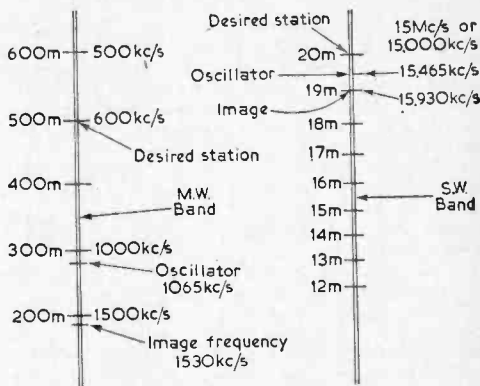

Fig. 8.—Image frequency reception.

higher in frequency than the desired station, throughout all bands (with an I.F. of 465kc/s).

One way of avoiding such interference is to have sufficient selectivity *before* the frequency changer. For this reason, a communications receiver with a 465kc/s I.F. may have two R.F. stages. Two such stages prove a little difficult for home construction, but a single selective R.F. stage will be helpful, and can be provided fairly easily. It is, in fact, possible to obtain quite reasonable results with no R.F. stage, if most interest lies in the lower frequency bands. But for most purposes it is wise to plan with the R.F. stage in view.

Increased I.F.

Another method of reducing image frequency interference is to use a higher intermediate frequency, such as 1.6Mc/s. Image interference is then twice this, or 3.2Mc/s (3,200kc/s) away, through all bands. The tuned circuits ahead of the frequency-changer then need to reject signals 3.2Mc/s away from the desired station, instead of 930kc/s away, and are more easily able to do so.

Unfortunately, a high intermediate frequency does not give good adjacent channel selectivity. For this reason, it is quite usual to employ about 1.6Mc/s in an early stage, followed by 465kc/s or a similar lower frequency in later stages. This results in the double superhet, which will be dealt with later.

Some commercial communications receivers are single superhets, with an I.F. of around 465kc/s. Others are double superhets, a high I.F. being followed by a much lower I.F.

(To be continued)

JOIN THE PRACTICAL GROUP

PRACTICAL TELEVISION	1/6
Every Month	
PRACTICAL MECHANICS	1/3
Every Month	
Devoted to Mechanics, Science and Invention	
PRACTICAL MOTORIST	1/6
Every Month	
PRACTICAL HOUSEHOLDER	1/3
Every Month	

THE P.W. SIGNAL

CHASSIS No. 3

VARIABLE FREQUENCY AUDIO OSCILLATOR SECTION

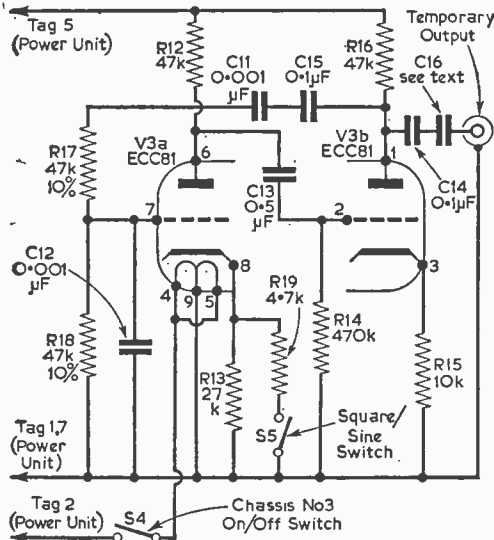

Fig. 16.—The theoretical circuit of the audio oscillator. There are no variable components and the circuit given above produces a single fixed note.

GOOD variable frequency audio oscillators are not cheap to purchase or easy to make and although the one to be described has limitations it will fulfil nearly every requirement of the beginner, and will be an asset in every amateur radio laboratory. (The author wishes to thank Mullard Ltd. for permission to use information

from their Educational Pamphlet describing a simple Wien Bridge Oscillator.)

Chassis Number 3 will consist, finally, of a variable frequency oscillator, a triode amplifier and a cathode follower output stage and will incorporate a coarse frequency change switch, fine frequency adjustment by ganged potentiometers, a on/off heater switch and a switch giving sine or square waves. The range will be approximately from 15c/s to 33kc/s (which is beyond the range of normal human hearing). The output voltage being, if required, over 100.

This chassis will be wired in stages:—

1. a simple Wien Bridge oscillator.
2. addition of triode stage.
3. addition of the cathode follower stage.
4. addition of variable frequency components.

The Oscillator

The circuit is shown in Fig. 16 and reference to Fig. 17 will show the positions of the main components for the first part of the oscillator. This will work on a single, fixed, frequency.

Verify that the centre post of the coaxial output socket is not shorted to chassis and also that the tags of the tag strip (except the two at the ends) are not earthed. Check that the valveholders are fitted exactly as shown or the wiring in Fig. 17 will not hold good.

In order that connections to the power unit may be made easily, a small tag strip (tag strip A) should be mounted at the rear of this chassis in the same position as that on Chassis Number 2— see Fig. 5 on page 1106 of the April issue. This

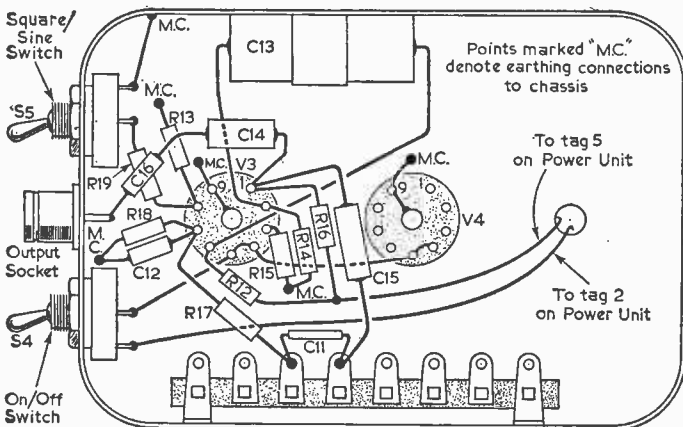

Fig. 17.—The wiring of the fixed frequency audio oscillator.

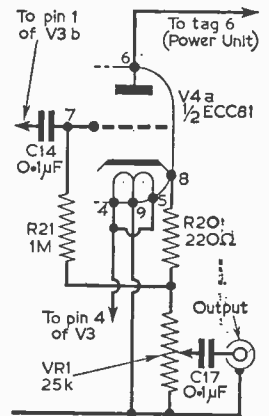

Fig. 18.—The circuit of the cathode follower stage.

GENERATOR

By
E. V. King

tag strip should have three insulated and either one or two earthed tags: the insulated tags are used for H.T. positive connections and for the heater wiring and one of the earthed tags is used for the other heater connection and H.T. negative. Wire one of the insulated, unearthened, tags of this tag strip to one tag of S4. This will be the connection for the heater supply. Wire the other tag of S4 to pin 5 of V3 and continue the wire to pin 4 (Fig. 17). Earth the centre spigot of V3 valveholder via pin 9, to the chassis. Now, connect tag strip A to the heater supply from the power unit (Chassis Number 1) and check that the heater of V3 heats up when S4 is switched on.

Continue the wire from pins 4 and 5 of V3 to pins 4 and 5 of V4; earth pin 9 of V4 and the centre spigot. Check that the heaters of V3 and V4 heat up when S4 is switched on.

Wiring of V3b

Next attach R16 to pin 1 (we are dealing only with V3) and connect a red wire to it and take this through a grommet to an insulated tag on tag strip A (which will later be connected to tag 5 on the power unit to supply H.T. to V3). Also connect C14 to pin 1, and its other end to condenser C16 (100pF). The other side of C16 connect to the centre of the coaxial output socket (C14 and C16 are in series). Connect pin 3 to earth via R15 and pin 2 to earth via R14. Connect the H.T. positive from the power unit (tag 5) to the V3 H.T. tag

on tag strip A and plug in to the mains. Connect phones to the output socket. Touch pin 2 with a metal object held in the hand (beware of touching pin 1 in error or you may get a shock). Buzzing or humming should be heard in the phones. Switch off the unit.

Connect C13 to pin 2 and the other side of C13 to tag 6. Make sure C13 is securely fixed with a clip and that it cannot slide about. Repeat the phones tests above, but this time touch pin 6 with an insulated screwdriver. Humming or at least

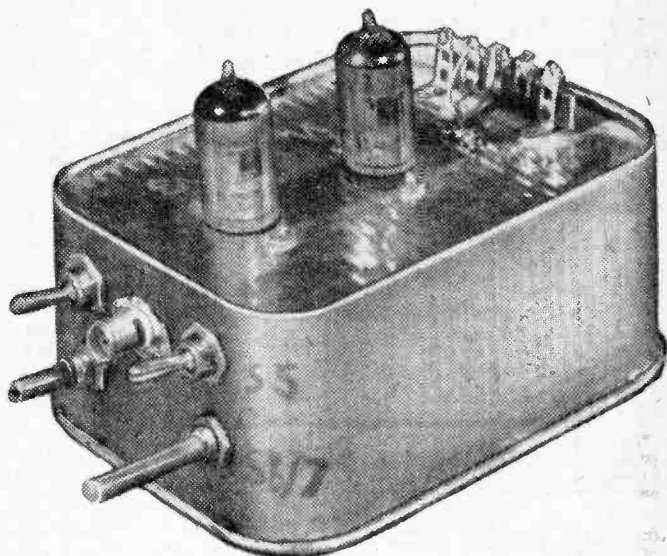

The completed unit

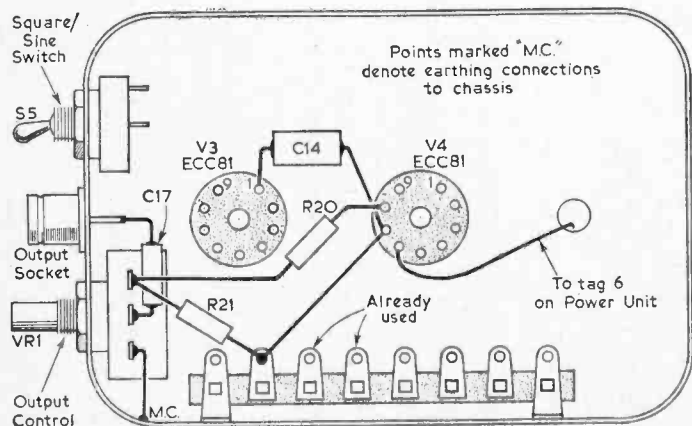

Fig. 19.—The wiring of the cathode follower stage—only wiring additional to Fig. 17 is shown.

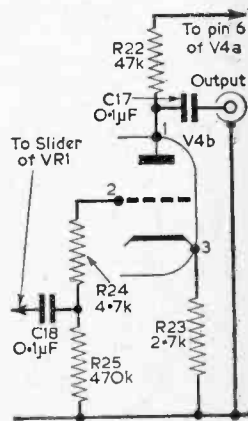

Fig. 20.—The circuit of the triode amplifier.

COMPONENTS LIST

For Figs. 16 and 17

R12 47k	R16 47k
R13 27k (see text)	R17 47k 10per cent
R14 470k	R18 47k 10per cent
R15 10k	R19 4-7k
C11 0-001 μ F	C14 0-1 μ F 350VW
C12 0-001 μ F	C15 0-1 μ F 350VW
C13 0-5 μ F 350VW	C16 100pF

Chassis as for the Power Unit

S4 and S5 Two toggle switches—any single pole switch is suitable

Coaxial output socket

V3a and b ECC81

For Figs. 18 to 21

R20 220 Ω $\frac{1}{2}$ W	R23 2-7k $\frac{1}{4}$ W
R21 1M $\frac{1}{2}$ W	R24 4-7k
R22 47k $\frac{1}{4}$ W	R25 470k

VR1 25k pot; small type—linear

C16 no longer used

C17 0-1 μ F 350VW

C18 0-1 μ F 350VW

V4a and b ECC81

crackles should be heard as the screwdriver is moved about on pin 6.

Wiring of V3a

Attach R12 to pin 6 and by suitable bending join the other end of R12 to the H.T. end of R16. Take pin 8 to earth via R13. Join pin 7 to earth via R18.

Plug in to the mains and switch on. Repeat the phones test, but touch pin 7 with the metal object and take care not to touch pins 1 and 6. The humming should now be much louder.

Now attach C12 between pin 7 and earth, and repeat the above test. The tone may be somewhat different but hum should still be heard.

Attach R17 to pin 7 and take it to the second unearthed tag of the internal tag strip (the third tag usually, as the first one is earthed)—see Fig. 17. Bend the wire of C11 suitably so that it may be soldered between the third and fourth unearthed tags (see Fig. 17). Connect C15 between the third unearthed tag and pin 1. The feedback path is now complete.

Attach the phones as before and switch on. A strong musical note of somewhere about 3kc/s will be heard. If the note is not heard, check all the parts added since the last test. If necessary, but only as a last resort, reduce the value of R13.

The Value of R13

The value given will suit almost every case. Where second-hand valves, or other, faulty, components are used it may be necessary to reduce R13 gradually until oscillation is obtained. Where it is possible to make it of higher value than 27k

and still maintain oscillation this should be done. The author found all valves will work with 27k and many with 33k, and a few with even higher values. The higher the value of R13, the more likely is the wave produced to be pure.

Wiring in the "Square Wave" Components

When the value of R13 is reduced greatly, the biasing of the valve is small and considerable distortion produces waves which approximate to square waves. This type of waveform is useful for amplifier testing. Beginners may not have an immediate use for this type of wave and they may, if they wish, omit R19 and S5. If this facility is required, wire R19 to one side of S5 and the other side of the switch to earth. The complete wiring is shown in Fig. 17. The output is now available for limited use. If it is applied to the pick-up terminals of a radio, the note will be reproduced loudly in the speaker. An amplifier section of a radio may be checked by touching each valve grid (or transistor base) with the output lead, the two chassis being joined together. The note should be amplified each time, and some idea of stage gain can be obtained by the volume levels.

Adding the Cathode Follower Stage (V4a)

The output from V3a and V3b is to be fed into V4a which does not amplify, but serves to isolate the oscillator from the external connections.

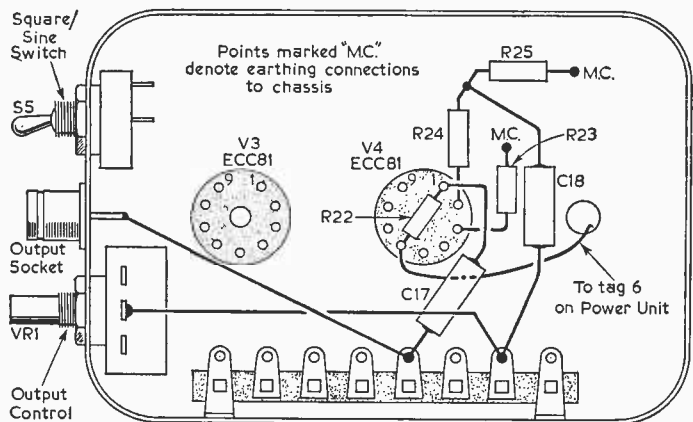

Fig. 21.—The wiring added to that of Figs. 17 and 19 to complete the triode amplifier stage.

Readers may have noted that if various phones (or amplifiers) are connected in circuit the note is different. The stage using V4a will prevent this from happening. It also allows a convenient and simple control of volume.

The circuit for V4a is given in Fig. 18 and the additional wiring in Fig. 19.

Unsolder the junction of C14 and C16, take C16 out of circuit, and wire C14 to pin 7 of the valve being wired (V4a). Connect R21 between pin 7 and one end of VR1 (see Fig. 19), and from this connection wire in R20, taking the other end to

(Continued on page 257)

NEW 1961 EDITION

**THE GREATEST MONEY-MAKER
EVER OFFERED TO THE RADIO MAN!**

ALL THE CIRCUITS, DIAGRAMS, REPAIR DATA
AND INFORMATION YOU NEED FOR NEARLY

2,700 Models

TELEVISION • RADIO • RADIOGRAMS • CAR RADIOS
TAPE RECORDERS • RECORD REPRODUCERS

Newnes RADIO AND TELEVISION SERVICING provides at instant call, any time, day or night, all the circuits and data you need for almost all the popular TV and Radio sets in use. It is the only complete library of servicing data and worth its weight in gold!

1954-1961 Popular Models—Over 4,400 Pages

Servicing Data for all these makes—Ace, Alba, Ambassador, Argosy, Armstrong, Baird, Banner, Beethoven, Berec, Brayhead, B.S.R., Bush, Capitol, Champion, Channel, Collaro, Cossor, Cyldon, Dansette, Decca, Defiant, Dynatron, E.A.R., Eddystone, Ekco, Elizabethan, E.M.I., Emerson, English Electric, Ever Ready, Ferguson, Ferranti, Ford Motor Co., Garrard, G.E.C., Gramdeck, Grundig, H.M.V., In-victa, K-B, McCarthy, McMichael, Marconiphone, Masteradio, Motorola, Murphy, Pageant, Pam, Perdio, Peto Scott, Philco, Philips, Pilot, Portadyne, Portogram, Pye, Pye Telecommunications, Radiomobile, Rainbow, Raymond, Regentone, R.G.D., Roberts' Radio, Sobell, Sound, Spencer-West, Stella, Strad, Ultra, Valradio, Vidor, Walter, Webcor.

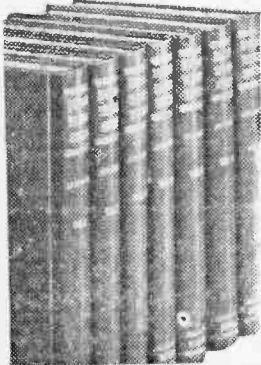

**MORE THAN 4,500 CIRCUITS AND
COMPONENT LAYOUT DIAGRAMS
ALSO LATEST DEVELOPMENTS AND
TIME-SAVING HINTS**

**Every purchaser is entitled to 2 YEARS'
FREE POSTAL ADVISORY SERVICE**

TEST IT ON
7 DAYS
**FREE
TRIAL**
ABSOLUTELY
NO OBLIGATION
TO BUY!

Make sure of seeing
this great profit-maker
in the quiet of your
own home!

ACT TO-DAY

Please send me Newnes
RADIO AND TELE-
VISION SERVICING
(in 7 Volumes) without
obligation to purchase. I
will return it in 8 days or
send 15/- deposit 8 days
after delivery, then fifteen
monthly subscriptions
of 20/-, paying
£15. 15s. in all. Cash
price in 8 days is £15.

To: George Newnes, Ltd., 15-17 Long Acre, London, W.C.2

Name _____

Address _____

Occupation _____

Your Signature _____
(Or Your Parent's Signature
if you are under 21)

RV167

Tick (✓) where applicable

HouseOWNER	<input type="checkbox"/>
Householder	<input type="checkbox"/>
Living with Parents	<input type="checkbox"/>
Lodging Address	<input type="checkbox"/>

HOME RADIO OF MITCHAM

(Dept. P), 187 London Road, Mitcham, Surrey.
MIT 3282
Shops hours 9 a.m. to 6.30 p.m. Wed. 9 a.m. to 1 p.m.

P.W. POCKET PORTABLE

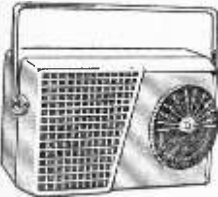

All parts in stock and detailed price list on request. Set of guaranteed specified components £9.9.0.

ARMSTRONG CHASSIS AND TUNERS

Full range of these precision engineered units in stock. **AF208 Radio**. Long, medium, and VHF. 5 watts output. Independent tone controls. 22 gns. **Jubilee Radio**. Long, medium and VHF. 6 watts push-pull. Separate tone controls. Tape sockets. 29 gns. **Stereo 55 Radio**. Long, medium and VHF. 5 watts each channel. Separate tone controls. Facilities for tape, etc. Full Mono and Stereo. 32 gns. **Stereo 12 Mk. 2**. The most complete Radio and Hi-Fi chassis ever produced. 8 watts push-pull each channel. Long, medium and VHF. Send for full specification of this and all other Armstrong radio and tuner chassis.

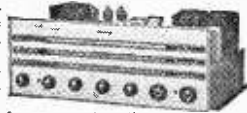

P.W. "ROADFARER"



We are stocking all the parts of this unique set and full price list will be sent on request. Set of guaranteed specified parts £18.19.0.

MICROPHONES

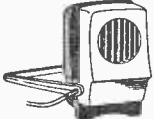

A high-quality crystal hand microphone with built-in stand for desk use. Strong neat moulded case and complete with 5-foot screened lead. Very sensitive and ideal for tape recorders, amplifiers, transmitters, etc. Individually boxed and brand new. Offered while available at only 21/- each, 9d. post.

WE ARE ACTUAL STOCKISTS OF HEATHKITS



GOING AWAY?

Now is the time to invest in the easy modern way of electric shaving. The **UNIC Dry Shaver** operates from a single U2 battery and will give you quick, close shaves anywhere. Ideal for holidays. Swiss engineered. PRICE £2.19.6 complete. Leaflet on request.

FOR EVERYTHING FOR THE RADIO ENTHUSIAST. SEE OUR SUPER 128 PAGE CATALOGUE Get a copy today

2/-, plus 9d. post.

PULLIN SERIES 100

This multi-range test set has a wide angle of vision and clear scales. Printed circuit gives rugged, accurate construction. 21 ranges and a sensitivity of 10,000 ohms per volt. Full specification sent on receipt of s.a.e. PRICE £12.7.6 post paid. Or H.P. terms. Deposit £2.7.6 and 6 monthly payments of £1.5.0, or 12 monthly payments of 18/6.



VALVES

SAME DAY SERVICE NEW! TESTED! GUARANTEED!

SETS

IR5, IS5, IY4, 3S4, 3V4, DAF91, DF91, DK91, DL92, DL94 .. Set 4 for 19/6
DAF96, DF96, DK96, DL96 4 for 27/8
6K7G, 6K8G, 6Q7G, 6V6G, 6X5G of 5Y3G 5 for 24/6

1A7GT 11/6	6P1 13/8	30L15 11/-	ECC40 17/6	EZ41 7/-	PZ30 17/-
ID5 8/-	6P25 9/-	35A5 14/-	ECC81 5/-	EZ80 6/3	T41 9/6
1HG2T 10/-	6Q7G 8/-	35L6GT 9/-	ECC82 6/3	EZ81 7/-	U22 7/3
1NSGT 10/-	6Q7GT 9/8	35Z4GT 8/9	ECC83 7/-	FW4/500 8/-	U25 13/-
IR5 5/6	6SL7GT 6/3	35Z5GT 9/8	ECC84 8/9	GZ30 8/6	U26 10/6
IS4 5/3	6SN7GT 4/9	50L6GT 8/9	ECC85 8/6	GZ32 9/8	U30 8/6
IS5 5/8	8U4GT 11/-	AC/TH1 16/9	ECCF80 8/6	HBC90 7/8	U52 4/6
1U3 3/8	6V8G 5/-	AZ31 9/6	ECCF82 8/6	KT39C 7/-	U78 4/9
1U5 5/9	6V8GT 6/6	E36 8/6	ECH21 13/6	KT41 11/8	UABC90 7/9
3A5 9/-	6X4 4/9	CL33 12/9	ECH33 6/3	KT44 6/6	UAF42 9/-
3Q4 7/-	6X5GT 5/-	DAC32 10/-	ECH42 8/6	KT63 6/6	UB41 7/9
3S4 6/6	7R6 9/6	DAF91 5/3	ECH81 9/-	KT63 6/6	URC41 7/9
3V4 7/-	7B7 7/6	DAF96 7/6	ECL80 7/6	MU14 7/8	UBF80 8/9
5U4G 4/6	7C5 7/6	DCC90 9/-	ECL82 4/6	MX40 9/6	UBF89 8/9
5V1G 8/6	7C6 7/6	DF33 10/-	EF39 4/6	N19 7/6	UC92 12/6
5Y3GT 8/6	7H7 7/6	DF91 3/6	EF40 12/6	N77 10/6	UC94 12/9
5Z4G 7/9	7S7 9/-	DF96 7/6	EF41 8/3	PC95 10/6	UCC85 7/6
6AL5 3/9	7Y4 7/-	DH76 4/9	EF42 9/6	PCC84 7/6	UCF80 14/-
6AM5 3/6	10C1 11/6	DH77 6/9	EF80 5/6	PCC89 11/8	UCH21 13/6
6AQ5 6/6	10C2 11/6	DK92 11/6	EF85 5/6	PCF80 7/9	UCH42 8/6
6AT6 6/9	10P13 14/6	DK91 5/6	EF86 9/9	PCF82 8/6	UCH41 8/6
6BA6 6/9	12AT6 7/-	DK92 7/6	EF89 9/6	PCF86 14/-	UCL82 8/9
6BB6 5/9	12AT7 5/-	DK96 7/6	EF91 3/6	PCL82 9/-	UCL82 8/9
6BH6 6/6	12A06 8/6	DL33 9/-	EF92 4/3	PCL83 11/6	UCL33 13/3
6BJ6 5/9	12A07 6/3	DL38 9/6	EF133 14/-	PCL84 7/8	UF35 8/6
6BW6 8/-	12AX7 7/-	DL92 6/-	FL33 10/-	PEN4 11/-	UF39 9/6
6CD6G 26/9	12K7GT 5/3	DL94 7/-	EL41 8/6	PEN36C 8/-	UL41 8/-
6F1 12/6	12K8GT 11/6	DL96 7/6	EL42 7/-	PL36 11/6	UL84 7/6
6F6G 6/6	12Q7GT 4/9	EABC80 7/-	EL84 9/-	PL31 9/6	URIC 8/6
6F13 11/-	12Z3 7/8	EAF42 8/6	EM34 8/6	PL32 7/-	UY21 11/3
6F14 16/6	14S7 18/6	EB91 3/9	EM80 8/6	PL33 7/6	UY41 6/6
6K7G 2/6	20F2 17/6	EB93 5/-	EM81 8/6	PL84 10/-	UY85 6/6
6K8GT 5/3	30L1 17/8	EB40 8/-	EM84 10/-	PY32 11/-	VP4B 9/6
6K9G 6/3	35A6G 8/-	EBF80 8/-	EX51 7/6	PY80 7/6	VP41 5/-
6K8GT 9/3	35L6GT 7/9	EBF89 8/9	EX84 10/-	PY81 6/9	W76 5/3
6L8 10/3	25Z4G 7/8	ELR21 13/8	EY96 7/9	PY82 9/9	W77 4/6
6LD20 8/-	25Z6GT 9/8	EC92 11/-	EZ40 6/9	PY83 7/9	Z77 3/6

3-TRANSISTOR POCKET RADIO

With Miniature Loudspeaker
ABSOLUTELY NO SOLDERING REQUIRED



UNIQUE DESIGN

Superb appearance. Simple instructions. Built in an evening. No drilling. No soldering. Complete in every detail. Receives entire broadcast band. Aerial required in certain areas. Pocket size 4 1/2 x 2 1/2 in.

ALL PARTS SOLD SEPARATELY

42/6 Battery 1/- extra P. & P. 2/-.

SAVOY BARGAINS

- High gain audio transistors, 4/8, P. & P. 3d.
- Ferrite rod. 4 x 1/2 in., 1/8, P. & P. 6d.
- Solid dielectric tuning condensers: 0.003 mid, 4/-; 0.005 mid, 4/3; P. & P. 6d.
- Miniature dynamic speakers. Resistance 30 or 70 ohms. 4/8, P. & P. 9d.
- 5 ft. phone cord with No. 9 Jack plug. 2/-, P. & P. 6d.

SAVOY ELECTRONICS LTD.
15 Maiden Lane, Strand, London WC2
(Back of Adelphi Theatre)

READERS RADIO
24 COLBERG PLACE, STAMFORD HILL,
LONDON, N.16. STA. 4587

Post 6d. per valve extra.
Any Parcel Insured Against Damage in Transit 6d. extra.
Any C.O.D. Parcel 3/- extra.

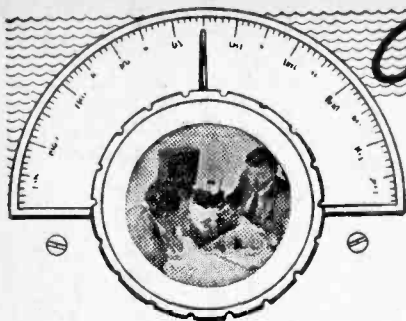

On Your Wavelength

BY THERMION

provide all the smoothing; but I do not like this arrangement, and I still prefer a good transformer and choke, and I am glad to note that the Editorial policy of this paper is now to avoid the "live chassis" type of receiver wherever possible.

The Transistor Controversy

As a result of my notes in the April issue concerning the popularity among service engineers of transistor receivers, I have received a considerable number of letters both for and against these sets. It seems from the remarks made by my correspondents, that the main complaint is from the servicing angle. The transistor is usually well placed to permit heat dissipation, but the three leads are generally tucked away very close together, and the serviceman resents the time which he has to spend tracing the position of these leads—unfortunately they are not generally placed in the same order as on the base of the transistor. With a valve base, all that is necessary is to look for the spigot or the wide space between two of the pins, and then one knows from the valve type number exactly which pin is which. There are three leads to the transistor, but from the back of the panel one cannot see easily which is the emitter, which the base and which the collector. It is necessary first to find from the circuit the value of the resistors feeding these points and then trace the appropriate lead.

Communication Receiver Design

MOST readers will be familiar with the older type of American communication receiver in which the coil unit was built as a large inset, pushed in from the front of the receiver, and carrying on the face-plate two large scales showing all the tuning ranges and the exact dial settings. Making one of the latter types of scale is one of the main difficulties encountered by the home-constructor, as no matter how accurately the coils are made and the wiring is carried out, without the aid of a really good signal generator one is faced with the difficulty of locating a wanted station, or ascertaining the wavelength of a station which one picks up. Nowadays it appears that there is no coil unit available which is supplied with a suitable tuning scale. Not only in the field of short-wave working, but also on the normal broadcast bands, complete coil units with their accompanying tuning scales, many of them carrying station names, were at one time readily available, and I look for the day when the amateur will again be able to purchase a ready lined-up coil pack, with a really reliable tuning dial. This not only gives the finished set a commercial appearance, but greatly simplifies its use and gives one a greater interest in station searching. The rather large type of plug-in coil which was at one time so popular has now apparently ceased to have any interest, probably owing to the difficulty of winding coils for modern circuits.

Delivery Delays

Although not my province, I receive a large number of letters from readers asking me to use my influence to try and ginger up some firms whom they accuse of slackness in delivering components. Whilst I am at all times only too willing to do what I can to help readers, I am afraid that I cannot do much in such instances, other than to pass the request or complaint to our advertising section, as very often these complaints are accompanied by the most drastic accusations. In the few cases which I have investigated, I have found that the readers themselves are to blame. The most common fault is the failure to send a stamp or stamped addressed envelope with their request for information concerning goods. It must be realised that in many business establishments the post is very extensive, and all letters asking for information are put to one side whilst orders are dealt with separately. The cost to a firm of postage on letters can be very large, and as you know it is usual in quoting the cost of goods to include a percentage for postage. The second and most glaring fault is failure to enclose your name and address. This is avoided, of course, if you enclose a stamped and addressed envelope, but if you merely send a postal order for "the following goods . . ." and fail to give your name and address, you obviously will not hear from the firm, and until you lodge a complaint they will not have the faintest idea who you are.

Mains Unit

Whilst dealing with some of the older types of equipment I am reminded that the power pack or power-unit of today is a very much simplified version of the older units, but is it so useful or, what is more important, so safe? The earlier idea was to use a really well-made transformer delivering adequate output, and with a really good choke, with plenty of iron in it, and adequate reservoir and smoothing capacities. Besides providing a really smooth and steady D.C. output, this also had the merit of isolating from the mains any apparatus which it fed.

The arrangement of a resistance wound integrally with the mains leads and known as "line cord" does not seem ever to have really caught on in this country, although at one time it was extremely popular, especially in the U.S.A. Today the transformer appears conspicuous by its absence, and tiny little resistors, sometimes as low as one watt, and no greater in value than 1,000 ohms,

A Top-Band Transistor Tx

Note: To operate this unit, the operator must own a transmitting licence.

A POCKET-SIZED INSTRUMENT FOR SHORT RANGE COMMUNICATIONS

By A. E. Watson

THE following article describes a pocket transmitter which is suitable for short range car communications. It has been found useful at a sports meeting for relaying the various results of the field events, as well as for testing the sensitivity and selectivity of a top-band receiver.

The Circuit

The modulator consists of a one-transistor amplifier, using an audio transistor such as an OC71 or any surplus red-spots. The A.F. output of this is developed across R1 and is fed via C2 to the base of the transistor oscillator Tr2 (which

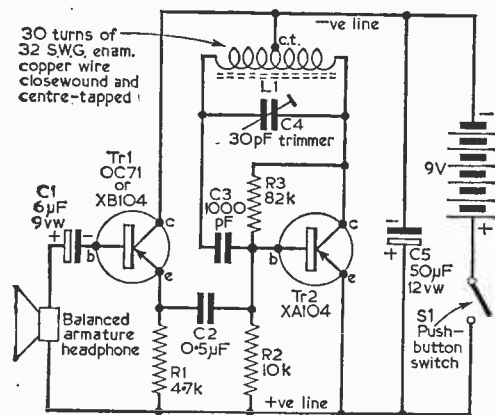

Fig. 1.—The circuit diagram.

COMPONENTS LIST

Condensers

- C1 6µF 9VW
- C2 0.5µF
- C3 1000pF
- C4 30pF beehive trimmer
- C5 50µF 12VW

Resistors (All 1/4W)

- R1 4.7k
- R2 10k
- R3 82k

Transistors

- Tr1 OC71 or red spot, or XB104
- Tr2 XA104 or red/yellow spot

2 Transistor holders

9V battery PP3

Low impedance balanced armature headphone (surplus)

Push button on-off switch

1/2 in. x 4 in. ferrite rod (broken in half)

4ft. 8 B.A. threaded rod (aerial)

is a transistorised version of the Hartley oscillator). Note: Poor stability will develop if R2 is omitted, and it is therefore advisable that this be included.

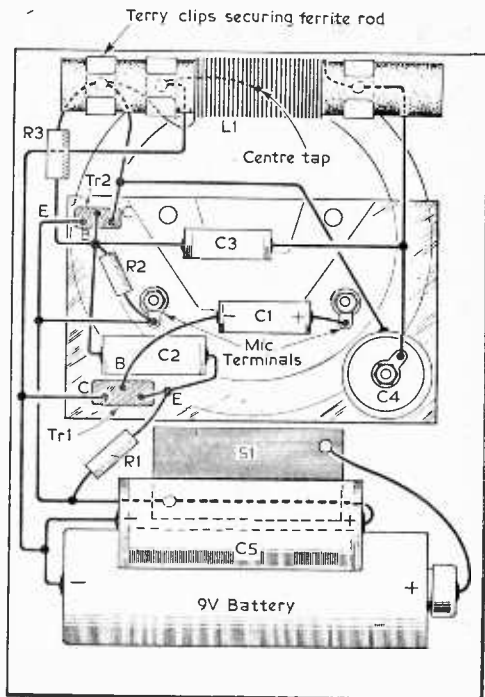

Fig. 2.—The internal wiring diagram.

Components

The voltage across Tr2 may seem rather high, but the maximum Vc-e (in volts) for this transistor is (-12), and therefore this transistor is not overloaded, and as can be seen from Fig. 2 any heat dissipated will be carried away by the metal ring on the balanced 'phone. The coil consists of 30 turns of 32s.w.g. enamelled copper wire, close wound on a double length of 1/8 in. diameter ferrite rod.

Construction

The ferrite rod is mounted behind the balanced headphone (the hole for mounting the Terry Clip is

(Continued on page 231)

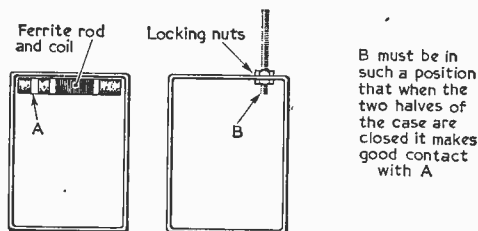

Fig. 3.—The position of the ferrite rod.

A Valve/Transistor Short Waver

AN EASILY MADE RECEIVER FOR THE NEWCOMER TO SHORT WAVE LISTENING

By P. K. Cripps

THIS receiver is highly sensitive and selective, and, although it cannot equal the performance of the more expensive commercial sets, it will provide a useful introduction to the short-wave, amateur, and broadcast bands.

Specifications

The coverage is from about 18m (16.66Mc/s) to 60m (5Mc/s), and from 150m (2Mc/s) to 300m (1Mc/s) in another band. This covers the 20, 40, and 160m amateur bands and the 19, 25, 31, 41, and 49m broadcast bands. The 15 and 10m bands have been omitted, but, owing to the 11-year sunspot cycle, 10 and 15m will open up very rarely for some years. In any case, the condition of these bands nowadays is rather poor owing to the large numbers of stations operating.

The output from the receiver will be from 250mW to 600mW according to the transistors used. As might be expected, selectivity is excellent owing to the well-designed coils, and no difficulty will be experienced in separating stations, even on the crowded amateur bands. Sensitivity is sufficient to allow Dx reception on phones, and loudspeaker reception of the stronger broadcast stations.

Circuit Details

The detector circuit is unusual as only a single tapped coil is used (for each band) with anode reaction. The detector is of the leaky grid type, chosen for its high sensitivity and simplicity.

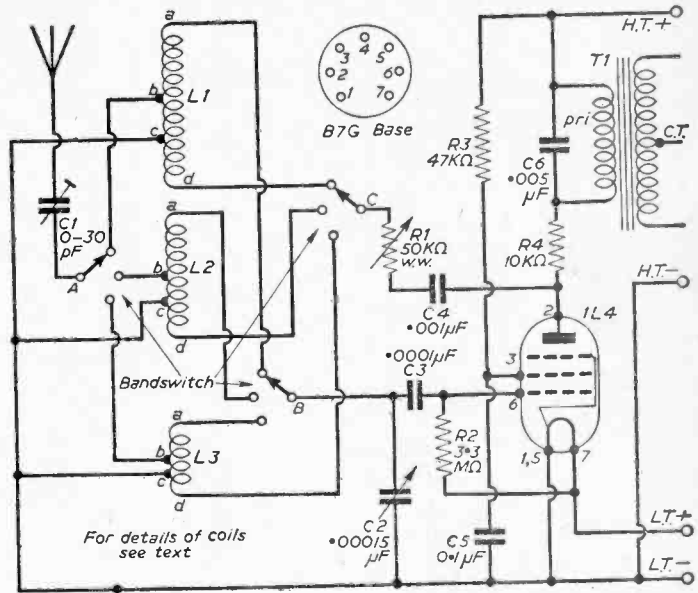

For details of coils see text

Fig. 1.—The circuit of the detector stage.

However, if carelessly constructed, with poor quality components, it will prove very unstable with the type of reaction used. Transistors have been used in the output stage owing to their low current requirements and high efficiency. These components have a reputation of an extremely high noise level, and, although this is true, in some circuits using cheap transistors, the noise in this circuit is very low and will not prove troublesome even where faint signals are concerned.

The valve for the detector stage is the 1L4. Its current requirements are 0.1A at 1.4V, and 2mA at 90V. Other types which may be used are the 1AE4, 1AF4, 1AJ4, 1F2, 1F3, 1AF5, ZD17, 1AH5, 1FD9, 1S5, 1T4, 1U4, DAF91, DAF96, DF91, DF92, DF96 and DF904. The base connection details of all these valves, together with their approximate filament voltage and current requirements are given in Table 1.

COMPONENTS LIST FOR THE DETECTOR STAGE

- L1, L2, L3—see text and Table II
- C1 0.30pF trimmer
- C2 0.00015µF S.W. variable capacitor
- C3 0.0001µF silver mica capacitor
- C4 0.001µF silver mica capacitor
- C5 0.1µF paper 150VV
- C6 0.005µF paper 150VV
- R1 50k variable w.w.
- R2 3.3M ½W
- R3 47k ½W
- R4 10k ½W
- Slow motion drive
- Switch 3-pole, 3-way

Table 1

Valve	Filament Voltage (V)	Filament Current (A)	Valve-holder type
1L4	1.4	0.1	1
1AE4	1.25	0.1	1
1AF4	1.4	0.025	1
1AJ4	1.4	0.025	1
1F2	1.4	0.05	1
1F3	1.4	0.05	1

Table I (continued)

Valve	Filament Voltage (V)	Filament Current (A)	Valve-holder type
1T4	1.4	0.05	1
1U4	1.4	0.05	1
DF91	1.4	0.05	1
DF92	1.4	0.05	1
DF96	1.4	0.025	1
DF904	1.4	0.05	1
DAF91	1.4	0.05	2
1AF5	1.4	0.025	2
1AH5	1.4	0.025	2
1FD9	1.4	0.1	2
1S5	1.4	0.05	2

The pin connections of these are as follows:—

- Pin Connections VALVE GROUP 1**
- 1—negative filament and suppressor grid
 - 2—anode
 - 3—screen grid
 - 4—no connection
 - 5—negative filament, suppressor grid
 - 6—control grid
 - 7—positive filament

- Pin Connections VALVE GROUP 2**
- 1—negative filament, suppressor grid
 - 2—no connection
 - 3—diode anode (wire to earth)
 - 4—screen grid
 - 5—anode
 - 6—control grid
 - 7—positive filament

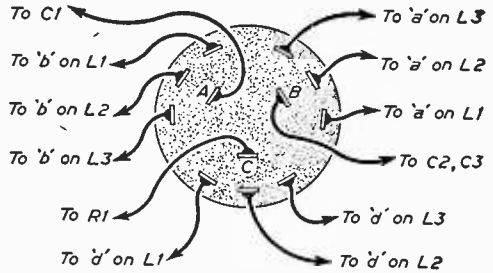

Fig. 3 (above).—The connections for the bandswitch.

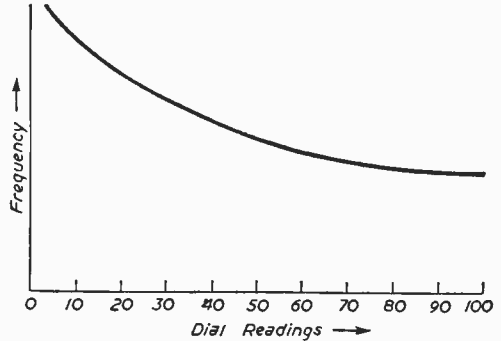

Fig. 4 (above).—A calibration graph.

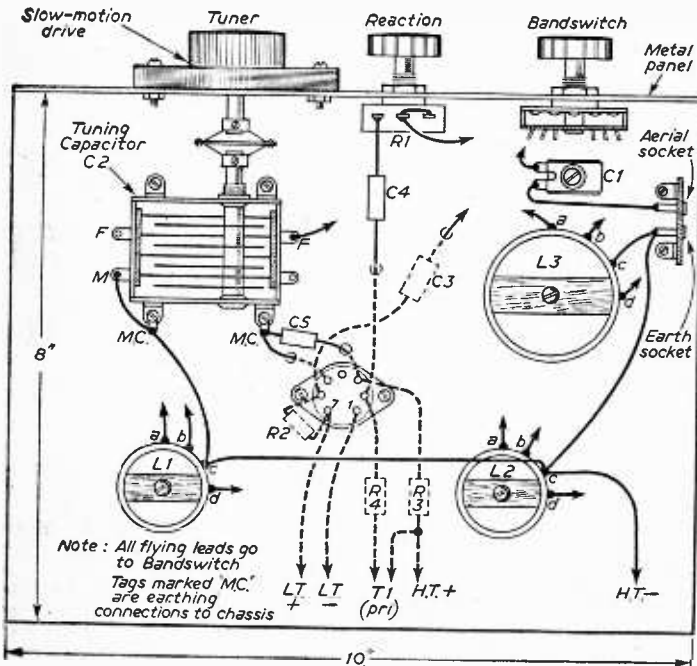

Fig. 2.—The component-layout diagram of the detector stage.

Constructional Details of Detector

The wiring diagram of this stage is given in Fig. 2. It may be constructed on a metal or wooden chassis, metal being better than wood on account of its superior screening properties. In either case a metal panel is essential to screen the controls from the operator to prevent hand-capacity effects. At all times, short, direct, wiring is extremely important. The layout diagram is given for guidance, but it should not be adhered to rigidly; i.e., if you can make a wire shorter than is shown, do so. Any long leads should be of coaxial or screened cable.

The Coils

These coils are home-wound, their winding details being given in Table II. For L1 and L2, the turns should be of enamelled copper wire of the gauge recommended. The turns should start and finish securely, and the taps can be made by twisting the wire and scraping the enamel insulation at the positions given.

Table 11

Coil	No. of turns		s.w.g.
L1	100		28
L2	30		22
L3	10 spaced over 2in.		18

Coil	Tappings		Diameter of former
	b	c	
L1	50	75	1½in.
L2	15	20	1½in.
L3	5	2½	2in.

COMPONENTS LIST FOR THE OUTPUT STAGE

- R1 2.2k ½W R2 220Ω ¼W R3 33Ω ¼W
- C1 200µF 3VW electrolytic
- C2 0.05µF
- T1 Push-pull input transistor transformer
- T2 Push-pull output transistor transformer
- T3 Standard pentode output transformer
- Tr1, 2 OC71 or any other small power output transistors not requiring a heat sink

The slow motion drive deserves mention: any type will serve. It should be possible to obtain one of Admiralty pattern fairly cheaply from ex-Service stores. The prototype used one of 200 : 1 ratio of this type, which is excellent.

A type marked in frequencies will not be suitable in view of the home-wound coils used. A 1-100 scale will allow stations to be logged with reasonable accuracy, and a graph may be drawn up for a more accurate determination of frequency. The procedure is as follows:—

First, a station is accurately tuned in and its frequency noted. The dial reading is also taken and the procedure repeated until a number of stations at different frequencies are logged. Then, a graph is drawn up of dial reading against frequency. This is shown in Fig. 3. The curve obtained may or may not be a straight line according to the type of tuning condenser used, but it should be regular. Any points well away from the main curve should be disregarded—they are either from faults in reading the tuning dial, or harmonics of a strong station.

Operation of the Detector

If desired, 4000Ω headphones may be connected to the output, instead of the primary of T1, to test the detector. First, check the wiring to ensure that the H.T. voltage cannot reach the filament of the valve. and then connect the batteries: 90-120V H.T. and 1½V L.T. Without an aerial, advance the

50k potentiometer. There should be no crackling or other noises. Somewhere between the middle and end of the travel of the control, there should be a faint "plop" and the set will break into an oscillation howl.

Now that it is proved that reaction is functioning satisfactorily, an aerial may be plugged in and the set tested on all bands. The reaction control should be adjusted to be just below the point of oscillation.

The Output Stage

The circuit of this is shown in Fig. 5. It is constructed on a "breadboard" which can be mounted in the loudspeaker cabinet. The loud-

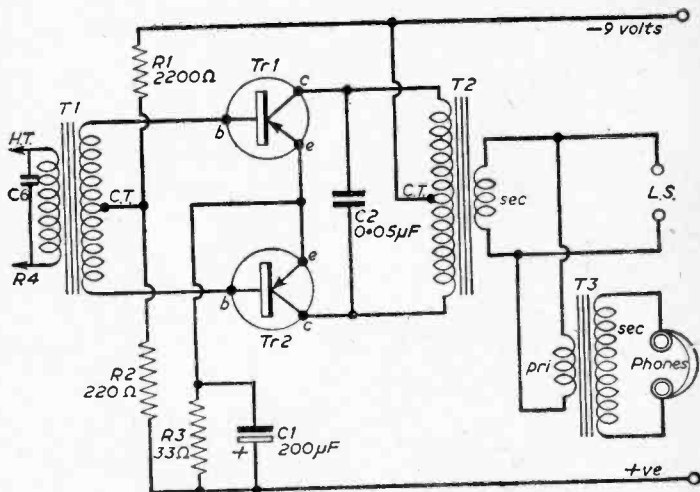
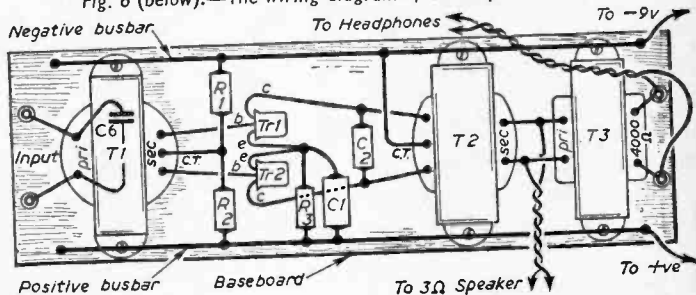

Fig. 5 (above).—The circuit of the transistorised output stage.

Fig. 6 (below).—The wiring diagram of the output stage.



speaker is best a 5in. or larger unit, although smaller types can be used, but they will not give such a good tone.

The bus-bars can be of 18s.w.g. bare copper wire attached to the breadboard with insulated staples. The current for this unit is supplied by a PP9 battery, which will have a useful life of a year or even more. The switch for this part of the set can be accommodated in the loudspeaker cabinet. If a switch is desired for the detector stage, it may be wired in the positive L.T. lead and mounted on a suitable place on the panel.

An Amateur Communicati

COMPLETE CONSTRUCTIONAL DETAILS FOR THIS COMPREHENSIVE UNIT

THIS receiver was designed for use by the amateur or S.W. listener who requires an instrument which gives a better performance than the average domestic receiver. Such a receiver usually has no R.F. stage and only one I.F. stage. Consequently, it suffers from a lack of selectivity and sensitivity, and is prone to second-channel interference especially at the higher frequencies. Thus, to give above-average selectivity and sensitivity, the receiver to be described employs a number of I.F. stages.

Second Channel Interference

To reduce second-channel interference, the I.F. frequency should be increased or an R.F. stage included. In this design, the I.F. has been kept at the conventional figure of 465kc/s., so enabling the use of easily obtainable components; and therefore an R.F. stage is used.

The Circuit

The circuit is shown in Fig. 1, and it will be noticed immediately that a coil-pack is employed. There are many suitable coil-packs on the market, but if these are unobtainable or thought too expensive, separate coils may be used. If separate coils are used, one set can be purchased to reduce initial expense and the other wavebands added at a later date.

In the prototype, the R.F. stage was capacity-coupled to the EF91 mixer because the coil-pack used by the author did not have provision for inductive-coupling, but there is no reason why this method of coupling should not be used, provided the particular coils are suitable for such an arrangement.

The local oscillator is separate to reduce pulling and drift, especially at higher frequencies.

A triode-connected EF91 has a mutual conduction of nearly 10mA/V, and thus it is used as the oscillator valve, because a valve with a high mutual conductance helps towards stability.

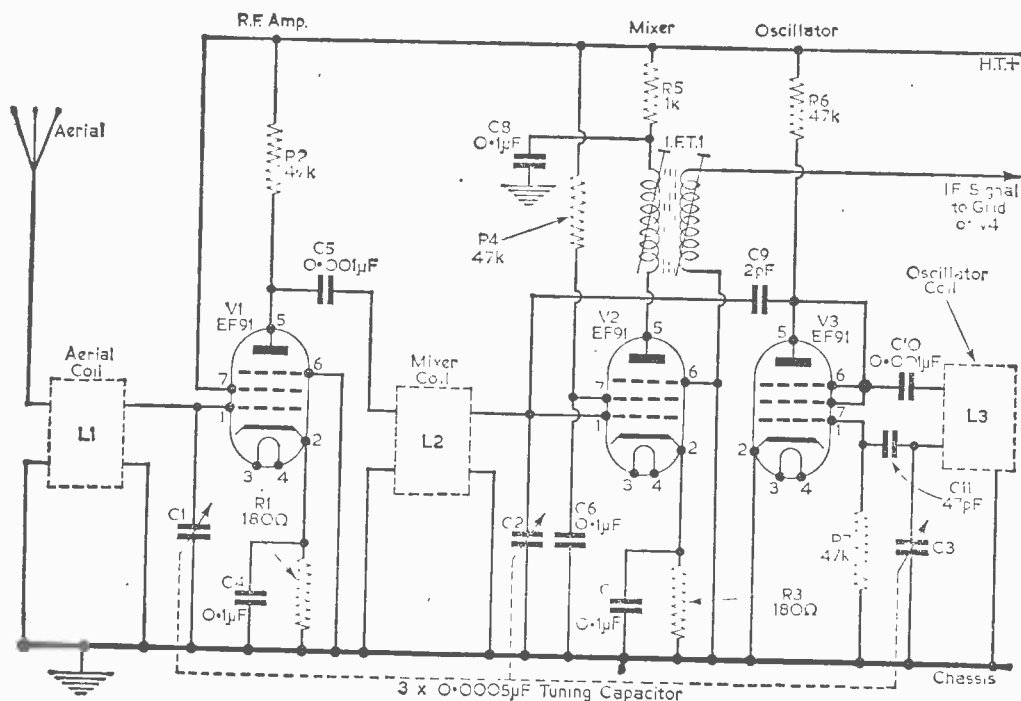
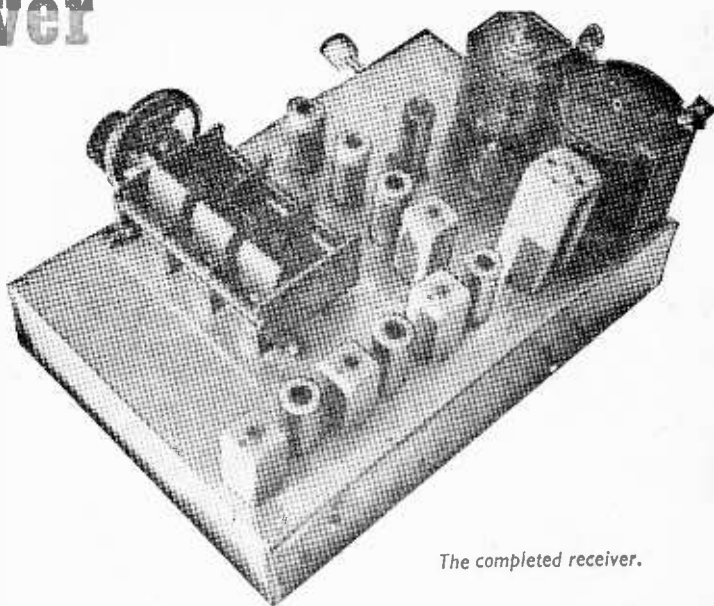

Fig. 1a.—The R.F. amplifier oscillator and mixer stages.

ons Receiver

By P. Hayes

The I.F. signal appears at the anode of V2, and is transferred via I.F.T.1 to the grid of V4. The screen grid of this valve is strapped to the screen grid of V5 and the voltage varied by VR1. This controls the gain of the I.F. amplifier. A comparatively high value of bias resistor (1k) is used to reduce gain (intended to enhance stability, reduce valve noise, and increase valve life). No AVC is applied as this would only serve to reduce the gain of the I.F. amplifier, thus destroying the aim of having three I.F. stages. The amplified I.F. signal appears across V7 and is demodulated. The resulting A.F. signal appears across VR2—the audio volume control—



The completed receiver.

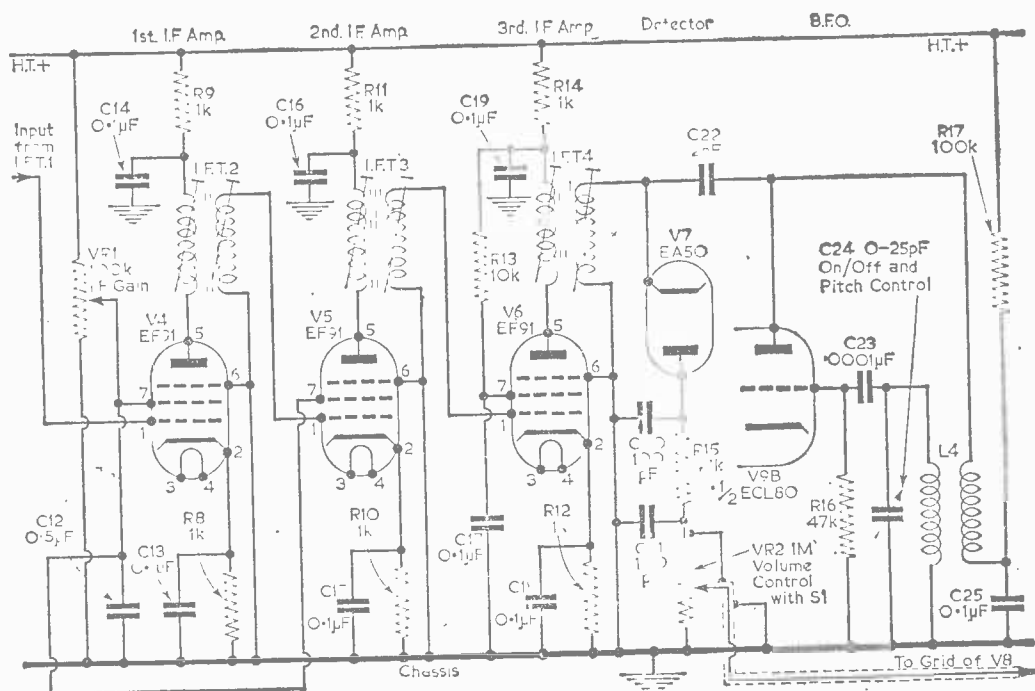
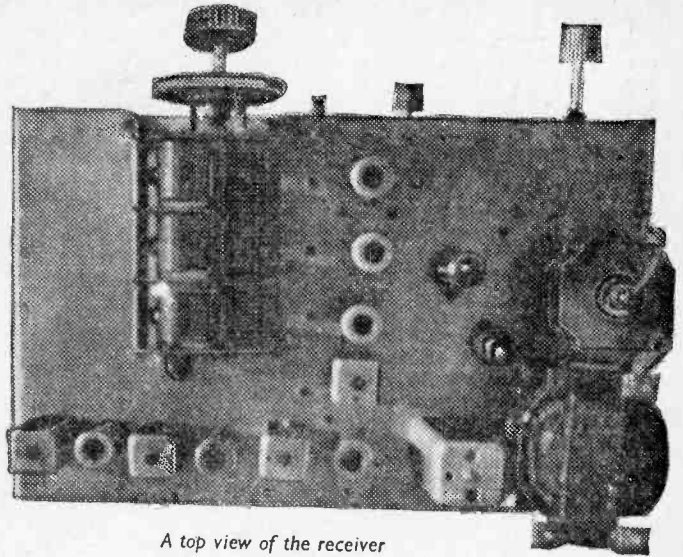

Fig. 1b.—The I.F. amplifier, detector and BFO stages.

and is applied to the grid of V8. (The audio volume control was not used in the prototype because the author found that it was always at maximum and gain was controlled by the I.F. gain control. A headphone jack was put in its place.) The amplified A.F. signal from V8 anode is coupled via C27 to the control grid of V9A. The audio output is developed across T1 and the headphones are capacity coupled via C32.

It will be noticed that the triode section of V9 is used as BFO, instead of, as usually, the first A.F. amplifier. This is because, firstly, the DH77 gives greater gain than the ECL80, and secondly, it completely avoids instability owing both to the close wiring and the fact that the amplifier stage might act as a "cathode-coupled multi-vibrator" caused by the cathode being common to both triode and pentode sections in the ECL80.

The BFO is conventional except for the method of switching on and off; one vane of the moving plates is bent to touch the corresponding fixed vane. This shorts out the grid coil and prevents oscillation.



A top view of the receiver

The power supply is conventional, and either a metal rectifier or a valve rectifier may be used. If a valve rectifier is employed, there must be a suitable winding on the mains transformer to supply its heater.

(To be continued)

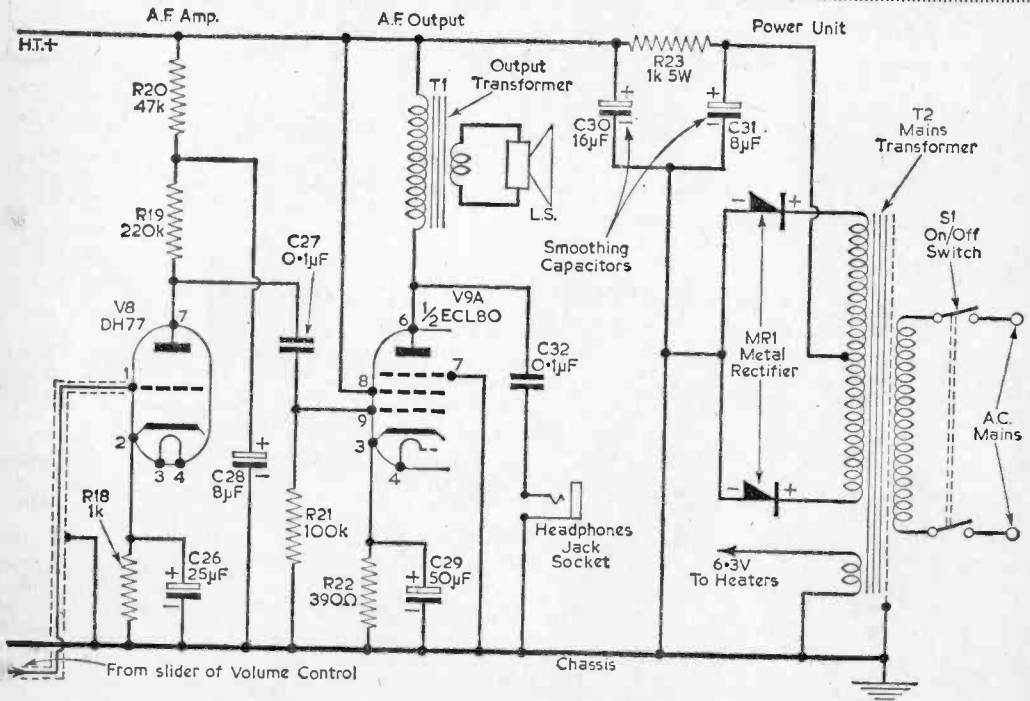

Fig. 1c.—The circuit of the A.F. amplifier and power unit.

Transistorised Signal Tracer

By D. P. Francis

WHEN tracing circuit faults this transistorised signal tracer will be found invaluable. It can be constructed with miniature components, thus making the unit very compact. Alternatively, standard size items may be used, and although they produce a comparatively larger unit it is not clumsy, owing to the fact that there are few components. An additional feature of this unit is the fact that it is transistorised and therefore

THIS COMPACT UNIT WILL BE FOUND INVALUABLE WHEN TRACING FAULTS

The Circuit

The signal tracer comprises a two stage resistance-capacity coupled amplifier using transistors. The method used to trace a fault is simple and consists of switching the unit on and placing the two input terminals on the appropriate points of the receiver under test. The diode section is switched in for tracing, e.g. either R.F. or I.F. circuits.

Fig. 1.—The circuit diagram.
(The lead from SW1 to C1 may be connected to the junction of D1 and C1 if desired to give D.C. isolation in the input circuit.)

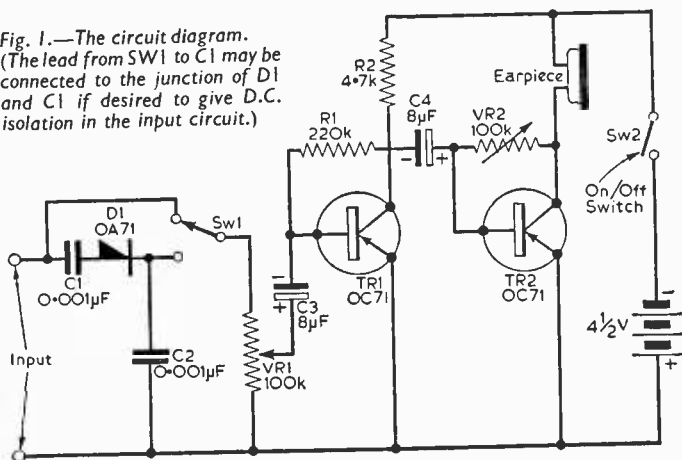

COMPONENTS LIST

Capacitors

C1 0.001 μ F C3 8 μ F 6V D.C.
C2 0.001 μ F C4 8 μ F 6V D.C.

Resistors

R1 220k $\frac{1}{2}$ W R2 4.7k $\frac{1}{2}$ W
VR1 100k (with SW2)
VR2 100k (preset)
D1 OA71
TR1 OC71
TR2 OC71

SW1 S.P.D.T. switch

4 miniature plugs and sockets

Baseboard

Suitable container

Miniature earpiece

4.5V battery

Transistor Holders

independent of any mains supply. The original model was built in a small plastic box, 2½ in. x 3 in. x 1½ in., the components being mounted on a piece of acrylic sheet. The sockets, system switch and VR1 and VR2 were mounted on the lid of the box, which may be any suitable piece of insulated material.

One adjustment is necessary however. The collector current of TR2 must be 3mA. This can be accomplished by first wiring the unit temporarily, inserting a meter in series with emitter of TR2 and adjusting VR2 until the meter reads 3mA. The meter is then disconnected and VR2 is locked.

A TOP-BAND TRANSISTOR TX

(Continued from page 224)

already drilled and tapped. The mounting of the rod is thus somewhat simplified. The headphone is mounted by means of four small screws on to one side of the case (which can be purchased from multiple stores in the form of a soap box). The sub-chassis is constructed of Perspex, and is mounted on the back of the headphone; it functions also as a clip to keep the transistors in place, and as a clip for keeping the oscillator transistor (Tr2) against the headphone for heat shunt purposes (see page 224).

The battery, too, is mounted by means of Terry clips on the same side of the case as the headphone, and thus every component (excepting the threaded aerial rod) is mounted on the other half of the case.

The aerial (a length of 8B.A. threaded rod) is mounted on the remaining half of the case, so that it comes in contact with one of the ferrite rod connecting clips (see Fig. 3).

Testing

First check that the battery is connected correctly. Check also that the transistors are inserted in their appropriate holders the correct way round.

The unit is switched on and placed about 15ft away from the receiver, which is tuned to a point on the top-band, and then the transmitter should be trimmed finally to the required frequency, on the same band. It should then be tested with modulation, and should be received up to a distance of at least 50ft.

For general radio work, the serious constructor requires some form of multimeter; this article will help you in

Designing Multimeter Circuits

By A. Foord

to suit your requirements

FOR general radio work, the serious constructor requires some form of multimeter. It is essential to be able to measure at least D.C. voltage and direct current. It is also desirable to be able to measure A.C. voltage and to be able to determine resistance. Some while ago the author required a fairly comprehensive meter. After a quick survey of the prices of good commercially available meters the author decided that a home-constructed meter had its advantages.

An outline will be given of the methods of converting meters to read different ranges, and of switching methods.

The Measurement of D.C. Voltage

A moving coil meter can be made to measure voltage by connecting a high value resistance in series with it; as shown in Fig. 1. In effect, the meter measures the current the battery can force through the resistance. In Fig. 1, R_m represents the meter resistance, R_s represents the series resistor, I represents the FSD (full scale deflection) of the meter, and V represents the applied voltage.

By Ohm's Law,

$$V = IR \text{ (where } R \text{ is the total resistance)}$$

$$\text{or } V = I(R_m + R_s) \text{ volts.}$$

$$\text{Thus } R_s = \frac{V}{I} - R_m \quad (1)$$

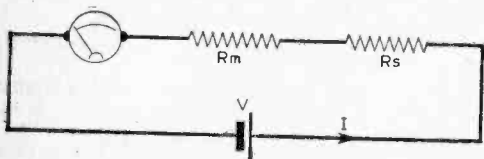
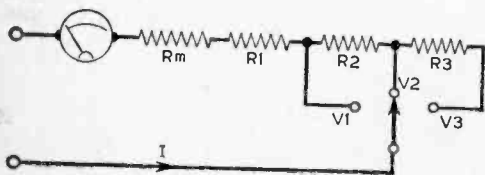

Fig. 1 (above).—Adding a resistance, R_s , in series with a moving coil meter enables it to be used to measure D.C. voltages.

Fig. 2 (below).—One method of switching resistors in series with a meter.



Where R_m is less than about 2 per cent of R_s , then R_m can be ignored for most purposes. On low voltage ranges, however, R_m should be taken into account. By means of equation (1), the value of R_s for any single range can be calculated. In multirange meters, a number of series resistors may be switched to provide the required ranges.

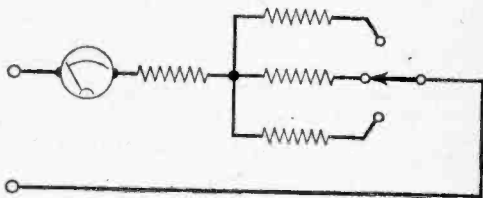

Fig. 3.—Alternative switching for series resistors.

Switching

Two methods of switching are available, as shown in Fig. 2 and Fig. 3. In Fig. 2, all the resistors are in series, while, in Fig. 3, separate resistors are used for each range. It should be noticed that in Fig. 2 the total series resistance for each range is made up of several resistors. In this case R_2 , say, has to drop $(V_2 - V_1)$ volts only.

$$\text{Thus, } R_2 = \frac{V_2 - V_1}{I} \Omega$$

In Fig. 3, each series resistor is calculated by means of equation (1).

The Measurement of A.C. Voltage

To measure A.C. voltage, it is necessary to place some form of rectifier in series with the meter. Normally, a bridge rectifier is used—as shown in Fig. 4. If the series resistors are calculated from Ohm's Law as in the previous case, then the meter reads average values of A.C. voltage. However, A.C. voltages are normally given in r.m.s. (root mean square) values.

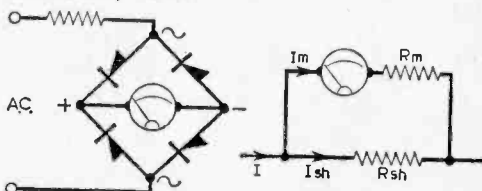

Fig. 4 (left).—The circuit of a bridge rectifier.

Fig. 5 (right).—Adding a resistance, R_{sh} , in parallel with a moving coil meter enables it to be used to measure direct current.

If the same resistors are used for A.C. and D.C. either a separate scale could be used for A.C. or a chart could be made up to show the A.C. r.m.s. values corresponding to particular meter readings. To avoid this inconvenience, it is desirable to use separate series resistors for A.C. and D.C.

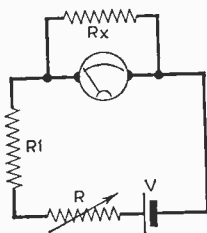

Fig. 6 (left).—For measurements of low resistance, the unknown resistor is shunted across the meter terminals.

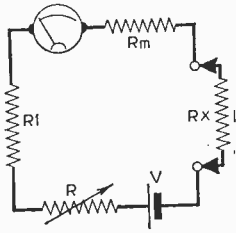

Fig. 7 (right).—For measurements of high resistance, the unknown resistor is wired in series with the meter.

For a sine wave:—

$$\text{r.m.s. value} = (\text{average value} \times 1.11) \text{ volts.}$$

It will be seen that for the meter to read r.m.s. values, more current will have to flow through the meter than before. For this to occur the D.C. value of the series resistor will have to be reduced.

Thus,

$$\text{A.C. resistor} = \frac{\text{D.C. resistor}}{1.11} \quad (2)$$

In using bridge rectifiers, there is one disadvantage: they are not quite linear. This means that when the rectifier forms a large part of the series resistances, the meter scale is not linear. For voltages of 10, or lower, the meter scale would have to be calibrated against known voltages.

The Measurement of Direct Current

A normal ammeter or milliammeter only measures one range. By placing a shunt across the meter the FSD can be altered. By bypassing a suitable fraction of the total current to be measured, any required range can be obtained. In Fig. 5, I_m is the current to flow through the meter,

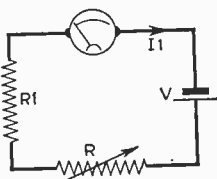

Fig. 8 (left).—Shorting out the R_x terminals in Fig. 7 enables the meter to be set to its FSD.

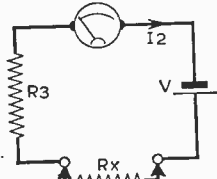

Fig. 9 (right).—When the meter has been set to FSD, R_x may be connected into circuit.

I is the total current to be measured, and R_{sh} is the shunt resistance. It will be seen from the diagram that the current to be measured (I) splits up into I_m and I_{sh} . Thus:—

$$I = (I_m + I_{sh})$$

$$\text{or } I_{sh} = (I - I_m).$$

It can also be seen that the P.D. across the shunt is the same as the P.D. across the meter.

Thus,

$$I_{sh} \cdot R_{sh} = I_m \cdot R_m$$

$$\text{or } R_{sh} = \frac{I_m \cdot R_m}{I_{sh}}$$

$$\text{but } I_{sh} = I - I_m$$

$$\text{Thus } R_s = \frac{I_m \cdot R_m}{I - I_m} = \frac{R_m}{I/I_m - 1}$$

If $I/I_m = N$ = number of times FSD is to be multiplied,

$$\text{Then } R_s = \frac{R_m}{N - 1} \quad (3)$$

The Measurement of Resistance

For low resistance measurements, it is usual to shunt the unknown resistor R_x across the meter, as shown in Fig. 6. For high resistances, the unknown resistor is placed in series with the meter, as shown in Fig. 7. In Fig. 6, the meter reads high for high resistance, and low for low resistance. A scale could be marked out by Ohm's Law, but it is better to calibrate a scale using known resistors. R_1 and R are used to set the meter to FSD before the unknown resistor is connected. The values of R and R_1 should be chosen so that it is only possible to pass just over FSD current through the meter. R is adjustable to compensate for the fall in battery voltage with use, and should be

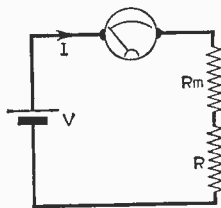

Fig. 10 (left).—The internal resistance of the meter may be found by using a known resistance, R , in series.

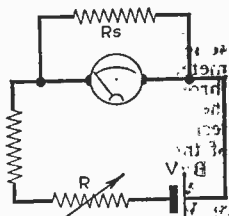

Fig. 11 (right).—Circuit for obtaining the correct shunts (see text).

about 10 per cent of the total resistance of the circuit.

In Fig. 7 the meter reads FSD for zero resistance, and zero for an infinitely high resistance. R and R_1 serve the same function as in Fig. 6. Again, it is better to calibrate the scale using known resistors. However, the calibration expected can easily be worked out in this case.

In Fig. 7, the R_x terminals are shorted out (see Fig. 8) and the meter adjusted to FSD by means of R . Then the total resistance in the circuit (R_3) is V/I_1 where I_1 is the FSD current. R_x is now connected into the circuit as shown in Fig. 9.

$$V = I_2(R_3 + R_x) \quad \text{where } I_2 \text{ is the current now read by the meter}$$

$$= I_2 \cdot R_3 + I_2 \cdot R_x$$

$$\text{Thus } I_2 \cdot R_x = V - I_2 \cdot R_3$$

$$\text{Therefore } R_x = \frac{V}{I_2} - R_3$$

$$\text{But } R_3 = \frac{V}{I_1}$$

$$\text{Thus } R_x = \frac{V}{I_2} - \frac{V}{I_1} \quad (4)$$

Practical Matters

It will be noticed that frequent mention has been made of the internal resistance R_m of the meter. This will normally be marked on the scale, but may be calculated if it is not marked. This can be carried out quite simply by placing a known resistor in series with the meter and a battery. As shown in Fig. 10, the current I can be read from the meter, and V and R are known. Thus only R_m remains unknown. For this method, R should be known accurately, preferably to within 1 per cent or 2 per cent, and should be of such a value that I cannot exceed the FSD current. It would be best to use as low a voltage as possible for V , so that R_m is an appreciable part of the total resistance in the circuit.

$$V = I(R_m + R)$$

$$\text{Thus } R_m = \frac{V - IR}{I}$$

$$\text{or } R_m = \frac{V}{I} - R$$

Once the internal resistance of the meter has been found, the calculations for D.C. voltage presents no difficulty. For A.C. ranges, however, the effect of the bridge rectifier has to be taken into account. Since this will depend on the meter, and on the rectifier used, the procedure is difficult. The best method would be to use a pre-set potentiometer for the lowest A.C. voltage range. This can be set so that the lowest range reads true (as compared with a known voltage). Once the lowest range has been set the others will automatically be correct. If desired, the resistance of the potentiometer could be measured and the nearest standard value inserted.

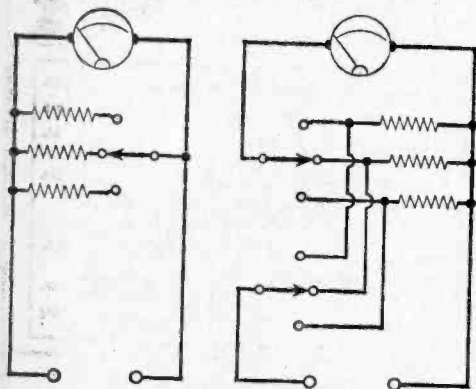

Fig. 13 (left).—A simple switching circuit for shunts which may endanger the meter or introduce errors.

Fig. 14 (right).—A circuit for switching shunts without risk to the meter.

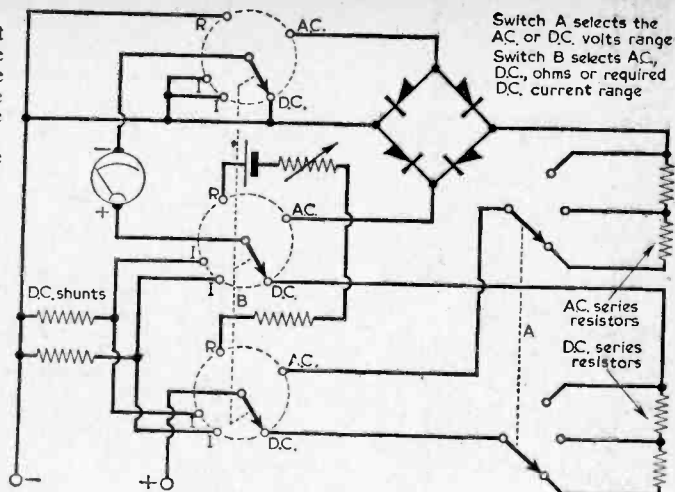

Fig. 12.—A complete multimeter switching arrangement which may be adapted to suit individual requirements.

Calibration

When calibrating the direct current ranges, the approximate value of the shunt resistor can be calculated using equation (3). Once the shunt resistor value has been calculated, the length of resistance wire can be found. In Fig. 11, with the shunt resistor disconnected, the resistor R can be adjusted until the meter passes FSD current. When R_s is connected, the current through the meter will fall, and the length of the shunt can be adjusted until the meter reading is correct for the new range.

The other D.C. ranges can be adjusted in a similar manner. The only disadvantage is that any errors will be accumulative. Where possible the highest current ranges should be checked against another meter.

Tolerances

For best results the series resistors for A.C. and D.C. should be 1 per cent or 2 per cent tolerance. The bridge rectifier could be one designed for meters; or four crystal diodes such as OA81's could be arranged in bridge form. Most constructors will be able to borrow some form of meter for a short while, and it is highly desirable to check all the ranges against a standard meter.

Final Design

In conclusion, Fig. 12 shows a switching arrangement which could be adapted by the constructor to suit any meter or desired ranges. The values for the series and shunt resistors, and for the ohms range, can be calculated from the formulae given above. It will be noticed that in Fig. 12, both the meter and the shunt are switched on direct current ranges. The reason for this will be clear from Figs. 13 and 14; in Fig. 13, if the switch became open circuit, the meter would pass an excessive current. In Fig. 14, however, it will be seen that if the switch became open circuit the meter would not be damaged. Switch contact resistance effects are also minimised.

PORTABLE RADIO OR CAR RADIO

PUSH-PULL SIX

(6 Ediswan Transistors plus 2 Diodes)

MEDIUM, LONG WAVE AND TRAWLER BAND EXTENDING TO 80 METRES WITHOUT COIL CHANGING



350 Mw XC101's push-pull output Transistors. Powerful magnet 3in. high grade speaker. Miniature push-pull transformers. This is a top performing receiver. Nearly 30 stations listed in one evening including Luxembourg loud and clear. A pleasure to listen to. **FERRITE ROD AERIAL.** All parts sold separately, including pale blue gleaming polystyrene case with duo-diffusion grilles in red. Uses 9 volt battery. Sockets for car aerial.

Build for **£6.19.6** P.P. 2/6. Size 6½ x 4½ x 1½in.

"Agreeably surprised with Trawler Bana reception. Luxembourg as loud as local. Your easy build diagrams helped a lot... my first attempt."—H.S., Penzance, Cornwall (poor reception area). "Super car radio."—L.B.V., Liverpool.

ALL PARTS SOLD SEPARATELY

TRANSONA-4

(4 Ediswan Transistors, plus 2 Diodes)

Miniature speaker. **FERRITE ROD AERIAL.** MW/LW and Trawler Band coverage down to 80 metres. On test tuned in over 30 stations. This sensational new radio is simple to build with our easy-build plans. Handsome pocket case.

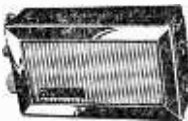

May be built for **65/-** P.P. 2/6.

NEW!

POCKET RADIO

(5 Ediswan Transistors and 2 Diodes)



MEDIUM, LONG WAVE AND TRAWLER BAND TO 80 METRES. Designed round super sensitive ferrite rod aerial and 3in. speaker. Home and Continental stations at your finger tips. Attractive 2-tone pocket size case in gleaming polystyrene. No aerial required, test receiver. Easy-build plans for beginners. Powered by 9 volt battery.

Over 30 stations listed separately. Total cost of parts required **£4.19.6** P.P. 2/6

ALL PARTS SOLD SEPARATELY

NEW PUSH-PULL FIVE

(MW/LW and TRAWLER BAND)
(5 Ediswan Transistors)



Now greatly improved Sensitive **FERRITE ROD AERIAL.** Pale blue polystyrene case with speaker grilles in red. Volume/sensitivity control. Noiseless compression tuning condenser. Miniature push-pull transformers. 350 Mw XC101's in push-pull. Sensitive R.F. stage for station selection.

Total building cost **£5.7.6** P.P. 2/6
ALL PARTS SOLD SEPARATELY

PUSH-PULL POCKET SIX

MEDIUM AND LONG WAVES AND 400 TO 750 METRES WITHOUT COIL CHANGING.

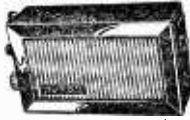

Sensitivity of a superhet. tonal quality of a TRF. Volume control. Tuning condenser. Latest type switches. Handsome two-tone pocket case. Ferrite rod aerial. 3in. quality speaker. Easy build diagrams. 6 Transistors (including Ediswan and Semiconductors) plus 2 diodes.

All parts **£5.19.6** P.P. 2/6
ALL PARTS SOLD SEPARATELY

NEW! EASY BUILD THREE RADIO

(3 Ediswan Transistors plus 2 Diodes)

Easy to build, easy to operate. This transistor radio operates over the M.W. and L.W. extending down to 80 metres without coil changing. Ferrite rod aerial, volume/sensitivity control. Sonotone high fidelity miniature earpiece or miniature speaker.



May be built for **49/6** P.P. 2/6

First-grade Miniature Push-pull Transformers.....pair	11/-
Ferrite Rod Aerial, M/L wave (7in.).....	8/6
Ferrite Rod Aerial, M/W (4in.).....	5/-
Transformers: 300 ohms primary, 5 ohms secondary. Brand new boxed.....	3/6
High Fidelity Headphones with miniature earpieces and transformer with lead and jack plug for high or low impedance, matching. Brand new. Boxed.....	25/-
Sensitive balanced Armature Headphones. Boxed. Brand new.....	pair 9/-
Sensitive 2½in. Speakers. Only ¾in. deep, 3 ohm.....	16/6

DATA SHEETS AND PARTS PRICE LIST FOR THE ABOVE 1/3 EACH

ALL PARTS SOLD SEPARATELY
AFTER SALES SERVICE

RADIO EXCHANGE COMPANY

27 HARPUR STREET, BEDFORD

PHONE 2367

(Opposite Co-op)

CLOSE 1 p.m. SAT.

Electronics (FLEET ST) Ltd

Dept. B

152-153 Fleet St., London, E.C.4. Tel. Flc 2833
Business Hours: Weekdays, 9-6, Saturdays 9-1

Stockists for
AMPLIFIERS, V.H.F. TUNERS, HI-FI SPEAKERS BY ALL THE LEADING MANUFACTURERS

The Transistor Set you "THE FLEET SIX" have been waiting for!

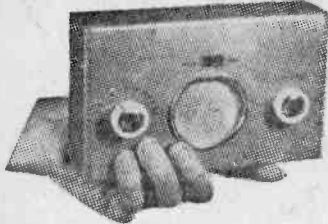

The Transistor Set you have been waiting for, the "Fleet 6," a wow of a transistor set that really gets the stations. New design 6 transistor superhet pocket receiver, using 6 guaranteed first grade transistors plus sensitive diode, push pull

output medium and long wave bands, new type printed circuit, high Q internal ferrite rod aerial, 2 1/2 in. high flux speaker, provision for car aerial, overall size 6 1/2 x 4 1/2 x 1 1/2. Simple to follow instructions. All components guaranteed, service after sales. This is equal to many manufactured sets at double the price. All components including cabinet, transistors, speaker, circuit, etc., only £8/19/6 complete, post and pkg. 2/6. PP4 Battery 2/- extra. Due to overwhelming demand from last month's advert, we have been able to reduce this receiver from £9/19/6. All components sold separately. Send S.A.E. for details. Circuit and Instructions 2/6 post free.

THE FLEET 6 PORTABLE TRANSISTOR RECEIVER

Using 6 guaranteed first grade transistors, sensitive diode, p/pull output, medium and long wave bands, printed circuit, high Q ferrite rod aerial, 6 x 4 high flux speaker. Provision for car aerial. Attractive 2 tone cabinet, overall size 10 1/2 x 8 x 1 1/2 in. Easy to follow instructions all components including cabinet, transistors, speaker, circuit etc. £9.19.6d. complete P. & Pkg. 3/6. Battery extra. All components guaranteed and sold separately. Send S.A.E. for details. Circuit and instructions 2/6 post free.



ANOTHER FAMOUS MANUFACTURER'S BARGAIN

COSOR 4 VALVE SUPERHET PORTABLE

Long and Medium wave bands, 5in. speaker, built-in frame aerial using Ever-Ready B126 90 volt H.T. and AD35 1 1/2 volt Batteries. Attractive 2-tone finish, dimensions 9in. x 8 1/2in. x 4 1/2in.

Original Price 15 gns.

Our Price £8/19/6. P. & P. 3/-.

Batts. 10/- extra.

Suitable mains unit to fit in place of batteries. Original Price 63/- Our Price 39/6 P. & P. 2/-.



RETURN-OF-POST SERVICE

We offer a really efficient Mail Order Service on all items stocked. All cash orders are dealt with on the day of receipt. Hire purchase orders are subject to slight delay but this is kept to the absolute minimum.

● LATEST TEST METERS

	Cash Price	Deposit	Hire Purchase Mthly/Pmts.
AVO Model 8	£24. 0.0	£4.16.0	12 of £1.15. 2
AVO Model 8 with leather carrying case	£27.18.0	£5.12.0	12 of £2. 0.11
AVO Model 7	£21. 0.0	£4. 4.0	12 of £1.10.10
AVO Model 7 with leather carrying case	£24.18.0	£5. 0.0	12 of £1.16. 6
AVO Multimeter with leather carrying case	£9.10.0	£1.18.0	12 of 14/4
TAYLOR Model 127A	£11. 9.0	£2. 5.0	12 of 17/-
CABY A10	£10. 0.0	£2. 0.0	12 of 15/-
CABY B20	£4.17.8	£1. 7.8	3 of £1. 6. 8
CABY A10	£6.10.0	£2. 0.0	3 of £1.13. 4

● GRAMOPHONE EQUIPMENT

ALL LATEST MODELS ALL POST FREE	Cash Price	Deposit	Hire Purchase Mthly/Pmts.
RECORD CHANGERS			
GARRARD RC210 (GC8 PU)	£9.19.8	£1.19.8	12 of 15/-
B.S.R. UA14 (TC8 PU)	£7.15.0	£1.11.0	12 of 12/-
B.S.R. UA8 (TC8 PU)	£7. 5.0	£1. 9.0	12 of 11/4
B.S.R. UA14 Mono (TC8 PU)	£7. 8.0	£1.16.0	12 of 13/6
SINGLE RECORD PLAYERS			
GARRARD TA (GC8 PU)	£8.10.0	£1.14.0	12 of 13/-
B.S.R. TU9 (TC8 PU)	£4.10.0	£1. 5.0	3 of £1.5.0
E.M.I. Acos Stereo (Mono PD)	£6.15.0	£1. 7.0	12 of 10/8
TRANSCRIPTION UNITS			
GARRARD JHF (GC8 PU)	£18. 8.0	£3.15.9	12 of £1.7.0
PHILIPS AG3009	£2. 2.0	£2. 2.0	12 of 15/8

Many of the above can be supplied for stereo working. See our Gramophone Equipment List for details.

● TAPE DECKS
All carriage free

	Cash Price	Deposit	Hire Purchase Mthly/Pmts.
B.S.R. T12	£8.19.6	£1.16.8	12 of 13/7
ARMSTRONG PAB33	£12.19.6	£2.12.8	12 of 19/-

Tape Pre-amp .. £16.18.0 £3. 8.0 12 of £1.4.7

All components in stock for the Mullard Tape "C" Pre-Amplifier Kit. Fully detailed list available.

● "BRAND FIVE" RECORDING TAPE

Long Play: 600ft (5"), 18/8; 1200ft (5 1/2"), 23/6; 1800ft (7"), 35/6; Double Play: 1200ft (5"), 37/8; 2400ft (7"), 60/- (All Post Free)

● JASON FM TUNER KITS

Complete with Valves

Standard Tuners: FMT1, £8.19.8; Power Pack, £2.12.6; FMT2, less power supply, £8.9.6; with power supply, £10.8.6. Fringe Tuner: FMT3, less power supply, £10.9.8; with power supply, £12.7.6. FM/TV Switched Tuners: JTV2, £15.17.6; Mercury 2, £11.7.8. (Important. When ordering JTV2 and Mercury 2 kits it is essential to give TV Channel required.) Hire Purchase terms available. Instruction manuals available separately if required. Data Booklets for FMT1, FMT2 and FMT3, 2/10. JTV2, 3/10. Mercury 2, 3/10. All post free.

● OUTPUT TRANSFORMERS

GILSON: W0696A, W0696B, 50/6, post 2/-; W0710, W0710/8K, 55/6, post 2/-; W0822, 62/3, post free; W0767, 27/-, post 1/6.
P.A.I.R.I.D.G.E.: P3667, 52/6, post 2/-; P4014, 98/6, post free; P4131, 60/-, post free; P3551A, 99/-, post free; P5202, P5203, 95/-, post free.
P.A.R.M.E.K.O.: P2641, 28/-, post 1/6.

● LOUDSPEAKERS

GOODMANS: Axiom 110 10in. £5.0.0; Axiom 112 10in. £8.10.0; Axiom 114 12in. £6.12.1; Axiom 300 12in. £11.5.8; Axiom 400 12in. £16.1.0; Audion 60 Bass, 12in. £9.12.9; Trebas Tweeter £6.4.0; CX300 Cross-over unit £1.19.0.
WHITELEY: HF 1016 10in. £8.0.0; HF 1012 10in. £5.0.0; HB816 8in. £6.17.3; TB16 8in. £8.10.0; T10 Tweeter £4.8.3; T339 Tweeter £1.5.9; CX3000 Cross-over unit £1.11.6; CX1500 Cross-over unit £2.0.0. H.F. Terms available.

● AMPLIFIER KITS

We have full stocks of all components for the Mullard Stereo, Mullard 510, Mullard 3-3, Mullard 2 and 3 Valve Pre-amps, GEC 912 Plus. Fully detailed list on any of these sent upon request.

Instruction Manuals: All Mullard Audio Circuits in "Circuits for Audio Amplifiers" 9/5. GEC 912, 4/6. All post free.

● **ILLUSTRATED LISTS are available on LOUDSPEAKERS, TAPE DECKS, TEST GEAR, RECORDING TAPES, GRAMOPHONE EQUIPMENT AMPLIFIER KITS, MULLARD CATHODE RAY TUBES.** Any will be sent free upon request.

● TERMS OF BUSINESS

Cash with order or C.O.D. We charge C.O.D. orders as follows. Up to £3, minimum of 28. Over £3 and under £5, 1/8. Over £5 and under £10, 1/8. Over £10, no charge. Postage extra on CASH orders under £3 except where stated. Postage extra on Overseas orders irrespective of price.

WATTS RADIO (MAIL ORDER) LTD.
54 CHURCH STREET, WEYBRIDGE, SURREY
Telephone: Weybridge 4556
Please note: Postal business only from this address.
Please note: Closed for Annual Holidays AUG. 11th-26th

Trade News

NEW PRODUCTS AND DEVELOPMENTS

XENON-FILLED GRID-CONTROLLED RECTIFIER

THE Ediswan 21B12 is a Xenon-filled valve designed for ignition control in welding equipment, motor control duty, or as a straight grid-controlled rectifier.

The Ediswan 21B12 is a direct replacement for the American C3JA and conforms to joint Army and Navy specification. The disc-sealed construction of the valve offers a number of advantages: it is mechanically robust, the electrical characteristics are maintained to closer limits, the risk of backfiring is reduced, and the valve life is increased.

Direct heating of the valve, coupled with the use of Xenon gas for filling reduces the heating time to approximately 30 seconds. The 21B12 is now available from *Industrial Valves and Cathode Ray Tubes Department, A.E.I. Radio and Electronic Component Division, 155, Charing Cross Road, London, W.C.2.*

TAPE TRANSCRIPTOR

AMONG other exhibits at this year's R.E.C.M.F. Exhibition, Collaro Ltd. had on show the latest version of the "Studio" Tape Transcrip-tor. This is a three-speed deck (1½, 3½, and 7½ in./s) with either half or quarter track magnetic heads, giving a frequency response of 50 to 12,000c/s at

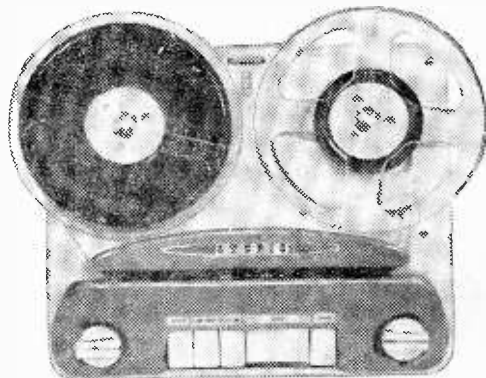

The "Studio" tape transcrip-tor made by Collaro Ltd.

7½ in./s. plus or minus 3dB with suitable equalisa-tion. *Collaro Ltd., Ripple Works, By-Pass Road, Barking, Essex,* produce this tape transcrip-tor.

NEW MAINS RADIO

CONTEMPORARY styling is the main feature of a new table model receiver made by Philips Ltd. This set, the 2205U, replaces the model 204U, and includes some internal refinements which makes servicing easier.

The tuning system has been adapted for control from the outside band rather than the centre button. The receiver works on A.C. or D.C. between 200 and 250V and is made by *Philips Electrical Ltd., Century House, Shaftesbury Avenue, London, W.C.2.*

PORTABLE RECORD PLAYER

A NEW four-speed record player, manufactured by Electronic Ades Ltd., uses for its operation the amplifying sections of any radio receiver or tape-recorder that is convenient. The "Super Ten" as the record player is called, is connected either to a radio or a tape recorder by a lead supplied by the makers.

The high impedance crystal cartridge pick-up has a response of 30 to 8,000c/s. The player is housed in a lightweight case of small dimensions and weighs about 5lb. The "Super Ten" costs £7 19s. 0d., and is made by *Electronic Ades London Ltd., Alpha Road, Teddington, Middlesex.*



The "Super Ten" record player uses the amplifying section of radio sets or tape recorders for reproducing music.

TRANSISTOR TESTER

THE T.T.I. transistor tester from Advance Components Ltd., has been specially designed for testing low and medium power transistors while still in circuit. This not only saves considerable time, but eliminates the risk of physical damage, particularly to printed circuit boards.

Grounded emitter current gain may be measured in or out of circuit and leakage current (grounded emitter) with the transistors out of circuit.

The tester is battery operated and provision is made for checking the condition of the batteries. The tester is made by Advance Components Limited, Hainault, Essex.



This instrument from Advance Components Ltd. checks transistors in circuit.

PORTABLE RECEIVER

THE "Sky Captain" is a new battery portable receiver made by Ever Ready Ltd. It is powered by a B141 battery which combines 90V H.T. and 1½V L.T.

The receiver is a 4-valve superhet with a printed circuit. The loudspeaker is a 4in. highly sensitive moving coil type. The price of this receiver is 9 guineas and is made by Ever Ready Ltd., Hercules Place, Holloway, London, N.7.



The Brenell Engineering Co. Mk. 5, Type "M" tape recorder.

PORTABLE TAPE RECORDER

THE Mk 5 Type "M" tape recorder, which is made by the Brenell Engineering Co. Ltd., has improved frequency response over the earlier Mk 5. The amplifier response is from 40c/s to 40,000c/s.

It has superimposing and mixing facilities, a recording level meter and an adjustable rotary tape guide. The Mk 5 is made by the Brenell Engineering Co. Ltd., 1a Doughty Street, London, W.C.1 and costs 88 guineas.

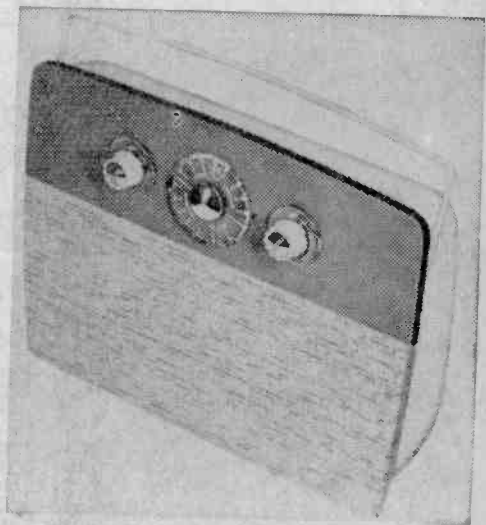

The "Sky Captain" portable radio made by Ever Ready Ltd.



**A NEW-PRACTICAL WAY
of UNDERSTANDING**

Radio • Television • Electronics

Including: Transistors; VHF/FM; Hi-Fi equipment; Computers; Servo-mechs; Test Instruments; Photo-electrics; Nucleonics, etc.

FOR ... Your Career ... Your Own Business ... An Absorbing Hobby

Radiostructor—an organisation specialising in electronic training systems offers a new self-instructional method using specially designed equipment on a "do-it-yourself" basis. You learn by building actual equipment with the big kits of components which we send you. You advance by simple steps, performing a whole series of interesting and instructive experiments—with no complicated mathematics! Instructional manuals employ the latest techniques for showing the full story of electronics in a practical and interesting way—in fact—you really have fun whilst learning! Post the coupon below, now, for full details.—

RADIOSTRUCTOR

**LEADS THE WORLD
IN ELECTRONICS TRAINING**

POST NOW

To RADIOSTRUCTOR (Dept. G82)
READING, BERKS.

Please send brochure, without obligation, to:

★ Name _____

Address _____

7/61

★ BLOCK CAPITALS PLEASE
(We do not employ representatives)



another NEW instrument
from Salford, the
minitest
POCKET-SIZED MULTIRANGE TEST SET

A new compact instrument suitable for the measurement of D.C. voltages and currents, A.C. voltages and ohms. Its high sensitivity renders it suitable for testing and fault location in all types of electrical and electronic circuits. It is well built to ensure long and satisfactory service. The instrument is economically priced and supplied with test leads with plug connections at one end. (Leather carrying case available as an extra).

RANGES: A.C. Volts. 2.5, 10, 25, 100, 250, 1000.
D.C. Volts. 2.5, 10, 25, 100, 250, 1000.
D.C. Amps. 50 μ A, 1mA, 10mA, 100mA, 1A.
Ohms. 2000 200,000 20 M Ω

ACCURACY: D.C. Volts & Amps. $\pm 2\%$ of full scale deflection
A.C. Volts $\pm 3\%$ of full scale deflection
 $\pm 5\%$ at centre scale.

Send for leaflet MIN/6009/PW

neat and compact, with large instrument performance

SALFORD ELECTRICAL INSTRUMENTS LIMITED
Peet Works · Silk Street · Salford 3 · Lancs · Tel: Blackfriars 6688
London Sales Office: Magnet House, Kingsway, W.C.2. Tel: Temple Bar 4668
A Subsidiary of THE GENERAL ELECTRIC CO. LTD. OF ENGLAND

SEI

★ **POST HASTE** ★
JASON F.M. TUNER KITS

We are the authorised Jason dealer and the whole kit is as supplied by them.

FMT1	Standard variable tuner, complete with valves	£6.17.6
	Hire purchase deposit £1.7.6 and 6 monthly...	£1. 1.8
FMT1	Power pack ready drilled chassis, complete...	£2.12.6
FMT2	Shelf mounting, less power supplies, complete	£7.17.6
	Hire purchase deposit £1.11.6 at 6 monthly...	£1. 4.4
FMT2	As above, but with power supplies, complete	£9.15.0
	Hire purchase deposit £1.19.0 and 6 monthly...	£1. 9.4
FMT3	Fringe model, less power supplies, complete	£9.12.6
	Hire purchase deposit £1.18.6 and 6 monthly...	£1. 9.0
FMT3	As above, with power supplies, complete ...	£12. 0.0
	Hire purchase deposit £2.8.0 and 8 monthly...	£1. 6.6
Mercury 2	Switched tuner with A.F.C. TV sound ...	£10.15.0
	Hire purchase deposit £2.3.0 and 8 monthly...	£1. 4.0
JTV/2	As above, but shelf mounting and powered...	£14.15.0
	Hire purchase deposit £2.15.0 and 12 monthly...	£1. 2.0

The Instruction Book is included in all kits.
REQUIRED CHANNELS MUST BE SPECIFIED FOR SWITCHED TUNERS

Instruction Book for FMT1, FMT2, and FMT3, 2/6. Mercury 2 and JTV/2, 3/6.

A more detailed list can be sent upon request.

ALL JASON TUNERS ARE ON DEMONSTRATION
ALL THE ABOVE TUNERS ARE ALWAYS IN STOCK

SURBITON PARK RADIO
(Established over 30 years)
48 SURBITON ROAD,
KINGSTON UPON THAMES, SURREY

Telephone: KIN 5549

Hours: 9 a.m. to 6 p.m. 1 p.m. Wed.

We do not close for lunch
Open all day Saturday

★ **POST FREE** ★

TRANSISTORS

OCC44 Mixer 12/- OC71 Audio ... 8/6
OC45 I.F. ... 12/- OC72 Audio ... 8/6

All Brand New Mullard and Not Sub-Standard.

Matched pairs of OC71 and OC72 can be supplied at no extra cost.

"PRACTICAL WIRELESS"
POCKET SUPERHET

Osmor printed circuit version. Osmor Rod Aerial, 10/-, I.F.T.s and Osc. Coils, 22/6. Osmor Driver 11/6. Osmor Output, 10/6. Set Mullard Transistors, 61/6. J.B. Gang, 11/-, Trimmers, 2/8 pr. Set Condensers, 15/-, Resistors, 6/6. Ardent Vol. Control, 10/6. Ardent W/C, 3/6. Speaker, 19/10. OAB1 diode, 4/-, Hardware, 4/6. Printed Circuit, 9/-, Case and Knob, 7/6. PP4 Battery, 2/-. Leaflet illustrated, giving full instructions and constructional details, 1/9.

All the above components, if purchased at one time £9.19.6

WEYRAD P50 Coils and transformers for a dual wave transistor Superhet, with printed circuit and ferrite rod aerial. Long and medium wave aerial RA2W, Osc. coil P50/1AC, 1st and 2nd I.F. Transformers P50/2CC, 3rd I.F. transformer P.50/3CC, Driver transformer LFDT2. Printed circuit PCAL. Constructors' Booklet 2/3. The above WEYRAD set with book, £2.16.0.

COLLARO STUDIO DECK. List price £17.10.0, OUR PRICE £12.19.6. Hire purchase deposit £2.19.6 and 8 monthly 17/6.

WE PAY ALL POSTAGE AND INSURANCE
ALL ORDERS DESPATCHED SAME DAY
MONEY WILL BE REFUNDED IF REQUESTED

Phase Splitters and Phase Reversers

By J. B. Dance

CIRCUITS FOR AUDIO AMPLIFIERS AND OSCILLOSCOPES

THE circuits to be discussed in this article enable two balanced push-pull voltages to be obtained from a single (unbalanced) input voltage. When one of the output voltages from a phase splitter becomes momentarily more positive, the other output voltage becomes more negative by the same amount. These two voltages feed a following push-pull amplifier. The design of phase splitter circuits is closely connected with the requirements and design of the following push-pull stages themselves.

Why Push-pull?

Push-pull amplifiers are widely used in high fidelity audio amplifiers which have a large power output for the following reasons:—

(1) There is no steady magnetic flux in the output transformer, because the flux

Fig. 1 (right).—A push-pull input transformer.

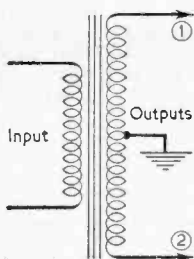

due to the D.C. currents through the output valves cancels in the transformer; this considerably eases the problems of transformer design and efficiency.

(2) Even harmonic distortion (second, fourth, sixth harmonics, etc.) is cancelled out in the output stage.

(3) No A.C. of the signal frequency flows through the power supply. A small reservoir condenser is therefore satisfactory, as a low impedance power supply is unnecessary.

(4) Less smoothing is required, as any hum voltage on the H.T. line will not appear in the output.

(5) It is a convenient method of obtaining at least twice the output power than could be obtained from a single valve of the same type.

Oscilloscopes

Push-pull amplifiers are also used to feed the deflector plates of the cathode ray tubes used in oscilloscopes. As the potential of one of the plates rises with respect to earth, the potential of the other plate falls by the same amount so that the average potential of the two plates remains constant. If one of the deflector plates were to be kept at a constant potential with respect to earth, whilst the other was connected to the output of a single valve amplifier, the oscilloscope pattern would be distorted ("trapezium distortion") owing to a change in the deflection sensitivity with the average deflector plate voltage. Push-pull operation also enables a voltage output to be obtained which is twice the maximum obtainable from a single valve under the same conditions.

Balance

If full advantage is to be taken of push-pull operation, it is necessary that the two sections of the push-pull amplifier shall be reasonably closely balanced. That is, the signal currents and voltages in any part of one section of the amplifier must be as close in value as possible to the corresponding current or voltage in the other section, or otherwise the even harmonic distortion will not cancel and currents of the signal frequency will flow in the power supply circuit. It is necessary that the phase splitter shall provide two accurately balanced voltages over the whole frequency range for which it is designed, and that the two succeeding sections of the push-pull amplifier shall give the same gain.

Unbalance can be classified into two types. The first type consists of ordinary amplitude unbalance and can easily be corrected by a suitable choice of resistor values. The second type of unbalance occurs when voltages and currents which are 90° out of phase with the signal voltage exist in one half of a push-pull amplifier. This is known as phase quadrature unbalance or, more briefly, phase unbalance. It cannot be corrected merely by altering the gain of one of the sections of the push-pull stage or by any other simple method. Phase unbalance is caused by currents flowing through coupling or decoupling condensers.

Transformer Method

Audio transformers were widely used for inter-stage coupling about twenty to thirty years ago instead of the resistance capacity coupling which

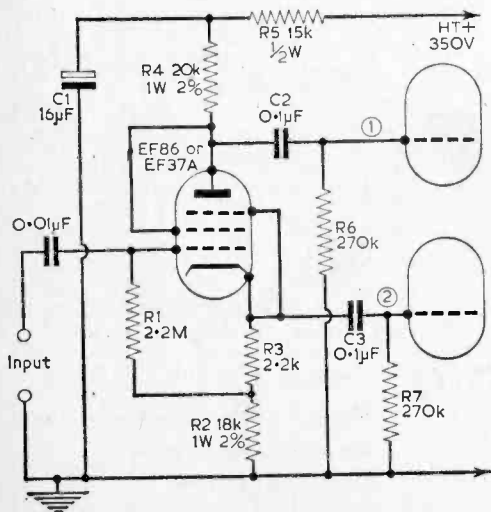
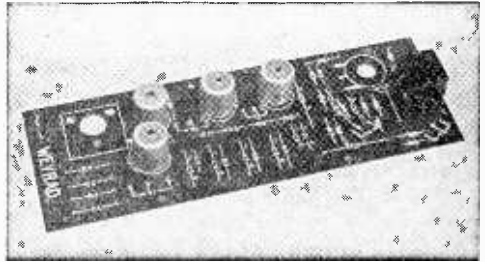

Fig. 2.—The "concertina" phase splitter.

WEYRAD

COILS AND TRANSFORMERS FOR A 2-WAVE TRANSISTOR SUPERHET WITH PRINTED CIRCUIT AND FERRITE ROD AERIAL

- LONG AND MEDIUM WAVE AERIAL—RA2W
On 6 in. rod, $\frac{7}{16}$ in. diameter, connections to
6-Tag Ring, 208 pF tuning 12/6
- OSCILLATOR COIL P50/1AC
Medium wave in screening can. For 176pF
tuning condenser 5/4
- 1st AND 2nd I.F. TRANSFORMERS—P50/2CC
470 Kc/s operation with 250 pF tuning in cans.
 $\frac{1}{8}$ in. diameter by $\frac{3}{4}$ in. high 5/7
(2 REQUIRED)
- 3rd I.F. TRANSFORMERS—P50/3CC
Last stage transformers to feed diode detector.
Size at P50/2 6/-
- DRIVER TRANSFORMER—LFDT2
Upright mounting with six connecting tags—
 $1\frac{5}{8}$ in. x $\frac{7}{8}$ in. x $1\frac{3}{4}$ in. 9/6



PRINTED CIRCUIT—PCA1

Size $2\frac{3}{4}$ in. x $8\frac{1}{4}$ in. Ready drilled and printed with component positions 9/6

THESE COMPONENTS ARE APPROVED BY TRANSISTOR MAKERS
AND PERFORMANCE IS GUARANTEED.

Constructor's Booklet with full details, 2/-.

WEYMOUTH RADIO MANUFACTURING CO., LTD.

CRESCENT STREET, WEYMOUTH, DORSET

CODAR "CLIPPER" ALL BAND RECEIVERS 10-2000 METRES

LISTEN TO AMATEURS, AIRCRAFT, SHIPPING, SHORT, MEDIUM, LONG WAVE BROADCAST STATIONS
THROUGHOUT THE WORLD

THE MINI-CLIPPER

39/6

The miniature valve radio with the BIG SET features! Covers all Short, Medium, Long waves 10-2000 metres (5 coils). Smart all satin silver ali. front panel with engraved dials, etc. Ball bearing, air spaced variables. Size only $6\frac{1}{2}$ x $3\frac{1}{4}$ x 4 in. Battery lasts months. No drilling. Total building cost including punched chassis, valve, front panel. One coil for 20-60 metres, nuts, bolts, wire, Step-by-step pictorial plans, 39/6. P. & P. 2/-.

Additional coils and electrical bandspread optional extras. Parts sold separately. Full plans, parts list, 2/-.



THE SUPER CLIPPER 88/6

This world famous hybrid receiver has achieved remarkable success. Tremendous performance with Hi-gain valve detector PLUS two Ediswan transistor amplifiers which are supplied assembled, only 3 wires to connect! Large precision dial, 7 x 4 in., with 2 pointers, bandset and bandspread, dual slow motion drives, air spaced variables. Punched chassis: 8 x 5 1/2 in. Batteries last months. Covers 10-2000 metres (5 coils). Total building cost including chassis, valve, 2 transistor stages, 2 coils 20-60 and 55-190 metres. Step-by-step pictorial plans, nuts, bolts, wire, 88/6. P. & P. 2/6.



THE CLIPPER. As above but one transistor stage, 79/6. P.&P.2/6. Optional Front Panel, Silver Hammer finish, all holes, 6/9.

THE CLIPPER CR 45

£6.17.6



This A.C. Mains receiver is the latest model in the famous CLIPPER Series and combines really top performance with superb professional finish. It is the finest ALL BAND receiver at the price with a new high gain circuit using ECC81 double triode, EL84 output, EZ80 full wave rectifier. Power output $3\frac{1}{2}$ watts for 2/3 ohm speaker. Covers 10-2000 metres (5 coils). World wide reception. Outstanding features include 3 planetary slow motion drives, separate electrical bandspread, air spaced low loss variables, satin silver dials, black crackle front panel. Total building cost, including 10 x 5 1/2 in. punched chassis, valves, front panel, 2 coils 20-60 and 55-190 metres, nuts, bolts, wire, etc., 10 pages pictorial plans, £6.17.6. P. & P. 3/6.

Modern styled cabinet, rear panel, black crackle, 27/6. Parts sold separately. Full plans, parts list, 3/-. Speaker cabinet, matching black crackle 8 x 6 x 5 in. for all makes 5 in. units, 18/6. P.P. 2/-.

No technical knowledge is required to build these fine receivers. Only new guaranteed components are supplied. Send 3d. stamp for illustrated leaflets, testimonials. Suppliers to Educational Authorities, Government Departments, etc.

CODAR RADIO COMPANY, COLEBROOK ROAD, SOUTHWICK, SUSSEX

(Continued from page 242)

to approximately ten times R_1). The coupling capacitor on the input side of the phase splitter can therefore be about one-tenth of the usual value. When the component values shown in Fig. 2 are used, the input impedance will be about twenty megohms.

The output impedance is much higher at the anode than at the cathode, but in actual practice this is of no importance, as it does not affect the balance.

The amount of unbalance at high frequencies owing to stray capacities is negligible at 15kc/s (assuming the two sections of the following push-pull amplifier are similar), but the decoupling condenser, C_1 , should be $8\mu\text{F}$ or more if low frequency phase unbalance is to be kept small. R_5 should be fairly large, but not large enough to reduce the anode voltage too much.

A triode or triode-connected pentode is almost always used in the cathode follower phase splitter, as a pentode would require a screen supply which would have to be decoupled to the cathode, and this would be likely to cause unbalance at the ends of the frequency range.

If a bypassing condenser is connected across R_3 , then R_2 should be increased to equal R_4 , and the cathode output should be taken from the junction of R_2 and R_3 .

Hum

The concertina phase splitter is liable to introduce a very small amount of hum, but it will not be possible to detect this unless the phase splitter is followed by a fairly high gain amplifier. The principal cause of the hum is that the cathode is at a higher potential (about 100V) than the heater owing to the large value of cathode resistor; electron emission can, therefore, occur from the heater to the cathode. The hum can usually be greatly reduced by operating the valve from a separate heater supply insulated from the chassis and kept at about the same potential as the cathode (approximately +100V with respect to the chassis).

Care must be taken that the cathode resistor is not too large or the maximum heater-cathode voltage rating of the valve may be exceeded.

Output Voltage

The audio voltage obtainable from either output without distortion varies with the H.T. supply voltage, but is about half that which can be obtained from the same valve used in a normal amplifier circuit with an anode resistor of value twice R_4 and with the same H.T. voltage. This is because in this phase splitter circuit one valve supplies both outputs. When the voltage across C_1 is 200, the maximum peak voltage from each output is about 15 for 2per cent distortion, but this increases as the voltage across C_1 is increased. Unless the H.T. voltage is high, this type of phase

splitter will not be capable of driving a pair of large output valves such as KT66's. A push-pull amplifying stage is almost always required between the phase splitter and the output valves (as in the Williamson amplifier), or appreciable distortion will be found at large audio outputs. This require-

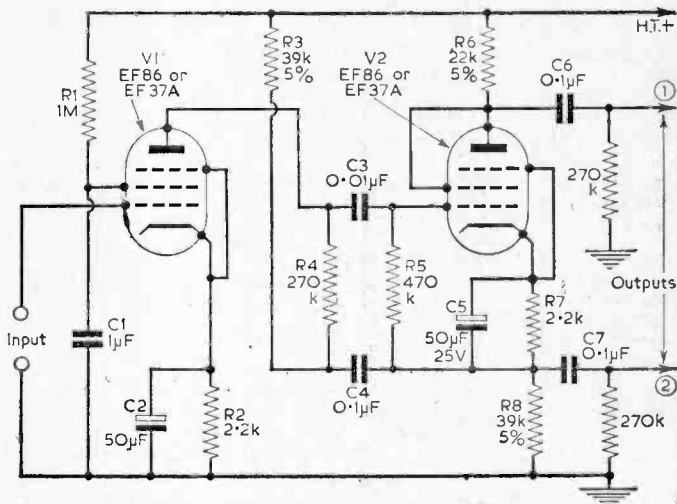

Fig. 4.—A high gain amplifier with a phase splitter.

ment increases the number of stages which are needed and is one of the principal reasons why this type of phase splitter (or modifications of it) is not used in most modern equipment.

Direct Coupling

The grid of the concertina phase splitter can be directly coupled to the anode of the previous stage as shown in Fig. 3, this circuit being part of the Williamson amplifier. Besides avoiding the cost of the three coupling components, the direct coupling eliminates any phase shift; this is very advantageous if the circuit is within a negative feedback loop. The very slight unbalance due to the flow of current from the input through R_1 of Fig. 2 is also avoided.

The current through the valve automatically adjusts itself so that the voltage across the cathode resistor of $V_1(b)$ is a few volts more than the positive voltage applied to the grid of $V_1(b)$. This few volts difference constitutes the bias voltage. Any increase in the voltage applied to the grid causes an increase in the cathode voltage; thus the bias is stabilised.

Increased Gain

As mentioned previously, the use of the concertina phase splitter causes a slight loss in voltage. Increased gain may be obtained when the circuit of Fig. 3 is used by connecting a suitable resistor from the cathode of $V_1(a)$ to a tapping on the cathode resistor of $V_1(b)$ so as to introduce some positive feedback.

Another circuit (Fig. 4) enables increased amplification to be obtained, not from the phase splitter itself, but from the preceding stage. It

utilises the high input impedance of the cathode follower phase splitter as a load on an EF86 pentode stage so as to obtain a gain of well over 1,000. If the pentode had been connected by an ordinary resistance capacity coupling to the phase splitter, the gain would have been a little less than that of the pentode alone—approximately 100. The second pentode is, of course, triode-connected.

Such circuits have been used to feed a pair of KT66's directly without an intermediate push-pull voltage amplifying stage, but appreciable distortion would probably occur in the phase splitter if an attempt were made to operate the KT66's at their maximum rated output. There is slight unbalance in the circuit, as the sum of the alternating

first valve alone. There is quite a variety of phase reversing circuits; they are also known as para-phase amplifiers.

Simple Phase Reverser

A typical circuit which has often been used in the past is shown in Fig. 5. The first valve is a normal amplifying stage providing one of the push-pull outputs. A portion of the output from V1 is tapped off by the potential divider R3, R4 and fed into V2 which functions as an ordinary resistance capacity coupled amplifier. The output of V2 is of opposite phase to its input and therefore serves as the other output voltage. R3 and R4 are chosen so that the two push-pull outputs are equal in amplitude.

A rather better high frequency response can be obtained by using a tapped anode load resistance instead of the tapped grid resistance. The input to V2 is taken from the tapping on the anode load. The position of the tapping must be chosen so that the two outputs are equal in amplitude. The cathode resistor is not bypassed, as the signal currents in the two valves should be equal and opposite; if they are not, the omission of this capacitor helps to balance the stage, provided that the two valves are of the same type.

Disadvantages

The balance of either of these two circuits is critically dependent on the valve characteristic of V2, the position of the tapping point and the value of the anode load resistor of V2. The position of the tapping point requires adjustment for accurate balance when the amplifier is first made, whenever V2 is replaced, and from time to time during use to compensate for valve and resistor ageing. A pre-set potentiometer is therefore used as one of the resistors from which the tapping is taken.

There is serious phase unbalance at low frequencies owing to the presence of C2 in one channel and not in the other. Similarly there is considerable high frequency phase unbalance owing to the valve capacities.

Advantages

The above disadvantages prevent the circuit of Fig. 5 from meeting the requirements of a modern high fidelity amplifier, but there are nevertheless two advantages over the cathode follower phase splitter circuit. In the circuit of Fig. 5, each valve provides only one output and therefore each of the output voltages can be twice as great as when a cathode follower phase splitter is used. Phase reversers can therefore usually drive power valves direct without any intermediate stage of push-pull voltage amplification. In addition, phase reversers do not have the large heater-cathode voltage which is found in the cathode follower phase splitter circuits.

In order to remove the disadvantages of the simple phase reverser, it is necessary to introduce feedback which will preserve the balance of the stage over the whole frequency range and at the same time vastly reduce any changes in gain of the phase reversing stage when the valve characteristics change.

(To be continued)

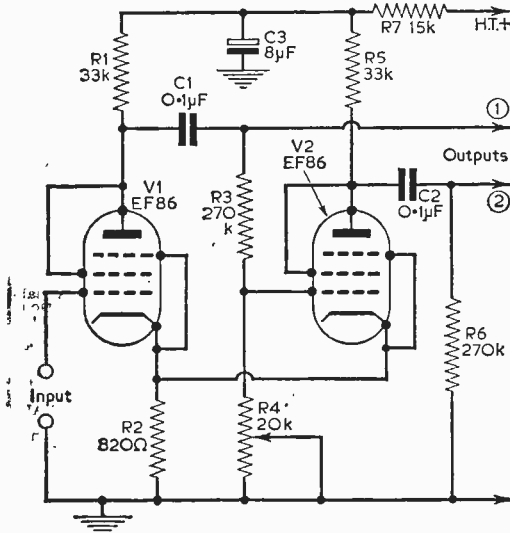

Fig. 5.—A phase reverser with a preamplifier.

anode currents flows in the cathode load of V2 (R8 and R3), whilst only the alternating anode current of V2 flows in the anode load of this valve (R6). The unbalance is, however, only about 1 per cent of the signal voltage. R7 is bypassed to increase the input resistance of the stage. The cathode load of V2 is R3 and R8 in parallel (each 39k) as far as signal frequencies are concerned, whilst R6 (22k) forms the anode load. This circuit gives more gain than any other two valve phase splitter. Various forms of it have been used in many amplifier designs.

The cathode follower phase splitter is an excellent circuit which has been used in many high quality amplifiers.

Phase Reversers

In phase reversing circuits the input voltage is used as one of the output voltages and is also applied to a valve circuit which reverses the phase whilst not affecting the amplitude. Such circuits are usually drawn as two valve circuits, but the first valve is actually an ordinary amplifying stage which takes no part in the phase inversion. The amplification is equal to that of the

CLYNE RADIO LTD

THE COMPONENT SPECIALISTS

18 TOTTENHAM COURT ROAD, W.1
162 HOLLOWAY ROAD, LONDON N.7
9 CAMBERWELL CHURCH STREET, S.E.5

MUSEum 5929/0095
NORTH 6295/617
RODney 2875

All post orders and correspondence to 162 HOLLOWAY ROAD, LONDON N.7

NEW! "CITIZEN"

Introducing our new Super-Sensitive 5-Stage (4 transistor plus diode) pocket transistor receiver—for full medium wave reception—with the following outstanding features:

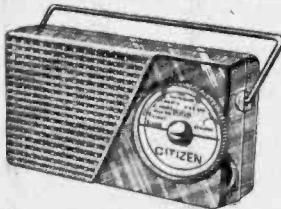

Only
95/-
Plus
2/6
P & P

- ★ Completely self-contained—No external aerial or earth required.
- ★ Genuine 24in. High Flux P.M. Speaker.
- ★ Push-pull output—250 milliwatts.
- ★ Genuine Ediswan transistors.
- ★ Socket provided for personal listening.
- ★ Socket provided for connection to Car Aerial.
- ★ Volume Control with on/off switch—Condenser tuning.
- ★ Easy assembly on colour coded pre-tagged circuit board.
- ★ Attractive red polystyrene cabinet measures 8 1/2 x 3 x 1 1/2in. chrome handle, attractive dial. All required components including full instructions, solder, etc. and battery at special inclusive price of only 95/- (Yes, Ninety-Five Shillings Only!) Plus 2/6 P. & P. Nothing more to spend. Suitable crystal dead-aid type miniature earpiece fitted with miniature jack plug at 7/6 extra only! If req. All parts available separately—Itemised list and full assembly instructions, sent for 1/6 post free. Hear this amazing little receiver working at any of our branches.

JUST ARRIVED! NEW!

LIGHT-WEIGHT HIGH RESISTANCE HEADPHONES. 4,000 ohms, adjustable headband, brand new. Limited quantity at 13/6 per pair, plus 1/- P. & P.

SMALL SOLDERING IRON.

Complete with tinny! Carrying case, mains lead and 2 pin plug. A.C. 220/240 v. Handle unscrews and becomes protective cover for the bit. Only 18/9, plus 1/- P. & P. Spares available. Bit 1/3. Element 4/6.

CRYSTAL MICROPHONE

(Hius). Sensitive Miniature Lapel-type. Complete with clip and screened lead. Brand new. 7/6, plus 2/- P. & P.

MINIATURE 2P. 2 WAY SLIDER SWITCH

as used in P.W. pocket superhet and "Roadfarer". 2/6 each, plus 3d. P. & P.



PRINTED CIRCUIT CAR RADIO (for Home Construction)

We are proud to be able to offer this new type of Car Radio employing up-to-the-minute circuitry special 12 volt valves and transistorised output stage. The highest degree of sensitivity is assured by the incorporation of Permeability Tuning and a tuned R.F. Stage. Covers Medium and Long Wavebands. NO VIBRATOR PACK IS REQUIRED. This is a really compact receiver that will fit any car. Comprehensive assembly instructions are provided with all necessary components, including valves and transistor at a Special New Low Inclusive Price of Only £11.19.6 plus 3/6 P. & P. Instruction booklet with itemised price list, full description, dimensions, etc., available separately.



"PAGEBOY" 2-TRANSISTOR POCKET PORTABLE

Completely portable—No external Aerial or Earth Req'd.

An amazing little receiver with built in aerial and small enough to be held in the palm of the hand. Medium wave reception at wonderful volume. No fiddly tuning. Condenser tuned.



Supplied with drilled chassis and colour coded components. Easily assembled with the aid of the easy-to-follow assembly instructions provided. Total cost, of all necessary components, including transistors, wiring wire and even solder. ONLY 32/6, plus 1/6 P. & P. Battery 3/- extra. Ardent type dead-aid earpiece complete with cord and plugs 12/6 extra. Parts price list and Easy Lay-out Plans 1/6 post free. Demonstrated at all our branches.

NEW BRANCH! NOW OPEN

AT
9 CAMBERWELL CHURCH STREET

S.E.5
Telephone: RODney 2875

Situated 25 yards only from Camberwell Green.

OPEN ALL DAY SATURDAY

We regret this owing to CITY roadwidening scheme our branch at Cheapside is now closed for building reconstruction.

RADIO JACK

Covers local medium wave stations variably tuned. Compact self contained unit requiring only connection to aerial (no power supplies req'd.) for 1st class reception when used in conjunction with your tape recorder or high gain amplifier. All necessary parts available at a special inclusive price of ONLY 19/6, P. & P. 1/6.

THE P.W. 'ROADFARER'

As described in current "Practical Wireless"

Now available the "Osamor" version at special inclusive price of **£16.19.6** Plus 2/6 P. & P.

A completely self-contained transistor portable with many novel features. For Battery or mains operation. Medium Long and V.H.F. bands. Full details and individually priced parts list on request.

OPEN: Tottenham Court Rd., 9 a.m. to 6 p.m. Mon. to Fri., Sat. 1 p.m. Holloway Rd. and Camberwell: 9 a.m. to 6 p.m. daily. Thurs. 1 p.m. Sat. 5.30 p.m. Our Advantageous H.P. and Credit Sale Terms are available on any single item over £5. Your enquiries invited. Please print your name and address.

THE "WAVEMASTER" 7-TRANSISTOR LUXURY PORTABLE

400 Milliwatt Output

To build yourself, Medium and Long Waves—Push-Pull Superhet A. V. C. Perfect Car Radio reception. Size 10in. x 6in. x 4in. at base tapering to 4in. at top. Very attractive two-tone grey Vyndle covered cabinet with black and gold printed escutcheon plate, cream and gold knobs, handle and cabinet fittings. * Weight—complete with long-life 74 volt battery—4lb. * Mazda high-grade transistors throughout. * High-Flux 7in. x 4in. Elliptical Speaker. * Slow motion tuning. * Co-axial socket at rear for direct connection to Car Radio Aerial. * Improved reception by use of seven-section plated telescopic aerial disappearing into Cabinet when closed. 34in. above Cabinet when fully extended. Construction simplified by Bakelite chassis board with the following components already mounted: I.F. Transformers (3). Oscillator Coil, Trimmer Bank, Output Transformer, Interstage Transformer, Aerial Brackets and Earth Bar. SPECIAL INCLUSIVE PRICE for all required components, full assembly instructions—nothing more to buy—is £10.19.6 plus 3/6 P. & P. Alignment service available. Full assembly instructions and individually priced parts list, all of which are available separately, 2/6, post free.



OUTSTANDING METER IMPORT!

20,000 ohms per volt!

MODEL 200H. Volt-ohm-Milliammeter



Ranges: A.C. Voltage: 10, 50, 100, 500 and 1000 volts (10,000 ohms per volt). D.C. Voltage: 5-25, 50, 250, 500 and 2.5k. (20,000 ohms per volt). D.C. Current: 0-50 microamps, 0-2.5 mA, 0-250 mA. Resistance: 0-6k, 0-6 meg. (300 ohm and 30k at centre scale). Capacitance: 10 pF to 1 mfd. .001 mfd. to 1 mfd. Decibels: -20 to +22 dB.

A fully guaranteed pocket size meter, (actual size: 4 1/2 x 3 1/2 x 1 1/2) knife edge pointer, top quality supplied complete with test leads and full operating instructions at £6.19.6 ONLY. Plus 2/6 P. & P. Optional extra, attractive carrying case 13/6 only. (Bonus trade enquiries invited) Leaflet available.

"PRACTICAL WIRELESS" CIRCUITS
All required components for the complete Osamor Version of the Pocket Superhet described in "Practical Wireless" now available at special new low inclusive price of £6.19.6 complete, including Printed Circuit and Osamor booklet. All items available separately send for list. Enquiries invited for all other "P.W." circuit specified components.

WIRECOMP ELECTRONICS

378 HARROW ROAD, LONDON, W.9

TEL: CUNNINGHAM 9530

Hours of business: 9 a.m. to 6 p.m. Open all day Saturday. Opposite Paddington General Hospital. Buses 18B and 36 pass the door.

COMPLETE POCKET RADIO KIT

"THE COMPANION"

(Our improved version of the Traveller's Friend)



£8.19.6 COMPLETE KIT OF PARTS

P. & P. 3/6. in leatherette case.

This amazing set can be built complete for £8.19.6. Size 6½ x 4½ x 1½in., just right for the pocket. Uses 6 guaranteed first grade transistors, covering Long and Medium wavebands, latest printed circuit. High Q internal ferrite rod aerial, with socket for car aerial. Complete with step by step instructions. All parts sold separately. Battery PP.4 (Ever Ready 2/- each).

MINIATURE EARPHONE FOR TRANSISTOR RADIOS

Light weight plastic earpiece, can be worn without discomfort, provides excellent reproduction of music and speech. Fully guaranteed complete with 3 ft. of fine flex, plug and socket. Crystal earpiece as illustrated

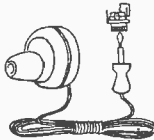

Magnetic " " " " **8/-**
R. & P. 1/-

P.V.G. MAGNETIC RECORDING TAPE

600ft on 5in. spool 15/-	900ft on 5in. spool 18/6
850ft on 5in. spool 16/6	1200ft on 5in. spool 21/-
1200ft on 7in. spool 21/-	1800ft on 7in. spool 32/6

P. & P. 1/-

SEND S.A.E. FOR FREE PRICE LIST OR PAY US A PERSONAL CALL

"SONIC SIXTY" TRANSISTOR KIT

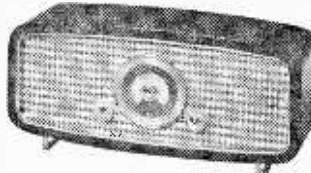

6 Mullard Transistors. 1 Diode. Internal Ferrite Rod Aerial. 7 x 4in. high quality Speaker. 500 mW push-pull output. MW and LW. Calibrated Direct Drive Assembly. Modern Walnut Cabinet 17 x 7½ x 5in.

COMPLETE KIT READY TO BUILD **£9.15.0** P. & P. 4/6

ALL PARTS SOLD SEPARATELY

BATTERY ELIMINATOR

Convert your Battery Set to Mains with a COSSOR BATTERY ELIMINATOR

MU2. For operation on 200/250 v. 50 c/s A.C. mains. Output: L.T., P. & P. 2/6
1.5 v. 125 mA; H.T. 9.0 v. 10 mA.

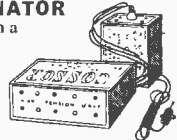

OUR LATEST RECORD PLAYER KIT

£7.19.6 COMPLETE KIT OF PARTS P. & P. 3/6

A.C. Supply 200—250 v. Attractive cabinet covered in Red plastic, size 14 x 12½ x 6½in. with gilt fittings. Uses Collaro Junior single play 4-speed motor, Acos GP67—32 cartridge and ready assembled amplifier with UL41 valve, 7 x 2in. speaker.



REDUCTIONS IN MULLARD TRANSISTORS

OC19 48/-	OC72 8/-	OC87D 8/-
OC35 25/6	OC73pair16/-	OC81 3/-
OC44 11/-	OC73 16/-	OC84 11/-
OC45 10/-	OC75 8/-	OC170 13/6
OC70 6/6	OC77 15/-	OC171 14/6
OC71 6/6	OC78 8/-	OC202 36/-

A SPECIAL OFFER OF SIX MULLARD TRANSISTORS

1 OC44, 2 OC45, 1 OC87D, 2 OC81. Only 42/6 set.

EDISWAN TRANSISTORS

XA104 12/- ea. XA103 10/- ea. XB102 6/6 ea.

ALPHA RADIO SUPPLY CO.

VALVES GUARANTEED ALL TESTED BEFORE DESPATCH

AZ1 10/-	EY51 8/6	5Y3G 7/-
AZ31 10/-	EY86 10/-	5Z4G 9/-
DAF96 8/-	EZ40 7/6	6AL5 4/6
DF96 8/-	EZ81 7/-	6BJ7 6/6
DL96 8/-	GZ32 11/6	6K7G 4/-
FAF42 9/6	PC384 8/6	6K8G 6/6
EBC33 6/9	PC385 11/6	6L6M 9/6
EBC41 8/9	PCF80 8/9	6AM6 4/-
ECC82 9/6	PCL33 13/6	6Q7G 7/6
ECC83 9/-	PL36 13/6	6V6G 5/-
ECC84 10/-	PL81 11/-	6V6GT 7/6
ECC87 12/6	PL82 8/6	6X5GT 7/-
ECC88 12/6	PL83 9/6	7B6 10/6
ECL30 9/6	PY81 8/6	7C5 8/-
ECL31 9/6	PY82 7/-	7C8 8/-
ECL32 9/6	U25 13/6	7H7 8/-
ECL33 14/-	U26 8/6	7S7 9/6
EF41 9/6	UA F42 9/6	7Y4 8/6
EF80 7/-	UBC41 8/6	10F1 12/6
EF86 12/6	UL41 9/-	10P13 23/3
EK32 7/-	UY1N 12/6	12AT7 7/6
EL33 14/-	UY41 6/6	12AX7 8/-
EL41 9/-	1S5 6/6	12AU7 8/-
EL84 9/-	1T4 5/6	35Z4 9/6
EM34 9/6	3S4 7/6	3L6GT 10/-
EM80 9/6	3V4 8/-	3Z4GT 8/-

CATALOGUE

Our 1961 catalogue is now available. Please send 1/- in stamps for your copy. Trade catalogue also available. Please attach your business letter heading.

RECORDING TAPE

Special Offer of Top quality recording tape. 3in. spool 200ft, 5/3. 5in. spool 600ft, 13/9. 5in. spool 850ft, 18/6. 7in. spool 1200ft, 23/-. Extra-play tape. 3in. spool 300ft, 7/-. 5in. spool 300ft, 21/-. 5in. spool 1275ft, 26/6. 7in. spool 1800ft, 37/6. Empty spools, 3in., 1/6. 5in., 2/-. 7in., 3/-.

TAPE RECORDER

Clarion transistorised battery. twin track, complete with tape and microphone. Listed 25 gns. OUR PRICE 19 gns.

GARRARD UNIT

Model TA Mk. II single record player. Mounted on rectangular unit plate, fitted GCB cartridge. Price £8.10.0.

Model 209 Automatic Unit, fitted with GCB cartridge. Price 10 gns.

Model Laboratory Series A. transcription record player, with provision for playing records automatically. Prices from £21.1.5-. Plug-in pick-up heads to your choice extra.

LOUDSPEAKER UNITS

All Brand New

2in. square Rola C25	26/10
2in. square EMI	18/6
4in. square Elac Tweeter	12/6
5in. round Plessey with O.P.T.	16/6
6in. round Celestion	17/6
8in. round Richard Allen	18/6
10in. round Elac	25/-
12in. round Plessey	29/6
6in. x 4in. Plessey	19/6
7in. x 4in. Plessey	19/6
8in. x 4in. Celestion and Richard Allen	19/11
10in. x 5in. Celestion and Plessey	21/6

P.W. TRANSISTOR SIX PRINTED CIRCUIT VERSION

All components available from stock. Complete kit £9.15.0. Full detailed shopping list, point to point wiring diagram, fully illustrated 1/6. Coil Set (Osc. and 3 I.F.T.s) 22/6. Driver Transformer 11/6. Output Transformer 10/6. Ferrite Rod Aerial 10/-. Printed Circuits 9/-. 50 Gang Condensers 11/-. Volume Control V.C. 1545 10/6. Switch 3/6. Hardware Kit 4/6. Transistors (set of 6 plus crystal diode GD8) 70/-. Speaker 19/10. Case 7/6. Complete Kit of Condensers 15/-. Complete Set of Resistances 6/6. Trimmers (2) 2/8. All above components are brand new and are fully guaranteed.

ALPHA RADIO TERMS.—Cash with order or C.O.D. Postage and Packing charges extra, as follows: Order value 10/- add 1/3; 20/- add 1/9; 40/- add 2/6; £5 add 3/6. Minimum C.O.D. Fee and Postage 3/-. For full terms of business see inside cover of our catalogue. Personal Shoppers 9 a.m. to 5 p.m. Monday to Friday. Saturday 10 a.m. to 1 p.m.

ALPHA FOR VALVES AND SPARES FROM STOCK. RETURN POST

102 LEEDS TERRACE WINTON STREET LEEDS 5

Letters to the Editor

The Editor does not necessarily agree with the opinions expressed by his correspondents

Whilst we are always pleased to assist readers with their technical difficulties, we regret that we are unable to supply diagrams or provide instructions for modifying commercial or surplus equipment. We cannot supply alternative details for receivers described in these pages. **WE CANNOT UNDERTAKE TO ANSWER QUERIES OVER THE TELEPHONE.** If a postal reply is required a stamped and addressed envelope must be enclosed with the coupon from page iii of the cover.

ITV SOUND

SIR,—I recently constructed a four-valve battery TRF set using two tuned circuits. (On the medium wave the coils cover 200 to 557m.)

On completing and testing the set I was amazed to find that on the medium waveband, using an inverted "L" aerial, with the tuning condenser at minimum capacitance, I could hear, quite clearly, the ITV sound.

Reception is quite independent of my television set, and the ITV sound can be heard throughout the time of transmission. Can any reader explain this occurrence?—B. QUEST (Leeds, 7).

QUARTZ CRYSTAL ETCHING

SIR,—Several articles have appeared in PRACTICAL WIRELESS from time to time explaining the use of hydrofluoric acid and ammonium bifluoride for crystal etching. In the May issue G30FJ points out ammonium bifluoride dissociates in solution to hydrofluoric acid and ammonium fluoride.

No one has yet pointed out that a crystal can have its frequency raised by careful grinding.

Place a small amount of scouring powder—the type used for cleaning sinks, etc.—on a plate of glass and moisten it with a little water to a smooth paste. Spread the paste evenly over the glass and lay the crystal on top of it. By moving the crystal in a circular motion over the paste, with one finger, small amounts of the crystal will be ground away. After a short while rinse the crystal and dry it well. Now replace it in a crystal holder and check the new frequency with a calibrated receiver.

This method can be repeated until the required frequency is obtained.

However crude this method of grinding a crystal may seem, the complete operation may be carried out with no danger whatsoever.—G. GALLAMORE (Manchester).

CRYSTAL SETS

SIR,—I would like to add something to the great amount of comment that has recently appeared on this page of your magazine, about the usefulness and reception of crystal sets.

Firstly, crystal sets are almost the best type of tape tuners, and are certainly the cheapest.

The other point I would like to make is about reception. One night three stations came in together: Moscow Radio, Stara Zagore—a Bulgarian station—and Luxembourg, and to me this proved enjoyable listening. I read the explanation of this given by A. Dyson in the May issue, but I still think that crystal set reception is far more exciting than with an ordinary commercial set.—N. J. PLANT (Staffordshire).

TRANSMITTER LICENCES

SIR,—The low power transistor transmitters, which are ever growing in popularity, usually have a maximum range of two to five miles, and yet the owner of such a transmitter must sit exactly the same GPO examination as a person owning a 75W instrument.

Would it not be possible to have a separate test for enthusiasts with transmitters of, say, one watt and under and to abolish the morse test for those not using morse? The test could be on transmitting techniques and radio theory. Only a fairly simple test would be required to satisfy the authorities that the operator is not a potential nuisance.—D. C. DICK (Glasgow, C5).

HIGH FIDELITY

SIR,—How I agree with P.H. (March issue) on the mis-use of the term High Fidelity. Now-a-days everything seems to be termed high fidelity, even to articles not in the radio or sound field. I would go so far as to state that many items sold under this name, even although very expensive and employing multi-stage amplifier with quite large output valves, are not really "high-fidelity". Is it not time the British Standard Institute drew up some standard to which the term could be applied? I would say that this is not the frequency range—an amplifier stated to be suitable for reproduction "from 20 to 20,000c/s" is not necessarily "high fidelity". What about its handling of transients and square waves? No, let us have some standard of fidelity.—G. NOTTAGE (Wimbledon).

AERIAL RE-RADIATION

SIR,—The various letters which you have published on the subject of unusual crystal reception, can, I think, be in very many cases, attributed to aerial re-radiation. I remember some years ago I carried out some tests on this subject, and found that under certain conditions with some receivers, an aerial re-radiated a signal to which the set was tuned. In one case, even with aerials at right-angles, it was possible to use a receiver with reaction as a miniature short-range transmitter, one listener shouting into his loudspeaker, the other being able to hear him. The aerials in this case were over 20ft apart at the nearest point.—F. NASH (Wembley).

VINTAGE MODELS

SIR.—While listening to a friend's radio recently I was much impressed by its excellent reproduction. I then discovered that it was a 1934 model with what appeared to be the original valves. It also had a mains energised moving coil loudspeaker, which obviously accounted for its superb quality.

It seems a pity that this type of speaker went out of fashion, as now, to obtain comparable quality from its permanent magnet counterpart, one has to pay quite a large sum of money.—A. V. NEWMAN (London, S.E.25).

RADIO MOSCOW

SIR.—With reference to J. Lowrie's letter in the May issue, the 1734m waveband is used by both the million watt Voice of America transmitter at Munich, and the 500,000W Radio Moscow transmitter. Radio Moscow transmits its main programme between 03.00 and 23.00hr GMT, while Voice of America has three transmissions a day at 04.30 to 07.30 hr, 10.45 to 12.00 hr, and 17.00 to 24.00hr. These transmissions are in English, German, Polish and Russian. During these programmes Radio Moscow cannot usually be heard.—T. THOMPSON (Bristol).

Short-wave Listeners' Log

IT can be found that an expensive, high-quality receiver with a bad aerial may give less satisfactory results than a much more simple and inexpensive set which is provided with an efficient aerial. A poor aerial may cause insufficient signal strength, inability to receive distant stations, and a high background noise.

A random length of wire, merely connected to the aerial terminal, is often used. Actually, the wire will be some fraction of a wavelength, on the frequency to which the receiver is tuned. Assume, for example, that the wire chances to be near a quarter wavelength. Its end impedance is then roughly 50Ω . If the wire were twice as long, it would be about a half wavelength, and its end impedance can be assumed to be roughly $1,000\Omega$. To obtain a proper transfer of energy from aerial to receiver, the receiver input impedance should equal the aerial impedance—which is obviously impossible if the latter is anything between about 50Ω and $1,000\Omega$ or more. In addition, the aerial wire will be a different fraction of a wavelength on other frequencies, so that its impedance continually changes as the receiver is tuned.

π-Coupler

One way of overcoming this difficulty is to use a radio frequency impedance matching network, or pi coupler. This is easily made for receiving purposes, by means of two air-spaced variable condensers, and a coil. The condensers can usually be about 100pF to 500pF. The coil may be tapped, to obtain resonance at the band wanted. The coil is inserted in series with the aerial lead to the receiver, and one condenser is connected from each end of it, to earth, which also forms the receiver earth.

Resonant Aerial Tuner

A parallel resonant aerial tuner is also suitable with some aeriels. This has a coil with a parallel variable condenser, tunable to the waveband wanted. The aerial is taken to one end of the coil, and a centre-tap to earth. A loop consisting of a few turns of wire, round the centre of the coil, is connected to the receiver aerial and earth terminals.

Such tuners may increase signal strength five to ten times, or even more, when the original impedance match was bad. They can be easily adjusted to permit reception on several bands.

Another cause of bad results may be poor signal pick-up of the aerial itself. For good signal strength, the aerial should be as high as possible, well clear of earthed objects, and reasonably long. Insulation at all suspension points should be good. These conditions are usually most easily met by using some kind of outdoor aerial. The down-lead forms part of the system. Single 14s.w.g. wire, 7/22 wire, or anything similar, with one or two ribbed insulators each end, will do very well.

Simple, single wire aeriels can give world-wide reception, when efficiently arranged. They do, however, result in a rather high level of background static and untunable interference. This can be greatly reduced by using some form of doublet aerial. The simplest is cut to be a half-wave on the desired band, and has a twin feeder from its centre. For use on several S.W. bands, an aerial tuned at the receiver end is preferable.

A Tunable Doublet

A tunable doublet can consist of two equal lengths of wire, which form both the aerial and feeder. The two portions forming the feeder are kept a few inches from each other by means of spacers. The aerial is suspended by insulators at its ends, so that it forms a long "T", the twin feeder being the vertical portion.

The parallel tuner mentioned can be used for receiver coupling, with one feeder connected to each end of the centre-tapped coil. The whole system is tuned to resonance on the required frequency. This can be done by parallel tuning where the whole is a little short of a multiple of half-waves. On bands where the aerial is too long, a variable condenser in one feeder (series tuning) will provide resonance. The simplest procedure is simply to adjust tuning for maximum signal strength.

Good single wire aerial lengths for amateur bands are about 138ft ($\frac{1}{2}$ -wave on 80m), 68ft ($\frac{1}{2}$ -wave on 40m), or 34ft ($\frac{1}{2}$ -wave on 20m band).

There's **NO BETTER WAY** *than*
THE "PICTURE BOOK" WAY
of learning

ELECTRICITY & ELECTRONICS

(as 1000's have already discovered)

from

THE ILLUSTRATED COURSES of ELEMENTARY TECHNICIAN TRAINING

Published by THE TECHNICAL PRESS LTD.

BASIC ELECTRICITY (5 PARTS)

BASIC ELECTRONICS (6 PARTS)

BASIC SYNCHROS & SERVOS (2 PARTS)

★ ★ ★

In preparation BASIC RADAR, BASIC ELECTRONIC CIRCUITS, and BASIC TELEVISION

Ask your bookseller about

THE "PICTURE BOOK" WAY

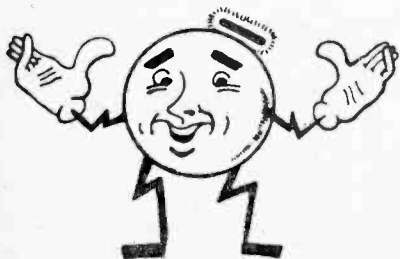

OR fill up this coupon

COUPON - SEND NOW!

To THE TECHNICAL PRESS LTD.

112 Westbourne Grove, London, W.2.

Please send me your FREE prospectus describing 'BASIC ELECTRICITY' 'BASIC ELECTRONICS' and 'BASIC SYNCHROS and SERVOMECHANISMS'

NAME _____

ADDRESS _____

PW

"P.W." 6 TRANSISTOR PERSONAL RECEIVER

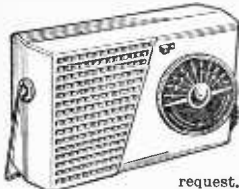

request, Constructural details 1/6.
TOTAL COST INCLUDING BATTERY AND CABINET £8.18.6.

Designed by the technical staff of *Practical Wireless*: easy to build, using printed circuit, and 1st Grade Matched Transistors and Diode. Full Medium and Long Wave coverage to internal speaker. All parts sold separately (new components only) enabling you to buy as required, and full detailed price list will be sent on request.

SPECIAL OFFER

20,000 OHMS PER VOLT TESTMETER. Just purchased from the Air Ministry, these magnificent American PRECISION Testmeters provide 31 ranges for reading Voltage, Current and Resistance, 6 Decibel ranges, 7 Output ranges, and facilities for testing Electrolytic and Paper Condensers. Single switch control, meter size 4 1/2 x 4 1/2 in., with Red and Black Scales, mounted on Black and Silver Panel, size 8 1/2 in. x 7 in., which is fitted into sturdy wood carrying case with removable hinged lid and compartment for leads, etc., the overall size being 10 x 9 x 6 in. Has 7 D.C. Voltage ranges up to 6,000 volts at 20,000 ohms per volt, 7 similar ranges at 1,000 ohms per volt, 7 similar A.C. ranges at 1,000 ohms per volt, 7 D.C. Current ranges from nought microamps to 12 amps, 3 Resistance ranges up to 60 Megohms, 6 Decibel ranges from -12 to +70 DB, 7 Output ranges up to 6,000 volts. Supplied with test leads, internal batteries and operating instructions. Case finished medium oak, and fitted with leather handle. 40 only. In first-class condition, overhauled and checked before ONLY **£9.19.6** (post, etc., 5/6) despatch.

UNIVERSAL VOLT-OHM-MILLIAMMETER

At last a first grade multi-tester within the reach of everyone's pocket, and a necessity to all interested in Radio and TV. Reads A.C. and D.C. Volts up to 1,000 in 5 ranges, at 1,000 ohms per volt, D.C. current (3 ranges) to 500 mA. Resistance readings to 200 K ohms in 2 ranges. Basic movement 300µA sensitivity. Easily read open scale, beautifully made and fully guaranteed. Limited number available under import quota. Complete with leads, prods. and internal battery.



ONLY **59/6**

H.R.O. SENIOR COMMUNICATIONS RECEIVERS.

With all 9 coils, giving coverage of 50 kc/s—30 Mc/s. Checked and in perfect working order. Back mounting type 18 gns., Standard Table Model 21 gns. (Carr., etc. 22/- either type.)

H.R.O. MAINS POWER UNITS. A.C. Input 115/230 v. output D.C. (fully smoothed) 230 v. 75 mA, and 6.3 v. 3.5 A. Complete in black crackle case. ONLY 59/6.

POCKET VOLTMETERS. Read 0-15 volts and 0-300 volts A.C. or D.C. BRAND NEW and UNUSED. ONLY 19/6.

B.C. 221 FREQUENCY METERS. The famous American crystal controlled, portable frequency measuring standard. Coverage 125 kc/s—20 Mc/s. With original numbered calibration book. Perfect order. Illustrated details on request. ONLY 11/6.

STOP PRESS

EX. A.M. AVO METERS

Thoroughly overhauled & perfect. Complete with leads and internal batteries.

MODEL 7 £12.10.0. MODEL 8 £17.10.0. Registered post 5/- extra/each model. Full details S.A.E.

ACOS TYPE 39-1 STICK MICROPHONE. With screened lead and stand, 39/6, plus 1/6 p. & p.

CRYSTAL DESK MICROPHONE. With screened lead and built-in stand, 16/6, plus 1/6 p. & p.

HARRIS ELECTRONICS

(LONDON) LTD.

138 Gray's Inn Road, London, W.C.1.

(Phone: TERminus 7937)

Please include carriage costs on All items.

(Open until 1 p.m. Saturdays). We are 2 mins. from High Holborn (Chancery Lane Station) and 5 mins. by bus from King's Cross.

REPANCO

HIGH GAIN COILS AND TRANSFORMERS
for
THE HOME CONSTRUCTOR

Send 6d. stamp for comprehensive List of
REPANCO COMPONENTS
and Easy-to-Build Receivers,

RADIO EXPERIMENTAL
PRODUCTS LTD

33 Much Park Street, Coventry

Tel. 27114

SOUTHERN RADIO'S WIRELESS BARGAINS

PORTABLE TEST METERS. (As featured in March issue, pages 105 to 1010) 0-5000 ohms; 0-60 mA; 0-1.5 v., 0-3 v. 12/6 each.

METERS. 30-0-30 and 3-0-3 volts, with leads. 15/-.

ATTACHMENTS FOR "38" TRANSMITTER-RECEIVER;

Headphones 15/6; Throat Microphones, 4/6; Junction

Boxes, 2/6; Aerials, No. 1, 2/9, No. 2, 5/3; Webbing, 4/-;

Haversacks, 5/6; Valves—A.R.P.12, 4/6, A.T.P.4, 3/6. Set

of five valves, 19/- Postage on each item 1/6 extra (except valves)

TRANSMITTER-RECEIVERS. TYPE "10", MARK 111. Brand

New complete with 6 valves, etc. £4.10.0, carriage paid.

ATTACHMENTS FOR "118" TRANSRECEIVER. Head-

phones, 15/6; Microphone 4s, 12/6; Aerials, 5/-; Morse

Key, 6/6; Valves—A.R.P.12, 4/6, A.T.P.4, 3/6, A.R.8, 7/6; Set

of six valves, 25/- Postage extra (except valves) 1/6 each item.

QUARTZ CRYSTALS. Types F.T.241/F.T.243 2-pin 1/2" spacing,

F.T.241 20 to 38.9 Mc/s (54th and 72nd Harmonic). F.T.243 5700

to 8650 kc/s (Fundamental), 4/6 each. Lists of available frequencies

on request. Crystal Holders for F.T.241/243, 1/3. F.T.241/243

Crystals. New but not guaranteed (ideal for using the case or

regrinding). 12/6 per dozen, post paid.

RECORDING BLANKS. New 13in., 6/- each or 15 complete in

Tin, 1/4.

BOMBSIGHT COMPUTERS. Ex-R.A.F. Wealth of gears,

motors, blowers, etc. Ideal for experimenters. £3.12.6, carr. paid,

RESISTANCES. 100 Asstd. Useful values, new wire-ends.

12/6 per 100.

CONDENSERS. 100 Asstd. Mica, Elec., Tubular, etc. New

15/- per 100.

MORSE PRACTICE SETS. Key with Buzzer on Base, with

battery, 12/6, postage 2/-.

LUBRICA HOLE CUTTERS. Adjustable. 3/6 to 3 1/2". 7/3.

STAR IDENTIFIERS. 1-AN. Covers both hemispheres, 5/6.

VISUAL INDICATORS (10 Q4). Type 3 with 2 meter move-

ments, 2 neons. New, 12/-.

MAGNETS. Strong Bar, 2" x 1/2". 1/6 each.

COMMAND RECEIVERS B.C. 454-3-6 Mc/s. B.C. 455 6-9 Mc/s.

Complete with 6 valves, new condition, 47/6 each.

POST OR CARRIAGE EXTRA, FULL LIST OF RADIO BOOKS, ETC., 3d.

SOUTHERN RADIO SUPPLY LTD.

11 LITTLE NEWPORT ST., LONDON W.C.2. GER. 6653

The book for the serious model-maker ...

RADIO-CONTROLLED MODELS

by F. J. Camm

The remote control by radio of models—whether aeroplanes, boats, locomotives, tanks or steam rollers as well as stationary models—is an important post-war development with a keen, wide-world following of hundreds of thousands of enthusiasts. This practical book is the result of the author's numerous experiments and long research on the subject and includes information already published in the nationally read "Practical Mechanics" plus additional material. Contents include steering control gear; receivers; transmitters; control box; tuned reeds; model actuators; tuning transmitting aerials; details for model battleship and aircraft, etc. Fully illustrated with circuit details, diagrams and photographs, etc.

12s. 6d. FROM ALL BOOKSELLERS

... or, in case of difficulty, 13s. 6d. by post from C. ARTHUR PEARSON, LTD., Tower House, Southampton Street, London, W.C.2.

TRANSMITTING TOPICS



TUNING UP

By O. J. Russell

CONSIDERABLE argument prevails on various aspects of the efficiency of amateur transmitters under varying conditions of drive, loading and so on. These aspects often confuse beginners and even experienced amateurs into uncertainty as to what is actually happening when they tune up their rigs, and tends to create doubt as to whether the transmitter is operating at proper efficiency.

Artificial Aerial

A few facts and figures may be of assistance in illuminating what is really happening when a transmitter is tuned up and adjusted for loading with variable grid drive. The use of an artificial aerial is to be recommended when experimenting with a new transmitter. With a suitable artificial load circuit the transmitter may be tuned up, and the effects of various adjustments noted, without radiating needless interference to fellow amateurs.

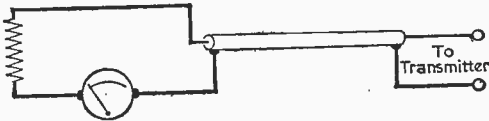

Fig. 1.—The simplest "artificial aerial" is a resistance and R.F. ammeter.

Unless the artificial aerial is well screened, it most certainly will radiate. Local amateurs may be copied as good signals when they are using unscreened artificial aeriels. The local DX record is a VP6 contact when the amateur in question was using a 50Ω R.F. resistor as an "aerial". Hence, unless constructed with load resistors in a screened enclosure, feeding with coaxial cable, an artificial aerial may well radiate appreciably and even be a cause of TVI. Normally there is no need to screen an artificial aerial, but the possibility of some radiation should be remembered. Even if the aerial is screened, enough R.F. for monitoring is usually present in the shack. Monitoring of the "leakage" signal with a receiver is needed to check note quality, on CW, and modulation quality on telephony.

With the popular π -tank transmitters, the simplest artificial load is an R.F. resistor of 50Ω or 75Ω resistance (see Fig. 1). This may be connected by 50Ω or 75Ω coaxial cable to the transmitter output socket. An R.F. ammeter in series with the resistor gives a convenient indication of the transmitter output. Suitable carbon film R.F. resistors may be obtained in high power ratings from "surplus" supply houses. Wire-wound resistors have appreciable inductance and are not suitable. Medium power load resistors may be made by wiring composition type 2W resistors in parallel. Thus, nine resistors of 470Ω wired in parallel will give a 50Ω load resistor, and if 2W resistors are used, will handle 18 or 20W comfortably, and thus serve for a 30W P.A. stage. Similar parallel combinations of 2W composition resistors will enable higher wattage rating loads to be built up if suitable large wattage R.F. resistors are not available.

Lamp loads may be used, but these have the disadvantage that their resistance varies very greatly with the power input. If an R.F. resistor is available that does not match the output impedance of the transmitter, a simple tuned matching unit may be built that will enable it to be matched into the transmitter as shown in Figs. 2, 3 and 4.

Variations in Efficiency

Having arranged a suitable loading circuit, so that the transmitter may be loaded into a more or less non-radiating load, the owner can investigate the actual efficiency variations that occur with loading. This is of interest because, under some conditions, there is a choice of power level control by such means as controlling loading or controlling (by means of a clamp valve) the screen voltage of the P.A., and hence the P.A. input power. Moreover, grid drive also alters efficiency and power input, particularly if a clamp valve is in use, as the clamp valve may start to conduct if the grid drive falls off below a certain figure.

Indeed, grid drive is somewhat of a problem with many hams, and constantly one hears anguished cries concerning low grid drive. To show just how

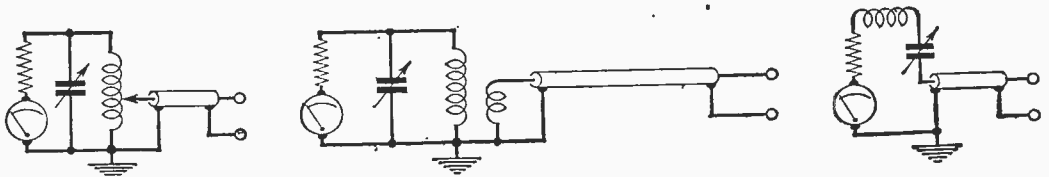

Figs. 2, 3 and 4.—If an R.F. resistor is available that does not match the output impedance of the transmitter, one of the above three tuned matching units may be built. This will enable the resistor to be matched.

grid drive affects P.A. operation, the reader may be interested in the curves taken on a P.A. stage with the loading normal but with varying amounts of grid drive. The P.A. valve is an 807, but similar results will apply for many other types.

For the record, all measurements were taken on a conventional P.A. stage, running 500V H.T. Two 807 valves were used in parallel, but the grid drive per valve is the figure used. Similar results will be obtained with the usual valve-types used in P.A. stages. It should be understood that the P.A. stage employed a clamp valve. This affects the issue somewhat, as at low grid drive figures, the clamp valve may start to draw current, and thus reduce the P.A. screen voltage. This results in a further efficiency drop in the P.A. stage. This in fact, is the situation with most P.A. stages using clamp valves, so that the curves represent practical operating conditions, rather than textbook examples. Any question about the "right" amount of grid drive are settled by Fig. 5. Provided the drive is about 2mA, the efficiency is high and constant. This assumes of course that the correct grid leak, or the correct grid bias, is in use. Thus, for C.W. operation, the recommended grid current value of 2mA is confirmed. For 'phone use 2.5 to 3mA grid current is desirable in order that the P.A. tube may be adequately excited at the peaks of modulation, when the instantaneous anode potential is double the actual H.T. voltage in use.

Required Drive Power

However, notice that even with only 1.5mA of grid current the P.A. performance is still good. It is only at below about 1mA grid current that performance drops off drastically. Hence, a grid current between 1mA to 3mA gives good performance. Hence, if one has adequate drive there is little point in trying to increase it. One point is that the grid driving power required increases as the square of the grid current. Thus increasing the grid current from 1mA to 3mA involves a ninefold increase in grid drive power. This is shown in Fig. 6 which shows that if drive is adequate, even a small increase in efficiency requires a very large increase in driving power. Furthermore, if drive is *not* adequate, a relatively small increase in driving power effects an appreciable improvement. However, it is clear that to increase drive from a barely adequate amount to "plenty of drive" involves quite a large increase in driving power. Most amateurs would rightly consider 1mA drive for an 807 to be on the low side. To increase this to 2mA, however, requires that the exciter should furnish four times as much power. This does mean that an exciter stage capable of giving 1mA drive may be quite incapable of giving the four times increased output needed to give 2mA of drive, let alone the nine times increase needed to achieve the 3mA drive. Thus, "low drive" may require more than a perfunctory "tune-up" of the exciter before it is overcome.

It may require a radical overhaul, and possibly a complete redesign in order to provide the increase in drive power needed for obtaining grid current to spare. This is why the man who tinkers around with a rig complaining he cannot get enough grid drive is likely to be dissatisfied until the driver stages are rebuilt to provide several times more power. If three or four times as much drive power is needed a fairly drastic modification may be needed. However, in some cases where the driver stages provide adequate drive power,

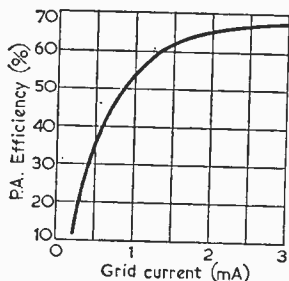

Fig. 5.—The power-amplifier efficiency/grid-current curve.

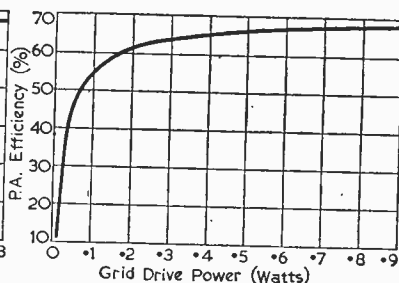

Fig. 6.—The curve of the power-amplifier efficiency plotted against the grid driving power.

some investigation may reveal a circuit error or a wiring slip if drive is low. Fig. 6 shows that if we have around 1mA of drive, rather than 2 or 3mA, the drive is providing only a quarter or a ninth of the required power output to the P.A. grid circuit. Investigation may reveal a simple cause for this.

Loading

Having disposed of, or eliminated, the question of drive power, the question of "loading" may be investigated. It is often necessary or advisable to reduce power. One case is when engaged in local contacts. In other cases many learned observations on beam aerials, S-meter readings and so forth are obtained by reducing power input. It is often assumed that a decrease in power by reducing the P.A. loading to a fraction of full loading results in a similar decrease in output power. On this basis many erroneous assumptions may easily be made about S-meter calibrations and aerial gain. As Fig. 7 shows, the P.A. efficiency is *not* constant with reduced loading, and starts to drop rapidly as P.A. loading is reduced. This fact is not too well appreciated in amateur circles. If, for example, an 807 P.A. for top-band were religiously reduced to 10W input by underloading, the P.A. efficiency would be very low indeed. Naturally, a P.A. stage for top-band would be operated in any case with reduced H.T. voltage, and this is important, for the P.A. efficiency is actually reduced still further with reduced anode potentials, so that the P.A. efficiency of a top-band rig using popular valves might indeed be quite small. As top-banders very often assume that 160m is an "easy" band, little attention is paid to P.A. efficiency, and provided the P.A. stage works—that is provides RF output—it is assumed that efficiency is, at any rate, "reason-

(Continued on page 257)

DON'T MISS THESE BIG SUMMER BARGAINS!

LASKY'S RADIO

**TRANSISTOR RECORD PLAYER
CAN BE BUILT FOR
£9.19.6 Carr. free**

6 v. operation. For all L.P. and standard records. All components available separately.

AMPLIFIER. 300 milliwatts push-pull output, using two OC71 and two OC72 transistors. Fully assembled. 79/6. Knobs. 3/6 extra.

LOUDSPEAKER. 30 ohms, 7 x 4in. elliptical, matched to Amplifier, 25/-.

3-SPEED TURNABLE. 6 v., complete with t.o. crystal cartridge and two sapphire styl. 79/6.

CARRYING CASE. smart two-tone finish. 17 x 11 x 5 1/2 in. High. 49/6. Batteries extra.

LASKY'S CAR RADIO

12 v. operation. Transistor output. Medium and long waves. Small size will fit any car. Build and install now for Summer pleasure.

Can be built complete with speaker for £9.19.6, post 3/6. Booklet 2/6 (refunded if you order).

SAVE ON COMPONENTS !!!

Send for Lasky's 100-page COMPONENTS CATALOGUE. Price 2/-, post 6d. Our latest 12-page Bargain Bulletin included free.



The "CLARION" Transistor Battery Tape Recorder. Capstan drive, push-button controls. Speed 3 1/2 i.p.s., uses 3in. spools. High impact plastic case with transparent upper. Size: 9 1/2 x 5 x 3 1/2 in. List 25 Gns. **18 Gns.** LASKY'S PRICE, with Mike and Tape. Carr. 7/6.

THE "SHERWIN SIX" TRANSISTOR POCKET SUPERHET

Very latest printed circuit, using 6 matched top grade S.T.C. transistors and germanium diode. Push-pull output feeding 3in. P.M. speaker. Full coverage of medium and long waves. Internal ferrite aerial; provision for car aerial. Housed in leatherette-covered case, 6 1/2 x 4 1/2 x 1 1/2 in. Full, point-to-point instructions supplied.

CAN BE BUILT FOR £8.19.6

All components available separately. Circuit etc., 2/6. (Refunded if you order.)

WHARFEDALE 12" FULL FREQUENCY HIGH FIDELITY SPEAKER

Mod. SUPER 12/FS/AL. Aluminium voice coil, 15 ohms, 17,000 lines, foam plastic suspension, 15-30 watts peak. Brand new in maker's cartons. List £17.10.0

LASKY'S PRICE **£12.19.6** Carr. 7/6.

THE "CROWN" 6-TRANSISTOR POCKET SUPERHET

Medium wave. The very latest from Japan. Earphone automatically cuts out loudspeaker when plugged in. Very efficient set, approx. 3 1/2 x 2 1/2 x 1 1/2 in. in leather case. List 14 Gns. LASKY'S PRICE **£10.19.6** Post 3/6.

"SUPER 60" 6-TRANSISTOR S/HET TRANSPORTABLE

CAN BE BUILT FOR £9.15.0 Post 4/6.

Printed circuit construction, all components of highest quality. Uses 6 Mullard matched transistors, 1 diode, two OC81 valves in push-pull, giving 1 watt undistorted output. I.F. 470 Kc/s. Medium and long wavebands. Ferrite rod internal aerial, high flux 7 x 4in. Loudspeaker. Walnut veneer finish Cabinet with gold embellishments. Size: 18 x 8 1/2 x 5 1/2 in. deep. Circuit diagram and full data supplied. Every component available separately.

207 EDGWARE ROAD, LONDON, W.2.
Near Praed St. PADDINGTON 3271/2

42 TOTTENHAM COURT ROAD, W.1.
Nearest Stn. Gooch St. MUSEUM 2605

BOTH OPEN ALL DAY SAT. Early Closing Thurs. Mail Orders to Dept. P.W., Edgware Road.

THE PEMBRIDGE COLLEGE OF ELECTRONICS offers training in RADIO TELEVISION AND ELECTRONICS

ATTENDING COURSE

Full-time One Year Course in Radio and Television. College course in basic principles for prospective servicing engineers.

Next course commences 5th September, 1961.

This course is recognised by the Radio Trades Examination Board (R.T.E.B.) for the new Servicing Certificate examinations.

HOME STUDY COURSES

A. Radio and Television Servicing.

- (1) Introductory course.
- (2) Basic course covering R.T.E.B. Intermediate Radio and Television Servicing Certificate examination.

B. Courses in Radio, Telecommunications and Mathematics up to City and Guilds Telecommunication Technicians' Final Certificate.

For details, write to:

The Principal, P.10
THE PEMBRIDGE COLLEGE OF ELECTRONICS

34a Hereford Road, London, W.2

MAXI-Q
REGD.

COIL PACKS

CP.3/370 pF and CP.3/500 pF. These 3 waveband Coil Packs are available for use with either 370 pF or 500 pF tuning condensers. The coverages are: Long Wave 800-2,000 metres. Med. Wave 200-250 metres, Short Wave 16-50 metres. Designed for use with "MAXI-Q" glass scale type S2. Retail price of each unit: 32/- plus 10/8 P.T.—total 42/8.

CP.3/G. As above but with Gram. position, suitable for use with 500 pF tuning condenser: 39/- plus 13/- P.T.—total 52/-.

C.P3/F. This Coil Pack is for use with a 500 pF tuning condenser and covers the standard, Long, Med. and Short wavebands with the addition of the band 50/160 metres. This covers the Trawler band, Aeronautical and the 80 and 160 metre Amateur bands: 49/- plus 16/4 P.T.—total 65/4.

CP.3F/G. As CP.3/F but with Gram. position: 57/- plus 19/- P.T.—total 76/-.

CP.4/L and CP.4/M. These compact 4-station Coil Packs are available for either 1 Long Wave and 3 Medium Wave Stations (CP.4/L) or 4 Medium Wave Stations (CP.4/M.). They are fully wired and require only four connections for use with any standard frequency changer valve. 25/- plus 8/4 P.T.—total 33/4.

C.P.4L/G and CP.4M/G. As CP.4/L and CP.4/M but with provision for Gram. position. 31/- plus 10/4 P.T.—total 41/4.

See Technical Bulletin DTB.9 for details of all Coil Packs, 1/6.

GENERAL CATALOGUE covering full range of components, send 1/4 in stamps or P.O. PLEASE SEND S.A.E. WITH ALL OTHER ENQUIRIES.

DENCO (Clacton) LTD. (Dept.P.W.) 357/9 Old Road, Clacton-on-Sea, Essex
STOP PRESS: TDO.3 Tape Oscillator Coil for Mullard 3 watt Tape Amplifier, 7/6 each.

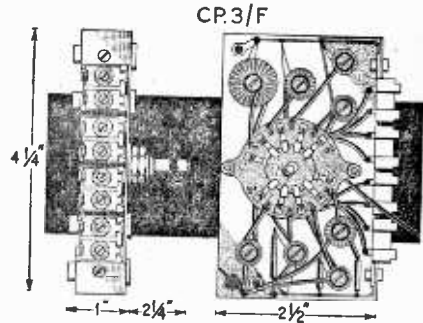

For Safety's Sake
use
AVO Prodclips



Safety first every time with these patented spring-loaded AVO Prodclips.

Cleverly designed for use as insulated prods, they are invaluable for reaching and holding test points which are difficult of access.

Suitable for use with AvoMeter, Multiminor and Avo Electronic Test Meter Leads.

Post Free
15/-
per pair.

AVO LTD • AVOCET HOUSE,
92-96 VAUXHALL BRIDGE ROAD, LONDON, S.W.1.
Victoria 3404 (12 lines)

A MEMBER OF THE METAL INDUSTRIES GROUP OF COMPANIES

FUNDAMENTALS OF RADIO RECEIVER SERVICING

By E. M. Squire

3rd Edition

A concise introductory guide to the practical operation of a radio receiver, presented in such a way that new radio receiver engineers, testers, and dealers may be able to obtain a working knowledge of receivers and servicing equipment in the shortest possible time. In this new third edition particular attention has been paid to F.M. receivers, transistor receivers and printed circuits, and in addition the whole text has been carefully revised and brought up-to-date. 15/- net.

From all Booksellers

PITMAN

Parker St., Kingsway, London W.C.2

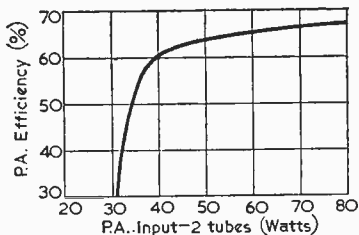

Fig. 7.—The variation in power-amplifier efficiency with loading.

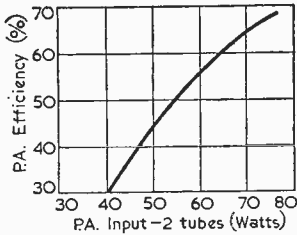

Fig. 8.—The graph obtained from the power-amplifier efficiency when the power level is varied by the clamp tube control.

(Continued from page 254)

able." In fact, an efficient P.A. stage running at reduced input of ten watts is a case where special consideration of valve operating conditions is necessary if efficiency is to be good. The large drop in efficiency with reduced loading shown in Fig. 7 should illustrate this.

Screen Voltage

It might be argued that "input" and hence "output" could be satisfactorily reduced in a top-band P.A. stage by reducing the screen voltage. This, of course, is the function of the usual clamp valve in a conventional P.A. stage. As Fig. 8 illustrates, while reducing the screen voltage by means of the clamp valve reduces input, this is also accompanied by a drop in efficiency. However, the drop of efficiency is smoother than when output is controlled by

loading, and quite a linear response is obtained. This explains why a clamp valve may be used for modulation purposes. Here again it will be noted that efficiency drops off to a low figure at low inputs, being around only 25 per cent with 10W output power for around 40W D.C. input power. Thus, running a top-band P.A. valve with a reduced screen voltage to reduce the input down to 10W results in poor efficiency. This underlines the fact that the maker's ratings are those at which good efficiency may be achieved. Provided screen, anode and grid voltages are correct and the rated grid current is obtained, a P.A. stage will give good

efficiency. However, a reduction of P.A. input by one S-point—6dB as indicated on the anode meter, may show up in actual power output on a receiver as possibly two S-points or 10 to 12dB. This is borne out by the curves given, which are the results of careful measurements on a typical P.A. stage. Thus, a rough-check on aerial gain or S-meter calibration, or various other tests, may be hopelessly in error if the above facts are not appreciated. Finally, that top-band rig may give a healthy increase in output if the fact is appreciated that an "under-run" P.A. valve may in fact be giving a very low efficiency, so that for the 10W allowed on 160m very little is put into the aerial from the transmitter. All this underlines the fact that top-band operation is not as easy as it looks, and that in fact very few amateurs obtain optimum results there. ■

THE P.W. SIGNAL GENERATOR

(Continued from page 220)

pin 8. Connect the far end tag of VR1 to chassis, and the centre one to the output socket via C17.

Reference to the diagrams will show that R21 has been taken to pin 7 via an unearthed tag of the tag strip. This is not absolutely necessary, but it is thus held securely in position.

Finally, connect pin 6 (V4a) to tag 6 on the power unit via the remaining insulated tag on tag strip A (which is on top of the chassis).

Switch on as before. Connect the phones to the output socket. A note should now be heard and should be variable in volume, but not in pitch. If VR1 works the wrong way round, reverse the connection to the outside tags. If VR1 is linear, the output will be approximately in accordance with the setting, i.e. half rotation giving half output.

Adding the Amplifier Stage

For some tests of amplifiers it is necessary to have a high voltage signal for input, and in order to be able to obtain this, an additional amplifier stage is used. The other half of V4 (V4b) is used as a conventional triode amplifier. The circuit of the triode amplifier stage is shown in Fig. 20, and the additional wiring required in Fig. 21.

(To be continued)

NEW COMPONENTS

AMONG the range of components on the Egen Electric stand at the Radio and Electronic Component Manufacturers' Federation Exhibition, Olympia (May 30th-June 2nd), was a recently introduced range of miniature potentiometers for use in transistor circuits.

Constructed on a die-cast body of only $\frac{1}{4}$ in. diameter, these bush-mounted controls have a moulded spindle of $\frac{3}{16}$ in. maximum diameter and are available with standard resistance values in the range 1,000 Ω to 3M logarithmic or linear law. Lower values can be made to special requirements. Two models are being manufactured initially, Type 363—non-switch; and Type 365 with a 50V 150mA double-pole single tag switch—both with standard soldering tags, while other models for printed panel mounting are planned for production in the near future.

Another recent introduction to the Egen range is an aerial isolator, Type 364, which provides aerial isolation on A.C./D.C. television receivers in a single compact and rugged unit complying fully with the individual requirements of B.S.415. Insertion loss is less than 0.3dB at 50Mc/s and it is completely co-axial with full screening of the inner conductor. Egen Electric Ltd., Chaffect Industrial Estate, Canvey Island, Essex.

Club News

REPORTS OF CURRENT ACTIVITIES

BRITISH TIMKEN RADIO CLUB

Hon. Sec: J. B. Johnson, G3JJW 44 Castle Avenue, Duston, Northampton.

The club transmitter is now active on 80, 20 and 10m. Arrangements are in hand for the British Timken show day when the club will be on the air, from the show ground, on August 27th and 28th.

CLIFTON AMATEUR RADIO SOCIETY

Hon. Sec: C. H. Bullivant, G3DIC 25 St. Fillas Road, London S.E.6.

The society won the second round of the inter-club quiz, beating Crystal Palace by a very narrow margin. On May 19th G3HGE demonstrated "TW" VHF equipment.

DERBY AND DISTRICT AMATEUR RADIO SOCIETY

Hon. Sec: F. C. Ward, G2CVV 5 Uplands Avenue, Littleover, Derby.

The first Two Metre field day was held on May 7th. A direction finding practice run was organised for May 10th, and started at 7.30 p.m. from the club rooms. May 31st was an open evening.

GUILDFORD AND DISTRICT RADIO SOCIETY

Hon. Sec: E. Bennett, The Inglenook, Sravetts Lane, Worplesdon, Guildford.

The Annual General Meeting was held on Friday, April 28th. On April 13th Maurice Child gave a talk on the Early Development of Radio.

HALIFAX AND DISTRICT AMATEUR RADIO SOCIETY

Hon. Sec: A. Robinson, G3MDW Candy Cabin, Ogden, Halifax, Yorkshire.

The society has moved to the new meeting rooms at the Beehive and Crosskeys Inn Halifax; meetings start at 7.45 p.m.

MITCHAM AND DISTRICT RADIO SOCIETY

Hon. Sec: M. Pharaoh, G3LCH 1 Madeira Road, Mitcham.

"The History and Development of the National Grid System" was the subject of the talk given by Mr. W. G. Todd on May 5th. On June 2nd G3DWW gave a talk on "Recorded Noises". On May 14th the Dummy Run for the National Field Day was held.

The society recently gave a talk and demonstration of "Amateur Radio as a Hobby" at the Beverly Secondary School.

NORTHERN HEIGHTS AMATEUR RADIO SOCIETY

Hon. Sec: A. Robinson, G3MDW Candy Cabin, Ogden, Yorkshire.

April 19th saw the inauguration of this radio society. Meetings will be held every alternate Wednesday at 7.45 p.m. at the Sportsman Inn, Ogden, Halifax. The chairman is C. Longman, G2DYY.

ROYSTON AND DISTRICT RADIO CLUB

Hon. Sec: E. H. Taylor, G3NAH 32 Ledgard Drive, Wakefield, Yorkshire.

Meetings are held on the first, third and fifth Thursdays in each month, and on the second and fourth Thursdays members take part in some constructional practice. Slow Morse class is held every meeting night from 7.30 to 8.00 p.m. Meetings are all at the headquarters; The Cudworth Hotel, Cudworth, Barnsley, and start at 7.30 p.m.

SHEFFIELD AMATEUR RADIO CLUB

Hon. Sec: D R. A. Hill, 16 Tynley Road, Sheffield 2.

The club meets on the second and fourth Wednesdays of each month at the Dog and Partridge Hotel, Trippett Lane, Sheffield 1. Douglas Hill is now the new secretary of the club.

SLADE RADIO SOCIETY

Hon. Sec: C. N. Smart, 110 Woolmore Road, Erdington, Birmingham 23.

On May 5th, Mr. L. Sanders and Mr. Chilton gave a lecture called "The use of electronic devices in industry", which explained the principles of practical applications of industrial electronics. D. S. Chapman gave a talk on "Map reading for direction finding" on the 19th of May.

Future Events:

June 11th—Harcourt Trophy test.

June 16th—"Transistors", by N. B. Simmonds.

June 30th—A talk and demonstration of electric tools for the radio amateur entitled "Portable electric tools".

STOKE-ON-TRENT AMATEUR RADIO SOCIETY, G3GBU

Hon. Sec: J. R. Brindley, 40 Milehouse Lane, Newcastle, Staffordshire.

At the Annual General Meeting in April, K. Parkes was elected President, V. Bloor, Chairman, V. Reynolds is the new Treasurer, and J. H. Brindley is the Secretary. New members should contact A. Bucknall, 35 Freehold Street, Newcastle, Staffordshire.

WEST KENT AMATEUR RADIO SOCIETY

Hon. Sec: R. Trevitt, 28 Delves Avenue, Tunbridge Wells, Kent.

On April 28th G2UJ and G4LB gave their views on the subject of how to become a "Radio Amateur". Final preparations for the National Field Day were discussed.

Future Events:

June 9th—Quartz Crystals and how they work.

July 21st—Direction finding competition.

YEOVIL AMATEUR RADIO CLUB

Hon. Sec: D. Maclean, G3NOF 9 Cedar Grove, Yeovil, Somerset.

On March 29th members listened to a tape recorder lecture from the R.S.G.B. tape library. The Lecture was illustrated by coloured slides and was about the Expedition to the Saint Pierre and Miquolin islands by WIPFA and FP8BH.

YORK AMATEUR RADIO SOCIETY

Hon. Sec: M. Watson, G3JME 36 The Paddock, Boroughbridge Road York.

A new transmitter for C.W. or N.B.F.M. and using an 813 P.A. is being tried out, although there are a few minor amendments and additions to be made. The club transmitter is on the air mostly on 20m with the call G3HWW on meeting nights.

A 4-Watt Amplifier

SINCE this amplifier was described in the January issue of *Practical Wireless* several readers have written in with similar queries about this design. For those readers, and any others who have constructed this amplifier, the following explanation is given of one or two points.

The oscillation and feedback troubles that may be encountered can be cured by reducing the value of R17 to 100k or less, at the same time ensuring that the feedback connections to the output transformer secondary are in the correct sense and not giving positive feedback. The resistor R12 may be increased to 10k if required and it is very important to ensure that neither C1 nor C7 is leaky.

The readings given below were obtained from the prototype connected as shown in Fig. 1 (page 779 of the January issue). The figures in brackets in the Table were those obtained when pin 4, V2, was connected to full H.T. instead of to C10 and with R12 increased to 22k to achieve greater gain. The meter used was sensitivity 1000Ω/V.

Location	Reading	Meter Scale Range
H.T. Line	350V (320V)	1000V
Pin 4, V2	260V (320V)	1000V
Pin 3, V1	4.6V (4V)	10V
Pin 8, V1	2.8V (2V)	10V
Pin 8, V2	11V (14V)	50V

"6 plus 1" TRANSISTOR RADIO KIT
— UNBEATABLE VALUE —

Mrs. Current Production Offer—A fortunate bulk purchase enables us to offer one of the season's most outstanding bargains in Portable Transistor Radio Kits. This kit is a modern, sensitive quality circuit Receiver Unit with all the latest features. Six B.V.A. Transistors and 1 Diode, Printed Circuit, Med. and Long Waves, Ferrite Aerial, Car Radio Input, 4w Push-Pull output into 3 ohm Speaker, Calibrated Dial and Slow Motion Tuning, etc. Size: approx. 8½ x 2½in.



COMPONENT 5 Gns. KIT p. & p. 2/6
SET OF 6 TRANSISTORS and 1 DIODE 45/-

Complete Kit—SPECIAL BARGAIN PRICE—**£6/19/6**
3 ohm speaker only required—special 7 x 3½in HOLA carr. 2/6.
only 15/6. Circuit and Assembly Instruction 1/6 post free. CABINETS now available 25/- extra.

TRANSISTOR BARGAINS!

Sensational New Reduced Prices! Latest Types—1st Grade BVA

Mullard		G.E.C.	
OC44	10/6	Mixer	874 9/6
OC45	9/6	I.F.	873 9/-
OA31	3/6	Diode	GEX34 3/6
OC81D	7/6	Driver	GET114 6/6

Set of MULLARD **48/6** All post Free Set of G.E.C. **45/-**
6 Trans. 1 Diode
MATCHED PAIRS OC81's 17/6, GET114's 15/6.

SPEAKER FRET—Expanded Bronze anodised metal 8 x 8in., 2/8; 12 x 8in. 3/-; 12x1½in., 4/6; 12x16in., 6/-, etc.

SPEAKERS P.M. 3 ohms 2½in. Elac 17/6. 3½in. Goodmans, 18/6. 5in. Rola 17/6. 6in. Elac, 18/6. 7 x 4in. Goodmans, 18/6. 8in. Rola, 20/-, 10iu. R. & A., 25/-.

TYGAN FRET (Contemp. pattern) 12 x 12in., 2/-; 12 x 18in., 3/-, etc.

Portable Transistor Record Player

6 v. operation—1 watt output.

GARRARD BAI Player Unit **59/6**
p. & p. 2/6

1 WATT 4 TRANSISTOR AMPLIFIER KIT **79/6**
p. & p. 2/6

TWO TONE CABINET and 7 x 4in. SPEAKER **39/6**
p. & p. 2/6

Complete 3 Unit Kit **£7.19.6** Carr. 3/6.
BARGAIN PRICE

Send 3d. stamp for detailed list. Circuit & Assembly Instructions 2/6.



VALVES—New		Reduced		Prices—All		Guaranteed	
1T4	8/-	DK95	9/-	EF86	12/6	PCC84	9/6
1R5, 1S3	7/6	D186	9/-	EL84	8/6	PCF80	9/6
3A4, 3V4	7/6	BCL80	10/6	EY81	8/6	PCLS3	12/6
DAF96	9/-	ECL82	10/6	EY86	10/-	PL81	12/6
DF96	9/-	FF80	9/-	EZ80/81	7/6	U25	12/6

TAPE RECORDER KIT ONLY £16 10s.

Latest 5-valve circuit based on Mullard's design. Magic eye and tone controls. Printed circuit already wired. A sensitive quality recorder. B.S.R. Kit 95/-, B.S.R. Tape Deck £8.10.0. Collaro Kit £8.5.0. Collaro Tape Deck £12.10.0 Set of 5 valves 45/-. Special Unit. Kit Prices—Send stamp for detailed list. Handbook (full details) 2/6.



Jason Tuners—Approved Kits—comprehensive range in stock. Model FMT1 5 gas, etc. 48 hour Alignment Service. Send for complete bargain list.



RADIO COMPONENT SPECIALISTS

70 BRIGSTOCK ROAD, THORNTON HEATH, SURREY

Est. 1946.

Telephone THO 2198*

Terms C.W.O. or C.O.D. Post and Packing up to 1 lb. 7d., 11b 1/1, 3lb, 1/6, 5lb, 2/-, 10lb, 2/6. Hours 9 a.m.—6 p.m. 1 p.m. Weds.

CONSTRUCTORS

ORNER

EASY TO BUILD TWO STAGE TRANSISTOR SET

The BIJOU

The set that looks like a Radio Set

- Attractive Case
- Mini 0005 Tuner
- High Q Litz Coil
- Works for months off No. 8 Battery
- Simple to construct in 15 min.

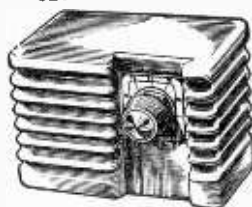

Total Building **25/-** P. & P. 1/6
Costs You can't go wrong. We guarantee good results.

Components Price List. Layout Plans 1/6 (free with order)

EXPLORE THE WORLD ON THIS 1-VALVE SHORTWAVE RADIO

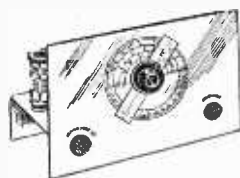

- Receives speech and music from all over the world.
- Construction price includes valve and one coil covering 40-100 metres.
- Can be extended to cover 10-100 metres.
- Can be converted to 2 or 3 valve.

Total Building **35/-** P. & P. 1/6
Costs Only

Send 2/6 for wiring diagram and components price list

IDEAL FOR THE BEGINNER

CRYSTAL RECEIVER All components including case for only **12/6** P. & P. 1/6
Covering Medium Wave Band

PUT YOUR FAVOURITE PROGRAMME ON TAPE TAPE IT WITH THE R.C.S. TAPE TUNER



Will operate on all types of Recorder. High impedance output, variable Medium wave tuning. Triple wound Super Hi-Q coil. Chassis and components colour coded. Easily constructed from full instruction data and layout diagrams. Size 3½ x 1½ x 1in.

Total Building **30/-** P. & P. 1/6
Costs Only

Send 1/6 for wiring diagram and components price list.

POWERFUL PERSONAL PORTABLE

This delightful set is designed to give you a completely personal portable radio. Ideal for the beach, bedroom, office—in fact anywhere. Sturdy bronze finished metal case. No holes to drill. Detachable rod aerial. All batteries self-contained. Can be built in 1 hour. Covers medium waves. Loud clear tone. Selective tuning. All parts are sold separately.



Total Building **35/-** P. & P. 1/6
Costs Only

Send 2/- for wiring diagram and components price list.

"Ensure success with R.C.S."

R.C.S. PRODUCTS (RADIO) LTD.
11, OLIVER ROAD, LONDON, E.17
Mail Order only. Trade Enquiries welcomed.

RECEIVERS & COMPONENTS

TRANSISTORS BRAND NEW. Mullard OC81D 2 OC81MAT 30/1. New-market set of 6 + 1 diode 45/-; Red spot 3/6, White spot 4/-, Green/Yellow 4/-. Yellow/Red 6/-. Diodes general 10d.. GEX34 3/3. OA81 3/3. Miniature cap 2/3 ea. Rectifiers RM5 12/6, SM5 13/6. All postage paid by CHAFFLE RADIO, 107 Neasden Lane, N.W.10.

SPEAKERS — ELAC 5in. 3 ohm: 12 £8; 50 £17. C. HEYWOOD, The Croft, Ladybrook Rd, Bramhall, Ches. £12.

LEADER RADIO

THE NEW TELETRON TRANSISTOR-6
A highly sensitive two waveband all transistor receiver tunable over long and medium wavebands. Re-tune case 4 1/2 x 4 x 1 1/2 in. Fully assembled and ready for use. Less battery..... £10.10.0
THE NEW OSMOR "P.W." TRANSISTOR-6
A highly sensitive six transistor superhet for medium and long wavebands. Design incorporates printed circuit and high 'Q' ferrite aerial, etc. Kit complete with instruction data, less battery..... £8.18.6
REPANCO MINI-4
The popular pocket four transistor superhet. Size 5 1/2 x 3 1/2 x 1 1/4 in. with pre-aligned coils and transformers. 2 1/2 in. high flux speaker, ferrite slab aerial. Easy to build. Kit complete with instruction data, less battery..... £8.18.6
REPANCO OSMOR, TELETRON, T.S.L. coils, transformers, etc., for transistor radios. S.A.E. for lists.
TELETRON transistorised tapejack. £5.9s. Carriage 2/6d.

F.M. TUNER. Covers 85-105 Mc/s, uses double triodes as R.F. and mixer stages (less valve), battery 95/-, carr. 1/6.
COLLARO STUDIO TAP DECK. 3 motors, 3 speed, only £11.10.0. S.A.E. with enquiries.
73 VISTA WAY, KENTON, HARROW, MIDD.
Phone: WOR 4512.

"HEATHKITS" can now be seen in London and purchased on easy terms. Free brochure. DIRECT TV REPLACEMENTS LTD., Dept. PW/7/6. 138 Lewisham Way, S.E.14. Tideway 6666.

COMPONENTS, VALVES, Tubes, etc. Write or phone for free list. ARION TELEVISION, 4 Maxted Rd., Peckham, S.E.15. (New X 7152).

SPEAKER REPAIRS. Cones/Fields fitted; Clock coils Wound. L. S. REPAIRS, Pluckley, Ashford, Kent.

REPAIRS. Pluckley, Ashford, Kent.

KINGSLAND

ELECTRONIC COMPONENTS Stupendous Offers

1958 ELECTRONIC COMPONENTS
500 Assorted Resistances and Condensers, 6 Miniature Valve Holders, two Tag Strips, 40 Separate Contacts each 3/9, & p. 1/6. Chassis 14 x 8 x 1 in. 12 Miniature Valves 1 1/2 x 1 1/2 in. with Valve holders, approx. 60 resistances and capacitors, 4 and 1 watt, 6 Germanium diodes, two tag strips, 100 contacts each 5/-, & p. 2/3.
120 Resistances 1 and 1 watt, 35 malmite and T/C.C. small Condensers, 9 Miniature Valve Holders, 3 Tag Strips, 100 contacts each and other useful pieces, 8/6, & p. 2/3.
BARGAIN PACK. Pair Throat Microphones, 2ft. 2in. Screened Lead with socket, one 5 Henry 200 mA Choke, 3 Electrolytic Condensers, Vibrator, 3 Toggle Switches, 6 Octal Valve Bases, 1 Waveband Switch, 6 Coax. Plugs, 6 Assorted Coils, 6 Cartridge Fuses, 6 Potentiometers, 6 W.W. Multipliers, 60 Variable Condensers, Coil of Wire, 15/6, & p. 3/6.
Instrument Rectifier with Circuits, 5/6, 6v. or 12 v. Vibrators, 2/6 each, & p. 1/6.
6 Assorted Droppers, 5/-, & p. 1/6.
Mike and Pick-up Transformers. Ideal for Eady Alarms, 4/6, & p. 1/-.
100 Assorted Resistances or Condensers or 50-50, 6/-, & p. 1/9.
6 Assorted Potentiometers, 5/-, & p. 1/9.

182 KINGSLAND RD., SHOREDITCH, E.2. Tel: SHO 6572. Sorry U.K. only.

RATES: 6/6 per line or part thereof, average five words to line, minimum 2 lines. Box No. 1/- extra. Advertisements must be prepaid and addressed to Advertisement Manager, "Practical Wireless", Tower House, Southampton St., London W.C.2.

In Scotland RENVUE for Better Value

COMPLETELY REPROCESSED TUBE (NEW GUN, RECREENED, ALUMINISED)

- 12.6v and 6.5v, 0.3 amp., 17 and 15in. Types £6.10.0
- 12.6v and 6.5v, 0.3 amp., 14in. Types £6. 0.0
- 12v, 15in. Types £7. 0.0
- 2v, 12 and 15in. Types £6. 0.0
- Electrostatic 90 degree and 110 degree tubes 10/- extra. Carr. paid.

10/- ALLOWED ON OLD TUBE Terms arranged

- FERGUSON**
- 14in. BBC and STV Consoles ... £12.10.0
 - 14in. BBC and STV Receivers ... £10.10.0
 - 17in. BBC and STV Receivers ... £19. 0.0

COMPLETELY OVERHAULED AND FITTED WITH COMPLETELY REBUILT TUBE

with One Year's Guarantee £5 Deposit. Terms on Balance

Renfrew Electronics Ltd. Anderson Drive Renfrew : Scotland

Tel.: Renfrew 2642

6in. Dia. (Yes—six inch) Millimeters 0/1 fl. round Ernest Turner 79/- (3/6), 2 1/2 in. Dia. Voltmeters 0/500 fl. round Weston 1000 ohms per volt. 47/6 (2/6). Special Valves 4/250A £8.10.0; Q73/125 £8.10.0; 4212 £4. Simpson Model 445 Volt-ohmmeters 2 1/2 in. meter in case £3.10.0 (5/-). Metal Rectifiers 24 v. 12A 20/- (3/6).

40 PAGE LIST OF OVER 1,000 ITEMS IN STOCK AVAILABLE—KEEP ONE BY YOU.

Wide Band Aerial Amplifiers. ten separate outlets from one aerial rack mounting £9.10.0 (7/6). **Pocket Radioactive Dosimeters,** quartz fibre fountain pen type 25/- (12/- reduction for quantities). **5 Foot P.O. Racks** 19in. wide drilled and tapped 65/- (10/-). Elliott 0/1 volt moving coil Voltmeters 2000 ohms per volt, 2 1/2 in. dia: ideal as basic meter 25/- (2/6). **Mains Filter Units,** laboratory precision type totally enclosed 2 1/2 amps. 10/- (2/6). **SIEMENS** 10,000 ohms SPDT Relays 12/6 (1/6). **Metal Rectifiers** 24 v. 12A 20/- (3/6). **AVO Geiger Counters** £9.10.0 (3/-). **Bondix** 6ft enclosed Transmitter cabinets, 1 1/2 in. wide £5 (20/-). **P.O. Racks** 19in. wide 3ft high £2 (10/-). **Metal Rectifiers** 12 v. 1 amp 5/- (1/6). **20 Foot Super Lightweight Aluminium Tripod** self supporting 1 1/2 in. dia. Masts, complete, 7 lbs. weight £10.10.0 (30/-).

We have large quantities of "bits and pieces" we cannot list—and invite your enquiries—we can probably help—every one answered.

Amounts in brackets are carriage Enland and Wales. P. HARRIS, ORGANFORD, DORSET.

RECEIVERS & COMPONENTS (continued)

"WEYRAD" TRANSISTOR RECEIVER

LONG & MEDIUM WAVE. P.P. O/P. ALL COMPONENTS AVAILABLE TOTAL COST £8.17.6. CONSTRUCTOR'S BOOKLET 2/-.

TRANSISTOR AM FEEDER UNIT, SUPERHET AVAILABLE NOW. Size 4 1/2 x 3 x 1 1/2 in. TOTAL COST OF CONSTRUCTOR'S BOOKLET 1/9. Send S.A.E. for Shopping Lists. 35 OHM ALLAN SPEAKERS. 27/1. JACKSON "00" GANG (with Trimmers), 10/6.

WESTHAM RADIO SUPPLIES Rear of 175 Abbotbury Road WEYMOUTH, DORSET

GUARANTEED VALVES from 1/- Radio, TV components. Transistor set Kits from 10/-. S.W. Kit 22/6. List. 3d. HAMILTON RADIO (W.), 13 Western Rd., St. Leonard's, Sussex.

RECLAIMED VALVES, tested and perfect: huge stocks; all one price, 5/- plus 6d. postage each. Delivery by return. LEWIS, 46 Woodford Ave., Ilford, Essex.

ANNAKIN

No. 1900 Transformer, 1/- ea., post 11d. 8/9 doz., post free. Periscope Prisms. Solled, 1/- pair, post 2/30 nc. I.F.T. 2/6 doz., post 1/- Motor Brushes, 48 for 1/-, post 8d. Mica Cond's. 01 mid, 500 v., 2/- doz., post 9d. Valves, 6AG5, 2C39, 12 A6, 6BS7, 2/- New. Silver Toggles, 3 A., 250 v., 4 for 1/6, post 8d. Postage extra. C.W.O. only. Many other bargains. 25 ASHFIELD PLACE, OTLEY, YORKS.

VALVES 100%. Most types, all 3/6, inc. postage. BOWMAN, 18 Plunket Rd, Wheatley, Doncaster.

POST-FREE BARGAINS

VALVES
EF36 3/-, 6SN7GT 3/-, 6H6GT 1/6, EF50(A) 2/-, EF50(Br.) 1/6, 5U4G 4/6, 807 5/-, EF37A 6/-.
TUBES. 3BP1 with base, mask, and Mu-Metal screen, as new 17/6, VCR517C (new) 8/-, 5FP7A 6/6.
SWITCHES. 21 positions, 2 pole, wired to 20,1000 ohm. ± .2% resistors giving 0-20k ohm ± .2% 2 1/2 in. diam. x 2 1/2 in. long, 1 in. long shaft, 1/2 in. diameter, 9/- each.
SWITCHES (Ceramic), 11 positions, 3 pole, new 5/6, ex-equip., as new 4/-, ex-equip 3/-.
CHARGER TRANSFORMERS. Primary 210-230v. 50 c/s output, 6.3 v. 4 a., 7 V's C.T. 8 a, 7 V's C.T. 4 a. twice, 2 V's C.T. 5 a., 19/6 each.
VARIAC TRANSFORMERS. Input: 20 v 50 c/s output 0-20 v. Continuously variable at 10 amp. Will work with much smaller input voltages. Ideal for battery charger control boards, etc., 19/6 each, two transformers on common shaft can be wired in series or parallel 27/6, three on one shaft 37/6.
Orders below 5/-, postage 9d. extra.
DENBY'S ELECTRONICS
"HILLSIDE", COLDASHAW, HAWORTH, KEIGHLEY, Yorks.

RECEIVERS & COMPONENTS
(continued)

NEW AM/FM STEREO

- INPUTS FOR TAPE, 78's, etc.
- MW—LW—VHF
- PUSH-PULL OUTPUTS—16W
- SEPARATE TONE AND VOLUME
- INTEGRAL PREAMPLIFIER

BEL, Marlborough Yard, London N.19
Arc 5078

DON'T DO IT YOURSELF. Kits built and tested. Details S.A.E. 6 Hooket Road, Heartsease, Norwich, Norfolk.

CONSTRUCTORS BARGAINS

200 Condensers, 5pF to 0.1 mfd., 5/-, 50 Resistors (1 to 1 watt mixed), 2/-, 4 Volume controls, 2/-, 4 Rotary switches, 5/-, P. & P. 1/-.

TRANSISTORS

Red Spot, 3/-; White, 3/9; Yellow (6 volt), 2/3; Yellow/Green, 3/9; Red/Yellow, 5/-; STC/TS1 (OC71), 6/8; TS17 (OC72), 6/- each. P. & P. 6d.

EDISWAN

XA101, 102, 103, 104, 9/- each. XB102, 103, 104, 8/- each. XC101, 10/-, P. & P. 6d.

NEWMARKET

NKT152A (OC44), 10/-, 153A (OC45), 8/6, 252A (OC71), 5/6, 253A (OC74), 6/8 each. P. & P. 6d.

MULLARD

OC16, 35/-, OC170 (up to 100 Mc/s.), 30/-, P. & P. 6d.

BARGAIN SETS FOR SUPERHET
6 Mazda plus 1 Diode, 52/6, 6 Newmarket plus 1 Diode, 43/-, 1-OC44, 2-OC45, 1-OC81D, 2-OC81, 52/6.

Condensers, Sub-Miniature, 1, 2, 4, 5, 8, 10, 16, 30 and 50 mfd. at 2/3 each. P. & P. 3d.

POTENTIOMETERS

All values Lin or Log, 3/-, with D/P switch, 4/6. Double gang 50K S/Log, 1 Meg, D/P switch, 6/-, Other types less switch, 7/-, P. & P. 6d.

SPEAKERS

2Hn. E.M.I. 3 ohm, 17/11, 15 and 35 ohm, 25/-, Elliptical 7 x 4, 35 ohm, 25/-, 3 ohm 8in., 15/-, 10in., 28/-, 12in., 45/-, P. & P. 1/6. CRYSTAL Stereo with chassis, dial, knobs, etc., all parts 12/6, P. & P. 1/-.

CRYSTAL EARPIECE, with lead and plug, high or low impedance, 9/6 each. Headphones for Crystal Sets, 15/- (light-weight), P. & P. 1/-.

Sub-Miniature Jack Plugs and Sockets 3/6 pair, Slider Wave Change Switch, 2/6. Transistor Holders, 1/-, P. & P. 6d.

PRINTED CIRCUITS

P.W. Pocket Superhet, 9/-, Weyrad, 9/6. Mullard, 3/3 Amplifier with drawing, 5/6. Mullard, 5/10. Amplifier with drawing, 11/9. Mullard 5/20 Amplifier with drawing, 11/9. Mullard 5/10 Stereo Board, 25/6. All other parts available, P. & P. 1/-.

METERS

"Caby" A-10, £4.10.6 B.20, £6.5.0 P. & P. 2/3. 2 1/2in. round, 500 mA, 10/- each.

VALVES

Post Free, SP41, 2/3; 6H6, 3/-; 6K7G, 2/6; 6F6, 6/6; KT66, 10/-; KT69, 6/-; ECC92, 5/-; FX4, 10/-; KT33, 5/6; 2525, 9/6; 2526, 10/-; PEN4B, 10/6; American 41, 5/-; 43, 5/-; 57, 6/-; 78, 6/6; 79, 6/6.

TRANSISTOR TRANSFORMERS

1 : 1 C.T. Sec., Driver, 10/-; 6.6 : 1 C.T. Prim Output, 9/-; 3.6 : 1 plus 1 Split Sec. Driver, 11/9; 2 : 1 Output, 9/-.
Vibrators — Pin, 6/6; Bob-Sync., 2, 12 and 24 volts, 4/- each. P. & P. 6d.
Stockists for: Jason, Armstrong, Lineair, Leak, Denco, Repanco, Osrom, etc., plus many bargain lines for the caller.

SOUND VISION
ANCHOR STREET
CHELMSFORD - ESSEX

RECEIVERS & COMPONENTS
(continued)

POWER IN PACKETS. New supplies of the following: W1649 Wavemeters/ Sig. Gen. Freq. 140/240Mc/s. 155/255Mc/s. Accurate to 0.2Mc/s containing 5M Xtal. Complete with Inst. book and Attenuator 30/- each delivered. 426a control units cont. 6 assorted Xtals 18/6 each delivered. 42/6 similar to above, 1 Xtal type 14/6 delivered. 90 x 1 1/2 V Hts. 10/6. 90 x 7 1/2 V 6/6. 1 1/2 V HD. 1/6. 1/20th Hp. 240V Series motors EX. Spin Drivers. Brand New ex works and unused, ideal sewing machines, etc. 20/- each. DIGGINS, 29/131 Radnor Street, Hulme, Manchester 15.

Guaranteed Perfect. Ex-equipment TUBES—VALVES—SPARES

TUBES 6in. Guarantee, FITTED FREE 9-10-12in., 30/-; 14in. 40/-; 17in., 50/- VALVES all tested before despatch. 50,000 in stock. 1000 types. Examples:

1D5	5/-	27SU	10/-	PC132	4/6
6B6	12/6	18B7	12/6	PL33	4/6
6BW6	4/6	AZ1	7/6	PL81	4/6
6C5	2/-	AZ31	7/6	PL82	4/6
6CS	4/6	B36	4/6	PL83	4/6
6C4	2/-	EB34	2/-	PY31	4/6
6F13	2/-	EB41	2/-	PY80	4/6
6F14	4/6	EB91	2/-	PY81	4/6
6F15	4/6	EB91	4/6	PY82	4/6
6K25	4/6	EBF90	4/6	PZ30	4/6
6L6	7/6	ECH35	6/-	SP61	1/-
6L18	4/6	ECH42	4/6	U41	2/-
6LD20	4/6	ELC80	4/6	U22	4/6
6N7	4/6	EF42	2/-	U24	7/6
6P23	4/6	EF50	1/-	U25	12/6
6F28	4/6	EF90	2/-	U31	4/6
6V6	4/6	EP91	2/-	U35	6/-
7B7	4/6	EL33	4/6	U281	7/6
7C5	4/6	EL38	4/6	U403	7/6
7C6	4/6	EL42	4/6	U801	12/6
7S4	4/6	EY51	4/6	UAF42	4/6
7Y4	4/6	EY86	4/6	UB41	2/-
10C1	4/6	KT33C	4/6	UB42	4/6
10C2	4/6	KT36	4/6	UF42	2/-
10C3	3/-	KT51	4/6	UL41	4/6
10P13	4/6	N7	4/6	UL44	7/6
10P14	4/6	N78	10/-	UL46	4/6
20D1	3/-	N108	12/6	UU7	7/6
20F2	4/6	PCC84	4/6	UY41	4/6
20W1	4/6	PCF80	4/6		

Pre-wired 4, 5, 7 pin valves 5/-, postage 6d. each Also old American Side-Contact, etc. NEW TRANSISTORS, Red Spot, 2/-; OC44, OC45, OC72, OC78, 10/-; OC35, 20/-; SELENIUM PHOTOCELLS 7/6, 12/6 and 25/-; SPEAKERS 6, 8 and 7 x 4in. 5/-, 10in. 10/-; 10V Tr. from £1 Def. Coils Osc. Tr. cheap CONSTRUCTOR'S PARCEL, 2lbs. assorted res. cond. electrolytics, pots etc. 7/6. Postage 2/6. Send S.A.E. with enquiries or for full list. "ST. JOHN'S RADIO", 156 St. John's Hill, London S.W.11. Phone: BAT 9838

TUBES! Mostly 70/75's, guaranteed year. Also good Televisions, 12/17in., £5/£12. 3 Panik Avenue, New Barnet. BAR 1934.

RESISTORS.—100 new, wire ended, assorted, all types, 7/6 box, post free. COOK'S OF BEDFORD, 29 St. Mary's Street, Bedford.

FOR SALE

INDEPENDENT 200/240 volt electricity supply for only £8. American Dynamotor Unit, runs Television, Electric Drills and all Universal AC/DC Mains Equipment from 12 volt car battery. Cost £40, our price £8. — S.A.E. full details. Scientific Products, P., Cleveleys, Lancs.

ASK your dealer for American Ferro-dynamics. "Brand Five" Recording Tapes—the best tape value!

FOR SALE (continued)

100 BAYS of Brand New Adjustable Steel Shelving, 72in. high x 34in. wide x 12in. deep; stove enamelled dark green, sent unassembled. Six shelf bay £3 15s. Sample delivered free. Quantity discounts. N. C. BROWN LTD, Eagle Steelworks, Heywood, Lancs. Tel: 69018.

AMERICAN MAGAZINES. — Year's subscription, "High Fidelity," 50/-; "Electronics World," 43/-; "Audio," 35/-; Specimens 5/- each. Full catalogue free. WILLEN LTD. (Dept. 40), 9 Drapers Gdns., London. E.C.2.

MULLARD HIGH-SPEED Valve Tester Cards available, 9d. ea. Postage 3d. any amount. HOBDEN, 1 Church Hill Avenue, Bexhill, Sussex.

FOR SALE
100.000
Brand New
RADIO VALVES

comprising
30,000 Ferranti 4 volt range; 20,000 Ferranti 2 volt range, 50,000 mixed int. octals, including miniatures, etc., £1000 lot. To first customer taking away (removal van needed).

FOR SALE
1,000 New 3/31
Television Tubes
12"

First to take away £500 lot.

FOR SALE
100.000
Wavox 'Invisible'
Radio Aerials
£100 lot.

5,000 Electrostatic Tweeter Speakers. 5TH87. £500 lot. 5,000 (Own Printed Both Sides) Stiff 12" Record Covers. £10 lot. Buyer takes goods away.

MAZEL RADIO, 124/138 London Rd., Manchester 1, Lancs.
Tel: Ardwick 3505/3565.

WANTED

BEST PRICE paid by return for new Valves and equipment. STAN WILLETS, 43 Spon Lane, West Bromwich, Staffs. Tel: WES 2392.

WANTED VALVES
All types for prompt cash. Must be new. State quantity.
WILLIAM CARVIS LTD.
103 North Street, Leeds 7

(continued on next page)

WANTED (continued)

NEW VALVES bought, state price. A. D. A. MANUFACTURING CO., 172 Alfreton Road, Nottingham.

WANTED. Service Sheets. No quantity too large. Highest prices paid. **SULTAN RADIO**, 29, Church Road, Tunbridge Wells, Kent.

A PROMPT CASH OFFER for your surplus Brand New Valves, Speakers, Components, Test Instruments, etc. R.H.S., 155, Swan Arcade, Bradford 1.

NEW VALVES WANTED

Any type, any quantity

CASH PAID

**R.S.T. 211, Streatham Road,
Mitcham, Surrey.
Telephone: MITcham 6201.**

SOUND RECORDINGS

RECORDING TAPE, save up to 30% send for list; also 50 second-hand recorders in stock.—E. C. KINGSLEY AND CO., 132 Tottenham Court Road, London, W.1. EUS 6500.

PRIVATE GRAMOPHONE Records made from your own recorded tape. Weddings, Choirs, Greeting records, etc. LP's from 17/6. S.A.E. **SOUND SERVICES** (Dept. 2), 28, Viewforth Terrace, Sunderland. Tel: 57032.

SERVICE SHEETS

SERVICE SHEETS, Radio, TV, 5,000 models. List 1/-. S.A.E. enquiries: **TELRAY**, 11, Maudland Bk., Preston.

FAULTFINDER FILES, showing common faults that each receiver is prone to and other useful servicing information, 2/- ea. List 9d., plus postage. S.P. DISTRIBUTORS, 44, Old Bond Street, London, W.1.

SERVICE SHEETS. We have the largest stock of Radio and TV Service Sheets in the country for sale at 4/- each. Why tolerate delay in obtaining your supplies when we will dispatch by return? Service Sheet List 1/-. Also Manufacturer's Manuals for sale and hire, 1961 List now available, 1/-. S.A.E. please. Mail orders only to S.P. DISTRIBUTORS, 44, Old Bond Street, London, W.1.

SERVICE SHEETS, TV 4/- ea. Radio 3/- ea. List 1/-. All orders dispatched on day received. Also Manuals for sale and hire. **SULTAN RADIO**, 29, Church Road, Tunbridge Wells, Kent.

SERVICE SHEETS; also Current and Obsolete Valves for sale, **JOHN GOLBERT RADIO**, 20 Extension, Shepherd's Bush, Market London, W.12. (Phone: SHE 3052.)

**38 SET WALKIE TALKIE
CIRCUIT INFORMATION**

Alignment Procedure. Typical faults in Ex W.D. Sets. Components location diagrams. Circuit diagram. Complete Circuit description. Instructions for use, etc. P.O. 5/-. Address in block capitals, please.

CAMPBELL

Laundry Lane, Hungerford, Berks.

SERVICE SHEETS

(continued)

SERVICE SHEETS (1930-1961) from 1/- with free Paul Finding Guide. Catalogue 6,000 models, 1/-, 125 Radio/TV Sheets covering 370 popular models 20/-. S.A.E. enquiries, **HAMILTON RADIO**, Western Road, St. Leonards, Sussex.

SERVICE SHEETS from 6d. each. Manuals, sale, hire. S.A.E. **DARWINS**, 45, Shaw St., St Helens, Lancs.

SITUATIONS VACANT

CITY AND GUILDS (Electrical, etc.) on "No pass—no fee" terms. Over 95% successes. For details of Electrical Engineering, Applied Electronics, Automation, etc., send for our 148-page handbook, free and post free. B.I.E.T. (Dept. 242A), 29, Wright's Lane, London, W.8.

A.M.I.Mech. E., A.M.Brit.I.R.E., City and Guilds, G.C.E., etc., brings high pay and security. "No pass—no pay" terms. Over 95% successes. For details of exams and courses in all branches of Engineering, Building, Electronics, etc., write for 148-page handbook, free. B.I.E.T. (Dept. 242B), London, W.8.

TV AND RADIO A.M.Brit.I.R.E., City, and Guilds, R.T.E.B. Cert., etc., on "No pass—no fee" terms. Over 95% successes. For details of Exams and Courses (including practical apparatus) in all branches of Radio, TV and Electronics, write for 148-page handbook, free. B.I.E.T. (Dept. 242G), 29, Wright's Lane, London, W.8.



Telecommunications
CAMBRIDGE ENGLAND



of

CAMBRIDGE

require

**TEST
ENGINEERS**

The Company is engaged in the manufacture of a wide range of Electronic Equipment, including V.H.F. and Micro Wave. Candidates should have had a minimum of two years' practical experience or have served in H.M. Forces as Wireless/Radar Fitters or Mechanics. Those who have taken any of the City and Guilds (London) Institute Courses have an added advantage. The Factory is a modern one, and there are excellent opportunities for the right men.

Please apply in writing giving details of age, experience, salary required, and quoting reference number (No. A.1889) to:

The Personnel Manager

**Pye Telecommunications
Limited,**

DITTON WORKS, NEWMARKET ROAD
CAMBRIDGE.

SITUATIONS VACANT

(continued)

**G. AND E. BRADLEY
LIMITED****TEST ENGINEERS**

Engineers with experience in one of the following fields are invited to apply to join a Laboratory Team working on specialised electronic equipment, Radar Systems, Navigational Aids, VHF/UHF Techniques, Microwave Measurements, Test Equipment and Standards, Pulse/Video Circuitry.

Industrial experience or training in the Services Radio Trades is essential.

Apply for an early interview to the Personnel Officer, G. & E. Bradley Ltd., quoting Reference S.G. at Electrical House, Neasden Lane, London, N.W.10 (DOLLIS Hill 7811), stating brief personal details. Evening, Saturday or provincial interviews can be arranged.

**A Member of Joseph Lucas
(Industries) Limited**

VACANCIES EXIST

in the
**ADMIRALTY SURFACE WEAPONS
ESTABLISHMENT EXTENSION**

at
**ROYAL NAVAL STORES DEPOT,
COPENACRE, HAWTHORN, WILTS**

for

ELECTRICIANS (RADIO)

and

ELECTRICAL FITTERS

Applicants for the former position should have at least five years' experience in the trade and for the latter must have completed a recognised apprenticeship.

The Establishment is located 8 miles from Bath. The work is interesting and varied, in modern test rooms and workshops, and is mainly concerned with the testing and modification of naval radio and radar equipment.

The commencing basic rate of pay is £9.18s.2d. for a five-day 42 hour week. In addition, new entrants are assessed for a merit award after three months' service and this award is back-dated to the date of joining. The initial award may be up to 25/- per week and further awards up to a total of £3 per week may be granted. After a minimum period of service all employees are considered for establishment on permanent staff.

Admiralty employment confers certain benefits, including assisted travel, paid sick leave entitlement, paid public holidays, and a fortnight's paid annual holiday. Recreation and welfare facilities are available.

Applications, in writing, should be addressed to the

**OFFICER-IN-CHARGE
ADMIRALTY SURFACE WEAPONS
ESTABLISHMENT EXTENSION,
ROYAL NAVAL STORE DEPOT,
COPENACRE, HAWTHORN,
WILTSHIRE**

SITUATIONS VACANT (continued)

MINISTRY OF AVIATION

**E.I.D.
ELECTRONIC
INSPECTORS**

required for

**RADIO, RADAR, COMPONENTS & ELECTRICAL
ANCILLARIES AT BROMLEY & WOOLWICH**
and elsewhere in London and Home Counties.

Varied and interesting work with opportunities for
gaining valuable experience and further training.

Excellent promotion prospects.

PAY 266/- to 281/- (with prospects of further progres-
sion to 306/-) for a 5-day week. Skilled men apply,
stating experience, to:

ELECTRICAL INSPECTION DIRECTORATE

AO/L

Aquila, Golf Road, Bromley, Kent.

MISCELLANEOUS

DIAMOND



STYL

FOR DIAMONDS

Manufacturer's offer to users—send us your old stylus arm and we will retip with
finest Transcription quality Diamond.
To ensure best reproduction every Diamond is inspected for finish and radius with
500 magnification.

FOR £1.0.0 ONLY

Or we will supply complete with any stylus arm for £1 5s. 0d. Tax Paid and will
despatch within 48 hours of receipt, post free.

All Diamonds are Guaranteed for One Year

(Sapphires also supplied 4/6 Tax Paid)
Mail Orders to:—Dasco, Frith Park, Tadworth, Surrey.

MISCELLANEOUS

(continued)

—YOU READ MUSIC?—

Then how about making yourself an electric organ? Constructional data available—full circuits, drawings and notes. It has 5 octaves, 2 manuals and pedals with 24 stops—uses 41 valves. With its variable attack you can play Classics and Swing.

Write NOW for free leaflet and further details to C. & S., 30 Maude Street, Dartington, Durham.

EDUCATIONAL

LEARN RADIO AND ELECTRONICS the new practical way! Hosts of absorbing experiments carried out at home under expert guidance to teach you Radio in a new, enjoyable and interesting way. Construction, servicing and fault-finding on equipment made easy for the first time! No previous experience needed. No mathematics used. Free brochure from: Dept. 11 P.W., RADIO-STRUCTOR, 40, Russell St., Reading, Berks.

City and County of Bristol
Education Committee

BRISTOL TECHNICAL COLLEGE

Principal: E. Poole.
B.Sc. (Eng.), M.L.Mech.E., M.I.Prod.E.
Bristol School of Marine Radio and Radar
(Formerly of A.S.T. Hamble)

Courses available for 1st and 2nd Class P.M.G. Certificates for Marine Radio Officers; M.O.T. Radar Maintenance Certificate; Six weeks Pre-Sea Training for qualified Radio Officers; (From September 1961)—Two-year course for Air Radar Maintenance Engineers Licences, Categories 'A' and 'B'.

For further details apply to the Registrar, Bristol Technical College, Ashley Down, Bristol, 7.

WIRELESS. See the world as a Radio Officer in the Merchant Navy; short training period; low fees; scholarships, etc. available. Boarding and Day students. Stamp for prospectus. **WIRELESS COLLEGE,** Colwyn Bay.

★ **LEARN** ★
**RADIO & T/V
SERVICING**
for your **OWN
BUSINESS/HOBBY**

● by a new exciting no-maths system, using practical equipment recently introduced to this country.

FREE Brochure from:—

RADIOSTRUCTOR

DEPT. G77, READING, BERKS. 7/61

(continued on next page)

CLASSIFIED ADVERTISEMENTS

(continued)

EDUCATIONAL (continued)

"HOW AND WHY" of Radio and Electronics made easy by a new, non-maths Practical way. Postal instruction based on hosts of experiments and equipment building carried out at home. New courses bring enjoyment as well as knowledge of this fascinating subject. FREE brochure from: Dept. P.W. 12, RADIOSTRUCTOR, 40, Russell Street, Reading, Berks.

FREE FROM THE I.P.R.E. Syllabus of famous radio and TV courses. Membership Conditions booklet 1/-. Sample copy The Prac. Radio Engineer, 2/- post free. Secretary, 20, Fairfield Road, London, N.8.

BOOKS & PUBLICATIONS

FIND TV SET TROUBLES IN MINUTES from the great book "The Principles of TV Receiver Servicing." 10/6 all book houses and radio wholesalers. If not in stock, from Secretary, I.P.R.E., 20, Fairfield Road, London, N.8.

ONE-FINGER PIANISTS

Build your own electronic keyboard and play everything! Send for free leaflet. Guitar, cello, flute and trumpet are all easy. Write now...

C. & S., 20 Maude Street, Darlington, Co. Durham

TRANSISTOR-BARGAINS

Transistors from 3/6. Packet of Mullards One O.C.44. Two O.C.45s. One O.C. 81d. Two O.C. 81s. 50/-, the set with diodes. All components for the P.W. pocket superhet I.F. job. £2.8.0. Set of coils 3 I.F.s. and Osc. coil 19/6. Mullard coil units to wind your own coils, 2/6 each. 10/- set of 4. Coil data provided. 7 days only. Ediswan X.A. 101s. and 102s at 6/- each.

Save money, S.A.E. for list. Jonno's, 32 Heathfield Gdns., Chiswick W.4. Phone Chf. 6912.

RES/CAP. BRIDGE 38/- p. & p. 2/-

Checks all types of resistors, condensers 6 RANGES

Built in 1 hour. Direct reading. READY CALIBRATED

Stamp for details of this and other kits. RADIO MAIL (Dept. NV) Raleigh Mews, Raleigh Street, Nottingham

"GLOBE-KING"

WORLD-FAMOUS KITS AND RECEIVERS

Designed and marketed specially for the newcomer and beginner, the "Globe-King" kits continue to enjoy world-wide popularity. Unsolicited Testimonials include many from Transmitting Amateurs and Professional Operators praising performance and efficiency of this miniature equipment. The single-valve kit costs only 79s. 6d. Complete down to the last screw. First-class components throughout, three coils, three low-loss S.W. variables includes band-spreading, Siemens-Ediswan Mazda valve, etc., Unit-assembly and construction, "Easy-Build" Diagrammatic Instructions enclosed with each Kit. Send now for Catalogue—It's free, but please enclose stamp for postage.

JOHNSONS (Radio) ST. MARTINS GATE, WORCS.

CABINETS & HI-FI EQUIPMENT

We can supply any Cabinet to your own specification

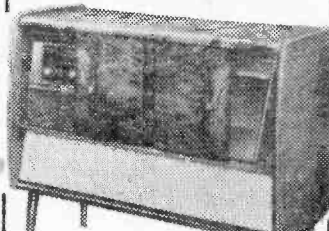

"Grosvenor" £19.10

This is only one example taken from our extensive range of stock cabinets. Write for our NEW 24 page fully illustrated catalogue on:

THE LARGEST RANGE OF CABINETS IN THE COUNTRY

Equipment is also our speciality and we now offer, in a novel book form: A NEW EQUIPMENT COMPARATOR, illustrating our range of radio chassis, speakers, tape decks, single players and autochangers.

SEND TODAY for a copy of these two books! which are absolutely FREE!

LEWIS radio

100 (P71) Chase Side Southgate, London, N.14. Pal 3733

NEW 7th EDITION

RADIO VALVE DATA

Characteristics of 4,800 valves & transistors, rectifiers & cathode ray tubes. Compiled by staff of "WW". Postage 10d.

PRINCIPLES OF SEMICONDUCTORS, by M. G. Scroggie. 21/- Postage 1/-.

BASIC ELECTRONICS, by Van Valkenburgh Nooger & Neville. Inc. 6 Vols. £3.6.0. complete. Postage 2/-.

PRINCIPLES OF TRANSISTOR CIRCUITS, by S. W. Amos. 21/- Postage 1/-.

THE RADIO AMATEUR'S HANDBOOK, 1961 Ed., by A.R.R.L. 32/6. Postage 2/-.

A BEGINNER'S GUIDE TO RADIO, by F. J. Camm. 7/6. Postage 6d.

STEREO—How it Works, by H. Burstein. 23/- Postage 1/-.

SERVICE VALVE EQUIVALENTS, an R.S.G.B. Pub: 2/- Postage 4d.

COMPLETE CATALOGUE 11/-.

THE MODERN BOOK CO.

BRITAIN'S LARGEST STOCKISTS of British and American Technical Books

19-21 PRAED STREET LONDON, W 2

Phone: PADdington 4185 Open 6 days 9-6 p.m.

OUR COMPREHENSIVE SERVICE INCLUDES:

12 CHANNEL TURRET TUNERS, 10, 16, 38 Mo/s. 40/-; VALVES, PCF80 and PCC84, 7/3 each. Cabinets, Glasses, Masks, Condensers, Resistors, Ion Traps, Speakers. RECLAIMED C.R. TUBES (Not boosted or reactivated) 9ln. and 12ln. 35/-; 14ln. 50/-; 17ln. 60/- All picture tested, taken from stripped TV's.

REGUNDED C.R. TUBES

(12 month guarantee) 12ln. 80/-; 14ln. 90/-; 17ln. 100/-

EXAMPLE OF TRANSFORMER LIST

L.O.F.T. SCAN COILS FERMGUN: (New) (Used) (New) (Used) 10T. 105T 69/9 35/- 60/- 35/- 892/4/6/8 .. 69/9 35/- 60/- 35/-

PYE: V4, VT4, V7 52/6 35/- 55/- 35/- VT7, CTM4 52/6 35/- 55/- 35/-

These are only examples of stocks, we have many thousands more, and would be pleased to quote for any component you may require.

We pride ourselves that we can obtain and supply any TV spare.

OUR GIGANTIC STOCKS INCLUDE:

LINE OUTPUT, FRAME OUTPUT, SOUND OUTPUT, LINE AND FRAME BLOCKING OSC. TRANS. AND SCAN COILS, FOR ANY MAKE OR MODEL TELEVISION. SOME OF OUR VALVES

AZ31	8/6	PCL82	10/9	SP41	2/3
B36	5/6	PCL83	11/3	SP61	2/3
D77	3/-	PCL84	9/6	W77	5/-
DH77	4/6	PL33	8/6	Z77	3/-
DK91	5/9	PL36	10/9	5U4	5/-
DK92	8/-	PL38	14/6	5V4	9/-
DK96	7/6	PL81	8/6	5Y3	10/6
DL92	5/9	PL82	6/9	5Z4	10/-
DL94	6/9	PL83	7/-	6AL5	3/-
DL96	7/6	PY31	7/-	6AM6	3/6
EB81	3/-	PY32	10/-	6CD6	27/6
EB33	5/-	PY80	6/6	6D2	3/-
EBF80	9/6	PY81	6/-	6F1	5/-
EC81	5/3	PY82	6/6	6F12	3/-
EC82	5/9	PZ30	10/-	6F13	7/6
EC84	8/-	U22	10/-	6F14	9/6
ECP80	8/-	U24	10/-	6F15	9/6
ECH35	9/-	U25	12/-	6L1	12/6
ECH81	6/-	U26	12/-	6V6	5/-
ECL80	6/9	U31	9/6	10F1	4/6
EF39	5/-	U50	8/6	10C1	10/-
EF50	3/9	U52	7/-	10C2	13/-
EF80	4/6	U191	9/-	10P13	9/-
EF91	3/-	U281	9/-	10P14	9/-
EF92	5/-	U282	20/-	12AT7	5/6
EL33	6/6	U301	20/-	12AU7	5/9
EL38	14/8	U801	22/6	20D1	8/6
EL84	7/-	UAF42	8/-	20F2	7/-
EY51SE	6/-	UBC41	7/9	20L1	12/6
EY51	7/9	UCH42	7/9	20P1	10/6
EY38	7/6	U41	8/6	20P3	12/-
EZ40	6/6	UH42	9/9	20P4	18/6
KT33C	6/-	UL41	7/3	27SU	14/-
KT36	8/6	UL46	7/3	30C1	7/-
KT86	15/-	UL44	11/6	30L1	7/-
PCC84	7/-	UY41	6/6	30P4	10/9
PCF80	8/6	U9	14/6	185BT	14/-
PCF80	7/-	U9	6/6		

These are only examples of our valves: if you do not see what you require send stamped addressed envelope for special quotation.

For the Finest, Fastest Service in the country, contact—

D. & B. TELEVISION 131a KINGSTON ROAD SOUTH WIMBLEDON LONDON S.W.19

Phone: Cherrywood 3955

And that's not all— WE ARE OPEN FROM 10 a.m. UNTIL MIDNIGHT

For any information or problems you have Call on us or Phone, we are always pleased to help.

TERMS: S.A.E. all enquiries. C.W.O. or C.O.D. 3/- extra. Postage on Valve 6d. each, C.R.T.s 12/6 inc. insurance.

SATISFACTION ASSURED RETURN POST SERVICE

AVO METERS

MODEL 7 £12.10.0. MODEL 8 £17.10.0. Guaranteed perfect. Complete with leads and batteries. Registered post and packing 5/- extra.

MULTIMETERS. 1000 μ /volt. A.C. and D.C. volts. (4.10, 50, 250, 500) & 1000 D.C. current 0-10, 100mA. Resistance 0-2k Ω and 0-200k Ω . Bakelite case, complete with test leads. BRAND NEW 59/6.

BC 221. The most accurate precision portable heterodyne frequency meter 125Kc/s to 20Mc/s. Complete with original individual calibration book. Guaranteed perfect £16.

CRYSTAL CALIBRATOR No. 10. Good condition, tested, with instruction manual ONLY 59/6 or AS NEW with three spare valves, leads, etc. £4.10.0. P. & P. 3/6.

CR100 COMMUNICATION RECEIVERS. 60 KC/s—50 Mc/s in 3 bands. 11 valves, 2RF and 3 I.F. stages. Crystal gate BFO etc. Input 200-230 v. A.C. mains. 2W output for Ω spkr. In superb condition £25. Carr. 30/- S.A.E. for illustrated details.

GRAM. MOTORS. Garrard AC6. 78 r.p.m. NEW 19/6. post 2/6.

DEAF AID—MEDRESCO TYPE (3 min. batt. valves). Complete with min. xtal earphone earplugs and leather case. Brand New 35/- or with batteries *2 post free.

R-1155-B, with latest drive, first class condition. *C.19.6. Mains Power Pack, 26.10.0. Data Book, 1/3 post paid. Moving Coil Phones, Finest quality Canadian, with Chamois ear-muffs and leather-covered headband. With lead and jack plus. Noise excluding, supremely comfortable. 19/6. post 1/6.

GIANT COMPONENT PARCEL. Contains 100 1 and 1 watt resistors, 50 Hi Stab resistors, W/W resistors, carbon and W/W pots, 100 capacitors (mica, paper, Sprague, bias variable, etc.), valveholders, tag strips, metal rectifiers, sieving, etc. All components are unused. GUARANTEED VALUE. 25/- plus 2/6 post.

T.C.C. VISCONOL CONDENSERS. 8 mid., 800 v. D.C. wkg at 71°C. CP 152V. 3 x 11 x 5 1/2 in. high. BRAND NEW. Boxed. 8/6 each. HRO COMMUNICATION RECEIVERS, complete with 9 coils. From 19 gns. S.A.E. for full particulars.

CALLERS CLEARANCE CORNER. We have a large amount of miscellaneous stock, either slightly imperfect or too few to advertise which we are offering at "Knock-out" prices.

CHARLES BRITAIN (RADIO) LTD.

11 Upper Saint Martins Lane, London, W.C.2.

TEMPle Bar 0545

Shop Hours 9-6 p.m. (9-1 p.m. Thursday).
Open all day Saturday

WE DO NOT THINK YOU STUPID!

and this is one reason why we do not make stupid claims and promises. Another is that we consider that to do so would be unethical.

OUR claim to your attention is that we really believe that we can help you to pass City and Guilds examinations. We have been doing this kind of thing for more than 20 years, and with success. We are also Consultants in the field of Recruitment, Selection and Promotion of Technical personnel and this puts us in the best possible position to find suitable jobs for our pupils.

If this interests you and only if you are prepared to WORK, please write to me today.

J. SYKES, M.I.E.E., M.Brit.I.R.E.

Principal :

**British National Radio School,
Red Lion Court, Stalbridge, Dorset**

IN THE HOME, IN THE CAR,
BY THE SEA, IN FIELDS AFAR

THE CONTESSA

IS VOTED BEST OF ALL

A really remarkable

2 BAND 6 TRANSISTOR SUPERHET KIT

(As displayed at the Radio Hobbies Exhibition)



The CONTESSA is the professional looking set with the professional performance.

Study these brilliant features which cannot be found in any other kit

- Waveband Coverage of 530 k/cs to 1620 k/cs and 160 k/cs to 270 k/cs.
- Assured reception of at least a dozen stations in daylight!
- Large clearly-calibrated station-named dial.
- Internal high-gain ferrox aerial.
- 5.1 ratio slow motion tuning.
- Fitted with the latest 12000 line high-flux loudspeaker.
- Power of 410 milliwatts from the single-ended push-pull final stage.
- Specially designed aerial matching coil for use in a CAR.
- Only first grade fully guaranteed Mazda matched transistors and diodes are used.
- Double tuned IF transformers for maximum gain and knife-edged selectivity.
- Fully drilled printed circuit panel marked with component numbers.
- The two-colour case measures 10 x 7 1/2 x 3 1/2 in. and weighs approx. 4 lb.
- Battery lasts 4 months with normal usage.
- Book supplied with detailed assembly instructions, diagrams and circuitry.
- Anyone can build this set—everything supplied just a soldering iron required.

Inclusive price for all associated components, cabinet and battery, complete in every detail. **£10.19.6**
Plus 3/6 Regd. P.F.
Or our BUY AS YOU BUILD SCHEME any parts sold separately. Send for comprehensive descriptive manual and parts list. 3/6 post free.

See and hear a working model at:—

RADIO CLEARANCE LTD.

27 Tottenham Court Road, London W.1
Telephone: Museum 9188

SELENIUM RECTIFIERS

F.W. BRIDGE	H.T. Types H.W.
6/12v. 1 a. . . 3/11	150 v. 40 m.a. . . 3/9
6/12v. 2 a. . . 6/11	250 v. 50 m.a. . . 3/11
6/12v. 3 a. . . 9/9	250 v. 80 m.a. . . 3/11
6/12v. 4 a. . . 12/3	250 v. 80 m.a. . . 5/11
6/12v. 6 a. . . 15/3	250 v. 250 m.a. . . 11/9
6/12v. 10 a. . . 25/9	CONTACT COOLED
6/12v. 15 a. . . 35/9	250 v. 80 m.a. H.W.
24 v. 2 a. . . 14/9	6/11. 250 v. 50 m.a.
	F.W. (Bridge) 8/11

B.S.R. MONARDECK TAPEDECKS.

Speed 31m. per sec. High quality recording heads, 7 kns. Carr. 5". Suitable polished veneered walnut carrying case for above 39/6. (Space for amplifier.)

EX-GOVT. CASES. Size 14-10in. high. Well ventilated. Plastic crackle finished, undrilled cover. IDEAL FOR BATTERY CHARGER OR INSTRUMENT CASE OR COVER. ONLY BE USED FOR AMPLIFIER. Only 9/9, plus 2/- postage.

LINEAR TREMOLO/PRE-AMP UNIT

Type TPU/1. with 3 controls, volume, amplitude and frequency. Inputs for guitar and microphone. Requires power supply of 250 v. 10 m.a. and 6.3 v. 1 a. available from any R.S.C. or LINEAR amplifier. The unit is merely connected to normal input socket of hi-fi amplifier or Guitar amplifier. Only £4.19.9.

MICRO-AMMETERS. 3in. diam. 0-50 micro-amps, 33/9.

R.S.C. MANCHESTER AND LEEDS
(Manchester) Ltd.

HI-FI 10 WATT AMPLIFIERS

Brand new. Manufacturer's discontinued line. Pitted Mullard valves, Dual inputs for "mike" and gram., etc. Bass and Treble Controls. High sensitivity and quality. For 230-250 v. A.C. **£6.19.6**

POCKET PORTABLE 3 TRANSISTOR RADIO DESIGN. Handsome plastic cabinet. "Built-in" ferrite rod aerial, and Miniature loudspeaker unit. Regenerative circuit using 2 Brimar R.F. transistors, 1 output transistor and crystal diode. Point-to-point wiring diagrams and instructions 11d. Total cost of all necessary parts only 49/9.

PRACTICAL WIRELESS SUPER SIX POCKET PORTABLE RADIO DESIGN Diagrams etc. 1/9 or All parts including printed circuit and first grade transistors **£8.19.6.**

MULTI-METERS. Ferranti Universal A.C./D.C., 59/6.

CABY A10. Basic Meter sensitivity 155 micro-amps, A.C. and D.C. ranges £4.17.6.

CABY B20. Sensitivity up to 10,000 ohms per volt, A.C. and D.C. **£6.10.0.** S.A.E. will bring leaflets on A10 or B20.

RELAYS. Carpenters' Type, Polarised 2 times 9,500 turns at 1,635 ohms, 13/9. Miniature Type G.E.C. 670 Sealed, wire ends, 4 covers, platinum M1095, 12/9.

SPECIAL OFFER EX-GOVERNMENT SELENIUM RECTIFIERS.

12 v. 15 amp. with large square cooling fins, 19/9 each.

EX. GOVT. SMOOTHING CHOKES. 200 mA., 3-5 H., 50 ohms, Parmeko 8/9; 100 mA., 5 H., 100 ohms 3/11; 150 mA., 10 H., 50 ohms 9/9; 80 mA., 20 H., 900 ohms 5/9; 120 mA., 12 H., 100 ohms 8/9; 50 mA., 50 H., 1,000 ohms 6/9; 100 mA., 10 H., 100 ohms 6/9; 80 mA., 5-10 H., 250 ohms 2/11.

EX. GOVT. MAINS TRANSFORMERS Primaries 230-250 v., 50 c.p.s. A.C. 250v. 60 m.a. 6.3v. 2a. . . 10/11
270-0-275v. 100 m.a. 6.3v. 7a. 5v. 3a. . . 21/9
200-0-300v. 60 m.a. 6.3v. 2a. . . 12/11
300-0-300v. 100 m.a. 6.3v. 2a. 5v. 2a. . . 18/9
350-0-350v. 160 m.a. 6.3v. 5a. 5v. 3a. . . 27/9
4-4v. C.T. 6-8amps, Parmeko . . . 11/9
400-0-400v. 200 m.a. . . 7/9
0-35-40-45-50v. 300 m.a. 6.3v. 3a. . . 17/9
450-0-450v. 100 m.a. 6.3v. 1.5a. 4v. 3.5a. 5v. 2.5a. . . 22/9

2 VOLT ACCUMULATORS Varleys small size 4 x 3 x 1 1/2 in., 2 v. 14 A.H., brand new, 6/9 ea., 3 for 15/6.

FIELD TELEPHONES

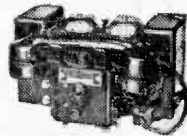

With bell, require only small battery. Suitable for office, factory, warehouse, or outside communication. 59/6 each.

TERMS: C.W.O. or C.O.D. No. C.O.D. under £1. Post 1/9 extra under £2. 2/9 extra under £5. Open 9 to 6. Weds. until 1 p.m. Trade supplied. S.A.E. with all enquiries.

Mail Orders to 29-31 Moorfield Road, Leeds 12.

Personal Shoppers to: 5 and 7 County (Mecca) Arcade, Briggate, Leeds 1. 8-10 Brown Street (Market Street), Manchester 2. 56 Morley Street (next to Majestic Ballroom), Bradford. 73 Dale Street, Liverpool 2.

EXPRESS ELECTRONICS
ROSEDEEN LABORATORIES
KINGSDOWN WAY, SELSDON, SURREY
VALVES NEW TESTED AND GUARANTEED FOR THREE MONTHS

10C1	7/6 6AT6	6/-	8D5	4/-	DF91	7/6	ECL82	9/6	PCL82	7/-
10C2	7/6 6BAU	7/-	12A8H	10/-	DF96	8/-	EF41	9/-	PCL84	7/-
10C3	8/- 6BE6	7/-	12A7	8/-	DH73	7/6	EF80	8/6	PL31	12/6
1F1	8/- 6BH6	5/9	12AU7	5/6	DH77	6/-	EF86	9/-	PL82	7/-
1F3	7/6 6BJ6	5/9	12AX7	6/-	DH142	8/8	EF91	4/-	PX81	6/9
1FD1	8/- 6BR7	8/8	12BE6	8/6	DH150	10/-	EF92	5/6	PY82	7/6
1FD9	7/6 6BS7	10/6	12BH10	10/6	DK91	7/6	EL41	9/6	PY83	7/6
1L4	6/9 6BW6	7/6	19K8GT11	8/6	DK92	7/6	EL54	7/-	R19	11/6
1P1	8/- 6BW7	7/-	19Q7GT	7/6	DK96	8/-	EM84	10/-	U52	9/6
1P10	7/6 6C10	9/-	128N7	7/6	DL92	7/6	EM84	10/-	U52	7/6
1P11	7/6 6D2	4/-	16A5	5/-	DL94	7/6	EY51	7/6	U76	7/6
1B5	6/- 6F12	4/-	25AG6	8/8	DL96	8/-	EY81	10/-	U78	5/-
1B5	6/- 6HG0T	2/-	25LGT	7/6	EB91	4/-	EZ40	7/6	UBC41	8/8
1T4	7/6 6J7GT	7/6	25Z4G	8/-	EB41	10/-	EZ80	5/6	UC42	9/6
1U5	6/- 6K7G	5/6	30C1	6/9	EBF80	8/6	EZ81	6/9	UF41	8/8
3Q4	8/- 6K80	6/-	30L1	7/-	ECC81	6/-	KT33C	9/6	UL41	8/8
3V4	7/6 6K7GT	6/-	35LGT	8/6	ECC82	5/8	KT66	11/8	UY41	7/6
5U4G	7/6 6SN7GT	6/-	35Z4G	8/6	ECC83	6/-	N17	7/6	W76	6/6
5Y3GT	4/8 6V6G	7/6	53KT	10/6	ECC80	8/6	N19	8/-	W142	8/8
5Z4G	9/6 6X4	5/-	5763	7/6	ECC82	6/9	PC87	10/8	X142	9/6
6AK5	6/6 6X6G	5/-	80	6/-	ECH42	8/-	PC84	6/9	X160	8/8
6AL5	4/- 6X6GT	7/6	DAF91	7/6	ECH81	10/6	PCF80	6/9	Z77	4/-
6AM6	4/- 7B7	7/6	DAF96	8/-	ECL80	8/6	PCF82	7/-	ZD17	7/6

Coax. Super quality 1in., 6d. yd. Plugs, 9d. Sockets, 9d.

VOLUME CONTROLS MIDGET SIZE LONG SPINDLES. D.P. switch 4/- Less switch, 2/6. Values 10K to 2M, B9A, B7G v. Holders 9d., Screens 9d., Contact Coated Rectifiers 250v. 50mA, 6/8, 85mA, 8/6.

MATCHED PAIRS

EL84 17/-, 6V6G 17/-, 6V6W 18/- per pair. Push Pull O.P. Transformers for above 3-15Ω 14/6. P. & P. 1/6. 12in. P.M. Speakers 3Ω 24/6. Baker's "Selhurst" 12in. 15Ω 15W, 90/-, P. & P. 3/6. 12in. Stereo Model 27.7.0.

SETS OF VALVES

DK91, DF91, DAF91, DL92 or DL94, 19/6
DK96, DF96, DAF96, DL96 27/6
10C3, 1F1, 1FD1, 1P1 27/6
1B5, 1T4, 1U5, 3B4, or 3V4 19/6
Postage and packing 6d. Over £1 post free.

GZAK: This month's bargains

SCREENED CABLES

Screened Microphone Cable, 1st. Grade, 9d. yd. or 6/- per doz. yds. 12-Core Screened Cable, 2/- yd. 10-Core (5 Pairs) Screened Cable, 1/8 yd. All plus 1/6 P. & P.

AERIAL EQUIPMENT

TWIN FEEDER. 300 ohm twin ribbon feeder, similar K25, 6d. per yard. K35B Telcon (round) 1/6 per yard. Post on above feeder and cable 1/6 any length.

COPPER WIRE. 14 G., H/D 140ft. 17/-; 70ft. 8/6. P. & P. 2/- Other lengths pro rata.

RIBBED GLASS. 3in. aerial insulators, 1/9 each. P. & P. 1/6.
CERAMIC FEEDER SPREADERS. 6in. type F.S. 10d. each or 9/- dozen, P. & P. 2/-.

CERAMIC "T" PIECES. Type A.T.P. for centre of dipoles, 1/6 each. P. & P. 1/-.

2 METRE BEAM 5 ELEMENT W.S. YAGI. Complete in box with 1 x 2 1/2in. mast head bracket. PRICE 49/-, P. & P. 3/6.
SUPER AERAXIAL CABLE. 75 ohm, 300 watts, very low loss, 1/8 per yard, P. & P. 1/6. 50 ohm, 300 watt coax, very low loss, 1/6 yd. or 20 yds 27/6, P. & P. 1/9.

ABSORPTION WAVEMETERS. 3.00 to 35.00 Mc/s. in 3 switched bands, 3.5, 7, 14, 21 and 28 Mc/s. Ham Bands marked on scale. Complete with indicator bulb. A MUST for any Ham shack. 22/6 post free.

VARIABLE CONDENSERS. All brass with ceramic end plates and ball race bearings. 50 pF, 5/9. 100 pF, 6/6. 160 pF, 7/6. 240 pF, 8/6, and 300 pF, 9/6. All fitted with rear extension for ganging. P. & P. 1/-.

CHAS. H. YOUNG LTD.

THE COMPONENT SPECIALISTS
Dept. "P", 110 Dale End, Birmingham 4. (CEN 1635)
(No C.O.D. under £1 please). (By return service)

KINGSMERE SUPPLIES LIMITED

Insured Post 1/-, over £2 Free (Export extra).
Single valves, post 6d.

MAIL ORDER HOUSE

TERMS: Remit with Order or C.O.D.
Cash refund guarantee

Built to the highest specifications, these chassis offer the finest value to the enthusiast.

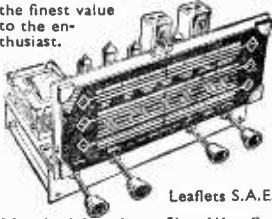

Leaflets S.A.E.

ALL BRITISH RADIOGRAM CHASSIS, 3 WAVEBANDS 5 MULLARD VALVES
ECH81, EF89, EBC81, EL84, EZ80
Brand new and guar. A.C. 200/250v. Short - Medium - Long Gram. P.U. High Q dust core coils. Latest circuit technique. AVC and neg. feedback. 4 watts. Chassis size 13½ x 6 x 7in. Aligned and calibrated ready for use. Quality at Low Cost. Chassis isolated. H.P. Dep. £5 and five monthly of £1.

OUR PRICE £9.9.0



The Brilliantly Successful

Manarch

BRAND NEW AND BOXED
with Template
4 SPEED
MODEL UAB
£6.15.0
STANDARD OR
STEREO PICK-UP

GARRARD 4-SPEED HIGH FIDELITY UNITS
Autochanger RC210 £9.19.6
Single Player TA Mk.11 £7.19.6
Transcription 4HF £16.19.6
Price inc. plug-in normal heads. Stereo hds. £2 ex.

Matched Speakers, 5in., 6½in., 8in., 17/6 ea. 10in. 25/-, 12in. 30/-.

BRAND NEW		VALVES		Matched Pairs 1/- extra		Famous Make RECORDING TAPE		Recording Tape "BRAND FIVE"							
OZ4	6/-	6BA6	7/-	6SJ7M	6/-	DF96	8/-	EL41	9/-	PCL82	8/-	5in. 600ft.	13/6	MYLAR DUPONT	
IRS	6/-	6BE6	7/-	6SN7GT	6/6	DK96	8/-	EL84	8/6	PY80	7/6	5in. 900ft.	15/6	Super High Fidelity	
ISS	6/-	6C4	5/-	6U5G	7/6	DL96	8/-	EM81	9/6	PY81	8/6	5½in. 1,200ft.	20/-	Double Play	
IT4	5/-	6D6	6/-	6V6G	5/-	EABC80	8/-	EY51	7/6	PY82	7/-	7in. 1,200ft.	20/-	5in. 1,200ft.	37/6
2X2	2/6	6F6G	7/-	6X5G	6/-	EB91	4/-	EY86	7/-	PY83	9/-	7in. 1,800ft.	32/6	7in. 2,400ft.	60/-
3Q5	9/-	6G6	5/-	12AT7	6/-	EBC41	8/-	EZ40	7/-	QP25	7/-	Spare Reels. 3in. 1/6, 4, 5, 5½in. 2/-, 7in. 2/6.			
354	7/6	6H6	3/6	12AU7	6/-	EBF80	10/-	EZ80	7/-	R3	7/6				
3V4	7/6	6J5	5/6	12AX7	6/-	ECC84	8/-	E1148	11/-	SP61	3/6				
5U4	6/-	6J6	5/6	12K7GT	6/6	ECH42	10/-	HABC80	12/-	UF41	8/6				
5Y3G	6/-	6J7G	6/6	12Q7GT	6/6	ECL80	10/-			UL41	8/6				
5Z4G	9/6	6K6GT	5/-	25Y5	9/6	ECL82	10/-	HVR2A	6/-	UY41	7/-				
6AC7	3/6	6K7G	5/-	35L6	9/6	EF39	5/6	KT33C	10/-	U22	8/-				
6AG5	5/-	6K7M	7/6	35Z4	6/6	EF41	9/-	MU14	7/6	VP23	6/6				
6AL5	4/-	6K8G	6/-	807	5/-	EF80	7/-	P61	3/6	U75	6/6				
6AM6	4/-	6N7M	6/-	954	1/6	EF91	4/-	PCC84	8/-	VR105/30	9/-				
6AT6	7/6	6Q7G	7/6	956	2/6	EF92	5/-	PCF80	7/6						
6BBG	5/-	6SA7M	6/-	DAF96	8/-	EL32	4/-								

25 FOAMCOURT WAY, FERRING, WORTHING, SUSSEX



- ★ **A to Z in AUDIO**
224 Pages 160 illustrations 15/6 (18/6 post free).
- ★ **STEREO HAND BOOK**
146 Pages 88 illustrations 10/6 (11/6 post free).
- ★ **LOUDSPEAKERS 5th Ed.**
336 Pages 230 illustrations 19/6 (20/9 post free).
- ★ **SOUND REPRODUCTION 3rd Ed.**
388 Pages 315 illustrations 17/6 (18/6 post free).
- ★ **PIANOS, PIANISTS & SONICS**
100 Pages 102 illustrations 10/6 (11/6 post free)
- ★ With R. E. COOKE, B.Sc. (Eng.) as Technical Editor.
The above books are sold by many radio dealers and bookshops.
In case of difficulty direct from

Wharfedale
WIRELESS WORKS LTD

IDLE BRADFORD YORKSHIRE
Telephone Idle 1285/8
Grams: 'Wharfedale' Idle, Bradford

Build these four up-to-the-minute REPANCO designs

- 1—THE "JOURNEYMAN", A SIX TRANSISTOR PORTABLE RECEIVER
 - ★ MEDIUM AND LONG WAVEBANDS
 - ★ POSITION FOR CAR RADIO AERIAL
 - ★ PRINTED CIRCUIT WITH COMPONENT NUMBERS MARKED
 - ★ PUSH-PULL OUTPUT
 - ★ FERRITE SLAB AERIAL
 - Step by step instructions. 1/6, post 3d.
- 2—MINI-4, A REMARKABLE FOUR TRANSISTOR SUPER-HEAT POCKET RECEIVER
 - ★ MEDIUM AND LONG WAVEBANDS
 - ★ SIZE OF CASE 5½ x 3½ x 1½ in.
 - ★ AUTOMATIC GAIN CONTROL
 - ★ 2½in. LOUDSPEAKER
 - ★ 3RD 1FT REFLEXED AS AUDIO DRIVER
 - Easy Wiring Plans and Step-by-Step Instructions. 1/6, post 3d
- 3—THE "TWINNETTE" A TWO TRANSISTOR LOCAL STATION PORTABLE RECEIVER
 - ★ LOUDSPEAKER RECEPTION
 - ★ MEDIUM AND LONG WAVEBANDS
 - ★ REFLEX CIRCUIT
 - Step by step instructions. 1/3, post 3d.
- 4—FULLY TRANSISTORISED CAR RADIO
 - ★ 7 TRANSISTORS
 - ★ 2 WATTS OUTPUT
 - ★ MEDIUM AND LONG WAVEBANDS
 - ★ A.G.C. AND AUXILIARY A.G.C. CIRCUITS
 - ★ SUPER PERFORMANCE
 - Step by step instructions. 2/-, post 3d.

Mail Order and Trade:
RADIO EXPERIMENTAL PRODUCTS LTD.
33 Much Park Street, COVENTRY
Tel.: 27114

Wholesale Inquiries and Export:
REPANCO LTD.
O'Brien's Buildings, 203-269 Foleshill Rd., COVENTRY
Tel.: 24224

TESTED AND GUARANTEED VALVES			
	New	Price	List Available
0A2	8/-		
0A3	10/-		
0B2	6/-		
0H3	8/-		
0C3	5/6		
0I3	5/6		
0Z1A	5/6		
1L4H	5/-	6CH6	6/-
1L4	3/6	6F6	5/-
1LD5	6/-	6P8G	6/6
1LN5	5/-	6E3	7/-
1R4	6/-	6G6G	2/6
1R5	6/-	6H6	1/6
1R4	6/-	6J5	4/-
1R5	6/-	6J6	3/6
1T4	4/-	6K7	4/-
1U3	6/-	6L6	9/-
1V	4/-	6L6G	7/-
2C34	4/-	6M7	5/-
2D21	6/-	6BH7	3/-
2X2	4/-	6SJ7	5/-
3A4	5/-	6BK7	5/6
3A5	5/-	6BL7	5/6
3D6	4/-	6BTGT	6/6
3Q4	7/-	6BS7	3/-
3R4	5/-	6V6G	5/6
3V4	6/6	6X4	5/-
5V4G	10/-	6X3GT	5/-
5V4GT	6/-	6V6G	6/-
5Z3	7/-	7AG7	5/-
5Z4	7/-	7P7	5/6
6A7	7/-	7N7	5/6
6A7B	4/-	7Z4	4/6
6G5	3/-	11E3	17/6
6G7	7/-	12A6	2/6
6K5	5/-	12AH7GT	2/6
6K5G	7/-	6V6G	6/-
6L15	4/-	12AHT	6/-
6M5	4/6	12A7	6/-
6M6	4/-	12A7T	7/-
6Q5	7/-	12A7T	10/-
6A7B	7/-	12C8	3/-
6A8	7/-	12C8	3/-
6A8	10/-	12J5GT	3/6
6B8	6/-		
6B4F	6/-		
6B8F	6/-		
6C4	2/6		

B.T.H. Tape Deck Motors
 200-250V A.C., 2 watts at approx. 1450 r.p.m. Can be run either way.
 Second hand, guaranteed. **17/6** p.p.

We Buy Special VALVES and TUBES, KLYSTRONS, MAGNETRONS, etc., and High-class TEST EQUIPMENT and COMMUNICATIONS RECEIVERS.

Z & I AERO SERVICES LTD

Retail Shop: 85 TOTTENHAM CT. ROAD, W.1.
 Tel. LANGHAM 8403
 Head Office and Warehouse: 14 SOUTH WHARF ROAD, W.2. Tel. AMB 0161/2, 0677.
 Please send all correspondence and Mail Orders to the Head Office.

Modelmakers' Motors

Reversible 12V miniature motors; output 5 watts at 7000 r.p.m. Dimensions 1 1/2 in. long x 1 1/2 in. dia. Shaft 0.077 in. dia. x 1 in. long. Centre-off reversing switch integral with the motor. Self-lubricating. Post sintered bronze bearings. **15/6** free.

VENNER TIME SWITCHES

Eight-day clockwork type. One make and one break every 24 hours. 1 amp, 250V contacts. Dial graduated in hours. Second hand, guaranteed, complete **27/6** p. & p. 1/9.

RELAYS

Second hand, guaranteed

S.T.C. MIDGET RELAYS

1 M. Contact at 5A, 250V Coil. Operating 40mA. Release 15mA. **6/6**
 2 C.O. Bifurcated Contacts at 500mA, 70V Coil; operating 15mA; release 3mA. **7/6**
SIGMA TYPE 4C1 or ALLIED TYPE 4C2
 High speed, 1B contact, 5000V coil; current 4mA ± 5mA. Will operate with change of current of 0.2mA. **5/6**
SIEMENS HIGH SPEED, SEALED
 1 C.O. contact at 900mA. Twin coil 2 x 140V coil; operating 15mA with coils in series, 30mA with coils parallel. **5/-**
POST OFFICE RELAYS
 Type 800, 400V coil, 2 C.O. contacts **6/6**
 Type 3000, 500V coil, 2 C.O. contacts **7/6**
 Type 3000, 100V coil, 2M-2B contacts, break before make. Operating 60mA. Release 20mA. **7/6**
AMERICAN TELEPHONE RELAYS
 Standard type A18268, 1 C.O. contact at 60mA, slow release, 200V coil, operating 20mA, release 6mA. **3/-**
 Short, type A18269, 2C.O. + 1B contacts at 500mA; 150V coil. Operating 60mA, release 20mA. **3/6**
 Allied, type A103817, miniature 1M. contact at 2A; 75V coil. Operating 30mA, release 50mA. **1/6**

I.F. CHASSIS

9.72Mc/s, Type 47G. Bandwidth ± 23kc/s for 6db down and ± 90kc/s for 40db down. Three I.F. stages: two CV131 and one CV138; detector CV140; squelch and AVC amplifier CV138. **5/-**
 25Mc/s, I.F. Unit No. 1. Bandwidth ± 180kc/s for 6db down. Two I.F. stages, CV138 and CV131. Second mixer to which a 21.75Mc/s signal is applied to obtain a frequency of 3.25Mc/s (CV132). Dimensions: 8 1/2 x 1 1/2 in. **12/6**
 3.25Mc/s I.F. Unit No. 2. Bandwidth ± 45kc/s for 6 db down. Three I.F. stages (CV131), AM detector/AVC CV140; noise limiter-crystal CV448; muting CV137. Dimensions: 12 1/2 x 1 1/2 in. **15/-**
 All the above are supplied complete but less valves, with circuit diagrams.

Cathode Ray Tubes 5 GPI

Green coating medium persistence 5in. flat face electrostatic tube. Anodes No. 1—575V; No. 2—2000V; No. 3—4000V. Sensitivity: Y—92V D.C./in. p-p. X—75V D.C./in. **30/-** 5/-.

IMPULSE MOTORS

12V D.C. Ratchet Motors, 5.75V coil. Ratchet wheel, 100 teeth. Can be arranged to index every 4 rev. Second hand, guaranteed. **3/6** p.p. 1/6.

FIRST-CLASS RADIO COURSES . . .

GET A CERTIFICATE!

QUALIFY AT HOME—IN SPARE TIME

After brief, intensely interesting study—undertaken at home in your spare time—YOU can secure your professional qualification. Prepare for YOUR share in the post-war boom in Radio. Let us show you how.

FREE GUIDE

The New Free Guide contains 132 pages of information of the greatest importance to those seeking such success-compelling qualifications as A.M., Brit. I.R.E., City and Guilds Final Radio, P.M.G. Radio Amateurs' Exams, Gen. Cert. of Educ. London, B.Sc. (Eng.), A.M.I.P.E., A.M.I.Mech.E., Draughtsmanship (all branches) etc., together with particulars of our remarkable Guarantee of

SUCCESS OR NO FEE

Write now for your copy of this invaluable publication. It may well prove to be the turning point in your career

FOUNDED 1885—OVER 150,000 SUCCESSSES,

NATIONAL INSTITUTE OF ENGINEERING
 (Dept. 461), 148 HOLBORN LONDON, E.C.1

S. Africa: P.O. Box 8417, Jo'burg.
 Australia: P.O. Box 4570, Melbourne.

Fully Guaranteed Magnetic Recording Tapes

at **BARGAIN PRICES**

Guaranteed suitable for any normal tape recorders. Full frequency 20-20,000 C.P.S. balanced reel, high output, low distortion. The 3" reel is also suitable for the Grundig Stenorette. Usually retail at 22/6 (p. & p.)

1 spool 1/-, 2 1/6, 3 1/9, 4 or more free

SEND for yours NOW

GOLDEN TAPES LTD. (PW)
 46 Asylum Road, London, S.E.15



TAPES ONLY

3" 200 ft. **7/11**

5" 600 ft. **12/11**

7" 1,200 ft. **21/-**

EMPTY SPOOLS

3" 2/- Post Free

5" 2/6 Post Free

7" 3/- Post Free

A.R.R.L. RADIO AMATEURS HANDBOOK 1961

New edition, 32/6, Postage 1/9

Principles of Transistor Circuits. 2nd ed. by AMOS, 21/-, postage 1/9.

Radio Receiver Servicing. 3rd ed. by Squire, 15/-, postage 1/9.

Beginners Guide to Radio. 5th ed. by Camm, 7/6, postage 9d.

The Oscilloscope at Work by Haas, 18/-, postage 1/9.

Model Boat Radio Control by Casebrook, 6/-, postage 9d.

Mullard Reference Manual of Transistor Circuits, 12/6, postage 1/9.

R.S.G.B. Amateur Radio Call Book, 4/-, postage 6d.

Junction Transistors in Pulse Circuits by Neelson, 28/6, postage 1/9.

Radio, TV, Hi-Fi, and Transistor Equipments Manual by Babani, 9/6, postage 9d.

UNIVERSAL BOOK CO.
 12 Little Newport Street, London, W.C.2 (adjoining Lisle Street)

THE PUNCH YOU NEED!

HOLE PUNCHES

One Minute Type

3/8" diameter ... 5/6 ea.
 1/2" " ... 6/4 "

Screw-up Type

1" diameter ... 6/8 ea.
 3/4" " B7G ... 7/2 "
 3/8" " B8A, B9A ... 7/8 "
 1 1/4" " ... 8/3 "
 1 1/2" " ... 8/7 "
 1 3/4" " ... 9/6 "

Postage and packing 1/-
 1 1/2" diameter Int. Octal ... 10/11 ea.
 1 1/4" " ... 13/3 "
 1 3/8" " ... 15/6 "
 1 1/2" " B9G ... 17/11 "
 2 3/32" " Meter ... 27/8 "

Post and packing 1/9

Complete set including postage and packing £7.

OLIVER & RANDALL LTD

Dept. 1.
 40 Perry Hill, London S.E.6
 Tel.: BECKenham 8262

Premier RADIO

23 TOTTENHAM COURT ROAD, LONDON W.1
and at 309 EDGWARE ROAD, LONDON W.2

Tel: MUSEUM 3451/2
Tel: PADDINGTON 6963

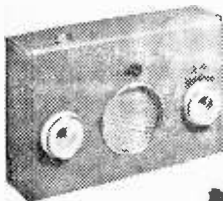

6-TRANSISTOR POCKET SUPERHET

May be Built for **£8.19.6** Plus 2/6 P. & P.

PP3 Battery extra at 2/6.

This receiver uses the most up-to-date printed circuit method and construction is simplicity itself with the aid of the point-to-point instructions supplied, using 6 Transistors and one Diode and internal Ferrite Rod Aerial, with provision for Car Radio Aerial. Full medium and long waveband coverage and when constructed the Receiver is housed in an attractive leatherette Case, size 6½ in. x 4½ in. x 1½ in.



The "Petite" PORTABLE

MAY BE BUILT FOR

£7.0.0 Plus 3/- p. & p.

BATTERIES EXTRA.
H.T. 10/- (Type B126) or equivalent L.T. 1/6 (Type AD35) or equivalent.
★ Size only 8in. x 8in. x 4½in.
★ instruction book 1/6.

The SUPER 60

6-Transistor
Battery Receiver
May be Built for
£9.15.0



Plus 4/6 P. & P.
Ever-Ready PP10
Battery Extra 11/-

STAR FEATURES:—
★ Six 1st grade Mullard Transistors and one Diode.
★ Internal Ferrite Rod Aerial.
★ 7in. x 4in. Elliptical Speaker.
★ Printe^d Circuit.
★ 500 mW Push-Pull Output.

★ Full medium and long waveband coverage.
★ Calibrated Direct Drive Dial Drive Assembly.
★ Full point-to-point instructions supplied.
★ Dimensions 18in. x 7½in. x 5½in.

The Receiver is housed in an attractive contemporary mahogany finished cabinet trimmed with gilt, supported by gilt stands.
The receiver will operate for months on one 9-volt long-life battery.
Instruction Book separately at 2/6 p.p.

Why not convert your battery portable to mains operation with the **COSMOR MU2 BATTERY ELIMINATOR?**
This Eliminator is completely assembled and supplied with 4ft of Mains Lead and Torpedo Type of On/Off Switch. It is housed in 2 Metal Containers approximately the same size as the AD35 and B126 Batteries, and suitable for receivers using DK96 range valves for use on 200-250V A.C. mains. Size: L.T. Unit 3in. x 2½in. x 1½in. H.T. Unit 4in. x 2½in. x 2in. Original price 3 gns. **39/6** plus 2/- P. & P.
OUR PRICE for a limited period only.

FOR BARGAINS M.S. RADIOPOST CO. MAIL ORDER SPECIALISTS

Please quote Dept. M.O.P.W.
Rear of 19 HARPENDEN ROAD, WANSTEAD PARK, LONDON, E.12.
Wanstead 1534

MINIATURE DYNAMIC SPEAKERS

A must for all Build-it-yourself-Hi-fis. As supplied with all current transistor Kit. Can also be adapted for home phones or intercom. 2in. diameter. Resistance 70 ohms. **ONLY 5/-**



SENSITIVE RELAY. Miniature Type 250 ohms. 1 P.P.I.T. 12 v. D.C. Overall size 1 x 1½ x 1 in. Adjustable armature tension spring. Will operate on less than 1 m/a. Suitable all model radio control. Brand new, 15/6 each.

CARBON HAND MICROPHONES.
Brand new and in original cartons. Built-in on/off switch, bakelite construction, with lead and plug. Only 6/8 each.

MINIATURE AMERICAN LEAD ACID ACCUMULATORS. 36 volts 20 m.A. 4 x 1½ x 3 in. 3/6 each.
12 VOLT VIBRATORS. 4 pin non-synchronous. Mtd. by Mallory in cartons of 20. 21/- per 20.

MINIATURE MODEL MOTOR

(Not Ex-Govt.)
Removed from Transistor Tape Recorders and in perfect condition. 3 to 12 volts.
Dual spindle fully reversible, protected bearings. Approximately 34000 r.p.m. Size: 2½in. long x 1in. wide. Spindle: 1in. x 1/32in.



Only 9/6 each

HYSTERESIS BLOWER MOTOR

Manufactured by SMITH'S Aircraft Instr. Type: 11M/14. 115 volts 400 cycles. Removed from New Automatic Pilot equipment but in perfect condition. Only 60/- ea. 8ft. WHIP AERIALS. 8 x 1ft. sections. For model radio control, etc. 7/6 each.



SOLDERING EQUIPMENT



PRECISION SOLDERING for the ELECTRONICS INDUSTRY

Comprehensive range - Robust & Reliable
- Light weight - Rapid heating - Bit sizes 3/32in. to 3/8in. - 'Permagit' or Cooper bits - All voltage ranges 67v. to 230/250v. - Prices from 19/6.

- Also
- Plastic Cable Strippers
- Miniature Solder Pots
- Heat Guards
- Long Life Bits



Illustrated is the 25w. 3/16in. replaceable bit model with safety shield.

ADAMIN—the new range of precision micro-soldering instruments—
Have you had details?

Brochure No. S10 sent free on request.
Sole proprietors and manufacturers:
LIGHT SOLDERING DEVELOPMENTS LTD.
28 Sydenham Road, Croydon, Surrey
Phone: CROYdon 8589 Grams: Litesold Croydon

TERMS: C.W.O. or 7 days approved accounts. All our goods are guaranteed new or in working order. Money refunded in full if not absolutely satisfied. Orders despatched same day. **NO POSTAL OR PACKING CHARGES.** C.O.D. 2/- extra. Carriage extra Eire and N. Ireland and countries outside U.K.

NEW VALVES !

Guaranteed Set Tested
24 HOUR SERVICE

1R5, 1S5, 1T4, 3S4, 3V4, DAF91, DF91, DK91, DL92, DL94, SET of 4, 18/6.	DAF95, DF95, DK95, DL96, SET of 4 28/-
1D5 7/- DL82 5/11 PCF80 7/8	1R5 5/- DL94 6/9 PCF82 7/8
1R5 4/6 DL96 6/9 PCL82 8/3	1T4 3/3 EB91 3/- PCL83 11/8
3S4 5/11 EBC41 7/6 PCL84 7/8	3V4 6/9 EBF30 7/9 PL35 10/9
5U4G 4/3 EB121 12/6 PL81 9/-	5Y3GT 4/6 ECC40 17/- PL82 7/-
5Z4G 7/3 ECC81 4/9 PL83 7/-	6AM6 2/9 ECC82 5/9 PL84 9/6
6AK7 1/9 ECC83 6/3 PY32 10/3	6K7G 4/9 ECC84 8/- PY30 7/-
6K9G 5/8 ECC85 7/9 PY81 6/6	6V6G 4/9 ECF80 8/3 PY82 6/3
6V6GT 6/6 ECF82 8/3 PY83 7/3	6X3GT 4/9 ECH21 7/6 U25 12/-
12K7GT 4/9 ECH42 7/9 UABC90 7/8	12K8GT 11/- ECL80 12/3 UAF42 8/8
12Q7GT 4/6 EF40 12/3 UBC41 7/-	35L6GT 8/6 EF41 7/6 UBF80 8/8
35L6GT 8/6 EF41 7/6 UBC85 7/-	4Z31 8/9 EFB50 5/- UCH21 12/8
4Z31 8/9 EFB50 5/- UCH21 12/8	CL33 11/9 EFB86 9/6 UCH42 7/6
DAC32 9/6 EFB89 6/9 UCH81 8/-	DAF91 4/6 EFB91 2/9 UCL82 10/-
DAF96 6/9 EL41 7/- UCL83 13/-	DF91 9/6 EL84 6/3 UCL81 12/8
DF91 3/3 EY31 7/3 UF85 8/-	DF96 6/9 EY36 7/6 UF89 6/6
DH77 6/- EZ40 7/- UL41 7/-	DK32 11/- EZ41 6/9 UL84 7/-
DK91 5/- EZ80 5/9 UY21 11/-	DK92 7/3 EZ81 6/6 UY41 5/6
DK96 6/9 MU14 7/- UY85 6/3	DL33 8/6 PCC84 7/3 VP45 8/8
DL33 8/6 PCC84 7/3 VP45 8/8	DL35 9/6 PCC89 10/- Z77 2/9

Postage 6d. per valve extra. Any Parcel Insured Against Damage in Transit 6d. extra

Any C.O.D. Parcel 3/- extra. Office Address, no callers.

GERALD BERNARD

(Note new address—formerly of Leeds)
25 NEWBURY ROAD
HIGHAMS PARK, LONDON, E.4

Lyons Radio Ltd.

Telephone: SHEPHERDS Bush 1729

3 Goldhawk Road, London W.12

10,000 OHMS P/V A.C. D.C. MULTI-METERS. Brand new, specially imported test meters which embody many special features including extra-large 3 1/2 in. scale, knife edge pointer for accurate reading. Unique single, easy to use, slide selector switch which even the novice would have difficulty in setting incorrectly and can be conveniently carried in the pocket. Ranges are: Volts A.C. and D.C.: 0/6, 0/30, 0/120, 0/600, 0/1200; D.C. Current: 0/120 microamps, 0/12mA, 0/100mA. Resistance: 0/20K, 0/2Meg.; Decibels: mfnus 20 to plus 63 dB in 5 scales; Capacitance: 0/005 to 0/15mfd. Supplied complete with test leads and prods and instructions. PRICE for this superb meter ONLY £5-19-6.

MAINS POWER UNITS. Input: 200/250v. 50cps. A.C. mains. Output: H.T. 300v. smoothed D.C. at 150mA. L.T. 6.3v. A.C. at 4A special. Size 10 1/2 in. high x 13 in. deep x 7 1/2 in. Special features include double filter unit ensuring negligible hum, Mansbridge smoothing condensers throughout, separate fuses and switches for mains and H.T., with pilot light indicator for each. Everything of top quality. 50A rectifier included, condition as new and unused. Truly remarkable value. PRICE ONLY 59/6, carriage 7/6.

I.F.F. UNITS. Contain a wealth of useful components including relays, 10 valves (6-6SH7, 2-7193, 2-61H6) and a rotary converter rated at 18v. D.C. input for 480v. D.C. output. With 12v. input the output obtained is approx. 250v. at 80mA. One end of converter is fitted with blower fan, other end with a gearbox. Both can easily be removed. The converter can also be operated from 6v. D.C. Two driving shafts protrude from the gearbox and rotate at approx. 4 and 18r.p.m. for 12v. input and about half this speed for 6v. Offer good value and usefulness for experimenter and handy man. PRICE ONLY 25/-, carriage 5/-.

SOLDERING TOOL

12/6. Brand New A.C. 110v or Car Batt. Adaptor 250v. 10/- extra. Auto/feed cannot burn. P. & P. 3/6.



BAKELITE CABINET 2/9



Brand New. Attractive design in brown. Size: 12 x 7 x 5 1/2 in. Ideal for small receivers, etc. P. & P. 3/9.

9d. each VALVES 7/6 doz. SALVAGE GUARANTEED

2D21	6SJ7	AR6	HL41DD	VR35
4D1	8D2	AR10	LP2	VR37
6AL5	9D2	BW48	KT36	VR51
6C5	10C2	C2C	F41	VR107
6C9	10F3	CV86	F81	VR137
6D1	11D3	D1	PM202	VR150
6D2	12Y4	EA50	R19	VT201
6H6	15D2	EB34	SP41	VT501
6J5	78	EB81	SP61	W150

Many more at 9d., 2/- and 5/9. Post on 1-7d.; 6-1/8; 12-2/6.

P.P. COMPONENTS LTD.
219 Ilford Lane, Ilford, Essex.
Stamp for FREE Catalogue.

BBC - ITV - F.M. AERIALS

B.B.C. (BAND 1). Tele-scopic loft, 19/6. External, S/D. 26/3.

I.T.V. (BAND 3). 3 Element loft array, 24/-, 5 Element, 32/6. Wall mounting, 3 Element, 33/8, 5 Element, 41/3.

COMBINED B.B.C. + I.T.V. Loft 1+3 Element, 41/3. 1+5 Element, 48/8. Wall mounting, 1+3 Element, 56/3. 1+5 Element, 63/8. Chimney and mast mounting units also available.

F.M. (BAND 2). Loft "H", 28/-, 3 Element loft, 52/8. S/D loft, 12/6. External S/D, 26/3. State channel when ordering. C.W.O. or C.O.D. P.P. 2/6. Coaxial cable, 8d. yd. Coaxial plugs, 1/8. Send 6d. stamps for illustrated lists.

K.V.A. ELECTRONICS (Dept. P.W.)
3B, Godstone Road, Kenley, Surrey.

LOOK! IT'S TRUE

RED SPOT TRANSISTORS 3/- each, 3 for only 8/6.

WHITE SPOT TRANSISTORS 3/- each.

YELLOW/GREEN 3/6 each, 3 for 10/-.

RED/YELLOW TRANSISTORS now only 5/6 each.

SURFACE BARRIER SB305 TRANSISTORS 9/6 each.

SPECIAL PRICE OFFER OF OC71, 8/6; OC72, 10/-; OC45, 11/6; OC44, 13/6; XA102, 12/6; XA101, 11/6.

SIX MATCHED TRANSISTORS OC44. 2xOC45, OC81D and 2xOC81. Set of Six 59/6.

TRANSISTOR HOLDERS 1/3. 3 for 3/6.

MINIATURE SLIDER SWITCHES DP/DT 2/9.

SUB-MINIATURE TRANSISTOR TRANSFORMERS. Push-Full Driver 4.5:1, Push-Pull Output 20:1. Boxed with Spec. 9/6.

DIODES 1/- each, 3 for 2/6, 7/6 doz.

CRYSTAL EARPIECES with lead 8/6.

LOW IMP. EARPIECES with Lead 8/6.

VARI-LOOP STICK M.W. Coils with CIRCUIT 4/6.

ALL SENT POST FREE IN U.K. by
PETHERICK'S RADIO SUPPLIES
22 High Street, Bideford, N. Devon
Tel: Bideford 1217
S.A.E. WITH INQUIRIES PLEASE

RESTORE T.V. TUBE PICTURE QUALITY & BRIGHTNESS



Pat. No. 826181
Reg. design.
JUST PLUG ON TO TUBE
No technical knowledge required.
Important! State Make, Model No. Name and Address in Block Letters Please.

STANDARD MODEL .. 20/-
DE LUXE MODEL .. 30/-
Postage 2/6 either model.

SINCLAIR ELECTRONICS Dept. P.W.1
18 Newport Court, Charing Cross Rd.
Terms: C.W.O., C.O.D. REGent 5520

BOOKS FOR THE CONSTRUCTOR

NEW PICTORIAL APPROACH TO LEARNING

BASIC ELECTRICITY, 5 parts.
BASIC ELECTRONICS, 8 parts.
The Complete Set sent on payment of first instalment.

LEARN WHILE YOU PAY
Write for FREE Illustrated Prospectus giving details of instalment plan!

BOYS' BOOK OF CRYSTAL SETS AND SIMPLE CIRCUITS. 3/6.

TRANSISTOR CIRCUITS Nos. 1, 2, 3, 4, 3/- each.

ELECTRONIC NOVELTIES, 5/6.

ELECTRONIC GADGETS, 4/-.

REPAIRING TRANSISTOR RECEIVERS 6/8.

Postage included in above prices.
SEND STAMP FOR LISTS.

SELRAY BOOK CO.
60 HAYES HILL, HAYES, BROMLEY, KENT.
Tel. HURStway 1818

H.A.C. SHORT-WAVE EQUIPMENT

AND SHORT-WAVE KITS

Famous for over 25 years for S.W. Receivers and Kits of Quality.

H.A.C. were the original suppliers of SHORT-WAVE RECEIVER KITS for the amateur constructor. Over 10,000 satisfied customers—including Technical Colleges, Hospitals, Public Schools, Hams, etc.

Improved designs with Denco coils: One-valve Kit, Model "C". Price 25/-.
Two-valve Kit, Model "E". Price 50/-.
New Addition: Model "K".
Super sensitive "All Dry" Receiver. Special incl. price. Complete Kit, 77/-.

All kits complete with all components, accessories and full instructions. Before ordering call and inspect a demonstration receiver, or send for descriptive catalogue and order form.

POST THIS COUPON NOW!

"H.A.C." SHORT-WAVE PRODUCTS
(Dept. TH), 4 Old Bond Street, London W.1

Please send me FREE and without obligation your 1961 literature.

NAME

ADDRESS

PADGETTS RADIO STORE

40 MEADOW LANE, LEEDS 11
Phone: Cleckheaton 2866

Special Offer. 62A tube unit, complete with 12 valves. In new condition, less tuning dial. 22/6, carriage 3/6.

Tube Unit, Type 116A. Complete unit with all valves and VCR97 tube, as new. 15/-, carriage 7/6.

Complete 12in. TV Chassis. Less valves. four for 10/-, carriage 5/-.

SCR52 Receiver. Less valves. 5/-, carriage 7/8.

SCR52 Transmitter. Less valves. 5/-, carriage 5/-.

P.M. Speakers. Removed from TV sets. Guaranteed perfect. 6in. and 7 x 4in. 5/- each, post 2/-.

NEW VALVES. Ex-units. All post free.

6K7	3/6	EF91	1/9	DL50	1/-
6X6	3/6	EB91	1/9	KT63	4/-
6C4	4/-	EL51	1/9	U12	5/-
VR91	1/6	954	1/6	SU4	4/6
VR91 red 2/1	9001	9d.	1S4	2/-	

Valves removed from TV sets. All tested on the New Mullard Valve tester. are 100% as new. They carry a 3 months' unconditional guarantee. All valves Post Free.

EP80	2/6	6P25	5/-	10P14	5/-
ECL80	5/-	6F1	3/-	10F1	3/-
ECC82	6/-	SP51	1/6	10D2	3/-
EL38	5/-	6G6	2/6	20D1	5/-
EF50	1/3	8V6	2/-	20L1	5/-
EY51	5/-	8V6	2/-	20P3	5/-
EF90	5/-	6S67	5/-	U25	5/-
2F9	5/-	PY81	5/-	20F4	5/-
6F13	5/-	PL81	5/-	20P5	5/-
6F14	5/-	PL82	5/-	U281	5/-
6F15	5/-	PY80	5/-	U29	5/-
6L20	5/-	954	1/6	U801	8/6
6K25	5/-	PZ30	5/-	KT38	5/-
6AL5	1/6	PL38	5/-	L63	3/-
6P28	5/-	10P13	5/-	N37	5/-

Many more types in stock

Reconditioned 12in. TV sets. Bush TV24A and TV24C, 5 channels, 55/-; 13 channels, 250.0.0. carriage and 12in. sets, 17/-.

Tubes are not boosted and sets work well. TV Tubes. Returned. 12 months' guarantee. 12, 14 and 17in. all at £3.15.0 each, carriage and insurance 7/6.

BENSON'S BETTER BARGAINS

CONDENSERS: Block paper 6 mtd. 1 kVw 10/-; 8/400 v. 6/6; 8/400 v. 5/-; 8/250 v. 4/4; 4/2 kVw. 7/8; 4/1kV. 4/8. SWITCHES: Water: 2 pole, 4 way, 4 bank 1P4W6B, 4P2W2B, 1P7W3B, 1P11W3B, 4P2W2B, 3/6 each, Ceramic. 2P4W1B, 1P5W3B, 1P1W, 3P3W3B, 4P3W1B, 3/6. STUD, 1P24W2B, 1P8W2B, 3/6. 1P19W2B, 5/8; 1P40W3B in brass case, 12/6. MORSE KEY with buzzer board, wired for 4 v. battery, 3/8 (P. 100). TELE. "P" intercom sets, good condition, pair 65/-, post free Gr. B. METERS (10Q/4) with two movements, 600 and 400µA, 8/6. TRANSFORMERS. Open, upright, input 200/230 v. Outputs—250.0-250 v., 150.0-150 v. 3 A. and 6.3 v. 3 A., 250 v. Input 110/240. Output 1800 v. 4 mA., 12/6. MONITOR 58, triggered oscilloscope, 230 v. A.C. input, with cables and circuit. Cathode probe unit extra, 17/6. £3.10.0. (Rail 15/-).

ORLO Noise Limiter assembly with valve, 3/6. NEW M.C. METERS, 3 1/4in. round flush, 50µA 70/-; 200µA centre zero, 50/-; 1 mA. centre zero, 45/-; 1 mA. 56/-; 3 1/4in. 1 mA., 22/6; 100 mA. 8/6; 2in. 300µA, 2/6.

20 v. A.C., 3/6. VIBRATORS, Mallory G634C 12 v. 4-pin, 7/8; 6 v. 6-pin reversible, 7/8. DRIVES: slowmotion Admiralty 200 : 1 ratio, scaled 0-100, 1/6. R1155 S.M. "N" type, new, 10/6. VIBRAPAK, 5 v. D.C. to 250 v. 60 mA., smooth chaser, 22/6 (p.p. 3/6), or 12 v. 25/-.

DYNAMOTORS (post 3/6), 12 v. to 250 v. 60 mA., 11/6. 5 v. to 250 v. 60 mA., 11/6. CHOKES. LF 10H, 200 mA., 8/6; Potted 10H, 100 mA., 7/8; "C" 10H, 250 mA., 12/6; 100 mA., 10/6; 20H, 50 mA., 7/8; 10H, 500 mA., "C" 22/6; 80H, 100 mA., 9/8; 5H, 100 mA., 8/6; 16H, 150 mA., 9/6.

CLOSED HOLIDAYS
24 JUNE - 10 JULY (incl.)

RELAYS LONDON co-ax. small 1000 v. 7/6; 12/24 v. DP/CO, 1/6; 24 v. DP/CO plus 1M (two on base) 3/8. Rectifier Unit (U.S.A.) H1-C1 with 3/8T4, 3/8T6, 2/VR150, 1/68N7, 1/68L7, new, 65/- (rail 5/-). Valveholders: B7G W/Skirt, 5/- dozen; I.O. Ceramic, 1/- each. LIST AND ENQUIRIES S.A.E. please. Terms, C.W.O. Postage extra. Inm. despatch. Orders and post: W. A. BENSON (P.W.), 138 Rathbone Road, Liverpool 15. SEP 6853. Sellers: SUPERADIO (Whitechapel), Ltd., 118 Whitechapel, Liverpool 1. ROY 1150.

TRANSISTOR TOOL KIT



NO MORE HEADACHES with the specially selected miniature, extra small, high grade tools. Kit comprises:—**34/9**
Side Cutters
Telescopic car. awls
Tweezers, Circuit Brush, Steel Probe, Sharp Steel Midget Screwdriver, Watchmaker's Eyeglass, Extra Pointed Long-nosed Pliers.
IDEAL FOR EVEN TINY RADIOS.

Order Now. Supplies Limited
Send P.O. and 1/6 to cover post.
LUBRICANT ELECTRONIC AIDS
22 Hunton Street
Brick Lane, London E.1
Trade enquiries welcome

B. W. CURSONS

THE NAME TO REMEMBER
BARGAINS—OPENING SALE TO BREAK THE PRICE BARRIER TO All goods dispatched in good condition post free

Transistor XFMR5 Drive LT44
Output LT700 8/6 per pair
High or Low Imp sub-min. ear. 7/6 ea.
Crystal Mics 2/3 ea.
Transistor tuning cons. 150-250-450p 2/3 ea.
Red or White Spot transistors 3/6 ea.
Diode sets 2/- ea.
Telescopic car. awls 17/- ea.
Carbon Mics 2/6 ea.
25p Trimming Condensers 7 for 5/-
Standard Coax Plugs 7 for 5/-
.005 Gang Condensers 4/6 ea.
Crystal Mics 17/- ea.
Good quality coax cable cut to length. 9d. yd.
Ex Gov. mains filter units 3/- ea.
Rectifiers metal 12-18 1A 5/6d. ditto 2A 7/8d. 250 v. 100 mA 7/8.
Preset controls small 250 k. and 500 k. 2/- ea.
32 + 32µf 275 vdc Condensers 3/- ea.
10 way tag board strips 12 for 5/-
Crystal Mics 6B8G, 6K7G, EF60, 6H6, EB91, 4/- each, IT4, 807, EF91, EF90, 10F1, 5/- each, 6V8G, 6X5G, PZ30, U78, 20P3.
Minimum order 40/- C.W.O. only. All goods post paid by us.

B. W. CURSONS
78 Broad Street, Canterbury, Kent.
Phone: Canterbury 5442.

★★★ Special bargain offer—Complete Kit P.W. Superhet including genuine Ediswan Transistors, £7.19.6—a bargain not to be missed ★★ Red Spot Transistors, 3/-; White Spots, 3/-; Yell./Gr., 3/6; Ediswan XA102, 10/-; XA104, 9/-; XA103, 9/-; XA101, 9/-; XB103, 8/6; XB104, 7/6; XC101, 9/-.

Special bargain set for P.W. Superhet 6 Transistors (1-XA102, 2-XA101, 1-XB103, 2-XC101), plus Diode, 47/6; Newmarket V15 1/0 P, 15/-; Diodes, 1/-; 2/6; 4/-.

Transistor holders, 1/-; Ardent Trans. D239, 8/6; D240, 8/6; D.131, 10/-; D.132, 10/-; Sub. Min. Electrolytics (15v) 2, 4, 8, 10, 25, 50, 100, mfd., 3/-; 32 mfd., 2/9. M.C. Earpiece (used as speaker), 5/-; Balance Inserts (as earpiece or speaker), 3/6.

Silicon Rectifier bargain 70 p.i.v. 4 amp., 3/3; Vestalite Contact Rectifier 250 v., 60 mA, 7/6; Transformer 250.0-250 v., 6v. 5/-, 15/-.

Packard Bell Amplifiers, new 12/6; Garrard Portable Record Player, cabinet, battery turntable 45 r.p.m. and pick-up; takes transistor amplifier, £3/10.0, plus carr. 3/3. **REAL BARGAIN.** Limited quantity. Post extra, excess refunded. Morco Reflex Rx. best 2-transistor Receiver. Send Rdx. stamps for notes.

MORCO EXPERIMENTAL SUPPLIES
8 & 10 Granville Street, Sheffield 2
Tel.: 27461

EDDY'S (NOTTM.) LTD.

172 Alfreton Road, Nottingham
P.W. 6 TRANSISTOR Medium and Long Wave Pocket Superhet. 6 matched transistors and diode. 150 M.W. push-pull output easy to follow, printed circuit with all components marked. High "Q" internal ferrite aerial. Quality 2 1/2in. speaker size 5 1/2 x 3 x 1 1/2. No technical knowledge required. No extras to buy. Total cos. of all items £8/19/6. P.P. 2/6.

POCKET RADIO. 2 Transistors with miniature speaker complete with all parts wiring diagram and full instructions. 27/6, batteries 17/- P.P. 1/6.

CRYSTAL SETS complete 2 wave bands high gain good quality, 19/11, also with transistor amplifier extra, 9/11. P.P. 2/6.

HEADPHONES, high resistance to suit above crystal sets. Good quality, 13/11 pair. P.P. 1/6.

VIBRATORS, 12 volt 4 pin, 4/11. Post 1/-.

THROAT MIKES, 1/- each. Post 6d. Also super quality throat mikes 2/- each. Post 9d. Could be used for electrifying musical instruments, etc.

GERMANIUM DIODES, 9d. each, 7/- dozen. Post 6d.

HEADPHONE CORDS, 6ft length, 1/11. Post 6d.

NIFE ACCUMULATORS. 1.25v. size 3 x 2 1/2 x 3 1/2in., 7 amp. Hrs. weight 13 ozs., 1/11 each. P.P. 1/6 only, add 9d. per cell.

MORSE TAPPERS, plated contacts, adjustable gaps heavy duty. Good quality. Special price 3/6. Post 9d.

V.H.F. AERIALS. Expanding, complete and easy to fit. No technical knowledge required. 6/11. Post 10d.

LUXEMBOURG AERIALS. Expanding, complete and easy to fit. No technical knowledge required. Greatly improves reception, 3/11. Post 6d.

All above are new and guaranteed

New and Surplus Valves Guaranteed and Tested by Return Post.

ID5	7/6	35V4	6/9	EF80	5/-
1L4	3/6	35Z4	5/3	EF85	5/11
1R5	5/6	78	6/6	EF86	9/6
1S5	4/6	80	7/-	EF91	3/6
1T4	3/11	90AV	8/6	EL41	7/3
35A	5/11	95A	1/6	EL42	9/6
3Y4	6/9	955	2/6	EL84	6/6
5U4G	4/9	956	3/6	EL91	4/6
5Y3GT	5/9	AC2/PEN		EY81	7/11
6AG5	4/9	DC	7/6	EY86	7/9
6B16	5/11	CL	7/6	EZ80	6/-
6B8G	2/11	CY31	12/6	EZ81	6/9
6C4	3/6	DAF91	4/6	KT33C	6/6
6C6	4/9	DAF96	6/11	HL23DD	
6F33	6/9	DF91	3/11	MU14	7/11
6J5G	2/9	DF96	6/11	MU14	7/-
6J5GT	3/9	DL96	6/11	PCB84	7/3
6J5M	4/3	DK91	5/11	PCCB85	9/3
6K7G	1/11	DM70	6/11	PCF80	7/3
6K8G	5/3	EAF42	8/6	PCF82	7/6
6SA7M	5/9	EAC91	4/6	PEN36C	8/6
6SG7M	4/9	EB91	3/6	PEN46	7/6
6S17M	6/3	EFB80	8/6	PLC82	7/6
6S17GT	4/9	ECC81	5/3	PLC83	12/6
6S4GT	10/6	ECC82	5/11	PL33	8/3
6V6G	4/9	ECC83	6/6	PL36	10/9
6V6GT	6/11	ECC84	8/3	PL81	9/-
6X5GT	5/11	ECC85	6/11	PL82	7/6
10P13	9/6	ECF80	9/-	PL83	7/-
10F1	6/11	ECF82	9/-	PY80	7/-
12A6	5/3	ECF42	7/9	PY81	8/6
12AT6	7/6	ECF81	8/-	PY82	6/9
12AT7	8/6	ECL80	7/-	PY83	7/3
20P1	9/6	ECL82	10/-	PZ30	9/6
20P3	12/6	EF36	3/-	SP61	2/6
25L6GT	7/6	EF41	7/6	TD4	8/9
25Z4G	7/6	EF42	7/6	UAF42	8/9
30F5	8/6	EF50	1/9	VP23	6/6

Any parcel insured against damage in transit for only 6d. extra per order. All uninsured parcels at customer's risk. Post and Packing 6d. per valve extra. C.W.O. or C.O.D. only. C.O.D. charge 3/- extra. S.A.E. with inquiries.

6 MULLARD TRANSISTORS AND DIODE

1—OC44 ONLY
2—OC45 **50/-**
1—OC71
2—OC72 PER SET
and
1—OA81
or with 2—OA81, 52/6
Special offer of 1st grade transistors.

SUNDRIES

- ★ 1000 ohm Personal Phone with Leads and Jack Plug and Socket, suitable for most Commercial Transistor Radios. 17/6.
- ★ 9.065 Mc/s 3rd Overtone Crystal for all 27 Mc/s Model Control Transmitters. 12/6.
- ★ 7 section chromed Telescopic Aerials, 38 in. with fixing bracket, 12/6 P.P. 1/6. 64in. Version, 17/6, P.P. 1/6.
- ★ ACOS Crystal Mic Inserts. 2in., 12/6; 1 1/2in., 7/6; 1/2 x 3/4 in., 7/6.
- ★ Mercury Batteries, 1.3 v. 500MAH. 1/2in. x 1/2in. 1/3 ea. P.P. 3d.
- ★ Siemens High Speed Sealed Miniature Relay, 1700-1700 ohms. 15/- ea.
- ★ 4.7 volt 1 watt Zener Diode. 19/6 ea.

ALL COMPONENTS IN STOCK for "WEY-RAD" 6-Transistor Superhet. Booklet 1/3 post free.

Leaflet on request.

TRANSISTOR FM TUNER



(cover removed)

- ★ 2-OC171 and 3-OC170 Selected Transistors.
- ★ Fully Tunable 85 to 108 Mc/s.
- ★ 10.7 Mc/s I.F.

A new design for Hi-Fi to feed quality valve or transistor amplifiers. Noise level better than 55dB. Hammer finish case. Pre-aligned and tested units. Fully illustrated Book 376. All Parts as Shown 18 gns. P.P. 3/-

2 WATT POWER AMPLIFIER

- ★ Designed to boost up the output of Portable Transistor Radios when used in a Car. Works from 6 or 12 volt (state which) Car Battery—uses power transistor. All Parts 49/6, P.P. 2/-.

MULTI RANGE TEST METERS

Model A-10 (500 Micro-amp. movement) D.C. (2k per volt) 0/10/50/250/500/1,000V A.C. (2k per volt) 0/10/50/250/500/1,000 D.C. current 0/0.5/25/250mA. Resistance: 0/10K/1 Meg. Size 5 1/2 x 3 3/8 x 1 1/2 in. Weight 17 oz. inclusive of test probes, instruction book and batteries. £4.17.6. P.P. 1/6.

Model B-20 (100 Micro-amp. movement) D.C. (10,000 ohms per volt) 0/0.5/2.5 volts D.C. (4,000 ohms per volt) 0/10/50/250/500/1,000V A.C. (4,000 ohms per volt) 0/10/50/250/1,000V D.C. Current, 0/0.1/2.5/25/250mA. Size 5 1/2 x 3 3/8 x 2 1/2 in. Weight 24 oz. inclusive of test probes, instruction book and batteries £6.10.0 P.P. 1/6



MODEL A-10

★ FULLY GUARANTEED—EASY TO USE ★

3-TRANSISTOR AND DIODE PERSONAL POCKET RADIO



SUPER-3

QUALITY OUTPUT ON PERSONAL EARPHONE

A simple to build local station radio with personal earphone output. Built-in Ferrite Aerial and Battery lasting 9 months.

ALL PARTS **37/6** P.P. 1/6

★ NO EXTRAS TO BUY Size 4 3/8 x 3 x 1 1/2 in.

★ IDEAL for BEGINNERS

ALL PARTS IN STOCK FOR REPANCO "MINI-4" POCKET SUPERHET. ALL PARTS £6.19.6 — FREE LIST ON REQUEST

PRACTICAL TRANSISTOR CIRCUITS

3/6 Post Free.

Contains easy to follow plans of 40 all transistor units, including light operated switches, amplifiers, transmitters, receivers, test oscillators, signal tracers, hearing aids, radio control, etc. All parts available separately.

★ Designed for the Home Constructor.

SUNDRIES

- ★ Sub-miniature Jack Plug and Socket, 3/6 complete.
- ★ Mullard LA4 Pot Core complete 12/6. LA10 complete 17/6.
- ★ Sub-miniature 27 Mc/s 3rd Overtone Xtal for model control 30/-.
- ★ Personal Earphones used with RANGER 2 and 3. British made, 12/6.
- ★ 2 1/2 inch round deep 3 ohm speaker, 17/6
- ★ 2 1/2in. 80 ohm Speaker, excellent quality, 17/6.
- ★ 600 ohm Personal Car Phone with jack and socket, 10/6, p.p. 9d.

ALL TRANSISTOR MEDIUM LONG AND SHORT WAVE PRE-BUILT UNITS IN STOCK. FULLY ILLUSTRATED BOOKLET SHOWING USES. 2/6.

CRYSTAL MICROPHONES



ACOS 39-1 Stick Microphone with screened cable and Stand (list 5 gns.), 39/6, P.P. 1/6.

ACOS 40 Desk Microphone with screened cable and built-in stand (list 50/-) 19/6 P.P. 1/6.

ACOS 45 Hand Microphone with screened lead, very sensitive, 29/6, P.P. 1/6.

MC 43 Stick Microphone with mixing switch and screened cable 42/6, P.P. 1/6.

Brand New—Fully Guaranteed

ULTRA MINIATURE TRANSISTOR COMPONENTS

- Set of OSC. and 3 IF's. Size 1 1/8 x 1 1/8 x 1/2 inch. 21/-.
 - 1 1/8 inch Square Poly. 2-gang Tuner with Trimmers. 17/6.
 - Driver and Output Transformer, (matched to 8/10 ohms). 12/6 pr.
 - 2 1/2 inch 10 ohm Speaker. 17/6.
 - Ferrite Aerial Slab 3/6.
- Circuit Diagram Free with Coil Set.



TRANSISTORS From 3/6 each

FULLY GUARANTEED

We stock over 80 types of transistor. Let us have your enquiries.



LOOK AT THESE PRICES!

OC44	11/-	XA102	15/-	*XC121	15/-
OC45	10/-	XA101	12/6	XC141	30/-
OC71	6/6	XB103	10/-	OC169	18/-
*OC72	8/-	*XC101	12/6	OC170	13/6
OC76	8/-			OC171	14/6
OC75	8/-	XA104	12/6	XA131	35/-
OC26	25/-	XA103	10/-	2N502	55/-
				XC131pr.	34/-
				V15/20IP	20/-

* Available in matched pairs.

AVO MODEL—8 (List £24.10.0)

£17.10.0 Registered Post & Packing 5/- in new condition with test leads & batteries.

AVO MODEL—7 (List £19.10.0)

£12.10.0 Registered Post & Packing 5/- in new condition with test leads & batteries.

● Both Types Tested & Guaranteed

BABY SITTER ALL TRANSISTOR BABY OR INVALID ALARM

MORE SENSITIVE!



Battery operated, push-pull, 400mW output. Low impedance microphone enables unit to be used up to 200 yards. Output on 5in. speaker.

● GUARANTEED for 6 MONTHS and 100% SAFE.

● Microphone is placed within 6 ft. of Baby: twin flex is taken to amplifier unit and placed in any room required.

COMpletely BUILT AND TESTED £5.10.0 P.P. 2/6.

● Used All Night, Every Night, Battery Life 3 to 4 months.

★ VALVES ★

WE STOCK OVER 800 TYPES OF VALVES AND TUBES AT REALLY COMPETITIVE PRICES.

● FREE LIST ON REQUEST ●

Henry's Radio Ltd

DEPT. B7

5 HARROW ROAD LONDON W.2

Opposite Edgware Road Tube Station
OPEN MON. to SAT. 9-6, THURS. 1 o'clock
Telephone PADdington 1008/9

SEE BACK PAGE

OUR SPECIALITIES
Transistors, Valves,
Quartz Crystals, Components at Competitive Prices

Practical Wireless

BLUEPRINT

SERVICE

ALL OF these blueprints are drawn full-size and although the issues containing descriptions of these sets are now out of print, constructional details are available free with each blueprint except for the PW Monophonic Electronic Organ.

The index letters which precede the Blueprint Number indicate the periodical in which the description appeared. Thus PW refers to PRACTICAL WIRELESS; AW to *Amateur Wireless* and WM to *Wireless Magazine*.

Send (preferably) a postal order to cover the cost of the Blueprint (stamps over 6d. unacceptable) to

PRACTICAL WIRELESS, Blueprint Dept., George Newnes, Ltd., Tower House, Southampton Street, London, W.C.2.

SPECIAL NOTE

THE following blueprints include some pre-war designs and are kept in circulation for those constructors who wish to make use of old components which they may have in their spares box. The majority of the components for these receivers are no longer stocked by retailers.

Title	Number	Price
CRYSTAL SETS		
Junior Crystal Set	PW94	2/-
Dual-wave Crystal Diode	PW95	2/6

STRAIGHT SETS		
Battery Operated		
Modern One-valver	PW96	2/6
All-dry Three	PW97	3/6
Modern Two-valver	PW98	3/6

SUPERHETS		
Mains Operated		
A.C. Band-pass Three	PW99	4/-
A.C. Coronet-4	PW100	4/-
A.C./D.C. Coronet	PW101	4/-
The PW Pocket Superhet	—	5/-

MISCELLANEOUS		
The PW 3-speed Autogram	—	8/-
The PW Monophonic Electronic Organ	—	8/-
<i>(No constructional details are available with this blueprint)</i>		

TELEVISION		
The PT band III converter	—	1/6

Title	Number	Price
A.C. Fury Four	PW20	2/6
Experimenter's Short Wave	PW30a	2/6
Midget Short Wave Two	PW38a	2/6
Band-Spread Three (Battery)	PW68	2/6
Crystal Receiver	PW71	2/-
Signet Two (Battery)	PW76	2/6
Simple S.W. One-valver	PW88	2/6
Pyramid One-valver	PW93	2/6

BBC Special One-valver	AW387	2/6
Short-Wave Two	AW429	2/6
Short-Wave World Beater	AW436	3/6

Standard Four Valve S.W.	WM383	3/6
Enthusiast's Power Amplifier	WM387	3/6
Standard Four Valve	WM391	3/6
Listener's 5-Watt Amplifier	WM392	3/6

QUERY COUPON

This coupon is available until 7th July, 1961, and must accompany all queries in accordance with the notice on our "Letters to the Editor" page.

PRACTICAL WIRELESS, JULY, 1961.

Published on the 7th of each month by GEORGE NEWNES, LIMITED, Tower House, Southampton Street, London, W.C.2. and printed in England by WATMOUGHS LIMITED, Idie, Bradford, and London. Sole Agents for Australia and New Zealand: GORDON & GOTCH (A/asia), Ltd., South Africa and Rhodesia: CENTRAL NEWS AGENCY, LTD. Subscription rate including postage for one year: Inland £1.3.0. Abroad £1.1.5 (Canada 19s.). Registered at the General Post Office for the Canadian Magazine Post.

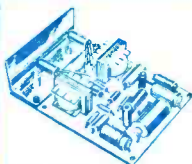

**1/2 WATT
4 TRANSISTOR
AMPLIFIER**

- 1 watt peak output
- ±3dB 70c/s to 12 kc/s.
- Output to 3 ohm speaker.
- 9 volt operated

**Built and Tested
69/6 P. & P. 1/6**

A printed circuit high gain amplifier size 4 x 2 1/2 x 3/4 in. using Mullard OC71/OC81D and 2-OC81 Transistors. Ideal for Intercomm., Record Player, Tuner Amplifier or any application requiring a quality and reliable amplifier.

- Full Details and uses on request ●

PRICES DOWN! →
NOW EVEN BETTER VALUE FOR MONEY

CONTESSA
6 TRANSISTOR MEDIUM AND
LONG WAVE SUPERHET
TERRIFIC SENSITIVITY

UNBEATABLE IN PERFORMANCE
AND APPEARANCE

SPECIFICATION

- 425mW Push-Pull Output
- 6 "Top-Grade" Edison Transistors
- New Type Printed Circuit with all Components marked
- Full Medium & Long Wave Tuning
- High "Q" Internal Ferrite Aerial
- Car Radio Adaptation and AVC
- Slow Motion Fingertip Tuning with Station Names
- "Hi-Fi" Quality Speaker
- Attractive Rexine Covered Cabinet

TOTAL COST OF ALL PARTS

£10.19.6 P.P. 3/6

● NO EXTRAS TO BUY ●

**COMBINED PORTABLE AND
CAR RADIO**



Call for demonstration. No technical knowledge necessary. All parts sold separately. Only the best in components used throughout. New descriptive Leaflet and Prices on request.

6-TRANSISTOR FIDELITY "CORONET"
MEDIUM AND LONG WAVE
POCKET RADIO

- Size 2 1/2 x 4 1/2 x 1 1/2 in.
- Quality Push-Pull Speaker Output.
- Guaranteed for 12 Months.
- Phone and Tape Sockets.

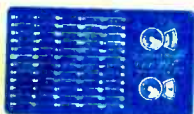

9 1/2 gns Reg. Post
2/6
(INCL. BATTERY)

**ALL BRITISH DESIGN AND
CONSTRUCTION**

★ **'PW' ROADFARER** ★

(as described in April edition of
Practical Wireless)

A.M. and F.M.



7-transistor mains/battery portable in attractive moulded case. Slow motion tuning; telescopic aerial; 7 x 4 in. speaker; Ferrite aerial, etc.

● Full tuning medium wave and VHF F.M. for clear reception of all programmes anywhere in the country.

- 500mW push-pull output with Mains or Battery supply built in.
- PRINTED CIRCUIT—
- FULLY ILLUSTRATED BUILDING INSTRUCTIONS

All Parts as Specified

£16.19.6 P.P. 3/-

All components sold separately.
List on request.

★ **'PW' 6-TRANSISTOR** ★
MEDIUM AND LONG WAVE
SUPERHET

(as described November P.W.)
● A sensitive superhet with 150mW push-pull output on 2 1/2 in. speaker. Uses 6 first grade Mullard transistors and printed circuit. Moulded cabinet. Red, Blue or Cream.



Size 5 1/2 x 3 x 1 1/2 in.

£8.19.6

ALL PARTS REQUIRED

★ NO EXTRAS TO BUY—EVERYTHING SUPPLIED ★

PLEASE

Henry's Radio Ltd

Dept. B.7. PADDINGTON 1008/9

5 HARROW ROAD, LONDON W2

Open Monday to Sat. 9-6, Thurs. 1 o'clock

SEND 6d. STAMP FOR NEW ILLUSTRATED PRICE LISTS



TURN
PAGE



Size 4 1/2 x 3 x 1 1/2 in.

★ **RANGER 3** ★

NO EXTERNAL AERIAL OR EARTH

3-TRANSISTOR and 2-DIODES

PERSONAL POCKET RADIO with 5 stages giving clear reception on medium wave, amateur top band and shipping. Only first grade components used throughout. As described in March RC.

ALL COMPONENTS

79/6 P.P. 1/6

NO EXTRAS TO BUY
Everything Supplied.

- Easy to follow instructions with pictorial layout.
- Reception of Radio Luxembourg guaranteed (most areas).

Free Instructions and Price List on request. Easy to build.

● AFTER SALES SERVICE, GUARANTEED SUCCESS ●

★ **MODEL CONTROL RECEIVERS** ★

Lightweight Transistor Receivers for even the smallest model boat, car, train, aircraft, etc. A really fascinating hobby. Any valve type tone transmitter may be used with the "Supertone" range, operating on 27 Mc/s radio control.

ALL TYPES ARE EASY TO BUILD WITH GUARANTEED RESULTS UP TO 1/2 MILE. 4 1/2 VOLT OPERATED AND TRANSFORMER COUPLED FOR HIGH SENSITIVITY.

● "SUPERTONE—RR4": Relayless Receiver. 4-transistor OC169/OC71/OC72/V15/201P, giving 300mA current rise. No relay couples directly to actuator or servo, etc. Size 2 1/2 x 2 x 3/4 in. All parts 72/6 P.P. 1/6.

● "SUPERTONE—IC", Single Channel OC169/OC71/OC72 transistors. Output to relay, 18mA rise. 2 1/2 x 2 x 1 in. All Parts 59/6 P.P. 1/6.

● "SUPERTONE—3C", 3 Channel Output to 3 Reed Unit, giving 3 Channels. OC169/OC71/OC72 transistors. Size as above. All Parts 59/6 P.P. 1/6.



SEND 6d. STAMP FOR DIAGRAMS AND DETAILS

RANGER 2 ★ PERSONAL
POCKET RADIO ★

● Two Transistor Two Diode version of "Ranger-3". See above. Similar in performance.

All Parts **59/6** P.P. 1/6.

● PICTORIAL PLANS AND DETAILS
FREE ON REQUEST

