

PRACTICAL 1/6 WIRELESS

MAY
1961

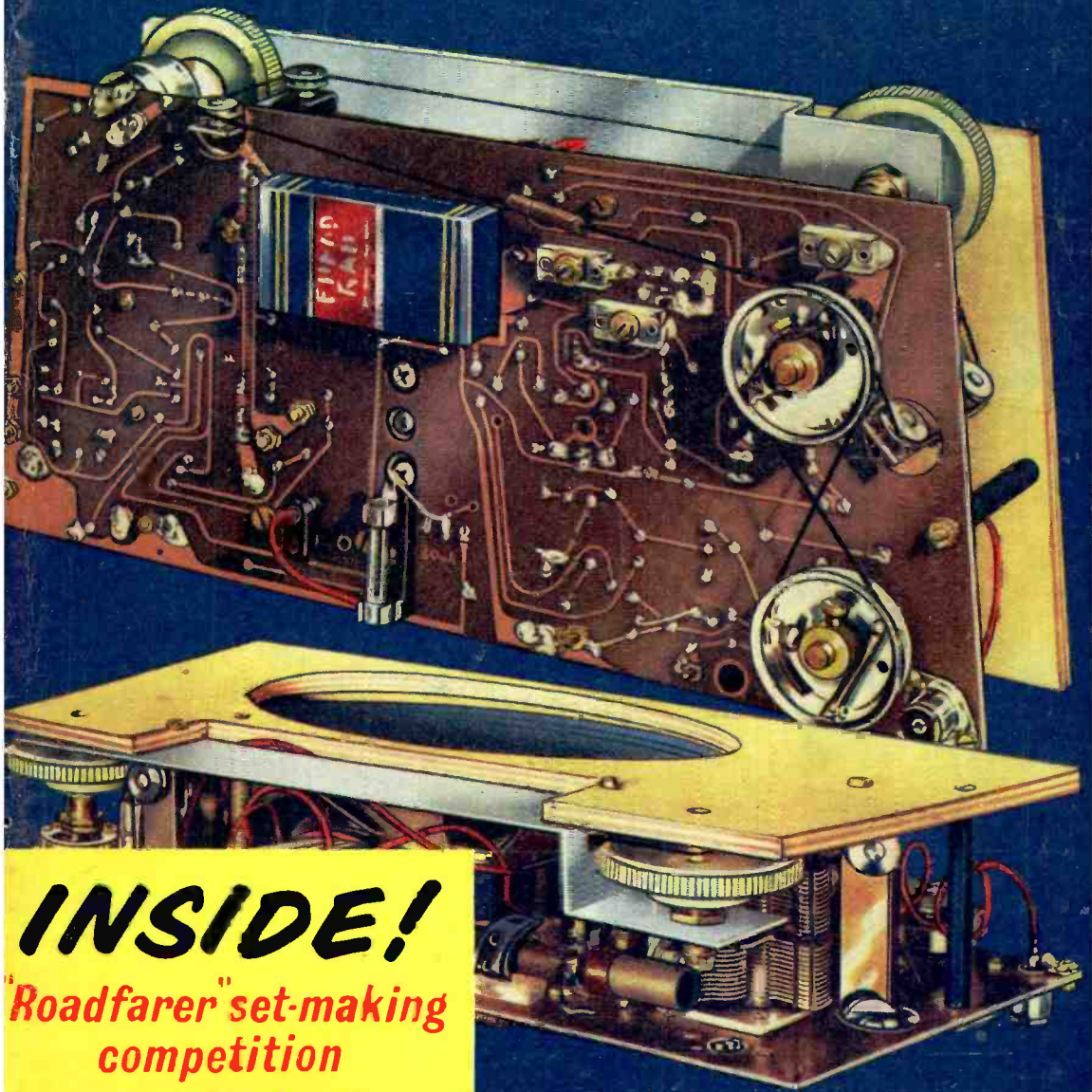

INSIDE!

*"Roadfarer" set-making
competition
—£100 first prize*



NEW! 10,000 O.P.V. MULTI-TESTER ON BOTH AC & DC

FULL SCALE RANGES:
 DC VOLTS: 0-6; 0-30; 0-120;
 0-600; 0-1200.
 AC VOLTS: 0-6; 0-30; 0-120;
 0-600; 0-1200.
 DC CURRENT: 0-120 uA; 0-12M;
 0-300M.
 RESISTANCE: 0-20K; 0-3 Meg.
 DECIBELS: -20 to +63 in five scales.
 CAPACITY: 50 uuf to .01 uf and .001 uf to .15mF.
 OUTPUT RANGES: 0-6; 0-30; 0-120; 0-600; 0-1200.

MODEL EP-10K OUTPERFORMS INSTRUMENTS MANY TIMES ITS SIZE AND PRICE!

UNBELIEVABLE BARGAIN!

A revolutionary new Multi-Tester. A complete wired and tested instrument (not a kit) incorporating extra large 3 1/2 in. meter face and unique slide range switch. Can be conveniently carried in the pocket and features unusually sensitive 10,000 ohms per volt AC-DC meter, 1 per cent precision resistors, and largest meter ever placed on an instrument this size. Single, easy to use range selector switch, can be appreciated by the novice and engineer alike. Complete with colour coded test leads and battery.
 Size: 4 1/2 x 3 1/2 x 1 1/2 in. **Model EP-10K ONLY £5-19-6 P. & P. 3/6.**

COMPLETE HEADPHONE & MICROPHONE ASSEMBLY.



A must for every constructor and "Ham", consists of moving coil padded headphones and phones and "Press to talk" microphone. **10/- P. & P. 3/6.**

R.C.A. COMMUNICATION RECEIVER AR-88 D.

Range: 540 kc/s-32Mc/s in 6 bands. Undoubtedly the finest communication receiver ever produced for service and laboratory use. Now Relda's exclusive purchase enables you to obtain this Rolls-Royce of communication receivers at the lowest price ever offered. Fully guaranteed. FEW ONLY AT **£39.10.0**, carr. 50/-.

WIRELESS SET No. 19



Incorporates TX/RX covering 2-9 Mc/s (37.5-150 metres), and intercom. amplifier, 500 microamp check and tuning meter, circuit and instruction book. **ONLY 65/-, Carr. 10/-.**

HI-FI HEADPHONES

These miniature HI-FI phones use a high quality permanent magnetic speakers with regulated voice coil. The softbruber gear moulds give correct spacing for optimum acoustic load. Each unit has a built-in miniature HI-FI transformer to ensure the finest music and voice reproduction. Supplied free is a small transformer unit which steps impedance up to 4000 ohms. **Only 15/- P. & P. 2/6.**
Standard High Resistance Phones. 12/6. P. & P. 2/6.



PORTABLE SOLDERING IRONS

MODEL SP-1. 30 watt Portable Hand Soldering Iron. The latest - smallest - coolest 30 watt iron available. Especially suited for precision wiring. Highly stable heat characteristics assure long life and safety in use. Features a removable handle that may be used to cover the tip and barrel to permit the iron to be carried safely even while hot. Supplied complete with vinyl bag, lead and plug. **Only 18/9. P. & P. 1/3.**



SLIM CRYSTAL MICROPHONE

MODEL 100-C. A unique design offering tremendous value. Has detachable 7 ft. shielded cable and muting switch. Smooth wide range response 60-10,000 CPS. Sensitivity: 52 db. High impedance. Satin chrome finish metal case. **Only 32/6. P. & P. 2/6.**



SUB-MINIATURE TRANSFORMERS

Here is outstanding value in transistor transformers consisting of one Driver Transformer and one Output Transformer. Ideal pair for miniature transistor portables, etc. **Driver Model LT44:** Primary: 20k. Secondary: 1k. Centre Tapped. Ratio: 3 : 1. **Output Model LT700:** Primary: 1.2k. Centre Tapped. Output: 3.2 ohms. Ratio: 2 : 1. Complete with detailed instructions. **Only 9/6 per pair. P. & P. 1/6.**



TELEPHONE PICK-UP COILS

MODEL FC-8 Induction Pick-up coils enabling conversations to be picked up without tapping of wires or special telephone circuits. No electrical connections! Simply place telephone on the pick-up platform and connect lead to the input of any medium gain amplifier or direct to any tape, disc, or wire recorder. The coil is electrostatically shielded to minimise FC-8 only. **16/- plus 1/6 P. & P.**



MORSE CODE SET WITH HEADPHONES

Complete morse code set, includes headphones, morse key, buzzer, pitch control, internal battery. Magnificent appearance and housed in portable wooden case with carrying strap. Supplied complete and ready for immediate use. **ONLY 19/6. Carr. 4/6.**



AERIAL VARIOMETERS

These magnificent instruments will enable you to receive maximum signal strength on all S.W. receivers. Precision calibrated control. **12/6. P. & P. 2/6.**



BC-221 HETERODYNE CRYSTAL CONTROLLED FREQUENCY METERS

Freq. range: 125 Kc/s to 20 Mc/s. Calibration: Individual Calibration Books and numerous Crystal Check Points. Accuracy: 0.01% or 25 cycles. Power supplies: 6 v. and 135 v. batteries. Size 14 x 10 1/2 x 9 1/2 in. Weight 43 lbs. Offered for the first time at the ridiculous price of only **£25**. Carriage Paid.

POCKET VOLT TEST METER

Two D.C. ranges: 0-250 v. and 0-25 v. Complete with test prods. and leather case. Very limited quantity. **Only 12/6. P. & P. 1/6.**



ACCUMULATORS

Two volt, 16 A.H. (unspillable). Ideal for 6 and 12 volts supply, etc. Brand new. Original cartons. Size 4 1/2 in. x 7 in. x 2 1/2 in. 5/6 each. **P. & P. 11/6. 3 for 15/-, P. & P. 3/6. 6 for 27/6. P. & P. 5/-.**



PORTABLE TRANS/REC. No. 18

A self-contained Trans/Receiver for Telephone and C.W. Range approx. 10 miles. Freq. 6-8 Mc/s. (50-338 metres). Valve line-up: 3 ARP-12, 2 AR-8, 1 ATP4. Complete with aerial, H.T. and L.T. meter and all accessories. Weight 20 lbs. Size 7 x 10 x 1 7/8 in. **ONLY 80/-, Carr. 10/-.**

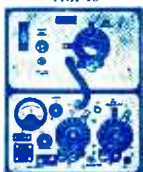

Relda Breaks the Tape Recorder Price Barrier!

NEW! MODEL TR-125 TRANSISTORISED PORTABLE TAPE RECORDER Size only 6 x 8 1/2 x 2 1/2 in. and weighs a mere 2 1/2 lbs. Fully transistorised, complete with mike, earphone, built-in speaker and amplifier. Powered by three inexpensive batteries. Twin track recording at 3 1/2 I.P.S. for maximum economy. Records and plays for over one hour on standard 3 in. reel. (34 minutes each track.) The TR-125 is a precision miniature tape recorder which slips easily into a brief case or handbag. Utilises advanced transistor circuitry and built-in 2 x 3 in. P.M. speaker and amplifier. Engineered for ease of operation. All controls are accessible on front panel. The magnificent two-tone plastic and metal case features a carrying handle and snap open top for fast, easy tape loading. Complete with batteries, tape and accessories. **ONLY 16 Gns.**
 Post Paid

MAIL ORDERS TO
 (DEPT. P.), 32a COPTIC STREET,
 LONDON, W.C.1



CALLERS WELCOME AT
 87 TOTTENHAM COURT ROAD,
 LONDON, W.1 MUS 9606

Tel: Mitcham 6201

Open Daily to Callers

RST

All Valves Brand New
and Fully Guaranteed

211 STREATHAM ROAD, MITCHAM, SURREY

Special 24 Hour Express Mail Order Service

OZ4 5/9	6CH6 12/-	10C2 27/10	32 13/6	CCH35 21/-	ECL83 12/6	H23DD	PCL83 12/6	U281 20/-
IA5 6/-	6E5GT 10/-	10F1 26/2	35AS 15/-	CL4 12/6	EF9 21/-	HL1 10/6	PENA4 17/6	U282 22/-
IA7 14/6	6F1 15/6	10F3 17/6	35L6GT 10/6	CL33 18/6	EF22 17/6	HL41 12/6	PENB4 17/6	U301 22/6
ID5 14/6	6F6 6/9	10F9 12/6	35W4 8/6	CY1 15/9	EF36 7/6	HL41DD	PEN4DD	U329 17/6
ID6 10/-	6F7 5/-	10LD3 12/6	35Z4 7/6	CY31 15/9	EF37 8/6	HL42DD	PL33 22/6	U339 19/-
IH5 10/6	6F13 17/6	10LD11 15/-	35Z5 9/6	D41 12/6	EF37A 8/6	HL42DD	PL38 18/6	U403 11/6
IL4 4/6	6F14 17/6	10P14 20/-	40SUA 15/-	D42 12/6	EF39 4/-	HY90 13/6	PL82 23/9	U404 10/-
ILN5 4/6	6F15 14/9	10P13 15/-	41STH 23/6	D73 5/6	EF40 15/-	IW4/350 10/-	PL83 10/6	U401 29/-
IN5 10/6	6F17 12/-	11D3 17/6	43 15/-	D77 5/6	EF41 9/6	IW4/500 10/-	PL82 8/-	U4020 15/6
IR5 9/6	6F33 5/6	11D5 17/6	50C5 15/-	DAC32 10/6	EF42 10/3	KBC32 9/6	PL83 10/6	U4020 15/6
IS4 8/6	6H6 2/6	12A6 6/6	50C6 15/-	DAF91 7/6	EF50(E) 3/6	KFC35 8/6	PL82 10/6	UAF42 9/6
IS5 9/6	6J5GT 4/6	12A8H 10/6	50C6DG	DF33 10/6	EF50(A) 4/-	KL32 10/6	PM2A 12/6	UB41 9/-
IT4 4/-	6J6 7/6	12AT6 9/-	50L6GT 9/-	DF91 4/-	EF85 6/6	KL32 10/6	PM2HL 14/-	UBC41 9/6
IU5 10/6	6J7GT 9/6	12AU7 9/-	61BT 17/6	DF92 7/-	EF86 11/-	KL35 9/6	PM24M 21/6	UBF80 9/6
2D21 8/6	6K7G 3/-	12AX7 9/6	61SPT 17/6	DF96 9/6	EF89 10/-	KT32 7/6	PM202 16/-	UBF89 8/6
2X2 5/-	6K8GT 12/6	12BA6 9/6	62BT 17/6	DF97 9/6	EF91 4/9	KT33C 10/-	PY31 16/6	UCC85 10/-
3D6 14/6	6K25 19/6	12BE 7/6	65 12/6	DH63 10/-	EF92 5/-	KT33C 10/-	PY32 15/6	UCH42 9/-
3Q4 8/6	6L1 15/6	12J7GT 9/6	77 12/6	DH76 7/6	EF93 7/6	KT36 28/6	PY81 7/6	UCL81 12/6
3Q5 10/6	6L6 7/6	12K7GT 8/6	80 10/6	DH77 8/3	EF95 15/-	KT41 22/6	PY81 7/6	UCL82 13/6
3K9 8/6	6L18 12/6	12K8GT 12/6	85A2 12/6	DH107 13/6	EL31 13/6	KT44 12/6	PY82 8/6	UCL83 13/6
3V4 9/6	6L19 21/-	12Q7GT 8/6	150B2 12/6	DH179 7/6	EL32 5/-	KT55 22/6	PY83 8/6	UF41 9/6
5R4GY 9/6	6L34 10/-	12SC7 8/6	150B3 15/-	DK92 9/6	EL33 12/6	KT61 18/6	PZ30 18/6	UF42 11/6
5U4G 4/6	6L30L2 10/-	12SG7 8/6	185BT 32/-	DK96 10/-	EL35 12/6	KT66 17/6	QF23 14/6	UF80 9/6
5V4 8/6	6LD3 9/6	12SH7 4/-	303 7/6	DL33 9/-	EL38 23/9	KT71 9/-	QF230 17/6	UF85 9/6
5Y3GT 8/6	6M1 10/6	12SJ7 4/-	304 7/6	DL35 12/6	EL41 10/6	KT74 12/6	RF10 12/6	UF89 8/6
5Z3 10/6	6M10 7/6	12SK7 8/6	305 7/6	DL92 8/6	EL42 10/6	KT76 12/6	R19 19/6	UF91 9/6
5Z4G 10/6	6M1 10/6	12SQ7 11/6	328 7/6	DL94 9/6	EL81 14/9	KT101 25/-	SD6 8/6	UL84 9/6
6A7 18/6	6M2 10/6	12SN7 17/6	329 7/6	DL96 9/6	EL84 7/-	KTW62 7/6	SP4 14/6	U16 20/11
6A8 10/-	6P25 19/6	12Z3 15/-	807 7/6	EASO 2/-	EL85 10/6	KTW63 7/6	SP41 3/6	U17 15/-
6AB8 9/6	6P28 26/-	13D3 12/6	955 4/-	EAB8C80 7/6	EL90 8/6	KTZ41 8/-	SP42 12/6	U18 26/-
6AJ8 9/6	6Q7GT 10/6	14H7 12/6	5763 17/6	EAC91 7/6	EL91 5/-	KTZ63 10/6	SP61 3/6	U19 15/6
6AK5 8/6	6SA7GT 7/6	14R7 12/6	9002 7/6	EAF42 10/-	EM80 10/-	L63 4/9	T41 22/6	U24 7/6
6AK8 7/6	6SG7 7/6	14S7 21/-	9003 7/6	EAF41 7/6	EM81 10/-	LN309 15/-	TDD4 17/6	U25 7/6
6AL5 6/6	6SH7 6/6	15A2 17/6	AC4/PEN	EB91 5/-	EY51 8/6	LZ319 12/6	TDD13C	U26 7/6
6AM5 5/-	6SJ7 5/6	15D2 23/9	25/-	EB94 9/6	EY81 10/6	MH4 8/6	TH41 23/9	U27 7/6
6AMJ 4/-	6SK7 7/6	19A5 10/6	AC5/PEN	EBF80 9/6	EY84 10/6	MHD4 17/6	TP22 17/6	U28 7/6
6AN5 7/6	6SL7GT 6/6	19B6G6G	22/6	EBF89 9/-	EY91 9/-	MHL 10/-	TP25 17/6	U29 7/6
6AQ5 8/3	6SN7GT 5/6	20D1 12/6	AC6 21/-	ECLB31 21/6	EZ35 7/6	MS4B 17/6	U14 15/9	U30 7/6
6AQ8 9/3	6U4GT 11/6	20D2 23/-	ACTP 32/-	EC90 9/6	EZ40 7/6	MS4B 17/6	U16 10/-	U31 7/6
6AT6 8/3	6U5 7/6	20F2 26/6	ACHL 12/6	EC91 9/6	EZ41 7/6	MS4B 17/6	U18/20 10/-	U32 10/-
6AU6 10/6	6U7 7/6	20P2 26/6	AC/PEN	ECC31 10/-	EZ80 7/6	MU14 9/-	U22 10/-	U33 10/-
6B7 10/-	6V6G 5/-	20L1 26/6	17/6	ECC32 10/-	EZ81 7/6	MX40 17/6	U25 29/6	U34 21/-
6B8 4/-	6V6GT 8/-	20P1 26/6	ACTH1 34/9	ECC33 5/-	EZ90 7/6	N18 8/-	U25 14/-	U35 21/-
6BA6 7/6	6X4 5/-	20P3 23/-	ACVP1 17/6	ECC34 15/-	FC2 21/-	N19 8/-	U26 12/6	U36 21/-
6BE6 7/6	6X5GT 5/-	20P5 22/6	ACVP2 17/6	ECC35 8/-	FC13 17/6	N37 18/6	U31 9/6	U37 21/-
6BG6G 21/-	7B7 8/-	25L6GT 9/6	AC2/PEN	ECC40 21/-	FC13C 21/-	N78 17/6	U33 21/-	U38 21/-
6B16 7/6	7C5 8/-	25Y5 10/6	21/-	ECC81 8/-	FW4,500 10/-	N108 18/-	U35 21/-	U39 21/-
6BW6 8/6	7C6 8/-	25Z4 9/6	AC2	ECC82 9/6	FW4,800 10/-	N142 9/6	U37 25/-	U40 10/6
6BW7 6/6	7D5 15/-	25Z5 9/6	PENDD21/-	ECC3 9/6	GZ30 10/6	N150 10/6	U45 21/-	U41 10/6
6BX6 6/-	7D6 15/-	25Z6 10/6	AZ1 15/6	ECC84 9/6	GZ32 11/6	N309 11/6	U47 21/-	U42 12/6
6BY7 7/6	7D8 15/-	275U 10/6	AC/PEN	ECC85 9/6	GZ34 13/6	N329 10/6	U50 7/6	U43 7/6
6C4 6/6	7H7 8/-	30C 13/6	B36 21/-	ECC91 5/6	H30 5/6	N727 7/6	U52 7/6	U44 19/6
6C5GT 8/6	7K7 10/-	30C1 12/6	B65 8/6	ECC80 12/6	H63 9/6	N729 8/-	U56 7/6	U45 19/6
6C6 6/6	7Q7 11/6	30F5 11/6	B152 8/6	ECH22 12/6	HBC90 9/6	P2 10/-	U78 7/6	U46 19/6
6C9 12/6	7R7 12/-	30FL1 10/6	B309 9/6	ECH21 22/-	HL92 6/6	PCC84 9/6	U78 7/6	U47 7/6
6C10 12/6	7S7 10/6	30L1 11/6	B329 9/6	ECH35 21/-	HL93 6/6	PCF80 10/6	U78 7/6	U48 7/6
6CD6G 27/6	7Y4 7/6	30P4 22/-	B339 9/6	ECH42 10/-	HL133DD	PCF82 9/6	U78 7/6	U49 7/6
6D1 8/-	8D3 4/-	30P12 11/6	B719 9/6	ECH81 9/-	HL23 12/6	PCL82 11/6	U78 7/6	U50 7/6
6D2 5/-	9BW6 14/9	30P16 10/-	CBL1 17/6	ECH83 12/6	HL23 12/6	U251 17/6	U78 7/6	U51 7/6
6D3 15/-	10C1 18/-	30PL1 15/-	CBL31 21/-	ECL80 9/-				

METAL RECTIFIERS

RM1 6/-	18RA 1-1-8-1 4/6	16RE 2-1-8-1 8/6
RM2 8/-	18RA 1-1-16-1 6/6	18RA 1-2-8-1 11/-
RM3 9/-	16RA 1-1-16-1 8/6	14A86 17/-
RM4 16/6	14RA 1-2-8-2 18/-	14A97 23/6
RM5 22/-	14RA 1-2-8-2 21/-	14A100 24/-

TERMS OF BUSINESS C.W.O. or C.O.D.
2/9 PACKING CHARGE ON ALL C.O.D.
ORDERS. 1 POSTAGE 3d. PER VALVE

SPECIAL OFFER

IT4 4/-, 6K8 8/-, 6K7G 3/-, 6V6G 5/-,
EF39 4/-, EF80 8/-, EF91 4/9, 6X5G 5/-,
6X4 4/6, 5U4G 4/6.

OBSOLETE VALVES A SPECIALITY.
QUOTATIONS GIVEN ON ANY TYPE
NOT LISTED.

Brand new, individually checked and guaranteed

VALVES

ACSPENDD	EAC91	4/6	EY86	8/-	PL82	8/-	VU39	6/-	6C4	3/6	6X4	5/-	84	8/-	Cathode
	EB34	1/6	EY91	3/6	PL83	7/9	VU111	3/3	6C5	6/-	6X5GT	6/6	89	6/-	Ray Tubes
AL60	EB91	3/9	EZ40	8/-	PT25H	7/6	VX3138	12/-	6C6G	4/3	6Y6G	8/-	210LF	3/-	5BP1
AP4	EB21	8/-	EZ80	6/6	PX4	19/-	W31	7/-	6C8G	5/-	6Z4	8/-	210VPT	7 pin	5CP1
AR8	EB33	5/-	EZ81	6/9	PX25	9/-	Y63	5/-	6D6	6/-	6E5	4/6	7C7	6/6	5FP7
ARDD5	EB91	3/9	FW4/500	6/9	PY80	6/9	Y66	8/-	6E5	5/-	7Q7	7/-	7 pin	2/6	7BP7
AR3	EC52	3/-	GL450	10/-	PY81	7/-	Z31	3/-	6F6	7/-	7V7	5/-	705A	17/6	12D7P
AR4	EC81	5/6	GZ32	9/-	PY82	8/-	IA3	3/-	6F6G	4/-	7Y4	6/-	715B	97/6	CV1596
AR12	ECC82	6/6	HL23	8/-	QP21	6/-	IA5GT	5/-	6F8G	6/6	7Z4	6/6	717A	8/6	(O9J) 55/-
AR21	ECC83	7/-	HL23DD	8/-	QP25	5/3	IC5GT	7/6	6F12	6/6	8D2	2/6	801	6/-	VCR97
AR24	ECC84	3/6	HVR2	12/6	QS75/20	6/9	IEGT	7/6	6G6G	3/-	9D2	3/-	803	22/6	VCR139
AR34	ECC85	7/9	HVR2	12/6	QS95/10	6/9	IEGT	7/6	6H6M	2/-	12A6	5/-	804	55/-	VCR139A
ARTH2	ECC91	4/-	KF35	5/6	QS108/45	6/9	IG6GT	12/-	6J5	3/6	12A7H	5/6	805	30/-	35/-
ATP4	ECL80	8/-	KRN2A	19/-	QS150/15	6/9	ILN5	4/9	6J6	4/3	12AU7	6/-	807AMER	7/-	VCRX258
ATP7	EF22	7/3	KT2	4/-	R3	8/-	IR5	6/-	6J7	7/6	12AX7	7/-	(with scanning coil 45/-)		
AU1	EF32	5/6	KT31	8/-	R10	12/6	IS5	5/9	6J7G	5/-	12C8	3/-	807B	5/-	Photo
AU4	EF36	3/6	KT32	8/-	REL21	25/-	IT4	4/-	6K6GT	6/6	12E1	22/6	808	8/-	Tubes
AU5	EF37A	8/-	KT33C	4/9	RK34	2/6	2A5	8/-	6K7G	2/3	12H6	2/-	810	80/-	CMG8
AV3	EF39	4/3	KT44	6/3	RX235	10/-	2A6	7/-	6K8G	5/9	12K8M	9/-	813	67/6	CMG25
AZ	EF39	4/3	KT44	6/3	SP2	4/-	20A	2/6	6K8GT	8/9	12SA7	7/6	815	40/-	GS16
BL63	EF50	2/6	KT63	6/6	SP4B	7/6	2D4A	4/-	6K8M	8/3	12SC7	4/6	816	30/-	931A
BS4A	EF54	3/3	KT	11/-	SP13C	4/6	2X2	4/-	6L5G	6/-	12SG7	6/6	826	10/-	Special
BT45	EF55	6/-	KTW62	7/6	SP41	2/6	3A4	5/-	6L6	9/-	12SH7	3/-	829A	30/-	Valves
BT83	EF70	4/-	KTW63	6/6	SP61	2/-	3B7	5/-	6L6G	6/6	12SJ7	6/-	832	15/-	2J31
BT9B	EF73	6/-	MH4	3/6	STV280/40	12/-	3E29	3/-	6L34	4/6	12SK7	4/-	832A	35/-	231
CY31	EF80	5/6	MH41	5/6	SU2150A	4/9	(829B)	60/-	6N7G	5/9	12SL7	7/-	843	7/6	3A1/481
D41	EF85	6/10	ML4	4/-	TT25	15/-	354	5/-	6N7GT	6/-	12SN7	8/-	866A	12/6	723AB
D77	EF86	9/-	MS/PEN	6/-	TT11	3/-	3V4	7/3	6R7G	6/-	12SR7	6/-	872A	35/-	725A
DA30	EF89	7/9	NT37	3/6	TZ20	16/-	5T4	9/-	6R7GT	6/-	15D2	6/-	930	8/-	726A
DAF86	EF91	3/6	(4033A)	10/-	U17	5/-	5U4G	5/-	6SA7	6/-	20A2	7/6	954	2/-	931A
DAF91	EF92	4/6	OD3	5/-	U18	6/6	5Y3GT	9/-	6SC7G	5/6	21B6	5/-	958A	5/-	ACT6
DETS	EF95	7/6	OZ4	5/-	U27	8/-	5Z3	8/6	6SG7	5/-	35T	30/-	1625	6/-	ACT17
DF72	EL32	3/9	PCC84	5/-	U52	5/-	5Z4G	8/-	6SH	5/-	35Z4GT	7/6	1626	6/-	CV691
DF91	EL33	8/-	PCC85	7/-	UL41	7/6	6AB7	4/-	6SH7	4/6	37	4/-	1629	4/6	KR3
DF96	EL35	8/3	PCC87	8/-	UL84	7/6	6AC7	3/-	6S17G	5/9	38	4/-	4120	4/-	LS7B
DK96	EL41	8/3	PCC82	8/-	UL85	7/6	6AG5	3/6	6SK7	5/3	58	6/-	7193	1/9	V1924
DL92	EL42	8/3	PCC82	8/-	UU9	5/6	6AG7	6/-	6SL7GT	6/6	59	6/-	6475	5/-	VX7110
DL94	EL84	9/-	PCL82	8/6	VP23	3/6	6AJ7	4/3	6SN7GT	4/6	75	5/-	8013A	25/-	WL47A
DL96	EL85	10/-	PEN25	4/6	VP41	5/6	6AK5	5/-	6SQ7	6/-	76	5/-	8020	6/-	Current
DX25	EL91	7/6	PEN65	6/6	VR78	4/-	6AK7	8/-	6SR7	6/6	77	6/-	9001	4/6	Production
E1232	EM80	8/-	PEN220A	3/-	VR99	8/-	6AM6	6/3	6SS7	6/-	78	7/-	9002	5/6	3/1/70E
E1323	EN32	7/6	PENDD/		VR105/30	7/6	6AT6	5/-	6SF5	8/-	80	6/3	9003	5/6	£35
E1524	ESU208	8/-	1360	9/6	VR150/30	7/6	6B8	5/6	6V6G	5/6	82	8/-	9004	4/-	3/1/92E
EA50	EY51	8/-	PL81	7/6	VT4C	25/-	6B8G	2/6	6V6GT	6/-	83V	12/-	9006	4/-	£37.10

AND MANY OTHERS IN STOCK, INCLUDING CATHODE RAY TUBES AND SPECIAL VALVES. All U.K. Orders below 10/-, P. & P. 1/- over 10/-, 1/6; Orders over £2 P. & P. free. C.O.D. 2/- extra. Overseas Postage extra at cost.

Transmitter/Receiver No. 22. 2 Mc. to 8 Mc. Built almost exactly as No. 19 set but much more economical in battery consumption. Complete in fully working condition with power pack for 12 v., Headgear and Microphone assembly and Key, £9.19.6. Carriage 15/-.

Telephone Handset. Standard G.P.O. type, new, £1. P. & P. 1/6.

Marconi SIGNAL GENERATOR. TF144G. 85 kc/s, 25 Mc/s. Made up to new standard. £70 delivered free.

U.H.F. SIGNAL GENERATOR
TYPE T.S.14. 3,200-3,370 Mc/s, power measuring range 20-200 mW, R.F. output power —20 to —100 dbm below 1mW. Power supply 115w A.C. Price £15. Carriage 15/-.

S.C.R. 522 Receivers (BC624) 100-156 Mc/s, without valves, 7/6. P. & P. 5/-.
H.T. Chokes made by Bendix Radio (U.S.A.), 3 Henry's 0.600A D.C. 25 ohms D.C. resistance 18,000 v. R.M.S. 60 cycle test, £1.12.6. P. & P. 6/-. Ditto 10 Henry's 250A D.C. 90 ohms resistance 1,500 v. R.M.S. 60 cycle test, 16/6. P. & P. 3/6.
Carbon Inset Microphone, G.P.O. Type 2/6. P. & P. 1/-.
Miniature Relays. Changeover 12-30 v. D.C. supply, 5 amps contacts, 5/-, P. & P. 2/-.

Pre-set Double Potentiometers. 2 x 3,000 ohms linear 4 w, 5/-, P. & P. 1/6.
Vacuum Condenser. 32,000 v, 50pF, 12/6. P. & P. 3/-.

Laboratory Precision Variable Condenser. Manufactured by General Radio Co., U.S.A. 50-1,500pF with micro metric drive and calibration chart. Overall dimensions of case 9 x 8 x 7/16. Price £15. Carriage 15/-.

BRAND NEW ORIGINAL SPARE PARTS FOR AR88 RECEIVERS

I.F. Transformers. 1st, 2nd, 3rd, 4th (for type D), 12/6 each or complete set of 6, 60/-.

I.F. Transformers. Crystal Load, 12/6 each.

Plates escutcheons (for D and LF), 15/- each.

Dials (for type D), 10/- each.
Logging Dial (for D and LF), 10/- each.
Filter Chokes (for D and LF), 22/6 each.

Output Transformers (for LF), 30/- each.

Antenna Trimmers (LF and D), 2/6 each.

Filter Condenser 3 x 4 µF, £2.10.0

Condensers:

3 x .25µF (D and LF), 2/6 each.

3 x .01µF (D and LF), 2/6 each.

RF Antenna Inductors (D and LF), 7/6 each.

Mains Transformers (LF), £3 each.

Small Mica Condensers. various values, 1/6 each.

Instruction Manual for AR88D, £1.

Specially Built Power Pack for T.C.S. Receiver. 230 v. A.C. mains, including 6X5GT valve, £3.10.0. Carriage 5/-.

Marconi CR-100 Communications Receiver. 60 kc/s-30 Mc/s with noise limiter. Completely reconditioned, £25. Carriage 25/-.

T.C.S. Receivers. Made by Collins of U.S.A. In fully guaranteed working condition. 1.5-12 Mc/s. Line up: 12SA7 (1) 12SQ7 (1), 12A6 (2), 12SK7 (3). Power requirements 12 v. L.T., 225 v. H.T. £11.10.0. Carriage 12/6

P. C. RADIO LTD.
170 GOLDHAWK RD., W.12
 Shepherds Bush 4946

R209 Reception Set. A 10-valve High-Grade Super Heterodyne Receiver with facilities for receiving R/T (A.M. or F.M.) and C.W. Frequency 1-20 Mc/s. Hermetically sealed. Built on miniature valves and incorporating its own vibrator power supply unit driven by a 6 v. battery (2-pins connector included). The set provides for reception from rod, open-wire or dipole aerial with built-in loud-speaker or phone output. Overall measurements: Length 12in., width 8in., depth 9in. Weight 23 lbs. in as new, tested and guaranteed condition £23.10.0, including special headpiece and supply leads. Carriage £1.

Supply Unit Rectifier No. 21. Fully sealed enabling all sets built for 6 v. (R209, R109, etc.) to work from A.C. mains. Input 90-260 v. A.C. (Taps at 10 v. intervals). Output excellently smoothed up to 10 amps with meter indicating exact output voltage. Measurements: 12 x 9 x 10in. Price £8. Carriage and packing 15/-.

19 Set Owners. To increase output of your set 6 to 10 times use **RF Amplifier No. 2** with built-in rotary converter for 12 v. input. Four 807 valves output. Simple connection with transmitter. Fully tested condition, £9.15.0, including necessary connectors and instructions. Carriage and packing 15/-.

AR 88's. Completely rebuilt with new IVC wiring. Type "D", £75; Type "LF", £70.

R109 Receivers. 1.8-8.5 Mc/s working from 6 v. D.C. Complete with all valves and built-in speaker. In excellent, guaranteed working condition. £55.0. Carriage and packing 15/-.

HARVERSON SURPLUS CO. LTD.

HERE IT IS !

HARVERSON'S F.M. TUNER KIT

At last a quality F.M. Tuner Kit at a price you can afford. Just look at these fine features, which are usually associated with equipment at twice the price!

- ★ Philips F.M. Tuning Head.
- ★ Guaranteed Non-drift.
- ★ Permeability Tuning.
- ★ Frequency coverage 88-100 Mc/s.
- ★ OA81 Balanced Diode Output.
- ★ Two I.F. Stages and Discriminator.
- ★ E.M.84 Magic Eye.
- ★ Self powered, using a good quality, mains transformer and valve rectifier.
- ★ Valves used ECC85, two EF80's, EM84 (Magic Eye) and EZ80 (rectifier).
- ★ Fully drilled chassis.
- ★ Everything supplied, down to the last nut and bolt.
- ★ Size of completed tuner 8 x 6 x 5½ in.
- ★ All parts sold separately.

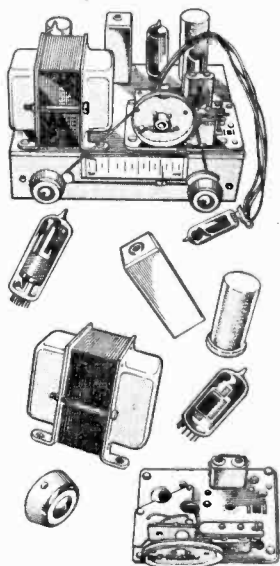

£4.19.6

PLUS 8/6 P.P. & Ins.

Note:—To show the chassis more clearly the attractive 8 x 3in. black and gold dial supplied with this kit, is not shown in the illustration.

C.R.T. TESTER/REACTIVATOR

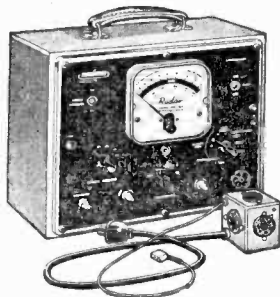

- ★ TESTS any tube without removal from set or carton.
- ★ REPAIRS tubes discarded for low emission.
- ★ MEASURES A.C. Volts, ★ D.C. Volts, E.H.T.

The Radar Model 202 Tester-Reactivator is the most comprehensive instrument of its type on the British Market.

(Complete with E.H.T. probe)

- Measures TRUE Beam Current ● Visual Indication when reactivating is complete (a Radar exclusive) ● Tests and Measures ALL tube Voltages including E.H.T. (another exclusive) ● Measures Resistance up to 100 Megohms ● Clears leaks by pressing a button ● Heater Current measurement 0-0.5A and 0-2.5A Linear Scale ● Adjusts heater current to ensure accurate Emission Test ● Portable for field or bench service.

BRIEF SPECIFICATION

Tests: Filament Continuity, Heater Current, Inter-Electrode Insulation, Final Anode Beam Current, Heater-Cathode Leakage, 4-stage Reactivation by New Pulsing Method. Universal socket fits all tubes. E.H.T. Probe. Measures: 0-25k Volts A.C., 0-500 Volts D.C., 0-25 kV., 0-100 Megohms, 0-250 microamps, 200-250 Volts A.C. Mains. Size 13in. by 10in. by 6in. Weight 14lb.

List Price ~~39~~ OUR PRICE £17.17-0

Plus 9/- P. & P.

Introducing

HARVERSON'S Monaural Amplifier Kit

39/6

In response to numerous requests from delighted purchasers of our "SUPER STEREO KIT" we have produced a "MONAURAL AMPLIFIER" on similar lines.

★ A UCL 82 valve provides a triode amplifying stage, and a pentode output stage (3 watts), enabling good amplification and sparkling reproduction to be combined with physical compactness (amplifier size, 7 x 3½ x 6½ in. high).

★ Modern circuitry design, good quality O.P. transformer (to match ★30) keep hum and distortion to a low level.

★ The controls, volume on/off, and tone, are complete with attractive cream and gold knobs.

★ The amplifier has a built-in fully smoothed power supply, using a good quality mains transformer (A.C. mains only) and metal rectifier.

★ All you need is supplied including easy to follow instructions which guarantee good results for the beginner and expert. All components, leads, chassis, valve, knobs, etc. are first grade items by prominent manufacturers.

OUR PRICE Plus 4/6 Post and Packing. **39/6**

5in. LOUDSPEAKER TO SUIT 14/6 EXTRA ALL PARTS SOLD SEPARATELY

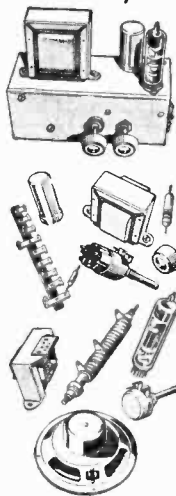

For ADDRESS and 3 more pages of STUPENDOUS BARGAINS PLEASE TURN OVER

DEPT.
P.W.3.

HARVERSON SURPLUS CO. LTD.

MONAURAL AMPLIFIER



This amplifier as illustrated, made by a leading manufacturer. Mullard valves—ECC83, EL84 x EL84, EZ80. Bass, Treble and Volume on remote panel. Elegant Knobs. OUR PRICE one month only £4.16.6 plus P. & P. 3/6.

STEREOPHONIC AMPLIFIER

£5.10.0

Complete with 2 Loudspeakers

Plus 4/6 P. & P.

This is a compact amplifier embodying the latest features and giving a high standard of reproduction, with ample volume. Supplied complete with valves (ECL82, ECL82, EZ80), panel, knobs, etc., and two specially selected 3Ω matched loudspeakers. Few only at such a low price. Don't risk disappointment. Order now.

BATTERY CHARGER RECTIFIERS

- 12 v. 1 amp. ... 5/-
 - 12 v. 2 amp. ... 8/-
 - 12 v. 3 amp. ... 10/-
 - 12 v. 4 amp. ... 14/-
 - 12 v. 5 amp. ... 16/-
- P. & P. 6d.

TRANSISTOR BARGAINS

— ALL FIRST GRADE —

- OC71 8/-
- OC72 12/-
- OC72 Matched Pair ... 25/-
- OC45 Green Spot..... 15/-
- OC45 Blue Spot..... 15/-
- OC44 15/6
- OA41 Diode 3/6

SPECIAL OFFER

DON'T MISS THIS

MULLARD
O.C.74 10/6
MATCHED PAIR 18/0

Postage on all above 6d.

Post and packing 6d.



HARVERSON SUPERHET 4 KIT

A medium and long wave superhet, incorporating two I.F. stages modern B9

valves (UCH81, UB89, UCL83, U785), built-in ferrite rod aerial. All you need supplied from theoretical wiring diagram to last nut and bolt (main components ready mounted), including an attractive contemporary styled cream plastic cabinet with gold trimmings. Size 1½ x 4½ x 6½ in.
PRICE £6.12.6 Post 3/6
All parts sold separately.

TRANSISTOR RECORD PLAYER CASE

A few only—Transistor record player cases in light grey cloth—complete with motor board. Size: 12 x 8 x 6in.

P. & P. 1/9

1/6 H.P. MOTOR

140 Watt (Approx. 1/6 H.P.). Series wound, 220/250 volt 50 cycle motor. Off load 14,000 rev/min. on load 8,500 rev/min. Ideal small saw, sewing machine, etc. post free.



30/-

SLOW MOTION TUNERS

500-500 Twin gang condensers with geared slow motion drive. 3/6 ea. 36/- per doz. P. & P. 6d.

WIRE WOUND POTS

12 Wire Wound Colvern Pots —all different values 10/6 P. & P. 9d.

COSSOR C.R.T. SNIP

108K 10-in. New and boxed 15/-, plus 6/- P. & P.

18/6 each.

75K 10-in. New and boxed 15/-, plus 6/- P. & P.

ION TRAP MAGNETS

To suit the above, 2/9 each. P. & P. 3d.

Mazda CRM 172—Not a Regun. Picture tested—12 months' Guarantee. £3.17.6. 12/6 P. & P.

CYLDON 12 CHANNEL TURRET TUNERS

New purchase offered at still lower price I.F. 33-38 Mc/s. Complete with PCC84 and PCF80 valves and 8 sets of Coils for 5 Band I Channels and 8, 9, 10 Band III. New and unused. Value over £7. OUR PRICE, post paid 32/6

GRAM & TAPE EQUIPMENT BARGAINS

THE WORLD FAMOUS E.M.I. ANGEL TRANSCRIPTION P.U. (Model 17A)

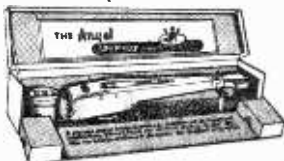

A Pick-up for the connoisseur originally priced at £17.10.0. The last remaining few offered at £4.10.0 Plus P. & P. 5/-.

CONDENSER/RESISTOR PARCEL

50 mixed P.F. Condensers and 50 mixed Resistors. An assortment of useful values. All popular sizes—all new—a must for the serviceman and constructor. P. & P. 1/-.

ONLY 10/-

RECORD CHANGERS

	GARRARD	
RC 98 Mk. 4H.	4-speed autochanger	£16.10.0
RC 120/D Mk.2	" "	£9. 0. 0
RC 120 Mk. 4D	" "	£9. 0. 0
RC 120 Mk. 4H	" "	£9. 0. 0
RC 121 Mk. 1	" "	£11.0. 6
RC 121 Mk. 4H	" "	£11.0. 6
RC 121/40 Mk.2	" "	£11.0. 6

Write for our new super list of Tape Decks and Changers.

B.S.R.

Monarch UAB 4-speed autochanger. £6.19. 6
TUB 4-speed single player less pick up £2.10. 0
UA14 Stereo Changer ... £9.5. 0
NOTE: Any of the above with Stereo Cartridge and FITTINGS, 16/- extra. Carriage and ins. on each of above 5/- extra.

TAPE DECKS

LATEST B.S.R. MONARDECK (single speed) 3½in. per sec., simple control, uses 5½in. spools £7.5. 0
plus 5/6 carriage and insurance (tapes extra).
TRUVOX MARK III TAPE DECK. New and Boxed £10.6.6
Plus 6/- carr. and ins. (tapes extra).

E.M.I. 4-SPEED RECORD TURNTABLE & PICK-UP

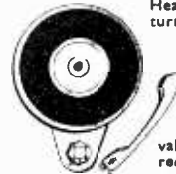

Heavy 8½in. metal turntable. Low flutter performance 200/250 v. shaded motor with tap at 80 v. for amplifier valve filament if required. Turn-over LP/78 head.

89/6 COMPLETE Plus 4/6 P. & P.

SWITCHED ATTENUATOR

Audio to V.H.F. in four steps of 20 dB ± 0.02 dB up to 300 Mc/s. Cost £5.10.0 OUR PRICE £2.19.6 Plus 1/-, P. & P.

MIDGET I.F. TRANS & COILS

A Pair of midget 465 kc/s I.F. transformers, plus LW and MW coils. PRICE 10/- per set. P. & P. 1/9. Set of I.F. transformers for transistor superhet. 12/6. P. & P. 1/9.

83 HIGH STREET, MERTON, S.W.19

CHerrywood
3935/6/7

HARVERSONS SUPER STEREO KIT

The product of a renowned maker, this stereo amplifier is composed of "ready-built" units, only requiring interconnection. This system has the advantage of being adaptable to fit any cabinet. Each unit is made from first-grade components, and valves used (ECL82, EZ80 range) are genuine Mullard. The comprehensive instructions supplied make the simple interconnection of units easy even for the novice.

THE KIT COMPRISES...

TWO MIDGET AMPLIFIERS each of 3W output, good reproduction from both your stereo or monaural records. Both amplifiers complete with well-designed O.P. transformers providing perfect matching 3-711 speakers, and have remote bass, treble and volume controls. Size 5" x 2½" x 3" high (each amplifier).

CONTROL UNIT, is a flying panel with three 2-gang pots, enabling the bass, treble and volume controls of each amplifier to be conveniently positioned. Supplied with attractive cream and gold knobs.

A.M. RADIOGRAM CHASSIS

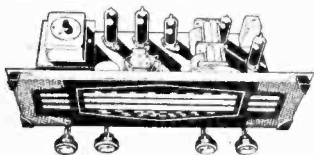

A chassis of distinction, by a famous maker. Covering Long, Med. & Short Waves, plus gram position, this chassis (Size 15½ x 7 x 6½ in. high) incorporates the latest circuitry, using fully delayed A.V.C., and negative feedback. Controls: Tone, Vol., On/Off, W/Change (L.M.S. & Gram), Tuning. Tapped input 200-250 v. A.C. only. An attractive brown and gold illuminated dial with matching knobs, make this one of the most handsome, in addition to being one of the best performing chassis yet offered. Complete with valves (ECH81, EF89, EBC81, EL84, EZ81), knobs, output transformer, leads etc. **OUR PRICE ONLY £9.19.6** plus 4/6 post & packing.

SEPARATE POWER PACK with valve rectifier, midget size (5" x 2" x 3½" high.)

ISOLATED MAINS TRANSFORMER of robust construction may be mounted independently.

VOLTAGE SELECTION PANEL. Fitted with the "valve base" type of mains 1/p selector and a channel output socket.

ONE SPEAKER, a quality 5-in. speaker. (Note: The 2nd speaker may be purchased from us for 14/6 extra.)

CREAM DOUBLE PUSH BUTTON SWITCH of neat design gives positive on/off switching.

INDICATOR LIGHT. Provides visual indication of equipment operating and is complete with gold-finished escutcheon

59/6

PLUS 6/6 POST & PACKING

E.M.I. 4 SPEED STEREO PLAYER

To suit the above

£6.12.6

Plus 5/- carr.

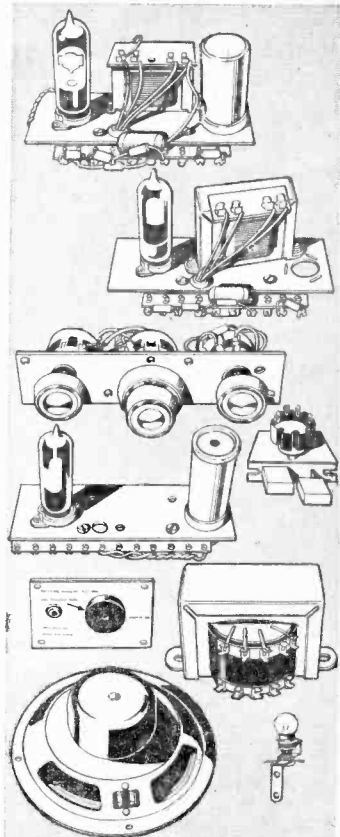

GUARANTEED VALVES ★ NEW and BOXED

PROMPT DESPATCH ★ Post 6d. per valve extra

ACPLD	EBL31	22/-	EL31	15/6	KTW91	6/-	PCF81	8/6	UBG41	3/6	WE1	11/8	6R4GY	9/-	6F1	10/6	6C80L2	12/6	50/6	30L1	18/6
ACP	9/3	PC31	7/-	EL34	8/6	KTW93	7/-	PCF80	9/8	W76	7/-	31-46	6/3	6F11	10/-	6C80L1	10/6	12/6	50/6	30P4	19/6
ACP4	7/-	PC081	7/6	EM84	8/6	KTZ41	3/6	PEN2204	10/-	W77	5/-	31-47	8/6	6Y30	10/6	6C80L2	8/-	12/6	50/6	30P12	11/9
ACPEN	PC083	8/6	EM81	9/6	ML4	8/-	PEN46DD	10/6	N22	16/9	5Y30T	7/6	6H9	2/3	6V6G	5/6	12/6	50/6	30P11	11/9	
ACPEN	8/-	ECR85	9/3	RY51	9/3	MS4B	16/-	PCF81	8/6	N41C	16/9	5Z4G	8/6	6A6T	10/6	6B5M	4/6	6N4	7/6	12K7GT	7/-
ACPVP1	50/3	ECF50	11/3	EZ40	7/-	MS4P7	7/-	PMT2	7/6	CL82	11/6	Z21	9/3	6A6G	8/6	6B5M	4/6	6N4	7/6	12K7GT	7/-
ATP4	3/3	ECF82	12/3	EZ41	7/-	MV8/PEN	Q/21	4/6	CL83	11/6	Z21	9/3	6A6G	8/6	6B5M	4/6	6N4	7/6	12K7GT	7/-	
AZ1	9/3	ECB21	22/-	EZ80	6/6	MX40	18/-	SP41	2/9	UF80	8/6	Z309	7/-	6AC7	5/3	6AK5	6/6	6K7M	8/6	7Bd	9/6
AZ31	11/2	ECB42	22/-	EZ80	6/6	MX40	18/-	SP41	2/9	UF80	8/6	Z309	7/-	6AC7	5/3	6AK5	6/6	6K7M	8/6	7Bd	9/6
B36	13/6	ECB81	8/6	EZ81	6/6	N37	18/6	SP91	2/9	UF89	8/6	LA3	3/-	6AK5	6/6	6K7M	8/6	7Bd	9/6	12K7GT	7/-
CB131	22/6	ECB80	9/3	EL148	1/6	N78	18/6	SP95	5/9	UL41	9/6	LA5GT	11/6	6AL5	6/6	6K7M	8/6	7Bd	9/6	12K7GT	7/-
CCB35	22/6	ECB82	9/3	EL148	1/6	N78	18/6	SP95	5/9	UL41	9/6	LA5GT	11/6	6AL5	6/6	6K7M	8/6	7Bd	9/6	12K7GT	7/-
CL4	11/9	EF22	8/-	FW/50093	0/24	5/-	T41	22/-	UL46	25/-	UC2	11/-	6AM5	11/9	6K8G	7/6	7C5	7/6	12K7GT	7/-	
CL33	13/6	EF26	4/6	GTW	25/6	PA1	3/3	TD13C7	7/6	UL84	8/6	UC5GT	11/9	6AQ5	7/-	6K7M	8/6	7Bd	9/6	12K7GT	7/-
CV31	15/9	EF37A	14/6	FTW	25/6	PA1	3/3	TD13C7	7/6	UL84	8/6	UC5GT	11/9	6AQ5	7/-	6K7M	8/6	7Bd	9/6	12K7GT	7/-
CV73	5/9	EF39	5/8	G232	11/-	PC084	8/6	TH233	17/6	UL6	18/6	UD5	11/9	6AT6	6/-	6K8T	9/6	7Bd	9/6	12K7GT	7/-
C86A	6/-	EF40	13/6	H03	9/3	PCF80	9/6	TP22	7/6	UL8	25/-	UD6	11/9	6A6G	8/6	6K25	18/6	7Q7	8/6	1487	15/9
DAF96	8/3	EF41	9/3	H122DD	5/-	PC182	11/6	U10	8/9	UY11	11/6	UH5GT	10/-	6B8G	3/8	6L1	14/6	787	8/6	15192	7/3
DFW	6/6	EF42	10/3	H122	6/6	PC182	11/6	U10	8/9	UY21	11/6	UH5	10/-	6B8G	3/8	6L1	14/6	787	8/6	15192	7/3
DH63	11/6	EF50	3/6	H122	6/6	POL83	13/6	U14	8/-	UY41	7/-	ULD5	5/-	6B8G	3/8	6L1	14/6	787	8/6	15192	7/3
DH101	11/6	EF805YL	7/6	H141	5/3	PL38	16/6	U16	11/9	UY85	6/3	1R5	9/8	6B06G	6/6	6L1G	7/6	9D2	3/8	6D1	5/-
DK96	3/6	EF88	6/6	HN309	23/6	PL38	16/6	U17	11/9	VP13C	3/3	1R5	7/-	6B116	8/6	6L1G	7/6	9D2	3/8	6D1	5/-
DL96	8/6	EF54	5/6	K133	8/6	PL81	11/9	U22	12/6	VP23	6/-	1R4	9/9	6B116	8/6	6L1G	7/6	9D2	3/8	6D1	5/-
DL145	9/3	EF55	5/6	K133	8/6	PL81	11/9	U22	12/6	VP23	6/-	1R4	9/9	6B116	8/6	6L1G	7/6	9D2	3/8	6D1	5/-
DM70	7/-	EF80	7/6	KK32	20/6	PL83	11/6	U26	11/9	VP11	8/-	1R4	9/9	6B116	8/6	6L1G	7/6	9D2	3/8	6D1	5/-
DN41	16/6	EF85	7/6	KL132	3/-	PX25	11/9	U37	25/-	VR22PM	2P	22	1/3	6B64	8/-	6Q7G	7/6	10L11	9/6	20P4	25/6
EA50	1/3	EF86	11/6	K72	4/-	PY26	7/-	U45	14/6	2A	20	25/-	6B74	3/8	6Q7G	7/6	10L11	9/6	20P4	25/6	
EAB080	8/6	EF89	8/6	KT24	4/6	PY81	8/-	U60	7/6	VR105/30	2X2	4/6	6C3GT	6/6	6A6T	7/6	10L11	9/6	20P4	25/6	
EAF42	9/6	EF91	5/6	K792	8/6	PY92	6/6	U76	7/6	VR116	3/8	30GT	5/6	6C31	7/6	6A6T	7/6	10L11	9/6	20P4	25/6
EB31	1/6	EF91(BVA)	KT33C	8/-	PY83	8/-	U91	10/6	VR116	3/8	30GT	5/6	6C31	7/6	6A6T	7/6	10L11	9/6	20P4	25/6	
EB41	8/-	8/6	KT36	28/-	PZ30	18/6	U93	11/9	VR150/30	3/3	304	7/6	6D6	4/6	6A6T	7/6	10L11	9/6	20P4	25/6	
EBC33	6/3	EL32	4/3	KT55	10/3	PEN4DD	U403	15/6	7/6	6D6	4/6	6A6T	7/6	10L11	9/6	20P4	25/6				
EBC41	8/9	EL33	13/6	KT61	9/6	25/-	U404	10/6	VR120A	3/8	30QGT	9/6	6C16	9/9	6A6T	7/6	10L11	9/6	20P4	25/6	
EF59	9/6	EF43	24/6	KT63	7/-	PEN4VA	U801	28/-	VR190MU	384	7/-	6D6G	4/6	6A6T	7/6	10L11	9/6	20P4	25/6		
EF89	9/-	EF44	9/6	KT60	16/-	14/-	UAC09	9/6	(2/14)	8/6	31A	8/-	6D6M	7/6	6Q7G	7/6	10L11	9/6	20P4	25/6	
EBL21	22/-	EL42	9/6	KT88	21/-	PEN25	5/6	LA42	8/9	U111	2/3	31A	2/9	6F1	13/-	6C3GT	11/3	12BA4	8/6	30PL1	9/9

HARVERSON SURPLUS CO. LTD. Dept. R.W.3
83 HIGH STREET, MERTON, S.W.19. CHerrywood 3985/6/7

HI-FI STEREO/MONAUURAL AMPLIFIER

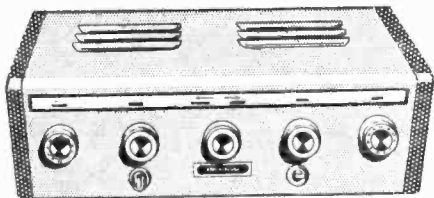

It is with great pleasure that we are able to offer an amplifier of this quality, (it will satisfy the most discerning enthusiast) at a price which places it within the reach of most people. This being the product of a company famed as a specialist in the audio Hi-Fi field it is made to very exacting standards.

It is designed for stereophonic reproduction from records, or tape, and monaural reproduction from records, tape, microphone, radio tuner, etc. Setting the STEREO/PHONIC/MONAUURAL control to stereo operation divides the amplifier section into two 2 valve Hi-Fi amplifiers, whilst switching to the monaural position reunites these into a quality push pull amplifier.

The unit is self powered by an internal power-pack, employing valve rectifier and mains transformer. The latter has a tapped input (200-210, 220-230, and 240-250 volts A.C. 50 cycles only) and is double wound, providing complete isolation from the mains. This enables the amplifier to be used in conjunction with any equipment in perfect safety.

Five controls are provided in addition to an on/off switch, VOLUME I, TONE I, STEREO/PHONIC/MONAUURAL switch, TONE II, and VOLUME II. Both volume controls are calibrated to assist in securing perfect balance, and the tone controls are so designed that clockwise movement increases the treble response, whilst turning anti-clockwise causes the bass to predominate.

The complete unit is mounted in a stylish hammer finished metal case, stove enamelled in glossy two tone grey and slate blue. The cabinet front panel is equipped with a white on/off switch, red indicator neon with gold escutcheon, cream and gold name plate, five gold and white knobs and a cream and gold strip running full length above the knobs bearing the control names. On the back are the stereo and monaural inputs, mains voltage selector, and loudspeaker terminals. Matching is provided for a 3 ohm and 15 ohm speaker, for each channel. This enables the use of a bass speaker and tweeter on each channel, provided that one speaker has 15 ohm and the other speaker has 3 ohm impedance.

Unrepeatable at this price.

OUR PRICE **£9.19.6**

plus 4/6 post & packing.

YET ANOTHER HARVERSON AMPLIFIER SCOOP FOR ONLY 21'-

PLUS 6/6 P.P. & INS.

Owing to a fortunate purchase, we are able to supply these amplifiers at a fraction of the price normal for comparable equipment. Although not new, these units are in good condition, and represent a first class buy. Originally made for a relay wireless company, they are built to strict specifications by a prominent maker.

BASICALLY EACH UNIT COMPRISES . . .

R.F. AMPLIFIER, using a 10F3 valve, all contained in a screening box.

AUDIO AMPLIFIER, employing a 10P14 valve, and giving a good reproduction at 3 watts.

POWER PACK both the R.F. and the Audio amplifier are fed by a common internal fully smoothed power supply. This is provided by a tapped mains dropper (input 200/250 volts AC/DC), and a U404 rectifier valve.

INPUTS. Inputs are supplied for AC/DC mains, crystal pick-up, and six pre-set channels.

SPEAKER. A good quality 15 Ω permanent magnet 8-inch round speaker is fitted.

CABINET. All the above are housed in an attractive brown bakelite case, with cream speaker slats. (Case size 14" x 11½" x 6").

The applications to which these amplifiers can be put are limitless, for apart from the obvious use as a gram amplifier (2 can be used for stereo) they can be adapted for countless other uses, e.g. baby alarms, inter-coms, guitar amplifiers, etc.

OUR PRICE, including valves.

ONLY 21/- plus 6/6 post & insurance.

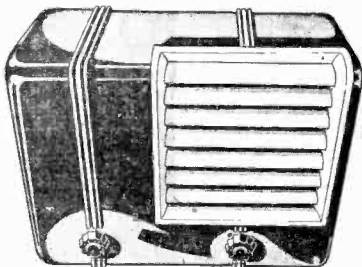

◀ Please turn back for another 3 pages of Bargains



VITAL TO ALL IN THE INDUSTRY

NEWNES PRACTICAL ELECTRICAL ENGINEERING

Written by 87 Recognised Authorities Assisted by 170 World-famous Companies

Advisory Editor: G. F. Tagg, B.Sc., Ph.D., M.I.E.E., F.Inst.P.

Produced with the full technical resources of NEWNES, this new edition covers every important activity in the industry—it enables you, the forward-looking engineer, to acquire and retain knowledge so essential to your career. Every facet of the vast field of modern electrical engineering is dealt with—by qualified electrical engineers, who draw upon their knowledge and long experience to guide you to advancement. Prove its value by Free Examination for 7 days—post coupon to-day!

Everything you want to know about—

- **Installation Work of All Kinds**—Commercial buildings, small houses and flats, hospitals, schools, theatres, cinemas, electric appliances, alarm systems.
- **Instruments, Machines, Equipment**—Electric motors, control gear, transformers, rectifiers, electronic control in industry, measuring and recording, instruments and electricity, supply meters.
- **Operation, Maintenance, Repair**—Welding plant, electric traction, cranes, lifts, X-Ray equipment, testing domestic equipment, batteries.
- **Generation, Transmission, Distribution**—Power stations, power cables, public supply, underground distribution systems, town and rural supplies, cable-laying and faults.

This is what you receive without obligation—

4 Volumes strongly bound in Grey Morocquette. 2,352 pages of instructive information on latest practice. 2,100 Photographs, Diagrams, Perspective and Working Drawings, Electrical Circuits, and Data on test procedure, etc. 24 Data Sheets in colour and 12 Quick-reference Blueprint Charts complete in Strong Chart Case. *Nuclear Power Stations Booklet*. Fascinating cut-away sections in full colour enabling you to see how they operate. With full explanatory text. **FREE!** NEWNES ELECTRICAL POCKET BOOK. The Electrical Engineer's "bible". Nearly 400 pages with 258 illustrations, diagrams, tables.

PLUS 2 YEARS' TECHNICAL ADVISORY SERVICE

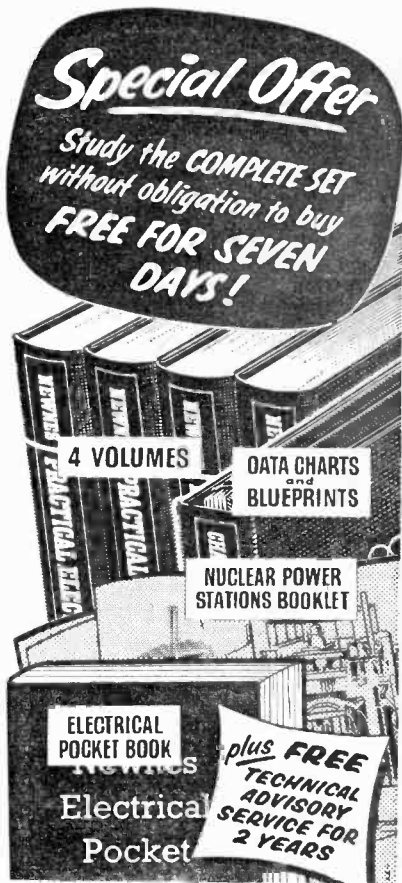

Act now for this thoroughly practical work—the complete set is yours for 7 days without cost or obligation to purchase.

Post Coupon To-day

To: George Newnes Ltd., 15-17 Long Acre, London, W.C.2

Name _____

Address _____

Occupation _____

Your Signature _____

(Or Parent's signs if you are under 21) **PEE3**

Please send me Newnes PRACTICAL ELECTRICAL ENGINEERING without obligation to purchase. I will return it in 8 days or send the first payment of 15/- eight days after delivery and 15 monthly subscriptions of 20/- until the sum of £15. 15s. has been paid. Cash price within eight days is £15.

Tick (✓) where applicable

HouseOWNER	<input type="checkbox"/>
Householder	<input type="checkbox"/>
Living with Parents	<input type="checkbox"/>
Lodging Address	<input type="checkbox"/>

Solderless Transistor 3

Any boy from eight years onwards will easily make this pocket size transistor set. No soldering is involved and in fact the set can be made up virtually without tools. It is nevertheless a workmanlike job which, when completed, will receive Luxembourg and local stations entirely without aerial or earth. Uses two transistors and diode in reflex circuit. Other features include optional medium and long waves and loud speaker.

The parcel contains everything necessary to complete as follows—
 Packet of Solderless terminals.
 Packet of Condensers.
 Packet of Resistors.
 Packet of Transistors.
 Connecting wire.
 Proper plastic transistor set case with printed scale and tuner.



Hearing aid type headphone. Plug and socket with on/off switch, and full comprehensive easy to follow instructions. Price 37/6 plus 2/6 post and insurance.

Miniature Earphones



For Transistor Circuits or Deaf Aid. Very light weight and easy to wear, cord almost invisible, good quality production of music and voice, complete with miniature plug and socket, ready to use—correct impedance OK for red spot and similar transistors. Crystal and Magnetic. 9/-. Post and Insurance 1/-.

Miniature Plug and Socket

as used with the above can be supplied separately. Price 3/6.

Smallest Possible 2-gang



With built in trimmers, polystyrene cased, size only 1 x 1 x 7/16in., price 17/6. Smallest IF and oscillator to match. 21-, P.P. input and P.P. output transformers, 12/6. Circuit diagram free with any of above.



- Transistor Set Cabinet

Very modern cream cabinet, size 3 x 1 1/2 in. with chrome handle, tuning knob and scale. Price 7/6, plus 1/6 postage and packing.

High Voltage Rectifiers

CV16 63 kV., Peak 800 mA	£4 17 6
CV15 04 60 kV., Peak 1,200 mA	£5 17 6
CV74 40 kV., Peak 600 mA	£2 17 6
CV1508 8 kV., Peak 1,000 mA	£1 17 6
CV1111 14 kV., Peak 350 mA	7 6

THE REAL COMPANION CAR RADIO PORTABLE

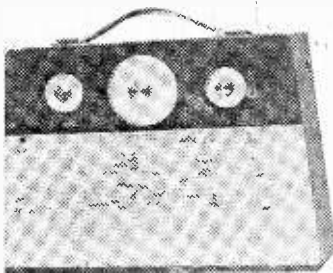

There's nothing to compare with so don't buy your portable until you have heard this one—call at any branch for demonstration—you will be well satisfied—why not earn spare time cash making them up for your friends?

NOTE THESE FEATURES

★ 400/500 mw. Output Push-Pull. ★ 4 First Grade Transistors. ★ Latest Type Superhet Circuit. ★ Medium and Long Wave. ★ Internal Ferrite aerial 1/2" wound. ★ High "Q" coils. ★ Latest type printed circuit with components plan. ★ Slow motion tuning. ★ Car aerial attachment. ★ Two-tone cabinet. ★ High flux elliptical speaker. ★ Size 11 1/2 x 8 x 3in. approximately. ★ Easy to follow instructions. ★ 12 months' guarantee all components. ★ No technical knowledge required. ★ Service available at moderate charges.

ORDER IN CONFIDENCE

Money returned in full if parcel not up to expectation and returned unassembled. Price complete, less battery £9/19/6. Battery 3/6 plus carr. and insurance 7/6.

PHILIPS TRANSCRIPTION UNIT

Philips AG 200 Record Player, 4 speed. Ideal for the enthusiast

Pick-up arm wired for stereo, fine adjustment on all four speeds. Continuously variable pick-up weight (2.12 gms.) Supplied with Philips Hi-Fi crystal type AG3019 for microgroove and 78 r.p.m. Frequency response 30-15,000 c/s. balanced heavy turntable. Muting switch. Can be used with any amplifier or radio set. Complete with monaural pick-up £10, 10.0, or 2xms, deposit and fortnightly payments of 10/-. Available also with stereo head diamond or sapphire stylus. Prices on request.

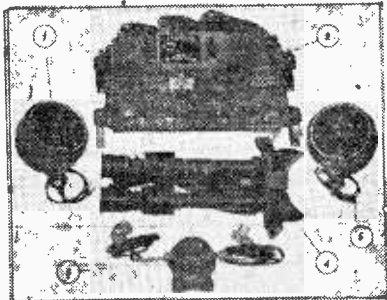
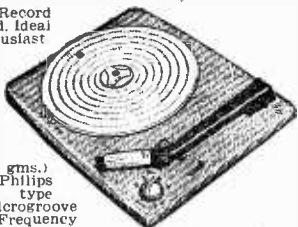

TABBY EQUIPMENT COMPLETE

Complete equipment for seeing in the dark, as fitted to Army vehicles for night driving, etc. Complete working equipment comprises: 2 Infra Red Radiators, adjustable binoculars, power pack for 8 or 12 volts, control units and inter-connection cables. Original cost probably around £100. Unused and in perfect order —£8, 19/6 or 10/- deposit and 15 fortnightly payments of 10/-.

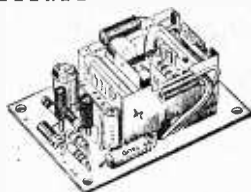

1 Watt Transistor Amplifier

2 x CX71's direct coupled cascade drive to 2 precision matched OC74's in Class B push-pull provide up to 1 W. undistorted output from 5mV. in at 1.5 K-ohm Frequency response. 60-16,000 c/s ± 3 db. Overall size 3 x 2.2 x 1.2in 92/6. Post and ins. 2/6.

Yaxley Switches

Price-69/6 plus 2/6 post and insurance.	
1 Pole 3 Way	1/6
1 Pole 6 Way	2/6
1 Pole 12 Way	3/6
2 Pole 4 Way	2/6
2 Pole 6 Way	2/6
2 Pole 8 Way	3/6
2 Pole 12 Way	4/6
3 Pole 3 Way	1/6
3 Pole 6 Way	3/6
4 Pole 4 Way	3/6
6 Position Shorting	2/-
6 Pole 3 Way	2/6
6 Pole 6 Way	3/6
9 Pole 3 Way	2/6
12 Pole 2 Way	2/-

Hi-Fi Snip Infinite Wall Baffle

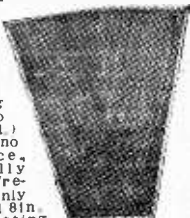

Nicely veneered, and polished, Corner fitting (attaches to picture rail). Takes up no floor space. Gives really fantastic results with only low-priced 8in. speaker. Fitting for tweeter. Only 45/- each, carriage and insurance 3/6.

Building A Scope?

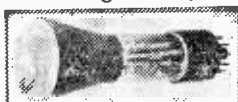

3in. oscilloscope tube. American made type No. 3FP7, octal base 6.3 v. 0.6 amp. heater, electrostatic deflection. Brand new and guaranteed, with circuit diagram of scope. 15/- each, plus 1/6 post and insurance.

Connecting Wire



P.V.C. covered in 100ft. coils—2/9 a coil or four coils different colours. 10/- post free.

Miniature Microphone

American made. Dynamic type, real bargain at 2/6, plus 6d. postage.



POCKET LOUDSPEAKER TRANSISTOR RADIO

Available Again at 42/6

Read these Testimonials

D. A. Hilton, Leigh, Lancs.
 "I received 'Pocket 4' on Christmas Day. I made it up on Boxing Day and I am very pleased with the results. It brings in local stations and many foreign stations including Luxemburg at good strength. I am 13 years old".

Mr. J. Bell, Wolverhampton.
 "I am writing to express my satisfaction at the standard of your kit for your Pocket 4 Transistor set and also to state that it has come up to my expectations in regard to performance".

Mr. R. Bell, Newcastle-on-Tyne.
 "I have built your Pocket 5 Transistor set, I am very pleased with it".

Mr. F. Jackson, Ickenham, Middx.
 "I have built the Pocket 4 and more than pleased with the results".

Mr. G. Bamford, Ramsgate.
 "I find this set even better than you claim it to be and most certainly up to your usual standard of quality. I feel that nobody could fail to build it and get results. Even the first-time-ever novice, as your circuit diagrams and instructions are so clear and precise".

Mr. A. J. Simmonds, Welton, Kent.
 "I purchased from you a week ago the Pocket 4 Transistor Kit. I put it together last night in 14 hours, on switching on the set I was right on Radio Luxemburg. I must say thank you because not only has the set a very attractive appearance, it also behaves fantastically".

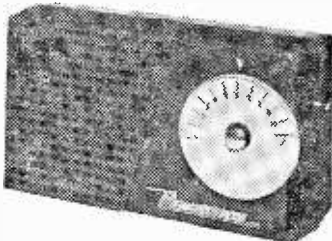

AVAILABLE WITH FIRST GRADE TRANSISTORS AND FOR LONG AND MEDIUM WAVES

Circuit comprises 2 HF transistors reflexed to equal 4 stages. Permanent germanium diode and high gain AF output stage, fitted with miniature speaker. Proper tuning condenser, volume control and in case with handle as illustrated (less monogram), completely portable. No aerial or earth required. Pocket 4 uses 3 transistors and 1 diode, price 52/6, plus 2/6 post and insurance. Pocket 5 uses 4 transistors and 1 diode and has feedback control, price 67/6, plus 2/6 post and insurance.

GOOD RESULTS EVERYWHERE

Nothing can be more disappointing than to find that despite care in making up, your radio just will not work or needs a long high aerial and water pipe earth. We can prove good results in all areas and we guarantee all components for 12 months. Read just a few of the hundreds of testimonials we have received from constructors who have made these sets. Send in confidence. Money refunded if not up to your expectations. Plans free with parts, or separately 1/6. More details S. A. E.

Also again available with S.B. transistors as last year 42/3 and 52/6, plus 2/6 post and packing M.W.

SUB MINIATURE COMPONENTS FOR TRANSISTOR SETS

- ★ Push-pull o.p.t. and driver 17/9 pair (500 milliwatt). 12/6 pair (300 milliwatt).
- ★ Push-pull driver with Sep. Secondaries for transformerless output 6/8.
- ★ 3 IF transformers and oscillator and circuit 23/6.
- ★ Ferrite aerial with coils for medium and long wave and circuit 7/6. Ditto for standard size set 10/6.
- ★ Two gang tuning condenser to suit above I.F.S. and rod aerial—11/6, fast and slow; 9/6, ordinary.
- ★ Printed circuit for above with construction data superhet pocket size 8/6. Standard size 7/6.
- ★ Smallest possible electrolytics 1/9 each, 1 mfd., 2 mfd., 8 mfd., 10 mfd., 20 mfd., 30 mfd., 50 mfd., 100 mfd., 200 mfd.
- ★ Smallest 1/2 watt resistors 5d. each all popular values.
- ★ Miniature 0.1 mfd., 1/-, 0.05, .01 9d. values up to 0.005 6d. each.
- ★ Miniature slide switch 2/6.
- ★ Transistor holders 1/8 each.
- ★ Edgewise Volume controls, 2K. 5K., 10K., 20K., all 2/6 each.
- ★ Ditto with switches 8/- each.
- ★ Set of 6 transistors for superhet in original packets guaranteed. Mullard OC5., OC7., OC71 matched pair OC72 £3.10.0 the set.
- ★ Superhet 6 all first grade includes matched pair 45/-, 35/-.
- ★ Ditto, seconds but tested 30/-.
- ★ Oscillator and 2 IF—new American High gain 35/-.
- ★ Red Spots 3/6.
- ★ White Spots 3/9.
- ★ Surface barrier (super white spot) 6/6.
- ★ Surface barriers 15 M/cs 9/6.
- ★ Diodes 1/-. Sub-miniature 2/6.
- ★ 3in. Speakers 3 ohm 18/6.
- ★ 3in. Speakers 80 ohm 18/6.
- ★ 2in. Speakers 3 ohm 19/6.
- ★ Elliptical Speaker, 7" x 4", 3 ohm or 35 ohm 19/6.

Over 1,000 letters received.

Speaker Bargain



12in. Hi-fidelity loudspeaker. High flux, permanent magnet type with standard 3 ohm speech coil. Will handle up to 12 watts. Brand new by famous maker. Price 32/6, plus 3/6 post and insurance.

Last Month's Blueprint Come to us for all the parts—or send for list.

TRANSISTORISED STETHOSCOPE



Trace signal right through; Radio, T.V., Tape amplifier, Hi-Fi, etc.—simplest way to fault find—carry it like a fountain pen—all parts in cluding transistor barrel crystal, everything except battery, 12/6 plus 1/6, data included or separately 1/6. Or complete with deaf aid type earphone, 20/-.

Transistors for R.F., F.M., T.V. and U.H.F.

Frequencies quoted are approx. cut-off.

SH 078 15-20 Mc/s	8/6
SH 305 20-30 Mc/s	9/-
SH 231R 40-50 Mc/s	15/-
AMERICAN 2N1727 100-150 Mc/s	15/6
AMERICAN 2N1728 100-150 Mc/s	12/6
AMERICAN 1N1832 1000-1300 Mc/s	25/-
AMERICAN 1N1833 1000-1300 Mc/s	25/-

Re-gunned Tubes

We offer television tubes which have had new gun assemblies, new getters, new screens and have virtually been rebuilt as new

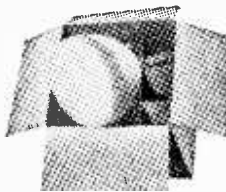

12in. £4.19.6
 14in. £5.4.6
 17in. £5.19.6
 Non-callers please add 10/- carriage and insurance.

Component Storage Drawers

Stout board construction these drawers are ideal for small parts. Supplied complete with simple erection instructions—1/6 each or 12 drawers each 6 x 24 x 6in., 13/6, post 2/-



"Dim and Full" Switch

Particularly useful for controlling photofool lamps which have only a short life at full brilliance. This switch has three positions; the first position puts two lamps in series at half brilliance for setting up, the second position is off and the third position full brilliance for the operation shots. Also useful for controlling night lights, heaters, etc. Price 3/9 each, post 9d. Circuit diagram included. Ditto but without the off position i.e. d.p.d.t., 10 amp 2/8.

ELECTRONIC PRECISION EQUIPMENT LTD.

post orders are dealt with from Eastbourne, so for prompt attention please post your orders to 66 Grove Road, Eastbourne, marked Department 7. Callers may use any one of the Companies below.

- | | | | | |
|--|--|--|--|--|
| 286 London Road,
Croydon
Phone: CRO 6559
Half day Wednesday | 29 Stroud Green Rd.,
Finchbury Park, N.4.
Phone: ARChway 1049
Half day Thursday | 520 High Street North,
Manor Park, E.12.
Phone: ILFord 1011
Half day Thursday | 42-46 Windmill Hill,
Ruislip, Middx.
Phone: RUISlip 3780
Half day Wednesday | 246 High Street,
Harlesden, N.W.10.
Phone: ELGar 4444
Half day Thursday |
|--|--|--|--|--|

SENSATIONAL NEW 1961 DESIGNS—BY CONCORD

LOW PRICES ★ PICTORIAL STEP-BY-STEP PLANS ★ EASY AS A.B.C.

THE NEW "LISBON" TRANSISTOR SET

Build the miniature, highly sensitive "LISBON" design. This is a pocket 2-stage transistor set not much larger than a matchbox. Excellent clear reception covering all medium waves and working for months and months on a tiny 11 or 3 volt battery costing only 3/6. A very simple set to build and an excellent introduction to transistor circuitry. Everything can be supplied down to the last nut and bolt including **SIMPLE AS A.B.C. PICTORIAL STEP-BY-STEP PLANS FOR ONLY 19/6**, plus post and packing 1/6 (C.O.D. 2/- extra). Parts sold separately, priced parts list 1/-.



"MAJORCA" 7 TRANSISTOR RADIO

Build this 7-TRANSISTOR £10.19.6 "MAJORCA" superb portable with Car Radio aerial attachment. An exceptional high quality design giving remarkable tone with push-pull output. Can be built for **ONLY £10.19.6**, including everything down to the last nut and bolt and **SIMPLE AS A.B.C. PICTORIAL STEP-BY-STEP PLANS**. Post and packing 3/6 (C.O.D. 3/- extra). Parts sold separately.

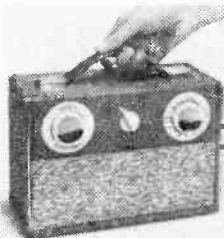

OUR NOVEL WRIST RADIO

Our engineers have designed this novel Wrist Radio using latest transistor techniques. Size only 1 1/2 x 1 1/2 in. "Featherweight" yet gives clear, crisp reception over all medium waves. Tiny battery lasts months and months costing only 4d. No sings—anyone can build it in an hour or two using our **SIMPLE AS A.B.C. PICTORIAL STEP-BY-STEP PLANS**. All parts can be supplied including case and strap **FOR ONLY 22/6**, plus post and packing 1/6 (C.O.D. 2/- extra). Parts sold separately, priced parts list 1/-.

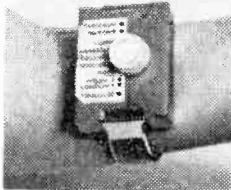

THE NEW "FLORIDA" VALVE RADIO

This sensational "FLORIDA" model is one of our most sensitive valve radios. It is a highly compact, self-contained, miniature push button base, valve pocket radio at absolutely rock bottom building cost. Covers all medium waves with very latest circuitry bringing in stations from all over Europe without fuss. Size only 4 1/2 x 2 1/2 x 1 1/2 in. A fascinating pocket radio. We can supply all the parts including beautiful 2-tone case and **SIMPLE AS A.B.C. PICTORIAL STEP-BY-STEP PLANS**, screws, wire, etc. Can be built for the exceptionally **LOW PRICE OF 27/6**, plus post and packing 1/6 (C.O.D. 2/- extra). Parts sold separately, priced parts list 1/-.

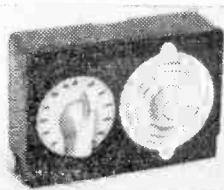

OUR NEW 4 STAGE "MINUETTE"

Build this newly-designed "MINUETTE" 4-STAGE transistor set in very strong ready drilled **ULTRA-MODERN CASE**, size only 6 x 3 1/2 in. Uses three transistors and diode and **SELF-CONTAINED LOUD SPEAKER**. Very sensitive, ideal for office, bedroom, holidays, etc. Months and months of listening off an 81. battery. Can be built **FOR ONLY 39/6**, including **PROPER CASE**, miniature speaker, etc. **SIMPLE AS A.B.C. PICTORIAL STEP-BY-STEP PLANS**, etc., plus post and packing 1/6 (C.O.D. 2/- extra). Parts sold separately, priced parts list 1/-.

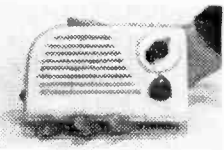

THE NEW "MONTE-CARLO" RADIO

One of our new, exciting designs, the "MONTE CARLO" is a powerful, all mains, miniature table radio with the latest trimmings, gold insert knobs, special unmarkable plastic veneer, etc. The amazing circuit covers all medium and long waves with good selectivity, fantastic tone and output. Includes rarely drilled and punched chassis, standard octal base valves, etc. All the parts can be supplied including **SIMPLE AS A.B.C. PICTORIAL STEP-BY-STEP PLANS**. Everything down to the last nut and bolt **FOR ONLY 25.15.0**, plus post and packing 3/6 (C.O.D. 2/- extra). Parts sold separately, priced parts list 1/-.

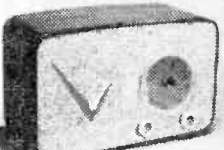

THE NEW 3-STAGE "RIO"

Our fabulous new 3-STAGE **MINIATURE LOUSPEAKER DESIGN** THE "RIO" covers all medium waves including Home, Light, etc. Very reliable and lightweight. Works for months and months off an 81. battery. Can be assembled in an hour or two. All parts can be supplied including miniature speaker and everything down to the last nut and bolt with **SIMPLE AS A.B.C. PICTORIAL STEP-BY-STEP PLANS** for **ONLY 29/6**, plus post and packing 1/6 (C.O.D. 2/- extra). Parts sold separately, priced parts list 1/-.



BRAND NEW RECORD CHANGERS

ONLY £8.15.0 BRAND NEW! the latest 4-speed Autochanger, B.S.R. UA14, as illustrated, few only **OUR PRICE £8.15.0**. P.P. 3/6.

BRAND NEW! the B.S.R. 4-speed Autochanger, UAS, few only left. **OUR PRICE £6.15.0**. P. & P. 3/6.

BRAND NEW! the COLLARO Junior 4-speed record player. **OUR PRICE 75/-**. P. & P. 3/6.

BRAND NEW! COLLARO "Conquest", 4-speed Autochanger. **OUR PRICE £7.15.0**. P. & P. 3/6.

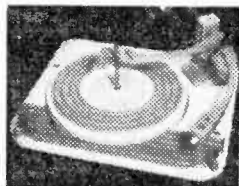

CONCORD ELECTRONICS

210, Church Road, Hove, Sussex

Dept. PW30

Cheques accepted. Cash on delivery 2/- extra. Please print name and address in block letters. Suppliers to Schools, Universities, Government and Research Establishments. Complete range of components and valves stocked. Regret no C.O.D. abroad. DEMONSTRATIONS DAILY AT WORKS

R.S.C. HI-FI TAPE RECORDER KIT

REALISM AT INCREDIBLY LOW COST, CAN BE RECORDED IN HALF AN HOUR The Recorder incorporates the Latest Collaro Studio Tape Transcriber. The Linear LT45X High Quality Tape Amplifier listed at 12/0. High Flux P.M. Speaker listed 30/-, empty Tape Spool, a Reel of Best Quality Tape listed 22/6, and a Handsome Portable carrying Cabinet with latest attractive two-tone polychrome finish, size 18 x 15 x 9 in. high, listed 14.10.0, and circuit. Total cost if purchased individually approximately £40. Performance equal to units in the £60-£80 class. S.A.E. for leaflet.

HIGH FIDELITY 12-14 WATT AMPLIFIER TYPE A11

PUSH-PULL ULTRA LINEAR OUTPUT "BUILT-IN" TONE CONTROL PRE-AMP STAGES

Two input sockets with associated controls allow mixing of "mike" and gram, as in A10. High sensitivity. Includes 5 valves, ECC83, ECC83, EL84, EL84, 5Y3. High quality sectionally wound output transformer specially designed for Ultra Linear operation, and reliable small condensers of current manufacture. IN DIVIDUAL CONTROL'S FOR BASS AND TREBLE, "Lift" and "Cut." Frequency response \pm 3 D.B. 30-30,000 c/s. Six negative feedback loops. Hum level 60 D.B. down. ONLY 23 millivolts INPUT required for FULL OUTPUT. Suitable for use with all makes and types of pick-ups and microphones. Comparable with the very best designs. For STANDARD or LONG PLAYING RECORDS For MUSICAL INSTRUMENTS such as STRIAD BASS, GUITARS, etc., OUTPUT SOCKET with plug provided 300 v. 30 mA. and 6.3 v. 1.5 a. For supply of a RADIO PUMP UNIT. Size approx. 12-9-7in. For A.C. mains 200-250 v. 50 c.p.s. Output for 3 and 15 ohm speakers. Kit is complete to last nut. Chassis is fully punched. Full instructions and point-to-point wiring diagrams supplied. Only (Or factory built 45/- extra).

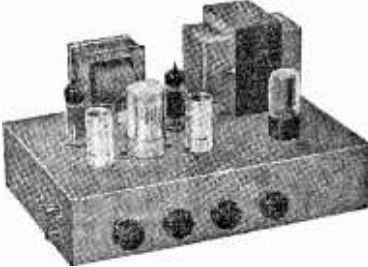

8 Gns. Carr. 10/-

If required louvred metal cover with 2 carrying handles can be supplied for 18/9. TERMS ON ASSEMBLED UNITS. DEPOSIT 24/3, and 9 monthly payments of 24/3. Send S.A.E. for illustrated leaflet detailing Ready-to-assemble Cabinets, Speakers, Microphones, etc., with cash and credit terms.

R.S.C. STEREO/TEN HIGH QUALITY AMPLIFIER

A complete set of parts for the construction of a stereophonic amplifier giving 5 watts high quality output on each channel (total 10 watts). Sensitivity is 50 millivolts, suitable for all crystal stereo heads. Ganged Bass and Treble Controls give equal variation of "lift" and "cut." Provision is made for use as strap (monaural) 10 watt amplifier. Valve line-up ECC83, ECC83, EL84, EL84, EZ81. Outputs for 2-3 ohm speakers. Point-to-Point wiring diagrams and instructions supplied. Send S.A.E. for leaflet. Full constructional details and price list 2/6.

8 Gns. Carr. 10/-

DEAF AID EARPIECES. Low Impedance with lead. 8/9. High Impedance Crystal 8/9. MICROPHONE INSERTS. Crystal type. 6/9.

R.S.C. BATTERY CHARGING EQUIPMENT

All for A.C. Mains 200-250 v., 50 c/s. Guaranteed 12 months.

ASSEMBLED CHARGERS

6 v. 1 amp. 19/9
6 v. or 12 v. 1 amp. 29/9
6 v. 2 amps. 29/9
6 v. or 12 v. 2 amps. 38/9
6 v. or 12 v. 3 amps. with ammeter. 59/9
Above ready for use. With mains and output leads. Carr. 3/6.

HEAVY DUTY CHARGER KIT
6/12 v. 6 amps. variable output. Consisting of Mains Transformer 0-200-250 v., F.W. (Bridge) Selenium Rectifier; Ammeter. Variable Resistor. Panels, Plugs, Fuses, Fuseholder and circuit. 59/9. Carr. 4/6.

Assembled 6 v. or 12 v. 4 amps.



Fitted Ammeter and variable charge rate selector. Also selector plug for 6 v. or 12 v. charging. Louvred steel case with stoved blue hammer finished. Fused. 69/9 and ready for use with Car. 5/- mains and output leads. Terms: Deposit 13/3 and 5 monthly payments 13/3.

ASSEMBLED CHARGER

6 v. or 12 v. 2 amps. Fitted Ammeter and selector plug for 6 v. or 12 v. Louvred metal case finished attractive hammer blue. Ready for use with mains and output leads. Double Fused. Only Carr. 3/9. **49/9**

BATTERY CHARGER KITS
Consisting of Mains Transformer, F.W. Bridge, Metal Rectifier, well ventilated steel case. Fuses, Fuse-holders, Grommets, panels and circuit. Carr. 3/6 extra.
6 v. or 12 v. 1 amp. 24/9
As above, with Ammeter. 32/9
6 v. 2 amps. 25/9
6 v. or 12 v. 2 amps. 31/6
6 v. or 12 v. 2 amps. inclusive of Ammeter. 42/9
6 v. or 12 v. 4 amps. 53/9
6 v. or 12 v. 4 amps. with Ammeter and variable charge rate selector. 59/9
CHARGER AMMETERS
0-1.5 a., 0-3 a., 0-4 a., 0-7 a., 0-25 a., 0-60 a. 8/9.

R.S.C. MAINS TRANSFORMERS (FULLY GUARANTEED)

Interleaved and Impregnated. Primaries 200-230-250 v. 50 c/s. Screened TOP SHROUDED DROP THROUGH
250-0-250 v. 70 mA, 6.3 v. 2 a. 5 v. 2 a. 17/9
350-0-350 v. 60 mA, 6.3 v. 2 a. 5 v. 2 a. 19/9
250-0-250 v. 100 mA, 6.3 v. 2 a. 6.3 v. 1 a. 19/9
250-0-250 v. 100 mA, 6.3 v. 3.5 a. C.T. ... 19/9
250-0-250 v. 100 mA, 6.3 v. 4 a. 5 v. 3 a. 25/9
300-0-300 v. 130 mA, 6.3 v. 4 a. 6.3 v. 1 a. for Mullard 510 Amplifier ... 29/9
300-0-300 v. 100 mA, 6.3 v. 4 a. 5 v. 3 a. 25/9
350-0-350 v. 100 mA, 6.3 v. 4 a. 5 v. 3 a. 25/9
350-0-350 v. 100 mA, 6.3 v. 4 a. 4 a. C.T. 3-4-5 v. 3 a. 25/9
350-0-350 v. 150 mA, 6.3 v. 4 a. 5 v. 3 a. 29/9

FULLY SHROUDED UPRIGHT
250-250 v. 60 mA 6.3 v. 2 a. 5 v. 2 a. 25/9
Midket type 21-31in. 17/11
250-0-250 v. 100 mA, 6.3 v. 4 a. 5 v. 3 a. 26/9
300-0-300 v. 100 mA, 6.3 v. 4 a. 5 v. 3 a. 26/9
350-0-350 v. 100 mA, 6.3 v. 4 a. 5 v. 3 a. 26/9
350-0-350 v. 150 mA, 6.3 v. 4 a. 5 v. 3 a. 25/9
425-0-425 v. 200 mA, 6.3 v. 4 a. C.T. 6.3 v. 4 a. C.T., 5 v. 3 a. 49/9

FILAMENT TRANSFORMERS
All with 200-250 v. 50 c/s. primaries 6.3 v. 1.5 a, 5/9; 6.3 v. 2 a, 7/9; 0-4-6.3 v. 2 a, 7/9; 12 v. 1 a, 7/11; 6.3 v. 3 a, 9/11; 6.3 v. 6 a, 17/6; 12 v. 1.5 a twice, 17/6.

OUTPUT TRANSFORMERS
Midket Battery Pentode 66:1 for 3S4, etc. 3/9
Small Pentode, 5000 to 30 ... 3/9
Small Pentode 7/8, 3000 to 30 ... 3/9
Standard Pentode 5,000 to 30 ... 5/6
Standard Pentode 7/8, 3000 to 30 ... 5/6
10,000 to 30 ... 5/6
Push-Pull 10-12 watts 6V6 to 3n or 15n
Push-Pull 10-12 watts to match 6V6 to 3-5-8 or 15n ... 19/9
Push-Pull EL84 to 3 or 15n ... 18/9
Push-Pull 15-18 watts, 6L6, KT66 ... 22/9
Push-Pull for Mullard 510 Ultra Linear ... 29/9
Push-Pull 20 watts, sectionally wound 6L6, KT66 etc., to 3 to 15n ... 47/9

ELIMINATOR TRANSFORMERS
Primaries 200-250 v. 50 c/s.
120 v. 40 mA, 5-0-5 v. 1 a. 15/9
90 v. 15 mA, 4-0-4 v. 500 mA ... 7/9

SMOOTHING CHOKES
150 mA, 7-10 H 250 ohms ... 11/9
100 mA, 10 H 200 ohms ... 9/9
80 mA, 10 H 300 ohms ... 5/9
60 mA, 10 H 400 ohms ... 4/11

CHARGER TRANSFORMERS
All with 200-230-250 v. 50 c/s Primaries; 0-9-15 v. 1 a, 11/9; 0-9-15 v. 2 a., 14/9; 0-9-15 v. 3 a, 16/9; 0-9-15 v. 5 a, 19/9; 0-9-15 v. 6 a, 23/9; 0-9-15 v. 8 a, 28/9.

AUTO (Step up/Step down) TRANS.
0-110-120-200/250 v. 50-80 watts. 13/9;
0-110-120-200/230/250 v. 150 watts 27/9.

MICROPHONE TRANSFORMERS
120:1 high grade, clamped, 6/9; 120:1 Potted, Mu-metal screened, 9/9.

25 1/2 GNS.
Carr. 17/6



T.V. TERMS. Deposit £5.7.6 and 12 monthly payments of 2 gns. Cash price if settled in 3 months.

TELEVISION RECTIFIERS 250 v. 200 mA, small size. Only 6/9 each.
RE-ENTRANT SPEAKERS. Tannoy, 8 watt, 7.5 ohms. Only 22/6 each.
Pantrick Horn Type. 10 watt, 15 and 200 ohm matchinr. 59/6. R.C.A. 20 watt, 15 ohms or 200 ohms. 6 kns.
COLLARO RC 47 4 SPEED MIXER AUTO-CHANGERS. Turnover Studio Pick-up head, for 200-250 v. A.C. 27.18.6. Carr. 4/6.
THE SKYFOUR T.R.F. RECEIVER. A design of a 3-valve Long and Medium wave 200-250 v. A.C. Mains receiver with selenium rectifier. High gain H.F. stage and low distortion detector. Power pentode output. Valve line-up 6X7, 5P6L, 6V6G. Selectivity and quality excellent. Simple to construct. Point-to-point wiring diagrams, instructions and parts list. 1/9. maximum building costs 24.18.6. Inc. attractive Walnut veneered wood cabinet 12 x 6 1/2 x 5 1/2 in.
D.C. SUPPLY KIT. 12 v. 1 a. consisting of a partially drilled metal case, mains trans. F.W. Bridge Rectifier, 2 fuseholders and fuses. Change Direction switch, variable Speed regulator and circuit. For 200-250 v. A.C. mains. Suitable for Electric Trains. Limited number available at 33/9.

R.S.C. A12 STEREPHONIC AMPLIFIER KIT

A complete set of parts to construct a Stereo amplifier with an undistorted output total 6 watts. For A.C. mains input of 200-250 v. Outputs for matched 2-3 ohm speakers. Sensitivity 130 m.v. Ganged Vol. and Tone Controls. Preset balance control. Full instructions and point-to-point wiring diagrams supplied. Only good quality components and latest high grade valves used. Exceptionally realistic reproduction can be obtained at ample volume for the home, as can be demonstrated in typical surroundings at our County Arcade premises. A really sensational offer.

4 Gns.

Carr. and pkg. 5/-

STEREO EQUIPMENT OFFER.
Comprising A12 Kit, 2 matched 8in. L/ Speakers, £6.19.6 and Acos T/O Stereo head Carr. 7/6 with sapphire stylus suitable most pick-ups.

PICK-UP ARMS complete with Hi-Fi turnover crystal head. Acos GP54. Limited number, brand new, perfect at approx. half price. Only 35/9.

ACOS CRYSTAL MICROPHONES. Mic49 stand or desk. Listed 45s. Only 27/9. 39-1 Stick type. Listed 55s. Only 38/6.

R.S.C. 30 WATT ULTRA LINEAR HIGH FIDELITY AMPLIFIER A10

A highly sensitive Push-Pull high output unit with self-contained Pre-amp. Tone Control Stages. Certified performance figures compare equally with most expensive amplifiers available. Hum level 70 db. down. Frequency response—2 db. 30-30,000 c/s. A specially designed sectionally wound ultra linear output transformer is used with 807 output valves. All components are chosen for reliability. H.F. valves are used EF86, EF86, ECC83, 807, 807, GZ33. Separate Bass and Treble Controls are provided. Minimum input required for full output is only 12 millivolts so that ANY KIND OF MICROPHONE OR PICK-UP IS SUITABLE. The unit is designed for CLUBS, SCHOOLS, THEATRES, DANCE HALLS or OUTDOOR FUNCTIONS, etc. For use with electronic ORGAN, GUITAR, STRING BASS, etc. For standard or long-playing records. OUTPUT SOCKET PROVIDES L.T. and H.T. for a RADIO FEEDER UNIT An extra input with associated vol. control is provided so that two separate inputs such as Gram. and 'Mike' can be mixed. Amplifier operates on 200-250 v. 50 c/s. A.C. Mains and has output for 3 or 15 ohm speakers. Complete kit of parts with fully punched chassis and point-to-point wiring diagrams and instructions. If required cover as for All can be supplied for 18/9.

|| Gns.
Carr. 10/- amplifier can be supplied, factory built with EL34 output valves and 12 months guarantee, for 14 Gns.

TERMS: DEPOSIT 33/9 and 9 monthly payments of 33/9.

FULL RANGE OF LINEAR AMPLIFIERS ALWAYS IN STOCK.

R.S.C. BATTERY TO MAINS CONVERSION UNITS

Type BM1. All-dry battery eliminator. Size 5 1/2 x 4 1/2 x 2 1/2 in. approx. Completely replaces battery supplying 1.4 v. and 90 v. where A.C. mains 200-250 v. 50 c/s is available. Suitable for all battery portable receivers requiring 1.4 v. and 90 v. Includes latest low consumption types. Complete kit with diagrams, 39/9, or ready to use, 46/9.

LINEAR TAPE PRE-AMPLIFIER Type LP1

Switched Negative feedback equalisation. Positions for Record 1In. 3In. 7In. and Playback. EM84 Recording Level Indicator. Designed primarily as the link between a Colmar Tape Transcriber and a high fidelity amplifier, but suitable for almost any Tape Deck. Only 9 gns. S.A.E. for leaflet.

LINEAR L45 MINIATURE 4/5 WATT QUALITY AMPLIFIER. Suitable for use with any record playing unit, and most microphones. Negative feed-back 12 db. Separate Bass and Treble Controls. For A.C. mains input of 200-250 v. 50 c/s. Output for 2-3 ohm speaker. Three miniature Mullard valves used. Size of unit only 7-5 in. high. Guaranteed for 12 months. Only £5.19.6. Send S.A.E. for illustrated leaflet. Terms. Deposit 22/6 and 5 monthly payments of 22/6.

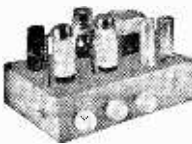

A highly-sensitive 4-valve quality amplifier for the home, small club, etc. Only 50 millivolts input is required for full output so that it is suitable for use with high fidelity pick-up heads, in addition to all other types of pick-ups and practically all 'mikes'. Separate Bass and Treble Controls are provided. These give full long-playing record equalisation. Hum level is negligible being 71db. down. 15db. of Negative feedback is used. H.T. or 200 v. 25 mA. and L.T. of 6.3 v. L.T. is available for the supply of a Radio Feeder Unit, or Tape-Deck pre-amplifier. For A.C. mains input of 200-250 v. 50 c/s. Output for 2-3 ohm speaker. Chassis is not alive. Kit is complete in every detail and includes fully punched chassis (with baseplate) with Blue Hammer finish and point-to-point wiring diagrams and instructions. Exceptional value at only £4.15.0, or assembled ready for use 25/- extra, plus 3/6 carr.; or Deposit 22/6 and 5 monthly payments of 22/6 for assembled unit.

R.S.C. PORTABLE GUITAR AMPLIFIERS

Junior 5 watts High quality output. Separate Bass and Treble 'Cut' and 'Boost' controls. Sensitivity 15 m.v. Twin inputs. High Flux 8in. Loudspeaker 'built-in'. Handsome, strongly made Cabinet (size approx. 14 x 14 x 7in.) finished in attractive and durable polychrome, and fitted carrying handle. H.P. Terms. Deposit £1 and 9 monthly payments of 4/- Carr. 7/6

£8.19.6

Senior 10 watts High Fidelity output. Separate Bass and Treble 'Cut' and 'Boost' controls. Twin separately controlled high gain inputs so that two instruments such as Guitar and String Bass can be used at the same time. Two loudspeakers are incorporated, a high Flux 12in. for Bass notes and a 4 x 4 in. elliptical for Treble. Cabinet is well made and finished as junior model. Size approx. 18 x 18 x 18in. H.P. Terms. Deposit 34/9 and 9 monthly payments of 34/9. Both models for 200-250 v. Carr. 10/- Above model fitted Linear Tremolo Unit 5 gns. extra. Or Deposit 11/6 and 9 Monthly payments 11/6.

12in. 10 WATT HIGH QUALITY LOUD-SPEAKER IN POLISHED WALNUT FINISHED CABINET

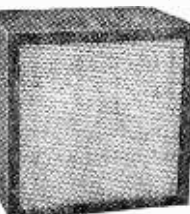

Gauss 12,000 lines. Speech coil 3 ohms or 15 ohms. Only £4.19.6. Carr. 5/- Terms: Deposit 11/3

and 8 monthly payments of 11/3.
12in. 20 WATT HI-FI LOUD-SPEAKERS IN CABINETS. Size 18 x 18 x 10in. Finish as above. Terms: Deposit 17/9 and 9 monthly payments of 17/9. Only £7.19.6. Carr. 8/6.

R.S.C. 4-5 WATT A5 HIGH-GAIN AMPLIFIER

A highly-sensitive 4-valve quality amplifier for the home, small club, etc. Only 50 millivolts input is required for full output so that it is suitable for use with high fidelity pick-up heads, in addition to all other types of pick-ups and practically all 'mikes'. Separate Bass and Treble Controls are provided. These give full long-playing record equalisation. Hum level is negligible being 71db. down. 15db. of Negative feedback is used. H.T. or 200 v. 25 mA. and L.T. of 6.3 v. L.T. is available for the supply of a Radio Feeder Unit, or Tape-Deck pre-amplifier. For A.C. mains input of 200-250 v. 50 c/s. Output for 2-3 ohm speaker. Chassis is not alive. Kit is complete in every detail and includes fully punched chassis (with baseplate) with Blue Hammer finish and point-to-point wiring diagrams and instructions. Exceptional value at only £4.15.0, or assembled ready for use 25/- extra, plus 3/6 carr.; or Deposit 22/6 and 5 monthly payments of 22/6 for assembled unit.

R.S.C. JUNIOR BASS REFLEX CABINETS. Specially designed for W.B. HF102 Speaker, but suitable for any good quality 10in. speaker. Acoustically lined and ported. Polished walnut veneer finish. Size 18 x 12 x 10in. Handsome appearance. Ensure superb reproduction for only £3.19.6

SENIOR MODEL for 12in. speakers, £6.19.6. Suitable legs with brass ferrules, 25/- per set of four.
PLESSEY DUAL CONCENTRIC 12in. 15 ohms HIGH FIDELITY SPEAKER (12,000 lines) with built-in tweeter completely separate elliptical speaker with choke, condensers, etc.) providing extraordinarily realistic reproduction when used with our All or similar amplifier. Rated 10 watts. Price only £5.19.6.

P.M. SPEAKERS. 2-3 ohm. 2In. Perdio 21/9. 5in. 17/9. 6in. 16/9. 8in. 19/9. 8 x 5in. 25/9. 10in. 26/9. 10 x 6in. 29/9. 12in. 29/11. 10in. W.B. 'Stentorian' 3 or 15 ohm type HF1012 10 watts, high-fidelity type. Recommended for use with our All Amplifier, £4.10.9.12in. Plessey 3 ohms 10 watts (12,000 lines), 59/6.

TWEETERS. Plessey 3in. 12/9, 15.0 25/9.
HI-FI CRYSTAL PICK-UP HEADS. (Turnover type with sapphire stylus.) Acos. Standard replacement for Garrard and B.S.R. Stereo/Monaural 39/11.

GLEA MINIATURE 2-3 WATT GRAM AMPLIFIER. For use with any single or auto-change unit. Output for 2-3 ohm speaker. For 200-250 v. 50 c.p.s. A.C. mains. Over-all size 1 1/2 x 2 1/2 x 2 1/2 in. Vol. and Tone with switch. Guaranteed 12 months. Only 59/6.

SUPERHET FEEDER UNIT. Design of a high quality Radio Tuner Unit (specially suitable for use with any of our Amplifiers). Delayed A.V.C. employed. The W.Ch. Sw. incorporates Gram position. Controls are Tuning, W.Ch. and Vol. only 250 v. 15 mA. H.T. and L.T. of 6.3 v. 1 amp. Required from amplifier. Size of unit approx. 9-6-7in. high. Simple alignment procedure. Point-to-Point wiring diagrams, instructions and priced parts list with illustration, 2/6. Total building cost £4.15.0. For descriptive leaflet send S.A.E.

COLLARO JUNIOR 4-speed single player units and Hi-Fi crystal pick-up with turn-over head, £3.19.6.
B.S.R. UNAS 4-SPEED AUTO-CHANGERS with Hi-Fi turnover pick-up head, £6.19.6. Carr. 5/-.
TERMS: C.W.O. or C.O.D. under £1. Post 1/9 extra under £2, 2/9 extra under £5. Open 9 to 6 Weds. until 1 p.m. Trade enquiries S.A.E. with all enquiries.

R.S.G. (Manchester) Ltd.

COLLARO CONQUEST 4-SPEED AUTO-CHANGER with high fidelity Studio pick-up. Latest model. For 200-250 v. 50 c.p.s. A.C. mains. Our price £6.19.6. Carr. 5/6.

Mail Orders to 29-31 Moorfield Road, Leeds 12.
Callers to 5 and 7 County (Mecca) Arcade, Briggate, Leeds 1 and 8-10 Brown Street (Market Street), Manchester 2, or 56 Morley Street (next to Majestic Ballroom), Bradford.

BRADFORD, MANCHESTER and LEEDS



FOR VALVES - TUBES AND COMPONENTS - BY RETURN POST SERVICE

EF91(BVA) 9/-	KT61 13/6	TH30C 5/-	VP23 6/6	5V4 11/6	6F15 14/-	6X5GT 7/-	12SL7 8/-
EF92 6/-	KTW61 6/6	TP22 10/-	VR105/30 8/-	5Y3G 8/-	6J5GT 5/6	6/30L2 12/6	12SN7GT 10/6
EK32 7/-	MX40 12/6	U10 9/6	YR150/30 5/6	5Y3GT 7/6	6J5M 6/6	7B6 10/6	15D2 7/9
EL32 4/6	N78 19/11	U25 13/6	6A7 7/6	5Z4G 9/-	6J6 5/6	7B7 8/6	15A8 9/-
EL33 14/-	OZ4 5/6	U50 8/-	VU39(MU 6A7 10/-	12/14) 8/9	6J7G 6/6	7C5 8/-	25L6GT 10/-
EL41 9/-	P61 9/6	U61 12/11	Y63 7/6	6A8G 5/-	6K7M 6/9	7H7 8/-	25Z4 9/6
EL84 9/-	PCC84 8/6	UAF42 9/6	IA7GT 13/6	6A5 4/-	6K8G 6/6	757 9/6	25Z5 8/-
EL91 4/6	PCC85 11/6	UBC41 8/6	IC2 11/6	6A6S 7/6	6K7GT 5/9	7Y4 8/6	25Z6 10/-
EM34 9/6	PCF80 8/9	UBC81 11/4	ICSGT 12/6	6A6E 4/-	6K8GT 10/-	IOF1 12/6	30FL1 10/6
EM80 9/6	PCF82 11/6	UBF80 9/-	IHSGT 9/-	6A5 7/6	6L6G 8/-	IOF13 23/3	30L15 23/3
EM81 10/6	PCL83 13/6	UCC8410 11/6	INS 10/6	6A6E 8/6	6L6M 9/6	12A6 5/-	30P4 15/-
EF42 9/6	N78 19/11	UCC85 9/6	IR5 7/6	6BA6 7/6	6L8 11/6	12AH8 12/-	30P12 12/6
EY51 9/6	EY86 10/-	PL36 13/6	UCC85 9/6	IR5 7/6	6B6E 7/6	6N7GT 7/6	30P11 12/6
EZ40 7/6	EZ40 7/6	PL81 11/-	UCH42 9/6	IS4 10/6	6BE6 9/-	6Q7G 7/6	35L6GT 10/-
EZ41 7/6	EZ80 7/6	PL82 8/6	UCH81 9/6	IS5 6/6	6BH6 9/-	6Q7GT 9/6	25X7 9/9
EZ80 7/6	EZ81 7/6	PL83 9/6	UCL82 11/6	IT4 5/6	6BJ6 9/-	6K7G 6/6	25Y5 9/9
EF61 5/6	EF61 5/6	PX25 12/6	UCL83 13/6	3D6 5/-	6BV6 4/6	6S17GT 8/6	35Z4GT 8/-
EF62 9/6	EF62 9/6	PY80 7/6	UF85 9/-	3Q4 7/6	6C4 6/6	6S17GT 8/6	35Z5GT 9/-
EF63 3/6	EF63 3/6	PY81 8/6	UF89 9/-	3Q5GT 9/6	6C5GT 4/6	6S2G 9/3	50L6GT 8/6
EF64 8/9	EF64 8/9	PY82 7/6	UL41 9/-	354 7/6	6C6 5/-	6U4GT 12/-	12K7GT 10/6
EF65 9/6	EF65 9/6	PY83 8/6	UL84 9/-	3V4 8/-	6D6 8/6	6V6G 6/9	12K8M 13/6
EF66 12/6	EF66 12/6	PEN4A10/-	UU6 10/-	VALVES 6C6H6 7/6	6V6GT 7/6	6X4 7/6	12Q7GT 6/6
EF67 8/9	EF67 8/9	PEN45 8/-	UY41 7/6	5R4GY 9/6	6F6M 14/-	6X5G 7/6	12SK7 6/6
EF68 8/9	EF68 8/9	SP4 5/6	UY85 7/6	5U4G 6/6	6F1 7/6		

LOUDSPEAKER UNITS

All Brand New

- 2 1/2 in. square Rola C25.....26/10
- 2 1/2 in. square EM1.....18/6
- 4 in. square Elac Tweeter.....12/6
- 5 in. round Plessey with O.P.T.16/6
- 6 1/2 in. round Celestion.....17/6
- 8 in. round Richard Allen.....18/6
- 10 in. round Elac.....25/-
- 12 in. round Plessey.....29/6
- 6 in. x 4 in. Plessey.....19/6
- 7 in. x 4 in. Plessey.....19/6
- 8 in. x 5 in. Celestion and Richard Allen.....19/11
- 10 in. x 6 in. Celestion and Plessey.....22/6

RECTIFIERS

- RM1 5/3; RM2 6/9; RM3 7/6;
- RM4 13/6; RM5 19/6; 14A 86 19/6;
- 14A 97 19/6; 14A 100 19/6; LW7 17/6;
- 18RA 1-1-16-1 6/-; FC31 (14Ra 1-2-8-3) 22/6; FC101 (14Ra 1-2-8-2) 16/6.

Rectifiers suitable for Battery Chargers 6 and 12 volt output:
 2 amp 7/- 3 amp..... 10/-
 4 amp 12/6 5 amp 14/6

'HEATER TRANSFORMERS

All 240 v. input 4 v. 3 amp. 10/-.
 6.3 v. 1 1/2 amp. 6/9. 6.3 v. 3 amp. 10/-.
 12.6 v. 3/4 amp. 5/9. 5 v. 2 amp. 10/-.
 2 v. 3 amp. 8/3.

"CABY" SUPREME MULTI-RANGE TESTER METER

Solves your problems with speed and accuracy.
 Model A10. Measurement ranges:
 D.C. volts 10 v. to 1,000 v.
 A.C. volts 10 v., 50 v., 250 v., 500 v., 1,000 v.
 Resistance ohm; 10K ohms, 1 megohm. Size of meter 5 1/2 in. x 3 1/2 in. x 1 1/2 in. Price £4/17/6 inclusive of test prods., instruction and batteries.

P.W. TRANSISTOR SUPERHET PRINTED CIRCUIT VERSION

- All components available from stock. Complete kit £9/15/0.
 - Full detailed shopping list, point to point wiring diagram, fully illustrated 2/6
 - Coil Set (Osc. and 3 I.F.T.s) 22/6
 - Driver Transformer 11/6
 - Output Transformer 10/6
 - Ferrite Rod Aerial 10/-
 - Printed Circuits 9/-
 - OO Gang Condensers 11/-
 - Volume Control V. 1545 10/6
 - Switch 3/6
 - Hardware Kit 4/6
 - Transistors (set of 6 plus crystal diode GD9) 70/-
 - Speaker 19/10
 - Case 7/6
 - Complete Kit of Condensers 15/-
 - Complete Set of Resistances 6/6
 - Trimmers (2) 2/8
- All above components are brand new and are fully guaranteed.

MICROPHONES

- ★ Acos mic. 39/1, crystal stick microphones for use as a hand, desk or floor stand unit, listed at 3 gns. Our price 39/6. Table stand 7/6 extra, floor stand adaptor 12/6 extra.
- ★ Acos Mic. 40, as supplied with modern tape recorders with a folding res. and 8ft. lead, listed at £1/15/0. Our price 19/6.
- ★ GBS Microphone Pencil Stick type, fitted with muting switch 42/-.
- ★ T.S.L. Crystal "Stick" microphone, model MX3, for general purpose use, complete with table stand 45/-.
- ★ T.S.L. Moving Coil Microphone, for high or low impedance. Brown and cream plastic case with a fold-in table rest. 6ft. cable and a standard 3-way connecting continental plug, £4/4/0.

COLLARO Mk. IV TAPE TRANS- CRIPTR

Four heads. Twin track operation. Pause control. Tape measuring and calibration device. Two motors. Fast re-wind. 7 in. tape spool. 3 speeds. 3 1/2 in., 7 1/2 in. and 15 in. per second. Finish cream polystyrene cover plate with maroon control. Delivery from stock £16/19/6.

LATEST B.S.R. "MONARDECK" SINGLE SPEED

3 1/2 in. i.p.s., takes 5 1/2 in. spools. Simple controls. £8/8/0. Tapes extra. Carr. and insurance 5/6.

AUTOMATIC RECORD CHANGER UNITS

BSR "MONARCH" UA8. 4-speed unit with BSR FULFI cartridge. £6/15/0.

BSR "MONARCH" UA8. As above, but fitted with BSR FULFI STEREO cartridge. £6/19/6.

GARRARD 210 Automatic Record Changer. 4-speed will take eight records 10 in. and 12 in. arm wired for stereo fitted MPM head moulding with GCB monaural cartridge. £10/19/6.

BSR "MONARCH" UA14 4-speed unit in two-tone grey. £7/19/6.

GARRARD RC120 Mk. 2 4-speed unit with manual control to enable records to be played singly. Fitted GC2 cartridge. £6/19/6.

E.M.I. Single player. 4-speed with automatic stop. Fitted with Acos stereo turnover cartridge. £6/19/6.

CATALOGUE

OUR 1961 CATALOGUE IS NOW AVAILABLE PLEASE SEND 1/- IN STAMPS FOR YOUR COPY. TRADE CATALOGUE ALSO AVAILABLE. PLEASE ATTACH YOUR BUSINESS LETTER HEADING.

TERMS: Cash with order or C.O.D. Postage and Packing charges extra; as follows: Orders value 10/- add 1/-; 20/- add 1/6; 40/- add 2/-; £5 add 3/- unless otherwise stated. Minimum C.O.D. free and postage 3/-. For full terms of business see inside cover of our catalogue. Personal Shoppers 9 a.m. to 5 p.m. Mon. to Friday; Saturday 10 a.m. to 1 p.m.

ALPHA RADIO SUPPLY CO



**103 LEEDS TERRACE
 WINTOUN STREET
 LEEDS 7**

CHECK with these



1



2



3



4

ORDERS BY POST WILL RECEIVE OUR PROMPT ATTENTION

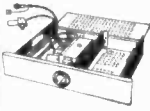

5



6

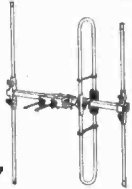

7

EASY TERMS AVAILABLE EXCEPTING AUTO-CHANGES

Three miniature valves and Metal Rectifier. A.C. mains 200/250 v. Internal modulation of 400 c.p.s. to a depth of 30 per cent. Modulated or unmodulated R.F. output continuously variable 100 millivolts. C.W. and mod. switch, variable A.F. output. Magic eye as output indicator. Accuracy ± 2 per cent.

10. **SIGNAL GENERATORS.** Cash $\pounds 4.19.6$ or 25/- deposit and 4 monthly payments of $\pounds 1.6$. P. & P. 5/-. Coverage 120 kc/s to 84 Mc/s. Case $10 \times 8 \times 4 \frac{1}{2}$ in. Size of scale $8 \frac{1}{2} \times 3 \frac{1}{2}$ in. 2 valves and rectifier. A.C. mains 200-250 v. Internal modulation of 400 c.p.s. to a depth of 30 per cent. modulated or unmodulated R.F. output continuously variable 100 millivolts. C.W. and mod. switch variable A.F. output and moving coil output meter. Accuracy ± 2 per cent.
11. **BATTERY RECORD PLAYER AND AMPLIFIER.** 45 r.p.m. "Star" motor "Acos" crystal pick-up, 3 transistor push-pull amplifier complete with transistors. Output 500 milliwatts, 49/6. P. & P. 3/6.
12. **8-WATT PUSH-PULL 5 VALVE AMPLIFIER.** A.C. mains 200-250 v. Size $10 \frac{1}{2} \times 6 \frac{1}{2} \times 2 \frac{1}{2}$ in. 5 valves. For use with all makes and type of pick-up and mike. Negative feed back. Two inputs, mike and gram, and controls for same. Separate controls for Bass and Treble lift. Response flat from 40 cycles to 15 kc/s. ± 2 db; 4 db down to 20 kc/s. Output 8 watts at 5 per cent total distortion. Noise level 40 db down all hum. Output transformer tapped for 3 and 15 ohms speech coils. For use with Std. or L.P. records, musical instruments such as guitars, etc. Suitable for small halls. $\pounds 19.8$. P. & P. 6/-. Crystal mike to suit 15/-, P. & P. 1/6. 8in. P.M. Speaker to suit 12/6. P. & P. 1/6.
13. **B.S.R. MONARCH UAS WITH PUL-PI HEAD.** 4-speed, plays 10 records, 12in., 10in., or 7in. at 16, 33, 45 or 78 r.p.m. Intermixes 7in., 10in. and 12in. records of the same speed. Has manual play position; colour, brown. Dimensions: $12 \frac{1}{2} \times 10 \frac{1}{2}$ in. Space required above baseboard $4 \frac{1}{2}$ in., below baseboard $2 \frac{1}{2}$ in. Fitted with Full-Pi turnover crystal head. $\pounds 19.8$. P. & P. 5/-. With Stereo Head $\pounds 19.8$. P. & P. 5/-.
 14. **TRANSISTOR TESTER.** For both P.N.P. and N.P.N. transistors incorporating moving coil meter. In metal case size $4 \frac{1}{2} \times 2 \frac{1}{2} \times 1 \frac{1}{2}$ in. Scale marked in gain and leakage. 19/6. P. & P. 2/6.
15. **PUSH-PULL OUTPUT STAGE** inclusive of transistors with input and output transformers to match 3 ohms speech coil, suitable for use with the POCKET RADIO. Kit of parts, including transistors. 19/6 P. & P. 1/6. Wiring diagram 1/6, free with kit.
16. **PORTABLE AMPLIFIER.** On printed circuit for A.C. Mains 200/250 v. Size $4 \times 3 \frac{1}{2}$ in. with tone and volume control. Valves: ECL82 and EZ80. 39/6. P. & P. 2/6.

BARGAINS

1. **3-TRANSISTOR POCKET RADIO** with MINIATURE SPEAKER, FERRITE ROD, PRINTED CIRCUIT and GERMANIUM DIODE. The only 3 transistor radio available at the price. Build it in 1 evening. Tunable over M/L waves. Complete with easy-to-follow instructions and all components (less batteries obtainable anywhere 10d.). 22/6, P. & P. 1/6. (All parts available separately).
2. **3-TRANSISTOR SUPER POCKET RADIO** with MINIATURE SPEAKER. Plus Germanium Diode and Printed Circuit. Size $3 \frac{1}{2} \times 4 \times 1 \frac{1}{2}$ in. Ferrite Rod Aerial. Two surface Barrier Transistors and one Audio. Tunable over medium and long waves. To build yourself 39/6, P. & P. 1/6. Circuit diagram 1/6, free with kit. All parts of items 1 and 2 sold separately.
3. **DOUBLE BEAM "SCOPE"** for D.C. and A.C. APPLICATIONS. A high gain, extremely stable differential Y-amplifier (30 mV/C.M.). Provide ample sensitivity with A.C. or D.C. inputs. Especially suitable for measurements of transistor operating conditions where maintenance of D.C. levels is of paramount importance. Push-pull X amplifier; Fly-back suppression; Internal Time-base Scan Waveform available for external use; pulse output available for checking TV line O/P Transformers, etc. Provision for external -1P and CRT Brightness Modulation. A.C. mains 200/250 v. $\pounds 19.19.0$, P. & P. 7/6 or 50/- deposit plus P. & P. 7/6 and 12 monthly payments of 33/4. FULL 12 MONTHS' GUARANTEE INCLUDING VALVES and TUBE.
4. **A.C. D.C. POCKET MULTI-METER KIT.** 2in. moving coil meter, scale calibrated to A.C./D.C. volts, ohms and milliamps. Voltage range A.C./D.C. 0-50, 0-100, 0-250, 0-500. Milliamps 0-10, 0-100. Ohms range 0-10,000. Front panel, range switch, wirewound pot (for ohms zero setting), toggle switch, resistor and rectifier. 19/6. P. & P. 1/6. Wiring diagram 1/-, free with kit.
5. **CHANNEL TUNER.** Will tune to all Band I and Band III stations. Complete with P.C.C.84 and P.C.P.80 valves (in series) I.F. 16-19 or 33-38. Can be modified as an aerial converter (instructions supplied). 32/6, plus 3/6 P. & P. HEATER TRANSFORMER to suit above, 200-250 v., 6/-, plus 1/6 P. & P.
6. **MAINS TRANSFORMERS.** All with tapped primaries, 200-250 volts, 0-160, 180, 200 v., 60 mA, 4.3 v., 2 amp, 10/6. 250-0-250 80 mA, 6.3 v., 2 amp, 6.3 v. 1 amp, 10/6. 350-0-350 v., 70 mA, 4.3 v. 1 amp, 6.3 v., 2 amp, 10/6. 250-250 v. 70 mA, 6.3 v., 2 amp, 10/6. P. & P. 3/-.
 7. **WOLSEY 3-ELEMENT FOLDED DIPOLE.** I.T.V. Aerial less mounting bracket for external use, complete with 12 yds. of coaxial cable, 15/-, P. & P. 2/6.
8. **CYLDON TURRET TELETUNERS 1 P 34/38 Mc/s.** Brand new complete with biscuit for channels 2, 4, 8 and 9. Less valves, 10/-, P. & P. 2/6. Pair of knobs to suit, 3/6. (Valves required P.C.C. 84 & P.C.P. 80).
9. **SIGNAL GENERATORS.** Cash $\pounds 19.8$ or 25/- deposit and 6 monthly payments of $\pounds 1.6$. P. & P. 5/-. Coverage 100 kc/s to 100 Mc/s on fundamentals and 100 Mc/s to 200 Mc/s on harmonics. Case $10 \times 6 \frac{1}{2} \times 5 \frac{1}{2}$ in.



9



10



11



12

SATISFACTION GUARANTEED OR MONEY REFUNDED



13



14



15



16

RADIO & T.V. COMPONENTS

(Acton) LTD.

23B HIGH STREET, ACTON, LONDON, W.3.

ALL ENQUIRIES S.A.T.E.
GOODS NOT DISPATCHED OUTSIDE U.K.

TECHNICAL TRAINING in radio television and electronics

Whether you plan to have your own business, to become an electronics engineer, to take up a career in industry, or to brush-up your knowledge and study new developments, transistors, etc., an I.C.S. Course will help you to succeed. You learn at home in your own time, under expert tuition. Moderate fees include all books.

EXAMINATION COURSES FOR:-

C. & G. Radio and TV Servicing Certificate
(R.T.E.B.)

C. & G. Radio Amateurs' Exam.
(Amateurs' Transmitting Licence)

British Institution of Radio Engineers, etc. C. & G. Telecom. Technician's Cert.

LEARN AS YOU BUILD

Practical Radio Servicing Course

A basic course in radio electronic and electrical theory backed by thorough practical training. You build radio receivers, signal generator and multimeter.



Post this Coupon TODAY! for FREE book on careers in Radio, and full details of other I.C.S. Courses

INTERNATIONAL CORRESPONDENCE SCHOOLS

(Dept. 171), Intertext House, Parkgate Road, London S.W.11.

Please send book on.....

Name..... Age.....
(Block Letters Please)

Address.....

Occupation..... 61

Electronics (FLEET ST) Ltd

Dept. B
152-153 Fleet St., London, E.C.4. Tel. FLE 2833

Business Hours: Weekdays, 9-6, Saturdays, 9-1

Stockists for
AMPLIFIERS, V.H.F. TUNERS, HI-FI SPEAKERS BY ALL THE LEADING MANUFACTURERS

The Transistor Set you have been waiting for! THE "FLEET SIX"

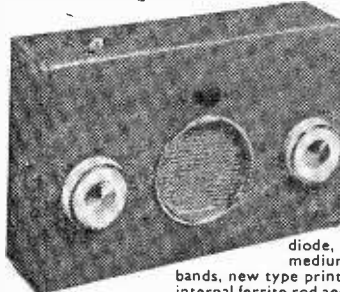

The Transistor Set you have been waiting for, the "Fleet 6," a wow of a transistor set that really gets the stations. New design 6 transistor superhet pocket receiver, using 6 guaranteed first grade transistors plus sensitive

diode, push pull output medium and long wave bands, new type printed circuit, high Q internal ferrite rod aerial, 2 1/2 in. high flux speaker, provision for car aerial, overall size 6 1/2 x 4 1/2 x 1 1/2. Simple to follow instructions. All components guaranteed, service after sales. This is equal to many manufactured sets at double the price. All components including cabinet, transistors, speaker circuit etc., only £8/19/6 complete, post and pkg. 3/6. PP4 Battery 2/- extra. Due to overwhelming demand from last month's advert, we have been able to reduce this receiver from £9/19/6. All components sold separately. Send S.A.E. for details. Circuit and Instructions 2/6 post free.

SUPER SIX Table Model

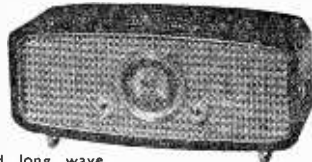

The "Super 6" Table Model Transistor Receiver using six Mullard latest top grade transistors, printed circuit, medium and long wave bands, 500 M/VV push pull output,

7 x 4 High Flux Speaker, high Q ferrite rod aerial, calibrated direct drive, beautifully polished cabinet, gilt trimmed, size 18 in. x 7 1/2 in. x 5 1/2 in. Using Long-life power pack battery. All necessary components including easy to follow instructions and theoretical circuit, £9/15/- complete, post and pkg. 4/6. Battery extra. All components sold separately. Send S.A.E. for details. Circuit and instructions 2/6.

ANOTHER MANUFACTURERS' SURPLUS BARGAIN

The Corsor 4 valve s/het portable. L. and med. wave bands. 5in. speaker, using Ever Ready B126 90VHT, & AD35 1 1/2 VLT batt. Attractive 2-tone finish in red and grey. Dimensions 9 x 8 1/2 x 4 1/2 in. Original price 15 gns. Our price £8/19/6 plus P. & P. 3/- Batts. 10/- extra. Also suitable mains unit. Original price 63/- OUR PRICE 45/- plus 2/- P. & P.

PORTABLE BATTERY ELIMINATOR MADE BY COSSOR

Housed in two containers which are to replace AD35 and B126 Batteries. 45/-, plus 2/- P. & P. Only suitable for use with Dk96 Series valves.

A SNIP FOR CONSTRUCTORS

Build the Labgear Audio Output meter. Two ranges—25 milliwatts to 1 watt, 1 watt to 100 watts. Accuracy 5%; input impedance 3, 15 and 600 ohms. Printed circuit. All components including O-1MA moving coil meter and silver hammettone enamel case. Kit complete with instructions 59/6, post and pkg. 1/6.

INTERNATIONAL CORRESPONDENCE SCHOOLS

FURTHER HUGE PURCHASES DIRECT FROM SOURCE
13 CHANNEL TVs

TABLE MODELS, FAMOUS MAKERS. Constitute with all valves and tubes. Unequaled in value. They are untested and not guaranteed to be a working order.

AMAZINGLY POPULAR-IDEAL SECOND SETS

- 12" - £3.19. (p. & p.) 12/6
14" - £5.19. (p. & p.) 15/-
12" 5 CHANNEL TV's 45/- (p. & p.) 12/6
14" 5 CHANNEL TV's 85/- (p. & p.) 12/6

External ITV Converters with power pack

Hammered finish. Very compact. Gain an 1 Trimming controls. Listed at 47.7. 39/1 Carriage 2/6. OUR PRICE

100 RESISTORS 6/6

100 CONDENSERS 10/-

Miniature Ceramic and Silver Mica Condensers, 5 pF to 5,000 pF. LIST VALUE OVER 25.

★ RECTIFIERS ★

For Chargers, selenium, full wave, 12 volt, 3-4 amps; 9/8; (Carr. 1/-); 250 v. 80 mA, 5/-, RM1, 8/8; RM2, 9/-; RM3, 9/-; RM4, 15/6; RM5, 21/-; 14A36, 17/-; 14A87, 22/-; 14A100, 25/-; 10A5, 15/-; 17/8; 18A1A1-18-1, 7/8; 18RD2-2-8-1, 14/-; 14RA1-2-3-2, 17/-; 14RA1-2-3-3, 20/-.

MULTIMETER

Reads A.C. and D.C. volts to 1000, 5 ranges at 1000 ohms. Det. volt. 145. current 15 ranges to 500 mA. Resistance reading to 200K in 2 ranges. Complete with Frods. 77/6. P.P. 1/6.

PICK-UP CARTRIDGES

AGOS 92/6 POWER POINT 18/6 STEIG AND REUTER 15/- SONOTONE 17/6

TUBES DIRECT FROM OUR FACTORY

Due to the increasing demand for our wide range of CRT's and our efficient handling methods we offer unbeatable value.

REGUNNED TUBES have new Guns Getters. Aquadac Coating. Bases. etc.

Table with columns: TOP QUALITY, GUARANTEED 6 MONTHS SECONDS, 12 MONTHS RETURNED, 12 MONTHS BRAND NEW TYPES. Lists various tube models and prices.

SPECIAL OFFERS TRANSISTORS

Yellow Spot, 2/8, Green Spot, 2/8, Red Spot, 3/6, White Spot, 4/8, Edwan X8194, 3/8, XA103 (4 Mc), 10/-, XA104 (6 Mc), 12/-, O.C. 11 15/3, O.C. 45, 15/-, O.C. 70, 14/-, O.C. 71, 8/-, O.C. 72, 12/-, (Matched Pairs 22/-), V12/10P (10 watt power), 14/-, Yellow/Green, 5/-.

4 Speed Record Players

Latest Turntable, together with light weight "Staar-Galaxy" dual Sapphire Crystal Turn-over Pick-up Head, Amazing value, £3.10.0. P.P. 3/6.

Audiotape

3in., Plastic 150ft. 6/-; 4in., 300ft. 10/6; 5in., 600ft. 16/-; 5in., 250ft. 24/6; 7in., 1200ft. 30/-.

VALVES AVAILABLE 3 MONTHS. PL81 SOILED, AMAZING VALUE AT ONLY 4/6 EY51 SHORT ENDS 4/6 U25 SHORT ENDS 8/-

LOUDSPEAKERS

TOP MAKES-MANUFACTURER FRESH 2 1/2in., 18/-; 3in., 19/-; 3 1/2in., 19/-; 5in., 16/-; 6 1/2in., 18/-; 8in., 19/-; 10in., 22/6; 12in., 25/6; 7 x 4in. elliptical, 18/-; 9 x 5in. elliptical, 25/6; 10 x 6in. elliptical, 23/6. Sm. Stereoph. 15 ohms HF810, 60/-; 10in. bronze "Wnarated", 89/-; 12in. Closed Field, 27/6. STOP PRESS, 8 x 13in. Speakers, 29/-; 8 x 13in. Hi-Fi (10 Watt), 39/-.

PM SPEAKERS Surplus 3 ohm

Tested, top makes, performance guaranteed 6 1/2in. 9/- 5in. 11/- 7 x 4 10in. 13/-

B.S.R. MONARDECK TAPE DECKS .. 29 10 0 COLLARO TRANSCRIPTION DECKS .. 218 15 0

COMPLETE RECORD PLAYERS

B.S.R. UA8, 4 Speed Autochanger ... 26.15 0 B.S.R. UA8, 4 Speed Autochanger ... 26.15 0 B.S.R. UA14, 4 Speed Autochanger. ... 27.19 0 Collaro Conquest 4 Spd. Autochanger. ... 26.15 0 Garrard Model 210 Autochanger. ... 29.19 6 Collaro 4 Speed 4546 Single Player. ... 25.19 0

★ VALVES BY RETURN OF POST ★

10% DISCOUNT SPECIAL OFFER TO PURCHASERS of any SIX VALVES marked in black type (15% in dozen). Post: 1 valve, 6d., 2-11, 1/6.

NEW LOW PRICES GUARANTEED 3 MONTHS

FREE TRANSIT INSURANCE. All valves are new or fully guaranteed ex-Government or ex-military origin. Satisfaction or Money back Guarantee on goods if returned unused within 14 days

Large table listing various vacuum tube models and their prices, organized in columns.

Post: 2 lbs. 1/6, 4 lbs. 2/-, 7 lbs. 2/9, 15 lbs. 3/6, etc. No C.O.D. ALL ITEMS 5% & POST FREE IN DOZENS. (Callers always welcome). LIST OF 1000 SNIPS 6d.

TECHNICAL TRADING CO. P.O. BOX 21 (W) 350-352 FRATTON ROAD, PORTSMOUTH.



Stern's "fidelity" TAPE RECORDERS

BEFORE YOU BUY — YOU SHOULD HEAR THESE RECORDERS. THEY ARE COMPARABLE TO THE MUCH HIGHER-PRICED MODELS

There are no better value-for-money Tape Recorders on the market—if you can't call and hear them, send S.A.E. for fully descriptive leaflets.

All prices quoted provide for the COMPLETE RECORDER including CRYSTAL MICROPHONE and 1,200 ft. Spool of Tape.

Each Model incorporates the highly successful HF/TR3 Amplifier (described below) thus ensuring truly "Hi-Fi" record and playback facilities.

TAPE AMPLIFIERS and PRE-AMPLIFIERS PRESENTED FROM MULLARD DESIGNS

MODEL HF/TR3 TAPE AMPLIFIER
(Mullard Type "A" design)
A very high quality Amplifier incorporating 3-speed treble equalisation, by the latest FEROCUBE POT CORE INDUCTOR, FOR COLLARO-TRUVOX-BRENELL or WEARITE Tape Decks, has GILSEN Output Transformer, includes separate Power Supply Unit.



KIT OF PARTS **£13.13.0** OR ASSEMBLED **£17.0.0**
H.P. Deposit **£3.8.0** and 12 months at **£1.4.11.**

FOR THE HOME CONSTRUCTOR SPECIAL 'COMBINED ORDER' PRICES

- (a) The COLLARO "STUDIO" TAPE DECK and our Mullard Type "C" PRE-AMPLIFIER and POWER Unit Assembled and Tested. **£29.10.0**
H.P. Deposit **£5.18.0** and 12 months **£2.3.3.**
- (b) As above but TYPE "C" PRE-AMPLIFIER supplied as complete KIT OF PARTS. **£26.10.0**
- (c) The TRUVOX Mk. VI DECK and the assembled Type "C" Pre-amplifier and Power Unit. **£40.0.0**
H.P. Deposit **£8.0.0**, and 12 months **£2.18.8.**
- (d) As above but Type "C" as complete KIT OF PARTS. **£36.10.0**
- (e) The BRENELL Mk. V DECK and the assembled Type "C" PRE-AMPLIFIER and POWER UNIT. **£46.0.0**
H.P. Deposit **£9.4.0**, and 12 months **£3.7.6.**
- (f) As (e) but Type "C" as complete KIT OF PARTS. **£43.0.0**
- (g) THE WEARITE 4A DECK with TYPE "C" assembled and tested. **£56.0.0**
H.P. Deposit **£11.4.0**, and 12 months **£4.2.1.**
(Carriage and Insurance on above quotes 10/- extra).

EACH OF THE ABOVE CAN BE SUPPLIED IN A PORTABLE CASE FOR **£5.10.0** EXTRA. THUS FORMING A COMPLETE PORTABLE PRE-AMPLIFIER. FULL DETAILS ON REQUEST.

SPECIAL OFFER OF TAPE spools. New, boxed and guaranteed.
25ft. on 3in. Spool..... **5/9**
900ft. on 5in. Spool..... **18/5**

P.V.C. base on latest type plastic
1200ft on 5in. Spool..... **21/-**
1200ft. on 7in. Spool..... **21/-**
1800ft. on 7in. Spool..... **32/6**

A LARGE PURCHASE OF BRAND NEW AND FULLY GUARANTEED TRUVOX AND GARRARD TAPE RECORDERS

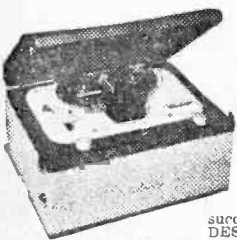

ENABLES THESE OUTSTANDING PRICE REDUCTIONS
The "MODEL HF/G2R" PORTABLE TAPE RECORDER (Original Price £33.0.0) **FOR ONLY 22 gns.**

H.P. Dep. **£4.14.0**, 12 months **£1.13.9** (Curr. & ins. 10/- extra). Incorporates THE LATEST GARRARD "MAGAZINE" TAPE DECK and a HIGH QUALITY AMPLIFIER which is entirely based on the very successful MULLARD TYPE "A" DESIGN and specifically developed to operate the GARRARD DECK. Price INCLUDES SUPPLY OF THE GARRARD TAPE MAGAZINE and 4in. SPOOL OF DOUBLE PLAY TAPE. Comprises a Twin Track Recorder operating at 1/4 sec. speed and providing up to 1 hour 10 mins. playing time. This "Portable" weighs only 22 lbs. Outstanding features are excellent performance and simplicity of operation.

The "MODEL TK/MkIV" PORTABLE TAPE RECORDER (Original Price £49 10.0) **FOR ONLY £36.10.0** Price includes a 7" spool of EMI tape

H.P. Dep. **£7.8.0**, 12 months **£2.1.1** (Curr. and ins. 10/- extra). Incorporates the Truvox MkIV Tape Deck, Rola/Clestone 9 x 3 in. Loudspeaker and the Truvox Type 'K' Amplifier specifically developed by Truvox Ltd to correctly operate their MkIV Tape Deck. As a result we are able to present a highly perfected tape recorder providing sound reproduction which truly justifies the title "High Fidelity". A Twin Track Two Speed model operating at 31 and 7 1/2 in/sec. speeds and incorporating Magic Eye Indicator, Safety Button. (Prevents accidental erasure). Ext. Speaker output, tone and volume controls.



FULLY DESCRIPTIVE LEAFLETS ON ALL OF ABOVE ARE AVAILABLE—BUT PLEASE ENCLOSE S.A.E. AND STATE WHICH LEAFLET IS REQUIRED.

STERN RADIO LTD.

STERN'S MULLARD DESIGNS

Designed by MULLARD—presented by STERN'S strictly to specification

COMPLETE KIT OF PARTS— MULLARD "5-10" MAIN AMPLIFIER

For use with the MULLARD 2-valve pre-amplifier with which undistorted power output of up to 10 watts is obtained. We supply SPECIFIED COMPONENTS AND NEW MULLARD VALVES, including PARMKO MAINS TRANSFORMER and choice of the latest Ultra-Linear PARMKO or the PARTRIDGE Output Transformer. PRICE COMPLETE KIT (PARMEKO Output Trans.) **£10.00**
Alternatively we supply ASSEMBLED and TESTED. **£11.10**

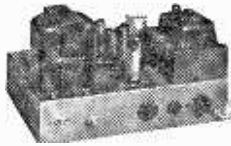

ABOVE INCORPORATING PARTRIDGE OUTPUT TRANSFORMER, £1.60 EXTRA

MULLARD'S PRE-AMPLIFIER TONE CONTROL UNIT

Employing two EF96 valves, and designed to operate with the MULLARD MAIN AMPLIFIERS, but also perfectly suitable for other makes.



PRICE COMPLETE KITS OF PARTS **£6.60** ASSEMBLED AND TESTED **£8.00**

Supplied strictly to MULLARD'S SPECIFICATION and incorporating:
● Equalisation for the latest R.L.A.A. characteristics.
● Input for Crystal Pick-ups, and variable reluctance magnetic types.
● Input (a) Direct from High Imp. Tape Head, (b) From a Tape Amplifier or Pre-amplifier
● Sensitive Microphone Channel. ● Wide range BASS and TREBLE Controls.

COMPLETE MULLARD "5-10" AMPLIFIER

The popular and very successful complete "5-10" incorporating Control Unit providing up to 10 watts high quality reproduction. Only Specified Components and new MULLARD VALVES are supplied including PARMKO MAINS TRANSFORMERS and choice of the latest PARMKO or PARTRIDGE ULTRA-Linear Output Transformers. KIT OF PARTS **£11.10** OR ASSEMBLED and TESTED **£13.10**
HIRE PURCHASE (Assembled Amp. only). DEPOSIT **£2.14** 12 months at 19/10. ABOVE incorporating PARTRIDGE OUTPUT TRANS. **£1.60** extra.

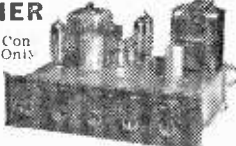

COMPLETE MULLARD "3-3"

THE IDEAL AMPLIFIER FOR A SMALL HIGH QUALITY INSTALLATION PROVIDING EXCELLENT REPRODUCTION OF UP TO 3 WATTS OUTPUT. COMPLETE KIT OF PARTS **£7.10** OR ASSEMBLED and TESTED **£8.19.6**
(plus 6/8 carriage and Insurance) H.P. Terms: Deposit **£2.00** and 8 Months at **£1.00**. Complete to MULLARD'S SPECIFICATION including Mullard valves and a PARMKO OUTPUT TRANSFORMER.

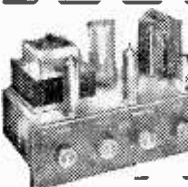

THE "ADD-A-DECK"

Incorporating GARRARD "MAGAZINE" TAPE and the MATCHED MODEL HF/G2P PRE-AMPLIFIER

Supplied on ONE CHASSIS (as illustrated) READY FOR USE **18 Gns.**

Price includes Garrard Magazine and a 4in. Spool Double Play Tape. H.P. Deposit **£3.16.0** and 12 months at **£1.7.8**. Provides complete tape recording facilities and designed to operate through the pick-up sockets of the standard type of RADIO RECEIVER, or an AMPLIFIER, from which really first class reproduction is obtained. It consists of a Twin Track Deck connected to the Pre-amplifier and operates at 3 1/2 in/sec. speed providing up to 1 hr. 16 mins. playing time.

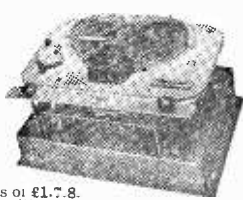

RECORD PLAYERS THE LATEST MODELS ARE IN STOCK, MANY AT REDUCED PRICES

- SEND S.A.E. FOR ILLUSTRATED LEAFLET
- B.S.R. MONARCH LAM 4-speed mixer Autochanger with Crystal Pick-up. **£6.19.6**
- The NEW COLLARO MODEL RP594 4-speed Single Record Player. Studio Cartridge. **£9.18.9**
- The NEW COLLARO C60 4-speed Autochanger unit with Studio "O" Pick-up. **£7.19.6**
- The E.M.I. 4-speed Single Record Player with crystal Pick-up. **£6.9.6**
- THE NEW B.S.R. Model UA12 in Stock. A4 "SPEED" MIXER AUTOCHANGER. **£8.7.6**
- UA12 also available incorporating the B.S.R. STEREO Pick-up, plays L.P. and 78 Records. **£10.10.0**
- GARRARD MODEL TA/MK11 4-speed Player fitted high output Crystal Pick-up. **£8.10.0**
- GARRARD MODEL RT/300. Autochanger 4-speeds. High output Crystal Pick-up. **£9.10.0**

Carriage and Insurance on each above. 5/- extra.

Dept. P.W. 109 FLEET ST. LONDON, E.C.4
Telephone: FLEET STREET 5812/3/4

PRICE REDUCTIONS

- (a) The KIT OF PARTS to build both the "5-10" Main Amplifier and the 2-valve PRE-AMP CON- TROL UNIT. **£15.15.0**
- (b) The "5-10" and the 2-stage PRE-AMP both ASSEMBLED and TESTED H.P. Dep. **£3.16.0** and 12 months at **£1.7.8**
- (c) The KIT OF PARTS to build the DUAL-CHANNEL "3-3" AMPLIFIER and the DUAL-CHANNEL PRE-AMPLIFIER CONTROL UNIT. **£21.10.0**
- (d) The DUAL-CHANNEL "3-3" AMPLIFIER and the DUAL-CHANNEL PRE-AMPLIFIER CONTROL UNIT BOTH ASSEMBLED and TESTED H.P. Terms: Deposit **£5** and 12 months of **£1.18.8**
- (e) THE KIT OF PARTS to build one "5-10" MAIN CHANNEL and the DUAL-CHANNEL PRE-AMP CONTROL UNIT. **£21.10.0**
- (f) ONE "5-10" AMPLIFIER and the DUAL-CHANNEL PRE-AMPLIFIER both ASSEMBLED and TESTED H.P. Terms: Deposit **£5**, 12 months of **£1.18.8**.
- (g) KIT OF PARTS to build Two "5-10" MAIN AMPLIFIERS (incorporating Parmeko Output Transformers) and the DUAL-CHANNEL PRE-AMPLIFIER CONTROL UNIT. **£31.0.0**
- (h) TWO "5-10" AMPLIFIERS and the DUAL-CHANNEL PRE-AMPLIFIER CONTROL UNIT BOTH ASSEMBLED & TESTED **£36.0.0**
H.P. Terms: Deposit **£7.4.0**, 12 months **£2.12.0**.
Carriage and Insurance 7/6 extra. Prices quoted are subject to **£1.60** extra for Partridge Transformer.

STEREO PRE-AMPLIFIER

This model incorporates two Mullard 2-valve Pre-Amplifiers combined into a Single unit enabling it to be used for both STEREO-PHONIC or MONAURAL operation. It is designed primarily to operate with our range of MULLARD MAIN AMPLIFIERS but will also operate equally well with any make of Amplifiers requiring an input of 250 mV/ohms.



COMPLETE KIT OF PARTS **£12.10.0** ASSEMBLED AND TESTED **£15.0.0**
H.P. £3 Dep. and 12 mths. at **£2.0**

MULLARD FOUR CHANNEL MIXER UNIT

Self powered with Cathode follower output. Incorporates Two inputs for MICROPHONES One for CRYSTAL PICK UP and a fourth for RADIO or TAPE Complete Kit of Parts **£8.8.0**
Assembled and Tested **£10.0.0**

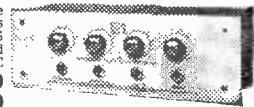

TERMS: Deposit **£2** and 12 months at 15/-

MODEL LL one microphone Input matched for moving coil or Ribbon Mike. **£1.17.0** extra.

Mk.11 "Fidelity" FM TUNING UNIT

An attractively presented Unit incorporating MULLARD PERMEABILITY TUNING HEART and corresponding Mullard valve line up. FOR THE CONSTRUCTOR **£10.10.0** ASSEMBLED **£14.5.0**

A SPECIAL CASH OFFER!!

This very attractive PORTABLE AMPLIFIER CASE together with a good quality GRAM AMPLIFIER and a matched P.M. SPEAKER. FOR ONLY **£8.7.6** (Plus 7/6 Carr. & Ins.)



The amplifier consists of a 2-stage design incorporating 3 modern B.V.A. valves and has separate BASS and TREBLE CONTROLS. The Portable Case will also accommodate almost any make of Autochanger and is attractively finished in Mushroom Grey Rexine. WE ALSO SUPPLY SEPARATELY—
(a) The 2-stage (plus Rectifier) AMPLIFIER **£4.2.6**
(b) THE PORTABLE CARRYING CASE **£3.17.6**
(c) 6in. P.M. SPEAKER 18/9 Carriage and Insurance 4/- extra.

Easy-to-build kit-sets of



highest quality at lower cost

AMATEUR TRANSMITTER Model DX-100U
Covers all amateur bands from 160-10 metres. Self-contained including Power Supply £78.10.0
Modulator V.F.O.

"HAM" TRANSMITTER Model DX40U
From 80-10 m. Power input 75 w. C.W., 60 w. peak C.C. phone. Output 40 w. to aerial. Compact and self-contained. Prov. for V.F.O. £29.10.0

VAR. FREQ. OSCILLATOR VF-1U
From 160-10 m. ideal for our DX-40U and similar transmitters. Price less valves £8.19.6 £10.12.0

R.F. SIGNAL GENERATOR Model RF-1U
Up to 100 Mc/s fundamental and 200 Mc/s on harmonics and up to 100mV. output on all bands. £11.11.0

AUDIO SIGNAL GENERATOR Model AG-9U
10 c/s to 100 kc/s. switch selected. Distortion less than 0.1% 10 v. sine wave output metered in volts and dB's. £19.3.0

VALVE VOLTMETER Model V-7A
Measures volts to 1,500 (D.C. and R.M.S.) and 4,000 pk. to pk. Res. 0.1 Ω to 1,000 MΩ D.C. input impd. 11M Ω. Complete with test prods leads and standardising battery. £13.0.0

Portable 2 3/4 in. SERVICE 'Scope Model OS-1
Compact portable scope ideal for servicing and general work. Y amplifier sensitivity 10 mV/cm; response ±3 dB 10 c/s-2.5 Mc/s. Time base 15 c/s-150 kc/s. Printed circuit. Case 7 1/2 × 4 1/2 × 1 1/2 in. long. Wt. only 10 1/2 lb. £18.19.6

5 in. OSCILLOSCOPE Model O-12U
Has wide-band amplifiers, essential for TV servicing. F.M. alignment, etc. Vertical freq. response 3 c/s. to over 5 Mc/s. without extra switching. T/B covers 10 c/s to 500 kc/s. in 5 ranges. £34.15.0

RES.-CAP. BRIDGE Model C-3U
Measures capacity 10pF to 1,000 μF resistance 100 Ω to 5 M Ω and power factor 5-450 v. test voltages. With safety switch £7.19.6

SINGLE CHANNEL AMPLIFIER, MA-12
10-12 watt Hi-Fi amplifier. Extremely low distortion and wide frequency range. £9.19.6

HI-FI EQUIPMENT CABINETS
Range of cabinets available with at least one to suit your particular needs. From small to large, housing Tape Deck, Record Player and full equipment. In the white for finishing to personal taste.
From £10.10.0 to £17.18.6

THE "MOHICAN" GENERAL COVERAGE RECEIVER, Model GC-1U
Fully transistorised, including 4 piezo-electric transmitters. The very latest and an excellent portable or Fixed Station receiver for the Ham and £38.15.0 short-wave listener.

'PACKAGED DEALS' of Hi-Fi Equipment including TAPE DECKS (Collaro or Truvox), RECORD PLAYERS (Collaro or Connoisseur) and DECCA ffs PICK-UPS

Write in to see how these deals save you further money:



F.M. TUNER



S.33



S.5



DX-40



UXR-1



OS-1



SSU-1

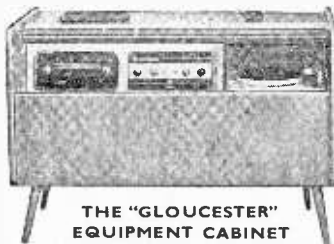

THE "GLOUCESTER" EQUIPMENT CABINET

GRID DIP METER Model GD-1U
Coverage from 2 Mc/s. to 250 Mc/s Complete set of plug-in coils provided. £9.19.6

TAPE RECORDING/PLAYBACK AMPLIFIER Model TA-1
Monaural (TA-1M) £16.14.0. Conversion unit to Stereo £6.0.0. Stereo (TA-1S). £22.4.9

SHORT-WAVE TRANSISTOR PORTABLE Model RSW-1
Extending aerial leather case four band (2 short-wave bands Trawler and Medium). £20.18.6

6-TRANSISTOR PORTABLE Model UXR-1
Pre-aligned I.F. transformers, printed circuit, 7 × 4 in. high-flux speaker. Real hide case. £14.18.6

DUAL-WAVE TRANSISTOR RADIO UJR-1
This sensitive headphone set is a fine introduction to electronics for any youngster. £2.16.6

HI-FI F.M. TUNER
Tuning range 88-108 Mc/s. For your convenience this is available in two units sold separately as follows: Tuner Unit (FMT-4U) with 10.7 Mc/s. I.F. output (£32.0 inc. P.T.). I.F. Amplifier (FMA-4U) complete with cabinet and valves (£10.10.6). £13.12.6

HI-FI 16W STEREO AMPLIFIER Model S-88
10mV. basic sensitivity (2 mV available £1 extra). Ganged controls. Stereo-Monaural gram. radio and tape recorder input. Push-button selection. Two-tone grey metal cabinet. £25.5.6

6W STEREO AMPLIFIER Model S-33
3 watts per channel, 0.3% distortion at 2.5 w/chn 20dB N.F.B. Inputs for Radio (or Tape) and Gram. Stereo or Monaural, ganged controls. £11.8.0 Sensitivity 100 mV.

TRANSCRIPTION RECORD PLAYER RP-1U
4-speed A.C. motor Ronette Stereo/ Mono pick-up. Complete with plinth. £12.10.0

HI-FI SPEAKER SYSTEM Model SSU-1
Ducted-port bass reflex cabinet "in the white" Twin speakers With legs £11.12.6. £10.5.6

"COTSWOLD" HI-FI SPEAKER SYSTEM KIT
Acoustically designed enclosure "in the white" 26 × 23 × 15 1/2 in., housing a 12 in. bass speaker with 2 in. speech coil, elliptical middle speaker and pressure unit to cover the full frequency range of 30-20,000 c/s Complete with speakers, cross-over unit, £19.18.6 level control, etc.

COMPLETE MATCHED STEREO OUTFIT
includes record player, amplifier and twin speaker systems (pedestal speaker legs optional) £4.14.0 extra. £42.10.0

STEREO CONTROL UNIT USC-1
Luxury model with press-button inputs to suit any pick-up or tuner and most tape-heads. Output 1.3 v. R.M.S. per channel. Printed circuit construction. £17.19.6

STEREO HEAD BOOSTER USP-1
Ideal for boosting tape-head output and low output pick-ups (e.g. Decca ffs). £5.19.6

Prices include free delivery UK
Deferred Terms
available on orders over £10

Please send me FREE CATALOGUE (Yes/No) _____
Full details of model(s) _____

NAME _____

ADDRESS _____

PWS

DAYSTROM LTD.

DEPT. P.W.5, GLOUCESTER, ENGLAND

A member of the Daystrom Group, manufacturers of the
WORLD'S LARGEST-SELLING ELECTRONIC KITS

Practical Wireless

VOL. XXXVII No. 651 MAY, 1961

Editorial and Advertisement
Offices:

PRACTICAL WIRELESS

George Newnes, Ltd., Tower House,
Southampton Street, W.C.2.

© George Newnes Ltd., 1961

Phone: Temple Bar 4363.

Telegrams: Newnes, Rand, London.
Registered at the G.P.O. for trans-
mission by Canadian Magazine Post.

SUBSCRIPTION RATES
including postage for one year

Inland - - - - £1.3.0 per annum
Abroad - - - - £1.1.6 per annum
Canada - - - - 19s. per annum

Contents

	Page
Editorial ...	21
Round the World of Wireless ...	22
The P.W. Signal Generator ...	24
A Compact Add-in B.F.O. Unit ...	28
Servicing All-Dry and Mains/ Battery Portables ...	30
On Your Wavelength ...	35
An Introduction to Stereo ...	36
A VHF Tuner ...	39
An Audio Booster Stage ...	45
The P.W. "Roadfarer" ...	48
A Switch Tuned TRF Receiver ...	50
Transistor Characteristics ...	52
Transmitting Topics ...	57
Trade News ...	61
An All Band 75W Transmitter ...	65
A Versatile Tape Recorder ...	69
Short-Wave Section ...	73
Short-wave Listeners' Log—7 ...	78
Club News ...	81
Letters to the Editor ...	82

The Editor will be pleased to consider articles of a practical nature. Such articles should be written on one side of the paper only, and should contain the name and address of the sender. Whilst the Editor does not hold himself responsible for manuscripts, every effort will be made to return them if a stamped and addressed envelope is enclosed. All correspondence intended for the Editor should be addressed: The Editor PRACTICAL WIRELESS, George Newnes, Ltd., Tower House, Southampton Street, London, W.C.2. Owing to the rapid progress in the designs of wireless apparatus and to our efforts to keep our readers in touch with the latest developments, we give no warranty that apparatus described in our columns is not the subject of letters patent.

Copyright in all drawings, photographs and articles published in PRACTICAL WIRELESS is specifically reserved throughout the countries signatory to the Berne Convention and the U.S.A. Reproductions or imitations of any of these are therefore expressly forbidden. PRACTICAL WIRELESS incorporates "Amateur Wireless."

THE "ROADFARER" COMPETITION

AS announced in the Editorial of the previous issue, prizes are to be offered for the best constructed "Roadfarer" receivers. This competition has been organised in conjunction with several manufacturers and a panel of judges has been formed from representatives of those firms whose products are used in the receiver, and, in judging the competition, the neatness and soundness of the constructional work will be taken into account.

Further details of the competition are given on page 85 and the rules and conditions of entry are clearly set out below.

RULES AND CONDITIONS OF ENTRY

1. There is no entrance fee.
2. The set must be the unaided work of the entrant and be built to the design given in *Practical Wireless* with the specified components.
3. No sets are to be submitted for examination until an announcement to this effect is made in *Practical Wireless*; intending entrants should complete the coupon published in the April or May issues of *Practical Wireless*.
4. Each set will remain the property of its constructor and although all reasonable care will be taken of entries while they are in the hands of the Committee, no responsibility can be accepted for any loss or damage.
5. The decision of the Committee in all matters related to the Competition shall be final.
6. Employees of George Newnes Limited and associated companies are not eligible to enter the Competition.

CONTRIBUTIONS

THOSE of our readers who wish to submit articles should send them direct to the Editor at the address given on this page. Manuscripts should be typewritten with double spacing although legible hand-written articles are also acceptable. Articles should be between 1,000 and 2,000 words in length, be written on one side of the paper only, and deal with the home construction of items of radio and electronic equipment. We do not require articles of a theoretical nature unless these are written expressly for the amateur constructor. Clear drawings of the apparatus should be included with the article and need only be sufficient for our draughtsmen to prepare suitable illustrations. We also like to include with articles photographic illustrations. Large clear prints, or preferably negatives, should be sent if possible but we are prepared to take the necessary photographs ourselves if the apparatus can be sent to us for inspection. An illustrated article is always of more appeal as the methods of construction are shown more clearly.

Our next issue, dated June, will be published on May 5th.

Round the World of Wireless

POTENTIAL AND CURRENT NEWS

Broadcast Receiving Licences

THE following statement shows the approximate number of Broadcast Receiving Licences in force at the end of January, 1961, in respect of wireless receiving stations situated within the various Postal Regions of England, Wales, Scotland and Northern Ireland. The numbers include Licences issued to blind persons without payment.

Region	Total
London Postal	707,932
Home Counties	664,350
Midland	485,231
North Eastern	532,269
North Western	460,170
South Western	398,307
Wales and Border Counties	236,717
Total England and Wales	3,484,976
Scotland	352,287
Northern Ireland	118,885
Grand Total	3,997,148

Electronic Telephone Switching

RESEARCH work on electronic telephone switching has been carried out in the G.E.C.'s Hirst research centre laboratories at Wembley, since the late 1940's. By 1955 the stage had been reached where the model electronic exchange, "Andrew", had established the basic feasibility of the time division multiplex technique as a basis for telephone switching.

More recently particular emphasis is being placed on system security, that is to say the ability of the exchange to continue to give service in the presence of component faults. Every effort is also being made to make the system simple in order to keep down cost and to facilitate maintenance and understanding of the operation of the exchange. On the component and circuit side the laboratories have established techniques in which full use of transistors is achieved.

The work of the electronic switching laboratories includes the design of models of a transistorised speech switching network and magnetostriction delay lines which are used for pulse generation and storage. Final engineering of the circuits for production is undertaken in the development laboratories at Coventry.

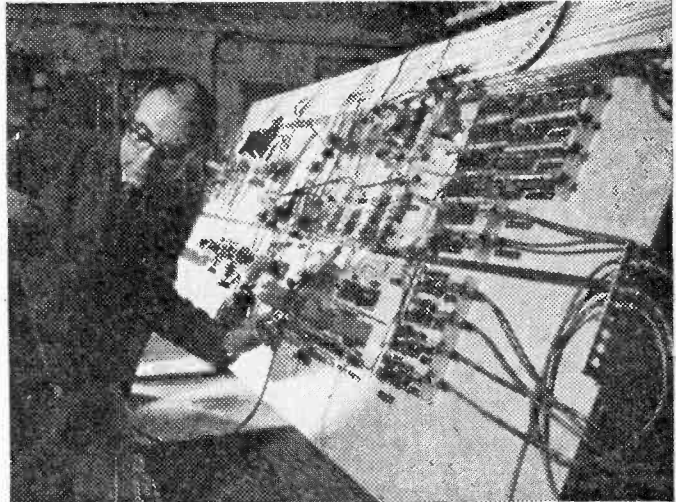

Here adjustments are being made to the typical experimental apparatus used by the Electronic Switching Group in the development of electronic telephone switching networks at the G.E.C. laboratories at Wembley.

Oxford University Study of Recruitment to Higher Technological Education

THE University of Oxford Department of Education led by its director, Mr. A. D. C. Peterson, is to investigate the reasons for comparatively fewer students electing to read for technological qualifications in this country than in the U.S.A. and Russia. This research, which will occupy a period of two years, has been made possible by a grant of £2,500 to the University from the Capitol Radio Engineering Institute of Washington, D.C., through their International Division, C.R.E.I. (London).

Commenting on the grant, Mr A. F. R. Cotton, Managing Director for International Operations for C.R.E.I., said: "There is a feeling that some of the best brains in the country are being kept out of technology by the academic nature of grammar school curricula.

"This, and the tendency to regard technological studies as being more suitable for less able pupils, could cripple Britain in the world race for highly qualified technologists by closing the doors in this field to the most talented young men in the country. The Oxford University Department of Education is setting out to test

both these theories and to compare secondary school curricula in England and Wales with those in the U.S.A., Russia, Sweden, Holland, Germany, Switzerland and France."

The Capitol Radio Engineering Institute, as well as running a residential school in electronic engineering technology in Washington, are pioneers of home study courses in advanced technological subjects, including nuclear engineering. These courses are now available in the U.K. and Europe. Students in Britain include serving officers and men of the Royal Air Force.

Intercommunications Contract

ULTRA ELECTRONICS LTD. have received a contract to supply their UA60 intercom equipment for the Westland P.531 aircraft being supplied to the Army Air Corps. The value of the contract, which covers forty sets of equipment, is approximately £21,000.

Delivery of the equipment will commence this summer.

Plastics at Radio Components Exhibition

THE Ekco Plastics stand at the 1961 Radio and Electronic Components Exhibition, Olympia (30th May—2nd June), will

feature the Company's extensive moulding service to the industry, which started nearly 30 years ago with the production of the first Ekco radio cabinets.

The use of plastics to enhance the styling of radio receivers is exemplified by a selection of the latest radio cabinets in a variety of colours, tuning scales, control knobs, etc. The back cover and front of the latest Ekcovision portable receiver represents the increasing application of plastics in television receiver design, while escutcheons, television tube masks and implosion screens will also be featured.

Plastic components also fill vital roles in the chassis of modern receivers, and the representative selection of such mouldings in the Ekco display includes coil formers, terminal blocks, transformer housings, etc.

Radar Fault Locator on Show

THE A.C. radar fault locator made by Ferranti Ltd., was on show to Britain's electrical engineers for the first time at the Electrical Engineers' Exhibition at Earls Court in March.

The prototypes have been tried by the North of Scotland Hydro-Electric Board and the South of Scotland Electricity Board, both of whom assisted in their development.

The locator has been designed to detect the position of arcing faults, ice build-up and conductor oscillation on 132 and 275kV transmission lines, although it can also be used for higher or lower voltages.

The prototypes were installed at Fort Augustus and Clydesmill Power Station, near Glasgow, and were successful in locating a number of faults. Two of the arcing faults which took place at Clydesmill were identified to within a span. An arcing fault caused by lightning was recorded at Fort Augustus.

The Ferranti fault locator operates on the radar principle of pulse reflection, the reflection being caused by any fault which may be caused by a flashover or to ice build-up on the line. The reflected pulses are received by the locator and displayed on a cathode ray tube for visual or automatic photographic record. The distance to the fault is found by measuring the time interval between the sending of the pulse and reception of its reflection.

Radar Defence Order from Sweden

THE Royal Swedish Air Board has placed a further contract to the value of over £1,700,000 with Marconi's Wireless Telegraph Co. Ltd., for the supply of secret electronic equipment for their air defence system. This follows substantial orders placed in 1959.

The twin problems which face any defence organisation are those of range of operation and warning time. The Swedish Air Force is powerfully equipped with fast fighters and surface-to-air missiles, but to use these effectively means must be found of collating relevant information and arriving at swift decisions.

At the centre of the Marconi system is a very high speed computer which solves a large number of interception problems simultaneously and enables the defence weapons — fighters, guided missiles and other defensive devices—to be brought into action at precisely the right instant. Black and white television and colour projection together with automatic information-dissemination techniques also play a vital part in the overall system. Approximately 500,000 transistors and diodes and 15,000 valves are incorporated in the equipment.

From the information bank the data are fed to the synthetic displays at positions manned by controllers and executive officers, who, by pressing buttons, can see the category of information they require—for example, hostiles,

unengaged hostiles, all aircraft above a certain height, and so on. The constitution or number of aircraft is obtained from a special display nicknamed the "Magic Carpet" where the radar picture shows the numerical composition of a formation. The targets displayed for analysis are presented automatically in a "queue".

Analogue Computer

THIS 112-amplifier computer, made by Short Brothers and Harland Ltd. is designed to cope with the steady increase in the size and complexity of problems being encountered in engineering research and development. It incorporates all the automatic aids necessary to ease the handling of complicated problems, including those of nuclear kinetics.

Important features of Simlac are its new wiring techniques and a revolutionary patching system which completely eliminates cord clutter. The flexible selector system and associated problem check are unrivalled in the analogue computer field.

The computer consists of seven standard racks containing the electronic equipment. The three central racks being fronted by a double pedestal desk. The twin racks on either side of the central block are identical in construction and contain the computing elements. By plugging specified components into these racks the design of the basic Simlac can be varied to meet an individual customer's requirements.

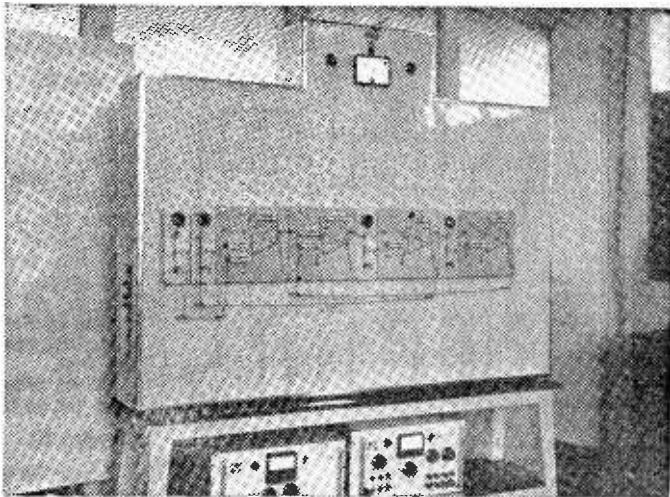

The Simlac analogue computer made by Short Brothers and Harland Ltd.

THE P.W.

ADDING THE R.F. GENERATOR TO THE AUDIO MODULATOR UNIT

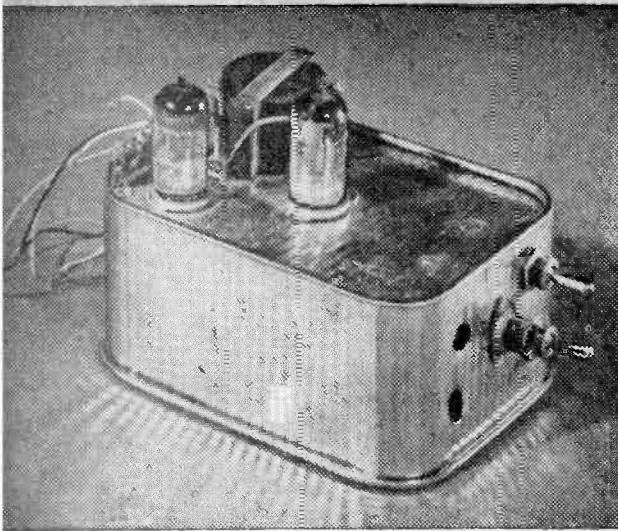

THIS chassis (No. 2) should have been completed to the stage shown in Figs. 5 and 6 (last month). Before proceeding this stage should be coupled up to the power unit (chassis No. 1) and 'phones connected to the output plug to check that the unit is in working order. Note that the heater circuit of V5 should have been wired and tested—pins 4/5, and 9 (see "Wiring and progressive testing" on page 1106 of the April issue).

Mounting the Components

The variable condenser is mounted to one side of the chassis, on top, as in Fig. 9. The condenser must open in such a way that it will not foul the coils to be mounted later. Any type of condenser with air spacing is suitable provided it is not too large for the available space. When mounted, check with a meter or torch bulb and battery that the fixed (stator) vanes are not shorted to the moving vanes at any part of their travel.

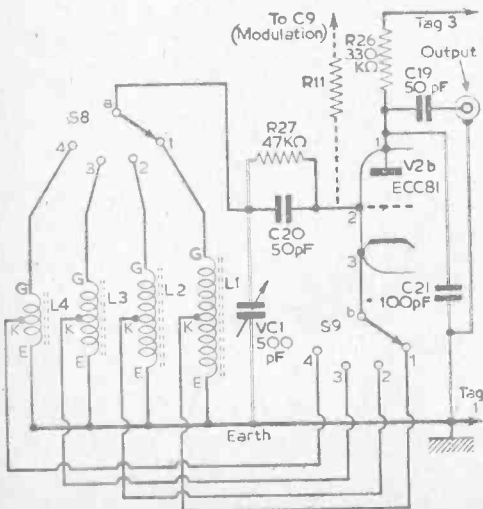

Fig. 7.—The circuit of the R.F. generator.

Making the Coils

The type of former required is shown in Fig. 8. All windings are carried out with 32s.w.g. copper wire, enamelled and new. Salvaged wire is unsuitable and must not be used. As each coil is completed, the turns are fixed with polystyrene cement.

Winding L4 (Fig. 8)

Leave about a foot of wire to spare and fasten it temporarily by one of the holes at the base (these are not used for connections) and wind on eight turns exactly, side by side starting almost at the bottom of the former. Now stretch the wire out for about 4in. and double it back again, and twist it together tightly near the coil. Now continue to wind another eight turns in the same direction. Then, wind the wire round a few more times about $\frac{1}{4}$ in. further up the former. Now fix the winding with cement and allow it to dry overnight; then remove the extra turns.

Winding L3

This is carried out in the same way as L4 but 40 turns are wound on, side by side, each side of the centre tap (see Fig. 8).

Winding L2

This coil has more turns than L4 and L3 and the winding technique is therefore different. The turns of this coil (and those of L1) are not wound side by side but in a manner known as "pile winding". Coil L2 consists of 200 turns with a centre tap. Each half of the winding is wound over a length of $\frac{1}{2}$ in. When winding the two parts of this coil, wind more turns in the centre of each $\frac{1}{2}$ in. length than at the ends—as shown clearly in Fig. 8. As in the case of L3 and L4, the two halves of the winding must be wound in the same direction; the second half forms a continuation of the first.

When winding is completed, cement the turns together as for L3 and L4.

Winding L1

Mark the former about 1in. up from the bottom and proceed as for L2 but wind on 460 turns either side of the tap. Cement as before.

SIGNAL GENERATOR

By E. V. King

(Continued from page 1109 of the April issue)

COMPONENTS LIST
(to be added to Chassis No. 2)

Additional parts
C9 47pF (formerly 500pF)
R11 1M $\frac{1}{4}$ W (formerly 100k)
 Valve (V2) is already fitted (ECC81)

Switch
S8/R R.F. range switch: two-pole, four-way rotary type

Coils
L1, 2, 3, 4, are made up on formers as shown in Fig. 8. $\frac{1}{8}$ lb of 32s.w.g. enamelled copper wire will be required. The four formers required are $2\frac{1}{4}$ to $2\frac{1}{2}$ in. long and $\frac{1}{4}$ in. in diameter. No cores are required
Variable condenser (VC1), 500pF max., air spaced. Single gang—any type which is small and the blades of which do not foul the coil formers when mounted as indicated (Fig. 9)
R26 330k $\frac{1}{4}$ W
R27 47k $\frac{1}{4}$ W
C19 mica or ceramic 50pF
C20 mica or ceramic 50pF
C21 mica or ceramic 100pF

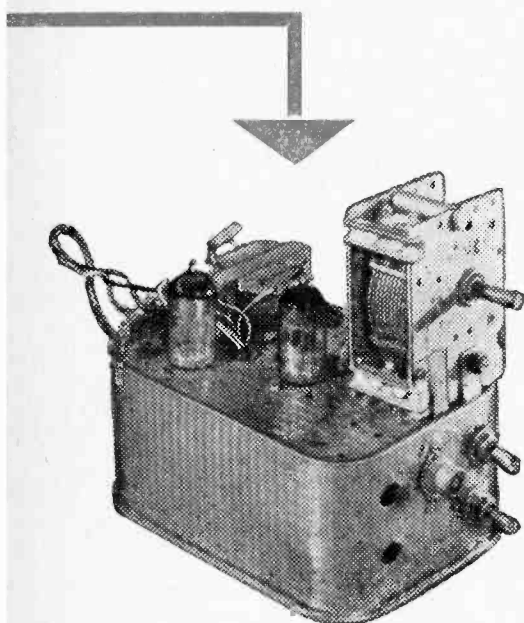

Continuity Check

Scrape the enamel from the ends E and G of each coil and test them for continuity using a meter or battery and lamp. The battery voltage will have to be greater in the case of L1 as the resistance of the wire is fairly high.

The R.F. range switch is fitted as indicated in Fig. 10 with VR4 underneath it. These, however, are not used until later. The coils are now made up (Fig. 8) and L1 is mounted in position as shown in Fig. 9. To do this, two small screws are used from underneath. The coil positions are not unduly critical.

Wiring the Oscillator Stage

The completed circuit is shown in Fig. 7. Feedback is via the cathode and grid, and the tuned circuit is L1, 2, 3 or 4. The values of C20 and R27 will give good results from 150kc/s to 20Mc/s

and should not be altered. If low emission valves are used the value of R26 may have to be reduced. It should always be as high as possible or the oscillations tend to be distorted (not pure sine waves).

Unsolder R11 from the output socket (see Fig. 6 last month) and leave it "in the air" for now. Refer to Fig. 10 and note that only additional wiring is shown for clarity. Wire C21 from pin 1 (valve V2b) to chassis, and from the same tag, R26 to the unused tag on the tag strip tag 3—eventually it will be connected to tag 3 of the

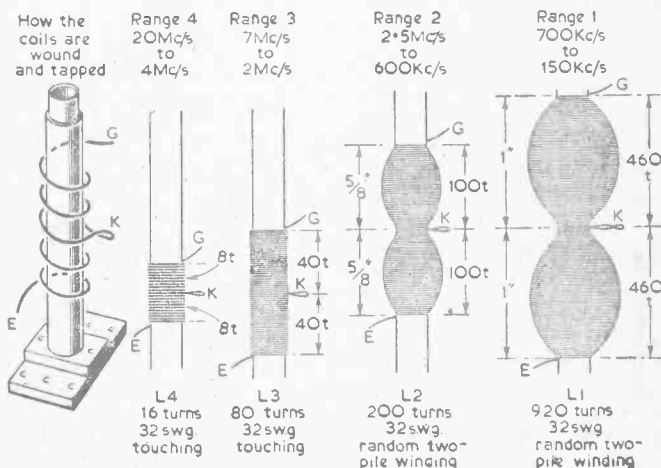

Fig. 8.—The coil winding details.

power unit. Solder R27 and C20 to pin 2 and join them together at the other ends.

The coil L1 is now wired as follows and not as in Fig. 10—note that the switch is not wired at all yet. Slip sleeving over the top lead (G) and wire it to the junction of the grid condenser and leak (R27, C20); then verify that three wires are soldered together at this point. Take the bottom lead of the coil (E) and solder it directly to the top of the chassis. Sleeving is not essential here. Clean the tap on the coil, tin the wires and solder an insulated wire to them which is then connected to pin 3 of the valve being wired. Make sure that both leads at the tap were tinned and soldered together. Now solder a temporary condenser of 50 to 500pF from the junction of R27, C20, L1 to chassis.

Testing for Oscillation

Connect the unit to the power pack and wire a milliammeter in the lead from tag 3 of the power pack to tag 3 of this unit. Switch on, and the current reading should be about 0.7mA. Now using an insulated screwdriver, short the junction of R27, C20 and G of the coil to earth. The anode current will now rise by a value of 0.01 or 0.02mA to give a reading greater than before, if the valve is oscillating. If the current does not alter, the unit is not working and the fault must be investigated. If no meter is available then you must assume for the time being that the unit is oscillating.

Varying the Frequency of Oscillation

The unit will be oscillating at a frequency of about 700kc/s if the temporary condenser fitted is only 50pF or at about 150kc/s if it is 500pF. Remove the temporary condenser and then con-

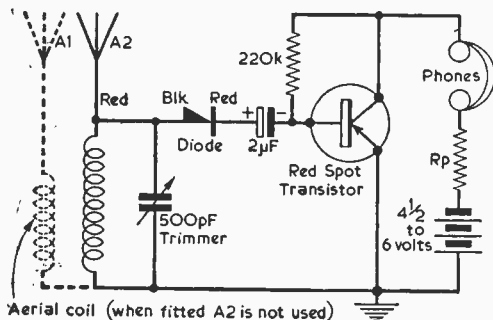
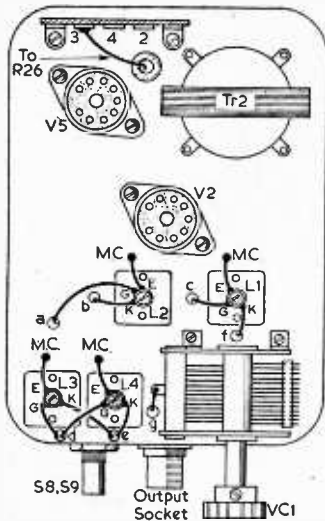

Fig. 11.—The circuit of a crystal diode receiver suitable for testing the R.F. section.



Tags marked MC are earthing connections to chassis

End bent down to clarify wiring

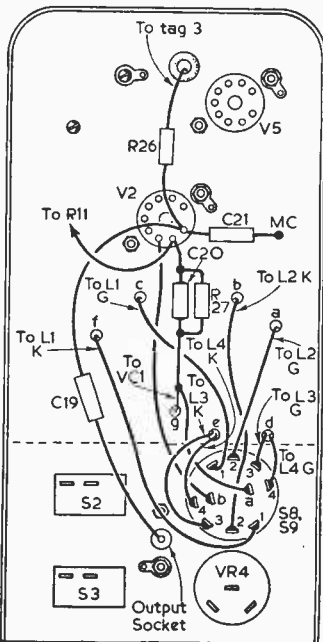

Fig. 9 (left).—Above-chassis layout of the R.F. generator—the audio modulator section is not shown wired.

Fig. 10 (right).—The underchassis wiring.

nect the stator vanes of VC1 (already tested) through a hole in the chassis (using insulated wire) to the junction of R27, C20 and G of L1. Four wires are now joined at this position. VC1 is now tuning the inductance L1 and the frequency of oscillation will be variable from about 150kc/s to 600kc/s.

Second Check

A meter is wired as previously described in the H.T. lead to tag 3 of the power unit. Verify that in all positions of VC1 there is the required rise in anode current when G of coil is shorted to earth as before. Verify that the actual increase in current is more when the condenser is fully closed (about 0.06mA rise on shorting G) than when it is fully out (about 0.01 or 0.02mA rise on shorting G). Also, as the vanes are moved from the open position to the closed position the current drawn by the valve falls from about 0.77mA to 0.72mA. The actual current drawn does not matter, but the fact that it falls as the vanes are moved in does show that the valve is oscillating.

Modulating the R.F. Wave

The resistor R11 which was disconnected earlier may now be wired to pin 2 of V2 as indicated in Fig. 10. Note carefully that the values of R11 and C9 have to be changed to those given in the list of components on page 25.

Condenser C19 must now be wired from pin 1 of V2 to the output socket (see Fig. 10).

Testing the Modulation

Preliminary tests may be made by connecting 'phones to the output socket. With S3 switched on (Fig. 4 last month), the modulation note should be heard faintly independent of the position of the variable condenser. However, if the R.F. section is not oscillating, no mixing will occur, but the note will still be audible, the valve acting as an amplifier. Further tests follow.

Testing on a Receiver

Use any TRF receiver which will receive long waves. A superhet is not really suitable as spurious oscillations will make tests very difficult. If a TRF receiver is not available then a small and cheap transistor/diode receiver can be made up quickly. Selectivity is not important at this stage and long waves only are required. A dual coil could be fitted for testing other ranges of the oscillator.

The circuit of a suitable receiver is shown in Fig. 11. A suitable layout is shown in Fig. 12.

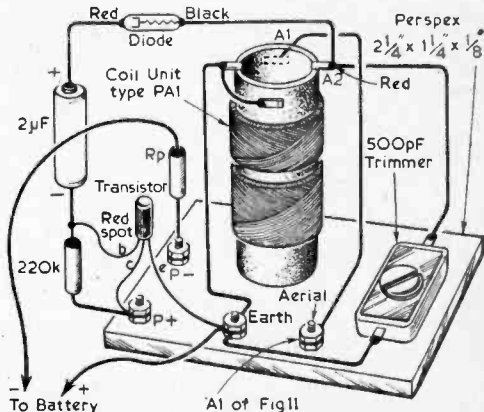
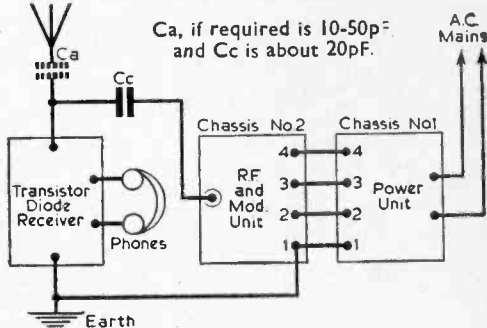

Fig. 12 (above).—Layout of the crystal diode receiver. (The collector of the transistor is indicated either by a spot of paint near to it or by wider spacing from the middle wire, which is the emitter. The remaining wire is the emitter.)

Fig. 13 (below).—The interconnections required for the testing of the generator.



The units are wired as shown in Fig. 13 for the test. If an ordinary receiver is used the wiring is the same. If the receiver is sensitive then the aerial need only be short, if insensitive it must be long. Ca may be necessary for reasonable selectivity if a long aerial is used on very simple receivers.

Only sufficient power is required from the aerial for the long wave Light Programme to be heard very faintly. Any other Long Wave Station may be used if Droitwich reception is poor, e.g. Paris on 128kc/s.

Testing Procedure

Tune the receiver to L.W. Light Programme (200kc/s). Connect as shown in Fig. 13. If an A.C./D.C. receiver is used the receiver itself must not be earthed.

Parts for the diode receiver
 This is so simple that no constructional details are given. Parts for the receiver of Figs. 11 and 12 are as follows:
 Coil in prototype—Wearite PA1 (any long wave aerial coil will suit)
 Trimmer—750 or 500pF
 Transistor—Red spot or yellow/green
 Diode—"surplus" type
 Coupling condenser—About 2µF, above 6VW
 One 220k ½W resistor and one of 1000Ω if low resistance phones are used. Leave out Rp with high resistance phones
 Aerial—Preferably outside, and over 50ft.
 Battery—Torch or cycle lamp type

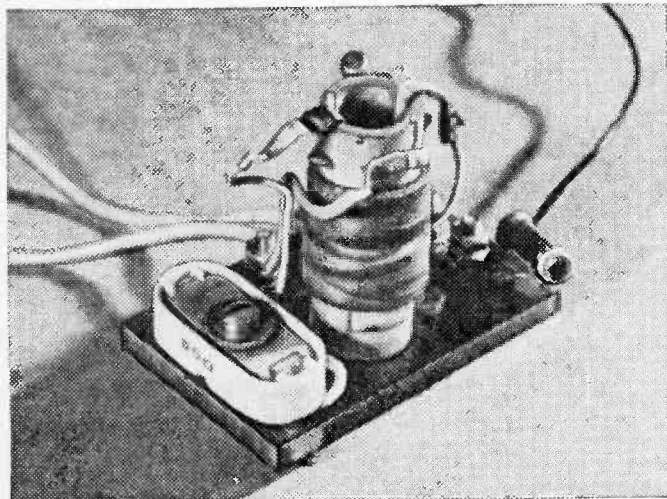

The crystal diode receiver—constructed on a paxolin chassis.

(Continued on page 47)

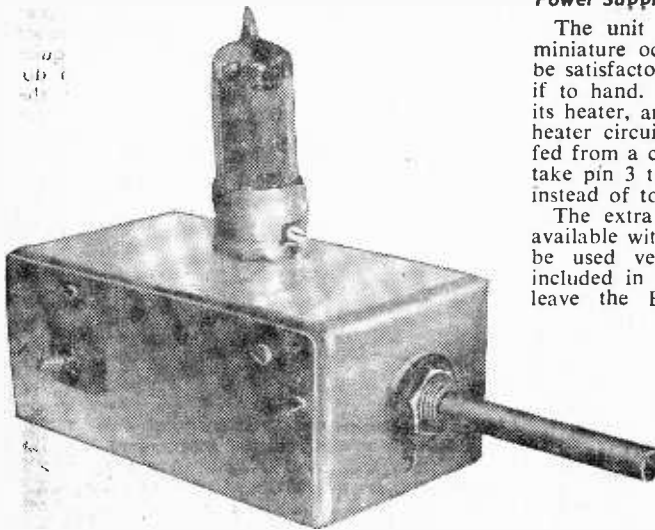

A Compact Add-in B.F.O. Unit

A SIMPLE ONE-VALVE STAGE

By J. Barrat

IN the usual type of superhet C.W. Morse is not audible, as a beat frequency oscillator is necessary for C.W. reception. Such an oscillator is always provided in a communications receiver, but is not normally fitted in ordinary all-wave or similar receivers. A beat frequency oscillator can, however, be added, and the B.F.O. described here is for this purpose.

A C.W. signal is an unmodulated radio-frequency wave. After detection, it does not in itself produce any audible tone, though it may be manifest as a rapid, intermittent clicking. The C.W. signal, as obtained from the receiver intermediate frequency stage, will be at intermediate frequency. The B.F.O. is tuned a little to one side of this frequency, and its output is mixed with the C.W. signal. As a result, an audio tone is produced when the C.W. is present.

As example, assume the receiver I.F. is 465kc/s. If the B.F.O. is tuned to 466kc/s, the frequency difference will be 1kc/s, or 1,000 cycles per second, so an audio note of this frequency will be heard. The B.F.O. might equally well be tuned to 464kc/s. In practice, the B.F.O. stage is usually tunable over a narrow band. This allows the audio note to be adjusted at will, and sometimes allows better reading through interference.

Power Supplies

The unit described uses a 6BA6, but any miniature octal-based or other H.F. pentode will be satisfactory. A triode can also be used instead, if to hand. This valve requires 6.3V for its heater, and this is drawn from the receiver heater circuit. In some receivers, heaters may be fed from a centre-tapped transformer. If this is so, take pin 3 to the other side of the heater circuit, instead of to chassis.

The extra heater current should normally be available without difficulty. If the B.F.O. will only be used very occasionally, a switch may be included in the heater circuit. But it is usual to leave the B.F.O. stage heater permanently in

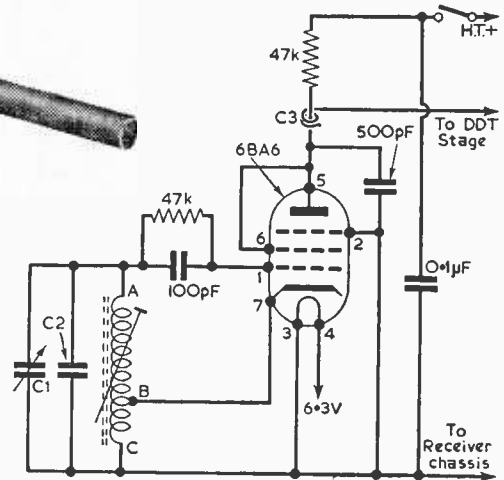

Fig. 1.—The B.F.O. stage circuit diagram.

circuit, so that the B.F.O. can be switched on at once by means of the H.T. switch shown.

With A.C./D.C. sets having heaters in series, the B.F.O. valve heater must be of the same current rating as other heaters.

The small H.T. current required also comes from the receiver. If the H.T. line voltage, or supply point, is over 200 or so, the 47k anode resistor can be increased to 100k.

C1 is a panel operated trimmer, to modify the note, and select upper or lower beat frequencies. A value of about 25pF to 50pF is generally satisfactory. If the B.F.O. cannot be mounted near the receiver panel, this condenser is operated through an extension spindle. C2 is fixed, and allows the B.F.O. coil to tune to the receiver intermediate

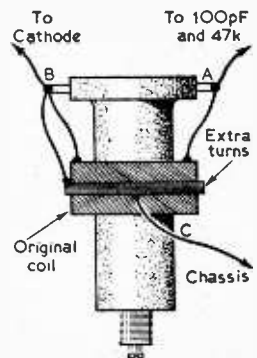

Fig. 2.—The windings on the B.F.O. coil.

frequency when C1 is about half closed. C3 in Fig. 1 is a very small capacity, formed by looping an insulated lead round the anode connection.

B.F.O. Coil

Any coil tunable to the receiver I.F. is suitable. This may be from a disused I.F. transformer, or may be an ordinary aerial or oscillator coil which will tune to the intermediate frequency. A coil with an adjustable core is handy, as this allows easy setting of the frequency.

The B.F.O. coil has a few extra turns added, as in Fig. 2. The end of this additional winding goes to chassis. The junction of the original winding and additional winding forms the cathode tap B. The extra turns must be in the same direction as those on the original coil, and about 4 turns will generally be satisfactory. If the coil has aerial couplings or other windings, these are ignored.

Many receivers have an I.F. of about 465kc/s. This is about 645m. Some medium-wave coils will reach this, with a 500pF condenser for C2 which should be a silver mica condenser. For a coil with more turns, or an I.F. transformer winding, C2 will be less than 500pF. If the I.F. transformer winding were intended for the same frequency as the receiver, the fixed condenser already fitted will, of course, be correct.

stage" is taken to the detector diode. It should be noted particularly that a very strong signal from the B.F.O. is *not* wanted, as this will reduce sensitivity. Coupling may, therefore, be quite loose. For C3, a 1 or 2-turn loop should do. Coupling may be sufficient if the lead to the DDT stage is similarly looped round the detector diode connection. This depends on the receiver circuit, and H.T. voltage used with the B.F.O.

To adjust initially, tune in any ordinary programme on the receiver. Switch the B.F.O. on, and adjust C1, or the coil core, or both, until an

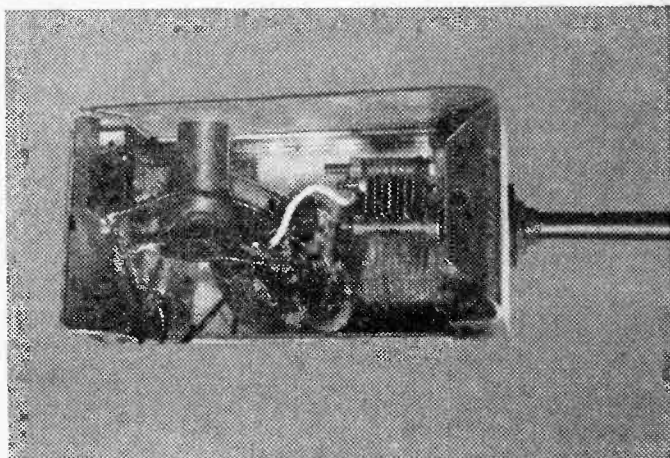

Above is shown the under-chassis wiring—details of which are given in Fig. 3 (below)—of the prototype unit.

B.F.O. Layout

Fig. 3 shows the unit built upon a chassis 4in. x 2in. x 1½in. The coil can be mounted on the top, back, or either side runner, so that it can be reached easily when the unit is installed in the receiver.

A chassis this size can be made by bending 1½in. flanges on a piece of aluminium 7in. x 5in. Leave extra to form flanges to bolt to the receiver chassis, or use small angle brackets for this. The side plates of the unit are then 4in. x 1½in. When completed and fixed to the chassis, the whole is screened. This is recommended, or harmonics of the B.F.O. frequency will be heard at multiples of about 464kc/s or 466kc/s.

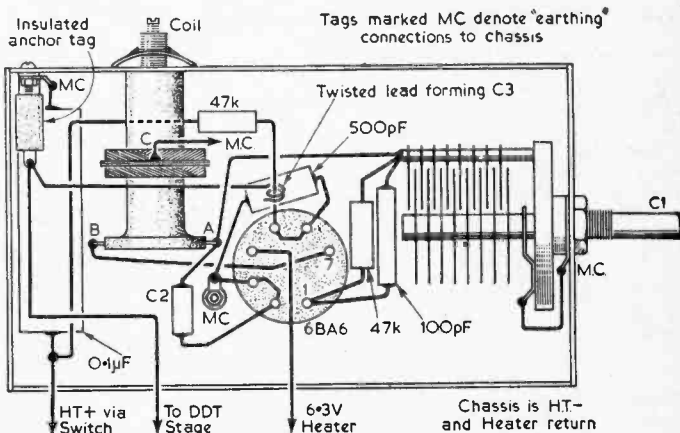

Connections

Wiring should be reasonably short and direct. Leads are provided as in Fig. 3, to connect to the receiver power circuits. The most suitable position for the unit is near the double-diode stage of the receiver.

The unit should be tested before permanently bolting it in place. The lead marked "to DDT

audio oscillation is heard. If possible, adjust the coil core so that zero beat comes with C1 about half closed. If this is not possible, the value of C2 may need changing.

A fairly weak signal should then be tuned in, and the coupling into the DDT stage modified for maximum results. This coupling is not critical,

(Continued on page 47)

Servicing All-Dry and Mains/Battery Portables

A FAULT-FINDING GUIDE

By G. J. King

BASICALLY there is virtually no difference between servicing "all-dry" and "mains/battery" portables and standard mains-operated receivers. Nevertheless, portables require extra care during the course of servicing to avoid damaging the relatively delicate valve filaments. Moreover, they also tend to develop faults which are only characteristic to receivers using 1.4V valves.

All-dry Receivers

The circuit diagram of a typical all-dry receiver is given in Fig. 1. This uses four valves in a conventional superhet circuit. V1 is the frequency-changer, V2 the I.F. amplifier, V3 the detector and A.F. amplifier and V4 the output valve. In this particular receiver the valves are of the very low consumption type.

The current range of 1.4V valves show a major advance over the former ranges. They employ the B7G base, and have filament consumptions as low as 25mA at 1.4V. These valves are used extensively in present-day valve portables, and owing to their low filament power can work on batteries at least half the capacity (and size) of those required in the older portable. The filaments

are connected either in series or parallel, requiring a 7.5V or 1.5V L.T. battery, and in the circuit of Fig. 1 the filaments are all connected in parallel. The output valve, V4, will be seen to have a tapped filament. When the battery is connected across each section, as the circuit shows, the consumption of that particular valve is 50mA. However, if the two sections were connected in series (ignoring the tap), it would then take 25mA at 2.8V. The series method is invariably adopted in mains/battery versions. These very low consumption valves are designated DK96, DF96, DAF96, DL96, etc. In spite of the filament power difference between the various 1.4V valves there is hardly any difference in circuit design among receivers using the different valves. One practical difference, however, is that in most modern receivers a ferrite rod aerial is used instead of the frame aerial of earlier receivers.

No Signals

This is a common symptom with this type of set. The first action should be to establish whether the circuits appear to be "live". One way of doing this is to hold an ear close to the loud-

COMPONENTS LIST for Fig. 1

Resistors	
R1	27k
R2	33k
R3	33k
R4	2.2M
R5	4.7M
R6	1M
R7	4.7M
R8	6.8M
R9	2.2M
R10	560 Ω
VR1	1M potentiometer log-law with D.P. switch

Capacitors	
C1	100pF
C2	100pF
C3	65pF
C4	65pF
C5	532pF
C6	200pF
C7	280pF
C8	0.05 μF
C9	0.05 μF
C10	0.1 μF
C11	65pF
C12	65pF
C13	200pF
C14	0.001 μF
C15	0.05 μF
C16	200pF
C17	0.01 μF
C18	2 μF or 1 μF

Inductors	
L1	M.W. Frame Aerial
L2	L.W. Frame Aerial
L3	M.W. Loading Coil

L4	L.W. Loading Coil
L5	} M.W. Oscillator Coil
L6	
L7	} L.W. Oscillator Coil
L8	
L9	} 1st I.F. Transformer
L10	
L11	} 2nd I.F. Transformer
L12	
L13	Aerial Coupling

Miscellaneous	
S1	Wavechange Switch
T1	Output Transformer

Variable Capacitors	
TC1	} 4-70pF Two Bank
TC2	
TC3	} 528pF Swing Two Gang
TC4	
TC5	} 4-70pF Two Bank
TC6	

Valves	
V1	Mullard DK96
V2	Mullard DF96
V3	Mullard DAF96
V4	Mullard DL96

Table 1.—The list of components for the receiver in Fig. 1.

speaker and gently tap the DAF91 or DAF96, etc., valve. This is always slightly microphonic, and if a ringing sound can be heard the A.F. and output sections are in order. Alternatively, if the volume control causes slight crackling when operated, the same applies.

If the set uses a 7.5V L.T. battery, indicating that the filaments are connected in series, then a positive result from the above test would indicate that the filaments of the first two valves are also in order. However, if a 1.5V battery is used, in spite of the A.F. and output stages being in order, the filament of either the frequency changer or I.F. amplifier valve may be open-circuit. An open-circuit filament in one or more valves would not affect the operation of the other valves in a parallel-connected filament circuit, but this, of course, does not follow in a series-connected filament circuit.

condition, it may be found to operate only at the extreme end of the dial or on one waveband only, usually medium-wave.

These troubles are aggravated, however, by a low emission frequency-changer valve. This fault also makes it necessary to replace the L.T. battery before it is completely exhausted, since the oscillator may fail due to the low emission valve when the L.T. drops to about 1.3V, whereas with a normal valve the set may continue working with the L.T. down to about 1.1V.

Low Volume and Distortion

There are three components which are prone to cause trouble if they develop a fault. Referring to the circuit of Fig. 1, these are R6, R7 and C17. R6, which is in the region of 1M, is rather difficult to check on an ordinary medium resistance tester in terms of measuring the voltage at V3

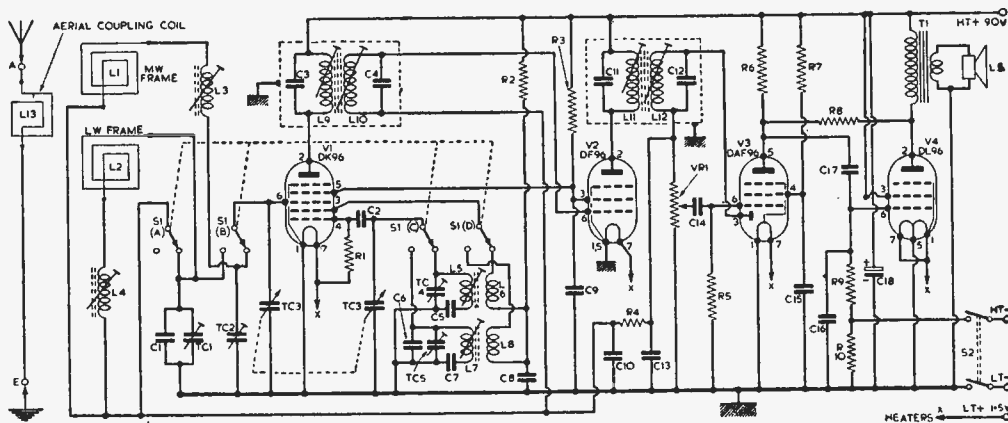

Fig. 1.—The circuit diagram of a typical all-dry battery portable.

The filament is connected across pins 1 and 7 on B7G type valves, and can be checked easily by connecting an ohmmeter across the pins. A low resistance ohmmeter, however, must never be used for this test, as the current in the ohmmeter circuit may exceed 25mA and thus either overrun or open-circuit the filament of the valve under test. If in any doubt, it is desirable to take the suspect valves to a dealer for testing.

If all the valves are in order and the set appears to be "live" but will not pick up stations, the most likely cause of the trouble is failure of the local oscillator associated with the DK-type valve (frequency changer). In most cases insufficient L.T. voltage is the primary trouble. If the L.T. battery is tested off-load with a high resistance voltmeter or multimeter it may well indicate the full 1.5V, but on-load it may be well below this value. It is essential, therefore, always to measure battery voltages when the batteries are connected to the set and with the set switched on.

Some all-dry portables will operate with the L.T. voltage as low as 1.1V, but others cease operating when the on-load L.T. is around the 1.3V figure. Another symptom of low L.T. voltage is that the set may operate satisfactorily for about five or ten minutes and then suddenly cut off. Under this

anode, owing to the loading effect of the meter across the high resistance. The same applies to the screen feed resistor, R7, and in both of these cases only a very low voltage is indicated, even if the resistors are in order. With some meters no reading at all will be obtained at the screen grid of V3, since R7 may be as high as 4.7M. If in any doubt, it definitely pays to check these resistors by substitution.

The coupling capacitor C17 may leak slightly and reflect a small positive potential on the control grid of the output valve V4. This cannot usually be measured, again owing to the very high associated resistances involved, but even an apparently negligible leak in this component causes severe distortion and low volume. This fault also causes a higher than normal H.T. current in the output valve, which not only ruins the valve after a while, but also causes the H.T. battery to be discharged quicker than it should.

Mains Battery Receivers

Fig. 2 shows the circuit diagram of a typical mains/battery portable (the Double Decca). Apart from the mains power pack and switching arrangements, it will be seen that the basic circuit is rather like its battery-only counterpart. The troubles

which have already been described apply also to the mains/battery type portable, but in addition other troubles often occur which are associated with the mains H.T. supply.

When switched to "mains", switch S6 directs the power supply to the H.T./L.T. rectifier; switch S5 picks up the rectified voltage, via the required tapping on the voltage dropper, R13/14/15, and directs it to the H.T. line; switch S7 switches the series-connected valve filaments also across the H.T. supply, via the filament dropping resistor R12. The switch sections are, of course, ganged.

This arrangement of operating the valve filaments from the H.T. supply, via a dropping resistor, is common practice, though on certain

should be an immediate suspect, especially if the set has been operating correctly for a considerable period before the fault develops. An approximate measurement of the H.T. voltage may not reveal the trouble, but if the rectifier is at fault, the voltage across each valve filament will be below the required 1.4V.

This trouble is aggravated if the power supply voltage falls, as it does in many areas these days of heavy mains demands. A contributory factor is also a low emission frequency changer valve, as has already been discussed under battery receivers.

In order to enhance the filament voltage distribution, resistors are sometimes connected in parallel with the filaments. Such a resistor is R18

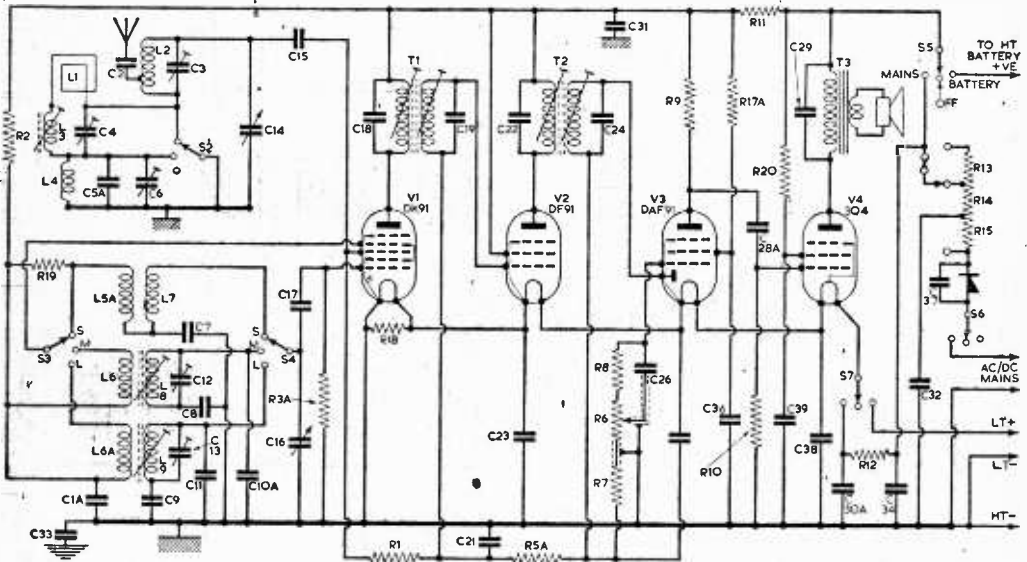

Fig. 2.—Circuit diagram of a mains/battery portable.

receivers a separate L.T. power pack is provided, including a small transformer and rectifier. The rectifier is, therefore, called upon not only to supply H.T. power, but also filament power, and the total can add up to almost 100mA.

The most critical part of the circuit is the filament chain, for if the current is less than, or in excess of, the filament rating of the valves, each filament will either have too little or too much voltage across it. Insufficient voltage will give low volume and possibly prevent the local oscillator from working, while too great a voltage will ruin the valves and prevent them from operating when normal voltage is restored. At this stage it should be carefully noted that once the filament of the all-dry type of valve is overrun, the valve might just as well be thrown away, for it will never operate again under correct conditions. Thus, when servicing, extreme care should be taken not to short out the filament dropper or by-pass part of the filament circuit. The receiver should also be adjusted carefully to suit the applied mains voltage.

In the event of the set suddenly cutting out after operating for, say, an hour or so, the H.T. rectifier

in Fig. 2. These should never be removed or changed in value in order to obtain a greater voltage across a filament. If the voltage differs between each filament, and the filament resistors are of correct value, then one or more of the valves may have been overrun at some time causing an alteration in filament resistance.

Hum and Distortion

Adequate smoothing is essential in order to eliminate mains ripple from the H.T. and L.T. lines, and this is accomplished by the use of relatively low voltage, high capacitance electrolytic capacitors. Excessive hum accompanied by distortion should, therefore, first lead to a check of these components, not forgetting those in the L.T. circuit.

Finally, a word of warning, as the chassis is connected direct to one side of the mains supply on most mains/battery portables, care must be taken when making tests with the set connected to the supply. It is desirable first to check the chassis with a neon bulb to make sure that it is connected to the neutral of the supply.

BRAND NEW AM/FM (V.H.F.) RADIOGRAM CHASSIS AT £14 (Carriage paid)

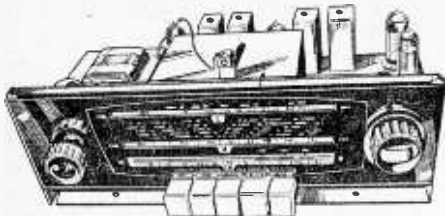

Tapped input 200-225 v. and 226-250 v. A.C. ONLY.
 Chassis size 15 x 6 1/2 x 5 1/2 in. high. New manufacture, 12 mths. guarantee.
 Dial 1 1/4 x 4 in. in black and gold.
 Pick-up. Extension Speaker. Ae., E., hd Dipole Sockets. Five "plano" push buttons—OFF L.W., M.W., F.M. and Gram. Aligned and tested. With all valves and O.P. Transformer. Tone Control Fitted.
 Covers 1.000—1.900 M.; 200-500 M.; 88-98 Mc/s.
 Valves EZ80 rect., ECH81, EF89, EABC80, EL84, ECC85.
 Speaker and Cabinet to fit chassis (table model). 47/6 (post 3/6).
 10 x 6 in. ELLIPTICAL SPEAKER. 20/-, to purchasers of this chassis.
TERMS:—(Chassis) £5.10.0 down and 6 Monthly Payments of 30/-, or with Cabinet and Speaker £5.17.0 down and 7 Monthly Payments 32/-.

BATTERY ELIMINATOR. For 4 Low Consumption Valves (96 range). 90 v. 15 mA. and 1.4 v. 125 mA. 42/6 (2/5 post). 200-250 v. A.C. Size 5 1/2 x 3 1/2 x 2 1/2 in. Also for 250 mA. 1.4 v. and 90 v. 15 mA at same price.

THE "CABY" TEST METERS

Prices include Test Prods, Batteries, Instruction Book. Also measure dB. Accuracy: A.C., 3 per cent. D.C., 2 per cent.



- A-10 **£4.17.6**
- B-20 **£6.10.0**

A.10—2K ohms/v. on A.C. and D.C. volts (10, 50, 250, 500 and 1000 v.); 10K and 1M ohms; 1 mA, 25 mA and 250 mA. D.C. Size: 5 1/2 x 3 1/2 x 1 1/2 in. Weight 17 oz.

B-20—10K ohms/v. on 0.5 v. and 2.5 v.; 4K ohms/v. on 10, 50, 250, 500 and 1000 v.. A.C. and D.C. Resistance, 2K, 200K, 2 M and 20M ohms.; D.C. current, 100 microA, 2.5 mA, 25 mA, 250mA. Size: 5 1/2 x 3 1/2 x 2 1/2 in. Weight, 24 oz.

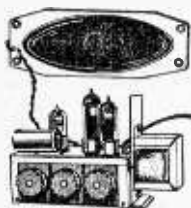

3-VALVE AMPLIFIER (INC. RECT.). 4 watts. Valves ECC83, EL84, and EZ80. Controls, volume, bass and treble. On/Off switch. (Chassis size 6 1/2 x 3 x 2 1/2 in.) 6 1/2 in. round or 7 x 4 in. elliptical speaker. Not suitable for microphone input. A.C. only.

75/- (3/- p. & p.)

TAPE RECORDER FOR ONLY £17.10.0 (10/- carriage)

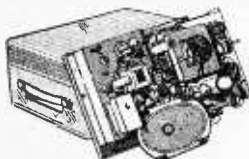

A QUALITY ARTICLE. Valves EZ80, ECC83, ECL82, DM70. Acos Crystal "mike", 850ft. Tape and extra spool. 3 1/2 in./sec. Mike and Radio Inputs: Vol. on/off tone. Ext. L.S. and Monitor. Fast forward and reverse. Cannot be accidentally erased. Magic Eye Indicator. 6 x 4 in. Speaker. Cabinet 14 x 11 1/2 x 7 in. Supplied completely built and in cabinet.

B.S.R. "MONARDECK" TAPE DECK SINGLE SPEED. Our price only £7.2.8 (5/6 carr.). 850 ft. first grade tape 5 1/2 in. plastic spool. 16/-, post 1/-.

ELECTROLYTICS. ALL 275 v. 100+200mF. 5/-; 100-400mF. 7/6; 100-400-32mF. 8/6; 200-200-300mF. 9/1; 32-32mF. 3/-; 60-250mF. 5/- . Please add Postage 9d. for 1; 1/6 for 3; 6 post free.

NEW WAXED TUBULARS. 350 v. of above. 0.001, 0.002, 0.0005, 0.01, 0.02, 0.05, 0.1, 0.25, 0.5 mF. Total 21 for 4/8, post 9d.

GLADSTONE RADIO 58A HIGH STREET, CAMBERLEY, SURREY. Tel. 22791

Also at 247 New Road, Portsmouth, Hants, and 56 Stokes Croft, Bristol 1.
 Camberley closed Saturdays. Portsmouth and Bristol closed Wednesdays.



LISTEN WITHOUT INTERFERENCE
 Fully built V.H.F./F.M. Set for £8.8.0 (3/- post). Covers 88-95 Mc/sec. Wired, aligned and tested. Mullard permeability tuner and 4 valves (ECC85, ECL82 and two EF91), + 2 diodes. Cheap room dipole, 10/-, 300 ohm twin feeder. 8d. 3d. Available as self-powered tuner chassis at £7.13.0. Carriage paid.



GRAMOPHONE AMPLIFIER with 5in. SPEAKER. Baffle 12 x 6in. EZ40 and EL41. Tone and Volume. On/Off switch. Two Knobs. Ready to play. Useful for Stereo.

ONLY 63/-, post 3/-

AUTOMATIC RECORD CHANGERS COLLARO CONQUEST with manual play also. 4-speed. A.C. mains 200-250 v., see illus.

£7.10.0 (5/- P. & P.)

B.S.R. UA8 4-speed auto-changer. **£6.10.0 (5/- carr.) UA14. £7.10.0 (5/- carr.)**

All with Crystal Turnover Head.



PUSH-PULL AMPLIFIER £4.15.0 (3/- P. & P.)

Brand new 200-240 A.C. mains. Bass, treble and vol. controls on flying panel. Valves EZ80, ECC83 and 2-EL84 giving full 8 w. Chassis 12 x 3 1/2 x 3 1/2 in. With o.p. trans. for 2-3 ohm speaker. Suitable for Crystal Mike Input. Stereo Version same size £4.15.0 (P. & P. 3/-).

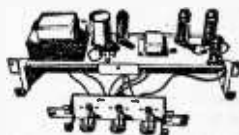

TWO-TONE BROWN RECORD PLAYER CABINET (with Motor Board for Autochanger) and Gramophone Amplifier to fit Cabinet for £5.5.0 (5/- carr.). Size 17 x 15 x 8 1/2 in. Brand New. BSR UA8 autochanger to fit £6.10.0 (extra carriage 2/6).

COLLARO STUDIO TAPE TRANSCRIBOR. 3 MOTORS. 3 SPEED. Push Button Controls with tape and spool. **£12.15.0 (10/- carr.)**.

ALL ITEMS GUARANTEED 12 MONTHS—B.V.A. VALVES 3 MONTHS

Send 6d. (stamps will do) for 20 p. illustrated catalogue. All New Goods. Delivered by return. Terms:—One-third down and balance plus 7/6 in four equal monthly payments. Postage with down payment (C.O.D. 2/- extra).
SEE SPECIAL TERMS FOR A.M./F.M. CHASSIS.

Posted Orders to Camberley Please.

LASKY'S RADIO

Transistor Record Player

CAN BE
BUILT
FOR

£9.19.6

Carr. free



6 v. operation. For all L.P. and standard records. All components available separately.

AMPLIFIER. 300 milliwatts push-pull output, using two OC71 and two OC72 transistors. Fully assembled. 79/6. Knobs, 3/8 extra.

LOUDSPEAKER. 30 ohms, 7 x 4in. elliptical, matched to Amplifier, 25/-.

3-SPEED TURNTABLE. 6 v., complete with t.o. crystal cartridge and two sapphire styl. 79/6.

CARRYING CASE. smart two-tone finish. 17 x 14 x 5in. High. 49/6. Batteries extra.

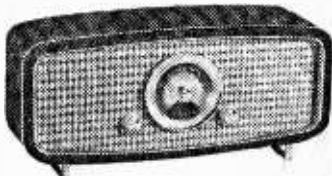

SUPERB 6-TRANSISTOR S/HET TABLE RADIO

CAN BE BUILT COMPLETE FOR £9.15.0
plus 4/6 p. & p.

Printed circuit construction, all components of highest quality. Uses 6 Mullard matched transistors, 1 diode, two OC81 valves in push-pull, giving 1 watt undistorted output. I.F. 470 Kc/s. Medium and long wavebands. Ferrite rod internal aerial, high flux 7 x 4in. Loudspeaker. Cabinet with first quality walnut veneer finish and gold embellishments. Size: 18 x 8½ x 5in. deep. Circuit diagram and full data supplied. Every component available separately.



LASKY'S CAR RADIO 12 v. operation.

Transistor output. Medium and long waves. Small size will fit any car. Build and install now for Summer pleasure.

Can be built complete with speaker for £9.19.6
Instruction booklet 2/6 (refunded if you order) plus 3/6 p. & d.

207 EDGWARE ROAD, LONDON, W.2.

PA.Ddington 327112.

42 TOTTENHAM COURT ROAD, W.1.

MUSEUM 2605.

BOTH OPEN ALL DAY SAT. Early Closing Thurs. Mail Orders to Dept. P.W., Edgware Road.

SPECIAL OFFER !

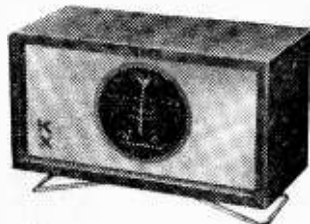

THE "KINEMATIX" STEREO BALANCE METER UNIT

No more guessing! Perfect balance in seconds. Brand new U.S.A. import supplied with full operating instructions. Suitable for use with all hi-fi stereophonic amplifiers. Enables you to recreate the stereo effect in any particular area of the room. Smart polished wood Cabinet, 6½ x 8½ x 4in. LIST PRICE £7.7.0.

LASKY'S PRICE 67/6

Post 2/6

THE PEMBRIDGE COLLEGE OF ELECTRONICS offers training in RADIO TELEVISION AND ELECTRONICS

ATTENDING COURSE

Full-time One Year Course in Radio and Television. College course in basic principles for prospective servicing engineers.

Next course commences 18th April, 1961.

This course is recognised by the Radio Trades Examination Board (R.T.E.B.) for the new Servicing Certificate examinations.

HOME STUDY COURSES

A. Radio and Television Servicing

- (1) Introductory course.
- (2) Basic course covering R.T.E.B. Intermediate Radio and Television Servicing Certificate examination.

B. Courses in Radio, Telecommunications and Mathematics up to City and Guilds Telecommunication Technicians' Final Certificate.

For details, write to:

The Principal, P.10
**THE PEMBRIDGE COLLEGE
OF ELECTRONICS**

34a Hereford Road, London, W.2

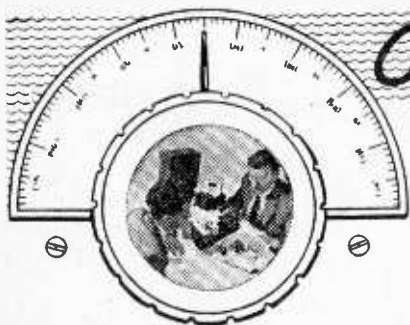

On Your Wavelength

BY THERMION

Aerial Design

I RECENTLY visited a country district and saw something which reminded me of the very early days of broadcasting, and awakened in my mind a problem which has worried me for some time. Attached to the roof of a house was what at first sight appeared to be a home-made sweep's brush, attached to the outside of a chimney. I looked closer, and sure enough it was one of those aerials which was all too familiar in the early days, made up of a number of lengths of the stranded copper wire which were known as 7/22's, soldered to a small ring and attached to the end of a down-lead. It brought back memories of many novel aerial designs which were not only published in the early issues of this and other magazines, but which were used successfully and which had many fantastic claims made for them.

There was the type made from a length of wire, similar to an ordinary inverted "L" aerial, and hanging on to it, were small clusters of short wire, at intervals of 18in. or so. Then there was the aerial made from two hoops (about 2ft in diameter) supported on a pole, with the aerial attached firmly to one hoop and then run up and down round the hoops. No doubt some of the older readers can remember others, but they all had one good feature—they gave improved results at that time. Valves were, of course, not so efficient as they are to-day, and it was common to use a two or three valve set and receive over remarkable distances. The air was clearer, of course, and there were not so many stations, so that selectivity did not have to be so good as it is to-day. The performance of these aerials all appeared to rely upon the added amount of wire which was "up aloft" and the very few experiments which I carried out seemed to indicate that it mattered very little how this extra wire was accommodated—whether it was soldered together in a bunch, or hung from another wire at short intervals.

I believe that, round about the time of which I am speaking, there was a commercial aerial on sale in the U.S.A. which consisted of a flat sheet of copper about 2ft

square, for which most remarkable claims were made. To-day, of course, as I have mentioned before, a very short wire, supported vertically seems to be most productive of a really reliable all-round all-wave performance. Many of to-day's transmitters use the metal mast as a radiator, and, in fact, a very prevalent trouble (known as the "Luxembourg effect") can be avoided by using such an aerial. On television the same thing now appears to be happening in the U.S.A. in an endeavour to produce an aerial which will be equally efficient on all bands, but, of course, the very short wavelengths, which are used, complicate the problem.

"Pocket" Portables

I must thank reader Gilbanks for writing to me concerning the nuisance caused by the popular transistor portables referred to in my notes in the February issue. Amongst other things, he reminds me that the L.C.C. has a bye-law in all their parks covering the use of radios, record players and other musical instruments, which states that they must not be used if they are a nuisance to other people. He rightly anticipates that at the rate at which the use of these sets is increasing, there will shortly be such laws introduced at most seaside resorts and beauty spots. If the nuisance becomes too great then I can foresee the portable practically killing itself and I believe the Noise Abatement Society have this type of set quite high on their list of public "nuisances".

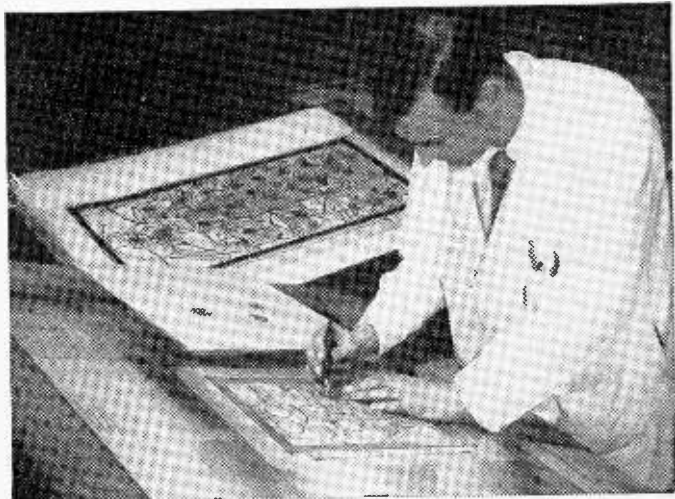

A printed circuit designer at the St. Albans Works of Marconi Instruments, draws up an Astrofoil master. Subsequently, the design is photographed; from the negative, any number of printed circuit boards can be run off.

An Introduction to Stereo

THEORETICAL AND PRACTICAL CONSIDERATIONS

By N. A. Walter

THIS article is intended to give guidance firstly to those about to enter the field of stereophonic sound, and secondly to enable mono hi-fi enthusiasts to convert their present systems to stereo by adding another amplifier.

The Complete System

A complete system is shown in Fig. 1. Radio has been included, although stereophonic radio is, at the moment, only being broadcast on an experimental basis.

Stereo recordings give us two separate sets of intelligence on the record, and these are kept separate throughout the two amplifier and loud-speaker systems. Our ears recombine these two sets of information and give the illusion of depth and breadth of music.

A study of the block diagram of a stereo system Fig. 1, shows that it comprises a turntable, a pick-up, pre-amplifier and tone control unit, the main amplifiers (preferably identical), the two loud-speaker systems, radio feeder unit (if fitted), and the power supply.

The Turntable

If the reader already possesses a turntable, it is advisable to write to the manufacturer to ensure that the unit is suitable for stereo. Some of the earlier 3-speed units are not suitable for conversion. If, on the other hand, a new unit is to be purchased, there is a large choice,

Transcription Motor

If expense is no object, a transcription type motor is undoubtedly the best, but, for the majority of readers, a good quality autochanger or single player will be more than adequate and the money saved can be put to good use on the loudspeaker system.

Autochanger

Since their first appearance many years ago, fierce arguments have taken place over the merits

and otherwise of autochangers. However, modern changers are vastly superior to their earlier counterparts, and if the reader requires to play a number of records without the need to keep putting records on, an autochanger is the obvious choice.

Before deciding upon a unit, the following points should be borne in mind:

1. it should be a four speed (78, 45, 33 and 16rev/min.) unit.
2. it should be possible to adjust the playing weight of the pick-up to between, say, 4 and 8gm.
3. both the stylus and the cartridge should be easy to change.
4. there must be sufficient clearance both above and below the baseboard for the unit of your choice (6in. above and 2in. below is a typical value).

Before finally deciding, hear each unit working and listen for the following three points.

"Wow"

This consists of slow changes in the speed of rotation of the turntable and may best be heard on a long sustained sound, or on piano music, the ear being very sensitive to slight changes of pitch on a continuous note.

"Flutter"

This is a high frequency modulation superimposed on the music, resulting in a "roughness" to the tone of the recording. It is usually less noticeable than "wow".

"Rumble"

Rumble is of a very low frequency—hence the name—and is best heard on a record with no, or only light modulation, such as a light violin passage. An electrical filter is given later, which can be used to minimise the effect.

The Pick-up

If an autochanger is purchased, a pick-up will normally be fitted. This will almost invariably be of the crystal type, and have advantages of a good frequency response (40-12,000c/s is quite

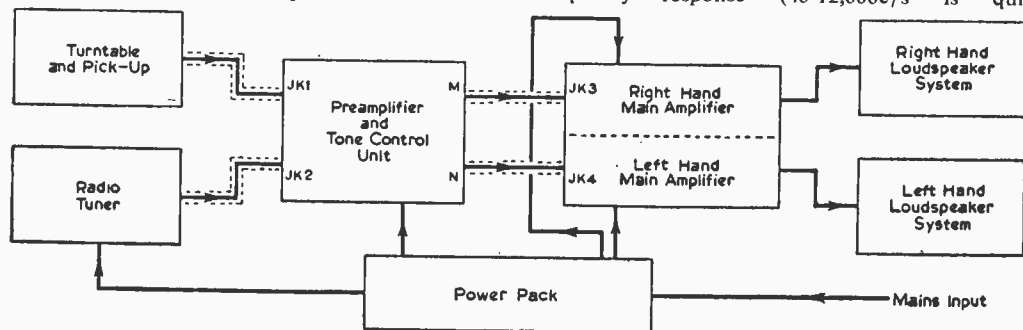

Fig. 1.—Block diagram of the complete system.

common); a good output (100 to 300mV from each channel in stereo); and be inexpensive and quite robust.

However, it must be remembered that crystal pick-ups are high impedance devices and a few elementary precautions can bring excellent results. First, they should be fed into an impedance of 1M if possible, but certainly not less than 0.25M, or a falling off of the bass response will result. Secondly, the shorter the leads from the pick-up to the pre-amplifier the better, and a maximum of two feet should be allowed. This lead can represent quite a high capacity in shunt with the pick-up and can result in heavy losses. A screened lead should be used to prevent hum pick-up, but the screening should be insulated and earthed only at the pre-amplifier input. If hum is objectionable, the main power transformer should be re-orientated to find the optimum position.

As a general rule, a crystal pick-up can be represented as a capacity of the order of 0.01 μ F in shunt with several megohms. For this reason, shunting of the pick-up output by a capacitor does not result in a high frequency cut, as in the case of a magnetic pick-up, but only in a reduction of the output as a whole. Also, in some cases, a correction circuit is recommended by the pick-up manufacturer and this usually consists of a simple capacity/resistance circuit.

Before leaving the subject of turntables and pick-ups it is worth mentioning a few of the faults of stereo cartridges.

They are more responsive to turntable rumble, owing to the fact that they must respond to a vertical as well as horizontal component of the recording. Acoustic feedback through the cabinet can be a serious problem, unless the baseboard and cabinet are very substantial, and the speakers well shielded from the turntable, and unless there is a definite reason against it, the loudspeakers should be separately housed.

The Radio Feeder Unit

The only decisive factor to bear in mind here is whether to use F.M. or A.M. for reception. F.M. is the obvious choice, and unless there are any other strong reasons, A.M. may be ignored.

The H.T. and L.T. requirements are dealt with under the power-pack section, but in general, most units require an H.T. between 200 and 250V. and take 30 to 50mA.

Pre-amplifier and Tone Control Unit

The function of this single valve unit is to provide some measure of gain, to provide switching for stereo records, mono records and radio (if desired another position can be included if tape is to be used), and tone, volume and balance

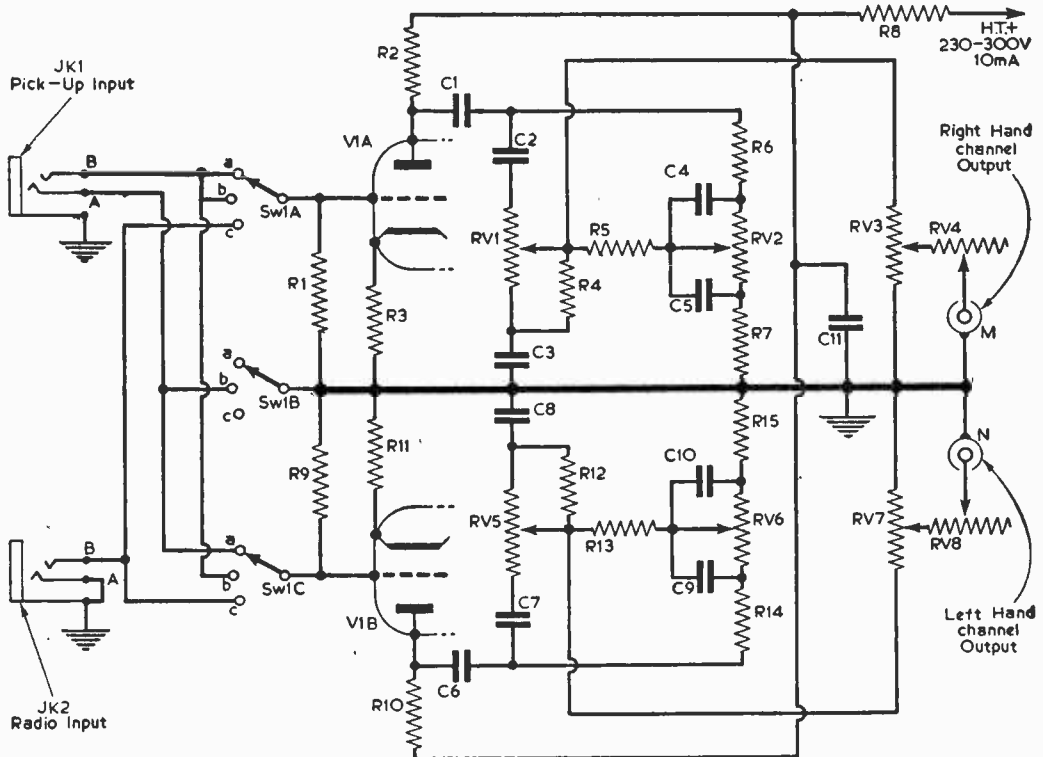

Fig. 2.—Circuit of the pre-amplifier and tone control unit. (Note: RV4 is connected so that when the spindle is turned clockwise, the resistance decreases; RV8 is connected in the opposite sense. The cables linking the pre-amplifier to the main amplifier (to be described in a future issue) should be single-core, flexible, screened cable. Position (a) of SW1 is for stereo; position (b) for mono; and position (c) for radio.

COMPONENTS LIST

R1, R9	1M $\frac{1}{4}$W high stability
R2, R10	100k $\frac{1}{4}$W high stability
R3, R11	1500 Ω $\frac{1}{4}$W
R4, R12	47k $\frac{1}{4}$W
R5, R13	39k $\frac{1}{4}$W
R6, R14	68k $\frac{1}{4}$W
R7, R15	6.8k $\frac{1}{4}$W
R8	(common to both units) 15k $\frac{1}{2}$W
RV1, RV5	dual, ganged, 250k linear potentiometer
RV2, RV6	dual, ganged, 250k linear potentiometer
RV3, RV7	dual, ganged, 250k log. potentiometer
RV4, RV8	dual, ganged, 500k linear potentiometer

Note: See text for function of each variable control

C1, C6	0.25 μF 350VW
C2, C7	600pF
C3, C8	8200pF
C4, C9	300pF
C5, C10	3300pF
C11	(common to both units) 0.25 μF 350VW
V1	ECC81 or 12AT7 (heater connected for 6.3V operation)
JK1, JK2	2-pole earth input jack sockets
SW1	3-pole, 3-way, rotary type
Valveholder:	B9A, nylon loaded, skirted and resiliently mounted

Chassis to suit components:
3ft of light, twin-core, screened cable (for wiring pick-up to input socket)
Suitable length of single-core screened cable to connect output of each channel to main amplifier

controls. In this particular design, this has been kept as a separate chassis since all the amplifier controls are on this unit, and can, therefore, be bolted to the control panel of the radiogram, leaving the heavier units such as power pack and main amplifiers to be housed at the bottom of the cabinet. This arrangement is also less likely to suffer from hum pick-up, as the pre-amplifier can be kept close to the pick-up and well away from the mains transformer.

If we now consider the detailed circuit (Fig. 2) we see that a single double triode valve (12AT7) is used. This is purely for economy purposes, and two EF86's connected as triodes would be a slightly better arrangement. One half of the valve is used as a pre-amplifier for the right hand channel and the other half for the left hand channel, each circuit being identical.

Taking one half of the circuit, it can be seen that the pick-up is fed into a 2-pole jack, JK1, on to the "selector switch" SW1. This selector switch arranges that in position "A" the common lead of the pick-up is earthed, and the left and right hand channel leads are connected to their respective grids.

With the cathode resistors R3 and R11 not bypassed, a gain of 26 is obtained (if bypassed by a 50 μ F 12VW capacitor, a gain of 40 is obtained), and the amplified signal is fed via C1 to the tone

control circuits. Network C2, C3 and RV1 forms the treble boost and cut control and R6, RV2, R7, C4 and C5 constitute the bass boost and cut circuits. RV3 is the master volume control, and RV4 the balance control. The tone control circuits introduce a loss of approximately 10 to 1, so that the overall gain of the pre-amplifier is of the order of two. This is adequate since the main amplifiers need only 100mV for full output. The overall distortion of the pre-amplifier circuit is less than 0.2 per cent.

Let us now consider each control and its function in a little more detail.

Selector Switch (SW)

As has been said already this has three positions, "stereo", "mono", and "radio" and a fourth ("tape") can be added if needed.

Treble

RV1, RV5, is a twin-gang, linear, $\frac{1}{2}$ M potentiometer and provides a boost of approximately 10dB and a cut of 10dB, continuously variable (measured at 10kc/s relative to 1kc/s).

Bass

RV2, RV6 is a twin-gang, linear, $\frac{1}{2}$ M potentiometer and provides a boost of approximately 10dB and a cut of 5dB continuously variable (measured at 50c/s relative to 1,000c/s).

Master Volume Control

RV3, RV7 is a twin-gang, logarithmic law, potentiometer, providing simultaneous volume control of each channel. A log law potentiometer is needed here in order to avoid the "fierceness" at the minimum volume position which would result if a linear potentiometer were used.

Balance Control RV4, RV8

This is a twin-gang 500k linear potentiometer, the function of which is to adjust the volume from the two loudspeakers for equal level. In theory, if everything in the amplifiers and loudspeakers were identical, this control would not be needed, but owing to tolerances in components, and room acoustics, this control will be found very useful.

Reverse Stereo

A reverse stereo control has not been fitted. The function of such a control is to reverse the output to the speakers, i.e. to change the right hand channel to the left hand loudspeaker and vice versa, if such a control is considered necessary, a simple change-over switch can be fitted to change over the outputs M and N (Fig. 2) in such a way that, in one position, M can be fed into the right hand channel main amplifier and by reversing the switch into the left hand main amplifier, N is simultaneously changed over in the opposite sense.

Precautions in Wiring

The following points should be considered standard practice in any high quality sound reproducing equipment and if followed, hum and noise will be inaudible.

(Continued on page 54)

A VHF TUNER

By
E. H. Berney

(Continued from page 1122 of the April issue).

THE tuner requires a power supply of about 50mA at 250V and it must be well smoothed. This is rather a large demand to make upon an existing amplifier and so the design includes a built-in power pack, the circuit of which was given in Fig. 2 last month. The prototype uses a 6X5 rectifier but others such as 5Z4, EZ80 etc., will serve equally, the only requirement being that the appropriate heater voltage is available from the transformer. Resistance smoothing is used and the value of R27 may need some adjustment to produce the correct H.T. rail voltage of 250. This resistor must be mounted above the chassis in a position where its heat is easily dissipated; in the prototype it is mounted on a tag strip bolted to the top of the mains transformer. No mains switch is included, the supply being controlled by a switch in the associated A.F. amplifier.

THE
POWER
SUPPLY

Construction of the Tuner

The tuner is a little more complicated than some and the constructor with VHF experience will be at an advantage. It is advisable, generally, to adhere to the layout and wiring given but minor departures are not likely to cause trouble in view of the comprehensive screening below the chassis. The controls, input and output sockets, etc., are in the positions best suited to the service for which the prototype was built but the tuning switch for instance, which is mounted on a bracket underneath the chassis, can be reorientated so as to bring the control out at the front; or if it is desired to keep the long sides clear, the input and output sockets can be repositioned on the deck of the chassis so that the cables plug in vertically. The performance will not be affected so long as the connections are kept short.

It is necessary to observe VHF technique throughout the construction. This means short direct connections, especially in the case of by-pass and decoupling components. It is not necessary to go to extremes but connections should not exceed $\frac{1}{8}$ in. in length unless it is unavoidable. Miniature components should be used, care being taken not to damage them when soldering. An iron of the instrument type, having a bit, about $\frac{1}{16}$ in. in diameter, is the most suitable tool.

Wiring

In the wiring diagrams, Figs. 3 and 4, some of the connections appear rather long because they have been opened out for clarity. In construction, they should be as short and direct as possible, without regard to appearance. One or two of the connections in the oscillator circuit are in fact rather longer than might be thought permissible but in these cases, the inductance of the wire merely adds to the inductive reactance of the circuit and no harm results. Tinned copper wire of 22s.w.g. is suitable for all wiring except the valve heaters, for which 5A flexible p.v.c. covered is recommended. It should be noted that although, in the circuit

diagram—Fig. 1, last month—the aerial was shown with the normal aerial symbol, it is in fact a conventional F.M. dipole. In order to improve stability, the heater and screen pins of V1 should be by-passed to the cathode of the valve, and not to chassis, as in Fig. 1. The value of C19 (which was indistinct in Fig. 1) is 10pF.

It must be emphasised that the wiring diagram (Fig. 3, last month) must not be followed exactly; as is usual at VHF, leads must be as short and direct as possible if instability is not to occur. In Fig. 3, the wiring was shown opened out for clarity, and in particular, the by-pass capacitors, C1, C2 and C4, should be taken to a common point at cathode potential. This common point is by-passed to chassis via C3.

In view of the amount of detailed work required below the chassis, it is an advantage to make a rough wooden box into which it can be placed upside down, suspended by the end flanges. The valve holders should be fitted first, followed by the transformers and electrolytics. The screens should then be made

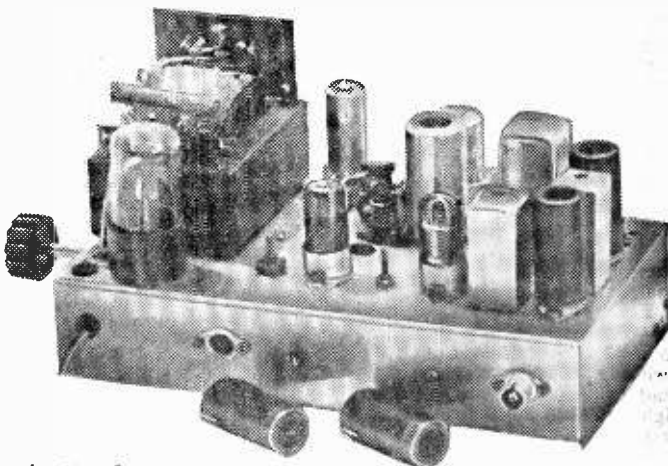

The completed receiver.

and fitted and their positions marked on the chassis; after which they may be removed until construction is practically complete. Commence wiring with the valve heaters and their associated by-pass capacitors, after which work can proceed stage by stage from aerial to output and power supply. Take care to place all components clear of the screen positions. Dropping and decoupling resistors can conveniently be mounted vertically (except for V2a) so that when the screens are in position the H.T. rail can be run round above them to each stage in turn.

Chassis

The tuner with its power supply is built on a chassis measuring 9in. x 5in. x 2in., a plan of which is given in Fig. 5. Aluminium of 18s.w.g. is suitable. Note that the long sides are only 1½in. deep so that there is a space of ¼in. through which air can enter to pass out through the vents provided in the deck for the purpose.

Screens

The dimensions of the screens which are also of 18s.w.g. aluminium, and a plan showing their assembly, is given in Fig. 6. The three pieces should be bolted or riveted together and the whole assembly placed in the chassis and secured in four places with bolts or self-tapping screws; the holes for these are best drilled with the screens in position, through both thicknesses of metal in one operation. Cut-outs are provided in the screens for the three wiring connections which must pass beneath them.

The oscillator coil L3 and the tuning correction network, are mounted above the chassis. No radiation from this source has been detected in the prototype, but if trouble is experienced, the whole assembly should be covered with a light aluminium screen.

Components

Ceramic capacitors are suitable for most positions and are generally to be preferred for their small physical size. C14, 15, 17 and 20 should be silver mica. The electrolytic, C35, must be a wire ended type as neither end is at earth potential, and the working voltage should be not less than 50. C36 and 37 may be one double

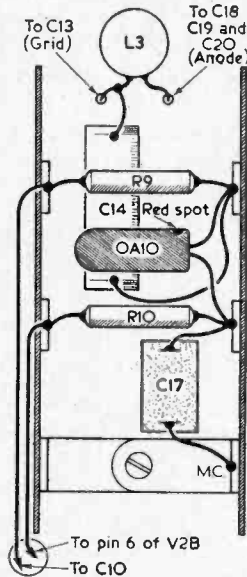

Fig. 4.—Wiring of the oscillator coil and tuning correction assembly.

component if it can be accommodated. The resistors may be all ¼W except R20 (¼W) and R27 (10W). The junction diode, OA10 is an industrial type not usually stocked by component dealers, but is obtainable to order at short notice. The valves should be screened except for V6 and V7.

The Coils

The signal frequency coils are wound with 20s.w.g. tinned copper wire on formers ⅜in. in diameter, having ¼in. dust cores. L1 consists of 3½ turns and L2, 3 turns which should be spaced at slightly more than one wire diameter. The aerial coupling coil on L1 is one turn of 22s.w.g. enamelled wire. The oscillator coil, L3, is 4½ turns of 20s.w.g. with the same spacing on a ⅝in. former with ¼in. core. Details of the windings are shown in Fig. 7. All the windings must be fixed firmly in position with polystyrene cement and it is an advantage to wind the wire first on a slightly smaller former, putting on an extra turn. It can then be transferred to the proper former where it will fit tightly and the turns can be adjusted for number and spacing.

I.F. Alignment

When construction is complete, check first that the correct H.T. rail voltage is present and adjust R27 if necessary. Alignment can then be commenced, after allowing about 15 minutes for warming up. A high resistance D.C. voltmeter is required and also if possible an A.M. signal generator. The procedure is as follows.

Detach the automatic tuning control lead from R21 and solder it to earth in the vicinity. Connect the voltmeter on the 10V range across C35 and inject, at the grid of V4, an unmodulated signal of 10.7Mc/s. Adjust the top core of the ratio detector transformer and both cores of I.F.T.2 for maximum response. The generator signal should be reduced progressively as the circuits come into line so that the meter indication does not exceed 5V. Now connect the meter between point "Z" (Fig. 1) and earth and adjust the bottom core of the detector transformer for zero. This will affect the adjustment of the top core which should therefore be readjusted for maximum. Only a small adjustment should be required.

Now transfer the generator to the grid of V3 and adjust both cores of I.F.T.1. Finally, with injection at V3, check that all cores are properly peaked and that the output at point "Z" is zero. Care is necessary with the bottom core of the detector transformer.

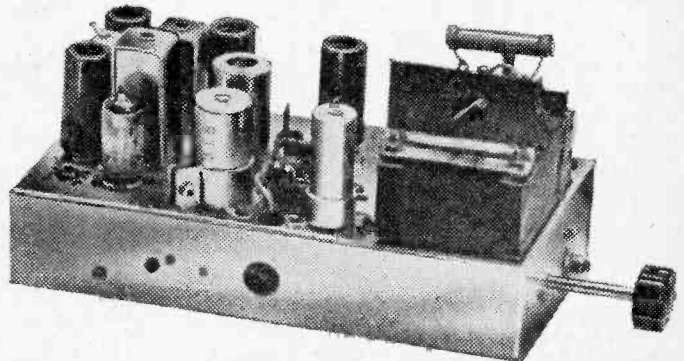

Another view of the tuner.

RETURN-OF-POST SERVICE

We offer a really efficient Mail Order Service on all items stocked. All cash orders are dealt with on the day of receipt. Hire purchase orders are subject to slight delay but this is kept to the absolute minimum.

LATEST TEST METERS

	Cash Price	Hire Purchase Deposit	Mthly/Pmts.
AVO Model 8	£24. 0. 0	£4.16. 0	12 of £1.15. 2
AVO Model 8 with leather carrying case	£27.18. 0	£5.12. 0	12 of £2. 0.11
AVO Model 7	£21. 0. 0	£4. 4. 0	12 of £1.10.10
AVO Model 7 with leather carrying case	£24.18. 0	£5. 0. 0	12 of £1.16.6
AVO Multimeter	£9.10. 0	£1.18. 0	12 of 14/4
AVO Multimeter with leather carrying case	£11. 9. 0	£2. 5. 0	12 of 17/-
Taylor Model 127A	£10. 0. 0	£2. 0. 0	12 of 15/-
CABY A-10	£4.17. 8	£1. 7. 8	3 of £1. 6. 8
CABY B20	£6.10. 0	£2. 0. 0	3 of £1.13. 4

Full details of any of the above supplied free on request.

AMPLIFIER KITS

We have full stocks of all components for the Mullard 612, Mullard 3-3, Mullard 2 and 3 Valve Pre-Amplifiers, GEC 912 Plus. Fully detailed list on any of these sent upon request. Instruction Manuals. Mullard. All Mullard Audio Circuits in "Circuits for Audio Amplifiers", 9/5. GEC 912, 4/6. All post free.

TAPE DECKS

	Cash Price	Hire Purchase Deposit	Mthly/Pmts.
B.S.R. TD2	£8.19. 6	£1.16. 6	12 of 13/7
COLLARO STUDIO	£12.19. 6	£2.12. 6	12 of 19/-

All carriage free
All components in stock for the Mullard Tape "C" Pre-Amplifier Kit. Fully detailed list available.

RECORDING TAPE

DOUBLE PLAY
B.A.S.F. 300ft. (3"), 14/-; 600ft (4"), 25/-; 1200ft (5"), 45/-; 1800ft (5"), 58/-; 2400ft (7"), 77/6.
BRAND FIVE. 1200ft (5"), 37/6; 2400ft (7"), 60/-.
EMITAPE 100. 400ft (3"), 17/-; 1200ft (5"), 45/-; 2400ft (7"), 80/-.
SCOTCH BOY 200. 400ft (3"), 17/-; 1200ft (5"), 45/-; 2400ft (7"), 80/-.
TELEFUNKEN. 1200ft (5"). In plastic container, 40/-; 1800ft (5") in plastic container, 50/-; 2400ft (7"), 75/-.

LONG PLAY
B.A.S.F. 210ft (3"), 9/-; 850ft (5"), 28/-; 1200ft (5"), 35/-; 1800ft (7"), 50/-.
BRAND FIVE. 900ft (5"), 18/6; 1200ft (5"), 23/6; 1800ft (7"), 35/-.
EMITAPE 99. 99/3 250ft (3"), 9/6; 99/3N 250ft (3"), 9/6; 99/9 850ft (5"), 28/-; 99/12 1200ft (5"), 35/-; 99/18 1800ft (7"), 50/-; 99/9 99/12 and 99/18 available in Emitape, 2/6 extra.
SCOTCH BRAND 150. 300ft (3"), 9/6; 900ft (5"), 28/-; 1275ft (5"), 35/-; 1800ft (7"), 50/-.
ALL TAPE POST FREE!

MULLARD CATHODE RAY TUBES

ALL AT THE NEW REDUCED PRICES
We supply both Mullard Radiant Screen (Brand new factory fresh) and Mullard Luminar (Re-builds by Mullard with reclaimed tubes—all other parts brand new). List of types available with prices and hire purchase terms available.

STEREO COMPONENTS

Morganite ganged potentiometers as specified for the Mullard circuits. Log/Anti-Log, 500k, 1 meg., 2 meg. Log/Log, 50k, 250k, 1 meg., 2 meg. Lin/Lin, 500k, 1 meg. All 10/6 each.
Denco Chassis for the Mullard circuits. All drilled with printed front panel. Three Valve Stereo Amplifier Chassis, 22/-; Seven watt Stereo Amplifier Chassis, 24/6. Stereo Pre-Amplifier Chassis, 24/6. Set of switches for Pre-Amp, 34/8. Pick-up cartridges. B.S.R. TC85 £2.4.11. Ronette DC284, £3.19.6. Both are turn-over types for Stereo, LP and 78 records. List of all components for Mullard Stereo Designs is available.

JASON FM TUNER KITS

We supply kits for the Jason FMT1, FMT2 and FMT3 (Fringe) Tuners with variable tuning also the JTV2 and Mercury 2 Switched Tuners with TV Sound. We take great care in the making up of these kits to ensure that every item needed is included and we can confidently claim that our kits are the best and most complete available. We are continually receiving compliments on the quality and above all the completeness of our kits. Prices: Standard Tuners: FMT1, complete kit, £8.19.6. Power Pack kit, £2.12.6; FMT2, complete kit, less power supply, £8.9.6; Kit with power supply, £10.9.6. Fringe Tuner: FMT3, kit less power supply, £10.9.6; Kit with power supply, £12.7.6. FM/TV Switched Tuners: JTV2, complete kit, £15.17.6; Mercury 2, complete kit, £11.7.6. (Important: When ordering JTV2 and Mercury 2 kits it is essential to give TV Channel and FM Stations required on Tuner). All kits are supplied complete with valves and instructions manual. Hire Purchase terms available. Fully detailed lists are available free upon request. Instruction manuals available as follows. Data Booklet for FMT1, FMT2 and FMT3, 2/10. JTV2, 3/10. Mercury 2, 3/10. All post free.

TRANSISTORS

All Brand New — Not Surplus — All post free
MULLARD, OC70, OC71, 14/-; OC72 matched pair, 34/-; OC44, 29/-; OC45, 29/-.
M.A.Z.D.A., XB102, XB104, 10/-; XA101, 23/-; XA102, 26/-; XA103, 15/-; XA104, 18/-.

GRAMOPHONE EQUIPMENT

	Cash Price	Hire Purchase Deposit	Mthly/Pmts.
ALL LATEST MODELS ALL POST FREE			
RECORD CHANGERS			
GARRARD RC210 (C8 PU)	£9.19. 6	£1.19. 6	12 of 15/-
B.S.R. UA14 Monarch (C8 PU)	£7.15. 0	£1.11. 0	12 of 12/-
B.S.R. UA8 Monarch (C8 PU)	£7. 5. 0	£1. 9. 0	12 of 11/4
B.S.R. UA14 Monarch (TC85 Stereo/LP78)	£9.18. 0	£1.18. 0	12 of 13/6
SINGLE RECORD PLAYERS			
GARRARD TA (C8BP)	£9.10. 0	£1.14. 0	12 of 13/-
B.S.R. TU9 (C8 PU)	£4.10. 0	£1. 5. 0	3 of £1.5.0
E.M.I. (Acos Stereo/Mono PU)	£6.15. 0	£1. 7. 0	12 of 10/8
TRANSCRIPTION UNITS			
GARRARD 4HF (C8 PU)	£18. 9. 9	£3.15. 9	12 of £1.7.0
PHILLIPS AG2009	£10.10. 0	£2. 0. 0	12 of 15/8

Many of the above can be supplied for stereo working. See our Gramophone Equipment List for details.

LOUDSPEAKERS

GOODMANS: Axiom 110 10in. £5.0.0; Axiom 112 10in. £8.10.0; Axiom 114 12in. £9.12.1; Axiom 300 12in. £11.5.8; Axiom 400 12in. £18.1.0; Audiom 60 Bass, 12in. £9.12.9; Trellax Tweeter £6.4.0; CX5000 Cross-over unit £1.18.0.
WHITELEY: HF 1016 10in. £7.12.3; HF1012 10in. £4.15.0; HF816 8in. £6.10.8; TN16 8in. £6.3.9; T10 Tweeter £4.4.0; T359 Tweeter £1.13.3; CX3000 Cross-over unit £1.10.0; CX1500 Cross-over unit £1.18.3.
H.P. Terms available.

OUTPUT TRANSFORMERS

GILSON
W0696A, W0696B, 50/6, post 2/-; W0710, W0710/8K, 55/6, post 2/-; W0892, 62/3, post free; W0761, 27/-, post 1/6.
PARTRIDGE
P3667, 52/6, post 2/-; P4014, 98/6, post free; P4131, 60/-, post free; P3391A, 99/-, post free; P5202, P5203, 85/-, post free.
ELSTONE. OT3, 25/-, post 1/6; OT/ML, 45/-, post 2/-.

ILLUSTRATED LISTS

Illustrated lists are available on LOUDSPEAKERS, TAPE DECKS, TEST GEAR, RECORDING TAPES, GRAMOPHONE EQUIPMENT. Any will be sent free upon request.

HIRE PURCHASE TERMS

are available on any item. Repayments may be spread over 3 or 12 months. Details as follows: Three months: Deposit 6/- in the £. Service charge 5 per cent but minimum charge of 10/-. Six and Twelve months: Deposit 4/- in the £. Service charge 10 per cent, but minimum charge 20/-.

TERMS OF BUSINESS

Cash with order or C.O.D. We charge C.O.D. orders as follows. Up to £5, minimum 2/8. Over £5 and under £5, 1/6. Over £5 and under £10, 1/8. Over £10, no charge. Postage extra on CASH orders under £3 except where stated. Postage extra on Overseas orders irrespective of price.

WATTS RADIO
(MAIL ORDER) LTD.

54 CHURCH STREET, WEYBRIDGE, SURREY

Telephone: Weybridge 4556

Please note: Postal business only from this address

Armstrong Quality Tuners

T4 FM TUNER (illustrated) 19 GNS.

A high fidelity VHF tuner which is designed to match any amplifier or tape recorder. Incorporating features normally found only in the most expensive tuners it represents outstanding value at its price. It is completely stable with no trace of drift and A.F.C. provides broad easy tuning. A polished wood cabinet (£2.16s.0d.) is available for those who require a separately mounted tuner.

- Self powered
- Full VHF band (87-108 m/cs)
- Automatic frequency control
- Cathode follower output
- Variable output 0-500 mV
- Multiplex output for stereo radio adaptor
- Separate 75 ohm and 300 ohm aerial inputs

Post this coupon for free descriptive literature or call at your High Fidelity dealer or our Holloway showroom for demonstration. Open 9-5 including Saturdays.

NAME _____

ADDRESS _____

PMT

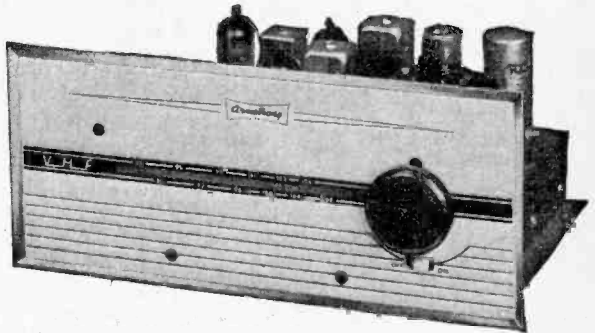

ST3 Mk. 2 AM/FM TUNER 27 GNS.

A self-powered high fidelity tuner which covers the VHF, medium and long wavebands. It includes all the features of the T4 tuner and is similar in styling and is also designed to match any amplifier or tape recorder. On AM bands the ferrite aerial and unique 2nd IF stage ensure good Continental reception and there is a bright-line indicator for easy tuning.

The name ARMSTRONG is the registered trade mark of ARMSTRONG WIRELESS & TELEVISION Co. Ltd. Warlters Road, London N.7. Tel: NOR 3213

New from REPANCO

1—THE "JOURNEYMAN" A SIX TRANSISTOR PORTABLE RECEIVER

- ★ MEDIUM AND LONG WAVEBANDS
- ★ POSITION FOR CAR RADIO AERIAL
- ★ PRINTED CIRCUIT WITH COMPONENT NUMBERS MARKED
- ★ PUSH-PULL OUTPUT
- ★ FERRITE SLAB AERIAL

Step by step instructions. 1/6, post 3d.

2—COMPONENT PACK No. 3

CONTAINS REPANCO COMPONENTS FOR THE "JOURNEYMAN". FS30, 5 $\frac{1}{2}$ in. Ferrite Slab Aerial, two XT26's 1st and 2nd IFT's XT27 3rd IFT, XO28 osc. coil, all pre-aligned, TT29, single ended push-pull driver transformer, printed circuit and aerial fixing bracket. £2.15.6.

3—MINI-4. A REMARKABLE FOUR TRANSISTOR SUPER-HET POCKET RECEIVER

- ★ MEDIUM AND LONG WAVEBANDS
- ★ SIZE OF CASE 5 $\frac{1}{2}$ x 3 $\frac{1}{4}$ x 1 $\frac{1}{4}$ in.
- ★ AUTOMATIC GAIN CONTROL
- ★ 2 $\frac{1}{2}$ in. LOUDSPEAKER
- ★ 3RD IFT REFLEXED AS AUDIO DRIVER

Easy Wiring Plans and Step-by-Step Instructions. 1/6, post 3d.

4—COMPONENT PACK No. 2

CONTAINS REPANCO COMPONENTS FOR THE MINI-4. FS39, Ferrite slab aerial, two XT26's, 1st and 2nd IFT's, XT27 3rd IFT, XO28 osc. coil, all pre-aligned. TT5 transformer group board, switch and speaker pillars. £2.7.6.

5—SHORT WAVE TRANSISTOR COILS.

All coil litz wire, enclosed in high frequency Ferrite pots and tuned with Ferrite cores. Can size $\frac{1}{2}$ in. sq. x $\frac{1}{4}$ in. Send S.A.E. for Full Details. 10/- each.

Mail Order and Trade:
RADIO EXPERIMENTAL PRODUCTS LTD.
33 Much Park Street.,
COVENTRY
Tel.: 27114

Wholesale Inquiries and Export:
COVENTRY
O'Brien's Buildings,
203-269 Foleshill Rd.,
COVENTRY
Tel.: 24224

SPECIAL FOR THE "HAMS" RADIO STATION

Illustrated

$\frac{1}{8}$ inch detachable bit
soldering instrument
List No. 70

Combined Protective Unit
with Wiper/Abrasion Pad
and Solder Reel
List No. 700

Apply SALES & SERVICE

ADCOLA
(Regd. Trade Mark)

**GAUDEN ROAD
CLAPHAM HIGH ST.
LONDON, S.W.4**

Telephones:
MACaulay 4272-3101

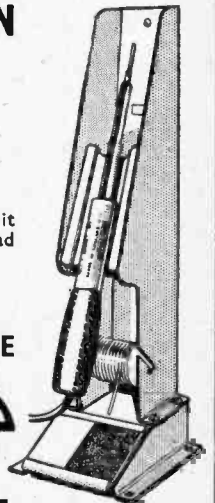

British & Foreign
Patents. Registered
Designs, etc.

Telegrams:
"SOLJOINT, LONDON"

Alignment Without a Generator

The tuner can be aligned satisfactorily without a signal generator but this should not be attempted in areas of poor signal strength unless pre-tuned transformers are used. Connect a good aerial and proceed first as already described for adjustment of the oscillator. When any transmission is heard, tune it for maximum strength on the voltmeter by adjusting the I.F. and detector cores; adjust the bottom core of the detector transformer as already described. The meter indication must be kept below 5V and it will be necessary to attenuate the signal in some way as the circuits come into line, as for instance, by connecting a less efficient aerial. The signal frequency circuits can be aligned in the same way, using the centre frequency transmission in place of the generator signal. If pre-tuned transformers have been used, the adjustment will be limited to those necessary to compensate for differences in stray circuit capacities and will be quite small as a rule.

If pre-tuned transformers have not been used, the operation is more difficult but may nevertheless be achieved if a good aerial and a strong signal are available. First make sure that V2a is oscillating. A rough approach can then be made to alignment by setting L1 core almost fully engaged and L2 about a quarter engaged; both cores of I.F.T.2 and the bottom core of I.F.T.1, $\frac{1}{4}$ in. deep in the formers and the top cores of I.F.T.1 and the detector transformer $\frac{1}{2}$ in. deep. Ignore the bottom core of the detector

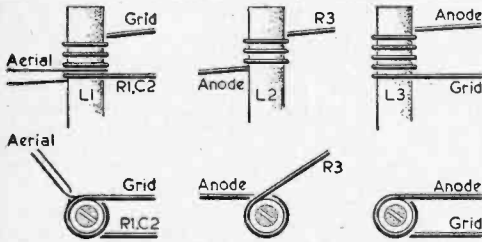

Fig. 7.—Construction of the coils.

transformer at this stage. Connect an aerial and amplifier and with the volume control fully advanced, search for a transmission by manipulating the core of L3. Some perseverance is necessary and the signal when received will probably be weak and distorted, but it can be "nursed" by careful core adjustment until it registers on the meter, when alignment can proceed as described before. The intermediate frequency arrived at in this way will not be accurate but provided all the cores are properly peaked and the output at point "Z" is zero, the discrepancy will be of no consequence.

Drift Test

The automatic frequency control is capable of maintaining accurate tuning over a wide range but it will be appreciated that if the thermal drift of the oscillator is excessive, there will be difficulty in "locking on" to the new transmission when the tuning switch is operated. In the extreme case, the receiver will "hunt" between adjacent transmissions. If this trouble is experienced, carry out a drift test as follows.

Detach the control line from point "Z" and connect it to earth. Solder a short length of wire to point "Z" for connecting the voltmeter and place the tuner

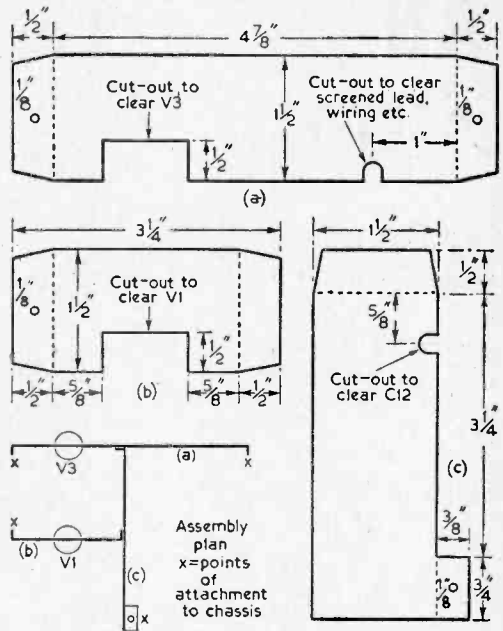

Fig. 6.—Details of the screens and their assembly.

right side up on the bench to simulate service conditions. Set the tuning switch to receive the lowest frequency transmission, switch on and tune the transmission accurately for zero on the meter by manipulating L3 core. Observe the meter at 15-minute intervals thereafter and note whether the correction of drift requires an increase or decrease in the inductance of L3. If it is an increase, the negative co-efficient in the parallel combination C19, C20 must be reduced; if a decrease, it must be made larger. Whatever alteration is made, the total capacitance of the combination should be maintained within the limits 20-24pF. Exact compensation is not necessary.

Operation

Many constructors will no doubt install the tuner in a cabinet with other equipment. Reasonable ventilation is necessary and space is required to bring the tuning control to a convenient operating position together with some means of programme identification. A simple pointer knob will serve for this, but, if desired, spare contacts on the tuning switch may be used to control indicator lamps. Suitable lamps for this purpose are the 6V 0.04A type as used for cycle dynamo rear lights.

Aerial

Within the primary service area of the transmitter, a "picture rail" aerial will usually suffice. This can be formed from a length of flat twin flex by parting the conductors over a length of 2ft 6in. and extending them along a picture rail etc., to form a rough dipole 5ft long, the remainder of the flex being used as a down lead. At greater distances, or in poor reception conditions, a loft mounted dipole with reflector is recommended.

AN AUDIO BOOSTER STAGE

By R. Murray-Shelley

INCREASING THE SENSITIVITY OF AN AMPLIFIER

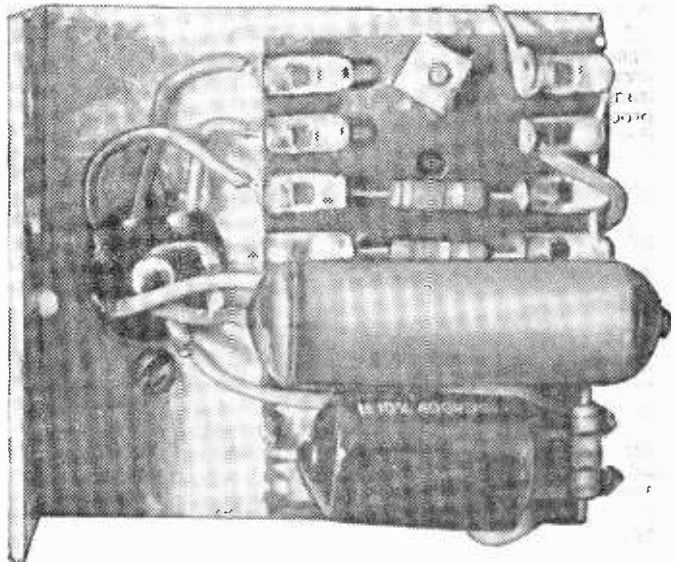

ALTHOUGH this unit was designed in the first instance to increase the output which could be obtained from a tape recorder amplifier, it can be used to give a very worth-while increase in sensitivity to almost any amplifier into which it is connected.

The Circuit

The circuit was designed to be as simple as possible, consistent with good results. It is not intended to produce the maximum gain which can be obtained from the valve used, since too much gain only results in overloading of the output stage of the main amplifier with resultant distortion. It will be seen that a single valve is used, a 6AT6, which is a double diode triode, and which fits a B7G base. In this case the diodes are not used and are connected to the chassis. The choice of valve which may be used is by no means limited, and almost

any small triode such as a 6C4 or EC90 will give good results.

Noise

Decoupling of the anode of the valve does much to reduce hum, and the omission of a cathode bypass condenser introduces a measure of negative feedback over the stage, which, though reducing the effective gain of the circuit, adds to its stability and reduces any distortion which may be introduced by the unit.

The resistor, R4, was introduced to attenuate the output of the unit further, since the gain

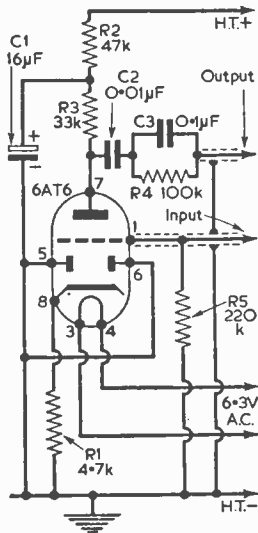

Fig. 1 (left).—The basic circuit of the booster unit.

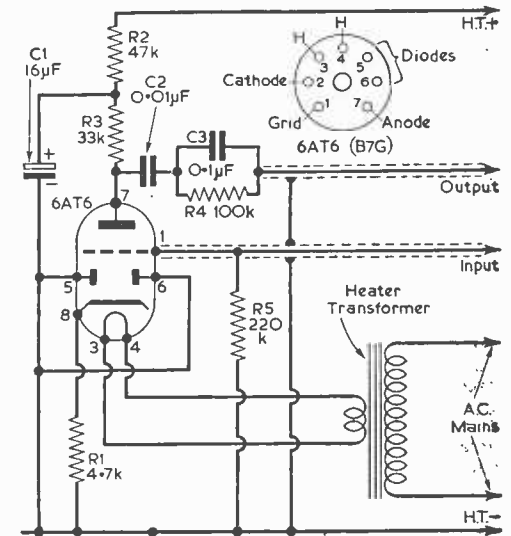

Fig. 2 (right).—A modified circuit for A.C./D.C. amplifiers.

was found to be greater than that which was required, and with C3, it adds a degree of treble boost to the output. This was found to be necessary in the particular application for which the booster was designed. The inclusion of R4 and C3 is entirely optional, but if these components are omitted it is then considered advisable to include a 10 or 20k resistor between C2 and the grid of the output valve.

Power Supplies

The power requirements of the unit are very modest, 250V D.C. are required at only 1 or 2mA with 6.3V at 0.2A for the valve heater. This power can usually be taken from the amplifier which is being modified. High tension power can very often be easily located at the main smoothing condensers on the amplifier side of the smoothing choke or resistor, or, alternatively, at the output transformer primary. The heater supplies can usually be obtained at the heaters of the valves already present. The heater wiring can be readily identified, since in most cases it consists of a pair of tightly twisted wires—this twisting is intended to reduce the hum produced by induction caused by the A.C. carried in the heater wires. The heater connections are often coloured brown to the BSI specification.

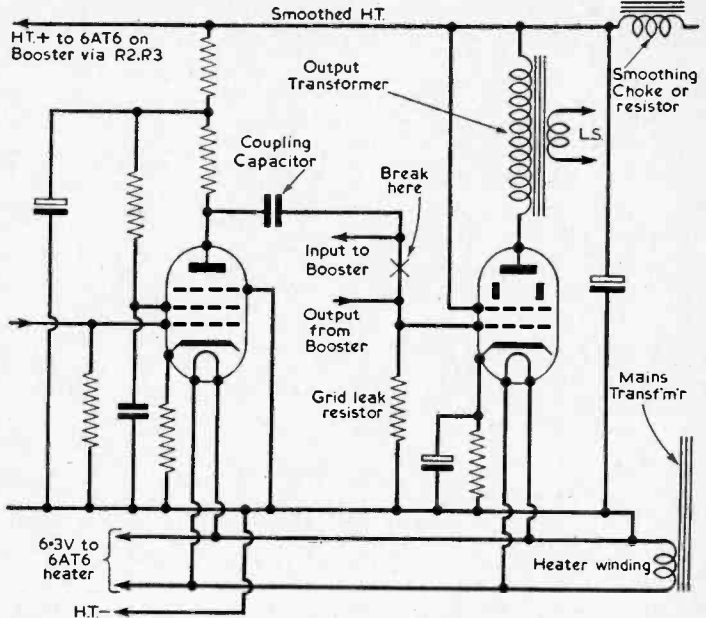

Fig. 3.—The circuit of a typical amplifier, showing the booster unit connections.

control. The high tension supplies are, as before, taken from the main amplifier.

Construction

The unit was, in the writer's case, constructed on a small aluminium sub-chassis, size 2½in. x 2½in., with a 1in. deep flange on the shorter side. The components are mounted on a tag board, which must be insulated from the chassis, and the result is a small compact unit which can be mounted in any convenient position, either on or near to the existing amplifier.

There are six connections which must be made to the unit, two for the heaters, one each for the high tension positive and negative, and for the signal input and output to the unit. Screened lead should be used for the input and output connections to the chassis, the screening being bonded to the H.T. line. The chassis on which the unit is built should be bonded to the chassis of the original amplifier.

Fitting

When fitting the unit in place, only one connection in the main amplifier should be cut. This is the existing feed to the control grid of the output valve. A valve data book is invaluable when locating the control grid pin on the output valveholder. In case such a book is not available, the grid may easily be located in the following manner:—using an insulated screwdriver, touch each of the tags of the valveholder in turn with the blade. On touching the control grid, a click will be heard in the loudspeaker. One should be careful not to short any of the tags to each other or to the chassis when making this test. The unit

COMPONENTS LIST

- V—6AT6 valve
 R1—4.7k
 R2—47k
 R3—33k
 R4—100k
 R5—220k
 C1—16μF 350 VW (electrolytic)
 C2—0.01μF 500 VW
 C3—0.1μF 250 VW
 BTG valveholder, tag board etc.
 Heater transformer—Primary to suit A.C. mains; Secondary 6.3V, 0.5A

Note: With A.C./D.C. receivers, an earth must not be used and the mains should be wired so that the neutral lead is connected to the chassis.

The unit that has been considered so far may only be used on amplifiers which have parallel connected heaters, since amplifiers with series heaters, or having A.C./D.C. types of circuit are not capable of supplying the necessary heater current. The same unit may, however, be used with this type of amplifier, the only modification to the design that is then necessary, is that a small heater transformer must be provided. The modified circuit is shown in Fig. 2. The primary of the transformer must then be connected to the A.C. mains on the set side of the mains switch. This switch is usually carried on the volume or tone

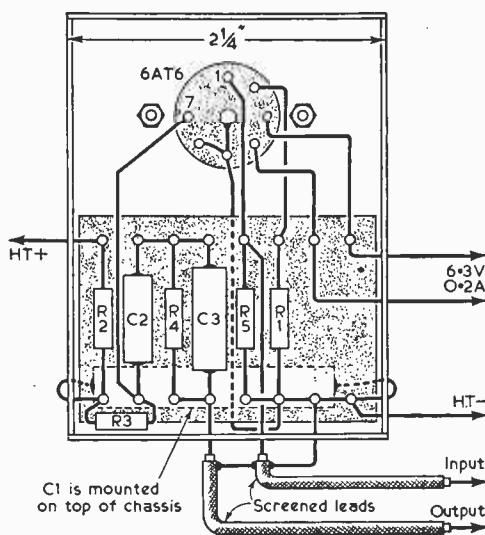

Fig. 4.—The wiring diagram of the unit (see Fig. 1).

THE P.W. SIGNAL GENERATOR

(Continued from page 27)

Make C_c about 20pF and switch on the R.F. oscillator with the modulation switch off. Rotate the condenser. Heterodyne whistles should be heard. If they are not heard, the valve is not oscillating and the circuit must be rechecked.

The whistles are high pitched and each reduces in pitch and then increases again as the condenser is rotated. Pick out the whistle (actually, a pair of whistles) which is obviously the loudest. This oscillator will then be at 200kc/s when the zero pitch position is reached. The vanes of the oscillator tuning condenser should be about half-way in. Calibration will be carried out later.

In parts of Southern England, very near the Channel, it may not be possible to pick out the whistle corresponding to 200kc/s. This does not matter much at this stage, but if the receiver is selective enough, and tuned to one station only, there will be no doubt.

To the beginner, who has not used a signal generator before, this exercise is of great interest and he should spend many hours experimenting and trying to work out what station is causing each heterodyne (there are about 16 or so stations broadcasting on the L.W. band, the Moscow transmitter being the most powerful on 173kc/s).

Testing the Modulation

Without an oscilloscope it is not easy to check the depth of modulation or the waveform. The best test for the beginner to apply is as follows. Tune the receiver to a position on the long wave band where no station is received. Switch on the R.F. unit modulation switch. Rotate the tuning condenser and one position will be found where the modulation note will come over the receiver loudly. If the receiver is calibrated you can tune in either end of the receiver band and thus gain

should then be connected as shown in Fig. 3. The existing output valve grid leak resistor should be retained as shown.

Components

All resistors should be of $\frac{1}{4}$ or $\frac{1}{2}$ W rating. The coupling condenser, C2, should be a new component of high voltage working, and beyond question as regards leakage. A nylon-loaded valve-holder should, if possible, be used for the 6AT6 valve. The connections to the unit itself are shown in Fig. 4.

Using with a Record Player

This additional stage is also very useful for boosting such small amplifiers as are found in many small record reproducers now on the market. The amplifiers in these consist in most cases of only one valve having a high slope, such as an EL84 or, more commonly, a UL84. Connections in this case are made as before, only now the pick-up is connected to the input. When the booster is used in such circumstances, R5 should be increased to 470k.

Uses for the unit can also be found in boosting the audio stages of radio receivers, etc. The same unit can also be used as a microphone pre-amplifier. (In this case, R5 should be increased to 470k, and R3 to 100k.)

an idea of the spread of the wave lengths over the oscillator condenser control (dial not yet fitted).

Remaining Wiring

Now that it has been established that the oscillator and modulator circuits work using coil L1, the remaining coils, L2, L3 and L4, may be wired in circuit together with the switch S8/9. All wiring is shown clearly in Figs 9 and 10. Note that all coil top leads are "G" and bottom leads—all earthed—are "E".

Coils L3 and L4 must have short leads taken exactly as shown, or the ranges obtained may be incorrect.

When wiring is complete, re-test L1—with S8/9 at position 1.

A COMPACT ADD-IN B.F.O. UNIT

(Continued from page 29)

but if the signal from the B.F.O. is too strong, weak C.W. signals will be lost.

The B.F.O. control switch can be mounted at any convenient point. If the B.F.O. signal is kept down, it will not have any significant effect on the AVC system of many receivers. But if the AVC system is very sensitive (e.g. has little or no delay voltage) the B.F.O. signal will bring the AVC circuit into action, and reduce signal strength of stations tuned in. A trial will soon show if this is happening. If it should be found to arise, an AVC switch should be fitted. This may be ganged with the B.F.O. switch, or may be separate. It renders the AVC circuit inoperative by shorting the AVC line to the receiver chassis. With slow C.W., such a switch is also helpful, as it prevents the receiver trying to follow the C.W. signals, and thereby giving bursts of increased volume after each interval.

The P.W.

THE F.M. SECTION

F.M. Tuner Construction

Strip the insulation from the lead-out wires of the transformer T3 and mount this component on to the board. The component locations printed on the board should be followed and the appropriate components inserted and soldered.

Some slight modifications have been found advantageous in this section of the receiver since the

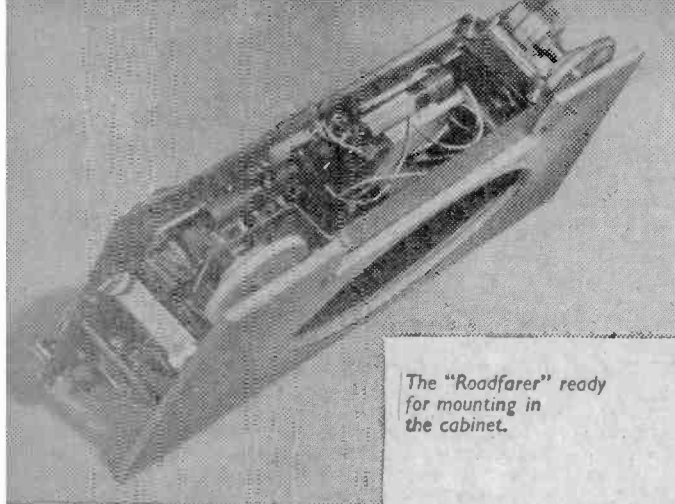

The "Roadfarer" ready for mounting in the cabinet.

THE F.M. tuner employs a 2N502 VHF transistor which is capable of amplification up to frequencies of several hundred megacycles per second. Because of the cost of this type of transistor, conventional circuitry becomes very expensive and the circuit chosen uses only the single transistor to carry out the functions of R.F. amplification, demodulation of the F.M. signal and also A.F. amplification. This is achieved by using a super-regenerative circuit. Whilst basically unconventional, the functioning of this circuit is relatively simple.

Battery Mains Power Unit

The power unit consists of a subminiature mains transformer, T4, with a tapped primary for mains voltages from 200 to 250. The secondary is centre-tapped to give full wave rectification using two semi-conductor diodes D2 and D3. Because of the extremely fast response time of semi-conductor diodes they must be protected against switching surges. This is achieved by including the resistance-capacity network C34/R25.

prototype design, which is shown in the blue-print was completed. A resistor of 680Ω has been substituted in place of the coil L9, and the value of C26 altered from $0.04\mu\text{F}$ to $10\mu\text{F}$. The value of resistor R24 has been increased to 8.2k and the value of R26 reduced to 10k. For ease of tuning C24 has been increased to 5pF. The telescopic whip aerial has been found to give excellent results without the use of the loading coil L7, and the value of C33 has been reduced to 1pF.

Having mounted the components shown on the printed board, the tuning capacitor C25 may now be fitted. Having ensured that the capacitor is correctly positioned, the fixing nut should be secured. A short length of tinned copper wire should connect one of the rotor solder tags of C25 to one end of C32. This is clearly shown in the illustration of the tuner unit, given on the blue-print. The coil L4 should now be mounted using two 6B.A. screws for fixing. Solder the capacitor C28 across the terminations of this coil; one end of the coil terminates on the upper tag ring and one end on the lower tag ring. A short length of tinned copper wire should be connected from the

coil termination on the lower tag ring, to the hole marked "Z" on the printed board; this hole is near one of the coil former fixing holes. The capacitor C24 should now be soldered across the tuning capacitor which has already been fitted. It is vital that this capacitor and all other components in this section are mounted exactly as shown in the blue-print. The tuning coil L3 should now be fitted across the tuning capacitor in the position shown. The coupling coil L8 may also be soldered into position. The end of the coupling coil which



Rear view of the "Roadfarer".

“Roadfarer” A.M./F.M. Portable

fits in the aerial socket must at this stage, be left free until the socket itself has been fitted. The VHF transistor TR7, type 2N502 should now be soldered into position. This high performance transistor should be soldered with extreme care and under no circumstances should the lead wires be overheated since this will, immediately, either destroy the transistor or impair its properties. Each wire as it is being soldered should be held with a pair of long-nosed pliers which will act as a heat shunt and so prevent damage to the transistor by

Once TR7 has been fitted the capacitor C27 may be soldered into position as illustrated. Again, when soldering one end of C27 on to the other terminating tag of the coil L4, to which the emitter of TR7 is already soldered, considerable care should be taken not to overheat the transistor lead.

One end of the telescopic aerial coupling capacitor C33 should now be soldered to the pillar of the tuning capacitor C25 as illustrated. The tuner is now complete except for the aerial connections which are made after mounting the front baffle.

Power Unit Construction

Mount the voltage selector panel using two 4B.A. fixing screws. Now insert the mains transformer, T4, into the board, bend over the fixing lugs and solder to the copper circuit. Before soldering, check that the transformer has been fitted the correct way round. From the side of the transformer nearest the heat sink for the amplifier, three wires emerge and these should be passed through the appropriate holes in the board and

soldered. From the other side of the transformer four leads will be found. The brown lead should be inserted into the appropriate hole in the board and soldered. The three remaining leads should be connected to the voltage selector panel, the colours being located as shown. The two rectifier diodes D2 and D3 should be bolted to the board using the two 4B.A. nuts and washers provided. The solder tags should be fitted to the screw terminals and a short length of tinned copper wire soldered between each tag and the hole in the board directly beneath each tag. The resistor R28, capacitor C34 and C21 should now be fitted. Mount the fuse holder securely in position.

Next Month: Alignment

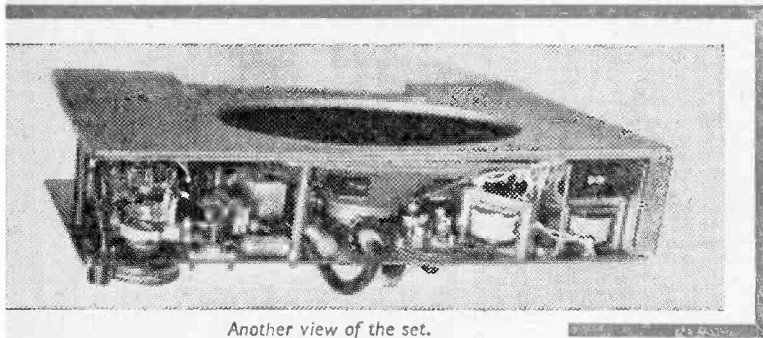

Another view of the set.

overheating. In spite of this precaution the soldering of the leads should be carried out as rapidly as possible. *The importance of the foregoing warning cannot be overstressed and the constructor is well advised to exercise the utmost care when dealing with this particular transistor.*

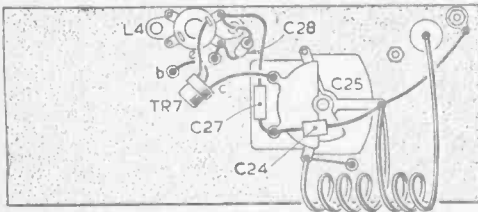

Fig. 1 (above)—The revised F.M. unit wiring (changes from the prototype wiring given on the blueprint are shown).

Fig. 2 (below)—The mains transformer wiring.

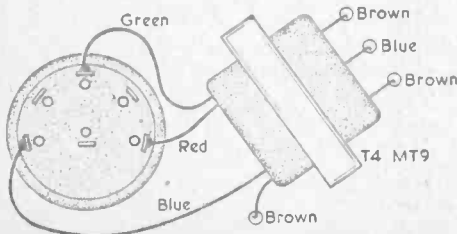
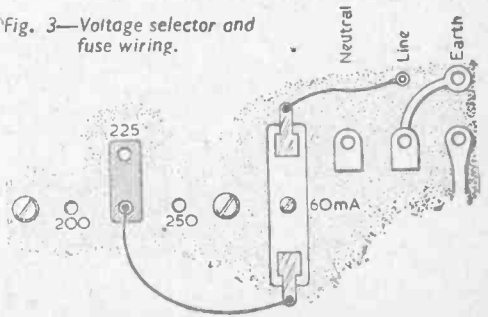

Fig. 3—Voltage selector and fuse wiring.



A SWITCH TUNED TRF RECEIVER

TUNING PROCEDURE AND POSSIBLE MODIFICATIONS

By J. Harrison

(Continued from page 1072 of the April issue)

ALTHOUGH it was stated last month that this receiver employed the "live chassis" technique, the power supply circuit given below incorporates a transformer which has a separate winding for the H.T. The mains is thus isolated from the chassis and the receiver is safe to handle, there being no possibility that the chassis will be live. The transformer should have a tapped mains primary and supply 6.3V at 2A and 200-250V at about 60mA.

Tuning Procedure

The tuning of the receiver is quite simple, the following procedure being followed. A length of wire, as long as possible, is connected via a 100pF capacitor to the anode of V1, to act as a temporary aerial. The trimmers C6, C7 and C8 are then adjusted to receive the stations chosen for the switch positions. The temporary aerial is then removed and the trimmers C1, C2 and C3 adjusted to give the maximum output in each case. Fine adjustments are then made to the detector trimmers to compensate for the removal of the capacity of the wire aerial. After the final adjustments are made, each trimmer is locked by applying a dab of paint to its screw.

Performance

The receiver constructed gives reception of the local medium-wave Home and Light services of the BBC with more than adequate volume, it being possible to overload the output valve if the gain is advanced too far. The audio output of the final valve under these conditions is about 4W. However, it is difficult to estimate how much of this is radiated by the small speaker.

The receiver has been tuned to receive the Radio Luxembourg transmitter with the switch in its fourth position, which it does quite efficiently when propagation conditions are good. The lack of any form of AVC does, of course, render reception of this station a little erratic. It has also been used to receive various other transmissions, among the more successful being the BBC Third

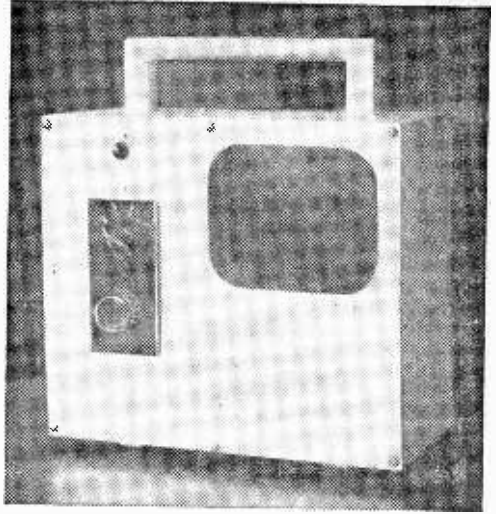

programme and the Hilversum programmes. The use of a ferrite rod aerial has resulted in the receiver being somewhat directional. In use, therefore, it has to be turned into the position which gives the greatest output.

The complete apparatus, in its case, weighs about 8lb, which is quite light enough to be moved frequently from one room to another.

The consumption of power from the mains is of the order of only 25W, and thus, the cooling is quite adequate.

Possible Modifications—Addition of Further Switch Positions

There is no reason at all why a receiver of this type should not be constructed with more than three pre-set tuning positions. All that would be necessary for this modification would be the provision of a four-pole switch with as many ways

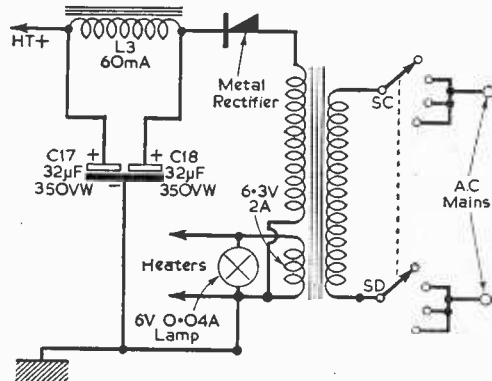

Fig. 7.—The circuit of the power supply. (Although the transformer specified last month was adequate if the "live chassis" technique were to be employed, this circuit shows a transformer with an H.T. secondary winding which enables the receiver to be isolated from the mains supply.)

as required, and two trimmers for each position.

If extension beyond five stations is contemplated, it must be remembered that the cost of the switching assembly and the amount of space which it will occupy will become inconveniently large. A double-gang variable capacitor with padding and trimming capacitors would probably represent a better solution.

Addition of Long-wave Switch Position

The receiver which has been described was intended for use in London, where the reception of the medium-wave Light programme is quite satisfactory. In some districts this would not be the case and it would be necessary to provide for reception of the Light programme transmission at 1500m. It would not be possible, in practice, to do this by providing very large capacities to tune the existing coils and a larger inductance would have to be incorporated in the aerial and detector coils. It is possible, at the cost of a loss of sensitivity, to switch in the extra inductance by using the existing switch arrangement. This method was shown in Fig. 6. The long-wave winding should consist of 130 turns of Litz wire, pile wound on the short length of ferrite rod exposed between the end of the medium-wave winding and the receiver chassis. This is not a good method of providing the extra range since there is bound to be a loss of sensitivity and selectivity and there

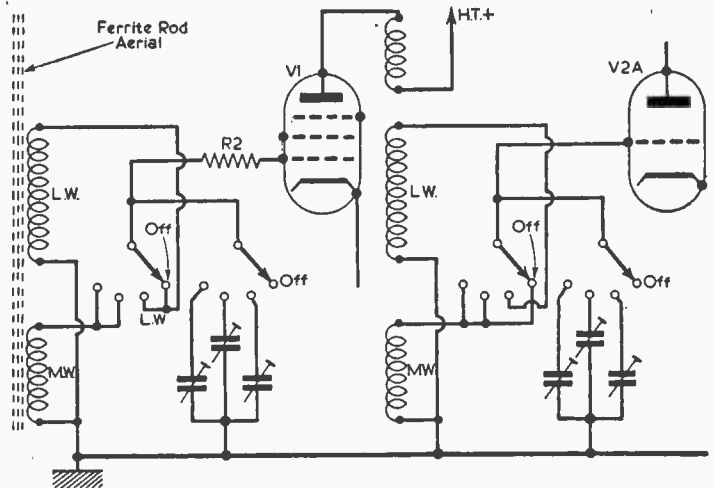

Fig. 8.—A circuit more satisfactory than that of Fig. 6 (last month) for reception of one L.W. station. Two extra switch wafers are required.

may be some cross-talk between the ranges. A much better method would involve the use of extra switch wafers. Such an arrangement is shown in Fig. 8.

Use of a Larger Speaker

This circuit is capable of giving an audio output of high quality and so it might be considered worth while using a larger speaker unit. This would, however, defeat one of the original objects of the design, which was to keep the cost as small as possible. If a suitably loaded 8in. or 10in. unit were available, it would be worth while improving the bass response of the A.F. amplifier by increasing the values of C11 and C12 from 0.01μF to 0.1μF.

Alternative Valves

If the following valve substitutions were made, no modifications to the circuit would be necessary, other than changing the value of the cathode bias resistor of the output valve.

V1	V2	V3	R12
EF36	6SQ7GT	6V6	220Ω
(EF50)	6SU7GT	KT63	410Ω
(SP61)	6SL7GT		

Any combination of these valves could be used and many other types are suitable, but it must be remembered that the total heater current drawn by them is likely to be greater than that needed originally. The rating of T2 must therefore be adjusted accordingly.

Note: The values of capacitors C4 and C14 (see Fig. 1, last month) should be increased from 0.01μF to 0.1μF to increase stability and bass response.

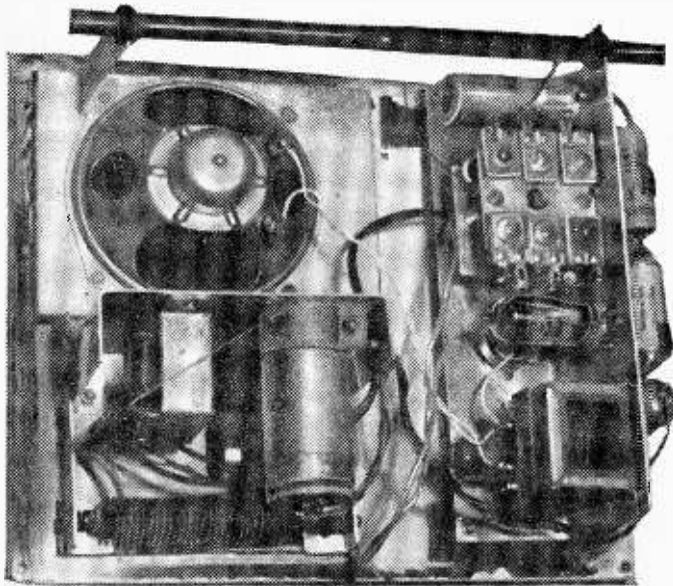

The construction of the receiver.

Transistor Characteristics

A SERIES OF TESTS, WITH WHICH THE READER MAY OBTAIN HIS OWN SET OF RESULTS

By P. Westwood

IN completing the following series of tests to obtain the characteristics of a transistor, the author has attempted to include all details which will enable the reader to carry out similar experiments with a minimum of basic instruments. The results are analysed and some guidance is given to enable appreciation of the various points which arise.

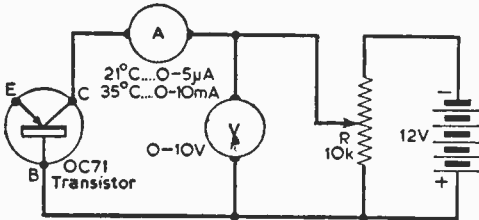

Fig. 1.—The collector-diode test circuit.

When considering a junction transistor; e.g. an OC71, in common base configuration, it can be looked upon as two distinctly separate emitter-base and collector-base diodes representing the "input" and "output" of the transistor. In this sense, their separate characteristics can be obtained with the following apparatus (which will not be beyond the scope of the average enthusiast): one microammeter having a maximum

TABLE I

Transistor Temperature			
21°C		35°C	
Collector P.D. (-V)	Collector Current (µA)	Collector P.D. (-V)	Collector Current (mA)
0.1	1.8	0.1	6.4
0.15	1.88	0.15	6.75
0.2	1.89	0.2	6.8
0.25	1.9	0.25	6.81
0.5	1.9	0.5	6.89
0.75	1.9	0.75	6.9
1.5	1.93	1.5	7.0
2.0	1.94	2.0	7.0
4.0	1.98	4.0	7.0
6.0	2.0	6.0	7.0
8.0	2.05	8.0	7.05
10.0	2.075	10.0	7.1

Collector-diode results

reading of about 5µA, and two millimeters which will indicate fairly accurately small currents up to 10mA, a multi-range voltmeter, and a few potentiometers and batteries as shown in the circuit diagrams.

Determination of the increase in collector current for increases in applied voltage.

The circuit should be wired as shown in Fig. 1 and the following point noted. The polarity of the battery is such that the negative side is connected to the collector. It cannot be stressed too strongly that in all transistor experiments, correct battery connections are essential if permanent damage to the transistors is not to result. It is suggested that, at this stage, a table be drawn up for entry of the results which should, if possible, include the temperature of the transistor at the start of the experiment, i.e. room temperature. The significance of temperature will be realised later.

The collector-base P.D. should now be increased in small steps to a suggested maximum

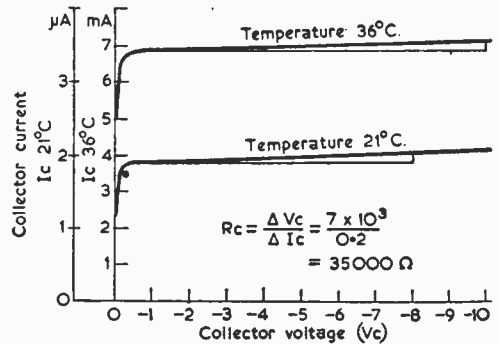

Fig. 2.—Collector-diode curves.

for this particular transistor of 10V. Each time an increase is made the readings of both instruments should be recorded. Before disconnecting, the whole procedure should be repeated with the transistor held tightly in the palm of the hand, which will cause a temperature rise of about 15°C. From the new results thus obtained, together with the original set, collector-diode characteristic curves can be constructed as shown in Fig. 2. From these, several important facts emerge; firstly, the curves can be recognised as being similar in shape to those of a pentode valve, which immediately suggests that the collector-base "slope" resistance is very high. In other words, a small change of collector current will cause a large change in collector voltage. Further, it has been shown that when the temperature of a transistor is increased by approximately 15°C, the collector current increases by some four times

that for the same given collector voltage. This illustrates the need for the use of "heat sinks" to dissipate any excessive heat which may be built up. No doubt the reader is already familiar with the many simple types which are used in commercial equipment.

Emitter-Base Characteristics

If we now rewire the test circuit so that it corresponds to that shown in Fig. 3, we can, by taking a few simple readings, obtain sufficient information to plot the emitter-base diode characteristics. Eight or nine steps of voltage

To carry out this part of the experiment we increase the emitter-base voltage until the milliammeter in that part of the circuit reads 1mA. The collector voltage rheostat should be adjusted to give a reading of (-5)V. Maintaining the emitter current at 1mA, the collector P.D. is reduced in steps of 1V until zero potential is reached. At each stage, as before, all instrument readings are recorded. The whole procedure should be repeated using fixed emitter currents of 1 to 4mA. If the method still appears a little hazy to any reader, examination of the results table will give a clearer picture of what has been done.

The characteristic curves of collector current against collector voltage, constructed from the table of results we have just drawn up, show clearly that when the emitter is no longer left disconnected, the collector current is not of the order of a few microamperes as previously found, but has increased considerably, and within the limits of the accuracy of the measuring instruments used, would appear to follow the value of the fixed emitter currents: when an emitter current of 2mA was flowing we found that the collector current was also 2mA and remained constant at that figure even when the collector potential was reduced from (-5V) to (-1)V. It can be seen that under "diode" conditions (-5)V produced a current of only 2μA, and now, with a zero collector potential, this figure is considerably exceeded. It is quite obvious that under the new test conditions we have set up, the

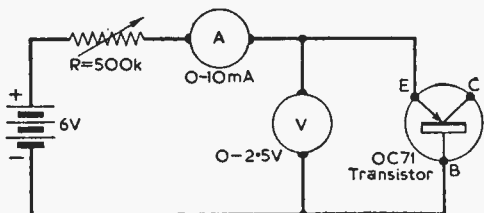

Fig. 3.—Emitter-diode test circuit.

increase with their corresponding current readings are sufficient, as is indicated by the writer's table of results. By taking the slope of the characteristic curve constructed, we can determine the emitter-base resistance; in this case approximately 76.5Ω. It should also be noted that for small emitter voltages, the curve becomes extremely non-linear.

So far, we have taken a transistor and treated it as two entirely separate diodes, and have shown that the input resistance of one (emitter-base) is fairly low and that the output resistance of the other (collector-base) is very high. We have also shown that potential across each respective "diode" is in the opposite sense for conduction in common base connection. Finally, it has been seen that, in general, transistors are extremely temperature sensitive.

Now, once again, we shall plot the collector-base characteristics, but instead of the emitter being left disconnected, emitter-base currents will be set up by an associated circuit and their effect on the collector current examined; that is to say, we shall try to find out if there is any difference in the collector current when its applied voltage remains constant and the emitter current is varied, say from 1mA to 4mA. (The circuit used is given in Fig. 4.)

TABLE 2

Emitter Current <i>I_e</i> (mA)	Emitter P.D. (V _e)
1.0	0.35
2.0	0.48
3.0	0.58
4.0	0.66
5.0	0.74
6.0	0.81
7.0	0.87
8.0	0.92

Emitter-diode results

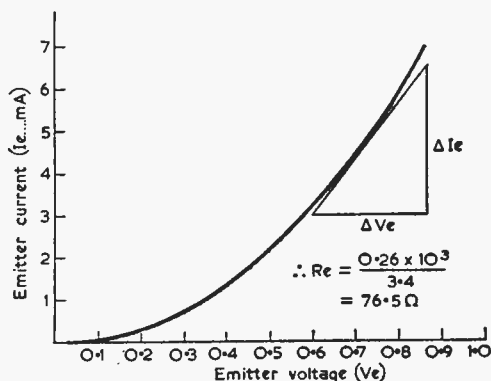

Fig. 4.—Emitter-diode curve.

OC71 transistor can no longer be considered as two separate diodes since there has been some interaction between the "input" (emitter) and "output" (collector) circuits.

It would also seem reasonable that as the only thing which is common to the emitter and collector is the base, that is where we should look for a possible explanation, and so without offering any highly technical or long-winded theories the phenomenon can be reasonably understood using the information already gained as follows.

From the relevant circuit diagram it can be seen that the emitter is biased in a forward or positive direction with respect to the base and thus an emitter-base current flows, this current consisting of conduction by "holes" is diffused in a random

manner across the common base, many of these "holes" reaching the base-collector junction, just as the reader has come to accept such terms as "electron charges" and "free electrons" so he must accept that current flowing in transistors causes a proportional number of "holes" or "positive charges" to be made available in the base particularly at the collector-base junction.

It can also be seen that the collector circuit is biased in the opposite sense to the emitter with respect to the common base and so collects the positively charged "holes" when they arrive at the junction. Thus, the current flowing in the emitter-base input circuit causes a similar value of current to flow in the collector-base output circuit. In reality, the collector current is slightly less than that of the emitter, the difference being due to the small base current flowing. It would, therefore, seem reasonable to ask how amplification can be said to have taken place when in fact a current loss has been experienced.

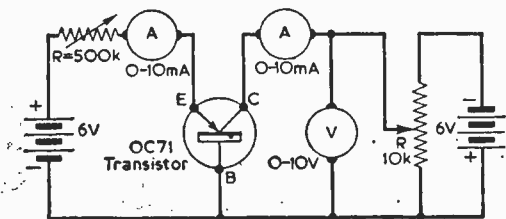

Fig. 5.—Transistor test circuit.

The answer to this question is simple, we have shown that the emitter-base or input resistance is relatively low and that the collector-base output resistance is very high. Our characteristic curves showing collector current against collector voltage under transistor conditions would suggest that there is no detectable current change for a potential difference of 5V but it must be appreciated that a current change of 0.01mA would give a "slope" resistance of 500,000 Ω which emphasizes the need for care in taking all readings and constructing the graphs. We have the same current, in fact, in two circuits, one having a high resistance and the other low. Voltage is equal to current multiplied by the resistance through which it flows ($I \times R$), and for maximum power transfer, the resistance of the external circuits of the transistor should be equal to the internal resistances of the transistor, it follows

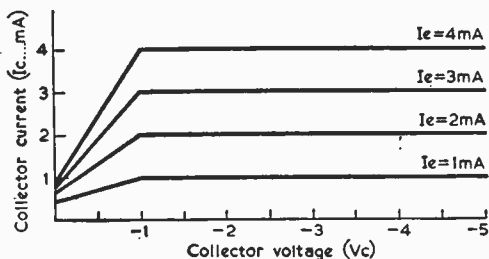

Fig. 6.—Transistor curves.

TABLE 3

Collector P.D. (-V)	Collector Current (mA) for four values of Emitter Current (mA)			
	1	2	3	4
-5	1	2	3	4
-4	1	2	3	4
-3	1	2	3	4
-2	1	2	3	4
-1	1	2	3	4
0	0.43	0.63	0.8	0.975

Transistor results

that although there has been a slight current reduction there has also been a high voltage gain. The collector load, of course, in many instances consists of an inductance having a high impedance at the working frequency and providing a low D.C. path so that small battery potentials may be used. The emitter is provided with a standing bias to ensure that the superimposed alternating signal operates over the straight portion of the emitter curve.

This completes the work we have set out to do and, although a number of points have been left unexplained, a far better understanding of working of a transistor from a practical point of view should have been achieved enabling the reader readily to understand more complex circuits.

An Introduction to Stereo

(Continued from page 38)

1. High stability resistors should be used where shown in the circuit diagrams, otherwise carbon composition types are quite suitable.
2. The valveholder should be of the loaded nylon, resilient type, and if the loudspeakers are housed in the same cabinet, acoustic shielding in the form of a wooden partition should be arranged between the loudspeakers and the pre-amplifiers.
3. The mains power transformer should be kept as far away from the pre-amplifier unit as possible, and if hum is found, re-orientation of the transformer may cure the trouble.
4. A good earth bus-bar of 12 or 14s.w.g. tinned copper wire should be run on insulators around the chassis and earthed to the chassis at one point only, the input jack, JK1. All earth connections should be made to this bus-bar and not to the chassis.
5. Heater leads should be twisted closely together, kept close to the chassis and well away from input and grid leads.
6. Input leads to the grid circuits should be kept as short as possible, and if the above instructions are carried out, no screened leads need be used in the pre-amplifier and no internal shielding will be required.

Radio & TV Engineers' Reference Book

FREE
 to every keen radio man
FOR A WEEK
 WITHOUT
 OBLIGATION
 TO BUY



Now you can have for free examination the new and revised 3rd Edition of this very practical engineering and servicing work. If you are a Radio Engineer, Technician, Mechanic, Instructor, Student, Keen Amateur, or engaged in the electronics field, this great wealth of data in all branches of radio and television will prove invaluable. It covers a most comprehensive range of subjects, new developments and techniques.

**BROADCASTING • COMMUNICATIONS
 SERVICING • NAVIGATION**

**High Fidelity Recording
 and Reproduction. Components**

Written for you by nearly 50 Specialists

Including L. S. Allard, B.Sc., A.INST.P. (*G.E.C. Cathode-ray Tube Group*); S. W. Amos, B.Sc.(HONS.), A.M.I.E.E. (*B.B.C. Tech. Instructions Section*); E. S. Bacon, M.Sc.(LOND.), A.R.I.C. (*Chief Supervisor Elec. Labs. Ever Ready Co. (G.B.) Ltd.*); W. T. Blackband, M.Sc., A.M.I.E.E. (*Aerials Research, R.A.E., Farnborough*); R. H. Burdick, A.C.G.I., A.M.I.E.E. (*Marconi's*); L. Driscoll, B.Sc., A.M.I.E.E., A.M.BRIT.I.R.E. (*Murphy Radio*); E. A. Fielding, B.Sc.TECH.(HONS.), A.M.C.T., M.I.E.E., A.I.R.A.E. (*Salford Electrical Instruments Ltd.*); D. H. Fisher, A.M.I.E.E. (*Regentone*); L. S. Foskett (*E.M.I.*); R. C. Glass, M.A., B.Sc., A.M.I.E.E. (*Lecturer Applied Physics, Northampton Coll. Adv. Technology, London*); F. J. Grimm, A.M.BRIT.I.R.E. (*Pye*); P. Jones (*Aerialite Ltd.*); J. M. Kirk, M.B.E., B.Sc.(HONS.) D.I.C., A.C.G.I., M.I.E.E. (*Standard Telephones and Cables Ltd.*); L. A. Moxon, B.Sc.(ENG.), A.M.I.E.E. (*R.N. Scientific Service*); D. F. Urquhart (*Erie Resistor Ltd.*); V. Valchera (*Valradio Ltd.*); A. H. B. Walker, B.Sc.(ENG.), D.I.C., A.C.G.I., M.I.E.E. (*Westinghouse Research Lab.*).

1,800 PAGES, 47 SECTIONS

Includes:—Formulæ, Calculations, Communication Theory, Electron Optics, Colour TV, Materials, Studio Equipment, Transmitter Power Plant, Broadcasting and Communication Transmitters, V.H.F. Equipment, Amateur Radio Equipment, TV Transmitters and Aerials, Radio-Frequency Transmission Lines, Waveguides, Broadcasting Receivers, TV Receiver Design, Commercial H.F. Radio Links, Broad-Band Systems, Radio Navigation and Radar, Aero Radio and Radar, Radio Astronomy and Satellite Communication Aerials, Valves, Tubes, A.C. Rectification and Ripple Filters, Transistors, Diodes, Resistors, Capacitors, Inductors, Transformers, Gramophone Pick-ups, Speakers, Interference, Recording, Batteries and Conversion Equipment, H.F. Reproduction, Measuring and Test Equipment, R/TV Installation and Servicing, Noise, Projection TV, Oscillators, Industrial TV, Units and Symbols, Progress and Developments, etc.

2,000 DIAGRAMS AND TABLES

**POST NOW
 7-DAY
 FREE
 TEST**

GEORGE NEWNES LTD., 15-17 LONG ACRE, LONDON, W.C.2.

Please send me Newnes RADIO AND TELEVISION ENGINEERS' REFERENCE BOOK without obligation to purchase. I will either return the work within eight days or I will send the first payment of 5/- eight days after delivery, then ten monthly subscriptions of 10/- until the sum of £5 5s. has been paid. Cash price within eight days is £5.

Name _____
 Address _____
 Occupation _____
 Your Signature _____
 (Or your Parent signs if you are RB62 under 21)

Tick (✓) where applicable

HomeOWNER	<input type="checkbox"/>
Householder	<input type="checkbox"/>
Living with Parents	<input type="checkbox"/>
Lodging Address	<input type="checkbox"/>

"P.W." 6 TRANSISTOR PERSONAL RECEIVER

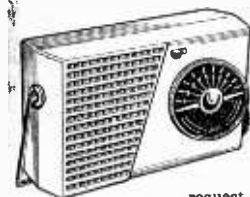

Designed by the technical staff of *Practical Wireless*: easy to build, using printed circuit, and 1st Grade Matched Transistors and Diode. Full Medium and Long Wave coverage to internal speaker. All parts sold separately (new components only) enabling you to buy as required, and full detailed price list will be sent on request. Constructional details 1/6. **TOTAL COST INCLUDING BATTERY AND CABINET 28.19.6.**

TRAWLER BAND RECEIVER R1155. The late version of the famous Bomber Command receiver known the world over to be supreme in its class. Covers 5 wave ranges 18.0 to 7.5 Mc/s, 7.5 to 3 Mc/s, 3.0 to 1.5 Mc/s, 1,500 to 600 kc/s, 500 to 200 kc/s, and is easily and simply adapted for normal mains use. Full details being supplied. All sets thoroughly tested and in perfect working order before dispatch, and on demonstration to callers. Fitted latest type super slow-motion tuning assembly. Have had some use but are in excellent condition. **ONLY £12.19.6.** A.C. MAINS POWER PACK OUTPUT STAGE, for the above in black crackle case to match receiver, enabling it to be operated immediately, but just plugging in, without any modification. With built-in 8 Ω speaker, **£6.10.6.** DEDUCT 10/- IF PURCHASING RECEIVER AND POWER PACK TOGETHER. Send S.A.E. for illustrated leaflet, or 1/3 for 10-page booklet which gives technical information, circuits, etc., and is supplied free with each receiver. Add carriage 10/6 for Receiver, 5/- for Power Unit.

UNIVERSAL VOLT-OHM-MILLIAMETER

At last a first grade multi-tester within the reach of everyone's pocket, and a necessity to all interested in Radio and TV. Reads A.C. and D.C. Volts up to 1,000 in 5 ranges, at 1,000 ohms per volt, D.C. current (3 ranges) to 500 mA. Resistance readings to 200 K ohms in 2 ranges. Basic movement 300 μ A sensitivity. Easily read open scale, beautifully made and fully guaranteed. Limited number available under import quota. Complete with leads prods. and internal battery.

ONLY 59/6



H.R.O. SENIOR COMMUNICATIONS RECEIVERS. Complete with all 9 coils, giving coverage of 50 kc/s—30 Mc/s. Checked and in perfect working order. Rack mounting type 18 gns., Standard Table Model 21 gns. (Carr., etc. 22/- either type.)

H.R.O. MAINS POWER UNITS A.C. input 115/230 v. output D.C. (fully smoothed) 230 v. 75 mA. and 6.3 v. 3.5 A. Complete in black crackle case. **ONLY 59/6.**

POCKET VOLTMETERS. Read 0-15 volts and 0-300 volts A.C. or D.C. BRAND NEW and UNUSED. **ONLY 18/6.**

B.C. 221 FREQUENCY METERS. The famous American crystal controlled, portable frequency measuring standard. Coverage 125 kc/s—20 Mc/s. Complete with original numbered calibration book. Perfect order. illustrated details on request. **ONLY £16**

INTERCOM TELEPHONE SET. Two pairs of Brand New headphones connected to Brass Microphones, with leads, etc. in fitted carrying cases. Supplied with 4 volt battery, 10 yards twin wire, and full instructions for connecting to make super intercom. **ONLY 27/6** (post 3/6). Extra Wire 3d. per yard.

HARRIS ELECTRONICS

(LONDON) LTD.

138 Gray's Inn Road, London, W.C.1.

(Phone TERminus 7937)

Please include carriage costs on All Items.
(Open until 1 p.m. Saturdays). We are 2 mins. from High Holborn (Chancery Lane Station) and 5 mins. by bus from King's Cross.

Take the trouble OUT of trouble-shooting with the NEW

Lab-Craft

TRANSISTOR SIGNAL INJECTION PROBE

Price
99/6

QUICKLY CHECKS:

Radio, T.V. Sound.
All forms of Audio Ccts.
Printed Wiring.

Complete with long life MERCURY BATTERY

- ★ Self contained.
- ★ Completely safe.
- ★ Light in weight.
- ★ Wide frequency range.



$\frac{1}{2}$ Actual Size

Used for rapid signal injection. Functions as a Wide-Band Modulated Signal Generator emitting a signal rich in AF, IF and RF components. Useful range: 2 Kc/s to 25 Mc/s.

LAB-CRAFT LTD.

83 ILFORD LANE, ILFORD, ESSEX. Tel. 2576

WE DO NOT KNOW HOW TO TEACH RADIO

to any useful standard without employing MATHEMATICS but then we know how to teach **MATHEMATICS** and have been doing so successfully for 21 years.

Our speciality is coaching candidates to sit and pass City & Guilds Telecommunication Technicians' Certificate Examinations and the Radio Amateurs' Exam. Our record of successes is second to none.

Write for details, today, to:

Mr. J. SYKES
(M.I.E.E., M. Brit. I.R.E., M.I.N.)

Principal:

BRITISH NATIONAL RADIO SCHOOL
Red Lion Court, Stalbridge, Dorset.
Britain's premier Radio Correspondence School specialising in City and Guilds examinations.

TRANSMITTING TOPICS

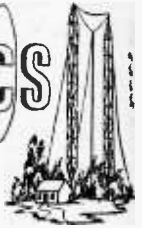

END-FED TRANSMITTING AERIALS

By Amateur Transmitter

THE end-fed transmitting aerial, in which one end is brought right to the transmitter, has the advantage of simplicity. It is also quite efficient. This does not mean that stations already equipped with centre-fed dipoles, or other aerials, should abandon them in favour of an end-fed wire. But it does mean that an end-fed aerial is extremely easy to erect, so that a transmitter may be brought into action without delay. It can also be operated on its harmonics, permitting working on more than one band, with the single wire.

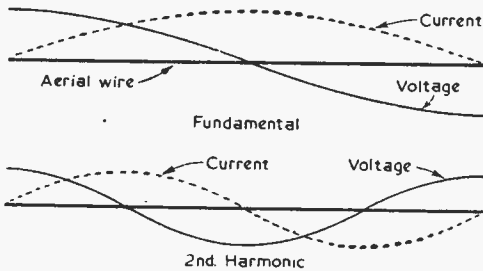

Fig. 1.—Voltage and current distribution for fundamental and second harmonic.

Popularity

A record kept of about one hundred contacts on the 80m band showed the following percentage of aerials:

- 40 end-fed Hertz, or longer.
- 15 Marconi types.
- 34 centre-fed dipoles.
- 11 various other types.

This appears to show that the end-fed aerial is quite popular. These figures do not necessarily represent the aerials used on other bands, where the harmonic efficiency may be undesirable, and where other types of aerial are popular.

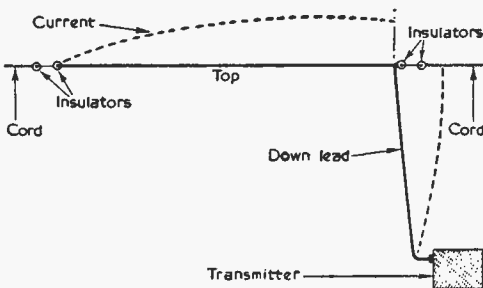

Fig. 2.—A practical end-fed aerial.

The aerial will probably be supported at the house, and a distant pole, tree, or other building. It is thus easy to fix, and among the least conspicuous of out-door transmitting aerials. The length can also be varied considerably.

As would be expected, an increase in aerial height increases radiation efficiency. This may be calculated approximately, but the simplest method is merely to support the aerial as high as possible. It will often be something between about 15ft and 30ft high.

The aerial will also be directional, the pattern changing with harmonic operation. The bearing of the various lobes can be calculated, but this again is scarcely worth while. Instead, it can be assumed that for general use there is no need to pay much attention to the directional characteristics. Briefly, radiation is greatest away from each side of the antenna, and smallest in line with it, when it is used on its fundamental. When used on harmonics, the side lobes break up into smaller lobes.

End-fed Hertz

Fig. 1 shows an end-fed Hertz operating on its fundamental. This ideal will not be achieved in practice, but each end will correspond to a point of relatively high voltage, and low current. This is the equivalent of a high impedance. The actual figure may be 1,000Ω or more, depending on aerial height, and other factors.

When the aerial is operated on its second harmonic (e.g. 40m, for an 80m aerial) it is still voltage-fed at its termination with the transmitter. This remains so with higher harmonics. The same wire can thus be used on two or more bands.

Its efficiency as a harmonic radiator makes this type of aerial an unwise choice for the higher frequency bands. For example, harmonics of the 21Mc/s or 28Mc/s bands can readily cause TV interference.

A typical end-fed Hertz is shown in Fig. 2. The downlead and connection to the transmitter actually form part of the aerial. For practical

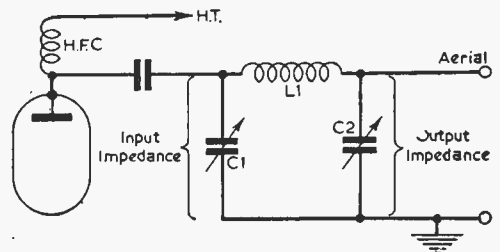

Fig. 3.—π network used for loading

heights on 80m most of the aerial will be horizontal.

Aerial Length

The calculated length will be approximately 124ft for the 3.8Mc/s end of the band, and around 133ft for the 3.5Mc/s end of the band. A "middle" length will easily allow satisfactory working through the whole band.

When the aerial is bent, as in Fig. 2, the actual total length of top and down lead needs to be a little longer. For average purposes, 132ft to 136ft will be satisfactory. Current and voltage distribution will then be approximately as in Figs. 1 and 2. Should the actual length vary somewhat from these figures, the resultant reactance can be tuned out at the transmitter end, and effective operation still obtained. Longer wires may, of course, be used, when space permits. For example, 266ft would be approximately full-wave at 3.6Mc/s, and would thus be working on its second harmonic, on this frequency.

For the actual aerial, 14 s.w.g. hard-drawn wire is often used. About two insulators can be used each end, with cord or wire from the house, pole, or other supports.

Impedance Matching

The end-fed Hertz is high impedance, as explained, and thus needs a high impedance feed point. Many popular transmitters employ a π -output circuit, as shown in Fig. 3. This allows an impedance transformation from the valve to the aerial.

Standard formulae will give the impedance transformation from input to output, for known values of C1, L1, and C2, but it is sufficient to know that changing from a high to a lower impedance requires that C1 be smaller than C2.

From the point of view of simplicity, it is highly convenient to attach the aerial directly to the output point shown in Fig. 3. Capacitor C2 will then usually have to be at quite a low value. It may, in fact, be found that C2 has to be opened so far that resonance can no longer be reached by means of C1. If so, one solution is to increase the value of C1, or to add another condenser of suitable high voltage rating in parallel with it.

In some transmitters it may be inconvenient to increase C1. If so, an external means of obtaining the necessary high impedance output for the aerial can be used. One such method is shown in Fig. 4. This is a reversed π network, C1 being large, and C2 small. For C1, a standard 2-gang 500pF broadcast receiver condenser will be satisfactory. C2 should resemble C1 in Fig. 3. That is, have wide plate spacing (for other than low power) and be of about 140pF to 250pF capacity. Coil L1 is resonant at the operating frequency.

It is now possible to leave C2 in Fig. 3 at fairly high capacity, and difficulties in obtaining resonance with C1 in the P.A. output circuit will then no longer arise. C1 in Fig. 4 is adjusted to moderate capacity, and C2 set to obtain resonance. It will be noted that if the coupler in Fig. 4 is closely wired to the π circuit in Fig. 3, the two large capacity condensers are in parallel. In these circumstances it is sometimes possible to omit C1 in Fig. 4.

Another method of matching the low impedance transmitter output to the high impedance aerial is

shown in Fig. 5. The coil is tuned to resonance. Loading can be adjusted by tapping the antenna down the coil, or by changing the number of turns on the link, or by adjusting the loading controls on the transmitter. The latter should, however, usually be set for fairly low impedance. That is, C2 in Fig. 3 at fairly high capacity.

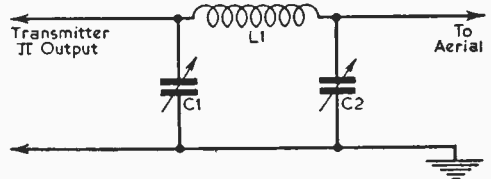

Fig. 4 (above).—A coupling circuit for transforming to a high impedance.

Fig. 5 (below).—A second tank for impedance matching.

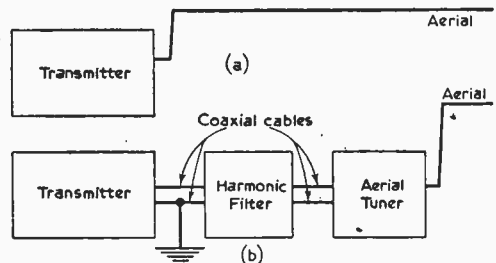
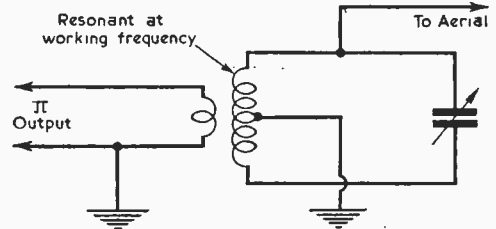

Fig. 6.—Two methods of connecting the aerial.

Harmonic Suppression

The method of feeding the aerial directly from the transmitter is shown at "A" in Fig. 6. When C2 is reduced to a low value, to obtain loading of the high impedance aerial, the harmonic suppression becomes poor. If harmonic interference is not caused, this form of working may be adopted, for its convenience.

If harmonic interference arises, it may prove sufficient to use one of the circuits in Figs. 4 and 5. These provide some harmonic rejection themselves. They also allow the transmitter π tank to work into a low impedance, which improves its harmonic suppression.

If harmonics remain troublesome, it is usual to add a harmonic filter between transmitter and aerial tuner, as at "B" in Fig. 6. Such filters are normally designed to work in a low impedance line, and cannot be included in series with the aerial, at "A".

(Continued on page 78)

CLYNE RADIO LTD.

THE COMPONENT SPECIALISTS

162 HOLLOWAY ROAD, LONDON, N.7
18 TOTTENHAM COURT ROAD, W.1

NORth 6295/6/7
MUSeum 5929/0095

OPEN: Tottenham Court Rd.,
9 a.m. to 6 p.m. Mon. to Fri., Sat.
1 p.m. Holloway Rd.: 9 a.m. to
6 p.m. daily. Thurs. 1 p.m.
Sat. 5.30 p.m.
Our Advantageous H.P. and
Credit Sale Terms are available
on any single item over
£5. Your enquiries invited.
Please print your name and
address.

All post orders and correspondence to 162 HOLLOWAY ROAD, LONDON, N.7

NEW! "CITIZEN"

Introducing our new Super-Sensitive 5-Stage (4 transistor plus diode) pocket transistor receiver for full medium wave reception—with the following outstanding features:

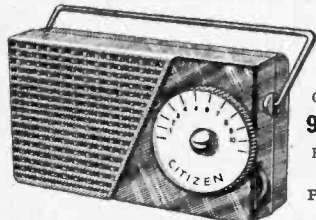

Only
95/-
Plus
2/6
P.&P.

★ Completely self-contained—No external aerial or earth required. ★ Genuine 2 1/2 in. High Flux P.M. Speaker. ★ Push-pull output—250 milliwatts. ★ Genuine Ediswan transistors. ★ Socket provided for personal listening. ★ Sock. provided for connection to Car Aerial. ★ Volume Control with on/off switch—Condenser tuning. ★ Easy assembly on colour coded pre-tagged circuit board. ★ Attractive polystyrene cabinet measures 5 1/2 x 3 x 1 1/2 in., chrome handle, attractive dial. All required components including full instructions, solder, etc. and battery at special inclusive price of only 95/-. (Yes, **Ninety Five Shillings Only**) Plus 2/6 P. & P. Nothing more to spend. Suitable crystal deaf-aid type miniature earpiece fitted with miniature jack plug at 7/6 extra only! If req. All parts available separately—Itemised list and full assembly instructions, sent for 1/6 post free. Hear this amazing little receiver working at any of our branches.

STOP PRESS !!

All components available ex stock for the "P.W. ROADFARER" AM/FM TRANSISTORISED RECEIVER. Send stamp for itemised price list. **Special inclusive price available £16.19.6**

Have you tried the famous American Ferrodynamics "BRAND FIVE" Recording Tape. An enthusiast's must! High Quality Acetate Base: 5' 900ft. 18/6; 5' 1,200ft. 23/6; 7' 1,200ft. 25/-; 7' 1,900ft. 35/-; Extra Quality Mylar Dupont 3' 300ft. 12/6; 5' 1,200ft. 37/6; 7' 1,900ft. 44/-; 7' 2,400ft. 60/- Each on plastic spool. All post free.

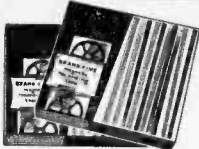

BRAND NEW—NOT SUB-STANDARD PLASTIC TAPE SPOOLS—Best quality 3in. 1/8" Sin. 2/-; 3in. 2/6; 5in. 4/6; **PLASTIC SPOOL CONTAINERS** for spool sizes 5in. 1/6; 5 1/2 in. 2/-; 7in. 2/3. Any single item Plus 6d. P. & P. Total over £1. Post free.

1 VALVE SHORT-WAVE RADIO

World-wide coverage at most reasonable cost.

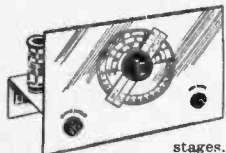

Covers 40-100 metres with the coil supplied. Can be extended to cover 10-100 metres. Provision is also made for the addition of two extra valve stages. Employs the famous Acorn-type 6S4 valve. All necessary components can be supplied complete with full assembly instructions at **ONLY 35/- plus 2/- p. & p.** Send 2/- for point-to-point wiring diagram and price list.

"PAGEBOY" 2-TRANSISTOR "POCKET PORTABLE"

Completely portable—No external Aerial or Earth Req'd.

An amazing little receiver with built-in aerial and small enough to be held in the palm of the hand. Medium wave reception at wonderful volume. No fiddly tuning! Condenser tuned! Supplied with corrugated chassis and colour coded components. Easily assembled with the aid of the easy-to-follow assembly instructions provided. Total cost of all necessary components, including transistors, wiring wire and even metal CKGT, **ONLY 32/6 plus 1/6 P. & P.** Battery 3/- extra. Ardente type deaf-aid earpiece complete with cord and plus 12/6 extra. Parts price list and Easy Lay-out Plans 1/6 post free. Demonstrated at all our branches.



THE R.C. 3/4 WATT AMPLIFIER

Compare the advantages Treble, Bass AND middle controls. For crystal or magnetic pick-up A.C. Mains 200/250 v. Valve line-up 6V6GT, 6SG7, 6XSGT. Negative feedback. Built on stove enamelled steel chassis, measuring only 8 x 4 x 1 1/2 in. Four engraved cream knobs are included in the price of the complete kit with all necessary practical and theoretical diagrams at £4.5. only, plus 2/6 p. & p. or Instruction Book fully illustrated for 1/- post free. This amplifier can be supplied, tested, and ready for use at £5.5.0 plus p. & p.

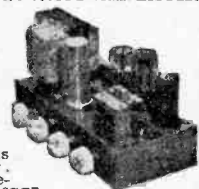

RECORD PLAYERS H.P. Terms available

E.M.I. MODEL 985 4 SPEED SINGLE RECORD UNIT. Very latest type. Heavy 8 1/2 in. dia. turntable. Low Butler Performance, 200/250 v. with tap at 80 v. for amplifier valve filament if required. Complete with matching pick-up with mount and rest. Brand new and fully guaranteed. **ONLY 89/6 plus 3/6 P. & P.** Pick-up available separately, complete with mount and rest 25/-, plus 1/6 P. & P.
JUST ARRIVED! 4 Speed Battery Operated Version of Above 6 v. operation, complete with pick-up, £5.9.6 plus 3/6 P. & P.

LATEST GARRARD MODEL

210. Four-speed manual or automatic. 10in. and 12in. records of same speed can be mixed in any order, wired for stereo, attractive white colour scheme. Price 104 gns. plus 3/6 P. & P.
LATEST B.S.R. UA15. 4-speed. Attractive appearance. Wired for stereo. Fully guaranteed. £7.19.6, plus 3/6 P. & P.
B.S.R. UA8 Brand new and guaranteed. **MONAURAL £6.19.6, STEREO/MONAURAL £7.19.6.** Both plus 3/6 P. & P.

THE "WAVEMASTER" 7-TRANSISTOR LUXURY PORTABLE

400 Milliwatt Output

To build yourself. Medium and Long Waves—Push-Pull Superhet A.V.C. Perfect Car Radio reception. Size 6 1/2 in. x 4 1/2 in. at base tapering to 4in. at top. Very attractive two-tone grey Vyndle covered cabinet with black and gold printed eucoutheron plate, cream and gold knobs, handle and cabinet fittings. ★ Weight—complete with long-life 7v. volt battery—4lb. ★ Mazda high-grade transistors throughout. ★ High-Flex 7in. 4in. Elliptical Speaker. ★ Slow motion tuning. ★ Co-axial speaker at rear for direct connection to Car Radio Aerial. ★ Improved reception by use of seven-section plated telescopic aerial disappearing into Cabinet when closed. 34in. above Cabinet when fully extended. Construction simplified by Bakelite chassis board with the following components already mounted: I.F. Transformers (3). Oscillator Coll. Trimmer Bank. Output Transformer, Interstage Transformer, Aerial Brackets and Earth Bar. **SPECIAL INCLUSIVE PRICE** for all required components, full assembly instructions—nothing more to buy—is **£10.19.6 plus 3/6 P. & P.** Alignment service available. Full assembly instructions and individually priced parts list, all of which are available separately, 2/6, post free.



RADIO JACK

Covers local medium frequencies variably tuned. Compact self contained unit requiring only connection to aerial (no power supplies required) for 1st class reception when used in conjunction with your tape recorder or high gain amplifier. All necessary parts available at a special inclusive price of **ONLY 19/6 P. & P. 1/6.**

PRINTED CIRCUIT CAR RADIO (for Home Construction)

We are proud to offer this New type Car Radio employing P.C.B. to the minute circuitry special 12 volt valves and transistorised output stage. The highest degree of sensitivity is achieved by the incorporation of Permeability Tuning and a tuned R.F. Stage. Covers Medium and Long Wavebands. **NO VIBRATOR PACK IS REQUIRED.** This is a really compact receiver that will fit any car. Comprehensive instructions are provided with all necessary components, including valves and transistor at a Special New Low Inclusive Price of **Only £11.19.6 plus 3/6 P. & P.** Instruction booklet with itemised price list, full description, dimensions, etc., available separately at 3/6 post free.



"PRACTICAL WIRELESS" CIRCUITS

All required Components for the complete Osamor Version of the Pocket Superhet, described in Practical Wireless, now available at special **LOW price of £8.19.6 complete**, including Printed Circuit and Osamor booklet. All items available separately, send for list. Enquiries invited for all other "P.W." circuit specified components.

HOME RADIO OF MITCHAM

(Dept. P), 187 London Road, Mitcham, Surrey.
 MIT 3282
 Shop hours 9 a.m. to 6.30 p.m. Wed. 9 a.m. to 1 p.m.

SUPER CATALOGUE!
128 PAGES—HUNDREDS OF PICTURES



GET YOURS TO-DAY **PRICE 2/- PLUS 9d. Post**

ULTRA SENSITIVE MICROMINIATURE LOUDSPEAKER

TSL LP45F represents a remarkable development in the field of small speakers. So sensitive that a clear output can be heard from only 1 mW yet will handle up to 300 mW. Actual size 1 1/2 in. dia. by 3/16 in. deep. Send for leaflet. PRICE 25/- post paid.



1 WATT TRANSISTOR AMPLIFIER

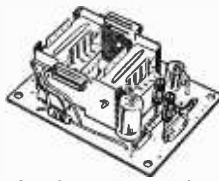

This mighty midget 4-transistor amplifier measures only 3 by 2 1/2 by 1 1/2 ins. and will give a full 1-watt output from microphone, radio, guitar, or pick-up.

Output for 3-ohm speaker. Send for leaflet. PRICE £4.12.6, post paid. Ready built and tested.

HEADPHONES



The famous "Royal" lightweight high-resistance headphones are ideal for crystal sets, battery sets, transistor sets, short wave receivers, etc. Brand new and boxed. 4,000 ohms.

PRICE 15/6, post 1/6. S. G. Brown type 'F' 37/6, post 1/6.

NEW 4-SPEED MOTORS AND PICK-UPS

E.M.I. model "985" player unit. Heavy 8 1/2 in. dia. metal turntable. 200 to 250 volt A.C. mains. Complete with high quality pick-up with turn-over crystal cartridge for standard and LP records. Limited number available, and offered subject to being sold. PRICE £4.10.0, post 2/-.

ANTEX "PRECISION" SOLDERING IRON



A wonderful new miniature iron for the constructor. Five different sizes of interchangeable bits are available; also practical bench stand and solder holder. All voltages from 6 to 240 in stock. S.A.E. for illustrated leaflet. Iron as shown, 29/6, post paid. (State voltage please). WE ALSO STOCK IRONS BY SOLOIN, REMFLOY, ADCOLA, and LITESOLD.

OSCILLOSCOPES

Heathkit OSI-service oscilloscope kit is a light compact portable scope ideal for the engineer. PRICE £18.19.6 Also available from stock, the well-known Treco-scope 3in. high performance scope, ready built and tested. Constructed of all brand new proprietary parts to highest standards. PRICE £17.10.0, plus 5/- part carriage. WE ALSO STOCK TEST GEAR BY AVO, TAYLOR, PULLIN, CABY, GRAYSHAW, ADVANCE, etc., etc.



DUKE & CO. (London) LTD.

621/3 ROMFORD ROAD, MANOR PARK, E.12
 ILF 6001/3

SEND FOR FREE CATALOGUE

Hours 9 a.m.—6 p.m. Half Day Thursday

RECORD PLAYER CABINET

99/6



Show Model Portable in two-tone colours. Suitable for stereo with extension speaker cabinet secured in lid. Size 18 x 14 x 8 1/2 in. Ins. & Carr. 5/6.

BAKELITE CABINET ONLY 2/9

Brand new. Size 12 x 7 x 5 1/2 in. Ideal for small receivers, converters, etc. P. & P. 3/8.

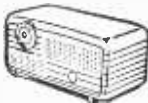

SPEAKER SALE

Extension Speaker 18/9. 8in. P.M. Speaker. Fitted in polished cabinet. Complete P. & P. 3/9.

TO CLEAR 8/9 EACH

Manufacturers Salvage. 5, 6 and 8in. 7 x 4in. other sizes available. P. & P. 2/9.

VALVES

SALVAGE GUARANTEED

9d. each 7/6 doz.
 2D21, 4D1, 6AL5, 6C8, 6C9, 6D1, 6D2, 6H6, 6J5, 6J7, 6LD20, 6SC7, 6SG7, 7B, 6SH7, 6SK7, 8D2, 9D2, AR6, AR10, T41, EB91, EF36, EF39, EF50, SP41, SP61, HL14DD, T41, TT11, VT501, VT510.
 2/9 each 30/- doz.
 6A8, 6AM6, 6C4, 6D6, 6F12, 6F13, 1A, 6F14, 6F15, 6K7, 6K25, 6L18, 6P28, 6AL7, 6BN7, 68Q7, 6U4, 6Z4, 7B7, 7Q7, 10F1, 12SH7, 12BK7, 25A6, 25Z5, 8D3, 35Z4, 42, 43, CL33, EOC34, EOC91, EF80, EF91, EF92, EL32, EY31, TH41, U22, U24, U801, VP41, EF30.
 5/9 each 60/- doz.
 5U4, 6Q7, 6V6, 6X5, 12AU7, 12AT7, 12K7, 12K8, 12Q7, 20P1, EOC33, EBF80, EOC31, EOC81, EOC82, EOC84, ECF80, ECL80, EL33, EL38, EL41, PCC84, PGR80, PL38, PY81, PY82, PZ30, PL81, PL82, U76, W76.
 Post and Packing: On 1 valve 7d. On 6 valves 1/6. On 12 valves 2/6.

RECORD PLAYER CABINET "PETITE"

29/9



Portable cabinet in smart two-tone colours. Size 12 x 10 1/2 x 6in. Light and easy to carry. Ins. & Carr. 4/6.

LOOK!

SOLD SEPARATELY

- Cabinet 49/6.
- B.S.R. Deck £8.9.6.
- Amplifier £7.19.6.
- L. Speaker 15/9.
- Also Mike 27/6.
- Tap 19/9. Spools 2/9
- Jack Plugs 1/9.

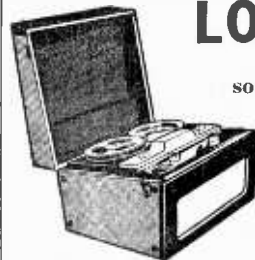

(Amplifier Accessories:- Dial incl. Sockets and superimpose switch, 3/6 each. Knobs. 2/6).

COMPLETE KIT 16 1/2 Gns.

COMPLETELY ASSEMBLED 18 Gns. Ins. & Carr. 12/6.

Postage: Kit 12/6. Amp. 4/6. L.S. 2/9. Cabinet 4/6. Deck 4/6.

AMPLIFIER, 5 valve 3.5 watts. Level indicator and superimpose switch. Size 8 1/2 x 3 x 4 1/2 in.

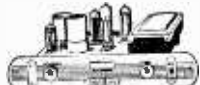

Drawings Included.

RECORD PLAYER AMPLIFIERS
 12 months guarantee

Mk. D2. 79/6. Latest design incorporating negative feedback giving 4 watts undistorted output. Valves ECL82 and metal rectifier. Tone and volume control panel on flying leads. Mains isolated. P. & P. 3/6.
 Mk. D.3a. 89/6. As above de luxe model, with separate tone controls for treble and bass boost. P. & P. 3/6.

Trade News

NEW PRODUCTS AND DEVELOPMENTS

VARI PHASE STROBE UNIT

THE Type 1208 Variphase Strobe Unit has been specifically designed to enable components or equipment, undergoing vibration test, to be viewed stroboscopically in "slow motion," irrespective of the drive frequency, within the range 5c/s to 5kc/s.

The equipment can also be used to facilitate the optical calibration of vibration pick-ups or to provide a calibrated, continuously variable phase sine wave from a single phase sine wave input.

Used with the Dawe Type 444 Automatic L.F. Sweep Oscillator, a suitable power amplifier, a vibration generator and a Dawe stroboscope, it provides the basic equipment needed for vibration resonance search and endurance tests called for in British Standards BS2011 and G100. This Strobe Unit is produced by *Dawe Instruments Ltd., Harlequin Avenue, Great West Road, Brentford, Middlesex.*

PRECISION POTENTIOMETERS

PRECISION potentiometers with infinite resolution, even at the lowest resistance values, incorporating CIC-SuperCon Film elements are now available for application in analogue computers, industrial instrumentation and control, following many years of military usage.

Originally restricted for use in missile and fire-control projects, supplies are now adequate to permit a new concept of reliability and accuracy to be introduced into servo- and control systems.

Multiple fingered wipers tracking on the resistance element, integral with the interior periphery of the case, provide absolutely smooth output even under vibration and shock. Patented internal trimming process reference to the male pilot, eliminates errors caused by misalignment, and there is no error build-up in ganged assemblies.

Linear models to a linearity accuracy of 0.01 per cent and sine-cosine models to a conformity of 0.025 per cent, are in current production. There is also a range of rectilinear potentiometers up to 16in. in track length.

CIC-proprietary, these potentiometers are made by *Computer Controls Ltd., 91, Buckingham Street, Strand, London, W.C.2.*

PORTABLE TRIGGER GENERATOR

TO fulfil the need both in the laboratory and in the field for a compact portable trigger generator at low cost, yet which is capable of delivering fast high-voltage triggering pulses from a low source impedance, the new Winston Portable Pulse Generator Type M.640 has been developed. Through the use of semi-conductor devices and printed circuits the usual bulk and power consumption associated with this type of instrument has been eliminated.

Another important point is that the load capacity has a negligible effect on the rise time. In fact, the only effects are a small reduction in the size of the output pulse and a slight shift in the Pulse Recurrence Frequency. Although appearing contrary to the normal rules of pulse techniques this has been made possible by the use of a unique circuit. Both positive and negative going pulses are available.

This pulse generator has been developed by *Winston Electronics Ltd., Shepperton, Middlesex.*

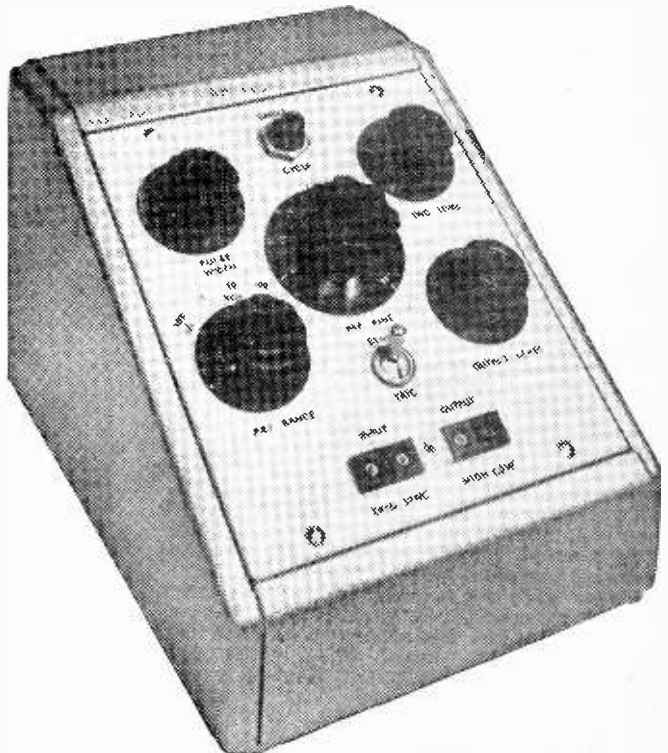

The Winston portable trigger generator.

NEW TAPE RECORDERS

SOUND Tape Recorders are exhibiting their range of versatile Tape Recorders, including twin and four-track models on Stand 25 and Demonstration Room 115.

The "Sound Master" tape recorder provides 10W undistorted reproduction from an acoustically-designed reflex loudspeaker system giving a full range frequency response. An ultra-linear 10W (13W peak) amplifier, plus separate amplifier for recording, give professional quality and the many features include mixing, monitoring and multiple superimposing, for every possible sound effect.

A "Sensimatic" level recording meter is provided for precise control when recording, and a unique feature of this tape recorder is that recording and play back can be effected simultaneously, such a feature being invaluable for example for cine-commentaries and learning languages.

The "Sound Master" has 3 speeds— $1\frac{1}{2}$ in., $3\frac{1}{2}$ in. and $7\frac{1}{2}$ in. per second, and four tracks give maximum tape economy. The recorder is housed in a polished wood case, which is designed to stand on top of the reflex loudspeaker system and for storage purposes is detachable and contained in the bottom of the speaker enclosure. The price is 105 guineas complete with all accessories, and the technical specification is attached. The "Sound Master" is made by *Sound Tape Recorders (Electronics) Ltd., 784-788 High Road, Tottenham, London, N.17.*

RING-TYPE LOUDSPEAKERPHONE

PROVIDING immediate two-way loudspeaking contact between positions without dialling, the A.E.I. "Ring Type" Loudspeakerphone is a fully intercommunicating system for offices, factories, laboratories and other similar locations. It is completely independent of a telephone switch-board and can, therefore, relieve an operator of the responsibility for connecting calls.

The system consists of a number of ten-line master control units with a single common amplifier. A complete installation incorporates eleven master control units, but any number up to eleven can be employed. Special units can be supplied if a larger system is required.

The "Ring Type" Loudspeakerphone operates from 200/250V A.C., 40-60c/s. Installations can be supplied to operate from 100/110V supplies or from 18V D.C. (e.g. a battery supply). Consumption of a complete installation is 70W in operation, and 35W in the "standby" condition.

Two fuses in the amplifier give protection against component damage and fire. The equipment is completely safe as the voltage on the line under all conditions never exceeds 25V D.C.

Master units are supplied in attractive cream coloured moulded plastic housings with light grey loudspeaker grilles. The dimensions of these units are: width 12in., height 6 $\frac{1}{2}$ in., depth 9 $\frac{1}{2}$ in. Amplifier units are "hammer" finished in dark grey and silver grey, and their dimensions are: width 10 $\frac{1}{2}$ in., height 7in., depth 14in. *Special Products and Radio Components Department, A.E.I. Radio and Electronic Components Division, 155, Charing Cross Road, London, W.C.2.*



The new "Sound Master" tape recorder is a 3-speed, 4-track model.

NEW SEMI CONDUCTOR DEVICES

FIRST of a series of silicon-diffused junction type power rectifiers, the Ediswan Mazda Type XU604 is suitable for use in television receiver and similar power supplies. It is hermetically sealed in a metal can with axial leads.

Maximum overall can dimensions are: length 0.34in., diameter 0.4in.

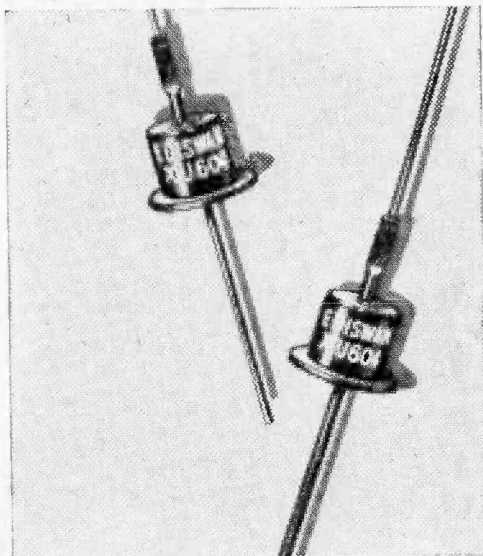

The Ediswan Mazda XU604 is a silicon p-n junction type power rectifier.

Maximum peak inverse voltage is 400V, an absolute value for 100°C working. Maximum mean rectified forward current is 500mA at an ambient temperature of 75°C or less, 150mA at an ambient temperature of 100°C. Maximum re-current peak forward current is 5A at an ambient temperature of 75°C or less, 1.5A at an ambient temperature of 100°C. *A.E.I. Ltd., 155 Charing Cross Road, London, W.C.2.*



SUPER 12/RS/DD

This fine 12in. loudspeaker employs a new type of double diaphragm assembly (patent application No. 40667/60). The main cone is moulded from a specially formulated soft pulp which reduces break-up effects to a minimum. Higher frequencies are radiated by a one piece tweeter cone with its edge supported on foam plastic to avoid resonance.

The moving assembly is supported by a roll surround formed from resin impregnated cloth permanently moulded under heat and pressure. Together with the high grade synthetic centring device this roll surround permits very large cone and coil excursions with minimum distortion. The powerful Alcomax III magnet gives maximum sensitivity and excellent transient response.

SUPER 12/RS/DD Specification

Fundamental Resonance	25-30 c/s
Frequency Range	20 c/s—15 kc/s
Flux Density	17,000 gauss
Total Flux	190,000 maxwells
1 1/2 in. dia. Centre Pole	
Aluminium Voice Coil	
Impedance	12—15 ohms only
Max. Input	20 watts r.m.s. 40 watts peak

PRICE £17.10.0

Tax Free

Descriptive literature and cabinet construction sheet free on request



IDLE • BRADFORD • YORKS.

Telephone: Idle 1235/6
Telegrams: 'Wharfedel,' Idle, Bradford

**New! A TRULY REMARKABLE
BRITISH INVENTION!**

Gramdeck

GRAMOPHONE TAPE RECORDER

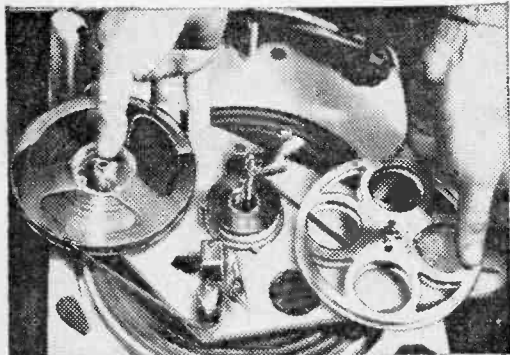

**Turns any gramophone into
a superb TAPE RECORDER!
and back into a record-player in a moment!**

- ★ Plays at 7½ per sec. or 3 other speeds.
- ★ Records direct from radio or microphone.
- ★ Erase and fast rewind.

11 Gns.

**YOURS FOR 13/-
DOWN AND 18
FORTNIGHTLY
SUMS OF 13/-.**
Ready to Record,
complete with Control
Unit and 600 ft.
of twintrack tape.
Special moving coil
microphone extra.

EASY TERMS

Free!



FREE BOOK—POST NOW!

Please send me the Gramdeck Book—
FREE and without obligation.

NAME

ADDRESS

Gramdeck

GRAMOPHONE TAPE RECORDER

(Dept. PA819), 29-31 WRIGHTS' LANE, LONDON, W.8

GRAMDECK TURNS A TURNTABLE INTO A TAPE-RECORDER

Gramdeck is an ingenious invention that instantly turns your gramophone into a tape-recorder and back into a gramophone at will! You simply slip it on to your turntable and you are ready to record direct-from-radio or microphone . . . the voices of your family . . . radio programmes . . . your favourite music—and you can instantly play it back through your own gramophone or radio with *Lifelike Fidelity*. Made by the people who make radar runs for Viscounts and Britannias, the amazing Gramdeck now brings full tape-recording facilities to every gramophone owner at little extra cost.

AS EASY AS PUTTING ON A RECORD

"Real hi-fi results." "Better than many so called hi-fi recorders . . ." These are typical comments of famous technical journals. Gramdeck enables any gramophone owner to add superbly good tape-recording facilities to existing equipment, at a fraction of the usual cost. Full details, photos, specifications, Easy Terms, etc., are given in the Gramdeck Book. Send for your FREE copy today.

NEW! EASY BUILD THREE RADIO

(3 Ediswan Transistors plus 2 Diodes)

Easy to build, easy to operate. This transistor radio operates over the M.W. and L.W. extending down to 80 metres without coil changing. Ferrite rod aerial, volume/sensitivity control. Sonotone high fidelity miniature earpiece. May be built for 49/6. P.P. 2/6.



PUSH-PULL SIX

(6 Ediswan Transistors plus 2 Diodes)

MEDIUM, LONG WAVE AND TRAWLER BAND EXTENDING TO 80 METRES WITHOUT COIL CHANGING.

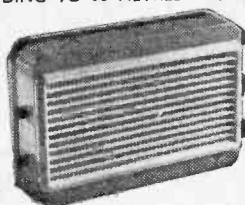

350 Mw XC101's push-pull output Transistors. Powerful magnet 3in. high grade speaker. Miniature push-pull transformers. This is a top performing receiver. Nearly 30 stations listed in one evening including Luxembourg loud and clear. A pleasure to listen to. Has **FERRITE ROD AERIAL**. All parts sold separately including pale blue gleaming polystyrene case with duo-diffusion grilles in red. Uses 4½ volt flash-lamp battery that lasts for ages. Sockets for car aerial. Parts £6.19.6. Size 6½ x 4½ x 1½in.

"Agreeably surprised with Trawler Band reception. Luxembourg as loud as local. Your easy build diagrams helped a lot . . . my first attempt."—H.S., Penzance, Cornwall (poor reception area).

PUSH-PULL FIVE

(MW/LW and Trawler Band)

(5 Ediswan Transistors)

Now greatly improved. Sensitive **FERRITE ROD AERIAL**. Pale blue polystyrene case with speaker grille in red. Volume/sensitivity control. Noiseless compression tuning condenser. Miniature push-pull transformers. 350 Mw XC101's in push-pull. Sensitivity R.F. stage for station selection. Parts £5.19.6. P.P. 2/6.

New P.P.6 may be built for £5.19.6.

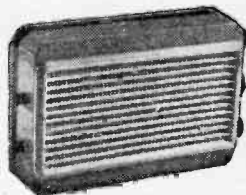

"RECO" PUSH-PULL FOUR

(MW/LW and 2 S.W. Coils)

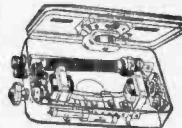

Ediswan Transistors, 350 Mw XC101's push-pull output, new miniature push-pull transformers. Volume/sensitivity control. Fine toned 3in. alni magnet speaker. Very simple to build with our easy-build plans. Uses 4½ volt battery. Parts for £4.19.6.

TRANSONA-4

(4 Ediswan Transistors)

Miniature speaker. **FERRITE ROD AERIAL**. MW/LW and Trawler Band coverage down to 80 metres. On test tuned in over 30 stations. This sensational new radio is simple to build with our easy-build plans. Handsome pocket case may be built for 65/-. P.P. 2/6.



**PARTS PRICE LIST AND DATA SHEETS, 1/3 each
AFTER SALES SERVICE
ALL PARTS SOLD SEPARATELY**

Radio Exchange Company

27 HARPUR STREET, BEDFORD
Phone 2367 Closed 1 p.m. Sat.

AN ALL BAND 75 W

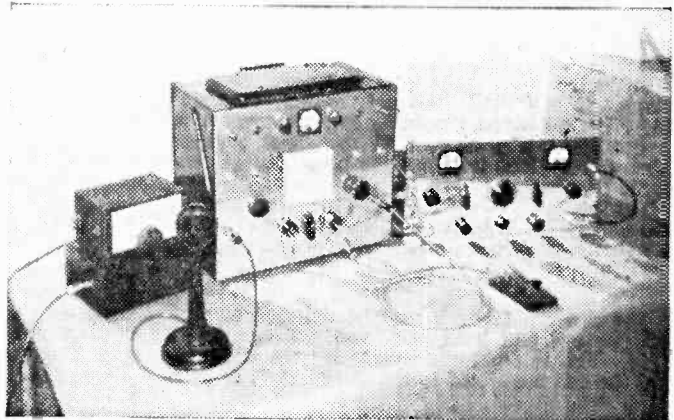

TRANSMITTER

A COMPREHENSIVE INSTRUMENT OF MODERATE COST

(Continued from page 1094 of the April issue)

By G. Favour

THE H.T. output passes through the low H.T. switch to L.F.C.1, C1 and C2 (8 + 16μF). This voltage supplies all stages except the P.A. One section of transmit/receive switching paralleled by the net switch applies voltage to the VFO. The mains to T2 may be connected to the 200V tap to increase the output. This works perfectly, and never causes even slight heating on full load. The H.T. secondary winding is connected to the metal rectifiers, the centre tap being left disconnected. This bridge rectifier system enables the voltage across the whole of the winding to be rectified, giving about 750V output. The H.T. output

passes through the high H.T. switch and transmit/receive switch to the smoothing circuit L.F.C.2, C3, C4, C5 and C6. Since high capacity, high voltage condensers are expensive, small surplus electrolytics are used in series, halving the capacity and doubling the working voltage. Each pair should be identical, new stock, and one of the pair have a thick insulating covering. The high H.T. output goes only to the 807 anode.

The 12V output from T3 is connected to a small 1A bridge rectifier. The D.C. (unsmoothed) output is switched either to the relay or the charging terminals by the second section of the Tx/charge switch. The insulated terminal may be made by putting a rubber grommet in the hole first.

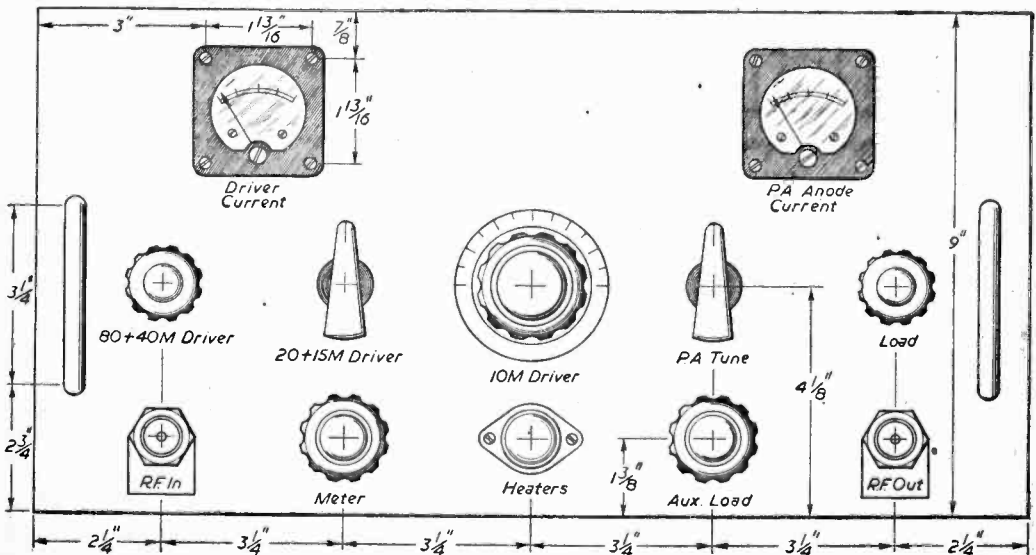

Fig. 6.—The layout of controls on the R.F. Section front panel.

The keying switch is the old 1154 function switch with all wafers except the front one removed. When only the oscillator is being keyed, it earths the driver cathode and connects the VFO screen to the key contact; when oscillator and drive are keyed, the driver cathode connection is broken, and connected to the front contact; when driver alone is keyed, the back contact connection is broken.

The 'phone/C.W. switch earths the front contact, disconnects the back contact, and, applies H.T. to the speech amplifier when in the 'phone position.

Meters

The meter M1 which may be switched to read grid current and both H.T. voltages, is also ex 1154. The internal thermocouple was removed, and the coil connected to the terminals. The FSD

receive. The earthy end of the existing R.F. (and I.F. if necessary) receiver gain control is disconnected from earth and taken, together with the power leads to the four-pin Jones socket. If the receiver has a power unit of its own, only two leads need be taken to it.

Speech Amplifier

The speech amplifier is quite conventional, employing one pentode and one triode-connected pentode. Alternative input circuits are given for moving coil, or crystal microphone inputs. The prototype uses a moving coil microphone (ex headphones) mounted on a lamp stand with a small transistor amplifier in the base, but it works perfectly without this amplifier if the gain is turned up further. The output from V3 is passed through screened wire to a section of the

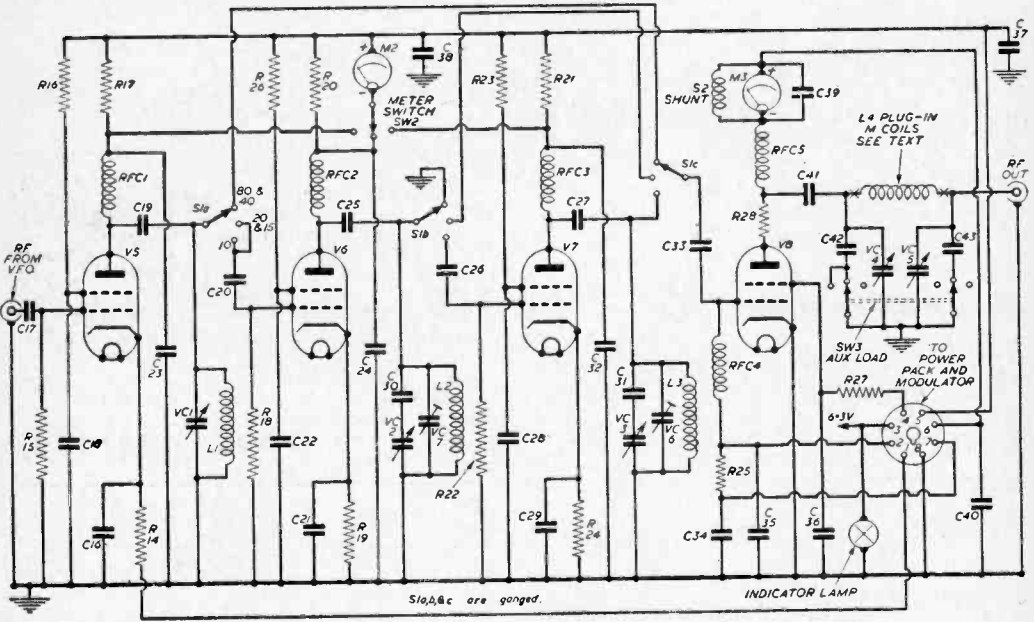

Fig. 7.—The circuit of the R.F. Section.

was found to be around 500µA, although this may vary with transmitters. Since the resistance could not be determined accurately, the shunt and series resistance could not be calculated correctly. To make the shunt S1, a testmeter was wired in series with the meter, and the resistance of the shunt altered until the FSD was 15mA. H.T. should be switched off, while adjustments are made, to avoid damage to the meter. Great care should also be taken to prevent contact with the nearby metal rectifiers which are at H.T. potential even when both H.T. switches are off. It is safest temporarily to disconnect the leads from the secondary of T2. The H.T. voltage indicated on the meter is only required to be qualitative, to indicate the presence of short circuits, blown fuses, etc., so a calibrated scale need not be made.

The receiver listen-through control is a 10k wire-wound potentiometer which is short circuited on

'phone/C.W. switch. The grid of V4A is connected to this output on phone, and acts as a positively biased direct-coupled amplifier. In the more usual series gate circuit where the standing carrier is well below the peak output, some distortion is caused by rectification in this stage, but with low biasing voltage, and the grid leak returned to earth instead of cathode, this is eliminated. V4B acts as an infinitely variable resistance supplying screen voltage to the P.A. On C.W. with the key up, V4A is positively biased, causing partial P.A. cut-off. Application of drive causes negative biasing, giving full screen voltage. A small neon in this circuit might give more positive control, but this has not been tried.

The power unit should not be operated without a load, with H.T. switches on, as voltage surges may break down the insulation of the electrolytics.

(Continued on page 81)

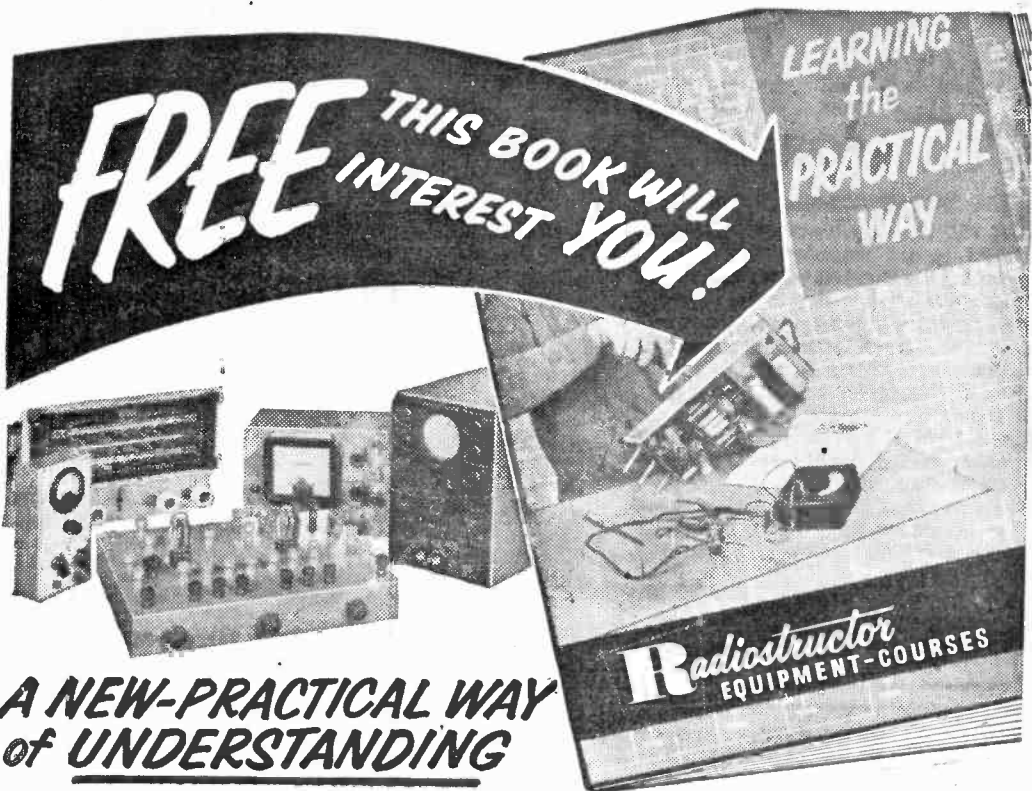

**A NEW-PRACTICAL WAY
of UNDERSTANDING**

Radio • Television • Electronics

Including: Transistors; VHF/FM; Hi-Fi equipment; Computers; Servo-mechs; Test Instruments; Photo-electrics; Nucleonics, etc.

FOR ... Your Career ... Your Own Business ... An Absorbing Hobby

Radiostructor—an organisation specialising in electronic training systems offers a new self-instructional method using specially designed equipment on a "do-it-yourself" basis.

You learn by building actual equipment with the big kits of components which we send you. You advance by simple steps, performing a whole series of interesting and instructive experiments—with no complicated mathematics! Instructional manuals employ the latest techniques for showing the full story of electronics in a practical and interesting way—in fact—you really have fun whilst learning! Post the coupon below, now, for full details.—

RADIOSTRUCTOR
LEADS THE WORLD
IN ELECTRONICS TRAINING

POST NOW

To RADIOSTRUCTOR (Dept. G82)
 READING, BERKS.

Please send brochure, without obligation, to:

★ Name _____

Address _____

5/61

★ BLOCK CAPITALS PLEASE
 (We do not employ representatives)

MAXI-Q
REGD.

TRANSISTORIZED F.M. RATIO DISCRIMINATOR & I.F. TRANSFORMERS FOR THE HOME CONSTRUCTOR . . .

I.F. TRANSFORMER, IFT.15

A 10.7 Mc/s double-tuned transformer with tapped secondary and primary windings. Wound on polystyrene former complete with iron-dust tuning cores and sub-miniature polystyrene foil capacitors. Completely enclosed in an aluminium screening can measuring 7/8in. high by 17/32in. square with two fixing clips. Termination is made to base mounted silver plated pins which are ideal for either printed circuit board or normal metal chassis mounting.

Bandwidth of single transformer at -6 db is approx. 250 kc/s. Unloaded 'Q' of winding 70. **Price 10/6**

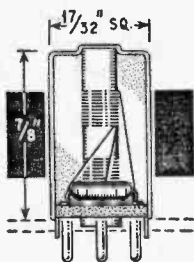

ACTUAL SIZE

RATIO DISCRIMINATOR TRANSFORMER, RDT.2

A sub-miniature 10.7 Mc/s transformer for use in ratio discriminator type circuits. Secondary winding is of bifilar construction. Dimensions as IFT.15. Peak Separation approximately 220 kc/s.

Connection diagram supplied with each coil. **Price 10/6**

GENERAL CATALOGUE covering full range of components send 1/4 in stamps.

PLEASE SEND S.A.E. WITH ALL ENQUIRIES

DENCO (CLACTON) LTD. (Dept. P.W.), 357/9 Old Road, Clacton-on-Sea, Essex

KINGSMERE SUPPLIES LIMITED

Insured Post 1/-, over £2 Free (Export extra).
Single valves, post 6d.

MAIL ORDER HOUSE

TERMS: Remit with Order or C.O.D.
Cash refund guarantee

Built to the highest specifications, these chassis offer the finest value to the enthusiast.

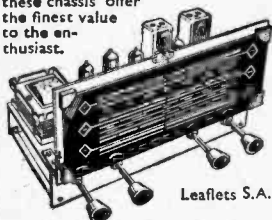

Leaflets S.A.E.

ALL BRITISH RADIOGRAM CHASSIS, 3 WAVEBANDS 5 MULLARD VALVES ECH81, EF89, EBC81, EL84, EZ80

Brand new and guar. A.C. 200/250v. Short - Medium - Long Gram. P.U. High Q dust core coils. Latest circuit technique. AVC and neg. feedback. 4 watts. Chassis size 13 1/2 x 6 x 7in. Aligned and calibrated ready for use. Quality at Low Cost. Chassis isolated. H.P. Dep. £5 and five monthly of £1.

OUR PRICE £9.9.0

Matched Speakers, 5in., 6 1/2in., 8in., 17/6 ea. 10in. 25/-, 12in. 30/-.



The Brilliant Successor

Mararch

BRAND NEW AND BOXED
with Template
4 SPEED
MODEL UAB
£6.15.0
STANDARD OR
STEREO PICK-UP

GARRARD 4-SPEED HIGH FIDELITY UNITS
Autochanger RC210 £9.19.6
Single Player TA Mk.II £7.19.6
Transcription 4HF £16.19.6
Price inc. plug-in normal heads. Stereo hds. £2 ex.

BRAND NEW

VALVES

Matched Pairs 1/- extra

American Magnetic Recording Tape

OZ4	6/-	6BA6	7/-	6SJ7M	6/-	DF96	8/-	EL41	9/-	PCL82	8/-	5in. 600ft. 16/-		Recording Tape "BRAND FIVE"	
IR5	6/-	6BE6	7/-	6SN7GT	6/6	DK96	8/-	EL84	8/6	PY80	7/6	5in. 900ft. 18/6		MYLAR DUPONT	
IS5	6/-	6C4	5/-	6U5G	7/6	DL96	8/-	EM81	9/6	PY81	8/6	5 1/2in. 1,200ft. 23/6		Super High Fidelity	
IT4	5/-	6D6	6/-	6V6G	5/-	EABC80	8/-	EY51	7/6	PY82	7/6	7in. 1,200ft. 25/-		Double Play	
2X2	2/6	6F6G	7/-	6X5G	6/-	EB91	4/-	EY86	7/-	PY83	9/-	7in. 1,800ft. 35/-		5in. 1,200ft. ... 37/6	
3Q5	9/-	6G6	5/-	12AT7	6/-	EBC41	8/-	EZ40	7/-	QP25	7/-	7in. 2,400ft. 60/-		7in. 2,400ft. ... 60/-	
3S4	7/6	6H6	3/6	12AU7	6/-	EBF80	10/-	EZ80	7/-	R3	7/6	Illustrated leaflet S.A.E.		Spare Reels, plastic, all sizes.....3/-	
3V4	7/6	6J5	5/6	12AX7	6/-	ECC84	8/-	E1148	1/-	SP61	3/6	"Instant" Bulk Tape Eraser and Head De-fluxer, 200/250 v. A.C., 27/6. Leaflet, S.A.E.		3/-	
SU4	6/-	6J6	5/6	12K7GT	6/6	ECH42	10/-	HABC80	8/-	UF41	8/6	SETS OF VALVES		19/6	
5Y3G	6/-	6J7G	6/6	12Q7GT	6/6	ECL80	10/-	U41	8/6	UL41	8/6	19/6		IR5, IT4, IS5, 3S4 or 3V4.	
5Z4G	9/6	6K6GT	5/-	25YG5	9/6	ECL82	10/-	UY41	7/-	U41	8/6	27/6		DK96, DF96, DAF96, DL96.	
6AC7	3/6	6K7G	5/-	35L6	9/6	EF39	5/6	U22	8/-	U22	8/-	37/6		6K8, 6K7, 6Q7, 6V6, 5Z4 or 6X5.	
6AG5	5/-	6K7M	7/6	35Z4	6/6	EF41	9/-	MU14	7/6	VP23	6/6	37/6		ECH42, EF41, EBC41, EL41, EZ40.	
6AL5	4/-	6K8G	6/-	807	5/-	EF80	7/-	P61	3/6	U76	6/6	39/6		ECH81, EF89, EBC81, EL84, EZ80.	
6AM6	4/-	6N7M	6/-	954	1/6	EF91	4/-	PC84	8/-	VR105/30	9/-	35/-		12K8, 12K7, 12Q7, 35L6, 35Z4.	
6AT6	7/6	6Q7G	7/6	956	2/6	EF92	5/-	PCF80	7/6						
688G	5/-	6SA7M	6/-	DAF96	8/-	EL32	4/-								

25 FOAMCOURT WAY, FERRING, WORTHING, SUSSEX

A Versatile TAPE RECORDER

CONSTRUCTING
THE CABINET

By D. L. Woolley

(Continued from page 1126
of the April issue)

THE cabinet described here is easy to make, but a commercially built cabinet can be used if of a suitable size. If such a cabinet is used, the amplifier may be mounted with the front panel horizontal and reduced in size. It cannot be made less than 5½ in. deep unless care is taken not to allow the tops of the valves to catch on anything, but it can be made shorter, say to 8½ in. or 9 in. For a wider tape-deck, the front panel can be up to 13 in. wide. The layout of the components remains the same for any size of panel down to the absolute minimum. Details of the home-made cabinet are given in Figs. 23 to 28. Care must be taken to make all parts of the cabinet square before gluing. Simple joints are used, but these can be elaborated by more proficient woodworkers, as long as the cabinet dimensions remain the same.

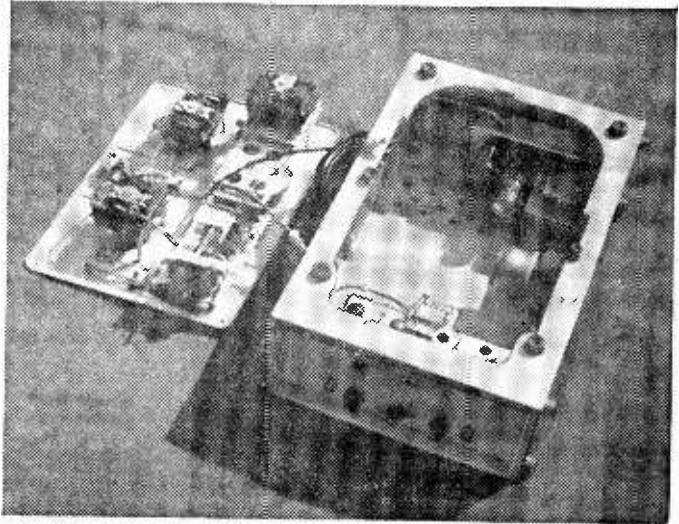

Finishing

The cabinet can be finished in a variety of ways; the simplest being varnish, or paint. Contact plastic is the most convenient, although the original was finished in paint, with the front panel, mains input panel and speaker grille painted to match the tape-deck; the rest of the cabinet being a light pastel green. Whichever method of finishing the box is chosen, the wood surface must be well prepared.

Expanded aluminium grille was used for the loudspeaker cut-out and to cover ventilation holes drilled in the base panel of the cabinet. Ventilation holes should be drilled under the rectifier valve and the tape-deck drive motors. A removable ventilation grille is fitted above the amplifier

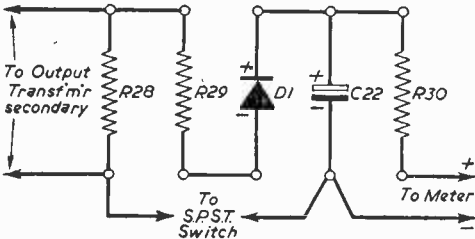

Fig. 20.—Layout of the record-level indicator components—see page 899 of the February issue and page 1075 of the April issue.

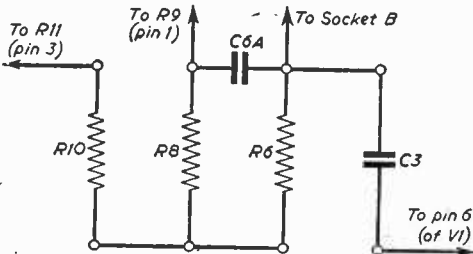

Fig. 21.—The layout on the tag-strip of the alternative equaliser circuit—see page 1021 of the March issue.

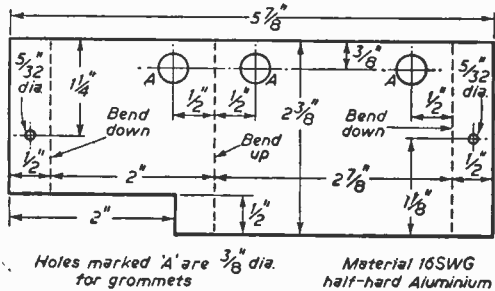

Fig. 22.—The aluminium screen to surround LI and V4 (see Fig. 11, page 991 of the March issue).

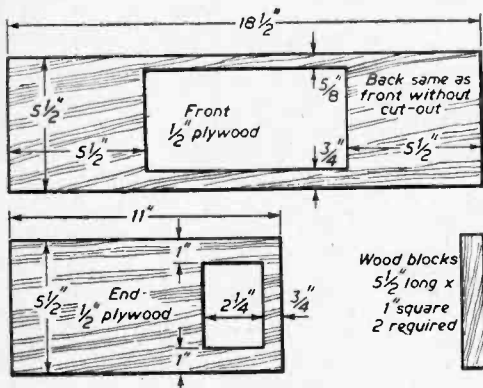

Fig. 23.—Constructional details of the end, front and back.

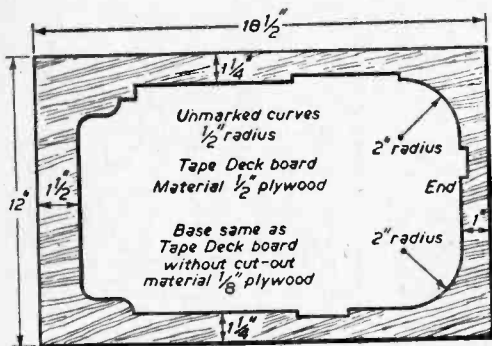

Fig. 24.—The tape-deck supporting board.

to enable the valves to be withdrawn without taking the recorder to pieces.

Fastenings for the cabinet can be of any neat, reliable kind—split-hinges were used to allow the lid to be removed entirely. The handle is fitted to all in a position that enables the recorder to be lifted without being unbalanced.

The amplifier, power-pack, mains input panel and loudspeaker are now fitted, using wood-screws (Fig. 27). Power leads from the power-pack to the amplifier are cut and connectors fitted. These enable the amplifier to be removed without the power-pack. The record-playback and erase heads

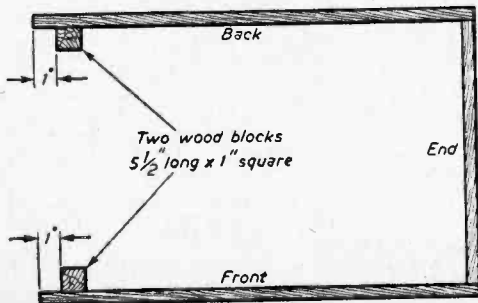

Fig. 25.—The end, front and back are glued as shown.

are now connected to two lengths of coaxial cable fitted with coaxial plugs, of sufficient length to reach from the amplifier to tape-deck when the latter is in position. The mains supply to the deck is taken, via a connector, from the switch on the mains input panel.

(Continued on page 78)

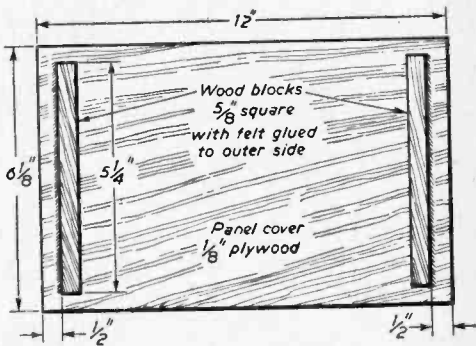

Fig. 26.—Felt glued to the wooden battens, makes the front panel a push-fit.

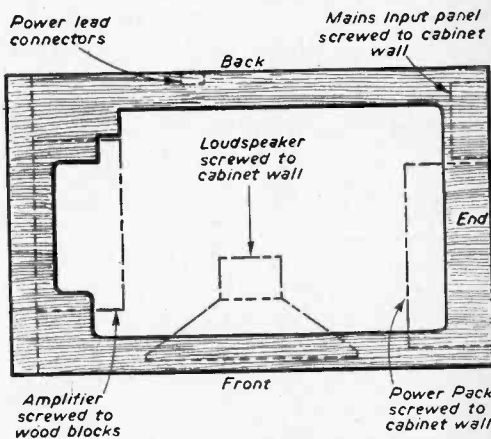

Fig. 27.—The position of the various parts, assembled in the cabinet.

Lid of thin flexible plywood, bent round end pieces and secured with glue and panel pins

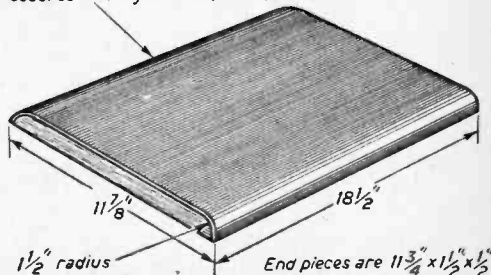

Fig. 28.—The cabinet lid is formed round two shaped battens.

"PW" ROADFARER AM/FM RADIO KIT
TRANSISTORISED THROUGHOUT. Advanced design, operated from internal batteries or direct from mains.
FOUR SECTIONS ON PRINTED CIRCUITS: A.M. Tuner; F.M. Tuner; Audio Amplifier; Mains Supply Unit.
ATTRACTIVE PLASTIC CABINET. Ferrite Rod Aerial for A.M., Telescopic Aerial for F.M. Order Now. **LOWEST PRICES!**

TRIMMERS, Ceramic 30, 50, 70 pF, 9d., 100 pF., 150 pF., 1/3; 250 pF., 1/8; 500 pF., 750 pF., 1/5.
RESISTORS, Preferred values. 10 ohms to 10 meg., 1 w., 4d.; 1 w., 4d. 1 w., 6d.; 1 1/2 w., 8d.; 2 w., 1/-.
HIGH STABILITY. 1 w., 1%. 2/-. Preferred values: 40 Ω to 10 meg. Ditto, 5%. 100 Ω to 5 meg., 9d.
5 watt { WIRE-WOUND RESISTORS 1/8
10 watt { 25 ohms-10,000 ohms 1/8
15 watt { 1/8
10.5K to 50K to 10 w. 3/-

AMERICAN "BRAND FIVE" PLASTIC RECORDING TAPE
Long Play 7in. reel, 1,800ft. 35/- Spare
5 1/2 in. reel, 1,200 ft. 23/6 Plastic
5in. reel, 900 ft. 18/6 Acells
3/- ea.
Double Play 7in. reel, 2,400 ft. £8 Metal
Standard 7in. reel, 1,200ft. 25/- 7/ Reels
5in. reel, 600 ft. 15/- 2/- ea.

"Instant" Bulk Tape Eraser and Head De-fuzzer. 200/250 v. A.C., 27/6. Leaflet, S.A.E.

O.P. TRANSFORMERS. Heavy Duty 50 ma, 4/6. Miniature, 384, etc., 5/6. Multiratio push-pull, 7/6. Push-Pull 10 to 15/6. 10 to 20 v. 6K, 30/-.
L.F. CHOKES 15/10 H. 60/65 mA, 5/-; 10 H. 85 mA, 10/6; 10 H. 120 mA, 12/6; 10 H. 150 mA, 14/-.

MAINS TRANSFORMERS: 300/250 v. A.C. STANDARD, 250-0-250, 80 mA, 6.3 v. 3.5 a. Tapped 4 v. 2a., 250/0-250, 1 a. 5 v. 2 a. or 4 v. 2 a. Ditto, 350-0-350 29/6
MINIATURE, 200 v. 20 mA, 6.3 v. 1 a. 10/6
MIDGET, 220 v. 45 mA, 6.3 v. 2 a. 15/6
SMALL, 230-0-230, 50 mA, 6.3 v. 3.5 a. 17/6
STD., 250-0-250, 45 mA, 6.3 v. 3.5 a. 17/6
HEATER TRANS., 6.3 v. 1A. 10/6
Ditto 1.4, 2.3, 4.5, 6.3 v. 1A. 8/6
Ditto Tapped, 3 to 30 v., 2A. 2/6

ALADDIN FORMERS and core, 4in., 8d.; 2in., 10d. 0.3in. FORMERS 5987/8 and Cans TV2. 1 1/2 in. sq. x 3 1/2 in. and 1 1/2 in. sq. x 1 1/2 in., 2/- ea., with cores.
SOLON Midget Iron 200/100v. or 220/140v. 25w., 24/-.
MUSIC DROPPER, 5in. x 4 1/2 in. Adj. Switches, 0.3 amp., 1000 ohms, 4/3, 0.2 amp., 1000 ohms, 4/3.
LINE CORD, 0.3 amp., 60 ohms per ft., 0.2 amp., 100 ohms per ft., 2-way, 6d. per ft., 3-way, 7d. per ft.
LOUDSPEAKER P.M. 3 OHM, 5in. Dia., 17/6. 5in. Fliesky, 19/6. 7in. x 4in. Fliesky, 18/- 6 1/2 in. Dia., 18/6. 10 x 6in., 27/6. 10in. Dia., 30/-.
4in. Tweeter, 25/-, 12in. R.A., 30/-, 9 in. 25/-.
STENTORIAN HF012. 10in. 3 to 15 ohm 10 v., 95/-, 12in. Baker 15 watt 3 ohms or 15 ohms, 90/-.
12in. BAKER FORM SUSPENSION, 15 ohms, 26/-.
CRYSTAL DIODE, C. G. 20/-, GEX34, 4/-.
HIGH RESISTANCE PHONES, 4,000 ohms, 15/-, pre-LOW RESISTANCE PHONES (BA5), 7/6 p.
MIKE TRANS., 50-1, 3/9 ea.; 100-1, Potted, 10/6.
SWITCH CLEARER. Fluid spirit spout, 4/3 1/2 in.
TWIN GANG TUNING CONDENSERS, 395 pF. miniature box 1 1/2 in. x 1 1/2 in., 10/-, 0.0005 Standard with trimmers, 9/-; less trimmers, 8/-; midget, 7/6.
SINGLE, 50 pF, 2/6; 80 pF, 100 pF, 160 pF, 5/6.
Midget dielectric 100, 300, 500 pF, 9/6.
SPEAKER FRET, GOLD CLOTH, 17in. x 25in., 5/-; 25in. x 35in., 10/-, Tygan, 4ft. 6in. wide, 10/- ft.; 2ft. 3in. wide, 5/- ft. Brown or Red or Green.

"REGENT" 4VALVE "96" RANGE VALVES KIT PRICE £6. 6. 0. Carr. 4/-



PRINTED CIRCUIT BATTERY PORTABLE KIT
Medium and long wave. Powerful 7 x 4in. high Flux Speaker. T.C.C. Printed Circuit and condensers. Components of finest quality clearly identified with assembly instructions. Osamor Ferrite Aerial coils. Rexine covered, atache case cabinet. Size 12in. x 8in. x 4in. Batteries used B126 (L5512) and AD35 (L5040), 10/- extra. Instructions 9d. (free with kit). Mains Unit ready made for above 89/6. Sold separately.

ARMSTRONG AF 208 AM/FM RADIOGRAM AM/FM



★ Full VHF Hand (57-109 Mc/s) and Medium Band, 157-570M. ★ 7 Valves ★ 5 Warts Output ★ 15dB Negative Feedback ★ Separate wide range Bass and Treble Controls ★ 2 Compressed Pick-up Inputs ★ Frequency Response 30-22,000 c/s. ★ 2dB ★ Tape Record and Playback Facilities 2/ Continental Reception of Good Programme Value ★ For 3 7 1/2 and 15 ohm speakers. 12 Month guarantee ★ Installation and Service Manual Supplied.

Price **22 Guinea** Carr. Free.

 The Brilliantly Successful **Manarch** 4-Speed Autochangers, B.S.R., U.A.S. 26.15.0
4 Speed Autochangers, U.A.S. Stereo 27.10.0
Garrard 209 Acos 73 Head ... £10.10.0
Garrard Model 210, G.C.S Head ... £10.10.0
4 speed Single Players, E.M.I. ... £8.19.8
Garrard TA Mk. 11 G.C.S Head ... £8.00.0
Garrard 4 HF Transcription G.C.S. ... £27.19.8
Garrard Stereo Heads ... £2.00.0

Volume Controls 80 ohm COAX CABLE
Long spindles. Midget Semi-air spaced 4in. 5K ohms to 2 Meg. stranded core. 6d./yd. No. 8w. D.P.8w. 4/8 Fringe Quality 1/-yd. Linear or Log Tracks, Air Spaced.

COAX PLUG . . . LEAD SOCKET . . . 2/- PANEL SOCKETS 1/- OUTLET BOXES 4/6
BALANCED TWIN FEEDER yd. 6d. 80 or 300 ohms. DITTO SCREENED per yd. 1/8. 80 ohms only. WIRE-WOUND P.W. 3 WATT. Pre-set Min. TV Type. All values 10 ohms to 25 K. 3/- ea. 30 K. 50 K. 4/- (Carbon 30 K.), 2 to meg., 3/- WIRE-WOUND 4 WATT Pots. Long spindle. Values, 80 ohms to 50 K. 6/8; 100 K. 7/8.

ALUMINIUM CHASSIS. 18 s.w.g. undrilled. With 4 sides, riveted corners and latting fixing holes, 2 1/2 in. sides, 7 x 4 in., 4/8; 9 x 7 in., 5/8; 11 x 7 in., 6/8; 13 x 9 in., 8/8; 14 x 11 in., 10/8; 15 x 14 in., 12/8; 18 x 16 x 3 in., 19/6.

HI-GAIN BAND 3 L.T.A. PRE-AMP KIT. Cascade circuit with valve EC84, or PC84. Price 29/6, with Power Pack, 49/6. Plans only 6d. Band 1 BBC version, same price.

CONDENSERS. 1000 pF. 7 kv. T.C.C., 5/6. 500 or 1,000 pF, 20 kv., 9/6, 0.1 mfd. 7 kv., 9/6. Tubular 500 v. 0.001 to 0.05 mfd., 9d. 0.1, 1/-; 0.25, 1/8; 0.5/1000 v., 1/8; 0.1, 350 v., 3/-; 2,500/300 v., 1/9; 0.01/2,000 v., 1/9; 0.1 mfd., 2,000 volts, 3/6. CERAMIC CONDS. 500 v., 0.3 pF to 0.1 mfd., 6d. SILVER MICA CONDENSERS. 10% 5 pF to 500 pF, 1/-; 600 pF to 3,000 pF, 4/3. Close tolerance (+-1 pF) 2 pF to 47 pF, 1/6. Ditto 1% 50 pF to 815 pF, 1/8; 1,000 pF to 5,000 pF, 2/6.

I.F. TRANSFORMERS 7 1/2 pair
465 Kcs/8 Slug Tuning Miniature Can. 1 1/2 in. x 1/2 in. square. High Q and good bandwidth. By Fry Radio. Data sheets supplied.
Wormmouth 3 1/2 x 1 1/2 in. sq. I.F. 465 Kcs, 10/6 pair

NEW ELECTROLYTICS. FAMOUS MAKES

TUBULAR TUBULAR CAN TYPES
1/350v. 2/- 50/350v. 5/8 4/800v. 9/-
2/350v. 2/3 100/25v. 2/- 32/350v. 4/-
4/490v. 2/3 250/25v. 2/8 100/270v. 5/8
8/450v. 2/3 500/12v. 3/- 2,500/3v. 4/-
8/500v. 2/3 8 + 8/450v. 3/8 32 + 32/350v. 5/-
16/450v. 3/- 8 + 16/450v. 3/8 32 + 32/450v. 6/-
16/500v. 4/- 8 + 16/500v. 5/8 50 + 50/350v. 6/-
32/450v. 3/8 16 + 16/450v. 6/- 64 + 120/350v. 11/8
25/25v. 1/8 16 + 16/500v. 5/- 64 + 120/350v. 11/8
50/50v. 2/- 32 + 32/350v. 4/8 100 + 200/27v. 12/6

SELENIUM RECTIFIER. 300 v. 85 ma, 7/6.
CONTACT COOLED. 250 v. 50 ma, 7/6; 60 ma, 8/6; 85 ma, 9/6; 200 ma, 21/-, FC31, 300 ma, 27/6.
COILS Waffle. "21" type, 3/- each. Osamor Midget 7" type adj. dust cover from 4/-. All ranges.
TELETRON L. & M.T.R., wit reaction, 3/6.
FERRITE ROD AERIALS. M.W. 8/6; M. 8. 1. 19/6.
T.R.F. COILS. A.H.F. 7/- pair. H.F. CHOKES, 2/6.
FERRITE ROD. 8in. x 1 in. dia., 2/6.

JASON F.M. TUNER COIL SET. 29/-, H.F. coil, aerial coil, oscillator coil, two I.F. transformers. 10.7 Mc/s. Ratio Detector and heater choke. Circuit book using four 6AM6, 2/6.
COMPLETE JASON F.M. KIT FMT1. with set of 4 valves, £65.00. Details S.A.E.

FULL WAVE BRIDGE SELENIUM RECTIFIERS. 2, 6 or 12v. 1 1/2 amp. 8/9; 2 a., 11/8; 4 a., 17/6
CHARGER TRANSFORMERS. Tapped input 200/250 v. for charging at 2, 6 or 12 v., 1 1/2 amps, 15/6; 2 amps, 17/6; 4 amps., 22/6. Circuit included, 2 aamps. and IV TUBE equivalent components, 9/6.
VALVE and TV TUBE equivalent boxes, 9/6.
VALVE DATA. Vol. 1, 2 or 4, 5/- each.
TOGGLE SWITCHES. S.P. 2/-, D.P. 3/6, D.P.D.T. 4/-
WAVECHANGE SWITCHES
4-wave 2 waffer long spindle ... 6/6
2 p. 2-way, or 3 p. 2-way spindle ... 2/6
2 p. 6-way, or 4 p. 2-way, 4 p. 3-way long spindle 3/6
3 p. 4-way, or 1 p. 12-way long spindle ... 3/6
VALVEHOLDERS. Pax Int. Oct., 4d. EF50, EA60. 6d. B12A, CRT, 1 1/2. Eng. and Amer., 4, 6, 8, and 7 pin. 1 1/2. MOUNTED BA2DA and Int. Oct., 6d. B7G, B9A, 15G, B9A, 9d. B7G with can., 1/8. B9A with can., 1/8. CERAMIC EF50, B7G, B9A. Int. Oct., 1/-, S/Cans. B7G, B9A, 1/-.

NEW MULLARD TRANSISTORS
Audio OC71 10/- RF OC45 ... 15/6
OC72 .. 12/6 OC45 ... 12/6
8in Miniature Electrolytics. 15v. vft.
1, 2, 4, 5, 8, 25, 50, 100 mfd. 3/- each.
"SP.W." Pocket 6 Transistor Kit. All parts, Printed Circuit and Cabinet ... £8.15.0

CODAR "CLIPPER" ALL BAND RECEIVERS 10-2000 METRES

LISTEN TO AMATEURS, AIRCRAFT, SHIPPING, ALL SHORT, MEDIUM, LONG WAVE BROADCAST STATIONS THROUGHOUT THE WORLD

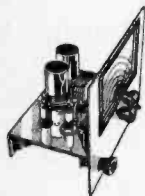

- ★ Full coverage 10-2000 metres (5 Coils).
- ★ Precision 7 x 4in. Dial with two pointers, dual slow motion drives, 8-1 and 48-1 ratios.
- ★ Bandsread on ALL Bands.
- ★ Air spaced variable condensers.
- ★ Polystyrene iron cored plug-in Coils.
- ★ Mazda Ediswan first grade Valve/Transistors.

Tremendous performance with latest circuitry Hi-gain regenerative valve detector PLUS transistor amplifiers which are completely assembled, tested, in sealed cans, only 3 wires to connect! Chassis 8 x 5 1/2in., all holes punched ready for easy assembly with step-by-step plans. Uses small dry batteries which last many months.

"CLIPPER" Total building cost all components, valve, chassis, one transistor stage, two coils 20-60 and 55-180 metres, all nuts, bolts, wire, solder, plans, 79/6 P. & P. 2/6. Extra transistor stage can be added at any time.

"SUPER CLIPPER" As above but two transistor stages for really high gain, 88/6 P. & P. 2/6. Optional Front Panel, beautiful stoved Silver Hammer finish, Dial aperture and all holes punched, dial glass, 6/9. P. & P. 1/6

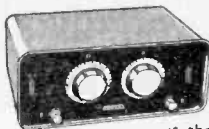

NEW! We proudly present the **CLIPPER CR 45** the latest Model in the famous Clipper series. This A.C Mains receiver combines really top performance with superb professional finish, and is the finest ALL-BAND receiver at the price. New high gain circuit uses ECC81 double-triode, EL84 output pentode, EZ80 full wave rectifier. Power output 3 1/2 watts for 2/3 ohm speaker. For A.C. Mains 200/250 volts.

- ★ Full coverage 10-2000 metres (5 Coils).
- ★ THREE Planetary Slow Motion Drives for easy tuning and logging.
- ★ Separate Electrical Bandsread on ALL Bands. Air spaced variables.
- ★ Satin Silver Dials, Ivory Knobs, Black Crackle Front Panel.
- ★ Polystyrene iron cored plug-in Coils.
- ★ First grade Mazda Valves and new components throughout carry full guarantee.

Modern styled Cabinet in handsome Blue Hammer stoved finish available as optional extra.

"CLIPPER CR 45" Total building cost all components, valves, punched chassis 10 x 5 1/2in., front panel, 2 coils 20-60 and 55-180 metres, nuts, bolts, wire, solder, plans. £6.17.6. P. & P. 3/6. Cabinet parts, louvred rear panel, feet. 27/6. P. & P. 2/6.

ANYONE can build these outstanding receivers which offer a new high standard of performance and finish to the home constructor. No technical knowledge required and success is guaranteed with our detailed step-by-step plans. Send 3d. stamp for full details, illustrated leaflets and copy of testimonials from "Clipper" enthusiasts.

CODAR RADIO COMPANY, COLEBROOK ROAD, SOUTHWICK, SUSSEX

1961 EDITION

RADIO AMATEUR'S HANDBOOK

32/6 by The A.R.R.L. Post 2/-

SERVICE VALVE EQUIVALENTS. CV-ARMY-NAVY-AIR FORCE TYPES, a R.S.G.B. Pub. 2/-, Postage 4d.

INTRODUCTION TO HI-FI, by C. Brown, 21/-, Postage 1/-.

HIGH FIDELITY SOUND ENGINEERING, by N H. Crowhurst, 50/-, Postage 1/-.

MODEL RADIO-CONTROL, by E. L. Safford, 21/-, Postage 9d.

BASIC ELECTRONICS in 6 Parts, by Van Valkenburgh, £3.6.0d, Postage 1/6.

TRANSISTOR SUPERHET RECEIVERS, by C. Sinclair, 7/6, Postage 6d.

FUNDAMENTALS OF SEMI-CONDUCTORS, by M. G. Scroggie 23/-, Postage 9d.

A GUIDE TO AMATEUR RADIO, a R.S.G.B. Pub. 3/6, Postage 6d.

COMPLETE CATALOGUE 1/-.

THE MODERN BOOK CO.

BRITAIN'S LARGEST STOCKISTS of British and American Technical Books

19-21 PRAED STREET LONDON, W.2

Phone: PADdington 4185

Open 6 days 9-6 p.m.

VALVES SAME DAY SERVICE NEW! TESTED! GUARANTEED!

SETS

1R5, 1S5, 1T4, 3S4, 3V4, DAF91, DF91, DK91, DL62, DL94 .. any 4 for 19/6
DAF96, DF96, DK96, DL96 4 for 27 2
6K7G, 6K8G, 6Q7G, 6V6G, 6X5G, or 5Y3G 6 for 24/6

1A1GT 11/6	6LD30 8/-	2528GT 9/6	ECC40 17/6	EZ41 7/-	PZ30 17/-
6E1 8/-	6E1 13/6	35A5 8/6	ECC81 9/6	EZ80 6/3	U17 19/6
1HSGT 10/-	6P25 8/-	35L8GT 9/-	ECC82 6/3	EZ81 7/-	T41 9/6
1NSGT 10/-	6Q7G 6/-	35Z4GT 6/6	ECC83 7/-	FW4/500 8/-	U22 7/3
1R5 5/6	6Q7GT 9/8	35Z5GT 8/9	ECC84 8/9	GZ30 8/8	U25 13/-
134 8/-	6SL7GT 6/3	50L8GT 8/9	ECC85 8/3	GZ32 9/6	U28 10/6
135 5/3	6SN7GT 4/8	AC/TH1 16/9	ECP90 8/8	HB30 7/-	U30 6/6
1T4 3/6	3U4GT 11/6	AZ31 9/6	ECP82 8/6	KT33C 7/-	U52 4/6
1U5 5/9	6V6G 5/-	B95 8/9	ECH21 13/6	KT41 11/6	U78 4/9
3A5 9/-	6V6GT 8/8	CL33 12/3	ECH35 6/3	KT44 6/8	UABC90 7/9
3Q4 7/-	6X4 4/9	DAC32 10/-	ECH42 8/9	KT61 10/-	UAF42 9/9
6S4 6/-	6X5GT 7/-	DAF81 5/3	ECH81 8/-	KT63 6/8	UBC41 7/9
3V4 7/-	7B8 8/-	DAF96 7/6	ECL80 7/6	MU14 7/6	UBF80 8/9
5U4G 4/6	7B7 7/6	DCC90 9/-	ECL82 9/6	MX40 9/6	UBF89 8/9
5V4G 8/-	7C5 7/8	DF33 10/-	EF39 4/6	N18 7/-	LC92 12/6
6Y3GT 6/-	7C6 7/8	DF91 3/6	EF40 12/6	N37 10/6	UCC84 12/9
5Z4G 7/9	7H7 7/6	DF96 7/6	EF41 9/3	PC35 11/6	UC05 9/6
6AL5 3/8	7S7 7/8	DH78 4/9	EF42 9/6	PC084 7/6	UCF80 14/9
6AM6 3/6	7Y4 7/-	DH77 6/9	EF80 5/6	PC089 11/-	UCH21 13/6
6AQ5 6/-	10C1 11/6	DK32 11/6	EF85 5/6	PCC80 7/9	UCH42 8/-
6A7B 6/9	10C2 17/6	DK31 5/6	EF86 9/9	PCF82 8/-	UCH81 8/3
6B48 6/-	10P13 14/6	DK32 7/6	EF89 7/-	PCF95 14/6	UCL82 10/9
6BE6 5/9	12A76 7/8	DK96 7/8	EF91 3/6	PCL82 7/6	UCH83 13/6
6BH6 5/9	12A77 5/-	DL38 9/-	EF92 4/3	PCL83 11/6	UF41 8/9
6BJ6 5/9	12AUG 8/9	DL35 9/6	EF183 14/-	PCL84 7/6	UF85 8/6
6BW6 8/-	12AU7 6/3	DL92 6/-	EL33 10/-	PEN44 11/-	UF89 7/6
6C6G 28/9	12AX7 7/8	DL94 7/-	EL41 8/6	PEN36C 8/-	UL41 8/-
6F1 12/6	12K7GT 11/6	DL96 7/8	EL42 8/-	PL36 11/6	UL84 7/6
6F8G 6/6	12Q7GT 4/9	EABC80 7/8	EL84 7/-	PL81 8/6	UR1C 8/-
6F13 11/-	12Z3 7/8	EAF42 9/6	EM34 6/9	PL82 7/-	UY21 11/3
6F14 13/6	14S7 13/6	EB31 3/8	EM80 8/8	PY32 7/6	UY41 6/6
6K7G 2/6	20F2 17/6	EB33 5/-	EM81 8/6	PL84 10/-	UY85 6/6
6K7GT 5/-	20L1 17/6	EB41 8/-	EM84 10/-	PL87 11/-	VP4B 9/6
6K8G 6/3	25A8G 8/-	EBP89 8/9	EY84 10/-	PY80 7/6	VP41 5/-
6K8GT 9/3	25L8GT 7/9	EEL21 13/6	EY86 7/9	PY82 6/8	W76 5/3
6L8 10/3	25Z4G 7/8	EC82 11/-	EZ40 6/9	PY83 6/8	W77 4/6
					Z77 3/6

READERS RADIO
24 COLBERG PLACE, STAMFORD HILL,
LONDON, N.16. STA. 4587

Post 6d. per valve extra.
Any Parcel Insured Against Damage in Transit 6d. extra.
Any C.O.D. Parcel 3/- extra.

SHORT-WAVE SECTION

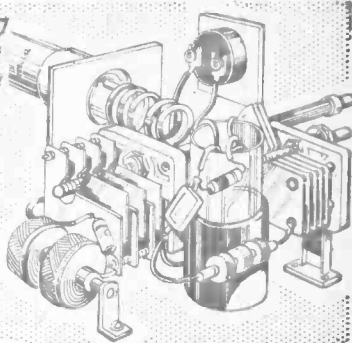

'S' METERS — CIRCUITS AND CALIBRATION

By J. B. Dance

NORMALLY, 'S' meters are intended to give only a very approximate indication or comparison of signal strength and also serve a useful purpose as tuning meters. The signal must be amplified before it can operate an 'S' meter, but because the gain of all receivers varies with frequency, a signal input of a certain voltage at one frequency

of the source of the AGC line voltage is usually of the order of 1M and the meter would therefore effectively short-circuit the AGC line. Also the AGC line voltage is too small to operate a high resistance voltmeter.

Some form of valve circuit which has a high input impedance is required. The simplest and most economical method of feeding the 'S' meter involves the use of one of the existing I.F. (or R.F.) valves to which AGC is applied. The meter is included in the anode or cathode circuit of the valve and is operated by the AGC voltage which has been amplified by the valve. The scale of dB indications is not evenly spread out owing to the variable- μ properties of the I.F. valve. A separate valve fed from the AGC line may be used, if desired, to give a rather more useful scale of readings.

In all of the circuits to be described the component values shown for the I.F. amplifiers are suitable for the 6K7 or EF39 types of valve. If an EF93 (or 6BA6) is used, the value of the cathode resistor could be reduced to about 68Ω in order to obtain more gain.

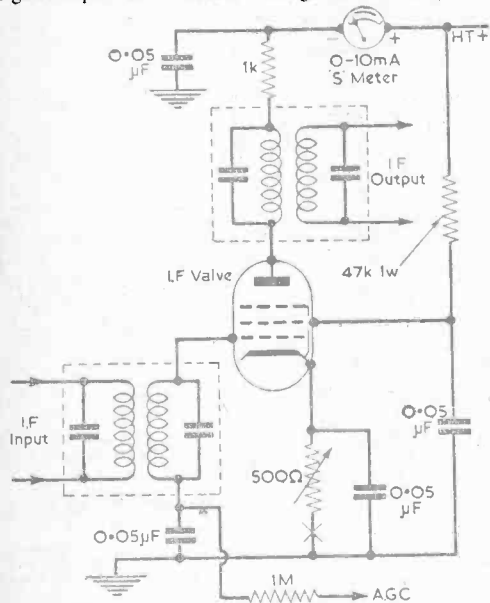

Fig. 1.—Circuit of a simple "S" meter.

will not normally give the same deflection of the 'S' meter as a signal of the same strength but of a different frequency. Within any one amateur band, however, an 'S' meter in a properly aligned receiver gives a fairly accurate comparison of signal strengths.

Principle of Operation

All common 'S' meter circuits operate from the AGC line. They depend on the fact that the AGC bias increases with increasing signal input from the aerial. The meter to be used as a 'S' meter cannot merely be connected directly from the AGC line to earth, as the internal resistance

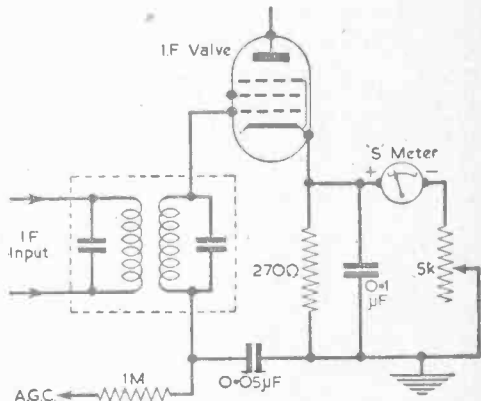

Fig. 2.—A circuit using a 1mA meter.

Economical Circuits

One of the simplest possible 'S' meter circuits is shown in Fig. 1. The meter could either be placed in the anode circuit as shown or alternatively at the point marked with a cross in the cathode circuit. In either case the performance

will be very similar. Alternatively, if it is desired to use a 0—1mA meter, the circuit shown in Fig. 2 may be used.

As the signal strength increases, the AGC voltage becomes more negative. This not only reduces the gain of the receiver but also reduces the anode and screen currents of the I.F. valve. An increase of signal strength therefore results in a decrease in the current passing through the meter. A large deflection of the meter occurs when the signal strength is small. This is a disadvantage of this type of circuit. In order to arrange that the meter shall deflect towards the right as the signal strength increases, special meters have been used in which the needle is on the right-hand side at zero current and moves to the left as the current increases. Such meters are quite expensive and therefore some constructors have used an ordinary meter in an inverted position in order to obtain a left to right reading with increasing signal.

Bridge Circuits

Simple bridge circuits can be employed with ordinary meters so that they read in a forward direction. An example is shown in Fig. 3 in which the bridge is in the anode circuit of one of the I.F. amplifiers. This circuit can be redrawn as a bridge in which the anode resistance of the I.F. valve is one arm; it varies with the changes of AGC voltage.

It is quite easy to add the 'S' meter circuit of Fig. 3 externally to an existing receiver. There are only three connections between the receiver and the meter, namely earth, H.T. positive and the H.T. supply to the I.F. valve. The parts which can conveniently be placed in the meter case outside the main receiver are shown within the dotted lines in Fig 3.

Preliminary Adjustments

The circuit of Fig. 3 should be adjusted as follows before use. First the I.F. valve should be removed and the resistor R4 adjusted for full scale deflection. Then the valve should be replaced and the resistor R1 adjusted with no signal input to the receiver so that current does not pass through the meter. The bridge is then balanced, and if a signal is applied to the input, the increase of the negative AGC voltage will cause the anode resistance of the valve to increase and the bridge to become unbalanced. The current passing through the meter depends on the degree of the unbalance which in turn depends on the signal strength.

No matter how strong the signal, the meter cannot be deflected off the scale, as the initial adjustment for maximum deflection was made at zero anode current (i.e. the I.F. valve was removed) and the strongest signal cannot produce enough negative AGC voltage to reduce the anode current of the I.F. valve to zero.

'S' Meter Valves

Instead of using an I.F. amplifier valve controlled by the AGC it is possible to use an additional 'S' meter valve to provide the current

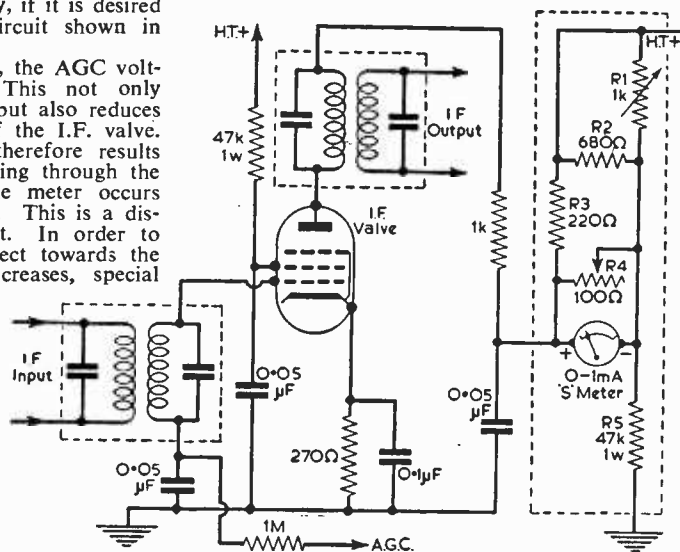

Fig. 3.—A forward-reading circuit.

required to operate the 'S' meter. Such a circuit is shown in Fig. 4. A 0—1mA or a 0—2mA meter should be used in this circuit. R1 should be adjusted so that the meter is fully deflected when the 'S' meter valve, V1, has been removed. The valve should then be replaced and the AGC line shorted to ground whilst the cathode resistor, R2, is adjusted to give zero reading on the meter. It is claimed that this circuit gives a linear dB scale; the distance between each 'S' point on the meter scale is constant.

Double Triode Circuit

Another good circuit is shown in Fig. 5. This employs a 12AU7 double triode which obtains its input from the cathode of one of the AGC controlled I.F. valves. The internal anode resistance of the two triodes and the cathode resistors form a bridge circuit. When an input voltage is applied to the first triode, its anode resistance is altered and the bridge is thrown out of balance. The anode resistance of V1(b) remains constant.

Before use, R2 is adjusted to balance the bridge at zero signal so that no current passes through the meter. The connection to the anode of V1(a) is then removed and R1 is adjusted for full scale deflection. When the anode of V1(a) is reconnected, the meter should deflect in a forward direction according to the strength of the signal being received.

Calibration By Ear

Various people have different ideas about what they mean by, say, S9. It is doubtful whether a really accurate calibration is worthwhile. Those who do not possess a signal generator which incorporates an accurately calibrated attenuator can best calibrate their 'S' meter by ear as described below. This method is probably as good as any.

AMAZING NEW TRANSISTOR RADIO KIT "SONIC SIXTY"

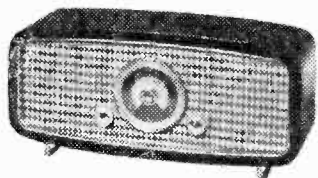

6 Mullard Transistors. 1 Diode. Internal Ferrite Rod Aerial. 7 x 4in. high quality Speaker. 500 mW push-pull output. MW and LW. Calibrated Direct Drive Assembly. Modern high polish Walnut Cabinet 17 x 7½ x 5in.

COMPLETE KIT **£9.15.0** P. & P. 4/6.
READY TO BUILD

ALL PARTS SOLD SEPARATELY

BUILD IT YOURSELF!

THE FAMOUS COSSOR

(Traveller's Friend) Transistorised

£7.19.6 POCKET RECEIVER

P. & P. 2/-
in leatherette case
All parts sold separately



This set can be built for £7.19.6. Size 6 x 3½ x 1½in. Weight 17 oz. This set covers medium waveband 190/500 metres intermediate frequency. 470 kc/s using 4 transistors (Ediswan) and 2 diodes on a printed circuit board, plus a 2½in. moving coil speaker. Instruction book with point to point wiring diagram. 2/6 each. Batteries, PP4 (Ever Ready) 2/- each.

THE LATEST MINIATURE EARPHONE FOR TRANSISTOR RADIOS

This lightweight superbly made instrument enables you to listen in to your radio wherever you are, ideal for all forms of travel, etc. Provides excellent reproduction and can be worn without any discomfort, complete with transparent earpiece, 3ft. of fine flex, plug and socket.



Crystal earpiece as illus. High Imp. 10/- Usual price £1.1.0
Magnetic " " " " Low Imp. P. & P. 1/-

YOUR EXISTING RADIOGRAM OR RECORD PLAYER CHANGED TO STEREO BY OUR STEREO ADAPTOR

Tech. Data 2 valves EF80 and EL84. Switch control for Stereo and Mono dual volume and tone control. Output 3ohms, suitable for use with Acos GC/71, GP/73 and Garrard GC/10. Complete with wiring diagram.

£2.19.6

P. & P. 2/6

8 WATT AMPLIFIER

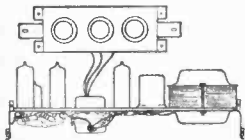

This superb 8 watt amplifier made by well-known manufacturer, ready for your Hi-Fi cabinet. Spec.: 2 EL84, 12AX7 and EZ81. Push-pull output. Separate Bass and Treble controls on panel with extended lead.

Special Bargain while stocks last **£4.15.0** P. & P. 3/6.

BATTERY ELIMINATOR

Convert your Battery Set to Mains with a COSSOR BATTERY ELIMINATOR

MU2. For operation on 200/250 v. 50 c/s A.C. mains. Output: L.T., 1.5 v. 125 mA; H.T., 90 v. 10 mA.

42/6

P. & P. 2/6



NEW POCKET MULTIMETER

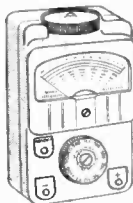

A must for all home constructors. Basic movement 300µA. Sensitivity 1,000/V. A.C. and D.C. Ranges 10-50-250-500-1,000V. D.C. and A.C. 1-100-500mA. D.C. 2K/200K ohms. Accuracy: 3% FSD and D.C. 5% F.S.D. and A.C. 10% on. Resistance scale. Dimensions 5½ x 3½ x 2½in. Complete with test leads, prods and 1.5V cell.

69/6

P. & P. 2/-

LABGEAR OUTPUT METER

£2.19.6

Complete Kit P. & P. 2/-

At last a Meter at the right price for the home constructor. An accurate Audio Power Output Meter. Two ranges 25mW to 1W and 1W to 10W. Accuracy 5% matched for 3, 15, 600 ohms with inst. and tech. data. New 3in. 0-1mA meter.

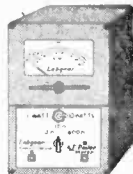

NOT GOVERNMENT SURPLUS

VERDIK TAPE RECORDERS

First class Tape Recorders using the famous Collaro transcription deck. 3-speed 1½-3½-7½IPS. Mic and Radio inputs. 7 x 3½in. internal speaker. Valve line-up ECC83, ECL82, EM84. Wow and Flutter 0.15% total at 7½ins./sec. Size width 15½in., depth 6½in., height 6½in., weight 26lbs.

LIMITED STOCK ONLY

Model S22 32 gns. Model S44 39 gns.
2 Track 4 Track
Carr. & Ins. 21/-

RECORDING TAPE OFFER

FAMOUS MAKE P.V.C. BASE ON PLASTIC SPOOL STANDARD LONG PLAY

600ft on 5in. spool 15/-	900ft on 5in. spool 18/6
850ft on 5½in. spool 16/6	1200ft. on 5½in. spool 21/-
1200ft on 7in. spool 21/-	1800ft. on 7in. spool 32/6

P. & P. 1/-

LOUDSPEAKERS

5in. 14/6; 6½in. 16/-; 8in. 16/6; 6 x 4in. 14/6; 7 x 4in. 15/-; 8 x 5in. 23/-; 10in. 30/-; 10 x 6in. 25/-; 12in. 32/6. All above 3 ohms impedance. P. & P. 2/6.
12in. 15 ohms. Hi-Fi Celestion £4.19.6.

SEND S.A.E. FOR FREE PRICE LIST OR PAY US A PERSONAL CALL

WIRECOMP ELECTRONICS

378 HARROW ROAD, LONDON, W.9
TEL: CUNNINGHAM 9530

Hours of business: 9 a.m. to 6 p.m. Open all day Saturday. Opposite Paddington General Hospital.

Buses 18B and 36 pass the door.

Premier RADIO

23 TOTTENHAM COURT ROAD, LONDON W.1
and at 309 EDGWARE ROAD, LONDON W.2

TEL: MUSEUM 3451/2
TEL: PADDINGTON 6963

"THE MID-FI" A NEW DESIGN 4 WATT AMPLIFIER KIT

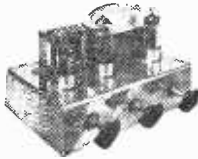

MAY BE BUILT FOR **95/-** plus 3/- p. & p.

A new circuit for the home constructor requiring a good quality medium powered Amplifier for reproduction of Records of F.M. Broadcasts. For use with Loudspeakers of 3 or 15 ohms impedance. Technical Specifications: separate bass and treble controls. Valve line-up EF86, EL84, EZ80. Voltage adjustment for A.C. mains from 200-250 volt. Negative feedback. Size 7 x 5 x 2in., overall height 5in. Silver hammered finish Chassis. Instruction Book 1/-.



The "Petite" PORTABLE

MAY BE BUILT FOR

£7.7.0 Plus 3/- p. & p.

BATTERIES EXTRA. H.T. 10/- (Type B126) or equivalent L.T. 1/6 (Type AD35) or equivalent.
★ Size only 8in. x 8in. x 4½in.
★ Instruction book 1/6.

The SUPER 60

6-Transistor
Battery Receiver
May be Built for

£9.15.0

Plus 4/6 P. & P.
Ever-Ready P.P10
Battery Extra 11/-

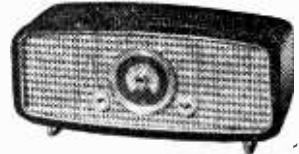

STAR FEATURES:—
★ Six 1st grade Mullard Transistors and one Diode.
★ Internal Ferrite Rod Aerial.
★ 7in. x 4in. Elliptical Speaker.
★ Printed Circuit.
★ 500 mW Push-Pull Output.

The Receiver is housed in an attractive contemporary mahogany finished cabinet trimmed with gilt, supported by gilt stands. The Receiver will operate for months on one 9-volt long-life battery. Instruction Book separately at 2/6 p.p.

- ★ Full medium and long waveband coverage.
- ★ Calibrated Direct Drive Dial Drive Assembly.
- ★ Full point-to-point instructions supplied.
- ★ Dimensions 18in. x 7½in. x 5½in.

OUTSTANDING BARGAIN OFFER

The Kapura Model UI Multi-

timer for only **59/6**

Complete with Test Leads P. & P. 2/6
A truly efficient Meter for the enthusiast; sensitivity 1000 ohms per volt A.C. and D.C. ranges (A.C./D.C.) 0-10-50-250-500-1000v. D.C. current 0-100-500 mA. 0-1mA (at D.C. 0-10v) resistance 1-2000 ohms (centre—24 ohms), 100-200K (centre—2400 ohms). Size 5 x 3 x 2½in. Brand new in manufacturer's original boxes.



SOLDERING EQUIPMENT

by



PRECISION SOLDERING for the ELECTRONICS INDUSTRY

Comprehensive range - Robust & Reliable - Light weight - Rapid heating - Bit sizes 3/32in. to 3/8in. - 'Permabit' or Copper bits - All voltage ranges 6/7v. to 230/250v. - Prices from 19/6.

Also

- Plastic Cable Strippers
- Miniature Solder Pots
- Heat Guards
- Long Life Bits

Illustrated is the 25w. 3/16in. replaceable bit model with safety shield.

ADAMIN—the new range of precision micro-soldering instruments—
Have you had details?

Brochure No. S10 sent free on request.
Sole proprietors and manufacturers:
LIGHT SOLDERING DEVELOPMENTS Ltd.
28 Sydenham Road, Croydon, Surrey
Phone: CROYdon 8589 Grams: Litesold Croydon



Write for Price List
and

Free Information

on

P.W. POCKET SUPERHET ROADFARER AM/FM

Several interesting positions available for serious amateurs residing near Croydon

OSMOR

418 BRIGHTON ROAD
SOUTH CROYDON, SURREY

Telephone CROYdon 5148-9

First check that, with no signal input to the receiver, the "S" meter reads only a little above zero. Then tune in a number of strong local amateur signals, noting their meter readings. There should be virtually no background "sharsh" noise on these signals. The average "S" meter reading of the weakest signal giving no background noise is about S8 or S9.

Then tune in a weak signal (preferably a fairly local one which does not fade) in which the level of background noise is very high so that the signal can only just be heard. The meter reading will correspond to about S3. Before marking this point on the meter as S3, check with a number of other weak signals.

S6 should now correspond to a reasonably strong signal with a fairly small amount of background hiss. Finally all of the remaining "S" points should be marked on the scale. The markings 10dB and 20dB above S9 will probably be spaced a little farther from each other than the "S" points.

Accurate Calibration

The following method of calibration may be employed by those who have a good quality signal generator with a calibrated attenuator.

It is first necessary to choose the input level in microvolts which will correspond to S9. This will normally be between about 50 and 200µV; 100µV is a good figure for normal amateur work.

The R.F. gain control should be fully advanced and a signal fed into the aerial terminal of the receiver from the generator. The signal should be exactly 100µV or whatever level is chosen as corresponding to S9. This allows the S9 point to be marked on the scale. The generator input is then halved whilst the S8 point is being found, halved again for S7 and so on until the calibration is completed. This gives a calibration in steps of 6dB per S point at the frequency of calibration. Now, 10dB above S9

is the point at which the input voltage is 3.16 times greater than at S9; this point can therefore also be marked using the generator. Above S9, 20dB is 3.16 times greater than 10dB above S9 and so on.

However accurately the receiver has been calibrated at one frequency, this calibration will not be exactly correct at other frequencies, especially on other bands. It is thus very doubtful whether calibration by means of a signal generator is of any more value than calibration by ear. Even at the one frequency of accurate calibration, the accuracy will decrease with time, as the receiver goes slightly out of alignment and as the gain of the valves alters.

If desired, the meter can be switched to perform other functions, e.g. measuring receiver H.T. and other currents and voltages so that any faults in the receiver could be found more quickly. It could also be switched to show the percentage modulation of the signal being received.

Use a Good Aerial for SWL

Simple receivers, such as 1, 2 or 3 valve TRF sets, are often used for S.W. listening. With these, a good aerial can make a great deal of difference to reception. This is very noticeable on 80m and top band (160m). Here, a TRF receiver, or even a sensitive superhet, fitted with a short aerial, may be tuned over the band and give only very poor results. The band may seem dead, or may seem to carry local stations only. If a long aerial is substituted, the band can become alive with dozens of transmissions which were previously unheard. For 160m, anything under 80ft or 100ft of aerial can be considered rather short. For shorter wavelengths, shorter wires are satisfactory.

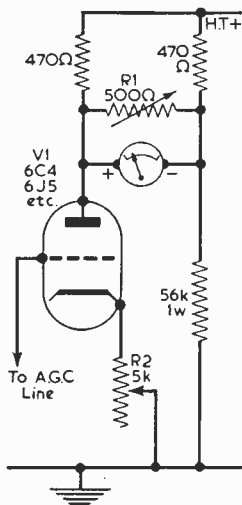

Fig. 4.—A circuit which requires an extra valve.

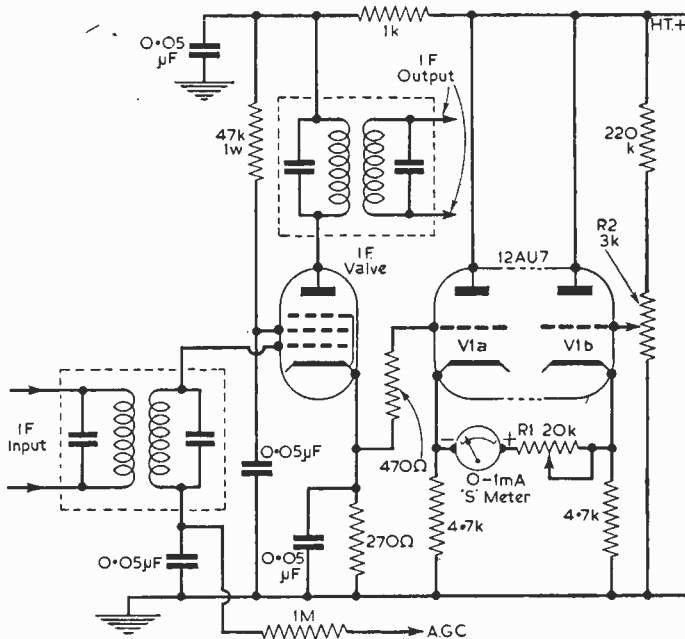

Fig. 5.—A circuit which employs a double triode.

Short-wave Listeners' Log—7

JHOUGH conditions on the amateur bands vary considerably, according to season, time of day, and other factors, each band has its own particular characteristics. As a guide to the short wave listener who has only recently become interested in this form of reception, the band characteristics may be listed as follows:

169m

Sparingly used, and mostly for fairly local contacts. The listener is most likely to hear stations working within a range of 50 miles or so. With darkness, the range increases, and transatlantic contacts have been made, but it is not very usual to hear distant stations on this band.

80m

Very popular for daylight contacts up to a few hundred miles. During daylight hours it is unusual not to hear at least a few stations working. At weekends, the band is often very fully occupied. As darkness falls, European stations often build up greatly in strength, and few local transmissions will be heard. Some activity is usual very early (before 7a.m.); from about midnight to early morning some long-distance contacts are possible.

40m

During daylight, skip may give best reception at a distance of some hundreds of miles, though ground wave or short range signals may be heard from locals. When darkness falls, the number

of powerful commercial stations in or near the band makes the reception of amateur stations difficult. Through midnight and up to early morning, long-distance reception may cover most continents.

20m

This band is usually good for very long-distance contacts. Results depend a lot on sunspot activity. During the hours of darkness, world-wide reception may be possible. Sometimes during summer, the band gives good results during the afternoon. Results tend to change from hour to hour, or day to day. This is the highest frequency band which many popular "all-wave" receivers will cover, and if often worth checking for possible long-distance reception.

15m

Conditions may result in no signals being heard on this band at some hours, or for several days at a time. But it is expected that changes in the sunspot cycle will make this band very useful for long-distance reception during coming years. At present it can furnish very good long-distance results, when conditions are good.

10m

This band is also very variable, but can also give excellent reception over very great distances. When the band is usable, the listener may hear many distant countries. There are also periods when the band seems quite dead, but conditions can change rapidly during the day.

TRANSMITTING TOPICS

END-FED TRANSMITTING AERIALS

(Continued from page 58)

Feedback Prevention

The end-fed Hertz has high voltage at the point where it is joined to the transmitter. Good insulation should be used here, and the lead should be taken away from the equipment as directly as possible. If near microphone or leads, or early stages of the transmitter, feedback may cause oscillation, or other troubles. This is particularly likely with fairly high power.

If this arises, and cannot be prevented by normal means (e.g. screened microphone leads, and reasonable separation of circuits) then an aerial coupler may be added. This coupler can use the circuit in Fig. 4, or that in Fig. 5. A few feet of coaxial cable are used between transmitter and tuner, and the tuner is situated a little clear of the transmitter, near the entry point of the aerial. The high impedance, voltage fed wire will then be well clear of the microphone, etc.

A Versatile

TAPE RECORDER

(Continued from page 70)

Now, mount the tape deck into the base of the cabinet, using four rubber buffers to mount the deck off from the top surface of the motor-board. Four chrome-plated screws secure the deck in place.

In making the connections from the tape-deck to the amplifier, only one earth connection must be used. The metal parts of the deck are bonded together by the manufacturer and the one earth connection should be made via the outer screening of the record/playback head coaxial cable. If multiple earths are used, there is a possibility of a high hum level on playback.

Final testing can now take place. A shorting plug for socket A can be made from a coaxial plug with the centre connector soldered to a piece of bare copper wire which is then shorted to the body of the plug.

Experience will soon show the correct indicator reading for good quality recordings.

There's **NO BETTER WAY** *than*
THE "PICTURE BOOK" WAY
of learning

ELECTRICITY & ELECTRONICS

(as 1000's have already discovered)

from

THE ILLUSTRATED COURSES of ELEMENTARY TECHNICIAN TRAINING

Published by THE TECHNICAL PRESS LTD.

BASIC ELECTRICITY (5 PARTS)

BASIC ELECTRONICS (6 PARTS)

BASIC SYNCHROS & SERVOS (2 PARTS)

★ ★ ★

In preparation BASIC RADAR, BASIC ELECTRONIC CIRCUITS, and BASIC TELEVISION

Ask your bookseller about

THE "PICTURE BOOK" WAY



OR fill up this coupon

COUPON - SEND NOW!

To **THE TECHNICAL PRESS LTD.**

112 Westbourne Grove, London, W.2.

Please send me your FREE prospectus.
 describing 'BASIC ELECTRICITY' 'BASIC
 ELECTRONICS' and 'BASIC SYNCHROS'
 and 'SERVOMECHANISMS'

NAME

ADDRESS

.....

PW

CONSTRUCTORS CORNER

Construction price includes valve and one coil covering 40-100 m
 ● Can be converted to 2v. or 3v.
 ● Receives speech and music clearly from all over the world.
 Send 2/- for diagram and price list.

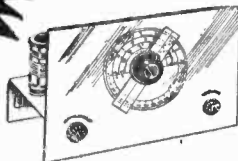

Explore the world on short-wave radio (10-100m)

FOR ONLY **35/-**



YOU CAN NOW BUILD THE R.C.S. TAPE TUNER

Will operate on all types of Recorder. Size $3\frac{3}{8} \times 1\frac{1}{2} \times 1\frac{1}{2}$ in. High impedance output, variable med. wave tuning. Triple wound Super-Hi-Q coil. Easily constructed from full instruction data and Layout Diagrams. Chassis and components colour coded.

All parts to Build.
Post 1/6.

30/-

CRYSTAL RECEIVER

Covers M/W Band

All components including case for

12/6

Ideal for the beginner.

Post and packing: Under 10/- add 9d.; under 40/- add 1/6; over POST FREE

Trade Enquiries
Welcomed

R.C.S. PRODUCTS (RADIO) LTD. 11 OLIVER RD., LONDON, E.17

Mail Order
Only

ENSURE SUCCESS WITH R.C.S.

AN IDEAL PRESENT!

EASY TO BUILD TWO STAGE TRANSISTOR SET
The set that looks like a Radio Set

- Attractive Case
- Mini .0005 Tuner
- High Q Litz Coil
- Works for months off No. 8 Battery
- Simple to construct in 15 min.

You can't go wrong. We guarantee good results.

Total Building Costs, P.P. 1/6 **25/-**

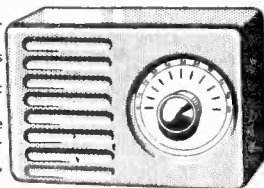

Components Price List. Layout Plans 1/6 free with order.

BUILD THIS AMAZING RADIO

POWERFUL PERSONAL PORTABLE
 FOR ONLY **35/-**

- ★ Sturdy metal case.
- ★ No holes to drill.
- ★ Detachable rod aerial.
- ★ All batteries self-contained.
- ★ Can be built in 1 hour.
- ★ Covers medium waves.
- ★ Loud clear tone.
- ★ Selective tuning.
- ★ All parts are sold separately.

This delightful set is designed to give you a completely personal portable radio.

Bronze-finished case. Ideal for the beach, the bedroom, the office—in fact anywhere.

Send 2/- for wiring diagram and components price list.



Radio Component DEALERS

You can obtain all the components for the

“ROADFARER”
and
POCKET 6 RECEIVER

from

NORMAN ROSE

(ELECTRICAL) LTD.

The Component Specialist Wholesalers!

47-49-53 HAMPSTEAD ROAD, LONDON, N.W.1
EUS. 6886/7

29 CONSTITUTION HILL, BIRMINGHAM 19
CENTRAL 4710

153 OXFORD ROAD, MANCHESTER 13
ARDWICK 1498

★ Bona fide dealers—please apply for catalogue and lists on official letter or order form.

Just out!
the NEW

STANELCO

100 WATT
SOLDERING IRON

costs only **29/-**

including post & packing

- Perfectly balanced
- Flat copper bit shaped for any application
- New stainless steel side plates eliminate corrosion
- Strong robust element with large surface ensures good heat transfer and long life
- Improved shock resisting moulded handle.

A really professional, high wattage iron at an economical price.

Suitable for operation at 12 v., 50 v., 100/110 v., 200/220 v., and 230/250 v.

Please state voltage required when ordering.

Send for leaflet or order direct from:

Standard Telephones and Cables Limited
Industrial Supplies Division
Stanelco Process Heating, Footscray, Sidcup, Kent
Footscray 3333



All elements flash tested at 1000 volts to earth to ensure RELIABILITY, QUALITY AND SAFETY

Club News

REPORTS OF CURRENT ACTIVITIES

BURY RADIO SOCIETY

Hon. Sec: G. Winter, 269 Lever Street, Radcliffe, Manchester, Lancashire.

As from April 11th, meetings will be held at the Knowsley Hotel, Kay Gardens, Bury.

Future Events

April 11th—My First 18 Months by G3NNW.
May 9th—Junk Sale.

FLINTSHIRE RADIO SOCIETY

Hon. Sec: L. W. Barnes, 1 Bryn Coed Park, Rhyl.

At the Annual General Meeting the following officers and committee were elected: President F. G. Southworth, GW2CCU, Chairman H. T. Jones, GW3NQP. Hon. Sec., L. W. Barnes, Hon. Treasurer W. Davies. Committee, J. T. Lawrence, GW3JGA/T, J. Nicholas, GW3OIN, K. Schofield, GW3KYT.

Future meetings will be held at the Bee Hotel on the last Monday in each month.

MITCHAM AND DISTRICT RADIO SOCIETY

Hon. Sec: M. Pharaoh, G3LCH 1 Madeira Road, Mitcham.

The Annual General Meeting was held on 24th February and was well attended. The RSGB Affiliated Societies contest was held on February 4th and 5th. The GSUX key award can be won by any transmitting member of the Society. Points are scored on the bases of one point per country worked on any of the amateur bands. Proof of contact is not required but inspection of station log entries may be required. Scores should be sent to the Hon. Sec., for inclusion in the News letter each month.

Future Events:

April 7th—Junk Sale.
April 21st—National Field Day arrangements.
May 21st—National Field Day dummy run.
June 3rd/4th—National Field Day.
June 30th—National Field Day post-mortem.

NORTHERN MOBILE RADIO RALLY

Hon. Sec: J. Charlesworth, G3JJC, 23 Craven Lane, Gomersal, Leeds.

The fourth Northern Mobile Radio Rally will again be held at Harewood House, (near Leeds) on Sunday May 28th.

REIGATE AMATEUR TRANSMITTING SOCIETY

Hon. Sec: F. D. Thom, G3NKT, 12 Willow Road Redhill, Surrey.

The Annual Dinner was held on February 11th, when 35 members and friends were present. The G8KW Trophy for the first place in the Open Class of the constructional contest was awarded to BRS 20809. The "XYL" Cup donated by mothers and wives of members was awarded to R. Wells for the Junior Class. Informal meetings are now being held on the first Thursday in the month at The Tower, Redhill, for seniors, and at the homes of transmitting members in rotation on the first Saturday in the month for juniors.

Future Event:

April 15th—G3BCM will demonstrate his "Top to Ten" Transceiver.

THE SLADE RADIO SOCIETY

2 Orchard Road, Erdington Birmingham 23.

Meetings are held at the Church House High Street, Erdington, Birmingham 23.

Future Events:

May 5th—Application of Electronic Devices in Industry by W. and T. Avery.
May 19th—Map Reading for Direction Finding by D. S. Chapman.

SOUTH YORKSHIRE AMATEUR RADIO SOCIETY

Hon. Sec: E. Brailsford, 15 Ayrstone Walk Cantley, Doncaster.

The R.A.E. course being held at the Doncaster Technical College is proving very popular and has 16 students. Meetings are held at the Palace Buffet, Silver Street, Doncaster every second and fourth Thursday in the month at 8 p.m.

Future Events:

April 13th—Ragchew.
April 27th—Talk on Receivers by Joe Clennell G3HNJ.
May 11th—Free Night.
May 25th—Supersonics by L. Bennett G2BOJ.

In the near future the society will be operational under its own call sign.

AN ALL BAND 75W TRANSMITTER

(Continued from page 66)

R.F. Section

The input from the VFO is by airspaced coaxial cable through a Pye elbow and socket. A short piece of similar cable goes from the input

socket to a point adjacent to V5 valveholder. Since the input is at high impedance, this cable causes some mismatch, but this is not important if the length is made about four feet.

COMPONENTS LIST

FOR POWER UNIT AND MODULATOR

(Fig. 1, page 1091 of the April issue)

R1	1k 1/2W	R9	220k 1/2W
R2	1M 1/2W	R10	220k 1/2W
R3	270k 1/2W	R11	100k 1/2W
R4	47k 1/2W	R12	about 1.5M 1/2W
R5	180k 1/2W	R13	about 700k 1/2W
R6	1k 1/2W	R14	3.3M 1/2W
R7	22k 1/2W	R15	100k 1/2W
R8	220k 1/2W	RX	0.8Ω (see text)
S1	see text		
C1	8μF 450VW elec	C9	8μF 250VW elec
C2	16μF 450VW elec	C10	0.01μF mica
C3	8μF 450VW elec	C11	8μF 25VW elec
C4	8μF 450VW elec	C12	0.05μF mica
C5	16μF 450VW elec	C13	100pF mica
C6	16μF 450VW elec	C14	0.01μF ceramic
C7	0.1μF paper 350VW		
C8	8μF 25VW elec	C15	0.01μF ceramic
VRI	0.5M	VR2	10k w.w.
LFC1	10H, 250mA	LFC2	10H, 250mA

V1	5R4GY or 5Z4G	V3	VR65 (SP61)
V2	VR65 (SP61)	V4	6F8 or 6SN7
M1	500μA FSD (see text)		
T1	350-0.350V, 5V 2A or 6.3V 2A with series resistor (RX)		
T2	350-0.350V, 6.3V 4A		
T3	12V 1A charger transformer		
MR1	} Bridge rectifier rated at 700V, 150mA. (This may be made up from four half-wave types each rated at 350V)		
MR2			
MR3			
MR4	12V 1A rectifier		
	3 Mazda octal valveholders		
	3 International octal valveholders		
	1 4-pin Jones socket		
	2 valvebases (plugs)		
	2 2-pole, 3-way switches		
	5 1-pole, 1-way toggle switches		
	1 2-pole, 2-way toggle switch		
	1 single contact jack socket		
	1 double contact jack socket		
	Aluminium knobs, hardware, chart frame, wire, etc		
F1	250mA	F2	150mA

(To be continued)

Letters to the Editor

The Editor does not necessarily agree with the opinions expressed by his correspondents

Whilst we are always pleased to assist readers with their technical difficulties, we regret that we are unable to supply diagrams or provide instructions for modifying commercial or surplus equipment. We cannot supply alternative details for receivers described in these pages. **WE CANNOT UNDERTAKE TO ANSWER QUERIES OVER THE TELEPHONE.** If a postal reply is required a stamped and addressed envelope must be enclosed with the coupon from page iii of the cover.

MODULATION

SIR.—During the last two months, I have received an overwhelming number of replies to my queries raised in the January PRACTICAL WIRELESS. All the letters except two were against the motion; one sent me a circuit of a transmitter based on my lines that "really worked" and the other pointed out its applications in the field of SSB, and in high power B/C installations where the problem of producing several kW of audio for modulation purposes is by no means small.

For the benefit of any readers who may want to know the values of the tuning capacitor referred to in my original letter, they are 50—5pF, 50—5pF, 35—5pF.

In conclusion I would like to thank all those who took the trouble to write such an interesting selection of letters to me. — J. R. MILLER (Somerset).

RADIO HOGS

SIR.—May I heartily endorse the comments about the use of pocket radios made by Thermion in February PRACTICAL WIRELESS?

These people are on holiday to enjoy themselves as much as they can without breaking any law. Nobody else matters! They are the only people who count (or so they seem to think!) and if they inconvenience anybody else, that doesn't matter.

These "radio-hogs" have their radio sets so loud that everybody (except the stone deaf) in the vicinity is compelled to listen to the personal choice of the owner of the offending set. The choice is not, as a rule, a very good one. It is quite possible to walk along the sea-shore in August and hear the whole of a radio programme without missing one demisemiquaver as one is never very far from a radio blaring the strains of some jazz band. It is surely time that the big-wigs concerned realised this and did something about these selfish people. May their valves burn out and their loudspeakers disintegrate!—D. A. PICKETT (London S.W.4).

RADIO MOSCOW

SIR.—I think T. Rooves (March issue) is wrong when he says that Moscow broadcasts on 1734m, because the Voice of America broadcasts jazz on this wavelength at 23.15 G.M.T. every day. On the same wavelength it also broadcasts news and discussion programmes in English and in a number of foreign languages.—J. LOWRIE (Edinburgh).

CRYSTAL SETS

SIR.—I have read with interest the various letters sent in by readers concerning crystal sets and the exceptional reception obtained.

However, if one gave thought to the subject it may not be so remarkable as it may seem.

I possess a crystal receiver and am able to receive (under favourable conditions) Radio Moscow, Voice of America, Luxembourg and many other transmissions, including Morse. The reason for this is as follows.

It is a well known fact that crystal sets only make the more powerful transmissions audible such as the Home Service; depending where you are situated and depending on the coil, e.g. 92 turns on a 1½in. former with capacitor at approximately 490-500pF; now when the capacitor is at minimum capacitance, the natural wavelength of the aerial in conjunction with the coil is obtained, which the diode converts to an audio signal.

Radio Moscow may be beaming a transmission to the U.K. and under favourable conditions will be at maximum strength, ideal for the crystal receiver to pick up clearly. Owing to atmospheric and the influence the ionosphere has on reception, it may fade out completely to be taken up by, say, the Voice of America, which in its turn drifts out for another station taking prominence such as Radio Luxembourg; and so it goes on. In fact this "exceptional reception" is a perfectly natural phenomenon based on the fact that crystal receivers when operating on a natural aerial wavelength only make audible the strongest signal. It all depends on the natural wavelength of the aerial and coil and conditions between the crystal receiver and radiating transmitter mast.—A. DYSON (Sheffield).

QUARTZ CRYSTAL ETCHING

SIR.—I have read with interest an article in PRACTICAL WIRELESS entitled "Quartz Crystal Etching", by J. B. Dance.

I feel that the author of this article has not stressed strongly enough the dangers of using the chemical ammonium bifluoride, for the purpose of etching silica. He points out the danger of using hydrofluoric acid without stating that ammonium bifluoride etches by virtue of its dissociation into ammonium fluoride and hydrofluoric acid thus:—

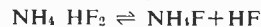

and therefore in solution ammonium bifluoride is potentially just as dangerous as hydrofluoric acid. To the chemist hydrofluoric acid is not a strong acid as measured by its dissociation constant; nevertheless it is extremely active chemically owing to its tendency to replace oxygen and complex formation. It is therefore *extremely dangerous* to

TAPE RECORDER

Manufacturers' brand new, current production offer. Latest 6-valve circuit based on Mullard's famous design. Magic eye level indicator. Volume and tone controls. T.C.C. printed circuit already wired. Only power pack and controls to assemble and wire. Valves EF80, EOX3, EL84, EM84 and EZ80. A sensitive quality recorder at Special Unit Prices.



Wired printed circuit, power pack components, controls and knobs, etc. \$5.15.00 p. & p. 2/6
 Set of 5 valves, as above \$2.50 p. & p. 1/-
 B.S.K. Monardeck Tape Unit \$8.19.6 p. & p. 4/6

BARGAIN REDUCTION—complete kit . . . \$16.10.0 carr. 5/-
 Attractive 2-tone Cabinet 13 x 12 x 7in., and 9 x 5in. Speaker . . . \$3.50 p. & p. 4/6
 Special Discount Price \$3.50 p. & p. 4/6

Illustrated Handbook with full details, 2/6 post free. Collaro Studio Tape Deck can be supplied with modified circuit as alternative as follows—

COLLARO Printed Circuit \$7.10.0 p. & p. 2/6

COLLARO Studio Tape Deck \$2.12.0 p. & p. 7/6

16 x 14 x 7in. Cabinet Speaker \$3.17.6 p. & p. 4/6

RECORDING TAPE—Special Offer

American COLUMBIA (C.B.S.) 1st Grade P.V.C. TAPE. Fitted leader and auto stop. Brand New and Boxed.

	Standard	Long Play
5in. 600ft.	13/-	900ft. 19/6
5in. 900ft.	14/8	1,300ft. 22/6
7in. 1,200ft.	21/-	1,800ft. 32/-

DOUBLE PLAY and OTHER SIZES AVAILABLE AT SPECIALLY REDUCED PRICES

Plastic Tape Reels 3in. 2/6. 5in. 3/- 5 1/2in. 3/3. 7in. 3/6

AUTOCHANGER RECORD PLAYER KIT

A.C. SUPPLY 200-250 v.

Attractive 2-tone cabinet—famous COLLARO 4-speed, full mixer, 10-record gram unit. Studio xtal pick-up with dual etch for Std.-L.P. recordings. 2-valve amplifier with quality neg. feedback circuit, volume and tone controls. Fully isolated from main by double-wound transformer. NOT the live chassis type as often offered in cheap commercial models.



Ready-wired 2-valve Amplifier, complete with

6in. high flux speaker \$3.19.6 p. & p. 2/6

Two-tone cabinet 18 x 13 x 8in. \$3.30 p. & p. 3/6

Collaro Conquest. Model 160/V \$5.19.6 p. & p. 4/6

Complete 3 unit kit, special Bargain Price . . . \$12.19.6 carr. 7/6

Simple assembly, a screwdriver only required.

JASON FM TUNER UNIT KITS (87-105 Mc/s) Standard Model (FMT1)—

as previously extensively advertised. Complete Kit—5 ins. P.P. 2/6. Set of 4 spec. valves now only 20/-

Tuner Coil Set, IFs and Ratio Detector, etc., 26/-

Model FMT2—attractively presented shelf mounting unit in enclosed metal cabinet with built-in power supply. Complete Kit £7. P. & P. 3/6. Set of 5 spec. valves. 37/6

Latest Model—JTW2—Switched Band 1-2-3 AM/FM Unit with AFC. Kit £12.19.6. P. & P. 2/6.

New Jason Comprehensive FM Handbook 2/6, post free. 48-hr. Alignment Service. 7/6. P. & P. 3/6.

TRANSISTOR PORTABLE

Famous manufacturers 6 x 1 design based on Mullard and G.E.C. developments. Printed circuit. 6BVA 1st grade transistors, XA102, XA101 (2), OA70, XB102, XC101 (2) or equivalents. Quality components only supplied to ensure best results at attractive price.



Set of 6 BVA Transistor and Diode 70/- p. & p. 6d.

Printed Circuit, IP's (3), osc. coil, Driver Trans., Ferrite rod aerial 5/6 p. & p. 1/6

Resistors, Condensers, Twin Gang and Volume Control 37/6 p. & p. 1/8

1 x 4in. Quality 35 ohm-matching speaker 25/- p. & p. 1/6

or Complete Kit at Special Offer—ONLY \$8.19.6 post free.

Handbook and Circuit details 2/- post free.

TRANSISTORS—BVA 1st grade—ex Mrs. Mazda XA102, 16/8; XA101, 14/8; XC101, 10/6; OC70, 9/8; XB102, 10/-; XA103, 15/-; OA81, 3/6; OA70, 2/8.
 Hours 9 a.m.—6 p.m., 1 p.m. Wednesday.



RADIO COMPONENT SPECIALISTS

70 BRIGSTOCK ROAD, THORNTON HEATH, SURREY
 Est. 1946 Telephone THO 2188

Terms C.W.O. or C.O.D. Post and Packing up to 4/6, 7d., 1/6, 1/1, 3/6, 1/6, 5/6, 2/-, 10/6, 2/9.

FOLLOWING THE STUPENDOUS SUCCESS OF THE "MIRACLE" WE NOW INTRODUCE FOR 1961 THE CONTESSA

A really remarkable

2 BAND 6 TRANSISTOR SUPERHET KIT

(As displayed at the Radio Hobbies Exhibition)

The CONTESSA is the professional looking set with the professional performance.

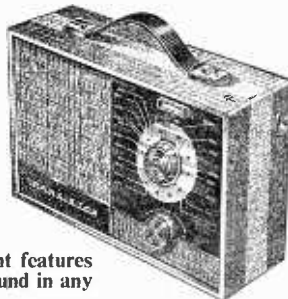

Study these brilliant features which cannot be found in any other kit

- Waveband Coverage of 530 k/cs to 1620 k/cs and 160 k/cs to 270 k/cs.
- Assured reception of at least a dozen stations in daylight!
- Large clearly-calibrated station-named dial.
- Internal high-gain FerroX Aerial.
- 5:1 ratio slow motion tuning.
- Fitted with the latest 12000 line high-flux loudspeaker.
- Power of 410 milliwatts from the single-ended push pull final stage.
- Specially designed aerial matching coil for use in a CAR.
- Only first grade fully guaranteed Mazda matched transistors and diodes are used.
- Double tuned IF transformers for maximum gain and knife-edged selectivity.
- Fully drilled printed circuit panel marked with component numbers.
- The two colour case measures 10 x 7 1/2 x 3 1/2 in. and weighs approx. 4 lbs.
- Battery lasts 4 months with normal usage.
- Book supplied with detailed assembly instructions, diagrams and circuitry.
- Anyone can build this set—everything supplied just a soldering iron required.

Inclusive price for all associated components, cabinet and battery, complete in every detail. **£11.10**

Plus 3/6 Regd. P.P.
 Or our BUY AS YOU BUILD SCHEME any parts sold separately. Send for comprehensive descriptive manual and parts list, 3/6 post free.

See and hear a working model at:—
RADIO CLEARANCE LTD.
 27 Tottenham Court Road, London W.1.
 Telephone: Museum 9188

★ POST HASTE ★

JASON F.M. TUNER KITS

We are the authorised Jason dealer and the whole kit is as supplied by them.

FMT1	Standard variable tuner, complete with valves	£6.17.6
	Hire purchase deposit £17/6 and 6 monthly...	£1. 1.8
FMT1	Power pack ready drilled chassis, complete...	£2.12.6
FMT2	Shelf mounting, less power supplies, complete	£7.17.6
	Hire purchase deposit £1.11.6 at 6 monthly ...	£1. 4.4
FMT2	As above, but with power supplies, complete	£9.15.0
	Hire purchase deposit £1.19.0 and 6 monthly	£1 9.4
FMT3	Fringe model, less power supplies, complete	£9.12.6
	Hire purchase deposit £1.18.6 and 6 monthly	£1. 9.0
FMT3	As above, with power supplies, complete ...	£12. 0.0
	Hire purchase deposit £2.8.0 and 8 monthly...	£1. 6.6
Mercury 2	Switched tuner with A.F.C. TV sound ...	£10.15.0
	Hire purchase deposit £2.3.0 and 8 monthly...	£1. 4.0
JTV/2	As above, but shelf mounting and powered ...	£14.15.0
	Hire purchase deposit £2.15.0 and 12 monthly	£1. 2.0

The Instruction Book is included in all kits.

REQUIRED CHANNELS MUST BE SPECIFIED FOR SWITCHED TUNERS

Instruction Book for FMT1, FMT2, and FMT3, 2/6. Mercury 2 and JTV/2, 3/6.

A more detailed list can be sent upon request.
ALL JASON TUNERS ARE ON DEMONSTRATION
ALL THE ABOVE TUNERS ARE ALWAYS IN STOCK

★ POST FREE ★

TRANSISTORS

OC44 Mixer ...	12/-	OC71 Audio ...	8/6
OC45 I.F. ...	12/-	OC72 Audio ...	8/6

All Brand New Mullard and Not Sub-Standard.

Matched pairs of OC71 and OC72 can be supplied at no extra cost.

"PRACTICAL WIRELESS"

POCKET SUPERHET

Osmor printed circuit version. Osmor Rod Aerial, 10/-, I.F.T.s and Osc. Coils, 22/6. Osmor Driver, 11/6. Osmor Output, 10/6. Set Mullard Transistors, 61/6, J.B. Gang, 11/-, Trimmers, 2/8 pr. Set Condensers, 15/-, Resistors, 6/6. Ardenite Vol. Control, 10/6. Ardenite W/C, 3/6. Speaker, 19/10. OA81 diode, 4/-, Hardware, 4/6. Printed Circuit, 9/-. Case and Knob, 7/6. PP4 Battery, 2/-. Leaflet illustrated, giving full instructions and constructional details, 1/9.

All the above components, if purchased at one time £9.19.6

WEYRAD P50 Coils and transformers for a dual wave transistor Superhet, with printed circuit and ferrite rod aerial. Long and medium wave aerial RA2W, Osc. coil P50/1AC, 1st and 2nd I.F. Transformers P50/2CC, 3rd I.F. transformer P.50/3CC, Driver transformer LFDT2, Printed circuit PCA1. Constructors' Booklet 2/3. The above WEYRAD set with book, £2.16.0.

COLLARO STUDIO DECK. List price £17.10.0, OUR PRICE £12.19.6. Hire purchase deposit £2.19.6 and 8 monthly 27/6.

WE PAY ALL POSTAGE AND INSURANCE
ALL ORDERS DESPATCHED SAME DAY
MONEY WILL BE REFUNDED IF REQUESTED

SURBITON PARK RADIO

(Established over 30 years)

48 SURBITON ROAD,
 KINGSTON UPON THAMES, SURREY

Telephone: KIN 5549

Hours: 9 a.m. to 6 p.m. 1 p.m. Wed.

We do not close for lunch

Open all day Saturday

AMERICAN REVIEW
 of the
STEREO HANDBOOK
 BY G. A. BRIGGS
 Technical Editor R. E. COOKE, B.Sc. (Eng.)
 PRICE 10/6 (11/6 post paid).



The High Fidelity Magazine
 Dealer Library, Jan. 1961 says:

To high fidelity fan and dealer alike, G. A. Briggs needs no introduction. The author is well known for both his work and writing on loudspeakers. The Stereo Handbook is written in Briggs' customary salty style and is, for a hard-cover, technical book profusely and interestingly illustrated.

The book is much to be recommended to anyone wishing to put stereo in an intelligent perspective. Additionally, it will serve as a guide to dealers plagued with customer questions about how to set up a system for optimum effect. Stereo Handbook is "must" reading for anyone who does not believe that there is room in the overall subject of stereo and high fidelity for a hearty chuckle. Highly entertaining and informative.

Sold by Radio Dealers & Bookshops.

Published by:

Wharfedale
 WIRELESS WORKS LTD

IDLE
BRADFORD
YORKSHIRE

Telephone:
 Idle 1235/6

Grams: 'Wharfedel'
 Idle, Bradford

For Safety's Sake
 use
AVO Prodclips



Pat. No. 748811

... with Trigger-Action Spring-Loaded Clips

PRESS TRIGGER TO OPEN
RELEASE TO GRIP

Safety first every time with these patented spring-loaded AVO Prodclips.

Cleverly designed for use as insulated prods, they are invaluable for reaching and holding test points which are difficult of access.

Suitable for use with AvoMeter, Multiminor
 and Avo Electronic Test Meter Leads.

Post Free
 15/-
 per pair.

AVO LTD - AVOCET HOUSE,
 92-96 VAUXHALL BRIDGE ROAD, LONDON, S.W.1.
 VICTORIA 3404 (12 lines)

A MEMBER OF THE METAL INDUSTRIES GROUP OF COMPANIES

handle and it is essential that protective clothing and eye shields should be worn when handling hydrofluoric solutions, especially as this acid has the insidious property of eating through flesh without any initial warning that acid has contaminated the skin. Such wounds, to my certain knowledge, are difficult to treat and take a considerable time to heal, even with hospital treatment.

In my opinion, it would be advisable for non-technical readers of PRACTICAL WIRELESS to leave such a potentially dangerous chemical as ammonium bifluoride strictly alone,—it would be safer and cheaper in the long run to buy the required crystal and keep one's fingers and eyes intact.—G. P. MITCHELL B.Sc. G3OFJ (Wallington).

A PLEA FOR PLASTICS

SIR,—Why are wax and pitch still used in the manufacture of some components? The only answer seems to be that they are both highly "moistureproof". They are also extremely thermoplastic, and are thus very messy to use. Why cannot plastics take their place? With such an excellent range of plastics at the manufacturers' disposal, there is no apparent excuse. The smaller the component, the larger the case weight, or so it would seem. This could be avoided by using more plastic and less metal etc.—N. J. CORNFORD (Beaconsfield).

THE 4W AMPLIFIER

SIR,—A friend and I both built the 4-watt amplifier described in the January 1961 issue. On completion, we both experienced the same fault. This had the effect of producing "beating" at a constant rate in the loudspeaker. By experiment, it was found that by connecting the 270k resistor directly across the treble control, the fault cleared.

We now have good results on both VHF/F.M. radio and with a record player.

This may interest other constructors.—J. B. C. (R.A.F., Scotland).

"ROADFARER" COMPETITION

AS announced in the Editorial of the previous issue, a prize of £100 will be awarded for the "Roadfarer" receiver which, in the opinion of a committee, is judged to be the most efficiently constructed and presents the neatest appearance. Consolation prizes will be awarded to runners-up.

The committee will consist of the Editor and representatives of the following firms:—

- Richard Allan Radio Ltd.
- Jackson Bros. (London) Ltd.
- Newmarket Transistors Ltd.
- Osmor Radio Products Ltd.
- Swindon Condenser Co. Ltd.

Readers who intend to participate in this competition should complete the coupon and send it to:—The Editor, PRACTICAL WIRELESS, Tower House, Southampton Street, London, W.C.2.

THE P.W. SUPERHET

SIR.—After some set-backs I have completed the construction of the P.W. Pocket Superhet Transistor Set, and I am very pleased with its performance. I derived much help in the adjustment of it from the article in the December issue. The article on "Checking Transistor Circuits" in the March issue was also of great value. I have built many sets in my time but none has given me greater pleasure or more satisfaction. It is remarkable that a set employing such a small battery can give such a loud signal.—W. LYNCH (Glasgow).

TRANSISTOR HOLDERS

SIR.—In reply to Mr. E. Krell (February), on transistor bases, I can only think that he is not very interested in his hobby. Whilst I was in Malta for a time, I had the opportunity of building a transistor radio and in the kit complete with transistors were their bases. Besides, Mr. Krell, surely as an enthusiast you must have come across a little tool called a "thermal shunt". If one of these is clipped against the base of the transistor, hardly any damage at all can be caused by heat from the soldering iron.—E. AVERY (Fareham).

REFLEX CIRCUITS

SIR.—In the days when valves were very expensive an arrangement known as reflexing became popular, as it enabled one to use a single valve for two purposes. It appears to me that the present position with transistors is parallel with the period of which I am thinking, and the use of transistor reflex circuits should be possible. Many old hands will remember the old S.T. circuits in which even two H.F. stages were reflexed for use as two audio stages, and I would think that some similar scheme would be practicable with good transistors (to avoid the disappointment and waste of time of using "surplus" transistors). Is there any "snag" in this suggestion, or is this yet another way in which the valve still holds precedence over the transistor?—G. TREEBY (Bath).

Mark your envelopes "Competition" in the top left-hand corner.

DO NOT SEND IN YOUR ENTRY YET. A further announcement will appear next month.

I intend to enter my receiver in your competition, and agree to abide by the decisions of the Committee.	
Name
Address
.....
.....
BLOCK LETTERS PLEASE	

RECEIVERS & COMPONENTS

KITS BUILT, tested. Details S.A.E. 6 Hooker Road, Heartsense, Norwich, Norfolk.

RECLAIMED VALVES, tested and perfect: huge stocks; all one price, 5/- plus 6d. postage each. Delivery by return. LEWIS, 46 Woodford Ave., Ilford, Essex.

GUARANTEED VALVES from 1/-. Radio, TV components, Transistor set Kits from 10/-. S.W. Kit 22/6. Lists 3d. HAMILTON RADIO (W), 13 Western Rd., St. Leonards, Sussex.

SPARES—VALVES—TUBES

1930-1960 Guaranteed Perfect, ex-working equipment LOTS from 21. POTS, C.O. 17, Coils cheap. TUBES guar. 6 months, picture shown or FITTED FREE. 9-10in. 30/-, 12in. 40/-, 14in. 50/-, 17in. 60/- VALVES, 3,000 types stocked. EF91, EB91, 6V6, 2/, EF80, UF42, 6FL, 20D1, 3/-, 10P1, 6V6, 6SN7, 4/-, PL81, PY81, ECL80, EY51, ECC81, 6F13, 20F2, 6K25, 7C5, 7Y4, 5/-, EL84, KT36, 6P28, PY31, U35, U281, 7/6, PL38, PZ30, 20P1, 20F3, U24, 10/-, Old 4, 5 and 7 Pin types, 3/-. Postage 6d. Speakers, 6-8in. 7/6, 10in. 7 x 4. 10/-. New transistors, 20C6, OC45, 15/-. Send S.A.E. for list or with enquiries to:

"ST. JOHN'S RADIO", 156 St. John's Hill, S.W.11. Tel. BAT 9838.

BARGAIN—Recovered speakers 7in. x 4in. and 8in. 5/- ea., p. and p. 2/6. Recovered Cydon Tuner Units (ex TV's) less valves with biscuit for 2, 9 and 18 and knobs. 9 megs, 16 megs, 34 megs. I.F. outputs. Series or parallel heaters. State type wanted. 5/- ea., P.p. 2/6. J. R. CALVERLEY AND CO. LTD., 130 Water Street, Radcliffe, Lancs.

STOCK SALE. Lists 2d. Mail only. 98 Greenway Avenue, E.17.

ANOTHER FANTASTIC OFFER. New Manufacturer's surplus S.M.L. Wave Band Chassis, complete—no valves—no test. Only 27/6 carriage paid. 22 Birchall Road, Rusden.

ANAKIN

STILL MORE BARGAINS—

Receiver No. 114. Has 3-EF91, 2-EL91 valves 124-156 Mc. for Conversion details see "Short Wave Mag", Feb issue, 25/- each, post 2/-. Periscope Prisms. Slightly odd silvering. But still a bargain at 1/- pair, post 2/-. Phones Output Transformers. 6d. ea. post 1d. Frost Warning Thermostats. Low voltage type, adjustable. Cheap at 9d. ea. post 6d. IFT, 30. mc. With can, 2-adj. cores, 3d. ea. Hook Condensers, 2 x 0.875 mfd., 400 v. 3d. ea. Ideal for Speaker cross-over net work. Control Units No. 89 and 90. Box with 3 P. 6W., switch, 250 V.3 A. slider switch, LT toggle, jacks and plugs. 3/6 ea. post 2/-. Silver Mica Condensers. 430 pf only, 1/- doz.

Allen Keys No. 8. 1/- doz. Disc Magnets. 2/- doz. Box of 4 Motor Brushes, 1/- doz boxes, 6/- gross boxes. Insulated Brushing. 1/4 hole. 1/- doz. Brush Holder Caps. 1/- doz. Ass'd. Potns. 3/- doz. 30K or 33K. 2W. carb. res. 1/6 doz. Ass'd. Valves, 24/- doz. Ass'd. A.F. Transformers 1/6-2/- doz. Ass'd. Coils and RFC. 1/- doz. Relays. 150 ohm., 2/C, 1-B; 3/6 ea. post 1d. 80 ohm., 1-Make, 2/6 ea. 200 ohm. 1-B. 3/6, post 1d. Free Gift with every order this month! All goods Postage Extra. Orders with insufficient postage not accepted. Mail order only. No C.O.D. No Export. Lists—Send stamped addressed envelope. 25 ASHFIELD PLACE, OTLEY, YORKS.

RATES: 6/6 per line or part thereof, average five words to line, minimum 2 lines. Box No. 1/- extra. Advertisements must be prepaid and addressed to Advertisement Manager, "Practical Wireless," Tower House, Southampton St., London W.C.2.

In Scotland RENVUE for Better Value

COMPLETELY REPROCESSED (NEW GUN, RECREENED, ALUMINISED)

- 12.6v and 6.5 v, 0.3 amp., 17 and 15in. Types ... £6.10.0
12.6v and 6.5 v, 0.3 amp., 14in. Types ... £6.0.0
12v., 15in. Types ... £7.0.0
2v, 12 and 15in Types ... £6.0.0
Electrostatic 90 degree and 110 degree tubes 10/- extra. Carr. paid.

10/- ALLOWED ON OLD TUBE Terms arranged.

FERGUSON 14in. BBC and STV Consoles ... £12.10.0
14in. BBC and STV Receivers ... £10.10.0
17in. BBC and STV Receivers ... £19.0.0

COMPLETELY OVERHAULED AND FITTED WITH COMPLETELY REBUILT TUBE with One Year's Guarantee £5 Deposit. Terms on Balance.

Renfrew Electronics Ltd. Anderson Drive

Renfrew : Scotland Tel.: Renfrew 2642

6in. Dia (yes—six inch) Millimeters 0/8. round Emer. Tuner 79/- (3/6), 2 in. Dia. Voltmeters 0/500. 5 round Weston 1000 ohms per volt. 47/6 (2/6). Special Valves 4/250A £8.10.0; QY3/125 £6.10.0; 4212 2/4. Simpson Model 443 Volt-ohmmeters 2/1n. meter in case £3.10.0 (5/-). Simpson Model 260 Test Meter 4in. sq. meter 20,000 ohms p.v. 24 ranges £6.10.0 (5/-).

40 PAGE LIST OF OVER 1,000 ITEMS IN STOCK AVAILABLE—KEEP ONE BY YOU.

Wide Band Aerial Amplifiers, ten separate outlets from one aerial rack mounting £9.10.0 (7/6). Variable Gearboxes, precision job 0/6000 f.p.m. variable throughout range driven by i.h.p. 230 v. A.C. motor £6 (3/-). Includes £1 returnable box. 5 Foot P.50. Racks 19in. wide drilled and tapped 65/- (10/-). Elliott 0/1 volt moving coil Voltmeters 2000 ohms per volt. 2 1/2in. dia. ideal as basic meter 25/- (2/6). Mainis Filter Units, laboratory precision type totally enclosed 2/1 amps. 10/- (2/6). Sigma 10,000 ohms SPDT Relays 12/6 (1/6). Metal Rectifiers 24 v. 12A 20/- (3/6). AVO Geiger Counters £9.10.0 (5/-).

We have large quantities of "bits and pieces" we cannot list—and invite your enquiries—we can probably help—every one answered.

Amounts in brackets are carriage England and Wales.

P. Harris, Organford, Dorset

RECEIVERS & COMPONENTS

(continued)

LEADER RADIO

THE "NEW COMPANION" TRANSISTOR-6 The latest Superhet Car Radio/Portable. Two-tone Cabinet. Slow motion tuning. Six transistor, printed circuit etc. tunable over long and medium wavebands. Cabinet 11 x 8 x 8in. speaker 7 x 4in. Complete kit with assembly instructions less battery £9.10.6. Battery 3/6. P.P. 5/-.

THE NEW OSOMOR "P.W." TRANSISTOR-6 A highly sensitive six transistor superhet for medium and long wavebands. Design incorporates printed circuit and high "Q" ferrite aerial etc. Kit complete instruction data less battery £9.15.0

REPANCO MINI-4

The popular pocket four transistor superhet. Size 7 1/2 x 3 1/2 x 1 1/2 in. with pre-aligned coils and transformers. 2 1/2in. high flux stacker, ferrite slab aerial. Easy to build. Kit complete with instruction data, less battery £7.10.0

REPANCO OSOMOR, TELETRON, T.S.L. coils, transformers, etc., for transistor radios. S.A.E. for lists.

THE TELETRON TAPEJAK (Transistorised Tuner). Converts your tape recorder into a high quality Radio Receiver. Recording of radio programmes directly on tape. High sensitivity. £5.0.0, less P.P.4 battery. Carr. 2/6.

TSL TRANSISTORISED F.M. HI-FI TUNER FRONT END, worm drive. £6.10.0. IF and RATIO DETECTOR STRIP £6.6.0. Both pre-aligned. COLLARO STUDIO TAPE DECK, 3 motors, 3 speed, only £11.10.0. S.A.E. for enquiries. 73 VISTA WAY, KENTON, HARROW, MIDD. Phone: WOR 4512.

COMPONENTS, VALVES, Tubes, etc. Write or phone for free list. ARION TELEVISION, 4 Maxted Rd., Peckham, S.E.15. (New X 7152.)

NEW AM/FM STEREO

- INPUTS FOR TAPE, 78's, etc.
● MW—LW—VHF
● PUSH-PULL OUTPUTS—16W
● SEPARATE TONE AND VOLUME
● INTEGRAL PREAMPLIFIER

BEL, Marlborough Yard, London N.19 Arc 5078

TELEVISION TUBES Rebuilt, 1 year warranty. Mostly 75" exchange, 3 Park Ave., New Barnet. BAR 3185 now!

KINGSLAND

ELECTRONIC COMPONENTS

Stupendous Offers

1958 ELECTRONIC COMPONENTS 50 Assorted Resistances and Condensers, 6 Miniature Valve Holders, Two Tag Strips, 40 Separate Contacts each 3/9, p. & p. 1/6. Chassis 14 x 8 x 1in. 12 Miniature Valves 1/4 x 1/2 in. with Valve holders, approx. 60 resistances and capacitors. 1 and 1 watt, 6 Germanium diodes, two tag strips, 100 contacts each, 5/- p. & p. 2/6. 120 Resistances 1 and 1/2 watt, 35 metalmit and T.C.C. small Condensers, 9 Miniature Valve Holders, 3 Tag Strips, 100 contacts each and other useful pieces, 8/6, p. & p. 2/3. BARGAIN PACK. Pair Throat Microphones, 2ft. 2in. Screened Lead with socket, one 5 Henry 200 mA Choke, 3 Electrolytic Condensers, Vibrator, 3 Toggle Switches, 6 Octal Valve Bases, 1 Waveband Switch, 6 Coax. Plugs, 6 Assorted 500s, 6 Cartridge Fuses, 6 Potentiometers 6 W.W. Multipliers, two Variable Condensers Coil of Wire, 15/6, p. & p. 3/6. Instrument Rectifier with Circuits, 5/6, 6 v. or 12 v. Vibrators, 2/6 each, p. & p. 1/6 6 Assorted Droppers, 5/-, p. & p. 1/6. Mike and Pick-up Transformers. Ideal for Baby Alarms, 4/6, p. & p. 1/-. 100 Assorted Resistances or Condensers or 50-50, 6/-, p. & p. 1/9. New headphones, low impedance, ideal for crystal sets, etc., 6/6, p. & p. 1/9. 6 Assorted Potentiometers, 5/-, p. & p. 1/9. 182 KINGSLAND RD., SHOREDITCH, E.2. Tel: SHO 6572. Sorry U.K. only.

RECEIVERS & COMPONENTS
(continued)

"HEATHKITS" can now be seen in London and purchased on easy terms. Free brochure. DIRECT TV REPLACEMENTS LTD., Dept. PW/7/4, 138, Lewisham Way, S.E.14. Tideway 6666.

SPEAKERS — ELAC 5in., 2 ohm: 12 £6; 50 £17. C HEYWOOD, The Croft, Ladybrook Rd., Bramhall, Ches.

"WEYRAD" TRANSISTOR RECEIVER

LONG & MEDIUM WAVE, P.P. O/P. ALL COMPONENTS AVAILABLE. TOTAL COST £8.176. CONSTRUCTOR'S BOOKLET 2/-.

TRANSISTOR AM FEEDER UNIT, SUPERHET AVAILABLE NOW. Size 4 1/2 x 3 x 1 1/2 in. TOTAL COST OF COMPONENTS £5.10.0. CONSTRUCTOR'S BOOKLET, 1/6. Send S.A.E. for Shopping Lists. 85 OHM ALLAN SPEAKERS, 27/1 JACKSON "OO" GANG (with Trimmers), 10/6.

WESTHAM RADIO SUPPLIES
Rear of 175 Abbotbury Road
WEYMOUTH, DORSET

SPEAKER REPAIRS. Cones/Fields fitted. Clock Coils Wound. L. S. REPAIRS, Pluckley, Ashford, Kent.

RESISTORS.—100 new, wire ended, assorted, all types, 7/6 box, post free. COOK'S OF BEDFORD, 29 St Mary's Street, Bedford.

BROADWAY ELECTRONICS

92 MITCHAM ROAD,
TOOTING BROADWAY,
S.W.17.

Telephone: BALham 3984

C.B.S. BRAND (COLUMBIA) AMERICAN TAPE (P.V.C. RECORDING TAPE). Attractively boxed with space for titles, etc. Tape fitted Leader and Autostop. 1800ft. 7in. L.P. 36/-; 1200ft. 5 1/2in. L.P. 30/-; 900ft. 5in. L.P. 22/6. Add 1/6 Post and packing.

B.T.H. EX-RELAY AMPLIFIERS. A.C./D.C. MAINS 210/250v. Contains 8in. 15 ohm speaker. Three valves—10F1, 10P14 and U404. Cabinet size 14 x 11 x 6 1/2 in. Attractive two toned cabinet with ivory knobs. 30/-, plus 5/6 Carriage and packing.

B.S.R. U48 MONARCH. 4-speed Auto-changer wired for Stereo. £6.12.6, plus 5/- Post and Packing.

SPECIAL OFFER: White Boxed Tape; Acetate Base, 5 1/2in. 850ft., 14/6; 5 1/2in. EMI Type Spools, 2/9.

Add 1/- Post and Packing.

DK96, DAF96, DF96, DL96, 6/6 each.

FOR SALE

ASK your dealer for American Ferro-dynamics "Brand Five" Recording Tapes—the best tape value!

100 BAYS Brand New Adjustable Steel Shelving. 72in. high x 34in. wide x 12in. deep; stove enamelled dark green, sent unassembled. Six shelf bay £3 15s. Sample delivered free. Quality discounts. N. C. BROWN LTD, Eagle Steelworks, Heywood, Lancs. Tel: 69018.

INDEPENDENT 200/240 volt electricity supply for only £8. American Dynamotor Unit, runs Television, Electric Drills and all Universal AC/DC Mains Equipment from 12 volt car battery. (C) 4/30. Our price £8. — S.A.E. full details. Scientific Products, P., Cleveleys, Lancs.

AMERICAN MAGAZINES. Year's subscription 'Electronics World' 43/-; 'Radio Electronics' 39/3; 'Audio' 35/-; Specimens 5/- each. Full catalogue free. WILLEN LTD. (Dept. 40), 9 Drapers Gardens, London E.C.2.

CLEARANCE LINES
(Limited quantities). Unused in Makers' cartons. Carriage 5/-.

ARMSTRONG STEREO 44	..	£28.19.6
B.S.R. CHANGER U14 MONO	..	£7.10.0
B.S.R. CHANGER U14 STEREO	..	£7.19.6
GARRARD " 210 MONO	..	£9.19.6
GARRARD " 210 STEREO	..	£10.19.6
" TA Mk II MONO	..	£7.19.6
" " STEREO	..	£8.19.6

" Credit or H.P. Terms.
A. L. STAMFORD LTD. (Dept. D 29)
84/86 Weymouth Terrace, London, E.2.

MISCELLANEOUS

— YOU READ MUSIC? —

Then how about making yourself an electric organ? Constructional data available—full circuits, drawings and notes. It has 5 octaves, 2 manuals and pedals with 24 stops—uses 41 valves. With its variable attack you can play Classics and Swins.

Write NOW for free leaflet and further details to C. & S., 20 Maude Street, Darlington, Durham.

ASTRO MIRRORS. Flats. Eyepieces. Object Lenses, Prisms, Geared Heads, Driers, Motors, etc. Ex-Gov. Telescopes, Microscopes. Gunsights, Reflector Sights, Binoculars, etc. List of over 1,000 items for S.A.E. How to use Ex-Gov. Lenses and Prisms, Nos. 1 and 2, 2/6 ea.—H. W. ENGLISH, 469 Rayleigh Road, Hutton, Brentwood, Essex.

"LITON" AUTOMATIC PARKING LIGHT SWITCH

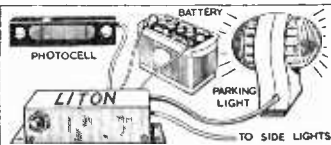

Controlled by a photocell, will turn your light on at dusk, off at sunrise automatically. Easy to build and fit. Kit of Parts, 52/6. Built and Tested 57/6. Mains PHOTOELECTRIC GARAGE DOOR OPENER, BURGLAR ALARM, etc. Kit: £4.12.6. Built: £5.10.0. Battery Model: Kit: 65/-. Built: 72/6. Photocells only 7/6, 12/6, and 25/-. Circuit and details of any project, 6d. stamp please. "ST. JOHN'S RADIO," 156 St. John's Hill, LONDON, S.W.11. BATtersea 9838

WANTED

WANTED. Service Sheets. No quantity too large. Highest prices paid. SULTAN RADIO, 29, Church Road, Tunbridge Wells, Kent.

NEW VALVES WANTED
Any type, any quantity.

GASH PAID

R.S.T. 211, Streatham Road,
Mitcham, Surrey.
Telephone: MITcham 6201.

A PROMPT CASH OFFER for your surplus Brand New Valves, Speakers, Components, Test Instruments, etc. R.H.S., 155, Swan Arcade, Bradford 1.

BEST PRICE paid by return for new Valves and equipment. STAN WILLETTS, 43, Spoon Lane, West Bromwich, Staffs. Tel: WES 2392.

WANTED VALVES

All types for prompt cash. Must be new. State quantity.

WILLIAM CARVIS LTD.
103 North Street, Leeds 7

DIAMOND



STYLIS

FOR DIAMONDS

Manufacturer's offer to users—send us your old stylus arm and we will retip with finest Transcription quality Diamond. To ensure best reproduction every Diamond is inspected for finish and radius with 500 magnification.

FOR £1.0.0 ONLY

Or we will supply complete with any stylus arm for £1. 5s. 0d. Tax Paid and will despatch within 48 hours of receipt, post free.

All Diamonds are Guaranteed for One Year

(Sapphires also supplied 4/6 Tax Paid)

Mail Orders to:—Dasco, Frith Park, Tadworth, Surrey

SOUND RECORDINGS

TAPE/DISC transfer. Fine U.S. tapes arrived (1.800ft 35/-). **UNIMORER** units for quality work. Sound News, 10, Clifford Street, W.1. REG 2745.

RECORDING TAPE, save up to 30%. send for list; also 50 second-hand recorders in stock.—**E. C. KINGSLEY AND CO.** 132 Tottenham Court Road, London W.1. EUS 6500.

BOOKS & PUBLICATIONS

FIND TV SET TROUBLES IN MINUTES from the great book "The Principles of TV Receiver Servicing," 10/6 all book houses and radio wholesalers. If not in stock, from Secretary, I.P.R.E., 20, Fairfield Road, London, N.8.

EDUCATIONAL

LEARN RADIO AND ELECTRONICS the "new practical way!" Hosts of absorbing experiments carried out at home under expert guidance to teach you Radio in a new, enjoyable and interesting way. Construction, servicing and fault finding on equipment made easy for the first time! No previous experience needed. No mathematics used. Free brochure from: Dept. 11 P.W., **RADIO-STRUCTOR**, 40, Russell St., Reading, Berks.

City and County of Bristol
Education Committee

BRISTOL TECHNICAL COLLEGE

Principal: E. Poole,
B.Sc. (Eng.), M.I.Mech.E., M.I.Prod.E.
Bristol School of Marine Radio and
Radar
(Formerly of A.S.T. Hamble)

Courses available for 1st and 2nd Class P.M.G. Certificates for Marine Radio Officers; M.O.T. Radar Maintenance Certificate; Six weeks Pre-Sea Training for qualified Radio Officers; (From September, 1961)—Two-year course for Air Radio Maintenance Engineers Licences, Categories 'A' and 'B'.

For further details apply to the Registrar,
Bristol Technical College, Ashley Down,
Bristol, 7.

WIRELESS. See the world as a Radio Officer in the Merchant Navy; short training period; low fees; scholarships, etc., available. Boarding and Day students. Stamp for prospectus. **WIRELESS COLLEGE,** Colwyn Bay.

Radio Television & Electronics

Learn at home with the world's largest home study organisation, Brit.I.R.E.; City & Guilds; R.T.E.B., etc. Also Practical Courses with equipment. No books to buy.

Write for **FREE** prospectus stating subject to

I.C.S.

(Dept. 541), Intertext House,
Parkgate Road, London, S.W.11

EDUCATIONAL

(continued)

FREE FROM THE I.P.R.E. Syllabus of famous radio and TV courses. Membership Conditions booklet 1/-. Sample copy The Prac. Radio Engineer, 2/-, post free. Secretary, 20, Fairfield Road, London, N.8.

★ LEARN ★ RADIO & T/V SERVICING for your OWN BUSINESS/HOBBY

by a new exciting no-maths system, using practical equipment recently introduced to this country.

FREE Brochure from:—

RADIOSTRUCTOR

DEPT. G77, READING, BERKS, 5/61.

"HOW AND WHY" of Radio and Electronics made easy by a new, no-maths Practical Way. Postal instruction based on hosts of experiments and equipment building carried out at home. New courses bring enjoyment as well as knowledge of this fascinating subject. **FREE** brochure from: Dept. P.W. 12, **RADIOSTRUCTOR**, 40, Russell Street, Reading, Berks.

SITUATIONS VACANT**SITUATIONS VACANT**

(continued)

TV AND RADIO A.M.Brit.I.R.E., City and Guilds, R.T.E.B. Cert., etc. on "No pass—no fee" terms. Over 95% successes. For details of Exams and Courses (including practical apparatus) in all branches of Radio, TV and Electronics, write for 148-page handbook, free. B.I.E.T. (Dept. 242G), 29, Wright's Lane, London, W.8.

A.M.I.Mech. E., A.M.Brit.I.R.E., City and Guilds, G.C.E., etc., brings high pay and security. "No pass—no pay" terms. Over 95% successes. For details of exams and courses in all branches of Engineering, Building, Electronics, etc., write for 148-page handbook, free. B.I.E.T. (Dept. 242B), London, W.8.

CITY AND GUILDS (Electrical, etc.) on "No pass—no fee" terms. Over 95% successes. For details of Electrical Engineering, Applied Electronics, Automation, etc., send for our 148-page handbook, free and post free. B.I.E.T. (Dept. 242A), 29, Wright's Lane, London, W.8.

SENIOR TECHNICIAN required for **ELECTRICAL ENGINEERING** Dept. for construction and servicing of electronic equipment, also general laboratory work. Commencing salary according to ability and experience. Application forms from Secretary, **UNIVERSITY COLLEGE LONDON,** Gower Street, W.C.1 quoting EE/1.



TEST ENGINEERS

We are manufacturers of:—

Fully Transistorised Digital Computers
Automatic Electronic Telephone Exchanges

We require:—

ENGINEERS

for our Test Department to work on these equipments and associated test gear.

Qualifications:—

We welcome Engineers experienced in the testing of any electronic equipment. R.N. Radio Electrical Artificers; Royal Signals and R.E.M.E. X Tradesmen, and R.A.F. Radar and Wireless Fitters will find a niche here. Whilst academic qualifications are desirable, they are not essential.

Starting salaries:—

ELECTRICAL TESTERS	£13 a week
TEST ENGINEERS	£833 a year
SENIOR TEST ENGINEERS	£963 a year

Apply:—

with full details to

The Staff Officer,

The GENERAL ELECTRIC COMPANY LIMITED

Copsewood, COVENTRY.

SITUATIONS VACANT (continued)

MINISTRY OF AVIATION

E.I.D.

ELECTRONIC INSPECTORS

required for

RADIO, RADAR, COMPONENTS & ELECTRICAL ANCILLARIES AT BRÖMLEY & WOOLWICH and elsewhere in London and Home Counties.

Varied and interesting work with opportunities for gaining valuable experience and further training.

Excellent promotion prospects.

PAY 266/- to 281/- (with prospects of further progression to 306/-) for a 5-day week. Skilled men apply, stating experience, to:

ELECTRICAL INSPECTION DIRECTORATE

AO/IL

Aquila, Golf Road, Bromley, Kent.

SERVICE SHEETS

SERVICE SHEETS. Radio, TV, 5,000 models. Lists 1/-. S.A.E. enquiries. TELRAY, 11, Maudland Bk., Preston.

SERVICE SHEETS. We have the largest stock of Radio and TV Service Sheets in the country for sale at 4/- ea. Why tolerate delay in obtaining your supplies when we will dispatch by return? Service Sheet List 1/-. Also Manufacturer's Manuals for sale and hire. 1961 List now available 1/-. S.A.E. please. Mail orders only to S.P. DISTRIBUTORS, 44, Old Bond Street, London, W.1.

38 SET WALKIE TALKIE CIRCUIT INFORMATION

Alignment Procedure. Typical faults in Ex. W.D. Sets. Components location diagrams. Circuit diagram. Complete Circuit description. Instructions for use. etc. P.O. 5/-. Address in black capitals, please.

CAMPBELL

Laundry Lane, Hungerford, Berks.

SERVICE SHEETS; also Current and Obsolete Valves for sale. JOHN GILBERT RADIO, 20, Extension, Shepherd's Bush, Market, London, W.12. (Phone: SHE 2052.)

FAULTFINDER FILES, showing common faults that each receiver is prone to and other useful servicing information 2/- ea. List 9d., plus postage. S.P. DISTRIBUTORS, 44, Old Bond Street, London, W.1.

SERVICE SHEETS. TV 4/- ea. Radio 3/- ea. List 1/-. All orders dispatched on day received. Also Manuals for sale and hire. SULTAN RADIO, 29, Church Road, Tunbridge Wells, Kent.

SERVICE SHEETS (1930-1961) from 1/- with Free Fault Finding Guide. Catalogue 6,000 models. 1/-, 125 Radio/TV Sheets covering 370 popular models 20/-. S.A.E. enquiries, HAMILTON RADIO, Western Road, St. Leonards, Sussex.

COYNE'S NEW PIN-POINT SERIES TAKES HEADACHES OUT OF ALL SERVICING PROBLEMS!

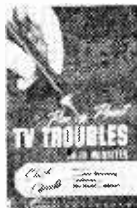

No. 1

Pin-Point TV troubles in 10 minutes

Find the exact sound or picture trouble in ANY TV set from 700 possibilities! Latest edition has now 332 pages of solid TV servicing information:

300 diagrams, check charts, 31/8. Postage 1/-.

SPECIAL OFFER

Circle Book No. 1 on coupon, send offly 16/3 after 7 days, and 16/3 in 30 days, making a total of 32/6 including postage.

No. 2

Pin-Point Transistor troubles in 12 minutes



Trouble-shoot every type of circuit in ALL transistorized equipment! 525 pages: hundreds of illustrations; 120 check charts, 47/8, postage 1/8. Circle Book No. 2 on coupon.

TRY ANY FOUR BOOKS ON NO RISK FREE TRIAL OFFER

- No. 3. Application of Radio and TV Principles. 299 pages..... 26/-
- No. 4. Radio, Television and F.M. Receivers. 403 pages..... 26/-
- No. 5. Radio & TV Circuits. 394 pages... 26/-
- No. 6. Latest Instrument for servicing Radio-TV. 367 pages..... 26/-
- No. 7. Practical Television Servicing and Trouble Shooting Manual. 406 pages... 34/-
- No. 8. Television Servicing Cyclopaedia. 848 pages..... 47/8
- No. 9. Transistor Circuits. 410 pages... 39/8
- No. 10. Coyne Technical Dictionary..... 18/-
- No. 11. Television and Radio Handbook... 22/-

SEND NO MONEY,

Use Time Payment Plan at No Extra Cost If You Wish

Just mail coupon for free trial. After 7 days send only low price or return books and pay nothing! If you keep more than one book, send £1 after 7 days and £1 each month until completed (maximum four books). To buy one book send one half in 7 days, one half in 30 days.

MAIL COUPON NOW FOR FAST RETURN SERVICE

SIM-TECH BOOK COMPANY.

MAIL ORDER DIVISION, DEPT. P.W.S. GATER'S MILL, WEST-END, SOUTHAMPTON, HANTS. Rush the books circled below for 7-day FREE TRIAL as per offer.

1 2 3 4 5 6 7 8 9 10 11
 Name.....
 Address.....

CITY..... County.....
 Tick here if enclosing full price, we pay postage. Same 7-day money-back guarantee. Postage 22 or less 1/-, 23 or more 1/6.
OVERSEAS ORDERS, PLEASE PAY FULL AMOUNT, MONEY BACK GUARANTEE IF NOT SATISFIED.

WEYRAD

COILS AND TRANSFORMERS FOR A 2-WAVE TRANSISTOR SUPERHET WITH PRINTED CIRCUIT AND FERRITE ROD AERIAL

LONG AND MEDIUM WAVE AERIAL—RA2W
On 6 in. rod, 7/8 in. diameter, connections to 6-Tag Ring, 208 pF tuning 12/6
OSCILLATOR COIL P50/1AC
Medium wave in screening can. For 176pF tuning condenser 5/4
1st AND 2nd I.F. TRANSFORMERS—P50/2CC
470 Kc/s operation with 250 pF tuning in cans. 1/8 in. diameter by 3/4 in. high 5/7
(2 REQUIRED)

3rd I.F. TRANSFORMERS—P50/3CC
Last stage transformer to feed diode detector. Size at P50/2 8/-

DRIVER TRANSFORMER—LFDT2
Upright mounting with six connecting tags—1 7/8 in. x 7/8 in. x 1 3/4 in. 9/6

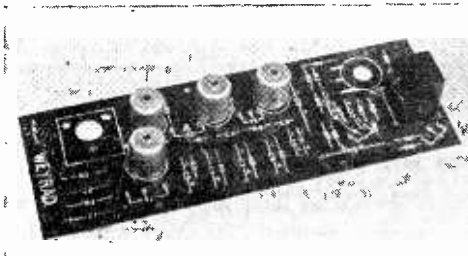

PRINTED CIRCUIT—PCAI
Size 2 3/4 in. x 8 1/4 in. Ready drilled and printed with component positions 9/6
THESE COMPONENTS ARE APPROVED BY TRANSISTOR MAKERS AND PERFORMANCE IS GUARANTEED.

Constructor's Booklet with full details, 2/-.

WEYMOUTH RADIO MANUFACTURING CO., LTD.

CRESCENT STREET, WEYMOUTH, DORSET

BENSON'S BETTER BARGAINS

CONDENSERS: Electrolytic 8 mfd. 375 v. 1/8; 1000/6 v. 3/8; 2000/50 v. 8/-; 500/25 v. 3/8; 32/375 v. 1/8; 50/50 v. 1/-; 25/12 v. 1/-; 200/275 v. 3/-; 40/350 v. 3/8; 25/50 v. 1/-; 32/200 v. 1/8; 4/350 v. 1/-; 20 + 20/450 v. 3/8. Block paper 8 mfd. 1 kV 10/-; 5/600 v. 6/8; 4/400 v. 5/-; 8/250 v. 4/-; 4/2 kV v. 7/8; 4/1kV v. 4/8.

SWITCHES: Water 2 pole, 4 way, 4 bank 1P7W5B, 4P2W2B, 1P7W3B, 1P11W2B, 4P2W3B, 3/8 each. Ceramic 2P4W1B, 1P5W3B, 1P11W, 3P3W2B, 4P3W1B, 3/8. STUID. 1P24W2B, 1P8W2B, 3/8; 1P19W2B, 5/8; 1P40W3B in brass case, 12/6. **MORSE KEY** with buzzer on board, wired for 4 1/2 v. battery, 8/6 (p.p. 1/6). **TELE "F"** intercom. sets, good condition, pair 65/-, post free Gr. B. **METERS** (10Q/4) with two movements, 600 and 400A, 8/6. **TRANSFORMERS:** Open, upright, input 200/250 v. Output:—250-0-250 v., 150 mA 5 v. 3 A. and 6.3 v. 5 A., 25/-, Input 110/240. Output 1860 v. 4 mA, 12/6. **MONITOR 58**, triggered oscilloscope, 250 v. A.C. input, with cables and circuit. Cathode probe unit extra, 17/8. **6S.10.0.** (Rail 15/-). **CR100** Noise Limiter assemblies with valve, 3/6. **NEW M.C. METERS 6**, 3 1/2 in. round flush, 50A, 70/-; 200A centre zero, 50/-; 1 m. centre zero, 45/-; 1 mA, 55/-; 2 1/2 in. 1 mA, 22/6; 100 mA, 3/8; 2 in. 300 mA, each 3/8; 2 1/2 in. M.L. 20 v. A.C. 8/8; 100 v. A.C. 3 1/2 in., 45/-; 150 v. A.C. M.L., 6 in., in case 45/-. **VIBRATORS**, Mallory G634C 12 v. 4-pin, 7/8; 3 v. 5-pin reversible, 7/8. **DRIVERS** slot motion Admiralty 300 : 1 ratio, scaled 6/10, 5/8. **R1155 S.M.** "N" type, new 10/8. **VIBRA-PAK** 6 v. D.C. to 250 v. 60 mA, smoothed case, 22/6 (p.p. 3/6), or 12 v. 26/-. **DYNAMOTORS** (post 3/6), 12 v. to 250 v. 60 mA, 11/6. 6 v. to 250 v. 60 mA, 11/8. **CHOXES:** LF 10H, 200 mA, 8/8; 9H, 100 mA, 5/8; Potted 10H, 100 mA, 7/8; "C" 10H, 250 mA, 12/8; 5H, 400 mA, 10/8; 30H, 50 mA, 7/8, 10H, 500 mA, "C" 22/6; 20H, 100 mA, 9/8; 3H, 100 mA, 8/8; 15H, 150 mA, 9/8. **RELAYS** (LONDEX) co-ax, small 12/24 v. 7/6.

LIST AND ENQUIRIES S.A.E. please. Terms, C.W.O. Postage extra. Imp. despatch. Orders and post. W. A. BENSON (P.W.), 130 Rathbone Road, Liverpool 15. S.F.P. 6853. Callers: SUPERADIO (Whitechapel), Ltd., 118 Whitechapel, Liverpool 1. ROY 1130.

A.R.R.L. RADIO AMATEURS HANDBOOK 1961

New edition, 32/6. Postage 1/9
World Radio Handbook for Listeners 1961 by Johansen, 18/6, postage 1/-.
Radio Valve Data, new 7th. ed., by Wireless World, 6/-, postage 9d.
Principles of Transistor Circuits by Amos, 2nd. ed., revised 21/-, postage 1/-.
Multiband Reference Manual of Transistor Circuits, 12/6, postage 1/-.
Model Boat Radio Control, by Casebrook, 6/-, postage 9d.
R.S.G.B. Amateur Radio Call Book 1961, 4/-, postage 6d.
Morse Code for Radio Amateurs, by R.S.O.R., 1/6, postage 6d.
High Fidelity Sound Engineering, by Crowhurst, 50/-, postage 1/6.
Introduction to Hi-Fi, by Brown, 21/-, postage 1/-.

UNIVERSAL BOOK CO.
12 Little Newport Street, London, W.C.2
(adjoining Lisle Street)

CABINETS & HI-FI EQUIPMENT

We can supply any Cabinet to your own specification



"Grosvenor" £19.19.0

This is only one example taken from our extensive range of stock cabinets. Write for our NEW 24 page fully illustrated catalogue on:

THE LARGEST RANGE OF CABINETS IN THE COUNTRY.
Equipment is also our speciality and we now offer, in a novel book form: **A NEW EQUIPMENT COMPARATOR** illustrating our range of radio chassis, speakers, tape decks, single players and autochangers. **SEND TODAY for a copy of these two books, which are absolutely FREE.**

LEWIS radio

100 (P.W.51) Chase Side Southgate, London, N.14. Pal 3733

ALL THE DATA YOU NEED OVER 4,500

CIRCUIT, COMPONENT AND CHASSIS LAYOUT DIAGRAMS

At a moment's notice you will be able to service the 1954-1961 popular models. Radio and TV and Tape recorders, Record Players, etc. Judge for yourself by Free Trial—send for full particulars of the New 1961 Edition to:

GEORGE NEWNES LTD.

Radio & TV Department (RSL)
15-17 Long Acre, London, WC2

FOR BARGAINS M.S. RADIOPOST CO. MAIL ORDER SPECIALISTS

Please quote Dept. M.O.P.W.

36 WINCANTON RD., HAROLD HILL, ROMFORD

MINIATURE DYNAMIC SPEAKERS

A must for all Build-it-yourself-Hi-ams. As supplied with all current transistor Kits. Can also be adapted for home phones or Intercom. 2in. diameter. Resistance 70 ohms. ONLY 5/-.

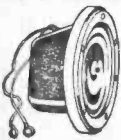

"HAM'S" BARGAIN PARCEL. Limited quantity only. Containing all brand new quality components. At least 100 assorted resistors, 25 assorted condensers, 4 crystal diodes, tag strips, etc. Only 15/- each.

CARBON HAND MICROPHONES. Brand new and in original cartons. Built-in on/off switch, bakelite construction, with lead and plug. Only 6/8 each.

MINIATURE AMERICAN LEAD ACID ACCUMULATORS. 36 volts 20 mA. 4 x 1 1/2 x 1 1/2 in. 3/8 each. CASES SPARE PARTS. No. 5C. ZA/US 1539. Complete. For W/S. No. 19. 15/- each. New.

MINIATURE MODEL MOTOR

(Not Ex-Govt.). Removed from Transistor Tape Recorders and in perfect condition. 3 to 12 v. 1/4 in. Dual spindle fully reversible. protected bearings. Approximately 3/4000 r.p.m. Size: 2 1/2 in. long x 1 1/2 in. wide. Spindle: 1/4 in. x 1/32 in.



Only 9/6 each

HYSTERESIS BLOWER MOTOR

Manufactured by SMITH'S Aircraft Instru. Type: HM14. 115 volts 400 cycles. Removed from New Automatic Pilot equipment but in perfect condition. Only 60/- ea. 8 1/2 WHIP AERIALS. 8 x 1ft sections. For model radio control, etc. 7/8 com.



TERMS: C.W.O. or 7 days approved accounts. All our goods are guaranteed new or in working order. Money refunded in full if not absolutely satisfied. Orders despatched same day. NO POSTAL OR PACKING CHARGES. C.O.D. 1/8 extra. Carriage extra Ireland and countries outside U.K.

EXPRESS ELECTRONICS ROSEDENE LABORATORIES KINGSWOOD WAY, SELSDON, SURREY VALVES NEW TESTED AND GUARANTEED FOR THREE MONTHS

1C1	7/8	6BA6	7/-	12AH8	10/-	DH77	6/-	EF80	8/6	PL81	9/-
1C3	8/-	6BE6	7/-	12AT7	8/-	DH142	8/6	EF86	9/-	PL82	7/-
1F1	8/-	6BR7	8/9	12AU7	5/-	DH150	10/-	EF91	4/-	PY81	8/6
1F3	7/8	6BR7	10/8	12AX7	7/6	DK91	7/6	EF92	6/8	PY82	7/8
1FD1	8/-	6BW6	7/8	12BH7	10/6	DK92	7/6	EL41	9/6	PY83	7/8
1FD9	7/8	6BW7	7/8	12K0TT11	7/6	DK96	8/-	EL84	7/-	TH19	11/6
1L4	6/8	6C10	9/-	12Q9T	7/6	DL92	7/8	EM34	7/-	TH41	15/6
1P1	8/-	6D2	4/-	16A5	8/-	DL94	7/6	EY51	7/8	U20	9/6
1P10	7/8	6F12	4/-	25A0G	8/6	DL96	8/-	EY81	10/-	U32	7/8
1P11	7/8	6HG7	2/-	25L6G	8/6	EB91	4/-	EZ40	7/8	U76	7/6
1R5	8/-	6K70	5/8	26Z4G	9/-	EBC41	10/-	EZ80	5/8	U78	7/-
1T4	7/8	6K9G	8/8	30L1	6/8	EBC42	9/8	EZ81	8/-	UBC41	8/6
1U5	6/-	6Q7GT	8/8	35L6GT	9/-	ECC82	5/-	KT63	11/8	UB41	8/6
3Q4	8/-	6S17GT	8/-	35W4	8/6	ECC83	7/6	N17	7/8	UL41	9/6
384	7/8	6SN7GT	8/8	35Z4GT	8/8	ECC84	7/8	N18	8/-	UL41	7/6
3V4	7/8	6V0G	7/8	3763	7/6	ECP80	8/8	N19	7/8	W76	8/6
4V4G	7/8	6X4	4/-	30	8/8	ECP82	8/8	N37	10/8	W142	8/6
5Y3GT	4/8	6X5G	5/8	DAF91	7/8	ECP82	8/8	PC84	6/8	X117	7/8
5Z4G	9/8	6X5GT	8/8	DAF96	8/8	ECH81	10/-	PCF80	6/8	X142	9/6
6AK6	6/8	6B3	7/6	DAF98	8/8	ECH82	10/-	PCF82	7/-	X160	9/6
6AL5	4/-	7C5	7/8	D1991	7/8	EC180	8/8	PC182	7/-	Z77	4/-
6AM6	4/-	787	9/8	D1996	8/8	ECL82	9/8	EPL84	9/-	ZD17	7/6
6AT6	8/-	8D3	4/-	DH76	7/8	EP41	9/-	EPL84	7/-	ZD17	7/6

VOLUME CONTROLS MIDGET SIZE LONG SPINDLES, D.P. switch 4/- Less switch, 2/8. Values 10K to 2M. E9A, B7D v. Holders 9d., Screens 9d., Contact Cooled Rectifiers 250v. 80mA. 6/8. 80uA. 8/8.

MATCHED PAIRS

EL84 17/-, 6V8G 17/-, 6V8G 18/- per pair. Push Pull O.P. Transformers for above 3-15U 14/8. P. & P. 1/8. 12in. P.M. speakers 3/8. 8" Baker's "selhurst" 12in. 16U 15W, 90/-, P. & P. 2/8. 12in. Stereo Model £7.70

SETS OF VALVES

DK91, DP91, DAF91, DL92 or DL94	19/8	ECH42, EF41, EBC41, DK96, DP96, DAF96, DL96	27/8	EL41, EZ40	37/6
1C3, 1F1, 1FD1, 1P1	27/8	UCH42, UP41, UBC41	19/8	UL41, UY41	35/-

Postage and packing 6d. Over £1 post free. C.O.D. 2/6.

Red Spot Transistors, 3/-; White Spots, 3/-; Yell./Gr., 3/6; Ediswan XA102, 10/-; XA104, 9/-; XA103, 9/-; XA101, 9/-; XB103, 8/6; XB104, 7/6; XC101, 9/-; Special bargain set for P.W. Superhet 6 Transistors (1-XA102, 2-XA101, 1-XB103, 2-XC101), plus Diode, 47/6; Newmarket V15/10 P, 15/-; Diodes, 1/-; 2/6; 4/-; Transistor holders, 1/-; Ardent Trans. D239, 8/6; D240, 8/6; D.131, 10/-; D.132, 10/-; Sub. Min. Electrolytics (15v) 2, 4, 8, 10, 25, 50, 100 mfd., 3/-; 32 mfd., 2/9; P.W. Superhet, complete kit, £9/17/0. M.C. Earpiece (used as speaker), 5/-; Balance Inserts (as earpiece or speaker), 2/6. Silicon Rectifier bargain 70 p.i.v. 1/2 amp., 3/3; Westalite Contact Rectifier 250 v., 60 mA, 7/6; Transformer 250-0-250 v., 6v. and 5 v., 15/-; 6 v., Vibrator Pack, 120 v., 60 mA, out 12/6; Garrard Portable Record Player, cabinet, battery turntable 45 r.p.m. and pick-up; takes transistor amplifier, £3/10/0, plus carr. 3/3. Real bargain. Limited quantity.

TERMS.—Cash with order. Post extra, excess refunded. Morco Reflex Rx, best 2-transistor Receiver. Send 8d, stamps for notes.

MORCO EXPERIMENTAL SUPPLIES
8 & 10 Granville Street, Sheffield 2
Tel.: 27461

ONE-FINGER PIANISTS

Build your own electronic keyboard and play everything! Send for free leaflet. Guitar, cello, flute and trumpet are all easy. Write now...

C. & S., 20 Maude Street,
Darlington, Co. Durham

Your hi-fi library is incomplete without this practical new book...

INTRODUCTION TO HI-FI

by Clement Brown

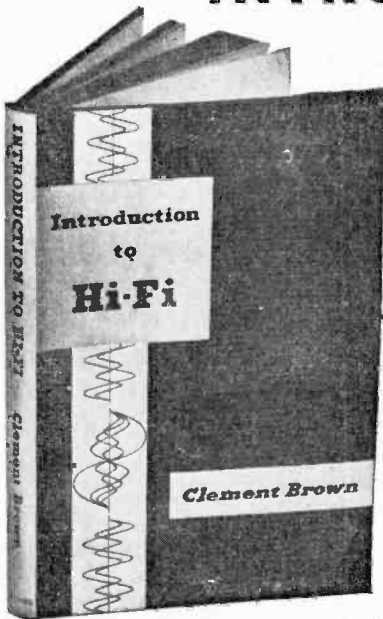

This book is a clear introduction to what we can and cannot do in the world of hi-fi, what is and is not important, which items of equipment can be bought cheaply, and for which this would be false economy. For all who are interested in stereo or monophonic reproduction from disc, tape or radio, Clement Brown offers pithy, intelligent suggestions.

CONTENTS

Introducing High Fidelity - Records and Pick-ups - Amplifiers and Radio Tuners Loudspeakers - Listening Room Acoustics Stereophonic Sound - Tape and High Fidelity - Choosing Your Equipment - Installing Your Equipment - Hi-Fi in the Future - Further Reading - Useful Data. The book also includes a list of Recommended Records and Tapes plus a glossary of terms used in hi-fi.

208 pages 85 illustrations

21/- FROM ALL BOOKSELLERS

... or, in case of difficulty, 22s. by post from GEORGE NEWNES LTD., Tower House, Southampton Street, London, W.C.2.

SELENIUM RECTIFIERS

F.W. BRIDGE	H.T. Types H.W.
6/12 v. 1a... 3/11	150 v. 40 m.a. ... 3/9
6/12 v. 2a... 6/11	250 v. 50 m.a. ... 3/11
6/12 v. 3a... 9/9	250 v. 60 m.a. ... 4/11
6/12 v. 4a... 12/3	250 v. 80 m.a. ... 5/11
6/12 v. 6a... 15/3	250 v. 250 m.a. ... 11/9
6/12 v. 10a... 25/9	CONTACT COOLED
6/12 v. 15a... 35/9	250 v. 80 m.a. H.W.
24 v. 2a... 14/9	6/11, 250 v. 50 m.a.
	F.W. (Bridge) 8/11

B.S.R. MONARDECK TAPEDECKS.

Speed 3 1/2 in. per sec. High quality recording heads, 7 3/8 in. Carr. 5/-. Suitable polished veneered walnut carrying case for above 39/6. (Space for amplifier.)

EX-GOVT. CASES. Size 14-10 1/2 in. high. Well ventilated, black crackle finished, undrilled cover. IDEAL FOR BATTERY CHARGER OR INSTRUMENT CASE OR COVER COULD BE USED FOR AMPLIFIER. Only 9/9, plus 2/- postage.

LINEAR TREMOLO/PRE-AMP UNIT

Type TPU/1, with 3 controls, volume, amplitude and frequency. Inputs for guitar and microphone. Requires power supply of 250 v. 10 m.a. and 6-3 v. 1 a., available from any R.S.C. or LINEAR amplifier. The unit is merely connected to normal input socket of hi-fi amplifier or Guitar amplifier. Only 24.10.9.

MICRO-AMMETERS. 3 1/2 in. diam. 0-50 micro-amps. 33/9.

R.S.C. BRADFORD MANCHESTER
(Manchester) Ltd. and LEEDS

HI-FI 10 WATT AMPLIFIERS

Brand new. Manufacturers discontinued line. Fitted Mullard valves. Dual inputs for "mike" and gram., etc. Bass and Treble Controls. High sensitivity and quality. For 230-250 v. A.C. **£6.19.6** Carriage 7/6.

POCKET PORTABLE 3 TRANSISTOR RADIO DENIN. Handsome plastic cabinet. "Built-in" ferrite rod aerial, and Miniature loudspeaker unit. Regenerative circuit using 2 Brimar R.F. transistors, 1 output transistor and crystal diode. Point-to-point wiring diagrams and instructions 11d. Total cost of all necessary parts only 49/9.

MULTI-METERS. Ferranti Universal A.C./D.C. 59/6.

CABY A10. Basic Meter sensitivity 155 micro-amps, A.C. and D.C. ranges 24.17.6.

CABY B20. Sensitivity up to 10,000 ohms per volt. A.C. and D.C. £6.10.0. S.A.E. will bring leaflets on A10 or B20.

RELAYS. Carpenters' Type. Polarised 2 times 4,500 turns at 1,685 ohms. 13/9. Miniature Moving Coil Differential Type. Single pole 2-way, or centre stable. Two coils each 350 ohms. Minimum operating current 150 micro-amps. Nominal 400 micro-amps maximum 8 milli-amps. Two way contact current 100 mA at 50v. A.C. or D.C. Size 14 x 1 1/2 in. approx. 13/9. Miniature Type G.E.C. 670 Sealed, wire ends. 4 c/vers. platinum M1095. 12/9.

SPECIAL OFFER EX-GOVERNMENT SELENIUM RECTIFIERS.

12v. 15 amp. with large square cooling fins. 19/9 each.

EX. GOVT. SMOOTHING CHOKES.
200 mA., 3-5 H., 50 ohms, Parmeko 8/9; 100 mA., 5 H., 100 ohms 3/11; 150 mA., 10 H., 50 ohms 9/9; 80 mA., 20 H., 900 ohms 5/9; 120 mA., 12 H., 100 ohms 8/9; 50 mA., 50 H., 1,000 ohms 6/9; 100 mA., 10 H., 100 ohms 6/9; 80 mA., 5-10 H., 250 ohms 2/11.

EX. GOVT. MAINS TRANSFORMERS
Primaries 200-250 v. 50 c.p.s. A.C.
250v. 60 mA. 6.3v. 2a. ... 10/11
270-0-275v. 100 mA. 6.3v. 7a. 5v. 3a. ... 21/9
300-0-300v. 60 mA. 6.3v. 2a. ... 12/11
300-0-300v. 100 mA. 6.3v. 2a. 5v. 2a. ... 18/9
350-0-350v. 160 mA. 6.3v. 5a. 5v. 3a. ... 27/9
5v. 10a. Parmeko. ... 11/9
4-4v. C.T. 6-8 amps. Parmeko ... 7/9
400-0-400v. 200 mA. ... 17/9
0-45-0-45-50v., 300 mA. 6.3v. 3a. ... 17/9
450-0-450v. 100 mA. 6.3v. 1.5a. 4v. 3.5a. 5v. 2.5 a. ... 22/9

2 VOLT ACCUMULATORS
Varleys small size 4 x 3 1/2 x 1 1/2 in. 2 v. 14 A.H. brand new. 6/9 ea. 3 for 15/6.

FIELD TELEPHONES

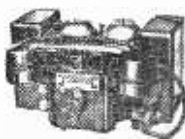

With bell. Require only small battery. Suitable for office, factory, warehouse, or outside intercommunication. 59/6 each.

TERMS: C.W.O. or C.O.D. No. C.O.D. under £1. Post 1/9 extra under £2. 2/9 extra under £5. Open 9 to 6. Weds. until 1 p.m. Trade supplied. S.A.E. with all enquiries. Mail Orders to 29-31 Moorfield Road, Leeds 12. Callers to 5 and 7 County Arcade, Briggate, Leeds 1, and 8-10 Brown Street (Market Street), Manchester 2, or 56 Morley Street (next to Majestic Ballroom), Bradford.

FREE TO AMBITIOUS ENGINEERS
— THE LATEST EDITION OF ENGINEERING OPPORTUNITIES

Have you sent for your copy? ENGINEERING OPPORTUNITIES is a highly informative 156-page guide to the best paid engineering posts. It tells you how you can quickly prepare at home for a recognised engineering qualification and outlines a wonderful range of modern Home Study Courses in all branches of Engineering. This unique book also gives full details of the Practical Radio & Electronics Courses, administered by our Specialist Electronics Training Division—the B.I.E.T. School of Electronics, explains the benefits of our Employment Dept. and shows you how to qualify for five years promotion in one year.

We definitely Guarantee "NO PASS — NO FEE"
Whatever your age or experience, you cannot afford to miss reading this famous book. If you are earning less than £25 a week, send for your copy of "ENGINEERING OPPORTUNITIES" today—FREE.

BRITISH INSTITUTE OF ENGINEERING TECHNOLOGY (Incorporating E.M.I. Institutes)
(Dept. SE/21), 29 Wright's Lane, London, W.8

WHICH IS YOUR PET SUBJECT?

- Mechanical Eng.,
- Electrical Eng.,
- Civil Engineering,
- Radio Engineering,
- Automobile Eng.,
- Aeronautical Eng.,
- Production Eng.,
- Building, Plastics,
- Draughtsmanship,
- Television, etc.

GET SOME LETTERS AFTER YOUR NAME!

- A.M.I. Mech. E.
- A.M.I.C.E.
- A.M.I. Prod. E.
- A.M.I.M.I.
- A.I.O.B.
- A.F.R. Ae.S.
- B.Sc.
- A.M. Brit. I.R.E.
- City & Guilds
- Gen. Cert. of Education
- etc., etc.

PRACTICAL EQUIPMENT

Basic Practical and Theoretical Courses for beginners in Radio, T.V., Electronics, Etc., A.M. Brit. I.R.E. City & Guilds Radio Amateurs' Exam. R.T.E.B. Certificate P.M.G. Certificate Practical Radio

Radio & Television Servicing
Practical Electronics
Electronics Engineering
Automation

INCLUDING TOOLS!

The specialist Electronics Division of B.I.E.T. (Incorporating E.M.I. Institutes) NOW offers you a real laboratory training at home with practical equipment. Ask for details.

B.I.E.T. SCHOOL OF ELECTRONICS



POST COUPON NOW!

■ Please send me your FREE 156-page "ENGINEERING OPPORTUNITIES"
■ (Write if you prefer not to cut page)

■ NAME.....

■ ADDRESS.....

.....

■ SUBJECT OR EXAM THAT INTERESTS ME..... (SE/21)

THE B.I.E.T. IS THE LEADING ORGANISATION OF ITS KIND IN THE WORLD

SOUTHERN RADIO'S WIRELESS BARGAINS

PORTABLE TEST METERS. (As featured in March issue, pages J005 to J01u) 0-5000 ohms; 0-60 mA; 0-1.5 v., 0-3 v. 12/6 each.

METERS. 30-0-30 and 3-0-3 volts; with leads. 15/-.

ATTACHMENTS FOR "38" TRANSMITTER-RECEIVER: Headphones, 15/6; Throat Microphones, 4/6; Junction Boxes, 2/6; Aerials, No. 1, 2/9, No. 2, 5/3; Webbing, 4/-; Haversacks, 5/6; Valves—A.R.P. 12, 4/6, A.T.P. 4, 3/6. Set of five valves, 19/-. Postage on each item 1/6 extra (except valves).

TRANSMITTER-RECEIVERS. TYPE "18", MARK III. Brand New, complete with 6 valves, etc. £4.10.0, carriage paid.

ATTACHMENTS FOR "18" TRANSRECEIVER. Headphones, 15/6; Microphone 4a, 12/6; Aerials, 5/-; Morse Key, 6/6; Valves—A.R.P. 12, 4/6, A.T.P. 4, 3/6, A.R. 8, 7/6; Set of six valves, 19/-. Postage extra (except valves) 1/6 each item

QUARTZ CRYSTALS. Types F.T.241/F.T.243 2-pin 1/2 spacing. F.T.241 20 to 38.9 Mc/s (54th and 72nd Harmonic). F.T.243 5700 to 8650 kc/s (Fundamental), 4/6 each. Lists of available frequencies on request. Crystal Holders for F.T.241/243, 1/3. F.T.241/243 Crystals. New but not guaranteed (ideal for using the case or regrinding). 12/6 per dozen, post paid.

RECORDING BLANKS. New 13in., 6/- each or 15 complete in Tin, £4.

BOMBSIGHT COMPUTERS. Ex-R.A.F. Wealth of gears, motors, blowers, etc. Ideal for experimenters. £3.12.6, carr. paid

RESISTANCES. 100 Ass'd. Useful values, new wire-ends, 12/6 per 100.

CONDENSERS. 100 Ass'd. Mica, Elec., Tubular, etc. New 15/- per 100.

MORSE PRACTICE SETS. Key with Buzzer on Base, with battery, 12/6, postage 2/-.

LUFBRA HOLE CUTTERS. Adjustable. 3 1/2 to 3 3/4". 7/3.

STAR IDENTIFIERS. I-AN. Covers both hemispheres, 5/6.

VISUAL INDICATORS (10 Q4). Type 3 with 2 meter movements, 2 neons. New, 12/-.

MAGNETS. Strong Bar, 2" x 1/2". 1/6 each.

COMMAND RECEIVERS B.C. 454 3-6 Mc/s. B.C. 455 6-9 Mc/s. Complete with 6 valves, new condition, 47/6 each.

POST OR CARRIAGE EXTRA, FULL LIST OF RADIO BOOKS, ETC., 3d.

SOUTHERN RADIO SUPPLY LTD.
11 LITTLE NEWPORT ST., LONDON W.C.2. GER. 6653

GZAK: This month's bargains

AMERICAN "SIGNAL" MORSE KEYS

Type M100 with switch. This excellent, lightweight, fast key is currently priced in U.S.A. at \$6.85 (£2 10s.), and is offered at only 12/6, p. & p. 1/6. Makes an acceptable present for the enthusiast.

AERIAL EQUIPMENT

TWIN FEEDER. 300 ohm twin ribbon feeder, similar K25, 6d, per yard. K35B Telcon (round) 1/6 per yard. Post on above feeder and cable 1/6 any length.

COPPER WIRE. 14 G., H/D 140ft. 17/-; 70ft. 8/6. P. & P. 2/-. Other lengths pro rata. Stranded 7/25, 140ft. 10/-; 70ft. 5/-, P. & P. 2/-.

RIBBED GLASS. 3in. aerial insulators, 1/6 each. P. & P. 1/6.

CERAMIC FEEDER SPREADERS. 6in. type F.S. 10d. each or 9/- dozen. P. & P. 2/-.

CERAMIC "T" PIECES. Type A.T. for centre of dipoles, 1/6 each. P. & P. 1/-.

2 METRE BEAM 5 ELEMENT W.S. YAGI. Complete in box with 1 x 2 1/2in. mast head bracket. PRICE 49/-. P. & P. 3/6.

SUPER AERAXIAL CABLE. 75 ohm, 300 watts, very low loss, 1/8 per yard, P. & P. 1/6. 50 ohm, 300 watt coax, very low loss, 1/6 yd. or 20 yds. 27/6, P. & P. 1/9.

ABSORPTION WAVEMETERS. 3.00 to 35.00 Mc/s. in 3 switched bands. 3 5, 7, 14, 21 and 28 M/cs. Ham Bands marked on scale. Complete with indicator bulb. **A MUST** for any Ham shack. **ONLY 19/6 EACH**, post free.

VARIABLE CONDENSERS. All brass with ceramic end plates and ball race bearings. 50 pF, 5/9. 100pF, 6/6. 160 pF, 7/6. 240 pF, 8/6, and 300 pF, 9/6. All fitted with rear extension for ganging. P. & P. 1/-. Also Flexible Couplers 1/- each.

CHAS. H. YOUNG LTD.

THE COMPONENT SPECIALISTS
Dept. "P", 110 Dale End, Birmingham 4. (CEN 1635)
(No C.O.D. under £1 please). (By return service)

REPANCO

HIGH GAIN COILS AND TRANSFORMERS
for the
HOME CONSTRUCTOR
Send 6d. stamp for comprehensive List of
REPANCO COMPONENTS
and Easy-to-Build Receivers.

RADIO EXPERIMENTAL PRODUCTS LTD

33 Much Park Street
Coventry
Tel. 27114

10,000 VALVES

SALVAGE GUARANTEED
Stocks to Clear. Ideal for Spares.

9d. Each	12Y4	7199	EP50
1D6	8D1	AR6	PM202
2D21	6D2	D1	SP41
3D6	6H16	EA50	SP51
4D1	6SA7	78	EB34
6B7	6SC7	210VPT	T41
6B8	8D2	2050	EF36
6C6	9D2	2151	EF37
6C9			VR21

2/9d. each	10F1	KTR1	U22
6A8	6P13	B36	KTW61
6AK8	6P14	DR66	P61
6B7	6P15	EP91	PEN45
6C4	6J5	ELJ2	PEN46
6P1	6K7		Z77
6P12	6K25		

5/9 each	12Q7	DH76	PL38
5U4	6V6	ECC81	PL81
5Y3	6X5	12SK7	PL81
6A7	10P13	20D1	ECC82
6F6	12AT7	20P2	ECL80
6K8	12AU7	30P1	EF80
6P28	12H6	35Z4	PC284
6SL7	12K7	120L1	PCP80
6SN7	12K8	1625	PL33
7/9d. each			
U76	W76		

POST & PACKING
One valve ... 7d. On six 1/6d.
On One Dozen 2/6d.

P.P. COMPONENTS LTD.
219 Iford Lane, Iford, Essex.
Stamp for FREE Catalogue.

LOOK DOWN PRICES

White Spot Transistors, 3/3 each, 3 for 9/6. Red Spot Transistors 3/- each, 3 for 8/6. Yellow/Green Transistors 3/6 each, 3 for 10/-. Red/Yellow Transistors, 5/9 each, 3 for 16/6.

Germanium Diodes 1/- each, 3 for 2/6, 7/6 dozen. Transistor Holders 1/3 each, 3 for 3/6. Miniature Slider Switches DP/DT 2/9 each. Crystal Earpieces High Imp 8/6. Mullard Diodes OA70, OA79 or OA81 4/- each. Vari-Loop Stick Coils M.W. with Transistor Circuits 4/6 each. Repanco DRX1 Crystal Set Coil M & L with Circuit 2/6 each. DRR2 Dual Range Coil with Reaction, and Circuits 4/- each. Reaction Condensers 0.0001 3/-, 0.0003 3/9, 0.005 4/-.

ALL COMPONENTS for P.W. TRANSISTOR POCKET SUPERHET, S.A.E. for Price List.

Headphones Lightweight for Crystal Sets 14/-. Solon Instrument Soldering Irons Model 625 25 watts 24/-.

ALL SENT POST FREE IN U.K. by PETHERICK'S RADIO SUPPLIES
22 High Street, Bideford, N. Devon

TRANSISTOR BARGAINS!

Transistors from 3/-. All components for the P.W. Pocket superhet I.P. job for £2.8.0. Resistors 2d. each. Complete set of coils, 3 I.P.s. and Osc. for 19/6. Mullard coil outfits to wind your own coils 9/- set. Wire and coil data 6d. If you want to save money send a S.A.E. for our list. P.W. pocket superhet job a speciality. Transistor Specialists.

JONNO'S

32, Heathfield Gdns., Chiswick, W.4

RES/CAP. BRIDGE 38/-

p. & p. 2/-
Checks all types of resistors, condensers 6 RANGES

Built in 1 hour. Direct reading
READY CALIBRATED

Stamp for details of this and other kits.

RADIO MAIL (Dept. LP)
Raleigh Mews, Raleigh Street, Nottingham

"GLOBE-KING"

WORLD-FAMOUS KITS AND RECEIVERS for the Radio Amateur and S.W. Listener. Catalogue Free, enclose stamp for Postage. Kits from 79/6 at your dealers, or direct from

JOHNSTONS (RADIO)
ST. MARTINS GATE, WORCESTER

FIRST-CLASS RADIO COURSES . . .

GET A CERTIFICATE!
QUALIFY AT HOME—IN SPARE TIME

After brief, intensely interesting study—undertaken at home in your spare time—YOU can secure your professional qualification. Prepare for YOUR share in the post-war boom in Radio. Let us show you how.

FREE GUIDE

The New Free Guide contains 132 pages of information of the greatest importance to those seeking such success-compelling qualifications as **A.M.Brit.I.R.E., City and Guilds Final Radio, P.M.G. Radio Amateurs' Exams., Gen. Cert. of Educ. London B.Sc. (Eng.), A.M.I.P.E., A.M.I.Mech.E., Draughtsmanship (all branches)** etc., together with particulars of our remarkable Guarantee of **SUCCESS OR NO FEE!** Write now for your copy of this invaluable publication. It may well prove to be the turning point in your career

FOUNDED 1885—OVER 150,000 SUCCESSSES—
NATIONAL INSTITUTE OF ENGINEERING
(Dept. 461), 148 HOLBORN LONDON, E.C.1

S. Africa: P.O. Box 8417, Jo'burg.
Australia: P.O. Box 4570, Melbourne.

BOOKS for CONSTRUCTOR

NEW PICTORIAL APPROACH TO LEARNING

BASIC ELECTRICITY, 5 parts.
BASIC ELECTRONICS, 6 parts.
The Complete Set sent on payment of first instalment.

LEARN WHILE YOU PAY

Write for **FREE Illustrated Prospectus** giving details of instalment plan! As advertised by **THE TECHNICAL PRESS**

- TRANSISTOR CIRCUITS** Nos. 1, 2, 3, 4. 2/8 each.
- RADIO TEST EQUIPMENT MANUAL** 2/10.
- RADIO INSTRUMENTS AND THEIR CONSTRUCTION.** 2/10.
- ONE VALVE RECEIVERS, TWO VALVE RECEIVERS, THREE VALVE RECEIVERS, FOUR VALVE RECEIVERS.** 1/8 each.
- 40 CIRCUITS USING GERMANIUM DIODES** 3/4.
- PRACTICAL TRANSISTOR RECEIVERS.** 5/6.
- TRANSISTOR SUPERHET RECEIVERS** 8/-.
- COIL DESIGN AND CONSTRUCTION MANUAL.** 5/6.
- HIGH FIDELITY TAPE RECORDER FOR THE HOME CONSTRUCTOR** 2/10.
- PUBLIC ADDRESS SYSTEMS.** 2/10.
- HIGH FIDELITY LOUDSPEAKER ENCLOSURES.** 5/6.
- TRANSISTORISED CAR RADIO for the HOME CONSTRUCTOR.** Fully illustrated 2/3.
- ROY'S BOOK OF CRYSTAL SETS AND SIMPLE CIRCUITS.** 2/10.
- ELECTRONIC NOVELTIES FOR THE CONSTRUCTOR** Bradley. 5/6.
- ELECTRONIC GADGETS.** Bradley 4/-.
- RADIO CONTROL OF MODELS.** 5/6. (Sommerhoff).
- SERVICING TRANSISTOR RECEIVERS** Pettit. 6/6.
- Using AN OSCILLOSCOPE.** Easterling. 7/-.
- BEGINNERS' GUIDE TO RADIO.** Camm. New and Revised Edition. 8/-.

- All above titles include postage.
- SEND STAMP FOR LISTS**

SELRAY BOOK CO.

60 HAYES HILL, HAYES BROMLEY, KENT

BBC - ITV - F.M. AERIALS

- B.B.C. (BAND D).** Telescopic loft, 19/6. External, 28/6. 28/3.
- I.T.V. (BAND 3).** 3 Element loft array, 24/-, 5 Element, 32/6. Wall mounting, 3 Element, 33/6. 5 Element, 41/3.
- COMBINED B.B.C. + I.T.V.** Loft 1+3 Element, 41/3. 1+5 Element, 48/6. Wall mounting, 1+3 Element, 56/3. 1+5 Element, 63/6. Chimney and mast mounting units also available.
- F.M. (BAND 2).** Loft "H". 28/-, 3 Element loft, 62/6. 5/2 loft, 12/6. External 5/2. 24/6. State channel when ordering. C.W.O. or C.O.D. P.P. 2/6. Coaxial cable, 8d. yd. Coaxial plugs, 1/3. Send 6d. stamps for illustrated lists.

K.V.A. ELECTRONICS (Dept.P.W.)
3B, Godstone Road, Kenley, Surrey.

Eddy's (NOTTM.) Ltd.

172 Alfreton Road, Nottingham

P.W. TRANSISTOR. Medium and Long Wave Pocket Superhet. 6 Matched Transistors and Diode. 150 m.w., push pull Output. Easy to follow. Printed circuit with all components marked. High 9in. internal ferrite aerial. Quality 2 $\frac{1}{2}$ in. speaker size 5 $\frac{1}{2}$ x 3 x 1 $\frac{1}{2}$ in. No technical knowledge required. No extras to buy. Total cost of all items £9.15.0. P. & P. 2/6.

POCKET RADIO. 2 Transistor with miniature speaker. Complete with all parts, wiring diagram and full instructions 27/6. Batteries 1/-, P & P. 2/6.

NIFE ACCUMULATORS. 1.25 v. Size 3 x 2 $\frac{1}{2}$ x 1 $\frac{1}{2}$ in. 7 amp. hrs. weight 13ozs. 1/11 ea. P. & P. 1/6 one only add 9d. per cell.

THROAT MIKES. Super Quality 2/- ea. Post 9d. could be used for electrifying musical instruments etc.

HANDMIKES. Carbon 3/11. Post 1/9.

VIBRATORS. 12 v. 4 pin 4/11. Post 1/-.

CRYSTAL SETS. Complete 2 wave bands. High gain. Good quality. 19/11 also with transistor amplifier extra 9/11. P. & P. 2/6.

HEADPHONES. High resistance to suit above crystal sets. Good quality 13/11 Pair. P. & P. 1/6.

All above are new and guaranteed

New or Surplus valves guaranteed and tested by return of post.

CIC	7/6	MU14	7/-	6C4	3/6
DAF91	4/9	PCC84	7/3	6CH6	9/-
DAF96	6/11	PCF80	7/3	6F6M	7/-
DF91	3/11	PCF82	7/6	6F13	11/6
DF96	6/11	PCL82	7/6	6F33	6/9
DL96	6/11	PCL83	12/6	6JSJ	2/9
EAF42	8/6	PCL84	12/6	6J5GT	3/9
EB41	6/11	PEN44	12/6	6J5M	4/3
EB91	3/6	PEN46	7/6	6J7C	5/-
EBF80	8/-	PEN36C	8/-	6K7G	1/11
EBC41	7/6	PL81	9/-	6K7GT	6/-
EB34	1/3	PL82	7/-	6K7M	7/6
EBC33	5/11	PL83	7/-	6K8G	5/3
ECC35	5/11	PL84	10/11	6P28	9/6
ECC81	5/3	PY31	7/6	6Q7G	5/9
ECC82	5/11	PY80	7/-	6SA7M	5/9
ECC83	6/6	PY81	6/6	6SG7M	4/9
ECC84	8/3	PY82	6/9	6SL7GT	6/6
ECC85	7/11	R19	18/6	6SN7GT	4/3
EFC80	9/-	TDD4	7/6	6U4GT	10/6
ECH82	9/-	TY86F	11/6	6V6G	4/9
ECH42	7/9	U25	12/6	6V6GT	6/-
ECL80	7/-	UAF42	8/9	6V6M	8/6
ECL82	10/-	UBC41	7/3	6X4	5/9
EF36	3/-	UCH42	7/6	6X5	4/11
EF41	7/6	UL84	7/6	10F1	6/11
EF42	7/6	UL41	7/3	12A6	5/3
EF50	1/9	UY41	6/3	12AT6	7/6
EF80	5/-	UY85	6/3	12AT7	5/3
EF85	5/11	VP23	6/6	12AU7	5/11
EF86	9/6	ID5	7/6	12K7	5/3
EF89	7/-	IL4	3/6	12Q7	5/3
EF91	7/6	IR5	5/6	20D1	9/6
EF92	4/6	IS5	4/6	25L7GT	7/6
EL41	7/3	IT4	3/11	25Z4G	7/6
EL84	6/6	3Q4	7/-	35L6GT	8/11
EL91	4/6	354	5/11	35W4	6/9
EY51	7/11	3V4	6/9	35Z4	5/3
EY86	7/9	5U4G	4/9	954	1/6
EZ40	6/3	5Y3G	5/9	955	2/6
EZ41	7/-	5Z4G	7/6	956	3/6
EZ80	6/-	6A7	10/-	80	7/-
EZ81	6/9	6AQ5	6/-	9001	3/11
GTIC	6/11	6AT6	7/-	9004	3/11
KT3C	6/6	688G	2/11	9005	3/11

Any parcel insured against damage in transit for only 6d. extra per order. All uninsured parcels at customers risk. Post and Packing 6d. per valve, extra. C.W.O. or C.O.D. only. C.O.D. charge 3/- extra. S.A.E. with enquiries.

H.A.C. SHORT-WAVE EQUIPMENT AND SHORT-WAVE KITS

Famous for over 25 years for S.W. Receivers and Kits of Quality.

H.A.C. were the original suppliers of SHORT-WAVE RECEIVER KITS for the amateur constructor. Over 10,000 satisfied customers—including Technical Colleges, Hospitals, Public Schools, Hams, etc.

Improved designs with Denco coils: One-valve Kit, Model "C". Price 25/-, Two-valve Kit, Model "E". Price 50/-, New Addition: Model "K". Super sensitive "All Dry" Receiver. Special incl. price. Complete Kit, 77/-.

All kits complete with all components, accessories and full instructions. Before ordering call and inspect a demonstration receiver, or send for descriptive catalogue and order form.

POST THIS COUPON NOW!

"H.A.C." SHORT-WAVE PRODUCTS
(Dept. TH), 44 Old Bond Street, London W.1

Please send me FREE and without obligation your 1961 literature.

NAME.....

ADDRESS.....

Matched Sets of Transistors

● SPECIAL OFFERS—FULLY GUARANTEED

6 Mullard Transistors and Diode

1—OC44 ONLY
2—OC45 **60/-**
1—OC71
2—OC72 PER SET
and
1—OA81
or with 2—OA81, 62/6

6 Ediswan Transistors and Two Diodes

1—XA102
2—XA101 ONLY
1—XB103 **57/6**
2—XC101 and
2—Diodes PER SET

6 Mullard Transistors and Diode — 1 watt output

1—OC44 ONLY
2—OC45 **62/6**
1—OC81D
2—OC81 PER SET
and
1—OA81
or with 2—OA81, 65/-

4 Mullard Transistors for 1 watt amplifier

1—OC71
1—OC81D ONLY
2—OC81 **49/6**
with Cooling Clips PER SET

All the above Transistors are 1st Grade and selected for Performance



Crystal Microphones

ACOS 39-1 Stick Microphone with screened cable and Stand (List 5 gns.), 39/6. P.P. 1/6.

ACOS 40 Desk Microphone with screened cable and built-in Stand (List 50/-), 17/6. P.P. 1/6.

ACOS 45 (Illustrated) Hand Microphone with screened lead, very sensitive, 29/6. P.P. 1/6.

MC 24 Stick Microphone with muting switch. Screened cable, etc. 42/6. P.P. 1/6.

Illustrated leaflet on request.

STOP PRESS!

SPECIAL OFFER

P.W. superhet, all items as listed on back page now

£8 - 19 - 6



ALL TRANSISTOR TIME SAVER OFFICE OR HOME TELEPHONE PICK-UP AMPLIFIER

★ No more "Holding On", wasting time waiting for your call to come through. When it does the amplifier can be switched off if required. No connections, just Sellotape the pick-up coil to back of phone as above.

● 5-inch speaker; 3 months battery life; 400mW output.

Now with the New "Hi-Sens" Amplifier.

BUILT, TESTED,
I READY TO USE
£5.10.0 P.P. 2/6

MULTI RANGE TEST METERS

Model A-10 (500 Micro-amp. movement) D.C. (2K per volt) 0/10/50/250/500/1,000V A.C. (2k per volt) 0/10/50/250/500/1,000 D.C. current 0/0.5/25/250mA. Resistance: 0/10K/1 Meg. Size 5½ x 3½ x 1½ in. Weight 17 oz. inclusive of test prods., instruction book and batteries. **£4.17.6.** P.P. 1/6

Model B-20 (100 Micro-amp. movement) D.C. (10,000 ohms per volt) p/0.5/2.5 volts D.C. (4,000 ohms per volt) 0/10/50/250/500/1,000V A.C. (4,000 ohms per volt) 0/10/50/250/1,000V D.C. Current, 0/0.1/2.5/25/250mA. Size 5½ x 3½ x 2½ in. Weight 24 oz. inclusive of test prods, instruction book and batteries. ... **£6.10.0.** P.P. 1/6.



● FULLY GUARANTEED — EASY TO USE ●

SUNDRIES

★ 9.065 Mc/s 3rd Over-tone Crystal for all 27 Mc/s Model Control Transmitters. 12/6.

★ 7 section chromed Telescopic Aerials, 42in., 12/6; 64in., 17/6.

★ Transistor Ultra-submin components in stock; I.F.s, Gangs, Speakers, Aerials and Transformers — and we mean Ultra-submin.

★ 1000 ohm Personal Phone with Leads and Jack Plug and Socket, 17/6.

★ ACOS Crystal Mic Inserts. 2in., 12/6; 1½in., 7/6; ½ x 1½in., 7/6.

● Send for new illustrated list.

ALL COMPONENTS IN STOCK for "WEYRAD" 6-Transistor Superhet. Booklet 1/3 post free. Leaflet on request.

Seven Transistor Superhet MEDIUM, LONG AND SHORT WAVE

(Units can be used for other circuits) UNIT 1

Press Button Osc/Mixer stage. OC170 Transistor. S.W. 5.9 to 19 Mc/s; MW 510 to 1620 kc/s; LW 150 to 275 kc/s. Printed circuit. Size 3.4 x 2.1 x 1.8in. Output 465 kc/s I.F. PRE-ALIGNED AND TESTED. 90/3. P.P. 1/-.

UNIT 2

465 kc/s I.F. Amplifier, 2-OC169 Transistors. Double tuned I.F.T.'s. Diode Detector, A.V.C., etc. Printed circuit. Size 3½ x 1½ x 1in. Ready to use. PRE-ALIGNED AND TESTED. 92/6. P.P. 1/-.

UNIT 3

4 Transistors, 1 watt Audio Amplifier 60-1600 c/s ±3dB. 5mV input for 1 watt. 2-OC71, 2-OC74 Transistors. Printed circuit. Size 3 x 2.2 x 1.2 in. Ready to use. 92/6. P.P. 1/-.

SUNDRIES (FOR ABOVE UNITS)
8 x ¼in. M.L.S. Ferrite Aerial and Coils. 12/6.
176pF ... 176pF Tuner, 9/6. 2-15 pF Trimmers, 1/- each. 7 x 4in. 3 ohm Speaker, 20/-.
Fully Illustrated Booklet 2/6

6-TRANSISTOR RADIO

Size 3 x 2½ x ¼in.

★ THE WORLD'S SMALLEST RADIO with Speaker

FITS INTO VEST POCKET or PURSE

Complete with Batteries
Leather Case, Earphone, or
Presentation Box.

- All your favourite stations; including Luxembourg.
 - Superhet Circuit with Push-Pull output on 2in. speaker.
 - 540 to 1600 kc/s coverage.
- BUILT & READY TO USE**



CASH OR C.O.D.
12 gns Reg. Post Free



TRANSISTORS From 3'6 each

SEND FOR NEW FREE LIST WITH DATA AND USES

FULLY GUARANTEED

We can supply a Transistor for every need!



PRACTICAL TRANSISTOR CIRCUITS 3/6 post free

Contains easy to follow plans of 40 all transistor units, including light operated switches, amplifiers, transmitters, receivers, test oscillators, signal tracers, hearing aids, radio control, etc. All parts available separately.

★ Designed for the Home Constructor

RANGER-2

PERSONAL POCKET RADIO

★ Two High Gain Transistor Version of "Ranger-3"—See back page. Similar in appearance and performance.

ALL PARTS **59/6** P.P. 1/6. Everything supplied.

● Pictorial plans and description **FREE ON REQUEST**

LET US HAVE YOUR ENQUIRIES FOR COMPONENTS

Henry's Radio Ltd

5 HARROW ROAD · LONDON W.2

Opposite Edgware Road Tube Station
OPEN MON. to SAT. 9-6. THURS. 1 o'clock
Telephone PADdington 1008/9

SEE BACK PAGE

Free Lists by Return.
Valves, Quartz, Crystals,
Transistors and
Components.

Practical Wireless

—BLUEPRINT—

—SERVICE—

ALL OF these blueprints are drawn full-size and although the issues containing descriptions of these sets are now out of print, an asterisk in the list below denotes that constructional details are available free with the blueprint.

The index letters which precede the Blueprint Number indicate the periodical in which the description appeared. Thus PW refers to PRACTICAL WIRELESS; AW to *Amateur Wireless* and WM to *Wireless Magazine*.

Send (preferably) a postal order to cover the cost of the Blueprint (stamps over 6d. unacceptable) to

PRACTICAL WIRELESS, Blueprint Dept., George Newnes, Ltd., Tower House, Southampton Street, London, W.C.2.

SPECIAL NOTE

THE following blueprints include some pre-war designs and are kept in circulation for those constructors who wish to make use of old components which they may have in their spares box. The majority of the components for these receivers are no longer stocked by retailers.

Title	Number	Price
CRYSTAL SETS		
Junior Crystal Set	PW94*	2/-
Dual-wave Crystal Diode	PW95*	2/6

STRAIGHT SETS		
Battery Operated		
Modern One-valver	PW96*	2/6
All-dry Three	PW97*	3/6
Modern Two-valver	PW98*	3/6

SUPERHETS		
Mains Operated		
A.C. Band-pass Three	PW99*	4/-
A.C. Coronet-4	PW100*	4/-
A.C./D.C. Coronet	PW101*	4/-

MISCELLANEOUS		
The PW 3-speed Autogram*		8/-
The PW Monophonic Electronic Organ		8/-

TELEVISION		
The PT band III converter*		1/6

Title	Number	Price
A.C. Fury Four	PW20*	2/6
Experimenter's Short Wave	PW30a*	2/6
Midget Short Wave Two	PW38a*	2/6
Band-Spread Three (Battery)	PW68*	2/6
Crystal Receiver	PW71*	2/-
Signet Two (Battery)	PW76*	2/6
Simple S.W. One-valver	PW88*	2/6
Pyramid One-valver	PW93*	2/6
<hr/>		
BBC Special One-valver	AW387*	2/6
Short-Wave Two	AW429*	2/6
Short-Wave World Beater	AW436*	3/6

Standard Four Valve S.W.	WM383*	3/6
Enthusiast's Power Amplifier	WM387*	3/6
Standard Four Valve	WM391*	3/6
Listener's 5-Watt Amplifier	WM392*	3/6

QUERY COUPON

This coupon is available until 5th May, 1961, and must accompany all queries in accordance with the notice on our "Letters to the Editor" page.
PRACTICAL WIRELESS, APRIL, 1961.



★ RANGER 3 ★

NO EXTERNAL AERIAL OR EARTH
3-TRANSISTOR AND 2-DIODES
PERSONAL POCKET RADIO with 5 stages giving clear reception on medium wave, amateur top band and shipping. Only first grade components used throughout.

Size 4½ x 3 x 1½ in.

ALL COMPONENTS

79/6 P.P. 1/6

NO EXTRAS TO BUY
Everything Supplied.

- Easy to follow instructions with pictorial layout.
- Reception of Radio Luxembourg guaranteed (most areas).

Free Instructions and Price List on request. Easy to build.

● AFTER SALES SERVICE, GUARANTEED SUCCESS ●

27 Mcs. MODEL CONTROL RECEIVERS

● "SUPERTONE I-C"

New design 3-transistor transformer coupled receiver for 27 Mc/s model control. Uses OC169/OC71/OC72 transistors. Overall size 2½ x 2 x 1½ in. Range about ½ mile. Easy to build.

- OUTPUT to MIN. RELAY

4-VOLT OPERATED

"SUPERTONE 3-C". (3-CHANNEL VERSION AVAILABLE, 69/6 P.P. 1/6.)

★ GUARANTEED RESULTS—DIAGRAM FREE ★



Total Cost of Parts

69/6 P.P. 1/6

RELAY 24/-

New, with new circuit design.

★ BABY SITTER ★

ALL TRANSISTOR BABY OR INVALID ALARM

Battery operated, push-pull, 250mW output. Low impedance microphone enables unit to be used up to 200 yards. Output on 5in. speaker.

- GUARANTEED for 6 MONTHS and 100% SALE.

- Microphone is placed within 6 ft. of Baby; twin flex is taken to amplifier unit and placed in any room required.

COMPLETELY BUILT AND TESTED

£5.10.0 P.P. 2/6.

- Used All Night, Every Night, Battery Life 3 to 4 months

750mW TRANSISTOR AMPLIFIER

OVER 1 WATT PEAK OUTPUT

- Uses OC71, OC81D and 2-OC81 matched transistors on Printed Circuit. Size 4 x 2½ ins. 3 ohms output. Very sensitive.

★ BUILT AND TESTED

79/6

P.P. 1/-

Ideal for Record Player, Intercomm, T.R.F. or Superhet Tuners, etc.

Supplied with diagrams showing uses.

REPANCO MINI-4



- 4-Mullard Transistor 5-stage medium and long-wave superhet.

- 2½-inch SPEAKER.

- Easy to build and use.

- Moulded Case Size: 5½ x 3½ x 1½ ins.

ALL PARTS **£6.19.6** P.P. 1/6

- NEW EASY DIAGRAMS, 1/6 plus post. PARTS LIST FREE ON REQUEST

★ TRANSISTOR FM ★

Pre-built Tuner Units Fully Tunable
DETAILS ON REQUEST

★ 'PW' ROADFARER ★

(as described in April edition of Practical Wireless)

A.M. and F.M.



7-transistor mains/battery portable in attractive moulded case. Slow motion tuning; telescopic aerial; 7 x 4in. speaker; Ferrite aerial, etc.

- Full tuning medium wave and VHF F.M. for clear reception of all programmes anywhere in the country.

- 500mW push-pull output with Mains or Battery supply built in.
- PRINTED CIRCUIT—SEVEN TRANSISTORS.

- FULLY ILLUSTRATED BUILDING INSTRUCTIONS

All Parts as Specified

18 GNS. P.P. 3/6

All components sold separately. List on request.

★ 'PW' 6-TRANSISTOR ★

MEDIUM AND LONG WAVE SUPERHET

(as described November P.W.)

- A sensitive superhet with 150mW push-pull output on 2½ in. speaker. Uses 6 first grade Mullard transistors and printed circuit. Moulded cabinet.

- All parts sold separately. Send for list. Illustrated Building Plans, 1/6 plus post.



Size 5½ x 3 x 1½ in.

ALL PARTS REQUIRED **£9.19.6**

★ NO EXTRAS TO BUY—EVERYTHING SUPPLIED ★

3-TRANSISTOR and DIODE PERSONAL POCKET RADIO ★ SUPER 3 ★

A simple to build local station radio with personal earphone output. Built-in Ferrite Aerial and Battery lasting 9 months.

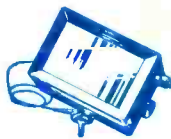

ALL PARTS

37/6 P.P. 1/6

- NO EXTRAS TO BUY
Size 4½ x 3 x 1½ in.

★ IDEAL FOR BEGINNERS

● CONTESSA ●

6 TRANSISTOR MEDIUM AND LONG WAVE SUPERHET
TERRIFIC SENSITIVITY

UNBEATABLE IN PERFORMANCE AND APPEARANCE

SPECIFICATION

- 425mW Push-Pull Output
- 6 "Top-Grade" Ediswan Transistors
- New Type Printed Circuit with all Components marked
- Full Medium & Long Wave Tuning
- High "Q" Internal Ferrite Aerial
- Car Radio Adaption and AVC
- Slow Motion Fingertip Tuning with Station Names
- "Hi-Fi" Quality Speaker
- Attractive Rexine Covered Cabinet

TOTAL COST OF ALL PARTS

£11.10.0 P.P. 3/6

- NO EXTRAS TO BUY ●

COMBINED PORTABLE AND CAR RADIO



Call for demonstration. No technical knowledge necessary. All parts sold separately. New Descriptive Leaflet and Prices on request.

PLEASE



TURN
PAGE

Henry's Radio Ltd 5 HARROW RD. LONDON W2

Opposite Edgware Road Tube Station. PADDINGTON 1008/9. Open Monday to Sat. 9-6, Thurs. 1 o'clock

★ COMPLETE COMPONENT LISTS FREE ON REQUEST ★

NOT ALL OUR UNITS ARE ADVERTISED ABOVE, SEND FOR DETAILS OF OUR RANGE