

# PRACTICAL 16 WIRELESS

MARCH  
1961

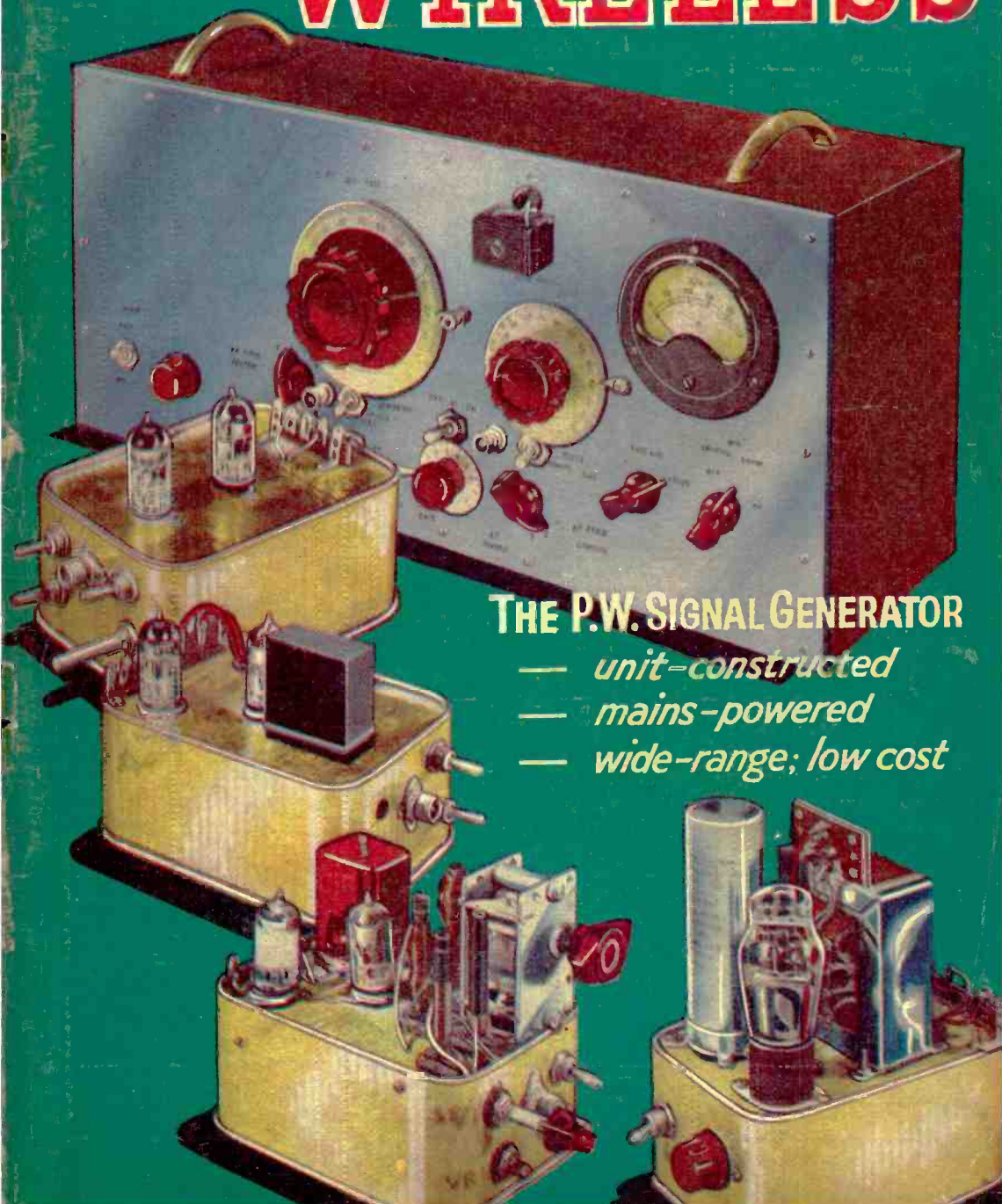

## THE P.W. SIGNAL GENERATOR

- *unit-constructed*
- *mains-powered*
- *wide-range; low cost*



# PORTABLE RADIOPHONES MODEL MK II

Brand New British Army Portable Transmitter Receivers.

Designed for reliable voice intercommunication operating up to 10 miles depending upon obstructions and elevation. The combined Transmitter Receiver covers the whole frequency range between 7.4-9 Mc/s. and is fully tunable on both Transmitter and Receiver. Simple and a delight to operate as all controls are mounted on the front panel of the set and clearly marked. Operates from standard dry batteries 3 v. L.T. and 120 v. H.T. Incorporates 5 valves: R.F. Amplifier, I.F. Amplifier, Second Detector, Output and Power Amplifier. All sets are supplied complete with all accessories comprising dynamic sound powered headphones, electro magnet supersensitive microphone, 4ft. aerial, junction box, battery connection details and full circuit diagram.

**PRICES:**

80/- EACH (P. & P. 4/-).  
**TWO FOR £8.0.0 (Post Free).**  
 Batteries 20/- per set.

**HI-FI HEADPHONES**



These miniature HI-FI phones use high quality permanent magnetic speakers with regulated voice coil. The soft rubber ear moulds give correct spacing for optimum acoustic load. Each unit has a built-in miniature HI-FI transformer to ensure the finest music and voice reproduction. Supplied free is a small transformer unit which steps impedance up to 4000 ohms. Only 15/- P. & P. 2/6.

**COMMAND TRANSMITTERS**  
 Complete with all valves, crystal etc. 3-4 Mc/s. 45/-, 4-5.3 Mc/s. 45/-, 5.3-7 Mc/s. 45/-, P. & P. 3/6 each.

**COMMAND RECEIVERS**  
 6-9.1 Mc/s. 60/-, P. & P. 3/6 ea.

**CRYSTAL MIKE INSERTS**  
 1 1/2 in. dia. 70-800 c/s response. Brand new ONLY 6/6. P. & P. 6d. 2 for 12/-.

**PORTABLE TRANS. RECEIVER No. 18.** A self-contained Trans/Receiver for Telephone and C.W. Range approx. 10 miles. Freq. 6-9 Mc/s. (50-33.3 metres). Valve line-up: 3 ARP-12, 2 AR-8, 1 ATP4. Complete with aerial, H.T. and L.T. meter and all accessories. Weight 20 lbs. Size 8 x 10 x 17in. Only 80/-, Carr. 10/-.

**AERIAL VARIOMETERS**



These magnificent instruments will enable you to receive maximum signal strength on all S.W. receivers. Precision calibrated control. 12/6. P. & P. 2/6.

**MICROPHONES, BRAND NEW.**



Throat, Dynamic 4/6; Throat carbon 3/6; No. 8 carbon with switch 6/6; No. 7 moving coil 7/6. Tannoy power mikes only 5/-. Crystal mike 22/6.



**NEW! TRANSISTOR RADIO**  
 With Miniature Speaker. Simple instructions enable anyone to build this miniature radio. Gives reception over the entire broadcast band. Each kit is supplied with all latest miniature parts including: ★ two transistors ★ ferrite rod ★ speaker ★ coloured plastic case ★ step by step illustrated instructions. Size 4 x 3 x 1 1/2 in. ONLY 27/6 P. & P. 1/6. Battery 1/- ex.

**VHF RECEIVER 1392**

15 valve superhet covering 95-150 Mc/s which includes police, aircraft and amateur bands. Complete with slow motion tuning, tuning meter, circuit diagram, etc. Here is your opportunity to explore the VHF bands on a really sensitive receiver offered at a fraction of original cost. ONLY £6.5.0 Carr. 15/-.

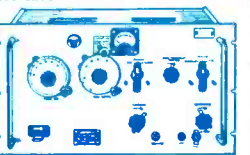

**OSCILLOSCOPE MODEL 74**

This basic scope represents one of the finest buy's we have ever made! Contains Brilliance, Focus, Gain and 2 speed time base controls. Separate X plate terminals. Signal Generator modulated at 2 frequencies over 150-255 Mc/s. Complete with 12 valves, VCR 139A tube, Internal A.C. power pack, and complete circuit and technical details. ONLY 97/6 Carr. 12/6



**MINIATURE EARPHONE**

A really sensitive dynamic earPhone of exceptionally fine quality. Provides clear reproduction of music as well as speech. Fully Guaranteed and complete with transparent ear insert, 3 feet cord, sub-miniature plug and socket. CR-5 High Imp. .. 8/- Each MR-4 Low Imp. .. Post 1/-



**SIGNAL GENERATOR**

Model SWO-300 150 kc/s-300 Mc/s; Frequency Range: 150 kc/s-150 Mc/s on fundamentals (6 bands). 150 Mc/s-300 Mc/s or harmonics. Calibration Accuracy within ± 1 per cent. Modulation: Internal and external. Attenuation: 10 to 40db. Output: Facilities for high and low. Power Supply: Internal 230 v. A.C. Size: 7 x 10 x 5 in. Complete with test leads and instruction manual. ONLY £14.19.6. Carriage 5/6.



Fully Guaranteed.

**T.C.S. RECEIVER.**

15 to 12 Mc/s 7-valve superhet, built like a dream. Panel controls: R.F. Gain, A.F. Gain, C.W. Pitch, band-switch, mod.-C.W. switch, power switch, ground and aerial posts, M.G. or crystal frequency switch, speaker jack, card holder to log 30 stations, hand vernier tuning knob turning a large etched calibrated plate behind hair lined window, anti-backlash gears used. 90% complete, store soiled, offered at ONLY £5.10.0. Carr. 10/-.



**MINIATURE MODEL MOTOR**

A really high-speed precision motor with 10 uses: Model control, fan, saw, buffer, etc. Operates from standard battery (3-6 volts). Complete with full instructions at only 5/- each. Post 1/-, 2 for 10/-, post free.

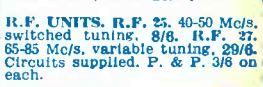

**R.F. UNITS, R.F. 25, 40-50 Mc/s. switched tuning, 8/6. R.F. 37, 65-85 Mc/s. variable tuning, 29/6. Circuits supplied. P. & P. 3/6 on each.**

**POCKET VOLT TEST METER**  
 Two D.C. ranges: 0-250 v. and 0-25 v. Complete with test prods. and leather case. Very limited quantity. Only 12/6. P. & P. 1/6.

**R.C.A. COMMUNICATION RECEIVER AIR-88 I.F. Range:** 73-550 kc/s and 1.48-30.5 Mc/s. Undoubtedly the finest communication receiver ever produced for service and laboratory use. Now Relda's exclusive purchase enables you to obtain this Rolls-Royce of communication receivers at the lowest price ever offered. Fully guaranteed. ONLY £37.10.0. Carr. 50/-.

**ACCUMULATORS.** 2 volts 16 A.H. (unspillable). Ideal for 6 and 12 volts supply, etc. Brand new. Original cartons. Size 4 1/2 x 7 1/2 x 2 1/2. 5/6 each. P. & P. 1/6, 3 for 15/-, P. & P. 3/6, 6 for 27/6. P. & P. 5/-.

**WIRELESS SET No. 19 MK. II**  
 Incorporates TX/RX covering 2-4 Mc/s (37.5-150 metres), and intercom. amplifier. Complete with 15 valves, 600 microamp check and tuning meter, circuit and instruction book. ONLY 65/- Carr. 10/-.

## Exciting New Product Exclusive to RELDA TELEPHONE PICK-UP COILS

MODEL FC-8 Induction Pick-up coil enabling conversations to be picked up without tapping of wires or special telephone circuits. No electrical connections! Simply place telephone on the pick-up platform and connect lead to the input of any medium gain amplifier or direct to any tape, disc, or wire recorder. The coil is electrostatically shielded to minimise hum pick-up. Brand new complete with 5ft. shielded cable. FC-8 only. 16/- plus 1/6 p. & d.



MAIL ORDERS TO  
 (DEPT. P.), 32a COPTIC STREET,  
 LONDON, W.C.1



CALLERS WELCOME AT  
 87 TOTTENHAM COURT ROAD,  
 LONDON, W.1 MUS 9606

Tel: Mitcham 6201

Open Daily to Callers



All Valves Brand New and Fully Guaranteed

211 STREATHAM ROAD, MITCHAM, SURREY

Special 24 Hour Express Mail Order Service

Table of vacuum tube specifications and prices, organized in columns. Includes part numbers like 6CH6, 12A7, 6AK5, etc., and their corresponding prices.

METAL RECTIFIERS

Table of metal rectifier specifications and prices, including models like 1B8A, 16RC, 14RA and their prices.

SPECIAL OFFER

IT4 4/-, 6K8 8/-, 6K7G 3/-, 6V6G 5/-, EBC33 4/-, EF39 4/-, EF80 6/-, EF91 4/9, 6X5G 5/-, 5U4G 4/6.

TERMS OF BUSINESS C.W.O. or C.O.D. 2/9 PACKING CHARGE ON ALL C.O.D. ORDERS. POSTAGE 3d. PER VALVE

OBSOLETE VALVES A SPECIALITY. QUOTATIONS GIVEN ON ANY TYPE NOT LISTED.

DEPT.  
P.W.I.

# HARVERSON SURPLUS CO. LTD.

## MONAURAL AMPLIFIER



This amplifier as illustrated, made by a leading manufacturer. Mullard valves—ECC83, EL84 x EL84, EZ80. Bass Treble and Volume on remote panel. Elegant Knobs. OUR PRICE one month only £4.16.6 plus P. & P. 3/6.

## STEREOPHONIC AMPLIFIER £5.10.0

Complete with 2 Loudspeakers Plus 4/6 P. & P.

This is a compact amplifier embodying the latest features and giving a high standard of reproduction, with ample volume. Supplied complete with valves (ECL82, ECL82, EZ80), panel, knobs, etc., and two specially selected 3Ω matched loudspeakers. We only have a few, and we will never be able to repeat this offer at such a low price. Don't risk disappointment. Order now.



### HARVERSON SUPERHET 4 KIT

A medium and long wave superhet, incorporating two I.F. stages modern B9

valves (UCH81, UBF89, UCL83, U785), built-in ferrite rod aerial. All you need supplied from theoretical wiring diagram to last nut and bolt (main components ready mounted), including an attractive contemporary styled cream plastic cabinet with gold trimmings. Size 11½ x 6½ x 6½in.

PRICE £6.12.6 Post 3/6

### RECTIFIERS FOR BATTERY CHARGERS

- 12 v. 1 amp. ... 5/-
  - 12 v. 2 amp. ... 8/-
  - 12 v. 3 amp. ... 10/-
  - 12 v. 4 amp. ... 14/-
  - 12 v. 5 amp. ... 16/-
- P. & P. 6d.

### TRANSISTOR BARGAINS ALL MULLARD FIRST GRADE

- OC71 ..... 8/-
  - OC72 ..... 12/-
  - OC72 Matched Pair..... 25/-
  - OC45 Green Spot ..... 15/-
  - OC45 Blue Spot ..... 15/-
  - OC44 ..... 15/6
  - SB305 Semi Conductor 10/6
  - OA41 Diode ..... 3/6
- Postage on all above 6d.

### SPECIAL OFFER

DON'T MISS THIS  
MULLARD O.C.76... 10/6  
MATCHED PAIR £10.0  
Post and packing 6d.

### TRANSISTOR RECORD PLAYER CASE

A few only—Transistor record player cases in light grey cloth—complete with motor board. Size: 12 x 8 x 6in. 18/6 each. P. & P. 1/9.

### COSSOR C.R.T. SNIP

- 108K 10-inch. New and boxed, 15/-, plus 6/- P. & P.
- 75K 10-inch. New and boxed, 15/-, plus 6/- P. & P.

### ION TRAP MAGNETS

To suit the above, 2/9 each. P. & P. 3d.

### SPEAKER FRET

Super quality heavily woven fret, 54 inches wide. Usual price 50/- per yard. P. & P. 1/-  
OUR PRICE 12/6 per yard.

### SLOW MOTION TUNERS

500-500 Twin gang condensers with geared slow motion drive. 3/6 ea. 36/- per doz. P. & P. 6d.

### WIRE WOUND POTS

12 Wire wound Colvern Pots—all different values 10/6 P. & P. 9d.

### THIS MONTH'S BARGAIN! SUPERHET CHASSIS

Complete and ready for your cabinet, 4 valve superhet chassis, complete with valves, ferrite aerial, dial and knobs. Valve line-up—UCH81, UBF89, UCL83, UY85. Long and Medium wave coverage.

PRICE £4.19.6 P. & P. 3/6.

## GRAM & TAPE EQUIPMENT BARGAINS

### THE WORLD FAMOUS E.M.I. ANGEL TRANSCRIPTION P.U. (Model 17A)

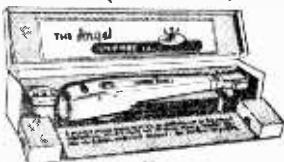

A Pick-up for the connoisseur originally priced at £17.10.0. The last remaining few offered at £4.10.0 Plus P. & P. 5/-.

### PICK-UP CARTRIDGE BARGAINS

- STUDIO P. ... 17/6
  - ACOS HIGH G. ... 17/6
  - E.U. POWER POINT ... 12/6
  - RONETTE ... 18/6
  - G.C.Z. ... 16/6
- P. & P. 1/-.

### RECORD CHANGERS

- | GARRARD                           |          |
|-----------------------------------|----------|
| RC 98 Mk. 4H. 4-speed autochanger | £16.10.0 |
| RC 120/D Mk.2                     | £9. 0. 0 |
| RC 120 Mk.4D                      | £9. 0. 0 |
| RC 120 Mk.4H                      | £9. 0. 0 |
| RC 121 Mk.1                       | £11.0. 6 |
| RC 121 Mk.4H                      | £11.0. 6 |
| RC 121/40 Mk.2                    | £11.0. 6 |

- | COLLARO                   |          |
|---------------------------|----------|
| RC 54 4-speed autochanger | £6.19. 6 |
| RC 594                    | £7.19. 6 |
| Conquest                  | £6.12. 6 |
| Challenger                | £7.19. 6 |

B.S.R.  
Monarch UAB 4-speed autochanger £6.19. 6  
TUB 4-speed single player less pick up £2.10. 0  
NOTE: Any of the above with Stereo Cartridge and Fittings, 16/- extra. Carriage and ins. on each of above 5/- extra.

### TAPE DECKS

- LATEST B.S.R. MONARDECK (single speed) 3½in. per sec., simple control, uses 5½in. spools ..... £7. 5. 0 plus 5/6 carriage and insurance (tapes extra).
- TRUVOX MARK III TAPE DECK. New and Boxed ..... £10. 6. 6 Plus 6/- carr. and ins. (tapes extra).

### CYLDON 12 CHANNEL TURRET TUNERS

New purchase offered at still lower price. I.F. 33-38 Mc/s. Complete with PCC84 and PCF80 valves and 8 sets of Coils for 5 Band I Channels and 8, 9, 10 Band III. New and unused. Value over £7.  
OUR PRICE, post paid 32/6

### MIDGET I.F. TRANS & COILS

A Pair of midget 465 kc/s I.F. transformers, plus LW and MW coils. OUR PRICE 10/- per set. P. & P. 1/9.  
Set of I.F. transformers for transistor superhet. 12/6. P. & P. 1/9.

### CONDENSER/RESISTOR PARCEL

50 mixed P.F. Condensers and 50 mixed Resistors. An assortment of useful values. All popular sizes—all new—a must for the serviceman and constructor. ONLY 10/- P. & P. 1/-.







**BUILD IT YOURSELF!**

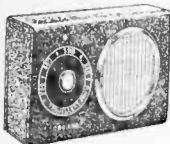

**THE FAMOUS COSSOR**

(Traveller's Friend) Transistorised

**£7.19.6** **POCKET RECEIVER**  
P. & P. 2/-

n leatherette case

This set can be built for £7.19.6. Size 6 x 3½ x 1½ in. Weight 17 oz. This set covers medium waveband 190/500 metres intermediate frequency. 470 kc/s using 4 transistors (Ediswan) and 2 diodes on a printed circuit board, plus a 2½ in. moving coil speaker. Instruction book with point to point wiring diagram, 2/6 each. Batteries, PP4 (Ever Ready) 2/- each.

**LABGEAR OUTPUT METER**

**£2.19.6** Complete Kit  
P. & P. 2/-



At last a Meter at the right price for the home constructor. An accurate Audio Power Output Meter. Two ranges 25mW to 1W and 1W to 10W. Accuracy 5% matched for 3, 15, 600 ohms with inst. and tech. data. New 3-in. 0-1mA meter.

NOT GOVERNMENT SURPLUS

**FERGUSON VHF/FM TUNER**

This F.M. adaptor is completely self-contained and can be fitted to any A.C. mains radiogram or radio with P.U. sockets. Valves 2-EF80's, ECF80. Input 200-250v. A.C. range 80-98 Mc/s.

Greatly Reduced

**£13**

P. & P. 2/-

LIST PRICE 18 gns.

**YOUR EXISTING RADIOGRAM OR RECORD PLAYER CHANGED TO STEREO BY OUR STEREO ADAPTOR**

Tech. Data 2 valves EF80 and EL84. Switch control for Stereo and Mono Dual volume and tone control. Output 3 ohms, suitable for use with Acos GC/71, GP/73 and Garrard GC/10. Complete with wiring diagram.

**£2.19.6**

P. & P. 2/6

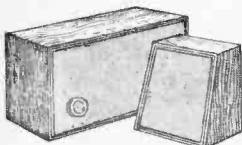

**INTERCOM UNIT**

This wonderful instrument can be used as a baby alarm or inter-speaker system for home or office. One control unit complete with one slave, attractive tygan grill and handsome natural finish wood cabinets. Extra slaves may be obtained.

**CARTRIDGES**

- Collaro Studio O .. 18/-
- Collaro Studio P .. 18/-
- B.S.R. .. 18/-

OUR PRICE

**£7.19.6**

P. & P. 3/6

**RECORD CHANGERS**

- B.S.R. UA8 comp. with latest "ful-fi" cartridge .. £6.19.6
- Stereo .. £7.19.6
- Collaro Conquest, 4-speed auto. .. £7.19.6
- Garrard RC 120, 4-speed auto. .. 9 gns.
- Collaro Junior, 4-speed Single Play Comp. with Arm and P.U. .. £3.15.0

P. & P. 3/6

**SPEAKERS**

- 3½ in. SPEAKER .. 17/6
- 5 in. SPEAKER .. 15/-
- 6½ in. SPEAKER .. 16/6
- 8 in. SPEAKER .. 17/6
- 6 x 4 in. SPEAKER .. 15/-
- 8 x 5 in. SPEAKER .. 19/6
- 10 x 6 in. SPEAKER .. 25/-
- 12 in. SPEAKER .. 32/6

P. & P. 2/6

**"SUPER-THREE"**

Transistor Pocket Radio



Printed circuit technique using 2 Surface Barrier type transistors, one A.F. Trans and one Diode. Ferrite aerial, fully tunable on LW and MW. Uses 2 U16 1½ volt batteries. And easily assembled by the beginner.

Kit of Parts Complete

**39/6**

P. & P. 1/6

**NEW POCKET MULTIMETER**

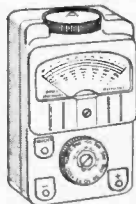

A must for all home constructors. Basic movement 300µA. Sensitivity 1,000/V. A.C. and D.C. Ranges 10-50-250-500-1,000V. D.C. and A.C. 1-100-500mA. D.C. 2K/200K ohms. Accuracy : 3% FSD and D.C. 5% FSD and A.C. 10% on. Resistance scale. Dimensions 5½ x 3½ x 2½ in. Complete with test leads, prods and 1.5V cell.

**79/6**

P. & P. 2/-

**MODERNISE YOUR GUITAR**

With Our New Guitar Pick

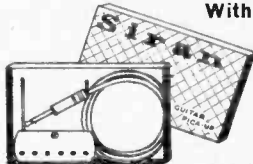

A truly precision made instrument complete with lead and jack plug ready to plug in to your existing amplifier. An unrepeatable bargain at **39/6** P. & P. 1/6.

**TAPE RECORDERS THE "VOGUE"**

Another fine recorder fantastically cheap. It also uses the famous Collaro Studio 3-speed tape deck. Separate inputs for microphone and gram. recording tone control for replay. Output 3 watts. Complete with microphone, reel of tape and spare spool.

**29 gns.**

21/- P. & P. & Ins.

**RECORDING TAPE OFFER**

FAMOUS MAKE P.V.C. BASE ON PLASTIC SPOOL  
1800ft on 7in. spool .. 32/6      1200ft on 7in. spool .. 21/-  
1200ft on 5½in. spool .. 22/6      850ft on 5½in. spool .. 16/6

**THE LATEST MINIATURE EARPHONE FOR TRANSISTOR RADIOS**

This lightweight superbly made instrument enables you to listen in to your radio wherever you are, ideal for all forms of travel, etc. Provides excellent reproduction and can be worn without any discomfort, complete with transparent earpiece, 3ft. of fine flex, plug and socket.



Crystal earpiece as illus. High Imp. 10/-      Usual price £1.1.0  
Magnetic .. .. Low Imp.      P. & P. 1/-

**SUB-MINIATURE TRANSISTOR PARTS**

We can now supply all sub-miniature parts for the home constructor—transformers, coils, condensers, resistors—from our large stock of component parts.

**SEND S.A.E. FOR FREE PRICE LIST OR PAY US A PERSONAL CALL**

**WIRECOMP ELECTRONICS**

378 HARROW ROAD, LONDON, W.9  
TEL : CUNNINGHAM 9530  
Hours of business: 9 a.m. to 6 p.m. Open all day Saturday. Opposite Paddington General Hospital, Buses 18B and 36 pass the door.

FOR VALVES AND SPARES FROM STOCK - RETURN POST



AZ1 10/-	ECF82 10/6	EL84 9/-	PCF82 11/6	UBF80 9/-	IS5 6/6	6C5GT 6/6	6V6G 6/-	12SK7 6/-
AZ31 10/-	ECH42 9/6	EL91 4/6	PCL82 11/6	UCB84 10/11	IT-1 5/6	6C6 5/-	6V6GT 7/9	12SL7 8/-
DAF96 8/-	ECH81 9/-	EM34 9/6	PCL83 13/6	UCB85 9/6	3D6 5/-	6D6 5/-	6X4 7/6	125M7GT
DF96 8/-	ECL80 9/6	EM80 9/6	PL36 14/6	UCH42 9/6	3Q4 7/6	6C6H 8/6	6X5G 7/6	10/-
DK96 8/-	ECL82 10/6	EM81 10/6	PL81 11/-	UCH81 9/6	3Q5GT 9/6	6F6G 7/-	6X5GT 7/-	15D2 7/9
DL96 8/-	EF41 9/6	EY51 9/6	PL82 8/6	UCL82 11/6	3S1 7/6	6F6M 7/6	6/30L2 12/6	25A6 9/-
DM70 7/6	EF50 4/-	EY86 10/-	PL83 9/6	UCL83 13/6	3V4 8/-	6F1 14/-	786 10/6	26L6GT 10/-
EAB80 9/-	EF50SYL 7/-	EZ40 7/6	PX25 12/6	UF85 9/-	4D1 3/-	6F15 14/-	787 8/6	25A6 9/9
EAF42 9/6	EF80 7/6	EZ41 7/6	PY80 7/6	UF89 9/-	5R4GY 8/6	6J5GT 5/-	7C5 8/-	25Z4 9/6
EB91 4/6	EF85 7/-	EZ80 7/6	PY81 8/6	UL41 9/-	5U4G 6/-	6J5M 6/6	7C6 8/-	25Z5 8/-
EBC33 6/9	EF86 12/6	EZ81 7/-	PY82 7/-	UL84 9/-	5V4 11/6	6J6 5/6	7H7 8/6	25Z6 10/-
EBC41 8/9	EF89 8/9	FV4/500	PY83 8/6	UJ6 10/-	5Y3G 8/-	6J7G 4/-	757 9/6	30FL1 10/6
EBF80 9/9	EF91 5/9	GZ32 10/-	PEN4VA	UY1 12/6	5Y3GT 7/6	6K7M 6/9	7Y4 8/6	30PL15 23/3
EBF89 9/6	EF91(BVA)	HL23DD 8/6	PEN25 6/-	UY41 7/6	5Z4G 9/-	6K7M 6/9	10F1 12/6	30P4 15/-
ECC81 8/-	N78 19/11	HL42DD	PEN45 10/-	UY85 7/-	6A7 10/-	6K8G 6/6	10F13 23/3	30P12 12/6
ECC82 7/6	EF92 6/-	KT2 5/-	PEN46 7/-	VR105/30 8/-	6AK5 5/-	6K8GT 5/9	12A6 5/-	30PL1 12/6
ECC83 9/-	EK32 7/6	KT33C 8/6	PEN220A 4/-	VR150/307/6	6AL5 4/-	6L6G 8/-	12A7 7/6	35Z4GT 8/-
ECC84 10/-	EL32 4/6	KT61 13/6	PEN44 12/6	VU39 (MU)	6AM5 7/6	6L6M 9/6	12A7 7/6	35Z5GT 9/-
ECC85 9/6	EL33 14/-	KT61 13/6	TP25 10/-	Y63 7/6	6A16 4/-	6L8 11/6	12A7 7/6	35Z5GT 9/-
ECC80 12/-	EL41 9/-	KW40 12/6	U10 9/6	Y67 7/6	6AQ5 7/6	6N7GT 7/6	12BA6 9/-	50L6GT 8/6
		MX40 12/6	U25 13/6	IA7GT 12/6	6AT6 8/6	6Q7G 7/6	12BE6 9/-	50L6GT 8/6
		N78 19/11	U25 10/6	IC2 11/6	6BA6 7/6	6Q7GT 9/6	12C8 7/-	1076 8/6
		OZ4 5/6	U50 8/-	IC5GT 12/6	6BE6 7/6	6S7 6/-	12J7GT 10/6	142BT 3/6
		P61 3/6	UABC80 9/-	IHSGT 9/-	6BH6 9/-	65K7GT 8/6	12K7GT 6/6	21ODDT 4/6
		PCC84 8/6	UAF42 9/6	INS 10/6	6B16 9/-	65N7GT 7/6	12K8GT 13/6	210VPT 3/6
		PCC85 11/6	UBC41 8/6	IR5 7/6	6BW6 9/-	65Q7 9/3	12K8M 13/-	
		PCF80 8/9	UBC81 11/4	IS4 4/-	10/6	64 4/6	12Q7GT 6/6	

**Best Quality Recording Tape**  
 1,200ft. on 7in. spool, 21/-  
 850ft. on 5 1/2in. spool, 18/6  
 600ft. on 5in. spool, 13/9  
 200ft. on 3 1/2in. spool, 5/3

**COLLARO JUNIOR**  
 Single 4-speed Record Player Unit in cream, complete with pick-up fitted turnover cartridge. Special Price 75/- each. Post 3/6.

**CATALOGUE**  
 Our 1961 Catalogue is now available. Please send 1/- in stamps for your copy. Trade catalogue also available. Please attach your business letter heading.

Printed Circuit Version of the PW Pocket Superhet. All components available from stock. Complete Kit £9.15.0. Full detailed shopping list, point to point wiring diagram, fully illustrated, 1/6.

Coil Set (Osc. and 3 I.F.T.s)	22/6
Driver Transformer	11/6
Output Transformer	10/6
Ferrite Rod Aerial	10/-
Printed Circuits	9/-
00 Gang Condensers	11/-
Volume Control V.C. 1545	10/6
Switch	3/6
Hardware Kit	4/6
Transistors (set of 6 plus crystal diode GD9)	70/-
Speaker	19/10
Case	7/6
Complete Kit of Condensers	15/-
Complete Set of Resistances	6/6
Trimmers (2)	2/8

All above components are brand new and are fully guaranteed.

**METAL RECTIFIERS**  
 Alpha range of Guaranteed Bridge Rectifiers, suitable for Battery Chargers 6 and 8 volt output:  
 2 amp. .... 7/-  
 3 amp. .... 10/-  
 4 amp. .... 12/6  
 5 amp. .... 14/6

**Practical Wireless 6 Transistor Superhet Osmore Dualwave Ferrite Rod Aerial 10/- Transistor Oscillator Coil and I.F. Transformers 22/6. Repanco Transformer TT9 12/6. Repanco Transformer TT10 12/6. I.B. Condenser with Internal Screen and Tapped Spindle 9/6. 2 Bank 60pF Trimmer 1/10.**

**Ardenite volume control with switch 10/6. Ardenite wavechange switch, 3 position 3/9. Celestion 2 1/2in. 3 ohms speaker 26/8. Diode OA81 4/-. Send for our Detailed Price List**

**T.S.L. Subminiature Components**  
 Solid Dielectric Tuning Condenser Type PVC-2M Capacity Aerial 196pF OSC 87pF, size 1 x 1 x 1/2in. 17/6 each.  
 I.F. Transformers, set of 3 and Oscillator coil, size of each 1/2in. x 1/2in. x 1/2in. high, per set 21/-.  
 Driver Transformer type TR 190/EIP, ratio 2 : 1 + 1, size 8 x 1/2 x 1/2in. 6/3 each.  
 Output Transformer type TR 190/EIE, ratio 5.3 to 1, Primary Impedance 240 ohms. Secondary 10 ohms. Max Output 800 MW. size 1 x 1/2 x 1/2in. 6/3 each.  
 T.S.L.-Lorenz Loudspeakers, 2 1/2in. diameter speaker designed for miniature receivers, 4/500 mV, impedance 10 ohms, Freq. response 120-14,500 c/s., price 25/-

**Elstone Multi-Ratio Output Transformer, 10 watts, 23/-.**  
 Westinghouse LW9 Rectifier, 250V, 250mA, 19/6.  
 WB Stentorian HF 1012, 10 watts, 95/- ea.  
 BSR Monarch UAB, Record Changer, £6.19.6.  
 Scotch Recording Tape 150/18, 7in. spool, 50/-.

**"Wireless World" Radio Valve Data Book, 5/-.**  
 Taylor Model 127A Multi-Meter, £10.0.0.  
 High Resistance Headphones, 4000 ohms, 13/6.  
 Repanco FS3 Ferrite Slab Aerial, 7/6.  
 Multicore Savbit Solder, 5/-.

**Henley Solon Instrument Iron, Model 625 24/-.**  
 J.B. "O" Gang Condenser, 365pF, I gang, 7/6.  
 Belling Lee Diplexer, L138B, 11/-.

**Output Transformer, 5000/3 ohms, 60mA, 5/9. 10in. Elac Loudspeakers, 25/-.**  
 Collaro Conquest with Studio Pick-up, £6.19.6.  
 Acos Crystal Stick Mic. 39/1, £1.19.6.  
 Decamatic Amplifier with speaker, 85/-.

**Bib Recording Tape Splicer, 18/6.**  
 Mullard Circuit for Audio Amplifiers, 8/6.  
**TRF Kit Complete £5.10.0.**  
 Line Output Transformer for Pye V4, etc. 55/2.  
**Repanco DRR2 Dual Range Coil with reaction, 4/-.**  
 J.B. SL8 Spin Wheel Drive Assembly, 27/6.  
 J.B. Solid Dielectric Ion Traps, Type IT6, IT9, BCC1, 5/6 each.  
**TCC Visconal Cond. 0.001 20KV, 10/-.**  
 Potentiometer SP5 for English Electric T40, etc., 13/6.

**Eric 6 and 10 watt Wirewound Resistors, 2/- ea.**  
 Semi-airspaced Co-axial Cable, 4d. yd.  
 Signal Lamp Fittings, Red, Green & Amber, 2/3 each.  
 3-way line cord, 0.2A, 100 ohms per ft., 1/9 yd.  
**Dropper Resistors for Ultra Twin 50, 5/3 ea.**  
 TV Electrolytic 100-200 mfd., 275V., 7/6 each.

**Car Radio Aerial (telescopic), 39/6 each.**  
 Igranite type P50 Jack Plugs, 2/9 each.  
**Osmore Ferrite Rod, L & M wave, 12/9 each.**  
 Repanco TT9 Interstage Transformer, 12/6.  
 Miniature I.F. Transformers, 465Kc/s, 9/- p.

**Low Resistance Headphones, 120 ohms, 7/6 per.**  
 Plastic Speaker Cabinets for 5in. unit, white, 15/-.  
 Acos Mic 40, with folding stand, 19/6 each.  
**Pick-up Matching Trans., BSR AF333, 36/-.**  
 Collaro Mark IV Tape Transistor, £17.19.6.  
 Celestion 2 1/2in. square Loudspeaker, 26/8.  
 Rectifier RM4, 250V, 275mA, 18/6.

**Microphone Transformer 100:1 ratio, 12/-.**  
 Elac 8 x 5in. Loudspeaker 25/6.  
**Garrard TA Mk.11, Single Player, £8.10.0.**  
 TSL Crystal "Stick" Microphone MX3, 45/-.  
 Gelsco 9010 Telephone Adaptor, 45/-.

**TERMS:** Cash with order or C.O.D. Postage and Packing charges extra; as follows: Orders value 10/- add 1/-; 20/- add 1/6; 40/- add 2/-; £5 add 3/- unless otherwise stated. Minimum C.O.D. free and postage 3/-. For full terms of business see inside cover of our catalogue. Personal Shoppers 9 a.m. to 5 p.m. Mon. to Friday; Saturday 10 a.m. to 1 p.m.



103 LEEDS TERRACE  
 WINTON STREET  
 LEEDS 7



# CHECK with these

# BARGAINS

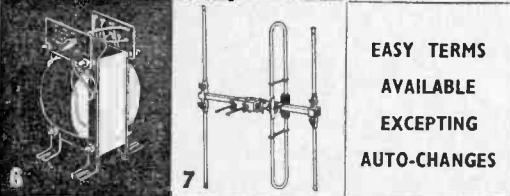
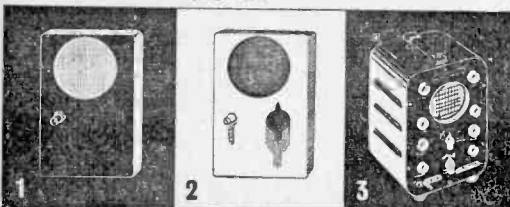

**ORDERS BY POST WILL RECEIVE OUR PROMPT ATTENTION**

**EASY TERMS AVAILABLE EXCEPTING AUTO-CHANGES**

- 3-TRANSISTOR POCKET RADIO** with MINIATURE SPEAKER, FERRITE ROD. PRINTED CIRCUIT and GERMANIUM DIODE. The only 3 transistor radio available at the price. Build it in 1 evening! Tunable over M/L waves. Complete with easy-to-follow instructions and all components (less batteries obtainable anywhere 10d.). 22/6, P. & P. 1/6. (All parts available separately).
- 3-TRANSISTOR SUPER POCKET RADIO** with MINIATURE SPEAKER. Plus Germanium Diode and Printed Circuit. Size 3 1/4 x 4 x 1/4 in. Ferrite Rod Aerial. Two Surface Barrier Transistors and one Audio. Tunable over medium and long waves. To build yourself 39/6, P. & P. 1/6. Circuit diagram 1/6, free with kit. All parts of items 1 and 2 sold separately.
- DOUBLE BEAM "SCOPE"** for D.C. and A.C. APPLICATIONS. A very high gain, extremely stable differential V-amplifier (30 mV/C.M.). Provide ample sensitivity with A.C. or D.C. inputs. Especially suitable for measurements of transistor operating conditions where maintenance of D.C. levels is of paramount importance. Push-pull X amplifier; Fly-back suppression; Internal Time-base Scan Waveform available for external use; pulse output available for checking TV line O/P Transformers, etc. Provision for external-1/P and CRT Brightness Modulation. A.C. mains 200/250 v. £19.10.0, P. & P. 7/6 or 50/- deposit plus P. & P. 7/6 and 12 monthly payments of 33/4. FULL 12 MONTHS' GUARANTEE INCLUDING VALVES and TUBE.
- A.C./D.C. POCKET MULTI-METER KIT.** 2in. moving coil meter, scale calibrated in A.C./D.C. volts, ohms and milliamperes. Voltage range A.C./D.C. 0-50, 0-100, 0-250, 0-500. Milliamps 0-10, 0-100. Ohms range 0-10,000. Front panel, range switch, wirewound pot (for ohms zero setting), toggle switch, resistor and rectifier. 19/6, P. & P. 1/6. Wiring diagram 1/-, free with kit.
- CHANNEL TUNER.** Will tune to all Band I and Band III stations. Complete with P.C.C.84 and P.C.F.80 valves (in series) I.F. 16-19 or 33-38. Can be modified as an aerial converter (instructions supplied). 32/6, plus 3/6 P. & P. HEATER TRANSFORMER to suit above, 200-250 v., 6/-, plus 1/6 P. & P.
- MAINS TRANSFORMERS.** All with tapped primaries, 200-250 volts. 0-160, 180, 200 v., 60 mA, 6.3 v. 2 amps, 20/6. 280-0-280 80 mA, 6.3 v. 2 amp, 6.3 v. 1 amp, 10/6. 350-0-350 v., 70 mA, 6.3 v. 1 amp, 6/3 v. 2 amp, 10/6. 250-250 v., 70 mA, 6.3 v. 2 amp, 10/6. P. & P. 5/-.
- WOLSEY 3-ELEMENT FOLDED DIPOLE.** I.T.V. Aerial less mounting bracket for external use, complete with 12 yds. of coaxial cable, 15/-, P. & P. 3/6.
- CYLDON TURRET TELETUNERS 1 F 34/38 Mc/s.** Brand new complete with biscuit for channels 2, 4, 8 and 9. Less valves, 10/-, P. & P. 2/6. Pair of knobs to suit, 3/6. (Valves required P.C.C. 84 & P.C.F. 80).
- SIGNAL GENERATORS.** Cash £8.19.6 or 25/- deposit and 6 monthly payments of 21/8, P. & P. 5/-. Coverage 120 kc/s to 84 Mc/s. Case 10 x 6 1/2 x 4 1/4 in. Size of scale 6 1/2 x 3 1/4 in. 2 valves and rectifier. A.C. mains 200-250 v. Internal modulation of 400 c.p.s. to a depth of 30 per cent, modulated or unmodulated R.F. output continuously variable 100 millivolts. C.W. and mod. switch, variable A.F. output and moving coil output meter. Accuracy ± 2 per cent.

Three miniature valves and Metal Rectifier. A.C. mains 200/250 v. Internal modulation of 400 c.p.s. to a depth of 30 per cent; Modulated or unmodulated R.F. output continuously variable 100 millivolts. C.W. and mod. switch, variable A.F. output. Magic eye as output indicator. Accuracy ± 2 per cent.

- SIGNAL GENERATORS.** Cash £8.19.6 or 25/- deposit and 4 monthly payments of 21/8, P. & P. 5/-. Coverage 120 kc/s to 84 Mc/s. Case 10 x 6 1/2 x 4 1/4 in. Size of scale 6 1/2 x 3 1/4 in. 2 valves and rectifier. A.C. mains 200-250 v. Internal modulation of 400 c.p.s. to a depth of 30 per cent, modulated or unmodulated R.F. output continuously variable 100 millivolts. C.W. and mod. switch, variable A.F. output and moving coil output meter. Accuracy ± 2 per cent.
- BATTERY RECORD PLAYER AND AMPLIFIER.** 45 r.p.m. "Starr" motor "Acos" crystal pick-up, 3 transistor push-pull amplifier complete with transistors. Output 500 milliwatts, 49/6, P. & P. 3/6.
- S.W.A.T. PUSH-PULL AMPLIFIER COMPLETE WITH CRYSTAL MIKE AND 2in. LOUDSPEAKER.** A.C. mains 200-250 v. Size 10 1/2 x 6 1/2 x 2 1/4 in. 6 valves. H.F. pen., 2 triodes, 2 output pens and rectifier. For use with all makes and type of pick-up and mike. Negative feed back. Two inputs, mike and gram. and controls for same. Separate controls for Bass and Treble lift. Response flat from 40 cycles to 15 kc/s, ± 2 db; 4 db down to 20 kc/s. Output 8 watts at 5 per cent total distortion. Noise level 40 db down to 20 kc/s. Output transformer tapped for 3 and 15 ohms speech coils. For use with Std. or L.P. records, musical instruments such as guitars, etc. £4.19.6, P. & P. 7/6 or 20/- deposit plus P. & P. 7/6 and 4 monthly payments of 23/-.
- B.S.R. MONARCH UAS WITH FUL-FI HEAD.** 4-speed, plays 10 records, 12in., 10in., or 7in. at 16, 33, 45 or 78 r.p.m. Intermixes 7in., 10in. and 12in. records of the same speed. Has manual play position; colour, brown. Dimensions: 12 1/2 x 10 1/2 in. Space required above baseboard 4 1/4 in. below baseboard 2 1/4 in. Fitted with Ful-Fi turnover crystal head. £6.19.6, P. & P. 5/- With Stereo Head £7.19.6, P. & P. 5/-.
- TRANSISTOR TESTER.** For both P.N.P. and N.P.N. transistors incorporating moving coil meter. In metal case size 4 1/2 x 3 1/2 x 1 1/4 in. Scale marked in gain and leakage. 19/6, P. & P. 2/6.
- PUSH-PULL OUTPUT STAGE** inclusive of transistors with input and output transformers to match 3 ohms speaker coil, suitable for use with the POCKET RADIO. Kit of parts, including transistors, 19/6, P. & P. 1/6. Wiring diagram 1/6, free with kit.
- PORTABLE AMPLIFIER.** On printed circuit for A.C. Mains 200/250 v. Size 4 x 3 in. with tone and volume control. Valves: ECL82 and E280. 39/6, P. & P. 2/6.

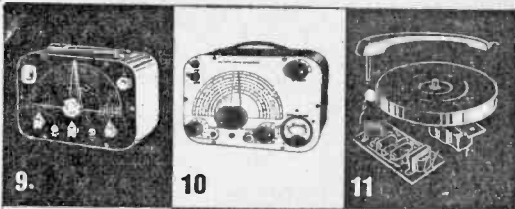

**SATISFACTION GUARANTEED OR MONEY REFUNDED**

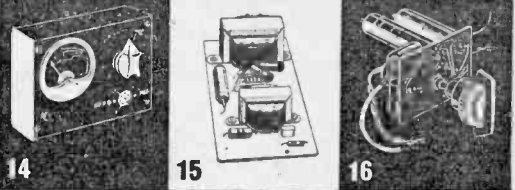

**RADIO & T.V. COMPONENTS (Acton) LTD.**

**23B HIGH STREET, ACTON, LONDON, W.3.**

ALL ENQUIRIES S.A.E. GOODS NOT DISPATCHED OUTSIDE U.K.

# SENSATIONAL NEW 1961 DESIGNS-- LOW PRICES ★ PICTORIAL STEP-BY-STEP PLANS

## THE NEW "LISBON" TRANSISTOR SET

Build the miniature highly sensitive "LISBON" design. This is a pocket 2-stage transistor set not much larger than a matchbox. Excellent clear reception covering all medium waves and working for months and months off a tiny 1½ or 3 volt battery costing only 3½d. A very simple set to build and an excellent introduction to transistor circuitry. Everything can be supplied down to the last nut and bolt including **SIMPLE AS A.B.C. PICTORIAL STEP-BY-STEP PLANS FOR ONLY 19/6**, plus post and packing 1/6 (C.O.D. 2/- extra). Parts sold separately, priced parts list 1/-.



## "MAJORCA" 7 TRANSISTOR RADIO

Build this 7-TRANSISTOR **£10.19.6**  
"MAJORCA"

superbly portable with Car Radio aerial attachment. An exceptionally high quality design giving remarkable tone with push-pull output. Can be built for **ONLY £10.19.6**, including everything down to the last nut and bolt and **SIMPLE AS A.B.C. PICTORIAL STEP-BY-STEP PLANS**. Post and packing 3/6 (C.O.D. 3/- extra). Parts sold separately.

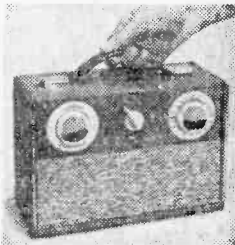

## OUR NOVEL WRIST RADIO

Our engineers have designed this novel Wrist Radio using latest transistor techniques. Size only 1½ x 1 x 1½ in. "Featherweight" yet yielding crisp reception over all medium waves. Tiny battery lasts months and months costing only 4d. No snags—anyone can build it in an hour or two using our **SIMPLE AS A.B.C. PICTORIAL STEP-BY-STEP PLANS**. All parts can be supplied including case and strap **FOR ONLY 22/6**, plus post and packing 1/6 (C.O.D. 2/- extra). Parts sold separately, priced parts list 1/-.

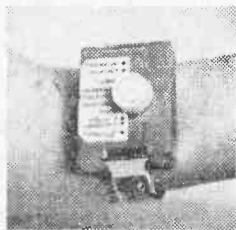

## THE NEW "FLORIDA" VALVE RADIO

This sensational "FLORIDA" model is one of our most sensitive valve radios. It is a highly compact self-contained,

**27/6**

miniature push button base, valve pocket radio of absolutely rock bottom building cost. Covers all medium waves with very latest circuitry bringing in stations from all over Europe without fuss. Size only 4½ x 2½ x 1½ in. A fascinating pocket radio. We can supply all the parts including beautiful 2-tone case and **SIMPLE AS A.B.C. PICTORIAL STEP-BY-STEP PLANS**, screws, wire, etc. Can be built for the exceptionally **LOW PRICE OF 27/6**, plus post and packing 1/6 (C.O.D. 2/- extra). Parts sold separately, priced parts list 1/-.



## OUR NEW 4 STAGE "MINUETTE"

Build this newly-designed "MINUETTE" 4-STAGE transistor set in very strong ready drilled **ULTRA-MODERN CASE**, size only 4 x 3½ x 1½ in. Uses three transistors and diode and **SELF-CONTAINED LOUDSPEAKER**. Very sensitive, ideal for office, bedroom, holidays, etc. Months and months of listening off an 8d. battery. Can be built **FOR ONLY 39/6**, including **PROPER CASE**, miniature speaker, etc. **SIMPLE AS A.B.C. PICTORIAL STEP-BY-STEP PLANS**, etc., plus post and packing 1/6 (C.O.D. 2/- extra). Parts sold separately, priced parts list 1/-.

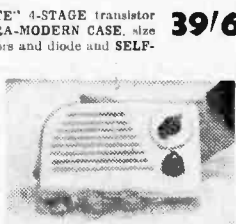

## THE NEW "MONTE-CARLO" RADIO

One of our new, exciting designs, the "MONTE CARLO" is a powerful, all maine, miniature table radio with the latest trimmings, gold insert knobs, special unmarkeable plastic valuer, etc. The amazing circuit covers all medium and long waves with good selectivity, fantastic tone and output. Includes ready drilled and punched chassis, standard octal base valves, etc. All the parts can be supplied including **SIMPLE AS A.B.C. PICTORIAL STEP-BY-STEP PLANS**. Everything down to the last nut and bolt **FOR ONLY £5.15.0**, plus post and packing 3/6 (C.O.D. 2/- extra). Parts sold separately, priced parts list 1/-.

**£5.15.0**



## THE TIME TESTED "OCEAN HOPPER"

Build this long range, powerful midget now! The "OCEAN HOPPER" is a very well tested all mains standard radio design in every respect. The price is the lowest possible consistent with high quality. No radio knowledge whatever needed. Can be built by anyone in two hours. The terrific new circuit of the "Ocean Hopper" covers all medium and long waves, has razor edge selectivity and exceptionally good tone. **PARTS TESTED BEFORE DESPATCH**, size 12 x 6 x 3 in. Uses standard octal base valves with low running costs, approximately 18 watts. Can be built **FOR ONLY 98/6**, including everything down to the last nut and bolt and **SIMPLE AS A.B.C. PICTORIAL STEP-BY-STEP PLANS**. Post and packing 3/6 (C.O.D. 2/- extra). Parts sold separately, priced parts list 1/-.

**98/6**

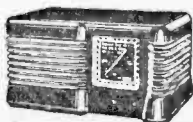

## THE ULTRA-MODERN "GOLD-STAR"

The exciting De Luxe "GOLD STAR" pocket radio in beautiful moulded plastic case is a highly sensitive, self-contained set covering all medium waves. Uses modern, miniature button base valve and "Denco" High efficiency coil. **EXCEPTIONALLY EASY TO BUILD**, the case is supplied ready drilled. Size of radio only 4½ x 2½ x 1½ in. We can supply all the parts including case, **SIMPLE AS A.B.C. PICTORIAL STEP-BY-STEP PLANS**, etc., for **ONLY 37/6**, plus post and packing 2/- (C.O.D. 2/- extra). Parts sold separately, priced parts list 1/-.

**37/6**

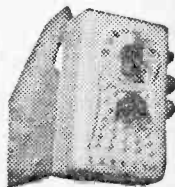

# CONCORD ELECTRONICS

210, Church Road, Hove, Sussex

Dept.  
PW28

Cheques accepted. Cash on delivery 2/- extra. Please print name and address in block letters. Suppliers to Schools, Universities, Government and Research Establishments. Complete range of components and valves stocked. Regret no C.O.D. abroad. DEMONSTRATIONS DAILY AT WORKS

# BY CONCORD

★ EASY AS A.B.C. ★

## BRAND NEW RECORD CHANGERS

ONLY £8.15.0 BRAND NEW! the latest 4-speed Autochanger, B.S.R. UA14, as illustrated, few only. OUR PRICE £8.15.0. P.P. 3/6.

BRAND NEW! the B.S.R. 4-speed Autochanger, UA8, few only left. OUR PRICE £6.15.0. P. & P. 3/6.

BRAND NEW! the COLLARO Junior 4-speed record player. OUR PRICE 75/- P. & P. 3/6.

BRAND NEW! COLLARO "Conquest", 4-speed Autochanger. OUR PRICE £7.15.0. P. & P. 3/6.

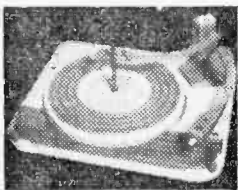

## THE NEW 3-STAGE "RIO"

Our fabulous new 3-STAGE MINIATURE LOUDSPEAKER DESIGN THE "RIO" covers all medium waves including Home, Light, etc. Very reliable and lightweight. Works for months and months off a 4d. battery. Can be assembled in an hour or two. All parts can be supplied including miniature speaker and everything down to the last nut and bolt with SIMPLE AS A.B.C. PICTORIAL STEP-BY-STEP PLANS for ONLY 27/6, plus post and packing 1/6 (C.O.D. 2/- extra). Parts sold separately, priced parts list 1/-.

27/6

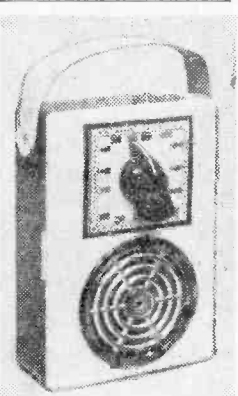

## "SKYROMA" VALVE SET

The "SKYROMA" design is an old favourite and is a highly sensitive valve set with provision for adding a further stage. An exceptionally efficient radio using a unique assembly system and can be built by anyone without any radio knowledge whatever in an hour or two. Handsome BLACK CRACKLE STEEL CASE with specially made BLACK AND GOLD DIAL WITH STATIONS PRINTED. Size of radio 8½ x 5 x 3in. Covers all medium and long waves. H.T. consumption only 1-2mA. Ideal for bedroom, garden, holidays, etc. Total building cost down to the last nut and bolt, including SIMPLE AS A.B.C. PICTORIAL STEP-BY-STEP PLANS, ONLY 39/6, plus post and packing 2/6 (C.O.D. 2/- extra). Parts sold separately, priced parts list 1/-.

39/6

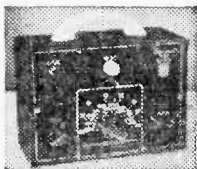

## THE FAMOUS "GABY" TEST METERS

Inmoulded case. Prices include Test Prods. Batteries, Instruction Book. FULLY GUARANTEED. Also measure db. Accuracy: A.C., 3 per cent, D.C., 2 per cent.

A-10 £4.17.6 plus 2/6 P.P.

B-20 £6.10.0 plus 2/6 P.P.  
C.O.D. 2/- extra.



A.10—2K ohms/v. on A.C. and D.C. volts (10,50,250,500 and 1000 v.); 10K and 1M ohms; 1 mA, 25 mA and 250 mA, D.C. Size: 5½ x 3½ x 1½in. Weight 17 ozs.  
B.20—10K ohms/v. on 0.5 v. and 2.5 v.; 4K ohms/v. on 10, 50, 250, 500 and 1000 v., A.C. and D.C. Resistance, 2K, 200K, 2M and 20M-ohms; D.C. current, 100 microA, 2.5 mA, 26 mA, 250 mA. Size: 5½ x 3½ x 2½in. Weight 24 ozs.

# TECHNICAL TRAINING in radio television and electronics

Whether you plan to have your own business, to become an electronics engineer, to take up a career in industry, or to brush-up your knowledge and study new developments, transistors, etc., an I.C.S. Course will help you to success. You learn at home in your own time, under expert tuition. Moderate fees include all books.

## EXAMINATION COURSES FOR:—

C. & G. Radio and TV Servicing Certificate (R.T.E.B.)

C. & G. Radio Amateurs' Exam. (Amateurs' Transmitting Licence)

British Institution of Radio Engineers, etc. C. & G. Telecom. Technician's Cert.

## LEARN AS YOU BUILD

### Practical Radio Servicing Course

A basic course in radio electronic and electrical theory backed by thorough practical training. You build radio receivers, signal generator and multimeter.

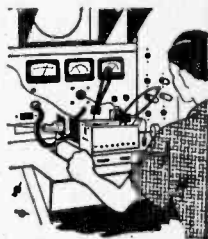

Post this Coupon TODAY! for FREE book on careers in Radio, and full details of other I.C.S. Courses

### INTERNATIONAL CORRESPONDENCE SCHOOLS

(Dept. 171), Intertext House, Parkgate Road, London S.W.11.

Please send book on \_\_\_\_\_

Name \_\_\_\_\_ Age \_\_\_\_\_  
(Block Letters Please)

Address \_\_\_\_\_

Occupation \_\_\_\_\_ 3.61

### INTERNATIONAL CORRESPONDENCE SCHOOLS

## R.S.C. HI-FI TAPE RECORDER KIT

**REALISM AT INCREDIBLY LOW COST. CAN BE ASSEMBLED IN HALF AN HOUR**  
The Recorder incorporates the Latest Collaro Studio Tape Transcriber. The Linear LT45X High Quality Tape Amplifier listed £12.12.0 High Flux P.M. Speaker listed 30/-, empty Tape Spool, a Reel of Best Quality Tape listed 22/6, and a Handsome Portable carrying Cabinet with latest attractive two-tone polytone finish 13 1/2 x 9 1/2 in. high, listed £4.10.0, and circuit. Total cost if purchased individually approximately £40. Performance equal to units in the £60-£90 class. S.A.E. for leaflet.

## HIGH FIDELITY 12-14 WATT AMPLIFIER TYPE A11

**PUSH-PULL ULTRA LINEAR  
OUTPUT "BUILT-IN" TONE  
CONTROL PRE-AMP STAGES**

Two input sockets with associated controls allow mixing of "mike" and gram, as in A10. High sensitivity. Includes 5 valves: ECC83, ECC83, EL84, EL84, 6Y3. High Quality sectionally wound output transformer specially designed for Ultra Linear operation, and reliable small condensers of current manufacture. **INDIVIDUAL CONTROLS FOR BASS AND TREBLE.** "Lut" and "Cut." Frequency response + 3 D.B. 30-30,000 c/s. Six negative feedback loops. Hum level 60 D.B. down. **ONLY 23 millivolts INPUT** required for **FULL OUTPUT.** Suitable for use with all makes and types of pick-ups and microphones. Comparable with the very best designs. For **STANDARD or LONG PLAYING RECORDS** For **MUSICAL INSTRUMENTS** such as **STRING BASS, GUITARS, etc., OUTPUT SOCKET** with plug provides 300 v. 30 mA. and 6.3 v. 1.5 a. For supply of a **RADIO FEEDBACK KIT.** Size approx. 12-9-7in. For A.C. mains 200-250 v. 50 c.p.s. Output for 3 and 15 ohm speakers. Kit is complete to last out. Chassis fully punched. Full instructions and point-to-point wiring diagrams supplied. **Only 8 Gns. Carr. 10/-** (Or factory built 45/- extra).

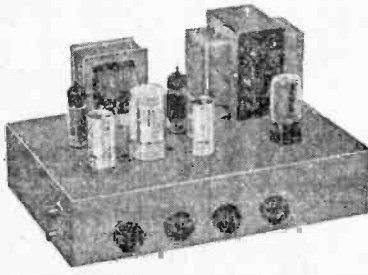

If required louvered metal cover with 2 carrying handles can be supplied for 18/9. **TERMS ON ASSEMBLED UNITS, DEPOSIT 24/3, and 9 monthly payments of 24/3.** Send S.A.E. for Illustrated leaflet detailing Ready-to-assemble Cabinets, Speakers, Microphones, etc., with cash and credit terms.

## R.S.C. STEREO/TEN HIGH QUALITY AMPLIFIER

A complete set of parts for the construction of a stereophonic amplifier giving 5 watts high quality output on each channel (total 10 watts). Sensitivity is 50 millivolts, suitable for all crystal stereo heads. Ganged Bass and Treble Controls give equal variation of "left" and "out." Provision is made for use as straight (monaural) 10 watt amplifier. Valve line-up ECC83, ECC83, EL84, EL84, E281. Outputs for 2-3 ohm speakers. Point-to-Point wiring diagrams and instructions supplied. Send S.A.E. for leaflet. Full constructional details and price list 2/6. **8 Gns. Carr. 10/-**

**DEAF AID EARPIECES.** High Impedance complete with lead, 15/6. **MICROPHONE INSERTS.** Crystal type, 6/9.

## R.S.C. BATTERY CHARGING EQUIPMENT

### ASSEMBLED CHARGERS

6 v. 1 amp. .... 19/9  
6 v. or 12 v. 1 amp. .... 29/9  
6 v. 2 amps. .... 29/9  
6 v. or 12 v. 2 amps. .... 38/9  
6 v. or 12 v. 3 amps. with ammeter .... 58/9  
Above ready for use. With mains and output leads. Carr. 3/6.



### Assembled 6 v. or 12 v. 4 amps.

Fitted Ammeter and variable charge rate selector. Also selector plus for 6 v. or 12 v. charging. Louvered steel case with stoved blue hammer finished. Fused and ready for use with Carr. 5/- mains and output leads. Terms: Deposit 13/3 and 5 monthly payments 13/3. **69/9**

### ASSEMBLED CHARGER

6 v. or 12 v. 2 amps. Fitted Ammeter and selector plug for 6 v. or 12 v. Louvered metal case finished attractive hammer blue. Ready for use with mains and output leads. Double Fused. **Only 49/9 Carr. 3/9**

### BATTERY CHARGER KITS

Consisting of Mains Transformer, F.W. Bridge Metal Rectifier, well ventilated steel case. Fuses, Fuse-holders, Grommets, panels and circuit. Carr. 3/6 extra.  
6 v. or 12 v. 1 amp. .... 24/9  
As above, with Ammeter 32/9  
6 v. 2 amps. .... 25/9  
6 v. or 12 v. 2 amps. .... 31/6  
6 v. or 12 v. 2 amps. inclusive of Ammeter .... 42/9  
6 v. or 12 v. 3 amps. .... 53/9  
6 v. or 12 v. 4 amps. with Ammeter and variable charge rate selector. 59/9.  
**CHARGER AMMETERS.**  
0-1.5 a., 0-3 a., 0-4 a., 0-7 a., 0-25 a., 0-60 a. 8/9.

### HEAVY DUTY CHARGER KIT

6/12 v. 8 amps. variable output. Consisting of Mains Transformer 0-200-250 v., F.W. (Bridge) Selenium Rectifier, Ammeter, Variable Resistor, Panels, Plugs, Fuses, Fuseholder and circuit. 59/9. Carr. 4/6.

## R.S.C. MAINS TRANSFORMERS

Interleaved and Impregnated. Primaries 230-230-250 v. 50 c/s. Screened **TOP SHROUDED DROP THROUGH**  
250-0-250 v. 70 mA. 6.3 v. 2 a. 5 v. 2 a. 17/9  
350-0-350 v. 80 mA. 6.3 v. 2 a. 5 v. 2 a. 18/9  
250-0-250 v. 100 mA. 6.3 v. 2 a. 3 v. 1 a. 19/9  
250-0-250 v. 100 mA. 6.3 v. 3.5 a. C.T. 19/9  
250-0-250 v. 100 mA. 6.3 v. 4 a. 5 v. a. 25/9  
300-0-300 v. 100 mA. 6.3 v. 4 a. 5 v. 3 a. 25/9  
350-0-350 v. 100 mA. 6.3 v. 4 a. 5 v. 3 a. 25/9  
350-0-350 v. 100 mA. 6.3 v. 4 v. 4 a. C.T. 0-4-5 v. 3 a. 25/9  
350-0-350 v. 150 mA. 6.3 v. 4 a. 5 v. 3 a. 29/9  
250-250 v. 60 mA. 6.3 v. 2 a. 5 v. 2 a. 17/9  
Midset Type 21-3-3in.  
250-0-250 v. 100 mA. 6.3 v. 4 a. 5 v. 3 a. 26/9  
370-0-370 v. 100 mA. 6.3 v. 4 a. 5 v. 3 a. 28/9  
350-0-350 v. 100 mA. 6.3 v. 4 a. 5 v. 3 a. 26/9  
300-0-300 v. 130 mA. 6.3 v. 4 a. 6.3 v. 1 a. for Mullard 510 Amplifier 35/9  
350-0-350 v. 150 mA. 6.3 v. 4 a. 5 v. 3 a. 35/9  
425-0-425 v. 200 mA. 6.3 v. 4 a. C.T. 6.3 v. 4 a. C.T., 5 v. 3 a. 49/9

## FULLY GUARANTEED

We can quote for special types singly or in any quantity.  
**FILAMENT TRANSFORMERS**  
All with 200-250 v. 50 c/s. primaries 6.3 v. 1.5 a. 5/9; 6.3 v. 2 a. 7/6; 0-4-6.3 v. 2 a. 7/9; 12 v. 1 a. 7/11; 6.3 v. 3 a. 8/11; 6.3 v. 5 a. 17/8; 12 v. 1.5 a. twice. 17/5.  
**OUTPUT TRANSFORMERS**  
Midset Battery Pentode 66:1 for 954 etc. .... 3/9  
Small Pentode, 5000  $\Omega$  to 3  $\Omega$  .... 3/9  
Small Pentode 7/8,000  $\Omega$  to 3  $\Omega$  .... 3/9  
Standard Pentode 5,000  $\Omega$  to 3  $\Omega$  .... 5/6  
Standard Pentode 7/8,000  $\Omega$  to 3  $\Omega$  .... 5/6  
10,000  $\Omega$  to 3  $\Omega$  .... 5/6  
Push-Pull 10-12 watts 6V8 to 3  $\Omega$  or 15  $\Omega$  .... 18/9  
Push-Pull 10-12 watts to match 6V8 to 3-3 or 15  $\Omega$  .... 19/9  
Push-Pull EL84 to 3 or 15  $\Omega$  .... 18/9  
Push-Pull 15-18 watts 6L6, KT66 22/9  
Push-Pull for Mullard 510 Ultra Linear 29/9  
Push-Pull 20 watts, sectionally wound 6L6, KT66 etc., to 3 to 15  $\Omega$ . 47/9

All for A.C. Mains 200-250 v., 50 ccs. Guaranteed 12 months.

## ELIMINATOR TRANSFORMERS

Primaries 200-250 v. 50 c/s.  
120 v. 40 mA. 5-0-5 v. 1 a. .... 15/9  
90 v. 15 mA. 4-0-4 v. 500 mA. .... 9/9

## SMOOTHING CHOKES

150 mA. 7-10 H 250 ohms. .... 11/9  
100 mA. 10 H 200 ohms. .... 5/9  
80 mA. 10 H 350 ohms. .... 5/9  
60 mA. 10 H 400 ohms. .... 4/11

## CHARGER TRANSFORMERS

All with 200-230-250 v. 50 c/s Primaries;  
0-9-15 v. 11 a. 11/9; 0-9-15 v. 2 a. 14/9; 0-9-15 v. 3 a. 16/9; 0-9-15 v. 5 a. 19/8; 0-9-15 v. 6 a. 23/9; 0-9-15 v. 8 a. 28/9.

## AUTO (Step up/Step down) TRANS.

0-110-120-230/250 v. 50-80 watts. 13/9;  
0-110-120-200/230/250 v. 150 watts 27/9.

## MICROPHONE TRANSFORMERS

120:1 high grade. clamped. 6/9; 120:1 Potted. Mu-metal screened. 9/9.



**R.S.C. A12 STEREPHONIC AMPLIFIER KIT**

A complete set of parts to construct a Stereo amplifier with an undistorted output total 6 watts. For A.C. mains input of 200-250 v. Outputs for matched 2-3 ohm speakers. Sensitivity 130 m.v. Ganged Vol. and Tone Controls. Preset balance control. Full instructions and point-to-point wiring diagrams supplied. Only good quality Carr. and pkg. 5/- components and latest high grade valves used. Exceptionally realistic reproduction can be obtained at ample volume for the home, as can be demonstrated in typical surroundings at our County Arcade premises. A really sensational offer.

**STEREO EQUIPMENT OFFER.**  
Comprising A12 Kit, 2 matched 8in. L/Speakers, and Acos 7/10 Stereo head Carr. 7/7 with sapphire stylus suitable most pick-ups.

**PICK-UP ARMS** complete with Hi-Fi turnover crystal head. Acos GP54. Limited number brand new, perfect, at approx. half price. Only 35/9.

**ACOS CRYSTAL MICROPHONES.** Mic40 stand or desk. Listed 45/-, Only 27/9, 35-1 Stuck type. Listed 5 gns. Only 39/6.

**R.S.C. 30 WATT ULTRA LINEAR HIGH FIDELITY AMPLIFIER A10**

A highly sensitive Push-Pull high output unit with self-contained Pre-amp. Tone Control Stages. Certified performance figures compare equally with most expensive amplifiers available. Hum level -3 db. down. Frequency response -3 db. 30-30,000 c/s. A specially designed sectionally wound ultra linear output transformer is used with 807 output valves. All components are chosen for reliability. Six valves are used. EF86, EF89, ECC83, 6X4, 6X5. Separate Bass and Treble Controls are provided. Minimum input required for full output is only 12 millivolts so that ANY KIND OF MICROPHONE OR PICK-UP IS SUITABLE. This unit is designed for CLUBS, SCHOOLS, THEATRES, DANCE HALLS or OUTDOOR FUNCTIONS, etc. For use with Electronic ORGAN, GUITAR, STRING BASS, etc. For standard or long-playing records. OUTPUT SOCKET PROVIDES L.T. and H.T. for a RADIO FEEDER UNIT. An extra input with associated volt. control is provided so that two separate inputs such as Gram. and 'Mike' can be mixed. Amplifier operates on 200-250 v. 50 c/s. A.C. Mains and has output for 3 and 15 ohm speakers. Complete kit of 30 parts with fully punched chassis and point-to-point wiring diagrams and instructions. If required cover as for A8 can be supplied for 18/9. The amplifier can be supplied, factory built with 12 months' guarantee, for £13.18.6.

**11 Gns.**  
Carr. 10/-  
TERMS: DEPOSIT 31/9 and 9 monthly payments of 31/8.

**FULL RANGE OF LINEAR AMPLIFIERS ALWAYS IN STOCK.**

**R.S.C. BATTERY TO MAINS CONVERSION UNITS**

Type BM1. An all-dry battery eliminator. Size 5 1/2 x 4 1/2 x 2in. approx. Cost £1.99. Replaces battery supplying 1.4 v. and 90 v. where A.C. mains 200-250 v. 50 c/s is available. Suitable for all battery portable receivers requiring 1.4 v. and 90 v. This includes latest low consumption types. Complete kit with diagrams, 39/9, or ready to use, 46/9.



Type BM2. Size 5 1/2 x 2 1/2 in. Supplies 120 v. 90 v. and 60 v., 40 mA. and 2 v. 0.4 a. to a fully smoothed. Thereby completely replacing both H.T. batteries and L.T. accumulators when connected to A.C. mains supply 200-250 v. 50 c/s. **SUITABLE FOR ALL B.S.R. U.S. BATTERY RECEIVERS** normally using 2 v. accumulator. Complete kit of parts with diagrams and instructions. 49/9, or ready to use, 59/6.

**R.S.C. 3-4 WATTS A7 HIGH-GAIN AMPLIFIER**  
For 200/250 v. 50 c/s. Mains input. Appearance and Specification, with exception of output wattage, as A5 amplifier. Complete Kit with diagrams, £3.15.0. Carr. 3/6.

**COLLARO JUNIOR** 4-speed single player units and Hi-Fi crystal pick-up with turn-over head, £3.19.6.  
**B.S.R. U.S. BATTERY RECEIVERS** with Stereo/Monaural pick-up head, £7.19.6. Carr. 5/-.  
TERMS: C.W.O. or C.O.D. No C.O.D. under £1. Open 9 to 6. Weds. until 1 p.m. Trade supplied.

**R.S.C. BRADFORD, MANCHESTER and LEEDS**  
(Manchester) Ltd.

**4 Gns.**

**LINEAR L45 MINIATURE 4 1/2 WATT QUALITY AMPLIFIER.** Suitable for use with any record playing unit, and most microphones. Negative feed-back 12 db. Separate Bass and Treble Controls. For A.C. mains input of 200-250 v. 50 c/s. Output for 2-3 ohm speaker. Three miniature Mullard valves used. Size of unit only 7-5-5 1/2 in. High. Guaranteed for 12 months. Only £5.19.6. Send S.A.E. for illustrated leaflet. Terms, Deposit 22/6 and 5 monthly payments of 22/6.

**R.S.C. 4-5 WATT A5 HIGH-GAIN AMPLIFIER**

A highly sensitive 4-valve quality amplifier for the home, small club, etc. Only 50 millivolts input is required for full output, so this is suitable for use with the latest high fidelity pick-up heads, in addition to all other types of pick-ups and practically all 'mikes'. Separate Bass and Treble Controls are provided. These give full long-playing record equalisation. Hum level is negligible being 15 db. of Negative feedback is used. H.T. or 300 v. 25 mA. and L.T. of 6.3 v. 1.5 a. is available for the supply of a Radio Feeder Unit, or Tape-Deck pre-amplifier. For A.C. mains input of 200-250 v. 50 c/s. Output for 2-3 ohm speaker. Chassis is not fitted. Kit is complete in every detail and includes fully punched chassis (with baseplate) with Blue hammer finish and point-to-point wiring diagrams and instructions. Exceptional value at only £4.15.0. or assembled ready for use 25/- extra, plus 3/6 carr. or Deposit 22/6 and 5 monthly payments of 22/6 for assembled unit.

**R.S.C. PORTABLE GUITAR AMPLIFIERS**

**Junior 5 watts High Quality output.** Separate Bass and Treble 'Cut' and 'Boost' controls. Sensitivity 15 m.v. Twin inputs. High Flux 8in. Loudspeaker built-in. Handsome, strongly made Cabinet (size approx. 14 x 14 x 7in.) finished in attractive and durable poliorome, and fitted with carrying handle. H.P. Terms. Deposit £1 and 9 monthly payments Carr. 7/6.  
**Senior 10 watts High Fidelity output.** Separate Bass and Treble 'Cut' and 'Boost' controls. Twin separately controlled high gain inputs so that two instruments such as Guitar and String Bass can be used at the same time. Two loudspeakers are incorporated, a high Flux 12in. for Bass notes and a 7 x 4 m. elliptical for Treble. Cabinet is well made and finished as Junior model. Size approx. 18 x 18 x 18in. H.P. Terms. Deposit 34/9 and 9 monthly payments of 34/9. **15 Gns.** Both models for 200-250 v. Carr. 10/- A.C. mains.

**SPECIAL TRANSISTOR OFFER.**  
TS1 Brimar. Brand new. Perfect. 3 for 10/9

**12in. 10 WATT HIGH QUALITY LOUD-SPEAKER IN POLISHED WALNUT FINISHED CABINET**

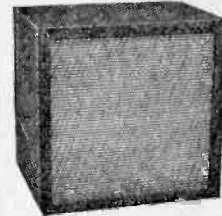

Gauss 12,000 lines. Speech coil 3 ohms or 15 ohms. Only £4.19.6 Carr. 5/-  
Terms: Deposit 11/3 and 8 monthly payments of 11/3.  
**12in. 20 WATT HI-FI LOUD-SPEAKERS IN CABINETS.** Size 18 x 18 x 18in. Finish as above. Terms: Deposit 17/9 and 9 monthly payments of 17/9. Only £7.19.6. Carr. 8/6.

**R.S.C. JUNIOR BASS REFLEX CABINETS.** Specially designed for W.B. HF1012 Speaker, but suitable for any good quality 10in. speaker. Acoustically lined and ported. Polished walnut veneer finish. Size 18 x 12 x 17 1/2 in. 19/9. 8in. 12/9. Ensure superb reproduction for only £3.19.6.

**SENIOR MODEL** for 12in. speakers, £6.19.6. Suitable legs with brass ferrules, 25/- per set of four.  
**PLESSEY DUAL CONCENTRIC 12in. 15 ohms HIGH FIDELITY SPEAKER** (12,000 lines) with built-in tweeter (completely separate elliptical speaker with choke, condensers, etc.) providing extraordinarily realistic reproduction when used with our A8 or similar amplifier. Rates 10 watts. Price only £5.19.6.

**PERMIO SPEAKERS:** 2-3 ohm, 2 1/2 in. £1/9. 5in. 17/9. 6in. 18/9. 8in. 19/9. 8 x 6in. 25/9. 10in. 28/9. 10 x 6in. 28/9. 12in. 29/11. 10in. W.B. "Stentorian" 3 or 15 ohms type HF1012 10 watts. High fidelity type. Recommended for use with our A8 Amplifier. £4.10.9. 12in. Plessey 3 ohms 10 watts (12,000 lines), 59/6.  
**TWEETERS:** Plessey 3 1/2 18/9, 15 25/9. **HI-FI CRYSTAL PICK-UP HEADS.** (Turnover type with sapphire stylus). HCP59. Standard replacement for Garrard and B.S.R. B.S.R. Ful-f. Garrard G2. 19/9. B.S.R. Stereo/Monaural 39/11. **GL3A MINIATURE 2-3 WATT GRAM AMPLIFIER.** For use with any single or auto-change unit. Output for 2-3 ohm speaker. For 200-250 v. 50 c.p.s. A.C. mains. Over-all size 1 1/2 x 2 1/2 in. Controls: Vol. and Tone with switch. Guaranteed 12 months.

**SUPERHET FEEDER UNIT.** Design of a high quality Radio Tuner Unit (specially suitable for use with any of our Amplifiers). Delayed A.V.C. employed. The W.Ch. Sw. incorporates Gram position. Controls are Tuning, W.Ch. and Vol. only 250 v. 15 mA. H.T. and L.T. of 6.3 v. 1 amp. required from amplifier. Size of unit approx. 9-6-7in. high. Simple alignment procedure. Point-to-point wiring diagrams, instructions and priced parts list with illustration. 2/6. Total building cost £4.15.0. For descriptive leaflet send S.A.E.

**COLLARO CONQUEST 4-SPEED AUTO-CHANGER** with high fidelity Studio pick-up. Latest model. For 200-250 v. 50 c.p.s. A.C. mains. Our price £6.19.6. Carr. 5/6.

Post 1/9 extra under £2. 2/9 extra under £5 S.A.E. with all enquiries.  
3-1 Moorfield Road, Leeds 12.  
Callers to 5 and 7 County Arcade, Briggate, Leeds 1, and 8-10 Brown Street (Market Street), Manchester 2, or 56 Morley Street (next to Majestic Ballroom), Bradford.

**MINIATURE EARPHONES**

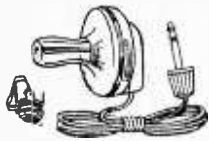

For Transistor Circuits: Very light weight and easy to wear. Cord almost invisible. Good quality production of music and voice, complete with miniature plug and socket, ready to use—correct impedance OK for red spot and similar transistors. Crystal 12/8. Magnetic 10/8. Post and In-lance 1/-.

**SUB MINIATURE COMPONENTS FOR TRANSISTOR SETS**

- Push-pull o.p.t. and driver 17/6 pair (500 milliwatt). 12/8 pair (300 milliwatt).
- 3 I.F. transformers and oscillator and circuit 23/6.
- Ferrite aerial with coils for medium and long wave and circuit.
- Smallest possible electrolytics 1/9 each. 1 mfd. 2 mf. 4 mfd. 8 mf. 10 mfd. 20 mfd. 30 mfd. 50 mfd. 100 mfd.
- Smallest 1 watt resistors 5d. each all popular values.
- Miniature 0.1 mfd., 1/-, 0.05 2.04 9d., valves up to 0.025 6d. each.
- Miniature slide switch 2/-.
- Pots edge-wise control 3/6, less switch.
- Transistor holder 1/8 each.
- Set of 6 transistors for superhet in original packets guaranteed Mullard OC44, OC45, OC45, OC71 matched pair OC72, £3.10.0. the set.
- Set of 6 all first grade includes matched pair 45/-.
- Oscillator and 2 I.F.—new American High Gain 35/-.
- Red Spots 3/6.
- White Spots 3/6.
- Surface barriers 25 mo/s 9/6, 50 mo/s 12/6.
- Diodes sub miniature 2/6 and 1/-.
- 3in. Speakers 3ohm 18/6.
- 3in. Speakers 80 ohm 18/6 and 19/6.
- 2 1/2in. Speakers 3ohm 19/6.
- Elliptical Speaker, 3 ohm or 35 ohm 19/6.

**1 Watt Transistor A.F. Amplifier**

Four transistors on printed circuit all wired up ready for immediate use—excellent performance from pickup, microphone or H.F. input. £4.12.6. post and insurance 1/6.

**Crystal Mike by Acos**



Model 39/1. This is ideal for tape or general amplifiers, complete with screened lead. 39/6. plus 1/- post.

**Transistor Set Cabinet**

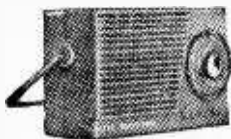

Very modern cream cabinet, size 5 1/2 x 3 x 1 1/2 in. with chrome handle, tuning knob and scale. Price 7/6. plus 1/6 postage and packing.

**INTRODUCING THE "REAL COMPANION"**

**CAR RADIO/PORTABLE**

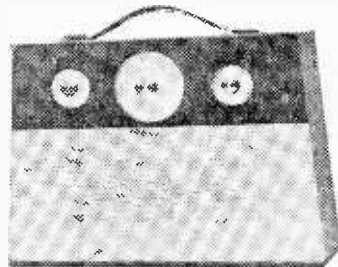

Now available is a modern receiver quite easy to make up and with all the features of sets being sold at twice the price. The circuit has been well tried and proved and will perform well all over the country. Here at Eastbourne, recognised as a bad reception area, performance on the Light, Home and many Continental Stations including Luxemburg, is extremely good. Demonstration Models can be heard at Eastbourne and our London address.

**NOTE THESE FEATURES**

- ★ 400/500 mw. Output Push-pull.
- ★ 6 First Grade Transistors.
- ★ Latest Type Superhet Circuit.
- ★ Medium and Long Wave.
- ★ Internal Ferrite aerial litz wound.
- ★ High "Q" coils.
- ★ Latest type printed circuit with components plan.
- ★ Slow motion tuning.
- ★ Car aerial attachment.
- ★ Two-tone cabinet.
- ★ High flux elliptical speaker.
- ★ Size 11 x 8 x 3in. approximately.
- ★ Easy to follow instructions.
- ★ 12 month guarantee all components.
- ★ No technical knowledge required.
- ★ Service available at moderate charges.

**ORDER IN CONFIDENCE**

Money returned in full if parcel not up to expectation and returned unassembled. Price complete. less battery. £3.19.6. Battery 3/6, plus carriage and insurance 7/6.

**PHILIPS TRANSCRIPTION UNIT**

Philips AG 200 Record Player, 4 speed. Ideal for the enthusiast.

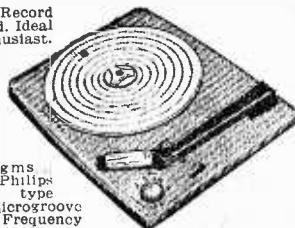

Pick-up arm wired for stereo, fine adjustment on all four speeds. Continuously variable pick-up weight (2.12gms supplied with Philips Hi-Fi crystal type AG3019 for microgroove and 78 r.p.m. Frequency response 30-15,000 c/s. Pick-up lifting and lowering device. Individually balanced heavy turntable. Muting switch. Can be used with any amplifier or radio set. Complete with monaural pick-up £10.10.0, or 2 gns. deposit and 20 fortnightly payments of 10/-. Available also with stereo head diamond or sapphire stylus. Prices on request.

**INFRA-RED HEATERS**

Make up one of these latest type heaters ideal for bathroom, kitchen, bedroom etc. They are simple to make from our easy to follow instructions—uses silica enclosed elements designed for correct infra-red wavelength (3 microns). Price for 750 watt element and instructions 15/6, plus 2/6 post and insurance.

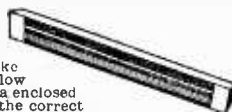

**Stop Freeze ups!**

Wrap our heater wire around the pipes in your loft, to prevent freeze-ups. Complete heater wire suitable for up to 50ft. of pipe, 10/- post free. With instructions.

**Speaker Bargain**



12in. Hi-fidelity loudspeaker. High flux. Permanent magnet type with standard 3 ohm speech coil. Will handle up to 12 watts. Brand new by famous maker. Price 32/6, plus 3/6 post and insurance.

**Miniature Microphone**

American made. Dynamic type, real bargain at 2/6. plus 6d. postage.



# TRANSISTOR LOUDSPEAKER POCKET RADIOS

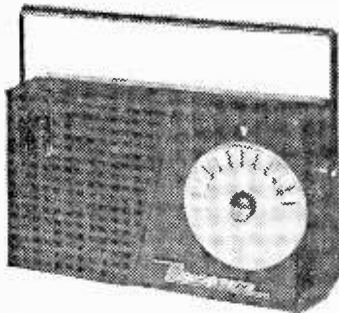

### NOW AVAILABLE WITH FIRST GRADE TRANSISTORS

Circuit comprises 2 HF transistors reflexed to equal 4 stages. Permanent germanium diode and high gain AF output stage, fitted with miniature speaker, proper tuning condenser, volume control and in case with handle as illustrated (less monogram), completely portable. No aerial or earth required. Pocket 4 uses 3 transistors and 1 diode, price 52/6, plus 2/6 post and insurance. Pocket 5 uses 4 transistors and 1 diode and has feedback control, price 67/6, plus 2/6 post and insurance.

### RESULTS GUARANTEED

Nothing can be more disappointing than to find that despite care in making up, your radio just will not work or needs a long high aerial and water pipe earth. We can prove good results in all areas and we guarantee all

components for 12 months. Read just a few of the hundreds of testimonials we have received from constructors who have made these sets. Send in confidence. Money refunded if parts or guarantees not up to your expectations. Plans free with parts or separately 1/6. More details S.A.E.

### READ THESE TESTIMONIALS!

**Mr. R. Ham, Birchington-on-Sea.**  
"Re Pocket 4. I must say that it is all you say of it. The stations roll in, and good volume too."  
**Mr. T. Bell, London, S.W.11.**  
"I have made up one of your 55/- transistorised radios and I am very pleased with the results."  
**Mr. A. J. Simmonds, Welling, Kent.**  
"I purchased from you a week ago the Pocket 4 Transistor Kit. I put it together last night in 1 1/2 hours on switching on the set. I was right on Radio Luxemburg. I must say thank you, because not only has the set a very attractive appearance, it also behaves fantastically."

**Mr. N. Elliott, Pontypool.**  
"I have completed the assembly of your Pocket 4 radio and am pleased to say that it works from the first switching on."  
**Mr. F. Jackson, Ickenham, Middx.**  
"I have built the Pocket 4 and am more than pleased with the results."  
**Mr. G. Bamford, Ramsgate.**  
"I find this set even better than you claim it to be and most certainly up to your usual standard of quality. I feel that nobody could fail to build it and get results. Even the first-time-ever novice, as your circuit diagrams and instructions are so clear and precise."

### ORIGINALS MAY BE SEEN AT THIS OFFICE

**Mr. R. Belt, Newcastle-on-Tyne.**  
"I have built your Pocket 5 Transistor set I am very pleased with it".  
**Mr. R. Morse, Birchington-on-Sea.**  
"I know nothing whatever about radio but I have just made up your transistor set from the kit of parts you sent. I am happy to say that it works perfectly and does all you claim of it. As you see, I live a good way from London, yet the B.B.C. comes in quite loud. The little set can be heard working in a good-sized room. Quite a number of other stations can be heard at night time with quite good separation. Wonderful value for money!"

### A.C./D.C. Multimeter Kit

Ranges: D.C. volts 0-5, 0-50, 0-100, 0-500, 0-1,000  
A.C. volts 0-5, 0-50, 0-100, 0-500, 0-1,000 D.C. milliamps 0-5, 0-100, 0-500, Ohms 0-50,000 with internal batteries. 0-500,000 with external batteries  
Measures A.C./D.C. volts, D.C. current and ohms. All the essential parts including metal case, 2in. moving coil meter, selected resistors, wire for shunts, range selector, switches, calibrated scale and full instructions. price 19/6, plus 2/6 post and insurance.



### Morganite Potentiometers

Single and 2-gang types available, standard size with good length spindle, all new and boxed. Single types, 1/- each, values available: 5K, 10K, 25K, 50K, 100K, 250K, 1 meg., 2 meg. Gang type 3/- each—values available: 5K±5K, 100K±100K ± meg. ± 1/2 meg. ± 2 meg. ± 2 meg.



### Fluorescent Light Bargain

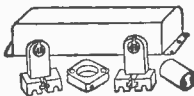

Kit of parts comprising: choke, two lamp holders, starter holder and starter, 40 watt, 19/6, 80 watt, 23/6. Plus 2/- post and insurance.

### The Taylor Meter Model 127A



A pocket size meter but with a big scale and a sensitivity of 20,000 Ohms per volt D.C., therefore an ideal unit for television servicing — robustly made and complete with leads and prods—20 ranges as follows:  
D.C. current 50 microamps. to 1 amp.  
D.C. voltages—0-1,000 volt in seven ranges (25 KV.) with external probe, optional extra.  
Volts A.C.—0-2,500 in six ranges.  
Ohms—0-20 meg. Ohm in three ranges (self-contained). Self-contained, 3 1/2 in. movement, Price £10 or 10/- deposit, and 23 fortnightly payments of 10/-. Non-callers add 5/- carriage and insurance.

### Taxley Switches

1 Pole 3 Way	1/6
1 Pole 3 Way	1/6
1 Pole 5 Way	2/-
1 Pole 12 Way	3/-
2 Pole 2 Way	2/6
2 Pole 4 Way	2/6
2 Pole 6 Way	2/6
2 Pole 8 Way	3/6
2 Pole 12 Way	4/6
3 Pole 3 Way	1/6
3 Pole 6 Way	3/6
4 Pole 4 Way	3/-
6 Position Shorting	2/6
6 Pole 3 Way	3/6
6 Pole 3 Way	3/6
8 Pole 2 Way	2/6
9 Pole 3 Way	2/6
12 Pole 2 Way	2/6

### TV Workshop Aids

**F.H.T. SEALER.** Apply with soldering iron. Stops corona discharge, etc. 2/6 per stick.  
**POLYTHENE TAPE.** 2in. x 10 thou, for E.H.T. insulation up to 25 kv. 5/- per 12ft. roll.  
**SPONGE STRIP.** 1in. x 1in. For sealing or cushioning, 9d. per foot.  
**ANTI-STATIC SCREEN CLEANER.** For TV tubes and screens. Perspex or glass. Delays accumulation of dust. 3/- per tube.  
**CELLULOSE CEMENT.** Specially prepared for radio gluing of metal, glass, ceramic, wood, fabrics 4/8 per tin.

## ELECTRONIC PRECISION EQUIPMENT LTD.

66, GROVE ROAD, EASTBOURNE, SUSSEX

This is the correct address for post orders and for prompt attention please mark your envelope Dept. 5, also enough for postage. Personal shoppers should use one of the companies below.

<b>Electronics (Croydon) Ltd.,</b> 266 London Road, Croydon. Phone: CRO 6558 Half day Wednesday	<b>Electronics (Pinsbury Park) Ltd.,</b> 29 Stroud Green Rd., Finsbury Park, N.4. Phone: ARCHway 1049 Half day Thursday	<b>Electronics (Manor Park) Ltd.,</b> 520 High Street North, Manor Park, E.12 Phone: Hford 1011 Half day Thursday	<b>Electronics (Ruislip) Ltd.,</b> 42-46 Windmill Hill, Ruislip, Middx. Phone: RUISLIP 5780 Half day Wednesday
---	---	---	--

# CONSTRUCTORS CORNER

Construction price includes valve and one coil covering 40-100 m.  
 ● Can be converted to 2v. or 3v.  
 ● Receives speech and music clearly from all over the world.  
 Send 2/- for diagram and price list.

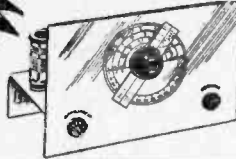

Explore the world on short-wave radio (10-100m)  
**FOR ONLY 35/-**

## YOU CAN NOW BUILD THE R.C.S. TAPE TUNER

Will operate on all types of Recorder. Size 3 1/2 x 1 1/2 x 1 in. High impedance output, variable med. wave tuning. Triple wound Super-Hi-Q coil. Easily constructed from full instruction data and Layout Diagrams. Chassis and components colour coded.



All parts to Build. Post 1/6.

**30/-**

## CRYSTAL RECEIVER

Covers M/W Band

All components including case for **12/6**  
 Ideal for the beginner.

Post and packing: Under 10/- add 9d.; under 40/- add 1/6; over POST FREE

# ENSURE SUCCESS WITH R.C.S.

## AN IDEAL PRESENT!

EASY TO BUILD TWO STAGE TRANSISTOR SET  
 The set that looks like a Radio Set

- Attractive Case
  - Mini .0005 Tuner
  - High Q Litz Coil
  - Works for months off No. 8 Battery
  - Simple to construct in 15 min.
- You can't go wrong. We guarantee good results.

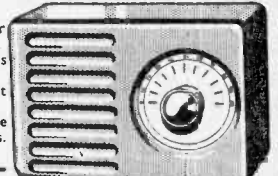

Total Building Costs. P.P 1/6 **25/-**

Components Price List. Layout Plans 1/6 free with order.

## BUILD THIS AMAZING RADIO POWERFUL PERSONAL PORTABLE

- ★ Sturdy metal case.
- ★ No holes to drill.
- ★ Detachable rod aerial.
- ★ All batteries self-contained.
- ★ Can be built in 1 hour.
- ★ Covers medium waves.
- ★ Loud clear tone.
- ★ Selective tuning.
- ★ All parts are sold separately.

FOR ONLY **35/-**

This delightful set is designed to give you a completely personal portable radio. Bronze-finished case. Ideal for the beach, the bedroom, the office—in fact anywhere. Send 2/- for wiring diagram and components price list.



Trade Enquiries Welcomed

**R.C.S. PRODUCTS (RADIO) LTD.** 11 OLIVER RD., LONDON, E.17 Mail Order Only

# FREE TO AMBITIOUS ENGINEERS

— THE LATEST EDITION OF ENGINEERING OPPORTUNITIES

**Have you sent for your copy?**  
**ENGINEERING OPPORTUNITIES** is a highly informative 156-page guide to the best paid engineering posts. It tells you how you can quickly prepare at home for a recognised engineering qualification and outlines a wonderful range of modern Home Study Courses in all branches of Engineering. This unique book also gives full details of the Practical Radio & Electronics Courses, administered by our Specialist Electronics Training Division—the *B.I.E.T. School of Electronics*, explains the benefits of our Employment Dept. and shows you how to qualify for five years promotion in one year.

**We definitely Guarantee**  
**“NO PASS — NO FEE”**

Whatever your age or experience, you cannot afford to miss reading this famous book. If you are earning less than £25 a week, send for your copy of “ENGINEERING OPPORTUNITIES” today—FREE.

**BRITISH INSTITUTE OF ENGINEERING TECHNOLOGY** (Incorporating E.M.I. Institutes)  
 (Dept. SE/21), 29 Wright's Lane, London, W.8

## WHICH IS YOUR PET SUBJECT?

- Mechanical Eng.,
- Electrical Eng.,
- Civil Engineering,
- Radio Engineering,
- Automobile Eng.,
- Aeronautical Eng.,
- Production Eng.,
- Building, Plastics,
- Draughtsmanship,
- Television, etc.

**GET SOME LETTERS AFTER YOUR NAME!**

- A.M.I.Mech.E.
- A.M.I.C.E.
- A.M.I.Prod.E.
- A.M.I.M.I.
- A.I.O.B.
- A.F.R.Ae.S.
- B.Sc.
- A.M.Brit.I.R.E.
- City & Guilds
- Gen. Cert. of Education
- Etc., etc.

## PRACTICAL EQUIPMENT

- Basic Practical and Theoretic Courses for beginners in Radio, T.V., Electronics, Etc.,
- A.M.Brit.I.R.E. City & Guilds Radio Amateurs' Exam.
- R.T.E.B. Certificate
- P.M.G. Certificate
- Practical Radio
- Radio & Television Servicing
- Practical Electronics
- Electronics Engineering
- Automation

## INCLUDING TOOLS!

The specialist Electronics Division of *B.I.E.T.* (Incorporating E.M.I. Institutes) NOW offers you a real laboratory training at home with practical equipment. Ask for details.

## B.I.E.T. SCHOOL OF ELECTRONICS

## POST COUPON NOW!

Please send me your FREE 156-page “ENGINEERING OPPORTUNITIES”  
 (Write if you prefer not to cut page)  
 NAME .....  
 ADDRESS .....  
 SUBJECT OR EXAM THAT INTERESTS ME ..... (SE/21)



# THE B.I.E.T. IS THE LEADING ORGANISATION OF ITS KIND IN THE WORLD



**Brand new, individually checked and guaranteed VALVES**

AC/DD 2/6	DH76 4/9	EL35 8/3	P2 4/-	TH41 9/-	3E29 60/-	6L6G 6/6	12SR7 6/-	1619 5/-
AC/HL 5/-	DK96 8/-	EL41 8/3	P41 4/-	TP22 11/-	(829B) 60/-	6L34 4/6	15D2 6/-	1625 6/-
AC/P 4/6	DL36 10/6	EL42 7/6	P61 2/3	TP25 15/-	3Q5GT 9/-	6N7G 5/9	15R 5/-	1626 4/6
AC/PI 2/6	DL71 8/-	EL84 10/-	PCC84 7/-	TT11 3/-	3V4 7/3	6N7GT 6/-	21B6 9/-	1629 4/6
ACV4 7/-	DL72 7/6	EL85 10/-	PCC85 8/-	U17 5/-	4A1 4/6	6Q7G 6/-	30 5/-	4120 4/-
AC5PENDD 4/-	DL94 6/-	EL91 7/6	PCF80 7/-	U18 6/6	4D1 2/6	6R7G 6/-	35T 30/-	7193 1/9
AC6/PEN 5/-	DL96 8/-	ESU208 8/-	PCF82 8/-	U27 8/-	5U4G 5/-	6RGT 6/-	35Z4 5/-	6475 5/-
AC/SP3 4/6	DX25 9/-	EY86 8/-	PCL82 8/6	U52 5/-	5Y3GT 6/-	6S47 6/-	35Z4GT 7/-	8019R 22/6
AL60 6/-	EL232 5/6	EY91 3/6	PL81 7/6	UL41 7/-	5Z3 8/6	6SC7G 5/6	39/44 6/-	8013A 10/-
AP4 4/-	EL1323 25/-	EZ40 7/6	PL82 8/-	UL84 7/6	5Z4G 8/-	6SC7GT 6/-	53A 3/-	8020 6/-
ARB 5/-	EL1524 6/6	EZ80 6/6	PL83 7/9	PM24A 4/-	6A6 5/-	6S7 5/-	59 6/-	9001 4/6
ARDD5 2/-	EA50 1/6	FW4/500 6/6	PM4DX 3/-	PR25H 7/6	6A7 4/6	6SH 5/9	59 6/-	9003 5/6
ARP3 3/-	EA91 4/6	GZ32 9/-	PT25H 7/6	PR99 8/-	6A7 8/-	6SR7 6/6	83V 12/-	9004 4/6
ARP4 3/6	EB34 1/6	H0 5/-	PX4 19/-	VRI05/30 7/6	6A16 6/3	6S57 6/6	84 8/-	9005 4/6
ARP12 2/9	EB91 3/9	H63 3/6	PY81 7/-	VRI50/30 7/3	6AT6 5/-	6F5F 8/-	85A1 12/-	9006 4/6
ARP24 3/6	EB33 5/-	HL2K 3/6	PY82 8/-	VS110 4/-	6B8 5/6	6V6G 5/6	89 6/-	9007 4/6
ARP21 5/6	EC91 4/6	HL23 6/-	QP21 6/-	VT25 8/-	6B8G 2/6	6V6GT 6/6	89 6/-	9008 4/6
ARP34 4/6	FC32 3/-	HL23DD 6/-	QP21 6/-	VU39 6/-	6C4 3/6	6X4 5/-	210LFP 3/-	9009 4/6
ARTH2 7/-	ECC32 4/-	HL41 4/-	QP25 5/3	VU111 3/3	6C5 6/-	6X5GT 6/6	210VPT 7 pin 2/6	9010 4/6
ATP4 2/9	ECC81 5/6	HL41DD 8/-	QP230 7/6	VU120 3/-	6C6G 4/3	6Y6G 80/-	217C 17/6	9011 4/6
ATP7 5/6	ECC82 6/6	KBC32 5/-	QQV06-40 4/-	VU133A 3/-	6C8G 5/-	6Z4 8/-	446A 14/-	9012 4/6
AU1 5/-	ECC83 7/9	KF35 5/-	QS75/20 6/9	W21 4 pin 7/-	6E5 5/-	7Q7 7/-	705A 17/6	9013 4/6
AU4 5/-	ECC84 7/9	KT2 4/-	QS95/10 6/9	W31 7/-	6F6 7/-	7Z4 6/6	715B 9/76	9014 4/6
AW3 4/-	ECC85 7/9	KT31 8/-	QS108/45 6/9	Y63 5/-	6F6G 4/-	8D2 2/6	717A 8/6	9015 4/6
AZ 8/-	ECC91 4/-	KT32 6/3	QSI50/15 6/9	Y66 8/-	6F8G 6/6	10Y 8/6	723A/B 45/-	9016 4/6
BL63 6/-	ECL80 8/-	KT33C 6/3	R3 8/-	Z31 6/-	6F12 4/6	12A6 5/-	801 8/6	9017 4/6
BT45 40/-	EF22 7/3	KT44 6/3	R10 12/6	IA3 3/-	6F32 6/-	12AH7 5/6	801 8/6	9018 4/6
BT98 40/-	EF32 5/-	KT63 6/-	REL21 25/-	IA3GT 7/6	6G6G 3/-	12AT7 5/6	801 8/6	9019 4/6
CY31 11/6	EF36 3/6	KT66 11/-	REL37 3/6	ICSGT 7/6	6H6GT 1/9	12U7 6/6	801 8/6	9020 4/6
D1 3/-	EF37A 8/-	KT74 9/-	RL21 25/-	IDBGT 6/-	6H6GT 1/9	12AX7 7/-	801 8/6	9021 4/6
D41 3/3	EF39 4/3	KTW62 7/6	RL37 3/6	IE7GT 7/6	6HA7 3/6	12C1 3/6	801 8/6	9022 4/6
D42 4/-	EF50 2/6	KTW63 6/6	RK34 2/6	ILD5 3/6	6J5 3/6	12C1 22/6	801 8/6	9023 4/6
D77 4/3	EF54 3/3	L30 4/6	SP2 4/-	IR5 6/-	6J5G 3/6	12H6 2/-	801 8/6	9024 4/6
DA30 12/6	EF55 6/-	MH4 3/6	SP4B 7/6	IS5 5/9	6J6 4/3	12J5GT 3/6	801 8/6	9025 4/6
DAF86 8/-	EF70 4/-	MHL4 3/9	SP13C 4/6	IT4 4/-	6J7 7/6	12K8GT 9/-	801 8/6	9026 4/6
DAF91 6/-	EF80 5/6	M14 4/-	SP21O 4/-	2A3 8/-	6K6GT 6/6	12SA7 7/6	801 8/6	9027 4/6
DD41 4/-	EF85 6/10	M16 6/-	SP41 2/6	2A5 8/-	6K7G 2/3	12SC7 4/6	801 8/6	9028 4/6
DE75 15/-	EF86 9/-	MPT42 5/3	SP61 2/-	2A6 7/-	6K7GT 4/9	12SG7 6/6	801 8/6	9029 4/6
DET19 2/6	EF89 7/9	M5/PEN 6/-	STV280/40 12/-	2034 2/6	6K8G 5/9	12SH7 3/-	801 8/6	9030 4/6
DET20 2/6	EF91 3/6	N34 8/-	SU2150A 4/9	2D4A 4/-	6K8GT 8/3	12SJ7 6/-	801 8/6	9031 4/6
DF70 9/-	EF92 4/6	NR15A 3/-	T41 7/-	2X2 4/-	6K8M 8/6	12SK7 7/-	801 8/6	9032 4/6
DF72 7/6	EF95 7/6	NT37 10/-		3A4 5/-	6L5G 6/6	12SL7 7/-	801 8/6	9033 4/6
DF91 3/3	HL32 3/9	(4033A) 10/-		3B24 3/-	6L6 9/-	12SN7 8/-	801 8/6	9034 4/6
DF96 8/-	EL33 8/-	OD3 5/-					801 8/6	9035 4/6

**Cathode Ray Tubes**  
 3BP1 25/-  
 5BP1 35/-  
 5CPI 45/-  
 5EFT 45/-  
 VCR138 30/-  
 VCR139A 35/-  
 VCRX258 (with scanning coil) 45/-

**Photo Tubes**  
 GL16 12/6  
 931A 50/-

**Special Valves**  
 807BR 5/-  
 808 8/-  
 813 6/6  
 815 40/-  
 816 30/-  
 827A 35/-  
 829A 30/-  
 832 15/-  
 843 7/6  
 861 15/-  
 866A 12/6  
 930 8/-  
 954 2/-  
 956 2/-

WL47A 15/-

**AND MANY OTHERS IN STOCK, INCLUDING CATHODE RAY TUBES AND SPECIAL VALVES.** All U.K. Orders below 10/-. P. & P. 1/-; over 10/-, 1/6; Orders over £2, P. & P. free. C.O.D. 2/- extra. Overseas Postage extra at cost.

**Marconi CR-100 Communication Receiver.** 60 kc/s to 30 Mc/s, in very good condition, £25. Carriage 30/-.

**T.C.S. Receivers.** Made by Collins of U.S.A. In fully guaranteed working condition. 1.5-12 mcs. Line up: 12SA7 (1), 12SQ7 (1), 12A6 (2), 12SK7 (3). Power requirements 12 v. L.T., 225 v. H.T. £11.10.0. Carriage 12/6.

**Specially Built Power Pack for the above.** 230 v. A.C. mains, including 6X5GT valve, £3.10.0. Carriage 5/-.

**Transmitter/Receiver No. 22.** 2 mc. to 8 mc. Built almost exactly as No. 19 set but much more economical in battery consumption. Complete in fully working condition with power pack for 12 v. Headgear and Microphone assembly and Key, £9.19.6. Carriage 15/-.

**Brand new original spare parts for AR88 Receivers.** Please write your requirements.

**Low Resistance Headphones, brand new.** Balanced Armature DLR, 7/6. P. & P. 1/-.

**Telephone Handset.** Standard G.P.O. type, new, £1. P. & P. 1/6.

**S.C.R. 522 Receivers (BC624)** 100-156 Mc/s, including all valves, 25/-, P. & P. 5/-.

**H.T. Chokes** made by Bendix Radio (U.S.A.), 3 Henrys 0.600A D.C. 25 ohms D.C. resistance 18,000 v. R.M.S. 60 cycle test, £1.12.6. P. & P. 6/-.

**Ditto 10 Henrys** 250 A D.C. 90 ohms resistance 1,500 v. R.M.S. 60 cycle test, 16/6. P. & P. 3/6.

**Three Microphones T 30 (U.S.A.),** 3/6. P. & P. 1/6.

**Carbon Inset Microphone, G.P.O.** Type 2/6. P. & P. 1/6.

**NEW PRODUCT OF TAYLOR**

Model 127A Pocket size meter. Sensitivity 20,000 D.C. 1,000 o.p.v., A.C. 2.0 ranges.

D.C. current 50µA to 1 amp.

D.C. volts 0.3 v. — 1,000 v. (25 kv by probe).

A.C. volts 10 v. — 1,000 v.

3 resistance ranges from 0.20 megohms (self contained). Meter 40µA 3 1/2 in. arc. Accuracy D.C. 3% A.C. 4%, ohms 5%. Dimensions 5 1/2 in. x 3 1/2 in. x 1 1/2 in. weight 14 ozs. Price £10 complete with instruction manual, test plots and clips. Leather case £1.12.0 extra.

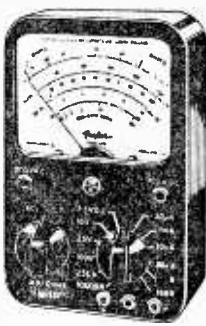

**Output Transformer** in screening can give 9 different ratios 10:1 up to 120:1 for battery receivers or any high resistance pentodes used as output valves, 6/6. P. & P. 1/6.

**P. C. RADIO LTD.**  
 170 GOLDHAWK RD., W.12  
 Shepherds Bush 4946

**Variometers for W/S No. 19.** Fully tested and working, 12/6. P. & P. 2/6.

**Filament Transformers.** Primary 0.190-210-230-250 v., 50 C. Sec. 1 2.5 v. C.T. at 10 amps.; 2.25 v. C.T. at 10 amps.; 3 10.5 v. C.T. at 11 amps.; 3,000 v. insulation. Price £2.19.0. P. & P. 5/-.

**Primary 0.190-210-230-250 v., 50 C. Sec. 1 10 v. C.T. at 4.5 amps.; 2 10 v. C.T. at 4.5 amps.; 4,000 v. insulation £1.16.0. P. & P. 5/-.** Primary 230 v. 50/60 c. 67 v. amp. Sec. 1 6.3 v. 1.6 amps.; 2 6.3 v. C.T. 3 amps.; 3 6.3 v. C.T. 3 amps.; 4 6.3 v. C.T. 3 amps. £1.12.0. P. & P. 5/-.

**Ferranti Transformer.** Oil cooled, 20/19.5 K.V.A., 3 phase, 50 cycles. Primary 360/380/400/420/440 v. Secondary 2,700/2,900/3,100/3,300/3,500 v., 2 1/2 amp. Voltage regulation by simple switches on primary and secondary. Weight 1.150 lbs. Price £125.0.0. Carriage at cost.

**Driver Transformers.** Primary 500 ohms imp. Sec. to match two 805 in push-pull. £1.7.6. P. & P. 5/-.

**Vibrator Unit.** 12 v./160 v. 35 mA. Exceedingly well filtered and smoothed, excellent for car radios. New, including 6X5G valve and vibrator, 17/6. P. & P. 5/-.

**Moving Coil Round Hand Microphone No. 13.** 2 1/2 in. dia. with press switch, 12/6. P. & P. 1/6.

**Complete Set of Strong Aerial Rods (American).** Screw-in type MP49, 50, 51, 52, 53, total length 15ft. 10in., top diameter 0.615in., bottom diameter 0.185in., together with matched aerial base. MP37 with ceramic insulator, ideal for car or roof insulator, £2.10.0, post free.

**PERSPEX FRONTS**

(As on 110: TVs). Heavy, ideal windscreen, etc., fraction of cost, 17in. 9/8, 21in., 15/-.

**SYSTOFLEX**

1.3 mm. assorted colours. Twenty-four 1 yd. lengths, 3/6.

**1,000 YDS. ASSAULT CABLE**

P.V.C. covered steel, ideal telephone lines, garden-ing. 9/- drum.

**MORSE KEYS**

V.G. finish, 2/8. Buzzers, 2/8.

**INSULATING TAPE**

Good quality, half price, 6 rolls, 2/8.

**CERAMIC CONDENSERS**

Top quality, rock-bottom prices, 3, 6, 8, 8.2, 9, 10, 12, 15, 16, 18, 20, 22, 26, 30, 33, 36, 47, 50, 70, 82, 100, 110, 120, 130, 150, 160, 200, 300, 350, 450, 470, 500, 600, 700, 750, 800, 1000, 1500, 1800, 2000, 3000, 4000, 5000. 6d. each. 5/- doz., 12/6 3 doz.

**TUBULAR CONDENSERS**

Top makes 350/500 vv. 0.001, 0.002, 0.003, 0.01, 0.02, 0.03, 8d.; 0.05, 0.1, 0.2, 0.25, 0.5, 10d.

**ELECTROLYTIC CONDENSERS**

4 mfd 500 vv, 1/8; 5 mfd 50 vv, 1/3; 8 mfd 275 vv, 1/3; 8 mfd 450 vv, 1/8; 8 mfd 450 vv, 2/8; 16 mfd 350 vv, 1/8; 16 mfd 350 vv, 2/8; 25 mfd 25 vv, 1/-; 32 mfd 350 vv, 2/-; 32-32 mfd 350 vv, 2/8; 50 mfd 12 v, 1/-; 50-50 mfd 400 v, 4/8.

**FERRITE RODS**

6 x 1/2 in. approx., 2/9 ea.; 6 x 1/2 in., 2/9 ea.

**BATTERIES**

All-Dry, ex-government, 60 plus, 1.5 vv, 2/8 ea.; 6 for 12/6; 1 doz. 22/6.

**INSTRUMENT KNOBS**

White, beautifully finished. 1/2 in., 1/-; 1 in., 1/3; 1 1/2 in., 1/6.

**RADIO AERIALS**

Top quality, insulated, 25ft., 1/- ea., 10/6 doz.

**SWITCHES**

TAXLEY type, 4 pole, 3 way, 3/3; 3 pole, 4 way, 3/3; 2 pole, 6 way, 3/3; 2 pole, 2 way, 3/3; Torflex, small, 1/9; 6-10 amp ratings, 2/3; Spring loaded odd, 1/3.

**COILS**

Techrad Midget Superhet coil sets, aerial and oscillator, long and medium wave, Polystyrene formers, complete circuit, 8/6.

**1000 ohm, 10 watt RESISTORS**

Ideal Smoothing Droppers, 1/3 ea.; 13/ doz.

**CARBON RESISTORS**

1/4 watt, 3d. ea.; 1 watt and above, 4d. ea.; Close tolerance resistors, 6d. Unless stated on order, near values will be supplied.

**MAINS DRIVEN BELLS**

200-250 A.C., incorporates step down transformer, 9/6 ea.

**CHARGING EQUIPMENT**

TRANSFORMERS. Primary 0.210/240, 12 v batteries, 1 amp size, 9/9, plus 1/- post. 2 amp size, 14/8, 1/6 post. 4 amp size, 19/-, 1/9 post. 6 amp size, 25/-, 2/- post.

**VALVE HOLDERS**

International Octal, Old English, 7 pin, B3G (EA50), 3d. ea., 2/9 doz. Moulded Mazda Octal, 3d. ea., 2/9 doz. International Octal, B7G, B8A, 6d. ea., 5/- doz. B7G with skirt, B8A with skirt, 8d. ea., 7/- doz. Screening Cases, B7G and B9A, 6d. ea., 9/- doz. Post 1/- doz.

**FOCUS MAGNETS**

Wide angle with focus control. Single Magnet type, 9/6; Double Magnet type, 12/6. Post 1/-.

**DEFLECTION COILS**

Standard, wide angle, low impedance, 18/-, post 1/-.

**PICK-UP CARTRIDGES**

AGOS 22/6 POWER POINT 18/6 FEIG AND REUTER 15/-, SONOTONE 17/6

**Amazing Value!**

**STEREO OUTFITS**

Consisting of two 3 valves (10F8, 10P14, U09) 3-watt mains amplifiers each complete with 5in. loudspeaker in neat bakelite cases with independent controls, together with UAS Stereo changer and screened leads. Unreproachable. **£11.10.0**

**PORTABLE RECORD PLAYERS**

COLLARO 4-speed autochanger, 2 1/2 watt high gain amplifier. Super two-tone case. 13 gns. Or case only 59/-. 2 1/2-watt Amplifier complete on baffle with speaker, £3.10.0.

**TAPE DECKS**

B.S.R. "MONARDECK". Latest type, 3 1/2 i.p.s., takes 5 1/2 in. spools. Simple controls. £9.15.0  
LATEST COLLARO STUDIO TAPE TRANSCRIBER. Three motors, three speed, 1 1/2, 3 1/2, 8 1/2 i.p.s., takes 7 in. spools, super quality finish, push button controls. £14.10.0.

**CO-AXIAL CABLE**

Semi-Air-spaced low loss. 1-10 yds., 7d. per yd., P. & P. 1/8. 30-30 yds., 6d. per yd., P. & P. 1/8. 50 YD. DRUMS. 24/-

**CONNECTING WIRE**

25 ft. P.V.C. insul., excellent (6 coils, diff. colours, 1/6)  
GORLA KIT: Consisting of Tuning Heart, assembled, with 1st I.F. Transformers, Second F.M. AM and Discriminator Transformers, complete kit. Comprehensive instruction booklet supplied. Booklet only 2/-; Kit, with EC035 valve, £3.13.6; Kit, less EC035 valve, £3.5.0.

**SOLDERING IRONS**

50 watts, 45° pencil bit, 18/6.

**SPARES FOR OLDER-TYPE SETS**

Frame Output Transformers, Blocking Oscillators, Line Output Transformers, Scan Coils, Focus Coils, etc. etc. (Send S.A.E. for Enquiries).

**SUPER STEREO KIT**

Two Midget Amplifiers 3w. Control Unit, Separate Power Pack. Voltage selection Panel. 5in. Loudspeaker. Double Push Button Switch. Indicator Light. The Kit 59/6. P. P. 3/6.

**JASON TUNER KIT**

FMTL .. £8.15.0  
Less Power Pack  
FMT3 .. £9.15.0  
Less Power Pack

**UNIVERSAL VOLT OHM MULTIMETER**

Reads A.C. D.C. Volts to 1000. 3 Ranges at 1000 ohms per volt. D.C. current 3 Ranges to 500 millamps. Resistance Reading to 200K in 2 Ranges. Complete with Prods. 52/6. P.P. 1/6.

**BATTERY CHARGERS**

6 v. and 12 v. 1.5 amps, 49/8; 6 v. and 12 v. 3 amps, 75/-; 6 v. and 12 v. 5 amps, 99/- P.P. 3/-.

**POTENTIOMETERS**

100 ohm 1/2 in. sp.	200k preset
200 ohm w.w. 1/2 in. sp.	250k preset
250 ohm w.w. 1/2 in. sp.	500k preset
500 ohm w.w. 1/2 in. sp.	1 m. ohm preset
500 ohm preset	1 m. ohm 1/2 in. sp.
1k 1/2 in. sp.	1.5 m. ohm
1k small 1/2 in. sp.	2 m. ohm preset
1k preset	5 m. ohm only
1k w.w. 1/2 in. sp.	25 m. ohm w.w. preset
2k d/p switch	22k w.w. preset
2k w.w. preset	25k 1 1/2 in. sp.
2k small preset	25k preset
2k 1 1/2 in. sp.	25k 1/2 in. sp.
5k w.w. 1/2 in. sp.	25k 1 in. sp.
5k w.w. preset	25k preset small
10k 1/2 in. sp. w.w.	50k 1 1/2 in. sp.
10k 1/2 in. sp.	50k 1 in. sp.
10k preset	60k preset
20k 1/2 in. sp.	100k 1/2 in. sp.
20k 1 in. sp.	100k 1/2 in.
20k w.w. preset	

**CABY MULTI-METERS**

Inclusive of Test Prods, Batteries, Instrn. Book.  
MODEL A-10. 2k ohms/v. 30 ranges of volts, current, resistance. £4.15.0, post 2/8.  
MODEL B-20. 10k ohms/v. on 0.5v. and 2.5v. 4k ohms/v. on (10v. to 1000v.) 19 ranges. £6.10.0, post 2/6.

**NEW METERS**

0-500 Micro amp m.c. 2in.	.. .. .	19/-
0-1 ma m.c. 2in.	.. .. .	19/-
0-30 ma m.c. 2 1/2 in.	.. .. .	15/-
0-500 ma m.c. 2 1/2 in.	.. .. .	15/-
0-4 amp hot wire 2 1/2 in.	.. .. .	10/-
0-20 amp m.c. 2in.	.. .. .	9/-

**RECORDING TAPES**

5in. 600ft., 18/-; 5in. 900ft., 18/6; 5 1/2 in. 1200ft., 23/6; 7in. 1800ft., 35/-.

**"MYLAR DUPONT" TAPES**

5in. 1200ft., 37/6; 7in. 1800ft., 44/-; 7in. 2400ft., 60/- All post 1/-.

**CAR RADIO AERIALS**

Telescopic. Heavily chromed, complete with mounting equipment. 22/6.

**CAR RADIO KITS**

Transistorised, M/L waves. No vibrator. 12 volt small. Can be built for £12.19.0.

**BBC/ITA AERIALS**

3 Element combined, 31/6. Post 2/6.

**LINE OUTPUT TRANSFORMERS**

Most types available. State make of receiver. S.A.E. all enquiries.

**TRANSFORMER FILAMENT**

230v. Primary: 6.3v.-1.5 a., 6/8; 210v.-240v. Primary: 6.3v.-2.75a., 8/6. Post 6d.

**J.B. DIAL ASSEMBLY**

Type SL16, a General Purpose Slide Rule Drive for FM/VHF units, Short Wave Converters, etc. Printed in three colours on aluminium with a 0-100 scale. Provision is made for individual calibrations. Travel of pointer 4 1/2 in., scale plate 7 x 4 1/2 in. scale aperture 5 1/2 x 1 1/2 in. Normally 11/8.

OUR PRICE 7/6

**MIDGET MAINS**

230v. Primary. 220v.-30 m.a. and 6.3v. 1 1/2. Standard, 9/-  
As above, Drop through mounting, semi-shrouded, 10/6; Fully shrouded, 11/-.

**TOOLS**

TWIST DRILLS. Set of 9 in plastic case, 1/16-1/2 in., 3/9 Set.

SCREWDRIVERS. Reversible blade, Phillips No. 1 and 2. Clear plastic handle. 2/6.

RADIO PLIERS. Gun finish. 5 1/2 in., 3/11; 6 1/2 in., 4/6.

**MINIATURE DYNAMIC SPEAKERS**

A must for all build-it-yourself hams. As supplied with all current transistor kits. Can also be adapted for homes phones or inter-com. 2 1/2 in. diameter resistance 70 ohms. 4/8. Post 6d.

**GRT HTR ISOLATION TRANSFORMERS**

New improved types, low capacity, small size and tag terminated, Prim. AC 200/250v. Secondaries N11, +25%, +50% BOOST for 2v., 4v., 6.3v., 12v. or 15v. Tubes. 12/6 each.

**TECHNICAL TRADING CO.**

POSTAGE MUST BE ADDED UNLESS OTHERWISE STATED

**FURTHER HUGE PURCHASES DIRECT FROM SOURCE**  
**13 CHANNEL TV's**  
 TABLE MODELS, FAMOUS MAKERS. Complete with all valves and tubes. Unequaled in value. They are untested and not guaranteed to be in working order.  
**AMAZINGLY POPULAR-IDEAL SECOND SETS**  
**12" - £3.19.** (P. & P. 12/6)  
**14" - £6.19.** (P. & P. 15/-)  
**12" 5 CHANNEL TV's 45/-** (P. & P. 12/6)  
**14" 5 CHANNEL TV's 85/-** (P. & P. 12/6)

**STARR GALAXY SPARES**  
 Huge quantity (Autochangers). S.A.E. enquiries.  
**★ Record Players** Carriage 4/-... £5 10 0  
 GARRARD 4-speed 45/46... £9 17 8  
 CARRARD RC120P Mk. II... £7 19 0  
 B.S.R. (UA14) Autochanger... £7 19 0  
 EM1 4-speed stereo... £6 19 0  
 B.S.L. (UAS) Autochangers... £8 15 0

**4-SPD. RECORD PLAYERS**  
 Latest B.S.R. TU9 Turntable, together with 3 lightweight Starr Galaxy dual sapphire crystal turnover pick-up head. Truly amazing value  
**£3.10.0** Carr. 2/6

**GALAXY PICKUPS**, as above, only 19/6.  
**External ITV Converters with power pack**  
 Hammered finish. Very compact. Gain and Trimming controls. Listed at £7.7.  
**Carrriage 2/6. OUR PRICE 39/-**

**★ TRANSISTORS ★**  
**RED SPOT** Now only 3/6. **WHITE SPOT 4/6**  
**DIODES** General purpose, famous make, 8d. 8/- doz. GEX44 type, 3/6.

**★ VALVES BY RETURN OF POST ★**

10% DISCOUNT		SPECIAL OFFER TO PURCHASERS of any SIX VALVES marked in black type (15% in dozen). Post: 1 valve, 6d.; 2-11, 1/-.	
OZ4	5/6 6AM6	3/8 6J79	5/6 6X2
1A5GT	5/6 6A05	6/6 6K6GT	7/8 6X4
1A7GT	11/8 6A76	7/- 6J8	8/6 6X59
1C6GT	9/8 6A06	7/- 6K6GT	6/6 6X93
1D5	9/6 6B7	9/6 6K7	5/8 7A7
1D6	9/6 6B89	6/6 6K7G	5/8 7B5
1H5GT	9/6 6B16	6/6 6K7GT	5/6 7B6
1L4	3/6 6BE6	6/6 6K8	10/- 7B7
1L5	3/6 6BE6G	12/6 6K8G	6/6 7C5
1L8	3/6 6BH6	6/- 6K9GT	10/- 7C6
1N3GT	9/6 6B16	6/- 6L1	12/6 7E7
1H5	5/6 6B7	9/6 6L6	9/6 7H7
1S4	8/6 6BWE	7/8 6L6G	7/6 7K7
1S5	3/6 6BW7	6/6 6L7	9/- 7K7
1T4	4/- 6BX6	5/6 6L7G	7/6 7F7
2P21	4/6 6C4	3/6 6L8	9/- 7V7
6A4	5/6 6C5	3/6 6L19	12/6 7Y4
6C3	5/6 6C5	3/6 6L19	12/6 7Y4
6C4	7/6 6C9	3/6 6L2	8/6 7Z4
3Q5GT	8/9 6C16G	18/6 6L21D	7/6 8D3
3R4	7/- 6D1	9/6 6L120	8/6 10C14
3R4G	7/- 6D1	9/6 6L120	8/6 10C14
5Y4G	5/6 6D2	12/6 6E25	9/- 10F9
5Y4G	9/6 6D4	9/6 6E25	12/6 10L14
5Y8G	8/- 6F1	9/6 6E27	6/6 10N13
6B3GT	9/6 6F2G	6/6 6G7GT	9/6 10P13
6Y4G	11/6 6F9M	7/6 6H3	9/6 10P14
6Z4	11/6 6H2	9/6 6H7	9/6 10P18
6Z4G	9/6 6H2	9/6 6H7	9/6 10P18
6Z4GT	11/6 6H4	9/6 6H7	9/6 10P18
6A7	10/- 6H5	9/6 6H8	9/6 10P18
6A8G	9/6 6H6	9/6 6H8	9/6 10P18
6A8GT	13/6 6H8	9/6 6H8	9/6 10P18
6A8S	9/6 6H8	9/6 6H8	9/6 10P18
6A8T	9/6 6H8	9/6 6H8	9/6 10P18
6A8S	9/6 6H8	9/6 6H8	9/6 10P18
6A8T	9/6 6H8	9/6 6H8	9/6 10P18
6A8S	9/6 6H8	9/6 6H8	9/6 10P18
6A8T	9/6 6H8	9/6 6H8	9/6 10P18
6A8S	9/6 6H8	9/6 6H8	9/6 10P18
6A8T	9/6 6H8	9/6 6H8	9/6 10P18
6A8S	9/6 6H8	9/6 6H8	9/6 10P18
6A8T	9/6 6H8	9/6 6H8	9/6 10P18

**NEW LOW PRICES GUARANTEED 3 MONTHS**

12E1 12/6 3E25GT 8/6 DA891 5/8 EC250 8/9 E191 4/9 N108 188- 741 7/6 UF4 9/6

12E1GT 7/8 3E32 8/6 DA906 7/6 EC31 9/6 E194 8/6 N152 10/6 TH30C 12/6 UF42 6/6

12K1A 12/1K C12B CRM121 CRM121A CRM121B CRM122 CRM123 MW31-14C MW31-16 MW31-18 MW31-74 141K 7201A C14FM CRM141 CRM142 CRM143 CRM144 MW36-24 MW36-44 17AS4 171K AW36/21 C17FM CRM171 CRM172 MW43-64 MW43-69 7301A AW43-30 C14BM C17BM CRM151 CRM152A CRM152B CRM153 CRM173 MW49-30 MW51-1 AW59-30 CRM212 MW53-20 MW53-80

24in. 18/-; 3in. 18/-; 3in. 16/-; 6in. 16/-; 6in. 18/-; 8in. 18/-; 10in. 22/6; 12in. 25/6; 7 x 4in. elliptical, 15/-; 9 x 6in. elliptical, 22/6; 10 x 6in. elliptical, 23/6; 8 in. Meteorian 15 ohms HF410, 70/-; 10in. Meteorian 65-15 ohms HF1012, 99/0; 12in. Closed Field, 27/6. STOP PRESS. 8 x 13in. Speakers, 22/6.

**★ Loudspeakers ★**  
**TOP MAKES—MANUFACTURER FRESH**  
 24in. 18/-; 3in. 18/-; 3in. 16/-; 6in. 16/-; 6in. 18/-; 8in. 18/-; 10in. 22/6; 12in. 25/6; 7 x 4in. elliptical, 15/-; 9 x 6in. elliptical, 22/6; 10 x 6in. elliptical, 23/6; 8 in. Meteorian 15 ohms HF410, 70/-; 10in. Meteorian 65-15 ohms HF1012, 99/0; 12in. Closed Field, 27/6. STOP PRESS. 8 x 13in. Speakers, 22/6.

**★ PM SPEAKERS Surplus 3 ohm**  
 Tested, top makes, performance guaranteed. 4in. 9/- 6in. 11/- 7x4 13/- 8in. 11/- 10in. 13/-

**TUBES DIRECT FROM OUR FACTORY**  
 Due to the increasing demand for our wide range of CRT's and our efficient handling methods we offer unbeatable value.  
 REGUNNED TUBES have New Guns Getters. Aquadac Coating Bases, etc.  
**TOP QUALITY GUARANTEED**  
 6 MONTHS 12 MONTHS 12 MONTHS  
 REVAQUINED REGUNNED BRAND NEW TYPES

£1-10	£3	MW31/74
£2	£4	£4-15
£2-10	£4-10	MW36/24
£3	£5-5	£5-15
£4	£6-10	MW43/64
		£6-15

**PLEASE NOTE:** Many other types not listed available. S.A.E. enquiries.

**SPECIAL OFFERS**

**UAS Stereo Changers**  
 B.S.R. famous Monarch autochangers fitted with quality stereo cartridge. Truly amazing value. **£6.19.0**

**MAINS AMPLIFIERS**  
 3 valve (10P3, 10P14, U101. 3 watt, 8in. loud speaker, in two tone cases with controls. Ideal for record players, P.A. work, etc. **49/-**

**★ Loutspeakers ★**  
**TOP MAKES—MANUFACTURER FRESH**  
 24in. 18/-; 3in. 18/-; 3in. 16/-; 6in. 16/-; 6in. 18/-; 8in. 18/-; 10in. 22/6; 12in. 25/6; 7 x 4in. elliptical, 15/-; 9 x 6in. elliptical, 22/6; 10 x 6in. elliptical, 23/6; 8 in. Meteorian 15 ohms HF410, 70/-; 10in. Meteorian 65-15 ohms HF1012, 99/0; 12in. Closed Field, 27/6. STOP PRESS. 8 x 13in. Speakers, 22/6.

**★ TRANSISTORS ★**  
**RED SPOT** Now only 3/6. **WHITE SPOT 4/6**  
**DIODES** General purpose, famous make, 8d. 8/- doz. GEX44 type, 3/6.

**★ RECTIFIERS ★**  
 For Chargers, scientific, full wave, 12 volt, 3-4 amps. 6/6; (Carr. 1/-) 250, 70, 80 mA. 5/-; KMI, 6/6; RM2, 8/-; RM2, 8/-; RM4, 15/6; RM5, 21/-; 14A56, 17/-; 14A87, 23/-; 14A100, 25/-; 16RC1, 1-1-1, 7/9; 17A1-1-1-1, 7/9; 18R12-2-8-1, 14/-; 14RA1-2-8-2, 17/-; 14RA1-2-8-3, 20/-.

**100 RESISTORS 6/6**  
**100 CONDENSERS 10/-**

Miniature Ceramic and Silver Mica Condensers. 3 pF to 5,000 pF. 100 VALUE OVER 65 VALVES ALL GUARANTEED 3 MONTHS  
**PL81 SOLED 4/6 EY51 SHORT ENDS 4/6**

**TV PROJECTION UNITS**  
 Complete Standard Philips optical units with Mullard MW6-2 projection tube **£3.10.0** (untested) at a fraction of cost.

**TURRET TUNERS**  
 38 Mergs at 29/-. 16 Mergs at 39/-. Complete with Valves PC24, PCF80. Famous make.

Post: 2 lbs. 1/6, 4 lbs. 2/-, 7 lbs. 2/9, 15 lbs. 3/6, etc. No C.O.D. ALL ITEMS 5% + POST FREE IN DOZENS. (Callers always welcome). LIST OF 1000 SNIPS 6d. P.O. BOX 21 (W) 350-352 FRATTON ROAD, PORTSMOUTH.

**TECHNICAL TRADING CO.**  
 www.americanradiohistory.com



# Stern's "Fidelity" TAPE RECORDERS

**BEFORE YOU BUY  
— YOU SHOULD  
HEAR THESE**

**RECORDERS. THEY ARE COMPARABLE  
TO THE MUCH HIGHER-PRICED MODELS**

There are no better value-for-money Tape Recorders on the market—if you can't call and hear them, send S.A.E. for fully descriptive leaflets.

**MODEL CR3/S** Incorporates the new COLLARO "STUDIO" TWIN TRACK 3-speed Deck H.P. Terms: Deposit £7.18.0 and 12 months of £39.10.0 £2.17.11.

**MODEL CR3/T** Incorporates the very popular 3-speed COLLARO Mk. IV "TRANSCRIPTOR", Deck which has both upper and lower tape tracks. £47.10.0 H.P. Terms: Deposit £8.10.0 and 12 months of £3.9.8.

**MODEL TR3/Mk.VI** Incorporates the New TRUVOX Mk. VI TWIN TRACK 2-speed Tape Deck H.P. Terms: Deposit £8.18.0 and 12 months of £3.12.7.

All prices quoted provide for the COMPLETE RECORDER including CRYSTAL MICROPHONE and 1,200 ft. Spool of Tape.

Each Model incorporates the highly successful HF/TR3 Amplifier (described opposite) thus ensuring truly "Hi-Fi" record and playback facilities.

## TAPE AMPLIFIERS and PRE-AMPLIFIERS PRESENTED FROM MULLARD DESIGNS

### MODEL HF/TR3 TAPE AMPLIFIER

(Mullard Type "A" design) A very high quality Amplifier incorporating 3-speed treble equalisation, using the latest FERROXUBE POT CORE INDUCTOR, FOR COLLARO-TRUVOX-BRENELL-WEARITE or MOTEK Tape Decks, has GILSEN Output Transformer. Includes separate Power Supply Unit.

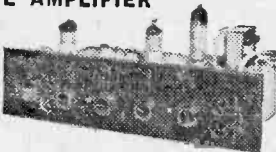

### MULLARD TYPE "C" TAPE PRE-AMPLIFIER—ERASE UNIT

The "Hi-Fi" link to add full tape recording facilities to High Fidelity home installations. Incorporates FERROXUBE POT CORE PUSH PULL OSCILLATOR and 3-speed treble equalisation by FERROXUBE POT CORE INDUCTOR, FOR WEARITE-COLLARO-TRUVOX-BRENELL or MOTEK TAPE DECKS. Includes separate power Supply Unit. OR ASSEMBLED KIT OF PARTS £14.0.0 H.P. £3.8.0 Deposit and 12 months £1.4.11. £17.0.0



OR ASSEMBLED £16.10.0  
H.P. Deposit £3.6.0 and 12 months at £1.4.2.

(Excluding power unit £11.5.0 and £14.10.0 respectively).

### FOR THE HOME CONSTRUCTOR SPECIAL 'COMBINED ORDER' PRICES

- (a) The COLLARO "STUDIO" TAPE DECK and our Mullard Type "C" PRE-AMPLIFIER and POWER Unit Assembled and Tested. £29.10.0  
H.P. Deposit £5.18.0, and 12 months £2.3.3.
- (b) As above but TYPE "C" PRE-AMPLIFIER supplied as complete KIT OF PARTS £26.10.0
- (c) The COLLARO Mk. IV TAPE DECK and the MULLARD TYPE "C" PRE-AMPLIFIER and Power Unit assembled, tested. £35.0.0  
H.P. Deposit £7, and 12 months £2.11.4.
- (d) As (c) but Type "C" as COMPLETE KIT OF PARTS £32.0.0
- (e) The TRUVOX Mk. VI DECK and the assembled Type "C" Pre-amplifier and Power Unit. £40.0.0  
H.P. Deposit £8.0.0, and 12 months £2.18.8.
- (f) As above but Type "C" as complete KIT OF PARTS £36.10.0
- (g) The BRENELL Mk. V DECK and the assembled Type "C" PRE-AMPLIFIER and POWER UNIT £46.0.0  
H.P. Deposit £9.4.0, and 12 months £3.7.6.
- (h) As (g) but Type "C" as complete KIT OF PARTS £43.0.0
- (i) THE WEARITE 4A DECK with TYPE "C" assembled and tested. £56.0.0  
H.P. Deposit £11.4.0, and 12 months £4.2.1.  
(Carriage and Insurance on above quotes 10/- extra.)

- (a) COMPLETE KIT to build the HF/TR3 Amplifier, together with the COLLARO "STUDIO" DECK. £25.10.0
- (b) As above but with HF/TR3 supplied ASSEMBLED and TESTED £29.0.0  
H.P. Deposit £5.18.0, and 12 months £2.2.6.
- (c) COMPLETE KIT to build the HF/TR3, together with the Mk. IV COLLARO "TRANSCRIPTOR" TAPE DECK £30.15.0  
(£1 extra if we are required to wire up Deck Switch Banks.)
- (d) As above but HF/TR3 supplied ASSEMBLED and TESTED £34.10.0  
H.P. Deposit £7.0.0, and 12 months £2.10.5.
- (£1 extra if we are required to wire up Deck Switch Banks.)
- (e) COMPLETE KIT to build the HF/TR3, together with the NEW TRUVOX Mk. VI TAPE DECK. £36.0.0
- (f) As above but HF/TR3 supplied ASSEMBLED and TESTED £39.10.0  
H.P. Deposit £7.18.0, and 12 months £2.17.11.
- (g) COMPLETE KIT to build the HF/TR3 AMPLIFIER with the BRENELL Mk. V TAPE DECK. £41.10.0
- (h) As above but HF/TR3 supplied ASSEMBLED and TESTED £45.0.0  
H.P. Deposit £9.0.0, and 12 months £3.6.0.
- (i) THE WEARITE 4A DECK with assembled and tested HF/TR3 Amplifier including WEARITE Head Lift Transformer. £55.0.0  
H.P. Deposit £11.0.0, and 12 months £4.0.8.

EACH OF THE ABOVE CAN BE SUPPLIED IN A PORTABLE CASE THUS FORMING A COMPLETE PORTABLE PRE-AMPLIFIER. FULL DETAILS ON REQUEST.

Carriage and Insurance on each above 13 10/- extra. Attractive PORTABLE CASE is available to accommodate the TRUVOX or COLLARO TAPE DECKS and we offer it, together with ROLA/CELESTION 10 x 9in. LOUSPEAKER—ACOS CRYSTAL MICROPHONE, and 1,200ft. SPOOL E.M.I. TAPE—ALL FOR £9.10.0, Carriage and Insurance 5/- extra.

## A LARGE PURCHASE OF BRAND NEW AND FULLY GUARANTEED TRUVOX and GARRARD TAPE EQUIPMENT

ENABLES THESE OUTSTANDING PRICE REDUCTIONS



The "MODEL HF/G2R" PORTABLE TAPE RECORDER (Original Price £33.0.0) FOR ONLY 22 gns.

H.P. Dep. £4.14.0. 12 months £1.13.9. (Carr. & Ins. 10/- extra). Incorporates THE LATEST GARRARD "MAGAZINE" TAPE DECK and a HIGH QUALITY AMPLIFIER which is entirely based on the very successful MULLARD TYPE "A" DESIGN and specifically developed to operate the GARRARD DECK. PRICE INCLUDES SUPPLY OF THE GARRARD TAPE MAGAZINE and a 4in. SPOOL OF DOUBLE PLAY TAPE. Completing a Twin Track Recorder operating at 3 1/2 in./sec. speed and providing up to 1 hour 10 mins. playing time. Truly "Portable", weighs only 22 lbs. Outstanding features are excellent performance and simplicity of operation.

The "MODEL TK/MkIV" PORTABLE TAPE RECORDER (Original Price £49.10.0)

FOR ONLY £36.10.0 Price includes a 7" spool of EMI Tape!

H.P. Dep. £7.8.0. 12 months £2.13.8 (Carr. and Ins. 10/- extra). Incorporates the Truvox MkIV Tape Deck, Rola/Celestion 8 x 5 in. Loudspeaker and the Truvox Type "K" Amplifier specifically developed by Truvox Ltd to correctly operate their MkIV Tape Deck. As a result we are able to present a highly perfected tape recorder providing sound reproduction which truly justifies the title "High Fidelity". A Twin Track Two Speed model operating at 31 and 7 1/2 in./sec. speeds and incorporating Magic Eye Indicator, Safety Button. (Prevents accidental erasure). Ext. Speaker output, tone and volume controls.



FULLY DESCRIPTIVE LEAFLETS ON ALL OF ABOVE ARE AVAILABLE—BUT PLEASE ENCLOSE S.A.E. AND STATE WHICH LEAFLET IS REQUIRED.

# STERN RADIO LTD.



# STERN'S MULLARD DESIGNS

Designed by MULLARD—presented by STERN'S strictly to specification

## COMPLETE KIT OF PARTS—

### MULLARD "5-10" MAIN AMPLIFIER

For use with the MULLARD 2-valve pre-amplifier with which undistorted power output of up to 10 watts is obtained. We supply SPECIFIED COMPONENTS AND NEW MULLARD VALVES, including PARMKO MAINS TRANSFORMER and choice of the latest Ultra-Linear PARMKO or the PARTRIDGE Output Transformer. PRICE COMPLETE KIT (PARMEKO Output Trans.)

Alternatively we supply ASSEMBLED and TESTED **£10.00**

**£11.10.0**

ABOVE INCORPORATING PARTRIDGE OUTPUT TRANSFORMER, **£16.0 EXTRA**



### MULLARD'S PRE-AMPLIFIER TONE CONTROL UNIT

Employing two EF86 valves, and designed to operate with the MULLARD MAIN AMPLIFIERS, but also perfectly suitable for other makes.

PRICE COMPLETE **£6.60** ASSEMBLED AND TESTED **£8.00**

Supplied strictly to MULLARD'S SPECIFICATION and incorporating:

- Equalisation for the latest R.L.A.A. characteristics.
- Input for Crystal Pick-ups, and variable reluctance magnetic types.
- Input (a) Direct from High Imp. Tape Head. (b) From a Tape Amplifier or Pre-amplifier
- Sensitive Microphone Channel. • Wide range BASS and TREBLE Controls.



### COMPLETE MULLARD "5-10" AMPLIFIER

The popular and very successful complete "5-10" incorporating Control Unit providing up to 10 watts high quality reproduction. Only Specified Components and new MULLARD VALVES are supplied including PARMKO MAINS TRANSFORMERS and choice of the latest PARMKO or PARTRIDGE ULTRA-Linear Output Transformers.

KIT OF PARTS **£11.10.0** OR ASSEMBLED and TESTED **£13.10.0**

HIRER PURCHASE (Assembled Amp. only). DEPOSIT **£21.0** 12 months at 19/10.

ABOVE INCORPORATING PARTRIDGE OUTPUT TRANS. **£16.0 extra.**

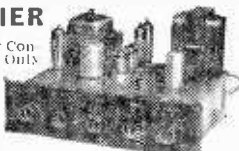

### COMPLETE MULLARD "3-3"

THE IDEAL AMPLIFIER FOR A SMALL HIGH QUALITY INSTALLATION PROVIDING EXCELLENT REPRODUCTION OF UP TO 3 WATTS OUTPUT COMPLETE KIT OF PARTS **£7.10.0** OR ASSEMBLED and TESTED **£8.19.6** (plus 6/6 carriage and insurance) H.P. Terms: Deposit **£2.0** and 8 Months at **£1.0**. Complete to MULLARD'S SPECIFICATION including Mullard valves and a PARMKO OUTPUT TRANSFORMER.

range of MULLARD MAIN AMPLIFIERS but will also operate equally well with any make of Amplifiers requiring an input of 200 mv/ohms.

COMPLETE KIT OF PARTS **£12.10.0** ASSEMBLED AND TESTED **£15.00** H.P. £3 Dep. and 12 mths. at **£1.20**

### MULLARD FOUR CHANNEL MIXER UNIT

Self powered with Cathode follower output. Incorporates Two inputs for MICROPHONES and a fourth for RADIO or TAPE

Complete Kit of Parts **£8.80** Assembled and Tested **£10.00**

TERMS: Deposit **£2** and 12 months at 15/-

MODEL LL one microphone input matched for moving coil or Ribbon Mfke. **£17.0 extra.**

### Mk.11 "Fidelity" FM TUNING UNIT

An attractively presented Unit incorporating MULLARD PERMEABILITY TUNING HEART and corresponding Mullard valve line up. FOR THE CONSTRUCTOR **£10.10.0** ASSEMBLED **£14.50**

### A SPECIAL CASH OFFER!!

This very attractive PORTABLE AMPLIFIER CASE together with a good quality GRAM AMPLIFIER and a matched P.M. SPEAKER. For ONLY **£8.7.6** (Plus 7/6 Carr. & Ins.)

The amplifier consists of a 2-stage design incorporating 3 modern B.V.A. valves and has separate BASS and TREBLE CONTROLS.

The Portable Case will also accommodate almost any make of Autochanger and is act. actively finished in Mushroom Grey Rexine. WE ALSO SUPPLY SEPARATELY—

(a) The 2-stage (plus Rectifier) AMPLIFIER **£4.2.6**

(b) THE PORTABLE CARRYING CASE **£3.17.6**

(c) 6 1/4 in. P.M. SPEAKER 18/9 Carriage and Insurance 4/- extra

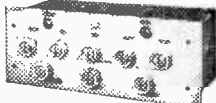

### THE "ADD-A-DECK"

Incorporating GARRARD "MAGAZINE" TAPE and the MATCHED MODEL HF/3P PRE-AMPLIFIER

Supplied on ONE CHASSIS (as illustrated) READY FOR USE **18 Gns.**

(Carr. & Ins. 10/- extra).

Price includes Garrard Magazine and a 4in. Spool Double Play Tape

H.P. Deposit **£3.16.0** and 12 months of **£1 7/8**. Provides complete tape recording facilities and designed to operate through the pick-up sockets of the standard type of RADIO RECEIVER or an AMPLIFIER. From which really first class reproduction is obtained. It consists of a Twin Track Deck connected to the Pre-amplifier and operates at 3 1/2 in/sec. speed providing up to 1 hr. 10 mins. playing time

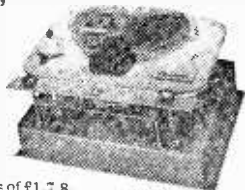

### RECORD PLAYERS THE LATEST MODELS ARE IN STOCK, MANY AT REDUCED PRICES

SEND S.A.E. FOR ILLUSTRATED LEAFLET

B.S.R. MONARCH CAN 4-speed mixer Autochanger with Crystal Pick-up. **£6.19.6**

The NEW COLLARO MODEL RP594 4-speed Single Record Player, Studio Cartridge. **£9.18.9**

The NEW COLLARO C30 4-speed autochanger unit with Studio "O" pick-up. **£7.19.6**

The E.M.L. 4-speed Single Record Player with Crystal Pick-up. **£6.9.6**

THE NEW B.S.R. Model UA12 in Stock. A4 "SPEED" MIXER AUTOCHANGER. **£8.7.6**

UA12 also available incorporating the B.S.R. STEREO Pick-up, plays L.P. and 78 Records. **£10.10.0**

GARRARD MODEL TA/MK11 4-speed Player fitted high output Crystal Pick-up. **£8.10.0**

GARRARD MODEL RC/21L Autochanger 4-speeds. High output. Crystal Pick-up. **£10.10.0**

Carriage and Insurance on each above. 5/- extra.

Dept. P.W. 109 FLEET ST., LONDON E.C.4

Telephone: FLEET STREET 5812/3/4

**Easy-to-build kit-sets of**

**Heathkit**  
DAYSTROM

**highest quality at lower cost**

**AMATEUR TRANSMITTER Model DX-100U**  
Covers all amateur bands from 160-10 metres. Self-contained including Power Supply **£78.10.0**

**"HAM" TRANSMITTER Model DX40U**  
From 80-10 m. Power input 75 w. C.W., 60 w. peak C.C. phone. Output 40 w. to aerial. Compact and self-contained. Prov. for V.F.O. **£29.10.0**

**VAR. FREQ. OSCILLATOR VF-1U**  
From 160-10 m. Ideal for our DX-40U and similar transmitters. Price less valves **£8.19.6** **£10.12.0**

**R.F. SIGNAL GENERATOR, Model RF-1U**  
Up to 100 Mc/s fundamental and 200 Mc/s. on harmonics and up to 100mV. output on all bands. **£11.11.0**

**AUDIO SIGNAL GENERATOR Model AG-9U**  
10 c/s to 100 kc/s. switch selected. Distortion less than 0.1% 10 v. sine wave output metered in volts and dB's. **£19.3.0**

**VALVE VOLTMETER Model V-7A**  
Measures volts to 1,500 (D.C. and R.M.S.) and 4,000 pk. to pk. Res. 0.1Ω to 1,000 MΩ. D.C. input impd. 11MΩ. Complete with test prods leads and standardising battery. **£13.0.0**

**Portable 2¾ in. SERVICE 'Scope Model OS-1**  
Compact portable scope ideal for servicing and general work. Y amplifier sensitivity 10 mV/cm; response -3 dB 10 c/s-2.5 Mc/s. Time base 15 c/s-150 kc/s. Printed circuit. Case 7¼ x 4¼ x 12½ in. long. Wt. only 10½ lb. **£18.19.6**

**5 in. OSCILLOSCOPE Model O-12U**  
Has wide-band amplifiers, essential for TV servicing. F.M. alignment, etc. Vertical freq. response 3 c/s. to over 5 Mc/s. without extra switching. T/B covers 10 c/s to 500 kc/s. in 5 ranges. **£34.15.0**

**RES.-CAP. BRIDGE Model C-3U**  
Measures capacity 10pF to 1,000μF resistance 100Ω to 5 MΩ and power factor 5-450 v. test voltages. With safety switch. **£7.19.6**

**SINGLE CHANNEL AMPLIFIER, MA-12**  
10-12 watt Hi-Fi amplifier. Extremely low distortion and wide frequency range. **£9.19.6**

**"GLOUCESTER" EQUIPMENT CABINET**  
4½ x 30 x 21 in. deep Mk. I houses Record Player Stereo Amplifier, F.M. Tuner, records, etc. Mk. II will house a Tape Deck in addition. Left in the white for finish to personal taste.  
Mk. I ... **£15.18.6** Mk. II ... **£17.8.6**

**"CHEPSTOW" EQUIPMENT CABINET**

Ideal cabinet for small rooms or armchair operation. Houses Record Player, F.M. Tuner and Stereo Amplifier. **£10.10.0**

**"PACKAGED DEALS" of Hi-Fi Equipment including TAPE DECKS (Collaro or Truvox), RECORD PLAYERS (Collaro or Connoisseur) and DECCA ffs PICK-UPS**

Write in to see how these deals save you further money:

Please send me FREE CATALOGUE (Yes/No) \_\_\_\_\_  
Full details of model(s) \_\_\_\_\_

NAME \_\_\_\_\_

ADDRESS \_\_\_\_\_



F.M. TUNER



S.33



S-38



DX-40



UXR-1



OS-1



SSU-1



THE "GLOUCESTER" EQUIPMENT CABINET

**GRID DIP METER Model GD-1U**  
Coverage from 2 Mc/s. to 250 Mc/s. Complete set or plug-in coils provided. **£9.19.6**

**TAPE RECORDING/PLAYBACK AMPLIFIER Model TA-1**  
Monaural (TA-1M) **£16.14.0**. Conversion unit to Stereo **£6.0.0**. Stereo (TA-1S). **£22.4.9**

**SHORT-WAVE TRANSISTOR PORTABLE Model RSW-1**  
Extending aerial leather case 2 short-wave bands Trawler and Medium. **£20.18.6**

**6-TRANSISTOR PORTABLE Model UXR-1**  
Pre-aligned I.F. transformers, printed circuit, 7 x 4 in. high-lux speaker. Real hide case. **£14.18.6**

**DUAL-WAVE TRANSISTOR RADIO UJR-1**  
This sensitive headphone set is a fine introduction to electronics for any youngster. **£2.16.6**

**HI-FI F.M. TUNER**  
Tuning range 88-108 Mc/s. For your convenience this is available in two units sold separately as follows: Tuner Unit (FMT-4U) with 10.7 Mc/s. i.f. output (£3.2.0 Inc. P.T.). I.F. Amplifier (FMA-4U) complete with cabinet and valves (£10.10.6). **£13.12.6**

**HI-FI 16W STEREO AMPLIFIER Model S-88**  
10mV. basic sensitivity (2mV. available, £1 extra). Ganged controls. Stereo-Monaural gram. radio and tape recorder input. Push-button selection. Two-tone grey metal cabinet. **£25.5.6**

**6-W STEREO AMPLIFIER Model S-33**  
3 watts per channel, 0.3% distortion at 2.5 w/chn 20dB N.F.B. inputs for Radio (or Tape) and Gram. Stereo or Monaural, ganged controls. Sensitivity 100 mV. **£11.8.0**

**TRANSCRIPTION RECORD PLAYER RP-1U**  
4-speed A.C. motor Ronette Stereo/Mono pick-up. Complete with plinth. **£12.10.0**

**HI-FI SPEAKER SYSTEM Model SSU-1**  
Ducted-port bass reflex cabinet "in the white" Twin speakers. With legs **£11.12.6**. **£10.5.6**

**"COTSWOLD" HI-FI SPEAKER SYSTEM KIT**  
Acoustically designed enclosure "in the white" 26 x 23 x 15½ in. housing a 12 in. bass speaker with 2 in. speech coil, elliptical middle speaker and pressure unit to cover the full frequency range of 30-20,000 c/s Complete with speakers, cross-over unit, **£19.18.6** level control, etc.

**COMPLETE MATCHED STEREO OUTFIT**  
includes record player, amplifier and twin speaker systems (pedestal speaker legs optional **£4.14.0** extra). **£42.10.0**

**STEREO CONTROL UNIT USC-1**  
Luxury model with press-button inputs to suit any pick-up or tuner and most tape-heads. Output 1.3 v. R.M.S. per channel. Printed circuit construction. **£17.19.6**

**STEREO HEAD BOOSTER USP-1**  
Ideal for boosting tape-head output and low output pick-ups (e.g. **£5.19.6** Decca ffs).

Prices include free delivery UK  
Deferred Terms  
available on orders over £10

**DAYSTROM LTD.**

DEPT. P.W.3, GLOUCESTER, ENGLAND

A member of the Daystrom Group, manufacturers of the  
WORLD'S LARGEST-SELLING ELECTRONIC KITS

PW3

# Practical Wireless

VOL. XXXVI No. 649 MARCH, 1961

Editorial and Advertisement  
Offices:

**PRACTICAL WIRELESS**

George Newnes, Ltd., Tower House,  
Southampton Street, W.C.2.

© George Newnes Ltd., 1960

Phone: Temple Bar 4363.

Telegrams: Newnes, Rand, London.  
Registered at the G.P.O. for trans-  
mission by Canadian Magazine Post.

**SUBSCRIPTION RATES**  
including postage for one year

Inland . . . . . £1.3.0 per annum  
Abroad . . . . . £1.1.6 per annum  
Canada . . . . . 19s. per annum

## Contents

	Page
Editorial . . . . .	965
Round the World of Wireless . . . . .	966
A Midget Push-pull Amplifier . . . . .	968
Crystal Controlled CW Transmitters . . . . .	972
A Band II Pre-amp . . . . .	973
Valve Bias Explained . . . . .	975
Quartz Crystal Etching . . . . .	979
Checking Transistor Circuits . . . . .	980
A Stereo Amplifier . . . . .	983
On Your Wavelength . . . . .	987
A Versatile Tape Recorder . . . . .	988
The P.W. Signal Generator . . . . .	992
Stylus Wear Timer . . . . .	995
A Valve Voltmeter . . . . .	996
A Capacity Tester for Small Values . . . . .	1001
A D.C. Test Meter . . . . .	1005
Trade News . . . . .	1013
Club News . . . . .	1014
Short Wave Section (H.R.O.)	
Senior . . . . .	1017
Letters to the Editor . . . . .	1022

The Editor will be pleased to consider articles of a practical nature. Such articles should be written on one side of the paper only, and should contain the name and address of the sender. Whilst the Editor does not hold himself responsible for manuscripts, every effort will be made to return them if a stamped and addressed envelope is enclosed. All correspondence intended for the Editor should be addressed: The Editor PRACTICAL WIRELESS, George Newnes, Ltd., Tower House, Southampton Street, London, W.C.2. Owing to the rapid progress in the designs of wireless apparatus and to our efforts to keep our readers in touch with the latest developments, we give no warranty that apparatus described in our columns is not the subject of letters patent.

Copyright in all drawings, photographs and articles published in PRACTICAL WIRELESS is specifically reserved throughout the countries signatory to the Berne Convention and the U.S.A. Reproductions or imitations of any of these are therefore expressly forbidden. PRACTICAL WIRELESS incorporates "Amateur Wireless."

## ANOTHER FREE BLUEPRINT

IN the next issue of PRACTICAL WIRELESS, the first of a new series will appear on constructing the "P.W. Roadfarer". This is an A.M./F.M. Receiver which is transistorised throughout. Its advance design allows it to be operated either from its own internal batteries or direct from the domestic mains supply. Printed circuits have been used and the construction of the receiver should therefore possess few difficulties even for the inexperienced constructor. The set is constructed in four main sections: the A.M. tuner; the F.M. tuner; the audio amplifier and the main power supply unit. The complete receiver is housed in an attractive plastic cabinet of small size which contains a ferrite rod aerial for A.M. reception and also a telescopic aerial for F.M.

Each copy of the April issue will contain a free blueprint of the "Roadfarer"—normal price 5s. 0d.—which will give the complete circuit diagram and components list and other information necessary to build the set. Be sure to order your copy NOW.

### The P.W. Signal Generator

THIS issue contains the first article of a new series on the progressive construction of a wide range Signal Generator which will provide all the facilities required by the amateur radio enthusiast and will stand comparison with many of the designs for the amateur which are now on the market. The series is written by E. V. King—the author of two popular, constructional series which have previously appeared in this magazine. Whilst the performance of the Signal Generator is excellent, great care has been taken in the design to minimise the cost of construction and together with the progressive constructional system used, enables the cost of the unit to be spread over as long a time as the constructor desires. The Generator is constructed in four chassis and if required one or two chassis may be omitted if the constructor has no use for the facilities which they would provide.

### Talking Books for the Blind

TALKING books for the blind have been used for some years but now a new library of tape recordings is being accumulated to replace the long-playing gramophone record system. A revolutionary type of play-back machine will be used which possesses a number of basic advantages over the present disc reproducer, the result of almost twenty-five years' research and development by the R.N.I.B. and St. Dunstan's. Amplifier, loudspeaker and drive mechanism are housed in one compact case, controls have been reduced to one On/Off—Volume switch and one Start/Stop lever.

The truly unique feature of the machine, however, is the tape cassette. Little larger in size than an average letterpress novel, this can contain up to twenty hours recorded speech. This has been achieved by the use of half-inch tape and recording on it not two tracks, as on domestic machines, but no fewer than eighteen tracks, which reduces the number of times a tape must be changed and so simplifies matters for the user.

Our next issue, dated April, will be published on March 7th

# Round the World of Wireless

## POTENTIAL AND CURRENT NEWS

### Broadcast Receiving Licences

THE following statement shows the approximate number of Broadcast Receiving Licences in force at end of November, 1960, in respect of wireless receiving stations situated within the various Postal Regions of England, Wales, Scotland and Northern Ireland. The numbers include Licences issued to blind persons without payment.

Region	Total
London Postal .. .. .	733,512
Home Counties .. .. .	688,009
Midland .. .. .	504,025
North Eastern .. .. .	555,770
North Western .. .. .	475,975
South Western .. .. .	411,295
Wales and Border Counties .. .. .	245,489
Total England and Wales .. .. .	3,614,065
Scotland .. .. .	409,088
Northern Ireland .. .. .	124,137
Grand Total .. .. .	4,147,310

### Factory Extensions

FACTORY extensions at Luaton Road, Dunstable, scheduled for occupation in March, 1961, are announced by Erg Industrial Corporation Ltd. The increased floor space will make it possible to increase the output of the wire wound Resistor division. Additionally, new and modern equipment for the now established Erg Transformer division will occupy a large proportion of the new extension, with an enlarged air-conditioned, constant-temperature laboratory. Test facilities covering full service requirements will be in operation to ensure the highest degree of reliability.

Erg Industrial, already serving the Electronic Industry with "Custom-built" special products, intimate that strong emphasis is being given to an immediate expansion of this service, for which highly qualified design engineers have been engaged and are solely devoted to this "Custom-built" division.

### Dopplers and Automatic Direction Finders

AFTER an exhaustive evaluation, the Ministry of Aviation has selected the Marconi Doppler Navigation Type AD2300B and the Automatic Direction Finder Type AD712 for use in their new

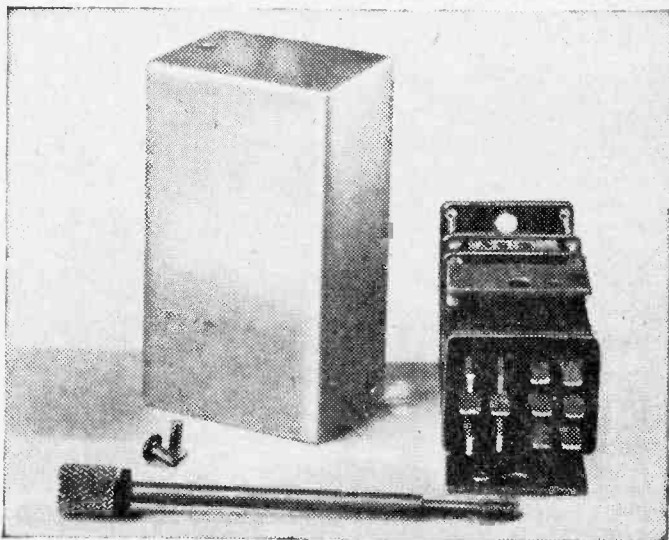

Transistorised plug-in logic units form the basis of the electronic signal interlocking developed by Mullard Equipment Ltd. for British Railways (see page 967).

Argosy C. Mark I aircraft for R.A.F. Transport Command.

The doppler order is worth £552,000 and the automatic direction finder order £100,000. Ancillary equipment and spares are included in both contracts.

The AD2300B comprises the basic AD2300 sensor, the 5452 computer and the 5453 display unit. The computer processes ground speed and drift angle from the doppler sensor, together with heading information from the aircraft compass system, and presents to the pilot the aircraft's displacement from selected track and distance to go to the turning point. It also feeds steering information into the flight system and/or autopilot to enable the selected track to be maintained.

The AD712 automatic direction finder is a crystal-controlled ADF embodying a true and positive decade tuning system and a fixed loop aerial system. Frequency selection is by switch; no tuning whatever is required. This equipment is in wide use by many airlines.

### Battery Firm Changes

TO achieve closer liaison between their technical, production and sales departments,

Chloride Batteries Ltd. transferred the major portion of their sales headquarters from London to the head office and the principal manufacturing centre of the company at Exide Works, Clifton Junction, near Manchester, on January 2, 1961.

Mr A. C. Stewart, the present sales manager, who is approaching retirement age, will not be moving north. He will be succeeded by Mr. M. A. Griffith-Jones on completion of the move, but his services will be retained by the company in the capacity of consultant until he retires.

### Export TV for Design Index

THE latest Ekco export television models — the 17in. models T737 and T738—have been accepted by the Council of Industrial Design for "Design Index". The "Design Index" already includes nearly sixty Ekco products and is Britain's record of well-designed goods from which exhibits are chosen for display in the Design Centre.

### Tape Recorders for BBC

THE BBC is purchasing two three-track portable and one twin-track console Philips mag-

netic tape recorders for use in engineering research work.

Negotiations for the order were carried out for Philips by Mr. Terence Perkins, the company's tape recorder section manager.

#### Silicon npn Diffused Junction Power Transistors

THE Semiconductor department of A.E.I. Radio and Electronic Components division entered the silicon power transistor field with the introduction of three Ediswan Mazda npn diffused junction type devices. Types XC703, XC713 and XC723 are intended for a wide variety of industrial applications in equipment operating at temperatures ranging from  $-65^{\circ}\text{C}$  to  $+175^{\circ}\text{C}$ . They are particularly useful in power-switching circuits, oscillator regulator and pulse amplifier circuits, and as Class A and Class B push-pull audio and servo amplifiers.

They are characterised by an extremely low saturation resistance, high current and power dissipation ratings, high Beta at high current, and excellent high temperature performance up to  $+175^{\circ}\text{C}$ . At  $100^{\circ}\text{C}$  they offer a range of dissipation of from 2 to 30W. They are available in standard JEDEC cans.

#### Direct View 3-D Picture Process

FULL-COLOUR 3-D pictures that can be "blown up" to 40in. x 30in. are now being produced for viewing without coloured spectacles or a stereoscope by a new process sponsored by Deep Vision Ltd.

This process is based on the familiar grid system in which each of the viewer's eyes sees the picture through a different set of "windows" — hundreds of extremely narrow vertical slits between invisibly fine opaque lines.

But apart from their size, the Deep Vision pictures can also be brought forward from their frames or set back in perspective — or both. And as in the case of the equally familiar lenticular system (in which vertical corrugations break up the picture into two eye-fields), they can also be made to "change".

Two more advantages are that any number of identical prints can be made in fast colours, and that as 2-D colour pictures can be made simultaneously, magazine advertising, for example, can be precisely matched in 3-D for illuminated display.

The process involves the use of a specially-designed camera which, although bulky and heavy, has no single awkward component, and so can be dismantled and reassembled in a matter of minutes for location work.

A shot takes about five seconds to complete, but considerable subjective movement can be tolerated without the picture being spoiled.

#### Talk-back System for New Tamar Bridge

TRIGGERS working high up, on and between the 250ft towers of the new Tamar Bridge — now being built by Cleveland Bridge and Engineering Co. to provide a new road link between Devon and Cornwall — keep in touch with the main control station at one end of the bridge through equipment supplied by Radio Components and Special Products Department, A.E.I. Radio and Electronic Components Division.

The twin towers of the bridge are 1,100ft apart and the distance between the top of each and two ground stations is 500ft so that communication was required over a total distance of about 2,000ft. To provide this

a transistorised loudspeaking intercommunication system has been supplied. A ten-line master unit, of a type specially developed by A.E.I. to work over a post office line and therefore eminently suitable for this application, is installed in the constructor's main office at one end of the bridge.

#### British Railways to use Electronic Signal Interlocking

AS part of the railway's modernisation programme, the British Transport Commission has awarded a contract to Mullard Equipment Ltd. for the development of an electronic signal interlocking plant. The equipment will be the first plant using electronic interlocking to be used on British Railways and will replace the mechanical interlocking on the lever frame at Henley-on-Thames Western Region signal box. It will be installed during the early summer of 1961.

Recently the company was able to demonstrate to British Railways' signal engineers a working model of a double junction, completely controlled by the new electronic system. The technique has the substantial advantage that it employs solid state electronic circuitry throughout.



Final testing in progress at the New Plymouth terminal station of the New Zealand microwave telephone network (installed by STC). The four equipment cubicles on the left are the transmitter and receiver equipments for the "working" and "standby" radio channels. The supervisory VHF radio equipment is in the background.



# A MIDGET PUSH-PULL AMPLIFIER

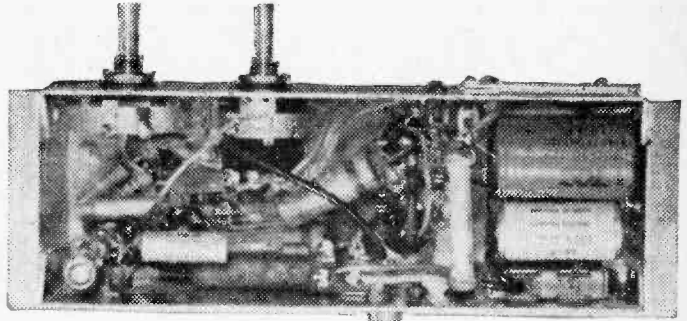

*The component layout of this amplifier.*

By V. E. Holley

**THIS 4W AMPLIFIER IS ESPECIALLY SUITABLE FOR PORTABLE RECORD PLAYERS**

**T**HIS amplifier was built originally for a portable record player. Though modest in size, weight and cost, it has an output of four watts and a very acceptable standard of reproduction.

**The Circuit**

Fig. 1 shows the circuit; it is largely conventional. The valve, V1, is a resistance coupled pentode voltage amplifier having in its grid circuit

the volume control, VR1, and a simple top-cut tone control, C1 and VR2. Matters are so arranged that in the minimum cut position, the tone control has practically no effect on the response, but there is sufficient range to enable the surface noise from the older 78rev/min shellac records to be reduced to inoffensive proportions. R3 is the bias resistor which is by-passed in the normal way by C3; R4, inserted between the

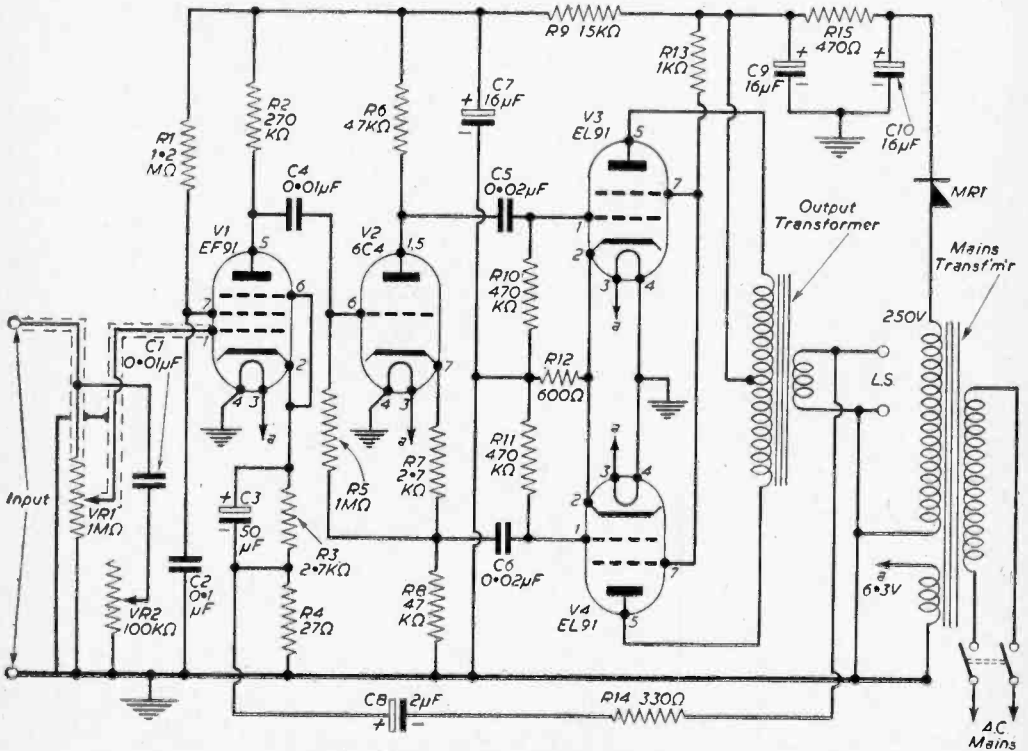

Fig. 1a.—The circuit diagram.

lower end of these components and chassis, provides a point for the injection of negative voltage feedback derived from the output transformer secondary.

**Inverter**

The amplified signal from V1 is passed to V2, a triode, 6C4, arranged as a phase inverter with

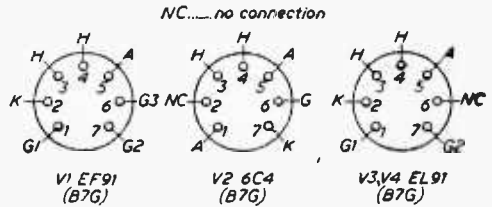

Fig. 1b (right).—The valve-base connections.

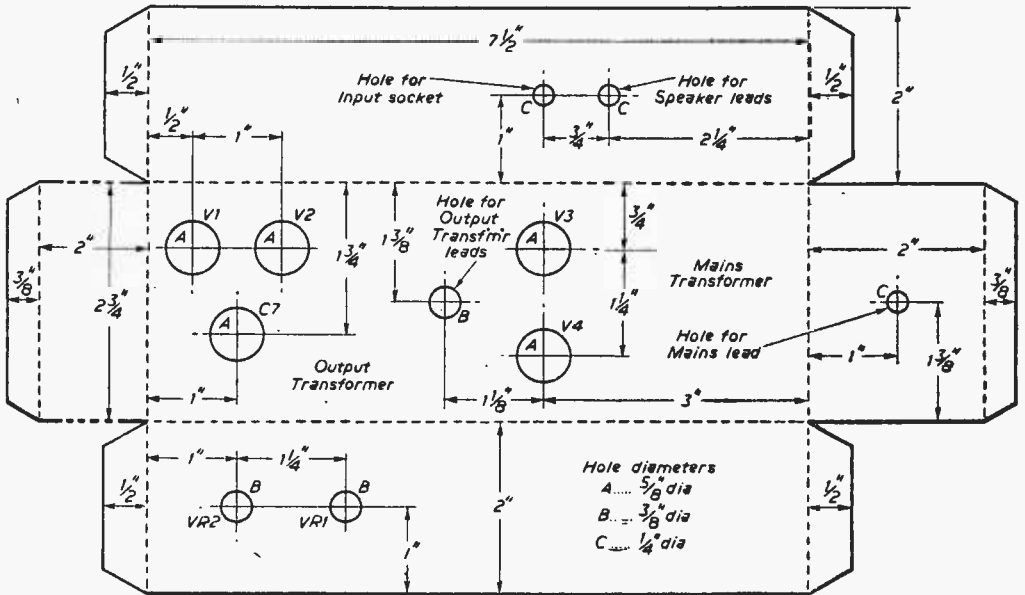

Fig. 2.—Constructional details for the chassis.

equal anode and cathode loads of 47k. Two signals, 180deg out of phase, are thereby produced for the push-pull output stage. A cathode bias resistor of 2.7k and a grid leak of 1M, returned to the junction of the bias and cathode load resistors, complete the stage. Heavy negative current feedback ensures excellent linearity though it limits the gain of the stage to 0.9 on each side, or 1.8 times overall. No de-coupling is necessary between V1 and V2.

**Output Stage**

Two miniature output pentodes, EL91, are employed in this stage with 250V on anodes and screens. They should be reasonably well matched but exact matching is not necessary as the common bias resistor tends to equalise them. The optimum load, anode-to-anode, is 24K, so that for adequate low frequency response, an output transformer with unusually high primary inductance is required. Such transformers are not readily available but the difficulty can be overcome by using one of lower inductance and making good the low frequency attenuation by negative feedback. Several small push-pull transformers are available commercially with a primary inductance of 40H

or so and affording ratios of around 80 or 90 to 1 for operating a 3Ω speaker. As the D.C. resistance of the speaker is rather high, there is some loss of volts at the valve anodes and the resistor R13 is included in the supply to the screens so that the voltage here will not rise above that at the anodes.

**Negative Feedback**

Heavy negative feedback is taken from the output transformer secondary via R14 and C8, to the cathode circuit of V1. The inclusion of C8 reduces the feedback at the lower frequencies and so allows the gain of the amplifier to rise in the region in which attenuation is introduced by the output transformer. The values of C8 and R14 will need adjustment according to the characteristics of the output transformer. It is suggested that the amplifier be completed with R14 equal to 330Ω and C8 omitted, and that the best combination should then be selected after a listening test under service conditions. The optimum value for R14 will lie between 200 and 600Ω and for C8 between 2 and 8μF. The circuit is very well behaved and none of these combinations will cause instability.



*The complete amplifier.*

### Power Supply

The mains transformer should be of the "miniature" type and should have a half wave secondary winding capable of supplying 35mA and a 6.3V, 1A heater winding. A contact cooled rectifier is adequate, and mains smoothing is provided by C9 and C10 in conjunction with R15. The smoothing is not lavish, but push-pull plus negative feedback reduces the hum to a very low level. Some additional smoothing is necessary for the supply to V1 and V2 and is provided by R9 and C7.

### Construction

The prototype was built on a chassis of 18s.w.g. aluminium sheet measuring 7½ in. x 2½ in. x 2 in., a plan of which is given in Fig. 2. There is nothing critical about the lay-out except that to prevent inter-action between them, the mains and output transformers must be mounted so that their magnetic axes are at right angles. There is a little difficulty here if both are of clamp construction but it can be overcome by mounting the mains transformer on its side in the "drop-through" position and securing it with a strap of 18s.w.g. aluminium across the top, the normal mounting lugs being bent inwards out of the way. This method was adopted in the prototype as will be seen from the illustration. A detailed wiring diagram for the amplifier is given in Fig. 3.

### Components

No special components are necessary but it is an advantage if the resistors and capacitors are on the small side. The resistors can be ¼W except R9 and R12 (½W) and R15 (1W). R6 and R8 must be a matched pair as also must be R10 and R11. If matching facilities are not available, close tolerance components must be used (5 per cent or better). All the capacitors should be 350VW D.C. except C3 and C8 for which 25VW will be adequate.

### Testing

When construction is complete and before switching on, a check should be made with a meter between C10 and the chassis to see that there are no shorts in the H.T. wiring. If all is well the power can be connected and measurements taken of the voltages on the output valve anodes and screens. It should be between 240 and 250V, measured between these electrodes and the cathodes, and some adjustment may be necessary to the value of R15 to make it so, depending on the output from the mains transformer. Likewise, it may be necessary to adjust the value of R13 according to the voltage drop in the output transformer primary. If there is instability, the connections to either the primary or secondary of the output transformer should be reversed so that the feedback becomes negative. All that now remains is to decide by trial and error on the most suitable values for R14 and C8. It should perhaps be mentioned that if the amplifier is operated without feedback, the reproduction will be very

### COMPONENTS LIST

Resistors (¼W unless otherwise stated):	Capacitors (350VW D.C. unless otherwise stated):
R1—1.2M	C1—0.01µF
R2—0.27M	C2—0.1µF
R3—2.7k	C3—50µF 25VW electrolytic
R4—27Ω	C4—0.01µF
R5—1M	C5—0.02µF
R6—47k	C6—0.02µF
R7—2.7k	C7—16µF electrolytic
R8—47k	C8—2µF 25VW electrolytic
R9—15k (½W)	C9—16µF electrolytic
R10—0.47M	C10—16µF electrolytic
R11—0.47M	
R12—600Ω (½W)	
R13—1k	
R14—330Ω	
R15—470Ω (1W)	

### Potentiometers:

VR1—1M log.  
VR2—100k log.

### Valves:

V1—EF91, B7G base and screen  
V2—6C4, B7G base.  
V3 } EL91, B7G base  
V4 }

### Mains transformer:

Miniature, 250V half wave, 35-40mA, 6.3V, 1A

### Output transformer:

Push-pull, high inductance primary (see text).  
Ratio 90 to 1 for 3Ω speaker or 40 to 1 for 15Ω

### Rectifier:

Contact cooled,  
250V, 40mA

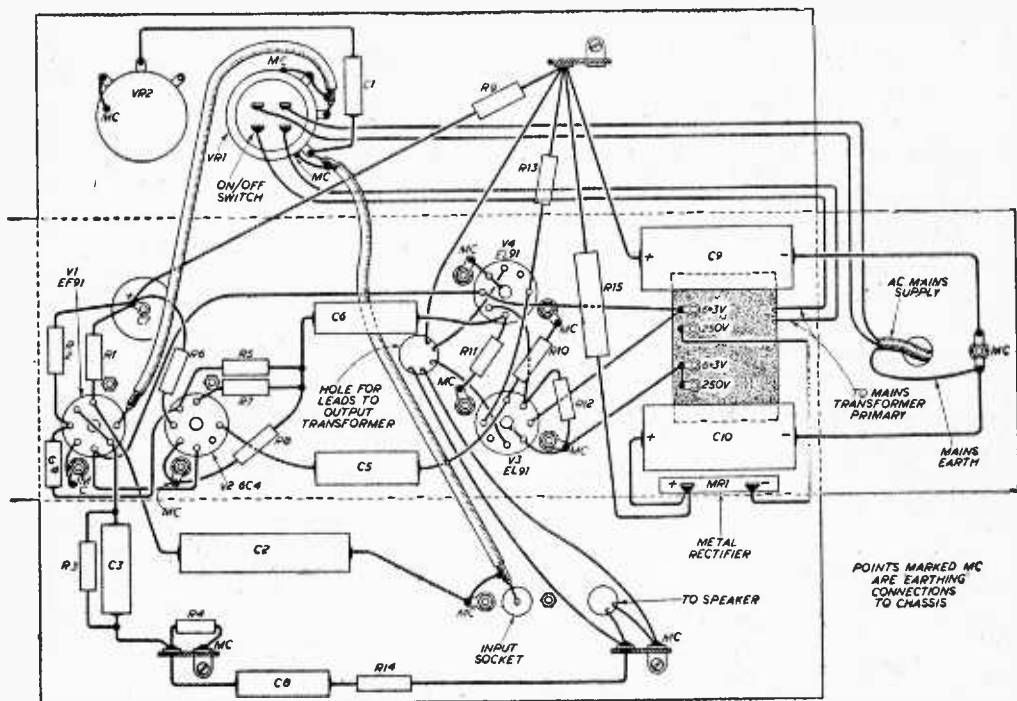

Fig. 3.—The component wiring details.

high pitched and, because the de-coupling is not generous, there may be a slight tendency to instability. These faults will disappear when the feedback circuit is connected.

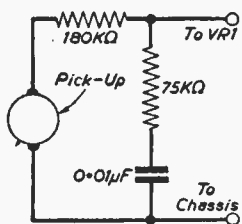

Fig. 4.—The pick-up compensation circuit.

**Operation**

If the amplifier is to be used with a pick-up, it will be necessary to provide some compensation for recording loss. While this could easily be incorporated in the chassis, it will usually be more convenient to fit it at the pick-up so that it is eliminated when the amplifier is used for other purposes. The output of the popular type of crystal pick-up rises in the low frequency region and it will generally be satisfactory to add external compensation at the rate of 3dB per octave below about 250c/s. This may be done with the circuit of Fig. 4.

**Heartbeat Timer**

An electronic heartbeat timer with no external wiring can be sewn into a patient's chest or near his heart because it has self-contained batteries. The circuitry is in a plastic envelope about 2½ in. in diameter, ¼ in. thick.

The timer supplies a stimulating pulse at regular intervals to keep the heart beating regularly, where otherwise it might beat dangerously out of time, slow down or stop entirely.

This heart timer will run for five years, and has been tested on dogs for periods up to 100 days. Dr. Wm. Chardack, of the Veteran's Administration, and electronic consultant Wilson Greatbatch, of Buffalo, N.Y., U.S.A., developed the device.

Meanwhile, it was reported that RCA in America developed a heart timer using a generator strapped around the patient's chest which induces power into a device sewn inside the chest cavity.

**High Power Klystron Installations**

One of the 50cm commercial radar installations using the English Electric Valve Company's K347, 600kW klystron is well on the way to completion at Kastrup, Copenhagen's new international airport, which is expected to be operational some time this month. The K347 is the first high power klystron to be designed specifically for use in commercial radar and in this installation two klystrons are used with a Marconi S264A radar comprising two transmitter/receivers feeding an aerial system on a main/standby basis.

The K347 is an external cavity tuned klystron operating in the 585 to 610Mc/s frequency range and repeated tuning operations can be made, to meet changing operational requirements, without stressing or damaging the tube.

# Crystal Controlled C.W. TRANSMITTERS

By G3OGR

(Continued from page 877 of the February issue)

**W**HEN using a doubler, make sure that the crystals chosen are of such a frequency that operation is always in the permitted bands. Provided this is remembered, a doubler will make available other frequencies, with a limited number of crystals. It is also in order to use a further doubler. This is often done to permit three bands working from one crystal, for example.

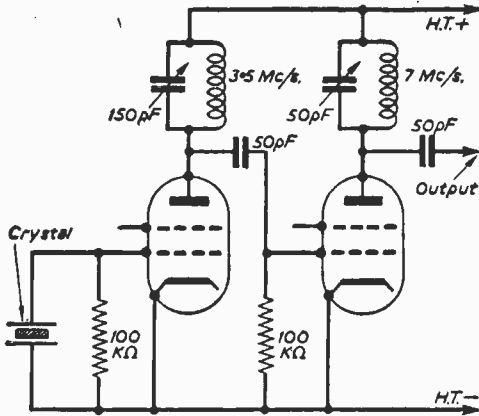

Fig. 6.—Oscillator and multiplier stages.

### Power Supplies

The circuits shown have great latitude in power supply requirements. Almost any power pack available may be used. This item can thus be arranged to suit the output wanted. Even a small receiver type supply will allow 10W or more input to a single valve transmitter.

A typical separate power pack is shown in Fig. 7. The mains transformer, choke, and rectifier should be chosen to suit the output voltage and current desired. For inputs of up to 50W or so, a 400/0/400V H.T. secondary rated at 150mA, with a 5R4GY rectifier, will be satisfactory. The choke current rating should at least equal the current drawn. The working voltage of the smoothing condensers should be rather higher than the actual H.T. voltage.

A fuse is an added safeguard against short circuits or similar defects. A 100mA or 150mA fuse will do for small power packs, with 250mA for larger supplies.

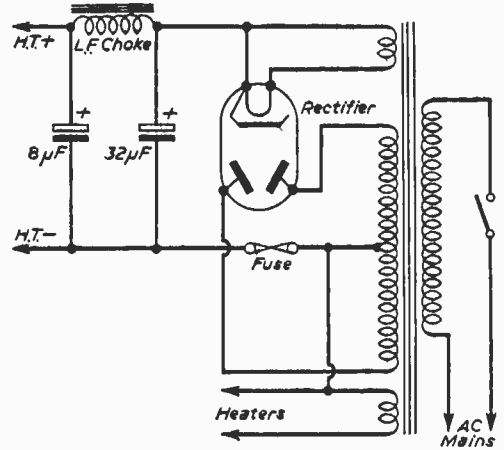

Fig. 7.—Power supply circuit for the transmitters.

If the power pack can be disconnected, or its circuit is interrupted by keying, a 100k 5W bleeder resistor should be connected across the H.T. supply, to discharge the condensers. In some circuits the screen grid resistors will act as a bleeder.

It is usually necessary to insert a switch, so that the valve heaters may be run without H.T. being applied. When initially testing a circuit, it is advisable to apply reduced H.T. voltage, until resonance has been found. A dropping resistor may be used for this purpose.

### Key Clicks

Crystal oscillators usually key well, but if key clicks are produced, the cathode or key by-pass condenser may be changed in capacity. Using a rather large capacity will tend to cause "tails" to the characters, but this depends on the current drawn by the valve.

If a condenser alone is insufficient, a choke may be added in series with the key. Another condenser may then be joined directly across the key contacts.

Many operators have favourite methods of keying. The key may interrupt the cathode circuit, or may be in the H.T. negative circuit. An alternative is to use a separate transformer to obtain H.T. only, and key this in the primary. The rise and decay time can then be adjusted by modifying the smoothing condenser capacity. When keying mains and other high voltage circuits a relay is preferable, for maximum safety.



# A BAND II Pre-Amp

A USEFUL ADDITION TO RECEIVERS FAR FROM THE TRANSMITTER

(Continued from page 874 of the February issue)

WHEN construction of the pre-amplifier is finished, all wiring should be checked carefully. The unit may now be switched on and if possible the H.T. and L.T. should be measured without the valve in position. If all is in order the unit should be switched off, the valve inserted and the unit switched on again. As a check, the H.T. and L.T. voltages may again be measured. Plug the downlead into the input socket and connect the output to the receiver aerial socket.

The dust cores in L2 and L4 should be altered in position for best results and finally the positions of the two coupling coils L1 and L3; movement of these coils may necessitate altering the position of the slugs again. If the slugs are loose in the coil formers they should be removed and a piece of thin elastic inserted down the threads of the former and the slug screwed in again. When the best positions for the slugs and coupling coils have been found, the coupling coils may be lightly cemented in position. (A tool for adjusting the position of the cores can be made from a plastic knitting needle.)

### Alternative Coupling

If the incoming signal is very weak, it may be

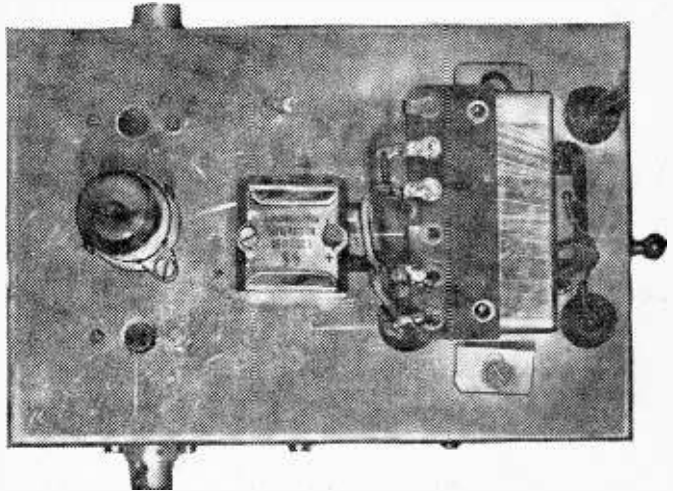

found that the signal from the pre-amp is less than that from the aerial direct. Whilst this may be due to L2 and L4 resonating at the wrong frequency, it is more likely that the coupling between the aerial and L2 and the receiver and L4 is not optimum. Various alternative methods of coupling may be tried instead of using the coil L1, the wire from the aerial input socket may be tapped directly on to L2 and the optimum position be determined by trial. The effect of including a small capacitor—2-10pF—may also be tried.

Matters are easier as far as L4 is concerned. The effect of omitting L3 and employing a small capacitor between the anode of V16 and the inner conductor of the output coaxial cable is certainly worth trying. The value of this capacitor may be again 2-10pF. If good results are obtained with the initial arrangement the number of turns on L1 and L3 may be altered in an endeavour to secure better results.

### Final Adjustments

The condenser C1, which is part of the neutralising network is set for optimum results. The turns of the inductance L5 may be opened out or closed up to secure best results. Accurate alignment of the circuit is best carried out by using a sensitive meter to monitor the voltage of the limiter grid of the F.M.

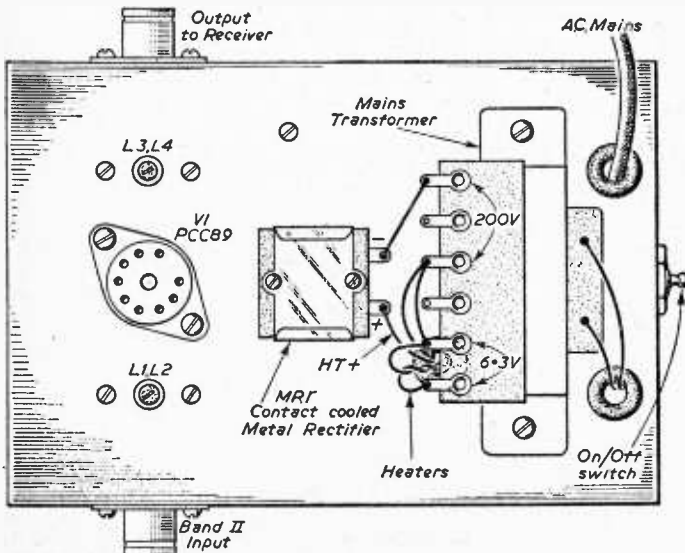

Fig. 4.—The above-chassis layout of the unit.

receiver. A resistor of about 10 to 47k should be included at the receiver end of the meter lead. (Note that the positive lead of the meter must be connected to the chassis of the receiver and the negative lead—through the stopper resistance just mentioned—to the grid of the limiter valve.)

If it is desired to avoid the losses which may be associated with change of cable at the input socket this socket may be omitted and the aerial downlead wired directly to L1a.

#### Instability

Owing to the high gain of the pre-amplifier it is possible and, if construction is not particularly well carried out, likely, that instability in the pre-amplifier will be experienced. In curing this instability the positions of the output and input leads relative to each other are critical and re-arrangement will often effect a cure. The decoupling capacitors can likewise have a great effect upon the performance—particularly C6 and C7. In the event of instability, it is worth while to experiment with these condensers by putting others in parallel, perhaps connected to different earth points, until the instability is cured.

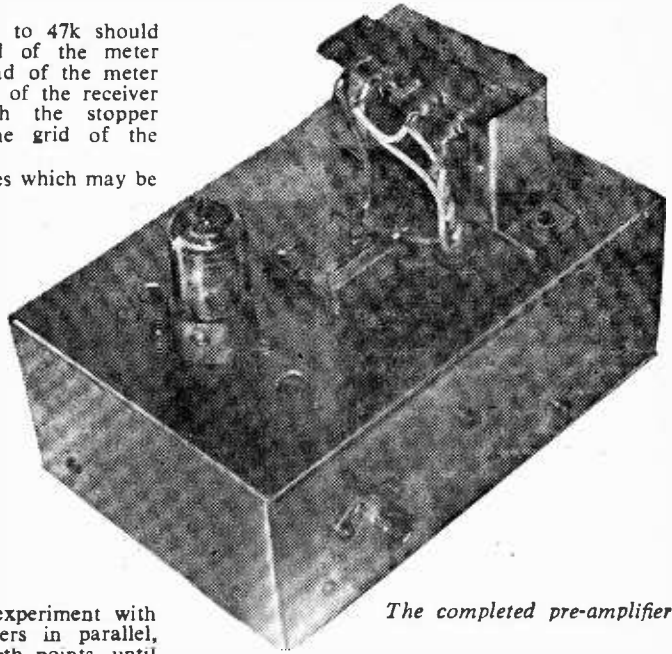

*The completed pre-amplifier.*

#### Housing

The finished unit may be housed in a wooden box which can be fitted or placed on top of the radio receiver.

Although a great deal of heat is not generated in the unit, adequate ventilation should be assured to avoid frequency drift. During the testing, the unit can be operated direct from the mains supply but finally when it is fitted permanently to the receiver the mains supply should be taken direct from the set (after its mains switch) and then the pre-amplifier cannot be left switched on inadvertently.

#### Bandwidth

The damping of the input tuned circuit is such that the coil resonates over the whole of Band II and no tuning is necessary. However, it may be found that the tuning of the anode coil is sufficiently sharp to render impossible a flat response over the complete band. In this event, a damping resistor may be connected across the coil L4 in parallel with the condenser C8. It may have a value of, say, 1k to 4.7k, depending on the damping required to obtain best results. This resistor may result in some loss of signal, and if reception is such that no signal can be "wasted," then it may prove necessary to employ variable tuning in either the input or the output circuit.

#### Conclusion

It is worth while emphasising again that where signal strength is low a pre-amplifier such as this must be "tailored" to suit the conditions of the location concerned. To obtain maximum transfer of energy from aerial to first grid and from second anode to receiver will necessitate, in most instances, some experiment, but it will then be certain that the best use is being made of the available signal.

#### COMPONENTS LIST

<b>Resistors:</b>	<b>Capacitors:</b>
R1—82k.	C1—2 to 10pF, beehive type (or similar).
R2—82Ω.	C2—2pF.
R3—100k 10per cent.	C3, C4, C5, C6, C7,
R4—180Ω.	1000pF, min. ceramic.
R5—100k 10per cent.	C8—3pF ceramic.
Valve: PCC89.	
<b>Power Unit Components:</b>	
Resistors, R6, 1k or to suit H.T. voltage.	
Capacitors, C9 and C10, 8 to 32μF, 350VW.	
Rectifier, miniature contact-cooled type for 200V r.m.s. input and rated at about 30mA.	
Transformer—type used for converters, with tapped primary and 7V secondary.	
Chassis: see diagram (Fig. 4.)	
Solder, wire, wooden case, etc.	

#### COIL WINDING DETAILS

	No. of turns	
L1 (over L2)	1	
L2	7	
L3/4 (over L7)	2	
L4	6	
Coils are wound on ½in. small polystyrene coil formers with purple coded dust cores. No spacing is used between turns—the coils are closewound.		
L5 consists of about 15 turns of 22-26s.w.g. enamelled or DCC copper wire wound to ½in. inside diameter.		

# Valve Bias Explained

## BASIC THEORY FOR THE BEGINNER

A CIRCUIT for a triode valve is shown in Fig. 1 and is representative of many audio-frequency amplifiers. At this stage let us consider the circuit purely from the D.C. point of view in relation to the resistive elements connected to the various electrodes.

The valve heater is energised either from a low voltage winding on the mains transformer or, as we will recall from the last two articles, direct from the mains through a voltage dropping resistor in series with the heaters of the remaining valves. With battery valves, of course, the heaters are powered from the L.T. battery.

It will not be out of place here to discuss in broad outline the action of a triode valve. The heater of the valve (see Fig. 2) is placed inside a hollow tube (the cathode) which is coated with a white powder such as thorium oxide. When the heater is switched on, it heats the cathode causing it to glow. The white powder as a result of the heating emits "electrons" which are tiny particles of electricity. These particles are charged negatively. Now negative charges are repelled by negative

charges and attracted by positive charges. Therefore, if the anode (made up of a metal plate) is charged positively with respect to the cathode, then the electrons emitted from the cathode are attracted to the anode and travel to it. This flow of electrons constitutes a current of electricity through the valve.

The grid of the valve consists of a mesh of fine wire through which the electrons from the cathode have to pass on their way to the anode. If this grid is charged negatively with respect to the cathode, then some of the electrons travelling to the anode will be repelled and the current through the valve will be decreased. It can be seen that the current through the valve depends on the potential of the grid with respect to the cathode—the current, *increases* as the grid becomes more positive (or less negative) relative to the cathode and *decreases* as it becomes less positive (or more negative).

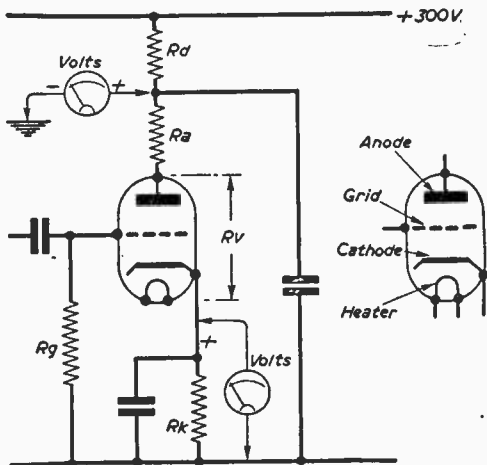

Fig. 1 (left).—A simple basic circuit for a triode valve.

Fig. 2 (right).—The conventional circuit symbol for a triode valve.

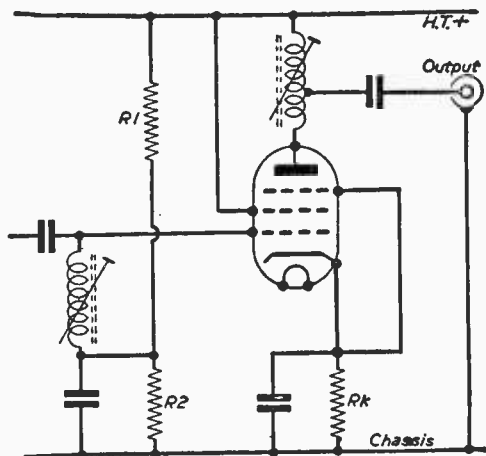

Fig. 3.—A valve bias system using both a cathode resistor and a grid potential divider.

The name "valve" is derived from the way in which the grid is used to control the flow of current, just as mechanical valves are used to control the flow of water in pipelines.

If, in Fig. 1 we assume that the grid potential is constant the conditions in the circuit are steady and the valve can be represented by a resistor of, say,  $R_v$  ohms (as indicated in Fig. 1). Thus we may consider, that there are five resistors in circuit,  $R_d$ ,  $R_a$ ,  $R_v$ ,  $R_k$  and  $R_g$ . Thus current flows through the valve of a value determined by  $(R_d + R_a + R_v + R_k)$ , neglecting  $R_g$ .

### Resistor Calculation

In Fig. 1 it is supposed that the H.T. line is 300V positive with respect to the chassis (H.T. negative). The circuit constants may be arranged so that with 200V at the junction of  $R_d$  and  $R_a$ , with respect to chassis, the current through the valve and resistive elements is 10mA (0.01A).

In this case, the value of  $R_d$  can easily be computed by using Ohm's law, this is,  $R_d = (300 - 200) /$

(0.01). This follows because  $R_d$  is called upon to drop 100V, this being the difference between the H.T. line voltage and the required voltage at the junction of  $R_d$  and  $R_a$ . This works out to 10,000 ohms (10k). Thus, a voltmeter connected to the junction as shown in Fig. 1 would read 200V, provided  $R_d$  is 10k and the meter does not load the circuit in any way. In practice, of course, the meter acts as a load across the resistive elements and the reading as indicated is below that computed as governed by the extent of the loading.

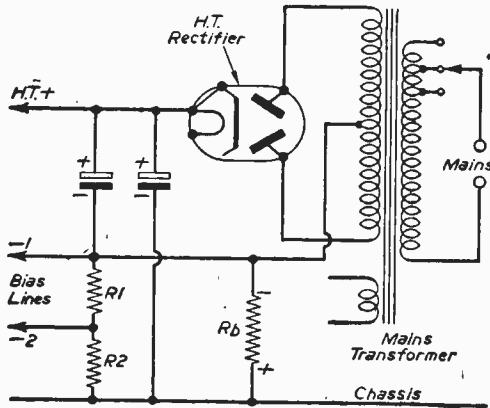

Fig. 4.—A circuit using a common bias resistor to obtain bias for all valves—the bias lines are connected to the grids of the valves through decoupling networks, and the cathodes are connected direct to chassis.

The 10mA of current is also flowing in  $R_a$  and  $R_k$ . The value given to  $R_a$  is usually decided by the operational factors of the circuit, as distinct from the D.C. or static aspect, and the same applies in some degree to  $R_k$  in the cathode circuit.

The value of  $R_g$  is usually very high, often in the region of 1M, but as current does not normally flow in this resistor, there is no potential difference across it and the grid is at chassis potential. (Use Ohm's Law:  $V=R_g \times I$ ,  $I=0$ , and therefore  $V=0$ .) This fact is essential to the understanding of the following explanation and one which often causes confusion or bewilderment in the mind of the beginner but is easy to grasp when the principle is understood. There is no current through  $R_g$ ; therefore there is no P.D. across it.

Let us suppose that  $R_k$  is 1,000 ohms, and that the circuit is set up as previously mentioned with 10mA flowing. The volts drop across  $R_k$  is then equal to  $(0.01 \times 1,000)$  which works out to 10V. Or another way of looking at it is to multiply the current in mA by the resistance in k $\Omega$ , which in this case is  $(1 \times 10)$ , 10 volts.

The polarity of the voltage across  $R_k$  is such that the cathode is 10V positive with respect to the chassis or H.T. negative line, as shown on the circuit. The grid of the valve is connected to the H.T. negative line or chassis through  $R_g$ . This means that the cathode grid is 10V positive with respect to the chassis and grid or stating it another way, the grid is 10V negative with respect to the

cathode, always provided 10 mA of current is flowing in the 1k cathode resistor.

The best way of measuring the bias voltage is by connecting a voltmeter across  $R_k$ . There will be the least error in the reading by adopting this method because the resistance of the voltmeter on the 10V range is almost certain to be far greater than the value of  $R_k$ . If it is attempted to measure the grid bias by connecting a voltmeter between the grid and cathode, then current will flow through  $R_g$  by way of the meter and the reading will be considerably less than the actual voltage.

If ever we require to discover the value of  $R_k$  for any grid bias voltage then all we do is divide the value of grid bias required by the cathode current of the valve. This, of course, is simply  $R=E/I$ , and where  $R$  is in ohms,  $I$  must be in amperes, but where  $R$  is in k $\Omega$ , then  $I$  must be in mA.

Where a pentode, tetrode of any other multi-electrode valve is in use, then the current through  $R_k$  is equal to the total H.T. current of the valve (i.e. anode current + screen grid current, etc).

Other curious methods are sometimes adopted to secure a bias voltage. Fig. 3, for example, shows such a method. Here is an R.F. amplifier which uses cathode bias, having  $R_k$  in the cathode circuit, but in addition has a positive potential on the control grid.  $R_k$  provides some fixed bias, but since the control grid is also connected to the junction of the potential divider  $R_1$ ,  $R_2$  some of the bias given by  $R_k$  is counteracted.

However, this arrangement provides a degree of compensation, and the circuit is stabilised to some degree in the event of a reduction in emission of the valve—when the white powder on the cathode begins to emit fewer electrons than before, resulting in an increase of the apparent resistance of the valve.

#### A Common Bias Resistor

Some receivers use a common bias resistor and have all the valve cathodes returned to chassis. The idea is shown in Fig. 4. Here  $R_b$  is the common bias resistor and is connected between the centre tap on the secondary of the mains transformer and chassis. It will be realised that the total current of the receiver flows through  $R_b$ , and a P.D., depending upon its value, is developed across it.

If the total current of the receiver is 100mA (0.1A) and  $R_b$  is 100 $\Omega$ , then 10V is developed across it (i.e.,  $E=0.1 \times 100$ ). The voltage across  $R_b$  is negative at the secondary tap with respect to chassis, so it can be used ideally as a negative bias. In some cases the potential is applied direct to the grid of a valve after passing through a suitable filter circuit, while more often it is applied across a potential divider, such as that made up of  $R_1$ ,  $R_2$  in Fig. 4. In this way two bias lines can be drawn off and suitably filtered individually.

Since the bias is usually applied to a high resistance circuit relating to the valve,  $R_1$  and  $R_2$  can be of fairly high value, considerably higher, in fact, than the value of  $R_b$ . This means that they have little shunting effect on  $R_b$ , which can be computed as given above.

The full bias voltage (10V in the case cited) is present on bias line 1, and the bias voltage on line 2 is governed solely by the ratio of  $R_1$ ,  $R_2$ , as fully detailed in a previous article in this series.

**BRAND NEW AM/FM (V.H.F.) RADIOGRAM CHASSIS AT £13.6.8 (P. & P. 10/-)**

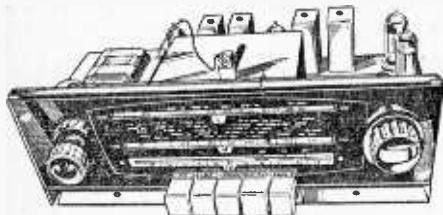

Tapped input 220-225 v. and 226-250 v. A.C. ONLY. Chassis size 15 x 6 1/2 x 5 1/2 in. high. New manufacture. 12 mths. guarantee. Dial 1 1/2 x 4 in. in black and yellow. Pick-up. Extension Speaker. Ae., E., hd Dipole sockets. Five "piano" push buttons—OFF L.W., M.W., F.M. and Gram. Aligned and tested. With all valves and C.P. Transformer. Tone Control Fitted. Covers 1.000—1,900 M.; 200-500 M.; 88-98 Mc/s. Valves E280 rect., ECH81, EP89, EABC80, EL84, ECC85. Speaker and Cabinet to fit chassis (table model). 47/6. 10 x 6 in. ELLIPTICAL SPEAKER. 20/- to purchasers of this chassis. TERMS:—(Chassis) £4.16.8 down + 10/- carr. and 6 Monthly Payments of 30/-, or with Cabinet and Speaker £5.10.0 down and 7 Monthly Payments 32/-.

**BATTERY ELIMINATOR.** For 4 Low Consumption Valves (96 range). 90 v. 15 mA. and 1.4 v. 125 mA. 42/6 (2/6 post). 200-250 v. A.C. Size 5 1/2 x 3 1/2 x 2 in. Also for 250 mA. 1.4 v. and 90 v. 15 mA at same price.

**THE "CABY" TEST METERS**

Prices include Test Prods. Batteries. Instruction Book. Also measure dB. Accuracy: A.C., 3 per cent. D.C., 2 per cent.

A-10 **£4.17.6**

B-20 **£6.10.0**



A.10—2K ohms/v. on A.C. and D.C. volts (10, 50, 250, 500 and 1000 v.); 10K and 1M ohms; 1 mA, 25 mA and 250 mA. D.C. Size: 5 1/2 x 3 1/2 x 1 1/2 in. Weight 17 oz.

B.20—10K ohms/v. on 0.5 v. and 2.5 v.; 4K ohms/v. on 10, 50, 250, 500 and 1000 v. A.C. and D.C. Resistance. 2K, 200K., 2 M and 20M ohms.; D.C. current, 100 microA. 2.5 mA, 25 mA, 250 mA. Size: 5 1/2 x 3 1/2 x 2 in. Weight, 24 oz.

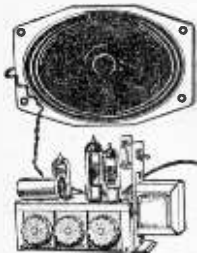

**3-VALVE AMPLIFIER (INC. RECT.).** 4 watts. Valves ECC83, EL84, and E280. Controls, volume, bass and treble. On/Off switch. (Chassis size 6 1/2 x 3 x 2 1/2 in.) 6 in. round or 7 x 4 in. elliptical speaker. Not suitable for microphone input. A.C. only.

**75/- (3/- p. & p.)**

**TAPE RECORDER FOR ONLY £17.17.0 (10/- carriage)**

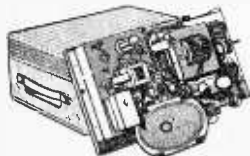

**A QUALITY ARTICLE.** Valves E280, ECC83, ECL82. DM70. Acos Crystal "mike" 850ft. Tape and extra spool. 3 1/2 in./sec. Mike and Radio inputs; Vol. on/off tone. Ext. L.S. and Monitor. Fast forward and reverse. Cannot be accidentally erased. Magic Eye Indicator. 7 x 4 in. Speaker. Cabinet 14 x 11 1/2 x 7 in.

**B.S.R. "MONARDECK" FOR TAPE SINGLE SPEED.** Our price only £8.10.0 including 850 ft. 1st grade tape. carr. paid.



**LISTEN WITHOUT INTERFERENCE**  
Fully built V.H.F./F.M. Set for £8.0 (0/- post). Covers 88-96 Mc/sec. Wired, aligned and tested. Mullard permeability tuner and 4 valves (ECC85, ECL82 and two EF91), + 2 diodes. Cheap room dipole, 10/-, 300 ohm twin feeder, 6d., yd. Available as self-powered tuner chassis at £7.10.0 (p. & p. 3/-).

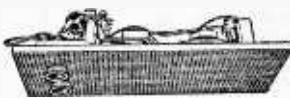

**GRAMPHONE AMPLIFIER with 5in. SPEAKER.** Baffle 12 1/2 x 6 in. E240 and EL41. Tone and Volume. On/Off switch. Two Knobs. Ready to play. Useful for Stereo.

**ONLY 63/-, post 3/-**

**AUTOMATIC RECORD CHANGERS COLLARO** (QUEST with manual play) also. 4-speed. A.C. mains 200-250 v., see illus.

**£7.10.0 (5/- P. & P.)**

**B.S.R. UA8 4-speed auto-changer.** £6.10.0 (5/- carr.) or with Stereo Head, £6.17.6 (5/- carr.). UA14, £7.10.0 (5/- carr.). All with Crystal Turnover Head.



**PUSH-PULL AMPLIFIER £4.15.0 (3/- P. & P.)**

Brand new 200-240 A.C. mains. Bass, treble and vol. controls on flying panel. Valves E280, ECC83 and 2-EL84 giving full 8 w. Chassis 12 x 3 1/2 x 3 1/2 in. With o.p. trans. for 2-3 ohm speaker. Suitable for Crystal Mike Input. Stereo Version same size £5.15.0 (P. & P. 3/-).

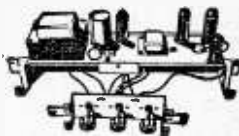

**TWO-TONE BROWN RECORD PLAYER CABINET** (with Motor Board for Autochanger) and Gramophone Amplifier to fit Cabinet for £5.5.0 (5/- carr.). Size 17 x 15 x 6 1/2 in. Brand New. BSR UA8 autochanger to fit £6.10.0 (extra carriage 2/6).

**COLLARO STUDIO TAPE TRANSCRIBOR. 3 MOTORS. 3 SPEED.** Push Button Controls. £12.10.0 (10/- carr.).

**ALL ITEMS GUARANTEED 12 MONTHS—B.V.A. VALVES 3 MONTHS**

Send 6d. (stamps will do) for 20 p. illustrated catalogue. All New Goods. Delivered by return. Terms:—One-third down and balance plus 7/6 in four equal monthly payments. Postage with down payment (C.O.D. 2/- extra). SEE SPECIAL TERMS FOR A.M./F.M. CHASSIS.

**Posted Orders to Camberley Please.**

**GLADSTONE RADIO 58A HIGH STREET, CAMBERLEY, SURREY. Tel. 22791**

Also at 247 New Road, Portsmouth, Hants, and 56 Stokes Croft, Bristol 1.  
Camberley closed Saturdays. Portsmouth and Bristol closed Wednesdays.





# "MINITEST" Model 127A

**20,000 o.p.v. POCKET SIZE!**

*Performance equal to a high priced instrument*

**OUTSTANDING FEATURES:**

- ★ Sensitivity 20,000 o.p.v. D.C. 1,000 o.p.v. A.C.
- ★ 20 Ranges.
- ★ D.C. Current 50µA, to 1 Amp.
- ★ D.C. Volts 0.3 v. to 1,000 v. (25 kv by probe).
- ★ A.C. Volts 10 v. to 1,000 v.
- ★ 3 Resistance Ranges from 0-20 megohms (self-contained).
- ★ Meter 40µA 3 1/2 in. arc.
- ★ Accuracy D.C. 3%, A.C. 4%. **PRICE: £10.0.0**
- ★ Dimensions 5 1/2 x 3 1/2 x 1 1/2 in.

**Credit Sale Terms available**  
9 monthly instalments of  
**£1.4.4**

Complete with instruction Manual and interchangeable test prods and clips. High quality leather case, if required, £1.12.0.  
H.V. Probe for 25 kv ... £4.15.0

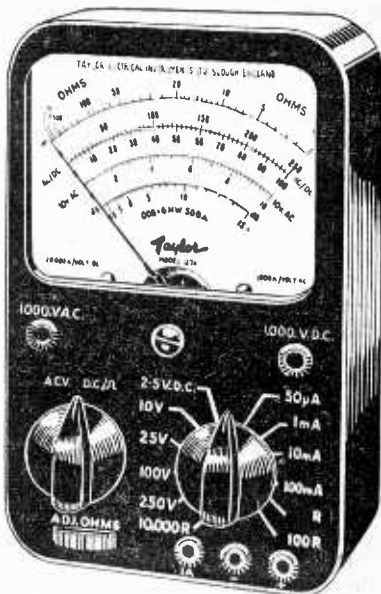

Write for  
fullest  
details to:

**TAYLOR ELECTRICAL INSTRUMENTS LIMITED**  
Montrose Avenue, Slough, Bucks. Tel: Slough 21381 Cables: Taylins Slough  
Member of the METAL INDUSTRIES GROUP OF COMPANIES

**"STUDIO TWIN"**

4 1/2 gns.  
**NOW 29 gns.**



Quality Tape Recorder at this amazing reduced price. 7in. Standard reels. Latest Studio 3-speed Deck. 14, 31, 74 I.P.S. 3 watts output. Attractive design cabinet in beige. Size 19in. x 13in. x 8in. Ins. & Carr. 12/6. EXTRAS: Microphone 27/6. Tape 25/-.

**RECORD PLAYER CABINET**

**"PETITE"**

ONLY  
**29/9**



Portable cabinet in smart two tone colours. Size 12 x 10 1/2 x 6in. Light and easy to carry. Ins. & Carr. 4/6.

**DUKE & CO. (London) LTD.**

621/3 ROMFORD ROAD, MANOR PARK, E.12  
ILF 6001/3

**SEND FOR FREE CATALOGUE**

Hours 9 a.m.—6 p.m. Half Day Thursday

**RECORD PLAYER AMPLIFIERS**

**MK. D5 39/6**  
New circuit employing ECL80 triode pentode output valve giving 3 watts output. A.C. only. Mains isolated. Single control for volume and on/off switch with knob. P. & P. 3/6.

**MK. D2A 79/6**  
Latest design incorporating negative feedback giving 4 watts undistorted output. Valves: ECL82, triode pentode and contact cooled metal rectifier. Tone and volume control panel on flying leads with compact amplifier chassis suitable to mount under modern autochangers to give easy mounting in small cabinet. A.C. only. Mains isolated. Output for 2-3 ohms. P. & P. 3/6.

**EXTENSION SPEAKERS 19/9**

8in. P.M. Speaker fitted into polished cabinet. Complete. Switch & flex included. P. & P. 3/6.

**ELLIPTICAL SPEAKERS 15/9**  
8in. x 3in. and 7in. x 4in. Brand new. Post and packing on each 2/9.

**TAPE RECORDER AMPLIFIER 27.19.6**



Compact, well designed 5 valve amplifier. Output 3.5 watts. Input for mike, radio and gram. Controls: record playback volume and on/off playback tone. Dia. 81 x 3 x 4 1/2 in. Ins. and Carr. 4/6. Terms available. EXTRAS: Knobs 2/6 per set. Beautiful Perspex dial plate, complete with sockets for mike, radio and super-impose switch 3/6.

**DE-LUXE TAPE RECORDER**

2 1/2 gns.  
**Our Price 18 gns.**



Beautifully styled 2 tone rexine covered cabinet in Red/Beige. Size: 14 1/2 x 13 x 9 1/2 in. Storage comp. in lid for tapes and mike. Speed 3 1/2 in. per second. 2 Controls. Contains 7 x 4 1/2 in. elliptical speaker. B.S.R. Tape Deck. 6 1/2 in. standard tape. 3 months' guarantee. Ins. & Carr. 12/6. Terms available.

**RECORD PLAYER CABINET**

**WITH EXTENSION SPEAKER CABINET**

**99/6**



1960 Show Model Portable in two-tone colours. Suitable for stereo with extension speaker cabinet secured in lid. Size 18 x 14 x 8 1/2 in. Ins. & Carr. 5/6.

# QUARTZ CRYSTAL ETCHING

## RAISING THE FREQUENCY OF A QUARTZ CRYSTAL

By J. B. Dance

THE resonant frequency of a quartz crystal can be increased somewhat by reducing the thickness of the crystal. It is not easy to alter the frequency of crystals which have gold or silver foil electrodes deposited on them (especially if the crystal is vacuum sealed), as these electrodes are usually "spluttered" on to the quartz using special apparatus. It would be difficult for the amateur to redeposit the electrodes on to the etched crystal or to connect wires to the foils. Such crystals are used mainly for frequencies below about 500kc/s. Above this frequency, rectangular quartz plates are common; the electrodes may consist of two metal plates held in position by a spring. The frequency of such crystals can be increased fairly easily by the method to be described.

### Technique

There are two main methods by which the frequency of a quartz crystal can be raised, namely by grinding (lapping) or by etching. It is preferable to maintain the surface of the crystal flat to within 1/100,000 of an inch and therefore grinding creates some problems. If the crystal is not maintained perfectly flat, its activity diminishes; that is, when it is used in an oscillator circuit, the amplitude of oscillation becomes smaller and the crystal may even refuse to oscillate at all.

to obtain a crystal of the desired frequency; otherwise preliminary grinding will be required.

### Etching Materials

Quartz is chemically very similar to glass and therefore very few liquids will etch it away. Hydrofluoric acid has been used for etching, but the average person is most strongly advised to avoid the use of such an extremely dangerous liquid. A solution of ammonium bifluoride, whilst much safer, is nevertheless quite dangerous. It can be ordered from most chemists at about 7s. 6d. for ½lb. A solution containing about 1 or 2 parts of the solid in 5 parts of water should be made in a plastic container. It is quite satisfactory to place the liquid inside a sheet of polythene which is put in the mouth of a wide-necked bottle or on a "tin-lid." It is wise to use the ammonium bifluoride solution out of doors and to keep a bucket of water nearby in case the liquid should be splashed on the hand. Only a very small quantity of the etching solution is required.

A pair of tweezers for handling the crystal is essential. They should be plastic tipped so that the etching solution does not come into contact with the metal. It was found convenient to coat the points of the tweezers with a solution of polystyrene in an organic solvent, allowing it to dry before use.

### Frequency Measurement

The crystal frequency should be measured as accurately as possible by means of a wave-meter or even an accurately calibrated receiver. The crystal has to be incorporated in a suitable oscillator circuit (such as that shown in Fig. 1) for frequency tests. The anode current is a measure of the crystal activity, being small with a crystal of high activity. The value of the anode current should also be found when the crystal has been removed from the circuit, as this is the value which indicates that no oscillation is taking place. The valve used was a 6AC7, but any sharp cut-off, high gm pentode such as the EF91, EF80, Z77, 6AM6, EF42 or EF54 would also have been suitable. No direct form of coupling was used between the oscillator circuit and the wave-meter, stray coupling being quite adequate.

The crystal should be removed from its holder by lifting it by the edges with tweezers, care being taken not to touch it with the fingers. If it is dirty or if it is accidentally touched with the fingers, it should be cleaned with chromic acid or with an organic solvent, as it is essential that the etching solution should come into contact with the whole of the crystal faces.

### Etching Rate

The rate of etching depends on the temperature, the strength of the etching solution, the crystal frequency and the type of crystal cut. A maximum

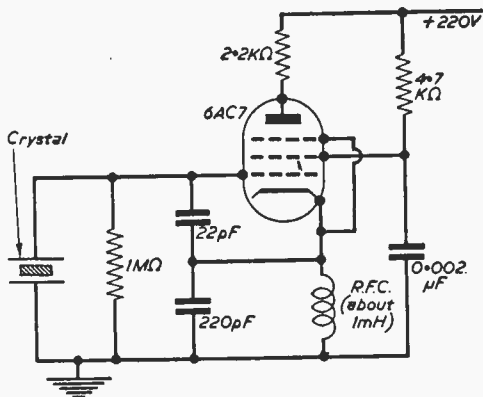

Fig. 1.—An oscillator circuit, using a crystal.

After a crystal has been ground, there is a certain optimum amount of etching which will lead to maximum activity. Ideally the amount of etching is such that the frequency is increased by etching by about the same number of kc/s as the square of the crystal frequency in Mc/s. Whilst this amount is not very critical, it is to be expected that a good commercially manufactured crystal will lose some of its activity during etching. This can usually be tolerated, however, in order

(Continued on page 1010)

# Checking Transistor Circuits

## FINDING FAULTS WITHOUT INSTRUMENTS

By F. G. Roger

### Checking Transistor Receivers Without Instruments

If a transistor receiver fails to work or to give normal results, stage by stage checking will probably be the quickest way of locating the fault. The tests described here are particularly intended for constructors who have no instruments, or perhaps only a simple meter for reading voltages, etc.

A typical transistor circuit, with check points, is shown in Fig. 1. Most of the tests described can be applied to any transistor receiver, though the number of stages, and exact circuit details, will vary.

### Newly-Built Sets

When the receiver has been constructed, but fails to work correctly, wiring should be carefully checked against the wiring plans or circuit. Any wrong connection, omitted lead, or short circuit can prevent the receiver working. Particular care should be taken to see that switch tags, or coil and transformer pins, are not shorted due to fragments of solder or projecting ends of wire. At the same time check that all joints are securely soldered.

If no fault is discovered, and components are new, the alignment of aerial, oscillator coil, and intermediate frequency stages may be so badly at fault that no signals can be received. If so,

this can be corrected as described later. In a superhet such as that in Fig. 1, wrong alignment can make the set quite dead, though no actual wiring or component fault is present.

Transistor connections, and the pin identification of all coils and transformers, should be checked. If no fault is found, stage by stage checks can be made as will be described.

When examining wiring, assure that resistor values are correct. Colour coding is usual, and a mistake can be made in reading the values. A slight change in value from that specified will not usually have a severe effect, but a large error (such as in reading the number of noughts) may prevent the set working or cause very poor reception.

### Resistance Checks

If a meter with "Ohms" scale is available, suspected resistors may be disconnected at one end, and measured. If a simple milliammeter is to hand, resistors can be checked with a 3V dry battery. From Ohm's Law, current will equal 3 divided by the resistor value in ohms. The result is changed to mA by multiplying by 1,000. For example, a 1k or 1,000Ω resistor in series with the meter and 3V battery will pass 0.003A, or 3mA. If no meter at all is available, suspected resistors should be checked again, to discover if any error was made in reading the values.

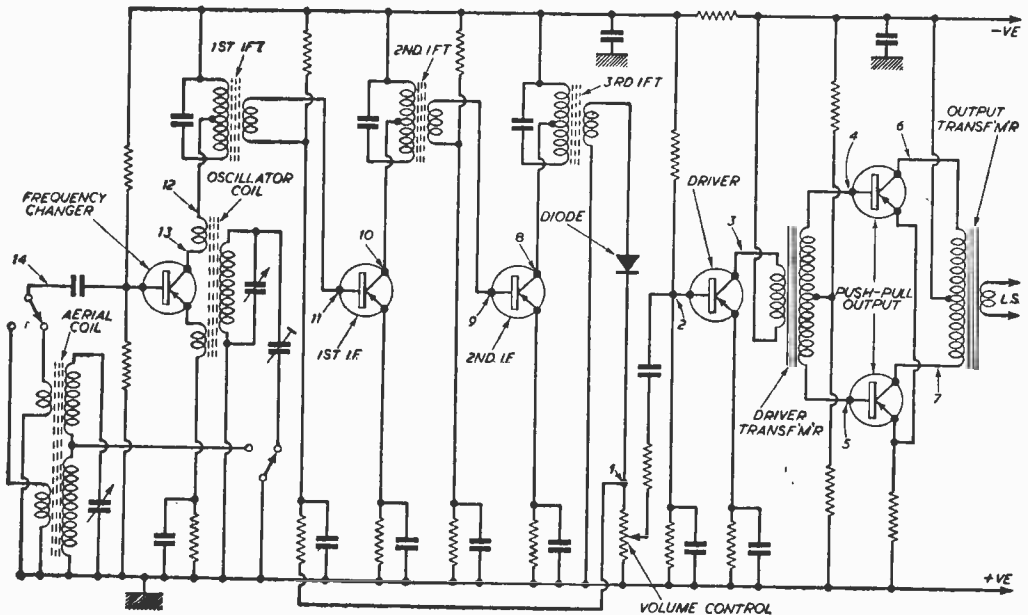

Fig. 1.—A typical transistor circuit with test points.

If these tests do not reveal any fault, stage by stage checks can be made. These checks apply both to a newly constructed receiver which has never worked correctly, and to an existing receiver which has failed.

**Stage By Stage Checks**

The purpose of these is to discover which stage in the receiver is at fault. Investigations are then localised to the few condensers, resistors, connections, and other items in the defective stage.

If headphones are available, they can be used to trace the audio signal. A 0.1μF or similar condenser should be included in one phone lead. Referring to Fig 1, the phones may be connected from (1) to chassis or earth line. If reception is good, the first three stages are working. Transfer one phone lead from (1) to (2). If reception ceases, the volume control or resistor and condenser between (1) and (2) are suspect. Remove the lead to (3). Signals should be considerably louder. If not, the driver transistor or associated connections and parts are defective. Try the lead on (4) and (5). If there is no signal at either point that half of the driver transformer, or connections to it, should be tested. If the signal is still available at (4) and (5), check at (6) and (7). A further amplified signal should be heard. If not suspect the associated transistor.

Similar tests can easily be carried out with a TRF type receiver. When the point at which the fault is present is passed, reception will cease. Unsuspected faults can often be quickly located by this method.

For checking all stages, a source of audio and intermediate frequency signals will be extremely useful. Such signals may, of course, be obtained from a generator. But assuming that such an instrument is not available, an ordinary radio receiver may be pressed into service.

Fig. 2 shows stages in a typical battery portable or similar receiver. If a station is tuned in, an audio output will be available at point (1). Point (2) also gives an audio signal, at greater power. The usual volume control allows the signal strength to be adjusted.

Many receivers have a 465kc/s I.F., so a modulated signal at about this frequency may be taken from points (3) or (4). A short piece of flex can be used as a test lead. For audio outputs, use points (1) or (2), and include a condenser of about 0.01μF in series with the lead. For 465kc/s outputs, use points (3) or (4), and wire a 100pF or similar condenser in series with the test lead.

Mains receivers may also be used, with appropriate care, and reliable isolating condensers in the test lead. With a TRF receiver, no intermediate frequency signal will be available.

**Method of Testing**

The valve receiver is tuned to a station and switched on. For I.F. outputs, the valve receiver speaker can be muted by turning the volume control to zero. When using audio outputs, the

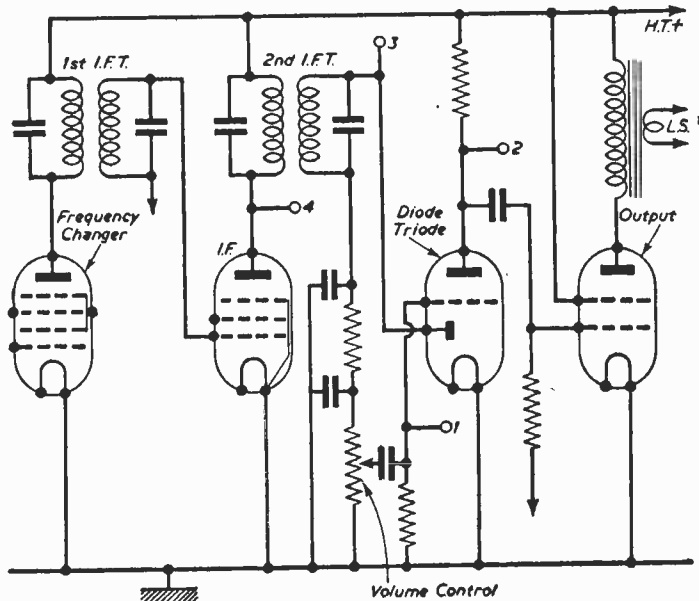

Fig. 2.—Obtaining audio and I.F. outputs from a receiver.

speaker in the valve receiver must be muted. This can be achieved by connecting an equivalent resistance in its place.

To check the transistor receiver speaker and output transformer, if necessary, apply the audio signal at (6) or (7). With the A.F. signal injected at (4) or (5) volume should be increased. If the lead is removed to (3) and reception ceases, the driver transformer, or connections to it, are defective.

Taking the lead to (2) should give increased volume. If not, the driver stage is faulty. With the lead taken to point (1) output should be adjustable by means of the volume control. If not, this component, or wiring to its tags, must be checked.

When working backwards from the output stage in this way, reception will cease when the point of the defect is passed. Also look for additional volume, as each additional stage is brought in, and reduce signal strength with the valve set volume control, to avoid overloading.

These tests will localise any defect in the audio stages of the receiver. Once this section has been cleared, or the defect found, attention can be given to the I.F. stages.

**Checking I.F. Amplifiers**

An intermediate frequency output is now obtained from the valve receiver, as described. The test lead is taken to point (8). If results are good, the third I.F.T. and diode are working. If signals were obtained with audio injected at (1), but not

with the I.F. signal injected at (8) suspect the third I.F.T., or diode, or associated connections.

If results are obtained, transfer the lead to (9). Amplified signals should be heard. If not, suspect the second I.F. transistor, and associated resistors and wiring. If a signal is obtained, and valve receiver and transistor receiver both have a similar intermediate frequency, it should be possible to adjust the core of the third I.F.T. for maximum results.

The lead is then connected to point (10). If reception ceases, the second I.F.T., or connections

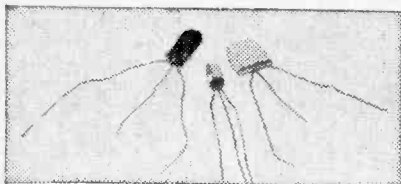

*Various types and makes of transistor differ in appearance and three of the common types are shown above to facilitate identification.*

to it, must be checked. When the lead is taken to (11), volume should increase. If not, suspect the first I.F. transistor, or associated components.

#### **AVC Action**

As more stages are brought into use, it will be necessary to avoid overloading the transistor receiver. A very small series condenser should be used in the test lead. This can be arranged by twisting two insulated wires together for an inch or so, and reducing the length twisted together if signals are too strong. When testing the I.F. stages, keep the transistor receiver audio volume control at maximum, and reduce volume if necessary by keeping down the strength of the signal injected.

With the lead connected at (11), or merely placed near this wire, the second and third I.F.T.s can be aligned. The lead may be transferred to (12). If reception ceases, suspect the first I.F.T. or connections to it. If results are obtained with the lead at (12) but not at (13) then the oscillator coil collector winding is defective, or the coil wrongly wired.

If the two receivers have the same intermediate frequency, and one of the transistor set, I.F.T.s cannot be adjusted for best results, connections to this transformer should be checked. The injected signal must be kept at a very low level, as explained, or the automatic volume control circuit of the receiver will make adjustment difficult.

If an intermediate frequency amplifier is suspected, it may be temporarily eliminated, with its transformer, by connecting point (11) to point (9), in the case of the first I.F. stage. Or the first I.F.T. can be eliminated by connecting point (10) to point (12), and so on. Any unused transistor should be unsoldered. One I.F. stage transistor can be compared with the other by using only one I.F. stage in this way, and trying the transistors in this stage in turn.

When the defective stage has been located, check wiring and resistor values carefully. If all com-

ponents are in order, and connections are correct, the associated transistor must be suspected.

#### **F.C. Stage**

When good results are obtained with a weak signal injected at (13), but the receiver will not operate, the F.C. stage is probably defective. If the defect shows up on one waveband only, this would have immediately made the associated coil windings, switching, and wiring suspect. These items should in any case be checked, when a fault has been localised to the F.C. stage.

To eliminate the aerial circuit, lead (14) can be disconnected from the switch, and taken to an exterior tuned circuit. This can be any coil and variable condenser tunable to the medium or long wave band. The coil is returned to the earth line, or base feed network. If good reception is then possible, the aerial circuit is probably faulty.

Alternatively, an aerial may be connected to point (14). If reception is possible, the aerial circuit may be faulty, or trimming badly in error. But if neither of these tests allow any signal to be received, after the checks previously described, then the F.C. transistor is probably not oscillating. Oscillator coil connections should then be checked.

When reception is good with an aerial, but ceases when this is disconnected, lack of alignment alone may be responsible. If so, adjustment of the oscillator coil core, or aerial coils, or trimming, will remove the trouble. Remember to adjust cores at a high wavelength on each band, and trimmers at a low wavelength. Alignment is correct when no further improvement in volume is possible. As reception is improved by early adjustments, select weak stations for subsequent adjustments, to prevent the AVC action already mentioned.

#### **Other Tests**

If a new battery is not being employed, it should be checked with a meter. The correct polarity is absolutely essential. Switch, and positive and negative circuit continuity, can be checked by working along point by point from the battery.

A meter and small battery can also be used to check continuity of aerial, oscillator coil, I.F. transformer, and other windings. Disconnect one end of suspected windings first.

In most cases only a few of the tests described will be required. For example, if A.F. is applied as explained, working back from the speaker, a defect in the A.F. amplifier may be at once located. Similarly, if the A.F. amplifier is cleared, applying an I.F. signal to points (8) through to (13) will quickly show where the fault is.

### **JOIN THE PRACTICAL GROUP**

**PRACTICAL TELEVISION** ... .. 1/6

Every Month

**PRACTICAL MECHANICS** ... .. 1/3

Every Month

Devoted to Mechanics, Science and Invention.

**PRACTICAL MOTORIST** ... .. 1/6

Every Month.

**PRACTICAL HOUSEHOLDER** ... .. 1/3

Every Month.



# A STEREO AMPLIFIER

## 8W WITH SINGLE-ENDED OUTPUT CIRCUITS

By R. Hindle

(Continued from page 902 of the February issue)

**T**HE main circuit is fully conventional. R4, C1 and R12, C4 serve to decouple the first audio stages. The gain controls (VR1, VR2) are placed between the two audio stages where the signal is of the order of 1V. It will be seen that the H.T. switch connects the centre-tap of the 300-0-300V winding to earth via the indicator lamp L1 which, when the switch is in the "on" position, carries the H.T. current of the whole amplifier, or more correctly the charging current to the capacitor C8 which is of pulse form. Normal current lights this lamp quite adequately, the initial surge on switching on being evidenced by the brightness of the bulb. Excessive current will burn out this lamp, however, so that it acts as a fuse. The transformer specified has two 6.3V centre-tapped windings in addition to the winding for the rectifier heater and these are used one for each amplifier line. It is not essential to feed these from separate windings if a transformer with only one such winding is available. The "mains on" indicator lamp may be across one half of one of these windings, this being found to give quite adequate light with the lamps used. Centre taps go to earth, of course, and both sides of the heaters of the valves are floating.

The gain of this amplifier even without a pre-amplifier is likely to be adequate for the popular type of stereo cartridge of the crystal or ceramic type and the constructor may like to try it out coupled directly into this amplifier pending the production of

the pre-amplifier. In this case it should be borne in mind that the crystal pick-up has to be correctly loaded in order to produce the correct frequency characteristic. The appropriate resistance is quoted by the makers and this value should be substituted for R1 and R9.

### Construction

The amplifier is constructed on an aluminium chassis 12in. x 6in. x 3in. The drilling diagram was given in Fig. 3, which shows the sides of the chassis as if they were opened up. The layout shown is as on

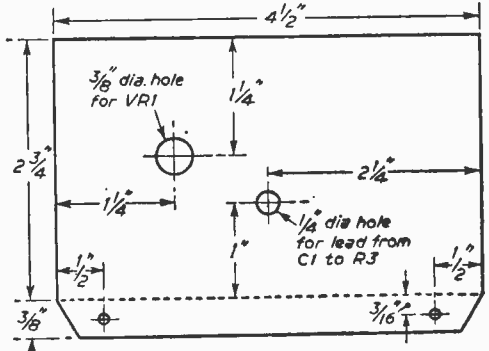
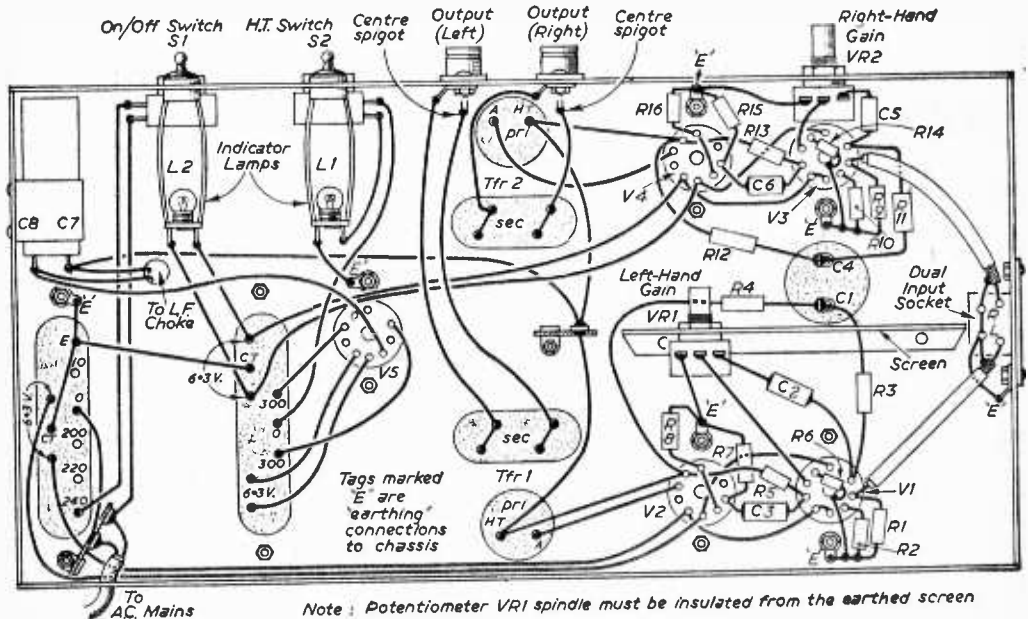
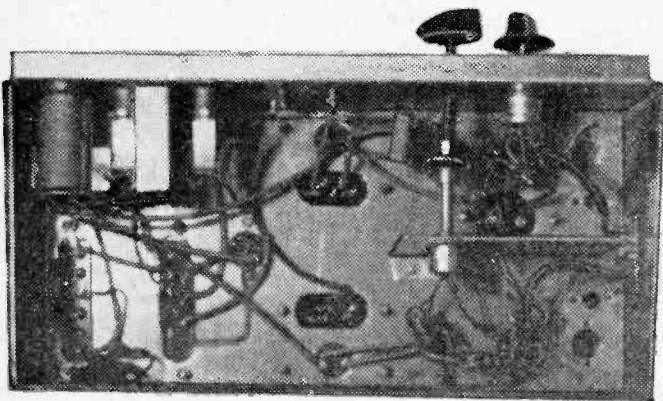

Fig. 4.—The drilling details for the screen to support the volume control.



Note: Potentiometer VR1 spindle must be insulated from the earthed screen  
Fig. 5.—The under chassis wiring diagram.



*The amplifier with all the wiring completed.*

the outside of the chassis. The actual components to be used should be measured of course before drilling in case they are found to vary somewhat from the sizes shown. No mounting holes are drawn for valve holders and electrolytic condenser clip. The best way is to drill the hole as shown, drop in the component, turn it until the pins are in the relative positions shown on the wiring diagram (Fig. 5) remembering that this is the underneath of the chassis, and then mark the positions for the fixing bolts.

The mains and output transformers are of the shrouded type with soldering pins projecting underneath. Slots have to be cut in the chassis to allow passage for these, the method being to drill holes at each end of the slot position, then cutting away the metal between the holes. The positions for the possible additional valves are shown but not the holes themselves. The position of the screen is shown in Fig. 3, and the dimensions of the actual screen are in Fig. 4, from which the positions of the fixing screws on the main chassis can be taken.

### Wiring

When the components are mounted, wiring should begin by feeding the heater supply with twin plastic flex, running this close to the chassis. A soldering tag under one of the securing bolts of each valve holder is used for all earths for the circuit associated with that valve. The only exception is the earth for the input socket which goes to a tag on one of the bolts holding this socket. All resistors are self-supporting on the valve-holders and are put as close as possible to the holder. The input lead from the socket to the valve is a short piece of coaxial cable of which the screen is earthed at the input socket end only.

If two signal lamps are to be fitted it will be found that the light from one bulb will shine through the window of the other, so obscuring the meaning of the lights, unless an aluminium shield is shaped and fitted between the lamps (or, of course, the enclosed type of signal lamp could be used).

Note that the output transformers can be used for either 15 $\Omega$  or 3 $\Omega$  speakers according to the connections made to the secondaries. The wiring diagram shows the two secondary windings of each transformer connected in parallel for 3 $\Omega$  working. If 15 $\Omega$  work-

ing is required the windings are connected in series.

The spindle of the volume control fitted to the screen is extended to the front of the chassis using a flexible coupler and a piece of bakelite rod. Bear this in mind when wiring so that there is room for the coupler. Knobs were fitted to the volume controls on the prototype, though these are really unnecessary; instead slots could be cut in the spindles for screwdriver adjustment.

This amplifier could supply 6.3V heater supply and up to 15mA of H.T. to a pre-amplifier if required. If this is needed it is suggested that an output socket be fitted at the mains transformer end of

the chassis to allow easy connection.

## Surrey's Most Modern Factory

The second stage in the erection of the new factory at Chessington for the Solartron Laboratory Instruments, Ltd. the electronic instrument manufacturing company of the Solartron Electronic Group, Farnborough, Hants., is now under way.

The administrative block of 25,000 sq.ft, which presently houses the instrument sales and the international division of Solartron, was occupied early in 1960. Also in this block are the instruments servicing and works training sections, together with some production facilities.

The second section of 50,000 sq.ft being built will be completed in October, 1961, and the third stage—a further expansion of 50,000 sq.ft, for which the Chessington site has available space—will be completed in three years' time. The final factory will be one of the most modern in Britain for the manufacture of electronic instruments and will employ more than 1,000 people.

The training centre, which is now incorporated in the new buildings, is claimed to be the most advanced for workers in electronics. A special study has been made of training methods, and the result is that operators are working confidently at full production at their benches after an initial training period of six weeks. The training continues from time to time in intensified courses for two years for the creation of an expert operator. In fact, training is integrated with production somewhat as is a University "sandwich" course.

The Solartron Electronic Group is a member of the Firth Cleveland Group of Companies, under the chairmanship of Mr. Charles Hayward, and currently Solartron's sales of electronic test instruments alone exceed £2,000,000 per annum, and it is planned to double this amount over the next five years.

The Solartron Group Director responsible for the Chessington factory is Mr. E. R. Ponsford, Managing Director of Solartron Laboratory Instruments, founded 13 years ago as the first Company of the Group.

The decision is YOURS. To be a success in your chosen career; to qualify for the highest paid job . . . to control a profitable business of your own. ICS home-study courses put your plans on a practical basis; teach you theory and practice; give you the knowledge and experience to take you, at your own pace, to the top.

Choose the *RIGHT* course .

RADIO & TELEVISION ENGINEERING  
INDUSTRIAL TELEVISION

RADIO & TELEVISION SERVICING  
RADIO SERVICE AND SALES

VHF/FM ENGINEERING : ELECTRONIC  
COMPUTERS & PROGRAMMING

ICS provides thorough coaching  
for professional examinations:

Brit. I.R.E., City and Guilds Tele-  
communication Technicians, C. & G.  
Radio & TV Servicing (R.T.E.B.);  
C. & G. Radio Amateurs.

### LEARN AS YOU BUILD

#### Practical Radio Courses

Gain a sound up-to-professional-standards knowledge of Radio and Television as you build **YOUR OWN** 4-valve T.R.F. and 5-valve superhet radio receiver, Signal Generator and High-quality Multi-meter. At the end of the course you have three pieces of permanent and practical equipment and a fund of personal knowledge and skill. ICS Practical Radio courses open a new world to the keen Radio amateur.

# Technical Training in Radio, Television and Electronics Engineering with

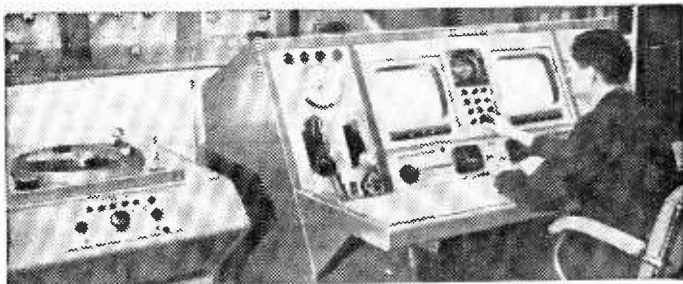

**THERE ARE ICS COURSES TO MEET YOUR NEEDS AT EVERY STAGE OF YOUR CAREER. FILL IN AND POST THIS COUPON TODAY.**

You will receive the FREE 60 page ICS Prospectus listing examinations and ICS technical courses in radio, television and electronics PLUS details of over 150 specialised subjects.

Other ICS courses include: MECHANICAL, MOTOR, FIRE, ELECTRICAL & CHEMICAL ENGINEERING. FARMING, GARDENING. ARCHITECTURE & WOODWORKING. SELLING & MANAGEMENT. ART. PHOTOGRAPHY, etc., etc.

**PLEASE STATE ON COUPON SUBJECT YOU ARE INTERESTED IN . . .**

**INTERNATIONAL CORRESPONDENCE SCHOOLS**  
(DEPT. 170), INTERTEXT HOUSE, PARKGATE RD., LONDON, SW11  
PLEASE SEND FREE BOOK ON.....  
NAME .....  
ADDRESS .....  
.....  
OCCUPATION..... AGE.....  
3-61

# LASKY'S RADIO

## TAPE DECK SCOOP!



Brand new and unused in maker's cartons. Limited number only. The well-known MOTEK K10 Deck with push-button controls, 3 motors, 3-speed (11, 31, 74 i.p.s.), rev. counter. Freq. response better than 40-12,000 c/s at 74 i.p.s. 3-tone grey finish. Listed at £22. **LASKY'S PRICE £9.19.6** Carr. & Ins., 7/6.

SUITABLE CASE AVAILABLE, 39/6.

Send for Lasky's 100-page COMPONENTS CATALOGUE. Price 2/-, post 6d. Our latest 12-page Bargain Bulletin included free.

## STEREO AMPLIFIER KIT ONLY 56/-

Twin 4 watt (or 8 watt monaural), employing two ECL82 and E230 rect. valves, double-wound mains transformer, etc. Separate panel with bass, treble and volume controls. Indicator lamp. push-button on/off switch, elegant gold/cream knobs. Kit comprises two Amplifier Units and Power Unit, all 5 x 2in. in size, fully assembled ready to be wired together. Kit is priced without Loudspeaker so that you can choose the type and size required.

**LASKY'S PRICE for the Kit 56/-** Post 3/- with 3 new Mullard valves.

Full data, circuit diagram, assembly instructions and suggested layout supplied.

## SPECIAL OFFER OF SPEAKERS WITH THIS KIT

Two 5in. for 20/- Two 6 x 4in. 25/-  
Suitable Cabinets available at bargain prices!

### LASKY'S CAR RADIO 12 v. operation, transistor output, medium and long waves. Can be built complete with Speaker for £11.10.6. Post 3/6. Booklet 2/6. (refunded if you order).



## 3-SPEED TRANSISTOR PORTABLE RECORD PLAYER

**CAN BE BUILT FOR £9.19.6** Carr. free

6 v. operation. For all L.P. and standard records. All components available separately.

**AMPLIFIER.** 300 milliwatts push-pull output, using two OC71 and two OC72 transistors. Fully assembled. 79/6. Knobs, 3/6 extra.

**LOUDSPEAKER.** 30 ohms, 7 x 4in. elliptical, matched to Amplifier, 25/-.

**3-SPEED TURNTABLE.** 6 v., with rubber mat and speed adjustment, complete with t.o. crystal cartridge and two sapphire styli. 79/6.

**CARRYING CASE,** handsome two-tone finish, 17in. deep, 14in. wide, 5 1/2in. high. Well made and finished. 49/6. Batteries extra.

## 'VANCOUVER' 3-TRANSISTOR POCKET RADIO

**CAN BE BUILT FOR 39/6** Post 1/6



Uses 3 transistors plus germanium diode on printed circuit, size 3 1/4 x 4 x 1 1/2 in., and incorporates ferrite rod aerial. Tunable over medium and long waves. Extremely simple to build. Circuit diagram and full instructions, 1/6 (free with parcel).

**207 EDGWARE ROAD, W.2** Near Praed Street. PAD. 3271/2 **42 TOTTENHAM COURT ROAD, W.1.** MUS 2605  
Both addresses open all day Saturday. All Mail Orders to Lasky's Radio, Dept. PW, 207 Edgware Road, London W.2

# VALVES SAME DAY SERVICE

**NEW! TESTED! GUARANTEED!**

**SETS** IR5, IS5, IT4, 3S4, 3V4, DAF91, DF91, DK91, DL92, DL94 any 4 for 19/6  
DAF96, DF96, DK96, DL96 4 for 27/6  
6K7C, 6K8C, 6Q7G, 6V6G, 6X5G, Or 5Y3G .. .. . 5 for 27/-

1A7GT 11/6	6L18 10/3	25Z6GT 9/6	ECC82 11/-	EZ41 7/-	T41 8/6
1D5 8/-	6LD20 8/-	30L15 10/6	ECC81 5/-	EZ80 10/6	TH41 19/8
1HG5T 10/6	6P1 13/6	38A5 9/6	ECC82 6/3	EZ81 7/-	U22 7/3
1NSGT 10/-	6P25 9/-	3L6GT 8/6	ECC83 7/6	FW4/500 8/-	U25 13/-
1R5 5/6	6Q7G 6/-	35Z4GT 6/9	ECC84 8/9	G232 8/6	U28 10/-
1S4 5/6	6K7GT 9/6	35Z6GT 8/6	ECC85 8/3	G232 8/6	U50 6/-
1S5 8/3	6SL7GT 6/3	50L6GT 8/9	ECC85 8/3	HBC90 7/-	U52 4/6
1T4 4/-	6SN7GT 4/9	AC/TH1 18/9	ECC82 8/6	KT33C 7/-	U78 4/9
1U5 5/9	6A31 11/-	AZ31 9/9	ECH21 13/6	KT41 11/6	UABC80 7/9
3A5 9/-	6V8G 5/-	B36 8/6	ECH35 6/3	KT44 10/6	UAF42 9/-
3Q4 7/-	6V6GT 6/6	CL33 12/3	ECH42 8/9	KT61 10/-	UBC41 7/9
3S4 8/-	6X4 4/9	DAC32 10/-	ECH81 8/-	KT63 6/6	UBF80 8/9
3V4 7/6	6X5GT 4/9	DAF91 5/3	ECL80 7/6	MU14 7/6	UBF89 8/-
5U4G 4/6	7B6 9/-	DAF96 7/6	ECL82 9/6	MX40 9/6	UC92 12/6
5V4G 8/-	7B7 7/6	DC990 9/-	EF33 4/6	N18 7/-	UCC84 12/9
5Y3GT 6/-	7C5 7/6	DF33 10/-	EF41 8/3	PCC84 7/6	UCC85 7/8
5Z4G 7/9	7C6 7/6	DF91 4/-	EF42 9/6	PCC89 11/-	UCF80 14/6
6AL5 3/9	7D7 7/6	DF96 7/6	EF80 5/6	PCF80 7/9	UCH21 13/6
6AM6 3/6	7S 9/-	DK66 8/9	EF85 6/6	PCF82 8/-	UCH42 8/-
6A05 6/-	7Y4 7/-	DH77 7/6	EF89 9/9	PCF82 8/-	UCH81 8/-
6AT6 6/9	10C1 11/6	DK32 11/6	EF91 3/6	PCL83 11/6	UCL82 10/9
6BA6 8/-	10P13 17/6	DK91 5/6	EF91 3/6	PCL83 11/6	UCL83 13/3
6BB6 5/9	12A7 14/6	DK92 7/6	EF92 4/3	PCL84 7/6	UF41 8/9
6BH6 5/9	12AT7 5/-	DL33 9/-	EL11 10/6	PEN44 11/-	UF85 8/6
6BL6 5/9	12AU7 6/3	DL35 9/6	EL42 8/6	PEN38C 8/-	UF89 7/-
6BW6 8/-	12AX7 7/-	DL92 6/-	EL81 12/-	PEN45 7/6	UL41 8/-
6CD6G 27/6	12K7GT 5/3	DL94 7/6	EL84 7/-	PL36 11/6	UL84 8/6
6F1 12/6	12K8GT 11/6	EM34 7/6	EM34 7/6	PL81 9/6	URIC 8/-
6F6G 6/6	12Q7GT 4/9	EM80 8/9	EM80 8/9	PL82 7/-	UY21 11/3
6F13 11/-	12Z3 7/6	EM81 8/6	EM81 8/6	PL83 7/6	UY41 6/6
6F14 16/6	14S7 16/9	EM84 10/6	EM84 10/6	PL84 10/-	UY85 6/6
6G14 2/6	20A2 17/6	EBC33 5/-	EY81 7/6	PY32 11/6	UY91 10/9
6K7G 6/6	20A6 17/6	EBC41 8/-	EY81 7/6	PY80 7/6	VP4B 10/9
6K8GT 5/-	25A1 7/6	EBC41 8/-	EY84 10/-	PY81 6/9	VP41 5/6
6K8G 6/3	25A6G 8/-	EBF80 8/-	EY86 7/9	PY82 6/6	W76 5/3
6K8GT 9/3	25L6GT 7/9	EBF89 8/9	EZ40 6/9	PY83 7/9	W77 4/6
6L1 14/-	25Z4G 7/6	EBL21 13/6		PZ30 17/6	Z77 3/6

## 1961 EDITION RADIO AMATEUR'S HANDBOOK

32/6 by The A.R.R.L. Post 2/-

- A BEGINNER'S GUIDE TO RADIO, by F. J. Camm, 7/6. Postage 6d.
- REFERENCE MANUAL OF TRANSISTOR CIRCUITS, Mullard, 12/6. Postage 1/-.
- R.S.G.B. AMATEUR RADIO CALL BOOK 1961, 4/-, Postage 6d.
- TELEVISION ENGINEERS' POKET BOOK, by J. P. Hawker, 12/6. Postage 6d.
- MODEL RADIO CONTROL by E. L. Dafford, 21/-, Postage 1/-.
- RADIO TELEVISION INDUSTRIAL TUBE, DIODE AND TRANSISTOR EQUIVALENTS MANUAL, by B. B. Babani, 9/6. Postage 6d.
- WORLD RADIO HANDBOOK for Listeners, Broadcasting and Television 1961, 16/6. Postage 1/-.
- CATALOGUE, 1/-.

## THE MODERN BOOK CO.

BRITAIN'S LARGEST STOCKISTS of British and American Technical Books  
**19-21 PRAED STREET LONDON, W.2**  
Phone: PADdington 4185  
Open 6 days 9-6 p.m.

# READERS RADIO

24 COLBERG PLACE, STAMFORD HILL, LONDON, N.16. **STA. 4587**

Post 6d. per valve extra.  
Any Parcel Insured Against Damage in Transit 6d. extra.  
Any C.O.D. Parcel 2/6 extra.

# On Your Wavelength

BY THERMION

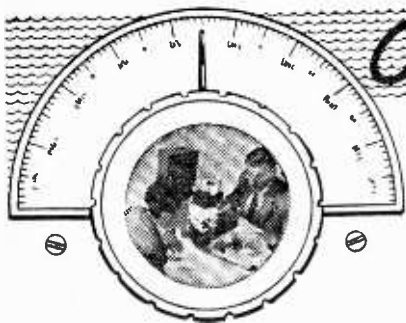

## Aerial Design

ONE important feature arising out of correspondence from some of my readers was regarding the choice of aerial suitable for short-wave section. In the old days one was content to erect a large horizontal aerial system, usually running the full length of a garden, with a large mast at each end and the lead to the set was taken from one end or from the centre. This type of aerial (an inverted 'L' or a 'T') was a good all-round arrangement, and many newcomers are inclined to copy this arrangement and in spite of the all-important feature of height and insulation, and the use of the multi-stranded wire, only obtain very indifferent results. I am asked why this is. The main reason is that nowadays the majority of high-powered short-wave stations use a very high metallic mast which itself is the radiator or aerial. Under these conditions, therefore the signal is vertically polarised. As most readers know, it is desirable that the receiving aerial and the transmitting aerial should be in the same plane—compare the television aerial or the VHF aerial, for instance. The types of aerial used earlier and referred to above, are horizontal types and must naturally, therefore, be productive of inferior results. I have found that a very good aerial for all-round short-wave reception (that is, for a receiver which may be used on a large number of bands and not tied down specifically to one amateur band) consists of a vertical wire. The arrangement which I have tried out and have indeed recommended to a number of amateurs, is to fit a length of stout battening to the soffit carrying the gutter and to the end of the batten attach an insulator. One end of a length of wire should be attached to the insulator which should be at least 3ft from the walls of the house. The lower end of the wire should be anchored to a similar arrangement of batten and insulator fixed to the lower part of the house so that the wire is about 15ft long. The lead to the receiver is taken from the lower end. In the majority of cases this arrangement will be found productive of very good all-round results except in some cases, where the house acts as a screen. Except on the very short wavelengths, this should not have a very marked effect, and the only ill-effects which have been noted were in the case of very heavy rain-storms when the wall immediately behind the aerial became soaked, and signals did then drop off. If you have not tried such an arrangement, and are experiencing indifferent results in your short-wave

working, perhaps you would try this scheme and let me know how you get on. I should like to stress that letters from my readers are always appreciated, especially where some scheme has been tried out and I will always be pleased to pass on the results of tests which may benefit other readers.

## Rain Effects

Whilst on the subject of aerials I should like to mention a peculiar effect which was reported to me by an acquaintance. He was listening to the short-waves one evening and suddenly a ticking noise started on the band on which he was listening and he thought that it was an amateur starting up his transmitter, or a new beacon which he had not previously heard. He found, however, that the noise extended over the entire band and was not tunable. For a time he put it down to some form of electrical interference, but as it continued he began to wonder whether something was wrong with his equipment and so started to take particular notice. The ticking had an almost clockwork regularity, and was of very constant strength. Suddenly the regularity fell off and longer intervals occurred between the individual "clicks", and after a very short time they ceased. He was left wondering what had been the cause of the trouble and then continued his "searching". After a few minutes the noise started again with the constant regularity, and fortunately at that moment the wind apparently changed and he heard rain beating against his window. This gave him an idea and he looked out at his aerial and from the insulator nearest his house he saw a constant steady drip of rain. The water was running down the aerial, over the insulator to its lowest point, and then dripping from there. There was obviously some electrostatic effect taking place, and when he pushed up a length of wood to take away the drips the noise ceased, as it did when it stopped raining. The insulator, incidentally was one of the ex-government Pyrex long components and was not fractured—but it was coated with a very heavy deposit of soot. He gave it a good scrub with warm water and a detergent and at the next heavy shower it gave no trouble at all. Perhaps, therefore, if your aerial equipment has been up for some long time it might be worth while lowering it and giving it a clean up; a heavy sooty deposit could cause signal losses.

## Heat Sinks

To obtain maximum efficiency from heat sinks used for power transistors, paint them dull black. Black is a much better radiator of heat, so that a small black heat sink may be much better than a larger shiny one. The principle can also be used for ordinary transistors. If a transistor is going to be near something warm, paint it with a shiny aluminium paint. If you are worried about the transistor itself heating, paint it dull black so it can easily radiate its excess heat.

# A Versatile TAPE RECORDER

COMMENCING THE  
WIRING

By D. L. Woolley

FOR the deck used by the author, the front panel should be made 11 in. wide. If the record-level indicator is to be built into the recorder, the front panel should be drilled as shown in Fig 5 but if not the panel should be drilled as in Fig. 4.

For the record-level indicator (whether built into the recorder or not) a small moving-coil milliammeter is required. Any value of full-scale deflection up to a maximum of 5mA can be used. An old thermo-couple R.F. meter with the thermo-couple removed should be ideal as the scale readings are unimportant—a linear scale is not required, any calibration will do. The diameter of the meter-case should be about 2 in. although up to 2½ in. can be fitted on the panel. A hole to suit the meter should be cut in the panel including the three or four fixing holes required. If the depth of the meter-case is greater than 1½ in. the meter will not fit flush with the front of the panel as it will touch the second and third valves. This small difficulty can be overcome by using small stand-off washers to keep the front of the meter about ¼ in. from the panel.

## Drilling

When drilling the front panel it is advisable to make sure that the lower holes coincide, as near as possible, with the similar ones on the front wall of

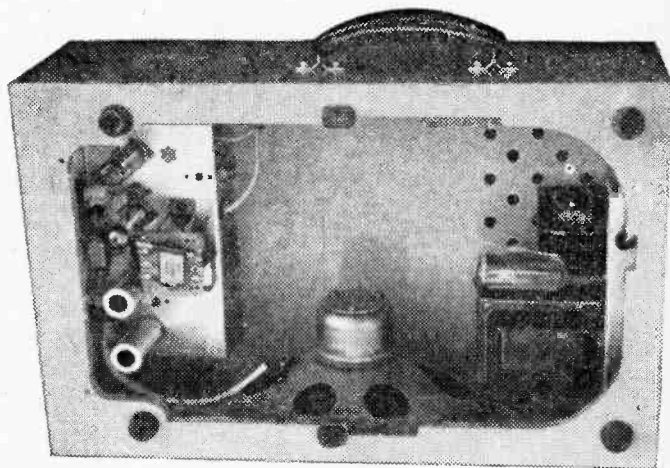

## The Function Switch

As stated before, the function switch is very important. A good quality well insulated 3-pole, 3-way, 2-bank switch is required. It must be of standard size and not a miniature. This is important as the stray capacitance between tags on a miniature switch is high and such strays must be kept low in order to avoid instability and unwanted feedback.

First of all, the switch is dismantled, except for the ball-bearing mechanism, and all parts cleaned,

especially the two wafers. These two wafers will, for convenience, be named Bank 1 and Bank 2. A small piece of Mumetal, radio-metal or similar high-permeability metal is now needed for a screen between the two banks. Ordinary tin-plate would do the job, but not as efficiently as the Mumetal. An old cathode ray tube screen would be a suitable source of high-permeability alloy. The size of the screen is 3¼ in. long by 2¼ in. wide and it should be cut and drilled as shown in Fig. 6 although the measurements are nominal and depend on the size of the switch.

Holes P and Q should be drilled to suit the two fixing bolts of the switch. Two small grommet-holes are needed as shown. The switch is now built up as illustrated in Fig. 7. More details are given in Fig. 11. After bolting the switch together,

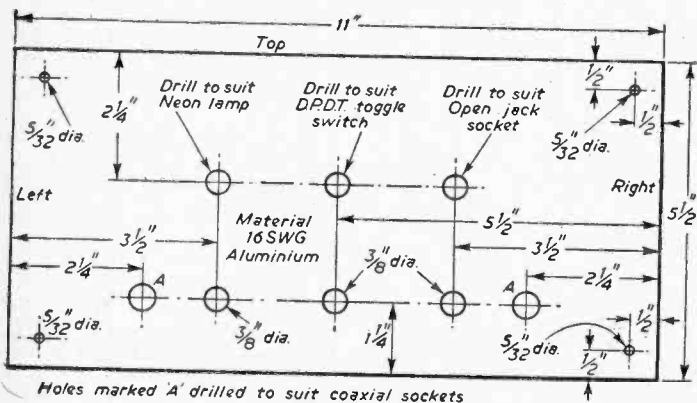

Fig. 4.—Drilling details of the front panel.

the chassis. The panel and chassis should now be cleaned with a cloth to remove all small metal particles and dust, before being put to one side.

shown. The switch is now built up as illustrated in Fig. 7. More details are given in Fig. 11. After bolting the switch together,



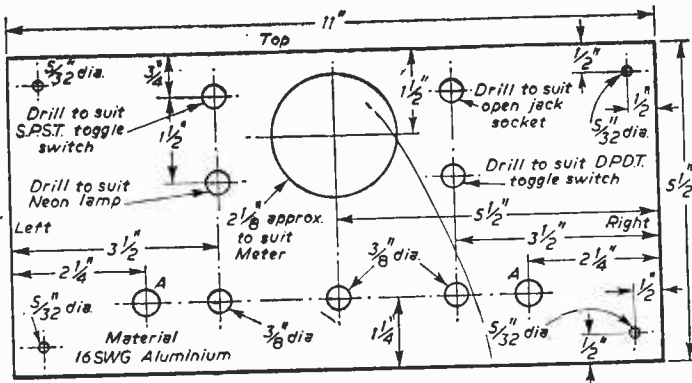
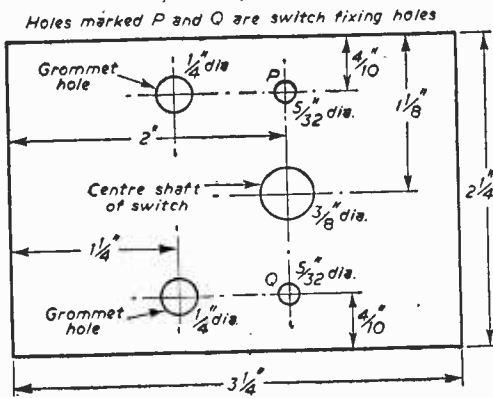

Fig. 5 (above).—Alternative front panel drilling details when a record-level meter is to be included.

Fig. 6 (below).—Dimensions of the Mumetal screen for the function switch.



it can be partially wired. The connection from SA3 to SC3 (Fig. 2, page 898 last month) goes through the lower grommet-hole in the screen, whilst the two earthed sections on Bank 1 and Bank 2 are connected via the upper grommet-hole. It should be noted that the two banks are back-to-back and that the tags of Bank 2 face the ball-locating mechanism. In all cases SA, SB and SC, SD indicate the moving contact and the numbers 1, 2 and 3 the fixed contact being touched by the wiper. Although the switch, when described, seems a little complicated, its function and building are easy to see once one actually handles the switch and can inspect the various contacts.

**Wiring the Amplifier**

The most difficult part has now been completed and the actual wiring of the amplifier can be commenced. Two tag-boards are needed, one 16-way, and one 5-way. Both should have two contacts per tag and about 1 1/4 in. between the inner tags. The larger tag-board is wired first; a complete wiring diagram is given in Fig. 10. It is best to wire in all connecting links before any actual components. Short leads of tinned-copper wire should be fixed to the lower, outer contacts, as shown,

for connections to the valve-bases. About 2 1/4 in. is a convenient length to make these leads. The tag-board has been designed in such a way that no leads need cross, and each can take a direct route to the valve-base in question. As a general rule, all resistors should be fitted first, between the inner contacts followed by the capacitors between the outer contacts. Any leads likely to short or touch other tags, should be covered with thin sleeving.

**Amplifier Components**

A word is now needed about the components used in the amplifier. Ordinary carbon resistors are apt to be noisy in operation. If such resistors are used in a high-gain stage, any small fluctuation in the current through them is amplified and produces quite a high background noise level. Thus for resistors R1, R2, R3 and R4, good quality cracked-carbon, high-stability components should be used. This type of resistor need not be very expensive—in the prototype amplifier, all 1/4W resistors were 10per cent tolerance high stability components.

C2 and C9 provide decoupling in the amplifier in conjunction with R16 and R5. These two capacitors are wire-ended tubular electrolytics, as are C1, C12, C19 and C22. Good-quality paper tubular capacitors must be used for C3, C10 and C14 as any leak in C3 and C10 will upset the biasing of valves 2 and 3, whilst a leak in C14 would pass a direct-current through the record/playback head and magnetise it. The equaliser circuit can now be built on to a small 5-way tag-board. The equaliser described uses a network of resistors and capacitors, but no inductors, as is more usual. In the recorder it was desired to use the fastest speed of 7 1/4 in. per second for recording concerts and the speed of 3 1/4 in. per second for ordinary work. Although a speed of 1 1/4 in. per second is available on the tape-deck, it was decided to use this speed for private work only,

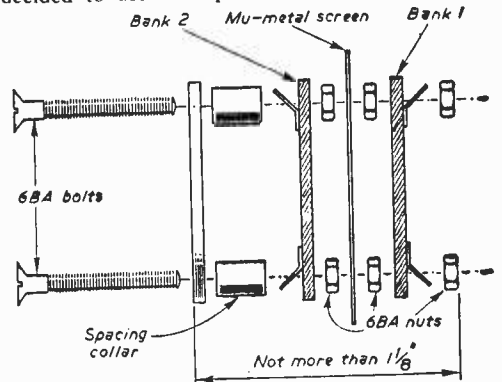

Fig. 7.—The assembly of the switch, including the Mumetal screen.

which did not require good quality at high volume. Recordings made at  $1\frac{1}{2}$  in. per second are good, but only if played back quietly. High volume tends to make the noise-level in very quiet passages too much of a distraction.

**Treble Boost**

It will be seen from the frequency response

speeds although it must be stated that it is a compromise, providing theoretically correct equalisation at 6 in. per second. R11 controls the amount of bass equalisation, and provides perfectly correct results at both speeds, being fully variable. Fig. 9 shows the approximate record/playback characteristics. The layout of the equaliser circuit and its tag-board are shown in Fig. 10. An alternative equaliser

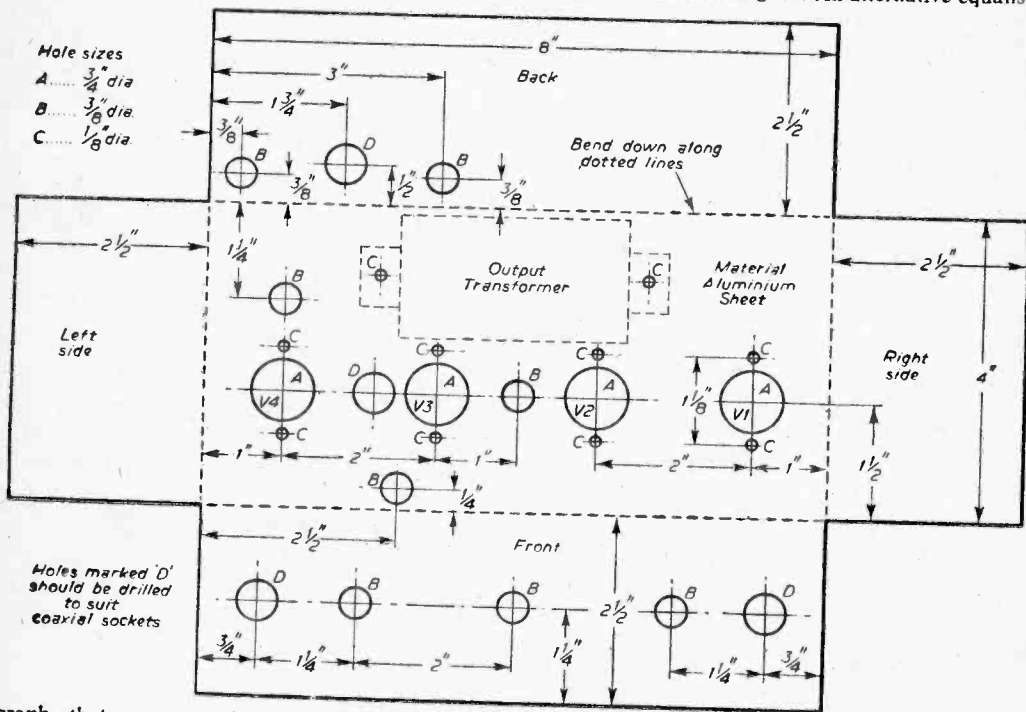

Fig. 8.—Drilling plan of the main chassis—holes for tag-strips, etc., have not been included.

graph that a great deal of treble boost is required above 1,500c/s. In many recorders, it is the practice to apply treble equalisation during recording and bass equalisation during playback, but for this recorder, treble boost is applied both during record and playback, whilst bass correction can be made on record or playback, or both. However, the magnetic tape is easily overloaded if too much bass equalisation is made during recording and only enough bass should be used to counteract any lack of it in the recording signal.

The circuit used for both  $7\frac{1}{2}$  in. and  $3\frac{1}{2}$  in. per second was shown in Fig. 2 (page 898, Feb. issue). This circuit gives ample treble equalisation at both

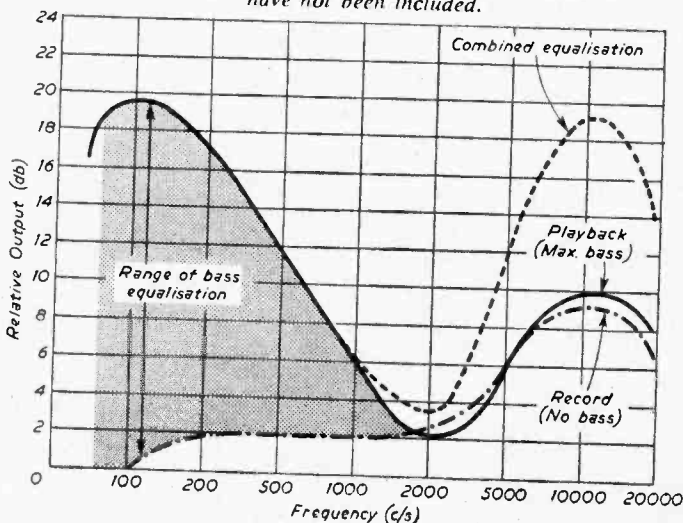

Fig. 9 (right).—Equalisation curves.

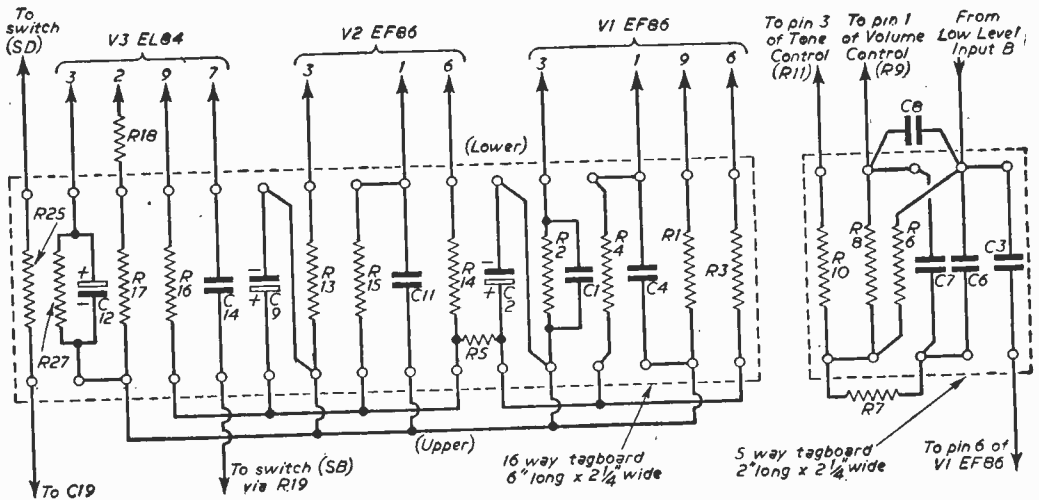

Fig. 10.—The main and equaliser circuit tag-boards.

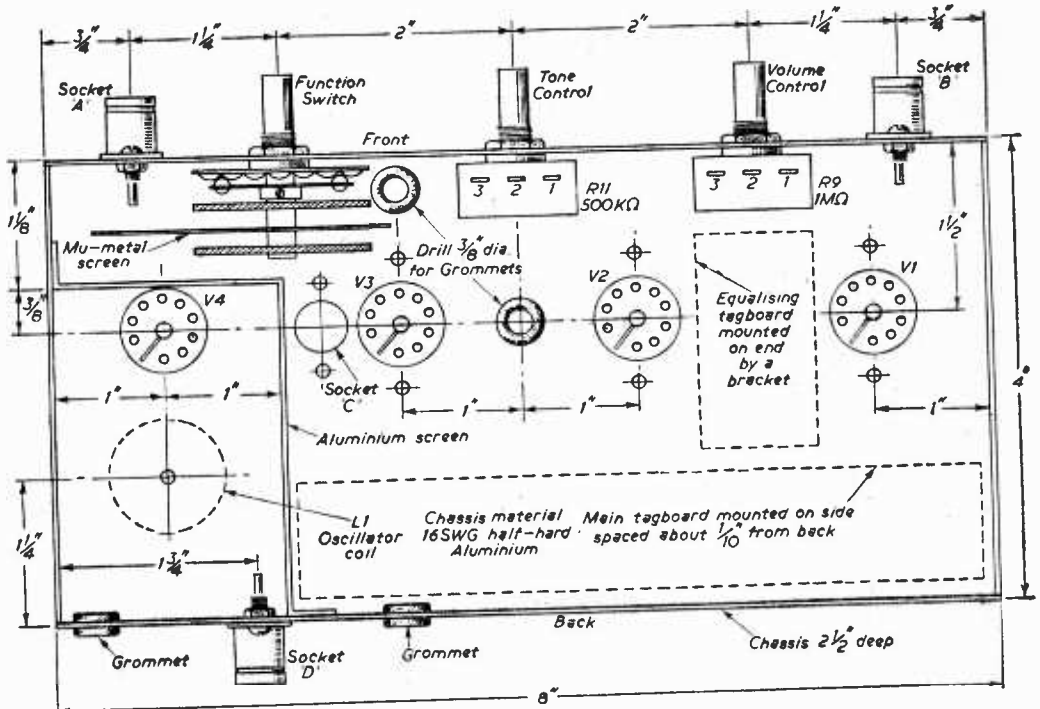

Fig. 11.—Underside view of the chassis.

circuit is shown in Fig. 12 with components from Fig. 2 to give the best equalisation at the three speeds. Either of the alternative equalisers can be built on to a 4 or 5-way tag-board. For C6a trial and error would probably give the best results, using a 300pF variable trimmer. For either type

of equaliser, the tag-board should be mounted on to the chassis using a small bracket, and details are given in Fig. 13. The amplifier proper can now be built. Grommets and valve holders are put in

(Continued on 1021)

# THE P.W. SIGNAL GENERATOR

MAKING THE POWER  
SUPPLY UNIT

**M**ANY constructors find they need a signal generator, but few eventually possess such a unit—their cost is generally too great. Although most enthusiasts cannot afford to buy a signal generator, they would nevertheless like to build one but are hampered by lack of plans. This new series has been especially prepared for the home constructor and will describe in detail the construction of a wide-range signal generator.

By E. V. King

by soldering as shown in Fig. 3. Make sure that tags 2 to 6 inclusive do not short to earth.

Grommets should be fitted in the holes A, B, and C. The switch S1 is fitted with the slot in the threaded portion uppermost, the switch is then "on" when pressed down. Leave plenty of thread showing outside the chassis and tighten the nut. For the position of S1 see Fig. 3.

The warning light is fitted from the inside using two nuts and bolts.

### Component Positions—Inside the Chassis

Fig. 3 shows the position of the transformer. It is bolted tightly to the tin plate and should have a small strip of mild steel fitted on top of the chassis. This strip is shown shaded in Fig. 2 and the general method of mounting in Fig. 6. If this is not incorporated the unit will work well, but will give rather more hum than necessary.

A small tag strip with two isolated

Fig. 1 (left)—The circuit of the power unit.

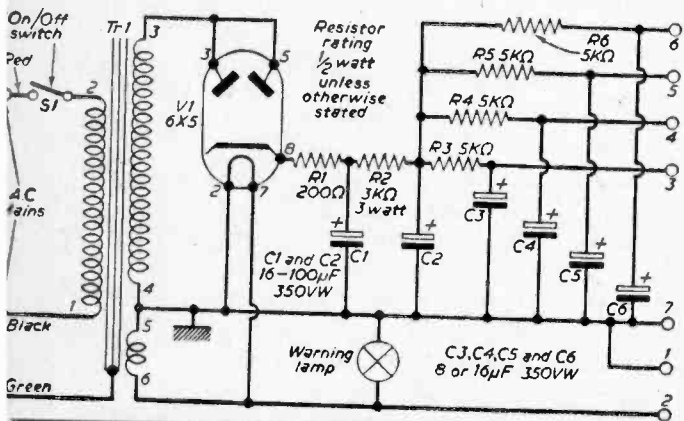

The chassis used for all the units are the same, basically a baking tin 6in. x 4in. x 2½in. high, and are easily obtainable. The bottom of the tin, after drilling the necessary holes for valve base, condenser and grommets, is soldered in position. The seam down one side of the tin is also soldered on both sides to give additional strength. There is no reason why readers should not make their own chassis or use aluminium instead of tin plate. If aluminium is used every earth connection to the chassis must be made via a solder tag and tight nut and bolt.

### Component Positions—Outside the Chassis

Reference to Fig. 2 will show where to drill for V1 and C1/C2. The hole for V1 is 1½in. in diameter, and can be made with an ordinary carpenter's bit, chassis cutter, tank cutter or using small tin snips. The condenser hole will probably have to be a little larger. The valveholder may be bolted or soldered in position and the condenser clip bolted up tightly. Verify that the valveholder is an International Octal, as damage to the valve pins will be caused if the wrong one is used. Fit the valveholder so that the central "keyway" is in the position shown in Fig. 2.

The tag strip is attached to the rear of the unit

tags is soldered to the side of the chassis near the primary side of the transformer. (Fig. 3)

### Alternative Component Positions

If an upright-mounting transformer is used, it will have to be fitted on the top of the chassis. The component positions remain the same with the exception of the following points.

The condensers C3 to C6, which are wired in, will be inside and not outside the chassis. The transformer itself will be outside in the position shown in Fig. 8, and grommet holes will be required at E, D, and F. Another 6-tag strip (with 4 tags isolated) is required and is soldered in place inside the chassis about ¼in. from the top, as in Fig. 9. Make sure that no tags are earthed other than those at the extreme ends (i.e. 1 and 7 in Fig. 9).

All other components are fitted during the wiring process.

### Wiring the Unit

It will pay the beginner dividends in both time and patience if he develops the habit from the start of checking, double checking and testing at every stage of his work. This will be explained in detail.

Refer to Figs 1, 2 and 3 as you proceed. Take the mains lead through the grommetted hole "C" and tie a knot in it. Connect the

black wire to one unearthed tag of the small tag strip. Also solder one primary lead from the transformer to the same tag. Check that all soldered joints are well made, strong, and with no sharp edges. Now solder the red mains lead to any tag on S1. Solder the other primary lead to the unused tag of S1. If a three-core cable is being used, solder the green lead to the chassis. The chassis may be separately earthed if desired, but it must be earthed in some manner.

**Testing the Transformer Primary**

Make sure that the leads on the secondary side of the transformer are not touching anything. Plug in and switch on. A hum should be heard. If no hum is heard check the power supply, mains lead, S1 and the primary wiring.

If a loud hum is heard check that the transformer is correctly mounted with the steel strip above, and that the secondary wires are not shorting.

**Wiring the Heater Circuit**

Scrape and tin the thick 6-3V on the secondary side of the transformer; solder one to the chassis (use a large very hot iron for this joint) and connect the other to one side of the warning lamp holder. Connect the other tag of the holder to earth (always use a very hot iron for chassis connections). Screw in a low wattage, 6V lamp. Plug into the mains and switch on. Ensure that the lamp lights. If it does not and the transformer appears to be operating correctly check the lamp, the lampholder and the heater wiring.

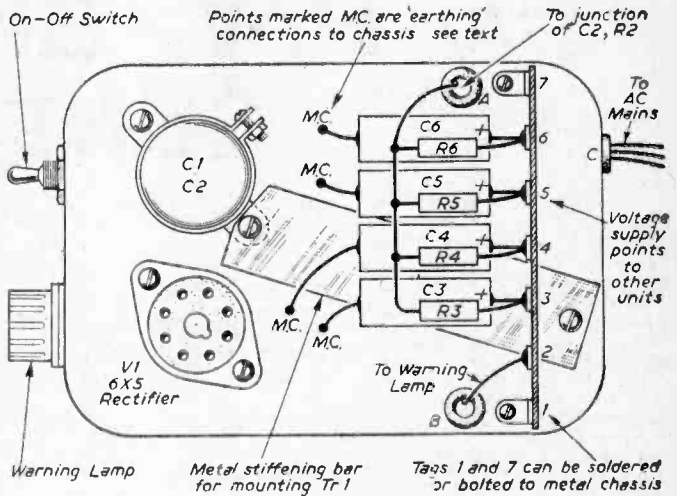

Fig. 2.—The above chassis view of the unit.

Refer to the valveholder and looking under it make sure you have the tags numbered correctly, sometimes this is not always easy. Be quite sure about this. Solder a wire from chassis to pins 1 and 2. Also solder a wire from pin 7 to the un-earthed tag of the lampholder. Plug in the 6X5 valve and check that when connected to the mains and switched on, the heater is alight. If it is not, check the valve pin numbers and the valve itself. Take an insulated wire from the un-earthed tag of the lampholder through the grommet at B and on to tag 2 above the chassis (see Fig. 2). This is the main external heater connection.

Take the lamp out of the holder and hold it between tag 2 (Fig. 2) and earth (chassis). Switch on. The lamp should light. If not, the last wire added has been wrongly connected or tag 2 is shorting to earth. Put the lamp back in the correct holder and test again.

**Warning**

When carrying out this procedure of building and testing, never be tempted to work with the unit plugged in. In any case, when working in a garage or other location with a concrete floor it is wise to have a thick rubber mat on the ground.

**Wiring the H.T. Circuit**

Temporarily connect the two red secondary leads of the transformer to a small wattage (15 or 25W) main lamp or mains neon lamp. Switch on and check that the secondary H.T. is all right. If this lamp does not light, but the one in the holder does, check that the lamp itself is not to blame, that the holder is correctly wired and fitted and that the wires are not shorting.

Disconnect the mains lamp, and connect one secondary wire to the chassis. Connect the other to pins 3 and 5 of the valveholder. If a voltmeter is available connect it on the 250V range (D.C.) to the chassis (negative) and pin 8 of the valveholder (positive). Switch on, and the meter should read about 100 to 150V D.C. The needle may quiver a little as the supply is unsmoothed. If no reading is obtained the valve is suspect.

The power supply unit before the above chassis wiring is carried out.

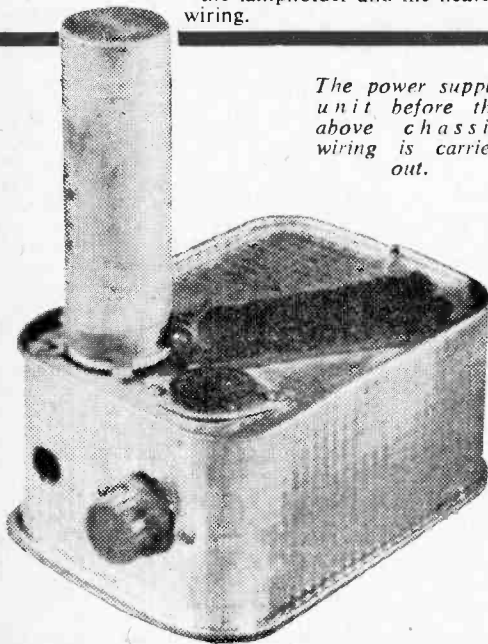

Connect pin 8 through a resistor (R1) to one positive tag of the large electrolytic smoother C1/C2. You will need to examine this carefully as they vary somewhat in their coding. One tag is the negative pole, usually either black or colourless. Two other tags are the C1 and C2 positive tags and are usually, but not always, yellow and red. Sometimes the positive tags are red and colourless, so care is needed. Details are printed on the side of the can. If the instructions tell you that one positive connection is for the maximum ripple, that is the one to use for the connection to R1. Connect the negative tag to the chassis.

**Testing the Initial H.T. Supply**

Connect the voltmeter on the same range as before, but with the positive lead on to the junction of R1 and C1. Switch on, and the D.C. voltage should be about 250 with no vibration of the needle. If not, verify that R1 is a good component and of the correct value, and that C1 is correctly connected.

**Wiring the Smoothing and Decoupling Circuits**

Connect R2 so that it stands in air supported on the tags of the electrolytic condenser C1/C2. Connect the voltmeter as before, but with the positive lead to the junction just made between R2 and C2. Switch on and the voltage should be about 250. Switch off. Leave for 30 seconds. Short, with an insulated screwdriver, R2 and earth (chassis) when a spark should jump, showing that the condenser C1/C2 is working properly and holding a charge. Henceforth, whenever you are working on the unit after switching it off always discharge the condensers twice at 15-second intervals before recommencing work.

Connect an insulated wire to the junction of R2 and C2, lead it through the grommet "A" and bare the end for 2½ in. to allow connection to resistors R3 to R6.

With reference to Fig. 2, cut the leads to R3, 4, 5 and 6 so as to leave about ½ in. lengths on each. Solder them as shown between tags 3, 4, 5 and 6 and the bared lead. Bend them more or less upright. Switch on the supply and connect each tag (3, 4, 5 and 6) to the voltmeter positive in turn. The voltage reading will depend on the voltmeter used. Expect a drop of the following voltages from the reading previously taken at the junction of R2 and C2:

	Voltage Drop:
2000Ω/V meter	... 50
5000Ω/V meter	... 20
10000Ω/V meter	... 10
50000Ω/V meter	... 2
Above 50000Ω/V	... Negligible

If one tag gives a different voltage from the others then the associated resistor may have been wrongly chosen. If any tag gives zero reading

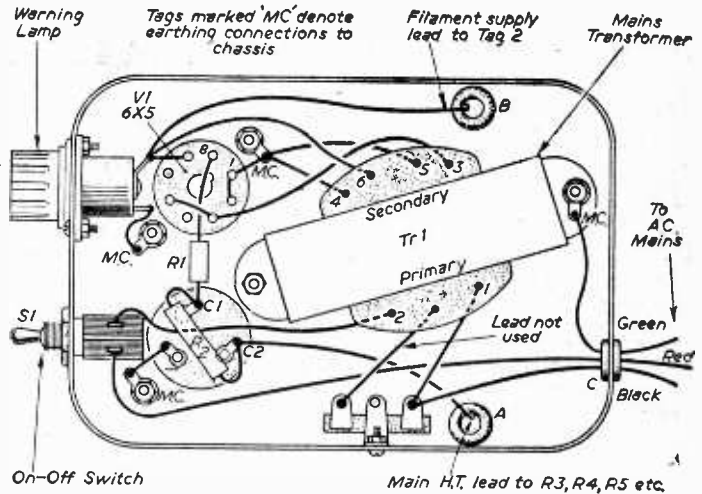

Fig. 3.—Underchassis wiring and layout.

it is earthing to chassis or the resistor is completely open circuit. Check by substitution.

Now solder in the four decoupling capacitors (C3 to C6). These need not all be the same type, but the constructor must again make sure of the polarity of the connections. Solder them as shown in Fig. 2, between the tags and the chassis. Negative ends going to chassis always.

Now check the voltage at each tag again and although they may vary somewhat (10V or so) from one to another, all should give over 200V. Switch off and quickly short each in turn to chassis with an insulated screwdriver. Each should give a good sharp spark and "crackle". Remember to discharge twice at junction R2/C2 as previously explained.

**Specification of the Power Unit**

The unit will operate from 200 to 240V A.C. mains and gives four outputs, almost independent of each other, at about 220V (low current). A 6.3 A.C. filament supply is also available. The unit may be used for other purposes than that in mind, and readers may take H.T. at 250V at up to 50mA from the junction of R2/C2 for driving amplifiers, tuners, etc. Being small, the unit is very useful in the radio laboratory. In this unit the various outputs will be used as follows:

- Tags 1 and 7, earth (chassis), this is H.T.— and one side of L.T.
- Tag 3, R.F. oscillator and cathode follower;
- Tag 4, L.F. 400c/s oscillator for modulation;
- Tag 5, L.F. variable Wien bridge oscillator (A.F.) and crystal calibration unit;
- Tag 6, amplifier for variable A.F. oscillator;
- Tag 2, heater lead to all units.

**Using Upright and Larger Transformers**

The type of transformer used is not critical so long as the ratings are those specified in the components list. The placing and mounting of the transformer will depend on its construction but

(Continued on page 998)



# STYLUS WEAR TIMER

AN EFFICIENT MEANS OF KEEPING A RECORD OF STYLI PLAYING TIME

By F. Churchill

**R**ECORD manufacturers point out that styli may be worn and in need of replacement long before this is made apparent by increased surface noise; with consequent damage to valuable records. The recommended life of a diamond tip is about 2,000 hours, and that of a sapphire about 40 hours. There are probably some methodical enthusiasts who keep a careful note of playing times, but I suspect that most of us quickly lose the habit. By using the simple little instrument described below, it is possible to know at any time, exactly how long a particular stylus has been in use.

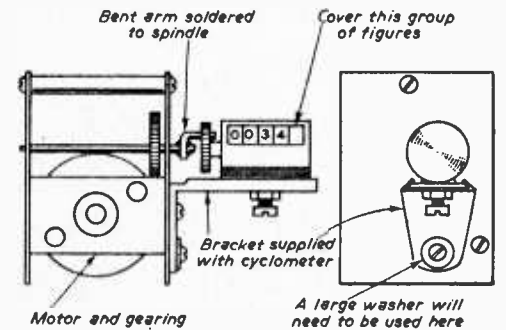

Fig. 1.—The method of coupling the motor to the cyclometer.

### Components Required

The parts required are, a small "shaded-pole" synchronous motor fitted with reduction gearing giving hours instead of miles, a cyclometer or small counter, a piece of  $\frac{1}{8}$  in. sheet brass— $2\frac{1}{2}$  in. x  $\frac{1}{2}$  in.—and a few 4B.A. nuts and bolts. The motor complete with suitable gearing can be obtained at moderate cost from suppliers advertising surplus equipment. (Note, an ordinary electric clock will *not* do, because it is not self-starting.) Whilst it is possible to get the counter from a similar source, if one buys a new cyclometer, this will be supplied complete with an adjustable bracket, and thus make it unnecessary to construct one from brass sheet.

### Transmitting the Drive

The method of transmitting the drive from the final spindle to the counter will depend on the type of spindle fitted to the latter instrument. A true cyclometer is fitted with a "star" wheel, and this type can be driven by a bent arm fixed to the gear spindle and engaging in one of the teeth of the "star" wheel. The author's cyclometer has a spindle which is slotted at one end; consequently it was only necessary to file two flats on the end of the gearing spindle, which, when engaged with the slot, formed a positive drive.

Many of these small motors with gear-train have a spring-loaded clutch on the final spindle, to facilitate altering the hards when used as a clock. It is essential that this clutch is made inoperable, so that the drive is direct. If this is not done, there will be a tendency for the drive to slip whenever the load increases, e.g. when the figures change from 99 to 100, etc.

It is advantageous to fit a length of thin twin-flex to the existing motor leads so that the unit can be placed in any convenient position; taking care to keep well away from pick-up leads and the pre-amp, to avoid inducing hum. These leads are connected to the terminal block on the gramophone motor, so that the counter only operates when the gramophone motor is actually switched on.

As fractions of an hour are not required, it will avoid confusion if the extreme right-hand set of figures are obscured with a piece of opaque Sellotape, or by some other method.

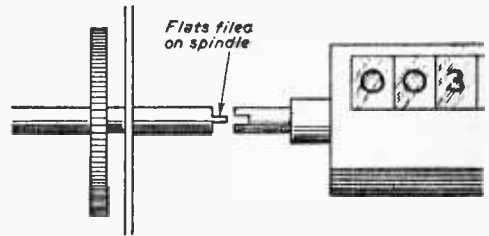

Fig. 2.—An alternative method of coupling the motor to the cyclometer.

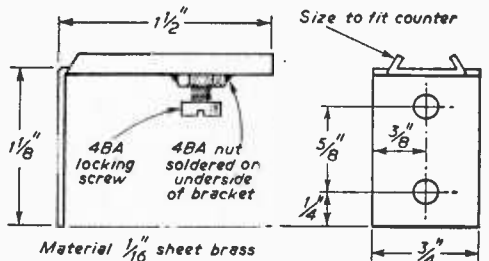

Fig. 3.—Dimensions of a suitable mounting bracket.

## CORRECTION

In an advertisement for Stern Radio Ltd., which appeared in the February issue of PRACTICAL WIRELESS, the price given for "A Complete Kit of Parts for Stereo Pre-amplifiers" should have read £12 10s. 0d. and not £21 10s. 0d. as printed.

# A valve voltmeter

THIS INSTRUMENT GIVES READINGS FROM 1 TO 1000V.

By J. B. Dance

IF an ordinary voltmeter is connected across two points in a circuit, it takes a certain amount of current from the circuit. The voltage across the two points will normally decrease when a current is being taken owing to the internal resistance of the circuit, and therefore the true voltage between the points when the voltmeter has been removed is not known. This error is often negligible, (e.g. when measuring power supply voltages) but it always exists and may be very large in high-resistance circuits. The error can be minimised by using a voltmeter which has a high internal resistance in comparison with the internal resistance of the circuit being measured.

The four main types of simple apparatus which can be used to measure voltages without taking any appreciable current are:—

1. neon bulb circuits,
2. electrostatic voltmeters,
3. potentiometer circuits,
4. valve voltmeters (including methods using cathode ray tubes).

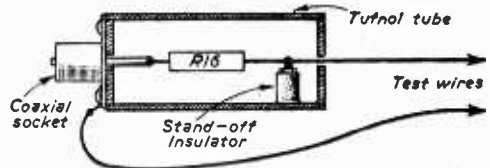

Fig. 2.—The test-probe for D.C. instruments.

Methods 1 and 2 cannot be used to measure voltages of values less than about 100V. Method 3, when used in skilled hands, is excellent, especially for low voltages, but method 4 is probably the most convenient method when quick direct readings over a large variety of ranges is required.

The circuit of a simple valve voltmeter is shown in Fig. 1. This has nine D.C. ranges shown in Table 1 (page 998), with full scale deflections varying from 1V to 1,000V. It can also be used to measure audio and radio frequency voltages below 50V. The D.C. input resistance is greater than 20M and is constant from range to range. On the one voltage range, at full scale deflection, the current taken by the instrument is about 50V/1000 of a microamp (20M/V) whilst on the 1000V range the current taken is 50μA at full scale deflection (20k/V).

### D.C. Probe

The probe shown in Fig. 2 is used for D.C. measurements. It is connected to the main instrument by coaxial cable. The body of the probe consists of a "Tuffnol" tube with end pieces which are glued on to the tube after the resistor (R16) and the stand-off insulator have been fitted inside the probe. The wire end of the resistor is used as one contact, the other contact being made by means of a wire connected to the outside of the coaxial cable. Coaxial connection to the main instrument is used in order to prevent hum voltage pick-up in the high resistance circuits.

### Components

All of the resistors, R2 to R10 should, if possible, be high-stability components and it is desirable that they should have a tolerance of ±1 per cent. If great accuracy is not required, however, ±5 per cent resistors could be used. R1 and the D.C. probe resistor, R16, should be high-stability components, but their tolerance is not important. If high-stability resistors are not available, it should be possible to obtain reasonably accurate readings by using the ordinary carbon type. The unusual resistor values can be made by using two or more resistors in series or parallel combinations.

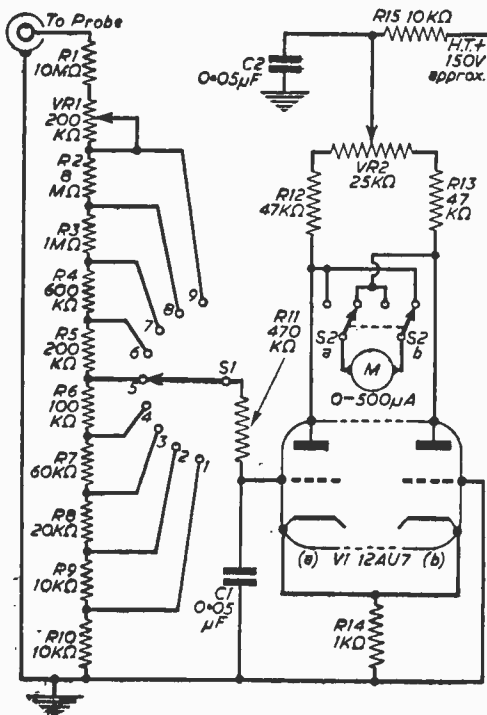

Fig. 1.—This circuit may be used over nine voltage ranges.

### Moving Iron Voltmeters

Moving iron voltmeters invariably have a low internal resistance. An expensive moving coil 0-50 microammeter has an internal resistance of 20,000Ω/V at full scale deflection when it is used as a voltmeter; even this is not high enough for some purposes, but all cheap meters have an internal resistance much lower than this.

A ceramic wafer switch was used for S1, so that the unwanted leakage current would be kept to a minimum.

C1 should be selected for high leakage resistance. A good quality component should have a leakage resistance of over 2,000M.

The valve used may be a 12AU7 (B9A base) or a 6SN7 (octal), but almost any small double triode would be satisfactory providing that the constructor is willing to adjust the resistor values to suit the valve chosen.

The double-pole double-throw switch S2(a) and S2(b), in the valve anode circuits, is provided so that the meter deflection can be arranged to be in a forward direction, no matter whether the voltage applied to the grid of V1(a) is positive or negative. If a centre reading microammeter had been available the switch S2 would not have been required. The meter was calibrated from 0 to 500µA and it was therefore easy to read the voltages being measured directly in volts for all of the ranges shown in Table 1.

**Principle of Operation**

The voltage from the probe is fed into the potential divider resistors R1 to R10. The total resistance of the potential divider (including the resistor in the probe, R16) is constant whatever the position of S1. The range is selected so that the switch S1 taps off a voltage from the potential divider which the valve circuit is capable of measuring (a fraction of a volt). R11 and C1 filter out any alternating voltages before the input reaches the grid of the valve. VR2 is adjusted before use so that the meter reading is zero when no input is being applied.

Let us suppose that a small positive voltage is applied to the grid of V1(a). The anode current of this valve will then increase, making the anode voltage more negative with respect to the chassis. At the same time both cathodes become more positive owing to the increased current through the common cathode resistor, R14, and V1(a). This is equivalent to a negative bias on the grid of V1(b) and the current through this valve therefore decreases and its anode voltage increases. A current will therefore flow from the anode of V1(b) through the meter to the anode of V1(a). If a negative voltage is applied, the current will flow in the reverse direction.

**D.C. Calibration**

The instrument should be used to measure any accurately known voltage which ought to give a full scale deflection on any particular range, e.g. 100V. The value of R1 should then be adjusted until a value is found which gives almost exactly a full scale deflection on the correct range. The value of this resistor will generally be of the order of 10M. Various high-stability resistors should be tried for R1, until a value which is very nearly correct is found. The final adjustment is then made by VR1. The value of this potentiometer should be kept reasonably small in order to preserve stability.

When one range has been calibrated, all of the others should be correct providing that the tolerance of the resistors R2 to R10 is within the limits of accuracy required.

**Simplified Version**

The number of high-stability resistors required can be reduced by constructing an instrument having fewer ranges. The ranges can be selected to meet the

- COMPONENTS LIST**
- R1—10M (see text), high stability.
  - R2—8M ½W high stability.
  - R3—1M ½W high stability.
  - R4—600k, ½W high stability.
  - R5—200k ½W high stability.
  - R6—100k ½W high stability.
  - R7—60k ½W high stability.
  - R8—20k ½W high stability.
  - R9—10k ½W high stability.
  - R10—10k ½W high stability.
  - R11—470k ½W.
  - R12—47k 1W.
  - R13—47k 1W.
  - R14—1k ½W.
  - R15—10k ½W.
  - R16—2 to 4M high stability.
  - R2-R10 are 1per cent tolerance; R11-R16 20per cent tolerance.
  - VR1—200k preset potentiometer.
  - VR2—25k (or 50k) potentiometer.
  - C1, C2—0.05µF, 500VW.
  - M—0.500 microammeter.
  - S1—Single-pole 9-way ceramic single wafer switch.
  - S2—Double-pole double-throw toggle switch.
  - V1a and V1b—12AU7 or similar (see text).

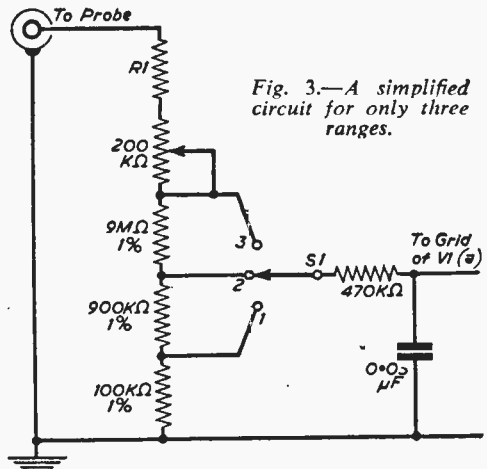

Fig. 3.—A simplified circuit for only three ranges.

requirements of the constructor, but an example of a simplified instrument is given in Fig. 3. In this circuit the ranges provided are 0 to 100V (switch position 1), 0 to 10V (position 2) and 0 to 1V (position 3).

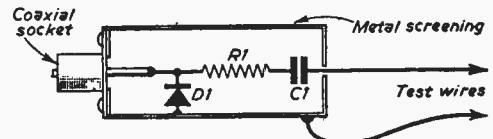

Fig. 4.—An A.C. test-probe.

**A.C. Probes**

A separate probe must be used for all A.C. measurements and it is desirable that different probes should

be used for audio and radio frequency measurements. The circuit of an A.C. probe is shown in Fig. 4. C1 removes all D.C. from the input and the series resistor R1 prevents the diode and the capacitance of the coaxial cable from loading the circuit under test to any appreciable extent. The diode D1 shunts all negative-going pulses to the screening, whilst positive pulses are fed down the coaxial cable to the main instrument. The valve grid receives a steady positive voltage which is measured.

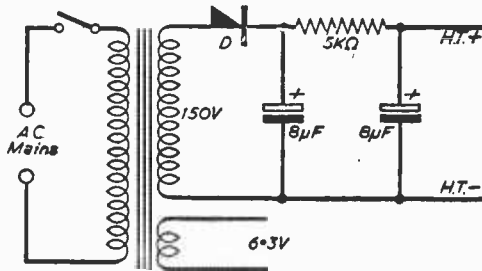

Fig. 5.—A suitable power supply unit. "D" should be 150V, 5mA, or more.

In the case of the audio probe, the value of C1 may be 0.05μF or 0.1μF, but a 500pF, ceramic condenser is much more suitable for the radio frequency probe. If one wished to make high audio and low radio frequency measurements only, it would be possible to do this with one probe by using the compromise value of about 0.002μF for C1 in Fig. 4.

The use of the resistor R1, shown in Fig. 4, not only enables the range to be accurately adjusted, but also prevents the circuit under test from being appreciably loaded by the capacitance of the coaxial cable. The average constructor will not wish to make actual measurements of radio frequencies in volts, but will only require to compare voltages (e.g. when aligning a receiver). It will therefore probably be unnecessary to calibrate the R.F. probe against a standard instrument. The audio probe can be calibrated by using suitable 50c/s voltages from transformers and a standard A.C. meter. R1 of Fig. 4 may be adjusted so that the instrument reads either peak A.C. voltages or root mean square voltages, as desired.

An OA81 is a suitable diode for both R.F. and audio probes, but care should be taken that no attempt is made to measure an A.C. voltage which has a peak value greater than about 50V. The

maximum frequency at which the R.F. probe can be operated satisfactorily is not known, but it should be quite satisfactory for comparative measurements to over 10Mc/s. The minimum frequency of accurate operation of the audio probe is well below the lowest audible frequency.

### Power Supply

The instrument requires 6.3V at 0.3A for the valve heater and approximately 3mA at about 150V as H.T. This can usually be obtained most conveniently from a receiver power supply using a suitable series dropping resistor. If the receiver H.T. voltage is 250V, a 33k, ½W resistor should be used in the H.T. lead. Alternatively the power supply shown in Fig. 5 could be used.

### Construction

The controls on the front panel are S1, S2, and VR2. The meter itself is also fixed there. Resistors R2 to R10 should be mounted around the switch wafer, S1. The potentiometer VR1 should be mounted on a piece of ebonite or perspex in order to minimise leakage. The insulating material used can be mounted on a hole cut in the chassis.

## The P.W. Signal Generator

(Continued from page 994)

little difficulty should be encountered if the transformer maker's connection details are followed carefully in conjunction with the circuit diagram.

### COMPONENTS LIST FOR POWER SUPPLY UNIT.

Resistors: R3—4.7k ½W.  
R1—220Ω ½W. R4—4.7k ½W.  
R2—3k or 3.3k 3W. R6—4.7k ½W.

Condensers:

C1—350VW, any value between 16 and 100μF. Electrolytic.

C2—As for C1. (These are both obtained in one can.)

C3, 4, 5 and 6—Each 350VW 8 or 16μF. Electrolytic.

Chassis: 6in. x 4in. 2½in. high of tin plate or aluminium. (Prototypes use baking tins. The removable bottoms are soldered in place and form the top.)

Switch: S1 Arcoelectric T600.

Transformers: Tr1. Input to suit mains (or 200/220/240V tapped). Secondary 0—250V or 0—300V at about 60mA and 6—6.3V at about 2A.

Note: Transformers with a centre tap, i.e. 250-0-250V secondary can be used, but one 250V lead must be cut short or taped and must on no account be used. This type was not used in the prototypes.

Valve: V1, 6X5. International Octal Valve base.

One or two tag strips, 5 tags not earthed, two earthed.

Warning Lamp: Arcoelectric SL82/1/3 from dealers or Messrs. Arcoelectric (Switches) Ltd., Central Avenue, West Molesey, Surrey.

Bulb: Any small wattage 6.3V M.E.S. type.

TABLE I  
VOLTAGE RANGES OF THE CIRCUIT SHOWN IN FIG. 1

Switch Position	Range (V)
1	0-1000
2	0-500
3	0-250
4	0-100
5	0-50
6	0-25
7	0-10
8	0-5
9	0-1

*You can't help earning more!*

WITH NEWNES  
**Radio & TV Servicing**

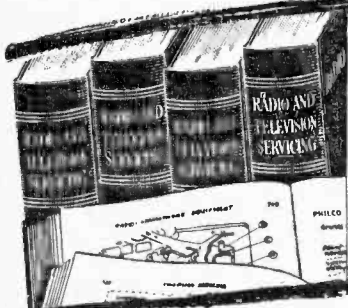

**2,300 Popular Models**  
(PRE 1954-1960) IN SIX PACKED VOLUMES

This is Newnes Complete Library of Servicing Data. It contains over 3,800 circuits, component and layout diagrams—vital for speedy, efficient repair work for over 2,300 models pre-1954 right up to 1960 including those contained in the two volumes offered below. Everything you want for profitable servicing and satisfied customers is in this comprehensive library. See it—test it free of charge for a week. *Absolutely no obligation to buy!*

TELEVISION · RADIO · RECORD REPRODUCERS  
TRANSISTOR PERSONALS · TAPE RECORDERS

Over 3,750 pages of Servicing Data for Ace, Alba, Ambassador, Argosy, Armstrong, Baird, Banner, Beethoven, Berec, Brayhead, Bush, Capitol, Champion, Channel, Collaro, Cossor, Cydon, Dansette, Decca, Defiant, Dynatron, E.A.R., Eddystone, Ekco, Elizabethan, E.M.I., Emerson, English Electric, Ever Ready, Ferguson, Ferranti, G.E.C., Grundig, H.M.V., Invicta, K-B, McCarthy, McMichael, Marconiphone, Masteradio, Motorola, Murphy, Pageant, Pam, Perdio, Peto Scott, Philco, Philips, Pilot, Portadyne, Pye, Pye Telecommunications, Radiomobile, Rainbow, Raymond, Regentone, R.G.D., Robert's Radio, Sobell, Spencer-West, Stella, Strad, Ultra, Valradio, Vidor, Walter, Webcor.

In addition—every purchaser receives 2 years' Free Radio and TV Postal Advisory Service.

**JUDGE FOR YOURSELF**  
WITHOUT OBLIGATION  
**7 DAYS' FREE TRIAL**

OR YOU CAN HAVE INSTEAD—  
**DATA FOR 1958/59  
AND 1959/60 MODELS**

750 Models in TWO handy volumes  
In these two volumes you have at your fingertips all the data you need to keep the newer sets working efficiently.  
The 1958-59 Volume contains 672 pages of data, circuits, components and chassis layout diagrams for over 300 popular models. TV, Radio, Tape recorders and Record Reproducers, etc.  
The 1959-60 Volume provides all the wanted servicing data for 350 popular models. 656 pages. Includes recent developments, servicing hints, etc.

Examine one or both Free for a week—stocks are limited, ACT NOW!

George Newnes Ltd.,  
15-17 Long Acre, London, W.C.2

Please send me the book or books I have selected, without obligation to purchase. I will either return the book or books in 8 days, or send the deposit 8 days after delivery, then the monthly subscriptions as set out on right, until the total subscription price of the book or books I have selected has been paid.

Full Name \_\_\_\_\_

Address \_\_\_\_\_

Occupation \_\_\_\_\_

Your Signature \_\_\_\_\_  
(Or Parent signs if you are under 21)

**RV135/R81**

Tick (✓) where applicable

HouseOWNER	<input type="checkbox"/>
Householder	<input type="checkbox"/>
Living with Parents	<input type="checkbox"/>
Living Address	<input type="checkbox"/>

**TICK YOUR CHOICE BELOW**

**RADIO & TV SERVICING, 6 VOLUMES**  
(1954/60 Models)

11/- Deposit. 20 monthly payments of 11/-, paying £11/11s.  
Cash in 8 days £11.

**2 VOLUMES (1958/60 Models)**

15/- Deposit. 9 monthly payments of 10/-, paying £5/5s.  
Cash in 8 days £5.

**(1958/59 Volume)**

12/6 Deposit. 4 monthly payments 10/-, paying 52/6 in all. Cash 50/-.

**(1959/60 Volume)**

12/6 Deposit. 4 monthly payments 10/-, paying 52/6 in all. Cash 50/-.

**MAXI-Q**  
REGD.

# COIL PACKS

**CP.3/370 pF** and **CP.3/500 pF**. These 3 waveband Coil Packs are available for use with either 370 pF or 500 pF tuning condensers. The coverages are: Long Wave 800-2,000 metres. Med. Wave 200-250 metres, Short Wave 16-50 metres. Designed for use with "MAXI-Q" glass scale type S2. Retail price of each unit: 32/- plus 10/8 P.T.—total 42/8.

**CP.3/G**. As above but with Gram. position, suitable for use with 500 pF tuning condenser: 39/- plus 13/- P.T.—total 52/-.

**CP.3/F**. This Coil Pack is for use with a 500 pF tuning condenser and covers the standard, Long, Med. and Short wavebands with the addition of the band 50/160 metres. This covers the Trawler band, Aeronautical and the 80 and 160 metre Amateur bands: 49/- plus 16/4 P.T.—total 65/4.

**CP.3F/G**. As CP.3/F but with Gram. position: 57/- plus 19/- P.T.—total 76/-.

**CP.4/L** and **CP.4/M**. These compact 4-station Coil Packs are available for either 1 Long Wave and 3 Medium Wave Stations (CP.4/L) or 4 Medium Wave Stations (CP.4/M.). They are fully wired and require only four connections for use with any standard frequency changer valve. 25/- plus 8/4 P.T.—total 33/4.

**CP.4L/G** and **CP.4M/G**. As CP.4/L and CP.4/M but with provision for Gram. position. 31/- plus 10/4 P.T.—total 41/4.

See Technical Bulletin DTB.9 for details of all Coil Packs, 1/6.

GENERAL CATALOGUE covering full range of components, send 1/4 in stamps or P.O. PLEASE SEND S.A.E. WITH ALL OTHER ENQUIRIES.

**DENCO (Clacton) LTD. (Dept. P.W.) 357/9 Old Road, Clacton-on-Sea, Essex**

STOP PRESS: TDO.3 Tape Oscillator Coil for Mullard 3 watt Tape Amplifier, 7/6 each.

CP.3/F

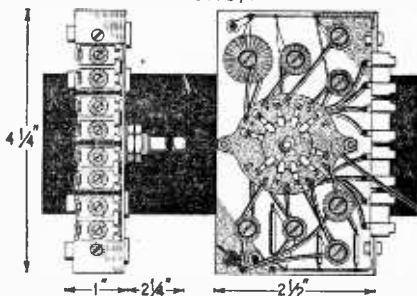

## TV CHASSIS 5/9

56 resistances incl. 7 variable controls, 54 condensers incl. electrolytics. Coils, 7 I.F. and R.F. Trans. Mains output, line and frame. Metal rectifier 300 v. at 200 mA. Fuse panel, focus magnet, plugs, sockets, switch, chassis screws, lag strips, etc.: I.F. strip can be separated. Power pack can be used without disassembling. These chassis have been used, but were working when stored. Six-page circuit available with order. Carr. 7/6.



**BAKELITE CABINETS**.....Sale Price 2/9 Brand New. Colour brown. Attractive design. Size: 12 x 7 x 8 1/2 ins. Ideal for small receivers, converters, etc. P. & P. 3/6.

## TRANSFORMERS

**HEATER TRANSFORMERS, 7/9**. 12 volt at 4 amp. 0-200-250 v. primary. Post and packing 1/9.

**OUTPUT TRANSFORMER, 1/8**. Salvage guaranteed. Standard size. 2-5 ohms matching pentode or tetrode O.P. valve. Post and Packing 1/9. Twenty for £1. Packing and carriage 5/6.

**FRAME OUTPUT TRANSFORMERS, 3/9**. To match low imp. coils. Postage 1/8.

**EVS1 ISOLATION TRANS., 2/9**. 1-1 ratio. Suitable 6.3 tube as isolation trans. Postage 1/9.

**MAINS TRANSFORMER, 5/9**. Primary 200-250 volt. Secondary 800-0-300. 6 volt at 3.3 amp, 5 volt at 2 amp. Post and packing 2/9.

**SOUND/VISION STRIP, 1/-**. "Plessey" I.F.'s 10.5 Mc/s sound. 14 Mc/s vision. Valve holders (six 6F1's and two 6D's, not incl.). Size 8 1/2 x 5 x 4 1/2 in. Circuit incl. post and packing, 2/6.

**SOUND/VISION STRIP, 1/-**. Not tested. Complete sound and vision strip. 8 valve holders (6F1's etc., not incl.) I.F.'s 16-19.5 Mc/s. Size 8 1/2 x 4 1/2 in. Drawings FREE with order. Postage 2/6.



REMEMBER

**COMPONENTS LTD.**

of 219 ILFORD LANE, ILFORD, ESSEX

## RECORD CABINET 29/6

### Model P.L.5

A petite portable player. Robust case with smart two-tone colour scheme. Takes 4-speed single player unit and an 8 x 3 in. elliptical speaker. Plays 7 in., 10 in. and 12 in. records. Width 12 in. Depth 10 1/2 in. Height 6 in. Insurance and carriage 5/6.



**EXTENSION SPEAKER, 19/9**. In polished oak cabinet of attractive design. Complete, fitted with 8 in. P.M. speaker for the highest quality, flex and switch. Ready for use. Ideal for kitchen or workshop, etc. Ins. and Carr. 3/6.



**8 in. P.M. SPEAKER, 5/9**. Limited quantity of these modern type speakers. They are tested and they have a slight cone fault that is repaired not affecting the quality. P. & P. 2/6.

**8 in. P.M., 6/9**. As above, but fitted with O.P. Transformer. P. & P. 2/6.

**8 in. P.M., 9/6**. Of highest quality, fitted with O.P. Transformer. P. & P. 2/6

**ELLIPTICAL SPEAKERS, 15/9**. 8 x 3 in. and 7 x 4 in. Brand New Specially made for Record and Tape Recorder Cabinet. P. & P. 2/9.

**SALVAGE STRIP, 1/1**. Contains 30 varied resistors, including elder resistors, 28 varied condensers including beehive trimmer, 8 8SA valve holders, 1-B91 and 1-B7G valve holders. H.F. choke and 8 x 4 in. aluminium chassis. P. & P. 1/9.

**TELEPHONE SETS, 7/9**. X.W.D. Wireless remote control unit. E.M.K.11. (ZA11954). Including Morse tapper, switched, jack plugs etc: Least phone. Insurance and carriage 3/6.

**VOLUME/TONE CONTROLS, 2/6 per doz.** Assorted volume and tone controls, stripped from working chassis. P. & P. 2/6.

**SCANNING COILS—ALL 2/9 each.** Wide angle 90°, 38 mm. Low imp. Postage 1/3. Also Brand New 38 mm. Low imp. Postage 1/3. And Low imp. 35 mm. Post and Packing 1/6.

**RECTIFIERS, 2/9**. 250V. 100mA. Half wave. Salvage guaranteed. Why hunt for those obsolete rectifier valves when you can cheaply replace with a modern selenium rectifier. P. & P. 1/3.

**STAMP FOR FREE CATALOGUE**  
Regret U.K. only - H.P. Terms available



# A Capacity Tester for Small Values

THE UNKNOWN CONDENSER IS USED TO ALTER THE TUNING OF AN R.F. OSCILLATOR

By B. J. Roome

**S**OME types of small capacitors are not marked with their capacitance value at all, whilst the values marked on other types—especially the markings on the small waxed mica types—often become obliterated with age. In addition the meaning of the colour coding of some old types of capacitor is not always clear and the colours may not be decisive. If such capacitors are to be used in any apparatus, it is first necessary to ascertain their value. Even if the value is clearly marked, a quick check is worthwhile if the component is not new and will also disclose any open circuited or short circuited component. It is much wiser to test a doubtful component before use than to spend a very long time finding out why a completed piece of apparatus will not function.

## Principles of Circuit

Fig. 1 shows a circuit which can be used for measuring the value of small condensers. V1(a) is an oscillator, working at a fixed frequency of a few megacycles. The exact frequency is unimportant providing that it is constant. The tuned circuit L/C2 determines the frequency of oscillation. The output of the oscillator is fed, via C7, into V1(b) which is a cathode follower buffer stage. This stage prevents pulling of the oscillator frequency by the test circuit. L4 couples the output from V1(b) into the test circuit

which absorbs maximum power from L3 when the tuned circuit formed by L4, L5, C8, C9 and any capacitors under test (Cx or Cy for future reference), resonates at exactly the same frequency as the frequency of oscillation of V1(a).

The voltage appearing across the test circuit is detected by the germanium diode D1 and the resulting D.C. current deflects the 0–500 microammeter M1. C10 by-passes the R.F. so that it does not pass through the meter, whilst VR1 enables the current passing through the meter to be adjusted to a suitable value.

The 12AU7 is perhaps the most convenient miniature valve, but the octal based 6SN7 is quite suitable. Alternatively two separate 6C4's or 6J5's could be used. Almost any small triodes or triode connected pentodes are perfectly satisfactory. The part of the circuit on the right-hand side of the screen in Fig. 1 is placed on or near the front panel with the valve behind it.

## Preliminary Adjustments

A 0–500 microammeter should be inserted between the lower end of R2 and the chassis at the point marked with a cross in Fig. 1. If no reading is obtained at first, reverse the connections of L2. The reading of the microammeter is a measure of the amplitude of oscillation of V1(a). The number of turns on L2 and the spacing of L2 from L1 should be adjusted until the ammeter in the R2 circuit reads about 100µA. The amount of feedback in the oscillator circuit is controlled by the number of turns on L2 and by its proximity to L1. Generally L2 will consist of about seven turns spaced ¼ to ½ in. from L1. After adjustment, L2 should be fixed in position with polystyrene cement. R1 drops the H.T. voltage to about 100V and also decouples the anode circuit of V1(a).

C8 and C9 should then be adjusted (with no connection across the Cx or Cy terminals) until a reading is obtained on the meter M1. The trimmer C5 should be adjusted for maximum reading on M1 and it should then be set in position with a suitable cement. No further adjustment of the circuit should be required for some years.

## Calibration

A fairly large type of tuning dial (calibrated from 0 to 180°) is fitted on the front panel and connected to C9. It has a vernier attachment for accurate reading to 0.1°, but this is not essential. It is advisable to arrange for the dial reading to be zero when the vanes are fully meshed.

A number of 1 or 2per cent tolerance capacitors should be used for calibration of the instrument, but 5per cent capacitors will suffice for

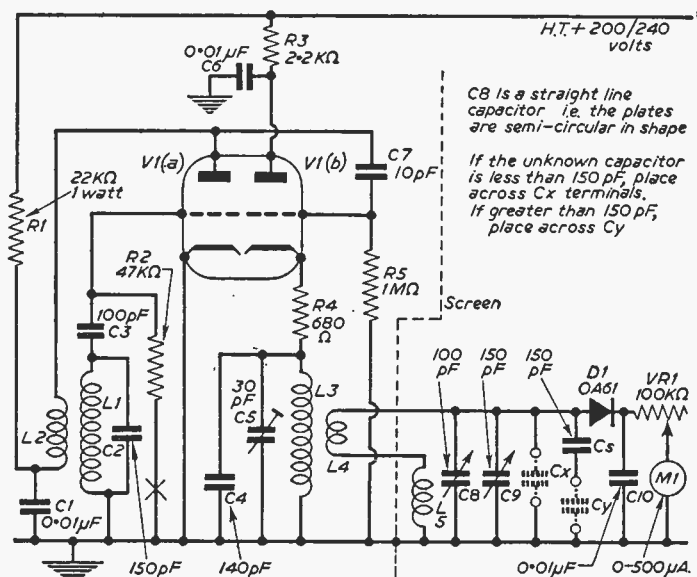

Fig. 1.—The circuit diagram.

approximate work, those used for calibrating the Cx position should all have values between 0 and 150pF.

C9 should be set so that the dial reading is zero when the vanes are fully meshed. C8 is then adjusted for resonance as shown by a maximum reading of M1. If the meter goes off the scale, the resistance of VR1 should be increased, but when C8 has been set, VR1 should be adjusted so that the meter does not read less than half scale (for accuracy). Place one of the calibrating condensers across the terminals marked Cx in Fig. 1; the meter reading falls as the circuit is now off resonance. Alter the value of C9 until resonance is again found, care being taken that C8 is not touched. The reduction in the value of C9 is then equal to the added calibrating capacitance, Cx. Note the reading of the dial connected to C9. Repeat this for other values of calibrating condensers.

A graph of Cx against the dial readings should then be plotted as accurate as possible. The graph should be almost exactly a straight line if C9 has semi-circular plates. The graph should be kept for use with the instrument.

### Operation

Values of capacitors from 0 to 150pF can be measured in the following manner. Adjust C8 to resonance with the dial reading of C9 at zero. Connect the unknown, Cx across the terminals and, leaving C8 unaltered, find the C9 dial reading at the new resonance. Using this dial reading and the graph, the unknown capacitance value can be found. The result should be accurate to  $\pm 1\text{pF}$  or better.

### Larger Values

The maximum value of the measuring condenser, C9, is 150pF, and therefore capacitance values greater than this cannot be measured by connecting the unknown directly across the Cx terminals. If however, the unknown condenser is placed across the terminals marked Cy in Fig. 1, it will be placed in series with a 150pF capacitor. The series combination will have a value of less than 150pF—in fact it will be between 75pF and 150pF—and the value of this combination can therefore be measured as before.

Thus it is possible to calculate the value of the unknown Cy, from the following equation

$$C_y = C_r C_s / C_r - C_s$$

where Cr is the capacitance of Cy and Cs in series, it is well worthwhile calibrating the instrument for values of Cy greater than 150pF. This should be done by placing various known calibrating capacitors across the Cy terminals and plotting the values of Cy against the dial readings as before. In this case, however, the graph will not be a straight line. The graph can then be used to obtain values of unknown capacitors directly from the dial readings.

Whilst there is no definite maximum limit to the value of capacitance which can be measured, the accuracy of the measurement will fall as the value of the unknown increases above 150pF. The practical upper limit is in the region of 2,000 to 10,000pF, depending on the accuracy required and on the accuracy with which the dial can be read.

### Final Check

The accuracy of the instrument and of the graph can be quickly checked by determining the capacity of two condensers separately and then determining their capacity in parallel. The latter value should be equal to the sum of the two separate capacities.

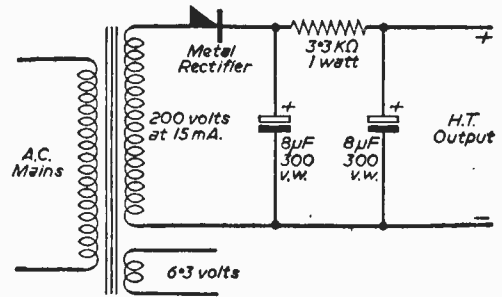

Fig. 2.—A suitable power supply circuit for the tester.

### Power Supplies

The instrument requires a 6.3V heater supply at about 0.3A and an H.T. supply of 200 to 240V at about 12mA. This can usually be obtained from a receiver power pack, but if it should be desired to make a separate supply for the unit, the circuit shown in Fig. 2 is quite adequate. The metal rectifier should have a rating of not less than 300V at 15mA.

Alternatively it would be possible to use a small battery double triode (e.g. type DCC90 or 3A5) and make the unit entirely portable. The H.T. voltage could be obtained from a 90V H.T. battery, in which case R1 should be reduced to 2k. The batteries should have a very long life—almost as great as their shelf life.

### COIL DATA

- L1—25 turns.
- L2—7 turns on chassis side of L1.
- L3—25 turns.
- L4—6 turns on chassis side of L3.
- L5—15 turns.

All coils close-wound on formers, 0.4in. in diameter, using 32 to 36s.w.g. single silk-covered wire. The wires of all coils to be cemented in position with polystyrene solution.

### HOLDING THIN WIRES

Sometimes it is difficult to hold very thin wires in ordinary alligator clips, since the wire slips through the teeth. The problem can be easily remedied by filing off the teeth. The jaws will now be flush and the tiny wire will be gripped easily, putting an end to the slipping.

### PYE Microwave System for the Irish Republic

Pye Telecommunications Limited of Cambridge, with their associates Telecommunications Limited of Dublin, have received a contract for the supply and installation of a Pye Microwave system between the towns of Waterford, Wexford and Enniscorthy. They will also provide the buildings, masts and aerials and emergency power supply equipment.

These radio links will form part of the trunk system of the Irish Republic's Telephone Service and are required to accommodate the ever-increasing traffic. The system will operate in the 7400Mc/s Band and is capable of transmitting 240 channels.

# BARGAIN OFFERS for the Constructor!



## TAPE RECORDER

Manufacturers' brand new, current production offer. Latest 5-valve circuit based on Mullard's famous design. Magic eye level indicator. Volume and tone controls. T.C.C. printed circuit already wired. Only power pack and controls to assemble and wire. Valves EF86, ECC83, EL84, E834 and EZ90. A sensitive quality recorder at Special Unit Prices.

Wired printed circuit, power pack components, controls and knobs, etc. . . . £5.15.0 p. & p. 2/6  
 Set of 5 valves, as above . . . £2. 5.0 p. & p. 1/-  
 B.S.R. Monarch Tape Unit £25.19.6 p. & p. 4/6  
 Bargain reduction for complete kit . . . £16.10.0 carr. 5/-

Attractive two-tone Cabinet and 9 x 5in. speaker at special discount price: £28.0.0 p. & p. 4/6  
 Illustrated Handbook with full details, 2/6 post free.  
 Collaro Studio Tape Deck can be supplied with modified circuit as alternative for approx £5.10 extra. Cabinet and Speaker to house Collaro deck, £28.15 plus 4/6 p. & p.



## RECORD PLAYER BARGAINS

All brand new latest 4-speed Models.

**SINGLE PLAYERS**—B.S.R. (TU9) 90/-; Collaro Junior, 90/-; Garrard TA Mk.2 with GCS Head, £7.19.6; Garrard 4HP Transcription Unit, £17.19.6 carr. 3/6.

**AUTO CHANGERS**, New reduced prices—B.S.R. (UA8), £26.15; UA8 Stereo, £7.10; UA14, £7.19.6; Collaro Conquest, £7.15.

**GARRARD EC210** 4-speed Autochanger Model with latest features and GCS Plug-in Head only 10 gna., carr. 4/6.

Latest Garrard Transcription Autochanger Model "A" £18.19.6 with balanced P.U. Arm. (Carr. 5/-).

**E.M.I.** 4-speed Single Player with Auto Stop-Start Dual Turnover Cartridge for Stereo and Monaural L.P. and 78—Bargain Buy at £28.19.6.

## AUTO CHANGER RECORD PLAYER KIT

A.C. Supply 200-250 v.

Attractive 2-tone cabinet — famous B.S.R. Monarch 4-speed, full mixer, 10-record gram unit. Pul-8 xial pick-up with dual stylus for Std. L.P. recordings. 2-valve amplifier with quality neg. feedback circuit, volume and tone controls. Fully isolated from mains by double-wound transformer, NOT the live chassis type as often offered in cheap commercial models. A recommended buy while stocks last!

Ready-wired 2-valve amplifier, complete with 8in. high flux speaker . . . £28.19.6 p. & p. 3/6  
 Two-tone cabinet 18 x 13 x 8in. £28. 3.0 p. & p. 3/6  
 Collaro Conquest 160v. . . . £5.19.6 p. & p. 4/6  
 Complete 3 unit kit, special Bargain price £18.19.6 carr. 7/6

Simple assembly by a screwdriver only required.



## RECORDING TAPE BARGAINS

EMI 1st grade. Brand new sealed boxes.

Standard	Long Play
3in., 175ft. . . . 7/-	250ft. . . . 9/-
5in., 500ft. . . . 19/-	850ft. . . . 25/-
5 1/2in., 800ft. . . . 25/-	1,200ft. . . . 31/6
7in., 1,200ft. . . . 31/6	1,800ft. . . . 45/-

SPARE REELS: Fmitape, new, boxed: 3in. 3/-, 5in. 3/8, 5 1/2in. 4/-, 7in. 4/6.

**SPECIAL PURCHASE.** Famous manufacturers. 1st grade tape in sealed white boxes.

Standard	Long Play
3in., 600ft. . . . 15/6	850ft. . . . 19/8
5 1/2in., 800ft. . . . 19/8	1,200ft. . . . 22/8
7in., 1,200ft. . . . 21/-	1,800ft. . . . 32/-

Plastic Tape Reels, special offer. Manufacturers surplus. 3in. 2/8, 5in. 3/-, 3/8, 7in. 5/4in. 3/6.

## TRANSISTOR PORTABLE

Famous manufacturers 6 x 1 design based on Mullard and G.E.C. developments. Printed circuit, 6BVA 1st grade transistors, XA102, XA101 (2) OA70, XB103, XC101 (2) or equivalents. Quality components only supplied to ensure best results at attractive price.

Set of 6 BVA Transistor and Diode 70/- p. & p. 6d.  
 Printed Circuit, I.F.'s (3), osc. coil, Driver Trans. Ferrite rod aerial . . . . . 51/6 p. & p. 1/6  
 Resistors, Condensers, Twin Gang and Volume Control . . . . . 27/6 p. & p. 1/6  
 7 x 4in. Quality 35 ohm matching . . . . . 25/- p. & p. 1/6  
 Speaker . . . . . 25/- p. & p. 1/6

or  
 Complete Kit at special offer ONLY £28.19.6 post free Handbook and Circuit details . . . 2/- post free.



## RE-GUNNED TV TUBES

Prices Reduced Again!

New Heater, Cathode and Gun Assembly fitted to all tubes, and now re-screened and aluminised at no extra cost!

12in. £5. 14in. £5.5.0. 17in. £5.10.0.

Mullard and Mazda types ex-stock Carr. and Ina. 10/- 10/- Part Exchange allowance on your old tube. 12in. tube allowance 5/-.

## JASON FM TUNER KITS

STANDARD MODEL (FM1) as previously extensively advertised. Complete Kit 5 gna. Set of 4 spec. valves now only 20/-.

MODEL (FM2). Attractively presented shelf mounting unit in enclosed Metal Cabinet with Built-in Power Supply. Complete Kit £7. Set of 5 spec. valves, 37/8. P. & P. 2/6.

LATEST MODEL—JTV2. Switched Band 1.9-3 AM/FM Unit with AFC. Kit £12.19.6. P. & P. 2/6.

NEW JASON COMPREHENSIVE FM HANDBOOK £2. 48 hr. Alignment Service, 7/8; P. & P. 2/6.

## REDUCED PRICES VALVES ALL GUARANTEED

1T4	6/-	ECH42	10/6	EZ90	7/8
1R5, 185	7/8	ECH80	10/6	EZ81	7/8
384, 3V4	7/8	ECL82	10/6	MU14	9/-
6Z4	9/6	EF80	8/-	PCC34	9/6
DAF98	9/-	EF-86	12/6	PCF90	9/6
DF98	9/-	EF91	5/-	PCL98	12/6
DK96	9/-	EL41	9/6	PL81	12/6
DL96	9/-	EL84	9/6	PL82	9/8
EAC80	8/6	EY51	8/6	PL83	10/8
ECF80	9/6	EY86	10/-	U25	12/8

## TRANSISTORS - BYA 1st GRADE

REDUCED PRICES

Mazda	Mullard	GEC			
XA101	14/6	OC70	9/6	GET114	9/6
XA102	15/6	OC71	12/6	GET115	12/6
XA103	15/-	OC72	15/-		
XA104	18/-	OC44	23/6	Newmarket "Goldtop"	
XB102	10/-	OC45	21/-	V15/10P	15/-
XC101	10/6				

Germanium Diodes, OA70 2/8, GEX34 4/-, OA81 3/6

## SPECIAL OFFER!

Superior type Art Leather covered Portable Case—well-known Manufacturer's surplus—in attractive Tan and Fawn with non-tarnish gilt fitted with latest Collaro Junior 4-speed Record Player Unit with Turnover Xtal Cartridge and dual sapphire stylus for 78 and LP records. Ready mounted and wired complete with Mains Lead and detachable screened PU lead. A.C. Mains 200/250v. Size 15 x 11 1/2 x 5 1/2in. An ideal unit for Tape or Amplifier use.

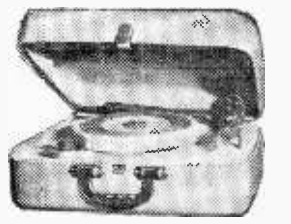

BARGAIN BUY—only £28.19.6 p. & p. 4/6d.

## 7 VALVE AM/FM RADIOGRAM CHASSIS

Valve Line-up: ECC85 ECH81 F89 EABC80 EL84 EM81 EZ80.

Three Waveband and Switched Gram position. Med 200-500 m., Long 1,000-2,000 m., VHF/FM 88-93 Mc/s. Philips Continental Tuning insert with permeability tuning on FM and combined AM/FM IP transformers, 460 Kcs and 19.7 Mc/s. Dust core tuning all coils. Latest circuitry including AVC and Neg. Feedback. Three watt output. Sensitivity and reproduction are of a very high standard. Chassis size 13 1/2 x 7 1/2in. Height 7 1/2in. Edge Illuminated glass dial 11 1/2 x 3 1/2in. Vertical pointer. Horizontal station names. Gold on brown background. A.C. 200/250 v. operation.



Aligned and tested ready for use £13.10.0. Carr. & Ins. 5/-.

Complete with 4 Knobs—walnut or Ivory to choice. Indoor FM aerial, 8/6 extra. Three ohm P.M. speaker only required. Recommended quality speakers.

10in. Roia (Heavy Duty) . . . . . 30/- 8in. Goodman special cone . . . . . 21/8. Post & Pkg. 1/6.

As previously announced fresh supplies are now being received, but we regret some slight delay may be experienced in fulfilling orders for this popular item.

ONLY A FEW ITEMS ARE LISTED FROM OUR COMPREHENSIVE STOCK  
 WRITE NOW FOR FULL BARGAIN LISTS, 3d.



## RADIO COMPONENT SPECIALISTS

70 Brigstock Road, Thornton Heath, Surrey

Phone: THO 2188. Hours 9 a.m.—6 p.m. 1 p.m. Wed. Open all day Saturday. By Thornton Heath Station. 2/9.

Terms: C.W.O. or C.O.D. post and packing up to 1/2 lb. 7d.; 1 lb. 1/1; 3 lb. 1/6; 5 lb. 2/-; 10 lb. 2/9.

# HOME RADIO OF MITCHAM

(Dept. P), 187 London Road, Mitcham, Surrey, S.W. 13  
MIT 3282  
Shop hours 9 a.m. to 6.30 p.m. Wed. 9 a.m. to 1 p.m.

## ANTEX "PRECISION" SOLDERING IRONS



A wonderful new miniature iron for the constructor. Five different sizes of interchangeable bits are available, also a practical bench stand and solder holder. All voltages from 6 to 240 in stock. S.A.E. for descriptive leaflet. Iron as illustrated, 29/6 post paid. (State Voltage.)

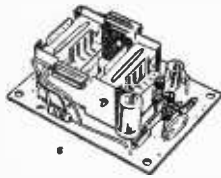

**1 WATT AMPLIFIER**  
Suitable for microphone, gram unit, guitar, or radio tuner, this mighty midjet printed-circuit amplifier measures only

3 x 2 x 1 1/2 in. Supplied completely assembled and tested with four top-grade transistors. Input less than 10 millivolts will give undistorted output of 1 watt into 3 ohm speaker. Response 60 to 16,000 cycles. S.A.E. for leaflet. PRICE £4.12.6 post paid.

## ARMSTRONG STEREO MK II—EVERYTHING ON ONE CHASSIS.

HERE IT IS, THE REAL ANSWER TO COMPACT HI-FI. This single unit comprises Sensitive AM tuner with ferrite aerial, High quality FM/VHF tuner, Hi-Fi 16 watt push-pull mono amplifier, Hi-Fi stereo amplifier with 8 watts push-pull each channel. Independent Bass and Treble boost controls. Modern streamlined appearance and precision engineering. Price 42 Gns., or H.P. terms. All other Armstrong models in stock.

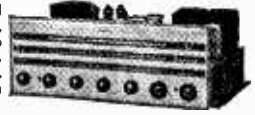

## "GLOBE-KING" SHORT WAVE



THE BEST HOBBY OF ALL. Short-wave radio operates 24 hours a day. You can explore the world from the comfort of your own armchair. Perfect relaxation from a day's work. Start now with this amazing little one-valve battery set which gives really long distance reception at minimum cost. Kit with three coils covering 10 to 100 metres. PRICE £3.19.6.

## P.W. POCKET SUPERHET

All the special components in stock for this super pocket portable including miniature gang, all coils, aerial, Ardente controls, switch, Rola speaker, etc. FULLY DETAILED PRICE LIST SENT ON RECEIPT OF S.A.E.

## WE ARE ACTUAL STOCKISTS OF HEATHKITS

## BUILD YOUR OWN CAR RADIO

Transistorised output- 2 wave-band, high-gain receiver supplied in three easy-to-assemble units making a first class compact car radio, equal to commercial set. Can be fully assembled and working in one hour. Available for 12 volt only. Complete set £13.15.0. Full constructional data 2/4 post paid.

## HEADPHONES



The famous "Royal" lightweight high-resistance headphones are ideal for crystal sets, one valvers, short-wave receivers, etc. New and boxed 15/-, post 1/-.

Also available Brown's type "F" 37/6, and Ericsson's professional type £2.15.0. Add 1/- post.

1000's & 1000's OF SATISFIED PEOPLE VIEW ON

E.M.S.

## REBUILT TELEVISION TUBES

- ★ A NEW GUN IN EVERY TUBE
- ★ BUY DIRECT FROM THE FACTORY
- ★ 12 MONTHS' GUARANTEE

12 inch £5.0.0 14 inch £5.10.0  
17 inch £6.10.0

Immediate dispatch on receipt of Remittance  
Carriage and insurance 12/6 extra  
£1 Refunded on receipt of your old Tube

SPECIAL TERMS TO THE TRADE

MARSHALL'S for TELEVISION LTD.

131 St. Ann's Road, Tottenham, London, N.15  
STAMFORD HILL 3267 & 5555

## EXPRESS ELECTRONICS ROSEBEN LABORATORIES

KINGSWOOD WAY, SELSDON, SURREY

## VALVES NEW TESTED AND GUARANTEED FOR THREE MONTHS

1C1	7/6	6BA6	7/-	12AH8	10/-	DH77	7/-	EF80	8/6	PL81	9/-
1C3	8/-	6BE6	7/-	12AT7	4/-	DH142	8/6	EF86	9/-	PL82	7/-
1F1	8/-	6BR7	8/6	12AU7	7/6	DH100	10/-	EF91	4/-	PY81	8/6
1F3	7/6	6BR7	10/6	12AX7	7/6	DK91	7/6	EF92	8/6	PY82	7/6
1FD1	8/-	6BW6	7/6	12BH7	10/6	DK99	7/6	EL41	9/6	PY83	7/6
1FD9	7/6	6BW7	7/-	12K8GT11	-	DK96	8/-	EL84	7/-	R19	11/6
1L4	6/8	6C10	9/-	12Q7GT	7/6	DL92	7/6	EM34	7/-	TH41	15/6
1P1	8/-	6D2	4/-	16A5	9/-	DL84	7/6	EY61	7/6	U36	9/6
1P10	7/6	6F12	4/-	25A6G	8/6	DL96	8/-	EY81	10/-	U39	7/6
1P11	7/6	6H6GT	2/-	25L6GT	8/6	EB91	4/-	EZ40	7/6	U76	7/6
1R5	6/-	6J7GT	7/6	25Z4G	9/-	EBO41	10/-	EZ80	5/6	U78	7/-
1R5	6/-	6K7G	5/6	30C1	6/6	EBF80	8/6	EZ91	8/-	UBC41	8/6
1T4	7/6	6K9G	8/-	30L1	7/-	ECC81	6/-	KK380	9/6	UCH42	9/6
1U5	6/-	6Q7GT	8/6	32L6GT	9/-	ECC82	7/6	KT86	11/6	UC11	8/6
3Q4	8/-	68L7GT	6/-	35W4	8/6	ECC83	7/6	N17	7/6	UL41	8/6
384	7/6	68N7GT	6/-	35Z4GT	8/-	ECC84	8/6	N18	8/-	UY41	8/6
3V4	7/6	6V8G	7/6	5763	7/6	ECP80	8/6	N19	7/6	W76	8/6
5U4G	7/6	6X4	7/-	80	8/-	ECP82	8/6	N27	10/6	W142	8/6
6Y3GT	4/6	8X6G	5/-	DAF91	7/6	ECH42	9/-	FC894	6/6	X17	9/6
6Z4G	9/6	8X5GT	6/-	DAF96	8/6	ECH81	10/-	PCF80	6/6	X142	9/6
6AK6	6/6	7B7	7/6	DFP1	7/6	ECL80	8/6	PCF89	7/6	X150	9/6
6AL5	6/-	7C5	7/6	DFP8	8/6	ECL82	9/6	PCL82	7/-	Z77	4/-
6AM6	3/-	787	9/6	8/6	8/6	ECL82	9/6	PCL82	7/-	Z77	4/-
6AT6	7/6	8D3	4/-	DH76	7/6	EF41	9/-	PCL94	7/-	ZD17	7/6

VOLUME CONTROLS MIDJET SIZE LONG SPINDLES, D.P. switch, 4/-; Less switch, 2/6. Values 10K to 2M. B9A, B7G v. Holders 9d., Screens 9d., Contact Cooled Rectifiers 250v. 50mA, 8/6, 86mA, 8/8.

### MATCHED PAIRS

EL84 17/-, 6V6G 17/-, 6BW6 18/- per pair. Push Pull O.P. Transformers for above 3-15Q 14/6. P. & P. 1/6. 12in. P.M. Speakers 3Q 84/8. Baker's "Belhurst" 12in. 15Q 15W, 90/-, P. & P. 2/6. 12in. Stereo Model £7.7.0.

### SETS OF VALVES

DK91, DF91, DAF91, DL92 or DL94... 19/6 ECH42, EF41, EBC41, DK96, DF96, DAF96, DL96... 27/8 EL41, EZ40... 37/6 1C3, 1F1, 1FD1, 1P1... 27/8 UCH42, UF41, UBC41, 1R5, 1T4, 1R5, 384, or 3V4... 19/6 UL41, UY41... 35/- Postage and packing 6d. Over £1 post free. C.O.D. 2/6.

# A D.C. TEST METER

A SIMPLE INSTRUMENT FOR MEASURING VOLTAGE, CURRENT AND RESISTANCE WITH EXTERNAL SHUNTS

**J**HIS meter is not intended to be the ultimate in test meters, but rather more as a beginner's instrument or as a second one for quick checks. It has the advantages that it is very easy to make, is inexpensive and the number of ranges available is almost unlimited. This is because the series resistors or shunts used to provide the voltage or current ranges are not installed internally in the meter, and switched in as required by a range selector switch, but are made up as jacks, and are plugged in externally. It is thus possible to provide additional ranges when required. To enable those interested to select their own choice of ranges and provide the correct shunts, etc., the calculations will be given for the general case, and a set of recommended ranges.

By B. E. Wilkinson

## An Ex-Government Meter

The meter, which is intended to measure D.C. current, voltage and resistance to about 5k, is constructed from a robust ex-government meter, which is intended for checking cells, and measuring resistances approximately. The only indication of type is "Instrument Testing No. 1", which appears at the top, in front of the three terminals and toggle switch. These meters are currently available. The meter is enclosed in a thick, black plastic case, the movement

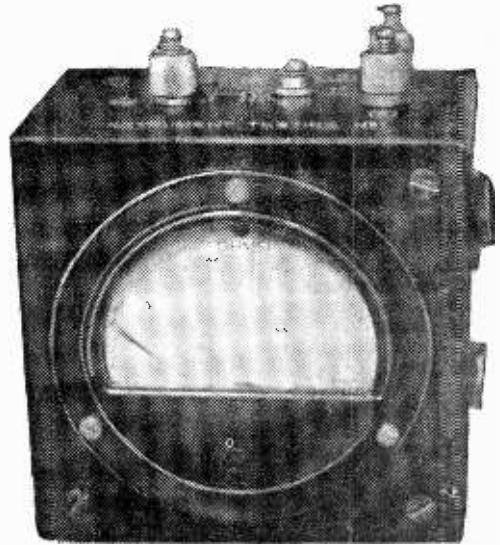

The completed meter.

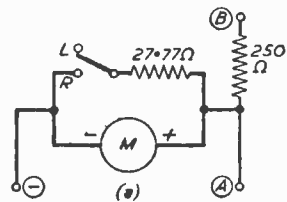

itself being protected by a circle of thick glass and a metal plate screwed over the front. The scale is graduated in volts to 1.5 or 3.0, milliamps to 60, and ohms to infinity, 5k being the highest indicated value.

## The Meter Movement

Before deciding upon the ranges required, it is necessary to know something of the meter movement. On the face for instance it states that it has a resistance of 250Ω.

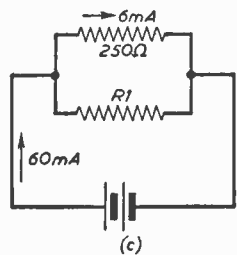
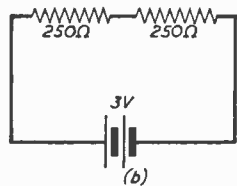

Fig. 1 (left):  
 (a) The circuit of the instrument.  
 (b) Equivalent circuit for the low voltage range.  
 (c) Equivalent circuit on the 60mA range.

This is essential to calculations, but is not sufficient, for the current required for full scale deflections of the meter needle must be known. However, it will be found that a circuit diagram of the instrument as it stands is provided on the top, and is reproduced in Fig. 1a. Now, from the back of the instrument, where operating instructions are given, it is seen that with the toggle switch to (L) voltages to 3V can be measured across (-) and (B). Since voltages are being measured it is clear that the 250Ω resistor must be in series with the meter and the 27.77Ω shunt resistor must not be connected. Position (L) must therefore be with the switch open. For this voltage range then, the circuit will be similar to Fig. 1b, where the second 250Ω resistor represents the meter movement. The total resistance of the circuit is 250+250=500Ω and the applied voltage for full scale deflection is 3, so that by Ohm's law the current flowing will be:

$$I = \frac{E}{R} = \frac{3}{500} = 6mA$$

This then is the current required fully to deflect the meter needle, and is a basic value in the calculations. This value may be checked by considering the current-measuring range of the instrument. It will be seen that with the switch in position (R) 60mA will cause a full scale deflection between (-) and (A). This is clearly with the shunt connected but without the series 250Ω. The equivalent circuit is shown in Fig. 1c. Here 60mA are being measured, but since only 6mA may pass through the meter, 60-6=54mA must pass through the shunt. The potential difference across the meter will be  $E=I \cdot R = 6 \times 250 = 1500mV$ . This must be the same as the P.D. across R (since they are in parallel), so that the value of R, will be, by Ohm's law,  $R = \frac{E}{I} = \frac{1500}{54} = 27.77\Omega$ , which is in fact the value of the shunt used. We are now in a position to discuss the required current and voltage ranges and the shunts and resistors necessary to provide them.

Fig. 2 (right):  
(a, b and c) How the shunts are calculated.

**Current Ranges**

As far as current is concerned, the meter scale is graduated in milliamps to 60. The ranges considered acceptable for this sort of meter are 6, 60 and 600mA. By using multiples of 6, confusion over readings is avoided. Now, since the meter itself has a 6mA movement, the first range is achieved without a shunt. In Fig. 2a the meter is in parallel with a shunt which is to be calculated for any current flowing (i). Since the meter must only pass 6mA, the shunt must pass (i-6)mA. The potential difference is again 1500mV, and by Ohm's Law R1 will be

$$R1 = \frac{E}{I} = \frac{1500}{i-6}$$

(where I is in milliamps). By substituting for I in this relation it is possible to provide R1 for any

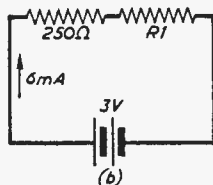
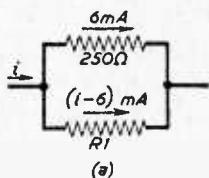

Range	Shunt	Resistor
6mA	None	—
60mA	27.77Ω	—
600mA	2.2525Ω	—
3V	—	250Ω
30V	—	475Ω
300V	—	4975Ω

Fig. 3 (right)—Circuit of the instrument when used as an ohmmeter.

desired current range (providing of course it is not less than the sensitivity of the meter movement itself). Thus for a 60mA range

$$R1 = \frac{1500}{60-6} = 27.7\Omega$$

Fig. 4 (right).—Complete circuit arrangement.

And for a 600mA range

$$R1 = \frac{1500}{600-6} = 2.252\Omega$$

**Voltage Ranges**

Two voltage ranges are provided on the meter scale, 1.5 and 3. It is suggested that multiples of 3 be considered, i.e.: 3V, 30V and 300V, though the reader is not bound to follow these ranges. To calculate the series resistors required, Fig. 2b must be consulted,

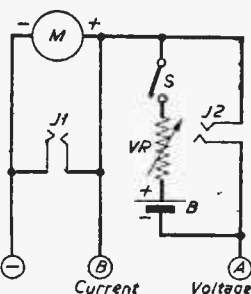

where the meter is shown in series with a resistor R1 and a voltage to be measured (V). The total circuit resistance (neglecting the source) is (250+R1), and since for full scale deflection, the current flowing must be 6mA the potential difference (V), must be given by

$$V = \frac{6(250+R1)}{1000}$$

To obtain R1

$$1000V = 1500 + 6R1$$

$$R1 = \frac{1000V - 1500}{6}$$

$$R1 = \frac{100(10V - 15)}{6}$$

(The 1000 factor is necessary to convert milliamps into amps.)

For 3V range, the relation becomes:

$$R1 = \frac{100(30-15)}{6} = \frac{100(15)}{6} = 250\Omega$$

For a 30V range,

$$R1 = \frac{100(300-15)}{6} = \frac{100(285)}{6} = 4750\Omega$$

and for a 300V range,

$$R1 = \frac{100(3000-15)}{6} = \frac{100(2985)}{6} = 49750\Omega$$

For convenience the required values are tabulated in Fig. 2c.

No multimeter should be without a continuity test and ohm range (in fact it is frequently felt that this range is the most useful of all) and since the face is provided with a scale in ohms the opportunity can hardly be missed.

The ohmmeter, which, as will be seen later is built into the instrument, consists of a series circuit—meter, battery, and two resistors, one for adjustment and the other being measured.

Now, on the back of the instrument, instructions will be seen, a note stating that to use the ohmmeter, a cell reading 1.5V should be connected in series with the resistor under test and the (-) and (A) terminals. No adjuster is provided, because the cell is known to be 1.5V before the measurement is made, and the scale is calibrated for use with this cell and a meter resistance of 250Ω.

Therefore the meter is used as it is for measuring resistance by merely providing a 1.5V dry battery. Since at first this may provide a little more than 1.5V, it is well to use a small variable resistance (10Ω) in the circuit to provide a zeroing adjustment. In Fig. 3, the ohmmeter circuit is shown, if the cell is giving exactly 1.5V, then R1 will be adjusted to zero resistance. Suppose that for a resistance R2 (as yet unknown), a current flow of, say, 5mA. The total circuit resistance is (250+R2). Thus we may write:

$$E = I \times R \quad 1.5 = 5 \frac{(250 + R2)}{1000}$$

$$1500 = 1250 + 5R2$$

$$5R2 = 250$$

$$R2 = 50\Omega$$

It will be seen from the meter scale that a current of 5mA (50 indicated because of the internal shunt), corresponds to a resistance of 50Ω. Since the ranges of the proposed multimeter have been discussed, and the values of resistors required have been established, the actual circuit may now be considered.



# RETURN-OF-POST SERVICE

We offer a really efficient Mail Order Service on all items stocked. All cash orders are dealt with on the day of receipt. Hire purchase orders are subject to slight delay but this is kept to the absolute minimum.

## GRAMOPHONE EQUIPMENT

ALL LATEST MODELS ALL POST FREE	Cash Price	Hire Purchase Deposit Mthly/Pmnts.
<b>RECORD CHANGERS</b>		
GARRARD RC210 (GC8 PU) ..	£9.18. 6	£1.18. 6 12 of 15/-
B.S.R. UA14 Monarch (TC8 PU) ..	£7.15. 0	£1.11. 0 12 of 12/-
B.S.R. UA8 Monarch (TC8 PU) ..	£7. 5. 0	£1. 9. 0 12 of 11/4
B.S.R. UA14 Monarch (TC8S Stereo/LP/78)	£8.18. 0	£1.16. 0 12 of 13/6
<b>SINGLE RECORD PLAYERS</b>		
GARRARD TA (GC8 PU)	£8.10. 0	£1.14. 0 12 of 13/-
B.S.R. TU (TC8 PU)	£4.10. 0	£1. 5. 0 3 of £15.0
COLLARO RP594 (O, P or T PU) ..	£9.18. 9	£1.18. 9 12 of 15/-
E.M.I. (Acos Stereo/Mono PU)	£6.15. 0	£1. 7. 0 12 of 10/8
<b>TRANSCRIPTION UNITS</b>		
COLLARO TRP 594 (TX88 PU) ..	£13.18. 3	£2.18. 3 12 of £1.04
GARRARD 4HF (GC8 PU) ..	£18. 9. 9	£3.15. 9 12 of £1.70

Many of the above can be supplied for stereo working. See our Gramophone Equipment List for details.

## LOUDSPEAKERS

**GOODMANS:** Axiom H6 10in. £5.00; Axiom H12 10in. £8.10.0; Axiette 8in. £6.12.1; Axiom 300 12in. £11.9.8; Axiom 400 12in. £16.1.0; Audiom 60 Bass. 12in. £9.12.9; Trebax Tweeter £6.4.0; CX5000 Cross-over unit £1.19.0.

**WHITELEY:** HF1016 10in. £7.12.3; HF1012 10in. £4.15.0; HF16 8in. £6.10.6; T16 8in. £6.3.9; T16 Tweeter £4.4.0; T359 Tweeter £1.13.3; CX3000 Cross-over unit £1.10.0; CX1500 Cross-over unit £1.18.3.

H.P. Terms available.

## LATEST TEST METERS

	Cash Price	Deposit	Hire Purchase Mthly/Pmnts.
AVO Model 8 ..	£24. 0. 0	£4.16. 0	12 of £1.15. 2
AVO Model 8 with leather carrying case	£27.18. 0	£5.12. 0	12 of £2. 0.11
AVO Model 7 ..	£19.10. 0	£3.18. 0	12 of £1. 8. 8
AVO Model 7 with leather carrying case	£23. 8. 0	£4.12. 0	12 of £1.14. 6
AVO Multimeter ..	£9.10. 0	£1.18. 0	12 of 14/4
AVO Multimeter with leather carrying case	£11. 9. 0	£2. 5. 0	12 of 17/-
Taylor Model 127A ..	£10. 0. 0	£2. 0. 0	12 of 15/-
CABY A-10 ..	£4.17. 6	£1. 7. 6	3 of £1. 6. 8
CABY B-20 ..	£6.10. 0	£2. 0. 0	3 of £1.13. 4

All details of any of the above supplied free on request.

## RECORDING TAPE

### DOUBLE PLAY

B.A.S.F. 300ft (3"), 14/-; 800ft (4"), 25/-; 1200ft (5"), 45/-; 1800ft (6"), 58/-; 2400ft (7"), 77/6.

BRAND FIVE. 1200ft (5"), 37/6; 2400ft (7"), 80/-.

EMITAPE 100. 400ft (3"), 17/-; 1200ft (5"), 45/-; 2400ft (7"), 80/-.

SCOTCH BOY 200. 400ft (3"), 17/-; 1200ft (5"), 45/-; 2400ft (7"), 80/-.

TRLEFUNKEN. 1200ft (5") in plastic container, 40/-; 1800ft (6") in plastic container. 50/-; 2400ft (7"). 75/-.

### LONG PLAY

B.A.S.F. 210ft (3"), 9/-; 850ft (5"), 28/-; 1200ft (6"), 35/-; 1800ft (7"), 50/-.

BRAND FIVE. 900ft (5"), 18/6; 1200ft (6"), 23/6; 1800ft (7"), 35/-.

EMITAPE 99. 99/3 250ft (3"), 9/6; 99/3N 250ft (3"), 9/6; 99/9 850ft (5"), 28/-; 99/12 1200ft (6"), 35/-; 99/18 1800ft (7"), 50/-; 99/9. 99/12 and 99/18 available in Emicase, 2/6 extra.

SCOTCH BRAND 150. 300ft (3"), 9/6; 900ft (5"), 28/-; 1275ft (6"), 35/-; 1800ft (7"), 50/-.

ALL TAPE POST FREE!

## TAPE DECKS

	Cash Price	Deposit	Hire Purchase Mthly/Pmnts.
B.S.R. TD2 ..	£8.18. 6	£1.18. 6	12 of 13/7
COLLARO STUDIO ..	£18.18. 6	£2.12. 6	12 of 19/5

All carriage free  
All components in stock for the Mullard Tape "C" Pre-Amplifier Kit. Fully detailed list available.

## NEW ILLUSTRATED LISTS

Illustrated lists are available on LOUDSPEAKERS, TAPE DECKS, TEST GEAR, RECORDING TAPES, GRAMOPHONE EQUIPMENT. Any will be sent free upon request.

## STEREO COMPONENTS

Morganite gated potentiometers as specified for the Mullard circuits. Log/Anti-Log, 500k, 1 meg., 2 meg. Log/Log, 250k, 1 meg., 2 meg. Lin/Lin, 500k, 1 meg. All 10/6 each.

Denco Chassis for the Mullard circuits. All drilled with printed front panel. Three Valve Stereo Amplifier Chassis. 22/-, Seven watt Stereo Amplifier Chassis. 24/6. Stereo Pre-Amplifier Chassis. 24/6. Set of switches for Pre-Amp. 34/8. Pick-up cartridges. B.S.R. TC8S £2.4.11. Ronette DC284, £3.19.6. Both are turn-over types for Stereo, LP and 78 records. List of all components for Mullard Stereo Designs is available.

## JASON FM TUNER KITS

We supply kits for the Jason FMT1, FMT2 and FMT3 (Fringe) Tuners with variable tuning also the JTV2 and Mercury 2 Switched Tuners with TV Sound. We take great care in the making up of these kits to ensure that every item needed is included and we can confidently claim that our kits are the best and most complete available. We are continually receiving compliments on the quality and above all the completeness of our kits. Prices: Standard Tuners: FMT1, complete kit, £6.19.6. Power Pack kit, £2.12.6; FMT2, complete kit, less power supply, £8.9.6; Kit with power supply, £10.9.6. Fringe Tuner: FMT3, kit less power supply, £10.9.6; Kit with power supply, £12.7.6. FM/TV switched Tuners: JTV2, complete kit, £15.17.6; Mercury 2, complete kit, £11. 6. Important. When ordering JTV2 and Mercury 2 kits it is essential to give TV Channel and FM Stations required on Tuner). All kits are supplied complete with valves and instruction manual. Hire Purchase terms available. Fully detailed lists are available free upon request. Instruction manuals available as follows. Data Booklet for FMT1, FMT2 and FMT3. 2/10. JTV2. 3/10. Mercury 2. 3/10. All post free.

## MULLARD CATHODE RAY TUBES

ALL AT THE NEW REDUCED PRICES  
We supply both Mullard Radiant Screen (Brand new factory fresh) and Mullard Lumenar (Re-builds by Mullard with reclaimed bulbs—all other parts brand new). List of types available with prices and hire purchase terms available.

## OUTPUT TRANSFORMERS

GILSON  
W0696A, W0696B, 50/6, post 2/-, W0710, W0710/8K, 55/6, post 2/-  
W0892, 62/3, post free; W0767, 27/-, post 1/6.

PARTRIDGE  
P3667, 52/6, post 2/-; P4014, 98/6, post free; P4131, 60/-, post free; P3511A, 99/-, post free; P3202, P3203, 95/-, post free.  
PARMEKO, P2641, 27/-, post 1/6. P2643, 41/3, post 3/-.  
ELSTONE, OT3, 25/-, post 1/6; OT/ML, 45/-, post 2/-.

## AMPLIFIER KITS

We have full stocks of all components for the Mullard 510, Mullard 2 and 3 Valve Pre-Amplifiers, GEC 912 Plus. Fully detailed list on any of these sent upon request.  
Instruction Manuals, Mullard, All Mullard Audio Circuits in "Circuits for Audio Amplifiers", 9/5. GEC 912, 4/6. All post free.

## HIRE PURCHASE TERMS

are available on any item. Repayment may be spread over 3, 6 or 12 months. Details as follows: Three months: Deposit 6/- in the £. Service charge 5 per cent but minimum charge of 10/-. Six and Twelve months: Deposit 4/- in the £. Service charge 10 per cent, but minimum charge 20/-.

## TERMS OF BUSINESS

Cash with order or C.O.D. We charge C.O.D. orders as follows. Up to £3, minimum 2/6. Over £3 and under £5, 1/6. Over £5 and under £10, 1/6. Over £10, no charge. Postage extra on CASH orders under £3 except where stated. Postage extra on Overseas orders irrespective of price.

**WATTS RADIO**  
(MAIL ORDER) LTD.

54 CHURCH STREET, WEYBRIDGE, SURREY

Telephone : Weybridge 4556

Please note: Postal business only from this address

ACCURATE READINGS IN ANY POSITION

ADVANCED DESIGN—MINIMUM WEIGHT

ALL-ROUND RELIABILITY

# THE *NEW* SALFORD SELECTEST

**MODEL SUPER K:** 1 mA movement.  
39 self-contained ranges for measuring  
A.C., D.C. voltages and currents and resistance.

**MODEL SUPER 50** 50  $\mu$ A movement  
*Send for leaflet No. S.K.50/0012/PT.*



**SALFORD ELECTRICAL INSTRUMENTS LTD.**

PEEL WORKS, SILK STREET, SALFORD 3, LANCs. Tel: Blackfriars 6688  
London Sales Office: Magnet House, Kingsway, W.C.2. Tel: Temple Bar 4668  
A Subsidiary of THE GENERAL ELECTRIC CO. LTD. OF ENGLAND

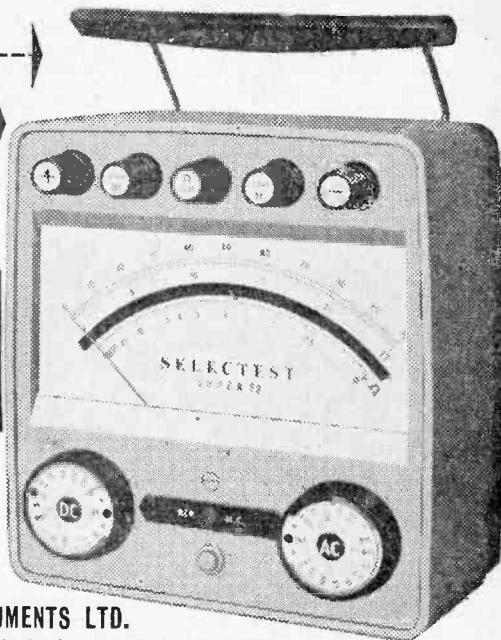

# WEYRAD

## COILS AND TRANSFORMERS FOR A 2-WAVE TRANSISTOR SUPERHET WITH PRINTED CIRCUIT AND FERRITE ROD AERIAL

- LONG AND MEDIUM WAVE AERIAL—RA2W  
On 6 in. rod,  $\frac{7}{16}$  in. diameter, connections to  
6-Tag Ring, 208 pF tuning ... .. 12/6
- OSCILLATOR COIL P50/IAC  
Medium wave in screening can. For 176pF  
tuning condenser ... .. 5/4
- 1st AND 2nd I.F. TRANSFORMERS—P50/2CC  
470 Kc/s operation with 250 pF tuning in cans.  
 $\frac{1}{8}$  in. diameter by  $\frac{3}{4}$  in. high ... .. 5/7  
(2 REQUIRED)
- 3rd I.F. TRANSFORMER—P50/3CC  
Last stage transformer to feed diode detector.  
Size as P50/2 ... .. 6/-
- DRIVER TRANSFORMER—LFDT2  
Upright mounting with six connecting tags—  
 $1\frac{1}{8}$  in. x  $\frac{1}{8}$  in. x  $1\frac{3}{4}$  in. ... .. 9/6

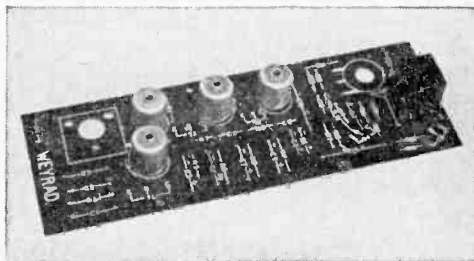

PRINTED CIRCUIT—PCA1  
Size  $2\frac{3}{4}$  in. x  $8\frac{1}{4}$  in. Ready drilled and printed with component positions ... .. 9/6  
THESE COMPONENTS ARE APPROVED BY TRANSISTOR MAKERS  
AND PERFORMANCE IS GUARANTEED.

Constructor's Booklet with full details, 2/-.

**WEYMOUTH RADIO MANUFACTURING CO., LTD.**  
CRESCENT STREET, WEYMOUTH, DORSET

### The Meter Circuit

The circuit is shown in Fig. 4. Here it will be seen that while there is no range selection switch, two jack sockets J1 and J2 are provided. J1 accepts shunts across the meter movement, so that current is measured between terminals (—) and (B). J2 accepts resistors for the voltage ranges, the terminals used being (—) and (A). When neither J1 or J2 is being used, the switch may be closed, and resistance measured between (—) and (A). The variable resistor shown is  $10\Omega$  and is for zeroing.

### Constructional Details

It is now necessary to modify the instrument, and rewire it using the circuit shown in Fig. 4. The unit is held together by eight 4B.A. screws, four at the front, and four holding the back plate in position. If all of these screws are removed the wiring inside may be disconnected and removed, and the meter movement pressed out, forward. Three spring clips, attached to the meter flange by three 6B.A. screws should be removed and discarded. A thick piece of glass under the front plate and two soft-rubber rings are no longer required and should also be discarded.

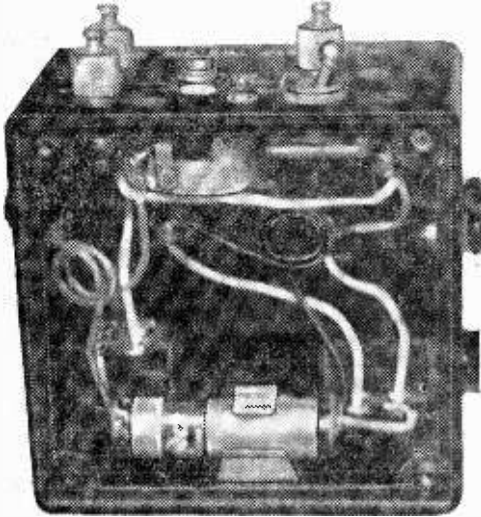

*A rear view of the complete instrument.*

The two resistors wound on a plastic former must be removed, but should be set aside as the resistance wire with which they are wound is required. Measurement of the centre hole in the brass plate which was screwed to the front of the unit shows it to be 2.5in. in diameter. The meter itself is 2.7in. in diameter, and since it is intended to fit the meter to the plate, the hole must be enlarged by 0.1in. all the way round. This can be done quite quickly with a sharp half-round file. When the meter will fit easily through the hole, it should be lined up so that a line drawn through the centre of the scale and the needle adjustment screw is parallel with two opposite sides of the plate. Clearance holes (6B.A.) may now be drilled through the plate to mate with the corresponding holes in the meter flange. The meter may then be bolted to the plate and the plate fitted back on the case.

Looking into the back of the unit, it will be seen that this modification has moved the meter forward, and thus provided sufficient space for further components. The two jack sockets J1 and J2 may now be fitted. They are fitted, one each side of the case, by means of  $\frac{1}{8}$ in. holes drilled as shown in Fig. 5b which also shows the meter mounted to the front plate.

The  $10\Omega$  variable resistor for adjustment of the ohmmeter range, is fitted through a  $\frac{1}{8}$ in. hole drilled in the top of the case, at the intersection of two lines drawn between the centres of the (—) and (B) terminals and the switch and the (A) terminal. The shank of this resistor should be cut down to about  $\frac{1}{8}$ in. and a saw cut made across the diameter to accommodate a screwdriver. The ohmmeter range needs a 1.5V cell to operate the meter, and this takes the form of a single pen cell held to the bottom of the inside of the case by means of a small Terry clip. This can be seen in the photograph of the back of the instrument.

### Additional Wiring

Wiring should be carried out with single-strand plastic covered wire similar to that removed from the meter initially. Fig. 5a shows the wiring system. A length of wire is connected between the (—) terminal, and the negative point of the meter. Then a wire is jointed to the positive side of the meter and one side of the toggle switch. The other side of the toggle switch is taken to one side of the  $10\Omega$  resistor. The two meter terminals are now connected to the two tags of J1, and the outermost tag of J1 is taken to the corresponding tag of J2. Terminal (B), is now taken to the positive side of the meter while terminal (A) is taken to the inner tag of J2 and the negative side of the 1.5V cell. Finally the centre tag of the resistor is taken to the positive side of the cell. In wiring, unless leads are taken to terminals, they should be soldered. The instrument is now virtually complete and the ohm range can be tested. Set the toggle switch to R and connect a piece of wire from (—) to (A). The meter should indicate zero resistance. If it tries to indicate less than zero; i.e. beyond full scale deflection, it can be set to zero by means of the  $10\Omega$  resistor. If it indicates a finite resistance, the cell is down and should be replaced. Tests can now be made using resistors up to about 5k. The rear plate of the instrument may now be screwed in position. However, it will be observed that engraved on the back are instructions which are no longer relevant, so that the back plate may be put on reversed, the four holes being countersunk slightly to receive the 4B.A. screws.

### The Jacks and Test Prods

To complete the instrument, it is necessary only to provide the shunts and resistors in jacks, and the test prods. Referring to the table of Fig. 2c, we see that for the recommended ranges we require five resistors. For the current ranges the resistors are 16w, and are made-up from resistance wire. The resistor removed from the meter initially consists of a  $27.7\Omega$  and a  $250\Omega$  resistor. If the  $27.7\Omega$  resistor is carefully unwound avoiding kinks, as this piece of wire is required, and measured, it will be found to be almost exactly 8ft long. Thus:

$$27.7\Omega = 8\text{ft} \text{ or } 96\text{in.}$$

$$\therefore 1\Omega = 96/27.7 \text{ in.}$$

$$\therefore 2.525\Omega = 96 \times 2.525 = 8.726\text{in.}$$

$$27.7$$

Thus a piece of resistance wire 8·726in. long, taken from the 250 $\Omega$  winding, will provide a shunt for the 600mA current range. When using this wire, the cotton covering should be removed at each end, and the wire tinned for soldering in. It should be remembered that the actual resistance between the two tags joined by a length of resistance wire does not include that wrapped around the tags, or tinned. Thus the length of wire cut should be slightly longer than that actually required. The jacks to which the resistances are connected are of the standard Post Office type. The resistances are connected across the two connections in the handle of the jack, and the handle replaced. No trouble should be experienced with the series resistors, but the shunts, being made of wire need some support. They may be wound upon a small Tufnol former, with small lengths of tinned copper wire at either end to provide lead-out tags. The range provided by each jack should be typed on a small label or piece of paper and stuck to the appropriate jack by means of Sellotape. Pieces of paper with "Current" and "Voltage", should be similarly fixed to J1 and J2 respectively, on the meter case, so that confusion does not arise.

Test prods are an essential part of every test meter, and should be made from flexible, stranded insulated wire. The ends connecting to the meter should be soldered to short lengths (1in. or so) of brass wire, the joint being neatly taped. The brass wire will then fit easily in the angled slots cut in the terminals. At

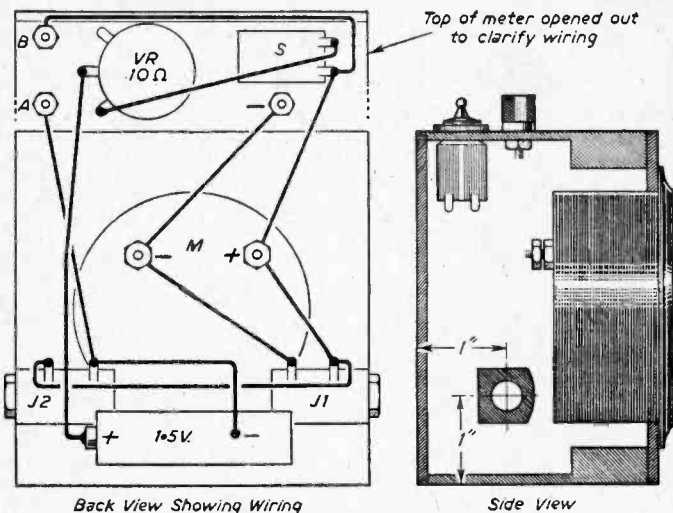

Fig. 5a (left).—Rear wiring details.

Fig. 5b (right).—Side view of the completed test-meter.

the other ends of the leads either brass prods or crocodile clips may be fixed. The brass prods should be sleeved almost to the end, so that one does not hold the bare metal when making measurements.

The instrument should require no calibration, but it is advisable to check it either against a test meter known to be correct, or resistors and cells known also to be correct. To check, for instance, the 3V range it is necessary only to use 1·5 and 3V cells, while the 30V range may be checked with grid bias batteries, car batteries, etc. Any adjustments necessary may be effected by varying slightly the values of resistance in the appropriate jacks.

## QUARTZ CRYSTAL ETCHING

(Continued from page 979)

rate of about 1kc/s per minute of immersion has been found with crystals of a frequency of about 8Mc/s, but a longer etching time per kilocycle frequency rise would probably be required for crystals of lower frequencies.

The crystal should be completely immersed in the etching solution for a comparatively short time—perhaps ten minutes—or less if a small frequency change is desired. The crystal should be removed from the etching solution with the coated tweezers, washed in two successive jars of water (not hard water) and finally dried in a current of warm (not hot) air. Alternatively, the final wash can be made with pure alcohol which is then allowed to evaporate.

The crystal is then remounted in its holder. If it is a type which is held at the corners only by the metal electrodes, care must be taken that the electrodes are replaced so that the projecting corners face the quartz crystal. The frequency of the etched crystal should be determined as accurately as possible. The rate of etching can be determined from the frequency change and an estimate can be made of the time for which the

crystal should be left in the same solution in order to achieve the desired increase of frequency.

The crystal should be etched for not more than three-quarters of the calculated time and the frequency checked again. It should now be possible to calculate fairly accurately the etching time required to increase the frequency to the desired value. If the final frequency must be extremely close to the desired value, it is advisable to etch for somewhat less than the calculated time and to check the frequency several times before completing the process. With care the error in the final frequency will not be appreciably greater than that of the measuring device used—certainly less than 1kc/s.

As etching proceeds, the anode current of the oscillator (Fig. 1) will probably increase somewhat with each frequency check owing to a reduction in the activity of the crystal. The anode current should be noted at each frequency check; an increase of more than a few milliamperes may indicate that the crystal is useless. Do not forget, however, that a change in the oscillator H.T. voltage may cause a change in the anode current.

★ POST HASTE ★

JASON F.M. TUNER KITS

We are the Authorised Jason Dealers and the whole kit is as supplied by them. You can therefore safely return to Jason for alignment without them rejecting it for non-standard components.

We can also align for the standard charge, to our kits only.

**FMT1** is the standard variable tuner for cabinet mounting, unpowered. Supplied complete with four EF91 valves ... .. £7.10. 0  
Hire purchase Deposit £1.10.0 and 6 monthly Instruction book, 2/6 extra. £1. 3. 4

**FMT1** Power pack kit with ready drilled chassis ... £2.14. 0

**FMT2** is a new tuner in a modern case, green, which can be used for shelf or cabinet mounting, and has space for power supplies if required. Supplied complete with four EF80 valves ... £8.12. 6  
Hire purchase Deposit £1.14.6 and 6 monthly £10.14. 0

**FMT2** With power. Complete kit ... .. £12.14. 0  
Hire purchase Deposit £2.4.0 and 8 monthly Instruction book 2/6 extra. £1. 3. 9

**FMT3** is the fringe version and should be used when farther than 70 miles from the transmitter. Supplied complete with 6 valves ... .. £10.12. 6  
Hire purchase Deposit £2.2.6 and 8 monthly £1. 3. 9

**FMT3** With power. Complete kit ... .. £12.13. 0  
Hire purchase Deposit £2.13.0 and 8 monthly Instruction book 2/6 extra. £1. 7. 7

NEW JASON SWITCHED TUNERS

The **JTV/2** and **Mercury 2** are both of the pre-set station type with the addition of BBC and ITA sound. They use the latest "Fireball" turret and the A.F.C. ensures freedom from drift. The **Mercury 2** is for cabinet mounting with external power supplies. The **JTV/2** has the same tuning heart, with power supplies mounted in a case. This again can be used for shelf or cabinet mounting. The **JTV/2** cannot be supplied less power.

**JTV/2** Complete with valves and book ... .. £16.14. 9  
Hire purchase Deposit £3.14.9 and 12 monthly £1. 3.10

**Mercury 2** Complete with valves and book... .. £12. 0. 0  
Hire purchase Deposit £2.8.0 and 8 monthly £1. 6. 6

**Power pack Kit for Mercury 2** with drilled chassis Instruction book for all switched tuners, 3/6. £2. 14.0

REQUIRED CHANNELS MUST BE SPECIFIED FOR SWITCHED TUNERS

All Jason kits can be supplied less valves. To find the cash price deduct 7/6 for each valve.

A more detailed list can be sent upon request.  
ALL JASON TUNERS ARE ON DEMONSTRATION

GRAMOPHONE EQUIPMENT

All these units are brand new and boxed	Cash	Deposit	Mthly.	pmts.
<b>B.S.R. Monarch TC8H</b> , cartridge, UA14 ... ..	£7.15.0	£1.11.0	6	£1.4.0
<b>COLLARO Conquest O</b> cartridge ... ..	£7.15.0	£1.11.0	6	£1.4.0
<b>GARRARD TA/Mk.2</b> , GC8, cartridge ... ..	£8.10.0	£1.14.0	6	£1.6.0
<b>GARRARD 4HF</b> , GC8, cartridge ... ..	£18. 9.9	£3.19.9	12	£1.6.7
<b>PHILIPS AG2009</b> , AG3016 cartridge ... ..	£10.10.0	£2. 2.0	8	£1.3.6

For further information please write for manufacturers' list.

★ POST FREE ★

**COLLARO STUDIO DECK.** 3 speed, 3 motors, 7in. spools. Pause control, space for third head, piano keys, counter.  
List price £17.10.0 OUR PRICE £13.10. 0  
Hire purchase Deposit £3.0.0 and 12 monthly £19. 3

**TAPE AMPLIFIER** for Studio deck, with two printed circuit boards, control and input panels, mains and output transformers, complete with knobs and plans, EF86, ECC83, EM84, EZ80, OAB1 and two EL84, 4 watts output. Magic eye, Radio and Mic inputs, Mixing and Superimposing facilities, EX L.S. socket, low level output, tone control. Can be used as amplifier.  
★ CASH PRICE £11.12. 6  
Hire purchase Deposit £2.6.6 and 8 monthly £1. 5. 9

**TAPE RECORDER CASE** to house the above deck and amplifier. Two-tone Grey ... .. £5. 5. 0

**E.M.I. Speaker** to fit case 10 x 5in. ... .. £1. 7. 6

**1200ft Brand Flugs** tape 25/-; Crystal Mic Stan Kelly Screened Jack Plugs, 4/6 each. Spare 7in. tape spool £1. 7. 0  
The above recorder complete to PERSONAL SHOPPERS ONLY for ... .. £35. 0. 0  
Hire purchase Deposit £7.0.0 and 12 monthly £2. 11. 4  
This machine is a first-class job and normally sells for £41. 0. 0

**SEND FOR MAKER'S ILLUSTRATED LEAFLET**  
Collaro Tape Heads Record/Playback and Erase.  
Lower track only ... .. 37/6 pair  
**B.S.R. Monardeck T.D.2**, 3 1/2 i/s, 5 1/2in. spool.  
List price £12. 12. 0 OUR PRICE £7. 9. 6

FERRODYNAMICS "BRAND FIVE"

Magnetic Recording Taps. Made in U.S.A. Fully guaranteed. High Grade Acetate base and boxed.  
600ft 5in. Standard 16/- 1200ft. 7in. Standard 25/-  
900ft 5in. L. play 18/6 1800ft. 7in. L. play 35/-  
1200ft 5 1/2in. L. play 23/6

SEND FOR MANUFACTURERS' LEAFLET  
Also stocked SCOTCH BOY, EMITAPE and BASF. LIST ON REQUEST.

TRANSISTORS

OC44 Mixer ... ..	12/-	OC78	Audio ...	15/-
OC45 I.F. ... ..	12/-	OC78D	Driver ...	17/-
OC70 Audio ... ..	14/-	OC71	Photo ...	25/-
OC71 Audio ... ..	8/6	OC81	Audio ...	18/-
OC72 Audio ... ..	8/6	Red spot	Audio ...	5/-
OC75 Audio ... ..	15/-	White spot R.F.	... ..	6/-

The above transistors, except the Red and White spot, are all BRAND NEW MULLARD, and are NOT sub-standard. Matched pairs of OC71 and OC72 can be supplied at no extra cost.

"PRACTICAL WIRELESS" POCKET SUPERHET

OSMOR PRINTED CIRCUIT VERSION  
Osmor Rod aerial, 10/-; IFTs and Osc. coils, 22/6; Osmor Driver, 11/6; Osmor Output, 10/6; Set MULLARD transistors, 61/6; JB Gang, 11/-; Trimmer, 1/4; Set Condensers, 15/-; Resistors 6/6; Ardent Volume Control, 10/6; Ardent W/C, 3/6; Speaker, 19/10; OAB1 diode, 4/-; Hardware, 4/6; Printed circuit, 9/-; Case and knob, 7/6; PP4 battery, 2/-; Press studs, 1/-; Leaflet, illustrated, giving full instructions and constructional details, 1/9.  
ALL THE ABOVE COMPONENTS IF PURCHASED AT ONE TIME—£10.0.0.

The above components are all new and miniature, by reputable manufacturers, and are fully guaranteed.

WE PAY ALL POSTAGE AND INSURANCE  
ALL ORDERS DESPATCHED SAME DAY  
MONEY WILL BE REFUNDED IF REQUESTED

SURBITON PARK RADIO

(Established over 30 years)

48 SURBITON ROAD,  
KINGSTON UPON THAMES, SURREY

Telephone: KIN 5549

Hours: 9 a.m. to 6 p.m. 1 p.m. Wed.

We do not close for lunch  
Open all day Saturday

# For Radio . . . For Records . . . For Tape an *Armstrong* Chassis

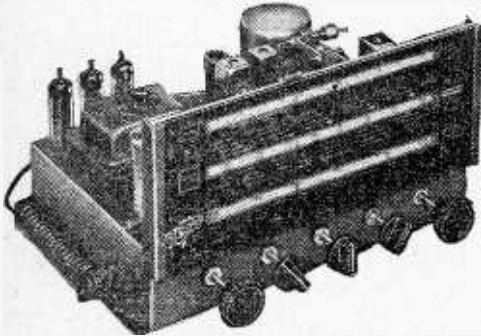

An Armstrong chassis is more than just a radiogram chassis. It is a carefully designed combination of tuner, control unit and amplifier in one compact unit which can be used as the basis of a complete high fidelity system. A system which can include tape recording and playback as well as the normal AM and FM radio and record reproduction. All Armstrong chassis are suitable for use with a complete tape recorder or with a tape deck and its associated tape pre-amplifier. Where a tape deck is used we recommend the Armstrong Pabo-3 tape pre-amplifier.

**JUBILEE Mk. 2** (illustrated) **29 GNS.**

The new and improved version of the famous Jubilee chassis. V.H.F., with automatic frequency control. Medium and long wavebands with ferrite aerial and magic eye tuning. Separate tone controls. Tape record and playback inputs. The improved amplifier provides 8 watts push-pull output.

**AF208** **22 GNS.**

An AM/FM chassis of 5 watts output, covering the VHF and Medium bands. Although an economically priced chassis, this has the same superior finish and components as our more expensive models.

**ARMSTRONG WIRELESS & TELEVISION Co. Ltd.**  
**WARLTERS ROAD, LONDON N.7. Tel.: NOR 3213**

Post this coupon or write for catalogue or call at our Showroom for full demonstration and professional advice on your installation. Open 9-5 including Saturdays.

NAME \_\_\_\_\_

ADDRESS \_\_\_\_\_

PMC

**YES—**

*But what if the boss  
doesn't have a  
daughter?*

Then it looks as if you may be reduced to **working** for promotion—but cheer up, it isn't too bad if you tackle it with a good heart and under skilled and sympathetic guidance.

Write for details, today, to:

**Mr. J. SYKES**  
(M.I.E.E., M. Brit. I.R.E., M.I.N.)

*Principal:*

**BRITISH NATIONAL RADIO SCHOOL**  
Red Lion Court, Stalbridge, Dorset.

Britain's premier Radio Correspondence School specialising in City and Guilds examinations.

## SPECIAL FOR THE "HAMS" RADIO STATION

*Illustrated*

½ inch detachable bit  
soldering instrument  
List No. 70

Combined Protective Unit  
with Wiper/Abrasion Pad  
and Solder Reel  
List No. 700

Apply **SALES & SERVICE**

**ADCOLA**  
(Regd. Trade Mark)

**GAUDEN ROAD**  
**CLAPHAM HIGH ST.**  
**LONDON, S.W.4**

Telephones:  
MACaulay 4272-3101

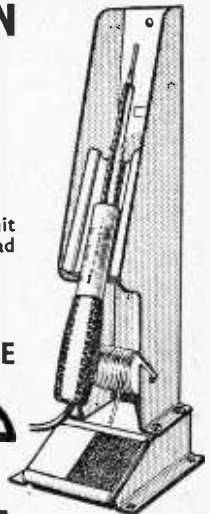

British & Foreign  
Patents, Registered  
Designs, etc.

Telegrams:  
"SOLJOINT, LONDON"

# Trade News

## NEW PRODUCTS AND DEVELOPMENTS

### A PRECISION MOULDED MAGNETIC TAPE CASSETTE

MUSIC of just the right kind for hotel lounges, ships' lounges, restaurants, fashion houses, etc. or even factories, is provided by the "Reditune" service. Music from a library of over 7,000 titles is provided on magnetic tape which is rented with a playback machine and the required number of speakers giving the effect of a portable orchestra with a repertoire exactly suited to the requirements of the user.

Reditune Ltd. is a member of the Rediffusion group of companies.

So that the programme can be changed as needed without any skill on the part of the user, tapes are supplied in ingeniously-designed cassettes which are simply inserted into the machine as easily as posting a letter.

The cassettes are injection moulded by Ekco Plastics Ltd. in polystyrene, each cassette comprising four separate mouldings—the body, the spool base, the spool top and the lid. All except the latter are in high-impact polystyrene, the lid being moulded in transparent polystyrene. The body incorporates two precision-ground brass inserts, a spindle on which the spool turns and a further small spindle to locate an interlocking brake lever. The spool spindle is internally threaded to take the single screw which attaches the lid to the body. The successful operation of the cassette demands freedom from distortion and a high finish with complete absence of flash. A feature which calls for rigidly controlled moulding technique is the need for moulding the spool centre hole to a tolerance of 0.002in. The endless magnetic tape unwinds and rewinds on the spool simultaneously and this involves considerable movement between tape and spool. To facilitate this movement, the base of the spool has 12 radially positioned graphite rods cemented to it, the tape actually resting on these rods during playing. The spool top is moulded separately and subsequently cemented in position. (Ekco Plastics Ltd., Press Section, Southend-on-Sea, Essex.)

### PERSONAL TRANSISTOR RADIOS

TWO personal transistor radios are now being marketed by Magnavox. Specially-designed printed circuits for really sensitive long-distance reception, plus hermetically sealed long-life transistors, are included in these new models, retailing at very reasonable prices.

The "Companion" eight transistor radio features a germanium crystal rectifier and a 2½in. PM dynamic high fidelity speaker. (Price, 13 gns., including purchase tax.) The "Pocketmate" is a six-transistor version with fine reproduction and performance. (Price, 11 gns., including purchase tax.)

Both are finished in coloured high impact plastic cases and have leather cases with carrying strap plus private listening earphones. An easel clip allows the Magnavox transistor sets to stand firm on any flat surface. (Magnavox, 129 Mount Street, London, W1.)

### WIRE RECORDER

AN improved and longer playing version of the well-known Minifon P55 pocket-size wire recorder has been introduced by the Office Equipment Division of E.M.I. Sales and Service Ltd. Known as the Minifon P55L, it now provides a recording/playing back time of five hours. Letters, notes, and memoranda totalling more than 30,000 words can thus be recorded. It is therefore a very convenient instrument for long overseas tours by directors and senior executives, also for busy people—architects, surveyors, civil engineers and plant managers—whose work takes them out and about.

The P55L is the same compact size (4in. by 6½in. by 1½in.) as the Minifon Attache tape dictation machine, and it slips easily into an overcoat pocket. The recording medium is very fine (0.002in. gauge) steel wire wound on two small

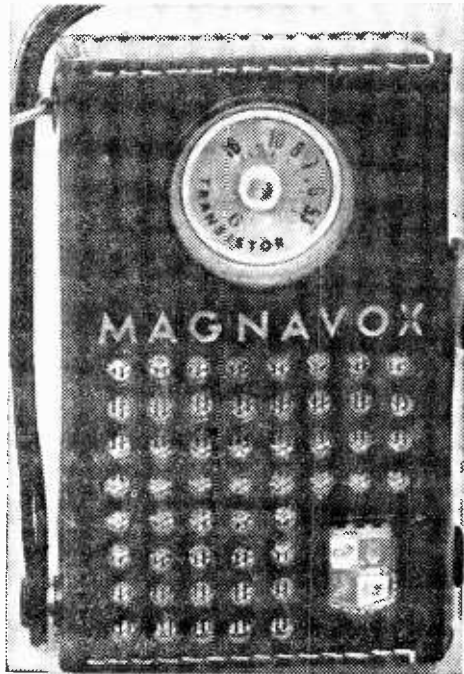

A new pocket transistor radio.

plastic spools. The fineness of the wire, even compared with ¼in. wide tape, gives the exceptionally long recording time.

The frequency response is 150-3,500 c/s, the input impedance 2M. and the output impedance 40k. The low-tension battery is a 1.4V standard single cell, with a working life of up to 20 hours. The high-tension battery is of 30V, with a working life of up to 200 hours. Both batteries are, of course, contained in the compact case. (E.M.I. Sales and Service Ltd., Blyth Road, Hayes, Middlesex.)



# Club News

## REPORTS OF CURRENT ACTIVITIES

### CLIFTON AMATEUR RADIO SOCIETY

Hon. Sec.: C. H. Bullivant, G3D1C, 25 St. Fillans Road, London S.E.6.

Recent meetings have included talks on "DX operating" and "G.P.O. equipment" and a constructional contest which produced 16 entries. On February 24th P. Deacon, G3BCM, will speak on International Radio Regulations.

### MITCHAM AND DISTRICT RADIO SOCIETY

Hon. Sec.: M. Pharaoh, G3LCH, 1 Madeira Road, Mitcham.

The G5UX Key Award was presented to G2BLA who won the 1959/60 contest for this trophy with a score of over 200 points. On January 13th a talk was given on Lifeboat Radio Equipment. The RSGB affiliated Societies Contest was held on February 5th and 6th. The Annual General Meeting will take place on Friday, 24th February.

Future Events:

April 7th—A talk by G2ZU.

### PETERBOROUGH AND DISTRICT RADIO SOCIETY

Hon. Sec.: D. Byrne, G3KPO, Jersey House, Eye, Peterborough. At their mid-winter rally held in Peterborough Technical College, members had a working demonstration of new transmitters and receivers by Mr. J. Herries, of Glasgow, who spoke on ssb techniques. Talk-in mobile stations were G3ARS/A on two metres and G3KPO/A on Top Band.

Future Events:

March 3rd—"Aerials". April 7th—Film show. May 5th—"Oscilloscopes".

### REIGILLATE AMATEUR TRANSMITTING SOCIETY

Hon. Sec.: F. D. Thom, G3NKT, 12 Willow Road, Redhill, Surrey.

The highlight of the December meeting was a demonstration by BRS 20809 of an ex-R.A.F. morse recorder (made in 1918) which coped quite efficiently with a modern electronic bug-key. The closing date for the constructional contest was January 31st and the entries will be judged at the Annual Dinner on February 11th. This will be held at Laker's Hotel, Redhill 7 for 7.30 p.m. The tickets can be obtained from any committee member price 15/6d. It is hoped that the chief guest will be Les Knight G5LK who was formerly Secretary of the East Surrey Radio Club for many years.

### SLADE RADIO SOCIETY

Hon. Sec.: C. N. Smart, 110 Woolmore Road, Erdington, Birmingham 23.

The Club Station (G3JBN) at the Church House, High Street, Erdington, Birmingham 23, is available for the use of members for constructional purposes. Thursday evening meetings will include informal discussions, operation of the Club transmitter, and instructional Morse classes. A licensed operator of G3JBN will always be in attendance on Thursday evenings. Slow Morse transmissions are radiated on the air each Monday evening from station G3AYJ on 1.9Mc/s from 8 p.m. to 8.30 p.m.

Future Events:

February 10th—A special meeting to consider alterations to rules and a discussion on D/F contests and equipment for the 1961 season.

February 24th—Sale of surplus equipment.

### SUTTON COLDFIELD RADIO SOCIETY

Hon. Sec.: L. E. R. Hall, 24 Calthorpe Road, Walsall, Staffordshire.

The G3GLQ Trophy was again won by Pat Darrag for a 2m transmitter. On January 12th George Collins, among others, gave a talk on the "Applications for Cheap Valves". A discussion on a standardised design for construction as a group project entitled "Build your own Communication Receivers" was the subject of the meeting on January 26th.

Future Events:

February 9th—"Methods of Receiving CW". A discussion of and about CW with demonstration of keys oscillator, B.F.O's etc.

February 23rd—"Crystal Grinding and Etching" by John Symes.

March 9th—Club Station Night.

March 23rd—"Tape Recorders". A talk by Len Hall about some commercial and industrial uses of tape recorders.

### PLYMOUTH RADIO CLUB

Hon. Sec.: R. Hooper, 2 Chestnut Road, Feverell, Plymouth.

Club meetings are held on Tuesday evenings at 7.30 p.m. at Virginia House Settlement, St. Andrews Cross.

Future Events:

February 14th—Junk Sale.

April 18th—Judging for the Ernie Hillyard Trophy.

May 2nd—Judging for the G5ZT Trophy.

### WANSTEAD AND WOODFORD RADIO SOCIETY

Hon. Sec.: J. Seaman, 67 Beattyville Gardens, Ilford, Essex.

The junior section of the club now meets on Tuesday evenings and not Wednesdays. The senior section meets on Wednesdays. They are then on the air with the club call sign G3BRK. The club shack is now being reorganised with better facilities for constructional work.

### WEST KENT AMATEUR RADIO SOCIETY

Hon. Sec.: H. F. Richards, 17 Reynolds Lane, Tunbridge Wells.

Meetings are held, unless otherwise stated, at Kent County Council Adult Centre, Culveden House, Culverden Park Road, Tunbridge Wells, Kent. Meetings commence at 7.30 p.m. and end at 10 p.m.

A meeting to plan club stand for Tunbridge Wells Hobbies Exhibition was held on January 13th, and a talk on Hi-Fi Techniques was given by R. Trevitt on the 27th.

Future Events:

February 10th—Film Show.

February 23rd—Visit to Crawley Radio Society to hear a lecture on the History of Radio by the Curator of the Science Museum G5CS.

March 10th—Informal meeting.

March 24th—Planning Meeting for National Field Day.

## APPOINTMENTS

Belling and Lee Ltd. announce the appointment of B. M. Lee as manager of their industrial group, reporting to the company's general manager, and to the board of executive directors. This is a further step in the divisionalisation of the company into separate industrial, and domestic groups, in a programme of controlled expansion which began with the reorganisation of the sales department earlier in the year. He will be responsible for co-ordinating the production, publicity and sales of the industrial group.

Mr. Lee, who is the son of E. M. Lee, B.Sc., M.I.E.E., director and General Manager, and one of the original founders, has spent a number of years in different departments of the Company, and in other companies in the industry, in training for his new post. His appointment will relieve the directors of a considerable amount of detailed work, allowing them more time for matters of general management and planning for the future.

L. A. Norman, assistant sales manager of Stella Radio and Television Co. Ltd. since May 1960, is appointed sales manager as from January 1st, 1961.

During the thirty-two years that Mr. Norman has spent in the radio industry he has become a well-known figure. He joined Philips in their radio sales office in 1928, and after serving in the R.A.F. from 1941 until 1946, re-joined the company in charge of the Century House showroom.

Shortly afterwards he represented Philips radio and television in S.E. and S.W. London and the West End.

**"Basic Electricity"**

**LOTS & LOTS of**



TINKERS, TAILORS,  
SOLDIERS, SAILORS,  
AIRMEN, APPRENTICES & *Ordinary Chaps*  
*like You and Me . . . . . Are Learning*  
**BASIC ELECTRICITY & BASIC ELECTRONICS**

**"Basic Electronics"**

**THIS NEW 'PICTURE BOOK' WAY**

**Why don't you too?**

read what the JOURNAL OF THE BRITISH INSTITUTION OF RADIO ENGINEERS says:—

★ "... The two series will no doubt be of value in the training of mechanics and technicians in radio and electronic servicing and certainly provide a new approach to the teaching of this subject."

and what the JOURNAL OF THE ROYAL AERONAUTICAL SOCIETY says:—

★ "... Seldom can a reveiwer emerge from a set of new books having learnt so much to his advantage . . ."

and what THE A.E.U. MONTHLY JOURNAL says:—

★ "The publishers of this set of books describe them as 'a brilliant new illustrated course' in the subject, and I am inclined to agree with them . . ."

**COUPON - SEND NOW!**

*please send me your FREE prospectus describing your three*  
**ILLUSTRATED COURSES of ELEMENTARY, TECHNICIAN TRAINING**  
**BASIC ELECTRICITY (5 PARTS) — BASIC ELECTRONICS (6 PARTS)**  
**BASIC SYNCHROS AND SERVOMECHANISMS (2 PARTS)**

*In preparation* **BASIC RADAR, BASIC ELECTRONIC CIRCUITS, AND BASIC TELEVISION**

Name \_\_\_\_\_

To THE TECHNICAL PRESS LTD.,

Address \_\_\_\_\_

112 WESTBOURNE GROVE

\_\_\_\_\_

LONDON W.2.

# KINGSMERE SUPPLIES LIMITED

Insured Post 1/-, over £2 Free (Export extra).  
Single valves, post 6d.

MAIL ORDER HOUSE

TERMS: Remit with Order or C.O.D.  
Cash refund guarantee!

Build to the highest specifications, these chassis offer the finest value to the enthusiast.

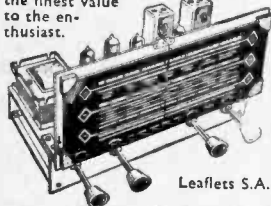

Leaflets S.A.E.

**ALL BRITISH RADIOGRAM CHASSIS. 3 WAVEBANDS 5 MULLARD VALVES**  
ECH81, EF89, EBC81, EL84, EZ80  
Brand new and guar. A.C. 200/250v. Short - Medium - Long Gram. P.U. High Q dust core coils. Latest circuit technique. AVC and neg. feedback. 4 watts. Chassis size 13 1/2 x 6 x 7in. Aligned and calibrated ready for use. Quality at Low Cost. Chassis isolated. H.P. Dep. £5 and five monthly of £1

OUR PRICE **£9.90**



The Brilliantly Successful

**Monarch**

**BRAND NEW AND BOXED**  
with Template  
4 SPEED  
MODEL UAB  
**£6.15.0**  
STANDARD OR  
STEREO PICK-UP

**GARRARD 4-SPEED HIGH FIDELITY UNITS**  
Autochanger RC210 £9.19.6  
Single Player TA Mk.11 £7.19.6  
Transcription 4HF £16.19.6  
Price inc. plug-in normal heads. Stereo hds. £2 ex.

Matched Speakers, 5in., 6 1/2in., 8in., 17 1/2 in. 10in. 25/-, 12in. 30/-

**BRAND NEW**

**VALVES**

**Matched Pairs 1/- extra**

OZ4	6/-	6BA6	7/-	6SJ7M	6/-
IR5	6/-	5BE6	7/-	6SN7GT	6/6
IS5	6/-	6C4	5/-	6U5G	7/6
IT4	5/-	6F8	6/-	6V6G	5/-
2X2	2/6	6F6G	7/-	6X5G	6/-
3Q5	9/-	6CG5	5/-	12A7	6/-
354	7/6	6H6	3/6	12AU7	6/-
3V4	7/6	6I5	5/6	12AX7	6/-
5U4	6/-	6I6	5/6	12K7GT	6/6
5Y3G	6/-	6I7G	6/6	12Q7GT	6/6
5Z4G	9/6	6K6GT	5/-	25Y5G	9/6
6AC7	3/6	6K7G	5/-	35L6	9/6
6AG5	5/-	6K7M	7/6	35Z4	6/6
6AL5	4/-	6K8G	6/-	807	5/-
6AM6	4/-	6N7M	6/-	954	1/6
6AT6	7/6	6Q7G	7/6	956	2/6
6B8G	5/-	6SA7M	6/-	DAF96	8/-

EL41	9/-	PCL82	8/-
EL84	8/6	PY80	7/6
EM81	9/6	PY81	8/6
EY51	7/6	PY82	7/-
EY86	7/-	PY83	9/-
EZ40	7/-	QP25	7/-
EZ80	7/-	R3	7/6
EI148	1/-	SP61	3/6
HABC80	10/-	UF41	8/6
HVR2A	12/-	UL41	8/6
UY41	7/-	UY41	7/-
U22	8/-	U22	8/-
VP23	6/6	VP23	6/6
U76	6/6	U76	6/6
VR105/30	9/-	VR105/30	9/-

**American Magnetic Recording Tape FERRODYNAMICS**  
5in. 600ft. .... 16/-  
5in. 900ft. .... 18/6  
5in. 1,200ft. .... 23/6  
7in. 1,200ft. .... 25/-  
7in. 1,800ft. .... 35/-  
5in. 1,200ft. .... 37/6  
7in. 2,400ft. .... 60/-  
Illustrated leaflet S.A.E.

**Recording Tape "BRAND FIVE" MYLAR DUPONT**  
Super High Fidelity  
Double Play  
5in. 1,200ft. .... 37/6  
7in. 2,400ft. .... 60/-  
Illustrated leaflet S.A.E.

Spare Reels, plastic, all sizes..... 3/-  
"Instant" Bulk Tape Eraser and Head Defeeler, 200/250 v. A.C., 27/6. Leaflet. S.A.E.

**SETS OF VALVES**

19/6 IR5, IT4, IS5, 354 or 3V4.  
27/6 DK96, DF96, DAF96, DL96.  
27/6 6K8, 6K7, 6Q7, 6V6, 5Z4 or 6X5.  
37/6 ECH42, EF41, EBC41, EL41, EZ40.  
39/6 ECH81, EF89, EBC81, EL84, EZ80.  
35/- 12K8, 12K7, 12Q7, 35L6, 35Z4.

## 25 FOAMCOURT WAY, FERRING, WORTHING, SUSSEX

**SELENIUM RECTIFIERS**

F. W. BRIDGE	H.T. Types	H.W.
6/12 v. 1 a. .... 3/11	150 v. 40 m.a. ....	3/9
6/12 v. 2 a. .... 8/11	250 v. 50 m.a. ....	3/11
6/12 v. 3 a. .... 9/9	250 v. 80 m.a. ....	4/11
6/12 v. 4 a. .... 12/3	250 v. 250 m.a. ....	11/9
6/12 v. 6 a. .... 15/3	250 v. 80 m.a. H.W.	11/9
6/12 v. 10 a. .... 25/9	CONTACT COOLED	
6/12 v. 15 a. .... 35/9	250 v. 80 m.a. H.W.	
24 v. 2 a. .... 14/9	6/11. 250 v. 75 m.a.	
	F.W. (Bridge)	10/11

**B.S.R. MONARDECK TAPEDECKS.**  
Speed 3in. per sec. High quality recording heads, 7 kns. Carr. 5/-  
Suitable polished veneered walnut carrying case for above 38/8. (Space for amplifier.)

**EX-GOVT. CASES.** Size 14-10 1/2in. high. Well ventilated, black crackle finished, un drilled cover. IDEAL FOR BATTERY CHARGER OR INSTRUMENT CASE OR COVER COULD BE USED FOR AMPLIFIER. Only 9/9. Plus 2/- postage.

**HI-FI 10 WATT AMPLIFIERS**  
Brand new. Manufacturer's discontinued line. Fitted Mullard valves. Dual inputs for "mike" and gram., etc. Bass and Treble Controls. High sensitivity and quality. For 230-250  
**£6.19.6**  
A.C. Carr. 7/6.

**R.C.A. TRANSCRIPTION PICK-UPS.**  
Variable reluctance type for 78 r.p.m. and L.P. records. Normal price approx. £14. Limited number, brand new, perfect, at £3.10.6.

**B.S.R. US AUTO-CHANGERS.** With Turn-over Crystal Head. £2.19.6, carr. 5/-.

**COLLARO CONTINENTAL DE-LUXE MIXER AUTO-CHANGERS** with TX88 Transcription Pick-up. Very limited number at only £9.19.6, carr. 5/-.

**"PRACTICAL WIRELESS" SUPER SIX POCKET PORTABLE TRANSMITTER RADIO DESIGN.** Full Constructional Details. 1/9. All parts including cabinet, printed circuit and Transistors. Only £9.19.6.

**MULTI-METERS.** Ferranti Universal A.C./D.C. 59/8.

**CABY A10.** Basic Meter sensitivity 155 micro-amps. A.C. and D.C. ranges. £4.10.0.

**CABY B20.** Sensitivity up to 10,000 ohms per volt. A.C. and D.C. £6.10.0.

**TAYLOR MODEL 127A.** 20,000 ohms per volt. 20 megs, 20 ranges. £10. S.A.E. will bring descriptive leaflet for any of above except Ferranti.

**MICRO-AMMETERS.** 3in. diam. 0-50 micro-amps, 33/8. 3 1/2in. diam. 0-500 micro-amps. 39/8.

**RELAYS.** Carpenters' Type. Polarised 2 times 9,500 turns at 1,685 ohms, 13/9. Miniature Moving Coil Differential Type. Single pole 2-way, or centre stable. Two coils each 350 ohms. Minimum operating current 140 micro-amps, nominal 400 micro-amps maximum 8 milli-amps. Two way contact current 100 mA at 50 v. A.C. or D.C. Size 1 1/2 x 1 1/2 in. approx. 13/9. Miniature Type G.E.C. 670 Sealed, wire ends, 4 covers, platinum M1095, 12/9.

**SPECIAL OFFER EX-GOVERNMENT SELENIUM RECTIFIERS.** 12v. 15 amp. with large square cooling fins. 19/9 each.

**EX. GOVT. SMOOTHING CHOKES.** 200 mA., 3-5 H., 50 ohms, Parmeko 8/9; 100 mA., 5 H., 100 ohms 9/11; 150 mA., 10 H., 50 ohms 9/9; 80 mA., 20 H., 800 ohms 5/9; 120 mA., 12 H., 100 ohms 8/9; 50 mA., 50 H., 1,000 ohms 6/9; 100 mA., 10 H., 100 ohms 8/9; 60 mA., 5-10 H., 250 ohms 2/11.

**EX. GOVT. MAINS TRANSFORMERS**  
Primaries 200-250 v. 50 c.p.s. A.C.  
250 v. 60 m.a. 6.3 v. 2 a. .... 10/11  
270-0-275 v. 100 m.a. 6.3 v. 7 a. 5 v. 3 a. 21/9  
300-0-300 v. 60 m.a. 6.3 v. 2 a. .... 12/11  
300-0-300 v. 100 m.a. 6.3 v. 2 a. 5 v. 2 a. 18/9  
350-0-350 v. 160 m.a. 6.3 v. 5 a. 5 v. 3 a. 27/9  
10 v. 10 a. Parmeko Fully Shrouded 16/9  
5 v. 10 a. Parmeko ..... 11/9  
4-4 v. C.T. 8-8 amps. Parmeko ..... 7/9

**2 VOLT ACCUMULATORS**  
Varley's small size 4 x 3 1/2 x 1 1/2 in. 2 v. 14 A.H., brand new, 6/9 ea., 3 for 15/8.

**FIELD TELEPHONES**

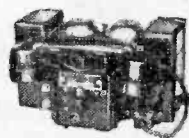

With bell, Requires only small battery. Suitable for office, factory, warehouse, or outside intercommunication. 59/8 each.

**R.S.C. MANCHESTER**  
(Manchester) Ltd. and LEEDS

TERMS: C.W.O. or C.O.D. No. C.O.D. under £1. Post 1/9 extra under £2. 2/9 extra under £5. Open 9 to 6. Weds. until 1 p.m. Trade supplied. S.A.E. with all enquiries.  
Mail Orders to 29-31 Moorfield Road, Leeds 12.  
Callers to 5 and 7 County (Mecca) Arcade, Briggate, Leeds 1.  
and 8-10 Brown Street (Market Street), Manchester 2.  
or 56 Morley Street (next to Majestic Ballroom), Bradford.

# SHORT-WAVE SECTION

## THE NATIONAL SENIOR H.R.O.

By A. W. Mann

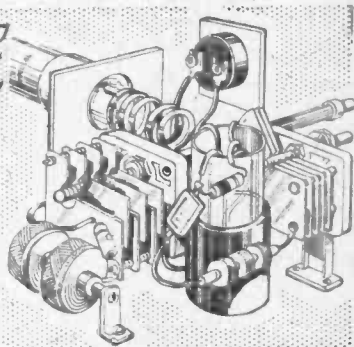

**T**HE Senior H.R.O. was designed and produced originally in 1935 to provide reliable communication even under adverse conditions and soon established a reputation of reliability. Based on a fundamentally sound design and built to precision standards, this high performance receiver was not cheap to produce, ranking among the more expensive representatives of its class.

### Superhet Models

The Senior H.R.O. is no longer manufactured having been superseded by more up-to-date double superheterodyne models of very advanced design.

The author however has had in daily use a Senior H.R.O. for some time in conjunction with a variety of aeriads. This particular model has been available for some time.

### Models Available

The models available on the surplus market are the H.R.O., H.R.O.-M and H.R.O.-MX, all of which apart from slight modifications are fundamentally alike. The valves used in all instances are of the UX based types.

### Valve Line Up

The valve line up is as follows: the first and second R.F. amplifiers are 6D6 valves, the first and second I.F. amplifiers are 6D6 valves and the mixer valve is a 6C6. There is a separate local oscillator 6C6 valve. The detector AVC diode and first audio amplifier is a 6Q7. The beat frequency oscillator is a 6C6 valve and the power output valve is a 42.

### Tuning Range

These receivers cover a very wide band of frequencies by means of a separate four-coil unit. The total range being from 10m to 6000m, nine coil units being provided. These are of the general coverage type which are not fitted with the extra band spread facilities common to the pre-war standard models.

### Standard Model Bandspread

In the standard models, bandspread was accomplished by the transfer of set screws from one set of contact plates to another. By this means small padding condensers were introduced in series with the tuning condenser to reduce the tuning range, and a parallel trimmer to adjust the range to the desired part of the tuning dial.

This system enabled the user to cover the amateur bands with the more limited spread of the general coverage setting with one coil and with extra band-

spread covering 400 divisions of the 500 division tuning dial. The overlap between the two coils being arranged with this idea in view.

That the surplus models are supplied only with nine general coverage coils is not the disadvantage it may appear, as the normal dial spread is sufficient to meet the requirements of the average listener, as later details relative to the main tuning arrangements will show.

### Later Models

In addition to the earlier models mentioned, all of which use glass valves, later models in which the international types are used are also available. The valve line up being 6K7M, 6K7M, 6J7M, 6J7M, 6K7M, 6K7M, 6SQ7M, 6J7M, and 6V6GT/G, and the models are the H.R.O. 5T and 5R. The former being the table model and the latter the rack model.

All were manufactured during the war and are fitted with a 0-1 milliammeter instead of a calibrated S meter. According to the National Company, 0.5 designates S9 and 1mA is 40dB over S9.

### Tuning Ranges

The full coverage of the H.R.O. is as follows:

Coil Set Type	L.F. Bands
J - 50 .. .. .	100kc/s band.
H - 100 .. .. .	200kc/s band.
G - 180 .. .. .	430kc/s band.
F - 480 .. .. .	960kc/s band.
E - 900 .. .. .	2050kc/s band.

Coil Set Type	H.F. Bands
JA-14.0 .. .. .	30.0Mc/s band.
JB-7 .. .. .	14.4Mc/s band.
JC-3.5 .. .. .	7.3Mc/s band.
JD-1.7 .. .. .	4Mc/s band.

This coverage is a most extensive one and reference to the chart mounted on each coil unit enables the operator to quickly check frequency. The calibration of each coil unit being very accurate indeed.

### A Useful Suggestion

One of the bugbears met by most users of mains driven short wave receivers is frequency drift after switching on. As the coil units in the H.R.O. are below the chassis and well insulated from the heat generated in the well ventilated steel cabinet frequency

drift after a twenty minutes warm-up period is negligible.

### Technical Features

One of the highlights of this receiver is the four gang tuning condenser, reduction gear box and tuning dial. The condensers being of the straight line frequency type of 225pF capacity.

Instead of a common rotor shaft each condenser is completely insulated from the others. This principle of construction has considerable bearing on the stability of the receiver.

Ceramic trimmers are used in all coil units and maintain their setting, resulting in a very superior L/C ratio with constant gain through the various tuning ranges.

The tuning dial with its 20-1 ratio gear drive which includes a precision hobbled worm is spring loaded. The direct reading dial is divided into fifty divisions with apertures ten divisions apart. Ten turns of the dial are necessary to cover the full travel of the condenser rotors. This totals 500 divisions providing an effective scale length of twelve feet and allows readings to one part in five hundred. The calibration is nearly linear.

### Controls

Fig. 1 shows a detailed sketch of the H.R.O., H.R.O.-M, and H.R.O.-MX type receivers.

#### Panel Controls

There are five controls mounted on the front panel and five switches, in addition to the tuning dial.

The R.F. gain control varies the gain of the second R.F. stage and the two I.F. amplifiers. This control is also used to zero the S meter in conjunction with an internal pre-set potentiometer.

An A.F. gain control is also fitted. The inclusion of these two controls enables the operator, by the combination of adjustment, to obtain a most satisfactory signal to noise ratio on both strong and relatively weak signals.

#### Selectivity Switch

At the top-right-hand side of the panel is the selectivity switch which tunes the secondary of the first I.F. transformer and is used in conjunction with the crystal filter. When the crystal filter is not in use the selectivity control is used as an I.F. trimmer and set to a point which provides maximum volume and sensitivity.

This control in operation is a very effective one; so much so that in many instances the crystal filter is not required.

#### Phasing Control

Below the selectivity control is the phasing control with an integral crystal filter switch.

The crystal phasing control dial plate is graduated from 0-10. When set at zero the crystal filter is out. When at settings between 1 and 10 the crystal filter is in, and the phasing control is used to balance the crystal bridge.

Using the phasing control in conjunction with the selectivity control enables the receiver selectivity to be varied according to requirements, and interfering signals suppressed. Band width variation is from 2.5kc/s to 200c/s in the sharp position.

As the official handbook supplied with the Senior H.R.O. receivers at present available provides full details as to setting up and operating the receiver controls including the crystal filter, the author does not propose to offer further comment on the subject.

Fig. 1, shows the beat oscillator control which also has an integral on/off switch. The dial plate is also graduated from 0-10. This control clockwise switches H.T. voltage to the anode and screen of the beat oscillator valve and between 0 and 10 provides a frequency variation over a range of 10kc/s.

While the beat oscillator tunes to the I.F. frequency, when set at approximately 9, the pitch of the note can be varied as desired.

With the facilities which enable the C.W. listener to vary the pitch of the C.W. note, the beat oscillator is an asset to the amateur phone and S.W. broadcast listener in the location of the DX stations carrier wave.

Immediately above the beat frequency oscillator control is the AVC switch. This is switched to the left for AVC in and to the right for AVC out. The AVC being switched out for C.W. reception, with the beat oscillator switched in and pitch control set initially to nine on the dial plate, later to be adjusted to a pleasing note.

10 revolutions of dial = 500 divisions

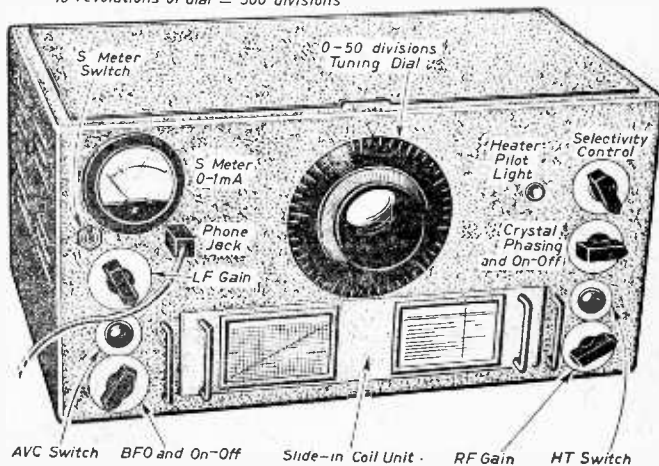

Fig. 1.—The controls of the Senior H.R.O.

#### L.F. Gain Control

Above the AVC switch is the L.F. gain control which also has the dial plate graduated from 0-10. Above this and slightly to the left is the S meter switch and to the right the headphones jack.

#### The S Meter

The S meter should always be switched out when receiving strong S.W. broadcast signals.

As previously mentioned the S meter is not as

# CLYNE RADIO LTD

## THE COMPONENT SPECIALISTS

OPEN: Tottenham Court Rd., and Cheapside: 9 a.m. to 6 p.m. Mon. to Fri., Sat. 1 p.m. Holloway Rd.: 9 a.m. to 6 p.m. daily. Thurs 1 p.m. Sat. 5.30 p.m. Our Advantageous H.P. and Credit Sale Terms are available on any single item over £5. Your enquiries invited. Please print your name and address.

162 HOLLOWAY ROAD, LONDON, N.7  
18 TOTTENHAM COURT ROAD, W.1  
99 CHEAPSIDE, LONDON E.C.2

North 6295/6/7  
MUScum 5929/0095  
MONarch 6860  
N7.

All post orders and correspondence to 162 HOLLOWAY ROAD, LONDON, N7.

**LATEST COLLARO STUDIO TAPE TRANSCRIBER.** 3 motors, 3 speeds, 11, 31, 74 i.p.s., takes 7in. spools. Push-button controls. £12.19.6 plus 5/- P. & P. Usual H.P. facilities.

**TAPE RECORDER AMPLIFIER.** Suitable for use with either of the above Tape Decks, and most other types. For A.C. mains: 4 watts output, 40-1200 CPS at 7 1/2 i.p.s. ± 3 db. Facilities for superimpose. Valves: 6BW6, ECL82, 12AX7, 6EM84, and contact cooled metal rectifier. Radiogram input, microphone input, monitor facilities. (Can be used as amplifier through amplifier), volume control and separate treble and bass controls. Chassis measurement 1 1/2 x 3 x 4 1/2 in. Supplied with attractive grey/blue escutcheon plate finish in black and gold. Circuit diagram and connecting instructions included. Price £11.5.0 only, plus 3/6 P. & P. If purchased with either of the above decks, both items post free.

**ATTRACTIVE TWO-TONE PORTABLE CARBURY CASE.** 20 watts, 1000 cycles, amplifier and Collaro Studio deck. Limited quantity only at 72/6 plus 3/6 P. & P.

**MIC 45-1** Aco's latest flat pistol-grin crystal microphone. Attractive black and gold finish. OUR PRICE 29/6 plus 1/6 P. & P.  
**ACOS MIC 30-1.** Crystal stick microphone. List price 5 s.n. Our price 39/6 plus 1/6 P. & P.  
**MIC 40.** General purpose crystal microphone with desk stand. Only 25/- plus 1/6 p. & p.  
**M.C. 24.** Imported, crystal, attractive streamlined polished metal case, incorporates muting switch. List price 64/-. OUR PRICE 42/- only. 1/6 P. & P.

**ANOTHER HAND MIKE BARGAIN!** Lightweight crystal with built-in desk stand at only 18/6. P. & P. 1/6.

**NEW! THE "PAGEBOY" 2-TRANSISTOR POCKET PORTABLE**  
Completely portable—No external Aerial or Earth Req'd.

An amazing little receiver with built-in aerial and small enough to be held in the palm of the hand. Medium wave reception at wonderful volume. No fiddly tuning; condenser tuned.



Supplied with drilled chassis and colour coded components. Easily assembled with the aid of the easy-to-follow assembly instructions provided. Total cost of all necessary components, including transistor, wiring wire and even solder ONLY 32/6, plus 1/6 P. & P. Battery 3/- extra. Ardente type deaf-aid earpiece complete with cord and plugs 12/6 extra. Parts price list and easy Lay-out Plans 1/- post free. Callers welcome to hear this set demonstrated at any of our branches. Our reputation is your guarantee.

**RADIO JACK**  
Covers local medium wave stations variably tuned. Compact self contained unit requiring only connection to aerial (no power supplies req'd.) for 1st class reception when used in conjunction with your tape recorder or high gain amplifier. All necessary parts available at a special inclusive price of ONLY 19/6. P. & P. 1/6.

**LATEST GARRARD MODEL 210.** Four-speed manual or automatic. 10in. and 12in. records of same speed can be mixed in any order, wired for stereo, attractive white colour scheme. Price 10/-s.n., plus 3/6 P. & P.

**B.S.R. CAR STEREO/MONOAURAL.** Brand new at £7.19.6, plus 3/6 P. & P. Guaranteed.

**LATEST B.S.R. U414.** 4-speed Attractive appearance. Wired for stereo. Fully guaranteed. £7.19.6, plus 3/6 P. & P.

**THE R.C. 3/4 WATT AMPLIFIER**

Compare the advantages. Treble, bass AND middle controls. For crystal or magnetic pick-up. A.C. Mains 200/250 v. Valve line up: 6V6GT, 6SG7 metal 6X5GT. Negative feedback. Built on stove enamelled steel chassis measuring only 8 x 4 x 1 1/2 in. Four engraved cream knobs are included in the price of the complete kit with all necessary practical and theoretical diagrams at £4.5.0 only, plus 2/6 p. & p. or Instruction Book fully included for 1/- post free. This amplifier can be supplied, tested, and ready for use at £5.5.0 plus p. & p.

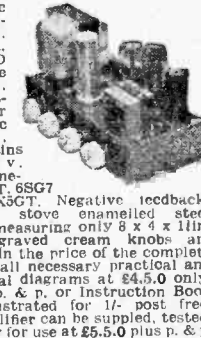

**"PRACTICAL WIRELESS" POCKET SUPERHET**  
All required components for the Complete Osom Version described in Practical Wireless now available at special inclusive price of £9.19.6 complete, including Printed Circuit and Osom booklet. All items available separately, send stamp for list.

Have you tried the famous American Ferrodynamics "BRAND FIVE" Recording Tape. An Enthusiast's must!

High Quality Acetate Base: 5" 600ft., 16/-; 5" 900ft., 18/6; 5 1/2" 1200ft. 23/6; 7" 1200ft. 25/-; 7" 1800ft. 35/-; 5 1/2" Extra Quality Mylar Dupont: 3" 300ft. 13/-; 5" 1200ft. 37/6; 7" 1800ft. 44/-; 7" 2400ft. 60/- Each on plastic spool. All post free. **BRAND NEW—NOT SUB-STANDARD**



**1 VALVE SHORT-WAVE RADIO**  
World-wide coverage at most reasonable cost.

Covers 40-100 metres with the coil supplied. Can be extended to cover 10-100 metres. Provision is also made for the addition of two extra valve stages. Employs the famous Acon-type 954 valve. All necessary components can be supplied complete with full assembly instructions at ONLY 35/- plus 2/- p. & p. Send 2/- for point-to-point wiring diagram and price list.

**SUPER PERSONAL PORTABLE**

A wonderful little set that you can take anywhere. Ideal for camping, picnics, etc. Detachable aerial rod supplied. Covers Medium waveband 200-500 metres. Can be built in approx. 1 hour. All necessary components available at the following SPECIAL INCLUSIVE PRICES: 1-valve version ONLY 35/- plus 2/- P. & P. Super 2-valve version ONLY 41/- plus 2/- P. & P. Send for point-to-point wiring diagram and parts price list 2/- post free. Extra for use with the above DLR5 balanced armature headphones, 7/6 pair.

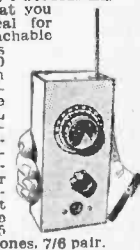

**PRINTED CIRCUIT CAR RADIO**  
(for Home Construction)

Wear proud to be able to offer this New type Car Radio employing up-to-the-minute circuitry special 12 watt valves and transistorised output stage. The highest degree of sensitivity is assured by the incorporation of Permeability Tuning and a tuned R.F. Stage. Covers Medium and Long Wavebands. NO VIBRATOR PACK IS REQUIRED. This is a really compact receiver that will fit any car. Comprehensive assembly instructions are provided with all necessary components, including valves and transistor at a Special New Low inclusive Price of Only £11.19.6 plus 3/6 P. & P. Instruction booklet with itemised price list, full description dimensions, etc., available separately at 3/6 post free.



### MODEL U.I. MULTI-RANGE TESTMETER

Ideal for amateurs and service engineers. Incorporates 3in. rectangular meter. Ranges: A.C. & D.C. voltage, 0-10, 50-250, 500-1000 v. D.C. current 0-100-500 mA. 0-1 mA (used at 0-10v. range). Resistance 1-2000 ohms (centre 2k ohms), 100-200,000 ohms (centre 2.4 k.). Sensitivity 1000 ohms per volt A.C. & D.C. Size 5 x 3 x 2 1/2 in. Wt. 22 ozs. only.

Fully guaranteed. Supplied complete and ready to use with test leads, at the very low price of ONLY 79/6. P. & P. 3/6. (Bona fide trade enquiries invited).

### "FAMILY FOUR"

Our super-sensitive T.R.F. Receiver for home construction. Covers Long and Medium wavebands. Is housed in very smart plastic table cabinet in Brown or Black. For A.C. mains 200/250 v. Comprehensive assembly instructions provided, including practical and theoretical diagrams, which are easy to follow and will enable you to complete this receiver which will be the envy of your friends. All necessary components ONLY 79/6, plus 2/6 P. & P. Instruction book available separately at 1/6 post free.

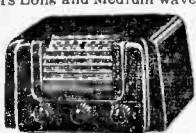

### TELEPHONE PICK-UP COILS

Designed to feed into the microphone ONLY. Input of either a tape recorder or any high gain amplifier. Easily attached to telephone by rubber suction attachment. The coil is electrostatically shielded to minimise hum pick-up. When positioned on telephone this model is more than adequate for a fully modulated tape recording. Brand new complete with 5ft. shielded cable.

ONLY 14/- P. & P. 1/6.



## VITAL, UP-TO-DATE WORK for AMATEUR or ENGINEER

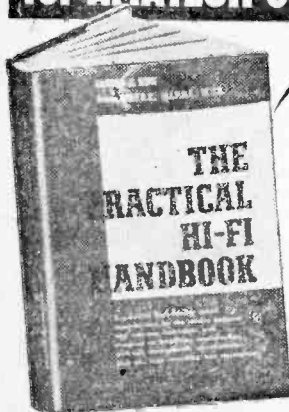

● Pre-amplifiers and power amplifiers, loudspeakers, microphones and mixers.

● Record players, disk and tape recording.

● Stereophony.

**224 PAGES**  
**Over 150**  
**Illustrations**

# PRACTICAL HI-FI HANDBOOK

An up-to-date practical survey of the whole field of high-fidelity sound reproduction and the various kinds of present-day hi-fi equipment—from disk and tape to loudspeaker. Of immense value to the amateur wishing to improve his technical knowledge and get the best out of his equipment, as well as to the service engineer working on this specialized equipment. Deals fully with the choice, installation, operation and improvement of equipment, and describes latest advances. Beautifully bound in scarlet buckram, yours for only 25/- inc. post, packing, etc.

By Gordon J. King

Assoc. Brit. I.R.E.,  
M.I.P.R.E., M.T.S.

### CONTENTS COVER:

Hi-Fi Fundamentals, Voltage Amplifiers, Feedback and Control Circuits. The Power Amplifier. Tracing and Clearing Faults in Amplifiers. Loudspeakers and Enclosures. Disk Recording. Pick-Ups and Record Playing Equipment. Microphones and Mixers. The use of Tape. Stereophony.

**ACT NOW!** Simply fill in form and post in 2d. stamped unsealed envelope to Dept. E.B.40, Odhams Press Ltd., Basted, Sevenoaks, Kent. Offered U.K., Eire only, closes March 31.

## SEND NO MONEY NOW!

To: Dept. E.B.40, Odhams Press Ltd., Basted, Sevenoaks, Kent.  
WITHOUT OBLIGATION reserve me "The Practical Hi-Fi Handbook" and send Special Invoice with "100% Satisfaction or No Charge" Guarantee.

BLOCK LETTERS BELOW

NAME \_\_\_\_\_  
Full Postal ADDRESS \_\_\_\_\_

E.B.40, March '61.

## BE TRANSISTOR-WISE! BE POCKET-WISE!

### "RECO" TRANSONA-3

(3 Ediswan Transistors)

M/L waves. Ferrite rod aerial. Tuning condenser. Home, Light and Radio Luxemburg too. Complete kit with easy-build plans and "Sonotone" miniature earpiece. 55/-. With "Min. speaker." 49/6. Post, etc. 2/6.

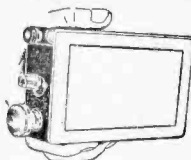

### NEW! "RECO" PUSH-PULL SIX KIT

(6 Ediswan transistors and 2 diodes)

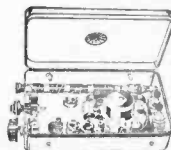

M/L waves and Trawler Band (short wave coil free on request). Tonal quality of a TRF. Performance as Transigen-3 but full loudspeaker strength. 9,000 lines 3in. loudspeaker with full-tone output. Without doubt the finest value in transistor kits today. Competitively priced at £6/19/6, post etc. 2/6. M/L waves only £6/9/6. "Am particularly pleased with Luxemburg and Trawler band reception." H.S.B., Penzance, Cornwall.

### "RECO" TRANSIGNER-3

(3 Ediswan transistors)



M/L waves and T.B. High-gain ferrite rod aerial. XA104 (Ediswan) RF stage. On test (50 miles London) tuned in Home, Light, Third, AFN, Radio Luxemburg and many others at good headphone strength. A really fine transistor kit complete with easy-build diagrams, and "Sonotone" min. earpiece 69/6. If reception conditions warrant a 3in. speaker may be fitted under speaker grille. (Case as P.P.5)

### "RECO" PUSH-PULL FOUR

(4 Ediswan transistors)

M/L waves with 2 S/W coils free upon request. 3in. HIGH-GRADE speaker affording fine tonal quality. Ferrite rod aerial. Bias sensitivity volume control. Complete kit with easy-build diagrams £4/19/6. Post etc. 2/6. Uses 4½ v. flashlamp battery.

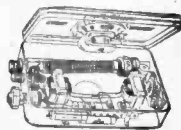

### "RECO" PUSH-PULL FIVE

(5 Ediswan transistors)

M/L waves and T.B. Indoors or outdoors this brilliant radio brings Home and Continental stations to your finger tips. 3in. Golden-Tone Speaker. 6in. Ferrite Rod Aerial. EDISWAN XC101's (350 mw). Push-pull output stage. Gleaming pale blue styrene case with speaker grille in red. Complete kit with easy-build diagrams £5/19/6. Post etc. 2/6. Dorset customer writes:—"Makes fine car radio."

### "RECO" SENSITONE THREE

(5 stage reflex) Medium and Long Wave

Uses latest Ediswan Transistors for sensitivity and selectivity. Improved, in-built ferrite rod aerial. Fitted volume/sensitivity control. Appearance as Transigen 3. Easy build diagrams. 3in. moving coil speaker. Complete kit, £4/9/6. Overseas customers please add 3/6 extra for post. Circuits and parts price list 1/3 each.

AFTER SALES SERVICE

## Radio Exchange Company

27 HARPUR STREET, BEDFORD  
(Opposite Co-op.) Phone 2367  
Closed Sat. 1 p.m.



fitted to pre-war commercial models and including dB above S9, but is a 0—1 milliammeter graduated as follows: 0, 0.2, 0.4, 0.6, 0.8, 1.0. This form of S meter is not easy to read at a glance and the operator should graph the scale with one graph from 0 to S9 and another from S9 to 10dB over S9. Alternatively the two can be combined in one graph.

Apart from its usefulness as a check on variations in signal intensity, an S meter is an adjunct which can be very useful in comparing the signal gain of one aerial and another be they of the same or different types.

This applies especially to fixed relay controlled doublets and rotary beams.

The H.R.O. S meter circuitry is in the form of a three element bridge all of which are fixed. Adjustment of the R.F. gain control brings the controlled valves to a predetermined value of A.C. resistance and the S meter needle to zero amplification will thus conform to the S meter scale.

**Modification**

In some instances competent amateurs have modified the H.R.O. by fitting the more modern octal valves or alternatively miniatures. The UX types fitted are, however, in plentiful supply and as it stands the H.R.O. receiver is an excellent performer more especially if used with an efficient aerial.

The sensitivity available far exceeds that which can be used in industrial locations. The judicious use of the R.F. and L.F. volume controls assuring a satisfactory signal to noise ratio on both strong and weak signals.

**Noise Limiters**

Most of the modern communication receivers are fitted with some form of noise limiter, but the H.R.O. models outlined in this article are not.

But while such modifying devices which have been designed are effective where there is strong electrical interference with signals of average strength, what effect the addition of a noise limiter will have on sensitivity and weak signals is worth considering. This being so, a tried and proved design of noise limiter is advised which should have provision for switching out.

**Aerials**

Provision is made in the H.R.O. for the use of single wire fed and twin wire fed aerials. If doublets are used the jumper lead from the E terminal to chassis is removed from the earth terminal end, and the twin feeders inserted in the aerial and earth terminals. This also applies to the noise reducing type doublets and vertical rod systems which are used in conjunction with matching transformers.

Owing to its wide frequency coverage, high sensitivity and selectivity the Senior H.R.O. will meet the requirements of both the amateur bands and short wave broadcast listener.

**Power Supplies**

Unlike many other communication receivers the H.R.O. has no built in power supply. Type D power units which include a built in 6in. speaker are of British manufacture and are readily available. Also the original National 697 unit which does not include a speaker.

In addition are the 697AB for 105 to 120V, A.C., and the 6V vibrator, 686S.

For those who wish to use a separate loudspeaker the output is 3W at a nominal impedance of 7k, the headphone jack being for high impedance headphones.

# A Versatile Tape Recorder

(Continued from page 991)

place and before anything else is added, the valve heaters are wired with twisted, P.V.C. covered copper wire. After being put in place the wire should be pushed flat on to the chassis. The leads from V4 out of the chassis should be wired with flexible, plastic covered wire.

If the neon bulb to be used has its own lead it should be mounted now to save difficulty later when wiring is commenced. The switch, volume and tone controls, coaxial sockets and front panel are now added. A screened lead (with screen earthed to the earthed sections on the switch) should be taken along the angle of the chassis from SA to pin 9 of V1. SA1 and SA2 are connected to socket A and SC is connected to socket C. (Care should be taken not to overheat the centre pin of sockets A, B, C and D as the insulation may melt.)

The oscillator coil L1 and C19 are now fixed in place, L1 being attached by its plastic fixing bolt so that the three contacts of the coil are in a convenient position for wiring. Wire the oscillator section completely, except for the earthed ends of R21 and R22 which will be connected later to the earth-bar.

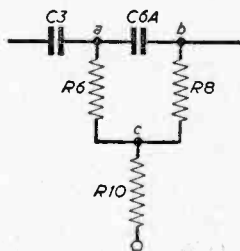

Fig. 12 (left).—An alternative equaliser circuit.

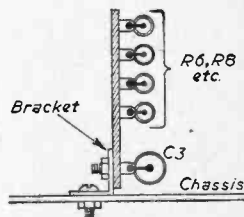

Fig. 13 (right).—The tag-board for the equaliser.

**The Oscillator Screen**

Bolt the oscillator screen in place, taking care not to short-out any wires. The next step is to fix the large tag-board to the back wall of the chassis by two 6BA bolts, using nuts as spacers. Using sleeving if necessary, wire the tag-board to valve holders 1, 2 and 3. The equaliser tag-board is now mounted as shown in the diagrams and wired in.

(To be continued)

# Letters to the Editor

*The Editor does not necessarily agree with the opinions expressed by his correspondents*

Whilst we are always pleased to assist readers with their technical difficulties, we regret that we are unable to supply diagrams or provide instructions for modifying commercial or surplus equipment. We cannot supply alternative details for receivers described in these pages. **WE CANNOT UNDERTAKE TO ANSWER QUERIES OVER THE TELEPHONE.** If a postal reply is required a stamped and addressed envelope must be enclosed with the coupon from page iii of cover.

## PUSH-PULL AMPLIFIER

**SIR.**—Referring to the query of J Haskell (January issue), the value of resistors for EL84 valves is about  $270\Omega$ , 5 per cent tolerance, 3 to 5W, and the cathode by-pass capacitors  $25\mu\text{F}$ , 12V.W. A suggestion I would like to make is that only one fixed resistor be used, the other being balanced. This ensures that the valves are balanced. If an ammeter is connected in series with the fixed resistor and by-pass capacitor, and the cathode of the valve, note the reading on the meter. Next connect the meter in series with the cathode of the other valve and the variable resistor and the by-pass capacitor, now adjust the variable resistor until the reading on the meter is the same as that for the first valve. The valves are now balanced. If the fixed resistor is  $270\Omega$  the variable resistor value should be about  $500\Omega$ .—R. DAVIES (Nottingham).

## HIGH FIDELITY

**SIR.**—I find it most annoying that the phrase "High Fidelity" is so mis-used.

Now I see small gramophones (with atrocious reproduction, scratch, etc.) described as High Fidelity reproducers; but I had always been taught that high fidelity apparatus was large, with several speakers and far more than portable.

Now, recently I have seen a cardboard disc with a plastic outside for the grooves (which, incidentally had far worse scratch than the average 78 r.p.m. record, for it was a 45 r.p.m. record) with "Hi Fi" Disc in letters one half of an inch high on it.

Would that people would only use "High Fidelity" in its proper sense.—P. H. (Langport, Somerset).

## ONE VALVER

**SIR.**—With reference to Mr. D. Illingworth's letter in the January issue, the internal resistance of his H.T. battery may cause a misleading voltmeter reading.

If his set continues to work while the voltmeter is connected, he can use with advantage a two cell battery for H.T. — C. H. WHITE (Ilfracombe, Devon).

## CRYSTAL SET RECEPTION

**SIR.**—with reference to Mr. A. Radmore's letter (P.W. January), I should like to inform him that the coil I used in my crystal set was a home wound, medium-wave type and consisted of 90 turns of 22s.w.g. copper wire, on a 2in. wooden former. The detector was a germanium diode.

He may also be interested to learn that French, German and other Continental stations have been received at good strength. — D. J. CONNOLLY (Edinburgh).

## MODULATION

**SIR.**—With reference to J. R. Miller's letter (January issue), the snag in his proposed method of modulation lies in the low plate efficiency of the final amplifier, the maximum efficiency obtainable being about 35 per cent. This is because the peak instantaneous power in a 100 per cent modulated signal is four times the carrier power. Under carrier conditions (i.e. with no modulation), the final amplifier will be producing one quarter of its maximum power output. The plate current, and therefore the power input, will be about half the maximum. The plate efficiency will therefore be only half the efficiency at maximum power, i.e. about 35 per cent. In practice the efficiency may be considerably less, since the amplifier must be operated in class AB or B.

In answer to Mr. Miller's second question, to give an output of 150W an input of 200W to 250W will be required (depending on the valve(s), used), 100W to 125W of audio will be needed for modulation. If, however, Mr. Miller means 150W input, which would give an R.F. output of 100W to 120W, 75W of audio are required. In order to allow for losses, the theoretical power output of the modulator valves should be about 20 per cent greater than the figures given above.

At 750V on the plate, a pair of 807's in class AB2 will deliver 120W into a  $6950\Omega$  load (plate to plate). At 600V, the output is 80W into  $6400\Omega$ , and may be increased to about 90W by reducing the load impedance. — D. PRICE (Cape Town, South Africa).

**SIR.**—Referring to Mr. J. R. Miller's letter in the January issue, I would like to explain why amplitude modulation is only carried out in the final R.R. amplifier. (Apart from the possibility of F.M. being caused by coupling or poor power supply regulation, etc.)

In most transmitters the doubling, amplifying and final stages are usually run in class "C" because of the high efficiency possible using this mode of operation (70 to 80 per cent). If modulation of intermediate stages is attempted, the



**New! A TRULY REMARKABLE  
BRITISH INVENTION!**

# Gramdeck

GRAMOPHONE TAPE RECORDER

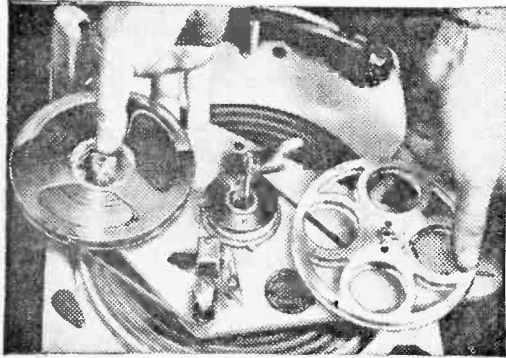

**Turns any gramophone into  
a superb TAPE RECORDER!  
and back into a record-player in a moment!**

- ★ Plays at 7 $\frac{1}{2}$  per sec. or 3 other speeds.
- ★ Records direct from radio or microphone.
- ★ Erase and fast rewind.

**11 Gns.**

**YOURS FOR 13/-  
DOWN AND 18  
FORTNIGHTLY  
SUMS OF 13/-.**  
Ready to Record,  
complete with Control Unit and 600 ft. of Twintrack tape. Special moving coil microphone extra.  
**EASY TERMS**

Gramdeck is an ingenious invention that instantly turns your gramophone into a tape-recorder and back into a gramophone at will! You simply slip it on to your turntable and you are ready to record direct-from-radio or microphone . . . the voices of your family . . . radio programmes . . . your favourite music—and you can instantly play it back through your own gramophone or radio with *Lifelike Fidelity*. Made by the people who make radar runs for Viscounts and Britannias, the amazing Gramdeck now brings full tape-recording facilities to every gramophone owner at little extra cost.

**As easy as putting on a Record**

"Real hi-fi results." "Better than many so called hi-fi recorders . . ." These are typical comments of famous technical journals. Gramdeck enables any gramophone owner to add superbly good tape-recording facilities to existing equipment, at a fraction of the usual cost. Full details, photos, specifications. Easy Terms, etc., are given in the Gramdeck Book. Send for your **FREE** copy today.

**Free!**



**FREE BOOK—POST NOW!**

Please send me the Gramdeck Book—**FREE** and without obligation.

NAME .....

ADDRESS .....

# Gramdeck

GRAMOPHONE TAPE RECORDER

(Dept. PA817), 29-31 WRIGHT'S LANE, LONDON, W.9

**GRAMDECK TURNS A TUR TABLE INTO A TAPE RECORDER**

## UNUSUAL SINGLE SPEAKER SYSTEM

### A CONCRETE COLUMN



An inexpensive column speaker constructed from a concrete pipe and fitted with a good 8in. or 10in. unit has attracted much interest and admiration because of its clean open sound.

Complete kits of wooden fixtures are available including absorbent wadding and diffusing cones

Price **£3.15.0** for 8" model. Recommended 8" unit—8/145 **£6.19.11** including purchase tax.

Price **£4.18.0** for 10" model. Recommended 10" units—W10/FSB **£12.9.10**; Golden/FSB **£8.6.7**; 10" Bronze/FSB **£5.5.11**. Prices include purchase tax.

Suitable concrete pipes can be purchased from builders' merchants at about 12/6 to 17/6.

Descriptive leaflet free on request from:



**IDLE, BRADFORD, YORKSHIRE**

Grams: Wharfedale Bradford

Phone: Idle 1235/6

modulated R.F. waveform would be extremely distorted since the output of a class C amplifier is not directly proportional to its input.

Modulation of an early stage, followed by amplification is possible however if the succeeding stages are operated in linear class B, but the efficiency of such a stage for a modulated R.F. input is only around 35 per cent, i.e. to give the same output in the final amplifier as a corresponding class C stage, the power drawn from the supply would have to be doubled (assumed to be within the valve's ratings).

To modulate 150W of R.F. the power output from the modulator valves should be around 85 to 90W to compensate for modulation transformer losses, and this can easily be supplied by 807's in AB2 with 550V on the anodes.—M. D. POLLARD (Chertsey).

### RADIO MOSCOW

**SIR**,—I read with interest both Mr. P. J. Kennett and Mr. E. Haines's letters (January 1961) concerning Radio Moscow. Mr. Haines in his letter states that the Moscow transmitters are the most powerful in the world, this is not so. In the 49m band Moscow broadcasts on about 20 wavelengths on three of these wavelengths, to be precise 49.67, 49.59 and 49.42m, the power output is 100KW. In the other short wavebands, Moscow commands many wavelengths, e.g. in the 25m band Moscow broadcasts on 23 wavelengths, and the most powerful output on one of these wavelengths is 100KW on 25.17m in fact.

Many of the American stations are twice as powerful, e.g. radio stations KRCA, at Dixon, and WLWO at Cincinnati.

In the longwave band, on 1734m, Moscow's output is 500KW, 100KW more than our own Light programme, on 1,500m. Even this phenomenal output cannot be compared with the V.O.A. transmitters, at San Fernando, in the Philippines, and at Okinawa in the Ryukyu chain. These stations broadcast on 263m, and 254m respectively, and both their power outputs are 1,000KW! This is twice as powerful as the known most powerful Russian transmitter.—T. ROEVES (Alcester).

**SIR**,—With reference to the letter of E. Haines (January 1961), I should like to state that the transmitters employed by Radio Moscow are not the most powerful in the world. The Voice of America fills this position with three transmitters each having an output of one million watts located at Munich (173kc/s), Okinawa (1180kc/s) and Manila (1140kc/s). It is possible that Radio Moscow's short-wave transmitters are more powerful than those of the Voice of America whose most powerful have an output of 200KW. However, the Voice of America is currently building a new short-wave station in North Carolina which will house six 500KW shortwave transmitters which will be in operation by the end of 1962.

Reader P. J. Kennett (January 1961), has already stated the correct facts which need not be duplicated here concerning the relay of Radio Moscow by other stations. However, it is of interest to note the following facts about the Voice of America relay stations:—

There are nine relay stations (excluding those in the U.S.A.) of which eight are land-based. The

ninth is situated off the island of Rhodes in the Mediterranean and takes the form of the United States Coast Guard vessel "Courier". The others are situated in Germany, Great Britain, Greece, Ceylon, Ryukyu Islands and Philippine Islands.

Those Voice of America stations which announce a call sign are located in the U.S.A. — stations WBOU, WDSI, WLWO and WGeo in New Jersey, New York and Ohio and KNBH and KCBR in California.

The only links which the Voice of America studios in Washington have with the relay bases overseas are via the transmitting stations in the U.S.A. Should trans-Atlantic or trans-Pacific communications be impossible due to prevailing atmospheric conditions the relay bases are obliged to broadcast recorded programmes from tapes.—B. J. AYRES (Chessington, Surrey).

### TRANSISTOR HOLDERS

**SIR**,—May I add a few comments to some of the letters and opinions expressed in the current issue of PRACTICAL WIRELESS.

E. M. Krell asks why nobody has produced a transistor holder to avoid soldering. If he cares to look through the advertisements in this or most of the other publications of a similar nature he will see them offered time and again.

F. Keating asks how to play a tape backwards. To do this he should turn his tape over as if he was going to play back the other track and then twist it so that the glossy back of the tape is running against the playback head instead of the dull-coated side.—J. G. WATT (Yorkshire).

### MODULATION

**SIR**,—Referring to Mr Miller's letter in the January issue of PRACTICAL WIRELESS, I would like to say that modulation of an oscillator is very undesirable. It is due to F.M. that always occurs when amplitude modulation is applied directly to the frequency-controlling stage (the oscillator).

In America, at least, amplitude modulation of an oscillator is permitted only on frequencies above 144Mc/s.—V. TH. KJARTANSSON (Reykjavik, Iceland).

### CRYSTALS

**SIR**,—In February PRACTICAL WIRELESS there is a letter from T. L. Mence who requires some Hertzite crystal. I was connected with the wireless trade from 1928 to 1938 and I have a small supply of Hertzite that we used to put into glass tubes for sales purposes.

If T. L. Mence or any other readers would like a piece (so far as my small stock allows) and cares to contact me I will let them have some if they would send a stamped addressed envelope. I have also been an amateur radio fan on and off since about 1922 and took the first PRACTICAL WIRELESS. So far back, anyway, that I can remember an issue that gave instructions for running a radio from gas.

I was very interested a month or so ago when Thermion looked back. I also remember the glass tube with practically all of a 3 valve set enclosed made by a German firm at about 1932.—B. ANDREW (37 Grimsbury Drive, Banbury, Oxfordshire).

### PLAYING A TAPE BACKWARDS

**SIR**,—With reference to the letter "Playing a record backwards," February edition, I have two solutions. Either record on a twin track tape-recorder then remove the spools, placing them on a four track tape-recorder, one of these tracks will play the recording backwards; or record as normal and then place the left spool on the right and right on left, pick up right spool and turn over (the twist in the tape take comes before the recording head) and play.—M. BRICKWOOD (London, E7).

**SIR**,—I was interested to read, in the February issue, how Mr. Keating played a gramophone record "backwards," and perhaps I can help him in his efforts to play a tape recording in this manner.

He must first make a normal recording near the end of a reel of tape. The tapes are then "changed over" so that what was once the "feeder" spool becomes the "take-up" spool. The other spool (which now "feeds"), is forced to move clockwise instead of anticlockwise as it would normally do.

Although this means that the tape can now be played "backwards", it also means that the tape is being played with the insensitive side towards the head and consequently a slight lessening of volume is also noted.—J. B. DE BOER (Huddersfield).

**SIR**,—I would like to let Mr. Keating know how to play a tape recording in reverse. The only disadvantages are that the output of sound is reduced, and that the higher treble frequencies are lost.

Having placed full reel of tape on the feed spindle as normal, turn it over and replace on spindle. Take the leader tape and join it to the take-up spool in the normal manner. The tape can now be played in reverse, but do not attempt to rewind as the tape will unreef from the spool.

Incidentally, if the reversed tape spools are interchanged to give the same pattern of feed and take-up, then the recorded sound will be heard as normal.

I hope this will enlighten all interested parties.—D. HARTLAND (Bournemouth).

## SHORT-WAVE LISTENERS' LOG—5

**S**HORT-WAVE listeners who are learning Morse, but cannot attend a group or class, may obtain good practice in reading by listening on the amateur bands. Many recently licensed amateurs commence working on the 80m band, and listening on frequencies around 3.5Mc/s to 3.6Mc/s will usually provide some Morse signals of only moderate speed. It is not, of course, possible to read Morse at once, even after the code has been memorised, but all practice at reading "off the air." will help to increase speed. Normally, listening and reading should not be for more than 10 or 15 minutes at a time, for a beginning. Amateur activity also varies greatly from time to time, so lack of suitable signals does not mean it is not worth trying the band again.

In addition to usual activity, broadcasts of particular interest are occasionally heard on the amateur bands. Shipping, or ship to shore, communications may be heard around 1850kc/s in the 160m band. Around 3.6Mc/s in the 80m band will often give good reception of special bulletins of particular interest to amateurs, commencing at 10 a.m. on Sundays. On the higher frequency bands it is usually possible to hear and identify transmissions from a number of distant countries, in addition to regulars such as the U.S.A. It is best to try each band at various times, as conditions change from hour to hour.

The listener who has no special short-wave set will find the 31m and 41m bands particularly satisfactory after dark. Strong signals from Prague, Rome, and other fairly near stations can be expected, with English programmes beginning at 18.00 G.M.T. Voice of America transmissions will often furnish 9-plus signals. For more distant reception, it is worth trying approximately 7.1Mc/s, as Radio Peking can easily be an R9 signal during the early evening, and gives a programme in English at 21.00 G.M.T.

It is interesting to hear the news in Special English, radiated each weekday except Saturday by the Voice of America at 19.00 and 20.00 G.M.T. Frequencies and wavelengths used include: 21.5Mc/s, 13.95m; 15.2Mc/s, 19.73m; 11.76Mc/s, 25.5m; 9.635Mc/s, 31.41m; 9.62Mc/s, 31.19m; 9.52Mc/s, 31.51m; and 6.185Mc/s, or 48.5m. Broadcasts in the international language Esperanto may also be heard, some of the transmissions being as follows: Rio de Janeiro, 30.78m and 25.48m, 09.00 to 09.30 G.M.T. Sundays; Sofia, 41.35m, 39.11m and 30.93m, 19.00 to 19.25 G.M.T. Sundays; Juiz de Fora, 60.91m, 00.45 to 01.00 G.M.T. Mondays; Bern, 48.66m and 31.46m, 17.35 to 17.40 G.M.T. Mondays; Rome, 50.34m, 41.24m and 30.9m, 17.55 to 18.10 G.M.T. Tuesdays.

Listeners who are badly troubled by untunable interference, or lack of good signal strength, may find that a simple dipole solves these problems. With a single-wire aerial, feeding the receiver from one end, static is carried to the set with the signal. But with a dipole, static is in phase in both halves of the aerial, and thus largely cancels out on reaching the twin feeder. The desired signals, on the other hand, are out of phase in the two halves of the aerial, and are thus carried to the receiver. In addition, a dipole does not have the broad-band reception characteristics of a single, end-coupled aerial wire, and this also reduces general interference very considerably.

A dipole can be made from 7/22 or similar aerial wire. Its total length is 0.95 of a half-wave—or about 66ft for the 40m band. This total length is cut in half, and an insulator is inserted. From this insulator a twin-lead or coaxial cable is taken to the receiver. One conductor of this feeder thus goes to each 33ft portion of the aerial. The whole is supported in the usual way with insulators at each end of the two 33ft horizontal top wires, the feeder descending from the centre to the receiver. Very good results will also be obtained on 20m and 10m bands.





**A NEW-PRACTICAL WAY  
of UNDERSTANDING**

# Radio • Television • Electronics

Including: Transistors; VHF/FM; Hi-Fi equipment; Computers; Servo-mechs; Test Instruments; Photo-electrics; Nucleonics, etc.

**FOR ... Your Career ... Your Own Business ... An Absorbing Hobby**

Radiostructor—an organisation specialising in electronic training systems offers a new self-instructional method using specially designed equipment on a "do-it-yourself" basis.

You learn by building actual equipment with the big kits of components which we send you. You advance by simple steps, performing a whole series of interesting and instructive experiments—with no complicated mathematics! Instructional manuals employ the latest techniques for showing the full story of electronics in a practical and interesting way—in fact—you really have fun whilst learning! Post the coupon below, now, for full details.—

**RADIOSTRUCTOR**  
**LEADS THE WORLD**  
**IN ELECTRONICS TRAINING**

**POST NOW**

To RADIOSTRUCTOR (Dept. G82)  
 READING, BERKS.

Please send brochure, without obligation, to:

★ Name \_\_\_\_\_

Address \_\_\_\_\_

3/61

★ **BLOCK CAPITALS PLEASE**  
 (We do not employ representatives)



RECEIVERS & COMPONENTS

SPEAKER REPAIRS. Cones/Fields fitted. Clock Coils Wound. L. S. REPAIRS, Pluckley, Ashford, Kent.

RESISTORS.—100 new, wire ended, assorted, all types. 7/8 box, post free. COOK'S OF BEDFORD, 29, St. Mary's Street, Bedford.

"WEYRAD" TRANSISTOR RECEIVER

LONG & MEDIUM WAVE, P.P. OP. ALL COMPONENTS AVAILABLE. TOTAL COST £8.17.8. CONSTRUCTOR'S BOOKLET, 2/-

TRANSISTOR AM FEEDER UNIT, SUPERHERF. AVAILABLE. NOW Size 4 x 3 x 1 1/2. TOTAL COST OF COMPONENTS £5.10.0. CONSTRUCTOR'S BOOKLET, 1/9. Send S.A.E. for Shopping Lists, 35 OHM AILAN SPEAKERS, 271L. JACKSON "OO" GANG (with Trimmers), 10/6.

WESTHAM RADIO SUPPLIES Rear of 175 Abbotsbury Road WEYMOUTH, DORSET

RECLAIMED VALVES, tested and perfect; huge stocks; all one price, 5/- plus 6d. postage each. Delivery by return. LEWIS, 46, Woodford Ave., Ilford, Essex.

TRANSISTOR Heat Shunts 3/6. 6, Hooker Road, Heartsase, Norwich, Norfolk.

LOUDSPEAKERS 7in. x 4in. 7/6, post 1/6. Aerials 100ft Reels, Bronze 2/-, post 1/6. Transistors and Components. 3d stamp for Lists. H. R. MAIL ORDER, 16, Regent Parade, Harrogate.

COMPONENTS, Valves, Tubes, etc. Write or phone for free list. ARION TELEVISION, 4, Macted Rd., Pechham, S.E.15. (New X 7152.)

ANNAKIN

WINTER SALE

Periscope Prisms. Were 3/-. now 1/6 pr. post 2/-. Chokes. 10H., 60mA. were 2/-. now 1/-. post 1/6. AF Transformers, f-200 ohm., were 1/-. now 6d. post 11d. Frost Warning Thermostats, were 1/6, now 9d. post 6d. Xtals 4860. Kc. were 3/6, now 1/9, post 6d. Valves. Sale Prices, VR136, CV93, EP91, EL91, 1/6. Vibrators. 12 v. now 2/3, post 9d. Allen Keys 2 for 3d. WW Resistors, 75K., 50W., 6d., post 9d. 2K., 50W., 6d., post 9d. Pot.ms. 5K. 6d., post 6d. Carbon, 500 ohm., or 100K, 2 for 9d., post 9d. Breast Mikes, 1/6 ea., post 1/6. Switches. Slider 250 v. 2 for 9d. 3P3W Tranz, 2 for 6d. Rotary 250 v. 10.A., 2 for 6d. Shaft Couplers. Ring type, 6d. B3G holders 1/2 doz. MO. holders, 1/2 doz. Screens for B7G, 2 for 3d. Panel Lampholders, MES., 9d., SBC 3A. Rectifiers, Copper Oxide, 200 v. 250 mA., 2/-, post 1/6. Aerial Wire stranded, 24 yds., 2/-, post 1/6. Block Condensers, 2 x 0.8 mid., 400 v. 3d. 1 mid., 600 v. 3d. 0.1 mid., 5kv. 6d., post 1/6. IFT 30, mc., 3d. Lecher Lines, 450, mc., 3d. U.S.W. Split Stator Condensers, various, 2 for 9d. Post Extra. Orders only accepted if enough postage sent. Mail Order only. No Export. C.W.O. only. Stamped addressed envelope for lists please.

25 ASHFIELD PLACE, OTLEY, YORKS.

RATES: 6/6 per line or part thereof, average five words to line, minimum 2 lines. Box No. 11 extra. Advertisements must be prepaid and addressed to Advertisement Manager, "Practical Wireless", Tower House, Southampton St., London W.C.2.

BROADWAY ELECTRONICS

92 MITCHAM ROAD,

TOOTING BROADWAY, S.W.17.

Telephone: BALham 3984

C.B.S. BRAND (COLUMBIA) AMERICAN TAPE (P.V.C. RECORDING TAPE). Attractively boxed with space for titles, etc. Tape fitted Leader and Autostop. 1800ft. 7in. L.P. 36/-; 1200ft. 5 1/2in. L.P. 30/-; 900ft. 5in. L.P. 22/6. Add 1/6 post and packing.

B.T.H. EX-RELAY AMPLIFIERS. A.C./D.C. MAINS 210/250v. Contains 8in. 15 ohm speaker. Three valves—10F1, 10P14 and U404. Cabinet size 14 x 11 x 6 1/2in. Attractive two toned cabinet with ivory knobs. 30/-, plus 5/6 Carriage and packing

B.S.R. U48 MONARCH. 4-speed Auto-changer wired for Stereo. £6.12.6, plus 5/- Post and Packing.

SPECIAL OFFER: White Boxed Tape, Acetate Base. 5 1/2in. 850ft., 14/6; 5 1/2in. EMI Type Spools, 2/9.

Add 1/- Post and Packing.

DK96, DAF96, DF96, DL96, 6/6 each.

Sigma Relays SPDT, 10,000 ohms, 1 mA, 15/6 (1/6). 40in. American Whip Aerials with loading coil, effectively increasing height to 12ft., 25/6 (5/-). Precision Infinitely Variable Speed Gearboxes, 0 to 6000 r.p.m. driven by 4 hp. 230 v. A.C. motor, 28 (15/-). American Amplifiers. Mike input 2 x 2000 ohm output 24 v. input uses 1-125J7 and 2-6V6, 7 x 3 x 5ins., 12/8 (less valves) (2/6). Kurman Relays SPDT 7000 ohms 3 amp contacts, 12/8 (1/6). Metal Rectifiers, 24 v. 12A. 20/- (3/6). 5ft. P.O. Racks, angle iron sides 19in. wide, 65/- (10/-). B.C.610 Whip Aerials, 3 sections, 9ft. in canvas holdall, 35/- (5/-). Heavy Insulated Bracket Mounts for above 25/- (5/-). BC-659 Transmitter Receivers crystal controlled 14 valves (less crystal) and valves 35/- (10/-). BC-659 Power Supply Unit, vibrator type for attachment to Tx Bx 6 v. or 12 v. input (less vibrator), 25/- (10/-). BC-659 Battery Box for attaching to Tx Rx for man pack use, 7/8 (5/-). 50 watt Power Amplifiers rack mounting, 230 v. A.C. input (1-MH4, 2-1X-25, 1-U50) with w/c and meter, less valves 25/- (15/-). AVO Portable Geiger Counters for Beta or Gamma Ray detection, new less batteries 28.10.0 (10/-). Laboratory Mains Filter Units 3 amps removes mainsborne interference, 10/- (2/6).

40 PAGE LIST OF OVER 1000 ITEMS IN STOCK AVAILABLE—KEEP ONE BY YOU

American Operators Tables, black crackle, 36 x 22 x 3 1/2in. jack boxes and switches under, ideal for many uses, 75/4 (15/-). Boeing Beehive 34in. stand off Insulators, 9/6 a doz. (2/6). Elliott 0 1/4 v. moving coil meters, 2000 o.p.v. 2 1/2in. dia. Bendix 6ft. enclosed transmitter cabinets open front 19" wide 26 (20/-). Amount in brackets is carriage England and Wales.

We have large quantities of "Bits and Pieces" that we cannot list—please let us have your enquiries, we can probably help—everyone answered.

P. HARRIS, ORGANFORD, DORSET

RECEIVERS & COMPONENTS

(continued)

TELEVISION TUBES Rebuilt. 1 year warranty. Mostly 75/- exchange. 3. Pank Ave., New Barnet. BAR 3185 now!

GUARANTEED VALVES from 1/-, Radio, TV components. Transistor set Kits from 10/-. S.W. Kit 22/6. Lists 3d. HAMILTON RADIO (W1), 13, Western Rd., St. Leonards, Sussex.

LEADER RADIO

REPANCO MINI-7

The amazing new transistor set for the home constructor. Seven transistors, superhet circuit, fully tuneable over long and medium wave. Equal to any manufactured set. Kit complete with instruction data (excluding batteries). . . . . £10.10.0

A super sensitive seven transistor superhet embodying A.G.C. and Negative Feedback Circuits. Fully tuneable over long and medium wave. Cabinet 9" x 7" x 4in. Speaker 7" x 4in. Kit complete with instruction data (less battery). . . . . £11.0.0 THE TELETRON TAPEAK (Transistorised tuner) Converts your tape recorder into a high quality Radio Receiver. Recording of Radio Programmes directly on tape. High sensitivity. 25.9.0, excluding PP4 battery. Carr. 3/6. B.S.R. MONARDECK TAPE RECORDING DECKS Bargain, only 29.10.0, carr. 3/6, excluding tapes. FERRODYNAMIC RECORDING TAPES. 5in. 600ft. 15/-, 5in. 900ft., 18/6; 5 1/2in. 1200ft., 23/6; 7in. 1200ft., 25/-; 7in. 1800ft., 35/-, post free. S.A.E. for leaflet. CABY MULTI-RANGE TEST METERS in moulded case. Model A10, £4.17.6. Model B20, 28.10.0. S.A.E. for illustrated leaflet. S.A.E. with enquiries 78 VISTA WAY, KENTON, HARROW, MIDD. Phone: WOR 4812

5 1/2 GNS. (Batt. p.p. 5/6). Transistor Spk. Radio. LW/MW etc. Transistor 2 Radio with Speaker and Aerial 58/6. Bat. p.p. 3/6. C.W.O. Reg. Post. DERLO (RADIO), 41, Newfield, Sandbach, Cheshire.

TRANSISTOR BARGAINS: Brand new Mullard OC44 11/6, OC45 9/6, OC72 9/6, OC76 (OC72, OC78 type) 8/6, Ediswan, PXA102 9/6, XB104 8/6. Special 14-3V Transistors 3/6, White Spot 4/6, Red Spot 3/3, D. E. CARTER (ELECTRONICS), 347, Lady-pool Road, Sparkbrook, Birmingham 12. (SOU 3007.)

KINGSLAND

ELECTRONIC COMPONENTS

Stupendous Offers

1958 ELECTRONIC COMPONENTS 50 Assorted Resistances and Condensers, 6 Miniature Valve Holders, two Tag Strips, 40 Separate Contacts each 3/9, p. & p. 1/9. Small Chassis, approx. 2 1/2 x 1 1/2 in., containing 2 Miniature Valves, 2 Germanium Crystal Diodes, 12 Resistances and Condensers, 2/9, p. & p. 9d. 120 Resistances 2 and 1/2 watt, 35 metalmite and T.C.C. small Condensers, 9 Miniature Valve Holders, 3 Tag Strips, 100 contacts each and other useful pieces, 8/6, p. & p. 2/3. BARGAIN PACK. Pair Throat Microphones. 150 Assorted Screws, 2ft. 2in. Screened Lead with socket, one 5 Henry 200 in. A Choke, 3 Electrolytic Condensers, 6 Knobs, 3 Toggle Switches, 6 Octal Valve Bases, 1 Waveband Switch, 6 Coax. Plugs, 6 Assorted Coils, 6 Cartridge Fuses, 6 Potentiometers, 8 W.W. Multipliers, one Variable Condenser, Coil of Wire, 15/6, p. & p. 3/6. Instrument Rectifier with Circuits, 5/6, 6 v. or 12 v. Vibrators, 2/6 each, p. & p. 1/6 6 Assorted Droppers, 5/-, p. & p. 1/6 Mike and Pick-up Transformers. Ideal for Baby Alarms, 4/8, p. & p. 1/- 100 Assorted Resistances or Condensers or 50-50, 6/-, p. & p. 1/9. New headphones, low impedance, ideal for crystal sets, etc., 6/6, p. & p. 1/9. 6 Assorted Potentiometers, 5/-, p. & p. 1/9. 182 KINGSLAND RD. SHRODDITCH, E.2. Tel: SHO 6572. Sorry U.K. only.

**RECEIVERS & COMPONENTS**  
(continued)

**BARGAINS**

Amplifiers, 8 watt push/pull output, complete with valves, £4.0.0. Less valves £2.15.0  
Line up: 2/EL34 x EZ50 x ECC83.  
Tape Decks: B.S.R. TD: Monardeck, 28.  
Collaro Studio £11.10.0. Terms: C.W.O.

**MILES RADIOVISION**

**NEWTOWN, WICKHAM, HANTS.**

"HEATHKITS" can now be seen in London and purchased on easy terms. Free brochure. DIRECT TV REPLACEMENTS LTD. Dept. PW/7/2. 138, Lewisham Way, S.E.14. Tideway 6666.

**NEW AM/FM STEREO**

- INPUTS FOR TAPE, 78's, etc.
- MW-LW-V.H.F.
- PUSH-PULL OUTPUTS—16w
- SEPARATE TONE AND VOLUME
- INTEGRAL PREAMPLIFIER

**BEL, Marlborough Yard, London N.19**  
Arc 5078

IT4	3/6	EB91	3/6	PCF80	7/6
IL4	1/9	EF91	3/6	PCC84	7/6
IR5	3/6	ECC81	5/-	PL81	8/6
IS5	3/6	ECC82	5/6	6K8G	5/-
DK92	6/6	ECH42	9/-	6V6GT	4/-
DK96	8/-	ECL80	7/6	6V6G	4/6
DL92	6/6	EY51	7/6	12AH7	4/-
DL96	6/9	EY86	7/6	954	1/3
DL94	7/6	EF86	9/-	EF50	1/-

All Brand New and Boxed. C.W.O. Over 200 Types Available. Woodward, 56 Wiverton Road, Forest Fields, Nottingham.

**FOR SALE**

**ANOTHER NEW** low-priced Tape Bargain! 1,800ft. latest polyester on 7in. reel. 32/6, p.p. 1/6. Also outstanding bargains in all other sizes 3in. to 8 1/2in. S.A.E. for list (includes American Audio Tape, BASF, etc.). Over 30 mint condition second-hand Tape Recorders and all are new Recorders and Hi-Fi Equipment on NO INTEREST H.P. Terms. E. C. KINGSLEY AND CO. (Dept. P.W.), 132, Tottenham Court Road, (near Warren St.), London, W.1. EUS6500.

ASK your dealer for American Ferrodynamics "Brand Five" Recording Tapes—the best tape value!

**100 BAYS** Brand New Adjustable Steel Shelving, 22in. high x 34in. wide x 12in. deep; stove enamelled dark green, sent unassembled. Six shelf bay £3 15s. Sample delivered free. Quality discounts. N. C. BROWN LTD., Eagle Steelworks, Heywood, Lancs. Tel.: 69018.

**AMERICAN MAGAZINES.** — Year's subscription, "High Fidelity," 50/-; "Electronics World," 43/-; "Audio," 35/-. Specimens, 5/- each. Full catalogue free. WILLEN LTD. (Dept. 40), 9, Drapers Gdns., London, E.C.2.

**CABINETS, EQUIPMENT & SPEAKERS**

Write for CATALOGUE.  
A.L. STAMFORD Ltd.  
Dept. A.29.  
84 Weymouth Terrace,  
London, E.2.



**FOR SALE (continued)**

"WEARIE" Tape Deck 230/250 A.C. speeds 31/71. Very little used. Cost new £35 Offers: PRICE. Grimston House, Tollerton Lane, Notts.

**HIGH QUALITY** Microphones for disposal. S.T. and C. 4033 Cardioid Microphones second hand, in good working condition, £20 each. R.C.A. LMI. 6203 Microphones (600, 250 and 50 ohms) reconditioned £15 each. Secondhand, in working condition. £13 each. C.W.O. MOSS EMPIRES SOUND DEPT., Cranbourn Mansions, Cranbourn Street, W.C.2.

**Gaby Meters**, A10. £4.17.6; B20. £6.10.0; with each 36 mixed resistors, 6d. Transistor Kit, 25.4.8. Transistor OC16, 27/- Cartridge, TC8M, 18/6. Plastic Recording Tape: Famous Brand, 5in. 800ft. 15/-, 7in. 1800ft. 32/6. CONTACT COOLED rect. 250v. 250mA. 19/6. 300mA. 17/6.

**Armchair Volume Control 30/-**  
CASH WITH ORDER, POST FREE  
C.O.D. 2/6

**DURHAM SUPPLIES**  
175 Durham Road, Bradford 8, Yorkshire.

**WANTED**

**WANTED.** Service Sheets. No quantity too large. Highest prices paid. SULTAN RADIO, 29, Church Road, Tunbridge Wells, Kent.

**WANTED VALVES**

All types for prompt cash. Must be new. State quantity.

**WILLIAM CARVIS LTD.**

103 North Street, Leeds 7

**BEST PRICE** paid by return for new Valves and equipment. STAN WILLETTS, 43, Spon Lane, West Bromwich, Staffs. Tel.: WES 2392.

**NEW VALVES WANTED**

Any type, any quantity.

**CASH PAID**

**R.S.T., 211, Streatham Road, Mitcham, Surrey.**  
Telephone: MITcham 6201.

**AERIALS**

**ITS NEWS!** The smallest Radio Aerial in the world, 1 1/2in. long, cuts interference all wave 2/11, p.p. 6d. VHP Aerials or TV Aerials, the real thing 19/14 p.p. 1/6. VISION AND SOUND CO., 52a, Water Street, Radcliffe, Lancs.

**BOOKS & PUBLICATIONS**

**FIND TV SET TROUBLES IN MINUTES** from the great book "The Principles of TV Receiver Servicing," 10/8 all book houses and radio wholesalers. If not in stock, from Secretary, I.P.R.E., 20, Fairfield Road, London, N.8.

**MISCELLANEOUS**

**SELL BY POST** — receive cash by post. Learn Mail Order Trading—unlimited trade expansion. Mail-methods Manual shows how. Details. S.A.E.—MAILMETHODS (M.14) CO., 170, Old Christchurch Road, Bourne-mouth.

**HOW TO USE EX-GOV. LENSES AND PRISMS.** Nos. 1 and 2 2/6 ea. Lists free for S.A.E. H. W. ENGLISH, 469, Rayleigh Road, Hutton, Brentwood, Essex.

**YOU READ MUSIC?**

Then how about making yourself an electric organ? Constructional data available—full circuits, drawings and notes. It has 5 octaves, 2 manuals and pedals with 24 stops—uses 4 valves. With its variable attack you can play Classics and Swing.

Write NOW for free booklet and further details to C. & S., 20 Maude Street, Darlington, Durham.

**SERVICE SHEETS**

**SERVICE SHEETS, TV 4/- ea.** Radio 3/- ea. List 1/-. All orders dispatched on day received. Also Manuals for sale and hire. Mail orders only. SULTAN RADIO, 29, Church Road, Tunbridge Wells, Kent.

**SERVICE SHEETS, Radio, TV 5,000 models.** Lists 1/-. S.A.E. enquiries: TELRAY, 11, Maudland Bk., Preston.

**SERVICE SHEETS (1930-1961)** from 1/- with free fault-finding Guide. Catalogue 6,000 models 6d. Books, Components, Valves, Constructors Kits. Lists 3d. S.A.E. enquiries: HAMILTON RADIO (W), 13 Western Road, St. Leonards, Sussex.

**SERVICE SHEETS.** We have the largest stock of Radio and TV Service Sheets in the country for sale at 4/- ea. Why tolerate delay in obtaining your supplies when we will dispatch by return? Service Sheet List 1/-. Also Manufacturer's Manuals for sale and hire. 1961 List now available 1/-. S.A.E. please. Mail orders only to S.P. DISTRIBUTORS, 44, Old Bond Street, London, W.1.

**SERVICE SHEETS;** also Current and Obsolete Valves for sale. JOHN GILBERT RADIO, 20, Extension, Shepherd's Bush Market, London W.12. (Phone: SHE 3052.)

**FAULTFINDER FILES.** showing common faults that each receiver is prone to and other useful servicing information 2/- ea. List 9d., plus postage. S.P. DISTRIBUTORS, 11, Old Bond Street, London, W.1.

**38 SET WALKIE TALKIE**

**CIRCUIT INFORMATION**  
Alignment Procedure. Typical faults in Ex W.D. Sets. Component location diagrams. Circuit diagram. Complete Circuit description. Instructions for use, etc. P.O. 5/-. Address in block capitals, please.  
**CAMPBELL**  
Laundry Lane, Hungerford, Berks.

(continued on next page)

## SITUATIONS VACANT



## A FIRST-CLASS JOB IN THE G.P.O.

Men between the ages of 20-35 are required to work in Central London on installing and maintaining telephone apparatus and transmission equipment. Older men, up to the age of 45, will be accepted if they have the experience which is particularly suitable.

Commencing pay is £9.16.0 per week rising to £12.2.0.

Men who show ability to progress will be given every opportunity to qualify for Technical Officer posts on which the salary is £600 a year rising to £850. Further promotion is available.

Apply in writing, stating age and experience to:

Chief Regional Engineer (Ref. S/D2A(X7)),  
London Telecommunications Region,  
Waterloo Bridge House,  
Waterloo Road, London, S.E.1.

**ELECTRONIC WIREMAN** with several years experience required by Clarendon Laboratory, University of Oxford. Salary according to age on scale £450-750 p.a. Child allowances, 32 working days leave, pension scheme. Write giving full details of training and experience to the Administrator.

## PHILIPS ELECTRICAL LTD.

(Medical X-Ray Division)

45 Nightingale Lane, S.W.12

ENGINEERS required for the service and installation of X-Ray equipment. Candidates with O.N.C. (electrical) or electronics experience would be considered. Also applicants with electronic experience as trainees.

Applications with full details should be addressed to the Personnel Officer, at the above address.

**CITY AND GUILDS** (Electrical etc.) on "No pass—no fee" terms. Over 95% successes. For details of Electrical Engineering, Applied Electronics, Automation, etc., send for our 148-page handbook, free and post free. B.I.E.T. (Dept. 242a), 29, Wright's Lane, London, W.8.

## SITUATIONS VACANT

(continued)

**TV AND RADIO A.M.Brit.I.R.E., City and Guilds. R.T.E.B. Cert., etc.** on "No pass—no fee" terms. Over 95% successes. For details of Exams and Courses (including practical apparatus) in all branches of Radio, TV and Electronics, write for 148-page handbook, free. B.I.E.T. (Dept. 242G), 29, Wright's Lane, London, W.8.

## CENTRAL ELECTRICITY GENERATING BOARD EASTERN DIVISION

BRADWELL (NUCLEAR) GENERATING  
STATION (ESSEX)

Applications are invited for the following position of

## INSTRUMENT MECHANICS

The rate of pay is 6/1 per hour for a 42-hour day, 5-day week. Housing accommodation will be available for successful applicants.

Applicants should have knowledge and experience of test and repair of common electronic equipment and ability to use electrical and electronic test equipment. A knowledge of pulse circuits or conventional industrial instruments would be an advantage.

Applications, giving details of age, education, qualifications and past experience, should be addressed to Station Superintendent, Bradwell Generating Station, Bradwell-on-Sea, Southminster, Essex.

**A.M.I.Mech.E., A.M.Brit.I.R.E., City and Guilds. G.C.E., etc.** brings high pay and security. "No pass—no pay" terms. Over 95% successes. For details of exams and courses in all branches of Engineering, Building, Electronics, etc., write for 148-page handbook, free. B.I.E.T. (Dept. 242B), London, W.8.

## EDUCATIONAL

"**HOW AND WHY**" of Radio and Electronics made easy by a new, non-maths, Practical Way, Postal Instruction based on hosts of experiments and equipment building carried out at home. New courses bring enjoyment as well as knowledge of this fascinating subject. FREE brochure from: Dept. P.W. 12, RADIOSTRUCTOR, 40, Russell Street, Reading, Berks.

## Radio Television & Electronics

Learn at home with the world's largest home study organisation, Brit.I.R.E.; City & Guilds; R.T.E.B., etc. Also Practical Courses with equipment. No books to buy.

Write for FREE prospectus stating subject to

## I.C.S.

(Dept. 541), Intertext House,  
Parkgate Road, London S.W.11

## MINISTRY OF AVIATION

## E.I.D.

# ELECTRONIC INSPECTORS

required for

RADIO, RADAR, COMPONENTS & ELECTRICAL  
ANCILLARIES AT BROMLEY & WOOLWICH

Varied and interesting work with opportunities for gaining valuable experience and further training. Excellent promotion prospects.

**PAY 257/6—272/6** (with prospects of further progression to 297/6) for a 5-day week. Skilled men apply, stating experience, to:

**ELECTRICAL INSPECTION DIRECTORATE (P.W.)**

AO/L

Aquila, Golf Road, Bromley, Kent.

**EDUCATIONAL**  
(continued)

City and County of Bristol  
Education Committee

**BRISTOL TECHNICAL COLLEGE**

School of Marine Radio and Radar

Courses are available for prospective Radio Officers in the Merchant Navy, leading to the 1st and 2nd Class P.M.G. Certificates, and for the M.O.T. Radar Maintenance Certificate.

Entry in January, April and September of each year.

**Fees** P.M.G. £7.10.0 per term  
Radar £5. 0.0.  
(Under 18 £1. 0.0. per session)

For further particulars apply to the Registrar, Bristol Technical College, Ashley Down Road, Bristol, 7.

**FREE FROM THE I.P.R.E.** Syllabus of famous radio and TV courses. Membership Conditions booklet, 1/-. Sample copy The Prac. Radio Engineer, 2/- post free. Secretary, 20, Fairfield Road, London, N.8.

★ **LEARN** ★  
**RADIO & T/V**  
**SERVICING**  
for your **OWN**  
**BUSINESS/HOBBY**

● by a new exciting no-maths system, using practical equipment recently introduced to this country.

FREE Brochure from:—  
**RADIOSTRUCTOR**  
DEPT. G77, READING, BERKS, 3/61.

**WIRELESS.** See the world as a Radio Officer in the Merchant Navy: short training period; low fees; scholarships, etc., available. Boarding and Day students. Stamp for prospectus. **WIRELESS COLLEGE.** Colwyn Bay.

$$X = \frac{-b \pm \sqrt{b^2 - 4ac}}{2a}$$

**DON'T FUMBLE** with Formula. Master Mathematics in 6 weeks the Understandable Way. First lesson and details free from:



**UNDERSTANDABLE MATHEMATICS**  
11F Dryden Chambers, Oxford St. London, W.1.

Name \_\_\_\_\_  
Address \_\_\_\_\_

**EDUCATIONAL**  
(continued)

**LEARN RADIO AND ELECTRONICS** the new practical way! Hosts of absorbing experiments carried out at home under expert guidance to teach you Radio in a new, enjoyable and interesting way. Construction, servicing and fault finding on equipment made easy for the first time! No previous experience needed. No mathematics used. Free brochure from: Dept. 11 P.W., RADIO-STRUCTOR, 40, Russell St., Reading, Berks.

**SOUND RECORDINGS**

**TAPE/DISC** transfer. Fine U.S. tapes arrived (£1.800ft 35/-). UNIMIXER units for quality work. Sound News, 10, Clifford Street, W.1. REG 2745.

**BOOKS**

for  
**CONSTRUCTOR**

A NEW PRACTICAL WAY OF UNDERSTANDING

**BASIC ELECTRICITY, BASIC ELECTRONICS.**

THE WAY

The Complete Set sent on payment of first instalment.

**LEARN WHILE YOU PAY**

Write for **FREE Illustrated Prospectus** giving details of instalment plan! As advertised by THE TECHNICAL PRESS

**MULLARD, REFERENCE MANUAL OF TRANSISTOR CIRCUITS.** As advertised, 12/6, postage 1/- GET YOUR COPY NOW it may be out of stock Shortly. **TRANSISTOR CIRCUITS No. 1** Gregory, 2/10. 32 pages, 8 circuits, 24 plans and illustrations. Full constructional details, suitable for beginners and advanced. **TRANSISTOR CIRCUITS No. 2**, Sinclair, 2/10. 13 new projects including Transistors, FM Tuners, 1 watt Hi-Fi amplifier, several pocket radios and sub-miniature Transmitters.

**TRANSISTOR CIRCUITS No. 3**, Sinclair, 2/10. 11 projects using prefabricated circuit units, complete commercial receiver included.

**TRANSISTOR CIRCUITS No. 4**, Sinclair, 2/10. Full circuitry and constructional details for Hi-Fi Tape and pick-up pre-amp, Hi-Fi 3-watt amplifier, Two transistor superhets, 11 projects described.

**HIGH FIDELITY LOUDSPEAKER ENCLOSURES**, 5/6. 48 pages, 40 diagrams. The only book giving comprehensive data for all types of enclosures.

**PRACTICAL STEREO**, Sinclair, 4/-, 40 pages, 15 plans & illustrations. Invaluable to all interested in Stereo. **TRANSISTORISED CAR RADIO for the HOME CONSTRUCTOR.** Fully illustrated, 2/6. **BOOK OF CRYSTAL SETS AND SIMPLE CIRCUITS**, 2/10. 36 pages, 29 illustrations and plans. The know how on constructing 12 different sets without any previous knowledge.

**ELECTRONIC NOVELTIES FOR THE CONSTRUCTOR**, Bradley, 5/6. **ELECTRONIC GADGETS**, Bradley, 4/-. **RADIO CONTROL OF MODELS** 5/6. (Sommerhoff). **SERVICING TRANSISTOR RECEIVERS** Pettit, 9/6. **USING AN OSCILLOSCOPE**, Easterling, 7/-. **BEGINNERS' GUIDE TO RADIO**, Camm, New and Revised Edition, 8/-. All above titles include postage.

SEND STAMP FOR LISTS

**SELRAY BOOK CO.**  
60 HAYES HILL, HAYES  
BROMLEY, KENT

**Eddy's (NOTTM.) Ltd.**

172 Alfreton Road, Nottingham

**BUILD YOUR OWN CAR RADIO!**



7 Transistors Long and Medium Waves. Two watts output. RF stage and automatic gain control. (6 or full instructions at Size: 7 1/2 x 7 1/2 x 2 1/4 in. **10 1/2 Gns.**

12 volts, please state). Supplied with full instructions at Size: 7 1/2 x 7 1/2 x 2 1/4 in. **10 1/2 Gns.** Speaker 17/11 extra (7 x 4 ellipt.) if required. Postage and packing 5/- extra per kit.

**POCKET RADIO, 2** Transistor with miniature speaker, Complete with all parts wiring diagram and full instructions 27/6, Batteries 1/-, P. & P. 1/6.

**GUITAR PICK-UPS.** Super hi-fi non-acoustical universal fitting. High output. Complete with lead and plug, full and easy instructions, 49/11, P. & P. 2/6.

**HEADPHONE CORDS.** High quality 6ft. lengths 1/11. Post 6d.

**THROAT MIKES 1/-** each. Super quality model 2/- each. Post 6d. Could be used for electrifying musical inst., etc.

**GERMANIUM DIODES** 9d. each, 7/- dozen. Post 6d.

**VIBRATORS**, 12v. 4 pin, 4/11. Post 1/-.

**LUXEMBURG AERIALS.** Expanding complete and easy to fit. No technical knowledge required. Greatly improves reception, 3/11. V.H.F. Model 6/11. Post 6d.

All above are new and guaranteed.

**New or Surplus Valves Guaranteed and Tested by Return.**

1A7gt	11/9	6J5gt	3/9	35Z4	5/3
1C5gt	9/9	6J5m	4/3	AZ1	12/6
1D5	7/6	6J7g	5/-	CY31	12/6
1H5gt	9/6	6K7g	1/11	DAF91	4/9
1L4	3/6	6K7gt	5/6	DAF96	6/11
1N5gt	9/9	6K7m	7/6	DF91	3/11
1R5	5/6	6K8g	5/3	DF96	6/11
1S5	4/9	6L6g	7/11	DK91	5/6
1T4	3/11	6O7g	6/-	DK92	8/6
354	5/11	6SA7m	5/9	DL96	6/11
3V4	6/9	6SG7m	4/9	EB34	1/3
5Y3g	5/9	6SN7gt	4/3	EB91	3/6
5U4g	4/9	6U4gt	10/6	EBF80	8/-
5Z4g	7/6	6V6g	4/11	ECC35	6/9
5Z4m	11/-	6V6gt	6/-	ECC81	5/3
6AG5	4/-	6V6m	8/6	ECC83	6/6
6AQ5	6/-	6X4	5/9	ECC85	7/11
6AT6	7/-	6X5g	4/11	EFC82	9/-
6BB8	2/11	12A6	5/3	ECL80	7/-
6BA6	5/11	12AT6	7/6	EF36	3/-
6BE6	5/11	12AT7	5/3	EF42	7/6
6B16	5/11	12AH7	6/6	EF50	1/9
6C4	3/-	12K7	5/3	EF80	5/-
6CH6	9/-	12Q7	6/6	EF86	9/6
6C6	4/9	25L6gt	8/11	EF91	3/6
6F6M	7/-	25Z4g	7/6	EL84	6/6
6F33	6/9	35L6gt	8/11	EL91	4/6
6J5g	2/9	35V4	6/11	EY51	7/11

Any parcel insured against damage in transit for only 6d. extra per order. All uninsured parcels at customer's risk. Post and Packing 6d. per valve extra. C.W.O. or C.O.D. only. C.O.D. charge 3/- extra. S.A.E. with enquiries.

**MULTIMETERS.** 1000v/volt. A.C. and D.C. volts. 0-10, 50, 250, 500, & 1000. D.C. current 0-10, 100mA. Resistance 0-2kΩ and 0-200kΩ Baskette case, complete with test leads. BRAND NEW 59/6.

**CRYSTAL CALIBRATOR No. 10.** Good condition, tested, with instruction manual. ONLY 59/6. P. & P. 3/6.

**CANADIAN RECEIVER No. 52.** 1.75-16 Mc/s (19-170 m.) in three wavebands. R.F., Mixer, Sep. Osc., 21 F.'s, Det./A.V.C., 1st Audio. Output, BFO (10 valves), plus a 3-valve dual Crystal Calibrator. Controls: R.F. Gain, L.F. Gain, Crash Limiter, C.W. Filter, Variable Selectivity, slow and Fast Tuning and Osc. Vernier Tuning. Man or A.V.C. BFO pitch control. Internal 3in. speaker and valve check meter. Power supply required 180 v. H.T., 12 v. L.T. Data and Circuit supplied. An excellent receiver. £8.19.6. carr. 15/6. Power Supply Unit. 59/6. carr. 5/6.

**MINIATURE 373 I.F. STRIPS.**—For F.M. tuner described in P.W. With 3 of EF91, 2 of EF92 and EB91. A fresh release enables us to offer these once again. BRAND NEW with circuit and full P.W. Reprint. 35/- or 10 less valves. 12/6. Post either 2/6.

**DEAF AID—MEDRESICO TYPE** (3 min. batt. valves). Complete with min. xtal earphone, earplugs and leather case. Brand New 35/- or with batteries £2 post free.

**R-455-B**, with latest drive, first class condition. £9.19.6. Mains Power Pack. £8.10.0. Data book. 1/3 post paid. Moving Coil Phones. Finest quality Canadian, with Chamolts ear-muffs and leather-covered headband. With lead and jack plug. Noise excluding, supremely comfortable. 19/6, post 1/6.

**GIANT COMPONENT PARCEL.** Contains 100+ and 1 watt resistors. 50 HI Stab resistors. W/W resistors, carbon and W/W pots. 100 capacitors (mica, paper, Sprague, bias, variable, etc.). valveholders, tag strips, metal rectifiers, sleeving, etc. All components are unused. **GUARANTEED VALUE, 25/-**, plus 2/6 post.

**CR100 COMMUNICATION RECEIVERS.** Covers 60 Kc/s—30 Mc/s in 6 bands. 11 valves, 2 R.F. and 3 I.F. stages. Crystal gate BFO, etc. Ready for 200-250 v. A.C. mains 21 watts output for 3 ohms speaker. Later models in superb condition. £25, carr. 30/-. S.A.E. for illustrated details.

**ROA AR-88 SPEAKERS.** 3in 8in. P.M. speaker in heavy gauge black crackled steel cabinet 11 x 10 x 6in. with rubber feet. Super Quality unit. Brand New. for only 45/- p. 3/6.

**CHARLES BRITAIN (RADIO) LTD.**

11 Upper Saint Martin's Lane, London, W.C.2

TEmpLe Bar 0545

Shop Hours 9-6 p.m. (9-1 p.m. Thursday).  
Open All Day Saturday.

**GZAK: This month's bargains**

**AMERICAN "SIGNAL" MORSE KEYS**

Type M100 with switch. This excellent, lightweight, fast key is currently priced in U.S.A. at \$6.85 (£2.10s.) and is offered at only 12/6, p. & p. 1/6. Makes an acceptable present for the enthusiast.

**AERIAL EQUIPMENT**

**TWIN FEEDER.** 300 ohm twin ribbon feeder, similar K25, 6d. per yd. K35B Telcon (round) 1/6 per yd. Post on above feeder and cable 1/6 any length.

**COPPER WIRE.** 14 G., H/D 140ft. 17/-; 70ft. 8/6. P. & P. 2/-. Other lengths pro rata. Stranded 7/25, 140ft. 10/-; 70ft. 5/-. P. & P. 2/-.  
**RIBBED GLASS.** 3in. aerial insulators, 1/6 each. P. & P. 1/6.

**CERAMIC FEEDER SPREADERS.** 6in. type F.S. 10d. each or 9/- dozen. P. & P. 2/-.  
**CERAMIC "T" PIECES.** Type A.T. for centre of dipoles, 1/6 each. P. & P. 1/-.  
**2 METRE BEAM 5 ELEMENT W.S. YAGI.** Complete in box with 1 x 2 1/2in. mast head bracket. PRICE 49/- P. & P. 3/6.

**SUPER AERAXIAL CABLE.** 75 ohm, 300 watts, very low loss, 1/8 per yd. P. & P. 1/6. 50 ohm, 300 watt coax, very low loss, 1/6 yd. or 20 yds. 27/6. P. & P. 1/9.

**ACOS MIC. 35-1 CRYSTAL HAND MICROPHONE.** ONLY 25/- P. & P. 1/6.

**Absorption Wavemeters.** 3.00 to 35.00 Mc/s in 3 switched bands, marked on scale. Complete with indicator bulb. A MUST for any Ham shack. ONLY 19/6, post free.

**VARIABLE CONDENSERS.** All brass with ceramic end plates and ball race bearings. 50 pF, 57/6. 100 pF, 6/6. 160 pF, 7/6. 240 pF, 8/6, and 300 pF, 9/6. All fitted with rear extension for ganging. P. & P. 1/-. Also Flexible Couplers 1/- each.

**CHAS. H. YOUNG LTD.**

THE COMPONENT SPECIALISTS  
Dept. "P", 110 Dale End, Birmingham 4. (CEN 1635)  
(No C.O.D. under £1 please). (By return service)

**NEW VALVES!**

**Guaranteed Set Tested  
24 HOUR SERVICE**

1R5, 1S5, 1T4, 3S4, 3V4, DAF91, DF91, DK91, DL92, DL94, SET of 4, 18/6.  
DAF96, DF96, DK96, DL96, SET of 4, 26/-.

1D5	7/-	DL92	5/11	PCF82	7/6
1R5	5/-	DL94	6/9	PCL82	7/6
1S5	4/6	DL96	6/9	PCL83	11/-
1T4	3/9	EB91	2/-	PCL84	7/6
3S4	5/11	EB41	7/6	PL36	10/9
3V4	6/9	EBF80	7/9	PL81	9/-
5U4G	4/3	EBL21	12/6	PL82	7/6
5Y3GT	5/6	EC81	4/9	PL83	7/6
5Z4C	7/3	ECC82	5/9	PL84	9/6
6AM6	2/9	ECC83	6/3	PY32	10/3
6KT7	1/9	ECC84	8/-	PY80	7/6
6K8G	4/9	ECC85	7/9	PY81	6/6
6QT6	5/6	ECF80	8/3	PY82	6/3
6V6G	4/9	ECF82	8/3	PY83	7/3
6V6GT	6/6	ECH21	12/6	U25	12/-
6X5GT	4/9	ECH42	7/9	U26	10/-
12K7GT	4/9	ECL90	7/3	UABC80	7/6
12K9GT	11/-	EF41	7/6	UAF42	8/6
12Q7GT	4/6	EF80	4/9	UBC41	7/-
35L6GT	8/6	EF85	5/6	UBF80	8/6
35Z4GT	5/9	EF86	9/6	UC65	7/-
AZ91	8/9	EBF89	6/9	UCH21	12/6
GL33	11/9	ECC81	2/9	UC442	7/6
DAC32	9/6	EL41	7/-	UCH81	8/6
DAF91	4/6	EL84	6/3	UCB82	10/-
DAF96	6/9	EY61	7/3	UCL83	13/-
DF33	9/6	EY86	7/6	UF41	7/9
DF91	3/9	EZ40	6/-	UF85	8/6
DF96	6/9	EZ41	6/9	UF89	6/6
DH77	6/-	EZ80	5/9	UL41	7/-
DK32	11/-	EZ91	6/6	UL84	7/-
DK91	5/-	CZ90	8/-	UY21	11/-
DK92	7/3	MU11	7/-	UY41	5/9
DK96	6/9	PCC84	7/3	UY85	6/3
DL33	8/6	PCC89	10/-	VP4B	8/6
DL35	9/6	PCF80	7/6	Z77	2/9

Postage 6d. per valve extra. Any Parcel Insured Against Damage in Transit 6d. extra. Any C.O.D. Parcel 2/6 extra.

Office address, no callers.  
**GERALD BERNARD**  
90 CARR MANOR AVENUE  
LEEDS 17

**REPANCO**

**HIGH GAIN COILS AND TRANSFORMERS**

for the  
**HOME CONSTRUCTOR**

Send 6d. stamp for  
comprehensive List of  
**REPANCO COMPONENTS**  
and Easy-to-Build Receivers.

**RADIO  
EXPERIMENTAL  
PRODUCTS LTD**

**33 Much Park Street  
Coventry  
Tel. 27114**

**"GLOBE-KING"**

**WORLD-FAMOUS KITS AND RECEIVERS** for the Radio Amateur and S.W. Listener. Catalogue Free, enclose stamp for Postage. Kits from 79/6 at your dealers, or direct from  
**JOHNSONS (RADIO)**  
ST. MARTINS GATE, WORCESTER

**FIRST-CLASS RADIO COURSES . . .**

**GET A CERTIFICATE!**  
QUALIFY AT HOME—IN SPARE TIME

After brief, intensely interesting study—undertaken at home in your spare time—YOU can secure your professional qualification. Prepare for YOUR share in the post-war boom in Radio. Let us show you how!

**FREE GUIDE**

The New Free Guide contains 132 pages of information of the greatest importance to those seeking such success-compelling qualifications as A.M.Brit.I.R.E., City and Guilds Final Radio, P.M.G. Radio Amateurs, Exams., Gen. Cert. of Educ., London B.Sc. (Eng.), A. M. I. P. E., A. M. I. Mech. E., Draughtsmanship (all branches) etc., together with particulars of our remarkable Guarantee of **SUCCESS OR NO FEE!**

Write now for your copy of this invaluable publication. It may well prove to be the turning point in your career.

**FOUNDED 1885—OVER**  
—150,000 SUCCESSES—  
**NATIONAL INSTITUTE OF  
ENGINEERING**  
(Dept. 461), 148 HOLBORN,  
LONDON, E.C.1

S. Africa: P.O. Box 8417, Jo'burg.  
Australia: P.O. Box 4570, Melbourne

# AERIALS

BAND I BAND II BAND III

**Combined Arrays I and III**  
 1+3 Element Loft Mounting .. 38/3  
 1+5 Element Loft Mounting .. 46/9  
 1+3 Element Wall Mounting .. 45/3  
 1+5 Element Wall Mounting .. 61/-  
 1+3 Element Chimney M'ting .. 57/10  
 1+5 Element Chimney M'ting .. 66/9

**Band I**  
 Single Dipole Wall Mounting .. 24/7  
 Single Dipole Chimney M'ting .. 40/2  
 X Aerial Chimney Mounting .. 62/3  
 H Aerial Chimney Mounting .. 67/7

**Band III**  
 3 Element Yagi Wall Mounting 33/-  
 6 Element Yagi Wall Mounting 43/-  
 9 Element Yagi Wall Mounting 56/-  
 Chimney Lashing Mounting add 10/-  
 Double 6 Array, only with clamp 83/-

**Band II**  
 Single Dipole Wall Mounting .. 20/5  
 Single Dipole Chimney M'ting .. 29/9  
 H Array Chimney Mounting .. 52/4

## REPAIR KITS

Band III Folded Dipole With Insulator, Complete .. 9/3  
 Band I Insulator With Two 1/2 inch Dipoles For 1 or  
 1/2 inch Booms, Complete .. .. 19/5  
 6 inch Lashing Kit, 12/11, 7 1/2 inch Lashings Kit .. 14/3  
 6 inch Wall Bracket With U Bolts .. .. 7/10  
 1-1; 1-1 inch Clamps, 3/10, 1-2 inch Clamps Universal 5/4  
 Bracket Repair Kit, 3 Bolts; U Bolts; 20ft. Lashing  
 Wire; Thimbles; Corner Plates .. .. 6/-  
 Insulators, All Types .. .. (Enquire)  
 Co-Ax. Semi Air Spaced, 7d. vd. .. .. Plugs, 1/2  
 Send 6d. for Lists. Please state Channel when ordering.  
*Cash with Order. Post and Packing 3/- extra.*

**SATISFACTION OR MONEY BACK GUARANTEE**

## WALKER & SQUIRES

PINNOX STREET, TUNSTALL, STOKE-ON-TRENT

Phone: Stoke-on-Trent 88767

# SOLDERING EQUIPMENT

by



## PRECISION SOLDERING for the ELECTRONICS INDUSTRY

Comprehensive range - Robust & Reliable  
 - Light weight - Rapid heating - Bit sizes  
 3/32in. to 3/8in. - 'Permabit' or Copper  
 bits - All voltage ranges 6/7v. to 230/  
 250v. - Prices from 19/6.

Also

- Plastic Cable Strippers
- Miniature Solder Pots
- Heat Guards
- Long Life Bits

Illustrated is the 25w. 3/16in. replaceable bit model with safety shield.

ADAMIN—the new range of precision micro-soldering instruments—  
 Have you had details?

Brochure No. S10 sent free on request.

Sole proprietors and manufacturers:  
**LIGHT SOLDERING DEVELOPMENTS Ltd.**  
 28 Sydenham Road, Croydon, Surrey

Phone: CROydon 8589 Grams; Litesold Croydon



FOLLOWING THE STUPENDOUS SUCCESS OF THE "MIRACLE" WE NOW INTRODUCE FOR 1961

## THE CONTESSA

*A really remarkable*

## 2 BAND 6 TRANSISTOR SUPERHET KIT

*(As displayed at the Radio Hobbies Exhibition)*



The CONTESSA is the professional looking set with the professional performance.

Study these brilliant features which cannot be found in any other kit . . . .

- Waveband Coverage of 530 k/cs to 1620 k/cs and 160 k/cs to 270 k/cs.
- Assured reception of at least a dozen stations in daylight!
- Large clearly-calibrated station-named dial.
- Internal high-gain Ferrox Aerial.
- 5:1 ratio slow motion tuning.
- Fitted with the latest 12000 line high-flux loudspeaker.
- Power of 410 milliwatts from the single-ended push pull final stage.
- Specially designed aerial matching coil for use in a CAR.
- Only first grade fully guaranteed Mazda matched transistors and diodes are used.
- Double tuned IF transformers for maximum gain and knife-edged selectivity.
- Fully drilled printed circuit panel marked with component numbers.
- The two colour case measures 10 x 7 1/2 x 3 1/2 in. and weighs approx. 4 lbs.
- Battery lasts 4 months with normal usage.
- Book supplied with detailed assembly instructions, diagrams and circuitry.
- Anyone can build this set—everything supplied just a soldering iron required.

Inclusive price for all associated components, cabinet and battery, complete in every detail. **£11.10**

Plus 3/6 Regd. P.P.  
 Or our BUY AS YOU BUILD SCHEME any parts sold separately. Send for comprehensive descriptive manual and parts list, 3/6 post free.

See and hear a working model at:—

**RADIO CLEARANCE LTD.**  
 27 Tottenham Court Road, London W.1.  
 Telephone: Museum 9188

Just out!  
the NEW



**100 WATT  
SOLDERING IRON**

costs only **29/-**

including post and packing.

- Perfectly balanced
- Flat copper bit shaped for any application
- New stainless steel side plates eliminate corrosion
- Strong robust element with large surface ensures good heat transfer and long life
- Improved shock resisting moulded handle.



A really professional, high wattage iron at an economical price.

Suitable for operation at 12 v., 50 v., 100/110v., 200/220 v., and 230/250 v.1

Please state voltage required when ordering.

Send for leaflet or order direct from:

**Standard Telephones and Cables Limited**  
Industrial Supplies Division

Stanelco Process Heating, Footscray, Sidcup, Kent.  
Footscray 3333

**New from REPANCO**

**1—MINI-4. A Remarkable Four Transistor Superhet Pocket Receiver**

- ★ MEDIUM AND LONG WAVEBANDS.
- ★ SIZE OF CASE 5½ x 3½ x 1½in.
- ★ 3RD IFT REFLEXED AS AUDIO DRIVER.
- ★ AUTOMATIC GAIN CONTROL.
- ★ 2½in. LOUDSPEAKER.

Easy Wiring Plans and Step-by-Step Instructions. 1/6, post 3d.

**2—COMPONENT PACK No. 2 £2.7.6**

CONTAINS ALL THE REPANCO COMPONENTS FOR THE MINI-4. FS39. Ferrite slab aerial, two XT26's, 1st and 2nd IFT's, XT27 3rd IFT, X028 osc. coil, all pre-aligned. TTS transformer group board, switch and speaker pillars.

**3—SHORT WAVE TRANSISTOR COILS**

Range	Aerial Coil	H.F. Coil	Oscillator Coil
1. 85 to 200 metres ...	XTA31	XTF32	XOT33
2. 35 to 85 metres ...	XSA34	XSF35	XOS36
3. 16 to 43 metres ...	XSA37	XSF38	XOS36

All coils Litz wire, enclosed in high frequency ferrite pots and tuned with ferrite cores. Can size ½in. sq. x ½in. 208-176 gang. 465 kc/s IFT's. With Circuits **10/- each**

**4—COMPONENT PACK No. 1 18/-**

Contains two XT26. 1st and 2nd IFT and XT27. 3rd IFT pre-aligned to 465 kc/s. Ferrite core and pots. Can size ½in. sq. x ½in. Designed for earthed emitter operation.

Mail Order and Trade:

**RADIO EXPERIMENTAL PRODUCTS LTD.**  
33 Much Park St.,  
COVENTRY  
Tel.: 27114

Wholesale Inquiries and Export:

**REPANCO LTD.**  
O'Brien's Buildings,  
203-269 Foleshill Rd.,  
COVENTRY  
Tel.: 24224

**BENSON'S BETTER BARGAINS**

**SWITCHES:** Wafer: 2 pole, 4 way, 4 bank 1P2W6B, 4P2W2B, 1P7W3B, 1P11W2B, 4P2W6B, 3/8 each. Ceramic 2P4W1B, 1P6W2B, 1P11W, 3P3W2B, 4P3W1B, 3/8. **STUD.** 1P24W2B, 1P8W2B, 3/8; 1P19W2B, 5/8; 1P40W3B in brass case, 12/8. **TOGGLE:** DPST, 2/-; SPST, 1/8. **MORSE KEY** with buzzer, on board, wired for 41 v. battery, 8/6 (p.p. 1/6). **TELE "P"** intercom sets, good condition, pair 65/-, post free **GT. B. METERS** (100/4) with two movements, 600 and 400 μA, 8/6. **TRANSFORMERS.** Open, upright, input 200/250 v. Outputs:—250-0-250 v., 150 mA 5 v. 3 A. and 6.3 v. 5 A., 25/-; Input 110/230 v. Outputs:—5 v., 2 A. twice, shrouded, 10/6 Input 110/240. Output 1800 v. 4 mA, 12/8. **MONITOR 58.** triggered oscilloscope, 230 v. A.C. input, with cables and circuit. Cathode probe unit extra, 17/8. **£8.10.0.** (Rail 15/-) **CR100** Noise Limiter assemblies with valve, 3/6. **NEW M.C. METERS,** 3½in. round flush, 50 μA, 70/-; 200 μA centre zero, 50/-; 1 mA, centre zero, 45/-; 1 mA, 55/-; 2½in. 1 mA, 22/6; 100 mA, 8/6; 2½in. 300 mA, each 8/6; 2½in. M.I. 20 v. A.C., 8/8; 300 v. A.C. 2½in., 15/-; 100 v. A.C. 3½in., 45/-; 150 v. A.C. M.I., 68/-; in case 45/-, **VIBRATORS,** Mallory 0634C, 12 v. 4-pin, 7/8; 8 v. 5-pin reversible, 7/8. **DRIVES:** slow-motion Admiralty 200:1 ratio, eased 0-100, 5/6. **R1155 S.M. "N"** type, new 10/6. **VIBRAK.** 2 v. D.C. to 250 v. 0.00 mA, unsmoothed used, 22/8 (p.p. 3/8), or 12 v. 25/-, **DYNAMOTORS** (post 3/6), 12 v. to 230 v. 80 mA, 11/8. 6 v. to 250 v. 60 mA, 11/8. **CHOKES.** LF 10H, 200 mA, 8/8; 100H, 80 mA, 8/8; 9H, 100 mA, 5/8; Potted 10H, 100 mA, 7/8; "C" 10H, 200 mA, 12/8 6H, 400 mA, 10/8; 30H, 50 mA, 7/8. **R.F. 27.** good cond., 18/- (p.p. 3/6). **HEATERS:** Strips, enclosed, 220 v., 100 watts, 3/8; finned, 115 v., 200 w. 2/-; **RELAYS.** (LONDEX) co-axial, small 12P4 v., 7/8. **CRYSTALS** 12 to 8 3/8 Mc/s 6/- each (state frequency required). **LIST AND ENQUIRIES** S.A.E. please. **Terms, C.W.O.** Postage extra. Imm. despatch. **Callers and post:** W. A. BENSON (P.W.), 138 Rathbone Road, Liverpool, 15. 8E2 P 6563. **Callers:** SUPERADIO (Whitechapel), Ltd., 118 Whitechapel, Liverpool 1. **ROY 1130.**

**A.R.R.L. RADIO AMATEURS HANDBOOK 1961**

New edition, 32/8. Postage 1/0  
World Radio Handbook for Listeners 1961, 16/6, postage 1/-.  
Radio, TV Tube, Diode and Transistor Equivalents Manual by Babani, 9/6, postage 9d.  
Mullard Reference Manual of Transistor Circuits, 12/6, postage 1/-.  
Coil Design and Construction Manual, R.F., A.F. Coils, Chokes and Transformers, 5/-, postage 6d.  
Surplus Radio Conversion Manual, New Vol. 3, 20/-, postage 1/-.  
Using an Oscilloscope by Easterling, 6/6, postage 6d.  
Radio Controlled Models by Camm, 12/6, postage 1/-.  
TV Engineers' Pocket Book, new 3rd edition by Hawker, 12/6 postage 9d.  
**UNIVERSAL BOOK CO.**  
12 Little Newport Street, London, W.C.2 (adj. to Inna Lisle Street)

**BBC - ITV - F.M. AERIALS**

**B.B.C. (BAND 1).** Tele-scopic loft, 19/8. External, S/D, 26/3.  
**I.T.V. (BAND 3).** 3 Element loft array, 24/-; 5 Element, 32/8. Wall mounting, 3 Element, 33/8. 5 Element, 41/3.  
**COMBINED B.B.C. + I.T.V.** Loft 1+3 Element, 41/3. 1+5 Element, 48/9. Wall mounting, 1+3 Element, 56/3. 1+5 Element, 63/8. Chimney and mast mounting units also available.  
**F.M. (BAND 2).** Loft "H", 26/-; 3 Element loft, 52/8. S/D loft, 12/6. External S/D, 26/3. State channel when ordering. C.W.O. or C.O.D. P.P. 2/6. Coaxial cable, 8d. yd. Coaxial plugs, 1/3. Send 6d. stamps for illustrated lists.  
**K.V.A. ELECTRONICS (Dept.P.W.)**  
3B, Godstone Road, Kenley, Surrey.

**CABINETS & HI-FI EQUIPMENT**  
We can supply any Cabinet to your own specification



**"Grosvenor" £19.10**  
This is only one example taken from our extensive range of stock cabinets. Write for our NEW 24 page fully illustrated catalogue on:  
**THE LARGEST RANGE OF CABINETS IN THE COUNTRY.** Equipment is also our speciality and we now offer in a novel book form: A NEW EQUIPMENT COMPARATOR illustrating our range of radio chassis, speakers, tape decks, single players and autochangers.  
**SEND TODAY for a copy of these two books, which are absolutely FREE.**

**LEWIS radio**  
100 (P.W.31) Chase Side  
Southgate, London, N.14. Pal 3733



FOR BARGAINS

# M.S. RADIOPOST CO.

MAIL ORDER SPECIALISTS

Please quote Dept. M.O.P.W.  
 36 WINCANTON RD., HAROLD HILL, ROMFORD



**MINIATURE DYNAMIC SPEAKERS**  
 A must for all Build-it-yourself-Hams. As supplied with all current transistor Kits. Can also be adapted for home phones or Intercom. 2 1/2" diameter. Resistance 70 ohms. ONLY 5/- each.

**HYSTERESIS MOTORS.** By Smith's Aircraft Instruments. Type: HM/21/D. Drag Cup, 2 v. 400 cycles, 40/- ea. New. Type: HM/14/L. 115 v. 400 cycles, 50/- ea. New. Type: HM/14 Blower type 115v. 400 cycles, 80/- ea.

**PLESSEY E.H.T. CONCENTRIC CONNECTORS**  
 Types available. Flugs: CZ 6462/6463/6464. Sockets: CZ 6465/6466. New and unused. For Radar Stations, TV Link-ups and Atomic research application.



8/6 pr. or 5/- ea.

**MINIATURE MODEL MOTOR**  
 (Not Ex-Govt.) Removed from Transistor Tape Recorders and in perfect condition. 3 to 12 volt. Dual spindle fully reversible. Protected bearings. Approximately 8/4000 r.p.m. Size 1 1/2" long x 1 1/2" dia. Spindle: 1" x 1/32"



**HEADPHONE AND MICROPHONE ASSEMBLY** No. 1. Moving coil. As used on W.S. No. 19. New and packed. 21/- complete assembly.

**AMPLIFIER FIELD TELEPHONE** No. 1. Single stage amplifying designed to extend the working range of Telephones Type B or L. Complete with working instructions, spare valve and Canvas carrying case. New. 27/6 each.

**BLOWER MOTOR.** Made by Hoover 80 volt. Will operate on 240 volt A.C. with 8 mfd. condenser in series. New and cartoned. 17/6 each.

TERMS: C.W.O. or 7 days approved accounts. All our goods are guaranteed new or in working order. Money refunded in full if not absolutely satisfied. Orders despatched same day. **NO POSTAL OR PACKING CHARGES.** O.O.D. 1/8 extra. Carriage extra Ireland and countries outside U.K.

## SOUTHERN RADIO'S WIRELESS BARGAINS

**PORTABLE TEST METERS.** 0-5000 ohms; 0-60 mA; 0-1.5 v. 0-3 v. 12/6 each.

**METERS.** 30-0-30 and 3-0-3 volts, with leads. 15/-.

**ATTACHMENTS FOR "38" TRANSMITTER-RECEIVER:** Headphones, 15/6; Throat Microphones, 4/6; Junction Boxes, 2/6; Aerials, No. 1, 2/9, No. 2, 5/3; Webbing, 4/-; Haversacks, 5/6; Valves—A.R.P. 12, 4/6, A.T.P. 4, 3/6. Set of five valves, 19/-. Postage on each item 1/6 extra (except valves). **TRANSMITTER-RECEIVERS.** TYPE "18", MARK III. Brand New, complete with 6 valves, etc. £4.10.0, carriage paid.

**ATTACHMENTS FOR "18" TRANSCEIVER.** Headphones, 15/6; Microphone 4s. 12/6; Aerials, 5/-; Morse Key, 6/6; Valves—A.R.P. 12, 4/6, A.T.P. 4, 3/6, A.R.8, 7/6; Set of six valves, 25/-. Postage extra (except valves) 1/6 each item.

**QUARTZ CRYSTALS.** Types F.T.241/F.T.243 2-pin 1/2" spacing. F.T.241 20 to 38.9 Mc/s (54th and 72nd Harmonic). F.T.243 5700 to 8650 kc/s (Fundamental), 4/6 each. Lists of available frequencies on request. Crystal Holders for F.T.241/243, 1/3s. F.T.241/243 Crystals. New but not guaranteed (ideal for using the case or regrinding). 12/6 per dozen, post paid.

**RECORDING BLANKS.** New. 13in., 6/- each or 15 complete in Tin, £4.

**BOMBSIGHT COMPUTERS.** Ex-R.A.F. Wealth of gears, motors, blowers, etc. Ideal for experimenters. £3.12.6, carr. paid. **RESISTANCES.** 100 Ass'd. Useful values, new wire-ends, 12/6 per 100.

**CONDENSERS.** 100 Ass'd. Mica, Elec., Tubular, etc. New. 15/- per 100.

**MORSE PRACTICE SETS.** Key with Buzzer on Base, with battery, 12/6, postage 2/-.

**LUBRA HOLE CUTTERS.** Adjustable. 3/8" to 3 1/2". 7/3.

**STAR IDENTIFIERS.** I-AN. Covers both hemispheres, 5/6.

**VISUAL INDICATORS (10 Q4).** Type 3 with 2 meter movements, 2 neons. New. 12/-.

**MAGNETS.** Strong Bar. 2" x 1/2". 1/6 each.

**COMMAND RECEIVERS** B.C. 454 3-6 Mc/s. B.C. 455 6-9 Mc/s. Complete with 6 valves, new condition. 47/6 each.

**POST OR CARRIAGE EXTRA, FULL LIST OF RADIO BOOKS, ETC., 3d.**

## SOUTHERN RADIO SUPPLY LTD.

11 LITTLE NEWPORT ST., LONDON W.C.2. GER. 6653

# Electronics (FLEET ST.) Ltd

Dept. B

152/153 Fleet St., London, E.C.4. Tel. FLE 2833  
 Business Hours: Weekdays, 9-6, Saturdays, 9-1

Stockists for  
**AMPLIFIERS, V.H.F. TUNERS, HI-FI SPEAKERS BY ALL THE LEADING MANUFACTURERS**

\*\*\*\*\*  
 ★ **THE NEW JASON range** ★  
 ★ **for CONSTRUCTORS** ★  
 ★ **JTV2 Tuner** completely assembled ready for use £25.7.  
 ★ **FMT1 FM Tuner.** In kit form for cabinet mounting. One of the most popular tuners. Up to 60 miles normal range. Including valves £6.15. Power Pack kit £2.14.9.  
 ★ **FMT2.** In kit form with free standing case with power pack. Including valves £8.19.6.  
 ★ **FMT3.** Variable tuner 88-108 mc/s. Variable AFC control dual limiters, approx. 80 mile range, including valves £10.19.6.  
 ★ **JTV2 Tuner** self-powered switched tuner for FM and TV sound. Both BBC and ITA as required, including valves £13.19.6.  
 ★ **MERCURY II** switched FM/TV sound tuner in kit form for building into cabinet, including valves, £10.10. Power pack kit, £2.14.9.  
 ★ **EVEREST 6** s/het transistor, portable, p/pull output, high quality speaker, matched transistors, neatly designed case, aerial input for use in car, complete kit £13.19.9.  
 ★ **EVEREST 7** transistor s/het portable, p/pull output, high quality speaker, extra RF stage, neatly designed cabinet, aerial input for use in car, all components complete £15.18.9. 2/6 post and pkg. on all the above, S.A.E. for details.  
 ★  
 \*\*\*\*\*

### PORTABLE BATTERY ELIMINATOR

MADE BY COSSOR

Housed in two containers which are to replace AD35 and B125 Batteries. 45/-, plus 2/- P. & P. Only suitable for use with Dk96 Series valves.

### LIMITED NUMBER THIS STEREO OFFER!

Compact Stereo amplifier, 3 watts each channel using 2-ECL82, 1-EZ80, separate balance and tone controls, volume and on/off switch channel reverse switch, designed for crystal pick-up, separate power pack, including 2-6 1/2 P.M. speakers in cabinets, finished imitation Rexine. Complete and ready for use £8.19.6. P. & P. 10/-.

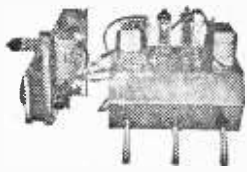

\*\*\*\*\*  
 ★ **DECCA PORTABLE AMPLIFIER.** As supplied in famous DECCAMATIC III. Complete with small cream knobs. Full range tone and volume controls. Employs ECL82 valve, Metal Rectifier. Size 3 x 3 x 8 1/2 in. Only 59/6 plus 2/6 P. & P.  
 ★ **SPECIAL CELESTION** 8 x 6in. elliptical high flux loudspeaker to fit. 30/- plus 1/- P. & P.  
 \*\*\*\*\*

### A SNIP FOR CONSTRUCTORS

Build the Labgear Audiot Output meter. Two ranges—25 milliwatts to 1 watt, 1 watt to 100 watts. Accuracy 5% Input impedance 3, 15 and 600 ohms. Printed circuit. All components including O-1MA moving coil meter and silver hammettone enamel case. Kit complete with instructions 59/6, post and pkg. 1/6.

# Premier RADIO

23 TOTTENHAM COURT ROAD, LONDON W.1  
and at 309 EDGWARE ROAD, LONDON W.2

TEL.: MUSEUM 3451/2  
TEL.: PADDINGTON 6963

## "THE MID-FI" A NEW DESIGN 4½ WATT AMPLIFIER KIT

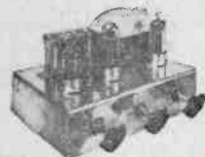

MAY BE BUILT FOR 95/- plus 3/- p. & p.

A new circuit for the home constructor requiring a good quality medium powered Amplifier for reproduction of Records of F.M. Broadcasts. For use with Loudspeakers of 3 or 15 ohms Impedance. Technical Specifications: separate bass and treble controls. Valve line-up EF86, EL84, EZ80. Voltage adjustment for A.C. mains from 200-250 volt. Negative feedback. Size 7 x 5 x 2in., overall height 5in. Silver hammered finish Chassis. Instruction Book 1/-.



## The "Petite" PORTABLE

MAY BE BUILT FOR

£7.7.0 Plus 3/- p. & p.

BATTERIES EXTRA. H.T. 10/- (Type B126) or equivalent L.T. 1/6 (Type AD35) or equivalent. ★ Size only 8 x 8 x 4½in. ★ Instruction book 1/6.



## THE PREMIER TR/2

Once again Premier is first with another magnificent offer. Introducing the "TR/2" the latest and cheapest addition to our range of popular Recorders.

- Star features:
- ★ Latest BSR Tape Deck, with interlocking device to prevent accidental erasure.
  - ★ Single speed 3½in. per sec
  - ★ Playing time 5½in. std. tape, 1½ hrs; L.P. tape, 2 hrs 8 mins.
  - ★ Volume on/off and tone control.
  - ★ Power output 3 watts.
  - ★ Input sockets for Microphone, Radio/Gram.

PRICE including Microphone tape and spare spool 19 Gns. Plus 15/- p. & p.

★ Extension speaker socket. Size: 13½ x 9½ x 6in., weight 17 lb.

### SPECIAL BARGAIN OFFER THE PERFECT STEREO SYSTEM:

Two DL7-35 power amplifiers; Original cost £91.0.0  
One SP21 Stereo Control Unit.

**Our Price 47 Gns.**

Brief Specifications: SP21 Power requirements 6.3V at 1.3A A.C., 250V at 5mA D.C. Dimensions 14½ x 9 x 4in. ORIGINAL PRICE £28.10.0 DL735 Power output each amplifier, 54 watts peak. Valve line-up: GZ34, 2-EL34, ECC83, EF86. L.S. impedance 4, 8 or 16 ohms, switch selected. ORIGINAL PRICE 30 GNS.

**MICROAMMETER.** 0-50µA. 3 x 2½in. brand new Weston, scaled 0-3, 0-30, 0-300, real bargain 22/6, post 1/3. Multimeter circuit 9d., FREE with meter.  
1% 1W High Stab. Resistors 1/6 each. Limited offer to clear, 100, 900, 1K, 8.2K, 10K, 15K, 20K, 39K, 70K, 100K, 150K, 225K, 250K, 270K, 500K, 900K, 1M, 1.5M, 2M.  
1% 1W High Stab. Resistors 2/- each, all standard values plus 5K, 3K, 3.5K, 25K, 30K, 40K, 50K, 60K, 70K, 75K, 80K, 200K, 300K, 400K, 450K, 500K, 600K, 700K, 750K, 800K, 2.5M, 3M, 4M, 5M, 6M, 7M, 8M, 9M, 10M. 1W, 2W, to order, many non-standard values.  
Min. Neoms, mains holder, resistor, 2/-.  
RF meter. 0-350mA RF, 5/-, post 1/3.  
Shunt for 1mA 100 ohm meter, ranges 10, 100, 1000mA, 1% accuracy. 8/6.  
Shunt for 500µA 500 ohm meter. Ranges 5, 50, 500mA, 1% accuracy. 8/6.  
Shunt resistors to order, please state requirements. Wirewound resistors 1%, 1% and 0.2% to order.

Postage extra. S.A.E. enquiries, please.  
**PLANET INSTRUMENT CO.**  
25 DOMINION AVE., LEEDS 7.

### CAN YOU BEAT THIS?

All the components in the I.F. chassis of P.W. Superhet Job. Nov. Issue, including Coils, Transistors (Ediswan), Resistors and Condensers for £2.9.0.  
The "Jonno" high rain potted coil for Transistors, 10/- per set. Let us quote you for your needs. S.A.E. for lists.

### JONNO

32 Heathfield Gardens, Chiswick W4

### DO IT YOURSELF

Build your own electronic keyboard and play everything! Send for free leaflet. Guitar, cello, flute and trumpet are all easy. Write now...

C. & S., 20 Maude Street,  
Darlington, Co. Durham.

The ideal book for every serious model maker . . .

## RADIO - CONTROLLED MODELS

by F. J. Camm

Contents Simple Steering Control Gear: A Single-valve Super-regenerative Receiver: A Two-valve Transmitter for Radio Control: Control Box: Wavemeter, Interference, Layout: Obtaining a Second Channel Using the "Mark/Space" System: A Proportional Steering Circuit and Reversible Sequence Engine Control Gear: Radio-controlled Boat using a Glow-plug Engine and an Electric Motor in the Power Unit: A Six-valve Super-heterodyne Receiver for Model Control: A Single-valve Crystal-controlled Transmitter: Radio Control for Model Aircraft (Sequence System): Tuned Reeds and Audio Control: More About Model Actuators: Tuning Model-control Transmitters Aerials: A Bulb Model-control Frequency Meter: An Auto-switch for Model-control Transmitters: A Radio-controlled Model Battleship: Building a Radio-controlled Model Aircraft.



Fully illustrated with circuit details, diagrams and photographs.

12s. 6d. FROM ALL BOOKSELLERS

... or in case of difficulty 13s. 6d. by post from C. ARTHUR PEARSON LTD., Tower House, Southampton Street, London, W.C.2.

PEARSON

# CODAR "CLIPPER"

All Band Receiver, 10-2000 metres!

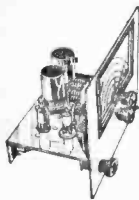

- Anyone can build this amazing radio in one evening. Listen to:
- ★Amateurs, shipping, aircraft, short, medium and long wave stations throughout the world!
  - ★Precision 7" x 4in. dial with two pointers, dual slow motion 8-1 and 42-1 ratios, complete with escutcheon!
  - ★Bandspread on ALL bands!
  - ★Air-spaced tuning and regeneration condensers!
  - ★Polystyrene iron-cored plug-in Coils!

Tremendous performance with latest circuitry using Hi-gain regenerative valve detector **PLUS** Transistor Booster Stages! Transistor stages are completely assembled, tested, in sealed cans, only 3 wires to connect! Chassis 8 x 5 1/2 in., all holes punched, ready for simple assembly with step-by-step instructions.

Uses small standard dry batteries which will last many months.

"**CLIPPER**" Kit, complete with all components, valve, one transistor stage, nuts, bolts, wire, 2 coils 20-60 and 55-180 metres.....79/6, P. & P. 2/-  
Extra transistor stage can be added at any time.

"**SUPER CLIPPER**" Kit, complete, two transistor stages.....88/6, P. & P. 2/-  
Optional Front Panel, 10 x 7 1/2 in., beautiful stoved Silver Hammer finish, dial aperture and holes punched, dial glass.....6/9, P. & P. 1/6.

Send 3d. stamp for Leaflet. Advanced details of other models now available.

## CODAR RADIO COMPANY

Colebrook Road, SOUTHWICK, Sussex

### PRINTED CIRCUIT

for

## "PRACTICAL WIRELESS"

# POCKET S'NET

(TRANSISTORISED)

A to Z Constructional Booklet 1/6

"Wonderful Results & So Easy to Build"

### PRICE LIST & INFORMATION

**OSMOR RADIO PRODUCTS LTD.**

418 BRIGHTON ROAD

8. CROYDON

## UNIVERSAL VOLT-OHM-MILLIAMETER



At last a first grade multi-tester within the reach of everyone's pocket, and a necessity to all interested in Radio and T.V. Reads A.C. and D.C. Volts up to 1,000 in 5 ranges, at 1,000 ohms per volt, D.C. current (3 ranges) to 300 mA. Resistance readings to 200 K Ohms in 2 ranges. Basic movement 300µA sensitivity. Easily read open scale, beautifully made and fully guaranteed. Limited number available under strict quota. Complete with leads, prods, and internal battery.

**ONLY 59/6**

**COMMUNICATIONS RECEIVER RH55.** The famous Bomber Command receiver known the world over to be supreme in its class. Covers 5 wave ranges 18.0 to 7.5 Mc/s, 7.5 to 3 Mc/s, 1.500 to 600 Kcs, 500 to 200 Kcs, and 200 to 75 Kcs, and is easily and simply adapted for normal mains use. Full details being supplied. All sets thoroughly tested and in perfect working order before dispatch, and on demonstration to callers. Fitted latest type super slow-motion tuning assembly. Have had some use but are in excellent condition. **ONLY £9.19.6. A.C. MAINS POWER PACK OR PLUG STAKE**, for the above in black crackle case to match receiver, enabling it to be operated immediately, but just plugging in, without any modification. With built-in 8in. speaker, **£8.10.0. DEDUCT 10/- IF PURCHASING RECEIVER AND POWER PACK TOGETHER.**

Send S.A.E. for illustrated leaflet, or 1/6 for 10-page booklet which gives technical information, circuits, etc., and is supplied free with each receiver. Add carriage 10/6 for Receiver, 5/- for Power Unit.

**R.C. 42 RECEIVERS.** A few only of these famous American sets covering 1.15—18.0 Mc/s in six bands. Internal 115 v. A.C. mains pack. Super receiver in first class condition, and perfect working order. **ONLY £25 (carr. 15/-).**

**H.R.O. MAINS POWER UNITS A.C. input 115/230 v. output D.C. (fully smoothed) 230 v. 75 mA, and 6.3 v. 3.5A.** Complete in black crackle case. **ONLY 59/6.**

**12 WAY SCREENED CABLE.** In 10 foot lengths, fitted with plugs, originally made of No. 19 Wireless Set. **UNUSED ONLY 15/- per lead.**

**POCKET VOLTMETERS.** Read 0-15 volts and 0-300 volts A.C. or D.C. **BRAND NEW and UNUSED. ONLY 18/6.**

**CANADIAN MOVING COIL PHONES.** Low resistance, fitted noise excluding chamomile ear muffs, and leather covered head band. Lead terminates to jack plug. Supremely comfortable. **BRAND NEW. ONLY 19/6 (post 1/6).**

**INTERCOM TELEPHONE SET.** Two pairs of Brand New Headphones connected to Breast Microphones, with leads, etc. in fitted carrying cases. Supplied with 4½ volt battery, 10 yards twin wire, and full instructions for connecting to make super intercom. **ONLY 27/6 (post 3/6). Extra Wire 3d. per yard.**

**RCA 8in. P.M. SPEAKER.** In heavy black crackle metal case. Can be used as normal 3 ohms extension. Size 1 1/2 in. x 10 1/2 in. x 6 1/2 in. **NEW IN MAKER'S CARTONS. ONLY 45/- (post 3/6).**

**AMERICAN HALLIBROTTERS 6 VOLT VIBRATOR-PACK.** Output 300 volts D.C. at 170 mA. Designed to run Communications Receivers from 6 volt car battery. In grey metal case, size 6 1/2 in. H. x 6 1/2 in. W. x 7 1/2 in. D. Complete with 2 valves, 6N6, and instructions, in maker's cartons. **BRAND NEW and UNUSED. ONLY 29/6 (carr. 3/6).**

**POWER UNIT TYPE 3.** Primary 200/250 volts A.C. 50 cycles. Outputs of 250 volts 100 mA, and 6.3 volts 4 amps. Fitted double smoothing, and 2 metres to read H.T. Current and Voltage. For normal rack mounting (or bench use) having grey front panel, size 19 in. x 7 in. **BRAND NEW. ONLY 79/6 (carriage 7/6).**

**10/- CONSTRUCTION PARCEL.** 10 yards each of 6 colours wiring wire, solder, 24 each assorted Resistors and Condensers. **RESISTORS.** 100 assorted values. **NEW 10/-.**

**CONDENSERS.** 100 assorted mica and silvermica. **NEW 12/6.**  
**SPRAGUE CONDENSERS.** Metal cased, wire ends. New 0.01 mfd. 1,000 volt, and 0.1 mfd. 500 volt, 7/6 per dozen. Special quotes for quantities.

**MINIATURE MOTORS.** Ideal for models. Will operate on 3-6 v. D.C. Size 1 1/4 x 1 x 1 1/2 in. plus 1/4 in. spindle. **BRAND NEW only 7/6.**

# HARRIS ELECTRONICS

(LONDON) LTD.

138 Gray's Inn Road, London, W.C.1.

(Phone TERMINUS 7937)

Please include carriage costs on all items.

(Open until 1 p.m. Saturdays). We are 2 mins. from High Holborn (Chancery Lane Station) and 5 mins. by bus from King's Cross.

**THE  
PEMBRIDGE  
COLLEGE  
OF ELECTRONICS  
offers training in  
RADIO  
TELEVISION  
AND ELECTRONICS**

**ATTENDING COURSE**

Full-time One Year Course in Radio and Television. College course in basic principles for prospective servicing engineers.

Next course commences 18th April, 1961.

This course is recognised by the Radio Trades Examination Board (R.T.E.B.) for the new Servicing Certificate examinations.

**HOME STUDY COURSES**

A. Radio and Television Servicing

(1) Introductory course.

(2) Basic course covering R.T.E.B. Intermediate Radio and Television Servicing Certificate examination.

B. Courses in Radio, Telecommunications and Mathematics up to City and Guilds Telecommunication Technicians' Final Certificate.

For details, write to:

The Principal, P.10

**THE PEMBRIDGE COLLEGE  
OF ELECTRONICS**

34a Hereford Road, London, W.2

PC12

**LOOK! TRANSISTORS**

RED SPOTS 3/- WHITE SPOTS 3/6  
YELLOW/GREEN 3/9 RED/YELLOW 6/6  
Germanium Diodes 1/- each, 3 for 2/6  
7/6 per dozen.

Mullard O A70, O A79, or O A81 4/- each.  
G.E.X. 34 Diodes 4/- each.

Transistor Holders 1/3 each, 3 for 3/6.  
Miniature Slider Switches DP/TD (ideal for  
Transistor Sets) 2/9 each.

Solon Instrument Irons 25W, 24/-.

**LOOK! RECORDING TAPE**

American Ferrodynamic, "Brand Five"  
Standard 5in. 600 ft, 16/- 7in. 1200ft, 25/-

Long Play, 5in. 900ft, 18/6 7in. 1800ft, 35/-

**LOOK! For the P.W. Pocket Superhet**  
Repaco TT9 or TT10 Transformers, 12/6  
each. Osmore Ferrite Rod Aerial, 10/-

Osmore Osc. Coil and Three I.F.T.s, 22/6 set.  
Celestion C25 2 1/2in., 3 ohm Speaker, 26/8.

Repaco DRX1 Crystal Set Coil M. & L., 2/6.  
DRR2 Dual Range Coil with Reaction, 4/-

Reaction Condensers, 0.0001, 3/-, 0.0003,  
3/9, 0.0005, 4/-. Miniature Type 0.0005,  
4/- each.

Sub. Miniature 15 volt Electrolytics in  
2μF, 5μF, 8μF, 10μF, 25μF, 50μF, 100μF,  
250μF, 500μF, or 1000μF, all 3/- each.

ALL SENT POST FREE IN U.K. by

**PETHERICK'S RADIO  
SUPPLIES**

22 High Street, Bideford, N. Devon

A 3d. stamp will bring you a copy  
of our latest

**RADIO & TELEVISION  
COMPONENT Catalogue**

**JAMES H. MARTIN & CO.**  
FINSTHWAITHE, NEWBY BRIDGE,  
ULVERSTON, LANCs.

**PADGETTS RADIO STORE**

40 MEADOW LANE, LEEDS 11

12in. TV Chassis for Spares. Four for  
10/-, carr. 5/-.

12in. TV Tubes. Mullard or Mazda types.  
3 months' guarantee as removed from sets.  
30/-, carr. 7/6.

SCR323 Receiver. Complete with all  
valves. Sets as new. 16/-, carr. 7/6.

SCR Transmitter. Less valves but  
complete with Mod. and Driven Transfor-  
mers. Like new. 5/-, carr. 5/-.

Special Offer, 14in. 13 channel BBC-ITV  
sets. Bush, Pye, Ferguson, Ekco, etc.

All sets in good working order, tubes not  
boosted. £7.10.0. 12in. TV sets as above

£4.10.0. 12in. BBC only five channels.  
55/- Carriage and Insurance on any TV  
Set 17/-, N.I. 30/- None Working TV Sets

14in. £3.0.0. 12in. BBC 30/-  
New Tube Units complete with VCR97 and  
EF50 valves, etc. 15/-, carr. 7/6.

1154 Tx. Complete, 18/-, carr. 12/-.

**SPEAKERS removed from TV sets,**  
P.M. 3Ω, 8in., 6in., 5in., 7 x 4in., all one  
price 5/-, post 2/- Best makes and in perfect  
guaranteed condition.

**Valves removed from TV Sets—all tested**  
and are 100 per cent as new. Three months'  
guarantee. These valves are from Rental  
TV Sets and a lot of them have been replaced  
and are as new.

EF80 2/6 6H6 1/- 6P28 5/-  
6SN7 2/9 KT63 5/- 6AL5 5/-

6SL7 2/9 ECL80 5/- 6K25 5/-  
10P13 5/- 6AB8 2/6 10P14 5/-

10F1 3/- EF90 2/6 L63 3/-  
10C2 3/- EY31 5/- 6J5 3/-

20P3 5/- PY82 5/- 6J5 3/-  
PY81 5/- PZ30 5/- KT36 5/-

PL82 5/- U25 5/- N37 5/-  
20D1 5/- PZ80 5/- 6LD20 5/-

20L1 5/- Z77 3/- 27SU 5/-  
20P1 5/- 6BX6 3/- 27SU 5/-

PL81 5/- Z152 3/- EBF80 5/-  
EF50 1/9 6P25 5/- DH77 5/-

VR150/30 4/- 6F1 3/- 6P13 5/-  
VR65 1/6 5U4 3/- 6F14 5/-

VR91 1/- PL38 5/- 6F15 5/-

All Valves Post Free.

All types for 12in. G.E.C. TV Sets in Stock

**TRANSISTORS**

Red Spots, 3/-; White Spots, 3/3; Yell/GR,  
3/9; Ediswan XB104, 8/6; XA103 (4  
Mc/s), 10/-; XA104 (6/8 Mc/s), 12/-;

Mullard OC70, 14/-; OC71, 14/-; OC72,  
17/-; OC44, 26/6; OC45, 23/-; OC170 (70  
Mc/s), 35/-; Newmarket V15/10P (10  
watt power), 15/-; Diodes, 1/- and 2/6;

Mullard Diode, 4/-; Transistor Holders,  
1/-; Electrolytics (sub. min. 15V) 2, 4, 8,  
50, 100μF, 3/- ea.; Ardenne Trans. D239,  
8/6; D240, 8/6; D131, 12/6; D132, 12/6;

T1079, 12/-; D167, 12/-; Headphones L.R.,  
8/6; H.R., 17/6; Resistors 10% tol.,  
6d.; 5% tol., 1/-; Tannoy Mike, 5/-;

Desk Mike, 3/16; Balance Inserts (use  
as earpiece or speaker), 2/6; M.C. Ear-  
piece (use Min. Speaker), 5/-; Westalite  
Contact Rectifier 250V, 60mA, 7/6; Trans.

200/250V in, out 250-0-250, 6.3V, 5V,  
15/-; Phillips Trimmers 30pF, 1/-; Jack P.  
and Socket, 2/6; Garrard Record Player  
Motor (45 r.p.m.) and Pick-up for Transis-  
tor Amplifier, 70/-; Meter 200mA MC,  
FM 2 1/2, 12/6; 5 amp RF (2mA), 8/6;

Hearing Aid Mike, 3/16; Super Coax.  
75 ohms, 6d. yd.

**TERMS.**—Cash with order. Post extra,  
excess refunded. Morco Reflex Rx, best  
2-transistor Receiver. Send 8d. stamps  
for notes.

**MORCO EXPERIMENTAL SUPPLIES**  
8 & 10 Granville Street, Sheffield 2  
Tel.: 27461

# COYNE'S NEW PIN-POINT SERIES TAKES HEADACHES OUT OF ALL SERVICING PROBLEMS!



No. 1  
*Pin-Point*  
TV troubles  
in 10 minutes

Find the exact sound or picture trouble in ANY TV set from 700 possibilities! Latest edition now has 332 pages of solid TV servicing information; 300 diagrams, check charts, 3176 Postage 1/-.

**SPECIAL OFFER**

Circle Book No. 1 on coupon, send only 16/3 after 7 days, and 16/3 in 30 days, making a total of 32/6 including postage.

No. 2  
*Pin-Point*  
Transistor  
troubles in 12  
minutes



Trouble-shoot every type of circuit in ALL transistorized equipment! 523 pages; hundreds of illustrations; 120 check charts. 47/6, postage 1/6. Circle Book No. 2 on coupon.

## TRY ANY FOUR BOOKS ON NO RISK FREE TRIAL OFFER

- No. 3. Application of Radio and TV Principles. 299 pages..... 26/-
- No. 4. Radio, Television and F.M. Receivers. 103 pages..... 26/-
- No. 5. Radio & TV Circuits. 334 pages.. 26/-
- No. 6. Latest Instruments for servicing Radio-TV. 367 pages..... 26/-
- No. 7. Practical Television Servicing and Trouble Shooting Manual. 406 pages... 34/-
- No. 8. Television Servicing Cyclopaedia. 108 pages..... 47/6
- No. 9. Transistor Circuits. 110 pages... 36/-
- No. 10. Coyne Technical Dictionary..... 16/8
- No. 11. Television and Radio Handbook... 22/-

### SEND NO MONEY,

Use Time Payment Plan at No Extra Cost If You Wish

Just mail coupon for free trial. After 7 days send only low price or return books and pay nothing! If you keep more than one book, send 6/- after 7 days, and 4/- each month until completed (maximum four books). To buy one book send one half in 7 days, one half in 30 days.

**MAIL COUPON NOW FOR FAST RETURN SERVICE**

## SIM-TECH BOOK COMPANY.

MAIL ORDER DIVISION, DEPT. P.W.6, GATER'S MILL, WEST-END, SOUTHAMPTON, HANTS.

Rush the books circled below for 7-day FREE TRIAL as per order.

1 2 3 4 5 6 7 8 9 10 11  
Name .....

Address .....

City .....

Tick here if enclosing full price, we pay postage. Same 7-day money-back guarantee. Postage 2/- or less 1/-, 4/- or more 1/6.

**OVERSEAS ORDERS. PLEASE PAY FULL AMOUNT. MONEY BACK GUARANTEE IF NOT SATISFIED.**

# Lyons Radio Ltd.

Telephone SLEPherds Bush 1729  
3 Goldhawk Road, London W.12

**ELECTRIC MOTORS.** Capacitor start type in used condition but in good working order. Operate from 200/250 v. A.C. mains. 143/6 r.p.m., 16th H.P. PRICE ONLY 47/6, carriage 9/6.

**POCKET MULTIMETERS.** Special 'v' imported multi-range compact instruments of a high order of accuracy housed in dust proof bakelite case with 3in. rectangular, clearly calibrated scale, single selector switch on front panel. *Types:* -Volts A.C. and D.C. 0-10-50-250-500 1,000 v. (1,000 ohms per volt). D.C. current; 0-1-100-500 mA. Resistance; 0-2,000 and 100 to 200K ohms. Includes full instructions, test leads and battery. PRICE ONLY 39/6, post free.

**BATTERY CHARGER or MODEL RAILWAY COMPONENTS.**

**RECTIFIERS.** Full wave bridge types for outputs up to 12 v. D.C. 1 Amp 5/3. 2 Amp 8/9. 4 Amp 12/6.

**TRANSFORMERS.** Pnl. 200/250 v. Sec. tapped 3.5, 9 and 17 v. for producing a D.C. output, when used with above rectifiers of 2 v., 6 v. and 12 v. respectively. 1 Amp size 11/3. 2 Amp 15/6. 4 Amp 18/6. Postage 1/6 up to 10/6, or 2/6 over. Wiring diagram supplied.

**MAINS POWER UNITS.** Input 200/250 v. A.C. Output: H.T. 325 v. at 100 mA. smoothed D.C. L.T. 6.3 v. A.C. at 1A. *Leads:* Size 20ins. high x 8ins. deep x 7ins. Special features include double filter unit ensuring negligible hum, Mansbridge smoothing condensers throughout, separate switches and fuses for mains and H.T. with pilot light indicator for each. Everything of top quality. 5U4 rectifier included. Truly remarkable value. PRICE ONLY 59/6, carriage 7/6.

**T.C.C. MANSBRIDGE CONDENSERS.** Type 500 v. wkg. at 60°C., inverted mlr. type 82 I.M. PRICE 5/6. 1 mfd. 1500 v. wkg. at 60°C. Type 121B inverted mtg. PRICE 4/6. 4 mfd. 750 v. wkg. at 60°C. type 92 PRICE 4/-. All as new and unused. For less than 6 add 1/6 post. over post free.

## H.A.C. SHORT-WAVE EQUIPMENT AND SHORT-WAVE KITS

Famous for over 25 years for S.W. Receivers and Kits of Quality.

H.A.C. were the original suppliers of SHORT-WAVE RECEIVERS, KITS, for the amateur constructor. Over 10,000 satisfied customers - including Technical Colleges, Hospitals, Public Schools, Halls, etc.

Improved designs with Denco coils! One-valve Kit, Model "C", Price 25/- Two-valve Kit, Model "E", Price 50/-. Now Addition, Model "K", Price 50/-. Super sensitive "All Day" Receiver. Special incl. price. Complete Kit, 77/-.

All kits complete with all components, accessories, and full instructions. Return ordering call and inspect a demonstration receiver, or send for descriptive catalogue and order form.

**POST THIS COUPON NOW!**

"H.A.C." SHORT-WAVE PRODUCTS  
(Dept. TH), 44 Old Bond Street,  
London W.1

Please send me FREE and without obligation your 1961 literature.

NAME .....

ADDRESS .....



# SEMICONDUCTORS AUDIO AMPLIFIER AND RADIO APPLICATION REPORTS

**250 mW** Class B push-pull using GET114 transistors operating from a 6V supply (SAR 5).

Class B push-pull transformerless output stage using GET114 transistors operating from a 9V supply (SAR 6).

**500 mW** Class B push-pull using GET114 transistors operating from a 6V supply (SAR 7).

Class B push-pull transformerless output stage using GET114 transistors operating from a 9V supply (SAR 8).

**1W** Class B push-pull using GET114 or GET115 transistors operating from a 6V supply (SAR 10).

Class B push-pull transformerless output stage using GET114 or GET115 transistors operating from a 12V supply (SAR 2).

**2W** Class B push-pull using GET116 transistors operating from a 12V supply (SAR 11).

**3W** Class B push-pull transformerless output stage using GET115 transistors operating from a 12V supply (SAR 12).

## RADIO RECEIVER

6-transistor superhet operating from a 9V supply (SAR 13).

For copies of any of these Semiconductor Application Reports (SAR's) or for information on the wide range of G.E.C. transistors please write to:

**THE GENERAL ELECTRIC COMPANY LIMITED**

Semiconductor Division  
School Street, Hazel Grove  
Stockport, Cheshire.

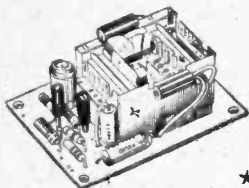

**MEDIUM LONG AND SHORT WAVE**

**SEVEN TRANSISTOR SUPERHET**

★PRE-BUILT UNITS★

— THE NEW EASY WAY TO BUILD A RADIO —

**UNIT 1**

Press Button Osc/Mixer stage. OC170 Transistor. 5.W. 5.9 to 13 Mc/s; MW 510 to 1620 kc/s; L W 150 to 275 kc/s. Printed Circuit, size 3.4 x 2.1 x 1.8in. PRE-ALIGNED AND TESTED 90/3 P. & P. 1/-.

**UNIT 2**

460 kc/s I.F. Amplifier. 2-OC169 Transistors. Double tuned I.F.T.'s. Diode Detector, A.V.C., etc. Printed Circuit, size 3½ x 1½ x 1in. PRE-ALIGNED AND TESTED. 92/6. P. & P. 1/-.

**UNIT 3 (ILLUSTRATED).**

4 Transistors, 1 watt Audio Amplifier, 60-1600 c/s ± 3dB. 5mV input for 1 watt. 2-OC71, 2-OC74 Transistors. Printed Circuit size 3 x 2.2 x 1.2in. 92/6. P. & P. 1/-.

**SUNDRIES (FOR ABOVE UNITS)**

8 x ¾in. M.L.S. Ferrite Aerial and Coils. 12/6. 176pF + 176pF Tuner. 9/6. 2-15pF Trimmers. 1/- each. 7 x ¼in. 3 ohm Speaker, 20/- OR 9 x 6in. Cels., 25/-.

**FULLY ILLUSTRATED BOOKLET SHOWING INTERCONNECTION OF ABOVE ... 2/6**

**TRANSISTORS**  
From **3/6** each

SEND FOR NEW FREE LIST WITH DATA AND USES  
**FULLY GUARANTEED**  
We can supply a Transistor for every need!

**Crystal Microphone Inserts**

Latest ACOS 43-1, 2½in. 12/6 P.P. 6d.  
¾in. square (ex units) 3/6 ea. P.P. 6d.  
ACOS 1½in. 9/6 P.P. 6d.  
Also ¾in. x ½in. 7/6 P.P. 6d.

**DECCA AMPLIFIER**  
IDEAL FOR PORTABLE RECORD PLAYERS

★ FULL TONE and VOLUME CONTROL  
★ SIZE 8½ x 3½ x 3in.  
★ ECL82 VALVE and MAINS OPERATED  
★ BUILT AND READY TO USE  
**59/6** P.P. 2/-

9 x 6in. Celestion Speaker for use with above Amplifier, 25/- P.P. 1/-.

**Telescopic Chrome Aerials**

7-Sections. 3ft 6in. open; 6in. closed. Ideal for Portable Receivers. Walkie-talkies, Radio Control, etc.  
With Clips 12/6, P.P. 1/-  
64in. version with clips 17/6. P.P. 1/-.



**"STEREO 3-D"**

New high-gain circuit with full tone, balance and volume controls. Can be used with all types of records as well as stereo.

★ 2 WATTS PEAK PER CHANNEL  
★ ECC83; 2-ECL82 VALVES  
★ MAINS 110/250V A.C. **£5.7.6**  
Complete with speaker sockets, calibrated dials, etc. P.P. 2/-

**BUILT AND TESTED**  
★ ★ COLLARO 4-SPEED STEREO AUTO-CHANGER, ideal for use with above Amplifier. £7.10.0 P.P. 3/6.  
★ ★ 9 x 6in. large magnet Elac speaker, for use with STEREO 3-D, 37/- pair. P.P. 1/6.

**Crystal Microphones**

ACOS 39-1 Stick Microphone with screened cable and Stand (List 5 gns.), 39/6. P.P. 1/6.  
ACOS 40 Desk Microphone with screened cable and built-in Stand (List 50/-), 19/6. P.P. 1/6.  
ACOS 45 Hand Microphone with screened lead, very sensitive, 29/6. P.P. 1/6  
Illustrated leaflet on request.

**PRACTICAL TRANSISTOR CIRCUITS**  
ALL TRANSISTOR CIRCUITS

**No. 2 3/6** POST FREE

GADGETS RECEIVERS  
AMPLIFIERS TEST UNITS  
TRANSMITTERS

Now contains 40 Easy to build Transistor Circuits for the home constructor with diagrams and prices.

**6-TRANSISTOR RADIO**

Size 3 x 2½ x ¾in.

**THE WORLD'S SMALLEST RADIO**

**FITS INTO VEST POCKET OR PURSE**



Complete with Batteries, Leather Case, Earphone, in Presentation Box.

- All your favourite stations, including Luxemburg.
- Superhet Circuit with Push-Pull output on 2in. speaker.
- 540 to 1600 kc/s coverage.

**BUILT AND READY TO USE**

CASH OR C.O.D. **12 gns** Reg. Post Free

**COMPLETE RANGE OF SUB-MINIATURE I.F.s, TRANS, TUNERS AND F.M. COMPONENTS BY TSL. FREE LIST ON REQUEST.**

**RANGER-2**

**PERSONAL POCKET RADIO**

**FULL TUNING OF MEDIUM WAVEBAND AND AMATEUR TOP BAND**  
● LUXEMBURG GUARANTEED ●  
(where normally receivable)

- ★ Full Station Separation
- ★ Two High Gain Transistors
- ★ 9 Months' Battery Life
- ★ Calibrated Dial
- ★ High Quality Output
- ★ 120 metres to 500 metres coverage
- ★ 4½ x 3 x 1½in.

**NO EXTERNAL AERIAL OR EARTH REQUIRED**

Total cost of all items with battery, transistors and personal earphone, etc. **65/-** P.P. 1/6

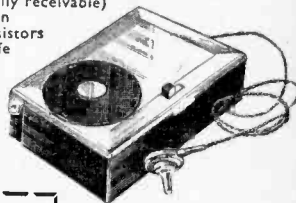

- All components sold separately and Fully Guaranteed.
- After Sales Service
- Simple to Build

Building Instructions and Prices FREE on Request

**Henry's Radio Ltd**

5 HARROW ROAD · LONDON W.2

Opposite Edgware Road Tube Station  
OPEN MON. to SAT. 9-6, THURS. 1 o'clock  
Telephone PADDINGTON 1008/9

**SEE BACK PAGE**

Free List by Return. Valves, Quartz, Crystals, Transistors and Components.



# Practical Wireless

## BLUEPRINT

## SERVICE

ALL OF these blueprints are drawn full-size and although the issues containing descriptions of these sets are now out of print, an asterisk in the list below denotes that constructional details are available free with the blueprint.

The index letters which precede the Blueprint Number indicate the periodical in which the description appeared. Thus PW refers to PRACTICAL WIRELESS; AW to *Amateur Wireless* and WM to *Wireless Magazine*.

Send (preferably) a postal order to cover the cost of the Blueprint (stamps over 6d. unacceptable) to

PRACTICAL WIRELESS, Blueprint Dept., George Newnes, Ltd., Tower House, Southampton Street, London, W.C.2.

### SPECIAL NOTE

THE following blueprints include some pre-war designs and are kept in circulation for those constructors who wish to make use of old components which they may have in their spares box. The majority of the components for these receivers are no longer stocked by retailers.

Title	Number	Price
<b>CRYSTAL SETS</b>		
Junior Crystal Set	PW94*	2/-
Dual-wave Crystal Diode	PW95*	2/6

<b>STRAIGHT SETS</b>		
<b>Battery Operated</b>		
Modern One-valver	PW96*	2/6
All-dry Three	PW97*	3/6
Modern Two-valver	PW98*	3/6

<b>SUPERHETS</b>		
<b>Mains Operated</b>		
A.C. Band-pass Three	PW99*	4/-
A.C. Coronet-4	PW100*	4/-
A.C./D.C. Coronet	PW101*	4/-

<b>MISCELLANEOUS</b>		
The PW 3-speed Autogram	—*	8/-
The PW Monophonic Electronic Organ	—*	8/-

<b>TELEVISION</b>		
The PT band III converter	—*	1/6

Title	Number	Price
A.C. Fury Four	PW20*	2/6
Experimenter's Short Wave	PW30a*	2/6
Midget Short Wave Two	PW38a*	2/6
Band-Spread Three (Battery)	PW68*	2/6
Crystal Receiver	PW71*	2/-
Signet Two (Battery)	PW76*	2/6
Simple S.W. One-valver	PW88*	2/6
Pyramid One-valver	PW93*	2/6

BBC Special One-valver	AW387*	2/6
Short-Wave Two	AW429*	2/6
Short-Wave World Beater	AW436*	3/6

Standard Four Valve S.W.	WM383*	3/6
Enthusiast's Power Amplifier	WM387*	3/6
Standard Four Valve	WM391*	3/6
Listener's 5-Watt Amplifier	WM392*	3/6

### QUERY COUPON

This coupon is available until 7th March, 1961, and must accompany all queries in accordance with the notice on our "Open to Discussion" page.

PRACTICAL WIRELESS, MARCH, 1961.



# The Contessa

**COMBINED PORTABLE and CAR RADIO**  
**6 TRANSISTOR MEDIUM AND LONG WAVE SUPERHET**  
**TERRIFIC SENSITIVITY**



**SPECIFICATION**

- 425mW Push-Pull Output
- 6 "Top-Grade" Ediswan Transistors
- New Type Printed Circuit with all Components Marked
- Full Medium and Long Wave Tuning
- High "Q" Internal Ferrite Aerial
- Car Radio Adaptation and AVC
- Slow Motion Fingertip Tuning
- "Hi-Fi" Quality Speaker
- Attractive Rexine Covered Cabinet

**TOTAL COST OF ALL NECESSARY ITEMS**  
**£11.10.0** p.p. 3/6  
 ● NO EXTRAS TO BUY ●

Definitely the easiest to build. Guaranteed to give the best in performance. Step by step instructions and full after sales service.

● Size 10 x 7½ x 3½in. Weight 4½ lb.

**CALL FOR DEMONSTRATION**

★ No Technical Knowledge Necessary. All Parts Sold Separately ★

NEW DESCRIPTIVE LEAFLET AND PRICES ON REQUEST

## RANGER-3

## PERSONAL POCKET RADIO

FULL TUNING OF MEDIUM WAVEBAND AND AMATEUR TOP BAND (120 metres to 500 metres)

- LUXEMBURG GUARANTEED (where normally receivable)

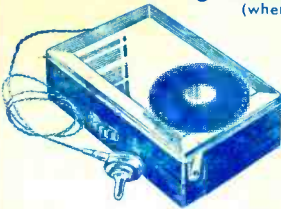

- ★ Full Station Separation
- ★ Calibrated Dial
- ★ Fingertip Control
- ★ 6 Months' Battery Life
- ★ Fitted Volume Control
- ★ 3 High Gain Transistors
- ★ Size 4½ x 3 x 1½in.

TOTAL COST with Personal Earphone, Battery, Transistors, etc.

**79/6** P.P. 1/6

All parts sold separately and guaranteed

- NO EXTERNAL AERIAL OR EARTH
- AFTER SALES SERVICE

New illustrated Instruction booklet **FREE** On Request Continental as well as local stations—**GUARANTEED!**

## Matched Sets of Transistors

● SPECIAL OFFERS—FULLY GUARANTEED ●

- |   |  |
|---|--|
| <p><b>1 6 Mullard Transistors and Diode</b></p> <p>1—OC44 ONLY<br/>                 2—OC45<br/>                 1—OC71<br/>                 2—OC72<br/>                 1—OA81<br/>                 or with 2—OA81, 62/6</p> <p><b>60/-</b> PER SET</p> | <p><b>2 6 Mullard Transistors and Diode — 1 watt output</b></p> <p>1—OC44 ONLY<br/>                 2—OC45<br/>                 1—OC81D <b>62/6</b><br/>                 2—OC81<br/>                 and<br/>                 1—OA81<br/>                 or with 2—OA81, 65/-</p> |
| <p><b>3 6 Ediswan Transistors and Two Diodes</b></p> <p>1—XA102 ONLY<br/>                 2—XA101<br/>                 1—XB103<br/>                 2—XC101<br/>                 and<br/>                 2—Diodes</p> <p><b>57/6</b> PER SET</p>       | <p><b>4 4 Mullard Transistors for 1 watt amplifier</b></p> <p>1—OC71<br/>                 1—OC81D ONLY<br/>                 1—OC81<br/>                 with Cooling Clips <b>49/6</b><br/>                 Capable of 1 watt Push-Pull PER SET</p>                                |

## "PW" 6 Transistor Medium & Long Wave Pocket Superhet

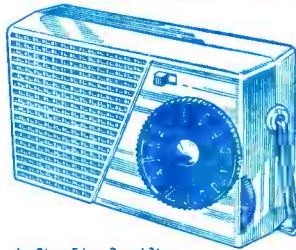

- 6 MATCHED MULLARD TRANSISTORS AND DIODE
- 150mW Push-Pull Output
- Easy to Follow Printed Circuit with all Components Marked
- Full Medium and Long Wave Tuning
- High "Q" Internal Ferrite Aerial
- Quality 2½in. Speaker

★ Size 5½ x 3 x 1½in.

## F.M.; SHORT WAVE

WE ARE NOW ABLE TO SUPPLY ALL COMPONENTS AND TRANSISTORS USED ON PUBLISHED CIRCUITS IN THIS MAGAZINE. PRICES AND DELIVERY OF REQUIRED ITEMS WILL BE QUOTED BY RETURN OF POST.

## TRANSISTOR COMPONENTS

**OUTSTANDING APPEARANCE AND PERFORMANCE**

- ★ All Parts Sold Separately
- ★ No Technical Knowledge Required
- NO EXTRAS TO BUY ●

**TOTAL COST OF ALL NECESSARY ITEMS**

**£9/19/6**

ILLUSTRATED LEAFLET FREE

PLEASE



TURN PAGE

**Henry's Radio Ltd 5 HARROW RD. LONDON W2**

Opposite Edgware Road Tube Station. PADDINGTON 1008/9. Open Monday to Sat. 9-6, Thurs. 1 o'clock

★ COMPLETE COMPONENT LISTS FREE ON REQUEST ★