

A.C. METER UNIT—See page 332

A
NEWNES
PUBLICATION

Edited by
F. J. CAMM
Vol. 16. No. 407.

Practical Wireless and

4^D

EVERY
WEDNESDAY
July 6th, 1940.

★ PRACTICAL TELEVISION ★

Contents

- Constructing Portables
- ◆
- Noise Suppression Circuits
- ◆
- Thermion's Commentary
- ◆
- A One-valve Signal Tracer
- ◆
- Practical Hints
- ◆
- What is Modulation?
- ◆
- Home-made Components
- ◆
- Comprehensive Tone-control Unit
- ◆
- Readers' Letters

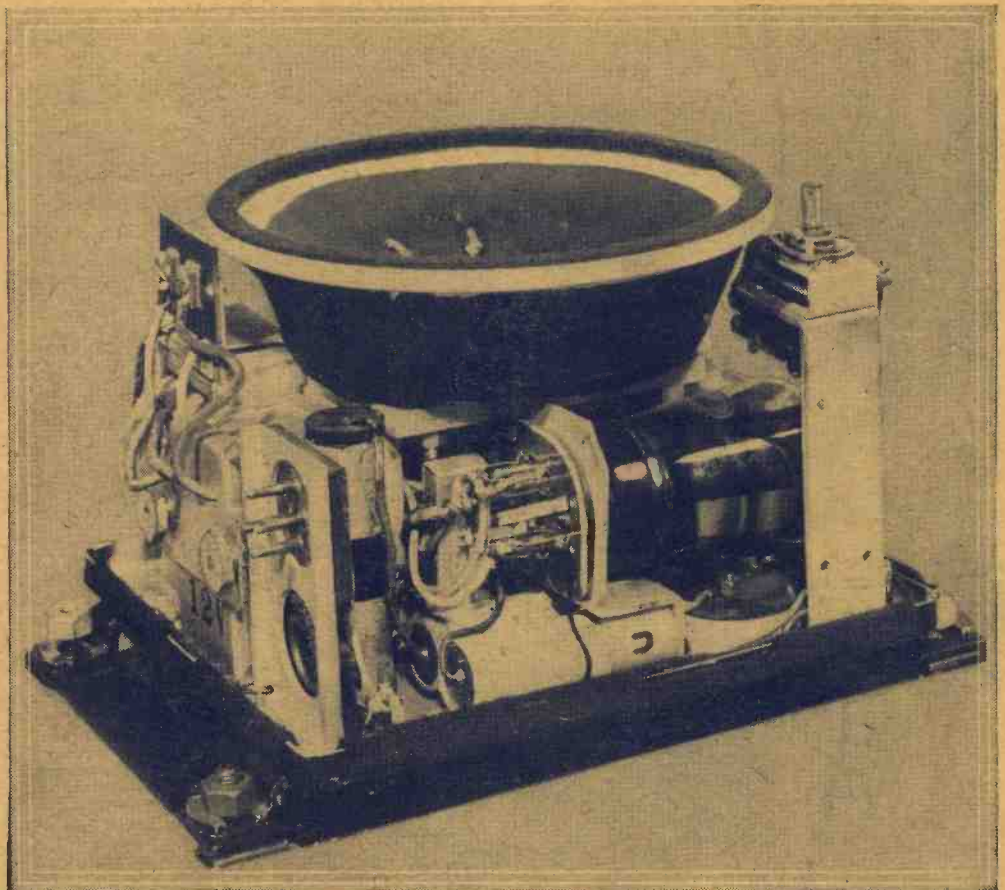

USES FOR CAR RADIO

With **200** illustrations and diagrams.

A Radio Consultant for the Expert and Amateur Constructor

EVERYMAN'S WIRELESS BOOK

By **F. J. CAMM**
5/- NET.

Explains the Operation, Upkeep and Overhaul of all types of Wireless Receivers, with special chapters on the Principles of Radio Telephony, Installation and Systematic Fault-finding.

From all Booksellers, or by post 5/6 from **GEORGE NEWNES, LTD.** (Book Dept.), Tower House, Southampton Street, Strand, London, W.C.2.

Practical Wireless BLUEPRINT SERVICE

FRACTICAL WIRELESS		No. of	SUPERHETS.	
Date of Issue	Blueprint	Battery Operated.		
CRYSTAL SETS				
Blueprints, 6d. each.				
1937 Crystal Receiver	—	PW71	Battery Sets : Blueprints, 1s. each.	5.0.37 PW40
The "Junior" Crystal Set	27.8.38	PW94	£5 Superhet (Three-valve)	— PW52
F. J. Camm's 2-valve Superhet ..				
STRAIGHT SETS. Battery Operated.				
One-valve : Blueprints, 1s. each.				
All-Wave Unipen (Pentode)	—	PW31A	Mains Sets : Blueprints, 1s. each.	— PW43
Beginners' One-valver	19.2.38	PW85	A.C. £5 Superhet (Three-valve)	— PW42
The "Pyramid" One-valver (HF Pen)	27.8.38	PW93	D.C. £5 Superhet (Three-valve)	— PW44
Universal £5 Superhet (Three-valve)				
F. J. Camm's A.C. Superhet 4 ..				
F. J. Camm's Universal £4 Superhet ..				
"Qualitone" Universal Four ..				
Two-valve : Blueprints, 1s. each.				
The Signet Two (D & LF)	24.9.38	PW76	Four-valve : Double-sided Blueprint, 1s. 6d.	— PW60
Push Button 4, Battery Model ..				
Push Button 4, A.C. Mains Model ..				
SHORT-WAVE SETS. Battery Operated.				
One-valve : Blueprints, 1s.				
Sixty Shilling Three (D, 2 LF (RC & Trans))	—	PW34A	Simple S.W. One-valver ..	23.12.39 PW88
Leader Three (SG, D, Pow)	—	PW35	Two-valve : Blueprints, 1s. each.	
Summit Three (HF Pen, D, Pen)	—	PW37	Midget Short-wave Two (D, Pen)	— PW38A
All Pentode Three (HF Pen, D (Pen), Pen)	29.5.37	PW39	The "Fleet" Short-wave Two (D (HF Pen), Pen)	27.8.38 PW91
Hall-Mark Three (SG, D, Pow)	—	PW41	Three-valve : Blueprints, 1s. each.	
Hall-Mark Cadet (D, LF, Pen (RC))	16.3.35	PW48	Experimenter's Short-wave Three (SG, D, Pow)	— PW30A
F. J. Camm's Silver Souvenir (HF Pen, D (Pen), Pen) (All-Wave Three)	13.4.35	PW40	The Prefect 3 (D, 2 LF (RC and Trans))	— PW63
Cameo Midget Three (D, 2 LF (Trans))	—	PW51	The Band-Spread S.W. Three (HF Pen, D (Pen), Pen)	1.10.38 PW68
1938 Sonotone Three-Four (HF Pen, HF Pen, Westector, Pen)	—	PW53	PORTABLES.	
Battery All-Wave Three (D, 2 LF (RC))	—	PW55	Three-valve : Blueprints, 1s. each.	
The Monitor (HF Pen, D, Pen)	—	PW61	F. J. Camm's ELF Three-valve Portable (HF Pen, D, Pen)	
The Tutor Three (HF Pen, D, Pen)	21.3.36	PW62	Parvo Flywheel Midget Portable (SG, D, Pen)	
The Centaur Three (SG, D, P)	14.8.37	PW64	Four-valve : Blueprints, 1s.	
F. J. Camm's Record All-Wave Three (HF Pen, D, Pen)	31.10.36	PW69	"Imp" Portable 4 (D, LF, LF (Pen))	
The "Cott" All-Wave Three (D, 2 LF (RC & Trans))	18.2.39	PW72	MISCELLANEOUS	
The "Rapid" Straight 3 (D, 2 LF (RC & Trans))	4.12.37	PW82	Blueprint, 1s.	
F. J. Camm's Oracle All-Wave Three (HF, Det., Pen)	28.8.37	PW78	S.W. Converter-Adapter (1 valve)	
1938 "Triband" All-Wave Three (HF Pen, D, Pen)	22.1.38	PW84	— PW48A	
F. J. Camm's "Sprite" Three (HF Pen, D, Det)	26.3.38	PW87	AMATEUR WIRELESS AND WIRELESS MAGAZINE	
The "Hurricane" All-Wave Three (SG, D (Pen), Pen)	30.4.38	PW89	CRYSTAL SETS.	
F. J. Camm's "Push-Button" Three (HF Pen, D (Pen), Tet)	3.9.38	PW92	Blueprints, 6d. each.	
Four-valve : Blueprints, 1s. each.				
Sonotone Four (SG, D, LF, P)	1.5.37	PW4	Four-station Crystal Set ..	
Fury Four (2 SG, D, Pen)	8.5.37	PW11	1934 Crystal Set ..	
Beta Universal Four (SG, D, LF, Cl. B)	—	PW17	150-mile Crystal Set ..	
Nucleon Class B Four (SG, D (SG), LF, Cl. B)	—	PW34B	STRAIGHT SETS. Battery Operated.	
Fury Four Super (SG, SG, D, Pen)	—	PW34C	One-valve : Blueprints, 1s.	
Battery Half-Mark 4 (HF Pen, D, Push-Pull)	—	PW46	B.B.C. Special One-valver ..	
F. J. Camm's "Limit" All-Wave Four (HF Pen, D, LF, P)	26.9.36	PW67	Two-valve : Blueprints, 1s. each.	
"Acme" All-Wave 4 (HF Pen, D (Pen), LF, Cl. B)	12.2.38	PW83	Melody Ranger Two (D, Trans.) ..	
The "Admiral" Four (HF Pen, HF Pen, D, Pen (RC))	3.9.38	PW90	Full-volume Two (SG det, Pen) ..	
Mains Operated				
A.C. Twin (D (Pen), Pen)				
A.C.D.C. Two (SG, Pow)				
Selectone A.C. Radiogram Two (D, Pow)				
Three-valve : Blueprints, 1s. each.				
Double-Diode-Triode Three (HF Pen, DDT, Pen)				
D.C. Ace (SG, D, Pen)				
A.C. Three (SG, D, Pen)				
A.C. Leader (HF Pen, D, Pow)				
D.C. Premier (HF Pen, D, Pen)				
Unique (HF Pen, D (Pen), Pen)				
Armada Mains Three (HF Pen, D, Pen)				
F. J. Camm's A.C. All-Wave Silver Souvenir Three (HF Pen, D, Pen)				
"All-Wave" A.C. Three (D, 2 LF (RC))				
A.C. 1938 Sonotone (HF Pen, HF Pen, Westector, Pen)				
Mains Record All-Wave 3 (HF Pen, D, Pen)				
Four-valve : Blueprints, 1s. each.				
A.C. Fury Four (SG, SG, D, Pen)				
A.C. Fury Four Super (SG, SG, D, Pen)				
A.C. Hall-Mark (HF Pen, D, Push-Pull)				
Universal Hall-Mark (HF Pen, D, Push-Pull)				

These Blueprints are drawn full size. Copies of appropriate issues containing descriptions of these sets can in some cases be supplied at the following prices which are additional to the cost of the blueprint. A dash before the Blueprint Number indicates that the issue is out of print.

Practical Wireless (issues dated prior to June 1st, 1940) 4d. Post Paid
 (issues dated June 1st, 1940, and after) 5d. Post Paid

Amateur Wireless ... 4d. " "
 Wireless Magazine ... 1/4 " "

The index letters which precede the Blueprint Number indicate the periodical in which the description appears: Thus P.W. refers to PRACTICAL WIRELESS, A.W. to Amateur Wireless, W.M. to Wireless Magazine.

Send (preferably) a postal order to cover the cost of the blueprint, and the issue (stamps over 6d. unacceptable) to PRACTICAL WIRELESS Blueprint Dept., George Newnes, Ltd., Tower House, Southampton Street, Strand, W.C.2.

Mains Operated.				
Two-valve : Blueprints, 1s. each.				
Consoelectric Two (D, Pen) A.C.	—	AW403	Battery Sets : Blueprints, 1s. 6d. each.	
Economy A.C. Two (D, Trans) A.C.	—	WM286	Modern Super Senior	
Unicorn A.C.-D.C. Two (D, Pen)	—	WM394	Varsity Four .. Oct. '35	
Three-valve : Blueprints, 1s. each.				
Home Lover's New All-Electric Three (SG, D, Trans) A.C.	—	AW383	The Request All-Waver .. June '36	
Mantovani A.C. Three (HF, Pen, D, Pen)	—	WM374	1935 Super-Five Battery (Superhet)	
£15 15s. 1936 A.C. Radiogram (HF, D, Pen)	—	Jan. '36	Mains Sets : Blueprints, 1s. 6d. each.	
Four-valve : Blueprints, 1s. 6d. each.	—	WM401	Heptode Super Three A.C. .. May '34	
All Metal Four (2 SG, D, Pen)	—	July '33	"W.M." Radiogram Super A.C. ..	
Harris' Jubilee Radiogram (HF Pen, D, LF, P)	—	May '35	PORTABLES.	
SUPERHETS.				
Battery Sets : Blueprints, 1s. 6d. each.				
Modern Super Senior	—	WM375	Four-valve : Blueprints, 1s. 6d. each.	
Varsity Four .. Oct. '35	—	WM395	Holiday Portable (SG, D, LF, Class B)	
The Request All-Waver .. June '36	—	WM407	Family Portable (HF, D, RC, Trans)	
1935 Super-Five Battery (Superhet)	—	WM379	Two HF Portable (2 SG, D, QP21)	
Mains Sets : Blueprints, 1s. 6d. each.				
Heptode Super Three A.C. .. May '34	—	WM359	Tyers Portable (SG, D, 2 Trans)	
"W.M." Radiogram Super A.C. ..	—	WM386	SHORT-WAVE SETS. Battery Operated.	
One-valve : Blueprints, 1s. each.				
S.W. One-valver for America .. 15.10.38	—	AW429	One-valve : Blueprints, 1s. each.	
Rome Short-Waver	—	AW452	S.W. One-valver for America .. 15.10.38	
Two-valve : Blueprints, 1s. each.				
Ultra-Short Battery Two (SG, det, Pen)	—	Feb. '36	Rome Short-Waver	
Home-made Coll Two (D, Pen)	—	WM402	Two-valve : Blueprints, 1s. each.	
World-ranger Short-wave 3 (D, RC, Trans)	—	AW440	Ultra-Short Battery Two (SG, det, Pen)	
Three-valve : Blueprints, 1s. each.				
Experimenter's 5-metre Set (D, Trans, Super-regen)	—	30.6.34	Home-made Coll Two (D, Pen)	
The Carrier Short-waver (SG, D, P) July '35	—	WM390	World-ranger Short-wave 3 (D, RC, Trans)	
Four-valve : Blueprints, 1s. 6d. each.				
A.W. Short-wave World-beater (HF Pen, D, RC, Trans)	—	AW436	Experimenter's 5-metre Set (D, Trans, Super-regen)	
Empire Short-waver (SG, D, RC, Trans)	—	WM313	The Carrier Short-waver (SG, D, P) July '35	
Standard Four-valve Short-waver (SG, D, LF, P)	—	22.7.30	Four-valve : Blueprints, 1s. 6d. each.	
Superhet : Blueprint, 1s. 6d.	—	Nov. '35	A.W. Short-wave World-beater (HF Pen, D, RC, Trans)	
Simplified Short-wave Super	—	WM307	Empire Short-waver (SG, D, RC, Trans)	
Mains Operated.				
Two-valve : Blueprints, 1s. each.				
Two-valve Mains Short-waver (D, Pen) A.C.	—	13.1.40	Standard Four-valve Short-waver (SG, D, LF, P)	
"W.M." Long-wave Converter ..	—	WM380	Superhet : Blueprint, 1s. 6d.	
Three-valve : Blueprint, 1s.				
Emigrator (SG, D, Pen) A.C. ..	—	WM352	Simplified Short-wave Super .. Nov. '35	
Four-valve : Blueprint, 1s. 6d.				
De Luxe Four-valve A.C. Short-waver (SG, D, RC, Trans)	—	WM391	MISCELLANEOUS.	
S.W. One-valve Converter (Price 6d.)				
Enthusiast's Power Amplifier (1/6)				
Listener's 5-watt A.C. Amplifier (1/6)				
Radio Unit (2w) for WM392 (1/-)				
Harris Electrogram battery amplifier (1/-)				
De Luxe Concert A.C. Electrogram (1/-)				
New style Short-wave Adapter (1/-)				
Trickle Charger (6d.)				
Short-wave Adapter (1/-)				
Superhet Converter (1/-)				
B.L.D.L.C. Short-wave Converter (1/-)				
Wilson Tone Master (1/-)				
The W.M. A.C. Short-wave Converter (1/-)				

Practical and Wireless

★ PRACTICAL TELEVISION ★

EVERY WEDNESDAY

Vol. XVI. No. 407. July 6th, 1940.

EDITED BY
F. J. C. AMM

Staff:

W. J. DELANEY, FRANK PRESTON,
H. J. BARTON CHAPPLE, B.Sc.

ROUND THE WORLD OF WIRELESS

Fault Finding

WE have published many interesting articles dealing with fault tracing and servicing, and in these have included constructional details of different items of test equipment. It is a recognised fact, however, that for quick fault location and for checking receiver performance, one of the devices known as a Signal Tracer is the best. This generally consists of a standard type of T.R.F. receiver, and by using the H.F. section alone, or the complete receiver, in conjunction with test prods it is possible to inject an artificial signal into a receiver and to check its passage from stage to stage. This idea is preferable to the use of a standard broadcast signal, as it is possible not only to obtain a constant signal, but also one of either the H.F. or L.F. type. Usually, however, such an instrument is, by its very nature, complicated and also bulky. We recently came across a design for a similar type of test set in which only one valve was used, and although it cannot be expected to function so well as a multi-valve tester, it does definitely offer some very interesting scope for test work, and, accordingly, we are reprinting details in this issue. These will be found on page 331.

Star Variety

A "STAR" variety programme for Home Service and Forces listeners will be broadcast from a Midland theatre on July 6th. "Top of the bill" is Carl Brisson, whose last broadcast from the Midlands was shortly before the war. A strong supporting company will include Forsythe, Seaman and Farrell, in a comedy and musical act; Vera Lynn, well-known radio singer; and Patricia Rossborough, a broadcasting pianist of great versatility. The programme will be supported by a theatre orchestra. The name of the compère will be announced later.

Tynwald Ceremony

THE ancient ceremony at Tynwald at which new laws for the Isle of Man are promulgated is to be held on July 5th, and J. H. L. Cowin, known to many listeners for his Manx broadcasts, is to give a commentary on this picturesque ceremony.

"Jack the Giant Killer"

THERE are many giants for any modern Jack to kill these days, and this idea has been seized upon by Francis Dillon, who is to produce an up-to-date and satirical version of "Jack the Giant Killer" in the Home Service programme on

July 9th. In this 1940 version of an old nursery favourite listeners will meet a Jack who has settled down in his castle, only to be disturbed by the rumours of a three-headed giant who is abroad. Jack's subsequent adventures as he sets out giant-killing should make good listening—particularly the good-humoured skits on the characters of famous personalities.



Another interesting example of a military portable radio transmitter-receiver. Note the novel aerial array.

Seaside Concert Party

JACK RADCLIFFE, the high-spirited Scottish comedian, is top of the bill in a seaside concert party which will be broadcast on July 6th. He will be supported by Coral Gunning, Ina Harris, Helen Norman, Bob Curnot and Jack Ansell and his Band.

Parlour Game

WILFRED PICKLES, already known for his versatility in the North as an announcer, Children's Hour artist, vocalist, compère and actor, is breaking fresh ground. This time he is devising and producing a Parlour Game—and a good

game it promises to be, as he plans to pit husbands and wives against each other. Wilfred is using four couples and he will ask a wife a question, or set her some task. If she fails in the attempt then it will be her husband's turn in the opposing team.

Death Travels First

LISTENERS who heard the first instalment of "Death Travels First," the murder thriller written by John Rhode and produced by John Cheate, will be able to hear the concluding instalment giving the solution to the crime on July 9th. The story is about five travellers on a suburban train from London during the black-out months. In the dimly-lighted compartment they all found that they knew each other. After the train had reached its destination, one of the five was found murdered in the compartment.

Variety from Scotland

SCOTTISH variety artists will entertain listeners in the Forces on July 6th in a programme which the producer, Howard Lockhart, has called "Skit to Skat." In the cast will be Jackie Kellar, a young Glasgow lad who toured and broadcast for some time with Roy Fox and his Band; he is an imitator, not merely of famous stars but of everyday sounds which he can reproduce faithfully and amusingly with the help of a microphone; the Four Smith Brothers, who model themselves on the Mills Brothers; Betty Hogg, the Rhythm Girl; and a comedy sketch will complete the programme, which will be accompanied by the George Bowie Quartet.

Editorial and Advertisement Offices:

"Practical Wireless," George Newnes, Ltd.,
Tower House, Southampton Street, Strand,
W.C.2. Phone: Temple Bar 4363.

Telegrams: Newnes, Rand, London.
Registered at the G.P.O. for transmission by
Canadian Magazine Post.

The Editor will be pleased to consider articles of a practical nature suitable for publication in PRACTICAL WIRELESS. Such articles should be written on one side of the paper only, and should contain the name and address of the sender. Whilst the Editor does not hold himself responsible for manuscripts, every effort will be made to return them if a stamped and addressed envelope is enclosed. All correspondence intended for the Editor should be addressed: The Editor, PRACTICAL WIRELESS, George Newnes, Ltd., Tower House, Southampton Street, Strand, W.C.2.

Owing to the rapid progress in the design of wireless apparatus and to our efforts to keep our readers in touch with the latest developments, we give no warranty that apparatus described in our columns is not the subject of letters patent.

Copyright in all drawings, photographs and articles published in PRACTICAL WIRELESS is specifically reserved throughout the countries signatory to the Berne Convention and the U.S.A. Reproductions or imitations of any of these are therefore expressly forbidden. PRACTICAL WIRELESS incorporates "Amateur Wireless."

Comprehensive Tone Control

Constructional Details of a Useful Full-range Tone-controlling Device

MOST receivers incorporating a pentode or tetrode output stage are fitted with some form of high-note cutting device, generally referred to as a tone control. In designing receivers for high standards of reproduction, a tone control is, of course, essential, and a control which functions over very wide ranges will be found much more useful than the usual high-note cut-off just referred to. Such a wide-range control is described in this article, and a study of the accompanying diagrams will show that the unit is composed of a tapped choke, four condensers and a potentiometer; the choke, potentiometer and condenser No. 4 being connected across the speaker windings whilst condensers 1, 2 and 3 are inserted in the leads to the speaker. The arrangement is very simple, and at the same time very effective, allowing the output required to be selected at will. The most important item for construction is the choke, and this must be to the specification given or the results are quite likely to fall very much below the standard required.

The Choke

The original design was made up by using two chokes connected in series, but experiment proved that a single-tapped

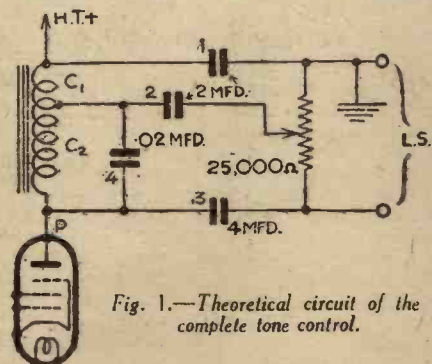

Fig. 1.—Theoretical circuit of the complete tone control.

choke might be used if the correct point of tapping was found, and it is proposed to use one choke on grounds of both expense and space. For the purpose of winding we will call the windings one and two, each part being dealt with as a separate choke until the finish. Commencing with choke 1, a hole must be drilled on one side of bobbin cheek low down near the tunnel for the commencement of the winding.

Pass a short length of flex, with the outer braid covering stripped off, through the choke, clean off the insulation, and solder the end of the 36 S.W.G. enamelled wire to it. Insulate the joint with a small piece of ordinary insulating tape and all is ready for winding.

Wind on to the bobbin as evenly as possible 1,620 turns, and finish off by soldering on a length of flex as for the commencement, and passing through a hole drilled in the same cheek. This hole may be made slightly larger than the hole for the commencement, as we shall pass the lead for the next winding through this, making two leads in one hole. Having completed the winding and made fast the finishing lead, put two layers of greaseproof paper over the winding, followed by a layer of good quality insulating tape, and choke 1 is finished. Choke 2 is wound in exactly the same manner as choke 1, the lead for the commencement being pushed through the finishing hole of choke 1, and the wire for the winding soldered to it. For choke 2, 3,240 turns are needed, and in winding this amount of wire the windings are apt to get very uneven. Therefore, at the end of every 800 turns cover the winding with a layer of paper as used for the finish of choke 1. Finish as for choke 1, securing the whole of the windings with an extra layer of insulating tape to make a good firm job. A word of warning, be quite sure that all winding is done in the same direction, otherwise one choke will be in opposition to the other.

Fitting Up

The laminations will be of the usual form of "T" and "U" type, and these are not fitted as so often described for transformers, but by placing all "T's" into the tunnel in the bobbin until it is filled tightly, and no further laminations can be driven in with a piece of wood. It is important that the laminations are tight if noise is to be avoided. Get the bolts loosely fitted into the clamping feet, ready to fit over the "U's," and then take enough "U" pieces to make up the thickness of the "T's" already in the tunnel. Fit the "U's" round the bobbin and slip the clamping feet over the ends to hold the whole in position, tighten up the bolts just enough to hold the laminations, but do not screw right home.

To maintain the inductance a gap must be made between the "T's" and "U's," the size of this being about the thickness of two sheets of the paper upon which this article is printed. Cut two slips of this

paper and place between the ends of the "U's" and the "T" pieces, afterwards closing the laminations up tight and clamping up the feet so that any movement of the laminations is impossible.

The unit may be built into a receiver, and should this be the case the components will

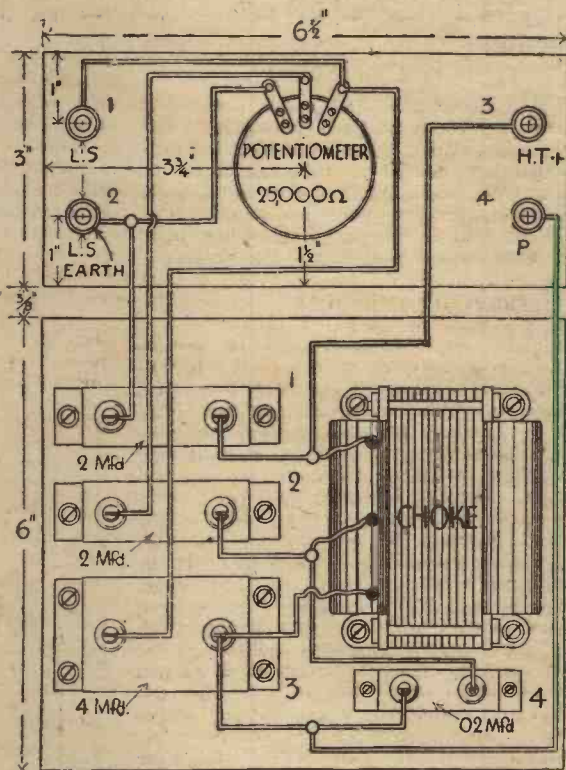

Fig. 2.—Wiring diagram showing components and layout.

be arranged to suit the available space and layout of the remainder of the set, but for existing receivers where a new unit has to be made, a small paxolin panel or even wooden panel can be used to advantage with the potentiometer, and terminals on the front, and the components mounted on a baseboard.

Wiring

The wiring is very simple, and as all the components, with the exception of the choke, will have terminals, these have not been included on the choke, and connections may be made direct to the different points.

When using a separate speaker the unit may be housed in the speaker cabinet, and as one side of the speaker will be at earth potential, as in ordinary choke-capacity coupling, the terminal marked earth may be taken to the nearest earthing point. This is particularly useful when extension leads are being used.

Connections to Receiver

- Terminal No. 1 to L.S.
- Terminal No. 2 to L.S. and earth.
- Terminal No. 3 to H.T.
- Terminal No. 4 to anode of output valve.

LIST OF COMPONENTS

- Seventy-two No. 30 Laminations.
- One Bobbin to fit.
- Four ounces 36 S.W.G. Enamelled Wire.
- One Set of Feet and Bolts.
- Short length of Flex.
- Insulating Tape.
- One 0.02 Fixed Condenser
- Two 2 mfd. Fixed Condensers
- One 4 mfd. Fixed Condenser
- One 25,000 ohms Potentiometer
- One Panel, 6 1/2 in. by 3 1/2 in. by 1/2 in.
- One Baseboard, 6 1/2 in. by 6 in. by 1/2 in.
- Four B.A. Terminals; 20 S.W.G. Tinned Copper Wire.
- One and a half dozen Small Screws.

A One-valve Signal Tracer

Constructional Data of a Simple and Efficient Test Unit

As a further contribution to the test instruments which we have described, the following data (taken from a recent issue of *Radio News*) will undoubtedly appeal to many who are making up such equipment for experimental or service use. It is a very novel and simple piece of apparatus which will certainly do all that is claimed for it.

IN servicing wireless receivers, it is almost a truism that a totally inoperative set is easier to fix than one that "sort of works," i.e., is noisy, distorting, or weak. It was to make it easier to diagnose these headaches that the following device was constructed.

It is essentially a signal tracer which makes it possible to follow a signal, either from a broadcast station or from a modulated test oscillator, from stage to stage and from component to component through a set and find out just where it goes wrong. When that is settled, it is seldom much trouble to find out what is the matter.

Features of the Design

The hook-up used is a pentagrid converter circuit whose oscillator section generates frequencies which lie in the regular broadcast band. This is coupled to the aerial and earth of a good set, either a T.R.F. or superheterodyne, but one preferably without A.V.C. A signal fed into the input of the set to be repaired may then be examined anywhere in its career, either as H.F., I.F., or L.F., by being fed into the input of the converter circuit through special test cables. If the signal is to be examined in the H.F. stage, the oscillator of the converter is rendered inoperative and the signal is simply amplified and passed on to the test set. If the signal is in the I.F. stages, it is changed back to broadcast frequency in the converter, and if the signal is in the L.F. stages it is used to modulate the oscillator frequencies in the converter in the same manner as a gramophone oscillator. Thus any defective stage may be located quickly.

One prerequisite in such trouble shooting is that the device used shall not load the circuit. That was one of the great difficulties of the analyser method of set-checking; the extra capacitances introduced by the analyser cables were generally sufficient to throw the set into an entirely different frame of mind, and with a sheet of analyser readings on hand it was often more difficult to figure out what *they* indicated than it would have been to diagnose the trouble "by ear."

That difficulty is avoided in this instance by using a probe which puts such an infinitesimal load on the circuit that the effect is practically zero. In fact, if the set under observation is operating strongly at all, it is not necessary to touch the probe to the components; by simply holding the probe near them, enough energy can be picked up from the stray fields to enable one to judge the quality of the signal at that point.

The probe is constructed of a 5in. length of bakelite or fibre tubing of an inside diameter just large enough to admit a flat-headed metal drawing-pin. Two of these drawing-pins, separated by 1/16in. make up a minute air-gap condenser in the body of the probe, which very effectually shields the probe tip from the earth capacity

of the shielded cable used to transfer the signal to the input of the converter.

Test Probes

To the point of one drawing-pin a 1in. length of stiff piano wire—gauge 20 or 21 is right—is soldered and the other end sharpened. A piece of wooden dowelling, of a diameter just large enough to fit snugly in the tubing, is cut 1/2in. long, and a 1/32in. hole is drilled from end to end down the centre. The piano wire is pushed through this until the drawing-pin is all the way in, and a turn or two of bare copper wire is wrapped around the free end of the piano wire flush with the dowel, and soldered to hold the piano wire in place.

The centre wire of a piece of shielded cable about 3ft. long is pushed through another similar piece of dowelling and soldered to the pin of another drawing-pin. The wire is then pulled back through until the head of the drawing-pin is flush with the end of the dowel, and the wire is secured in the same manner as the other.

A very thin coating of speaker cement is then applied to the second piece of dowel and it is pushed through the bakelite tubing until the head of the drawing-pin

the first except for the probe, which in this case has a .00025 mfd. mica condenser set into a slot in the end of another similar bakelite tube and taped fast. The inside wire of the cable is soldered to one terminal of the condenser, and a 1-in. length of piano wire is soldered to the other. This is the L.F. probe.

Circuit and Wiring

As to the converter itself, its construction is not difficult. The 6A7 should be well shielded and the current well filtered; any hum which is introduced into this valve will be very confusing when you're using it to locate hum somewhere else. L and C in the diagram are any ordinary broadcast band H.F. transformer with its primary cut down to about a dozen turns, if it has more than that, and the tuning condenser that goes with it.

The leads to the primary will have to be reversed if the polarity is not correct, for then the valve will not oscillate. Satisfactory evidence of oscillation will be had by removing the grid cap from the 6A7 and, with the dial of the test set turned to about 60 and the volume control turned down low, slowly turning the tuning condenser on the converter.

At about the same setting of the converter dial a loud hum should be heard when the finger-tip is touched to the control grid of the 6A7. If no such hum is heard and the connections are all right otherwise, reverse the primary leads.

Using the Unit

The method of using the instrument is quite simple. When listening in on the H.F. stages the switch on the tuning condenser is closed, rendering the oscillator inoperative. The set under observation is tuned

to the strongest local available and the test set tuned to the same station. Either one wire to the speech coil of the set under observation should be unsoldered or a jumper should be put across the speech coil. Then with the H.F.-I.F. test prod the quality of the signal can be ascertained throughout the H.F. stages. If nothing suspicious is disclosed there, the test set should be tuned to some place on the low-frequency end of the dial where no station whatever can be heard normally, the oscillator switch should be opened, and the oscillator dial set higher than the dial of the test set by an amount equal to the I.F. of the set in question. The test set will then receive the H.F.-I.F. of this set and, still using the H.F.-I.F. probe, the quality of the signal can be judged up to the grid of the second detector.

Passing to the low-frequency part of the receiver the L.F. probe is used and the oscillator dial is set to the same reading as the dial of the test set, and the volume of the latter turned down pretty low.

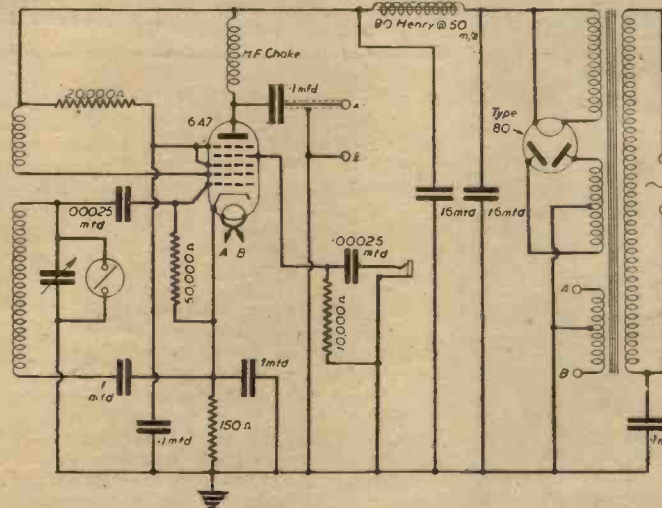

Circuit of the 1-valve Fault Finder.

is just 1/2 of an inch from the other end. A very small hole is drilled through both the tube and the dowel and a small brad nailed through to hold the dowel in place. The other piece of dowel is then pushed into the open end of the tube, drawing-pin first, until the two drawing-pins are separated by 1/16in. By pushing it in until the two drawing-pins touch, and then withdrawing it, this distance can be judged quite accurately. A few drops of cement and a brad hold it in place. The shielding on the cable is then brought up about an inch over the other end of the probe, and a couple of turns of friction tape wrapped around to hold it in place. A regular 'phone jack is fastened to the free end of the cable, the inside wire going to the tip and the shielding being connected to the earth side. It is then complete. This is the H.F.-I.F. probe.

Another cable is made up exactly like

An A.C. Meter Unit

An Add-on Unit for Use with the 12-range Meter Described in Last Week's Issue. By W. J. DELANEY

THE twelve-range meter described in last week's issue was essentially a D.C. unit, but it is interesting to note that arrangements were made in the switching to retain the actual meter as a completely separate unit, that is, on the 1 mA range. In this condition the two test leads which were provided become, in effect, merely extensions of the two terminals on the milliammeter and, therefore, by plugging these leads into any other piece of test equipment it is possible to dispense with the use of a separate meter. For example, suppose you are building up an all-valve tester. In the normal way this would consist of a panel carrying a number of valve-holders, switches and so on, with a milliammeter inserted somewhere on the panel for indicating purposes. If you intend to make up a number of pieces of test apparatus you will find, however, that many of them have as their main indicating unit a 0.1 milliammeter, and this means that you will have to purchase separate meters in the normal way for each piece of test equipment. However, by making the twelve-range meter a kind of standard, you can afford to purchase a really good meter, and then by fitting two sockets on all your other test equipment which requires a 0.1 mA meter you can merely plug in the two leads from the twelve-range meter, set the indicator on that to read 1 mA, and go ahead with tests on the other instrument.

A.C. Voltage Readings

The series resistors which were included in the meter already described will enable the meter to be used to test any D.C. circuit, but A.C. must not be applied to it. In order to read any A.C. supply with the meter in question it is first necessary to rectify that supply and convert it into D.C.

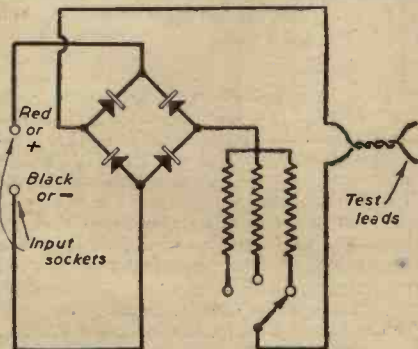

Fig. 1.—Theoretical circuit of the A.C. unit.

Smoothing is not necessary, and therefore all that is theoretically essential is a rectifier in series with the circuit. When this is done, however, it should be remembered that, as explained last week, in all tests which are made with such an instrument the meter is actually indicating the current flowing, and voltage readings are actually only interpretations of the current and resistance in circuit. Therefore, the rectifier in series will result in the meter indicating A.C. milliamperes. The needle on the meter will then indicate a mean value of the current flowing, but with a true A.C. supply it is necessary to read what is known as the

Root Mean Square (or R.M.S.) value. This is actually greater than the mean reading which the meter will indicate, the ratio actually being 1.11 to 1. Therefore if we include the meter across a circuit so that full scale deflection is obtained, instead of the current being 1 mA it will actually be 1.11 mA, R.M.S., A.C. The type of scale fitted to good quality moving-coil meters of the type which should be used in the meter described last week will be regular

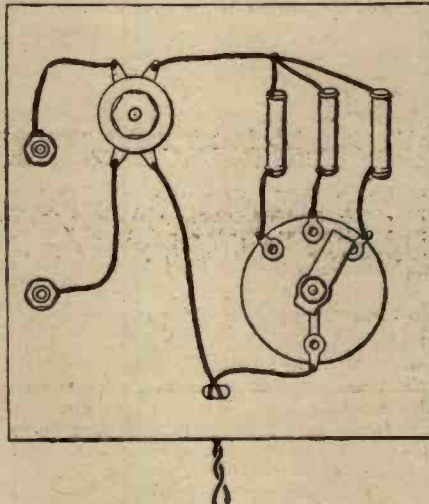

Fig. 2.—Suggested layout, and wiring diagram of the meter unit.

in its sub-divisions, and thus the proportionate readings at all parts of the scale will be correct. Thus the ratio just mentioned will hold for all ranges on that scale.

Series Resistance Values

It will be seen, however, that we do not wish to have to translate all our readings into such an odd amount, and when set to read 5 volts, for instance, we do not want to have to visualise the scale as being 5.55 volts, and then try to calculate the odd divisions of the scale in such proportions. Accordingly the series resistors which have already been fitted for D.C. will need some modification if the voltage readings are to be in A.C., and this means a fresh set of resistances. It would be difficult to make one self-contained switch also give a change-over of a range of such resistors, and it is therefore necessary to include a further switch to bring into circuit the rectifier and new resistances when A.C. voltages are to be read. Although these could all be included in one box or cabinet, in the present case it was found worth while to make up a special little A.C. box, including a selector or range switch, the rectifier, two test leads, and the necessary range of resistances. For a similar range of voltage readings to those given in the D.C. instrument one of the smaller types of selector switch may be used, for instance, the Bulgin type S:117/9. The rectifier must be of the 1 mA type, and it is held on the panel of the A.C. box by means of a small bolt. The resistors are arranged round the switch in a similar manner to those shown last week, and the wiring for the complete box will be as shown in Fig. 2.

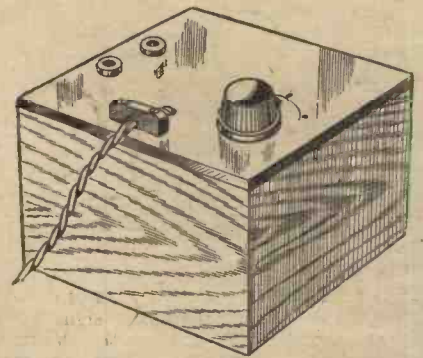

Fig. 3.—The completed unit in a suitable box.

The box may be of any desired size, either identical to the D.C. complete meter (for neatness in storage or for bench fitting) or a very small box may be made for portability. It will be noted that there are two input sockets, and into these the two leads from the D.C. meter are plugged. The two flexible leads attached to the A.C. box are then used for the purpose of testing, and there is a safeguarding element in using separate leads of this nature. You are at once aware of the fact that the meter has been changed over, and as an additional precaution and warning for this purpose it is recommended that a much heavier gauge of flex be used on the A.C. box, and also that the leads be twisted or plaited throughout their entire length. There is, of course no polarity with A.C. to worry about, and therefore two flex leads of the same colour may be used and are recommended. Thus, with the D.C. meter you have two separate red and black leads giving at once warning of polarity, whereas on the other you have similarly coloured leads indicating no polarity and thus A.C. When carrying out servicing work at high pressure, or under some form of stress such as working against time, you will find this a very valuable safeguard against connecting the instrument wrongly and damage is thereby avoided.

Resistance Values

For the benefit of those who wish to select any range of voltages for the A.C. box the following details will be found useful. The rectifier voltage drop will be about .9 volts and the voltage drop across the meter will be .1 volts. This should be deducted from the total voltage reading which is required, and the answer is then divided by 1.11 times the meter full scale current expressed in amperes. As exact values of commercial resistor to the required values will not be found obtainable it is preferable to obtain resistors of a slightly lower value which are standard products, and then by means of the meter described last week adjusted to the "resistance" range, to modify the value of the resistor until the desired value has been obtained. By using the carbon type of resistor (such as the Erie) the desired modification may easily be obtained by filing away the element, using a half-round file and making periodical tests as the work proceeds. Remember, however, that you need a low initial value and that removing some of the material does not lower the value, but increases it.

PATENTS AND TRADE MARKS

Any of our readers requiring information and advice respecting Patents, Trade Marks or Designs, should apply to Messrs. Rayner and Co., Patent Agents, of Bank Chambers, 29, Southampton Buildings, London, W.C.2, who will give free advice to readers mentioning this paper.

ON YOUR WAVELENGTH



By Thermion

Place Names

I NOTICE that a large number of wireless dealers are still displaying signs which locate the district, such as the *Mudtown Radio Stores*. Now that we have removed all signposts and obliterated milestones, and got rid of every roadside marking which would give an invader an idea of his location, it is particularly important that traders should not defeat the object by still proclaiming the name of the town in which they are situated. In any case, it is now illegal to do so, and they should remove signs at once.

The Morse Code

FROM the number of enquiries I receive it is obvious that there is an enormous revival in the interest in the morse code. Leslie Dixon tells me that he is selling large numbers of morse practice sets. Also, thousands are now listening in to morse. I do not know whether the transmitting brigade are keeping their hands in or whether it is the desire on the part of the youngsters to learn the morse code.

Valve Cartons

I AM told by a member of the B.R.V.M.A., which are the initials of the British Radio Valve Manufacturers' Association, that they are inviting dealers to save their valve boxes which they will collect for re-pulping. Apparently, they are considering the possibility of using these valve cartons again, so do not be surprised if when you purchase a valve you find that the carton has a rubber stamp impression on it, for such will be done every time the carton is re-issued. The words impressed will be "Carton Re-Issued" or "Re-issued Carton."

Another suggestion is that valves may be supplied in paper wrappings. Dealers should also salvage all cardboard boxes in which receivers are delivered.

P.A. Vans

IT now appears that the recent ban on radio in motor-cars does not apply to vans equipped with public address apparatus. The Postmaster-General has announced that he does not consider that P.A. vans come within the ambit of the recent order.

The Position of the Experimenter

I HAVE had some amusing stories from genuine British experimenters who have been suspect because of suspicious neighbours. One such experimenter was of the type who lived for the hobby, and spent most of his evenings and early mornings in his wireless den experimenting with short-wave apparatus. Naturally, therefore, he did not mix with his neighbours, who regarded him as a stand-offish fellow. Therefore, after the immense publicity which has been given to the activities of Fifth Columnists and the confiscation by the Post Office of all amateur transmitting apparatus, they immediately suspected him of being a spy. Some well-meaning or malicious soul informed the

police that they thought he was a spy and that he was transmitting secret messages to Germany. The police swooped down on him and collected a large amount of short-wave receiving apparatus whilst they detained him for some time for questioning. The local police could not tell a receiving-set from an Official Receiver, and it was not until he was able to satisfy them of his bonafides that they reluctantly let him go. In any case, he does not think that he convinced the police, and he suspects that they may be watching him. My advice to him is to let them have their suspicions and to let them go on watching. An innocent man has nothing to fear. There are thousands of genuine experimenters in this country, and it is unthinkable that they should be treated as spies, although none of them would object to answering reasonable questions properly put by the police. Members of wireless clubs can always produce as evidence of their honesty their membership card to prove that they are serious British experimenters—an added reason why every amateur should join some properly organised club.

The R.S.G.B.

I HAVE no doubt that a large number of members of the Radio Society of Great Britain have been worried in this way, and I have yet to learn of one of them who has failed to satisfy the authorities. The law prohibiting amateur transmissions is very necessary during the war, and amateurs during the last war had to suffer a similar ban. The members are, however, retaining their interest, and the Society is still publishing its members' journal. When the war is over there will be a veritable boon in amateur transmitting, as there undoubtedly will be in home construction. When those who return to civilian life have had a chance to forget the war, they will return to their old hobbies with renewed zest, keen to renew their acquaintance with radio. The letters I have from readers indicate that even though on active service they are following developments with the same interest as they did when in civilian life.

R.A.F. Wireless Operators

MANY readers are joining the R.A.F. or are interested in the wireless branches of the Air Force. It is therefore interesting to note that the designation "Cadet" has been officially approved for airmen training for air crew duties—that is as pilots, observers and wireless operators/

air gunners. They wear a white band round their caps.

Cadets who have been provisionally selected for commissioned rank wear, in addition, a white armband, and are known as "Air Cadets."

Pupils for training as pilots and observers now go straight to Initial Training Wings as soon as vacancies occur. The intake has recently been speeded up to cope with the increased numbers available. Those cadets for wireless operator/air gunner duties go to one of the technical training schools before doing their course at an "I.T.W."

Tabulating Faults

I WAS speaking to a really enthusiastic amateur serviceman the other day and I found that there are hundreds of readers who take such work really seriously. One of the main difficulties of service work is the identification of a fault from some peculiar symptoms in the performance. Usually the serviceman, from constant practice, will be familiar with the effects introduced by certain faults and thus is not very long in putting a set right. When, however, some unusual symptom is experienced, there is some difficulty in identifying the fault. The amateur I refer to had made a very neat form of loose-leaf alphabetical index of faults and their effects, and every one was cross-referenced in several different ways. This prevents a considerable amount of trouble and doubt when a fault is experienced, and a glance in the book helps to indicate something on the lines which may be taken in finding the fault. I should be glad to hear of any similar idea or other service aid which readers may have adopted in this connection, and I am sure other readers will be interested in the experiences of servicemen or experimenters in this particular field.

An Appeal

ONE of the gunners attached to a searchlight detachment, who is also a reader of this journal, tells me that his company are situated in a lonely spot and they want a wireless set of the battery type. If any reader has a battery portable which they would like to give to the detachment in question, I should be glad to pass along the name and address. Carriage will be refunded.

NOW READY

RADIO ENGINEER'S POCKET BOOK

By F. J. CAMM

Vest pocket size

3/6, or 3/10, by post from George Newnes, Ltd.
(Book Dept.), Tower House, Southampton Street,
Strand, London, W.C.2.

Constructing Portables

How to Construct Portable-type Receivers from Existing Sets or Spare Parts

THIS time of the year may justly be called the portable season, and the recent restrictions regarding the use of car-radio apparatus do not apply to ordinary portables, which may still be used. We can supply certain blueprints of portables, but there are no doubt hundreds of readers who do not feel inclined to go to the expense of a completely new set of components, due to the fact that they have many useful parts on hand which they wish to make use of. It is therefore proposed to suggest a few circuits and approximate layouts of simpler types of portable receivers for the benefit of such readers.

pentode output valve. The circuit is similar to that used for an ordinary "fixed" set, except that a frame aerial, with reaction winding, is used in place of the usual aerial and coil. A "stopper" resistance is included in the grid circuit of the pentode, and a .002 mfd. condenser is connected between the anode of the pentode and H.T. negative to prevent L.F. instability. A variable potentiometer is shown for controlling the voltage on the screen of the detector, but this might well be a baseboard-mounting pre-set component, since it need not be touched after the preliminary adjustment has been

made, so as to obtain smooth reaction control. The circuit is similar to that used for an ordinary "fixed" set, except that a frame aerial, with reaction winding, is used in place of the usual aerial and coil. A "stopper" resistance is included in the grid circuit of the pentode, and a .002 mfd. condenser is connected between the anode of the pentode and H.T. negative to prevent L.F. instability. A variable potentiometer is shown for controlling the voltage on the screen of the detector, but this might well be a baseboard-mounting pre-set component, since it need not be touched after the preliminary adjustment has been

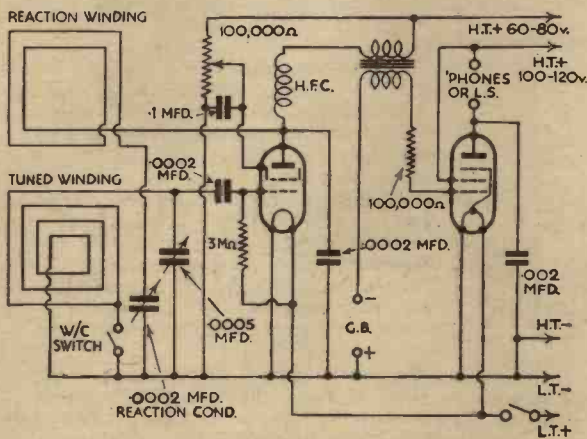

Fig. 1.—The above is a really good circuit for a simple type of portable receiver using modern valves.

Having decided to build a portable, the first question which arises is: must the set be really small and light, so that it can easily be carried by hand, or is it only required for transport from room to room? In the former case it will be better to make the simplest kind of two or three-valver, preferably housing the receiver proper in one container and the batteries in another. If weight and bulk are not very important considerations, a more pretentious and entirely self-contained outfit will be better. Another point which must be decided is whether loudspeaker or 'phone reception will be required. In most instances the speaker will be preferred, but many will content themselves with 'phones, using the set probably only for receiving news bulletins and the like.

In the majority of cases nothing more than local-station reception will be required, so that the use of a det.-L.F. type of circuit might prove quite satisfactory. Where long-distance reception is specially wanted at least one H.F. stage—preferably using a high-frequency pentode valve—will be especially desirable.

Simple Circuit Arrangement

Now that the preliminaries have been discussed a few useful circuit arrangements can be considered. One excellent circuit for local-station reception up to 20 miles or so on a loudspeaker, or over much greater distances with 'phones, is shown in Fig. 1. It will be seen that a screen-grid valve (which might be replaced by an H.F. pentode) is used as detector, this being followed by a 5:1 L.F. transformer and a

made, so as to obtain smooth reaction control. A suggested arrangement of the components and frame aerial is given in Fig. 2, but this may be modified considerably so as to accommodate the parts in some available attaché-case or other container.

When the set is to be accommodated in a case separate from that containing the batteries, it will be so small that a frame aerial wound round it would not prove very effective on account of its small size. It would, therefore, be better to replace the

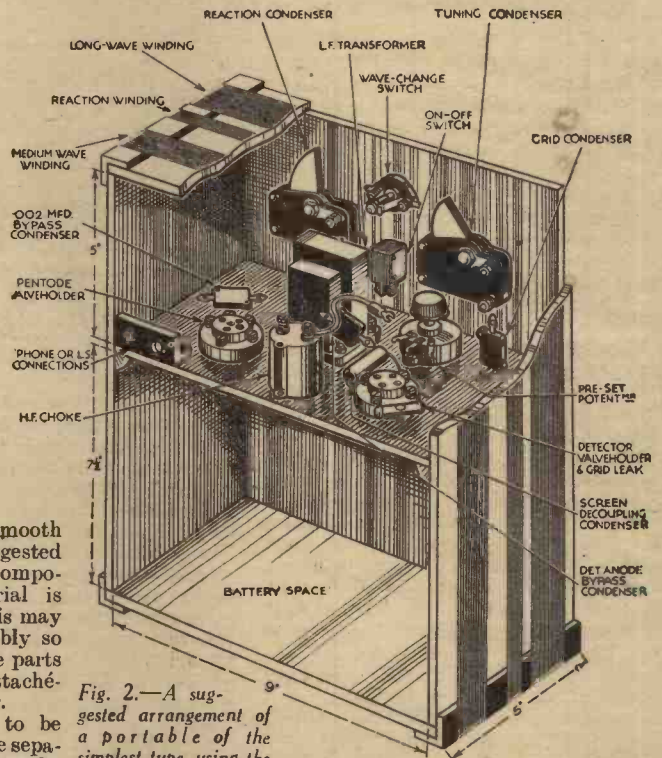

Fig. 2.—A suggested arrangement of a portable of the simplest type using the circuit given in Fig. 1. Dimensions are approximate and will have to be modified according to the batteries employed and if a speaker is to be accommodated.

It might be mentioned at this point that a fairly effective and particularly convenient "self-winding" aerial can be devised from one of the steel tape measures which can be bought from sixpenny stores. The end of the tape is soldered or otherwise connected to the aerial terminal, so that to "erect" the aerial it is only necessary to pull out the case. After use the "aerial" is wound up simply by pressing the spring-release on the side of the case. A measure only a yard long can be used but, naturally, better results can be obtained by employing a greater length than this.

Increased Volume with a Two-valve Set

The circuit given in Fig. 1 is not suitable when good speaker reproduction is required out of doors, unless the set is used within a very few miles of a regional station.

More volume can be obtained fairly easily
(Continued on facing page.)

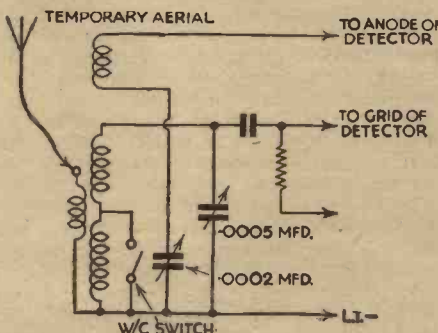

Fig. 3.—With a very small portable better results can often be obtained by replacing the frame aerial by a dual-range coil and using a short temporary aerial. The connections given above show how a coil is substituted for the frame aerial shown in Fig. 1.

CONSTRUCTING PORTABLES

(Continued from previous page.)

however, by replacing the single output pentode by one of the new Q.P.P. double pentodes. This would necessitate the use of an 8 or 10 to 1 Q.P.P. transformer in place of the ordinary L.F. transformer

gested so far would entail the purchase of at least a few new parts, and, therefore, a circuit is given in Fig. 6 to show what can be done by using the old and home-made parts throughout. The circuit is a standard one of the S.G.-Det.-L.F. and Power type, and operates from a frame aerial. Both

the bakelite dielectric variety, although existing air-dielectric condensers which are on hand might be used if compactness is not insisted upon. In regard to the loudspeaker, this can be of the balanced-armature type, and a suitable unit can be bought for a few shillings at the present time. Slightly

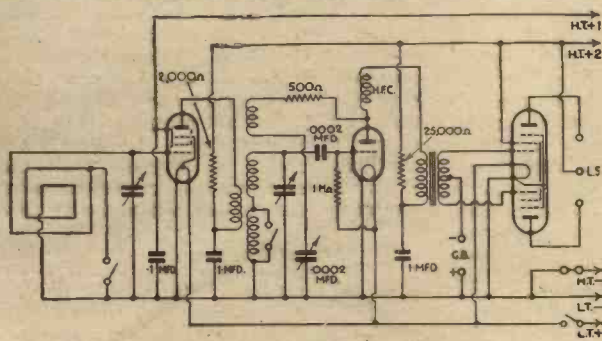

Fig. 5.—Circuit of a 3-valve portable. An H.F. pentode, detector and double output pentode are used.

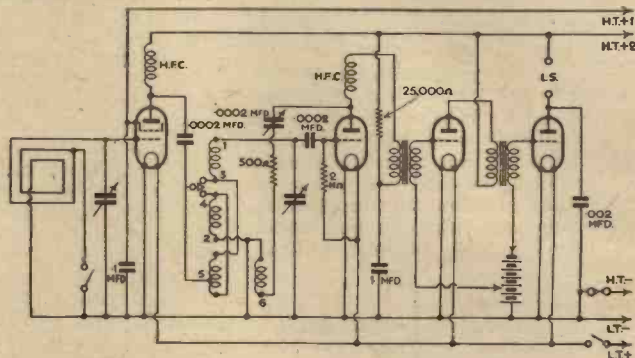

Fig. 6.—A 4-valve portable which can be built from spare parts.

shown in Fig. 1, whilst the loudspeaker would either have to be of Q.P.P. type or else fed through a special output choke. The double pentode circuit is given in Fig. 4, and this is simply added to the detector portion shown in Fig. 1.

H.F. chokes can be of any good screened, high-inductance type. In the interests of compactness and light weight the two .0005 mfd. tuning condensers might be of

better results would be obtained by using a moving-coil, but that would add to the weight and bulk, besides being more expensive if a new one were to be bought.

Increased Range

Neither of the arrangements described so far is suitable for any other than purely local reception, and when the set is to be used at distances of more than twenty miles or so from the nearest transmitter, it is better to use a stage of H.F. amplification. An excellent circuit for a powerful three-valve portable receiver is shown in Fig. 5, where it will be seen that an H.F. pentode is followed by a tuned transformer coupling, leaky-grid detector (a type H valve is very suitable), and a double pentode Q.P.P. output stage. The latter could, of course, be replaced by an ordinary pentode connected as shown in Fig. 1. When the set is being built as a separate unit the frame aerial would be replaced by a dual-range coil, and an "outside" aerial of one of the types mentioned above would be connected to it. Provided that the coil was of the same type



B.L.D.L.C.

IN spite of the existing strenuous times, during which the majority of us are having to curtail to some extent the number of hours normally devoted to our hobbies, it is very comforting to find that quite a number of members are still able to take a keen interest in the Club's activities. The harder one is working the greater the necessity for some diversion both mentally and physically; therefore if time only permits, say, half an hour devoted to receiving, the relaxation obtained from the sterner thoughts of to-day will refresh one's mind and body. As we have mentioned before, an hour at the control of the receiver is now likely to produce a more thrilling log than during normal times owing to the fact that the more distant stations are able to be received as the air is no longer swamped by the numerous British stations.

and I have found that a great deal depends on the following. Short-wave coils play a very important part in any S.W. receiver, therefore it pays one to give them careful attention when selecting suitable types. Some use coils covering two or three ranges, while others use the simple plug-in types; in my case I have always adopted the four or six-pin plug-in kind and have always found that they are superior to the multi-range types.

"High-frequency chokes can give lots of trouble if they are not carefully selected for the particular circuit under consideration. I do not agree with the idea of using a general-purpose H.F. choke, by which I mean one covering all wavelengths, in any receivers designed specifically for short-wave work.

"The selection of suitable valves is another very important matter, but from the articles which have already appeared in these pages readers will no doubt appreciate that without additional emphasis from me.

"The set in use at present consists of the following arrangement. A Mazda H.F. Pen acting as an untuned buffer between aerial and an HL2 as the detector. An L210 is used for the L.F. stage and this feeds into a PM2A in the output, the H.T. supply is obtained from an A.C. eliminator. Many short-wave enthusiasts condemn the untuned H.F. stage as being a waste of a good valve but, when one considers and appreciates the work it does, I think the man who converts an 0-v-1 to a 1-v-1 using this method, will agree that it obviates many sources of trouble experienced in 0-v-1 types of circuit. I found most definitely that the addition of the H.F. valve improved such snags as hand capacity and aerial damping in addition to giving an appreciable amount of amplification. I admit that the resultant selectivity is not what one would like, but have any of the straight types of circuit got that to their credit?"

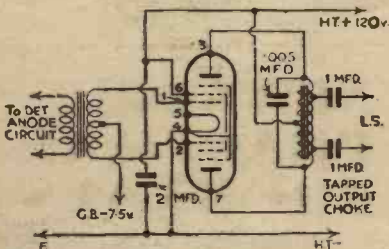

Fig. 4.—A Q.P.P. stage which can be used in a portable with good results.

as that used between the first two valves, a two-gang .0005 mfd. condenser could be employed for tuning. The component layout might well be very similar to that shown in Fig. 2, it being assumed that a frame aerial is to be employed, and that the set is to be entirely self-contained with its own loudspeaker and batteries. The dimensions will require to be at least 2in. greater in every direction than those shown in Fig. 2, to allow for the additional components, while an extra 4in. or so might be required in the width of the frame according to the particular loudspeaker used.

Using Old Components

Practically all the arrangements sug-

Member 6702

One or two points which we have stressed from time to time are contained in this member's letter and in view of their general interest we are repeating the major portion of his correspondence but space causes us to eliminate the rather fine log he sent in. "As a reader of PRACTICAL WIRELESS for over a long period I have noticed from time to time remarks made by readers who are contemplating trying out an H.F. Pen untuned stage of H.F. amplification in an S.W. circuit. I have also noticed that many of your readers appear to use sets of the 0-v-1 type or commercial superhets. I submit the following remarks with the hope that they will help prospective constructors who wish to try out H.F. amplification to obtain more accurate indications for them to judge its comparative worth. As an experienced short-wave constructor for over a period of ten years, I have constructed short-wave sets from the simple one-valvers to those utilising four valves,

More Unusual Faults

Servicing Experiences Showing How Troubles May Be Introduced in Unusual Ways

WE have published many articles dealing with fault-finding in its various phases, and many constructors are now turning their attention to practical radio servicing. Although there are many "rules" which can be followed in regard to the location of faults it is often found that what may be termed "unusual faults" are experienced which normal servicing methods do not reveal. For instance, an interesting problem was recently presented when it was noticed that reception had become gradually

An Earth Lead Astray

A really mysterious incident occurred in a set that worked fairly well through the winter, but with the coming of lighter days the volume fell off more rapidly than would have been expected. As in the previous case, there was apparently nothing wrong with the set itself or with the batteries. The aerial seemed perfect, and it was, therefore, suggested that the earth was faulty. This consisted of a good copper plate, with the wire securely soldered to it. The wire from the set disappeared in a hole in the floorboard behind the set, and passed through an "air brick" under the floor into the garden, and so to the earth plate (see Fig. 1). There was a thick, insulated wire emerging from the ventilating brick and dipping underground among the flowers. A sharp upward tug convinced us that the soldered joint on the earth plate was intact.

An attempt was then made to pull the wire gently away from the house. Ten feet of wire was pulled out!

On going back to the room where the set was installed, however, it was found that the earth wire was still in position. There was nothing for it but to take up a floor-board, and when this was done the mystery was solved, for the wire con-

ected to the earth terminal of the set just led into the empty space under the floor and no farther. It appeared that the aerial and earth had been fitted while the house was being built. The earth plate, with wire already soldered to it, had been buried just outside the wall and the wire fed through the air brick. It had not been possible to manipulate the wire through the hole in the floor, so a stout wire had been pushed down the hole to "fish" for the earth wire, which had eventually been hooked and pulled up through the hole. It will be clear that the hook would have brought up a loop of the earth wire, and the loop had been cut and the wrong end of it used for the earth connection, allowing what had been imagined to be the spare end (but really the end connected to the earth plate) to slip out of sight under the floor.

Cleating a Down Lead

Here is a word of advice to those who intend to use loft aerials. Pay particular attention

to their position with respect to any water pipes which may be installed in the loft. I once saw a beautifully erected aerial in a loft, the efficiency of which was reduced to a very low value because it was running immediately above a range of water pipes (Fig. 2). The "effective" height of that aerial was certainly less than one metre, and the performance of the set connected to it was very poor until the aerial was taken down and moved to another part of the loft where it was not shielded by well-earthed pipes.

A case of poor results with an indoor aerial was eventually traced to the down lead, which ran down the side of the house.

Insulated wire of the single-strand variety had been used, and it was fastened to the woodwork of various window frames by so-called "insulated" staples, that is, copper staples with a piece of thin, vulcanised fibre inside the "U." Intermittent-good and bad reception led one to suspect a loose contact. Ultimately the fault was found in the down lead under one of the staples which had severed the wire, causing a disconnection, although a rubbing

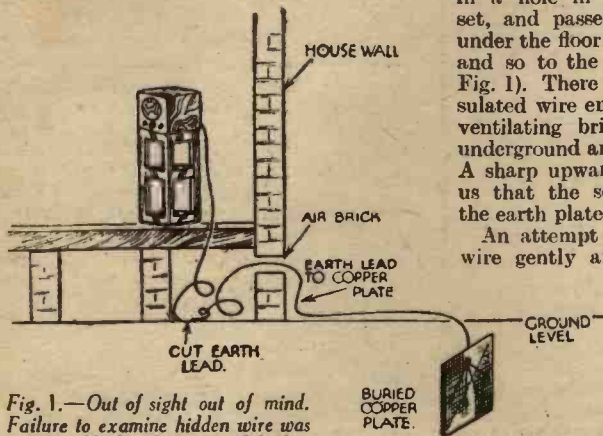

Fig. 1.—Out of sight out of mind. Failure to examine hidden wire was responsible for this unusual fault.

weaker and weaker, and was eventually not worth listening to. A few minutes with a milliammeter gave convincing proof that the set itself was functioning properly, and that the batteries, and so forth, were in good order. The aerial, installed in the loft, was inspected and appeared to be in excellent condition, the down lead was intact and well insulated, and the earth plate seemed beyond reproach.

The aerial and earth entered the house by two holes drilled in the window frame, and were led to a two-pin socket just inside the window, connection to the set being made by means of a plug inserted in the socket. It was in this socket that the fault was eventually located. The socket itself was a bakelite moulding, open at the back, and was packed with spiders' webs, while a certain amount of damp had gradually short-circuited the radio signals. When the socket had been cleaned out and dried, the set functioned as well as ever.

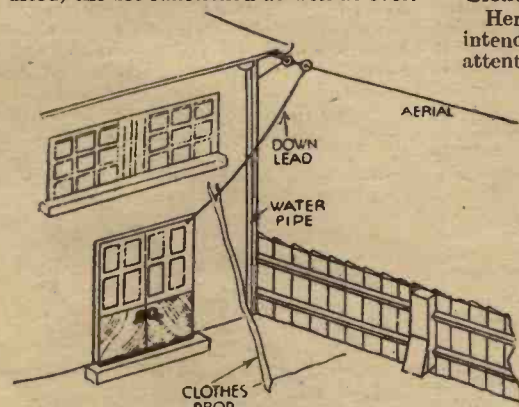

Fig. 3.—Another instance of thoughtlessness causing annoying troubles.

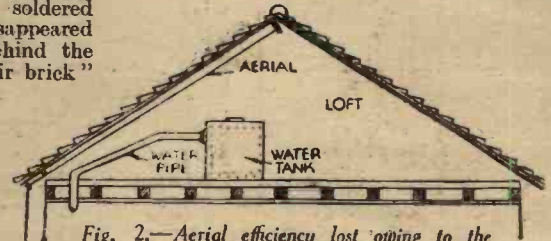

Fig. 2.—Aerial efficiency lost owing to the proximity of an earthed body.

contact sometimes gave the full effect of the complete aerial.

Clothes Props

A listener complained that quite suddenly his set had developed rather alarming cracklings, and although he had thoroughly overhauled it he could trace no faulty connection to account for the trouble. When the set was switched on one afternoon, the programme came over surprisingly well, and there was no sign whatever of the reported scratchings and crackles. It was about four o'clock when he started to listen, and everything went well until about the middle of the First News, when ominous scratchings began.

Examination of the aerial showed that a large clothes prop was leaning against the wall of the house, and was pressing on the lead-in wire, causing it to touch the metal guttering, as shown in Fig. 3. A few inches of insulating tape and the removal of the clothes prop restored the performance of the radio to normal.

NEWNES' PRACTICAL JOURNALS

Practical Engineering

The weekly journal for those engaged in all branches of the Engineering and kindred industries.

4d. Every Thursday

Practical Mechanics

The only English Journal of its type. It deals with every branch of Science, Mechanics, Invention, Model-making, Chemistry, Astronomy, Photography.

7d. Every month

Practical Hints

A Dual-purpose Switch

WHEN adding an extension speaker to my set recently, I found that I needed a switch which would break one circuit and make another, and finding an

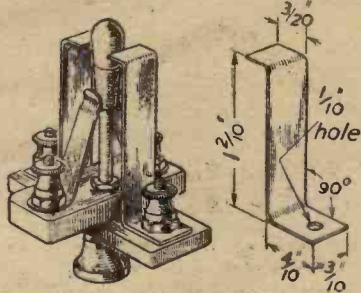

Adapting a push-pull switch for a dual purpose.

old wave-change switch, I converted this into the kind of switch I wanted by the following arrangement.

I cut a piece of 1/10in. insulation fibre, 1/2in. wide, and about 1 1/2in. long, and bored a 1/10in. hole in the middle. A 1/10in. hole was then bored about 1/2in. from each end. Two strips of tin were next bent, as shown in the sketch. I then fixed the piece of fibre under the central fixing nut and screwed it down tightly.

The stems of two small terminals were pushed through the holes at each end of the fibre after slipping on the tin contact strips. After adjusting the tin contacts, the switch was ready for use.—J. F. CATCHPOOL (Ampleforth).

Tightening a Loose Nut

I OFTEN find that terminals on components work loose and tightening them up again means a lot of trouble, especially with a transformer or similar component where the screw head is inside the component, and the thread will be damaged if held in pliers.

To overcome this difficulty I devised the following method for holding the screw while the nut A (see sketch) is being tightened.

Two nuts, B and C, of the same thread as the screw, were found and placed on the end of the screw. They were then locked against each other by holding one and tightening the other up against it. Then, by gripping the nuts with pliers, the screw was also held tight, and the slack nut, A, could then be made fast.—CECIL V. WILMAN (Beeston).

Screw head inside component

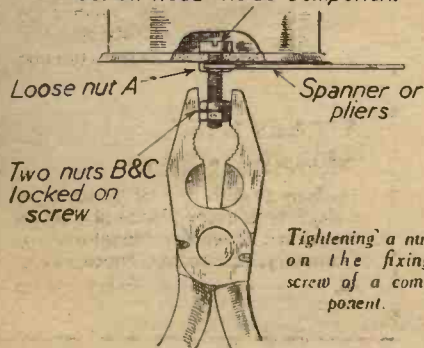

THAT DODGE OF YOURS!

Every Reader of "PRACTICAL WIRELESS" must have originated some little dodge which would interest other readers. Why not pass it on to us? We pay £1-10-0 for the best hint submitted, and for every other item published on this page we will pay half-a-guinea. Turn that idea of yours to account by sending it in to us addressed to the Editor, "PRACTICAL WIRELESS," George Newnes, Ltd., Tower House, Southampton Street, Strand, W.C.2. Put your name and address on every item. Please note that every notion sent in must be original. Mark envelopes "Practical Hints." DO NOT enclose Queries with your hints.

SPECIAL NOTICE

All hints must be accompanied by the coupon cut from page iii of cover.

Anchoring a Pencil

EVERY amateur knows that the most elusive piece of equipment is the common lead pencil.

It is always missing just when needed most to take down some real DX signals.

I therefore hit upon this scheme to keep

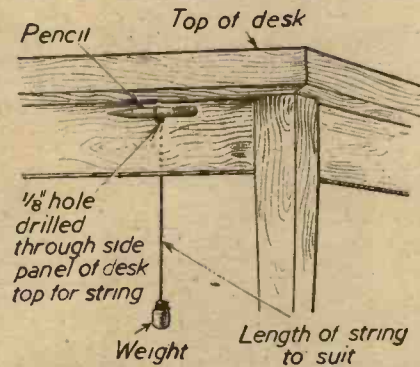

An effective dodge for keeping a pencil always at hand.

a pencil on the desk at all times. All that is necessary is to drill a 1/8 in. hole just below the desk top, put a piece of string through, tie the pencil to one end, and a weight to the other end. When you require the pencil, reach under the edge of the desk where the pencil is hidden and pull it out—the weight keeps the pencil in place.—JERVIS G. HAMER (West Bridgford).

PLEASE NOTE!

Will readers please adhere to our request that all Notions sent in must be original. Apart from the dishonesty of copying out an idea from another magazine or even from an early issue of this paper, considerable time has to be spent in comparing not only the sketches but also the text. It should be remembered that awards are only made for wrinkles which are original ideas.

Aerial Fixing

I RECENTLY wished to fit an aerial support to a chimney stack on the roof, but had no ladder which would enable me to get right round the stack. This meant that I could not place a band or similar device round the stack. After wondering how to fit the mast rigidly I adopted the following scheme: I obtained two 6in. coach bolts and a strip of iron. The latter was bent to form a "U" to fit round the mast and drilled at the ends to pass the bolt. The latter was then attached direct to the front of the stack (which was accessible) by scraping out mortar between adjacent bricks, filling the hole with cement and pushing the heads of the bolts into the wet cement. When dry the bolts are firmly held, and the mast was then held in position. The "U" clamps slipped over the mast and over the bolts and nutted up. The result is a rigid and neat-looking mast fixture.—J. HINES (Port Arthur).

Flex Bindings

TO keep the ends of flex wire tidy ordinary cycle valve tubing is ideal. The only difficulty is in getting it down over the flex braid without making this screw up and become still more untidy. I found that the simplest way of carrying out the idea was to stretch the tubing open first, after cutting off a length about 1in. long. I clamped three pieces of stiff piano wire in a small vice, and with a pair of ordinary pliers opened the three wires slightly. The valve rubber was then slipped over the three wires and they were then opened much wider, stretching the tubing out in a triangular formation. Now the bared end of the flex is slipped down inside the stretched rubber and when in the right place the vice jaws are loosened, the rubber springs in and the three wires are then removed.—O. BOURNE, (Caerphilly).

Repairing a Potentiometer

RECENTLY I had some trouble with my set, and found that the wire-wound potentiometer had broken down. Wondering what I should do, I eventually cured the trouble by taking the element off its bakelite body and, using 0-grade glass-paper, removed the insulation from the wire on either side of the break. A strip of copper foil 1/16in. wide was then placed over that section, and the element was then replaced. Contact between the body and the element kept the foil tightly in place. This effected a complete cure, and the shorting out of the few turns made hardly any difference to the resistance value.—R. HICKS (Jersey, C.I.).

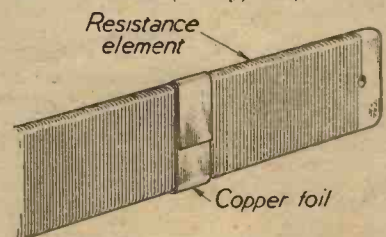

A simple method of repairing a flat potentiometer.

Noise Suppression Circuits

Interesting Developments for Use in Modern Circuits

KNOwn circuit arrangements for suppressing intermittent noise voltages having an amplitude greater than that of the desired signal, make provision for developing a bias potential proportional to amplitude excess of the interference over that of the desired signal, and the bias potential is used to render the detector inoperative so long as the high amplitude noise continues. One drawback to circuits of this type lies in the fact that noise-suppressing action cannot begin until the noise amplitude exceeds the amplitude of the desired signal, for otherwise the signal itself would be partly suppressed.

In the arrangement described below, the detector is rendered inoperative by a voltage which is determined not only by the amplitude of an interfering noise impulse, but also by its rate of growth, and Fig. 1 shows it included in the second detector network of a superheterodyne receiver. The circuit (1) is resonated to the operating intermediate frequency, and is coupled to any desired type of I.F. network for receiving its signal energy. The detector valve itself is a triode (2) whose anode (10) is coupled by condenser (11) to a desired point on the input coil (12). The cathode of valve (2) is at earth potential, and the load impedance (13) is connected between the anode and cathode of detector valve (2). Any desired value of audio-frequency voltage may be tapped off from impedance (13) by the slidable tap (P3).

The cathode and anode of (2) provide a diode rectifier whose conductivity is regulated by the grid (14). Control bias for grid (14) is developed by a so-called noise suppressor or "squelch" diode (3) which has its cathode (15) connected to coil (12). The anode (16) of diode (3) is connected to the positive potential terminal of a current source (not shown) by a resistor (17). The anode end of resistor (17) is earthed for alternating currents and a direct current blocking condenser (18) connects the low potential end of coil (12) to the earthed end of resistor (17). The anode end of resistor (17) is earthed for alternating currents and a direct current blocking condenser (18) connects the low potential end of coil (12) to the earthed end of resistor (17). The cathode (15) of diode (3) is adjustably biased positive by the slidable tap (P4) connected to resistor (17).

Rectified current flowing through diode (3) is transformed into a voltage proportional to the rate of change of input current. This is accomplished by the transformer (4), or equivalent inductive device, whose primary (20) is arranged in series between the anode (16) and earth, the radio frequency bypass condenser (22) being connected across the primary. The secondary (21) is arranged in a series path comprising the space current path of diode (5), and condenser (6) and the grid (14) of detector valve (2) is connected to anode (23) of diode (5). The adjustable tap (P5) is

employed to provide normal positive bias for the cathode of diode (5) and the tap (P6) is used to adjust the normal bias for control grid (14), the resistor (7) being arranged in the lead to the grid.

Operation

The operation of the arrangement is as follows. In the absence of interference, tap (P4) is adjusted to bias diode (3) sufficiently to prevent its drawing much

impressed upon the grid not only paralyses the detector tube during the time when the transient amplitude is increasing, but this charge dies out only after a length of time determined by the capacity of condenser (6) and the resistance of resistor (7). By a suitable choice of these constants the detector may be arranged to remain inoperative for a predetermined length of time which will be chosen sufficient to permit transients in the intermediate frequency circuits to die out. The normal bias on valve (5) will be so chosen that a slight amount of rectification can be permitted in the absence of noise voltage at diode (3) without developing enough voltage in the secondary of transformer (4) to overcome the bias on valve (5). This is because the modulation of the desired signal is relatively slow compared to the sudden building up of transients due to shock excitation. Hence, even though the amplitude of such a sudden transient may not exceed the amplitude of the signal, yet, due to its higher rate of change, it may still produce a noise-suppressing action while the normal signal itself will not. In order to simplify the explanation, separate electrodes have been shown for each of the various functions, but any type of detector may be used. It will, also, be apparent that a separate tube (3) may be dispensed with by placing the primary of transformer (4) in the circuit of the detector itself, although it is preferable to use a separate tube in order to limit its action to interfering voltages in excess of the unmodulated carrier.

Alternative Scheme

Fig. 2 shows an arrangement similar to that of Fig. 1, except that the normal bias

Fig. 1.—The system incorporated around the second detector of a superhet circuit.

current. It is permissible, however, for this bias to be adjusted to less than double the unmodulated carrier amplitude for reasons which will be pointed out subsequently. Assuming, now, that interference such as motor-car ignition sets up a transient oscillation in the intermediate frequency circuits of the receiver, the amplitude of this oscillation grows with extreme rapidity. Therefore, the resulting rectified current flowing through the primary (20) of transformer (4) has a large rate of change, and induces a correspondingly large secondary voltage. The polarity of the winding of transformer (4) is so chosen that the valve diode (5) permits current to flow only as a result of voltage caused by increasing current through diode (3). When the spark occurs, therefore, voltage induced in the secondary winding of transformer (4) overcomes the bias on valve (5), and produces a flow of current into condenser (6) thereby building up a negative charge on the grid (14) of detector (2).

The valve action of diode (5) prevents this charge from being withdrawn as transient dies away, and voltage of opposite sign is developed in the secondary of transformer (4). The negative charge thus

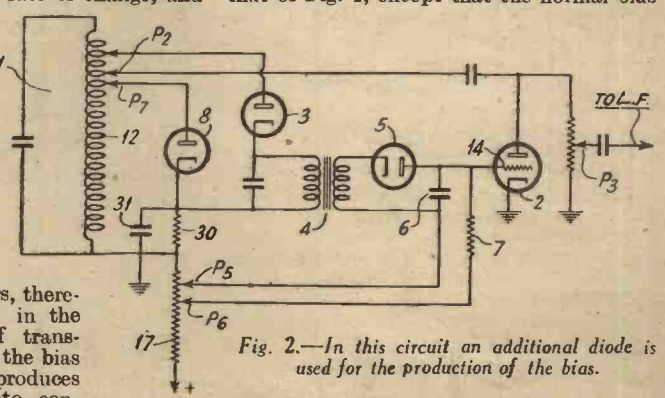
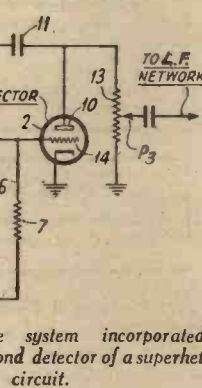

Fig. 2.—In this circuit an additional diode is used for the production of the bias.

on diode (3) is produced by a further diode rectifier (8). The amount of this bias, as compared to the intermediate frequency voltage on diode (3), may be adjusted by the position of the tap (P7) on coil (12) of circuit (1) to which rectifier (8) is connected. For a given signal level the action of the circuit of Fig. 2 is the same as that of Fig. 1, and the only difference is that the bias on diode (3) adjusts itself automatically in accordance with the carrier voltage of the desired signal. The cathode of diode (3) is connected to the cathode end of resistor (30) arranged between the cathode of diode (8) and earth, a large condenser (31) being shunted across resistor (30). This system has been developed by the Radio Corporation of America.

PRACTICAL WIRELESS SERVICE MANUAL

By F. J. CAMM.

From all Booksellers 6/- net, or by post 6/6 direct from the Publishers, George Newnes, Ltd. (Book Dept.), Tower House, Southampton St., Strand, London, W.C.2.

HOME-MADE COMPONENTS

In This Article Constructional Data is Given for Making Various Types of Wire-wound Resistances

THERE are many components which the beginner can construct quite easily, and which will be found just as efficient in operation as a factory-made article. There are, of course, various difficulties which sometimes have to be overcome, but one of the types of component which does not call for any elaborate tools or apparatus is the wire-wound resistance. This may be employed for all purposes where an inductive type of resistance is permissible. Such resistances are made up in various ways according to the service for which they are intended, and either have a fixed resistance value, or are variable by means of tappings or a sliding contact. As distinct from these differences

wound on formers made from fibre, bakelite, ebonite, glass, or similar insulating material. One of the type referred to is shown in Fig. 1. Connections may be provided in a variety of ways, with screws and nuts as illustrated, or by means of clips having extended ends forming soldering tags. Another simple way of doing the same job is to pierce the former at each end to take eyelets. The resistance wire is then anchored under one eyelet at the commencement of the winding and secured by the other at the finish. In this way it is a simple matter, by arranging the centre distance of the eyelets correctly, to allow the resistance to form a link between the terminals of two components without using connecting wires. Resistances like this may be wound with bare wire, in which case the wire must be spaced so that adjacent turns do not touch, or where a great number of turns are required the use of silk covered nickel-copper wire will effect a saving in space. Where this is used the turns can, of course, be close together in the same manner as when wire of the same quality having an oxidised surface is to be utilised.

metal clips at each end. The sleeving will then also form a safeguard against the inadvertent "pulling-out" of the wire, which otherwise might result were the string alone left to take any strain. At the ends, the resistance is finished off with tags for connecting purposes.

Adjustable Resistances of Low Carrying Capacity

Small rheostats having a rotating contact arm may be made in several ways. Perhaps the simplest is to prepare a disc of ebonite or similar material by turning



Fig. 1.—A small resistance wound on a flat fibre former.

the construction of the resistance may differ in regard to the material employed for the former, and also in the condition and the quality of the wire itself.

Types of Wire-wound Resistances

The types of this class of resistance range from small fixed ones of the strip variety, and flexible ones of the spaghetti type, to mains resistances. These are all made "fixed," or at the most adjustable by tapping. Adjustable ones that may vary in value by the rotation of a contact arm or movement of a slider range from small rheostats and potentiometers of 3 to 5 watts rating to larger ones, mostly adjustable by means of a slider, having ratings up to 60 watts.

Fixed Resistances of Low Carrying Capacity

Resistances which come under this heading as regards carrying capacity may be

When the wire is space wound it is advisable evenly to serrate the edges of the former as a preventive against the turns slipping and possibly shorting. This can easily be done, where the former material is thin and of a yielding nature, by rubbing each edge of the former across a file, thus reproducing a series of nicks of the same pitch as the teeth of the file used.

Where bare wire is used to wind cylindrical resistances greater satisfaction will be obtained from the use of a threaded former.

Flexible resistances of the spaghetti type are formed by winding the wire on to a former of asbestos string. For this type of resistance the wire needs to be insulated and securely anchored at the ends in good electrical contact with metal bands clipped on to the string. Protection is afforded to the winding by covering with a length of insulating sleeving which should pass freely over the wire, and be bound to the

a semi-circular groove in the edge. Two screws are fixed in the bottom of the groove about $\frac{1}{16}$ in. apart. The resistance wire is wound in the form of a small tension spring, the length being such that it is less than the circumference of the former at the bottom of the groove; less, of course, by the distance between the screws. After attaching each end of the coiled wire to a screw, it is sprung into the groove. When in position the "spring" must be in tension sufficiently to leave a space between each coil. A rotating contact arm, carried on a spindle working in a bush in the centre of the former, bears against the coils. Connections are made to one end of the resistance wire, and to the bush in contact with the spindle and arm. An alternative method is to cut a groove, slightly undercut towards the centre, in the face of the disc and concentric with the outside, the wire being prepared and sprung in as before.

In both cases the wire must be heavy enough so that when coiled up in position it will form a spring of sufficient rigidity to withstand the action of the contact arm, without bunching the turns close together. A superior method of construction may be obtained by winding the wire on to a threaded former made from ebonite or "erinoid" rod. The thread can be cut with a die larger than the diameter of the rod, so as to form a shallow flat, tapped thread. This is necessary to allow the wire when wound to project slightly above the surface of the rod. After winding, the rod is bent, first heating in hot water to soften the material, to fit round the edge of a grooved disc as before. In every instance bare wire is used.

Small potentiometers like that shown in Fig. 2 are wound on thin sheet fibre formers, the projections against the abutting edges forming stops for the contact arm. The wire is wound while the former is flat—Fig. 3 shows a simple means of winding—and afterwards bent to shape in steam. Wire with an oxidised surface is generally used

(Continued on next page.)

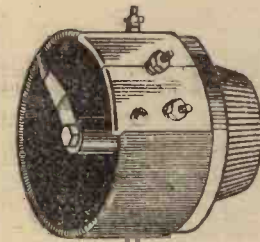

Fig. 2.—A potentiometer with the resistance wire wound on a thin sheet fibre former.

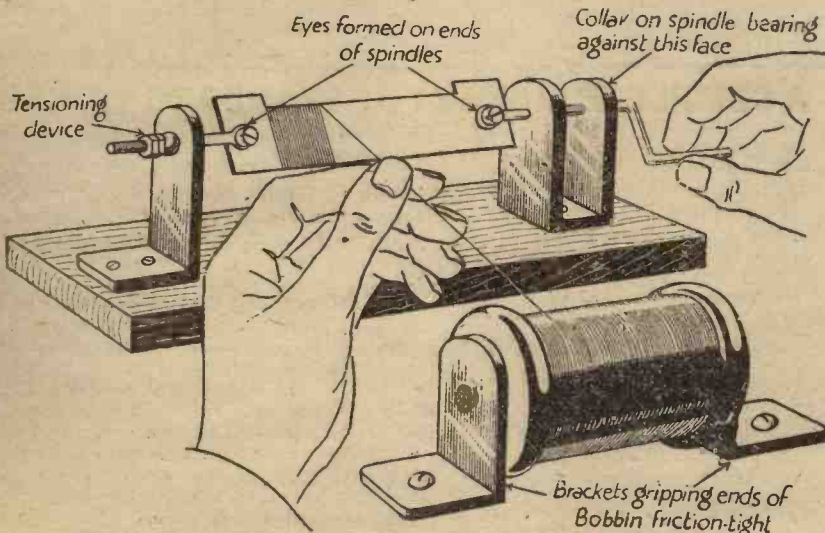

Fig. 3.—A simple method of winding resistance wire on flat formers.

HOME-MADE COMPONENTS

(Continued from previous page)

for winding, the adjacent turns touching each other. The oxidisation is removed with a fine oil stone, used dry, in the track of the contact arm.

Resistances for Heavier Duty

Resistances such as those for mains or power use must, without exception, be wound on heat-resisting formers. These are usually made of porcelain or from an asbestos preparation. Fairly thick mica of an electrical quality will also serve in cases where it would prove adaptable. The porcelain formers are made with a continuous groove like a thread so that the turns of wire when wound are separated. These formers are made with both fine and coarse pitched spiral grooves; with the latter type the resistance wire is space

is required to provide a resistance of a certain ohmic value which from a space-saving point is a valuable property.

The accompanying table gives the required data for selecting the proper gauge of wire, and an example of working out the amount of wire required is given in a simple manner.

EXAMPLE.—What gauge and how many feet of nickel-copper resistance wire is required to make a 100-ohm resistance to carry a maximum current of .3 amps. From the table it will be seen that No. 35 gauge will carry .33 amps. with a temperature rise of 100 degrees. The resistance per foot of wire equals approximately 4.09 ohms, therefore, 100 ohms, the value of the resistance required, divided by the resistance per foot of the wire, is equal to 24.5, this being the number of feet of wire required in the resistance. It should be pointed out that a silk wire would not be

A TABLE OF WIRE GAUGES AND RESISTANCE DATA

Standard Wire Gauge	Diameter of Wire in inches	Nickel-Copper.			Nickel-Chromium-Iron.		
		Number of feet per lb.	Resistance in Ohms per foot.	Carrying Capacity in Amps. at 100° C.	Number of feet per lb.	Resistance in Ohms per foot.	Carrying Capacity in Amps. at 100° C.
16	.004	80.3	.0705	6.0	86.7	.156	4.2
17	.056	105.0	.0921	4.9	113	.203	3.2
18	.048	143.0	.125	4.3	154	.277	2.7
19	.040	206.0	.180	3.7	227	.399	2.18
20	.036	254.0	.223	3.0	274	.492	1.93
21	.032	322.0	.282	2.8	282	.623	1.66
22	.028	420	.368	2.2	453	.813	1.52
23	.024	572	.501	1.8	617	1.11	1.39
24	.022	680	.597	1.5	734	1.32	1.23
25	.020	823	.722	1.25	888	1.59	1.10
26	.018	1016	.891	1.0	1066	1.97	1.01
27	.0164	1224	1.07	0.9	1321	2.37	.95
28	.0148	1503	1.32	0.70	1621	2.91	.88
29	.0136	1780	1.56	0.68	1920	3.45	.83
30	.0124	2141	1.87	0.59	2310	4.15	.78
31	.0116	2447	2.10	0.52	2639	4.74	.73
32	.0108	2823	2.48	0.47	3045	5.47	.67
33	.0100	3293	2.89	0.42	3551	6.38	.69
34	.0092	3890	3.41	0.37	4196	7.53	.64
35	.0084	4666	4.09	0.33	5033	9.04	.60
36	.0076	5701	5.00	0.28	6149	11.0	.58
37	.0068	7120	6.24	0.26	7680	13.8	.54
38	.0060	9148	8.02	0.19	9866	17.7	.50
39	.0052	12175	10.08	0.16	13132	23.6	.48
40	.0048	14291	12.53	0.15	15414	27.7	.46
41	.0044	17000	14.91	0.14	18390	32.93	.44
42	.0040	20960	18.05	0.13	22200	39.85	.42
43	.0036	25400	22.2	0.11	27400	49.2	.40
44	.0032	32200	28.2	0.10	34700	62.27	.38
45	.0028	42000	36.83	0.08	45300	81.32	.36
46	.0024	57200	50.13	0.07	61700	110.7	.34
47	.0020	82300	72.17	0.05	88800	159.4	.32
48	.0016	129000	112.7	0.03	139000	249.0	.30

wound on a core of asbestos string before coiling on the former.

End connections and tappings are made by means of strong clips in both cases. When made up as a variable resistance by means of a slider, the construction should be such that the whole instrument is mechanically sound, the control knob well insulated, and the slider contact must be continuous with the wire during operation.

Choice of Wire

In selecting the gauge of the wire to use for winding a resistance, the first thing to ascertain is, will the wire be capable of carrying the current. Thus it is not only necessary to know the resistance per foot or yard of the wire, but also the carrying capacity in amps. This is important, as if overloaded the wire will become unduly hot.

For the purpose of this article, resistance wire is either an alloy of nickel-copper, or nickel-chromium-iron having a high nickel content. The latter wire has a specific resistance of more than twice that of nickel-copper, consequently only half the amount

suitable, and where it is desired to use a covered wire a heavier gauge must be selected.

Screening the Earth Lead

SCREENING the aerial down lead to reduce local interference is now quite a familiar proceeding, and similar treatment of the earth lead is often found to help when such troubles are encountered on short waves. This latter operation, however, is not so well understood in amateur circles, and so it sometimes fails to yield the desired results; it has certain hidden snags, which must be taken into account if it is to function properly. I have a friend who is a very keen short-wave listener, and he recently moved into a house in which he found it necessary to install his receiver in a room on the second floor, where the earthing problem was a somewhat difficult one. A connection to a nearby water pipe proved unsatisfactory, producing much mains and other noises, and he was finally driven to installing a longish lead down to a plate buried in the ground.

This gave him very fair results, although he found that his set suffered from bad effects a trifle more than it had been accustomed to do in its previous location. Still, it was much the sort of practical compromise with which one must often put up under domestic conditions, and he was tolerably content with it until buses began to run past his house. When this commenced he was troubled on certain wavebands with the most acute interference from the ignition circuits of the buses, and after trying everything he knew, he inquired whether I could suggest anything further. I prescribed a screened earth lead.

When I saw him again a few weeks afterwards, he wasn't a bit pleased with me or my advice, and expressed strong opinions about both before calming down sufficiently to explain that he had spent many hours fitting up a really superfine screened earth lead, only to find that the interference was scarcely affected, while the performance of the set, he was convinced, has "gone all to bits." As I expected, he had gone astray in making connection to the screening sheath of the earth lead. He knew that it must usually be earthed, so he had simply joined it to the earth lead itself at the bottom, a method which is often less successful than one might expect.

In this case a remedy was found by simply making the earthing connection to the screen at its approximate centre, a separate lead being taken from this point to an earth tube placed a few feet away from the buried plate. The interference was then much reduced and the performance of the receiver quite unaffected.—(G. P. K.)

A COMPLETE LIBRARY OF STANDARD WORKS

By F. J. GAMM.

- PRACTICAL WIRELESS ENCYCLOPAEDIA 7/6, by post 8/-.
- EVERYMAN'S WIRELESS BOOK 5/-. by post 5/6.
- SIXTY TESTED WIRELESS CIRCUITS 3/6, by post 3/10.
- COILS, CHOKES and TRANSFORMERS 3/6, by post 3/10.
- PRACTICAL WIRELESS SERVICE MANUAL 6/-. by post 6/6.
- WORKSHOP CALCULATIONS, TABLES & FORMULAE 3/6, by post, 3/10
- NEWNES' SHORT-WAVE MANUAL 5/-. by post 5/4.
- THE HOME MECHANIC ENCYCLOPAEDIA 3/6, by post 4/-.
- WIRELESS TRANSMISSION FOR AMATEURS 3/6, by post 3/10.
- DICTIONARY OF METALS AND THEIR ALLOYS, 5/-. by post 5/4
- THE SUPERHET MANUAL 5/-. by post 5/6
- PRACTICAL MECHANICS HANDBOOK 6/-. by post 6/6.

All obtainable from or through Newsagents or from Geo. Newnes, Ltd., Tower House, Southampton St., Strand, W.C.2

For The Beginner

What Is Modulation?

An Explanation in Simple Terms of the Process Which is of the Utmost Importance in Radio Reception

THE recent article on the subject of a new form of modulation has created considerable interest, but many newcomers are unable to appreciate the arrangement to the full owing to a lack of understanding of what is really meant by modulation. The term occurs very frequently

wave which would be produced by the modulation of (a) by (b). Half the distance between the upper and lower crests is called the "depth of modulation," and is usually expressed as a percentage of the carrier amplitude. Two points in connection with the depth of modulation call for comment. In the first place it is clear that it is impossible to modulate a carrier-wave to an extent greater than 100 per cent. without distortion, and in Fig. 2 is shown how 25, 50, and 100 per cent. modulation is expressed diagrammatically.

Next, it must be understood that the depth of modulation for any radio transmission varies from moment to moment even during a single item. Suppose, for example, a military band performance is being broadcast, and that an average modulation of, say, 25 per cent. is being employed. This degree of modulation will be obtained over the bulk of the programme, but for particularly soft passages the percentage modulation will be less, and for specially loud passages it will be considerably more.

Possible Overloading

Now for a radio-frequency signal of a given strength (that is, a carrier of a given amplitude) and for a given degree of voltage amplification in the

H.F. and detector stages of the radio receiver, the audio-frequency signal applied to the grid of the output valve is proportional to the depth of modulation. If, then, the percentage modulation ranges, as it does, from a very small value up to 80 per cent. or

more, it is necessary to use an output valve which will handle, without distortion, grid voltages corresponding to the strongest signal, and the fullest modulation likely to be received.

This indicates that there are two forms of valve overloading which must be guarded against. Overloading due to a carrier of excessive amplitude, can be avoided by a volume control acting on the aerial circuit, or by the use of variable- μ valves whose signal-handling capacity can be increased by increasing the grid bias. On the other hand, overloading of the low-frequency valves during periods of deep modulation calls for a conservatively rated amplifier which, while giving adequate volume with signals of average modulation, can also handle audio-frequency signals of three or four times average amplitude. This explains why, as has been pointed out many times before in these pages, a valve having a maximum output rating much greater than the normal required output must be used in the last stage if really good reproduction is to be obtained.

Whenever we begin to talk about exact quantities, such as percentages, the question of measurement arises, and it is reasonable to ask whether it is possible to make exact measurements of the depth of modulation. It is not an impossibility, but an accurate modulation meter is rather beyond the resources of most amateurs, and the measurement itself involves the use of a valve voltmeter as well as other instruments. Moreover, it necessitates various circuit changes, and certainly could not be employed during the reception of a programme in the ordinary way.

It is, however, not only possible, but very helpful, to employ a simplified system of measurement which, while not giving a definite reading of modulation depth, serves as a comparative indication, and assists the listener in operating his set under optimum conditions.

(Continued on next page.)

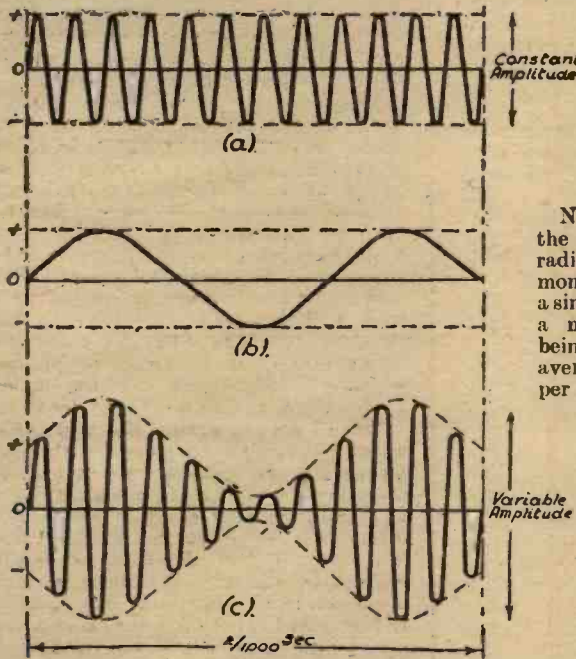

Fig. 1.—Diagrams illustrating the combination of L.F. and H.F. waves to give a modulated H.F. wave.

in the transmitting side of radio, but it is also brought into reception. The following explanation is therefore given for those who are not fully acquainted with the process of modulation. In the radio sense, "modulation" is the name given to the process whereby the audio-frequency currents, obtained from the microphone and its associated amplifiers, are combined with radio-frequency oscillations, prior to being led to the aerial from which their power is radiated as a "modulated carrier wave." Concurrently with this, corresponding modulated high-frequency currents are produced in the aerial circuit at the receiving end; and it is the modulation which is, so to speak, sorted out by the detector and passed on to the low-frequency stages, and speaker, for reproduction as sound.

But while this is a correct definition of the specialised meaning of the word "modulation," the term is also, and quite properly, applied to all cases in which an alternating current impulse is superimposed upon another current which may be either an alternating current of a different frequency, or a direct current.

The Scheme Explained

Fig. 1 shows, in the centre diagram, a conventional audio-frequency wave, and above it an unmodulated carrier of constant amplitude. At (c) is shown the resultant

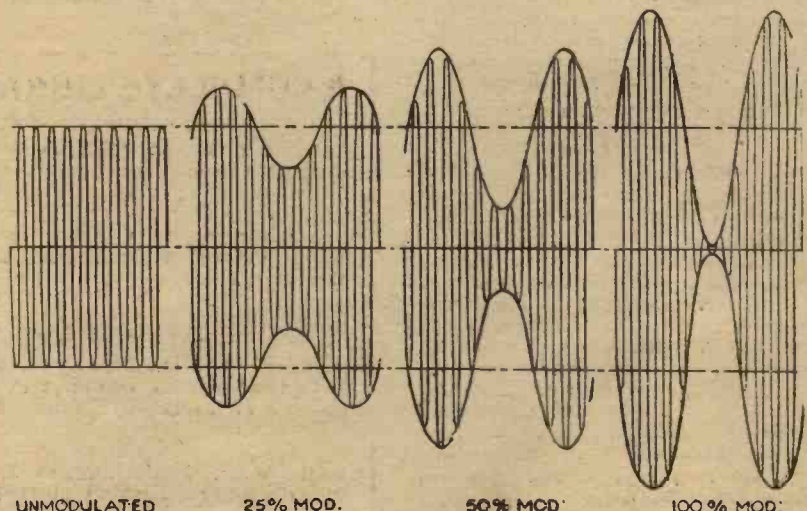

Fig. 2.—Curves illustrating the different degrees of modulation.

WHAT IS MODULATION?

(Continued from previous page.)

Before dealing with this point, however, it is necessary to consider other forms of "modulation." A receiving valve, when no signal is applied to the grid, passes a steady anode current, the value of which depends upon the rate at which the electrons are emitted by the filament or cathode, the voltage applied to the anode, and the bias voltage, if any, applied to the grid. When, however, a signal is applied to the grid, the value of the anode current will vary in sympathy with the signal variations, and the anode current may thus be said to be "modulated" at the frequency of the applied signal. The anode currents of the H.F. valves will be modulated at radio-frequency, the R.F. modulation being itself modulated at audio-frequency. The anode currents of low-frequency valves, will, of course, be modulated at audio-frequency; and the anode current of a detector valve will be modulated mainly at audio-frequency but with a certain R.F. component. Part of the R.F. energy component, in this case, may be returned to the grid circuit by means of the reaction arrangement, and the remainder may be—should be—filtered out by one method or another in order to avoid its transference to the low-frequency stages.

Anode Current Modulation

Consider, now, the effect of this modulation of the anode current. In the case of an amplifying valve, the anode current will swing above and below the mean or average value, as indicated in Fig. 3. Note, however, that owing to the curvature at the bottom end of the grid volts/anode current graph, distortion will occur if the swing overlaps this region. Similarly, distortion will occur if the positive swings overlap the region in which grid current can flow.

It will thus be seen that any over-modulation of the anode current produces distortion, and is, therefore, similar in its results to over-modulation of the carrier wave. An effect of this type can be avoided if care is taken to (1) bias the valve correctly, that is, to the mid point of the straight portion of its characteristic; (2) limit the grid-input signal to a value (at maximum modulation), which the valve can handle without distortion.

Here, then, is one point at which a rudimentary form of modulation meter might be of service. Such a method is, in fact, often used by wise listeners. It consists merely of a milliammeter of suitable range included in the anode circuit of the output valve. Its function is two-fold. In the first place its steady reading when no signal is being received gives an indication that the grid-bias is of approximately the correct value. When a signal is being received, the instrument should, theoretically, give a pulsating reading corresponding to the fluctuations of the anode current. But a milliammeter of the ordinary type cannot follow the rapid changes of an audio-frequency current. What it can do, however, is to give a general indication of the state of affairs. Thus, if the kicks are mainly in an upward direction, so that the mean value of the anode current appears, on the whole, to be increased, it shows that the incoming signal is overlapping the bottom bend, with resultant distortion. The remedy is, of course, to decrease the grid-bias slightly and/or to reduce the input by means of the volume control. On the other hand, a general tendency for the kicks to be downward, or an impression that the mean-anode current is reduced,

indicates grid-current distortion. In these circumstances the grid-bias voltage should be increased slightly, and if this fails to produce the desired result, or introduces bottom-bend distortion, the input should also be reduced.

The Detector Stage

In the case of a detector valve, the modulation of the anode current quite properly produces just the results we have to avoid in an amplifier. In a leaky-grid detector the application of a signal produces an effective reduction of mean anode current depending upon the strength of the incoming radio-frequency signal and its modulation depth. An anode-bend detector sustains a net increase in the anode current when receiving a signal.

Here again, the effective change of anode current depends jointly upon the strength of the incoming R.F. signal and upon its depth of modulation, and advantage can be taken of these changes to ensure that the set is operated in the most efficient manner. With a leaky-grid detector, for example, in which the anode current is depressed by a signal, the anode current will be at minimum when the receiver is accurately tuned to a station, and will rise as the set is brought off tune either above or below the correct tuning point.

If, therefore, a milliammeter of suitable range is connected in the anode circuit of a leaky-grid detector, it will indicate when the set is correctly tuned, because at that moment the anode current will be depressed to its lowest value. Quite a cheap instrument will do, and it need not be very accurate.

Another Case

It should be remarked that a device of this sort is not very sensitive in the case of feeble signals, but it is perfectly satisfactory when dealing with the more powerful transmissions. The same idea is also of great service in adjusting the trimming of ganged-tuning circuits. The method is to tune in to the optimum point for one station (that is, minimum reading of the milliammeter in the detector circuit), and then make any adjustments to the trimmers with the

object of obtaining a further drop in the reading.

In sets fitted with A.V.C., another version of this simple modulation meter should be employed. It will be understood that the amount of additional bias fed back to the H.F. and/or I.F. stages by the A.V.C. valve depends upon the strength of the received carrier. Also that the application of this controlling bias results in a decrease in the anode current of the variable- μ valves. Therefore, a milliammeter in the anode circuit of one of the H.F. or I.F. valves will again give the lowest reading when a signal is accurately tuned in.

Some visual tuning indicators fitted to older sets work more or less on the principles described above. Not all of them, however, are plain milliammeters. Some are simple instruments of this type, having a shutter or reflector device to vary a spot or band of light or shadow, thus giving the desired

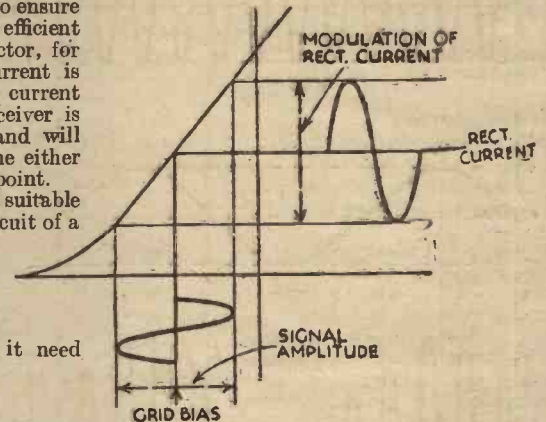

Fig. 3.—Showing the effect of modulating the rectified current in the anode circuit with a grid-voltage variation.

indication. Others make use of the voltage drop in some component included in the anode circuit to modify the glow from a small neon discharge tube, and in others the anode current is passed through one winding of a special differential transformer, thus varying the voltage applied to a small lamp bulb.

G. H. Elliott, the Chocolate-coloured Coon

G. H. ELLIOTT, the world-famous and original

"Chocolate-coloured Coon," and one of the outstanding personalities of the British Music-hall, will make a welcome return to the microphone in the Forces programme on July 5th. The famous delineator of coon studies, whose melodious voice is so well known to thousands of listeners, will broadcast a cavalcade of coon songs, from the smooth, swinging lilt of "Lily of Laguna" to the present-day foxtrot rhythm. Even his yodelling will be in rhythm, not the waltz time as of old.

Imagined Corners

"IMAGINED CORNERS," to be broadcast on July 8th, is an amusing parable play written by Maurice Brown, who is music adviser to the B.B.C. Feature and Drama Department. In fact, "Imagined Corners" might almost be described as an experimental play. It is timeless and dateless, and deals with the story of an old man who, despite his detractors, sets out to try and prove his theory that the world

is round. Strangely enough, the play ends by showing that the man does not prove his theory, but Brown says that the idea behind the

play is that "it is better to go and try and find Truth, even if it is not Truth, than just to accept without question anything you are taught."

"I Know What I Like."

WILFRED PICKLES, the well-known Northern announcer and radio artist, will give listeners to the Forces programme on July 7th his idea of a gramophone record programme in the series called "I Kuow What I Like." Wilfred's programme is well balanced—neither too high nor too low-brow—and it represents his own tastes entirely. While his listeners, for instance, will hear records of Paul Robeson singing "Mah Lindy Lou" and Turner Layton singing "These Foolish Things," they will also hear a record of the Sibelius "Valse Triste," played by the Philadelphia Orchestra, conducted by Leopold Stokowski, and Elizabeth Schumann singing "Solweig's Song."

PROGRAMME NOTES

Comment, Chat and Criticism

Outline of Musical History—7

Notes on the Works of Beethoven's Contemporaries

By Our Music Critic, MAURICE REEVE

BEETHOVEN had many remarkable contemporaries who have left their mark on musical history. Whilst the Bonn master may be likened to the fountain whose waters are needed by the parched soil around it, his colleagues could be compared to the plants who luxuriate and nourish under its splashes. Chief of these were Carl Maria von Weber, 1786-1826, and Franz Schubert, 1797-1829. It will be at once noticed that both had exceptionally brief lives granted them in which to complete their work.

Weber's Operas

Weber was the son of an aristocrat whose fortunes had suffered an eclipse. His life was not unlike that of most young musicians of that day, and in 1816 he was appointed chapel master to the King of Saxony in Dresden. Here he had to wage a fierce combat against Italian influence, but it would seem to have proved the turning point in his career, as it was at that time he produced his famous operas "Der Freischütz," "La Preciosa," "Eury-anthe" and "Oberon," in that order. He died soon after producing "Oberon" at Covent Garden.

Weber is called the first romantic composer, though "Don Giovanni" is unquestionably a romantic work; whilst some of Beethoven's own movements were infused with such a wealth of poetic feeling that they must be considered a leading inspiration of the movement that was on foot.

His great contribution to music lies in having imbued an intensely romantic spirit into opera, for the first time, by means of his masterly employment of German fairy tales and legends for his libretti, in place of the elaborate fustian then in use. But one must not forget the romantic plot of "Leonora," when referring to any possible antecedents.

Also, the modern overture is credited to Weber's ingenuity. He employed the themes and motifs of the opera as the subjects with better effect than anyone previously, and his practice has since been universally followed.

Mention must be made of his entrancing "Invitation to the Waltz," and some other notable piano works.

Schubert

Schubert's work is not only amongst the most highly esteemed in the musical repertory, but it is probably held in greater affection by the majority of music lovers than that of any other master. Born in Vienna, he was the son of a poor school-master. He became a chorister in the Imperial Chapel, and Salieri gave him lessons whilst he was an assistant at his father's school. Later, and for some years, he was the tutor to the children of Prince Esterhazy. His serenely contented nature, so perfectly reflected in his music, didn't seem to wilt under the stress of almost constant poverty, nor did that distressing circumstance ever hinder him from pouring out a constant flow of beautiful music.

Schubert is most renowned for his collection of 650 wonderful songs, songs such as the world had never seen before, nor since. Entirely to his own original pattern, he combined a peerless melody with an accompaniment which consisted of one rhythmic figure throughout. It formed an integral part of the little work and reflected the mood of the lyric to perfection. Each song is an art work in which the components are one as important as another. Their richness and variety are astonishing, whilst the fertility of his inventive genius seems unending.

But his limitations were shown up in those works written to a bigger pattern and on a larger scale. He wrote nine symphonies, including the immortal "Unfinished," a host of magnificent chamber works, piano sonatas, etc. They are all packed with heavenly melodies, and some of his astounding enharmonic modulations have never been equalled. But they suffer from a looseness of design; he frequently failed to realise just when the right moment to stop had arrived. Like some chatter-boxes, he would continue the conversation a little too long, giving the movement a lengthy incoherence and a discursive looseness.

How the "Unfinished" might have been completed has long been one of music's most puzzling enigmas. Many people have supplied a third movement, purporting to be in tune with their idea of how Schubert would have fashioned it. But the composer's idiom and personal style were so marked that the results have never achieved complete satisfaction. Had he completed it himself it is most probable he would have given it both a minuet and trio movement as well as a finale; that is going by his own precedents.

The divine "Wanderer" fantasia for piano must receive special mention even in the briefest sketch. The modulation to the second subject—from C major to C sharp minor—is one of the most astounding things in all music. Its extreme length—for a work in one movement—might of itself have made its title very appropriate. In reality, however, it is derived from the fact that the second subject, just referred to, was used by Schubert as the theme of his incomparable song "The Wanderer."

Liszt gave this great work an orchestral accompaniment, and thereby created a dazzling and fascinating addition to the "concerto" repertory.

Next week I intend to deal with the origin and rise of the great romantic movement which so dominated nineteenth-century music, and which gave the century's music its greatest names. So I will conclude this instalment with some brief notes on some minor though not unimportant musicians of the Beethoven era.

Rossini

I mention Rossini first, and slightly out of chronological order because almost all of his most important work was all done before Beethoven's death, and because he had what to-day we might in retrospect call the effrontery to crush the great master from the affections of the fickle Viennese public. Producing "The Barber of Seville," "Tancredi," and "Semiramide" there, they completely swept the board there and made such "trifles" as the seventh symphony and the "Missa Solemnis" seem *passé* and old fashioned!

They must be remarkable works even if only for the fact that they are as fresh and as entertaining to-day as ever before. But their superficiality and theatricality—the curse of so much Italian music—is evident when seen in comparison with the work of the German masters.

Rossini is famed for magnificent crescendos, especially as they are often built up on the most trivial figures, for his skilful use of the contralto voice for principal operatic rôles; and for the suitability of his accompaniments to the action being portrayed. His finest work, "William Tell," was produced in 1829, after which he is supposed to have grown sick of music. He wrote practically nothing more from then until his death forty years later!

Hummel

G. N. Hummel, 1778-1837, was a renowned pianist and improvisator, but except for some charming rondos, his many compositions are little known to-day. They are covered with the cobwebs of time. And in the musical world, cobwebs denote the reverse of quality, as in the wine cellar. Hummel knew Beethoven well, who employed him for copying and arranging.

Cherubini

Cherubini, 1760-1842, left a mark on operatic music. Beethoven greatly admired his work. His chief operas, "Lodoviska," 1791, "Les Deux Journées," 1800, and "Medée," 1797, were important events. He also wrote a standard work on fugue and counterpoint.

John Field

John Field, 1782-1837, invented the Nocturne, which Chopin was shortly to transform.

Clementi was a renowned teacher and pedagogue, and his remarkable technical exercises, notably "Gradus ad Parnassum" are still widely used. Beethoven employed him for the teaching of his nephew.

**The PRACTICAL WIRELESS
ENCYCLOPÆDIA**

By F. J. CAMM

(Editor of "Practical
Wireless")

7/6 Net

**Wireless Construction. Terms.
and Definitions explained and il-
lustrated in concise, clear language**From all Booksellers, or by post 8/- from George
Newnes, Ltd., Tower House, Southampton Street,
Strand, London, W.C.2.

Alternative Uses for Car Radio

Many Readers are Anxious to Know If and How they can Use their Car-radio Receivers now that they have Been Removed from the Car.

The Question is Answered here by Frank Preston

AS all readers are no doubt aware, it became illegal to have any radio apparatus on a motor vehicle after June 1st. And it has previously been pointed out in these pages that the Order applies to both built-in car-radio instruments and to portable sets which may have been carried in the car. It applies also to any aerial fitted to the car, whether it was of the roof pattern or of any other kind—fitted under the chassis, for example.

There is no reason to suppose, however, that suppressors and allied equipment, which cannot itself be of any use for wireless reception or transmission, need be removed. It is therefore unnecessary to remove resistors and condensers, which will be useful when car-radio is again permitted, and which are effective in preventing interference with short-wave receivers in the vicinity.

Principles of Operation

It may be assumed that every PRACTICAL WIRELESS reader who had a radio receiver on his car (and the Order applies with equal force if the car is being stored) has by now removed it completely and dismantled the aerial. The question which is exercising the minds of many concerns the possible use of the car receiver in the home, in an air-raid shelter, or for any other purpose. There are various methods of operating the receiver, but few are convenient or satisfactory.

It will be remembered that in nearly every case both high tension and low tension are taken from the car battery. The valve heaters are fed direct from the battery, and the H.T. supply is obtained by means of a vibrator type interrupter; this feeds into a step-up transformer, the output from which is rectified either by means of a valve or by means of a vibratory rectifier. It is customary, as far as British receivers are concerned, to have two separate models for 6-volt and 12-volt operation. In the case of many American receivers there is only one model for use on either 6-volt or 12-volt supplies. When a 12-volt battery is used a fixed resistor is fitted to drop the voltage to six; this resistor is often included in a battery feed wire, and is referred to as a line resistor.

Accumulator For H.T. and L.T.

The above general explanation is given so that the reader may more readily understand the possible methods of modifying the receiver for operation away from the car. Actually, however, it is generally agreed by designers and car-radio manufacturers that the most satisfactory method of operating the set is by means of an accumulator. This should be of the voltage for which the set was originally designed, and if a line resistor is used this should be removed so that power is not wasted by it.

If the car is laid-up, the obvious method is to remove the battery from the car and use it with the set. Not only does that permit of the set being employed, but it also enables the battery to be kept in use—and battery manufacturers never recom-

mend that a battery be allowed to lie idle, for it is almost sure to deteriorate. Where it is convenient to have the battery charged at a charging station this can be done in the ordinary way, taking care that a freshening charge is given once every month or so whether the battery is run down or not. A far better method when the house is wired for electricity is to employ a trickle charger. This is most satisfactory and economical with A.C. mains, of course. A charger with an output of one amp. is sufficient, and it can be put to good use when the car is again put into commission.

Current Consumption

Some readers may even consider it worth while to buy a new battery and charger to operate the radio, but that will be a fairly expensive undertaking, especially if a car-type battery is used—and this is best. In choosing a battery it is of use

polarity must be considered if the receiver was specially designed to operate with either positive or negative earth, although in many instances it is possible to reverse the polarity without producing any ill effects.

In any case it will be most convenient to follow the polarity used on the car from which the set was taken. If the positive terminal was earthed to the chassis, connect this to the case of the receiver; if the negative was earthed take a lead from this to the receiver case. An ordinary outside aerial may be used, but it will generally be found better to use a short indoor one, or a 6ft. length of wire out of doors. By this means there will be no danger of impairing selectivity or causing overloading of the receiver—which is necessarily of a sensitive type.

Since remote control is generally provided, the receiver can well be placed inside a convenient cabinet and the control panel brought out at an accessible spot. Do not "mask" the speaker, however, by enclosing the receiver completely, and avoid sharp bends in the remote-control cables.

A Charger for Power Supply

It can be argued that the idea of using a special battery for the car-radio is clumsy, but there is no doubt that that arrangement is best, especially when it is wished to avoid altering the set—and alterations to an instrument of this type are not advised unless they are made by a trained engineer who is fully conversant with the particular type of receiver. An alternative method which is sometimes satisfactory is to operate the set directly from a battery charger having an output of 3 or 5 amps.

at 12 or 6 volts, but it must be ascertained that the voltage, on load, does not exceed 6 or 12, and it will be necessary to add a parallel load resistor or a series resistor so that the voltage applied to the set is exactly 6 or 12, since a 12-volt charger delivers more than 12 volts. This is not a very simple matter if instruments are not available. Another difficulty when using a charger in this manner is that of preventing background noise caused by the comparatively "rough" or unsteady output of D.C. The use of a 25- or 50 mfd. electrolytic smoothing condenser across the output leads is often helpful, whilst more complete smoothing might be obtained by using a very low resistance choke in series with one of the leads. But as a choke of that kind must be very massive it cannot be made cheaply!

If the purchase of a charger for this purpose is contemplated it would be wise to have one on trial before finally buying

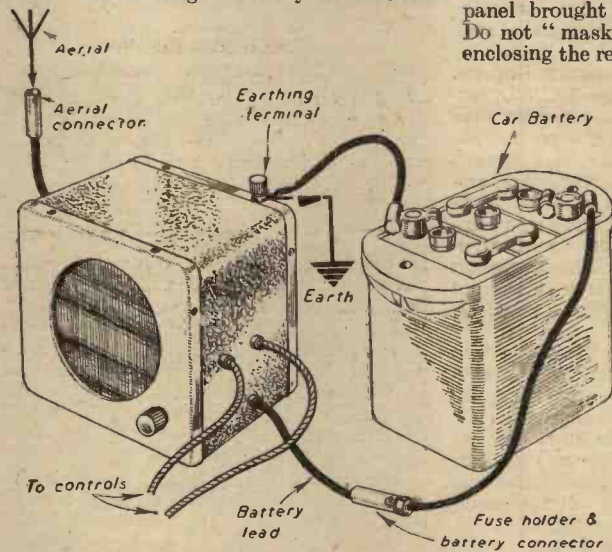

A general method of connecting a car-radio receiver when it is used apart from the car. Battery cables can be obtained complete with connectors.

to know that the average British car-radio takes between 2 and 3 amps. if of the 12-volt type, and about 5 amps. if it is a 6-volt model.

To connect the battery it will be necessary to join the battery lead attached to the receiver (this generally includes a fuse) to one battery terminal, and to make a good connection between the other battery terminal and the case of the set. The latter connection can often be made most conveniently by fitting a terminal in place of one of the screws used in fitting the front or back to the metal container. An earth lead should also be connected to the metal case. When using a car battery it is a good plan to buy a couple of terminal clamps which fit the slightly-tapered cylindrical lugs. Better still, leads of any suitable length, fitted with lugs at one end and connectors at the other, can be bought ready for use from a motor-accessory dealer. The question of

and to check the voltage with a high-class meter. There are, of course, many other uses for the charger, and it can later be used for the car battery. If the car is still in use the charger will be a convenience immediately. It is worth mentioning that a charger can be bought or made which will provide outputs of 2, 6 or 12 volts.

When the car-radio has a double vibrator, acting as both interrupter and rectifier, one of the above methods is practically essential and the makers of the Philips "Motoradio" are emphatic in stating that they do not consider any other arrangement feasible than that of using a battery. But where a separate rectifying valve is used it is possible to feed an A.C. mains supply into this, to provide H.T., and to use a small transformer to supply A.C. at a voltage suitable for feeding the valve heaters. Both Masteradio and Philco are working on components and attachments whereby mains operation will be possible and reasonably simple. Both, however, fully appreciate the difficulties and are not likely to market units for use with their respective receivers until they are completely satisfied with the results of their experiments. Readers of PRACTICAL WIRELESS will be kept informed of any developments in this direction. It should be understood, however, that there are many difficulties to be overcome, and that the conversion is not one which can readily be made by the amateur until suitable units have been produced by manufacturers.

It has been suggested that, by removing the plug-in vibrator unit it would be possible to feed mains-voltage A.C. into the secondary of the built-in transformer and to feed low-voltage A.C. to the heater connections. This appears a very simple arrangement, but in practice it does not work out as well as may be thought after making a superficial study. One important reason is that the step-up transformer built into the receiver, and used to supply A.C. to the rectifying valve is normally designed to operate at a frequency of between 100 and 150 c/s; if a 50 c/s supply is fed into it very serious overheating is almost inevitable. Readers will remember that the number of turns per volt used in transformer construction is inversely proportional to the frequency of the supply. Thus, if 6 t.p.v. were required for a 50 c/s supply, 2 t.p.v. would be sufficient on 150 c/s. This gives a clear indication of just one of the problems which confront manufacturers having a well-equipped research department, and shows how the amateur would fare in the absence of such facilities.

A NEW HANDBOOK!

THE SUPERHET MANUAL

5/-

or 5/6 by post from

GEORGE NEWNES, LTD.,
Tower House, Southampton St.,
Strand, London, W.C.2.

Open to Discussion

The Editor does not necessarily agree with the opinions expressed by his correspondents. All letters must be accompanied by the name and address of the sender (not necessarily for publication).

Radio Training Manual

SIR,—I should like to take this opportunity, now I have had the chance of studying your Training Manual, of thanking you for your effort to help us out in these hard times. I had dropped radio for the last few years and am now anxious to revise my knowledge with a view to making use of it in some branch of the services. I had looked through several books during the past few months, and all failed in some way or another. When I obtained the Training Manual I expected this to be on similar lines, but hoped it would add up to the material in the other books so as to give me a complete "course." I found instead that the Manual is complete in itself and I do not need the other books. I can recommend it to any other readers who are similarly situated and again must thank you for a splendid effort.—G. BOLTON (Aldershot).

Peculiar Fault

SIR,—I was interested in the fault described by J. Darby in a recent issue and I experienced a similar fault in a set I was once servicing. Although not exactly the same the tuning eye did not give true indications and the fault cleared just as in Mr. Darby's case. I could not find anything wrong and returned the set to the owner. Five weeks later it came back with the same trouble, and in view of the previous experience I this time took the trouble of getting a really good ohm-meter. I went over all connections in the set and the only fault I could discover was a low-resistance contact between one socket of the tuning indicator. This was due to it being bent. I straightened it and cleaned it up until the contact was sound, and when tested the fault had gone. The set has been in use now for nearly a twelvemonth without any recurrence of the trouble.—H. BRADLEY (Eastbourne).

Fleet Short-wave Two

SIR,—I have now had ample opportunity of putting the Fleet S.W. Two through its paces, after overcoming the initial difficulty which you so kindly helped me out with. The set is certainly a worth-while addition to my array of "hook-ups" and it puts them all in the shade. I append a log of the stations which I really heard during last week. I must say that all these stations came in easily, clear and free from interference, and I often thought that many of the logs you published were merely call signs which readers had just managed to hear through jumbles of atmospheric and other signals. If they use sets such as the Fleet I can now well understand their colossal scores in the short-wave station game, and I am now an ardent S.W. fan. I shall now try to improve on last week's log and get some really long-distance stuff, and at a later date may try an additional L.F. stage to get good L.S. working on many of these.—J. GORDON (Chesterfield).

[The log was very interesting, but was too long to publish.—ED.]

Mystery Station

SIR,—I wonder if any reader could tell me the station I heard recently broadcasting announcements in French (which I don't understand) close to Wayne. I cannot find a station in my list on this wavelength, which as near as I could judge would be about 49 metres. I have heard the station on several nights, not so loud as the Wayne station, but generally blotted out when I try to keep it by one of our Empire stations.—J. HALLORAN (Colwyn Bay).

[The station was probably Saigon, French Indo-China, call sign FZR, working on 49.10 metres (6.11 kc/s).—ED.]

A National Service

SIR,—As a reader of PRACTICAL WIRELESS for some time now, I feel that I must send a letter of congratulation on the splendid work your journal is doing at a time like this. To keep on in a time like we are passing through now is literally a high form of National Service, to which I and other readers are indebted. I spend many spare hours at night in my wireless room with different wireless receivers, which I have made up through the guidance of PRACTICAL WIRELESS.—RONALD ROSE, (Quinton, Birmingham).

Correspondent Wanted

J. BYRNE, of 10, Turriff Street, Glasgow, C.5, wishes to get into touch with a reader who has a battery-operated "Trophy 3," and who would assist in short-wave work.

Prize Problems

PROBLEM No. 407

JELVES had built a four-valve set for battery operation, incorporating two H.F. stages. The set was unstable and he decided that he would make a stage-by-stage test, which he did, and as a result decided that decoupling was necessary. He found resistances and condensers of suitable value in his spares box, and incorporated these. There was hardly any improvement, in spite of the fact that H.F. instability was responsible for his trouble. Why did his components fail to effect an improvement? Three books will be awarded for the first three correct solutions opened, and each entrant should express his choice of a book selected from the list published on page 340. Entries must be addressed to The Editor, PRACTICAL WIRELESS, George Newnes, Ltd., Tower House, Southampton Street, Strand, London, W.C.2. Envelopes must be marked Problem No. 407 in the top left-hand corner and must be posted to reach this office not later than the first post on Monday, July 8th, 1940.

Solution to Problem No. 406

The variable- μ property of a valve cannot be taken advantage of in a detector stage. Variation of the bias would affect the rectification properties of the valve and this accounted for the effects experienced by Abbott.

No readers successfully solved Problem No. 405.

In reply to your letter

Converted Switch

"Some time ago you published a wrinkle in your pages showing how to convert a simple push-pull on-off switch into a three-point component. The idea was to solder a flexible lead on the tip of the switch and make this a third point. Well, I recently did this to a little device I made up and it does not work. As a result the battery I was using was not switched off and it ran out in a few days. I should like you to see that wrinkles really work before publishing them as this sort of thing can be expensive."
—M. A. S. (Croydon).

THE idea of converting a switch in the manner indicated is perfectly practicable and does all that is claimed for it. It must be borne in mind, however, that with the average type of push-pull switch the component is mounted on the panel by means of a one-hole fixing bush. Through this the plunger of the switch works. Accordingly, if mounted on a metal panel the plunger and tip will be "live" to the panel. Thus, you must take the elementary precautions to see that any battery supply across the switch is open-circuited when the switch is in the off position. Even with the idea as described this could easily have been obtained by using one of the other terminals on the switch for the battery lead and transferring the lead from the tip to that terminal.

Fitting Fuses

"I enclose a circuit of a mains set I am building, and should like to know the best positions for fuses to afford maximum protection in this set. I have many different types of cartridge fuses rated at .5 and 1 amp. and do not mind how many I have to fit so that I shall not run the risk of expensive component or valve replacements."
—B. N. (St. Albans).

THERE is one drawback to fitting fuses all over a set and that is that should one of them blow it will take you some time to find the faulty one, and as this may take place during an important broadcast you will waste considerable time and perhaps miss the item you require simply because you cannot easily locate the fault. There are no self-indicating fuses available which would simplify the identification of a blown fuse and therefore tests across each will have to be made. We suggest, therefore, that in an A.C. mains receiver such as that you propose the maximum protection would be afforded by two fuses—one in series with the primary of the mains transformer (1 amp.) and one in series with the H.T. negative lead (.5 amp.). This should be as close as possible to the centre tap of the H.T. winding.

Fitting Pick-up

"I have a commercial seven-valve superhet, but there are no pick-up terminals on it. As I should like to fit a pick-up, I wonder if you can tell me the best position and simplest way of adding this device."
—P. T. (Nelson).

WE do not normally advise any modification to commercial apparatus. However, with a normal superhet no drastic modification is needed. The pick-up leads are merely connected across the L.F. volume control. This is generally included in the double-diode-triode stage, with the centre arm of the control joined to the grid of the D.D.T. valve. If such a valve is not fitted it may be possible to include the pick-up merely by connecting it to certain terminals of a plug-in adapter which can be inserted between one of the L.F. valves and its valvholder. Probably, therefore, the most satisfactory plan is to get into touch with the makers and ascertain their views on the modification required.

Testing a Transformer

"I have an L.F. transformer which had been taken from a set by a friend because he said it was faulty. I should like to test

RULES

We wish to draw the reader's attention to the fact that the Queries Service is intended only for the solution of problems or difficulties arising from the construction of receivers described in our pages, from articles appearing in our pages, or on general wireless matters. We regret that we cannot, for obvious reasons—

- (1) Supply circuit diagrams of complete multi-valve receivers.
- (2) Suggest alterations or modifications of receivers described in our contemporaries.
- (3) Suggest alterations or modifications to commercial receivers.
- (4) Answer queries over the telephone.
- (5) Grant interviews to querists.

A stamped addressed envelope must be enclosed for the reply. All sketches and drawings which are sent to us should bear the name and address of the sender.

Requests for Blueprints must not be enclosed with queries as they are dealt with by a separate department.

Send your queries to the Editor, PRACTICAL WIRELESS, George Newnes, Ltd., Tower House, Southampton Street, Strand, London, W.C.2. The Coupon must be enclosed with every query.

this and should be glad to know the best way of doing this. I have no test equipment available and must therefore carry out a kind of 'experimental test.'"
—S. T. E. (Bath).

A PAIR of 'phones in series with a 1.5 volt battery would be quite satisfactory for your test. Connect the two (in series) across primary and secondary in turn. A click in the phones when the circuit is made and broken will indicate continuity and that the windings are unbroken. Leakage or shorts from primary to secondary may then be checked by connecting the battery and 'phones between each of the primary and secondary terminals. You might also conclude the test by checking for a short-circuit between any of the windings and the core.

Speaker Repair

"I have been experiencing some trouble with my speaker lately and I believe it is due to some foreign body inside the gap. I have made an examination as far as possible, but am not quite certain whether

it is desirable to take it to pieces or send it to the makers. Is it possible to damage it by taking it down, or will there be any difficulty in getting it back properly, as I do not want to have to send it back half assembled?"—M. C. T. (Balcombe).

IT may be unnecessary to dismantle the speaker to carry out the desired cleaning. If you have a vacuum cleaner with a blowing attachment, we suggest you try the effect of placing this fairly close to the gap so as to clear out any dust which may have accumulated. Then, if it is possible to get to the gap with a small artist's paintbrush, dip this in paraffin and carefully wipe round the gap to remove any gritty bodies or metal filings which may become fixed there. Finally, combine these two processes, brushing whilst the air jet is directed into the gap. This should effect the desired clearance, but if there is no improvement we suggest that you let the makers overhaul the speaker.

Circuit Diagram

"I am working to a circuit which was given to me by a friend and was taken from an American magazine, I believe. It does not show the usual H.T. negative-earth line, but at various places in the circuit there are components on one side of which is the symbol for earth. My friend says this means that the points indicate connections to a chassis, but I am not clear about this and as I thought of using a wooden chassis I wonder if this is the case and if it will matter. Your advice would be appreciated."
—H. T. E. (King's Lynn).

THE method of indicating earthed points is quite common in America and also in some English papers. It does not, however, necessarily indicate that the points in question are connected direct to earth or to a metal chassis. Therefore it is quite in order for each of the components or points in question to be connected together and to earth or for any number to be connected together and taken to the nearest earth point. Generally speaking, a superhet or modern efficient circuit will be found more stable and satisfactory if all the points indicated are connected direct to the nearest point on the chassis, using a metal chassis earthed.

Amateur Call Signs

"I should be glad if you would tell me what countries have call signs with the letters KA and PY. Is there any place I can get a list of all call symbols?"
—L. F. (Chelmsford).

KA is used for amateur calls originating in the Philippines and PY for those from Brazil. A full list of Amateur Call Signs will be found in our publications "Wireless Transmission for Amateurs," "Encyclopædia" and "Short-wave Manual."

REPLIES IN BRIEF

The following replies to queries are given in abbreviated form either because of non-compliance with our rules, or because the point raised is not of general interest.

H. T. (Bangor). We approve the arrangement, and it should function perfectly satisfactorily.
N. R. (Liverpool). You will find all the details in the book you have ordered. Constructional data is given fully.

The coupon on page iii of cover must be attached to every query



SHORT-WAVE SECTION

Causes and Prevention of Dead Spots

AS there are some readers who are just entering the short-wave field, it might be explained that dead spots is the name given to those portions of the tuning range over which signals cannot be received or where signal strength is much lower than at other wavelength settings. It is not uncommon to find, after completing a new set, that above and below certain wavelengths the receiver functions perfectly well, although somewhere between the two extremes it seems to be lifeless. Generally, it is found that over a narrow band the reaction control has little effect; even if the detector can be made to oscillate at all, it is necessary to advance the reaction control well beyond its normal position.

The Simplest Remedy

The trouble is most often met when using a set of the detector-L.F. type, although it is not always absent even when an H.F. amplifier is incorporated, or when the set is of the superhet type. In the simplest type of instrument, the trouble can often be overcome completely by using a different aerial—a shorter length of wire generally produces the desired effect. The reason for this is that the aerial-earth circuit tunes to a "natural" frequency or wavelength of its own, and conditions may be such that the tuned circuit acts as a form of wave-trap. By altering the constants of the circuit the "natural" wavelength is altered so that it is different from any of the wavelengths to which the receiver tunes.

It will be understood from this that an alteration to the earth lead may have the same effect as changing the aerial. If the lead is more than a few yards in length, shortening the wire will often provide a complete remedy. It is also worth mentioning, in passing, that when a long earth lead must of necessity be employed, the wire should be insulated, since it forms an important part of the complete aerial-earth system.

A Variable Series Condenser

A similar effect to that obtained by changing the characteristics of the aerial or earth can be obtained by including a condenser in series with the aerial lead-in, and if a variable condenser is used the "natural" frequency can be adjusted between fairly wide limits. This means that if a dead spot is reached during the tuning process, its effect can be eliminated by altering the capacity of the condenser. A pre-set condenser can be used, as it is in a broadcast receiver for the purpose of improving selectivity, but it is far better to use a fully variable type condenser of the air-dielectric type and with a maximum capacity of about .0001 mfd. for wavelengths down to about 20 metres, or of half this capacity for still lower wavelengths. The condenser should be mounted on the panel

and the fixed vanes should be connected to the aerial terminal. The condenser is sometimes rather more useful screened, but in most cases screening has the effect of reducing sensitivity by increasing the fixed aerial-to-earth capacity.

The same effect as that obtained by using the condenser can be obtained by using a separate and untuned aerial coil variably coupled to the grid coil; a dead spot can then nearly always be eliminated by altering the position of the aerial winding. This method is not normally very convenient, however, for it is not an easy matter to mount a moving coil so that it can be moved smoothly by means of a control on the front of the set.

The Reaction Circuit

In very many cases, dead spots are due to the fact that the proportionate numbers of turns on the tuned (grid) winding and on the reaction coils are unsuitable. Some designers of coils use a greater number of turns on the reaction winding than on the grid winding, with the result that the reaction circuit is often inclined to "take charge" of the tuning; the usual result is that reaction adjustments affect the tuning and that dead spots are introduced. Because of this it is always "safer," and generally better, to have a coil whose reaction winding has about three-quarters of the number of turns used in the grid circuit. It should be remembered, however, that this makes it necessary to have a reaction condenser of comparatively high capacity. Thus, where a .00016 mfd. condenser is used for tuning, a .0002 mfd. component may be required for reaction.

Whilst referring to the reaction circuit, which is really a portion of the complete anode circuit of the detector valve, it is worth mentioning that the high-frequency choke can have a pronounced effect on the presence or otherwise of dead spots, for if this component is of too low an inductive value, or if the self capacity is comparatively high, it might be so ineffective at certain frequencies that it does not act as a "stopper" as it should, but permits the passage of H.F. currents into the high-tension circuit. Trouble need never exist in this respect if constructors make use of the correct type of choke recommended for any particular purpose by the makers of reputable components.

Look to the Grid Condenser

It is often overlooked that the grid condenser and leak may be the cause of dead spots if they are of unsuitable value. In nearly every case it will be found that a .0001 mfd. condenser and 3 to 5 megohm leak are perfectly satisfactory, but if trouble persists after checking the other parts of the set, it is worth while to try a pre-set condenser of about .00015 mfd. maximum capacity, and to experiment with various settings of this.

ELECTRADIX

ELECTRIC MOTOR PUMPS, A.C. or D.C., from 12 volts to 250 volts, 100 gals. per hour to 6 ft. 72/6. Fitted in 1/2 in. double-hinged container. 77/6. No. 2 R. 200 gallons per hour to 20 ft., £6 17s. 6d. J. & B., 1,000 gals., centrifugal, pump only, £8 10s.

PUMP FLOAT SWITCH, 45/- Dble. Pole, 55% Foot Valves 1/4 in., 2/6. Welded Steel 1 pint H.P. Containers or Surge Pots, 2/6.

ELECTRIC AIR COMPRESSORS for Spray Painting and Tyre pumping, coupled to motor, £5 15s. and £7 10s., A.C. or D.C. Foot operated Paint Spray Sets with Gun, 42/6.

A.C. MAINS LESDIN TUNGAR CHARGERS, Two models. No. 1 for 70 volts 6 amps. with meters and controls, etc., 100 cells a day, £7 17/6. No. 2 Tungar for two 6 amps. circuits with meters and variable volt controls, 70 volts, 10 amps., for 200 cells, bargain, £12 15/-.

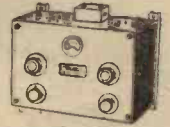

A.C./D.C. DAVENSET, Type G.C., Garage Wall Type Charger, 3 circuits, output D.C. 25 volts 6 amps. Independent circuits, capacity 40 radio cells, £7 10.

PHILIPS Model 1087, Steel case, for 24 volts 10 amps., £7 10.

DAVENSET A.S.C.4, 4-circuit charger for up to 80 cells. List Price £32. Four sets of Auto-charge regulators, of 1 amp., 1 amp., 2 amps., and 2 amps. or three of 1 amp., 2 amps. and 2 amps., or one of 50 volts 6 amps. Fine steel clad set complete, £14 10.

METAL RECTIFIERS for charging on A.C. Mains. The NITNDAY will keep your battery fit without attention.

Model N/A21, charge 2 volts, 1 amp., 12/6.
Model N/A61, Trickle Charger, charge 6 volts, 1 amp., 17/6.

Model N/B6/1, Car Charger, charge 6 volts 1 amp., 24/-.
Model N/B6/11, Car Charger, charge 6 volts 11 amps., 27/6.

Model N/C6/2, Car Charger, charge 6 volts 2 amps., 37/-.
Model N/D12/J, H.M. Car Charger. To charge 12 volts 1 amp., 38/-.

LARGE WESTINGHOUSE RECTIFIERS for Special Jobs. No. 1 250 watts in Steel cabinet, 24 in. x 24 in., 200/250 volts A.C. to 32 amps 8 volts D.C., £8 10.
No. 2. Larger size, 400 watts, in Steel cabinet, 48 in. x 24 in., 200/250 volts A.C. to 35 amps. 23 volt, D.C. £14 10.

ROTARY CONVERTERS, all sizes, large and small, single phase and 3-phase. Special Crypto Constant Potential Charger, coupled to S.P. motor with D.C. output of 8 volts 50 amps. and 100 volts 1 amp. Fine set, worth £50, with switchboard, sale £30.



POWER ALTERNATORS, H.F., 500 cycles, 20 amps., 10 volts, £3 10. Ditto double, type W. 500 cycles, 100 volts, 3 amps., and 70 volts, 3 amps. D.C., £5 10.

RADIO ROTARY CONVERTERS, For D.C. mains to 230 v. A.C. output. In silence cabinet, with filter. All sizes in stock from 15 watts upwards, 30, 50, 100, 200, 400 and 800 watts; 1 kw., 1 1/2 kw., etc. Also 50-watt size 12 volts and 50 volts input. T.V.T. Sets 8 volts to A.C. £5 10/-.

SERVICE EQUIPMENT AND GEAR. Keys, Buzzers, Sounders, Phones, Inklers, Aldis Lamps, Helios, Rangefinders, etc.



Lamp Signal training is very important.
FIELD SIGNAL LAMPS, ALDIS TRIGGER TYPE, £3 10.
TELESCOPES, Navy, Telescopes, small gun type, 25/-.
MAGNETIC COMPASS with Plain Scale, Bevel glass, brass body, 9d.
Pocket Field Compass, 10/- Binnacle Boat Compass, 45/-.

3/0 MILLIAMMETERS, Polarized Ferranti without calibration for tuning or galvo for testing. Back of panel type, as illus., 8 m.a. full scale. Plain scale and 1 in. needle with mica panel. Can be used as voltmeter with extra resistance. Great bargain at 3/0. Post free.



PHOTO CELLS, R.C.A. Cassium Vacuum, 8s list, for 25/- Electro-Photonic photo-cells, generate E.M.F. under light, 1 1/2 in. by 1 in., 22/6. Disc Selenium Cells, light to dark resistance ratio mounted in case, 10/6. **CATHODE TUBE**, New, 8 in. screen, Ediswan, £3 10.
ELECTRIC GOVERNORS, centrifugal control, 1,500 r.p.m., contacts, brushes, slip rings for auto. speed regulation, 7/6.
CLEARANCE Speakers, mov. coil, mains, cone damaged, 2/6. With speech transformer, 3/6.
Postage on either 1/-.

5/- EMERGENCY PARCELS of useful experimental electrical and radio repair material and apparatus, 7 lbs. for 5/- Post free.
Stamped addressed envelope must be enclosed for our New 1940 Bargain List "N." or reply to all enquiries.

ELECTRADIX RADIOS
218 Upper Thames Street, London, E.C.4
Telephone: Central 4611

ELECTRONIC BREVITIES

P.E. Cell Screening

THE efficient performance of a photo-electric cell, no matter for what purpose it is employed, is dependent on a number of important factors. Naturally, the maker's recommendations as to difference of potential between cathode and anode should be adhered to rigidly, for the figure furnished has been determined after a good deal of experiment and, furthermore, any excessive divergence may result in damage to the cell itself. While in the early days of gas-filled cells it was quite a common practice to "flash" them by bringing a bright light in the immediate vicinity (often a match was struck outside the glass envelope), this method of ascertaining whether the cells are still operating satisfactorily is now deprecated owing to the enormous improvements in sensitivity. For certain work it has been found absolutely essential to provide a metallic screen to the cell and its associated leads, and yet in no way interfere with its light reactive response. Obviously, the best way to meet this requirement is to use some form of fairly wide-mesh gauze or netting. In certain studio equipment for some early spotlight television scanning, to prevent any cut-off of the reflected light from the subject being televised, chicken-run netting was used to cover the front sections of each cell mounted in a cylindrical casing. In addition, fine-mesh gauze surrounded the leads passing from the cell terminals to the amplifier held on brackets in a metal box above the cells. The scheme, while presenting a rough and ready appearance, proved to be most effective, and satisfactorily neutralised the effects of any stray fields so that complete stability was ensured.

Electronic Instruments

A SHORT time ago a very interesting dissertation was given on the historical development and the present engineering problems involved in musical instruments

which depended for their operation on electronic circuits. Ever since the Duddill singing arc first made its appearance many years ago, inventors have been inspired to design electronic musical instruments which did not depend on "stroking" or striking wires of different lengths or the application of wind to pipes of different lengths, but instead made use of the oscillatory properties of electrical circuits which could be made to resonate at controllable frequencies within the acoustical range. While it is agreed that to date electronic instruments, especially the ambitious organs, are still in their infancy when compared with the traditional forms of musical instruments, a stage has been reached when developments should be of a very rapid character. In one case a cathode-ray method of waveform generation has been proposed and, although at first sight this may appear complicated, it has the attraction of avoiding moving parts in just the same way as it revolutionised both television transmitters and receivers. One of the most promising possibilities of the electronic scheme is the greatly increased scope which is offered to musicians in modes of expression. Composers are always anxious to express new ideas, but when using the standard musical instruments there is a limitation to the chromatic scale and tone colours which have remained approximately the same over a period of years. In the case of the electronic organ with its very full scope there is no reason why new tone colours and effects should not be expressed, and a minor revolution occur in the musical world.

A New Book

NEWNES SHORT-WAVE MANUAL

A Complete Treatise on the Design, Construction and Operation of all Short-wave Equipment.

Price 5/- or 5/4 by post

from George Newnes, Ltd., Tower House, Southampton Street, Strand, W.C.2.

LATEST PATENT NEWS

Group Abridgments can be obtained from the Patent Office, 25, Southampton Buildings, London, W.C.2, either sheet by sheet as issued on payment of a subscription of 5s. per Group Volume or in bound volumes price 2s. each.

NEW PATENTS

These particulars of New Patents of interest to readers have been selected from the Official Journal of Patents and are published by permission of the Controller of H.M. Stationery Office. The Official Journal of Patents can be obtained from the Patent Office, 25, Southampton Buildings, London, W.C.2, price 1s. weekly (annual subscription, £2 10s.).

Latest Patent Applications.

- 10106.—Philco Radio and Television Corporation.—Rotary indicating device. June 10th.
- 10125.—Scophony, Ltd., and Okolic-sanyi, F.—Television systems. June 10th.
- 9973.—Standard Telephones and Cables, Ltd.—Ultra-short wave radio systems. June 7th.
- 9974.—Standard Telephones and Cables, Ltd.—Directional antenna systems. June 7th.
- 10028.—White, E. L. C., and Ball, E. W.—Tuned amplifier circuit arrangements. June 8th.

Specifications Published.

- 521941.—Thornton, A. A. (Philco Radio and Television Corporation).—Control circuits for gas triodes.
- 521942.—Thornton, A. A. (Philco Radio and Television Corporation).—Methods and means for rapid heating of electron discharge tube filaments.
- 521931.—Radiowerk E. Schrack Akt.-Ges.—Chassis for a radio-receiver or the like.
- 521983.—M-O Valve Co., Ltd., and Cosgrove, C. W.—Tuning-indicators in radio receiving-sets.
- 521984.—General Electric Co., Ltd., and Edwards, G. W.—Apparatus for receiving television.
- 521992.—Marconi's Wireless Telegraph Co., Ltd.—Television transmitter cathode-ray tubes.

Printed copies of the full Published Specifications may be obtained from the Patent Office, 25, Southampton Buildings, London, W.C.2, at the uniform price of 1s. each.

Classified Advertisements

ADVERTISEMENTS are accepted for these columns at the rate of 2d. per word (minimum charge 2/- each paragraph). Series discounts of 5 per cent. for 13, 10 per cent. for 26 and 15 per cent. for 52 insertions are allowed. All advertisements must be prepaid.

EACH paragraph will commence with the first word printed in bold face capitals. Additional words in bold face capitals are charged at 4d. per word.

ALL communications should be addressed to the Advertisement Manager, "Practical Wireless," Tower House, Southampton Street, London, W.C.2.

CABINETS

A CABINET for every radio purpose. Surplus cabinets (undrilled) from noted makers. We have hundreds in stock (no catalogues). Send measurements of chassis, etc., and say what kind of cabinet required. Stamp for reply. Inspection invited.

H. L. SMITH AND CO., LTD., 289, Edgware Road, W.2. Tel.: Pad. 5891.

LITERATURE

NEW Edition. American Amateur Relay League Handbook. 500 pages of up-to-the-minute technical information, 7/-, post 6d. 1940 Jones Handbook: approximately 700 pages dealing with every aspect of Short-wave Radio, 8/6, post 6d.—Webb's Radio, 14, Soho Street, London, W.1. 'Phone: Gerrard 2089.

LOUDSPEAKER REPAIRS

LOUDSPEAKER repairs, British, American, any make. 24-hour service, moderate prices.—Sinclair Speakers, Pulteney Terrace, Copenhagen Street, London, N.1.

REPAIRS to moving coil speakers. Cones/coils fitted or rewound. Fields altered or wound. Prices quoted, including eliminators. Pick-ups and speaker transformers rewound, 4/6. Trade invited. Guaranteed satisfaction. Prompt service.

L.S. Repair Service, 5, Balham Grove, London, S.W.12. Battersea 1321.

MISCELLANEOUS

STAMPS.—50 Greece 1/-; 50 Turkey 1/3.—Harrowden, 224, King Street, Norwich.

MORSE EQUIPMENT

FULL range of Transmitting Keys, Practice Sets, Oscillators, Recorders and other Radio Telegraph Apparatus, designed and manufactured by T. H. McElroy, World's Champion Telegraphist. Sole distributors: Webb's Radio, 14, Soho Street, London, W.1. 'Phone: Gerrard 2089.

MORSE TRAINING

WIRELESS Code Courses. "Book of Facts" Free.—Candler System Co. (L.O.), 121, Kingsway, London, W.C.2.

NEW CHASSIS

ARMSTRONG Co. recommending the following economically priced Radio Chassis for good quality reproduction.

ARMSTRONG Model AW38.—8-valve all-wave Radio-gram chassis, incorporating the latest circuit, including 6 watts push-pull output. Price £8/8/0 + 5% war increase.

Armstrong Co. have many other models of equal interest, please write for catalogue, 6d. Post Free. Armstrong Manufacturing Co., Warlers Rd., Holloway, London, N.5.

NEW LOUDSPEAKERS

3,000 Speakers, P.M. and engravised 4in. to 14in. including several Epoch 18in.—Sinclair Speakers, Pulteney Terrace, Copenhagen Street, London, N.1.

RADIO MAP AND GLOBE

WEBB'S Radio Map of the World enables you to locate any station heard. Size 40" by 30" 2 colour heavy Art Paper 4/6, post 6d. Limited supply on Linen, 10/6, post 6d. **WEBB'S** Radio Globe—superb 12" full-colour model. Radio prefixes, zones, etc. Heavy oxidised mount. Post Paid. 27/6.—Webb's Radio, 14, Soho Street, London, W.1. Phone: Gerrard 2089.

READERS' BARGAINS

WANTED, 3-valve A/C receiver, any make. Pay £1 deposit, 5/- weekly. D. Sinclair, 16, Hillside, Oswestry, Shropshire.

RECEIVERS AND COMPONENTS

BANKRUPT Bargains. Brand new 1939/40 models, well-known best makes, makers' sealed cartons, with guarantees, at less 30%-40% below listed prices; also **Midgets**, portables. Send 2½d. stamp for lists.—Radio Bargains, Dept. P.W., 261-3, Lichfield Road, Aston, Birmingham.

COULPHONE Radio, 22, Grimsshaw Lane, Ormskirk. All goods previously advertised still available. Special offer. Cosmocond Series III. Crystal pick-ups, 18/6. Stamp for lists.

SOUTHERN Radio's Bargains.

ALL Guaranteed. Postage Extra.
 5/- Parcel of useful Components, comprising Condensers, Resistances, Volume Controls, Wira, Circuits, etc. Value 25/-. 5/- per parcel.
 15/- Service Man's Component Kit. Electrolytic Condensers, Volume Controls, Resistances, Tubular, Mica, Paper Condensers, Valve Holders, etc. 120 articles contained in strong carrying case, 9" x 7" x 7", 15/- the Kit.
 21/- Small Trader's Parcel of Components, 150 Articles comprising all types Condensers, Valve Holders, Resistances, Chokes, Coils, Wire, etc. Value 85/-; 21/- the parcel.
 5/- 100 Wire-end Resistances, assorted capacities. ½ and 1 watt, 5/- per 100.
ORMOND Loud-speaker Units, 2/6, Crystal Sets, 5/6; Westectors Type W2, 2/6; Crystal Detectors, 2/-; Crystals, 6d.; Marconi V24 Valves, 9d. "P.O." Microphones on Stand, for use with any receiver, 5/-; Telsen W349 Iron-core Midget D.R. Coils 5/6; Morse Tapping Keys, 3/-; Buzzers, 1/6.
 2/- Tool or Instrument Carrying Cases, ex Government Stock. Wood 9" x 7" x 7", 2/-.
SOUTHERN Radio, 46, Lisle Street, London, W.C. Gerrard 6653.

WE SUPPLY LATEST MODELS OF
ARMSTRONG
QUALITY CHASSIS ON
EASY TERMS
 ★ WRITE FOR FULL DESCRIPTIVE LIST & TERMS. PROMPT DELIVERY, CARR. PAID.
LONDON RADIO SUPPLY CO.,
 "WINDEN," ARDINGLY RD., BALCOMBE, SUSSEX (Evacuation Address).

FREE ADVICE BUREAU
COUPON
 This coupon is available until July 13th 1940, and must accompany all Queries and Inquiries.
PRACTICAL WIRELESS, 6/7/1940.

Turn Your Surplus Components Into Cash
 Those components for which you have no further use can be turned into cash through the classified columns of "Practical Wireless." Readers' advertisements are inserted at the special rate of 1d. per word (minimum charge 1l.).
 Send your advertisement with P.O. to—
 Advertisement Manager, "Practical Wireless," Tower House, Southampton Street, London, W.C.2.

PREMIER RADIO

PREMIER SHORT-WAVE BATTERY-OPERATED KITS FOR OVERSEAS NEWS

Incorporating the Premier 3-Band S.W. Coil. 11-86 Metres without coil changing. Each Kit is complete with all components, diagrams, and 2-volt valves. 3-Band S.W. 1-Valve Kit, 14/9; 3-Band S.W. 2-Valve Kit, 22/6.

DE LUXE S.W. KITS

Complete to the last detail, including all Valves and coils, wiring diagrams and lucid instructions for building and working. Each Kit is supplied with a steel Chassis and Panel and uses plug-in Coils to tune from 13 to 170 metres.

- 1 Valve Short-Wave Receiver or Adaptor Kit 20/-
- 1 Valve Short-Wave Superhet Converter Kit 23/-
- 1 Valve Short-Wave A.C. Superhet Converter Kit 26/3
- 2 Valve Short-Wave Receiver Kit 29/-
- 3 Valve Short-Wave Screen Grid and Pentode Kit 68/-

4 VALVE S.W. RECEIVER KIT for A.C. mains, £4/10/-, complete with valves, coils and circuits. Special Offer of Record Auto-Changer Units for A.C. Mains by famous manufacturer. Play 8 records. Latest type Magnetic Pick-up, Auto-stop, Start and Rejector. Limited number only at £4/19/6. Carriage Paid.

SPECIAL OFFER. ROTHERMEL PIEZO BRUSH CRYSTAL PICK-UPS. New Junior P.U. with arm, 19/6. Standard S.8 Model with arm, 29/6. P.U. head only, De Luxe Model, 19/6.

ROLA MOVING COIL SPEAKERS, complete with Transformers, 6lin. P.M. 12/6. Sin. P.M. 16/6. 10in. P.M. 22/6. G12 P.M. 66/-.

MAINS TRANSFORMERS. Manufacturers' surplus. All brand new and Guaranteed.

Input 110 v. and 220 v. A.C. Output 325-325 v., 120 m.a. 6.3 v., 2-3 amps., 5 v. 2 amps. C.T., 7/6 each. Input 230 v. A.C. Output 325-325 v., 75 m.a., 5 v. 2 amps., 6.3 v. 2-3 amps. C.T., 6/6 each. Input 100-250 v., 300-300 v. 60 m.a. 4 v. 5 a. C.T., 4 v. 1 a., 6/11. Output 325-325 v. 180 m.a., 5 v. 2-3 amps., 6.3 v. 2-4 amps., 12/6.

PREMIER BATTERY CHARGERS for A.C. Mains. Westinghouse Rectification complete and ready for use. To charge 2 volts at ½ amp., 11/9; 6 volts at ½ amp., 19/-; 6 volts at 1 amp., 22/6; 12 volts at 1 amp., 24/6; 6 volts at 2 amps., 33/6.

REPLACEMENT VALVES FOR ALL SETS
EUROPA MAINS VALVES. 4 v., A.C. Types, A.C./H.L., A.C./L., A.C./S.G., A.C./V.-M.S.G., A.C./H.P., A.C./V.H.P. (5-pin), all 5/3 each. A.C./H.P., A.C./V.H.P. (7-pin), 7/6. A.C./Pens-I.H., 7/6; A.C./P.K.4. 7/3; Oct. Freq. Changers, 8/6; Double Diode Triodes, 7/6; 350 v. F.W. Rect., 5/6; 500 v. F.W. Rect., 6/6; 13 v. 2 amps. Gen. Purpose Triodes, 5/6; H.F. Pens and Var-Mu H.F. Pen, Double Diode Triodes, Oct. Freq. Changers, 8/6 each. Full and Half-Wave Rectifiers, 6/6 each.

TRIAD HIGH GRADE U.S.A. VALVES, all types in stock. Standard tubes 5/6 each. Octal Base tubes, 6/6 each. 80's 4/6.

PREMIER Short-Wave Condensers all-brass construction, with Trolift insulation. 15 mmf., 1/9; 25 mmf., 1/10; 40 mmf., 2/-; 100 mmf., 2/3; 160 mmf., 2/7; 250 mmf., 2/11.

PREMIER SHORT-WAVE COILS, 4- and 6-pin types, 13-26, 22-47, 41-40, 76-170 metres, 2/- each, with circuit. Special set of S.W. Coils, 14-150 metres, 4/9 set, with circuit. Premier 3-band S.W. coil, 11-25, 19-43, 38-86 metres. Suitable any circuit, 2/11. 4- or 6-pin formers, 1/2.

PREMIER Morse Practice Key on Bakelite Base and Brass Movement 3/3.

GENERAL PURPOSE Morse Key, 5/10.

HEAVY DUTY TX Key on Cast Base, 10/-.

BATTERY AMPLIFIERS. Class B output complete with valves, 2 watts, 48/-; 4 watts, £3/13/6.

CARDBOARD ELECTROLYTICS, 500v. working, 4 mf. or 8 mf., 1/9; 8+8 mf., 3/6; 50 mf. 12 v., 1/2; 25 mf. 25 v., 1/2; 50 mf. 50 v., 2/-.

UTILITY Micro Cursor Dials. Direct and 100; 1 Ratios, 4/3. 3-wave Full Vision Dial, 6/9.
LISSEN Dual Range Screened Coils, medium and long waves, 2/9 each.

Orders 5/- and over sent Post Free. Under 5/- please add 6d. postage. All enquiries must be accompanied by 2½d. stamp.

YOU MUST HAVE A PREMIER 1940 CATALOGUE
 111 PAGES . . . PRICE 6d. plus postage, 2½d.
GET YOUR COPY TO-DAY!

ALL POST ORDERS TO: Jubilee Works, 167, Lower Clapton Road, London, E.5. Amherst 4723
CALLERS TO: Jubilee Works or our NEW PREMISES, 169, FLEET STREET, E.C.4. Central 2833 or 50, High Street, Clapham, S.W.4. Macaulay 2381

RECEIVERS AND COMPONENTS

VAUXHALL—All goods previously advertised are still available; send now for latest price list, free.—Vauxhall Utilities, 163A, Strand, W.C.2.

DENGO "Pocket Two" midget dry battery receiver. £2/15/0. Ideal for present conditions. Send for details, —Warwick Road, Clacton, Essex.

RADIO CLEARANCE, LTD. See previous issues for full list of bargains.

RADIO CLEARANCE, LTD., 63, High Holborn, London, W.C.1. Holborn 4361.

FEW only 5-valve A.C. Spartan sets still available, £4 5/-, carriage paid; see previous issues for technical details.—London Central Radio, 23, Lisle Street, London, W.C.2. Gerrard 2069.

TUITION

YOUNG MEN (15-20 years) urgently needed to train as Radio Officers for the Merchant Navy; military exemption obtainable; short training period; low fees; boarders accepted. Write or call for full particulars. Wireless College, Calmore, Southampton, or Wireless College, Colwyn Bay.

BOOKS

YOU need this war atlas when you read the newspapers or listen to the wireless bulletins. "Newnes Comprehensive War Atlas" will make the progress of the conflict understandable in all its aspects. 8 pages of war maps, including the Scandinavian countries, Western Front, Balkans, and all countries whose frontiers adjoin or are near those of the belligerents. With war strengths of the Armies, Navies, and Air Forces of the Nations.—Of all newsgroups and booksellers, 1s. 6d. net, or by post 1s. 9d. from the Book Publisher, George Newnes, Ltd., Tower House, Southampton Street, Strand, London, W.C.2.

KNOW what to do before the doctor comes.—Learn from the new book, "First Aid For The Householder," and your knowledge may be the means of saving a life. Deals in simple language with all kinds of injuries and their treatment, war-gases, shock, and the minor ailments of everyday life. Clearly illustrated.—Of all booksellers, 1s. 6d. net, or by post 1s. 9d. from the Book Publisher, George Newnes, Ltd., Tower House, Southampton Street, Strand, London, W.C.2.

PLUGS
 The CLIX range of Radio plugs is comprehensive to the last degree and covers every conceivable purpose.

CLIX
 British Mechanical Productions Ltd.,
 1, Church Road, Leatherhead, Surrey

"ENGINEERING OPPORTUNITIES"
 This unique Handbook shows the easy way to secure A.M.I.C.E., A.M.I.E., Mech.E., A.M.I.E.E., A.M.I.A.E., A.M.I.W.T., A.M.I.R.E. and similar qualifications. WE GUARANTEE—"NO PASS—NO FEE". Details are given of over 150 Diploma Courses in all branches of Civil, Mech., Elec., Motor, Aero, Radio, Television and Production Engineering, Draughtsmanship, Tracing, Inspection, Building, Government Employment, etc. Write for this enlightening Handbook to-day. FREE and post free. Men with radio knowledge can obtain attractive posts in the Services.
BRITISH INSTITUTE OF ENGINEERING TECHNOLOGY,
 409, Shakespeare House,
 17, 18, 19, Stratford Place, London, W.1

"PRACTICAL WIRELESS"
SPECIAL OFFER

to you **AT HALF PRICE!**

INDOOR MODEL RAILWAYS

(HO and OO Gauges)

By E. W. TWINING

(With a Foreword by F. J. CAMM, Editor of *Practical Wireless*)

HERE is a striking opportunity for all model railway enthusiasts to obtain a comprehensive, lavishly illustrated standard work on the subject at half the published price! The author is one of the best-known model railway experts, and his book deals with scales and dimensions, electric traction motors, reversing gear, modelling prototypes, motor mechanisms, carriages, waggons, third rail and two-rail systems, etc. It contains 126 specially prepared drawings and photographs.

Send in the Order Form below at once. Supplies of this book are strictly limited, so hurry if you wish to take advantage of this bargain offer.

This fully illustrated 5/- book is offered only to readers of **PRACTICAL WIRELESS** at the special price of

2/6

(Plus sixpence only for packing and postage)

POST THIS ORDER FORM WITHOUT DELAY!

To The Book Publisher, George Newnes, Ltd., Tower House, Southampton Street, Strand, London, W.C.2

Please send me INDOOR MODEL RAILWAYS at the special price of 2/6 plus 6d. for postage and packing.

I enclose P.O. value 3s. No.....

NAME

ADDRESS.....

P.W. 6.7.40.

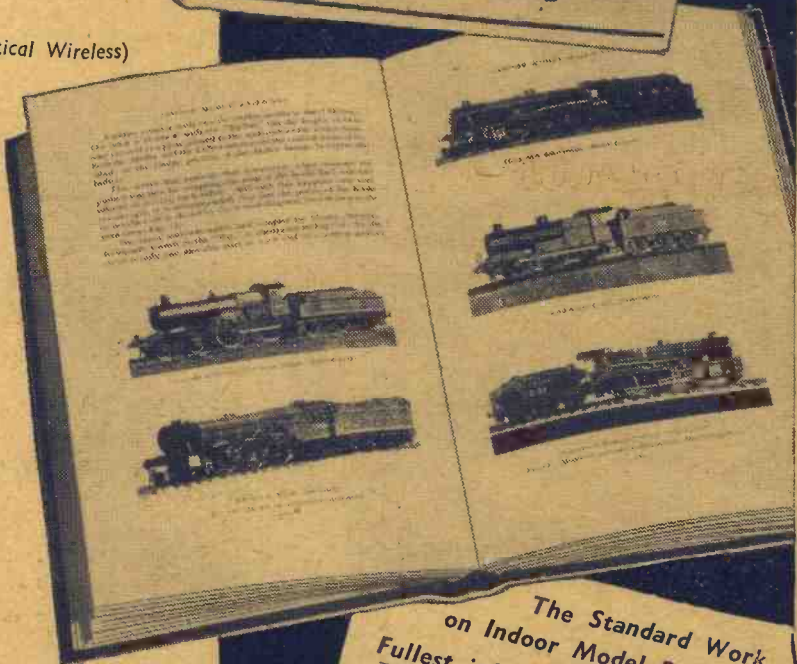
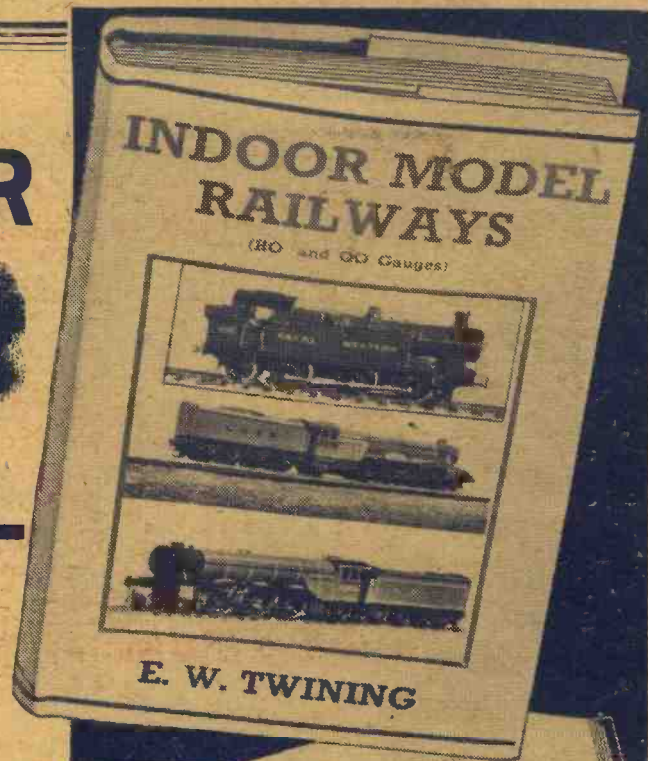

The Standard Work on Indoor Model Railways
Fullest information on:
 Early Small Gauge Railways: Origin of HO and OO Gauges.
 Gauges, Scales and Dimensions.
 Electric Traction Motors, Rotation and Reversing.
 Prototype Locomotives and Modelling Same.
 Motor Mechanisms and Their Adaptation to Prototype Engines.
 The Twin Railway, Its Locomotives and Electrical Working.
 Electric Motor Coaches, Carriages, Waggon and Auto-Couplers.
 Track, Layout and Engineering Works.
 Third-Rail and Two-Rail Systems, Control and Signalling.
 Architectural Features, Etc., Etc.
Profusely Illustrated and Handsomely Bound.

George Newnes, Ltd.

RADIO TRAINING 13 MANUAL P.W.

Published every Wednesday by GEORGE NEWNES, LIMITED, Tower House, Southampton Street, Strand, London, W.C.2, and Printed in England by THE NEWNES & PEARSON PRINTING CO., LTD., Exmoor Street, London, W.10. Sole Agents for Australia and New Zealand: GORDON & GOTCH, LTD. South Africa: CENTRAL NEWS AGENCY, LTD. Subscription rates including postage: Inland 25s. 10d. per annum, 11s. 11d. for six months; Abroad 21s. 8d. per annum, 10s. 10d. for six months. Registered at the General Post Office for the Canadian Magazine Post.
 CONDITIONS OF SALE AND SUPPLY.—This periodical is sold subject to the following conditions, namely, that it shall not, without the written consent of the publishers first given, be lent, resold, hired out or otherwise disposed of by way of Trade except at the full retail price of 4d.; and that it shall not be lent, resold, hired out or otherwise disposed of in a mutilated condition or in any unauthorised cover by way of Trade; or affixed to or as part of any publication or advertising, literary or pictorial matter whatsoever.