

60p

Practical Computing

April 1981

Volume 4 Issue 4

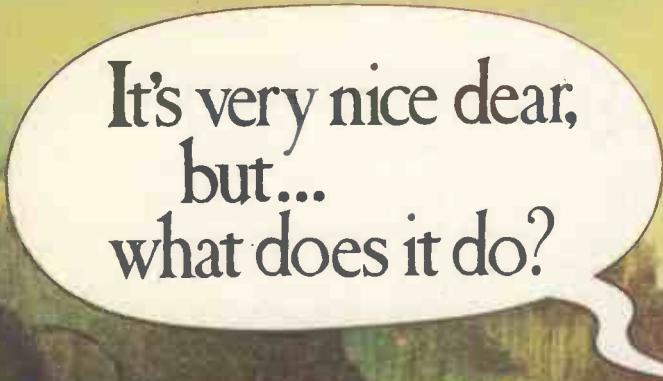

It's very nice dear,
but...
what does it do?

**Micros - the
woman's view**

Reviews:

Onyx

Prestel card

Business

software

**Computer-aided
learning**

Nestar Apple link

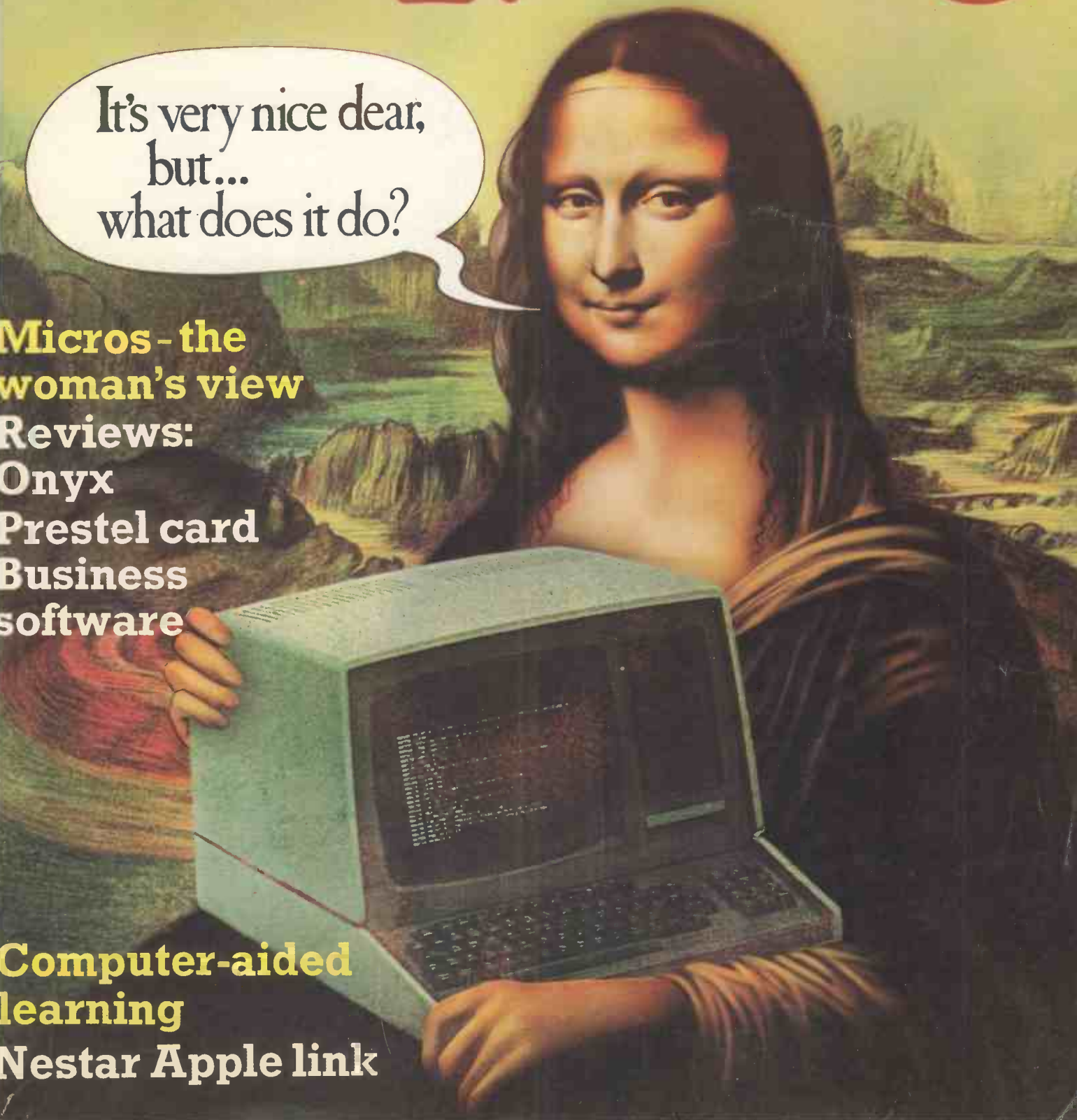

MicroCentre introduce System Zero

Basic System Zero £587
System Zero/D with DDF £2355

The System Zero is a small computer especially designed for dedicated applications. It is particularly useful in process control situations.

In the basic model you get Cromemco's famous Z-80A single card computer, 1k of RAM, 4k of ROM, Control Basic, and an attractive cabinet. The motherboard provides 3 extra card slots on the S-100 bus, for tailoring the system to particular applications. The basic model is designed for ROM-based programs, but it can be expanded by the addition of memory and I/O cards. It is fully compatible with all Cromemco peripherals, including floppy disks and hard disk systems. Suitably configured the System Zero can run any Cromemco operating system or software package.



New System Zero Computer with quad-capacity DDF disk drive. The system includes built-in diagnostics for a quick system test of memory, controller and disk drives

System Zero/D

This special version of the System Zero has 64k of fast RAM, and a model DDF dual disk drive. It includes two double-sided double-density 5 inch disk drives giving a total of 780k bytes storage; and RDOS-2, a new resident disk operating system with terminal and printer drivers, and self-test diagnostics.

The System Zero/D is an exceedingly inexpensive development computer ideal

for setting up dedicated applications to run in the basic model. It will support Cobol, Fortran IV, Ratfor, Structured Basic, Lisp, RPG II, Word Processing, DBMS, and the full range of Cromemco's business applications software.

Operating system

The System Zero/D will run any Cromemco operating system provided sufficient memory is available. The minimum configuration of 4k ROM runs control Basic; with 64k RAM the system will run RDOS-2 or CDOS (compatible with CP/M); and with 128k the Zero/D will run the Cromix system (based on Unix).



At the recent UK launch of the System Zero Computer, Cromemco's Technical Director Roger Melen presented a System Zero/D with 128k memory running Cromix. Here he is seen discussing the system with MicroCentre Director Andrew Smith (right).

For  **Cromemco... call the experts**

MicroCentre
Tel: 031-556 7354

**LEADING UK
DISTRIBUTORS**

Complete Micro Systems Ltd.,
30 Dundas Street
Edinburgh EH3 6JN

• Circle No. 101



Very nice dear, but what does it do? — page 66.

Editor

Peter Laurie

Assistant Editor

Duncan Scot

Staff Writer

Bill Bennett

Production Editor

Toby Wolpe

Prestel Editor

Martin Hayman

Editorial Secretary

Tracy Ebbetts

Consultants

Technical **Nick Hampshire**

Software **Mike McDonald**

Editorial: 01-661 3500

Advertisement Manager

David Lake

Advertisement Executive

Philip Kirby

Advertising: 01-661 3021

Midlands office:

David Harvett 021-356 4838

Northern office:

Ron Southall 061-872 8861

Publishing Director

Chris Hipwell

Published by IPC Electrical electronic Press Ltd, Quadrant House, The Quadrant, Sutton, Surrey, SM25AS. Tel: 01-661 3500. Telex/grams 892084 BIPRESG.

Typesetting and artwork by Bow-Towning Ltd, London EC1
Printed by Eden Fisher Ltd, Southend-on-Sea

Distributed by IPC Sales and Distribution Ltd, 40 Bowling Green Lane, London EC1R 0NE

Subscriptions: U.K., £8 per annum; Overseas £14 per annum; airmail rates available on application to Subscription Manager, IPC Business Press (S & D) Ltd, Oakfield House, Perrymount Road, Haywards Heath, Sussex RH16 3DH, tel 0444 59188

© IPC Business Press Ltd 1981
ISSN 0141-5433

Would-be authors are welcome to send articles to the Editor but PC cannot undertake to return them. Payment is at £30 per published page. Programs intended for publication should ideally be justified to 22 or 44 or 66 characters per line.

Submissions should be typed or computer-printed. Hand-written material is liable to delay and error.

Every effort is made to check articles and listings but PC cannot guarantee that programs will run and can accept no responsibility for any errors.

CONTENTS

- 41** Editorial / The business of education
- 42** Feedback / Buying the best; noughts and crosses; unsatisfied customer
- 46** Printout / New Hewlett-Packard micro; computer centre; Comal language
- 55** Printout Extra / London Computer Fair preview; Homeline software
- 56** Commercial Operating System / Reviewer Nick Horgan looks at Interface Computer Services' route to portability
- 58** Business Controller / Vincent Tseng's appraisal of the Commodore-approved Creamwood package
- 60** Onyx / We gauge the C-8001's computing potential
- 62** Teletext card / Mike Hughes tests the Hi-Tech board
- 66** Very nice dear, but what does it do? / Two women's views of micros
- 76** Nestar Apple link / A report by Larry Press on the new Model A network system
- 80** Planned Obsolescence / Fiction by Andrew Walker
- 85** Education / David Walton on computer-aided learning
- 87** PAYE / How the national system should have been computerised — a paper by MPs John Butcher and Philip Virgo
- 90** Gambling / Football pools prediction by Gavin Potter
- 94** Black Box / Bob Merry's micro version of the Waddingtons game
- 100** Applications / The impact a micro made at London Features International
- 102** Statistics on a micro / Owen Bishop discusses data coding
- 104** Software protection / Copyright or patent?
- 108** Basic Techniques
- 111** Z-80 Zodiac
- 113** ZX-80 Line-up
- 115** Tandy Forum
- 116** 6502 Special
- 118** Pet Corner
- 119** Apple Pie
- 120** Micromouse
- 121** Book Reviews
- 128** Recursion / Elegant recursive solutions
- 134** Hardware Buyers' Guide
- 149** The Hexadecimal Kid / Page 7 of Richard Forsyth's parable

Prestel page number 45631

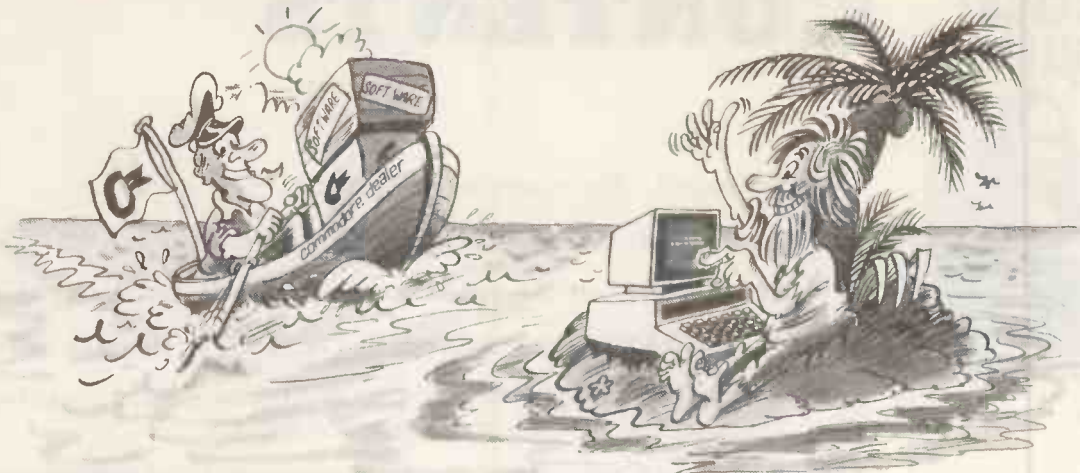

You're never alone with a Commodore PET

If you buy just any make of microcomputer you could find yourself on your own. And that's serious. Because without first class software and support, all you're left with is a box of wires.

On the other hand, when you buy Europe's No.1 microcomputer, the Commodore PET, you have access to the largest and finest range of software in the UK today; the most experienced dealer network; 24 hour field maintenance service; plus our very own training courses and user's club - all to ensure that you get the best from your system.

But how can Commodore offer so much? Well, we've been in the high technology business for over 20 years, whereas many of our competitors have just started out. We even manufacture the silicon chips for other microcomputers. This enables us to keep our costs to you down, so you can buy a self-contained PET for £450, or a complete business system from as little as £2,000 (+ VAT).

Of course, you could buy a box of wires for about the same price. But all you'll get from our dealers is sympathy.

LONDON AREA

Adda Computers Ltd.
W13, 01-579 5845
Advanced Management Systems.
EC2, 01-638 9319
C.S.S. (Business Equipment)
Ltd, E8, 01-254 9293
Centralex - London Ltd.
SE13, 01-318 4213
Computer Sales & Software
Centre Ltd.
ILFORD, 01-554 3344
Cream Computer Shop.
HARROW, 01-863 0833
Da Vinci Computer Shop.
EDGWARE, 01-952 0526
Henderson Bennett.
SE25, 01-654 5609
Home and Business Computers.
E12, 01-472 5107
L & J Computers.
NW9, 01-204 7525
Logic Box Ltd.
SW1, 01-222 1122
Merchant Systems Ltd.
EC4, 01-353 1464
Micro Computer Centre.
SW14, 01-878 7044
Micro-Facilities Ltd.
HAMPTON HILL, 01-979 4546
Sumlock Bondain Ltd.
EC1, 01-250 0505
Sumlock Bondain Ltd.
EC4, 01-626 0487

S.M.G. Microcomputers.
GRAVESEND, 55813
South East Computers.
HASTINGS, 426844
Bromwall Data Services Ltd.
HATFIELD, 60980
Alpha Business Systems.
HERTFORD, 57425
Commonsense Business Systems
Ltd, HIGH WYCOMBE, 40116
Kingsley Computers Ltd.
HIGH WYCOMBE, 27342
Brent Computer Systems.
KINGS LANGLEY, 65056
Computopia Ltd.
LEIGHTON BUZZARD, 376600
South East Computers Ltd.
MAIDSTONE, 681263
J.R. Ward Computers Ltd.
MILTON KEYNES, 562850
Sumlock Bondain (East Anglia)
Ltd, NORWICH, 26259
T & V Johnson (Microcomputers
Etc) Ltd, OXFORD, 73101
C.S.E. (Computers).
READING, 61492
Slough Microshop.
SLOUGH, 72470
Business Electronics.
SOUTHAMPTON, 738248
H.S.V. Ltd.
SOUTHAMPTON, 22131
Super-Vision.
SOUTHAMPTON, 774023
Symbic Systems Ltd.
SOUTHAMPTON, 38868
Stuart R Dean Ltd.
SOUTHEND-ON-SEA, 62707
The Computer Room.
TUNBRIDGE WELLS, 41644
Orchard Computer Services.
WALLINGFORD, 35529
Photo Acoustics Ltd.
WATFORD, 40698
Microchips.
WINCHESTER 68085
P.P.M. Ltd.
WOKING, 80111
Petatec Electronic Services
Ltd, WOKING, 69032
Oxford Computer Systems.
WOODSTOCK, 812838

Computer Services Midlands
Ltd, BIRMINGHAM, 382 4171
Marchant Business Systems Ltd.
BIRMINGHAM, 706 8232
Micro Associates.
BIRMINGHAM, 328 4574
Peach Data Services Ltd.
BURTON-ON-TRENT, 44968
Jondane Associates Ltd.
COVENTRY, 664400
Davidson-Richards Ltd.
DERBY, 366803
Allen Computers.
GRIMSBY, 40568
Caddis Computer Systems Ltd.
HINCKLEY, 613544
Machsize Ltd.
LEAMINGTON SPA, 312542
Arden Data Processing.
LEICESTER, 22255
Roger Clark Business Systems
Ltd, LEICESTER, 20455
Lowe Electronics.
MATLOCK, 2817
A.J.R. Office Equipment Services
Ltd, NOTTINGHAM, 206647
Betos (Systems) Ltd.
NOTTINGHAM, 48108
PEG Associates (Computer
Systems Ltd), RUGBY, 65756
Walters Computer Systems Ltd.
STOURBRIDGE, 70811
System Micros Ltd.
TELFORD, 460214

NORTH EAST

Currie & Maughan.
GATESHEAD, 774540
Elfton Ltd.
HARTLEPOOL, 61770
Dyson Instruments.
HETTON, 260452
Fiddes Marketing Ltd.
NEWCASTLE, 815157
Format Micro Centre.
NEWCASTLE 21093
Intex Datalog Ltd.
STOCKTON-ON-TEES, 781193

S. WALES & WEST COAST

Radan Computational Ltd.
BATH, 318483
C.S.S. (Bristol) Ltd.
BRISTOL, 779452
T & V Johnson (Microcomputers
Etc) Ltd, BRISTOL, 422061
Sumlock Tabdown Ltd.
BRISTOL, 276685
Sigma Systems Ltd.
CARDIFF, 34869
Reeves Computers Ltd.
CARMARTHEN, 32441
A.C. Systems.
EXETER, 71718
Milequip Ltd.
GLOUCESTER, 411010

Jeffrey Martin Computer Services
Ltd, NEWQUAY, 2863
Devon Computers.
PAIGNTON, 526303
A.C. Systems.
PLYMOUTH, 260861
J.A.D. Integrated Services.
PLYMOUTH, 62616
Business Electronics.
SOUTHAMPTON, 738248
Computer Supplies (Swansea).
SWANSEA, 290047

NORTH WEST & N. WALES

B & B (Computers) Ltd.
BOLTON, 26644
Tharstern Ltd.
BURNLEY, 38481
Megapalm Ltd.
CARNFORTH, 3801
Catlands Information Systems
Ltd, CHESTER, 46327
Catlands Information Systems
Ltd, WILMSLOW, 527166

LIVERPOOL

Aughton Microsystems Ltd.
LIVERPOOL, 548 7788
Stack Computer Services Ltd.
LIVERPOOL, 933 5511

MANCHESTER AREA

Byte Shop Computerland.
MANCHESTER, 236 4737
Computastore Limited.
MANCHESTER, 832 4761
Cytex (UK) Ltd.
MANCHESTER, 872 4682
Executive Reprographic Ltd.
MANCHESTER, 228 1637
Professional Computer Services
Ltd, OLDHAM, 061-624 4065

SCOTLAND

Gate Microsystems Ltd.
DUNDEE, 28194
Holdene Microsystems Ltd.
EDINBURGH, 668 2727
Gate Microsystems Ltd.
GLASGOW, 221 9372
Robox Ltd, GLASGOW, 8413
Thistle Computers (Macmicro).
INVERNESS, 712774
Ayrshire Office Computers.
KILMARNOCK, 42972
Thistle Computers.
KIRKWALL, 3140

N. IRELAND

N. Ireland Computer Centre.
HOLLYWOOD, 6548

HOME COUNTIES

Millhouse Designs Ltd.
ALTON, 84517
H.S.V. Ltd.
BASINGSTOKE, 62444
MMS Ltd.
BEDFORD, 40601
D.D.M. Direct Data Marketing
Ltd, BRENTWOOD, 214168
Amplicon Micro Systems Ltd.
BRIGHTON, 562163
T & V Johnson (Microcomputers
Etc) Ltd, CAMBERLEY, 20446
Cambridge Computer Store.
CAMBRIDGE, 65334
Wego Computers Ltd.
CATERHAM, 49235
Dataview Ltd.
COLCHESTER, 78811
Amplicon Micro Systems Ltd.
CRAWLEY, 26493

MIDLANDS & S. HUMBERSIDE

C.B.S. Consultants.
BIRMINGHAM, 772 8181

YORK & N. HUMBERSIDE

Ackroyd Typewriter & Adding
Machine Co. Ltd.
BRADFORD, 31835
Microprocessor Services.
HULL, 23146
Holdene Ltd, LEEDS, 459459
South Midlands Communications
Ltd, LEEDS, 782326
Yorkshire Electronics Services
Ltd, MORLEY, 522181
Computer Centre (Sheffield) Ltd.
SHEFFIELD, 53519
Hallam Computer Systems.
SHEFFIELD, 663125
Holbrook Business Systems Ltd.
SHEFFIELD, 484466

For further information about Commodore services and products, contact your local dealer, or send off this coupon to obtain our free literature pack.
To: Commodore Information Centre, 360 Euston Road, London W1 3BL Telephone: 01-388 5702

Name _____

Position _____

Address _____

Intended application _____

 **commodore**

This list covers dealers participating in our advertising.

• Circle No. 102

Comart Approved Dealers

Belfast
O & M Systems
95 Dublin Road
Tel: 0232 49440

Birmingham
Byteshop Computerland Ltd
94/96 Hurst St, B5 4TD
Tel: 021 622 7149

Cambridge
Cambridge Computer Stores
1 Emmanuel St, CB1 1NE
Tel: 0223 68155

Cornwall
Benchmark Computer Systems Ltd
Tremena Manor
Tremena Road
St Austell, PL25 5GG
Tel: 0726 610000

Dublin
Lendac Data Systems Ltd
8 Dawson St
Tel: 0001 372052

Glasgow
Byteshop Computerland Ltd
Magnet House
61 Waterloo St, G2 7BP
Tel: 041 221 7409

Leeds
Holdene Ltd
Manchester Unity House
11/12 Rampart Road
Woodhouse St
Tel: 0532 459459

London
Byteshop Computerland Ltd
324 Euston Road
London W1
Tel: 01-387 0505

Digitus
9 Macklin Street
Covent Garden WC2
Tel: 01 405 6761

Jarrogate
67 Tulseimere Road,
West Norwood,
London SE17
Tel: 01-670 3674

Manchester
Byteshop Computerland Ltd
11 Gateway House
Piccadilly Station Approach
Tel: 061 236 4737

NSC Computers
29 Hanging Ditch
Tel: 061 832 2269

Newbury
Newbear Computing Store
40 Bartholomew St
Tel: 0635 30505

Nottingham
Byteshop Computerland Ltd
92A Upper Parliament St,
NG1 6LF
Tel: 0602 40576

Sheffield
Hallam Computer Systems
451 Eccleshall Road, S11 9PN
Tel: 0742 663125

Southampton
Xitan Systems
23 Cumberland Place,
SO1 2BB
Tel: 0703 38740

Sudbury
Eurotec Consultants
Holbrook Hall
Little Waldingford
Tel: 0206 262319

Warwicks
Business & Leisure
Microcomputers
16 The Square
Kenilworth
Tel: 0926 512127

Watford
Lux Computer Services
108 The Parade
High Street
Watford WD11 2AW
Tel: 0923 29513

Comart Microcomputer dealers are located strategically throughout the country to give support, guidance and assistance. In the event of difficulty contact Comart direct.

comart communicator

The clean simplicity outside...

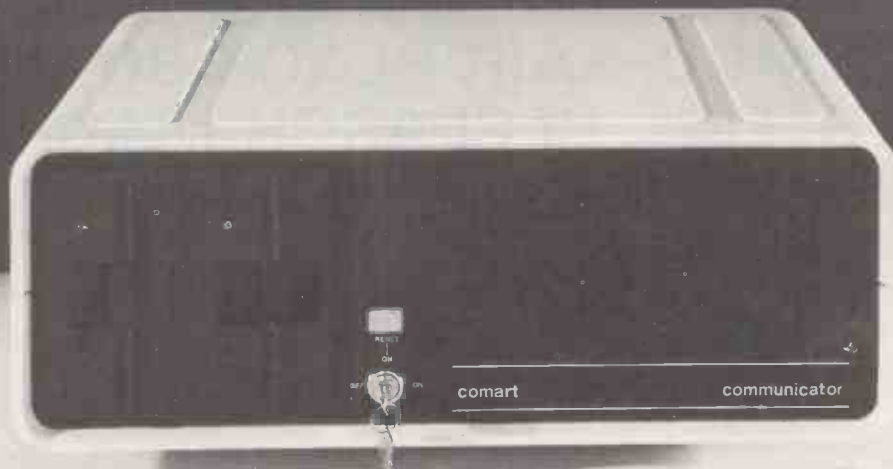

...conceals the pedigree inside.

Comart's CP100 Communicator is the new British designed, British made Microcomputer from Comart. It is the result of a carefully conceived development programme. It exploits Comart's first hand experience of the British computer market, and their growing strength as a manufacturer.

CP100 is the first of a new generation of flexible, expandable micros specifically developed to suit British operating conditions and communication requirements.

The clean lines outside, conceal the power within; its S-100 bus means wide ranging peripheral support, and simple after sales care. And, that's not all. Communicator is built to keep your future options open. It's ready for Prestel, asynchronous, and synchronous operation. It has expandable memory capability and yet it's price competitive as a stand-alone system with its CP/M™ operating system, and support software.

Find out more about Communicator today.

The U.K. Leaders in Microcomputer Development, Application and Support.

PRACTICAL COMPUTING April 1981

comart

St Neots HUNTINGDON Cambs PE19 2AF
Tel (0480) 215005 Telex: 32514 Comart G.

• Circle No. 103

Mail Order Software

from the world's leading microsoftware supplier

Software for most popular 8080/Z80 computer disk systems including

NORTH STAR HORIZON, VECTOR MZ, OHIO SCIENTIFIC, SUPERBRAIN, Z80 APPLE, CROMEMCO, RAIR BLACK BOX, DYNABYTE, SD SYSTEMS, RESEARCH MACHINES, EXIDY SORCERER, IMSAI, HEATH, and 8" IBM formats

Software with Manual / Manual Alone

Software with Manual / Manual Alone

Software with Manual / Manual Alone

DIGITAL RESEARCH

- CP/M* FDOS - Diskette Operating System complete with Text Editor, Assembler, Debugger, File Manager and system utilities. Available for wide variety of disk system including North Star, Helios II, Micropolis, ICOM (all systems) and Altair. Supports computers such as Sorcerer, Horizon, Cromemco, Ohio Scientific, RAIR Black Box, Research Machines, Dynabyte, etc. £75/£15
- CP/M version 2 (not all formats available immediately) £95/£15
- CP/M for Apple 11* Softcard Z80 Microsoft BASIC - 80 with high resolution graphics £250/£15
- MP/M £195/£25
- MAC - 8080 Macro Assembler. Full Intel macro definitions, Pseudo Ops include RPC, IRP, REPT, TITLE, PAGE, and MACLIB. Z-80 library included. Produces Intel absolute hex output plus symbols file for use by SID (see below) £55/£10
- SID - 8080 symbolic debugger. Full trace, pass count and break-point program testing system with back-trace and histogram utilities. When used with MAC, provides full symbolic display of memory labels and equated values £45/£10
- ZSID Includes Z80 mnemonics, requires Z80 CPU. £50/£10
- TEX - Text formatter to create paginated, page-numbered and justified copy from source text files, directable to disk or printer £45/£10
- DESPOOL - Program to permit simultaneous printing of data from disk while user executes another program from the console £30/£1

MICROSOFT

- BASIC-80 - Disk Extended BASIC Interpreter Version 5, ANSI compatible with long variable names, WHILE/WEND, chaining, variable length file records. £155/£15
- BASIC Compiler - Language compatible with Version 5 Microsoft interpreter and 3-10 times faster execution. Produces standard Microsoft relocatable binary output. Includes Macro-80. Also linkable to FORTRAN-80 or COBOL-80 code modules. £195/£15
- FORTRAN-80 - ANSI '66 (except for COMPLEX) plus many extensions. Includes relocatable object compiler, linking loader, library with manager. Also includes MACRO-80 (see below) £205/£15
- COBOL-80 - ANSI '74 Relocatable object output. Format same as FORTRAN-80 and MACRO-80 modules. Complete ISAM. Interactive ACCEPT DISPLAY, COPY, EXTEND £325/£15
- MACRO-80 - 8080/Z80 Macro Assembler. Intel and Zilog mnemonics supported. Relocatable linkable output. Loader, Library Manager and Cross Reference List utilities included £75/£10

- XMACRO-86 - 8086 cross assembler. All Macro and utility features of MACRO-80 package. Mnemonics slightly modified from Intel ASM86. Compatibility data sheet available. £155/£15
- EDIT-80 - Very fast random access text editor for text with or without line numbers. Global and intra-line commands supported. File compare utility included £45/£10

EIDOS SYSTEMS

- KBASIC - Microsoft Disk Extended BASIC version 4.51 integrated with KISS Multi-Keyed Index Sequential and Direct Access file management as 9 additional BASIC commands. KISS included as relocatable modules linkable to FORTRAN-80, COBOL-80, and BASIC COMPILER. Specify CP/M version 1.4 or 2.x when ordering. Requires 48K CP/M £295/£25 To licensed users of Microsoft BASIC-80 (MBASIC) £215/£25

MICROPRO

- SUPER-SORT 1 - Sort, merge, extract utility as absolute executable program or linkable module in Microsoft format. Sorts fixed or variable records with data in binary, BCD, Packed Decimal, EBCDIC, ASCII, floating, fixed point, exponential, field justified, etc. etc. Even variable number of fields per record £125/£15
- SUPER-SORT II - Above available as absolute program only £105/£15
- SUPER-SORT III - As II without SELECT/EXCLUDE £75/£15
- WORD-MASTER Text Editor - In one mode has super-set of CP/M's ED commands including global searching and replacing, forward and backwards in file. In video-mode, provides full screen editor for users with serial addressable-cursor terminal £75/£15
- WORD-STAR - Menu driven visual word processing system for use with standard terminals. Text formatting performed on screen. Facilities for text paginate, page number, justify, center, underscore and PRINT. Edit facilities include global search and replace, read/write to other text files, block move, etc. Requires CRT terminal with addressable cursor positioning £255/£15
- WORD-STAR/MAIL-MERGE - As above with option for production mailing of personalised documents with mail list from Dastatar or NAD. £315/£15
- DATASTAR - Professional forms control entry and display system for key-to-disk data capture. Menu driven with built-in learning aids. Input field verification by length, mask, attribute (i.e. uppercase, lowercase, numeric, auto dup., etc.). Built-in arithmetic capabilities using keyed data, constants and derived values. Visual feedback for ease of forms design. Files compatible with all CP/M-MP/M supported languages. Requires 32K CP/M £195/£25

GRAFFCOM

- PAYROLL - Designed in conjunction with the spec for PAYE routines by HMI Taxes. Processes up to 250 employees on weekly or monthly basis. Can handle cash, cheque or bank transfer payments plus total tracking of all year to date figures. Prints emp master, payroll log, payslips and bank giro's. Requires CBASIC-2 £475/£35
- COMPANY SALES - Performs sales accounting function. Controls payments of invoices and prints sales ledger and aged debtors report. Suitable for any accounting period. Comprehensive VAT control and analysis of all sales invoices. Requires CBASIC-2 £425/£35
- COMPANY PURCHASES - Performs purchase accounting function. Controls invoices, credit & debit notes. Prints purchase ledger, aged creditors report and payment advices. Comprehensive VAT control and analysis of all purchases. Interfaces with the ADD system. Requires CBASIC-2 £425/£35
- GENERAL ACCOUNTING - Produces Nominal Ledger, Trial Balance, P/L and Balance Sheet. Define your own coding system. Interactive data entry plus optional data capture from Company Sales and Company Purchases. Requires CBASIC-2 £375/£35
- STOCK CONTROL - Maintains stock records, monitors stock levels to ensure optimum stock holding. Details include stock desc., product code, unit, unit price, quantity on hand on order/minimum. Stock analysis reports can be weekly, monthly, quarterly etc. Interfaces with Order Entry Invoicing system. Requires CBASIC-2 £325/£35
- ORDER ENTRY & INVOICING - Performs order entry and invoicing function. Handles invoices for services and consumable items, part orders and part quantities. Sales Analysis report shows sales movements and trends for user-defined period Interfaces with Stock Control, ADD and Company Sales systems. Requires CBASIC-2 £325/£35
- ADD - Complete control of all your names & addresses including suppliers, clients, enquiries etc. Assign your own coding system and select all output via the report generator. Will print anything from mailing labels to directories. Requires CBASIC-2 £225/£35
- TIME RECORDING SYSTEM - Provides comprehensive control over manhour expenditures by job or account. Expense details can also be controlled. Up to 75 activities can be assigned and reports produced weekly/monthly showing movements and job account totals to date. Requires CBASIC-2. £375/£35
- LEASE RENTAL & HP SYSTEM - Designed to control agreements and contracts that are payable at regular intervals by fixed amounts. Handles lease, rental, HP or maintenance agreements with payments by invoice, SO, or cash. Can be used with ADD and CSS for complete credit control system. Requires CBASIC-2. £375/£35

Also available in bundles, contact us for details.

STRUCTURED SYSTEMS GROUP

- ANALYST** — Customised data entry and reporting system. User specifies up to 75 data items per record. Interactive data entry, retrieval and update facility makes information management easy. Sophisticated report generator provides customised reports using selected records with multiple level breakpoints for summarisation. Requires CBASIC-2, 24 x 80 CRT, printer and 48K system. **£125/£10**
- LETTERIGHT** — Program to create edit and type letters or other documents. Has facilities to enter, display, delete and move text, with good video screen presentation. Designed to integrate with NAD for form letter mailings. Requires CBASIC-2. **£105/£15**
- NAD** Name and Address selection system — interactive mail list creation and maintenance program with output as full reports with reference data or restricted information for mail labels. Transfer system for extraction and transfer of selected records to create new files. Requires CBASIC-2. **£45/£12**
- QSORT** — Fast sort/merge program for files with fixed record length, variable field length information. Up to five ascending or descending keys. Full back-up of input files created. Parameter file created optionally with interactive program which requires CBASIC-2. Parameter file may be generated with CP/M assembler utility. **£50/£12**

SOFTWARE SYSTEMS

- CBASIC-2** Disk Extended BASIC — Non-interactive BASIC with pseudo-code compiler and runtime interpreter. Supports full file control, chaining, integer and extended precision variables etc. **£75/£10**

MICRO FOCUS

- STANDARD CIS COBOL** — ANSI '74 COBOL standard compiler fully validated by U.S. Navy tests to ANSI level 1. Supports many features to level 2 including dynamic loading of COBOL modules and a full ISAM file facility. Also, program segmentation, interactive debug and powerful interactive extensions to support protected and unprotected CRT screen formatting from COBOL programs used with any dumb terminal. **£400/£25**
- FORMS 2** — CRT screen editor. Automatically creates a query and update program of indexed files using CRT protected and unprotected screen formats. Output is COBOL data descriptions for copying into CIS COBOL programs. No programming experience needed. Output program directly compiled by CIS COBOL (standard). **£100/£12**

- APL/V80** — Concise and powerful language for application software development. Complex programming problems are reduced to simple expressions in APL. Features include up to 27K active workspace, shared variables, arrays of up to 8 dimensions, disk workspace copy object library. The system also supports auxiliary processors for interfacing I/O ports. Requires 48K CP/M and serial APL printing terminal or CRT. **£270/£20**
- PASCALUM** — Compiler generates P code from extended language implementation of standard PASCAL. Supports overlay structure through additional procedure calls and the SEGMENT procedure type. Provides convenient string handling capability with the added variable type STRING. Untyped files allow memory image I/O. Requires 56K CP/M. **£195/£20**
- PASCALIZ** — Z80 native code PASCAL compiler. Produces optimised portable reentrant code. All interfacing to CP/M is through the support library. The package includes compiler companion macro assembler and source for the library. Requires 56K and Z80 CPU. Version 3 includes all of Jensen/Wirth. **£205/£15**
- PASCALUM** — Subset of standard PASCAL. Generates ROMable 8080 machine code. Symbolic debugger included. Supports interrupt procedures, CP/M file I/O and assembly language interface. Real variables can be BCD, software floating point, or AMD 9511 hardware floating point. Version 3 includes Sets, Enumeration and Record data types. Manual explains BASIC to PASCAL conversion. Source for the run time package requires MAC (See under Digital Research). Requires 32K. **£135/£20**

- TINY C** — interactive interpretive system for teaching structured programming techniques. Manual includes full source listings. **£45/£30**
- BDS C COMPILER** — Supports most major features of language, including Structures, Arrays, Pointers, recursive function evaluation, linkable with library to 8080 binary output. Lacks data initialization, long B float type and static B register class specifiers. Documentation includes "C" Programming Language book by Kernighan & Ritchie. **£60/£10**
- WHITESMITHS' C COMPILER** — The ultimate in systems software tools. Produces faster code than Pascal with more extensive facilities. Conforms to the full UNIX Version 7 C language, described by Kernighan and Ritchie, and makes available over 75 functions for performing I/O, string manipulation and storage allocation. Compiler output in A-Natural source. Supplied with A-Natural. Requires 60K CP/M. **£325/£20**
- ALGOL 60 Compiler** — Powerful block-structured language featuring economical run time dynamic allocation of memory. Very compact (24K total RAM) system implementing almost all Algol 60 report features plus many powerful extensions including string handling, direct disk address I/O etc. Requires Z80 CPU. **£110/£12**
- Z80 Development Package** — Consists of (1) disk file line editor, with global inter and intra line facilities; (2) Z80 relocating assembler, Zilog Mostek mnemonics, conditional assembly and cross reference table capabilities; (3) linking loader producing absolute Intel hex disk file for CP/M LOAD, DDT or SID facilities. **£50/£12**

- ZDT — Z80 Debugger** to trace, break and examine registers with standard Zilog/Mostek mnemonic disassembly displays. Facilities similar to DDT £20 when ordered with Z80. Development Package. **£30/£7**
- DISTEL** — Disk based disassembler to Intel 8080 or TDL/Xitan Z80 source code, listing and cross reference files. Intel or TOL Xitan pseudo ops optional. Runs on 8080. **£35/£7**
- OISLOG** — As Distel to Zilog Mostek mnemonic files. Runs on Z80 only. **£35/£7**
- TEXTWRITER III** — Text formatter to justify and paginate letters and other documents. Special features include insertion of text during execution from other disk files or console, permitting recipe documents to be created from linked fragments on other files. Has facilities for sorted index, table of contents and footnote insertion. Ideal for contracts manuals, etc. **£75/£3**
- DATEBOOK** — Program to manage time just like an office appointment book but using the speed and memory of a computer. Keeps track of three appointment schedules (three dental chairs, three attorneys, etc.) at once. Appointments consist of name, reason for the appointment, the date and time, and the length of the appointment. System can be quickly customized for the individual user. Many helpful features for making, changing, finding, and reporting appointments. Requires 48K CP/M and 180K bytes diskette storage. Not available for Apple CP/M. **£185/£15**
- POSTMASTER** — A comprehensive package for mail list maintenance that is completely menu driven. Features included keyed record extraction and label production. A form letter program is included which provides neat letters on single sheet or continuous forms. Compatible with NAD files. Requires CBASIC-2. **£85/£10**
- XASM-68** — Non-macro cross-assembler with nested conditionals and full range of pseudo operations. Assembles from standard Motorola MC6800 mnemonics to Intel hex. **£115/£15**
- XASM-65** — As XASM-68 for MOS Technology MCS-6500 series mnemonics. **£115/£15**
- XASM-48** — As XASM-68 for Intel MCS-48 and UPI-41 families. **£115/£15**
- XASM-18** — As XASM-68 for RCA 1802. **£115/£15**
- WHATSI7?** — Interactive data-base system using associative tags to retrieve information by subject. Hashing and random access used for fast response. Requires CBASIC. **£70/£15**
- XYBASIC** Interactive Process Control BASIC — Full disk BASIC features plus unique commands to handle bytes, rotate and shift, and to trist and set bits. Available in integer, Extended and ROMable versions. Integer Disk or Integer ROMable. **£165/£15**
Extended Disk or Extended ROMable. **£215/£15**
- SMAL/80** Structured Macro Assembly Language — Package of powerful general purpose text macro processor and SMAL structured language compiler. SMAL is an assembler language with IF-THEN-ELSE, LOOP-REPEAT-WHILE, DO-END, BEGIN-END constructs. **£40/£10**
- SELECTOR III-C2** — Data Base Processor to create and maintain multi Key data bases. Prints formatted, sorted reports with numerical summaries or mailing labels. Comes with sample applications including Sales Activity, Inventory, Payables, Receivables, Check Register, and Client/Patient Appointments, etc. Requires CBASIC Version 2. Supplied in source code. **£185/£12**
- IBM/CPM Utility Package** — has full range of functions to create or re-name an IBM 3741 volume, display directory information and edit the data set contents. Provides full file transfer facilities between 3741 volume data sets and CP/M files. **£125/£7**
- BASIC UTILITY DISK** Consists of (1) CRUNCH-14 Compacting utility to reduce the size and increase the speed of programs in Microsoft Basic and TRS-80 Basic. (2) DPFLN — Double precision subroutines for computing nineteen transcendental functions including square root, natural log, log base 10, sin, arc sin, hyperbolic sin, hyperbolic arc sin, etc. Furnished in source on diskette and documentation. **£30/£10**

- THE STRING BIT** — Fortran character string handling. Routines to find, fill, pack, move, separate, concatenate and compare character strings. This package completely eliminates the problems associated with character string handling in FORTRAN. Supplied with source. **£30/£10**
- BSTAM** — Utility to link one computer to another also equipped with BSTAM. Allows file transfers at full data speed (no conversion to hex), with CRC block control check for very reliable error detection and automatic retry. We use it! It's great! Full wildcard expansions to send *.COM, etc. 9600 baud with wire, 300 baud with phone connection. Both ends need one. Standard and M versions can talk to one another. **£75/£5**
- BSTMS** — Intelligent terminal program for CP/M systems. Permits communication between micros and mainframes. Sends character data files to remote computers under complete control. System can record character data sent from remote computer systems and data banks. Includes programs to EXPAND and COMPRESS binary files for transmission. This software requires a knowledge of assembler language for installation. **£115/£10**
- PLINK*** — Two pass disk-to-disk linkage editor/loader which can produce re-entrant, ROMable code. Can link programs that are larger than available memory for execution targeted on another machine. Full library capabilities. Input can be PSA Relocatable Binary Module, TDL Object Module or Microsoft REL files. Output can be a COM file, Intel hex file, TDL Object Module or PSA Relocatable file. **£75/£15**
- RECLAIM** — A utility to validate media under CP/M. Program tests a diskette or hard diskette hard disk surface for errors, reserving the imperfect, visible files, and permitting continued usage of the remainder. Essential for any hard disk. Requires CP/M version 2. **£40/£5**
- STRING/80** — Character string handling plus routines for direct CP/M BDOS calls from FORTRAN and other compatible Microsoft languages. The utility library contains routines that enable programmes to chain CP/M file, retrieve command line parameters, and search file directories with full wild card facilities. Supplied as linkable modules in Microsoft format. **£50/£12**
- STRING/80** source code available separately. **£185/n.a.**
- VSORT** — Versatile sort/merge system for fixed length records with fixed or variable length fields. VSORT can be used as a stand-alone package or load 4 and called as a subroutine from CBASIC-2. When used as a subroutine VSORT maximizes the use of buffer space by sorting the TPA on disk and restoring it on completion of sorting. Records may be up to 256 bytes long with a maximum of 5 fields. Upper/lower case translation and numeric fields supported. **£105/£15**
- CBS** — Configurable Business System is a comprehensive set of programmes for defining custom data files and application systems without using programming language such as BASIC, FORTRAN, etc. Multiple key fields for each data file are supported. Set-up program customizes system to user's CRT and printer. Provides fast interactive data entry and retrieval with transaction processing. Report generator program does complex calculations with stored and derived data. Record selection with multiple criteria, and custom formats. Sample inventory and mailing list system included. No support language required. **£185/£20**
- MAGIC WAND*** — Word processing system with simple, easy to use full screen text editor and powerful print processor. Editor has all standard editing functions including text insert and delete, global search and replace, block move and library files for boiler plate text. Print processor formatting commands include automatic margins, indentation, heading & footings, centred and justified text. Also prints with true proportional spacing, merges with data files for automatic form letters, and performs run-time conditional testing for varied output. Requires 32K CP/M and CRT terminal with addressable cursor. **£185/£20**
- T/MAKER** — Powerful new tool for preparing management reports with tabular data. Makes financial modeling projects easy. Do you want a weekly profitability report? Set up the table and compute. Just change the sales figures for next week and compute. You have a new T/MAKER includes a full screen editor for setting up tables which pages left, right, up and down. Compute includes standard arithmetic, percents, exponents, common transcendental functions, averages, maxima, minima, projections, etc. Requires 48K CP/M and CBASIC-2. **£155/£15**

Orders must specify disk type and format, e.g. North Star-Horizon single density.

Add 15% VAT to orders. Add £1 per item postage and packing

All orders must be prepaid. Make cheques POs etc payable to Lifeboat Associates.

Manual costs are deductible from subsequent software purchase

EFFECTIVE JANUARY 1981

The Software Supermarket is a trademark of Lifeboat Associates.

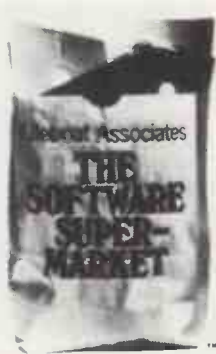

*CP M and MP M are trademarks of Digital Research
Z80 is a trademark of Zilog Inc
UNIX is a trademark of Bell Laboratories
WHATSI7? is a trademark of Computer Headware
Electric Pencil is a trademark of Michael Shrayer Software.
TRS 80 is a trademark of Tandy Corp
Pascal M is a trademark of Sorcim
Soft Card is a trademark of Microsoft
Apple is a trademark of Apple Computer
PLINK is a trademark of Phoenix Software Associates Ltd.
MAGIC WAND is a trademark of Small Business Application, Inc

Modified version available for use with CP M as implemented on Heam and TRS 80 Model 1 computers

User license agreement for this product must be signed and returned to Lifeboat Associates before shipment may be made

Lifeboat Associates P.O. Box 125 London WC2H 9LU 01-836 9028/9

• Circle No. 104

EUROPE'S LARGEST SELECTION OF MICROCOMPUTER SOFTWARE, BOOKS AND MAGAZINES
FOR THE HOBBYIST, EDUCATIONALIST, PROFESSIONAL AND RETAILER

BOOKS

BY OSBORNE

Introduction to Microcomputer Series	
Vol 0: Beginners Book	£5.95
Vol 1: BASIC Concepts	£8.25
Vol 2: Some Real Microprocessors (without binder)	£18.95
Vol 2: Some Real Microprocessors (with binder)	£20.50
Vol 2: Updating supplement set Nos. 1-6	£18.95
Vol 3: Some Real Support Devices (without binder)	£11.95
Vol 3: Some Real Support Devices (with binder)	£13.50
Vol 3: Updating supplement set Nos. 1-6	£18.95
1 Binder (Specify for Vol 2 or 3)	£5.75
1 Updating supplement (Specify for Vol 2 or 3)	£4.00
PET and the IEEE 488 (GPIB) Bus	£9.95
6800 Programming for Logic Design	£6.30
8080 Programming for Logic Design	£6.30
Z80 Programming for Logic Design	£6.30
Z80 Assembly Language Programming	£10.75
6502 Assembly Language Programming	£10.75
8080A/8085 Assembly Language Programming	£7.95
6800 Assembly Language Programming	£7.95
Accounts Payable and Accounts Receivable (C BASIC or Wang)	£13.15
Payroll with Cost Accounting (C BASIC or Wang BASIC)	£13.50
General Ledger (C BASIC or Wang BASIC)	£12.25
Some Common BASIC Programs	£8.95
Practical BASIC Programs	£9.25
Running Wild	£2.00
8085 I/O Processor Handbook	£4.00
Z8000 Assembly Language Programming	£13.50
The CRT Controller Handbook	£4.50
Apple User's Guide	£TBA
CP/M User's Guide	£TBA
The 68000 Handbook	£TBA
16 Bit Microprocessor Handbook	£TBA
6809 Assembly Language Programming	£TBA

GENERAL

See Magazines and Subscriptions!	See Osborne Books!
Microprocessors from Chips to Systems	£7.00
Microprocessor Interfacing Techniques	£9.95
IC OP-AMP Cookbook	£8.95
RTL Cookbook	£4.25
Ciarcias Circuit Cellar	£5.50
Buyers Guide to Microsoft	£2.40
Calculating with BASIC	£4.95
Computer Programs that Work (in BASIC)	£3.95
Dr Dobbs Journal Volume 1	£13.95
Dr Dobbs Journal Volume 2	£13.95
Dr Dobbs Journal Volume 3	£13.95
Best of Byte	£8.95
Scelbi BYTE Primer	£8.95
Best of Creative Computing, Vol 1	£6.95
Best of Creative Computing, Vol 2	£6.95
Program Design	£4.25
Programming Techniques: Simulation	£4.25
Numbers in Theory and Practice	£5.50
PIMS—A Database Management System	£6.50
Best of Interface Age—Software	£9.95
Programming the Z8000	£7.95
CPM Handbook	£8.95
K2 FDOS	£12.95
8086 Book	£11.25
Microsoft BASIC University Software Inc., Listings:	
Home and Economics Programs	£15.00
Education and Scientific Programs	£20.95
Small Business Programs	£29.50

FOR THE Z80

See Osborne Books!	
Z80 Instruction Handbook (Wadsworth)	£2.95
Programming the Z80 (Zacs)	£8.95
Z80 Software Gourmet Guide and Cookbook	£8.95
32 BASIC Programs for the TRS-80 (Level II) 16K	£10.10
Introduction to the T-Bug (Guide to TRS-80 Machine Language Monitor)	£4.50
30 Programs for the Sinclair ZX80	£6.95

FOR THE 6800

See Magazines and Subscriptions!	See Osborne Books!
6800 Software Gourmet Guide and Cookbook	£7.15
6800 Tracer—An aid to 6800 Program Debugging	£3.95
Tiny Assembler	£5.75
RA 6800 ML—An M6800 Relocatable Macro Assembler	£15.95
Link 68—An M6800 Linking Loader	£5.50
MONDEB—An Advanced M6800 Monitor Debugger	£3.50

CONCERNING LANGUAGE

Beginners guide to UCSD PASCAL	£7.50
SCELBAL—BASIC Language Interpreter (Source Code)	£15.00
Instant BASIC	£6.95
BASIC BASIC	£6.50
Advanced BASIC	£6.00
Users Guide to North Star BASIC	£10.00
A Practical Introduction to PASCAL	£3.95
Microsoft BASIC (a guide)	£6.50
Secret Guide to Computers	£4.00
BYTE Book of PASCAL	£16.25

FOR THE 6502

See Magazines and Subscriptions!	See Osborne Books!
Best of Micro, Vol 1	£5.50

FOR THE 6502

Best of Micro, Vol 2	£5.50
Programming the 6502 (Zacs)	£7.95
6502 Applications	£7.95
6502 Software Gourmet Guide and Cookbook	£7.25
The PET Revealed	£10.00
32 BASIC Programs for the PET	£10.10
First Book of KIM	£7.00
PET/CBM Personal Computer Guide	£10.00
Library of PET Subroutines	£10.00

FOR THE 8080

See Osborne Books!	
8080 Programmers Pocket Guide	£1.95
8080 Hex Code Card	£1.95
8080 Octal Code Card	£1.95
8080 Software Gourmet Guide and Cookbook	£7.15
8080/8085 Software Design	£6.75
8080 Standard Monitor	£9.95
8080 Standard Assembler	£9.95
8080 Standard Editor	£9.95
8080 Special Package: Monitor, Editor, Assembler	£20.00
BASEX: A Simple Language and Compiler for the 8080	£5.50

FOR FUN

BASIC Computer Games	£5.00
More BASIC Computer Games	£5.50
8080 Galaxy Game	£6.95
SUPER-WUMPUS—A Game in 6800 Assembler Code & BASIC	£4.25
Computer Music Book	£6.75
Computer Rage (a Board Game)	£6.95
Games, Tricks and Puzzles for a Hand Calculator	£2.49
Introduction to TRS-80 Graphics	£5.75
Take My Computer Please... (Fiction)	£3.25
Introduction to Low Resolution Graphics for PET, Apple TRS-80	£5.50
Starship Simulation	£4.50
Microsoft BASIC: University Software Inc., Listings:	
Fun and Games Programs 1	£9.50
Fun and Games Programs 2	£9.50
6502 Games	£7.95

FOR THE NOVICE

See Magazines and Subscriptions!	See Osborne Books!
Getting Down to Business with Your Microcomputer	£5.50
Introduction to Personal and Business Computing	£5.50
Getting Involved with Your Own Computer	£5.50
How to Profit from Your Personal Computer	£6.50
Microcomputer Potpourri	£1.95
Hobby Computers are Here	£3.95
New Hobby Computers	£3.95
Understanding Microcomputers and Small Computer Systems	£6.95
Understanding Microcomputers and Small Computer Systems and Audio Cassette	£8.75
How to Make Money with Your Microcomputer	£5.75
From the Counter to the Bottom Line	£10.00
Buying a Business Computer	£9.75
You Just Bought a Personal What?	£7.95

MAGAZINES

MAGAZINE SUBSCRIPTIONS (all processed within 3 weeks)	
Micro 6502 Journal (12 issues)	£14.50
68 Micro (12 issues)	£18.00
Personal Computing (12 issues)	£18.00
Interface Age (12 issues)	£25.50
Dr Dobbs Journal (12 issues)	£16.00
Recreational Computing (6 issues)	£11.50
BYTE (12 issues)	£33.00
Creative Computing (12 issues)	£22.00
Kilobaud Microcomputing (12 issues)	£26.00
Compute for the 6502 (12 issues)	£22.00
80' Microcomputing (12 issues)	£25.00
S-100 Microsystems (for CPM users) (6 issues)	£10.50

MAGAZINE BACK ISSUES

Micro 6502 Journal	£1.75
Personal Computing	£1.95
Interface Age	£2.95
Dr Dobbs Journal	£1.95
Computer Music Journal	£3.75
Recreational Computing	£1.95
BYTE	£3.25
Creative Computing	£1.95
Calculators and Computers	£1.95
Kilobaud Microcomputing	£3.25
Compute—for the 6502	£2.25
68' Micro	£1.95
80' Microcomputing	£2.95
On Computing	£1.95
S-100 Microsystems	£1.95
Magazine Storage Box (holds 12)	£2.00

BYTE NIBBLE REPRINTS:

a) A TMS-9900 Monitor	£3.50
b) BASIC Cross-Reference Generator	£1.25
c) A Micro Word Processor	£4.50
d) Tiny PASCAL in 8080 Assembly Language (e needed to use this)	£13.00
e) A Tiny PASCAL Compiler	£13.50
f) An APL Interpreter in PASCAL	£13.00
g) Computer Assisted Flight Planning	£2.35
h) Computerized Wine Cellar	£2.00
i) The Design of an M6800 Lisp Interpreter	£13.00

8-11 CAMBRIDGE HOUSE, CAMBRIDGE ROAD, BARKING, ESSEX IG11 8NT, ENGLAND.
Telephone: 01-591 6511. Telex: 892395

SOFTWARE Software/Manual Only

SOFTWARE Software/Manual Only

Byrom Software	BSTAM—Utility to link one microcomputer to another also using BSTAM BSTTIS—Utility to link a micro to a mini or mainframe	£70/5 £95/10
Compiler Systems	CBASIC v2.06	£65/15
Computer Plus	FMS 80 (File Management System)	£395/25
Computer Services	Bidirectional driver for Diablo Hytype printers for use on CPM & CDOS systems	£65/10
CP/M User Library	42 Volumes (one volume per disc) 8" 42 Volumes (one volume per 2 discs) 5" Index	£4/ £8/ £1/
Creative Computing	CS-9001 BASIC Games 1 CS-9002 BASIC Games 2 CS-9000 BASIC Games 1 and 2 CS-9003 ADVENTURE I.O. CS-9004 BILINGUAL Original Adventure CS-9005 BASIC Games 3 CS-9006 BASIC Games 4 CS-9007 BASIC Games 3 and 4 CS-9008 BASIC Games 1, 2, 3 and 4	£12/ £12/ £22/ £12/ £12/ £12/ £12/ £22/ £40/
Digital Research	(Most formats now available) MPM 1.1 CP/M 1.4 CP/M 2.2 CP/NET SID ZSID MAC TEX DESPOOL PL/1	£175/18 £65/18 £90/18 £130/12 £45/12 £55/12 £55/12 £45/12 £30/5 £325/25
Information Unlimited	WHATSIT (Database Management System) on North Star on CP/M on APPLE 2:48k (requires int Basic) on APPLE 2:32k (requires int Basic) on ITT 2020 (see Apple)	£59/ £75/ £72/ £59/
KLH Systems	Spooler for CPM systems	£65/5
MPI Ltd.	Diablo driver runs 110 to 9600 baud for CP/M or CDOS OMNIX—UNIX like multiuser, multitasking operating system for Z80 i.e. IMS, Cromemco NWiforth	£30/5 £495/40 £65/20
Micah Inc.	CP/M for CDOS Users: Program to Expand CP/M system to be compatible with Cromemco CDOS software	£59/5
Michael Shryer Inc.	Electric Pencil Word Processor SSII for ty etc DSII for Diablo TRS-80 Cassette/disc	£100/ £100/ £105/ £50/

Microfocus Ltd.	CIS COBOL version 4.3 FORMS 2	£425/25 £100/10
Micropro Inc.	WORD-MASTER 1.7 TEX-WRITER 2.6 WORD-STAR 2.1 MAIL-MERGE 2.1 WORD-STAR with MAIL-MERGE SUPER-SORT: Version 1 Version 2 DATASTAR 1.1	£70/20 £35/15 £240/35 £70/10 £310/45 £120/20 £100/20 £165/20
Microsoft Inc.	BASIC-80 BASIC Compiler 5.2 FORTRAN-80 COBOL-80 4.0 M/SORT EDIT-80 MACRO-80 MICROSEED MULISP MUMATH XMACRO-86 XFORTRAN-86	£175/17 £195/17 £220/17 £355/17 £70/11 £45/11 £80/11 £TBA/20 £TBA/20 £TBA/20 £185/11 £410/17
MT Microsystems	Pascal MT 5.1	£145/20
Northshare	Multi-user system for Horizon Users 5.1	£40/5
Osborne & Associates	Accounts Payable & Accounts Receivable (disc only) General Ledger (disc only) Payroll with Cost Accounting (disc only)	£50/ £50/ £50/
Phoenix Software Associates	PLINK—Disc to disc link loader PASM—Macro assembler PEDIT—Line editor with Macros BUG—Very powerful debug Package with all the above	£65/15 £65/15 £65/15 £65/15 £175/30
Structured Systems Associates	Sales Ledger Purchase Ledger Nominal Ledger Stock Control Letterlight Analyst (File management Reporting System) NAD (Name and Address selection system) OSORT	£350/15 £350/15 £350/15 £350/15 £95/10 £115/10 £50/10 £50/10
TDL Software (Technical Design Labs)	Business Basic ZTEL (Text Editing Lang.) MACRO II (Z80 Macro Assembler) LINKER DEBUG II (for 8080/Z80)	£80/ £35/ £35/ £35/ £45/
Tiny-C Associates	Tiny-C language for 8080, 8085, Z80 systems	£50/35
Supersoft Inc.	DIAGNOSTICS 1 TERM	£35/5 £65/5

• Circle No. 105

ORDER INFORMATION

Software prices reflect distribution on 8" single density discs. If a format is requested which requires additional discs a surcharge of £4 per additional disc will be added.

Please add £3.00 for postage, packing and insurance plus VAT on ALL software items (including manuals) purchased. For overseas please add £4.50 per item.

If required, DATAPOST D service is available for an extra charge of £8.50.

Most software on this Advertisement is available from stock and a 72-hour return service is thereby offered on most prepaid orders. When ordering CP/M software please specify the format you require otherwise software will be dispatched on an 8" single density disc.

For more information on any of these items, please phone, write or visit. (We are open during office hours).

All publications are published in the U.S.A. and are stocked in Britain by L.P. Enterprises: M.P.I. Ltd.

We aim to keep all of these books in stock and as a

result of this most mail orders are despatched by return of post.

MAIL ORDER TELEPHONE ORDER VISIT
Send Cash, Cheque, Credit Card No., Postal Order, IMO

All Payment must be in sterling and drawn against a UK bank.

Subscriptions are processed to start with the next current issue, after the date of order

Please add £0.75 for postage on ALL books or magazines purchased.

These details are all current as of December 1980.

Prices are subject to change without notice, due to fluctuation in the dollar rate.

Trade Enquiries welcome. Bulk Purchasers welcome.

L.P. Enterprises
Room P.C.
11 Cambridge House
Cambridge Road, Barking
Essex IG11 8NT, England
Tel: 01-591 6511
Telex: 892395

OEM
terms
available



SUPERBRAIN™

Intelligent Video Terminal Systems

350K or 700K of Disk Storage

SuperBrain's CP/M operating system boasts an overwhelming amount of available software in BASIC, FORTRAN, COBOL, and APL. Whatever your application... General Ledger, Accounts Receivable, Payroll, Inventory or Word Processing, SuperBrain is tops in its class. And the SuperBrain QD boasts the same powerful performance but also features a double-sided drive system to render more than 700K bytes of disk storage and a full 64K of RAM. All standard!



COMPUSTAR™

MULTI-USER TERMINAL SYSTEM

CompuStar user stations can be configured in a countless number of ways. A series of three intelligent-type terminals are offered. Each is a perfect cosmetic and electrical match to the system. The CompuStar 10 — a 32K programmable RAM-based terminal (expandable to 64K) is just right if your requirement is a data entry or inquiry/response application. And, if your terminal needs are more sophisticated, select either our CompuStar 20 or CompuStar 40 as user stations. Both units offer dual disk storage in addition to the desk system in the CompuStar. The Model 20 features 32K of RAM (expandable to 64K) and 350K of disk storage. The Model 40 comes equipped with 64K of RAM and over 700K of disk storage. But, most importantly, no matter what your investment in hardware, the possibility of obsolescence or incompatibility is completely eliminated since user stations can be configured in any fashion you like — whenever you want — at amazingly low cost!

DISK STORAGE

Options for the Superbrain and CompuStar Video Terminal

"Backup" for the 20 megabyte Century Data drive is provided via the dual disk system housed in the CompuStar or the SuperBrain. The Control Data CMD Drive features a removable, front-insertable top loading cartridge of 16 megabyte capacity plus a fixed disk capacity of either 16 or 80 megabytes. Each drive is shipped equipped with an EIA and standard 19" rack mounting system and heavy duty chassis slide mechanisms to permit easy accessibility for fast and efficient servicing.

**** WIDELY USED IN UK AND USA****
 *****TESTED AND PROVEN*****
 ****POWER AT YOUR FINGERTIPS****
 ****JUST COMPARE THIS LIST****

NO OTHER PROGRAM IN THE WORLD COMBINES THESE FEATURES IN ONE. MANY OTHER PROGRAMS, LESS INTEGRATED, DO NOT PROVIDE EVEN SOME OF THOSE FEATURES TO BE FOUND ON OUR 'BUS'.

- 1 = TOTAL INTEGRATION OF SALES 'PURCHASE' 'NOMINAL' 'STOCK' 'ADDRESSES ETC.
- 2 = FULL RANDOM ACCESS ENABLES RETRIEVAL OF ANY RECORD IN A SECOND.
- 3 = FLEXIBLES PROMPTS ENABLES WORD CHANGE EVEN TO FOREIGN LANGUAGE.
- 4 = FILES MAY BE NAMED AND SET TO DRIVE DEFAULT, MAXIMISING STORAGE.
- 5 = EASY TO USE, MENU DRIVEN, NO SERIOUS NEED OF MANUAL.
- 6 = TESTED AND DEBUGGED IN MANY INSTALLATIONS WORLDWIDE.
- 7 = PRICED LESS THAN THE ACQUISITION OF A LIBRARY OF PROGRAMS.
- 8 = THE PROGRAMS IS *** TOTALLY *** IN CORE, MAXIMISING DISK SPACE.
- 9 = CORE PROGRAM MEANS THAT DISKS MAY BE INTERCHANGED DURING USE.
- 10 = CORE PROGRAM MEANS YOUR MAIN DRIVE IS *** FREE *** FOR DATA.
- 11 = NUMEROUS REPORTS MAY BE GENERATED (EG: SALE LEDGERS UP TO 30).
- 12 = INVOICE PRODUCES IMMEDIATE STOCK UPDATE + DOUBLE JOURNAL ENTRY.
- 13 = REFERENCE ON INVOICES ENABLE COST CENTRE BUILD-UP ON LEDGERS.
- 14 = STOCK VALUATIONS AND RE-ORDER REPORTS EASILY GENERATED.
- 15 = BANK BALANCE AND REPORTS PLUS STANDARD MAILING FACILITIES.
- 16 = CUSTOMER STATEMENTS AND INVOICES PRINTED ON PLAIN PAPER.

*** SALES COMMENT ***

As prices vary from dealer to dealer we append for your guidance, some details of the justification in our prices being higher than the cash/carry concept of trade

A standard SuperBrain 64K * 320K Disk at 1795.00 includes the following values not normally expected at the lower price.

- 1) Equipment is burned and tested for a minimum 48 hours
 - 2) Delivery in U.K. is free of charge
 - 3) All goods & software are stocked on immediate delivery
 - 4) 6 month main unit, 12 month memory guarantee
 - 5) 24/48 hour mailing of any spare module free within warranty
 - 6) Same service as 5) outside warranty for ad hoc charge
 - 7) 10 free diskettes (28.50)
 - 8) 10% of hardware value in free software (1795.00)
 - 9) Positive before ** and ** after sales service
- If the transaction includes a printer and the business programs then the following are also added:
- 10) All cabling between printer and SuperBrain free (25.00)
 - 11) Ribbon and Thimble free (eg. Spinwriter 4.75 + 9.75)
 - 12) Extra 10 diskettes free (28.50)
 - 13) Additional free software based on 10% of printer value
 - 14) Free training session plus all necessary follow up
 - 15) Box printer paper (28.50)

A typical deal could look like this:

SuperBrain	1795.00	
NEC Spinwriter	1695.00	3490.00

Bus program 775.00 plus MBasic 150.00 (less 349.00) = 576.00 Total purchase price 4066.00 Plus V.A.T.

The total value of free items on this deal was in excess of 500 pounds in virtue of incidental items as well as extended warranty and software. Do consider your purchase on the basis of some of the things you may be likely to need after your equipment purchase, and may either fail to obtain because the dealer has no stock or has lost interest in you, or because you aimed at the short term gain in price and are then compelled to pay heavily for small needs afterwards.

*** MAIN MENU DISPLAY ***

NEW! PRODUCED IN U.K. AND WIDELY USED IN ENGLAND AND U.S.A.
COMPLETE BUSINESS PAGE

INCLUDES EVERYTHING FROM INVENTORY & DATABASE MANAGEMENT TO SALES SUMMARY.
PROMPTS USER, VALIDATES ENTRIES, MENU DRIVEN
PET AND CP/M SUPERBRAIN, TRS80 II, N'STAR, IMS5000.
APPROXIMATELY 6-100 ENTRIES/INPUTS REQUIRE 2-4 HOURS WEEKLY AND ENTIRE BUSINESS IS UNDER CONTROL
* PROGRAMS ARE INTEGRATED: : SELECT FUNCTION BY NUMBER.

- | | |
|-------------------------------------|--|
| 01 = *ENTER NAMES & ADDRESSES | 13 = *PRINT CUSTOMERS STATEMENTS |
| 02 = *ENTER/PRINT INVOICES | 14 = *PRINT SUPPLIER STATEMENTS |
| 03 = *ENTER A'C RECEIVABLES | 15 = *PRINT AGENT STATEMENTS |
| 04 = *ENTER PURCHASES | 16 = *PRINT TAX STATEMENTS |
| 05 = *ENTER A'C PAYABLES | 17 = LETTER TEXT AREA |
| 06 = *ENTER 'UPDATE INVENTORY | 18 = ALTER VOCABULARIES |
| 07 = *ENTER 'UPDATE ORDERS | 19 = PRINT YEAR AUDIT |
| 08 = *ENTER 'UPDATE BANKS | 20 = PRINT PROFIT 'LOSS A'C |
| 09 = *REPORT SALES LEDGER | 21 = OPEN AREA |
| 10 = *REPORT PURCHASE LEDGER | 22 = PRINT CASHFLOW FORECAST |
| 11 = *INCOMPLETE RECORDS | 23 = ENTER PAYROLL (NO RELEASE) |
| 12 = *USER DBMS AREA | 24 = DISK SWAP'EXIT |

ENTER WHICH ONE?

DATABASE MANAGEMENT INCLUDES

- **** FILE OR RECORD CREATE'DELETE'AMEND'SEARCH'PRINT 4 WAYS.
- **** INFORMATION RETRIEVAL ON ANY KEY RECORD OR PART THEREOF.
- **** AUTOMATIC CHECK TO PREVENT DOUBLE ENTRY TO FILE SYSTEM.
- **** DYNAMIC ALLOCATION OF INFORMATION CONSERVING DISK SPACE.

VERY FLEXIBLE. EASY TO USE

G.W. COMPUTERS LTD. UK. ARE THE PRODUCERS OF THIS BEAUTIFUL PACKAGE.
AUTHOR TONY WINTER (B.A.LIT;B.A.HON.PHIL).

- PET VER 3.00 LOW LEVEL INTEGRATION = 475.00
- PET VER 4.00 INCLUDES AUTO STOCK-UPDATE = 575.00
- PET VER 5.00 INCLUDES AUTO BANK UPDATE = 675.00.
- CPM VER 6.00 IN CORE, TRANSLATEABLE PLUS DBMS = 775.00.
- CPM VER 7.00 AUTO STOCK-UPDATE = 875.00.
- CPM VER 8.00 AUTO BANK UPDATE = 975.00.
- CPM VER 9.00 INCLUDES OPTIONS 19, 20, 22, 23. (LATER RELEASE).
- + + + EACH LEVEL AUGMENTS LOWER ONE

WE EXPORT TO ALL COUNTRIES CALLERS ONLY BY APPOINTMENT

CONTACT TONY WINTER ON 01.636.8210

89 BEDFORD COURT MANSIONS; BEDFORD AVENUE, LONDON W.C.1.

NOTE!!! LEVEL 9.00 TOTALLY IN CORE PROGRAM LEAVES MASTER DRIVE FREE (SAVING OF 200 POUNDS HARDWARE).

IMPORTANT!!! NO COMPUTER HARDWARE IS EVER OF VALUE WITHOUT SOFTWARE, SO WE PROVIDE YOU WITH A STARTING SET OF PROGRAMS **** FREE ****. AT TEN % OF HARDWARE PURCHASED. A SUPERBRAIN AND NEC SPINWRITER COULD GIVE YOU UP TO 400 POUNDS OF PROGRAMS. SEE ()

PET + PET + PET + PET + PET	SOFTWARE +	SOFTWARE	SUPERBRAIN +	SUPERBRAIN
CBM 3032 32K 595.00	BUS VER 3.00 PET 475.00	SUPERBRAIN 320K 1695.00	TWIN Z80 32K + CRT	
CBM 3040 DISKS 595.00	BUS VER 4.00 PET 575.00	+ 2 D'D-S'S DRIVE		
CBM 3022 PRINTER 425.00	BUS VER 5.00 PET 675.00	SUPERBRAIN 320K 1795.00	TWIN Z80 64K + CRT	
CBM 8032 32K 875.00	BUS VER 6.00 CP/M 775.00	+ 2 D'D-D'S DRIVE		
CBM 8050 1MEG DISKS 875.00	BUS VER 7.00 CP/M 875.00	SUPERBRAIN 800K 2195.00	TWIN Z80 64K + CRT	
CBM EPSON PRINTER 395.00	BUS VER 8.00 CP/M 975.00	+ 2 D'D-D'S DRIVE		
CBM MULTI USER 650.00	BUS VER 9.00 CP/M 1075.00	SUPERBRAIN 1600K 2795.00	TWIN Z80 64K + CRT	
CBM 3032 + EPSON +	CBM WORDPRO II 75.00	+ 2 D'D-D'S DRIVE		
CBM 3040 + BUS V3 2215.00	CBM WORDPRO III 150.00	SUPERBRAIN 1600K 2795.00	COMPUSTAR 10 1595.00	
PRINTERS + PRINTERS + PRINTERS	CPM WORD-STAR 195.00	COMPUSTAR 15 1495.00	COMPUSTAR 20 2295.00	
DIABLO 630 40 CPS 1595.00	CPM MBASIC 80 150.00	COMPUSTAR 30 2495.00	COMPUSTAR 40 2795.00	
DOLPHIN BD80 125CPS 495.00	CPM COBOL 80 320.00	INTERTUBE III 495.00	EMULATOR 495.00	
NEC 5510 PRINTER 1695.00	CPM PASCAL MT 150.00	10 MEG H'DISK 2950.00	16 MEG (8'8) 3950.00	
MICROLINE 80 120CPS 475.00	CPM FORTRAN 80 200.00	96 MEG (4DISK) 7950.00	(ADDRESS'MAILER) 95.00	
TELETYPE 43SR 30CPS 875.00	CPM DATASTAR 175.00	(STOCK CONTROL) 95.00	(DBMS DATABASE) 195.00	
DEC-LA34 TRACT 30CP 875.00	CPM BASIC-M 250.00	IEEE TO PARALLEL 55.00	IEEE'RS232 BI'DI 195.00	
NEC-5530PRINTER 1595.00	CPM BYSTAM S'BRAIN 75.00	IEEE TO RS232 75.00	S'HAND SWTP TERM 100.00	
QUME DAISY SPRINT5 1950.00	CPM SUPERSORT 120.00	WARRANTY	6 MONTH FULL REPAIR ***	
TEXAS 810 150CPS 1390.00	CPM BASIC COMPILER 190.00			
SPECIALS + SPECIALS + SPECIALS	CPM DESPOOL 30.00			
N'STAR QUAD ,7 MEG 1500.00	CPM BYSTAM IMS'N-STAR 75.00			
IMS 5000 48K d'D 1200.00	CPM TEXTWRITER 75.00			
COMPUTHINK * 800K * 795.00	CPM POSTMASTER 75.00			
2 WAY CRDLESS PHONE 135.00	CPM SELECTOR 3 180.00			
TELEPHONE ANSWER 230.00	CPM CBASIC 75.00			
SHUGART SA400 5'' DR 135.00	CPM MACRO 80 75.00			
	CPM W'STAR M'MERGE 245.00			
	BUS MANUAL ***** 9.00			

+ + + + + SPECIAL INSTITUTION AND UNIVERSITY DISCOUNTS + + + + +
MOST ITEMS IN STOCK. (ACCESS/AMEXCO/BCLYCARD OTHERWISE CHEQUE WITH ORDER)

CONTACT TONY WINTER 01.636.8210 / 01.631.4818
55 BEDFORD COURT MANSIONS, BEDFORD AVE W.C.1.

COMMERCIAL OPERATING SYSTEM FOR MICROS

The Interface Computer Services Commercial Operating System will enhance the capabilities of any Z80 or Z80A based microcomputer with a minimum of 32K running under CP/M* or MP/M*

Cobol Compiler

At the heart of the system is our own COBOL compiler. Designed to ANSI Level 1 specifications, with some extensions, it provides massive savings in disk and memory space requirements compared to interpretive systems.

Improved Screen Handling

The extended I/O routines provide greatly enhanced operator cursor control. COBOL DISPLAY and ACCEPT verbs have been modified to provide excellent screen-handling facilities and there is software control over the type, format and length of data accepted from the keyboard.

Optimised Disk I/O

Logical records are packed into physical sectors and may extend across sectors, even in direct access files. Disk I/O is also very fast.

Improved Printer Handling

Where a parallel printer port is used, the extended I/O routines recognise printer status signals and give operator messages on the screen. With a serial port, the system prompts the operator to prepare the printer when printing is about to commence.

On-Line Debugging Tool

A powerful interactive debugging tool provides trace, checkpoint, field monitoring and field change facilities.

Job Executive

Job control is user-written in COBOL so it has all the flexibility that COBOL provides. Subroutines are

provided to schedule single or multiple programs, to abort and restart jobs, to control mounting and dismounting of disks and to assign logical I/O units to physical units. Disk volumes are numbered and volume numbers can be checked by the system. Automatic disk backup, backup disk cycling and print spooling may be optionally configured and automatic job start-up is provided for end-user systems.

Print Spooling

Print spooling may be automatically implemented and provides the advantage of controlled printing independent of applications programs. Facilities are provided for restart, automatic production of multiple copies and special stationery alignment.

Cost

The cost of a full development system is £450. Additional systems for machines of the same type within the same company cost £250.

The system is also supplied in an end-user version (without COBOL compiler and debugging tool) for £200 (CP/M) or £400 (MP/M).

Applications and Utilities

A file dump utility (£30) and a sort utility (£50) are available. Application packages include Word Processing (£200), mailing (£200), generalised data management (£200), Stock Recording (£350), Invoicing (£250) and Sales, Purchase and Nominal Ledgers' (£350 each).

Availability

The Commercial Operating System and its associated utilities and applications are available directly from Interface Computer Services or from the following dealers:

- Computer Sales and Software Centre. 01-554 3344. Contact K. Neal
- Cullville. 024541 3919. Contact M. Knight
- Metrotech. 0895 58111 extensions 247 and 269
- Orchard Microbyte. 0268 741271. Contact M. Dean

Manuals are available at £15 each.

When ordering software please state make and model of micro, VDU and printer. Please add V.A.T. to all orders except for manuals.

FIRST FLOOR,
17 GUTHAVON STREET,
WITHAM,
ESSEX. CM8 1BJ
TELEPHONE: WITHAM (0376) 518112

*MP/M and CP/M are trademarks of Digital Research

**INTERFACE
COMPUTER
SERVICES
LIMITED**

Calisto Computers Ltd.

SPECIALISTS IN MICROCOMPUTERS AND SOFTWARE
119 JOHN BRIGHT STREET, BIRMINGHAM B1 1BE
Telephone: 021-632 6458

Our complete package offers you:

- Free initial discussion and advice
- Software Packages
- Supply and Installation
- Leasing and Financing Terms
- Maintenance Contracts
- Full After Sales Service

Apple

We offer a full range of equipment from the "Home/Hobbyist" type to the professional Business System. Ask about our "Starter packs". Prices from £700.00-£5000.00.

Sharp

We offer the full range of Sharp products from the PC-1211 Pocket Computer to the 48k MZ-80K with Disk Drives and Printers, we will also be stocking shortly the New Sharp PC-3200 computer system. Prices from £100-£3500.00.

Delta Systems

A range of Z80 based Micro-computers starting at 64k with 1Meg of 8" Floppy Disk Store, expanding to 512k with 34 Meg of Hard Disk Store and Tape Back-up. Prices from £2500-10500.00.

Approved Business Dealers for:

- Apple II Plus Delta Systems
- Sharp MZ80K Onyx Systems

As fully authorised Dealers for all the above equipment and as experienced computer professionals, we are the best people to assist you in choosing your computer system.

Onyx Systems

The C8000 series are a range of powerful small business computers from Onyx Systems. This state-of-the-art computer system combines high speed processors, memory, Winchester disk and cartridge tape drive in one efficient, compact package.

Industry-compatible versions of BASIC, COBOL, PASCAL and FORTRAN are available on several operating systems (eg. CP/M), along with communications software, wordprocessing and business application packages.

The C8000 series offers more features, better performance, higher quality and greater reliability than any other unit for the price. Prices from £6500-£15000.00.

We also supply a full range of printers both dot matrix and daisywheel, connection cables and also media (diskettes and disks), stationery (listing paper), ribbons etc. etc.

Contact us for all your requirements, write or telephone for full details and price lists.

THIS MONTH'S SPECIAL OFFER TELE VIDEO 912C TERMINAL

ANY QUANTITY **£485.00** + VAT

SOLE UK DISTRIBUTORS!!

**Instant Software
NOW AVAILABLE
IN UK!!**

DEALER ENQUIRIES
INVITED

TRS 80 LEVEL II

GAMES - Cassette

- Air Mail Pilot £8.50
- Ball Turret Gunner £8.50
- Battleground £8.50
- Cosmic Patrol £12.50
- Dare Devil £8.50
- Dynamic Device £16.50
- Drivers £16.50
- Flight Path £8.50
- Invaders £8.50
- Investors Paradise £8.50
- Jet Fighter Pilot £12.50
- 1 Night Flight £8.50
- Othello £8.50
- Romrom Patrol/ Tie Fighter £8.50
- Klingon Capture £6.50
- Space Trek IV £6.50
- Skirmish 80 £8.50
- Winners Delight £8.50
- Your Cribbage and Checkers Partner £8.50

- Kid Ventures £12.50
- Galactic Empire £12.50
- Ghost Train £12.50
- Mission Impossible £12.50
- Mystery Fun House £12.50
- Pirates Adventure £12.50
- Pyramid of Doom £12.50
- Slag £12.50
- Star Trek 3.5 £12.50
- Strange Odyssey £12.50
- The Count £12.50
- Voodoo Castle £12.50

- TRS 80 Utility £8.50
- TLDIS 16K, 32K, 48K £12.50
- The Disassembler 16K, 32K, 48K £8.50

Home (Personnel) Use

- Body Buddy £8.50
- Energy Audit £40.50
- Personal Bill Paying £6.50

Business

- Executive Expense Report Generator £8.50
- Oracle 80 £61.50
- Sales Analysis £20.50
- Terminal 80 £20.50
- The Wordslinger £24.50

Misc.

- Demo II £6.50
- Demo II £6.50
- TRS 80 Tests £8.50
- IRV £20.50

TRS 80 Disks

- Utilities Disk Editor £32.50
- Disk Scope £16.50

Education

- IQ Test £8.50
- Teacher £8.50
- Vocabulary Builder £8.50

Video Speed-Reading

- Trainer £8.50
- Word Watch £6.50

Utilities

- BP A Basic Programming £12.50
- TRS 80 Utility £8.50

SCOT ADAMS

ADVENTURE

INTERNATIONAL

- Adventure Land £12.50

TRS 80 Disks

Utilities

- Disk Editor £32.50
- Disk Scope £16.50
- DLDIS £16.50
- IRV £24.50
- Oracle 80 £81.50

Games

Scot Adams Adventure International

- Adventureland/ Pirate's Adventure/ Mission Impossible Adventure (3 pack) £32.50
- Galactic Empire Galactic Trilogy £32.50
- Local Call for Death £16.50
- Mystery Fun House/ Pyramid of Doom/ Ghost Town (3 pack) £32.50
- Six Micro Stories £12.50
- Star Trek 3.5 £16.50
- Two Heads of the Coin £16.50
- Voodoo Castle/ The Count/ Strange Odyssey £32.50

Business Galactic Software Ltd

- Mail list (Model 1 version) £81.50
- Mail list (Model 2 version) £162.50

TRS 80 Level I & II

Education

- Grade Book £8.50
- Ham Package 1 £6.50
- Electronics 1 £6.50
- Typing Teacher £8.50

Games

- Air Flight Simulation £8.50
- Chessmate BC £16.50
- Oil Tycoon £6.50
- Space Trek II £6.50
- Santa Poravia/ Fiumaccio £6.50

Scot Adams Adventure International

- Adventure/Pirates Adventure/ Mission Impossible Adventure (3 pack) £32.50
- Asteroid £16.50
- Mystery Fun House/ Pyramid of Doom/ Ghost Town (3 pack) £32.50
- Voodoo Castle/ The Count/ Strange Odyssey (3 pack) £32.50

Apple Disks Games

- Air Flight Simulation £16.50

Education

- Math Fun £16.50
- Math Tutor I £6.50
- Math Tutor II £6.50

Home (Personal) Use

- Solar (Energy) Home £32.50

Business

- Accountants Assistant £6.50
- Finance and Investment £16.50

PET Education

- Ham Package 1 £6.50
- Electrical Engineer's Assistant £8.50

Utility

- Pet Utility 1 £8.50

Games

- Trek X £6.50
- Dungeon of Death £6.50
- Santa Poravia and Fiumaccio £8.50

Instant Software Support System

Instant Software offers a special support and reporting system to enable the users of our software to get the very best support and advice on how to gain the maximum benefit from our products. Enquiries will be actioned promptly to provide a first class service.

*TRS-80 Trademark of Tandy Corp. CP/ M Trademark of Digital Res.

CBasic Trademark of Compiler Systems. Apple Trademark of Apple Inc.

E&OE

Please use this page as an order form: Tick program required

Name

Address

.....

.....

Tel:

Cheque/PO No.

All prices include VAT @ 15% packing & return postage to U.K. addresses.

Send 50p. for descriptive Catalogue.

PC4/81

• Circle No. 108

Amazing Value – compatible with TRS-80 16K level II

VIDEO GENIE (Mk1A model)



Fully Supported Hardware

Microdigital are the hardware experts – here's why you should buy your Genie from us.
 ★ Low Price of £280 + VAT. ★ Each computer tested by our engineers before despatch. ★ 12 month parts and labour guarantee. ★ Free delivery within mainland U.K. ★ Bona fide official orders welcome. ★ Latest version of Genie.

The Video Genie is a complete computer system, requiring only connection to a domestic 625 line TV set to be fully operational, or if required a video monitor can be connected to provide the best quality display.

The system case contains the Central Processor Unit (CPU), 16,000 bytes RAM memory, the cassette system, a 12,000 byte operating system and BASIC interpreter in ROM, and a full size keyboard, in a stylish case, at a price that makes the Video Genie better value than some "kit" computers.

Applications

The Video Genie System has many uses in all spheres of life, the easy-to-use BASIC language means that programs are easily written for specific applications, and pre-recorded program tapes are available in great variety.

The system has great scope in the home, sophisticated games programs can introduce the computer age to all the family, who can then progress to writing their own programs in BASIC or even machine code. Software is continuously being developed to aid home budgeting and education.

In a school or college the machine can be used with a large screen TV to allow a whole class to be taught at once.

The powerful Extended BASIC interpreter makes the solution of complex scientific problems simple, and the graphics allow pictorial displays of results.

Prices	Nett	Var	Total
Video Genie Computer	280.00	42.00	322.00
EG3013 Expander with RS232	215.00	32.25	247.25
EG3013 Expander without RS232	185.00	27.75	212.75
32K Memory Board S100	130.00	19.50	149.50
16K Memory Board S100	95.00	14.25	109.25
Dual Disk Drive (40 track)	410.00	61.50	471.50
2 Drive Cable	17.00	2.55	19.55
4 Drive Cable	32.00	4.80	36.80
Printer Cable	17.00	2.55	19.55
Centronics Parallel Interface for unexpanded Genie	33.00	4.95	37.95
Sound kit	10.00	1.50	11.50
fitting above	5.00	75	5.75
Lower case kit	35.00	5.25	40.25
fitting above	5.00	75	5.75

Fully Supported Software



- ✓ Business ✓ Programming Aids
- ✓ Personal ✓ Custom
- ✓ Games ✓ Utilities

7 Years Microprocessor Experience!

Send large SAE (44p) for our current Catalogue of TRS-80/Video Genie software.

A. J. HARDING (MOLIMERX)
 28 COLLINGTON AVE,
 BEXHILL, E. SUSSEX.
 Tel: (0424) 220391



24 Hr Telephone Credit
 Card Orders 051-236 0707



Mail Orders to:
 MICRODIGITAL LIMITED
 FREEPOST (No Stamp required)
 LIVERPOOL L2 2AB



Retail Premises at:
 25 BRUNSWICK STREET
 LIVERPOOL L2 0PJ
 Tel: 051-227 2535/6/7

MICRODIGITAL

MOLIMERX LTD

• Circle No. 109

THE



AMATEURS

THE PROFESSIONALS



Did You Know PETS have been carrying gently for 6 years now?
Did you know PETS offer insurance of £150,000 per vehicle FREE?
Did you know PETS have vehicle capacities from 35cwt to 32 Tons AIR RIDE?
Did you know their damage rate was the lowest bar NONE?
INTERESTED?

then pick up the telephone, and ask for Reg Holdaway.

**YOU KNOW
IT MAKES
SENSE!**

PETS
carry gently

Precision Equipment Transport Services
Hermitage Road, St. Johns, Woking, Surrey GU21 1TZ.
Telephone Brookwood (04867) 6977 Telex 859181 Precis G

• Circle No. 110

PRESTEL.

THE BIGGEST BREAKTHROUGH IN COMMUNICATION SINCE THE TELEPHONE AND TELEVISION.

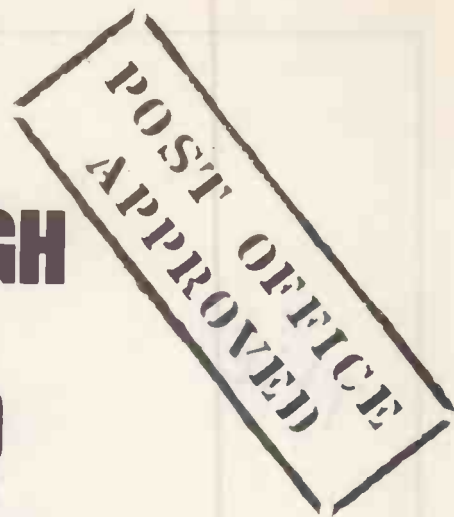

- 180,000 Pages of information instantly available
- Ask Prestel a question and up pops the answer in seconds in full colour on your own T.V. screen

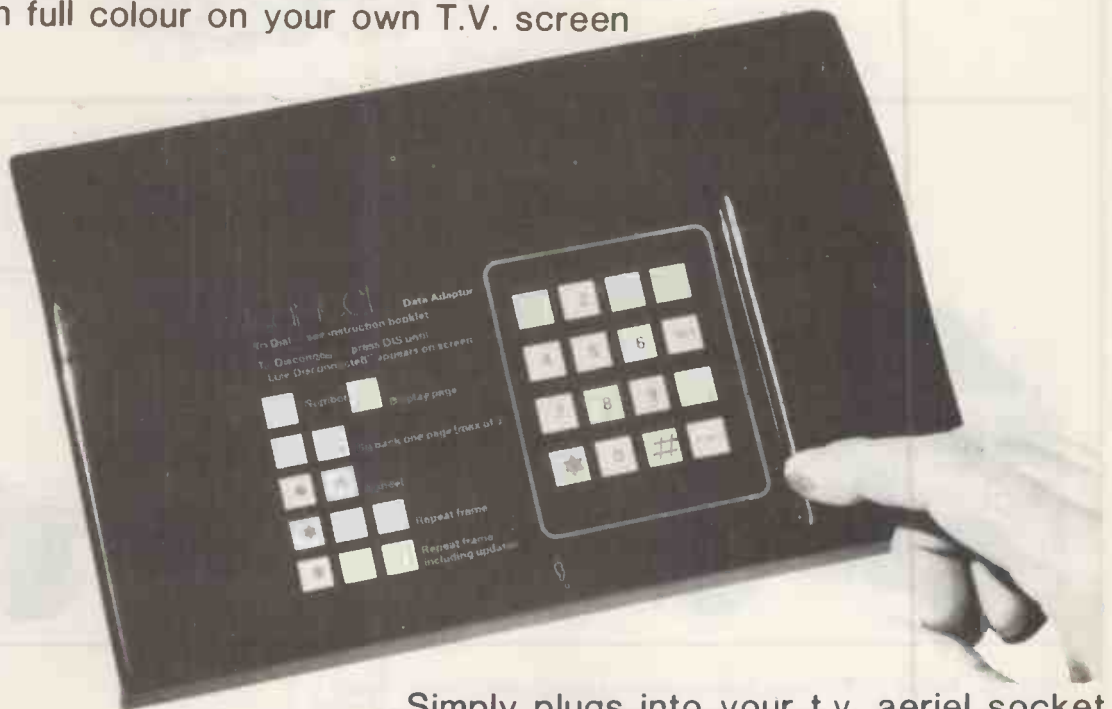

EXPENSIVE?

NOT ANY LONGER WITH

anet

BY TANGERINE

Only £170 + VAT

Simply plugs into your t.v. aerial socket

Tantel requires a jack socket on your telephone line (available from the Post Office)

PC4/81

PLEASE SEND METANTEL ADAPTORS
I ENCLOSE CHEQUE / P.O. TO THE VALUE OF
OR DEBIT MY ACCESS/BARCLAYCARD No.

NAME

ADDRESS

.....

PAYABLE TO TANGERINE COMPUTER SYSTEMS LIMITED

FOR FURTHER INFORMATION PLEASE SEND A 12p STAMP TO :-
TANDATA MARKETING
FOREHILL WORKS
ELY CAMBS CB7 4AE

• Circle No. 111

The Sinclair ZX80 is innovative and powerful. Now there's a magazine to help you get the most out of it.

Get in sync



SYNC magazine is different from other personal computing magazines. Not just different because it is about a unique computer, the Sinclair ZX80 (and kit version, the MicroAce). But different because of the creative and innovative philosophy of the editors.

A Fascinating Computer

The ZX80 doesn't have memory mapped video. Thus the screen goes blank when a key is pressed. To some reviewers this is a disadvantage. To our editors this is a challenge. One suggested that games could be written to take advantage of the screen blanking. For example, how about a game where characters and graphic symbols move around the screen while it is blanked? The object would be to crack the secret code governing the movements. Voila! A new game like Mastermind or Black Box uniquely for the ZX80.

We made some interesting discoveries soon after setting up the machine. For instance, the CHR\$ function is not limited to a value between 0 and 255, but cycles repeatedly through the code. CHR\$(9) and CHR\$(265) will produce identical values. In other words, CHR\$ operates in a MOD 256 fashion. We found that the "=" sign can be used several times on a single line, allowing the logical evaluation of variables. In the Sinclair, LET X=Y=Z=W is a valid expression.

Or consider the TL\$ function which strips a string of its initial character. At first, we wondered what practical value it had. Then someone suggested it would be perfect for removing the dollar sign from numerical inputs.

Breakthroughs? Hardly. But indicative of the hints and kinks you'll find in every issue of SYNC. We intend to take the Sinclair to its limits and then push beyond, finding new tricks and tips, new applications, new ways to do what couldn't be done before. SYNC functions

on many levels, with tutorials for the beginner and concepts that will keep the pros coming back for more. We'll show you how to duplicate commands available in other Basics. And, perhaps, how to do things that can't be done on other machines.

Many computer applications require that data be sorted. But did you realize there are over ten fundamentally different sorting algorithms? Many people settle for a simple bubble sort perhaps because it's described in so many programming manuals or because they've seen it in another program. However, sort routines such as heapsort or Shell-Metzner are over 100 times as fast as a bubble sort and may actually use less memory. Sure, 1K of memory isn't a lot to work with, but it can be stretched much further by using innovative, clever coding. You'll find this type of help in SYNC.

Lots of Games and Applications

Applications and software are the meat of SYNC. We recognize that along with useful, pragmatic applications, like financial analysis and graphing, you'll want games that are fun and challenging. In the charter issue of SYNC you'll find several games. Acey Ducey is a card game in which the dealer (the computer) deals two cards face up. You then have an option to bet depending upon whether you feel the next card dealt will have a value between the first two.

In Hurdle, another game in the charter issue, you have to find a happy little Hurdle who is hiding on a 10 X 10 grid. In response to your guesses, the Hurdle sends out a clue telling you in which direction to look next.

One of the most ancient forms of arithmetical puzzle is called a "boomerang." The oldest recorded example is that set down by Nicomachus in his *Arithmetica* around 100 A.D. You'll find a computer version of this puzzle in SYNC.

Hard-Hitting, Objective Evaluations

By selecting the ZX80 or MicroAce as your personal computer you've shown that you are an astute buyer looking for good performance, an innovative design and economical price. However, selecting software will not be easy. That's where SYNC comes in. SYNC evaluates software packages and other peripherals and doesn't just publish manufacturer descriptions. We put each package through its paces and give you an in-depth, objective report of its strengths and weaknesses.

SYNC is a Creative Computing publication. Creative Computing is the number 1 magazine of software and applications with nearly 100,000 circulation. The two most popular computer games books in the world, *Basic Computer Games* and *More Basic Computer Games* (combined sales over 500,000) are published by Creative Computing. Creative Computing Software manufactures over 150 software packages for six different personal computers.

Creative Computing, founded in 1974 by David Ahl, is a well-established firm committed to the future of personal computing. We expect the Sinclair ZX80 to be a highly successful computer and correspondingly, SYNC to be a respected and successful magazine.

Order SYNC Today

Right now we need all the help we can get. First of all, we'd like you to subscribe to SYNC. Subscriptions are posted by air directly from America and cost just £10 for one year (6 issues), £18 for two years (12 issues) or, if you really want to beat inflation, £25 for three years (18 issues) SYNC is available only by subscription; it is not on newsstands. We guarantee your satisfaction or we will refund the unfulfilled portion of your subscription.

Needless to say, we can't fill up all the pages without your help. So send in your programs, articles, hints and tips. Remember, illustrations and screen photos make a piece much more interesting. Send in your reviews of peripherals and software too—but be warned: reviews must be in-depth and objective. We want you to respect what you read on the pages of SYNC so be honest and forthright in the material you send us. Of course we pay for contributions—just don't expect to retire on it.

The exploration has begun. Join us.

The magazine for Sinclair ZX80 users

SYNC

27 Andrew Close
Stoke Golding

Nuneaton CV13 6EL, England

• Circle No. 112

LONDON COMPUTER CENTRE

New! – Improved! RP-1600 NEW LOW PRICE £1095
Additional Facilities – + Built in proportional spacing

60 CHARACTERS PER SECOND
 THE FASTEST DAISY WHEEL
 PRINTER.

FAST, heavy duty commercial DAISY
 WHEEL printer, with high quality
 printout, coupled with low noise
 necessary for office environment. 124
 char: upper/lower case. * 10/12 chars:
 per inch giving 126 or 163 columns.
 * 15 inch wide friction platen. *
 BOLDING, underline, and host of other
 features. * Centronics type parallel
 interface as standard options: serial
 interface £60 * PET interface £65 *
 APPLE interface £75.

Made by Ricoh in Japan
 DEALER ENQUIRIES INVITED

+ Look-ahead logic + On-off switch
 NEW LOW PRICE £1095



- ← TRS 80 Model I & II
- ← SUPERBRAIN
- ← APPLE
- ← PET
- ← HORIZON Etc

TRACTOR FEED O/E £175
 SHEET FEEDER OPTIONAL EXTRA £550

**NEW MAXI ANADEX WITH
 GRAPHICS £895**

Takes up
 to 13.6 inch wide
 paper * Upper/lower case with
 descenders * £ sign * 132 or
 175 chrs/line with double width
 printing * Fast 150 CPS bi-
 directional logic seeking printing
 * Heavy duty print head giving
 650 million chrs print life *
 serial, Parallel and Current Loop
 Interfaces built in * Host of other
 features found on printers costing
 twice as much.

Also Available
 DP8000 £425 (Not Illus)
 DP 9501 £995 (Same as 9500 Illus)



Epsom MX 80 F/T £425
 the PRINTER with FRICTION and
 ADJUSTABLE, REMOVABLE,
 TRACTOR FEED



ULTRA QUIET, HIGH quality
 PRINT, LOWER CASE
 DESCENDERS & DIRECTIONAL
 LOGIC SEEKING PRINT HEAD
 80, 66, 132 Columns per line
 UNIQUE BOLD FACE & DOUBLE
 STRIKE (BUILT IN FEATURE)
 64 Graphic Characters (TRS 80 &
 Prestel), 9 x 9 PRINT MATRIX,
 £ Sign Forms Handling, Top of
 Form, Horizontal and Vertical Tabs,
 Centronics parallel interface
 standard. Optional extra serial PET
 & APPLE interfaces Easily
 replaceable head.
 DEALER ENQUIRIES INVITED.

737 £425



80 CPS + double spacing and
 mono spacing 10 and 16.7 CPI *
 nx9 proportional spacing, 3 way
 paper handling * 96 character set
 * Expanded print * Right margin
 justification * Underlining *
 Bidirectional * £ sign
 centronics parallel and serial
 interfaces standard * optional
 extras: PET & Apple Interfaces.

**OKI MICROLINE 80/132, THE QUIET
 PRINTER YOU CAN LIVE WITH**



NOW
 WITH £ SIGN
 The quietest Dot Matrix available. 40, 80
 or 132 cols per line * excellent print
 quality * 3 way paper handling: letterheads,
 fanfold, or paper rolls * graphics * Ideal
 for software written for large 132 col
 printers * continuous rating printing day in
 and day out * centronics parallel standard.
 Options: RS-232, PET, Apple.
 Dealer enquiries invited.

NEW LOW PRICE £350



**TRS-80
 MODEL II**

State the art second generation computer. Over
 10,000 already sold in USA; 8 slot bus ensures
 expansion of hard discs & other peripherals., 76
 Key professional keyboard, self test on power up,
 TRSDOS & Level III basic standard. CP/M available
 as option, making a wide range of accounting,
 educational, scientific & word processing packages
 instantly usable.
 Nationwide service through 180 Tandy stores &
 computer centres.

NOW WITH CP/M 2.24 £1999

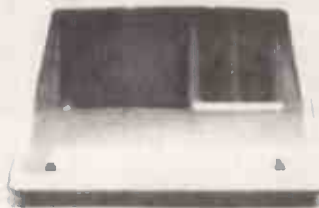

**NEW SUPER BRAIN
 DUAL DENSITY £1595
 QUAD DENSITY £1995**

Now with CP/M 2.2 & increased disc storage,
 Twin Z80-A 4MHZ * 2 disc drives, dual density
 320 K quad density 700 K storage * 64K ram *
 High resolution 12 inch CRT, 80 x 24 lines upper/
 lower case * 2 RS-232 printer ports * CPM 2.2
 operating system * M basic, Cobol, Fortran,
 Pascal, Word processing & accounts packages
 available.
 Dealer enquiries invited.

**NEW TRS-80 MODEL 1 48K
 SYSTEM WITH DUAL DISC
 DRIVES**



NEW LOW PRICE £1175
 WITH DESK AND EPSON
 PRINTER £1475

New greenscreen VDU, with rock steady display.
 Redesigned 32K expansion interface with trouble
 free disc operation, two 40 track teac disc drives,
 complete with cables.
 Tridata sales, purchase, invoicing, payroll packages
 available.

CPM SOFTWARE

Word Star	250.00
Word star mail merge	315.00
Magic Wand	250.00
Data Star	195.00
T/Maker	175.00
Report Writer (VisiCalc)	90.00
Accounts Packages	from 295.00
Accounts Packages	from 295.00
Payroll	from 295.00

Various other packages available — ask for details.

SOFTWARE FOR TRS-80

Electric Pencil (disc)	60.00
Electric Pencil (cassette)	35.00
Scriptis (disc)	75.00

Scriptis (cassette)	60.00
Mail Merge for Pencil/Scriptis	45.00
VAT Aid Programme	45.00

MISCELLANEOUS

Floppy discs (Box of 10) including library case.	
Scel Silver 5" single sided double density For Pet,	
Apple, TRS-80 & Superbrain	
Xcel Gold 5" double sided double density	25.00
	30.00
For Superbrain	30.00
Memorex 8" Single Sided double density	35.00
Qume Daisy Wheels	5.00
Richo RP 1600 *	15.00
Paper, Ribbons, etc.	POA

LOW COST WORD PROCESSOR I

Based on TRS-80 level 2 16K cassette recorder,
 electric pencil software, upper/lower case mod,
 printer interface and OKI Dot Matrix printer.
 Complete ready to go £895 free mailing list program.
WORD PROCESSOR II
 Same as above but with 48K, 2 disc drives
 and richo daisy wheel printer £2275
WORD PROCESSOR III
 Based on Superbrain Computer shown above.
 With Ricoh printer & "Magic Wand" the ultimate
 in word processing. Letters automatically formatted
 with addresses fetched from separate file.
 Complete system £2950. Invoicing, stock control,
 sales ledger, purchase ledger, payroll available for
 above computers from £250 per package.

43 GRAFTON WAY, (OPPOSITE MAPLES), LONDON W1
 TEL: 01-388 6991/ 2 OPENING HRS: 11-7 MON-FRI, 12-4 SATS, 24 HOUR ANSAPHONE 01-388 5721

• Circle No. 113

THE EAST MIDLANDS SUPERBRAIN CENTRE

**£1450
+ VAT FOR
SUPERBRAIN
'SD'
(320k bytes)**



**£1800
+ VAT FOR
SUPERBRAIN
'QD'
(700k bytes)**

THE 'TERMINAL' WITH A DIFFERENCE

A CP/M COMPUTER IDEAL FOR REMOTE DATA PROCESSING

CONNECTION TO DEC COMPUTERS WITH SPECIAL COMMS SOFTWARE NOW AVAILABLE

EX STOCK

- DUAL 4 MHZ Z80 CPU_s
- 64K RAM ● 12" CRT
- DUAL DD/DS FLOPPY DISKS
- 25 LINES X 80 COLS SCREEN SIZE

- FULL ASCII KEYBOARD
- S 100 BUS CAPABILITY
- DUAL SYNCHRONOUS/ASYNCRS232 PORTS
- TABLE TOP

MOST CPM LANGUAGES, UTILITIES, AND APPLICATION PACKAGES AVAILABLE including "SUPERACCOUNTS" with WAGES/SALARIES

"SUPER WORD"

a computer system to produce LETTERS & DOCUMENTS

BENEFITS

- Repetitive work becomes less monotonous.
- Mail shots, newsletters, documents, personalised letters, price lists, etc. can be produced and updated in a fraction of the time.
- Clear, accurate text every time.
- Staff have more time available for important duties.
- Alterations can be made to the text without complete re-typing.
- The unit is compact and convenient to use.
- Permanent storage of documents for future use.
- Greatly increases the efficiency in your office.

YOUR SYSTEM INCLUDES: A MICRO COMPUTER, WORD PROCESSING SOFTWARE & A LETTER QUALITY PRINTER

**TOTAL PRICE
£3,350**

Additional Packages

'DATASTAR'

File creation
File retrieval
& File updates

£195.00

'MAIL MERGE'

For merging names & addresses with letters. Personalised letters are produced without individually typing each one.

£75.00

Support Facilities available



**Office Computer
Techniques Ltd.**

Call or write for further details.
Kimberley House, Vaughan Way,
Leicester LE1 4SG.
Telephone Leicester (0533) 28631

• Circle No. 114

 **commodore**

**INDUSTRIAL
MICRO
SYSTEMS**



Qume

NorthStar 

 **apple** II

 **Anadex Ltd.**



MICRO FACILITIES

APPROVED

for
Commodore
Apple II
North Star Horizon
Industrial Micro Systems 5000
& 8000

APPROVED

by
Local Government
Central Government
National Laboratories
Maritime Research
Universities
Schools

APPROVED

by
Accountants
Importers/Exporters
Retailers
Manufacturers,
Printers
Surveyors

WE WILL GET YOUR APPROVAL

Why? Because Micro-Facilities know that whether you are a large establishment or a small business you are going to need **help** and good **service**. We believe, and our hundreds of satisfied customers seem to agree, that the service we give is second to none.

Our service starts right from your initial contact. We will meet with you to discuss your requirements and your **business**, without blinding you with computer jargon. We will arrange for you to have a demonstration of one or more computers from our range together with programs to suit your particular needs. If a ready-made program is not suitable then we can analyse, design and program your particular procedures (we have nearly twenty years experience of doing this).

As a further service we are able to arrange both **leasing** and **financing** of your computer equipment.

Our service does not stop when you have purchased your system; to ensure the smooth transfer of your work we **train** you and your staff to use the computer and its programs in your own environment. As additional security we offer full **maintenance contracts**. Above all we will be available to give you genuine **after sales service**. Not for just one week or one month but everytime it is wanted.

Please contact us to discuss your problems and requirements, we offer you a lot more, but only charge the same. Our ability will give you peace of mind and confidence that the job will be done properly.

Central Computer & Telecommunications Agency Approved
Tenders from Local Authorities, Education and Government
Departments welcomed.

Micro-Facilities Ltd. 129 High Street,
Hampton Hill, Middlesex TW12 1NJ

01-941 1197 and 01-979 4546

MICRO FACILITIES

• Circle No. 115



BUSINESS
MACHINES

Floppy Disk Drives REPAIRED

Fast Competitive
Repair Service on
Most Floppy Disc Drives

For further information

Phone — ROY HOLDEN

SUNBURY-ON-THAMES 80679

14 SUNBURY CROSS CENTRE
SUNBURY-ON-THAMES
MIDDLESEX TW16 7AZ

• Circle No. 116

SYSTEMICS LIMITED

3 Hillberry Court, School Lane,
Bushey, Hertfordshire WD2 1BS
(01) 422 3276 (24 hours)



HI-RES PROBLEM SOLVER £45

an all purpose hi-res processor, includes upper/
lower case, mixed graphics and text, two way
window scrolling, user shape definition with
rotation, enlargement, slanting, stretching,
reflection, inversion and many other hi-res
functions.

Literature search £25

a suite of four programs forming a complete magazine article
filing system allowing retrieval of references to items by keyword(s)
within category.

Many other quality packages include

Stock control £125
Linear programming £85
Time analysis £125
Mailing list £100

DEALER ENQUIRIES INVITED

• Circle No. 117

What...
throw away
my calculator,
pencil,
paper,
dictionary,
& reference
manual?

Yes!

Turn the page for the answer from
Almarc
DATA SYSTEMS

• Circle No. 118

NEW



The Professional

PSU

Photograph + Based on the "TUROIDAL TRANSFORMER"

Six new computer power supplies at a SPECIAL INTRODUCTORY PRICE TO END OF APRIL ONLY

Don't delay — post today — limited stock

- Type A. 8V @ 8A, +15V @ 1 Amp, -8V @ 1A, Unregulated £29.00
- Type B. +16V @ 3 Amp, -16V @ 3 Amp, Unregulated £26.95
- Type C. +8V @ 10 Amp, Unregulated £27.25
- Type A/R. as Type A, but Regulated to +5V, +12V, -5V £39.90
- Type B/R. as Type B, but regulated to +12V and -12V £38.50
- Type C/R. as Type C, but regulated to 5V @ 10 Amp £34.23

Add 15% VAT and £1.50 Post and Packing
Allow 21 days for delivery Parcel Post

All regulated supplies have current limiting and over volts protection.

Professionally made by established company.
Other types available — send sae with enquiries for quote.

TO: — IMAC LTD., Unit 3 Dodnor Industrial Estate,
Newport, I.O.W.
Please send me PSU, Type I enclose my cheque/P.O. for £ which includes £1.50 post and packing and 15% VAT.
Please debit my Access/Barclaycard No.

ACCESS																			
BARCLAYCARD																			

• Circle No. 120

Now, for every Atom owner . . . Atomic games!

Make even more of your Acorn Atom with these, the first in a fast-growing range of imaginative, challenging and sophisticated games!

Games Pack 1

- ASTEROIDS. Shoot them down before you collide.
- SUB HUNT. Choose your course and speed to catch enemy subs.
- BREAKOUT. Score points for knocking bricks from wall.

Games Pack 2

- DOGFIGHT. Shoot down your opponent without crashing into stars.
- MASTERMIND. Guess the computer's code.
- ZOMBIE. Lure all the zombies into the swamp to survive.

Games Pack 3

- RAT TRAP. Entangle your opponent before he entangles you. Action replay feature.
- LUNAR LANDER. Altitude, fuel, drift velocity.
- BLACK BOX. Deduce the position of four invisible objects.

Games Pack 4

- STAR TREK. The classic computer game. The Universe versus the Klingons.
- FOUR ROW. Beat the computer to get four marbles in a row.
- SPACE ATTACK. Save the earth from invasion.



Soft VDU Pack

SOFT VDU. Replaces the Atom VDU to give 128 characters, upper and lower case, mathematical symbols, etc.

Order today!

Just send a cheque or money order for £11.50 (inc VAT and p&p) per Pack, stating which Pack you want, or write for full details to **Acornsoft Limited, 4a Market Hill, Cambridge.** Allow 14 days for delivery.

ACORNSOFT

• Circle No. 121

The answer:
from
Almarc
DATA SYSTEMS
is Execuplan and Memorite III

Execuplan is a great new software package **NOW** available from Almarc.

It's the 'never-forget' perfect typist that lets you play 'What if?' It's a superb information system that you can type the changes and reprint. So for those whose daily need is pencil, paper and calculator — now is the time to consign them to the dustbin — **Execuplan** is here! Features include: matrix planning, budgets, cash flow analysis, estimates, formatting and printing capabilities, primer manual for easy learning, plus help screens. **Execuplan** out performs other calculator/planning systems on the market.

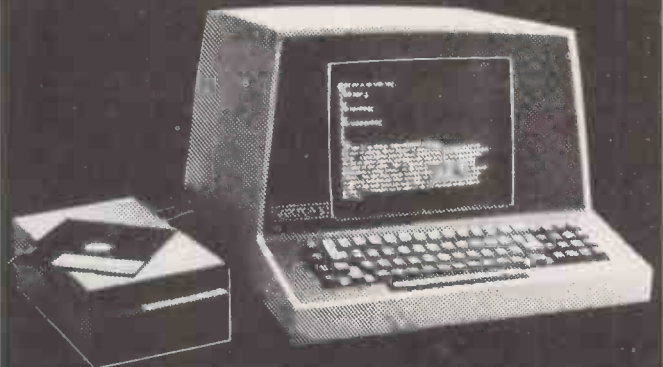

And here's another great innovation from Almarc. **The Memorite III** — the ultimate in up-to-date word processing economy from Vector. There's an on-screen reference manual, with automatic spelling verification. A phrase plus mass mailing and list-processing facility. It saves time, expense and most of all that 'frayed-at-the-edges' feeling. It's Vector's commitment to CP/M word processing designed specifically to allow systems houses and large company programming staff to add features easily. For more information cut out the coupon and post to:
Almarc Data Systems Ltd.,
906 Woodborough Road
Nottingham NG3 5QS.
Tel: (0602) 625035

Please send me lots more information on: Memorite III Execuplan

Name
Company
Position
Address
Tel. No

Almarc Data Systems Ltd.
906 Woodborough Road
Nottingham NG3 5QS
Tel: (0602) 625035

• Circle No. 122

DISTRIBUTORS — DEALERS END USERS

TRYAC SYSTEMS *OUR BEST SELLERS WILL INTEREST YOU*

1 FMS-80

FAST — VERY POWERFUL — EASY TO USE DATABASE MANAGEMENT SYSTEM LINKS WITH OTHER PROGRAMS — WORDSTAR ETC. FOR CP/M — MP/M — CDOS USERS

2 INSURANCE BROKERS SYSTEM

VERY COMPREHENSIVE SYSTEM REVIEWED BY THE B.I.B.A. FOR CP/M — MP/M USERS

3 MINIMODEL

FINANCIAL MODELLING PROGRAM BUDGETS — CASHFLOWS — PLANNING CAN CONSOLIDATE REPORTS, BUDGETS ETC. FLEXIBLE — POWERFUL — EASY TO USE FOR CP/M USERS

4 PRINTERS

TWO VERY FAST LARGE AND SMALL DOT MATRIX PRINTERS AT SLOW PRINTER PRICES

5 COMPUTERS

WE ALSO SELL COMPETITIVELY PRICED COMPLETE BUSINESS SYSTEMS WITH FULL INSTALLATION AND TRAINING

FOR FULL DETAILS CONTACT

TRYAC SYSTEMS

141 HIGH STREET, ALDERSHOT, HANTS.
TEL: ALDERSHOT (0252) 29804

• Circle No. 123

DON'T CONFUSE MIDAS WITH ORDINARY SMALL COMPUTERS

Midas offer a highly sophisticated range of computers. They come as a complete package with software, a program designed for your own specific business or application and include a word processor.

You get a continuous consultancy before and after installation, plus unlimited service from a nationwide team.

Midas will train your staff, check that the system meets your exact requirements and suggest ways of reaping utmost benefit from your investment.

Midas computers meet even the most demanding needs of a small or medium size business. For larger concerns they will act as intelligent terminals at branches etc, working in conjunction with a host computer.

You can buy or lease, including programming, software and full service, from as little as £40 per week.

Write or ring today for details

MIDAS

COMPUTER SERVICES LIMITED

2 High Street, Steyning.

W Sussex. BN4 3GG

Telephone (0903) 813913 or 814523

Telex 877886

• Circle No. 124

SHARPSOFT

SHARPSOFT LTD.
86-90 PAUL STREET,
LONDON EC2A 4NE
01-739 8559

SHARP PC 3201

COMPUTER SYSTEM
£2995.00 + VAT



- 64K RAM
- 12" Green display monitor
- 80 Characters x 25 lines • Standard QUERTY style keyboard with separate numerical key unit and separate cursor keys. Clock and calendar with back-up rechargeable batteries
- PRINTER 80 x 132 column bi-directional printer • Floppy disks
- Twin 5¼" double sided double density disks giving a capacity of 568K per pair of drives

Send to Sharpsoft for more information or come and see the equipment at the London Computer Fair

PC1211

Only £95.00 incl. VAT & P.O.

CE 122

Printer/Cassette interface for the PC1211 Available April.

Only £80.00 incl. VAT & P.P.

All the products will be on show on **Stand 35**, The London Computer Fair North London Polytechnic Holloway Road, London N7 April 14, 15 & 16.

CP/M®

FOR THE SHARP MZ80K. fig-FORTH with Editor, user group "Stoick" and Z80 Pilot disk contact Sharpsoft for the latest details.

LATEST SOFTWARE FOR SHARP MZ 80K

PILOT
ELECTION 1984
TOWERING INFERNO
HEAD ON
AN ADVENTURE GAME "ESCAPE FROM COLDITZ"

BLOCK KUZUSHI
LAS VEGAS
JINTORI-GAME

NOW AVAILABLE — The first issue of the SHARPSOFT USER NOTES, send for registration form.

MZ 80K

SHARP MZ 80K 20K Computer	£445.00 inc VAT. P & P
SHARP MZ 80K 36K Computer	£499.00 inc VAT. P & P
SHARP MZ 80K 48K Computer	£545.00 inc VAT. P & P
SHARP MZ 801/0 Interface Unit	£ 95.00 inc VAT. P & P
SHARP MZ 80FD Dual Disk Drive	£667.00 inc VAT. P & P
SHARP MZ 80P3 80 Col Printer	£448.50 inc VAT. P & P
XTAL® CP/M Operating System	£230.00 inc VAT. P & P



MZ 80K

For the SHARPSOFT hardware/software catalogue and registration/subscription form for SHARPSOFT USER NOTES send 35p stamps to Sharpsoft Ltd., 86-90, Paul Street, London, EC2A 4NE.

• Circle No. 125

6502 Books at Microdigital

Programming the 6502 - R. Zaks

This book is an educational text designed to teach programming, using the 6502. It does not require any prior programming knowledge, yet can be used to advantage by anyone wishing to familiarize himself with the 6502. An invaluable book for owners of the PET, Apple, Kim, etc. **8.70**

6502 Applications Book - R. Zaks

This book presents practical applications techniques for the 6502 ranging from a complete home alarm system to an industrial control loop for temperature control. Also includes analog to digital conversion and simple peripherals from paper-tape reader to micro printer. **8.70**

6502 Games - R. Zaks

A book of ten games which will teach you assembly language, algorithm design and data structures in a straight-forward and enjoyable manner. **8.90**

Programming a Microcomputer (6502) - Foster

This book will teach you how to program a microcomputer in machine language. Although designed specifically for the 6502 microprocessor used in the Kim 1, PET and the Apple. The basic principles involved apply to all computers. **7.20**

Practical Microcomputer Programming The 6502 - Weller

This book examines the detailed assembly level programming characteristics of the 6502 microprocessor and includes appendices giving an assembly listing of the assembly program (6502 Resident Assembler) an assembly listing of Apple II input/output subroutines for the assembly computers and assembly listing of the D-Bug program for Apple II. A very comprehensive reference book. **19.50**

6502 Assembly Language Programming - Leventhal

Another fine manual in the Osborne Assembly Language series to join the best selling 8080, 6800 and Z-80 books. **10.45**

6502 Cookbook - R. Findley

Various component programme units given may be combined at will, and these recipes will help you to explore some of the possibilities available. **7.70**

Programming and Interfacing the 6502

An excellent starting point for 6502 micro-computer novices, who need experience in assembly language programming or chip-level interfacing. Examples are shown using a KIM, AIM or SYM system. **8.90**

6502 Software Design - L. Scanlon

Fundamentals of 6502 operation are explained and then extended to give a comprehensive coverage of 6502 use. **7.90**

Post and Packing free. No VAT on Books. Bona Fide official orders welcome.

I enclose cheque/P.O. for: _____

Name _____

Address: _____

Post Code _____

Goods required _____

PC4/81



24 Hr Telephone Credit
Card Orders 051-236 0707

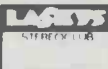

Mail Orders to:
MICRODIGITAL LIMITED
FREEPOST (No Stamp required)
LIVERPOOL L2 2AB



Retail Premises at:
25 BRUNSWICK STREET
LIVERPOOL L2 0PJ
Tel: 051-227 2535/6/7

MICRODIGITAL

• Circle No. 126

SUPERBRAIN SOFTWARE

HIGH RESOLUTION GRAPHICS BOARD

512 x 256/240 PIXELS

EXPANDED SYMBOL GENERATOR

GRAPHIC/SURFACE PLOTTER

3D TRANSFORMATION WITH TRUE

PERSPECTIVE AND TEKTRONIX

EMULATOR

£495.00

Z80/A COMMERCIAL OPERATING SYSTEM

(AS REVIEWED IN THIS MONTHS ISSUE—

£450.00

MICRO-80 (AS USED ON PETS)

NOW AVAILABLE ON SUPERBRAIN

A COMPLETE BUSINESS PACKAGE:

A TOTALLY INTEGRATED FINANCIAL

ACCOUNTING SYSTEM FOR SALES/

PURCHASE & NOMINAL LEDGERS

£975.00

DEMO PACKAGE AVAILABLE, SUPERBRAIN+PET SUPPLIED
DEALER ENQUIRIES WELCOMED.

COMPUTER SALES & SOFTWARE CENTRE LTD

190-192 CRANBROOK RD, ILFORD, ESSEX

01-554-3344

• Circle No. 127

OXFORD COMPUTER CENTRE

Recently opened in Central Oxford.

SHARP MZ-80K MICROCOMPUTERS

FROM

£380 PLUS V.A.T.

73-75 George Street, Oxford OX1 2BQ

Open: Mon-Sat; 9am-6pm

Tel: (0865) 49349

Circle No. 128

the printer people

0372 62071

Epson MX80

£359

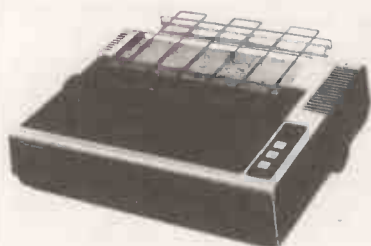

Complete range of interfaces

- * 9x9 dot matrix
 - * Fast bidirectional printing
 - * ASCII and graphics, with £ sign
 - * Bold, expanded, condensed print
 - * Parallel interface standard
- MX80FT friction/tractor variant: £399
MX70 with 7x5 matrix: £259



£329

OKI Microline 80

The quiet workhorse

- * ASCII and graphics characters
 - * 9x7 dot matrix
 - * Condensed, double width print
 - * Friction or pin feed
 - * Rugged, quiet and reliable
 - * Parallel interface standard
- Microline 82 — higher speed, more forms control: £499
Microline 83 — commercial unit 120 cps, 15" paper width: £749

Centronics 737

£349



Letter quality printer

- * 7x9 dot matrix
- * 3-way paper handling, up to 8 1/2"
- * 5, 10 or 16 characters per inch
- * Proportional characters/spacing
- * Up to 80 characters/second
- * Parallel interface standard
- * Serial interface option

TVI 912C terminal

£475

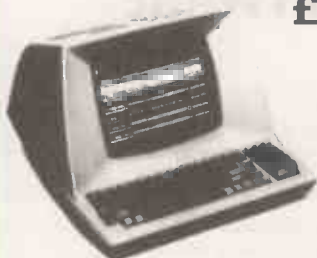

Fully intelligent terminal

- * 24x80 character display
 - * Dual intensity, blinking, reversed, underline, and protected fields
 - * Full upper/lower case ASCII
 - * Separate numeric keypad
- TVI 920C (illustrated) with full set of function keys: £550

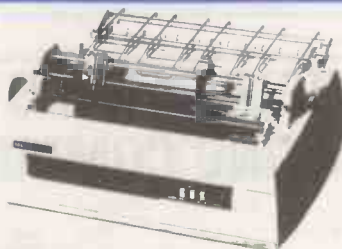

NEC Spinwriter

Professional quality for word-processing systems

NEC's 'Spinwriter' series of high-quality printers use a print 'thimble' for faster, quieter printing and more characters than equivalent daisy-wheels. 128 character set; 55 chars/sec; friction or tractor feed; up to 5 copies; single-sheet feed option.

£1390

KSR version: £1640

Anacom 150

£699

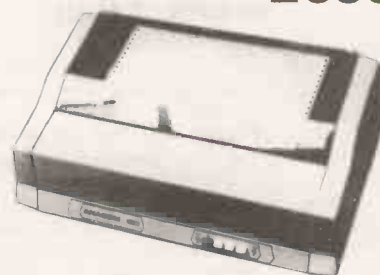

The reliable commercial printer

- * 150 characters per second
 - * 9x9 matrix, upper and lower case
 - * Up to 15" paper width
 - * Full forms control
 - * Centronics parallel/RS232 serial
- 4K buffer option now available

the best prices for peripherals

We specialise in printers and other peripherals, to pass cost savings on to you — with full dealer support. *Educational and dealer discounts are available — please phone 0372 62072 for details.*

All prices quoted exclude VAT and delivery.

NORTHAMBER

Importers, Distributors and Wholesalers

Great Oak House, Albany Close, Esher, Surrey
Telephone: Esher (0372) 62071

• Circle No. 129

MS-the Masterminds behind the systems



More and more users are beginning to appreciate that it is the software, not the hardware that is the governing factor in the efficiency and cost effectiveness of any computer system.

The following systems have been thoroughly tested and approved by Merchant Systems Software team, who will be pleased to demonstrate them on the Commodore Business Machines.

- 1 **MICRO-30, MICRO-40 & MICRO-80** A fully integrated accounting system for those users with book keeping experience. Monthly capacities, Sales and Purchase Ledger 800 accounts - 6000 postings. Nominal Ledger 400 accounts - 12000 postings. Comprehensive reports - Audit Trail/Daybook, Trial Balance, Age debtors/creditors, Cashbook, Statements, Profit and Loss account and Balance Sheet. PLUS a business information retrieval system and a Stock Control System. £950 - Micro-80, £750 - Micro-30 and Micro-40.
- 2 **VISICALC** An invaluable tool for accountants, managers, insurance brokers and engineers. This package is exceptional, absolutely no programming is necessary. Built-in functions giving nett present values, plus arithmetic functions. An electronic worksheet enabling the user to ask the "what if" question as many times as required. £150.00
- 3 **OZZ** This is an information wizard, the user can design a system in a matter of a few hours work. The user designs the database, then the print format and a special calculator segment if required. This system is very popular and very useful to the user who requires to set up a file of data, select information, carry out simple calculations and print the results in the desired format. £350.00.



To: **Merchant Systems Limited, Bride Court,**
5 New Bridge Street, London EC4 Tel: **01-583 6774**
 Please send me details and arrange a demonstration at your showroom.

Name

Position

Company

Address

..... Tel. No.

PC4/81

• Circle No. 130

APPLE COMPATIBLE BOARDS AND SOFTWARE via DIRECT MAIL FROM KEATING COMPUTER

Model	Description	Price (£)	Model	Description	Price (£)
7500A	Wire Wrap Board, up to 25 sixteen-pin or 6 forty-pin sockets.	12.00	7710A	Asynchronous Serial Board, for Paper-Tape Reader, Keyboard, VDU, Printer etc. Baud rates selectable from 50 to 19.2K baud.	95.00
7520A	Extender Board, with top connector.	15.00	7712A	Synchronous Serial Board, for high-speed interface communications.	105.00
7114A	12K ROM/PROM Board, 6 sockets for combination of 2316 ROMs, 2716 EPROMs.	65.00	7720A	Parallel Board, for Paper-Tape, Printer etc. control on/off devices such as low current relays, sprinklers etc.	95.00
7424A	Calendar/Clock Board, 12 or 24 hour formats, adjusts Feb. to 29 days for leap years.	149.00	7728A	Centronics Printer Interface Board, for Centronics-type parallel printers.	119.00
7440A	Programmable Timer Board, 3 independent software-controllable 16-bit timers.	75.00	7379A	Cable for all Centronics, Okidata Mikroline 80 or Microtek MT-88T printers - specify which desired.	17.00
7470A	Analog-to-Digital Converter Board, converts analog voltages to BCD numbers then to ASCII characters for VDU. Use for monitoring thermostats, fluid level in tank, Apple power supply etc.	75.00	7388A	Cable for MPI 88T printer.	17.00
7490A	IEEE488 Interfact Board, up to 15 interconnected controllers, talkers and/or listeners for Counters, Signal Generators, Digital Multimeters, Colour Graphics Output Devices etc.	195.00	7811B	Arithmetic Processor Board, floating-point hardware to increase execution speeds and math functions by order of magnitude. Includes interpreter software on diskette for disk drive users.	249.00
			7811C	Arithmetic Processor Board, same as item 7811B except interpreter software on ROM.	249.00

Prices INCLUDE all VAT, Post & Package charges. You pay only actual net prices as quoted. Complete the coupon-order, enclose your cheque/postal order made payable to: Keating Computer.

Please ship me:			
QUNTY.	MODEL	PRICE	PAYMENT ENCL.

Allow 30 days for delivery. Documentation includes installation guide, operating instructions, schematics & logic diagrams plus software listings where applicable. All products warranted for 6 months and backed by full money back guarantee if not satisfied.

KEATING COMPUTER WATCH US GROW

61 CEMETERY ROAD, WOMBWELL,
 NR. BARNESLEY, S. YORKS. S73 8HZ

• Circle No. 131

Your search for the right price stops here.



Pet

Well known for making short work of accounting, word processing, mailing lists. A great buy from NSC.



Apple

You know what the Apple system will do but you don't know the deal we're offering. Come and see for yourself.



Rair

The exciting new 3/30 system offering 5 mb of fixed disc storage on brand new 5 1/4" Winchester drives. 64K Machine £4,313 incl. VAT. Full range of black box systems available. Rental terms available.

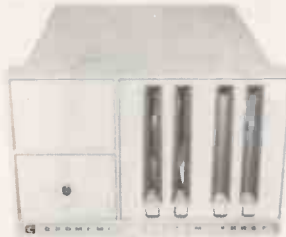

Cromemco

We can now supply the Cromix operating system for single and multi user working. The first big system operating system to be offered on a small system—the only system which offers up to 63K memory space per user.



Acorn Atom

Now available ex-stock. Special offer to ZX80 owners: We will take your ZX80 in part exchange for an Atom.

Used Bargain: Second hand ZX80's from £50.



North Star Horizon

A complete word processing system extendible from 32K-56K RAM, with up to four mini disc drives, 4MHz Z80A processor, serial and parallel I/O ports and extended BASIC. Full range of accounting packages available. You can lease this very popular system for as little as £25 per week.

Bargain Offers



South West Technical Products

56K 6809 based system, with twin 8" disc drives and Centronics 779 printer. From £3,163 incl. VAT, while stocks last. Keenest prices around on individual boards and peripherals.

48K Apple for £695

Buy a 16K Apple from NSC Computer Shops now and get 32K FREE.

After Sales Service

When you buy from NSC Computer Shops you have the opportunity to take advantage of a special service contract on favourable terms.

Order by post with confidence

Instead of calling personally at NSC Computer Shops you can send cash with order. Orders are despatched by carrier, please telephone for details of delivery charges.

BOOKS: Send s.a.e. for our full price list, or call in at our shop to see our wide range of publications.

Most of our prices are heavily discounted and therefore payment must accompany the order. Credit card payments will be accepted. Please quote credit card number and type of card.

WE WILL NOT BE KNOWINGLY UNDERSOLD.

NSC COMPUTER SHOPS

Computing to suit your size.

NSC Computer Shops, 29 Hanging Ditch, Manchester M4 3ES. Ring 061-832 2269 for further information.

• Circle No. 132

The only viewdata exhibition backed by the industry and exclusively by British Telecom's Prestel UK Division

The Seventies saw the beginning of the Post Office involvement in a brand new industry which came of age in 1979 with the launch of the Viewdata Exhibition for Professional and Business people. Since then the industry has been educating people round the world to the advantages of this new and efficient means of communication. British Telecom's Prestel UK Division are now backing this exhibition as the only meeting place where they will join with the rest of the industry to meet with international businessmen who realise the need to invest in this new and important market.

If YOU are a part of this industry . . . be a part of the third Viewdata Exhibition for Professional & Business people . . .

FILL IN AND RETURN THIS FORM TODAY!

To: The Exhibition Manager,
The Viewdata Exhibition,
IPC Exhibitions Ltd., Surrey
House, 1 Throley Way, Sutton,
Surrey. SM1 4QQ.

Please provisionally book me space at the 1981 show and send me more details.

Name _____ PC4 81
Company _____
Address _____
Tel _____

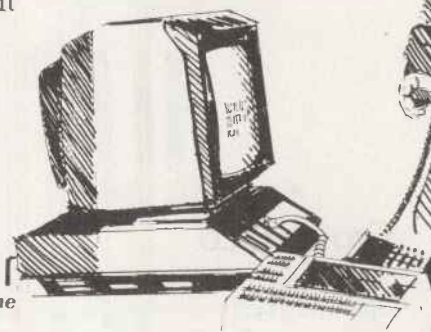

NOVEMBER 4, 5 & 6, 1981
WEST CENTRE HOTEL
LONDON SW6

Circle No. 133



TRS-80 OWNERS!



LEVEL II CASSETTE GAMES

Adventures:-	
Special Sampler*	£5.50
Adventureland*	£9.50
Pirates Adventure*	£9.50
Mission Impossible*	£9.50
Voodoo Castle*	£9.50
The Count*	£9.50
Strange Odyssey*	£9.50
Mystery Fun House*	£9.50
Pyramid of Doom*	£9.50
Ghost Town*	£9.50
Savage Island*	£9.50
Air Raid*	£8.50
Air Traffic Control*	£7.50
Amazon' Mazes	£5.50
Android NIM	£9.50
Backgammon	£6.50
Balloon Race	£6.50
Barricade*	£8.50
Baseball	£6.50
Battleship	£7.50
Bee Wary	£9.50
Bingo	£4.50
Bowling (Ten Pin)	£6.50
Breakaway	£4.50
Bridge Partner	£9.50
Cribbage	£6.50
Death Dreadnaught*	£9.50
Dogstar	£6.50
End Zone II	£6.50
Fastgammon*	£12.00
Galactic Blockade	£6.50
Galactic Empire	£9.50
Galactic Revolution	£9.50
Galactic Trader	£9.50
Galaxy Invasion*	£9.50
Game of Life*	£6.50
Gammon Challenger*	£9.50
Gangster	£5.50
Hangman	£4.50
I Ching	£6.50
Interlude*	£10.50
Invasion Orion*	£12.00
Invaders from Space*	£9.50
Kamikaze	£6.50
Kreigspiel II	£9.50
Life Two	£9.50
Lost Dutchman's Gold	£9.50
Lost Ship Adventure*	£9.50

MODEL I

Mastermind II*	£5.50
Mean Checkers*	£11.00
Morloc's Tower*	£9.50
Noughts & Crosses	£4.50
Othello III	£6.50
Pentominoes	£9.50
Pinball*	£6.50
Pork Barrel	£6.50
PR Dogfight	£6.50
Pre School Games	£6.50
Robots	£4.50
Round The Horn	£6.50
Safari	£6.50
Santa Paravia	£6.50
Sargon II*	£18.50
Ship Air Battles	£5.00
Slalom	£5.00
Snake Eggs	£9.50
Space Battles	£9.50
Starfleet Orion*	£12.00
Startrek III.5	£9.50
Super Nova*	£9.50
Taipan	£6.50
Time Trek*	£9.50
Trek 80	£6.50
Trolls Gold	£4.50
Up Periscope	£9.50
Warfare I	£5.50
X-Wing Fighter II	£6.50

EDUCATIONAL

Spelling Builder	£12.00
All other PDI Pgms	£9.50

BUSINESS & UTILITIES

Accounts Receivable II	£13.50
Amateur Astronomer	£9.50
APL-80*	£9.50
Basic 1P*	£11.50
Basic Toolkit*	£11.50
Biorythms	£4.50
Calendar Functions	£7.50
Cash Register	£6.50
Copys*	£9.50
Data Base II	£17.50
Debug*	£12.50
Editor Assembler Plus*	£18.50
Electric Pencil*	£50.00
Electronics Assistant	£6.50
EMU 6502*	£16.00
ESP Tester	£4.50
File Handling	£7.50

Finance Pack	£7.50
Flight Simulator*	£15.00
Forth* (incl. Primer)	£37.50
GSF*	£17.50
General Accounting	£8.50
Horn Radio	£6.50
Histogram/Scattergram	£7.50
Home Finance	£6.50
Infinite Basic*	£31.00
Infinite Business*	£18.50
Instant Calculator	£7.50
Inventory Control	£11.00
Inventory 'S'	£16.00
IRV*	£16.50
Keyboard 80*	£7.50
KVP*	£9.50
Level III Basic*	£30.00
Linear Programming	£7.50
Magic Paper Calculator	£9.50
Mathdrill	£5.00
Maths Library I	£8.50
Maths Library II	£8.50
Memdum*	£8.50
Microtext Editor	£6.50
Mortgage Calculator	£5.00
Pascal*	£26.00
Periodical X-REF	£9.50
Personal Finance	£6.50
Pilot 2.2*	£9.50
Pre-Flight	£9.50
Remodel & Proload*	£23.00
Renumber*	£6.50
RPN Calculator	£6.50
RSM 2 Monitor*	£16.00
SCRIPST*	£39.95
Screen Hold*	£8.00
Statistics	£6.50
S.T.A.D.*	£16.00
ST-80*	£30.00
Super Simon	£6.50
Super T-Legs*	£6.50
T-Step*	£7.50
System Copy*	£8.50
T-Short*	£6.50
T-Short**	£12.50
Tarot Cards	£6.50
Teachers Assistant I	£9.50
Teachers Assistant II	£9.50
Timer*	£9.50
Tiny Comp	£12.50
TRS80 Opera*	£6.50

Typing Tutor	£11.50
Ultra Mon*	£15.00
X-Ref*	£9.50
Y-Bar	£9.50
76 Basic Programs	£23.00
Manual for Above	£7.00
Library 100	£40.00

DISK

Accounts Receivable II	£40.00
Advanced Personal Finance	£15.50
Amateur Radio System	£15.50
APL 80	£30.00
Auto Disk Directory	£9.50
Basic Compiler	£110.00
CCA Data Management	£52.50
Comproc	£13.50
Data Base II	£30.00
DCV-1	£8.50
Dosort	£25.00
Dynamic Data Base	£22.50
Electric Pencil	£75.00
File Manager 80	£30.00
Flopp Disk Diagnostic	£13.50
Forth (incl. Primer)	£45.00
Inventory 2.3	£40.00
Inventory II	£50.00
Inventory 'S'	£40.00
KVP Extender	£16.00
Mailist iv	£45.00
Newdos 80	£87.50
Newdos +	£47.50
Newdos	£30.00
Pencil PAL	£12.00
Roots	£14.50
SCRIPST*	£65.00
Simplify It	£15.00
ST80D*	£45.00
ST80D III*	£85.00
SUPERSCRIPT*	£17.50
Visicalc*	£65.00
Taranto & Accessories Conversion of Osbourne & Associates Business Programmes	£90.00
Accounts Payable	£40.00
Cash Journal (for G/L)	£90.00
Invoicing	£90.00
Accounts Receivable	£90.00
General Ledger	£90.00
Complete Co-ordinated System with Manuals	£350.00

MODEL II

CPM 2.2 X	£165.00
CBasic (CPM)	£80.00
Disk Sort Merge	£87.50
Development System	£70.00
G.S.F.	£30.00
Pascal	from £100.00
Reference II	£30.00
RM Cobol	from £350.00
RSM II Monitor	£30.00
Supersort III (CPM)	£80.00
Utility Package	£87.50
Hard Disk Operating Sys	£250.00

WORD PROCESSORS

Electric Pencil II (CP/M)	£200.00
Electric Pencil II TRSDOS	£225.00
Magic Wand (CP/M)	£230.00
Wordstar (CP/M)	£275.00

BUSINESS SYSTEMS

Accounting	from £150.00
Mailist	from £100.00
Medical	from £100.00
Property Analysis	£175.00

CP/M USERS GROUP

23 Volumes	Each £12.00
------------	-------------

ALL PRICES INCLUDE VAT AT 15%, PACKAGING & RETURN POSTAGE TO U.K. ADDRESSES. PRICES TO OVERSEAS ADDRESSES INCLUDE RETURN AIRMAIL. SEND £1.00 FOR NEW DESCRIPTIVE CATALOGUE.

*Denotes Machine Language
TRS-80 Trademark of Tandy Corp.
CP/M Trademark of Digital Res.
C-Basic Trademark of Compiler Systems.



MICROCOMPUTER APPLICATIONS
11 RIVERSIDE COURT,
CAVERSHAM,
READING RG4 8AL,
ENGLAND.
TEL: (0734) 470425

ALL TANDY HARDWARE AND SOFTWARE AVAILABLE AT CATALOGUE PRICES

The high-capability calculator that accepts add-on peripherals – now just £149.95 (RRP)!

SAVE OVER £40 on previous RRP!

The Hewlett-Packard HP-41C is a fully programmable calculator – advanced, powerful and very versatile. Yet it's also remarkably easy to use, with a helpful alphanumeric display and a range of application modules.

Most important, it has its own dedicated peripherals – including printer, card reader and memory modules.

And now we've reduced the recommended retail price of the calculator from £192.55 to just £149.95!

A unique machine

PROGRAM POWER. 400 lines of program memory (or 63 data storage registers) as standard, expandable up to 2000 lines (319 data storage registers). With RPN logic, for faster problem-solving. **ALPHANUMERIC DISPLAY.** You can name and label programs, functions, variables and constants. The calculator uses words and sentences to prompt for data. The display shows calculator modes and status.

'CUSTOMISE' FEATURE. Assign any of 68 keyboard functions (or 130 library functions) – or any program you've written yourself – to any key on the HP-41C. To help you, the HP-41C comes with keyboard overlays. (Each assigned function or program name is displayed prior to execution.)

CONTINUOUS MEMORY. Maintains program and data when your HP-41C is switched off. Simply switch on, and continue with your calculation.

A unique system

Look at this impressive list of add-on peripherals! **HP-41C PRINTER.** Quietly gives numeric, upper and lower case alpha characters, in single and double width, as well as special characters. And performs high resolution plotting routines.

APPLICATION MODULES. For engineers, students, businessmen, scientists and others.



Instantly converts your calculator to a specialised discipline.

HP-41C CARD READER. Saves program and data on magnetic cards. Keeps track of cards as they're read, and prompts you for the next card.

MEMORY MODULES. Each contains 64 data storage registers (400 program lines, or any combination).

Incredible value at £149.95 (including VAT)!

This price includes the calculator, 63 registers for data or programs, owner's handbooks, overlay kit, zip-up pouch and batteries! Compare the HP-41C with other calculators in its price range. You'll find it has more functions and more options. See your dealer for a demonstration – you'll find his name below.



Aberdeen Tyseal Typewriter Services. Bath Wilding Office Equipment. Belfast Cardiac Services Company. Birmingham Anglo American Computing; John Mabon Associates. Bolton Wilding Office Equipment. Bournemouth South Coast Business Machines. Brighton Office Machinery Engineering Co. Bristol Decimal Business Machines; Wilding Office Equipment. Bromley Wilding Office Equipment. Cambridge W. Heffer & Sons; Wilding Office Equipment. Canterbury R. E. Typewriters. Cardiff Sigma Systems (Calculators). Carlisle Thos. Hill Group. Chelmsford Automatic & Electronic Calculators. Colchester Wilding Office Equipment. Croydon Landau Calculators; Wilding Office Equipment. Derby Office Machines. Dundee Tayside Office Equipment. Edinburgh Business & Electronic Machines; Holdene. Folkestone R. E. Harding. Glasgow Robox. Gloucester Wilding Office Equipment. Gravesend Wilding Office Equipment. Grimsby Teesdale Office Equipment. High Wycombe Wilding Office Equipment. Hornchurch Wilding Office Equipment. Ilford Wilding Office Equipment. Ipswich Anglia Business Machines; Wilding Office Equipment. Kingston-upon-Thames Wilding Office Equipment. Leeds Holdene; Wilding Office Equipment. Leicester A. C. Barratt & Co.; Sunlock Services. Liverpool Rockliff Brothers. London Automated & Electronic Calculators; City Business Machines – 57 Houndsditch, Bethnal Green Road; Concept Business Systems; Dixons Photographic – 64 New Bond Street; Euro-Calc – 128-132 Curtain Road, 224 Tottenham Court Road, 55 High Holborn; Landau Calculators – Bourne's Oxford Street, 227 Tottenham Court Road; McDonald Stores; Metyclean – 137 The Strand, 92 Victoria Street; Mountaine; Reid's Office Equipment; Sumlock-Bondain 263-269 City Road; Cannon Street Station; Wallace-Heaton; Wilding Office Equipment – 7 The Arcade Hoe Street, 21 Thomas Street, 120 The Broadway, Wimbledon; The Xerox Store Piccadilly, 76 High Holborn. Luton Wilding Office Equipment. Maidstone Wilding Office Equipment. Manchester Automated Business Equipment; Holdene; Wilding Office Equipment. Matlock Derby Office Machines. Middlesbrough Thos. Hill Group. Newcastle Thos. Hill Group. Northampton A. C. Barratt & Co. Norwich Leamons Office Machines; Sumlock-Bondain. Nottingham Bennett's (Typewriter & Office Supplies); Trent Office Equipment. Oxford Reid's Office Equipment; Science Studio. Plymouth JAD Integrated Services. Reading Central Southern Equipment; Reid's Office Equipment; – Caversham, 38 Market Place, Reading. Romford Wilding Office Equipment. Royston, Herts Electroplan. Sheffield Butlers Office Equipment. Slough Wilding Office Equipment. Southampton Leicester Typewriters. Southend Wilding Office Equipment. Sunderland Thos. Hill Group. Sutton Landau Calculators. Swindon Wilding Office Equipment. Waltham Cross Wilding Office Equipment. Watford Automatic & Electronic Calculators; Wilding Office Equipment. Worthing Office Machinery Engineering Co. All UK Comet branches. CHANNEL ISLANDS: Guernsey Professional Business Systems. Jersey Professional Business Systems. EIRE: Dublin Abacus Systems.

• Circle No. 134

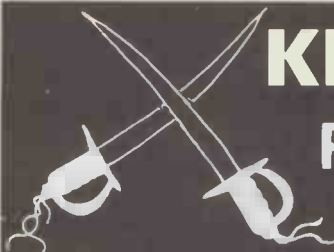

KRAM ELECTRONICS

RUTHLESSLY SLASHES THE COST OF PRINTING!!



- Centronics 730 100cps printer **£345**
- Centronics 737 Proportionally spaced word processing quality **£395**
- Case for UK101/ Superboard **£24**
- Pet-Centronics Decoded Interface **£50**
- 4K Ram for UK101 **£30**
- Additional Educational Discounts
- Pet-RS232 Interface **£80**
- Channel Synthesiser for Pet (IEEE Compatible) **£50**
- Numeric Pad for UK101/Superboard **£12**

KRAM ELECTRONICS

30 HAZLEHEAD ROAD
ANSTEY LEICESTER
053-721-3575

ALL PRICES SUBJECT TO 15% VAT



• Circle No. 135



TRITON — TUSCAN

WE — SUPPLY any TRITON or TUSCAN system. Built, customised or in kit form. From £235 upwards.

WE — ADVISE and can write any business suites based on these systems, and others CP/M Compatible.

WE — PROVIDE CP/M Compatible Standard Suites for Estate Agents, Insurance Agents, Business Accounting and Word Processing.

KIT ENHANCEMENTS FOR TRITON

- VDU RAM Peek, Reverse Display, Screen Antiflash, Bleeper. REF. 502/1 **£23.00**
- FOLLOWING PLUG DIRECT INTO MOTHERBOARD (On D/S. PCB) — NO MESSY CABLEFORMS**
- 2708/2716 EPROM Programmer. (L7.2 & L8.2 Monitor). REF. 501/1 **£29.50**
 - Modified BIOS ROM for 9.2 SYSTEMS TO USE 501/1. REF. 504/1 **£10.00**
 - S100 Converter and "CONDUCTOR" Socket on D/S PCB. REF. 503/1 **£25.00**
- 8" Floppy Disc Drives: Shugart SA800 — **£375**. SA850 — **£560**. Pertec FD 650 D/sided D/density — **£550**

**ALL KITS SUPPLIED COMPLETE AND WITH FULL INSTRUCTIONS.
KITS READY-BUILT AND TESTED-POA.**

ALL PRICES EXCLUDE VAT & CARRIAGE

PURLEY COMPUTER SYSTEMS LTD

21 BARTHOLOMEW STREET
NEWBURY, BERKS. Tel: 0635-41784



• Circle No. 136

CASTLE ELECTRONICS

SOUTH COAST MICRO CENTRE

Telephone Hastings (0424) 437875

TANGERINE

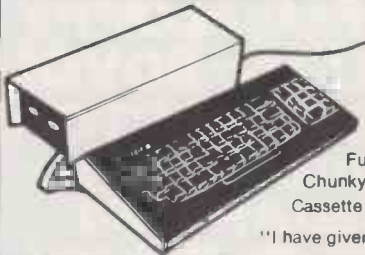

microtan 65 £69

Microtan 65 is the most advanced, most powerful, most expandable microcomputer available — it also happens to be the most cost effective.

6502 Microprocessor 1K Tanbug 1K User RAM Full TV Display £79 (ready-built), 20-way KEYPAD—£10. TANEX—£43
 1K 16 parallel I/O lines. Cassette Interface—1 serial I/O line, 2 x 16 BIT counter timers OPTIONS TK RAM total—32 parallel I/O lines, 4 x 16 BIT counter timers—RS232, 20MA current loop.
 10K MICROSOFT BASIC—£49
 System Rack—£49 in black / tangerine in brushed aluminium.
 Full Ascii Keyboard with numeric pad—£60.85. Cabinet available—£20. Lower Case option—£9.48.
 Chunky Graphics Pack—£6.52. Tanram Full Memory Expansion to 40K—£119.00. Mini Motherboard—£10.00.
 Cassette with counter—£21.70.

"I have given TANGERINE five bonus points for getting just about everything right"—E.T.I. Mag., May 1980.



video genie

WITH
 •16K user RAM plus extended 12K
 Microsoft BASIC in ROM •Fully TRS-80 level
 II software compatible •Self-contained, PSU,
 UHF modulator and cassette •Simply plugs into
 video monitor or UHF TV.

16K £299

Expander from £195.00

COMMODORE	8K	£399.00
	16K	£499.00
	32K	£649.00
SHARP MZ80	20K	£449.00
APPLE	16K	£599.00
	Epson Printer	£349.00
plus BOOKS/MEMORIES/SOFTWARE				

ALL PRICES ADD 15% VAT. DELIVERY CHARGES WILL BE NOTIFIED
 ACCESS AND BARCLAYCARD ORDERS TAKEN BY PHONE

7 CASTLE ST., HASTINGS, E. SUSSEX TN34 3DY Telephone: Hastings (0424) 437875

SHOP HOURS 0900 to 1730 MONDAY to SATURDAY. PERSONAL CALLERS WELCOME

• Circle No. 138



The Midlands Professional Computer Centre

The people with the personal approach

SPECIALISTS
 IN:—

CROMEMCO

HORIZON

NASCOM

SHARP

PERIPHERALS

(Excluding printers)
 Sharp Cassette Decks ASTEC 10"
 Cased Monitors.

PRINTERS

Nexos Ricoh RP 1600 Daisy Wheel
 Printer. Diablo Daisy Wheel Printer.
 Nascom Micro Imp, Dot Matrix Plain
 Paper Printer. Centronics Dot
 Matrix: Anadex Dot Matrix. Newbury
 Laboratories Dot Matrix Impact
 Printer.

SOFTWARE

Northstar. CAP-CPP. Cromemco.
 Petsoft. Supersoft. Nascom.

BOOKS

Very full range of books on 6502,
 Z80, Languages, Interfacing,
 Introductory books and games and
 General Programs.

MAGAZINES

Personal Computer World.
 Computing Today. Practical
 Computing. Educational
 Computing. Liverpool Software
 Gazette. I.N.M.C. Newsletter.

ADD-ONS FOR NASCOM

Input/Output Board. PIO Kit.
 Counter Timer Kit. UART Kit.
 Nas-Pen Text editor.

ZEAP 2.0 in EPROM or on Tape.
 Nas-Sys 3 Enhanced version of
 Nas-Sys1.
 Nas-Dis-Disassembler.
 Debug-Dynamic Debugger.

INTERFACE

Gemini floppy disc system D-DOS or
 CP/M single or dual drive.
 ROM EPROM board.
 EPROM burner 2708 and 2716.

BITS AND PC's

Tool Kit. Port Probe. Hex Key Pad. Sargon
 Chess. Programmers Aid. Dual Monitor
 Board.

NEW

Olympia Opus daisy
 wheel printer breaks
 £1000 barrier

THE KENILWORTH CASE
 for the Nascom 2 to
 complete a truly professional system.

Milham A/D Converter

NEW

Screen plus —
 Reverse video and blanking control
 unit perhaps the most advanced
 video control device for your Nascom.

Castle Interface

WILLIAM STUART
 Colour Graphics for
 Nascom 1 & 2.
 Speech Recognition Unit.

**WINCHESTER
 TECHNOLOGY**

Colour Graphics 1 & 2.

Business & Leisure Micro Computers

16 The Square, Kenilworth, Warwickshire CV8 1EB. Tel: (0926) 512127

• Circle No. 139

SUMLOCK BONDAIN

Makes the decisions easier



HEWLETT PACKARD SERIES 80 GRAPHICS SYSTEM . . .



DISCOVER THE FULL PROFESSIONAL POWER OF HEWLETT PACKARD'S PERSONAL COMPUTER

The New HP83A personal computer has the same powerful facilities as the HP85A excluding the cartridge and internal printer. This allows a full system to be installed at a much lower price. Add the HP2631B high-speed, high quality printer, the HP7225 high-resolution graphics plotter and the HP82900 5¼" flexible disc drives providing up to 270K bytes of formatted storage. The NEW HP9111A GRAPHICS TABLET can now also be added. Ask for a demonstration. It's your personal computer system. You decide which HP peripherals you need. See both the HP85A and HP83A and the new peripherals in action. Getting your hands on so much professional computing power was never so easy.

. . . INCLUDES NEW HP-83A PERSONAL COMPUTER FLEXIBLE DISC MEMORY, PRINTER AND GRAPHICS PLOTTER



**HEWLETT
PACKARD**



HEWLETT PACKARD'S NEW HP-41CV HANDHELD SYSTEM . . .

HP 41C PRICE DROP!

HP41C	£129.95
CARD READER	
HP82104A	£109.95
PRINTER	
HP82143A	£199.95
MEMORY MODULE	
HP82106A	£18.00
NEW QUAD RAM	
(4 times capacity of standard memory module) HP82170A	£54.00
NEW HP-41CV	£169.95

MAKE FURTHER SAVINGS!
PACKAGE DEALS
(including card reader and printers)

HP-41C	£425.00
HP-41CV	£460.00

All prices include postage, packing and VAT. Barclaycard/Access accepted by phone. Request full competitive price lists. Above prices refer to UK only.



. . . featuring memory that can accommodate up to 2,000 lines of program or five times that of the HP-41C. Thanks to the increased memory, HP-41CV owners can use the input/output parts for peripherals instead of memory modules. Shown here are the card readers and printers peripherals.

SUMLOCK BONDAIN

Head Office: 263-269 CITY ROAD, LONDON EC1V 1JX
and at CANNON STREET STATION, LONDON EC4
Tel 01-250 0505 Telex 299844

• Circle No. 140

WEST Electronics

3 Budworth Close
Oxton
Merseyside
051 653 8180



NEW COMPUTER BREAKTHROUGH

GET IN CONTROL OF YOUR BUSINESS
WITH THE "WESTON" MICROCOMPUTER

APPLICATION SOFTWARE:

Account Ledger	Marketing Lists	Financial Reports	External Agency Production
Customer Ledger	Salary Payments	Customer Ledger & Tracking	Property Management
Invoice	Supply Analysis	Inventory Control	Survey Systems
Stock Control	Market Penetration	Legal Reporting	Postcards
Personnel Services	Data Base Management	Letter Merging	Notes and Clips
	Branch Office Control		

SYSTEM SOFTWARE:

Operating System	FORTRAN	Relay static Code w. Array Functions
CP/M 1.1 CP/M 2.0 CP/M 2.2 IBM PC	PASCAL	
SDS, TEMPOS, Multi user - Realtime and batch capabilities	REPL and 286 ASSEMBLER & DISASSEMBLER	
QBASIC		
Language	Utilities	
BASIC - Auto Compiler	PRINT CONTROL	
DISK BASIC - Random access	FAST D. ACCESS	
CP/M Links	COM FILES	
Character Multi-user Basic	D. ACCESS	
LBASIC	TEXT EDITOR (w. file)	
Basic II	MEMORY TEST	
Industrial Basic	FILE LINK	
SI BASIC	DIAGNOSTIC	
MBASIC	REPAIR LOGS	
IBM PC Compatible	RELOCATABLE ASSEMBLER	
COBOL - IBM PC, 1974 A	PROGRAM RELOCATION	
	PROGRAMMER'S TOOL	

SPECIFICATION:

Z80 1MHz	16 EPROM Memory	16 5.25" 5 1/4" Soft Disk Drives
16KB RAM	16KB ROM	Parallel Printer Port & Auto Feed
800KB RAM on board	RS 232 Serial Port	Disk Controller - 5.25" & 8" - 16MB Port
800KB RAM on board	RS 232 Serial Port	BIOS - 5.25" & 8" - 16MB Port
800KB RAM on board	RS 232 Serial Port	Diagnostic - 5.25" & 8" - 16MB Port
800KB RAM on board	RS 232 Serial Port	Programmer's Tool

SPECIAL FEATURES:

Printer (800KB)	16KB RAM	16KB ROM
16KB RAM on board	800KB RAM on board	800KB RAM on board
800KB RAM on board	800KB RAM on board	800KB RAM on board
800KB RAM on board	800KB RAM on board	800KB RAM on board
800KB RAM on board	800KB RAM on board	800KB RAM on board

Units supported by in-house service facilities and software development
End User instruction in use and training

ALL FOR UNDER £4 000 INCLUDING PRINTER
Depending upon software & options required

DEALER AND TRADE ENQUIRIES WELCOME

New from Acorn Computers Ltd Two Computer Communications Systems

Econet

The lowest cost computer communication network system available in the world. A ten station network with 400K byte file station costs around £3,000 and as little as £50 for each additional station.

Cambridge Ring

A very high-speed (up to 20 million bits per second) ultra-low error rate, communications system for micro, mini and mainframe computers and their peripherals.

Now Acorn Computers can offer the very best in computer communications, covering all configurations, all price ranges. No other company can offer our experience and range of services.

For full details of Econet or Cambridge Ring please write to: Chris Curry, Acorn Computers Limited, 4a Market Hill, Cambridge CB2 3NJ.



• Circle No. 142



apple

Sales and Service

VISICALC £95

A program which can generate complex models using simple steps, for virtually any financial application.

APPLE PLOT £42

This program allows the user to take advantage of Apple's high resolution graphics by plotting numeric data in a variety of ways. Links directly to Visicalc.

Order both of these superb programs for only £120

ARISTOCARDS ONLY £65 EACH

A range of plug compatible boards for Apple II or IIT 2020

HIGH SPEED SERIAL INTERFACE
PARALLEL INTERFACE
CENTRONICS INTERFACE

*Manuals available separately at £2 each
DEALER ENQUIRIES WELCOME

ALL PRICES EXCLUDE VAT

WE STOCK AN EXTENSIVE RANGE OF HARDWARE AND SOFTWARE FOR THE APPLE II, INCLUDING COMPLETE BUSINESS SYSTEMS

FOR FURTHER DETAILS OR A DEMONSTRATION OF OUR PRODUCTS
RING 01-680 4646

SIMON COMPUTERS LIMITED
28 LOWER ADDISCOMBE ROAD, CROYDON,
SURREY CR0 6AA

• Circle No. 141

ADD SPEECH TO YOUR COMPUTER SYSTEM MICROSPEECH 50 SPEECH OUTPUT BOARD

LOW COST £99.50 + VAT

Price includes software on mini floppy disc (6800 Flex 1), operators manual, circuit diagrams and postage (in the UK). **MICROSPEECH 50** enables your computer system to generate a speech output. The text to be spoken is entered in the form of phonetic spelling. Using the 'Synthesis by Rule' technique, the MSP5 software converts the phonetic code into control parameters that drive an electronic model of the vocal tract. The output of this model is synthetic speech. Unlike other techniques, this method has very low memory requirements for the text, and is capable of generating an unlimited amount of speech.

FEATURES

- Plugs into the SS50 bus on the SWTP 6800 computer system. It fits into the main 50 way slot, being the same size as a memory board.
- MSP5 software uses only 4K of memory.
- 9 parameter vocal tract model.
- Real time software converts phonetic spelling to speech.
- External input for special musical effects.
- Software includes male/female voice option, repeat function, and text editing.

AVAILABLE FROM:

TIM ORR Design Consultant
55 Drive Mansions, Fulham Road, London SW6
Tel: 01-731 2077

• Circle No. 143

Last year we tested or reviewed 141 PET programs, evaluated 54 peripherals ranging from light pens to printers, and ran 27 major articles on PET programming. Our gossip columnist blew the gaffe on dozens of inside stories, receiving two death threats, five poison pen letters and a dead rat for his pains. We also published 53 letters from PET users, 88

THE TRUTH ABOUT THE PET

listings, 105 programming hints, and 116 news stories about the CBM/PET.

All this added up to more than 150,000 words of essential PET information. We are PRINTOUT, the independent

magazine about the CBM/PET. Shouldn't you subscribe?

£9.50 buys you the ten issues of Volume 2 (1981) or the complete set of Volume 1 (1980). Simply send us a cheque, postal or money order or the number of your Barclaycard/Visa, Access, Mastercharge or Eurocard. We also accept credit card orders by telephone on 0635-201131. Sample copies of the latest issue are available at £1. All prices include UK postage.

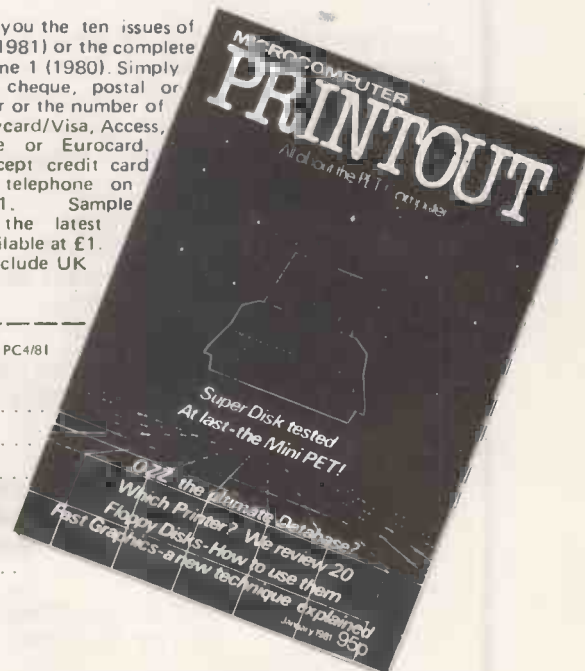

To PRINTOUT PO Box 48, Newbury, Berkshire RG16 0UJ, England. PC4/81

My Name is
 Address
 Postcode

Please Enter my Subscription to : Volume 2 (1981) Send me the set of Vol 1 (1980)
 I enclose my cheque or Postal Order OR
 Debit my Access/Mastercharge/Eurocard/Barclaycard/Visa account No.
 UK £9.50 Eire £12.50 Punts Europe (surface) £14.50
 Europe Airmail £18 USA Airmail \$45 USA (surface) \$36
 Rest of World Air £25 Rest of World (surface) £14.50
 Send me a sample copy UK £1 Europe Air £1.50 USA Air \$5
 Send me . . . binders @ UK £3.50 Eire £4.50 Punts Europe £5 Rest of World £7.50 USA \$19

• Circle No. 144

Da Vinci Computer Shop

65, High Street, Edgware, Middx HA8 7DD.

Open

Mon-Fri 9-5.30

Sat 9.30-5.30

Tel 01-952 0526



NEW PRICE PETS

CBM 32K £695.00
 CBM 3040 FLOPPY £695.00
 CBM 3022 PRINTER £425.00

SALES/PURCHASE -
 LEDGER ACCOUNTING
 INCOMPLETE RECORDS

WORD PROCESSING
 INVOICING - PAYROLL

STOCK CONTROL
 INFORMATION RETRIEVAL

NEW 80 COLUMN
 SCREEN PET
 £895.00
 NEW 1MEG DISC
 DRIVE £895.00

QUME SPRINTS
 DAISY PRINTER
 £2115.00



OUR SYSTEMS ARE MASTERPIECES - COME AND SEE THEM!

• Circle No. 145

VISIT US AT OUR NEW ENLARGED PREMISES



MICRO BUSINESS CENTRE

1ST FLOOR LEWIS HOUSE LINTHOUSE LANE
 WEDNESFIELD, WOLVERHAMPTON
 TEL. WOLVERHAMPTON 725687

FOR BUSINESS EDUCATION OR
 LEISURE USE —
 CONSULT THE EXPERTS!

* NEW ITEMS IN STOCK *

- 8" DISK DRIVES
- 3.3 D.O.S FOR 5" DRIVES
- QUME SPRINT 5 DAISY WHEEL PRINTER
- OKI 82 + 83 PRINTERS



* SEND FOR OUR COMPREHENSIVE
 SOFTWARE BOOKLET *

LOTS OF NEW GAMES, BUSINESS PROGRAMS LISTED.

• Circle No. 146

a special 24~page supplement in *Elektor*

THE 16-BIT PROCESSOR

The new generation of 16-bit microprocessor systems can equal or even better the performance of present day minicomputers. This means that a 'real' computer is now within the reach of any enthusiast. The only question is: "Which system do you choose?"

The April issue of *Elektor* contains a special 24 page supplement giving a brief survey of the field, concentrating in particular on the following types:

Manufacturer	Type	Second sources
Intel	8086	Mitsubishi, Mostek, Siemens
Motorola	68000	Hitachi, Rockwell, Thomson
National Semiconductor	16000 family	
Texas Instruments	9900	AMI, ITT
Zilog	8001	AMD, SGS-ATES

Comparisons are given of the basic capabilities, register sets, addressing modes, instruction sets, memory maps and support chips. The article has been checked for technical accuracy by specialists from the respective manufacturers.

elektor

April issue on sale now, price 60p.
 Or direct from address below, price 80p (inc. 20p P&P)
 Elektor Publishers Ltd., 10 Longport, Canterbury, Kent CT1 1PE.
 Tel. (0227) 54439/0

• Circle No. 147

If this ad. doesn't convince you that **Epson** produce the **worlds' best** low cost quality printers...

- the **FREE** printout samples will!!

THE MX 80 FT/1

- both single sheet (friction) and continuous (tractor) feed & 9 wire head with true descenders

£399 + VAT

THE MX 80 FT/2

- as MX80 FT/1 and with HIGH RESOLUTION GRAPHICS

£449 + VAT



Ideal for
PET, Apple,
Sharp, TRS80, Video
Geni, RM 380Z, Nascom,
Superbrain and most Micro's

THE MX 70 T

- budget printer, tractor feed 7 wire head, and HIGH RESOLUTION GRAPHICS

£259 + VAT

MX80 Features include:

- *True Descenders - 9 x 9 dot matrix for sharp legibility.
- *Emphasised and Double Characters - solid characters, a real must for word processing.
- *Dual Paper Handling - ideal for long print runs or single sheets with up to 3 copies.
- *Systems Flexibility - full range of optional interfaces and graphics ROM's.
- *International Versatility - internally selectable characters UK, USA, French and German.
- *Full Graphics Capability - 64 graphics blocks and on MX80 FT/2 high resolution graphics.
- *Fast through-put - 80 characters per second, bi-directional, quasi start line logic seeking.
- *Full Control - with a variety of print densities to 132 columns and top of form, horizontal and vertical tab controls.
- *Reliability - Precision engineered quiet operation. Full twelve months warranty.

Call us for your local dealer or return this coupon.

To: Micro Peripherals, 61 New Market Square, Basingstoke, Hants.
Please send me full details of the EPSON range including printers.

Name..... Position:.....

Company:.....

Address:.....

.....PC4

(BLOCK CAPITALS PLEASE)

THE EPSON DISTRIBUTOR

Micro Peripherals

61 New Market Square,
Basingstoke, Hampshire RG21 1HW

Tel: 0256 56468 (4 lines) Tlx: 858575

Ring lan for up to the minute prices and technical information on a whole range of Japanese Micro Products

• Circle No. 148

Is it time you had an Electronic Assistant in the office?

The micro chip has brought affordable computing to the small business and professional practice, as well as to individuals and departments in large organisations. Desktop computing is now a practical reality for a host of tasks that were too expensive or impractical on big computers. The microcomputer has become an Electronic Assistant in the office.

Number Cruncher

An Electronic Assistant can help collect, store, calculate and analyse numerical data. Microcomputers are aiding accountants, actuaries, administrators, analysts and architects. Budgeting, pricing, costing and estimating are just a few practical applications.

Word Processor

Change the disc and your Electronic Assistant becomes a word processor. It will help with proposals, contracts, reports, documents, price-lists, mailing and all those other wordy office tasks.

Information Retriever

Your Electronic Assistant will keep a file of personnel, pupils, properties, patients. Find what you want, when you want it. Match people to jobs, children to schools, buyers to houses, patients to treatments. Retrieve files and print information at the touch of a button.

Business Minder

And of course your Electronic Assistant will help mind your business. Send bills, keep

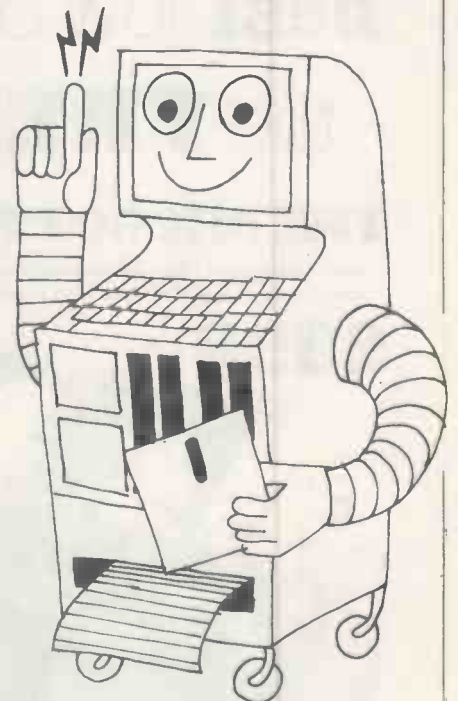

accounts, process orders, take stock. Give you time to look at the business information you've never had time to analyse properly.

Micros Can Grow on You

Microcomputers are cheap enough to add a second machine as jobs grow. Replicate them to perform similar tasks in different locations. Link them together in a local network. Program them to talk to big computers.

Ask Digitus to advise you and supply an Electronic Assistant to suit your present and future needs.

Call: 01-405-6761 or write for information to: Digitus Limited, 9 Macklin Street, Covent Garden, London WC2.

DIGITUS – ELECTRONIC ASSISTANTS IN THE OFFICE

Digitus

Digitus specialises in microcomputing, communications and the electronic office. The Company provides complete systems for the small business, professional practice and large organisation. Costs vary between £3,000 and £30,000 per system depending on facilities. We acquire software packages and equipment from all over the world to satisfy requirements and have the capability to put machines and software together, adding the special features you need.

• Circle No. 149

The business of education

MUCH FUSS IS made about the many questions created by micros in the field of education. Indeed, the whole subject makes one think. It seems that in this area, more than anywhere else, micros will first make a deep impact on the philosophy of civilisation as we know it. What, briefly are the issues? How do micros affect the business of education?

Firstly, a microcomputer can be used as a tool to reduce and standardise the teacher's work. This is nothing new. After all, a textbook is just such a tool: instead of 10,000 teachers explaining how to do long division, or relating the glories of the British Raj, the text book does it once. The pupils learn the same technique or the same political view of history, and at much reduced price. Even in these expensive times, each copy of a book costs less than a teacher/day.

Much noise was made a decade ago about programmed learning with machines that performed — rather crudely — just the function a micro might in presenting course material and testing students on their comprehension. It turned out that the television was less effective than Sir or Miss.

For all the enthusiasts' claims that computers can present material at the student's pace, can adapt to his strengths and failings, the software is not available to do the job, and even if it were, an eight-bit machine would not be sufficiently powerful to mimic the teacher well enough to be worth the money. Which is what is required. It is probably something we shall have to wait for until the Cray-on-a-chip is available, running a cerebral emulator — a piece of software we do not expect to review this decade.

It may be that as micros become as cheap and prevalent as people threaten — they sometimes sound like the plague of locusts in Egypt — there will be some routine teaching jobs they can do. Yet as so many people have found in computing, the job of teaching is one which is harder than it looks. The good teacher needs to be showman, clown, tyrant, philosopher and friend as well as a regurgitator of information. In fact, that, which the micro can do satisfactorily, is the least of his functions. Secondly, we obviously need to teach children to use micros. What does that involve and how should it best be done?

For all that the mainframe industry has told us for 20 years, computing is not difficult. It is merely tricky, and, as software becomes friendlier to its users, it should become increasingly less so. The only difficulty is in learning to think "computish" in the beginning. That is, to think through precisely what you want to do and to express it in terms a diligent idiot can follow. Once you learn to do that, the rest is relatively easy. The arguments about Pascal versus Basic, standardisation, portability and what have you are all fal-lals.

How should this skill be taught? In essence, it is an attitude to problem solving which is inculcated by solving a few computing problems. It is probably not something that needs to be taught formally — if computing power is available, children will teach themselves and each other the way they teach each other about sex. Adults may think they are doing something with their biology lessons and sex education classes, but really the kids learned it all in the garden shed years ago.

It is far from certain that all the apparatus we see gathering around computer education is useful, necessary or even relevant. The best way of teaching children is to give them

computers and let them develop a subculture among themselves. Thirdly, what effects will the touted prevalence of microcomputers have on education as a whole, even on those who never intend to touch a machine?

It might be worth remembering that full-time schooling, for everyone up to 16 at least, is a very recent idea which only really got started during the industrial revolution. Once children had been outlawed in factories and the mines, they had to be put to school to keep them out of the machinery.

Before it started, children were regarded as small adults — charming enough in their way, but subject to disabilities of size, strength, manners, discretion and general *savoir-faire*. The sooner a child learned how to be an adult, the better for all concerned. How much of our present curriculum is routine marking time, designed to keep the little dears out of grown-ups' hair?

That is certainly how it seems to the children, and looking back on personal experience, it seems that there was a compulsory wait, agonising for everyone, between the time the child was 12, able and willing to start adult life and the time he or she was 16 and legally allowed to do so. Of course, many of the poor things go on being educated until their early or mid-twenties — a whole decade of wasted energy and enthusiasm.

What is education for? Deep down it is, as they say, to inculcate habits of honesty, sobriety, co-operation, application and all the other -ions which make life less fun than it might be. Also, the child learns a number of useful techniques such as long division, reading words of six syllables, how to say "Hullo sailor" in Latin — will our classicists accept *salve naute*? The argument no doubt goes that learning the detail of the latter in the wholesome community of the school automatically produces the good effects of the former.

Two difficulties arise. The first is purely practical, in that the techniques which used to give people so much wholesome trouble to learn are now apt to be automated before they need them. Why bother to learn how to do arithmetic when chips will do it for you; how to say hullo sailor in a foreign language, if a hand-held speaking database will say it for you? What techniques can we make children learn so they benefit from the process of learning, at least — if not of the thing learnt — which they can be persuaded are worth learning? Because, willy nilly, one must have some co-operation from them.

The second problem flows from the first: if there are no techniques which are going to stand still long enough for children to get the benefit of learning them, is there any justification for wasting many of their best years in classrooms?

Would it not be better to return to the pre-industrial system, in which children learned about life at first hand from their parents and their businesses or, if they wanted, by sitting at the feet of noted masters? "That's all very well", the educationist will reply, "and suited to a society of farmers and cottage industries, but quite inappropriate to the modern industrial state". To which we would answer that the micro will bring back cottage industries; that the modern industrial state is quite visibly crumbling before our eyes; that the most prolific programmer is an enthusiastic 16-year-old. Why waste his time with A levels when he could be earning good money and making his elders rich into the bargain? □

Our Feedback columns offer readers the opportunity of bringing their computing experience and problems to the attention of others, as well as to seek our advice or to make suggestions, which we are always happy to receive. Make sure you use Feedback—it is your chance to keep in touch.

Buying the best

D MALTBY in Feedback, January 1981 makes an interesting and often-repeated point — he suggests that schools and other educational establishments should buy only U.K.-manufactured micros and peripherals. It is a point which can be heard in many industries, but it is not as simple as that.

With limited finances, among other things, you cannot afford to buy all the products you might feel you "ought" to. You should buy the best computer for the job, not just any old thing which happens to have "Made in Britain" on it.

We all know how many brilliant ideas there are in the U.K., in microcomputing and many other areas, yet can you find backing for a good idea? Is the Government pumping plenty of money into the computer industry like the Japanese and other administrations?

If we developed our computer industry as other countries have done, there would be no need to suggest that people should buy those items only if made in the U.K. — everyone would buy them simply because they were best, and made the most sense economically and technically.

If the present Government was not so interested in running things down, throwing people out of work, and cutting back essentials, and was more interested in starting things moving more sensibly by encouraging investment and the manufacture of the better products we know Britain can make, we would have not only an even more exciting British computer industry, we would not be the last country in the world to emerge from the recession.

Richard Elen,
London SW11.

Noughts and crosses

MANY THANKS to W N James for his excellent 3D noughts and crosses program in your January 1981 issue. I have made some slight changes to it which may interest other readers.

The changes add fun to the game so that on the first time through, you can beat the machine although it is still a difficult task. The second time through, however, the original program is played — I have yet to beat it.

Each subsequent turn is alternatively easy and then difficult, quite frustrating for someone watching you win and then playing the next game. I have added line 14 to clear the screen before play commences but it could be omitted if desired.

The program will now run as follows:

the first time through, the first set of data, line 15, is read. When a win or a draw is encountered, the program goes to line 6000. The keyboard is set to look for key 1 to be depressed. Line 6005 sets A to 1 — A is zeroed when initial RUN is pressed — and line 6025 checks for A=2?, i.e., the second time the game is played.

Line 6030 says GOTO 10 NOT RUN for the next game, ensuring that A is not re-set to zero and the second set of DATA, line 20, is now read. After the second game, A will equal 2 and the program will GOTO 6050 which, if key 1 is pressed, will RUN the program, zeroing A and reading the first set of DATA, line 15, again.

Although exceeding James' limit of 2K memory, the program will still run in 4K, in fact it uses about 3.25K. Many thanks for an excellent magazine.

Here are the changes to existing lines:
210 IF MC = 64 THEN PRINT "THE GAME IS DRAWN": GOTO 6000
5000 IF D = 16 THEN GOSUB 2000:PRINT:PRINT "I WIN": GOTO 6000
5020 IF D = 81 THEN PRINT:PRINT "YOU WIN": GOTO 6000

Re-number line 30 to become line 9, line 30 is no longer there. Add the following lines:

```
14 FOR X=0 TO 25:PRINT:NEXT X
15 DATA 3,10,2,14,9,98,4,100,27,90,8,100,
6,-14,10,-9,12,-10
6000 K = 57088: POKE 530,1: POKE K,127
6005 A = A + 1
6010 PRINT:PRINT "FOR ANOTHER TRY"
6020 PRINT:PRINT "PRESS 1"
6025 IF A = 2 THEN GOTO 6050
6030 IF PEEK(K) = 127 THEN GOTO 10
6040 GOTO 6030
6050 IF PEEK(K) = 127 THEN RUN
6060 GOTO 6050
```

Sgt. L R Cuff,
RAF,
BFPO 45.

Unsatisfied customer

I WAS very pleased to see your tirade, February 1981 editorial, against the ready-next-week promises which mean nothing of the kind. I, too, have had more than my share of them. Could I make some suggestions:

- You refuse adverts from companies which have a tradition of broken promises.
- You publish a list of those companies which follow the good business practice of not cashing your cheque/debiting your credit card until the goods are dispatched.

I realise you could well lose many of your advertisers by doing this. However, I feel there is very little that I, as a mere customer, can do. My letters of complaint

simply go unanswered, and telephone calls bring the inevitable "ready next week"

M J Baker,
London W7.

• If you have a complaint about an advertiser, write to *Practical Computing* with the details. We always do our best to solve any problem.

Basic issue exhumed

ON THE whole, I must agree with John TeSelle's comments in his letter, Basic Burial, in the January 1981 issue, but I think it only fair to point out that many people use a computer as a necessary evil in the course of some study programme, and the quicker one can obtain a working knowledge of the language, the better.

I feel that Fortran, with its rigid input and output formats and precise data descriptions, is learned more easily when one has a working knowledge of a simpler language and an appreciation why this simpler language fails in some processes.

When choosing a language for a particular task, it is very much a case of "horses for courses" and Basic is an easy-to-learn, very useful multi-purpose language. The only area in which I would criticise Basic is in its application in the personal computer where the facilities offered by the language are very much hardware-orientated, making programs less portable.

At the systems company where I work, we find that engineers explore general problems using Basic, systems analysts perform more detailed work in Fortran, and our professional programmers, as one would expect, have a favourite language, but are able to select and work with the most suitable language for the task.

G J Bell,
Haslington,
Cheshire.

TRS-80 Level 3 Basic

AS THE author of the Level IV enhancement to the Microsoft TRS-80 Level 3 Basic, whose marketing by Kansas and subsequent legal proceedings with Mollerx have attracted so much attention by the media, I would like to make a few observations.

Firstly, the extra commands I incorporated were designed to correct what I judged to be major deficiencies in Level 3 as it was marketed. When first written, most TRS-80s which had the expansion

(continued on page 44)

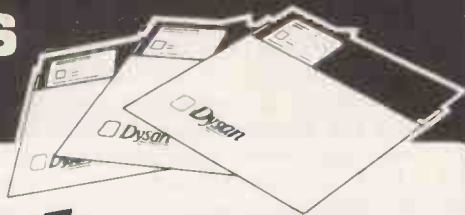

Dysan Diskettes **FROM STOCK**

30,000 Diskettes is our stock level !

FOR IMMEDIATE DELIVERY

Call Ann Perkins or Dan Taylor
on **Dysan Hotline: Weybridge (0932) 48346/7**

HAL COMPUTERS LIMITED

57 Woodham Lane, New Haw, Weybridge, Surrey KT15 3ND.

TWO SUPPLIES HOTLINES!

MICRO! USERS!

**The Solution to your
Short-Run Form problems!**

- * Single and Multi-Part Forms from our standard sizes to suit your systems. From 1000.
- * Word Processor Letterheads (tractor or friction feed).

- * Self Design Layout Sheets.
- * Full Artwork Service.
- * Listing Papers, Word Processor Papers, Self Adhesive Labels.
- * Diskette Storage Systems.

Small-User Packs of Listing Papers

(depth x width)	500 sheets	1000 sheets
11" x 9 1/2" (plain or green music line)	£ 6.00	£ 11.75
8" x 9 1/2" (plain only)	£ 5.50	£ 10.50
11" x 14 1/2" (green music line only)	£ 6.00	£ 11.75

These prices INCLUDE VAT and P & P - CASH with order please!

Call Bob Humphrys or Richard Wells
on **Forms Hotline: Weybridge (0932) 48218**

PRINTOUT BUSINESS FORMS

57 Woodham Lane, New Haw, Weybridge, Surrey KT15 3ND.

Printout Business Forms

(continued from page 42)

interface fitted suffered from frequent re-boots causing the loss of any Basic program in memory. It seemed ludicrous to me that a 17K interpreter could not at least recover the resident Basic program after a re-boot. That was corrected.

The Microsoft re-numbering routine in Level 3 increases the size of the resident program by always allocating room for a five-digit line number whenever they are referenced. Considering that the user has sacrificed 5K of RAM to accommodate Level 3, it seemed to be doubly wasteful, so a space-removing routine was added.

Again, with 17K of interpreter which claimed to provide all the most useful disc Basic commands a non-disc user could want, one could reasonably expect to find a program merge utility. Unfortunately, Microsoft did not include one, so that was added.

Finally, for those of us not blessed with bionic eyesight to keep up with the speed at which the TRS-80 scrolls program listings, etc., a command was provided which gave 10 speeds to the video output from flat-out to near dead-stop.

All of these routines were incorporated into Level 3 without taking any further memory by more careful use of RAM and the avoidance of duplicate sections of code. It is unfortunate to my mind, that this software, which undoubtedly was satisfying a need, has now disappeared from the market to the detriment of the TRS-80 user.

L A Shields,
Chesterfield,
Derbyshire.

British robots

THE British Amateur Robotic Association, which has been recently formed, will help those interested in all aspects of robotics to exchange and share new ideas and discoveries. Write to: BARA D Stocqueler, 66 Waterloo Rd, Penylan, Cardiff, South Glamorgan.

There is no membership fee but a nominal fee will be charged each month to cover the cost of producing a monthly newsletter.

D Stocqueler,
Cardiff.

Paragon for authors

BEFORE submitting a program to *Practical Computing* for publication, I would advise all authors to compare their documentation to that of Jonathan Dick. Apart from the usefulness of the program, his article, Incorporating a control-key function into your programs, January 1981 issue, is a lesson to all authors on how to explain a program. In particular, he tells the reader:

- The background to the program.
- How to call the program as a sub-routine, and what it returns to the main program.
- A clear explanation of how the Basic program works.

- Useful references to POKE locations for Pets with old ROMs.
- Suggests an application for the program.

Having read this clear and concise explanation of the Basic version of the program, his sensible comments and mnemonic labels make the assembler version understandable — even to those who may not be familiar with 6502 assembly language.

A final point — too many listings published have the spaces left out, rendering them nearly unreadable. Apart from one line, which is very full, Dick keeps his program very readable by the plentiful use of spaces. Well done, Jonathan Dick.

Mike Bruce,
Hounslow,
Middlesex.

Lesson in schooling

WITH reference to the statement in the January 1981 editorial that schools still use punch cards for computing, I would like to point out that many universities and colleges also still use them.

It is not totally to do with lack of money, although a major reason, but because, in business computing, punch cards are still the norm. The point is that it is not just computing which needs to be taught in schools but microcomputing.

Schools are just beginning to include computer science in their curricula. Schools should be teaching pupils that computers are common objects which can be small and easy to use, rather than being something large, indistinct and far away in a university and which seem to take two weeks to run a simple program.

Unless microcomputers are used in schools, the two fields of computing, in the sense of business data processing, and personal computing will not merge.

If they succeed and we have a young generation aware of personal computers, the micro revolution will have truly arrived.

A W Black,
Coventry.

Varied reactions

MARTIN HAWKINS in December 1980's Feedback columns provoked several reactions in me. First, I was moved to tears by the negative attitude of the letter. Next followed a strong sense of incredulity and annoyance. I agree with many of the statements in Hawkins' letter: programming is an art, and many find that it is beyond them. However, he and I view the situation from completely opposite ends of the spectrum.

First, I have a bone to pick about his statement that ZX-80s, Pets, Apples, Tandys are not suitable for more than the simplest operations. Certainly, a 4K TRS-80 Level I may not run your business, but can he truthfully claim that, for instance, an Apple II with Winchester discs and 48K is "not suitable for more than the simplest of operations"? Perhaps the reason for *Practical Computing's* constant present-

ation of machines such as ZX-80s, Pets, Apples, Tandys, etc., is because each one outstrips by far his Digico Micro 16 in sales.

Something else which caught my eye in his offering was the statement that "most of them (programs) are unusable and irrelevant in the average office". The reason *Practical Computing* is full of games and other light-hearted programs is because they are interesting. You above all people must realise that programs written for the "average office" are anything but this. For those masochists who prefer the sales production work-scheme analysis-type program, I refer them to less riveting magazines.

In my opinion, computers were invented for *Breakout*, and not the reverse. Whoever twisted their use to invoicing and general ledgers was a maniac, and a suitable candidate to be taken out and shot at dawn. Hawkins seems to think that a computer's main use is in boring data-crunching.

The "fun market" Hawkins mentions has made many a boffin rich. I hope the cynical observation that *Practical Computing's* future may lie there turns out to comply with that painful proverb — many a true word spoken in jest. I am proud to be a part of that wonderful section of society — amateur computer boffins.

I have reservations as to whether the expansion of computer usage of which Hawkins so whimsically speaks is altogether a good thing. I support wholeheartedly increased productivity created by computerisation, but frankly, I do not want to be told how to use my hex digits, or that my floppy tape is not switched on. I much prefer to be considered as a kind of electronic freak and to be left alone.

To sum up, I think the sooner a more liberal and accepting attitude is adopted by the computer industry to enjoyment, the better protection it will be for those of us who like messing around in bytes.

Mark Wood,
Wakefield,
West Yorkshire.

Educational game

I WAS most interested in the article concerning the quality of mathematics education packages, January 1981, by M P Thorne. In it, he describes a game, How the West was won, and states that it is not available on microcomputers — at least not from commercial sources.

We implemented a version of the game for the Pet some time ago, so it certainly is available on at least one microcomputer from at least one commercial source. Mind you, we know the game under the title, Mathstrek. Also, we have found that there has been remarkably little interest in the game. Perhaps we should rename it and try again.

Graham Browne
Pi-Lok Systems Ltd,
Heywood,
Lancashire. □

Buying Computers?

Commodore PET 32K
£675.75 plus VAT

Sharp MZ-80K
£480.00 plus VAT

ITT 20/20 16K
£607.00 plus VAT

ACT 808 inc dual
disk drive
£3950.00 plus VAT



ACT 808 inc dual
disk drive
£3950.00
plus VAT

We'll give you more than a good deal

Under one roof In London's West End you can find:

HARDWARE:

A comprehensive range of hardware to meet most applications - and budgets, with terms to suit you.

SOFTWARE:

Probably the widest range of off-the-shelf software in the UK. Try out the packages and choose the one that suits you, or take advantage of our consultancy services and we will analyse, recommend, demonstrate, modify and install the programs for you.

CONSULTANCY SERVICES:

To apply micro computer systems to business, education or the home, make an appointment with our trained professionals for friendly advice based on extensive experience of discussing problems with many others like you.

MAINTENANCE AND REPAIR CLUB:

A maintenance and repair club that guarantees microcomputer users minimum downtime at very attractive premiums.

REFERENCE MATERIAL:

A library of publications covering all aspects of the microcomputer world,

including back issues of this and other important periodicals.

Whether you are an experienced micro user or a novice, looking for a system for the home, business or pleasure, the **LION MICROCOMPUTER CENTRE** is the single source to meet all your requirements.

CALL IN ANY TIME. We are open six days a week, for you to take advantage of the good deal you get when you buy from **LION**.

The above prices do not apply to account sales



LION MICRO-COMPUTERS

SMALL COMPUTERS - TO MAKE YOUR BUSINESS BIGGER
Lion Computer Shops Ltd, Lion House, 227 Tottenham Court Road,
London W1 (First Floor). Telephone: 01-637 1601.
Telex: 28394 Lion G.
Open 9 to 6, Monday to Saturday (Thursday to 7).



• Circle No. 151

Disc-based HP-83 can run VisiCalc Plus

A NEW personal computer has been introduced by Hewlett-Packard. The computer, the HP-83 which costs £1,210, is identical to the HP-85 computer introduced in January 1980 except that the HP-83 does not have an integrated magnetic tape cartridge drive and integral thermal printer. It is aimed at those users who want a disc-based system and an external printer.

Like the HP-85, the HP-83 is a typewriter-sized computer with an integrated high-resolution CRT and keyboard, enhanced Basic and graphics capabilities. Two types of Hewlett-Packard floppy disc drives, providing storage from

Cobol now for Z-8000s

THE FIRST Cobol for Z-8000 16-bit microcomputers has been installed on the Onyx Systems C-8002 microcomputer. It is running under Onix, the Onyx version of the Western Electric Unix operating system. The Cobol has been supplied by Ryan-McFarland which is now planning releases of Cobol for the 8086 and 68000 chips. □

270KBytes to about five megabytes, can be connected to the machines. A Hewlett-Packard printer and plotter can also be connected.

New peripherals for the Series 80 systems include a graphics tablet for £1,071. The range can also support the new Hewlett-Packard VisiCalc Plus — an enhanced version of the popular software package which lets the user produce

four-colour charts and graphs from VisiCalc tables. VisiCalc Plus also features about 20 other functions not available on other VisiCalcs. These financial, statistical and maths functions include internal rate of return, standard deviation and variance.

On the software front, Hewlett-Packard has released an assembler ROM for the Series 80 for £159. □

Consultancy centre aims to help confused business users

PUZZLED businessmen may find assistance at a new micro-computer consultancy centre, which has been opened in the heart of London under the auspices of the National Computing Centre, NCC, Manchester. The idea of the centre is to provide a stock of literature, representative machines, software and knowledgeable people who can give advice to those who need it.

The enquirer can just walk in and browse, can pay a few pounds to experiment with a micro or can have a personal

consultancy with one of the Centre's staff for something like £25 per hour.

Alternatively, one can pay a £50 annual subscription in return for the same services, including microworkshops and a regular supply of information and advice about microcomputers.

The third part of the plan is designed to aid all those puzzled businessmen who do not live in London. The director of the new centre, Derek Scriven from the NCC, hopes to set-up a federation of the 40

CAD82 call to authors

THE FIRST call for papers has been issued for the CAD82, the Computer-Aided Design conference and Exhibition which will be held in Brighton in March 1982.

Authors should submit four copies of full papers, in English, not more than 3,500 words long, by Friday July 31, 1981 to Alan Pipes, Conference Organisers, IPC Science and Technology Press, PO Box 63, Westbury House, Bury Street, Guildford, GU2 5BH or call (0483) 31261. □

or so existing micro-consultancy centres, mostly in colleges and polytechnics, and encourage them to share standards, information and form a pool of expertise.

The experiment was originally the idea of Ian Litterick who first proposed it to the Department of Industry in January 1979. The service was introduced by the new Minister with responsibility for information technology, Kenneth Baker. His department has provided £250,000 over three years to help the project find its feet. The Centre is eventually supposed to be self-supporting. The official opening date is April 2 and the address is 11 Fetter Lane, London EC4. □

Zork fantasy game

THE LATEST and biggest micro-computer fantasy game, Zork, is now being sold by Personal Software in the U.S. Zork has a vocabulary of more than 600 words including nouns, verbs, adjectives, prepositions, articles and conjunctions. That means Zork can "speak" and understand many basic English sentences.

Zork is available from Personal Software on 5¼in. diskettes for the Apple and the Tandy TRS-80 computers with 32K of memory or more. The U.S. price is \$39.95. □



Two new business computer systems have been introduced by Olivetti, the company which claims to have a 52 percent share of the small business computer market. The two systems in the BCS 2000 range are similar to the existing Olivetti range of business computers but include a full-sized VDU. The BCS 2025 and 2030 are stand-alone units with double-density 1 megabyte floppy discs. The 2025 has a 13in. cps printer and a manual ledger card feed. The 2030 has an 18in. 100cps printer and an automatic card feed. Olivetti is promoting the range as a way of preserving traditional accounting systems such as ledger cards. The two computers will cost between £7,000 and £10,000. More details from Olivetti on 01-629 8807. □

Commercial satellite plan

BRITISH Telecom has announced its plans for an inexpensive business satellite system which will use a geo-stationary bird and dishes 10 to 13 ft. in diameter on the ground. The cost will be £250,000 for a full-feature ground station down to £20,000 for receive only. The service will be available from 1983. □



One of the latest trends seems to be making cases for Apple and ITT microcomputers to make them easier to carry without all the usual packing and unpacking. The Apple distributor Microsense has produced two cases: one contains the Apple and two disc drives; the second one holds a monitor. They cost £39.50 and £19.50 respectively. Another case which can store an Apple, a single disc drive, a smallish printer, a cassette recorder and various bits and pieces has been released by Phoenix Management Services of Beckenham in Kent which says it is now making a case for the Sinclair ZX-80 computer. □

Tipping the scales in favour of accurate weight records

EVER SINCE the new Weights and Measures Act was introduced at the beginning of 1980, there has been a strong market for weighing systems which automatically keep records of sample product weights from, for example, manufacturers of tinned beans. Under the require-

ments which are specified in the new Act, any goods which are sold by weight have to have their average weight marked on the container, whereas under the old Act the requirement was minimum weight. Although the change means savings for the suppliers, the burden of responsibility for ensuring that the goods supplied fall within the limits of the stated weight shifts away from the Government inspectors to the manufacturer.

The manufacturer now needs to take weighings of a sample of the goods leaving each production line and be able to produce the records of each weighing. Hence the market for automatic weighing and recording systems.

Many products have been designed along these lines and the latest connects the Apple II microcomputer to the Oertling electronic balances. The software for data acquisition, filing and statistical analysis is also available from the supplier, U-Microcomputers.

The company has also just received a contract to provide

an Apple on-line to a Gamma counter in the pathology department of a hospital. The contract apparently involves a substantial amount of software which may be of interest to other similar users.

Further details are available from (0925) 54117. □

New 8080/8085 package

A HARDWARE and software package for development work on 8080- and 8085-based systems has been designed to run in conjunction with the Commodore 32K Pet and 3040 floppy disc systems. It is a self-powered unit which plugs into the Pet and can be used to program PROMs of the 2716- or 2732-type.

The software is supplied on a disc suitable for the Commodore drive and is used with the standard Commodore editor which is part of the system for the 6502 microprocessor. The software consists of a two-pass assembler using standard Intel memories — source and object files are compatible with the Commodore 6502 development systems. Formatted listing can be produced on any IEEE-compatible printer.

The cost of the system, excluding Commodore components, is £700. Details from EDI on (0473) 211222. □

Public-domain Comal to stop use of unstructured Basic in schools

COMMODORE has announced the launch of a new structured form of Basic called Comal as public-domain software. Comal is a structured language developed to satisfy educationalists unhappy about the widespread use of unstructured Basic.

The inventor of the language, Danish mathematician, Borge Christensen, is himself a noted computer educationalist who realised that Pascal was not suitable because children tend to become bogged down with its declaration statements and its sheer complexity.

Christensen claims that: "As soon as the teacher's back is turned, children start writing Basic". He saw the answer as a compromise between the two — a language with the simplicity of Basic and the structure of Pascal.

Comal has been in use in

Denmark since 1976, but has been fully developed only recently. The method of development relies on the considerable amount of feedback Christensen receives from teachers and students using the language.

In the five years it took to develop, Comal has rapidly become widely used to the extent that it is the standard programming language taught in Danish schools.

Danish educational authorities have instructed that computers bought with public funds must, as a minimum requirement, have a Comal facility. Because Comal is a compiled language, this entails floppy discs. A tribute to its success is that it is in common use for business applications in Denmark and a large amount of Comal software is available.

Among the features of

Comal is automatic indentation, which clearly shows not only the structure of the program but is also a powerful debugging aid. Other features include IF—THEN—ELSE—END IF, REPEAT—UNTIL — long variable names to clarify their purpose, and true parameter passing.

Multi-branching, dimensional arrays, Boolean functions, file handling, etc., are all possible in Comal. In fact, Comal's links with both Basic and Pascal are obvious to the experienced programmer.

As Commodore is to release Comal as public-domain software, that means any Pet user will be able to copy and use the program without payment of royalties. This policy is part of an attempt by Commodore to establish the Pet as the main computer for the educational sector. □

Superbrain's Teletype role

THE Superbrain microcomputer can now be used as a Teletype terminal thanks to a program, TTY, which has been released by the London-based software house Systematica. TTY also permits the transfer of files to and from other computers and allows users to operate in CP/M while still linked to a host computer.

So far connections, up to 9,600 baud, have been made to IBM, ICL, CDC, DEC, Prime computers and other Superbrains. The one-off cost of TTY is £150. Details on 01-836 9379. □

SUPERBRAIN

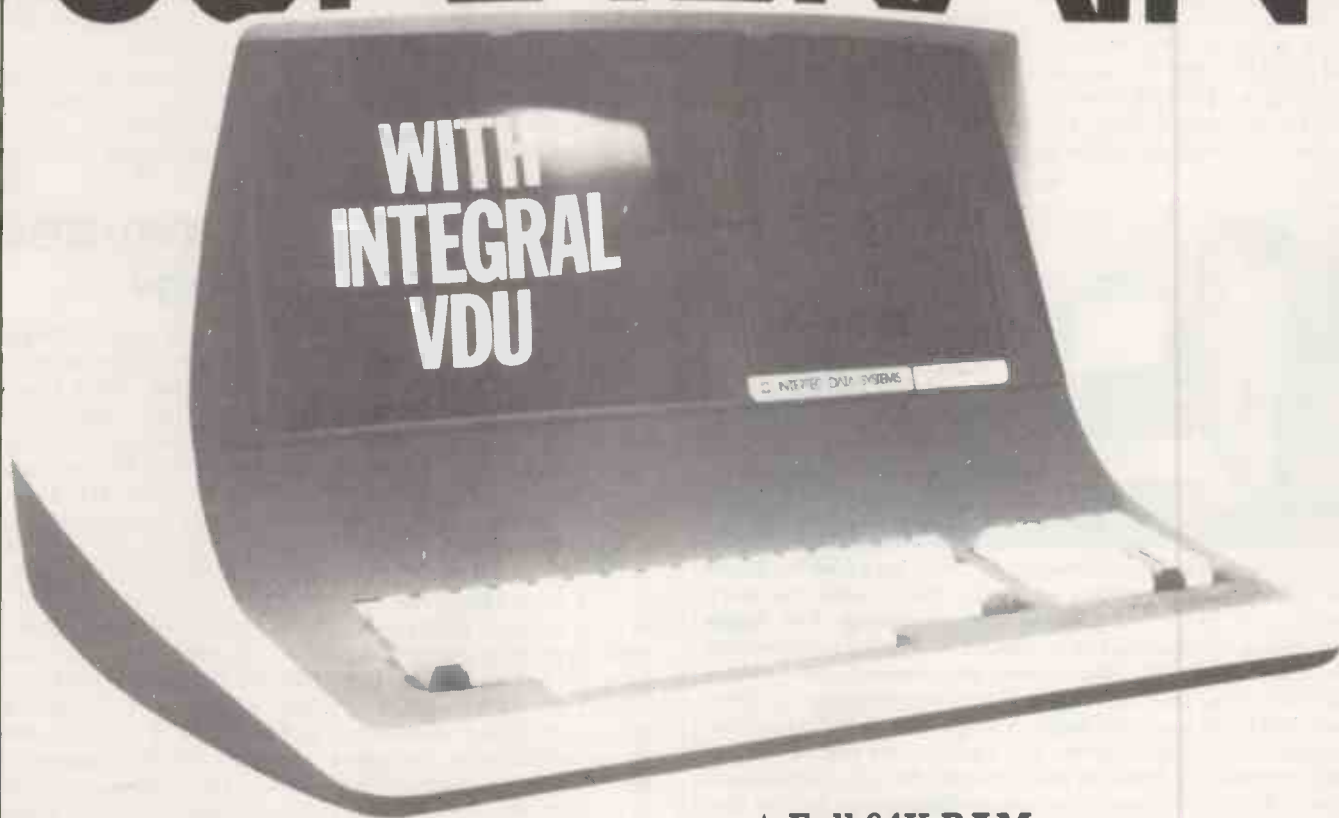

- ★ CP/M™ (2.2) operating system
- ★ Hard Disk available
- ★ Graphics (Prestel type)

- ★ Full 64K RAM
- ★ Twin Z80A microprocessors
- ★ Twin double density mini floppies (320K:670K or 1.54MB optional)

SUPERBRAIN -stand alone system and intelligent terminal combined in a single desk top unit (14³/₈"H×21³/₈"W×23¹/₈"D). Non-glare dynamically focused 12" CRT and Universal RS-232 Communications port. Reverse video. **SOFTWARE PACKAGES AVAILABLE.**

Full **SUPERBRAIN** details from the following dealers:

JAEMMA LTD.,
44 Manor Park Road, Castle Bromwich,
BIRMINGHAM Tel: 021 7474531

JENNINGS COMPUTER SERVICES LTD., 55/57 Fagley Road,
BRADFORD 2, W. Yorks.
Tel: 0274 637867

AERCO GEMSOFT,
27 Chobham Road, WOKING,
Surrey GU21 1JD. Tel: 04862 22881

RECMA COMPUTING
Chelwood House, Thornbury,
BRISTOL, BS12 2JT. Tel: 0454 776150

M.B.M. LTD.,
St. Davids Works,
Pentyrch Road, Casswell,
CARDIFF CF4 8XF Tel: (0222) 810804

COSMOS COMPUTERS LTD.,
Blackhorse Road, LETCHWORTH,
Herts. Tel: 046 26 6861

SHEFFIELD COMPUTER CENTRE,
225 Abbeydale Road, SHEFFIELD,
S7 1FJ. Tel: 0742 53519

MICRO-K
186 Martin Way, MORDEN
Surrey
Tel: 01.669.4150 or 01.542.3371

O.C.T., Kimberley House,
Vaughan Way, LEICESTER,
LE1 4SG. Tel: 0533 28631

COMPUTERISED BUSINESS SYSTEMS, 32/34 Huntriss Row,
SCARBOROUGH, N. Yorks.
YO11 2ED. Tel: 0723 75787

S.D.M. COMPUTER SERVICES
Broadway, Bebington
MERSEYSIDE L63 5ND
Tel: 051.608.9365

COMPUTER SALES & SOFTWARE CENTRE
190/192 Cranbrook Road, ILFORD

BORDER COMPUTING,
Dog Kennel Lane, BUCKNELL,
Shropshire SY7 0AX. Tel: 05474 368

DAYA, 20B West Street,
WILTON, Wilts. SP2 0DF.
Tel: 072274 3898

MICRO SOLUTION LTD.,
Park Farm House, Heythrop,
Chipping Norton, OXFORDSHIRE.
OX7 5TW. Tel: 0608 3256

MICROPEOPLE LTD.,
Microcomputer Consultancy Services,
1 Union Street, LONG EATON,
Nottingham, NG10 1HH.
Tel: 06076 68923

CULLOVILLE LTD., Thornfield,
Woodhill Road, Sandon,
CHELMSFORD, Essex.
Tel: 024 541 3919

PROMGLOW LTD., 12 Dene Road,
New Southgate, LONDON N11 1ES.
Tel: 01-368 9002

OMEGA ELECTRICS LTD.,
Flaxley Mill, Flaxley Road,
MITCHELDEAN, Gloucestershire.
Tel: 045 276 532

AMA (COMPUTING) LTD.,
1 Frog Hall Lane, WARRINGTON
WA2 7JJ. Tel: 0925 33137

ROGIS SYSTEMS LTD.,
Keepers Lodge, Frittenden,
Nr. CRANBROOK, Kent.
Tel: 058 080 310

GARCIA BUSINESS SYSTEMS,
106 High Street, BUSHEY, Herts.
WD2 3DE. Tel: 01-950 6255

ESCO COMPUTING LTD.,
74 Waterloo Street, GLASGOW,
G2 7DA. Tel: 3041 204 1811

DRAGON SYSTEMS LTD.,
54 Mansel Street,
SWANSEA, West Glamorgan.
SA1 5TE. Tel: 0792 794 786

For dealer enquiries, contact

ICARUS COMPUTER SYSTEMS LTD., 27 Greenwood Place, London NW5 1NN.

CP/M™ is the registered trademark of Digital Research.

• Circle No. 152

Recipe for success

RUNNING a bakery should be a piece of cake if a newly-released program, called Master Baker, lives up to expectations. The program has been designed for small bakery chains, with up to 10 shops, and can cope with up to 300 recipes, 250 different ingredients and sales, production and stock reports.

One item on the menu is "recipe costing" which is a system of re-calculating the cost of every recipe affected by a change in the price of an ingredient. The computer report can show the product name and number, the batch cost, the old and new retail price if the profit margin is kept the same.

The options then available are: hold at the old price; change to a new price; and change to an alternative price. When one has been selected, the computer records are updated and a price list printed-out. Master Baker was designed originally for a bureau operation but is now being made available as a complete micro-computer system for about £3,000. Details 01-368 6128. □

A music board for Nascom owners will plug directly into the P/I/O of the Nascom microcomputers and play musical notes over a range of eight octaves. The BBF music-board kit has construction details, test procedures, programming notes and software examples including routines to turn the computer into a live keyboard instrument. It can be programmed in either Basic or machine code, and can be plugged into a stereo system for full sound and driven from most parallel output ports. The kit costs £18.65 and an assembled-and-tested version is £21.65. A music-entry program which includes demonstration tunes and the ability to handle multiple channels is available on cassette for £7.50. Details from BBF on Luton (0582) 35930. □

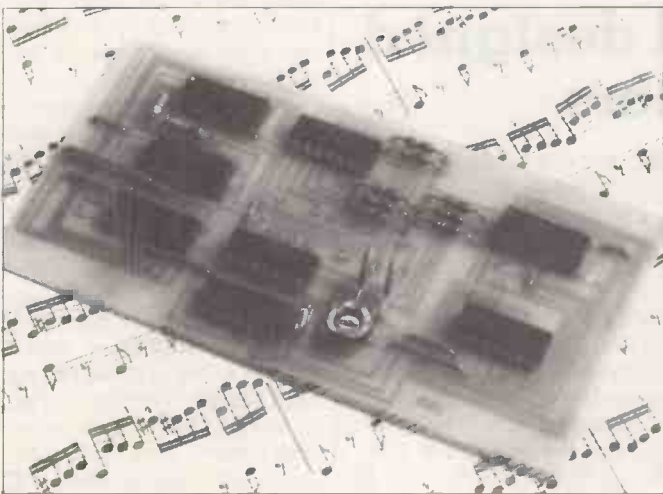

DMS 'solves problem' for WordPro and Wordcraft

ONE OF the limitations of the WordPro and Wordcraft word-processing packages on the Commodore Pet 8000 series computers is that while allowing users to store information, such as names and addresses which are used regularly, there is no facility for selecting categories before printing.

That problem may now have been solved by Comsoft which has linked an inform-

ation storage and retrieval package, DMS, to both WordPro and Wordcraft. It is designed to keep records in any format. The information can be retrieved using several search criteria and can be sorted on any field, either alphabetically or numerically.

The word-processing link allows users to select certain people to write to by asking DMS to search for all those

clients who, for instance, did not buy last month, and who spent £5,000 in 1980 and/or who live in Yorkshire.

Any information in those selected records is then transferred automatically to fill in the gaps in standard letters. Costing £190, the program is available on all 32K Pets and Computhink. A CP/M version is available at £330. Details on (0483) 39665. □

Fully-programmable HP-41CV has big capacity boost

THE top-of-the-line calculator from Hewlett-Packard, the HP-41CV, features five times the memory of the HP-41C and accommodates up to 2,000 program lines. The calculator is fully-programmable and has continuous memory so that programs and data are saved even while the calculator is switched-off. Other features include an alpha-numeric display and 130 functions. The

price of the HP-41CV is £169.35.

The company has also introduced a "super memory module" which plugs into the HP-41C calculator and boosts its memory to the same 2,000 program lines. The HP-41CV, like the HP-41C, has four ports to accommodate peripherals and program modules. Printer/plotters, magnetic card readers and an optical wand for reading bar code can all be added.

The new Hewlett-Packard memory module allows HP-41C owners to increase their machine's memory using only one port, leaving the three other ports free for software modules and peripherals. The

memory costs £49.96 and the price of the 41C has been reduced to £130.39.

Hewlett-Packard is adding to its effort in the calculator market by offering a custom calculator program which can be plugged into the 41 calculators. One example of an application for a customised calculator is with the Beech Aircraft Corporation which has had navigation formulae built into a calculator.

It is used in-flight by the pilot to compute the best altitude for minimal flight time or minimal fuel consumption. A fully-customised calculator should cost about £150 per unit. □

Printers' system will tackle job costing

ONE WAY a computer might find its way into the printing professions is by concentrating on peripheral tasks such as estimating, costing jobs and looking after stock control. The latest effort along these lines is from Sage Systems, Newcastle upon Tyne, which is offering an estimating system based on a 64K microcomputer with dual 5¼in. disc for £4,750. A more comprehensive package including job costing, stock control and a daisywheel printer will cost £8,500.

The estimating program simulates a standard estimating document and covers more than 90 production operations

from copy preparation right through to binding and delivery.

Also, there are 10 standard paper sizes stored in the program so when a job size is entered, the computer compares this to the stock sizes and shows the most economical sheet size, with percentage waste, how many flat sheets are required, the total weight and the total costs.

An ink calculator is included and there are facilities for calculating four different paper stocks for any one job. Sage, on (0632) 761669, claims productivity improvements of at least 50 percent. □

Dot-matrix colour printer at a competitive price

THE LOWEST-COST colour dot-matrix printer in the U.K. has just been released by Integrex, of Burton on Trent. The CX-80 prints in seven colours, with simple code controls, and with 96 ASCII plus 64 graphics characters in ROM.

The CX-80 is fully dot-addressable, has 15 user-programmable characters together with double-length, elongated, and reverse-char-

acter printing. Line feed and form feed are also programmable.

Normal tractor-feed plain paper, up to 10in. wide, is used in this 80-column 60 dots/in., 125 cps printer.

The colours are selected by sending one of seven control codes. All the data sent after the code being printed is the same colour. The control codes are terminated by carriage

return or line feed. There is a tricolour striped ribbon and the printer decides which stripes are printed to produce the required colour.

The end-user price of the printer is £895. Details from Integrex on (0283) 215432. □

Intel's 16K static RAM

A 16K static RAM, with deliveries to begin in the fourth quarter of this year, has been introduced by Intel. The new RAM is the first of the Intel chips to be manufactured using redundant designs to try and increase reliability in manufacturing. □

New S-100 clock works in real time

A REAL-TIME clock/calendar board for use with S-100 bus microcomputers is now being offered by Digital Devices. Known as the CLK-24, the board employs a new LSI CMOS device to provide day of week, date — day/month/year — hours, minutes, and seconds output in either a 12- or 24-hour format.

The board will maintain its time-keeping function even when the main power supply is switched-off since it reverts automatically to a standby mode and draws only 9 μ W from the on-board batteries. The board is delivered running on standby power with the time and date pre-set at the factory. Accuracy is better than 50 seconds per month and the batteries are guaranteed for a year.

Programming the board can be done in either Basic or assembler and standard I/O in-

structions can be used to re-set and read the time and date.

The board could be used in a variety of applications ranging from an automatic event timer in an industrial installation to data logging at pre-set times in a laboratory. In addition, it adds a real-time clock facility to any small business based on the S-100 microcomputers. Details on (0892) 37977. □

Versatile measurement system suits most control applications

ANALOG Devices has launched a single-board, micro-based measurement and control system designed for use in almost any measurement, control or monitoring application.

The versatile μ mac-4000 is pre-calibrated and includes complete on-board signal

conditioning, multiplexing, analog-to-digital conversion, input and output ports, power supply and serial communication to the host processor.

The master board has its own 8085A processor with 6K ROM and 1K RAM, which relieves the host computer of work by performing all linear-

isation, alarm checking and scaling the measurements into the relevant engineering units. Plug-in modules are available for measuring using different types of thermocouples, flow metering, pressure sensing and they can be mixed on one board.

There is also an extension board and several can be clustered so that up to 48 inputs may exist at one remote location.

The power consumption is only 12 watts, so the board could be run from a car battery — making it an excellent choice for remote monitoring in situations where mains supply is not available.

The serial interface can communicate with any host processor via RS232 or 20mA TTY, at a cost of about £80 per input channel. Applications are expected to be found in industrial control and laboratory data-logging among others. □

Speech-synthesis board designed for development engineers

ANOTHER speech synthesis board has been released, although the VSM from General Instruments is aimed primarily at designers and engineers planning the use of speech synthesis devices in future products.

The VSN printed-circuit assembly is pre-programmed to generate up to 32 standard words in any sequences and can be interfaced to any digital

systems. Eight TTL-compatible input signals are required to select the phrase to be spoken. Although the unit has been designed for development work, it can be replaced by a single-speed synthesiser chip for volume production.

The module card contains three main MOS—LSI devices, a pre-programmed single-chip microcomputer, a speech synthesiser and a 32K ROM.

The card is interfaced via a 15-pin edge connector.

The present standard vocabulary consists of words and syllables which can pronounce any number up to one billion and a few other phrases such as "It is", "Error" and the mathematical signs. Other vocabularies will be available for volume orders. The cost is £50 and the details are available on 01-439 1891. □



Every microprocessor and microcomputer family can be supported on a new microprocessor development system announced by VSI Electronics of Harlow. The Phoenix I development station, a product of AMI Microsystems, includes a 12in. VDU, keyboard, integral single mini-disc drives and two RS232 ports and a free-standing external dual mini disc drive. There are 48KBytes of RAM, numeric scratchpad, eight user-definable keys and 48KBytes of RAM and 2KBytes of ROM. Price £3,500, details (0279) 35477. □

CENTRONICS 730

SPECIAL PRINTER OFFER £375 VAT EXCL

STANDARD FEATURES

- | | |
|---|-------------------------|
| 10 CPI | 16.5 CPI |
| • 100 characters/second | • 165 characters/second |
| • 80 characters/line | • 132 characters/line |
| 10 CPI or 16.5 CPI selectable by software command. | |
| Expanded character selection for both 10 and 16.5 CPI. | |
| • 3-way paper handling: A4 cut sheet, paper roll and fanfold. | |
| • 7 x 7 dot matrix | |
| • 96 character ASCII plus five selectable European character sets | |
| • Microprocessor electronics | |
| • Unidirectional print at 10 IPS | |
| • 6 LPI vertical | |
| • Centronics colours and logo | |

INTERFACES

- Centronics Parallel (Standard)
- RS 232/V24 Serial (Option)

RIBBON SYSTEM

Continuous ribbon 9/16" (14mm) wide, 20 yards (18.3 meters) long Mobius loop allows printing on upper and lower portion on alternate passes.

OPERATOR CONTROLS

- Power on/of
- Reset switch — allows disabling of printer without dropping AC

DATA INPUT

7 or 8 bit ASCII parallel, TTL levels with strobe
Acknowledge pulse indicates that data was received.

ELECTRICAL REQUIREMENTS

60 Hz; 115VAC, + 10%/— 10% of Nominal
50 Hz; 230VAC, + 10%/— 10% of Nominal

PHYSICAL DIMENSIONS

Weight: less than 10 lbs./5 kg
Width: 14.5 inches/37cm
Depth: 11.0 inches/28cm
Height: 4.89 inches/13cm
Dimensions exclusive of roll paper holder.

TEMPERATURE

Operating: 40° to 100°F (4.4° to 37.7°C)
Storage: —35° to 140°F (—37.2° to 60°C)



HUMIDITY

Operating: 20% to 90% (No Condensation)
Storage: 5% to 95% (No Condensation)

FORMS HANDLING

Roll Paper: 8.5 in. x 5.0 dia. with 1 in. core maximum dimension.
3.5 in. wide with .38 in. core minimum dimension

Fan Fold: 9.0 in./22.9cm wide pin to pin
9.5 in./24.1cm wide overall

Up to 3 ply paper with 2 carbons (total thickness not to exceed .012 inches)

Cut Sheet: Maximum width 8.5 inches

FREE! Personal Computers 132 column software option.

Personal Computers Limited

194-200 Bishopsgate London EC2M 4NR

Telephone: 01-626 8121

The heart of a system...

NEW PRICE
effective
March 16th



Exidy's Sorcerer has stood the test of time and has proved to be one of the most complete and versatile machines available. Versatility and expandability were the principal aims of the original design and whilst other major suppliers have been continually changing models to try and compete, the Sorcerer range has remained ahead of its time

(48K) only £695.00
EX VAT

Whatever the application talk to the people who care — your Exidy Dealer. Consult your local supplier now or clip the coupon for further information about this outstanding machine.

LIVEPORT
DATA PRODUCTS

The Ivory Works, St. Ives, Cornwall TR26 2HF
Telephone: (0736) 798157

• Circle No. 154

Please send details of the complete Exidy range and a dealer list.

Name

Address

Tel No.

PCD 52

BLACK BOX III MICROCOMPUTER SOLUTIONS

Conventional microcomputers can have problems – too little memory, not enough storage, poor communications, no expandability. RAIR's Black Box III range provides all the solutions. With up to 512K bytes of memory, 200M bytes of

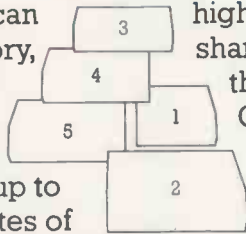

high-speed hard disk, 16 simultaneous users, and shared-resource multi-computer networking, the only thing micro about the Black Box III is the price. Call your nearest Dealer for details.

- 1 Single mini-disk system
- 2 Dual mini-disk system
- 3 Single mini-disk plus 5" hard-disk system
- 4 Single 8" hard-disk system
- 5 Add-on 8" hard-disk



RAIR

A. Healey Office Equipment Unit 7, Westfield Industrial Estate, Portsmouth Road, Horndean, Hants Tel: 0705 597555
 Digitus Ltd 9 Macklin Street, Covent Garden, London WC2 Tel: 01-405 6761 Hallam Computer Systems Ltd 1 Berkeley Precinct,
 Eccleshall Road, Sheffield S11 8PN Tel: 0742 663125 Holdene Ltd Manchester Unity House, 11-12 Rampart Road, Leeds Tel: 0532 459459
 Lion Micro Computers Ltd 227 Tottenham Court Road, London W1 Tel: 01-636 9613 and 21 Bond St Brighton Tel: 0273 601838
 Micromedia Systems, Seymour House, 14-16 Chepstow Road, Newport, Gwent Tel: 0633 59276
 Newbear Computer Store 40 Bartholomew Street, Newbury, Berkshire Tel: 025-671 2910 NSC Computer Shops 29 Hanging Ditch,
 Manchester Tel: 061-832 2269 T & V Johnson (Microcomputers) Johnson House, 75-79 Park St Camberley Tel: 0276 20446 also
 148 Cowley Road, Oxford Tel: 0865 721461 and 48 Gloucester Road, Bristol BS7 8BH Tel: 0272 422061

Rair Limited, 30-32 Neal Street, London WC2H 9PS Tel: 01-836 4663

0 to 60^{ch's} in one second



THE RICOH 1600S

If it's high performance you're looking for, the Ricoh 1600S is for you, offering an amazing 60 characters in just 1 second. An updated version of the tried-and-tested 1600, the new S model has been re-designed and fitted with all sorts of extras. Yet one thing hasn't changed — the price, making the 1600S cheaper than any equivalent model on the market. This superb performer incorporates the Z80 micro-processor, auto bidirectional printing and look-ahead logic, increasing speed and efficiency. Other capabilities include proportional spacing, graph plotting and word processing enhancements. The printer includes a standard centronics interface, and RS232 and IEEE options are available.

The Ricoh 1600S is available only from Micropute and their authorised dealers, all backed up with a nationwide service network. If you're interested in the 1600S either as a customer or as a dealer, send the coupon now.

Please send me details on the Ricoh 1600S.

Name _____

Position _____

Company _____

Address _____

Tel. No. _____

RICOH 1600S THE PERFORMANCE HAS RISEN — THE PRICE HASN'T

FEATURES COMPETITORS

	DIABLO 630	QUME SPRINT 5	SPIN-WRITER	RICOH RP. 1600 (10 DATA)	RICOH RP. 1600S
PRINT SPEED (CPS)	40	45/55	55	60	60
PRINT ELEMENT	DAISY-WHEEL	DAISY-WHEEL	THIMBLE	DOUBLE DAISY-WHEEL	DOUBLE DAISY-WHEEL
AUTO BIDIRECTIONAL	Yes	No	Yes	No	Yes
AUTO LOGIC SEEKING	Yes	No	Yes	No	Yes
PROPORTIONAL PRINT CAPABILITY	Yes	Yes	Yes	No	Yes
EXTENDED CHARACTER SET	No	No	Yes	Yes	Yes
LETTER QUALITY PRINT	Yes	Yes	Yes	Yes	Yes
CUSTOM INTER-FACE OPTION	No	No	No	No	Yes
PRICE	£1675	£1950	£1950	£1450	£1450

The above information was gathered from distributors and abstracted from their current literature. Prices shown are those advertised at the present time.

MICROPUTE

microcomputer systems

Comminque Place, 9 Prestbury Road, Macclesfield, Cheshire.
SK10 1AU. Tel: Macclesfield 612759

• Circle No. 156

London Computer Fair preview

THE SECOND London Computer Fair is being held at the Polytechnic of North London from April 14-16, 1981. The Fair is sponsored jointly by *Practical Computing* and *Educational Computing*. When first held last July, the event was a great success — it attracted more than 3,500 visitors in its two-day duration.

The Fair is organised by the Association of London Computer Clubs, ALCC, a regional co-ordinating group of 10 clubs in the London area. Because of the obvious demand, the Fair is open for three days this year and also is to have one late evening, Wednesday April 15.

There are 45 commercial stands, and exhibitors include Sinclair, Research Machines, Acorn, Diskdean, Computercraft, Wego Computers, Mine of Information, Central Calculators (Sharp), Chromasonic Electronics and TJ Brine Associates. A variety of user groups have taken stands and counted among their number are ZX-80 and British Apple Systems. Several computer press publications are also taking part in the Fair.

One area of the exhibition is devoted to club stands, and the participating clubs in the ALCC are demonstrating their activities. That proved very popular in 1980 and this year, the club stands are incorporated into the main exhibition

area. On Thursday, April 16, we are organising another "bring and buy" sale of computer equipment — public demand requires a repeat performance.

Running parallel to the exhibition are two conferences. The first, on Wednesday, April 15, is for teachers who use or would like to use, computers in their lessons. It will be a practically-orientated meeting with several well-known speakers. Topics under discussion include: How to start and where to find the money; a possible new language for first-time users; computers and education; Schools Council computers in the curriculum project and there will also be practical demonstrations.

On Thursday, the ALCC is putting on a day's seminar/conference for hobbyists and subjects include: CP/M — what is it?; S-100 bus and the future; producing moving graphic displays on a computer.

Details and booking forms for the seminars are obtainable from Dr NB Cryer, Physics Department, Chelsea College, Pulton Place, London SW6 9PR. The cost will be £10 per day and tea and coffee are included. Part of the exhibition complex will be devoted to the new Islington Community Computer Centre and there will be a continuous demonstration of small computer systems for

local businessmen. We have decided not to operate a specific seminar this year for business interests, but instead, to have experts on hand to answer questions in a specific area.

Unlike other computer fairs, the London Computer Fair is aimed at personal or hobby computers users and those businessmen and teachers who want to investigate how computing might be used in their professions. Consequently, the exhibitors tend to be smaller companies of a local nature and not distributors.

All in all, that means the Fair is more intimate than other exhibitions held during the year. That was proved by the number of exhibitors from last year who wished to book a stand again for the 1981 Fair.

The vast majority of people who attended last year indicated that they would like to return because the entrance fee is 75p and includes a free show guide aimed at those members of the public who would not normally go to a computer exhibition.

Transport to and from the Fair is also very easy — the Polytechnic is in the centre of London just north of Kings Cross and is well served by buses and trains. □

A FORMER civil engineer who designed the water distribution system for Istanbul, Turkey on a computer has turned his programming skills to an altogether different area and now claims to have grabbed more than one percent of the estate agency business in the U.K. with his Apple-based system.

Anthony Pearce, 31, uses a pair of Apples at his Kensington, London office to operate the do-it-yourself Homeline estate agency system. In its current configuration, Pearce uses the two Apples multiplexed with a variety of memories ranging from 5¼in. floppies to 10MB Corvus hard discs to handle a list of 2,000 properties and 1,500 buyers — with software which he wrote himself.

Pearce claims considerably reduced costs over the traditional estate agent. The Homeline fee for registration is 0.2 percent of the asking price up to a maximum of £90, and there is no time limit on the seller's registration. A conventional estate agent would normally expect to charge up to 3 percent of the selling price at completion. Cost to the seller, he says, is comparable with that of several advertisements in newspapers.

Part of the reason for the new low Homeline price is that it can dispense with large numbers of expensive staff and reduce the size of business premises — most estate agents operate from prestigious addresses.

Pearce's Apples, along with the Data

Homeline cuts costs in property market

Recording printer, have been used continuously for more than a year and so far, there have been no breakdowns. Now he is ordering two more for the London operation, and is going national with a Homeline franchise operation.

The most interesting part of the latest development is his co-operation with Liverpool's Stack Computers, which is to supply him with a Lobo peripheral memory with 5MB fixed, 5MB removable, which is due to be installed at the Nottingham office and which he expects, along with one Apple, to be capable of handling all the business in Nottingham's 1.2 million catchment area.

Anthony Pearce originally conceived the Homeline scheme when at the Cranfield School of Management. Personal experience led him to believe that many sellers of houses were dissatisfied with the service from estate agents and would prefer to sell their homes themselves if they could. Pearce's software essentially sorts and matches details of properties with buyers' requirements and leaves the parties to organise the conveyancing — although Homeline offers some extra

traditional services such as surveys.

In total, there are about 60 programs written in Applesoft which are available for a price of £750 and include many additional monitoring routines which are for the agent's own purposes — for example, to check the best areas in which to solicit business.

Pearce has also been consulted by the National Association of Estate Agents, AEA, which has been examining means of adapting its business to the micro age. The AEA are interested in the possibility of a national register of properties for sale and buyers, possibly to be held on a mainframe owned by Services in Informatics and Analysis.

The Homeline Apples could be interfaced to the IBM machine via a Stack card and an acoustic coupler, over the telephone network, thus giving instant access to a national homes' register. A similar system already exists for commercial properties but Pearce believes it would be a first for residential properties. Homeline — whose total investment in hardware so far is a paltry £8,500 — can be found at 01-221 3838. □

ONE OF THE failures of the mainframe world has been the lack of an operating system which allows true portability of programs and data. The most successful attempt for programs is, of course, Cobol. By and large, a program written on one machine in Cobol will run on another machine with few changes outside the environment division.

The transfer of data in computer form, e.g., disc or tape, has, however, proved a much bigger problem. With the exception of a few specialised bureaux, the IBM user wishing to transfer data to an ICL machine has to buy extra equipment.

The effect of all that has been twofold. Firstly, it means virtually no information, etc., has been passed between the user of one type of computer and another. Secondly, the cost of changing from one computer to another has meant that a company has to be unbelievably upset with its current computer supplier to involve itself with the cost of changing.

It is arguable whether that situation is good or bad. It obviously locks you into a particular computer supplier but, on the other hand, stops you changing to another computer which, when the chips are down, will probably be just as bad as your present one.

Accent altered

Now that the accent in computing has changed to communications, machine-to-machine transfers are becoming more common. Even so, if you wish to communicate with another type of computer, you will almost certainly have to go to a third-party soft/hardware house for the required equipment.

I think the main reason for the reluctance of large computer manufacturers to provide methods of communicating with other computers is reasonably obvious. With true portability of data and programs, the ability of the user to compare the performance of two or more machines is greatly increased. That leads to the fear that perhaps the computer you manufacture is not quite as good as the opposition's, and you will lose sales.

Benefits of CP/M

What the mainframe user has been seeking and the manufacturer avoiding, for a good number of years, has existed for more than two years on micro-computers. Thanks to a U.S. company, Digital Research, the majority of micro users can now benefit from a software product called CP/M.

In short, that means any programs or data created on a machine using CP/M are — with a few fiddles such as converting discs to single density — usable on any other CP/M-compatible micro. The number of micros using CP/M is vast, and increases every day. For example, the Apple now supports it, and I wonder how

COS from Interface avoids the portability pitfalls

long it will be before other major manufacturers also provide some form of CP/M-compatibility.

When buying a computer which will run CP/M, the user has three main advantages:

- There is a large amount of software.
- The system is very flexible regarding I/O.
- The system is provided with a large number of utilities.

Of course, as soon as a piece of software is written it attracts vast quantities of criticism, most of which is either trivial or concerns bugs which any competent technical user could easily avoid. CP/M is no exception to that rule, but I would like to concentrate on one particular aspect of it which can cause a great deal of problems to sellers and users of CP/M-based micros.

Most operating systems for micros are designed with the software writer in mind rather than the end-user. Obviously, that is reasonable, but what is a very useful feature for a programmer can be deadly when used by an end-user in the middle of a payroll run.

Certain problems are obvious. One of the most frequent is where a user removes

by Nick Horgan

a floppy disc, either in the middle of a run or at the end of a run before the directory is created. On most decent machines, that has been solved by putting a latch on the disc drive which can only be released by the system.

There are, however, a number — or should I say any number — of more subtle ways a user can commit data-processing suicide. I think a good example of how much trouble can be caused by that kind of problem is captured in the following sad tale.

A well-constructed sales-control program, written in Basic, had been running for more than a year when it started to give odd results. As the software had been thoroughly tested, suspicion fell on the hardware, but repeated checking suggested all was well.

Nothing could be found in the software but matters were brought to a head, when a chance meeting with one of the two operators found the cause. The operator complained that when inputting an invoice number to the cash posting program nothing happened. When asked

to demonstrate the fault, the operator, instead of going through the master menu, loaded the cash posting program straight from disc.

A question and answer session soon revealed that, prior to typing Run, the operator mistakenly typed an invoice number. Unfortunately, the invoice number was the same as one of the Basic I/O statements in the program and the effect was to delete that program statement. The operator then typed Run and the system appeared to work.

Problems like that cause hours and hours of wasted time. Among the most common mistakes are:

- Stopping programs in mid-run with CTL/C.
- Incorrect running of system copies, etc.
- Incorrect disc mounts.
- Running programs out of order.

Several companies have started to write special versions, or add-ons to CP/M to avoid some or all of these problems. Interface Computer Services Ltd has obviated almost all of the pitfalls with its Commercial Operating System. In addition to providing a secure user environment, COS can also be used as a powerful development tool. It includes improved screen, disc and printer controls a Cobol compiler and an excellent interactive debugging package.

The system arrives with a Cobol compiler conforming to ANSI Level 1 standards. The display and accept verbs have been modified to give the programmer greater control of the VDU. As well as the normal facilities found in Cobol for screen inputting, the user can:

- Set tabs within an input field.
- Insert into the middle of an input field.
- Move the cursor to the start or end of an input field.
- Move the cursor left or right.
- Clear the input field, to re-enter data.

There is a two-pass compiler which uses, as input, a Cobol source file created with the system editor. The first pass is primarily a syntax checker, and, if errors are detected, the user can stop the compiler for corrections. The second pass of the compiler generates an object file for input to the linkage editor.

Cobol, being a compiler, does not of course allow the fast program debugging of interpretive systems such as Basic. To assist the programmer in running and correcting his code it is necessary to have a good interactive debugging tool. Most compilers allow three basic debugging commands:

- TRACE — print the sequence of operations the program is going through.
- STOP — stops the program at a given point to allow the user to examine various locations.
- DISPLAY — print the contents of a variable each time the statement is processed.

Interface Computer Services has provided some excellent additions to the normal commands via its program Debug. The method most systems use to include debug facilities is to include them in the source module; changing the debug requirements requires a re-compilation.

With the Interface Computer Services system, however, debugging is truly interactive. The compiler program actually runs under the control of Debug, allowing operation modes to be changed without recompilation. Facilities provided are:

- Single-step mode.
- Automatic mode with reversion to single-step at the press of a key. In this mode, statement trace may be on or off.
- Breakpoints may be entered.
- Breakpoint and display the contents of a variable when the contents change.
- Sleep time sets a delay time between execution of steps when automatic mode is in operation.

At the end of a session COS can be made to perform automatic security copying. All diskettes running under COS are allocated a serial number when you first initialise them for the system. The serial number is written to the diskette as a null-length file. That file also informs COS whether the diskette is a prime data disc or a back-up disc, and also indicates if the last back-up was successful.

After checking to see if any updates were done to the data, in this case in drive B, COS returns with the following messages to prompt the user to take a backup.

```
DRIVE A: Remove diskette 001
DRIVE A: Insert diskette 2051
Press 'return' when ready
COPYING STOCKFILE — 50 records, 005K
COPYING TRANSACT — 10 records, 002K
DRIVE B: Remove diskette 2050
DRIVE A: Remove diskette 2051
SYSTEM IDLE
```

If an incorrect disc is mounted, DOS will ask the user to insert the correct one. You can tell COS how many back-up generations there are, and it will automatically ask for the oldest copy to be overwritten. That feature, more than any other, will ensure that the user takes back-ups at the correct time and on the correct diskettes.

COS will monitor printer operation and inform the user of the status of the printer. The same function is, of course, provided for in CP/M, but in a less sophisticated form. Printed output may be directed to a system spool file for later printing. It is not possible to print the spool file while processing another program, as happens when one is normally using a spooling system.

The sequence of operations is to create one or more spool files and then print them at a later date. That system allows you to print multiple copies of reports, ask the operator to mount special stationery, and to schedule similar types of print to follow one another.

The spool file should be used only where it is really necessary, because: most modern printers are buffered, sometimes up to 10K characters, and that allows the printer to store a large amount of information away from the main processor; printers are slow, programs and data transfer are very fast. A carefully-written program can arrange to print lines in bursts, and where there is a buffered printer it can appear that program and printer are working at the same time.

Stand-alone basis

However, with the type of spooling used by COS, you do not gain any advantage from using a buffered printer because the print run is done on a stand-alone basis.

Of course, if you are printing directly from a program and the printer malfunctions, your chances of recovering without a re-run of the program/system are very low. So, in a real commercial environment, you may well see an improved through-put due to the lack of print re-starts needed.

CP/M provides a basic batch command system which allows a number of jobs to be run in a set sequence. COS has improved that in two ways. Firstly, it is sensitive to three types of file which can contain Cobol programs to control the sequence of execution within a system. The three file types are:

- SIGNON — used for obtaining the system date, password, etc.
- JCL — controls the normal flow of the system.
- \$RERUN — contains recovery routines.

Each of these files is, in fact, a user-written Cobol program which will ask the user what action to take at various points in the system. A further extension to Cobol has been provided to interact with the job control system. The following two functions are provided for use in a Cobol program.

- JSCHED — allows up to 14 programs to be scheduled for operation in sequence.
- JCHAIN — used to override a JSCHED by interposing a specific job to be run.

COS will run on any system which supports CP/M such as the Superbrain.



The recovery routine is entered when one of the following happens:

- A previous incomplete job schedule is detected at start-up.
- A corrupt disc is loaded.
- A job abort call is issued by the JCL.

A recent addition to the system is an ISAM package. It is a standard Cobol-type ISAM system with the ability to read the file sequentially, randomly, or to obtain the next record after a random read; no read-previous exists. Where an exact key-match is not found the program can request the next higher key. Unfortunately, the index requires re-organisation at set periods. A utility has been provided to create a reorganisation program for a specific file, but the system writer has to ensure the correct reorganisation frequency. That situation is not as bad as it seems because the reorganisation program will run only if the ISAM overflow areas have been used.

The system is well documented with a large number of examples both in the manual, and on the diskette supplied with the system. Although most of the programs would obviously be best written in Cobol, there is nothing to stop any compiled program, e.g., a sort, being included in a job stream.

Conclusions

- The system is a serious and successful attempt to bring a real commercial operating environment into the micro field.
- Having a controlled environment installed on a micro used by non-computer staff will relieve untold problems for the average software house.
- Not being a Cobol fan, and in view of the power of the new compiled Basics, it would be useful to have this system supporting one of the common Basics.
- All in all, from the compiler, through the I/O control and job control structure, Interface Computer Services Commercial Operating System is a well-thought-out and valuable piece of software. M

Controller takes account of small-business finances

FOR THE more popular microcomputers on the market, there are many standard commercial/business packages with generally-accepted names such as payroll and stock control. Although the names are descriptive in a general sense, expectations of what constitutes, say, a stock-control package will vary.

The situation is further complicated by the fact that many potential buyers of a package are first-time computer users and, therefore, may not have seen some of the larger or better packages in operation.

Hardware restrictions

It is not generally known that some packages have to be compromised because of the restrictions imposed by hardware configurations. Microcomputers pose problems but at the same time present new opportunities, because of the advantages of versatility they offer over traditional computer installations.

Much packaged software appears to be modified or simplified standard main-frame or minicomputer packages. Yet what is done in a certain way on a main-frame is not automatically suitable for a micro. So it was refreshing to find a package, the Creamwood Business Controller, which seemed to take into account the needs of a small business and relate them to the way a dedicated and personal microcomputer can be used.

In running a business, one of the most basic requirements is a record of customers, and in a small organisation, some basic accounting ability. Traditionally, that is done by manual means, through filing pieces of paper with an index for cross-referencing. This system, although satisfactory for years, suffers from a number of disadvantages.

Information retrieval

For example, it is tedious to update and maintain, and information retrieval tends to be slow. With the availability of cheap and easily-obtainable microcomputers, it becomes a typical application for the computer, and that is what the Creamwood Business Controller attempts to do.

The software package is delivered on three 5¼in. floppy diskettes, and has been configured for a Commodore 8032 with 3040 disc drives and a serial printer — attached via an appropriate adaptor — or the standard Commodore tractor printer. The software has been configured for other systems as well, for example for the Apple and its use has been planned

for the new 8050 Commodore disc drives.

The review package was in fact, a dealers' demonstration version — the commercially-available package is supplied on one 5¼in. floppy disc and generates the transaction file on a scratch disc the first time the system is used. The three discs of the review package were: program/controller disc, transaction disc, and a history disc. A users' manual was also supplied, produced as seems to be the fashion by a line printer and therefore, I assume, using a word processor.

The controller diskette is inserted into drive 0, the systems disc drive and the transaction diskette into drive 1. On pressing shift Run on the Commodore 8032, the discs are booted-up. When the discs were working satisfactorily, after a few seconds, a prompt will appear on the screen asking for the date which is to be entered as DDMMYY. This means leading zeros are required to conform to the defined format. A useful check is that should the date entered be less than that of a previous run, the system will return to make sure you wish to proceed.

Once the date is accepted a menu of the operations available is displayed. There

by Vincent Tseng

are 15 options available selected by entering the appropriate number, 1 to 9 and A to E, as in hexadecimal, upper- or lower-case. The date entry, although simple, is indicative of how the rest of the program works — it is interactive and does not allow entries in incorrect format. It also checks for operational errors.

One of the first tasks a new user might want to perform with the package is the creation of a new account on file. This appropriately is the first item on the main menu.

The screen on all the pages in the program has a surrounding border and is laid-out as if it were a blank form. The bottom lines on the page are used to show the prompt line and the field where data could be entered between two squared brackets.

Under option 1, the first prompt asked for an account number of account name. The number is rejected unless it is the next consecutive one — there is no quick way under this option to discover how many accounts already exist on file. On entry of a customer name — the other option — an automatic customer number is given which is the next consecutive one in the file.

As the screen is like a form, the initial

temptation is to move the cursor on the Commodore 8032 to the appropriate lines and fill them with the information. In fact, there is a prompt line at the bottom of the display and the entry field is between two squared brackets. That format of data entry is the same for all the options listed in the menu and, once you are used to it, makes operating a reasonably simple operation.

The first item prompted is the account name — unless, of course, a name was used for entry into the option. Once the name is entered, duplication checking takes place, and should a match be found, the program checks to see if it may proceed. N causes the program to exit back to the main menu, Y allows the program to continue, where further checking and confirmation will take place, should another match exist. When this stage is passed, the account name is entered on the form displayed on the screen.

Further details

The other details requested are address, three lines, contact name, telephone number, up to 12 characters, credit limit, opening balance, and total to date. All the entries accept a zero-character field, and the number of characters each field is allowed to accept seemed sensible in length, except for the telephone number, where some times it may be useful to be able to enter both the STD code as well as the exchange name.

When the last line of information has been entered, the program gives you a chance to correct any errors by asking: Are the details entered correct? If the answer is N, the whole sequence of entry is run through again, where the operator uses the return key to confirm that an entry is correct, or re-enters a full line when the prompt for that line is reached.

Message displayed

Again, after the last line, the same chance to correct is given; that can be repeated as often as required. When the answer Y is given to the check, the account will be written to disc, with a message displayed on the screen indicating that it is doing so. However, the use of a return key to the checking prompt will abort the entry and the data is not recoverable. It is a minor point worth attention since it is easy to correct an entry early in the form, keep hitting the return key for the rest of the prompts, including the checking prompt, and to lose the

laboriously-entered and checked file.

Option 2 on the menu concerns post transactions for customer files already set-up. It allows for entry of invoices, credit notes, cash received/discounts and payments. A sub-menu is displayed to select these transactions. The account name or number is then entered and the program checks with the user if the correct account has been retrieved from the disc files.

The details requested in all the cases are: the date — checks that it is not greater than the date entered at the very start of the program — reference, analysis code — this allows for any type of transaction which is frequently used to be stored as an analysis code number — description — if an unknown analysis code or 0 is used — amount, VAT rate — S for standard, Z for zero, E for exempt and X for not relevant such as for export — and the VAT amount.

Useful technique

Account enquiries, option 3, search for an account or change some of the details. Entry is by account number or name. A useful technique is to enter an initial letter and to have the program search through the files for it. The program confirms the retrieved entry on the screen.

This feature is useful if the initial letter of the customer name was known, so that one can scan through the files, but it does not give a directory of all the account names and numbers which would seem an obvious facility to include.

End-of-month procedures are selected as option 4 which activates a printout of all the accounts held on file — a lengthy process. It clears the sales-ledger control account and it can zero on request all the total-to-date figures for the year end. The outstanding balances are aged and a transfer of the current month's postings is made to the third disc — the history disc. We had disc problems with the first set of discs delivered and the history disc was one of the ones corrupted. The second set of discs were demonstration discs where the last two features of the option were not available, so I was not able to test it fully.

Sales ledger

Option 5 printed the sales ledger control account for all the accounts on the file. Option 6 prints customer statements by requesting the account number or name as in the previously described options. Option 7 prints journal postings and aged-debtors' lists, the printing is selected by a sub-menu as:

- A. Sales Invoice journal
- B. Sales ledger credit note journal
- C. Cash and discount received journal
- D. Sales ledger cash paid
- E. Aged balance list.

or by entering ALL, all the journals are printed.

Analysis codes, as mentioned, are set-up and maintained in option 8. It allows a

Table 1. Options available.

- | | |
|---|---|
| 1. Set-up new account on file. | 8. Maintain analysis code descriptions. |
| 2. Post transactional data. | 9. Client history transaction listings. |
| 3. Account enquiries. | A. Prepare client invoice/quote. |
| 4. End-of-month procedures. | B. Mailing list. |
| 5. Print sales ledger control accounts. | C. Re-set today's date. |
| 6. Print customer statements. | D. Change user's details. |
| 7. Print journal postings and aged debtors' list. | E. System shut-down. |

20-character description for an analysis-code number between 1 and 99 — a convenient way of being able to describe items which are used often. Option 9, client history transaction listings, seems to be a mystery. When tested, it did not do anything. I deduce from the documentation, which did not list the option by either title or correct option number, that it will print from the history disc, either all or selected transactions.

Option A prepares a client invoice or quotation, where the user is again guided through the entry of data by prompts, as described. However, a slight inconsistency occurs — the dreaded VAT ratings are entered as in the initial letters as in option 2. This time, however, the VAT percentage is required and the VAT amount calculated automatically. This seems a sensible approach and option 2 should be brought into line.

Inconsistencies

The other options are straightforward: B prints a mailing list selected by a range of account numbers; C is used to re-set the day's date — not a very good feature, perhaps useful for pre-or post-dating statements or invoices, but it is bad practice to change the date so easily. D allows the user's details to be set-up or changed and E is used to close-down the system. The options are listed in table 1.

Using the package reveals certain inconsistencies. Sometimes it seemed as if it were written for another programmer rather than for a businessman, although I found the interactive usage and prompting was helpful.

A further point of inconsistency occurs on one of the most often-used parts of the package. For this version of the package for the Commodore 8032 business computer, it has been recently modified to allow lower-case alphabets. This means that when using the main menu, the numeric options are chosen by the normal unshifted number keys, whereas the letter options expect upper-cased alphabets, i.e., shifted keys.

This makes the operation slightly

awkward and I feel the letter options' perhaps could be made to accept both upper- and lower-cased alphabets for operational convenience. One can always use the shift-lock key and type the numerics on the separate numeric keypad on the 8032, but that seems to defeat the object of having the lower-case.

Another important point to bear in mind is that the package assumes working knowledge of accounting. In both the documentation and on the program screen displays, accounting terminology is used.

The manual supplied was reasonably well and clearly written, but, as mentioned, assumes the user knows the purpose of the options. It is more of an operations guide and does not teach accounting. However, what is more serious, some of the documentation did not correspond to what was on disc, and I had to deduce some of the information. Lastly, the manual was printed using a dot-matrix printer and one complaint is that the printer used had lower-case alphabets, but did not have true descenders. Creamwood Products Ltd is an associate company of Greenwood Associates Software Ltd and Cream.

Conclusions

- Overall, the package was easy to use — once one had grown used to its quirks.
- Potential users should already be familiar with the accounting methods used in the package or be prepared to study some aspects of accounting.
- The documentation should be checked and updated to ensure that it at least agrees with the software supplied.
- There are some inconsistencies in the package and the aborting of information by the use of return on the checking prompt should be altered.
- A directory of clients would also be helpful.
- The Creamwood Business Controller has been written specifically for a micro-computer, taking advantage of interactive usage and accessibility of the micro.
- The package has had Commodore approval. 

Access to CP/M packages adds to Onyx's popular appeal

The C-8001 is a Z-80-based central processor designed to be the nucleus of a small system. It is manufactured by Onyx Systems Inc of California and the system for review was supplied by Graham-Dorian Software Systems. To constitute a useful office system the C-8001 requires a serial, RS232, terminal incorporating a video display and keyboard together with a suitable printer. The last two items can be of the end-user's own choice.

To avoid any confusion, you should be clear that Onyx Systems has two central processors which look very similar but, in terms of internal hardware and ultimate versatility, are very different. The 8001, which is the subject of this review, is a Z-80-based system while its bigger brother, the 8002, uses the 16-bit Z-8000 as the main processing element. The Z-80 system can be upgraded to a Z-8000 by changing the single CPU board and adding a second board to house the extra memory which the Z-8000 has capacity to address.

The C-8001 is a single-board computer containing 64K of dynamic memory together with 4K of read-only memory which is used for bootstrap — initialisation — and self-test operations. Once the system is initialised, the read-only memory is removed from the address space which then becomes totally read/write.

Sealed enclosure

The CPU board is housed in a cabinet measuring 43.2cm. by 20.3cm. by 55.9cm. but occupies a minute portion of this volume. The bulk of the cabinet holds an 8in. fixed disc drive which has the capacity of storing either 10 or 20 megabytes of data. All the disc components operate in a sealed enclosure which needs to be good when used in a typical office environment.

As well as the disc drive, the cabinet also holds a cassette — not music cassette — tape transport as a high-capacity data storage medium which can be used to back-up the disc.

All software is supplied on tape cassettes which are then spooled into the disc. This is quite a lengthy process, even though high-speed digital recording techniques are used to drive the tape system. Once the software is on disc, the problem no longer exists, but in an office environment it would always be prudent to take a back-up copy of the disc data at the end of a day's transactions.

To test the system, which purports to be an office system, we thought it would be a good idea to try it in a real office environment so we arranged for Graham-



Dorian Software to deliver it to our reviewer's office where it would be tried and used by a wide range of people — both technical and non-technical.

In preparation for its arrival, and on the advice of Graham-Dorian Software, we had ready a small desk and a three-outlet 13amp extension lead. At the appointed hour, the van arrived from which three large packing cases and an installation engineer emerged. In half an hour, the C-8001 together with the display terminal and keyboard were sitting neatly on the 4ft.-by-2ft.-by-6in. desk-top — with space to spare.

Unfortunately, the space left was not sufficient for the printer which was as large again as the rest of the system. We had been under the misapprehension that the printer would be a free-standing unit. It is a point worth noting that so-called desk-top systems sometimes fill more space than bargained for.

Before connection, the engineer asked whether we intended keeping the unit in the same place. We were rather surprised by the questions as the system seemed so compact and easy to handle that we had assumed that — once familiar with its *modus operandi* — we would be able to re-position it ourselves.

We asked why he needed to know. The answer was simple. The fixed disc has a floating head which is particularly vulnerable to knocks and bangs. For that reason, it is locked by a screw when in transit and once unlocked, any unnecessary disturbance must be avoided. We assured him that we would not move

it, so he agreed to slacken the screw.

The printer and terminal units were switched-on and the key turned in the CPU box — a key prevents unauthorised use of the system. In a few seconds, the screen announced that the system had carried-out a satisfactory self-test and was ready to go. No more than an hour had elapsed from the arrival of the van to having the system up and running.

The engineer very thoughtfully loaded the software from the cassette tape on to the disc and, while it was running in, explained that he was leaving us with an accounting package containing programs for handling sales ledger, purchasing ledger and nominal ledger together with supporting programs which would handle order entry, invoicing and stock control.

This suite of programs was fully interactive — keeping all the books in order and leaving adequate audit trails. He added that he thought we might like to have a word-processing package called WordStar and a Basic compiler called CBasic-2 which can both support CP/M.

Control program

CP/M is a very widely-used disc-based control program with an internationally-standard set of commands. It means that it is comparatively straightforward for someone, familiar with the language, to communicate with any computer system that operates under CP/M — irrespective of its manufacturer.

Before describing the technical qualities

of the C-8001, it is worth considering its appearance. It is neat, compact and attractive. Although it is fan-cooled, there was very little noise and what little there was seemed insignificant compared to the noisy goings-on of a busy office.

One could not say the same about the printer — it was big, heavy, cumbersome and rather noisy. Perhaps it was only to be expected and, to be fair, it accepted standard 120-column fan-fold computer stationery as well as being an impact matrix printer. We could have had any printer capable of RS232 interconnection — the choice is vast.

On completion of its self-test and initialisation routine — which needed no human intervention after turning the key — we were left with a rather unhelpful message which said that we were operating with CP/M version 2.2 followed by "A<".

Having located STAT.COM, it becomes clear that the disc holds 10 megabytes of data — equivalent to 1,000 sheets of closely-typed A4 pages. It is logically divided into three parts labelled A, B and C — each part pretends that it is a separate disc independent from the others. Their respective storage capacities are 1.327, 4.091 and 4.091 megabytes.

Much of the software for the accounting packages is written using CBasic-2 and — it was menu-driven — thus presenting us with a simple accounting system to operate. Because the packages are written in this comparatively-simple language, coupled with the facilities that the operating system offered, it would be a practical proposition for anyone to carry-out minor modifications to the programs or, even, write one's own.

Silent operation

When continuously accessing the disc and carrying-out logical disc-to-disc transfers, one of the benefits of the 10megabyte fixed disc becomes very apparent — its almost silent operation. There are none of the clunks and whirrs normally associated with 8in. floppy drives.

The C-8001 seems a potentially very powerful machine and with little one could fault in the behaviour of the hardware. There were, however, a few misgivings about whether or not it could be handled by a non-technical clerical assistant. Our concern still remained when we sat down to study the sales ledger users' manual. The first 25 pages are devoted to comprehensive documentation of how the package is implemented within the CP/M operating system. The wording and jargon used are enough to floor even the most dedicated of specialists. After ploughing through the first 10 pages or so, one is inclined to throw the book away and shout help.

That would be a shame because, hidden in the middle — on page 26 to be precise — is the simple statement that all one has

to do after getting the CP/M prompt is type "CRUN2 MENU" followed by a carriage return. After doing that, everything becomes remarkably simple.

The screen clears and asks for today's date and when it has checked you have not put February 30, or something equally stupid, it puts up a self-explanatory list of options with reference numbers 1 to 7.

It remains only to type in the number, e.g., 2 will print a list of customers while 4 allows one to enter any payments received, and follow the instructions from there on. If any difficulties are encountered, the remaining 30 or so pages of the manual are very straightforward and could be followed by anyone.

We felt it a shame that we had the wrong impression because of the order of pages in the manual. Of course, one should not carp too much since many manufacturers and suppliers go too far the other way and do not tell the user enough. Our suggestion to Graham-Dorian Software is to leave all the material there but make the layman's language section more obvious.

Once we were into the swing of it we found the accounting package comparatively easy to use and certainly it provided a wealth of statistical information which would have been impracticable to obtain without the use of a computer.

Like any off-the-shelf program, it would not have lent itself to our existing accounts management or stock control system without considerable modification. That, of course, is the problem which has caused more headaches on the part of software developers — and heart-aches on the part of potential users — than any other.

It needs a very brave accounts manager to throw overboard a pen-and-paper system which has worked well for many years in favour of a more efficient but different style of computer-based accounting procedure.

To buy the programs we were using would have cost anything between £2,000 and £3,000. To develop our own from

scratch would probably take up to two man-years — with the possibility of disastrous bugs.

For a small new company without too much inertia, the Graham-Dorian standard software would certainly be an economic way of starting with a computer-based accounting system. Graham-Dorian Software is prepared to offer software support to its programs and, if its consultancy prices are acceptable, it might be a practical proposition to have it modify the procedures to match existing ones within the user's organisation.

It is impossible to review software and give an objective opinion which will be of any real value because the final desirability of a program is essentially subjective. To say that it works is of little benefit to the reader.

Certainly, the programs we had worked well and in two weeks' use, we did not encounter any problems.

Conclusions

- Anyone considering a change to computers would be well-advised to consider the C-8001/GDS combination.
- The computer is a beautiful piece of equipment by any standard and is a joy to use whether you are a programmer or an end-user.
- The CP/M operating system allows access to a massive range of very reasonably-priced software including compilers and interpreters of just about every conceivable language.
- The Graham-Dorian software price list already contains programs like WordStar — a powerful and proven word-processing package — Datastar — a general-purpose database system — and Mailmerge.
- There are also programs for estate agents, retailers, surveyors and even medical records and accounting programs for doctors and dentists.
- The latter, however, are of U.S. origin and have not yet been converted for use in the U.K. □



S-100 video card opens teletext to more micro users

There are now many makes of computer available in the U.K. which support the S-100 busbar and several manufacturers are taking full advantage of the large potential market for peripheral devices. Hi-Tech Electronics of Southampton has developed two versions of a colour, memory-mapped video card which operate in teletext format. That means the character font and range of graphics — together with other effects — match those used by the Ceefax, Oracle and Prestel systems.

THE TWO versions differ in that one interfaces directly to a domestic colour television set via an on-board modulator and the television aerial socket, while the other outputs red, green and blue signals on separate lines with synchronisation on a fourth line for connection to the more professional types of RGB monitors. The

by Mike Hughes

company also offers an attractively-styled RGB monitor to match the latter version.

The RGB output board is slightly more expensive than that having the modulator and a dedicated RGB monitor can be a costly item. Nevertheless, the bonus for an RGB system is the spectacular picture quality, high-colour saturation and resolution. For the purposes of the review, we looked at the RGB system plugged into a Tuscan S-100 microcomputer.

Although the S-100 busbar is now supposed to meet the IEEE specifications there are a number of older machines which do not adhere rigidly to the pinning and signal details. The Hi-Tech card should not, however, present any partic-

ular problems in that respect. It is very modest in the signals it expects to see on the busbar. In summary, they are:

- All 16 address bits
- All eight data-out bits
- All eight data-in bits
- SMEMR
- MWRITE
- PDBIN
- PWR
- SOUT
- The normal power rails

The board is conventional S-100 size, 10in. by 5in., and plugs straight into the Tuscan bus. It has a standard DIL socket on the top edge of the board into which a pin header can be inserted to extract the necessary RGB and synchronisation signals to feed a monitor direct. The board's display memory occupies 2K of the computer's memory map and a DIL switch can set its base address on any 2K boundary within 64K. A second DIL switch sets the address of a single output port which can be any available value between 0 and 255. That port is used to produce some special effects.

Having set the addresses, plugged in the board and connected it to its monitor, it

Block diagram of the Hi-Tech card.

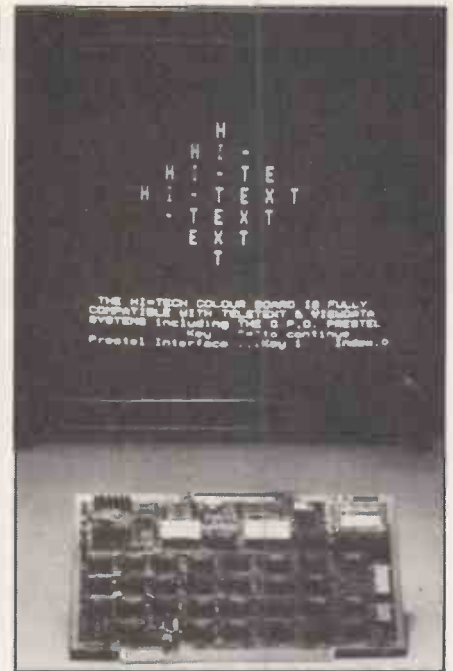
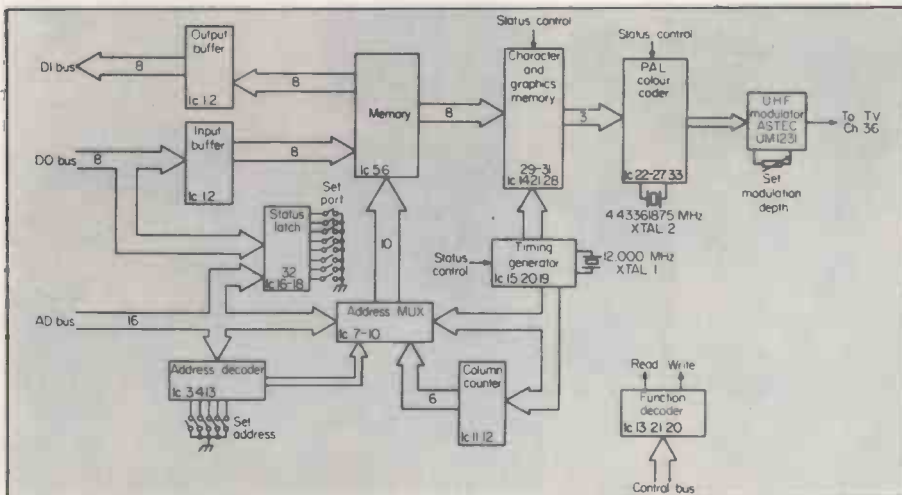

remained only to power-up the system. It worked first time without any fuss or bother. The only problem was how to use it properly.

At initial power-on, the VDU memory is, of course, in a random state of confusion and the colour display reflects that with a glorious jumble of graphics, letters and numbers in a myriad of different colours — some flashing, others double size, some on black backgrounds and others on bars of colour. Without going any further, one could see immediately the superb clarity and resolution of the display which is fully interlaced with character rounding.

The manual suggests the first experiment should be the use of the output port. Only bits one to six are used to convey data to the board and whatever is done through the port does not alter the contents of the display's memory. The instructions fed via the port affect only the general mode of operation. Once an instruction has been sent to the port, it is latched and held until the instruction is countermanded by another and each of the six bits has the following significance:

- Bit 1 when high, 1, inhibits the red gun of the display.
- Bit 2 when high, 1, inhibits the green gun of the display.
- Bit 3 when high, 1, inhibits the blue gun of the display.
- Bit 4 and bit 5 between them select either the top 12 lines or the bottom 12 lines and make all characters double-height.
- Bit 6 enables an extra range of colour options over and above the standard six colours plus white.

We set our output port to address 211 and using this simple program, produced a wonderful display of changing colours based on the scramble of random characters:

```
10 FOR A = 0 TO 7
```



```

20 OUT 211,A REM TCL BASIC PORT
   OUTPUT STATEMENT
30 FOR B = 1 TO 500: NEXT B REM
   SHORT DELAY
40 NEXT A
50 GOTO 10
    
```

As the variable "A" changed value, so the respective display guns were switched on or off. At the value seven, the screen went blank as they were all switched-off. A similar play on data bits four and five did what was expected and we obtained double-sized characters on the top and bottom halves of the display. The manual gives a word of warning that after playing with the port, it is wise to output a zero on all bits to set things back to normal.

To change the contents of the display memory — hence the picture on the screen — you need either software which allows the Poke or similar statement or operate in machine code. Clearly, if you consider using this display as a supervising VDU, you must have some suitable driver software in your system and Hi-Tech Electronics has thoughtfully provided an assembled source listing for such a routine called Screen Driver 7.0. It is written in 8080 mnemonics and code and is located to origin at 100H to be compatible with CP/M disc operating system. We did not use the software but chose to use our own via the TCL Basic Poke and VDU statements.

To clear the display, it is necessary to write the code for space, 32 decimal or 20 Hex, into every location and, thinking we knew best, we patched-up a simple program to do just that — assuming that the run of the display memory map was contiguous from line to line.

Certainly, the top line cleared but, following from that, about half of a line half way down the display cleared followed by the second full line from the top, and so on. We had forgotten that the teletext screen format is 40 characters per line with 24 lines on the screen. A further scan through the manual revealed that we had overlooked the clear Hi-Tech drawing showing the on-board memory architecture.

The only problem with this convenient map is that one needs a function written in Basic to keep track of the virtual cursor. TCL Basic rushed to our aid with its VDU A,B,C statement. Once the base address for the display has been set, the variable A defines the row, B the column and C the value of the character

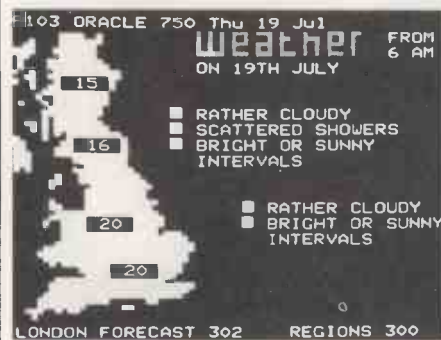

Bits	b7	b6	b5	b4	b3	b2	b1	Col	0	1	2	2a	3	3a	4	5	6	6a	7	7a
0	0	0	0	0	0	0	0	0	NUL ^①	DLE ^①			0		@	P	-		p	
1	0	0	0	1				1	Alpha ⁿ Red	Graphics Red	!		1		A	Q	a		q	
2	0	0	1	0				2	Alpha ⁿ Green	Graphics Green	"		2		B	R	b		r	
3	0	0	1	1				3	Alpha ⁿ Yellow	Graphics Yellow	£		3		C	S	c		s	
4	0	1	0	0				4	Alpha ⁿ Blue	Graphics Blue	\$		4		D	T	d		t	
5	0	1	0	1				5	Alpha ⁿ Magenta	Graphics Magenta	%		5		E	U	e		u	
6	0	1	1	0				6	Alpha ⁿ Cyan	Graphics Cyan	&		6		F	V	f		v	
7	0	1	1	1				7	Alpha ⁿ White	Graphics White	'		7		G	W	g		w	
8	1	0	0	0				8	Flash	Conceal Display	(8		H	X	h		x	
9	1	0	0	1				9	—	Contiguous Graphics ^②)		9		I	Y	i		y	
A	1	0	1	0				10	—	Separated Graphics	*		:		J	Z	j		z	
B	1	0	1	1				11	Start Box	ESC ^①	+		;		K	-	k		l	
C	1	1	0	0				12	Normal Height ^②	Black Background ^②	,		<		L	l	l		ll	
D	1	1	0	1				13	Double Height	New Background	-		=		M	-	m		3/4	
E	1	1	1	0				14	SO ^①	Hold Graphics	.		>		N	I	n		+	
F	1	1	1	1				15	SI ^①	Release Graphics ^②	/		?		O	#	o			

^① These control characters are reserved for compatibility with other data codes.
^② These control characters are presumed before each row begins.

Character rectangle
 Black represents display colour
 White represents background

The full set of character and control codes for the card.

to be Poked into memory. So long as we kept A within the bounds 0 to 23 and B within 0 to 39, everything became child's play.

Once the screen is totally cleared with space codes, any normal alpha-numeric ASCII codes produce the expected characters when poked into memory. The board translates ASCII codes into characters defined by the ISO7 code which is very similar but one can obtain the more typically British characters like £, ¼, ½, and ¾ at the expense of square brackets, curly braces and reverse slash etc. Provided the output port has been set to all zeros, the characters will be displayed in white against a black background.

By preceding any character on a particular line with one of a number of hidden control codes — falling in the ASCII range 00H to 1FH — one can make all following characters take up one of six colours — red, green, yellow, blue,

magenta or cyan — until another colour change code is encountered on the line. A similar set of codes will make following characters take the form of the 64 teletext pixel graphics in the same range of colours, plus white.

A colour code followed by a new-background code changes the background from black to the pre-selected colour and coloured alpha- numerics or graphics can be superimposed on the new background. Further hidden codes will cause following characters or graphics to flash, be double-height, be contiguous, i.e., the graphics join up with each other to produce solid blocks of colour, or separated graphics which reduce the intensity of the display.

Care has to be taken in the use of those hidden control codes because they occupy space in memory and as a result create a space on the screen. That is fine if they occur between words, but can be a nuisance

(continued on next page)

(continued from previous page)

ance in the middle of a complicated multi-coloured graphic picture. For that reason, there is another control code which allows graphic characters to be repeated over hidden codes.

Each line on the display is, to all intents and purposes, a separate entity. Any control codes which exist on one line do not carry on their effect to subsequent lines. The benefit, or problem depends very much on your application but is fundamental to the teletext display format.

Producing custom-designed pictures with the graphics is an extremely time-consuming job — particularly if a wide variety of colours are involved — but the results are well worth the trouble and, although there are limitations with pixels, very reasonable resolution can be obtained.

In theory, it is possible to produce coloured animated displays but in practice, it would be a very brave programmer who embarked on such an expedition and, furthermore, there are the usual flashes on the screen as the display memory is accessed.

An obvious application of the Hi-Tech board is to convert existing S-100 computers to Prestel terminals to interface with the main Prestel computer and, to that end, Hi-Tech Electronics has now produced a Prestel-compatible S-100 MODEM card. That, together with the display, would upgrade any disc operating system to an incredibly powerful machine with access to what must be one of the world's largest and most fascinating data banks of information.

By hooking-up the board with the MODEM and one of the recently available S-100 10megabyte disc drives, the mind boggles at what might be in store for the field of information handling — not least that of information copyright.

Conclusions

- We were unable to fault the quality and reliability of the RGB board.
- It more than matches the standard format for teletext.
- Quite clearly, the one more likely to attract users would be the modulated version — which we did not see — and it is bound to have impaired resolution but, judging from the way Hi-Tech has fulfilled its specification on the review board, it has to be good value for money at £295 plus VAT.
- Although it could be used as the main supervising monitor display for a system, its 40-character width would be limiting for some applications and it could consume a good deal of software space if full use was made of its colour-effects potential.
- It is more likely to be useful as a peripheral accessory and, to that end, in what better form could it come than an S-100 board?
- Full marks Hi-Tech Electronics on a first-class device.

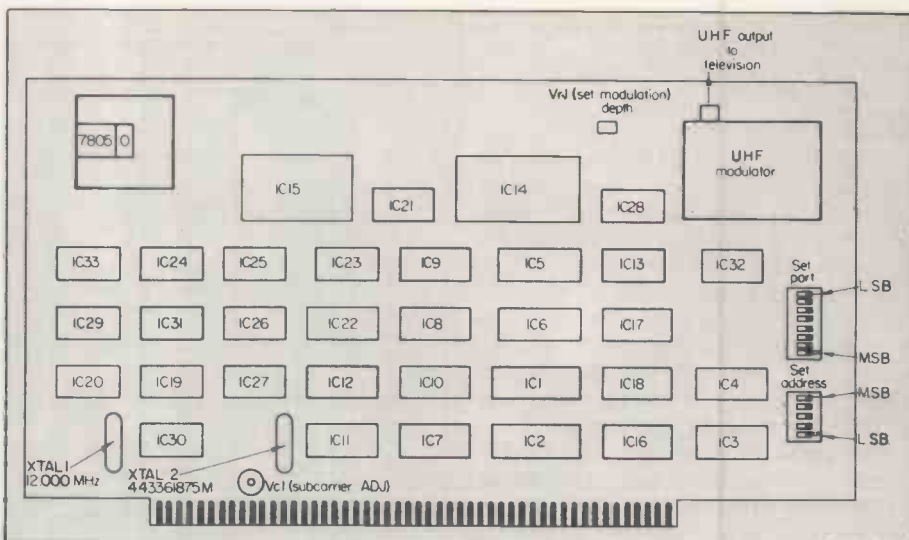

The chips on the Hi-Tech card.

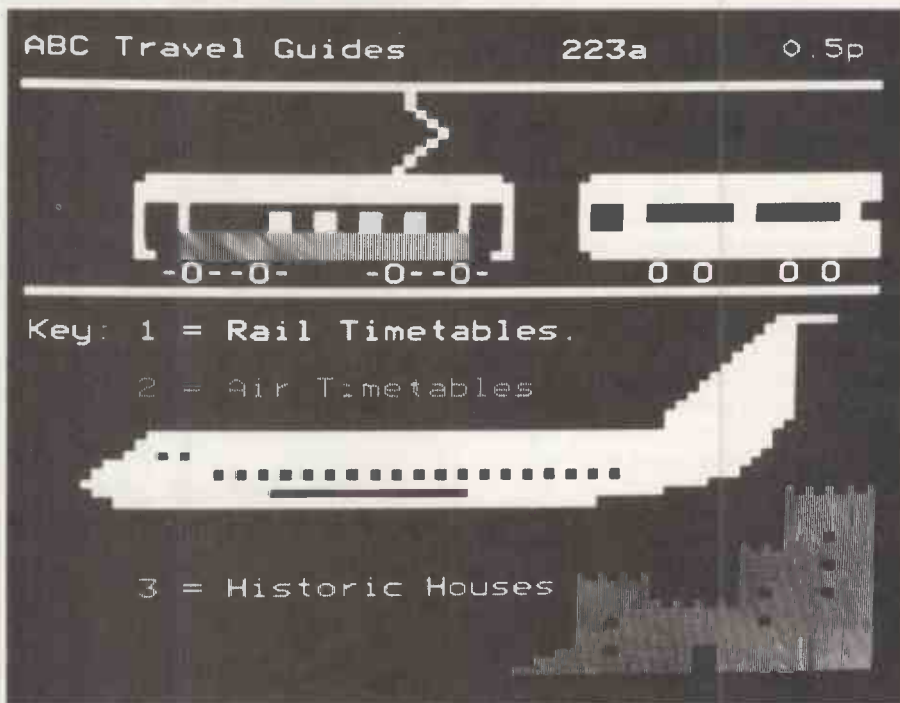

The Hi-Tech card interfaced to the Tuscan S-100 bus.



Do you have financial control of your company?



When did you last have an up-to-date financial statement?
Do you have effective cash flow management?
Do you get your statements out on time?

The Financial Controller is the solution to these problems, and is the first of a series of modular programs that form the basis of an integrated business system for the Apple II/Apple III/ITT 2020. All programs in the series will run on 5¼" disk drives, 8" drives and the 10 megabyte fixed disk. From a starting price of around £3500 inclusive of the micro computer system, the Financial Controller offers you Cash flow/budget planning. Balance sheet. Profit and loss statements. Invoicing. Sales ledger. Purchase ledger. General ledger. Payroll. For up to 1000 accounts. All fully integrated.

Available soon: Credit control, costing, stock, order processing, works scheduling, parts explosion, word processing, addressing and mailing, time recording, databased. All fully integrated.

For the solution to your business problems and a demonstration of the Financial Controller, contact your nearest distributor.

London Dalmington W1 01-580 6702 K.A.I. NW4 01-328 3968 The Xerox Store WC1 01-409 0694 The Xerox Store W1 01-629 0694 Bedfordshire Computopia Leighton Buzzard 0525 376600 Berkshire Lynx Computers Windsor 56322 Cambs Q.I.S. Peterborough 47191 Cheshire Systems Integration Altringham 9285784 U Microcomputers Warrington 54117 Cornwall Diskwise Callington 3780 Cumbria Furness Computer Services Barrow in Furness 24621 Essex Compuskill Romford 751906 Computerist Southend 335298 DDP Basildon 728484 Dair Electronics Halstead 472533 Hunt Smeed Basildon 21244 Kimfield Chelmsford 64230 Gloucs William-John & Co Stroud 70109 Herts Local Business Technology Hoddesdon 66157 Leics Leicester Computer Services Leicester 708483 Middlesex Leeway Data Products 01-898 4761 Norfolk Anglia Computer Centre Norwich 29652 Nottinghamshire Keen Computers Nottingham 583254 Oxon Micromark Henley on Thames 77926 Rocon Abingdon 24206 Surrey Ferguson West Byfleet 45330 Surrey Micros Godalming 22318 Sussex Datatech Eastbourne 36268 Oval Computers Worthing 44831 Tyne & Wear P.I.P.S. Computer Services Newcastle Upon Tyne 614939 West Midlands Above Systems Ltd Coventry 414258 MicroLogic Birmingham 021 550 8036 Worcs Celtip Star Kidderminster 66201 Scotland Peter McNaughton & Assoc East Kilbride 33562 Wales Cardiff Micros Computers Cardiff 64171 David Potter Office Equipment Cardiff 496785 Swansea 462502 Irish Republic CDS Computing Cork 23922 DB Micros Limerick 42733 Tomorrows World Ltd Dublin 776861 South Africa Spartan Microware Johannesburg 47-1883

**Systematics
International**



Systematics International Essex House Cherrydown Basildon Essex
Tel: (0268) 284601

• Circle No. 156

Very nice dear, . . . but what does it do?

WHEN MY husband first announced a desire for a home computer, I reacted with a blend of amusement and bemusement.

"What on Earth for?" I asked, "what possible use would a computer be to you?"

"They do all kinds of things", he replied vaguely.

"What kind of things?" I insisted.

"Well — you know". I didn't, but let the matter drop.

After months of poking around in the minds of friends and colleagues, some of whom either already owned computers or were exploring the various possibilities, he finally decided on a Video Genie EG3003. We went to our nearest dealer who not only had one in stock but could also provide a demonstration.

Reservations

The program we sampled was Bio-rhythms, and although my interest perked up a bit, I still had reservations: "Seems an expensive way to find out what mood you'll be in next week". But his mind was made up.

There was, however, one small problem — money. The price including VAT was

£425 and he was, he admitted, £100 short of being able to buy. He also pointed out that had it not been for his generosity concerning my birthday present, there would have been no problem. Only later did it dawn on me that he was actually attempting bribery and blackmail.

Unknown to him, for some time I had been filching from the housekeeping with

by Tina Billett

the intention of throwing a surprise party for his looming 50th birthday.

By juggling the figures, I decided instead I could give him £100 and at the same time save myself a considerable amount of work in cooking and organising.

The great day dawned and he left to buy his new toy. I suppose that most of my scepticism stemmed from past experiences of gadgets eagerly acquired, played with for a while, then stashed away in the spare room never to see the light of day again. As I had taken over the spare room, using it as an office for my own work, I was

alarmed at the thought of losing more precious space. Had I foreseen the consequences of the micro, I would have been horrified.

Innocent start

It all started innocently enough. A colleague at his work, who was possessed by a TRS-80, had adapted a Pet program, which had appeared in a U.S. magazine called *Quest* written by Roger Chaffee. My husband had been enthusing about that for some time and finally obtained a taped copy. "Here", he said, "you try it". I did — and was hooked.

The trouble with that kind of game is that once you understand it, the only excitement to be gained is in shortening the length of time it takes to remove the treasure from the caves. We were to return to treasure hunting later, but in the meantime, we decided to try our hand at book programs. When I say we, I really mean I, for by some freak coincidence I am a faster typist than he.

I spent hours typing programs from *Basic Computer Games* and *More Basic Computer Games* only to discover at the end of the day that they did not work. Not

Background

The two ladies who star in this month's distaff special could scarcely be more different; they are alike only in their consuming passion for the micro. Rose Deakin, pictured here with her Transam Triton, discovered the micro after a frustrating stint with an official mainframe which she was using to process data from her social services research project.

After the turgid protocol of the punch cards and the municipal pecking order, she found it a great relief to be able to edit so fluently and so easily. Before, she had had to wait to have anything run and if, as sometimes happened, even one punch card had been reversed — back in the queue, madam.

She comments favourably on the excellent service that

Transam have given her even when the problems were software bugs rather than hardware malfunctions. This surely argues patience on the part of the supplier, who must have heard that story before.

Tina Billett is a wiry and energetic spirit whose two youngsters, quarantined with chickenpox, looked on with curiosity as the pictures were taken. By contrast with Rose, whose micro operation is a freelance extension of an existing career, her passion for the Video Genie is an all-family fun operation and has to a large extent dislocated her occasional career as a writer.

By the looks of it, the Genie has seen a good deal of "open sesame". Not even a year old yet, it has been in use all day every day since it arrived in their Claygate, Surrey home, except when the family went away on holiday.

After three days of rain, they all by common consent headed for home and the micro — they had even considered taking it with them but this was precluded on grounds of car space. Games like Battleships are still very much the order of the day, and many well-leafed tomes of practical programs lay around the computing room.

She complained that many of them would not run as listed, but agreed that the real fun lies in making them work rather than using them. She still manages to run her spiritualist foundation, The Chalice Foundation, when not at the keyboard and uses the Video Genie for filing.

Her sect promises answers to such intriguing questions as: Is there a God? and: Is there life after death? though her controversial views on the spiritualist movement appear less frequently than formerly in the pages of the *Spiritualist Gazette*. After that, mastering the micro must seem easy.



knowing the first thing about computers in general and ours in particular, how was I supposed to know what was going wrong?

Commands appeared in the listings which did not appear in the users' manual supplied with the Video Genie for very good reason — the Video Genie does not know about things like:

```
"DEF FNA(X)=INT(RND(1)*X)+1" or
"H1=FNA(N)"
```

```
and
"H2=FNA(C(H1))"
```

So programs like Nomad seemed a useless waste of time. Then I discovered that by omitting the initial DEF FNA and inserting RND(n) wherever FNA appeared the problem should be solved — except that it was not. Only a line by line scrutiny finally revealed a comma, lurking on the end of a Data line, turning a vital positive constant into a zero and making a nonsense of the whole thing.

A similar problem arose with Seabattle except that in that case a semicolon omitted from a "PRINT AS;" statement turned what should have been a map into a stream of full-stops shooting up the edge of the VDU. There were many hitches besides typographical ones in this program. Some statements, such as

```
"S3=INT(RND(1)*20)+1"
```

could be simplified into

```
"S3=RND(20)"
```

but lines such as "RESTORE 6300" just do not work.

Perseverance

When I explained our difficulty to the man in the shop, he told me positively that I was wasting my time — the program was written on and for a computer with teleprinter rather than VDU so not only was the map larger than the screen, but it shot off the top at a great rate of knots, making strategic planning quite impossible.

Undeterred by the expert's opinion, we persevered, and after weeks of sporadic twiddling, we achieved a game not only with static map but also with the added advantage of seeing torpedoes on route to their target and which create a satisfying explosion on impact, but we have not yet managed to display a completely animated version. In any case, we have learned one thing — experts don't know it all.

During this time, I also toyed with Quest to the extent that on each run, the treasure is placed at different locations. Then we encountered the Adventureland programs, which made Quest seem kids' stuff by comparison. Pirates' Treasure took two weeks to find, but I still have not been able to elude the Adventureland bear without giving him honey.

The Tandy Pyramid 2000 insists on keeping the whereabouts of the last two treasures to itself, and I have now embarked on Ghost Town and Mystery Fun House. I am determined that the one-eyed monster who sits permanently on the dining table is not going to out-do me.

As you can probably guess by now, I am no longer merely hooked, but severely addicted, and so frequently burning the midnight oil. As well as playing ready-made games, I have typed-in and debugged many published listings, learning about programming into the bargain.

Whether it is a peculiarity in me, or symptomatic of the disease computer-mania, I do not know, but one thing I have discovered is that once the program has been debugged and runs to plan, I lose interest in it, turning my attention to yet more intricate and complicated plots.

When I thought I knew enough about the basics of programming I set about devising a simple reference system for my own work, which involves researching, and writing on, a totally unrelated subject. I frequently need to refer either to something written by myself, or contained in other works and can rarely find what I want without a great deal of scrabbling through papers or books.

The program I wrote, although short, is very effective and could be adapted easily to suit the needs of anyone in a similar position. In my case, I have entered under Data, file/book letter, A-Z, followed by page number, up to 999, then three factors of three letters each.

If, for example, I thought I may want to refer back to the article in the November issue of *Practical Computing* on, say, Micromouse I would enter "P 50ARTMICMOU". By entering on request ART,MIC,MOU the computer would sort through the DATA and print up "P 50".

If, on the other hand, I had by that time forgotten exactly how it had been entered, but knew it was connected with a mouse, by choosing the appropriate option, I would enter MOU I would then receive the entire entry. If by some remote chance I also had an entry MOU, meaning something quite different, all references would be printed leaving me to decide which one was the correct one.

Tina Billett, self-confessed micro addict.



To save unnecessary explanation I have inserted a few REMs in the listing, so that anyone will be able to understand it.

Obviously any individual wanting to adapt the program for their own purposes would need to devise their own coding system, adapting the listing accordingly.

Having spent so long tinkering with Adventure-type games, I allowed myself to be talked into devising something similar. Not yet conversant with machine code, I am limited to the use of Basic, but with 16K at my disposal there had to be something original worth trying. Not being of the class of people like Scott Adams, what I really wanted to try was something totally different.

Board-games

I have always enjoyed board-games, so after considerable thought, I chose Cluedo as the basis of the experiment. In the computer version, Computaclue, there are 30 locations, including a hazard-ridden garden, 10 suspects and 10 possible murder weapons.

Every run produces a different combination of location, murderer and weapon. The suspects and weapons are strewn at random about the three-storey mansion and can be taken, dropped or released at will. Solving the crime is, as in the board-game, by a process of elimination.

There are two versions; the first enables the player to move through the house at will, while the other moves one at random. The second takes longer in terms of finding the solution but has distinct advantages for those whose typing ability is questionable.

I am contemplating converting 'Monopoly' to the keyboard but have some doubts as to my ability to teach the machine to play intelligently enough to provide stiff opposition. My other half is, meanwhile, writing a program concerning the shooting of a certain well-known and much-hated soap opera character.

We each jockey for position at the keyboard with our 10-year-old son who has all the hallmarks of a budding genius. He has discovered the knack of Peeking and Poking, pointing and setting all over the place, sending the poor machine into apparent convulsions. If ever I decide to use graphics I shall know who to ask for advice.

We have had some technical difficulties with the Video Genie which may be worth a mention to prospective buyers. Having a built-in cassette recorder has distinct disadvantages, particularly when the head tends to be off-centre, and while CSAVEing and CLOADing our own efforts is straightforward enough, there are problems in loading bought System tapes.

I think I have spent as much time watching the left-hand asterisk change into a C as in actually playing the games. Also, those TRS-80 owners to whom we have given copies of our programs have

(continued on next page)

(continued from previous page)

constantly complained about not being able to load the tapes easily or effectively.

Loading reciprocal material is achieved through the second recorder input and if someone can devise an idea for loading machine-code programs in this manner, we would be thankful.

Substandard tapes

We have tweaked the head to make it compatible with other machines, but then had to spend hours transferring all the tapes from one system to the other. That involved dislocating the head of a standard cassette recorder to load the program, then re-record them on to the corrected built-in model.

We have also had trouble with sub-standard tapes. The inexpensive ones are

not the bargain they seem to be. Anything longer than a C-30 jogs up and down on the spindles like a thing possessed and only the judicial placing of a block of wood prevents it from happening. The metal spring on the underside of the cassette lid is as good as useless, for at regular intervals it falls off, leaving the cassette to its own devices and sometimes allowing the tape free access to the works.

Life with Genie is totally different from our prior existence. He — and I use the word with female intuition — has wrought havoc with a household which once ran smoothly and predictably.

Meals which used to appear on the table like clockwork are now haphazard and rushed; clothes are dragged reluctantly from the laundry basket, washed, and frequently re-worn in an unironed state;

dust thickens on the furniture and even the dog has to remind me when it is time for walkies.

As I write this there is a sink full of unwashed dishes and I really ought to go and to them — well, perhaps just a short dibble at Ghost Town.

References

Quest: Written by Roger Chaffee, inspired by Will Crowther's *Adventure*. Published in July 1979 by Byte Publications Inc.

Basic Computer Games and More Basic Computer Games published by Creative Computing Press, Morristown, New Jersey.

Nomad: written by Steve Trapp and published by Creative Computing Press September/October 1977, reproduced in *More Basic Computer Games*.

Seabattle: Originally written by Vincent Erickson, converted by Steve North and published in *More Basic Computer Games*.

Ghost Town and Mystery Fun House written by Scott Adams.

Pyramid 2000 Tandy Corp.

Pirates Treasure and Adventureland by Scott Adams.

```
10 Z$="" :GOTO90
20 A$=LEFT$(R$,4):C$=MID$(R$,5,3):D$=MID$(R$,8,3):E$=MID$(R$,11,3)
25 RETURN
90 CLS:PRINTTAB(17);"INDEX REFERENCE"
95 PRINT:PRINTTAB(5);"ENTER 1, 2 OR 3 THREE LETTER FACTORS, AS REQUESTED, FOR
  REFERENCES PERTAINING TO THE CHOSEN OPTION."
100 PRINT "OPTIONS:
      1) THREE FACTORS AS ENTERED.
      2) THREE FACTORS ANY POSITION.
      3) TWO FACTORS AS ENTERED.
      4) TWO FACTORS ANY POSITION.
      5) ONE FACTOR AS ENTERED."
101 PRINTTAB(12);"6) ONE FACTOR ANY POSITION
      7) ENTER NEW DATA.
      8) END OF SEARCH.
      9) OPTIONS."
110 PRINT "ENTER OPTION"
112 O$=INKEY$:IFO$=""THEN112
115 O=VAL(O$)
120 ONOGOTO140,200,250,300,350,400,450,990
130 IFO=>9THEN100
140 CLS:PRINT"THREE FACTORS AS ENTERED. ENTER THREE FACTORS.":INPUTF$,G$,H$:PRI
  NT
160 READR$:GOSUB20:ON ERRORGOTO175
165 IFF$=C$ANDG$=D$ANDH$=E$THENPRINTA$:Z$:
170 GOTO160
175 RESUME180
180 RESTORE:PRINT:PRINT:PRINT"THAT IS ALL":GOTO110
200 CLS:PRINT"THREE FACTORS ANY POSITION, ENTER THREE FACTORS.":INPUTF$,G$,H$:P
  RINT
210 READR$:GOSUB20:ON ERROR GOTO175
220 IFF$=C$ANDG$=D$ANDH$=E$THENPRINTA$:Z$:GOTO210
221 IFF$=C$ANDG$=E$ANDH$=D$THENPRINTA$:Z$:GOTO210
222 IFF$=D$ANDG$=C$ANDH$=E$THENPRINTA$:Z$:GOTO210
223 IFF$=D$ANDG$=E$ANDH$=C$THENPRINTA$:Z$:GOTO210
224 IFF$=E$ANDG$=C$ANDH$=D$THENPRINTA$:Z$:GOTO210
225 IFF$=E$ANDG$=D$ANDH$=C$THENPRINTA$:Z$:GOTO210
226 GOTO210
250 CLS:PRINT"FIRST TWO FACTORS AS ENTERED. ENTER TWO FACTORS.":INPUT F$,G$:PRI
  NT
255 READR$:GOSUB20:ON ERRORGOTO175
260 IFF$=C$ANDG$=D$THENPRINTA$:Z$:E$:Z$:
265 GOTO255
300 CLS:PRINT"TWO FACTORS ANY POSITION. ENTER TWO FACTORS.":INPUTF$,G$:PRINT
310 READR$:GOSUB20:ONERRORGOTO175
315 IFF$=C$ANDG$=D$THENPRINTA$:Z$:E$:Z$:GOTO310
320 IFF$=C$ANDG$=E$THENPRINTA$:Z$:D$:Z$:GOTO310
321 IFF$=D$ANDG$=E$THENPRINTA$:Z$:C$:Z$:GOTO310
322 IFF$=D$ANDG$=C$THENPRINTA$:Z$:E$:Z$:GOTO310
325 IFF$=E$ANDG$=C$THENPRINTA$:Z$:D$:Z$:GOTO310
```



```

330 IFF$=E$ANDG$=D$THENPRINTA$;Z$;C$;Z$;
335 GOTO310
350 CLS:PRINT"FIRST FACTOR IN FIRST POSITION. ENTER ONE FACTOR.":INPUTF$:PRINT
355 READR$:GOSUB20:ONERRORGOTO175
360 IFF$=C$THENPRINTA$;Z$;D$;E$;Z$;
365 GOTO355
400 CLS:PRINT"ONE FACTOR ANY POSITION. ENTER ONE FACTOR.":INPUTF$:PRINT
405 READR$:GOSUB20:ON ERRORGOTO175
410 IFF$=C$THENPRINTR$;Z$;:GOTO405
411 IFF$=D$THENPRINTR$;Z$;:GOTO405
412 IFF$=E$THENPRINTR$;Z$;
415 GOTO405
450 LIST1000-
990 END
1000 REM DATA EXCLUDED. USER SHOULD DEVISE AND IMPLEMENT
1010 REM METHOD BEST SUITED TO OWN PURPOSES.
1020 REM EXAMPLE - DATA A123ABCDEFghi,B 21DEVOWNMET, ETC
    
```

Bleak moments spent with an unsympathetic machine

A YEAR AGO I decided to make a complete change in my career, which had previously been social work and social research larded with a little teaching. I had been finding that the poetry of numbers, and more particularly of programs and systems called to me more powerfully than the compromises and uncertain premises of social studies.

It probably seems odd that anyone who has enjoyed, as I certainly did, an occupation as fulfilling in personal terms as social work should turn to computing. I was beginning to sense the kind of dissat-

For the past two years I had been going as a user to the University of London Computer Centre, ULCC, and using the statistical package for the social services for analysis of social survey data. I had discovered there the essential role of the advisory office, and also the need for

rudimentary programming skills and a language to write routines.

I took a course in programming in Fortran at Imperial College, London and had attended follow-up lectures.

That, and a row at work, inspired the decision. Next followed the search for

(continued on next page)

Rose Deakin in a happier moment.

by Rose Deakin

isfaction you might feel in trying to play tennis with a soft boiled egg, and, to pursue the sporting analogy, felt some of the thrill of mastering an obstinate horse in coming to terms with a computer.

The parallels are close; first, the sense of hopeless inadequacy and frustration when faced with an unco-operative beast and the lack of skills to dominate it. Then slowly feeling it beginning to respond; some success now in minor things and communication is beginning to be established, and gradually the heady sense of all that power at your command — a mighty beast working for you. It is no wonder that people have anthropomorphic feelings about computers.

The change was not quite as sudden and unheralded as I have implied, although the decision was a surprise even to me. Preparation had been gradual, over a period of years. After an entirely arts-based education and a degree in history I turned in 1971 to the Open University and did a degree in maths and statistics.



(continued from previous page)

advice. It was all very well as a decision, but how does a female over 40 break into a highly-technical, young man's world?

I cannot say that the answer was courage, as I did not feel very brave. Perhaps it was luck of a particular kind — meeting unbelievably kind and helpful people right from the start, and having moral and financial support from my family.

I talked to some people at ULCC first, and they were encouraging. They did not see why I should not try, and thought that the main requirement was a good logical mind. A major difficulty was that I wanted a part-time job, and so I was not an attractive training prospect. I next went to see Dan Oestreicher, a computer consultant and friend of the family.

He said much the same, but added, at the end of our meeting, the suggestion that I might think about microcomputers. He pointed out that the advantage of these was that, being new, the lack of 20 years' experience could not be held against me. Also, if I bought one and worked at home, the part-time problem would be solved.

Stroke of luck

I decided to do that, on the follow-your-nose principle. Although it seemed mad, it made me feel cheerful to think about it, and nothing else did. Then came my next stroke of luck. A few months earlier when trying to find a MK-14 for my 14-year-old son, I had ended up at Transam — the only people we could find who stocked them.

They had been friendly and helpful, and so I went to see them again, and returned with a Triton. My son was worried about my obvious gullibility. My answer was that if you went on studying all the magazines or thought about it too much, you could never decide that one machine was better than another and you would end up buying nothing — naturally, I do not agree with this now.

Certainly, my biggest stroke of luck was to go to Transam, as without its staff's help and support, I would have been a piece of litter on the verge of the great microcomputer highway.

Consumer backlash

Perhaps being a woman helped, as I think that if they had not got a certain amount of entertainment from the very unlikelihood of my struggles, they might have been less kind and more irritated.

My very bewilderment may also have helped in a curious way, as I was loudly insistent about the dangers of a consumer backlash, if the kind of people to whom microcomputers would soon be sold were not given more help in the initial stages. I saw the help as better documentation and a reduction in the complexity of what users had to do.

Transam quickly recognised an opport-

unity to see just what a novice to the field finds hard to understand and master. I noticed that many of my ideas were soon incorporated into its philosophy.

There followed six months desperate struggle to develop some more programming skills while learning Pascal, and mastering the system. I had soon decided to buy a single 8in. disc drive to add to my Triton and to run CP/M. My tangle with CP/M proved quite my worst experience in years.

Document criticisms

I had started being very critical of the Triton documentation, but although I stick by my criticisms, it was clarity itself compared to the CP/M manuals. I have since realised that the CP/M manuals do in most cases include a correct description of the procedures and commands, but that they are comprehensible only to someone who knows already how to do it — a useful reminder but a useless introduction.

The addition of a disc operating system added horribly to my problem, and since there was no help to be got from the manuals, even at fifth or sixth perusal, I had to turn to the telephone, or personal visits to Transam — very embarrassing, but there did not seem to be anyone else to ask.

I forced myself. I had a mental picture of everyone sighing and muttering: "Oh lord, here is that woman again with more stupid questions". Yet the alternative would have been a pile of expensive, rotting equipment looking reproachfully at me each day: so I went back and asked.

Diary entries

Some entries in my diary may give an impression of the agonies endured;

May 6: Got copy of master disc made by Brendan, but system not added because different size. He told me what to do and I spent the rest of the day, 11am-9pm, trying and failing.

May 7: In despair and humiliation, returned with all discs. B not there so Paul tried for ages to do it and could not. Is it something I have done? Went home and tried again. No joy. Rang and got B who had meanwhile decided what to do. He worked out a special routine for me and this was OK.

May 19: Desperate work on E's project. Nightmare. Can so nearly do it, but it won't function. Stuck on parameters again. I think it's types.

May 23: Cannot get the answer. Wrote in despair to Dan for help.

June 3: Worries: How will I be ready in time? What should I concentrate on? Will I have anything to offer? Shouldn't I also learn Basic?

June 11: N.b. Must find a better input routine to save all these tedious corrections.

July 16: Went to see Graham about back-up for the hospital project. He was really helpful and enthusiastic.

Sept 2-11: Worked really well, and everything went like a dream. Developed several new programs for graphing etc. Now I begin to feel more confident.

I had decided that the only way to learn was to do, and that the only way to do was for real, not a theoretical exercise. On the other hand, being clearly incompetent, I could not take on ordinary jobs, so I went round bullying friends who had businesses or work susceptible to computer aid.

One friend gave me some social survey analysis to do for my first project, and another put me in touch with a hospital department with student nurse time-tabling problems. In return for access to the hospital work and records, I devised and demonstrated a system of data files, information recall and update programs which they found useful as an introduction to the inevitable task of thinking out their own use of computers in the near future.

Under pressure

I had committed myself to producing results and so was under pressure to learn and to deliver the goods without the feeling of having taken any money for services I was not sure I could render. Now I feel I could render them.

The question today is: what happens next? I would like to write a fools' guide to the subject to help people like me, or even people who, though not so foolhardy, are interested in the subject. I want to develop teaching material and self-instruction guides. I want to improve my own skills almost indefinitely, and I want to set up some kind of advisory business.

The plan will be to help the people who, will find themselves in a mess trying to be their own systems analyst, programmer, operator and user all in one. I am afraid that this is what will happen with microcomputers, as they are so small and cheap that each one does not have a giant organisation to support it.

Advisory business

If I set-up an advisory business, my first piece of advice will always be: Find a reliable manufacturer or supplier but above all one that you can rely on for help and support. A friend once asked admiringly how on earth I had managed to learn it all, and laughed when I replied: "I read all the books and if I didn't understand them, I just kept on telephoning the shop".

The point is that you do have to have someone. There are few moments so bleak as being alone in a room with a computer which just says: "What"? Although machines can be enormously satisfying, and the use of them can be creative and poetic, they do not explain things to you; you cannot plead with them; they do not melt under the warmth of your smile; you cannot wheel and deal with them, nor can you bribe them or buy them off.

That all adds up to the fact that the people in your microcomputer life will be as important as the machine, despite the fact that a good machine is an essential part of the equation.

ORBIT STOCK

A **NEW** STOCK CONTROL PROGRAM IN A WORLD OF ITS OWN

Being out of stock means lost sales, lost revenue. Too much stock ties up working capital—at today's interest rates that can be expensive.

So what's the answer?—ORBIT STOCK

a program designed to be fast and flexible. It can be used on any micro computer supporting UCSD Pascal—Apple II & III, North Star Horizon, etc. Has fast access time to stock items even when totally full. Multi-user, with up to 25 different passwords and various levels of confidentiality access.

OTHER PLUS POINTS INCLUDE:

- ★ Up to 90 million products (therefore limited only by disk capacity)
- ★ 15-character alphanumeric item name/sort key.
- ★ 6 user-defined and named description partitions.
- ★ User-defined reports.
- ★ Full security, with user names, passwords and status throughout the system.
- ★ The following reports can be produced;
 - Stock Report and Valuations
 - Stock Levels and Shortages
 - Stock Movement with Current Forecast
 - Price Lists

For more details, contact your nearest APPLE DEALER, or come and see us at the APPLE BUSINESS SHOW, GRAND HOTEL, MANCHESTER, 24th-26th MARCH 1981.



**VLASAK
COMPUTER
SYSTEMS,
VLASAK HOUSE,
8 STUART ROAD,
HIGH WYCOMBE,
BUCKS.
(0494) 448633**

New! Sinclair ZX81 Personal Computer. Kit: £49.⁹⁵ complete

Reach advanced
computer comprehension
in a few absorbing hours

1980 saw a genuine breakthrough – the Sinclair ZX80, world's first complete personal computer for under £100. At £99.95, the ZX80 offered a specification unchallenged at the price.

Over 50,000 were sold, and the ZX80 won virtually universal praise from computer professionals.

Now the Sinclair lead is increased: for just £69.95, the new Sinclair ZX81 offers even more advanced computer facilities at an even lower price. And the ZX81 kit means an even bigger saving. At £49.95 it costs almost 40% less than the ZX80 kit!

Lower price: higher capability

With the ZX81, it's just as simple to teach yourself computing, but the ZX81 packs even greater working capability than the ZX80.

It uses the same micro-processor, but incorporates a new, more powerful 8KB BASICROM – the 'trained intelligence' of the computer. This chip works in decimals, handles logs and trig, allows you to plot graphs, and builds up animated displays.

And the ZX81 incorporates other operation refinements – the facility to load and save named programs on cassette, for example, or to select a program off a cassette through the keyboard.

Higher specification, lower price – how's it done?

Quite simply, by design. The ZX80 reduced the chips in a working computer from 40 or so, to 21. The ZX81 reduces the 21 to 4!

The secret lies in a totally new master chip. Designed by Sinclair and custom-built in Britain, this unique chip replaces 18 chips from the ZX80!

Proven micro-processor, new 8KB BASIC ROM, RAM – and unique new master chip.

**Built:
£69.⁹⁵
complete**

Kit or built – it's up to you!

The picture shows dramatically how easy the ZX81 kit is to build: just four chips to assemble (plus, of course the other discrete components) – a few hours' work with a fine-tipped soldering iron. And you may already have a suitable mains adaptor – 600 mA at 9 V DC nominal unregulated (supplied with built version).

Kit and built versions come complete with all leads to connect to your TV (colour or black and white) and cassette recorder.

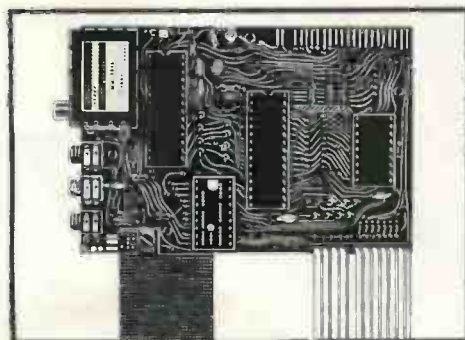

New Sinclair teach-yourself BASIC manual

Every ZX81 comes with a comprehensive, specially-written manual – a complete course in BASIC programming, from first principles to complex programs. You need no prior knowledge – children from 12 upwards soon become familiar with computer operation.



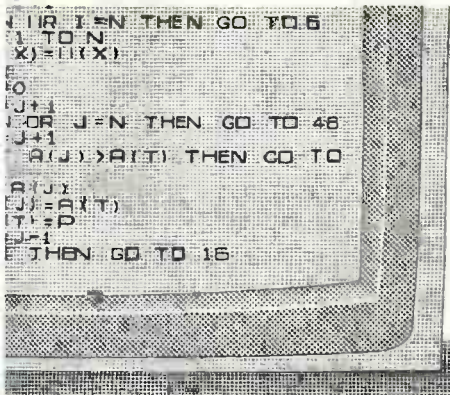

New, improved specification
 Z80A micro-processor – new faster version of the famous Z80 chip, widely recognised as the best ever made.

- Unique 'one-touch' key word entry: the ZX81 eliminates a great deal of tiresome typing. Key words (RUN, LIST, PRINT, etc.) have their own single-key entry.
- Unique syntax-check and report codes identify programming errors immediately.
- Full range of mathematical and scientific functions accurate to eight decimal places.
- Graph-drawing and animated-display facilities.
- Multi-dimensional string and numerical arrays.

Up to 26 FOR/NEXT loops.
 Randomise function – useful for games as well as serious applications.
 Cassette LOAD and SAVE with named programs.

1K-byte RAM expandable to 16K bytes with Sinclair RAM pack.

Able to drive the new Sinclair printer (not available yet – but coming soon!)

Advanced 4-chip design: micro-processor, ROM, RAM, plus master chip
 Unique, custom-built chip replacing ZX80 chips.

sinclair

ZX81

Sinclair Research Ltd,
 Kings Parade, Cambridge, Cambs.,
 CB2 1SN. Tel: 0276 66104.
 Reg. no: 214 4630 00

If you own a Sinclair ZX80

The new 8K BASIC ROM used in the Sinclair ZX81 is available to ZX80 owners as a drop-in replacement chip. (Complete with new keyboard template and operating manual.)

With the exception of animated graphics, all the advanced features of the ZX81 are now available on your ZX80 – including the ability to drive the Sinclair ZX Printer.

Coming soon – the ZX Printer

Designed exclusively for use with the ZX81 (and ZX80 with 8K BASIC ROM), the printer offers full alphanumerics across 32 columns, and highly sophisticated graphics. Special features include COPY, which prints out exactly what is on the whole TV screen without the need for further instructions. The ZX Printer will be available in Summer 1981, at around £50 – watch this space!



16K-BYTE RAM pack for massive add-on memory.

Designed as a complete module to fit your Sinclair ZX80 or ZX81, the RAM pack simply plugs into the existing expansion port at the rear of the computer to multiply your data/program storage by 16!

Use it for long and complex programs or as a personal database. Yet it costs as little as half the price of competitive additional memory.

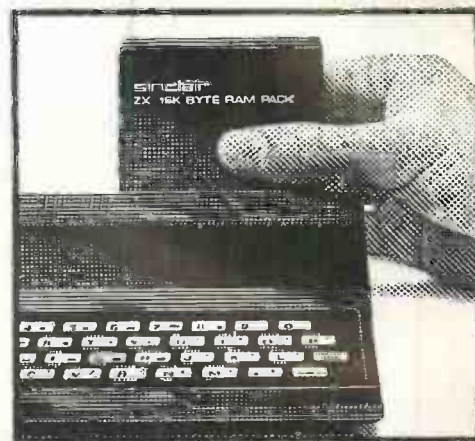

How to order your ZX81
BY PHONE – Access or Barclaycard holders can call 01-200 0200 for personal attention 24 hours a day, every day.
BY FREEPOST – use the no-stamp-needed coupon below. You can pay by cheque, postal order, Access or Barclaycard.
EITHER WAY – please allow up to 28 days for delivery. And there's a 14-day money-back option, of course. We want you to be satisfied beyond doubt – and we have no doubt that you will be.

To: Sinclair Research Ltd, FREEPOST 7, Cambridge, CB2 1YY.

Remember all prices shown include VAT, postage and packing. No hidden extras. Please send me:

Qty	Item	Code	Item price £	Total £
	Sinclair ZX81 Personal Computer kit(s). Price includes ZX81 BASIC manual, excludes mains adaptor.	12	49.95	
	Ready-assembled Sinclair ZX81 Personal Computer(s). Price includes ZX81 BASIC manual and mains adaptor.	11	69.95	
	Mains Adaptor(s) (600 mA at 9 V DC nominal unregulated).	10	8.95	
	16K-BYTE RAM pack(s).	18	49.95	
	8K BASIC ROM to fit ZX80.	17	19.95	

TOTAL: £

Please tick if you require a VAT receipt

*I enclose a cheque/postal order payable to Sinclair Research Ltd, for £

*Please charge my Access/Barclaycard account no.

*Please delete/complete as applicable.

Please print.

Name: Mr/Mrs/Miss

Address

FREEPOST – no stamp needed.

PRC04

• Circle No. 159

Accounting
Business Systems

TABS

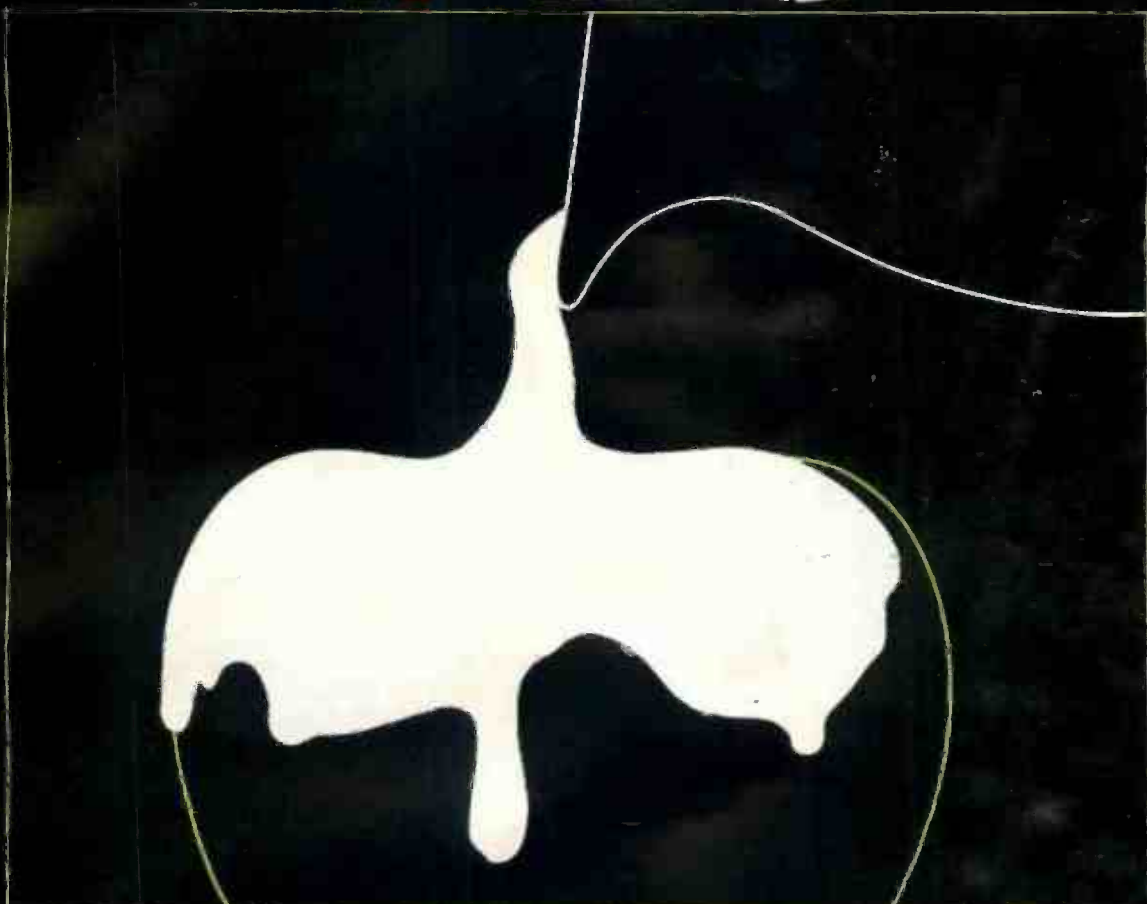

The cream for your apple.

Within the space of a few short months, TABS has rapidly become established as the best accounting software on the market for APPLE II.

Our unique modular accounting system, developed for the APPLE II microcomputer, has been designed specifically to meet an increasing demand from the small business.

The fully integrated system enables modules to be used independently or together so that as business expands so does the system simply by adding a new module.

To ensure that our low cost accounting system* is fully understood, TABS offer a full support service, through our national dealer network, that includes training courses, consultancy and free seminars.

Modules include: Purchase Ledger, Sales Ledger, Nominal Ledger, Payroll, Stock Control, Job Costing, Word Processing, Training, Support, Management Accounts, Invoice Compiler, Fast Data Entry, Sales Order Processing, Mail List. **£99**

Each module costs an astonishingly low

*The minimum system required to run the TABS modules is:
Apple 48K, Disk with controller, Disk without controller, Silentype printer, TABS Firmware card, total cost £2056

Expanding Dealer Network

LONDON Eurocalc Ltd 01-405 3223, Lion Computers 01-636 9613, Marchessa Ltd 01-726 4809, Micro Control Ltd 01-402 8842, Time & People Ltd 01-242 4706, AVON C & G Computer Group Ltd 0934 417724, Datalink Micro-Computer Systems Ltd 0272 213427, BERKS Hexagon Services 0753 21998, BUCKS. Chiltern Computers 0296 32642, Chiltern Office Efficiency Ltd 02405 72777, CAMBS. Top Mark Computers 0480 212563, CHESHIRE Systems Integration 061-928 5784, CORNWALL Diskwise Ltd 057-93 3780, ESSEX Compuskill 0708 751906, Meclac 03708 5047, GLOS. Casa Management Consultants Ltd 045383 4551, William John & Co 04536 70109, HANTS. Access Control Systems Ltd 0730 5274, Grist Business Services 0703 39061, Logan Electronics Ltd 0425 619761, HERTS. H G Services 0727 30129, Lux Computer Services 0923 29513, HUMBERSIDE Computer Facilities Ltd 0724 63137, KENT Microten Computers Ltd 0732 8454 12, Microspot 0622 858753, LANCs, K C Business Systems 0254 676077, Lancaster Computer Services Ltd 0772 31030, LINCOLNSHIRE Estate Computer Systems 0529 305637, MANCHESTER Shannons Radio Ltd 061-748 2339, MERSEYSIDE Micro Digital Ltd 051-227 2535, Rockcliff Micro Computer Division 051-521 5830, MIDDLESEX Microsolve Computer Services Ltd 01-951 0218/9/0, W. MIDLANDS Micro Business Centre Ltd 0902 725687, Westwood Computers Ltd 021-632 5824, NDRFOLK Anglia Computer Centre 0603 29652, Carlton Computers Ltd 0493 58897, NORTHANTS Co-Compute Ltd 0604 33767, OXFORDSHIRE Courtland Electrical 0865 779282, SALOP. Cressage Computer Services 0743 69009, STAFFS. Abel Computer Systems Ltd 0827 50804, SUFFOLK Blyth Computers Ltd 050-270 371, SURREY Ramm Computer Services 0284 64045, Aerco, Gemsoft Ltd 04862 22881, Ferguson Computer Services 09323 45330, SUSSEX Illexford Ltd 0273 23020, Datex Micro 0903 39290, I.D.T. Computers 044-483 370, Oval Computer Systems 0903 501355, Supabeam Computer Services 0403 61647, STAFFS. Britannia Computers Ltd 0384 233433, WORCS. Capricorn Computer Systems Ltd 0905 21541, Mike Dennis Associates Computer Systems 0386 48240, S. YORKS, Hallam Computers 0742 663125, EIRE Teletone Ltd Dublin 71595-4, N. IRELAND Medical & Scientific Computer Services Ltd 08462 77533, SCOTLAND Scoobyte Computers Ltd 031-343 1005, Gate Microsystems Ltd 0382 28194

If you are interested in TABS low cost Accounting Business Systems, please tick box(es) and return this coupon to us.

- User enquiry**
- Please send me an invitation to a free seminar.
 - Please send me the TABS User Manual (enclose £5 (postage and packing included))
- Dealer enquiry**
- Please send me details of your Dealer Plan

NAME _____
ADDRESS _____

Tel. No. _____

TABS Ltd, The Old Rectory, Blackford, Wincanton, Somerset.
Telephone: North Cadbury (0953) 40164



Sig net

If the front panel....

and the basic specification...

- * 4MHz Z80 processor and full 64K RAM
- * 2 or 4 dual density mini floppy disk drives
- * Serial RS 232 printer and VDU interfaces
- * CP/M compatible

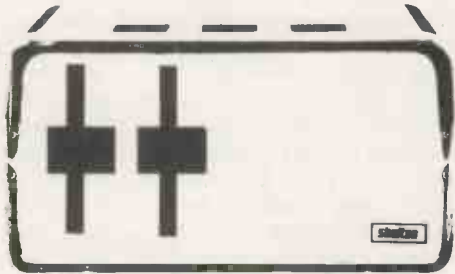

make you think you've seen it all before, then take a closer look at the....

Sig net range of microcomputers from shelton

A confident new approach to micro design, which combines the cost advantages of single board computers with the flexibility of bus systems

and the price! **£1299** for a twin-drive system including CP/M

expandable to

- * Multi-user, multi-processor operation
- * Virtually unlimited flexible or hard disk storage capacity
- * Support an almost unlimited number of other peripherals and users under MP/M, CP/NET or CP/NOS

OEMs — take advantage of the outstandingly low cost of Sig net modules

CPU-RAM: 4 MHz, Z80, 64K and hard disk controller interface	£299.50
FDC: supports 4 single, double or quad density drives — 8 or 5¼ in.	£159.50
TWO-SER: twin serial I/O RS 232, 80baud — 19.2kbaud (64kbaud synchronous)	£89.50
PSU-CPU: modules power supply	£49.50
PSU-FDD: disk drive power supply	£69.50



Sig net

microcomputers

another leading idea from

shelton

THE RESOURCE CENTRE

shelton

Sig net is a trade mark of Shelton Instruments Ltd.

Shelton Instruments Ltd.,
22-26 Copenhagen Street,
London N1 0JD.

01-278 6273/4

TELEX 869559 GECOMS G

Nestar local network gives micros large-computer benefits

IN THE mid-1970s, two exciting avenues of development opened in the computer world. The first was the emergence of networks of large computers. At that time, I was teaching at a major university which participated in the pioneering ARPA computer network. Therefore, I had the opportunity to learn at an early stage what fun it could be to send and receive computer "mail" from colleagues on the network, to browse through the Associated Press releases stored in a remote file, to participate in a nationwide teleconference, or to play spacewar games with distant opponents.

Second development

The second exciting development around that time was the beginning of affordable personal computing. It was not long after obtaining an account on the ARPA network, that I bought an Altair computer.

Today, about five years later, it seems that networking and personal computing are beginning to move together. I know of 10 companies which have announced plans to market local networks of personal computers in the last six months.

They are not like the ARPA network, in which the computers are relatively-large machines spread throughout the States and Europe. They are networks of small computers, located, typically, within 100s of meters of each other. About half of the entrants in this new local-network market are large companies with backgrounds in

semi-conductors and minicomputers and others are from the personal computer industry.

As far as I know, the first company to announce a product mixing network and personal computer technology was Nestar Systems of Palo Alto, California. Three years ago, Nestar developed a package which allowed several Pet or TRS-80 computers to be linked to share a common disc. That system was designed primarily with the schools market in mind.

Last year, Nestar announced a second-generation local network which ties together Apple computers and is aimed at providing the kinds of functions found on large computer networks. The new system, the Cluster/One Model A, is

by Larry Press

being developed with an eye to the office environment.

A recent consulting job provided me with the excuse I needed to visit Nestar and spend a few days using its system and talking with its staff.

The Model A enables one to network up to 65 Apple II computers. At the centre of the network is a master Apple which controls a Nestar 8in. floppy disc subsystem and an optional hard disc. The hard disc may be either 16.5 or 33Mbytes, though larger discs are planned for the future. The system is connected via a 16-wire flat cable to up to 64 Apples. Each Apple must have a network interface card

which plugs into any unused peripheral slot.

Any of the user systems can access the master disc as if it were a local Apple drive. It may be used to store commonly-used programs and, of course, shared databases. In addition to the use of the master system and its disc, the network members are able to communicate directly with each other since each has a local address set by switches on the interface card. That enables any user to control a resource which might be shared by others on the network. For example, one might control one or more printers which could be used by anyone on the network.

Figure 1 shows a typical configuration which could be installed in an office. The master system has a 16.5Mbyte hard disc in addition to the floppy-disc subsystem. There is one user system which is dedicated to controlling a relatively high-speed printer and 10 other user systems which are located on various people's desks in the office.

Shared resources

For the purpose of the example, let us assume that disc storage and printing are handled entirely by the shared resources, so that none of the users requires a floppy disc or printer. Each will, however, require a network interface card, memory, and probably an Apple Pascal card.

Table 1 shows the cost of such a system and table 2 the cost of 10 stand-alone Apples, each with two 143K floppy discs and an 80 character per second printer. As the tables show, the cost of the network system is roughly the same as 10 stand-alone machines. With more user stations, the network would begin to enjoy a cost advantage and with less, the stand-alone systems would be cheaper on a per-user basis. In fact, using those figures, the break-even point is reached at about 12 users.

As the example indicates, cost savings are not a significant factor in tempting one to install a 10-user network in an office environment, but there may be other reasons. I mentioned various functions such as electronic mail, teleconferencing and access to common data which contribute to the value of the ARPA network. It is clear that some software support is necessary if such facilities are to be provided.

We might distinguish among four general classes of software in the network environment. The first is associated with basic data transfer between the elements of the system. That software is responsible for the reading and writing of data,

Figure 1.

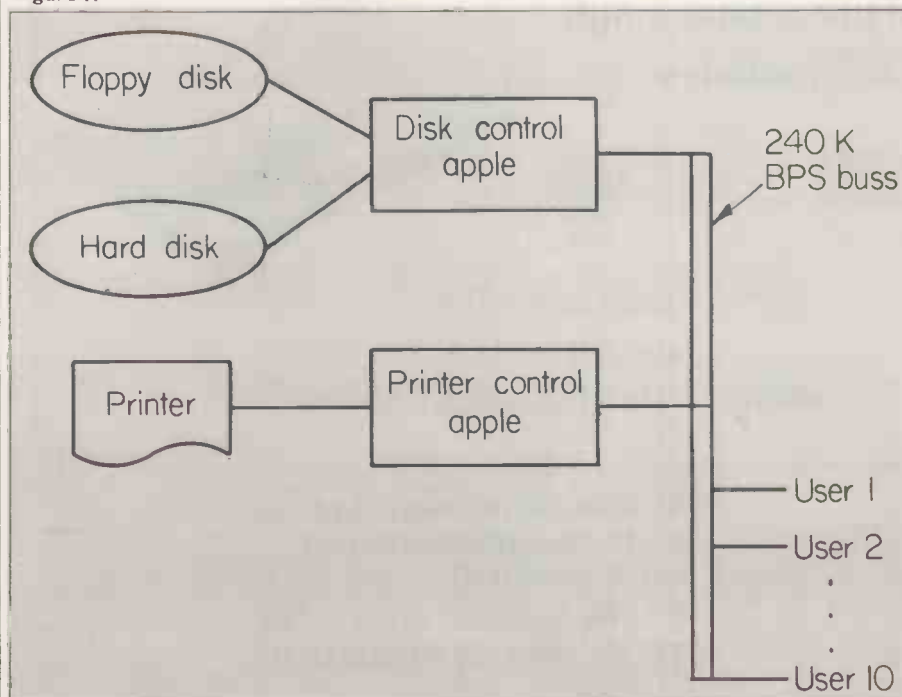

routing it to appropriate units, error detecting, etc.

Operating system software is the second level which must be provided. That is the software which manages disc files and other resources. It maintains directories of files, associates logical files with devices, handles security and billing, interfaces with the system operator if there is one, etc. Next is generic applications software — applications such as electronic mail or teleconferencing.

Those are useful in many kinds of organisation, as opposed to the fourth category, specific applications software. That software is designed for a specific industry, but is written for the network environment in which a common database is maintained and common resources such as printers are shared.

Nestar, of course, provides the basic data communications software with the system. Each of the interface cards has 1K RAM for data buffering and a 2Kbyte program in ROM for controlling communications.

User station

The operating systems software is partially that of Nestar and partially that of Apple. The user station is an Apple running either Apple DOS or Pascal. The fact that a file might be physically located on a shared hard disc is transparent to the local Apple operating system. However, a number of additional facilities are provided by Nestar.

The operating system functions, which are necessary since the network is a multi-user environment, are supplied by Nestar. When a user logs-on, the system verifies his identity and password. A user-supplied command file may also be executed automatically when he logs-on, for example, to display the titles of any messages which have arrived in his mail file since he last used the system.

The Nestar operating system software also manages the shared disc. It maintains a Unix-like directory and allocates space. The user has the ability to create many virtual diskettes on the shared disc. He may then mount them — like inserting them in an imaginary disc drive on his Apple. From that point, the Apple operating system and programs running under it read and write from this virtual diskette as

	List price	30 percent Discount
Shared facilities		
Floppy-disc subsystem	6,000	6,000
16.5 Mbyte hard disc	8,000	8,000
Disc control Apple	2,200	1,540
Printer	4,000	4,000
Printer control Apple	2,400	1,680
Cables and installation	500	500
User Apples		
10 at 2,400	24,000	16,800
Total	47,100	38,520

Table 1. Costs in U.S. dollars of a 10-user network assuming that a Teletype Model 40 printer and a floppy disc and a 16.5Mbyte hard disc are shared resources. The first column assumes list price for the Apples and the second assumes a 30 percent discount on the Apple components.

if it were a real diskette inserted in a real floppy disc drive.

The Nestar operating system also handles file protection, so that only authorised users can read or write specified files. Temporary locks are also provided so that one user does not inadvertently use a record while it is being processed by another. Finally, Nestar provides utilities for formatting and testing diskettes and backing up the hard disc on 8in., double-sided, single-density floppies.

The operating system facilities are all available for delivery today. A print-spooling utility package is also under development at Nestar. It is running now in a single-printer configuration, but is being extended to allow configurations in which several, heterogeneous printers are controlled by a single Apple.

Electronic mail

So much for operating systems and utility software. Nestar is also developing some generic applications software. I was able to use a preliminary version of its electronic mail package. An electronic mail system is a complex piece of software. The user creates and modifies messages he wishes to send to others. Once a message is composed, it must be sent; so, the system must maintain directories of user attributes and locations and it must be capable of routing and broadcasting mail to them. When mail is received, it is stored in the recipient's in-file

and he is informed that he has new mail.

The person receiving the mail will want to read through it and perhaps file it, erase it, forward it to someone else, make marginal notes on it, etc. Note that both the senders and recipients of mail need to edit documents and file them away in a meaningful manner for subsequent retrieval.

File-card handler

The software for that kind of editing, filing and retrieval is complex and its design is central to the utility of a network system. No-one who has used a screen-orientated word processor to edit documents will be satisfied with the clumsy line editors found in the electronic mail systems on most networks.

Nestar is also working on a file-card handler, which enables the user to create and manipulate lists of various kinds. Each file card in a list contains relevant information as well as tags for sorting and retrieval. Nestar will also provide a simple teleconferencing system in which several users may be on-line at the same time and exchange messages which may also be stored for further use. I saw only a brief demonstration of the package, but it is also planned for release this year.

The versions of those systems which I was able to use were preliminary and it would be possible to criticise them. For example, there was no screen-orientated editor for composing and modifying text. However, Nestar seems to be committed to continuing to refine those programs and to develop others. Its policy is to provide that kind of generic applications software with its systems.

The final type of software is specific applications packages. Nestar feels that these packages must be developed by people who are familiar with the specific application area so it is leaving this to end-users and OEMs. Several OEMs are writing applications packages and while Nestar will assist them technically, it has no plans for in-house products of this nature.

Anyone thinking of installing a network
(continued on next page)

Table 2. The price in U.S. dollars of 10 stand-alone Apples, each equipped with an 80 character per second printer and two 143K floppy discs.

	List price	30 percent Discount
48K Apple	1,400	980
Monitor	200	140
Pascal card	400	280
Dual discs	1,100	770
Printer and interface	1,200	840
Total per system	4,300	3,010
Total for 10 systems	43,000	30,100

(continued from previous page)

system must address the question of performance. Unfortunately, predicting how well a local network will perform in use is a difficult and yet unsolved problem. The problem is difficult because there are so many variables in each installation. How many users will usually use the system at once? What is the maximum number who will ever use it? Will the kinds of tasks they perform require frequent disc access? Will they produce a good deal of printed output? Will they have floppy discs or printers at their user stations? What are the seek and latency times for the disc used? What is the data rate on the buss? What is the algorithm for buss multiplexing? These factors will dramatically affect system performance.

As examples, let us consider several possible application environments. At Nestar, programmers use the in-house network for applications development and documentation. They do a great deal of program and text editing, compilation and debugging. This work uses the shared disc and printer rather heavily and they feel that six to eight users in this environment is about as many as the system can accommodate. At that load level, the response time becomes slow. Their guess is that the average time to run a job is about the same as on a stand-alone Apple, but that the standard deviation is high.

Amusement park

Another installation is at the Sesame Place Amusement Park. In that environment, users load programs from the disc, but then execute them locally. There is not much disc activity once a user has signed-on and loaded a program, so a single network can support more users. At Sesame Place, there are between 20 and 25 users on-line at a time.

There is a Nestar system installed at a bank in San Francisco which is being used for data entry. While there is a good deal of disc access in this case, the system accommodates 20 users satisfactorily.

To put the performance question in some perspective, I ran a few benchmark experiments comparing a stand-alone Apple with a floppy disc to the same Apple using a hard disc over the network. Table 3 shows the results I obtained when

Table 3. Sequential disc I/O. This table shows the time in seconds to read or write the numbers 1 through 1,000 on a sequential file using a stand-alone Apple computer with a floppy disc and a networked Apple using a hard disc. There were four users on the network at the time the test was run, but they were inactive. The figures are averages for several runs and there was virtually no variance due to changing system loads.

File size	Record size	Stand-alone	Network
100	10	8/13	7/11
100	100	12/22	11/17
100	200	14/24	15/25
100	1,000	17/27	19/32
200	200	28/44	30/47
300	100	38/50	32/45

	Stand-alone	Network
Read 1,000 numbers	22	21
Write 1,000 numbers	24	25

Table 4. Random disc I/O. This table shows the time in seconds to read and write — read time/write time — random files. In each case, the entire file was created — written — and read back sequentially.

trying sequential disc I/O. I wrote a Basic program which wrote the numbers 1-1,000 in a disc file and another which read sequentially through the file created by the first program. As the table shows, the stand-alone and network system were about equal in speed.

At the time I ran the experiment, there were four other users on the network — one was on the print spooling system. However, they were essentially inactive. I was using Apple Basic rather than Pascal



The Apple II.

and had an empty diskette on the stand-alone Apple, which presumably reduced seek times.

The second group of benchmarks are summarised in table 4. I wrote random files of fixed length records and subsequently read them back. In that case, I varied both the file size and the record size. As in the sequential case, write times are consistently longer than read times because data is checked after it is written. Those limited data also seem to indicate that the stand-alone system enjoys a com-

parative advantage in cases where record sizes are high. I suspect that reflects a feature of the I/O buffering system and it might be possible to tune the system to account for typical record and file sizes. I did not ask whether the user is able to tune the system in the field to perform well using his hardware, but this kind of thing should be possible.

Those tests are limited, but they do give a rough feel as to the speed of an Apple in this environment. I asked the people at Nestar if they had worked on either mathematical or simulation models of the system and was told that they had not had the time but that it would make a great masters thesis. I wholeheartedly agree. At the moment, it is difficult to configure intelligently a network system for a new application let alone compare two competing systems. With time, we will have to develop both far more "seat of the pants" experience and analytical models of the systems in the marketplace.

Enormous interest

Local networks are a enormous interest. Nestar has been a pioneer in the field, but it now has a much actual and announced competition. As we have seen, the cost of a local network will often be as great or greater than the equivalent number of stand-alone machines. Justification must derive from the value of sharing common data, and to do so, a heavy investment in software will have to be made. Middle managers are not going to be willing to have to learn an operating system which imposes a confusing view of the secondary store on them. Neither will they be willing to write electronic memos if they have to do it using editors which were designed for programmers sitting in front of Teletype machines operating at 10 characters per second over a phone line.

Nestar is off to an early start in that its second-generation system is in the field, while many other companies are just starting their advertising campaigns. However, it is my guess that software design will be the key to continued success in this area.

References

1. ARPA stands for the Advanced Research Projects Agency of the Department of Defence. ARPA has been instrumental in funding a good deal of development work in computing, including the earliest major time-sharing systems.
2. The same types of software must, of course, be provided in the stand-alone personal computing environment — device drivers, operating systems, and applications packages. While stand-alone applications packages will operate on a networked system, they must at least be modified if they are to take advantage of the capability for sharing data and other resources.

95% OFF

The cost of Financial Modelling

Too good to be true?
This is what the Financial Times said:

Financial modelling made easy

IF MICROMODELLER were a wine you might be forgiven for describing it as presumptuous and definitely non-vintage. As it is a software package, these may be seen as positive advantages.

Micromodeller comes to the market with the claim that it is the software program that will enable non-computer trained managers to do sophisticated financial modelling on a mere Apple microcomputer. It will cost a fraction of using an expensive program on a mini-computer let alone time sharing on a mainframe.

The Micromodeller software program costs just £425. A complete Apple II computer system, complete with video display, floppy disc drives for memory and a printer costs £4,000. By comparison the program for a mini-computer which rivals Micromodeller would cost around £10,000 according to Applied Computer Techniques the publicly quoted company, which is marketing the new program.

ACT believes that Micromodeller will rival Visicalc, the highly successful American software program which can be used on most micro-computers. Visicalc, which enables micro-computers to be used as sophisticated calculators, has itself been a significant driving force behind the success of mini-computers.

Micromodeller, which is considerably more sophisticated, is expected to encourage sales of micro-computers among business users. In the first 12 months, and it was only launched last week, ACT anticipates sales of over 2,500 programs. Many large companies with high financial modelling costs are expected to adopt Micromodeller on Apple computers.

Intelligence (UK) Limited, which wrote Micromodeller, says it has 95 per cent of the facilities offered by other financial modelling packages—including those costing around £10,000. It says the few features it does not offer are those like declining balance depreciation under French law, and third order polynomial regressions which are very seldom used.

The program has colour graphics and it can present information as line graphs, bar charts or pie charts. Instructions are given in English—the program is designed to be used by businessmen rather than by computer programmers.

ACT is claiming that it only takes a couple of hours to learn how to use—with the help of a tutorial guide. At its launch even some of the most jaundiced observers of the computer industry were making some highly favourable predictions for Micromodeller's future.

JASON CRISP

ACT MICROSOFT

5/6 Vicarage Road, Edgbaston,
Birmingham B15 3ES
Tel: 021-454 5341

Twx: 339396

PET is the trademark of Commodore Systems. Apple is the trademark of Apple Computers.

[] Rush me free details of MICRO-MODELLER

Name:

Address:

Postcode:

Credit card holders may order by telephoning 021-455 8585

PC4/81



Planned obsolescence

The last journey. An historical one, too, for soon the job of anti-societal-material disposal engineers would cease. Progress was at last overcoming the final bastion of human toil. All other forms of necessary manual work had long since given way to the advances of automation and now this much-treasured, much-coveted vocation was finally succumbing. Refuse collectors, that is — dustmen.

Henry stared in disbelief at the computed value that had just flashed on to the screen in front of him. It was a hobby of his to study population trends and the algorithm which had just been executed had been designed to forecast the number of inhabitants of Las Vegas in the year 2200.

He felt, with some justification, that the answer should not have been —2.07. Momentarily he wondered what —2.07 people looked like. With a quickly typed-in command he recalled the input, displaying it on the VDU.

There he saw the glaringly obvious causes of the erroneous output — a misplaced decimal point here, an extra minus sign there; and a misspelled character “W” instead of the digit “2” in one of the numbers.

“What a heap of garbage”, he rebuked himself.

He was about to correct things when the screen, which had been full of figures, suddenly blinked and Henry found himself looking at a live picture.

“We’ve picked up that piece of Saturn five, good buddy”, a voice said over his intercom, “and you’ve a green light for Box2. So let’s roll it. 10-four”.

Henry was a little bored with Commander Daly’s periodic fads. Space affects people in strange ways, but Daly was one of the extreme eccentrics. At present he was into 20th-century truck-drivers and CB radio — or at least his version of that jargon.

Henry was bored with many things and it was showing in his psychological read-out. He had a hard life and was long overdue for termination.

Henry reached to his side and punched a sequence of buttons on the navigation console. The view on the screen slowly changed as the Pandora, the vessel in which he was travelling, veered towards Box2 which was on a heliocentric orbit. They would rendezvous with it almost midway between Earth and the Sun and there they would deposit this, the latest and last, collection.

Of course, manual garbage disposal on the mother planet — and indeed on the five lunar bases — had been super-

seded by automated methods decades ago, but for some reason, possibly the sheer immensity of the task, space-sweeping had proved difficult to convert.

“Crew’s quarters to bridge. Mike here, Henry”, someone interrupted over the intercom. Several minutes had elapsed since the change of course.

“Go ahead, Mike”, Henry acknowledged.

“We’re going to get some shut-eye until we rendezvous. Look after things. Out”.

Of the five crew, only Henry never slept. Somehow the two concepts of robots and fatigue had never been combined and the artificial slave had always been a 24-hour-a-day worker. Of late, Henry had started to envy his colleagues for their ability to switch-off from the everyday problems which they encountered and regenerate their tired bodies and minds.

At first, in his early years, he had been unable to comprehend the human need for dormancy, but as years had passed, he

by Andrew Walker

had begun to have a real yen for that precious state. Perhaps it was the weight of responsibility or the worries of the world he heaped on his own shoulders which seemed to drain his energy.

Perhaps it was simply age and the wearing out, the fading, of his circuits. He should have gone for termination on the last call at Earth, but some bureaucratic blunder had forced him to make one more trip.

His type had long since become obsolete, succeeded by the newer, faster, more intelligent, more human-looking robots which now proliferated around Earth and its colonies. The present chubby chassis on which his arms and head — the real Henry — were mounted had been designed for “optimal volume compactness” and not for his own comfort.

By his own analysis, his metal state was close to break-down. Whatever the situation, he knew that it no longer mattered, for within days he would be terminated. At that he felt some relief.

He held no grudge against the human race, even though many had befriended him yet were still apathetic about his impending destruction. That, in his experience, was the way they seemed to treat everyone and everything. He felt a little jealous perhaps — he would have liked to have retired as they did when no longer useful and finish his life in a casual manner. But they had created him and — possibly — they had the right to destroy

him. A flash on the screen above his head interrupted his reverie. He operated one of the remote cameras and focused on the object which had, for a few moments, turned one of its silvery faces, catching the sunlight as it sailed through his field of vision.

Henry considered giving chase, but that would mean plotting a course, waking the crew and so on and he quickly decided to let it go. As a precautionary measure, he flicked a switch on the operational console. That caused an auxiliary micro to analyse the piece and its trajectory and relay the information back to one of Henry’s VDUs. There was no problem this time — it was a light mass and well away from normal shipping routes.

“Give the new collectors something to do”, he said aloud to himself.

He watched it pass for a while, wondering as ever why man had become such a litter-bug. His home planet had been close to self-destruction and was only now beginning to recuperate. Henry could still see the shores of the oceans, rotting fish scattered in their billions, suffocating, poisoned; birds crawling along the land, their feathers tarred and burned by the man-made pollutants; black city skies belched out by industrial gargantuans.

Even here, in the wide-open expanse of the solar system, whither man had been pushed by overcrowding, the debris of his conquest of space had become an eyesore and a danger.

A sudden thought crossed Henry’s mind — a silly thought really. What would it be like — he lay back in the seat attempting to be as relaxed as he could. He exhaled slowly, he didn’t know why, and closed his eyes.

His eyes blinked open and he looked at the screen in front of him. On it he could see Box2 away in the distance, but so soon? He wondered — had he really slept? What time was it? What time was it when he had closed his eyes? He could not remember. True, he felt a little less tired. Perhaps he had slept after all. Just a little. He nodded his head in hopeful confirmation. Well it would be a psychological fillip anyhow.

He pressed a button on the command console. The alarm in the crew’s quarters would be sounding, telling them of their imminent arrival.

Box2. Its predecessor, Box1 — naming things had never been its designer’s forte — had once been nicknamed the great scrapyards in the sky, but three more

identical ones had been added, making the name obsolete.

All had started as floating computers with one or two extra, peculiar peripherals. Their function was to catch any nearby debris and also to rendezvous now and again with ships like the Pandora and relieve them of their loads.

Gradually, they had grown to immense proportions — artificial asteroids with microcomputer cores. They were to all intents and purposes spherical, kept that way by the computer which could orientate the spheroid so as to distribute incoming garbage in the best manner.

Captured junk would be computer-analysed and appropriate agents sent to handle it. That could be cutting, bending, melting or even disintegration by bacteriological methods which had been developed during the Iranian Holy War of 2032-39.

"Welcome to Box2. Please go through correct identification and docking procedure. Thank you".

Henry read the incoming message from the Box2 computer by looking over the shoulder of Commander Daly who had taken Henry's seat at the controls. The cabin was full, each member of the crew not wishing to waste this last opportunity of seeing Box2 even though it was, after all, only a rubbish dump. Yet even Henry found himself savouring every moment — perhaps he did still have some emotive circuits left.

Yet this next part was pure routine and Henry knew every syllable of the exchange and he began to study his ship-board companions. Mike, whom he had known as a child, and Steve Duke were quite alike — blond curly hair, blue eyes; Steve was slightly taller and more solidly built; Mike was slim. Daly, the eldest, was stout, bald and a jolly character; his brown eyes always had a lively sparkle.

The fourth member and the youngest of the crew, who went by the assumed name of Ndabiningi Nkomo, was a six-foot-tall negro hailing from Hull in Canada. He was the rebel who hated convention — at the moment he was hovering above Henry in zero-G. After so many years in space, everyone had come to grips with the problems and advantages of free-fall, but only Nkomo refused to adopt the particular orientation chosen by the others.

There was one difference, Henry believed, between what he saw now and the images he had received when first meeting each of them. Wrinkles. The scars from an incessant war with time that all of them fought. All except Henry. The handsome features of his face were unchanged from those of decades ago. This, he knew, was a reason that robots had never quite been accepted into society.

On the outside, Henry stayed as young as every, while his colleagues began to exhibit the human weaknesses of age. On

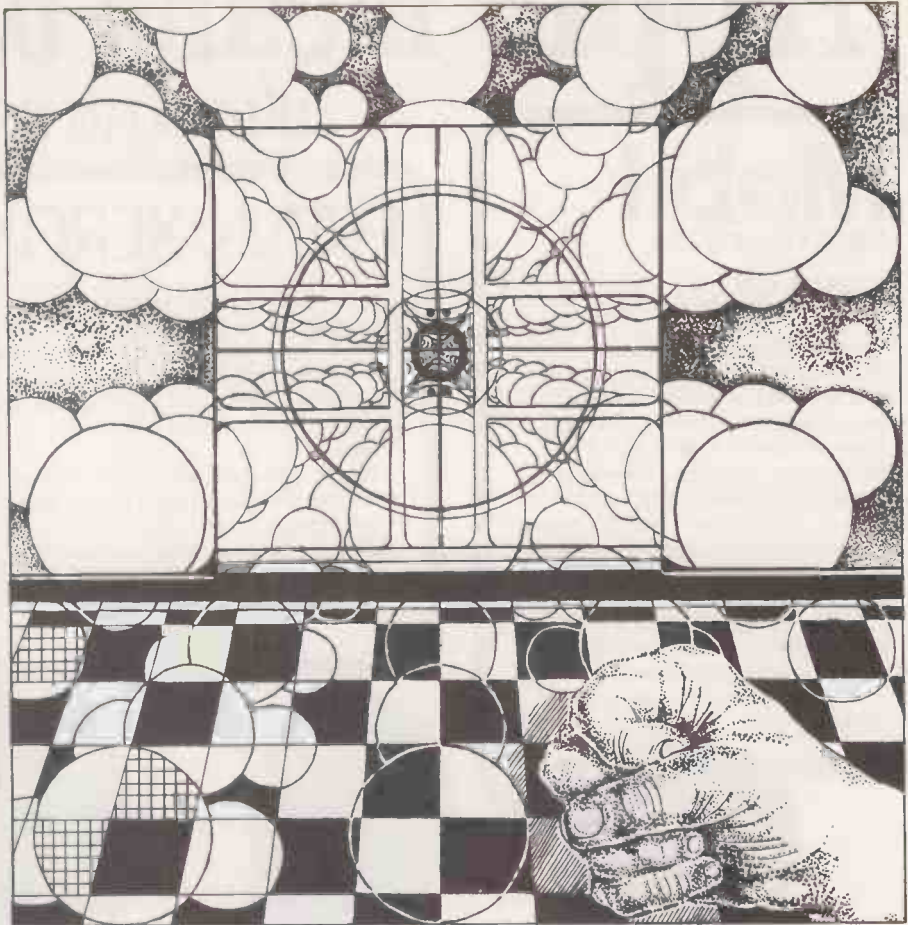

the inside, however, it was the opposite — the youthful dreams, lively minds of the crew were in sharp contrast to Henry's perpetually depressed and unhappy state.

Box2 and the Pandora had closed to within a few miles, and the asteroid of junk occupied the larger part of several screens around the cabin. They were now stationary relative to each other, but Box2 had just begun to rotate. After a few moments an irregular, concave facet showed itself and Box2 made a sudden halt. Characters appeared on the communications VDU:

Orientation complete
RELEASE CARGO — 23.74609 mph
suggested optimum

Commander Daly deftly punched in a command.

"Bloody computer telling me what to do", he said. So he punched in 23.75 mph.

Nothing seemed to happen at first — Henry thought he could see Box2 shifting slightly but otherwise there was no change on the screens. Then, when a few minutes had passed, an object, large and irregular in shape, began to appear at the bottom of them and to progress towards its target.

Gracefully the two junk-mobiles moved closer, one simply floating inanimately in one direction, the other intelligently analysing, predicting and manoeuvring so as to provide the best conjunction, until at

last they collided and Box2 held on to its prey. Now like Siamese twins they were joined permanently together.

For some reason everyone had been holding their breath as the tension rose and now that it was all over, there was a huge, accumulated sigh. Nkomo did a somersault before leaving and Daly stood up to allow Henry to take over.

"Well", the commander said glumly, "it's all over. Everything".

There was a general nodding of heads in agreement. Henry sat in the seat just vacated by Daly. The others were about to leave when a face flashed onto the communications screen and a voice was heard.

"Pandora, this is Earthcomm. Just a little news-flash for you guys to hear. The EEC space agency today launched its first fully-automated Solar-system material collection ship. That makes that old heap of yours, the Pandora, obsolete".

The face on the VDU spoke all of this with a smile, a joking pleasant smile. Then the man added:

"Say, I guess now that everything is automated, that makes humans obsolete, too. Never mind fellers — I'll buy you all a good drink when you arrive back. Signing off".

In silence, the human crew-members of the Pandora left the cabin. They could not share the speaker's joviality, for to them the Pandora was more than simply a ship.

(continued on page 83)

'Apple means business'

- who says so?

Mobil
Oil Company Ltd.

says so . . .

'Just one 48K Apple, VisiCalc, disc-drive and printer enabled us to save over £13,000 p.a. in outside computer bureau costs' states Mobil's Manager, Financial Analysis, Mr E.A.F. Peach. 'With this sort of saving it is hardly surprising that our use of Apples has grown from one Apple to five in under six months. Our trolley-mounted Apples bring the analytical powers of VisiCalc direct to the user's desk; and the simplicity and robustness of the system make it as easy to use as a desk calculator. Apples are now producing virtually all our analytical work, profit plans, forecasts etc., promptly and cost-efficiently.'

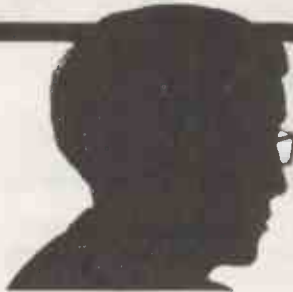

RANK XEROX says so . . .

'If small businesses are to continue trading successfully during the next 10 years they cannot afford to let the business equipment revolution pass them by' observed Mr B.H. Nicholson, International Director of Rank Xerox Ltd., at the recent opening of the Xerox Store, Piccadilly, London.

'This store carries almost everything the small business needs, and that has to include Apple microcomputers, and the software programs that go with them. Our research has identified 500,000 small businesses in the UK: Apple will feature strongly in our service to this mass market.'



CROWN JOINERY and LAMINATING says so . . .

'Faced with a 100% increase in turnover in our factories in Chesham and Aylesbury, we recently installed an Apple microcomputer in our Accounts Department' comments Mr R.F. Alderton, Partner of the Company. 'The results have been a revelation to us. Apple gives us prompt management information on sales and bought ledgers, our cash flow situation is much improved because of our debt analysis control, and my P.A. accountant has really enjoyed the transition to computerised accounting with Apple.'

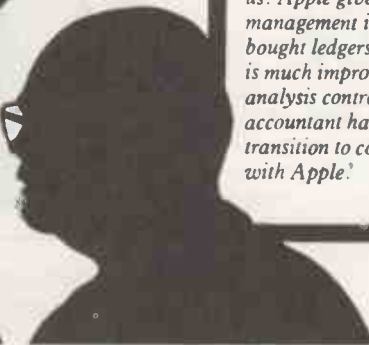

If you direct, manage or control a company or department then the Apple Computer can help you.

Apple means... business software

which is available and in everyday use now. Below is listed just a small selection of business management programs available for users of the Apple Computer System:

- Apple Cashier
- Apple Desk Top/Plan
- Apple Plot
- Mailing List
- Job Costing System
- Stock Control
- Time and Cost Recording
- Accounting Programs for Apple Users:
- Apple Business Controller
- Fixed Asset and Plant Package
- Incomplete Records
- Invoicing System
- Sales Accounting and Invoicing System
- Sales and Purchase Ledgers
- Specific professions can benefit too:
- Agriculture and Business Group Package
- Architecture
- Contract Costing
- Estate Agents
- Matching Vehicle Service Records
- Personnel Matching
- AND IN ADDITION—most companies can use:**
- Payroll and Salaries
- Apple Writer (Word Processing)

*This is just a small selection of the hundreds of programs available for the Apple business user.

*Prices exclusive of VAT and correct at time of going to press.
*Apple is a trademark of Apple Computer Inc, Cupertino, California, USA.

APPLE MEANS . . . that you can have immediate access to vital, accurate business information, keep that same information up-to-date more easily and have printed copies instantly, thus giving your company or department a competitive and efficient edge.

Apple means . . . solving problems not creating them! Executives can make valuable use of their Apple System within only a few hours of delivery, administrative staff lose any fear of computers and are soon planning and printing their data at the touch of a button.

Apple means . . . reliability and service. To assure the Apple user that there are no unanticipated service costs and that their System is fully maintained, Apple offer an optional, renewable Extended Warranty

Apple means . . . you are not alone. Over 200,000 Apple Systems have been sold throughout the world. At £2,400 (smaller starter systems available) the Apple Business System is capable of running any of the programs listed here and many more besides.

Sole UK Distributor

microsense computers limited

Finway Road, Hemel Hempstead, Herts HP2 7PS.
Hemel Hempstead (0442) 41191 and 48151. Telex: 825554 DATEFF G.

Apple means . . . educationalists, scientists, engineers and computer professionals have a choice. Apple grows — with many useful accessories including sound, music and colour graphics. In addition to the BASIC language, Apple have their own UCSD Pascal, and more recently PILOT for the courseware author, and FORTRAN for the scientist.

Apple means . . . a problem shared is a problem solved when you share it with an Apple Dealer. For details of your nearest dealer please contact us at the address below.



• Circle No. 163

PRACTICAL COMPUTING April 1981

(continued from page 81)

It was home and freedom. Now that their job was over, they would have to return to the claustrophobic Earth from the infinite emptiness of the Universe.

Henry felt little — he was technically obsolete anyway and would be terminated, so for him there would be no painful reunion with the mother planet; no mind-numbing unemployment.

"Hey", Mike interjected. All eyes fell on him. His own were focused on the navigation console VDU. "Has anyone increased magnification on Box2?"

Everyone shook their heads and on looking at the screen saw what had made him ask the question — Box2 appeared bigger, now covering the whole view.

"It's moving towards us", exclaimed Steve Duke in a voice of disbelief.

Suddenly, there was no doubt in anyone's mind.

".. makes the Pandora .. obsolete ..."

The words of the Earthcomm man echoed in the minds of the men in the cabin. If the Box2 micro had monitored that transmission — Henry, eyes glued to the vision of approaching doom, was the first to react.

"Suits", he shouted.

The others were snapped out of the hypnotic trance of their own individual Armageddon. Momentarily, they hesitated, their befuddled brains unable to grasp the meaning of Henry's call. Then, in unison, they rushed out, their movements hampered by zero-G and the flailing bodies of their companions. Suddenly, it was every man for himself.

Only Henry had no need of a space-suit — he could survive, had been built to survive, in most environments. He watched unemotionally as Box2 closed in. There was nothing to be done. Even if there were time to steer the Pandora clear of the on-rushing asteroid, Box2 would follow them and eventually catch up. Its job, Henry knew, was to gather up any floating garbage in its vicinity. Priorities would be assigned to pieces of debris by the computer and chase given accordingly.

".. makes the Pandora .. obsolete ..."

Those words, spoken only minutes ago, returned to Henry in all their chilling significance. The micro at the core of Box2 would have suddenly realised that a chunk of junk almost one-tenth its own size was sailing along only a few miles away.

It did not know that the junk had a name, Pandora, nor understand that human life existed within it; and it did not care. The Pandora would be the largest item Box2 had ever selected and it would hunt it down with all the zeal and ruthlessness of a jackal.

Earthcomm. If he could reach them, they might be able to do something, but then, with all the subtlety and timing of some cheap television adventure, the intercom began to fizzle and crackle and the scene on all VDUs turned to a heavy snowstorm. Finally everything went dead.

Henry settled back in the chair, staring at the blank screens. There was nothing to be done. Out there, somewhere, closing in rapidly on the blinded Pandora, was death itself in the shape of Box2. He wondered whether the crew would have time to don their suits.

He did not wonder long. For suddenly there was a huge jolt and everything not firmly fixed down flew about the cabin in a tumultuous display of free-fall chaos. Box2 had made its rendezvous with them. Henry found himself thrown to the back of the cabin, constantly being hit by the flying objects.

*OXYGEN SENSORY INTERRUPT.
AIR LOSS DANGEROUS TO HUMAN LIFE.*

Henry's inhalation sensory system chips suddenly interrupted all his prior thoughts — oxygen was leaking from the ship at an alarming rate — he realised that they must have been holed. If the crew had not reached their suits in time, they would be dead, the breath sucked mercilessly from their lungs.

As if an answer to his morbid thoughts, a voice came over his internal personal communicator.

"Henry". The speaker sounded distraught, breathing quickly and heavily. "For God's sake Henry, are you there?"

Henry sent an affirmative response which seemed to ease the distress of the other slightly.

"This is Mike", the voice continued. "The others — they, they're all dead. We were all racing for our suits", he hesitated and Henry sensed that he was trying to fight back the tears — "I arrived first. Then all hell broke loose".

By now, Henry had stopped listening to the sobbing, rambling voice. What now, he wondered. What would Box2 do? What did it do with all junk? Analysis first, he remembered. Then the agents would be — but his thoughts were stopped by a peculiar sensation he felt, of vibrations in the ship. Of course — for a structure the size of Pandora, the Box2 micro had only one option — the crudest method, cutting it down to manageable pieces. He must tell Mike, he decided.

"Mike —",

"I know", Mike interrupted, "I see them. They're cutting the Pandora up. We can't stay, Henry, I'm leaving. Maybe if we can get to the core of Box2, we can do something".

"Such as?"

"Stop the computer, perhaps", Mike proposed hopefully. "Or send an

SOS. We must try something. hell, I'm going — I just hope one of those damn cutters doesn't go for me".

Henry said nothing, but listened to his colleague's breathing quicken as he exerted himself. Not for the first time, Henry cursed the loose-tongued Earthcomm speaker who had initiated this predicament. He cursed also the creators of Box2, the first programmers who had created this inflexible gargantuan which had acted so decisively on an insignificant comment passed by an insignificant man. Then he swore at Earthcomm again.

He retrieved the words of doom from his Spram, the Semi-Permanent Random Access Memory, which made up 80 percent of his memory, where he stored all recent experiences.

".. makes the Pandora .. obsolete ..."

Damn stupid thing to say, Henry mused. But in the block of data he recalled from Spram lay other words which suddenly flashed into his registers.

".. everything is automated .. makes humans obsolete .."

A look of horrified realisation appeared on his face. He was about to warn Mike when a loud shout came over the communicator.

"Help. I can't move — something's holding my feet. What the hell's going on?"

Gazing at a sharp pointed object which had been thrust through a wall of the cabin as Mike spoke, Henry realised it must be a cutter. Then like a knife cutting through butter, the instrument began to move along the wall.

"What the hell is that coming toward me?" Henry heard Mike say.

Henry disconnected the receiver — he knew what it would be and had no desire to listen to the dying yells of his friend. For several minutes he simply stood, patiently where he was, watching the point of the cutter slice swiftly along the cabin's bulk-head. It was joined after a while by two more.

During those few minutes he pondered his own fate. Eventually the computer controlling Box2's actions would discover him, analyse him as a defunct cybernetic machine and finally destroy him. He resigned himself to that fact and perhaps felt a little relief that at last his troubled life would come to an end.

He was abruptly plunged into darkness as the power system of the Pandora failed but even in the darkness his powerful visual system was able to pick out the blade which was cutting through the floor towards him.

He wondered momentarily if it was destined for him and he launched himself upwards and across the cabin to float on to a narrow console top from where he watched the razor's edge glide blindly by.

(continued on next page)

(continued from previous page)

He decided that Box2 would not yet have detected him — the cutters themselves had little in the way of sensory instrumentation and he had not perceived the presence of any other hardware at any time.

Then, suddenly, before he could comprehend the events that took place, he found himself out in the open, the celestial sphere gazing down on him in its speckled, glittering glory. Disorientation overcome him initially, the walls of the cabin having disappeared apparently in the blink of an eye to be replaced by the limitless expanse of the universe. The temperature of his circuitry rose by almost a degree as they raced and worked more than ever before — his internal interrupt system boosted his metabolism like an electronic adrenalin.

Eventually he realised that the cutters had finished their work an instant before the walls had gone and that some giant mechanism must have ripped the superstructure away and out of sight behind the Box2 horizon.

Now he was out in the open — vulnerable. He looked round for the sign of approaching danger with mixed emotions — not all of his emotive circuits had gone, apparently, he reasoned. Then, aware of his own bizarre stance — feet apart, atop a console, staring out into space — he began to feel rather foolish, though he did not know why, as no-one would see him. But that embarrassing agitation was there and he elected to move elsewhere.

Box2 had other ideas. Whatever commands his CPU gave, his short legs refused to obey. They seemed to him to be rooted to the surface on which he was standing, paralysed almost by some unseen force and the words, the terrified voice of Mike, caught in a similar predicament at what felt an aeon ago, flooded back to him as if in a nightmare. He looked around nervously, waiting to catch sight of the thing that had invoked Mike's final cry of "What the hell is that coming toward me"?

Then for the first time he glimpsed a huddled figure 10 yards from the remains of the ship. It was still. It was dead. It was Mike. Henry could see little detail and preferred not to. He turned away.

"Damn Earthcomm. Damn Box2. Damn its negligent creators", he thought.

He wondered where his executioner was — and what it would be. How long had he been out in the open? Surely he had been analysed by now. He glanced at the chronograph built into his left wrist, but gawked instead at the arm which now ended halfway along the forearm. Somehow his hand and wrist had disappeared. He looked around in horror but there was no sign of the robotic member.

On closer inspection of the arm he discovered that it was smothered in a yellow

substance which seemed to be in a constant flowing motion. So that was it. Of course, he should have realised — the micro would have devised a different method of elimination from Mike's to cope with Henry's different structure. Yet to be eaten alive by an unintelligent bacterium? Henry closed his eyes sadly and shook his head. In a way he was relieved that termination was imminent. But he would never have wished to go like this — with the thoughts and problems that had dragged him down to such a low mental state being allowed to prey on his mind in these last moments.

The degeneration process was painless, Henry found. In fact his arm was without feeling completely and the bacteria had by now eaten to just past the elbow. Looking to his right hand he saw that that too was being attacked; the finger-tips had dissolved.

It would be quite a while, he reckoned, before any vital circuits went and he did not relish such a long drawn-out death — not that he had any option, of course, for suicide was precluded.

There was one thing he could do, at least, to relieve his mind of its burden. A microchip anaesthetic. With his perfect-recall memory, he could induce an almost realistic dream-state for himself to live in — for a few moments, at least. The method had long since been used on terminal human patients in hospitals and on suicide-freaks who proliferated during Henry's lifespan.

Suddenly Henry's body was bathed in heat from the dazzling Pacific sun set in a beautiful blue sky, which was flecked with a few wispy, snow-white clouds. There was a deafening roar in his audio-sensory system. He wobbled on an unsteady surface but skilfully retained his balance. A strong wind blew refreshingly on his skin. Carefully he glanced over his shoulder at the rushing, mountainous wall of ocean — the pipeline.

Ahead he could see the golden, shimmering, palmlined Hawaiian beaches. In his mind, the console top had become a slimline, waxed surfboard. A shadow fell across him and he found himself surfing along a darkened tunnel of water.

Only with a supreme effort did he manage to defy the power of the legendary pipeline.

What a thrill. The realism of this imaginary event which he had recalled from old video-documentaries was truly incredible. It was for him a dream come true.

He had always wanted to "hang 10" — surf with his toes dangling over the edge of his board, teetering on the edge of disaster. Would he be able to move his feet, secured as they were by the unseen energy of Box2? He looked down.

No, he could not "hang 10", and never would. For he no longer had

any toes, his feet, or what remained of them, being covered in the yellow matter which was slowly dissolving him.

The splash of the ocean on his chest. He tried to concentrate on his Hawaiian paradise. The spray from the water seemed to be increasing, he thought. He peered at his torso. There was no water. The Pacific panacea faded and he found himself back in reality, standing on a console not a surfboard; body bathed not in sunlight but in a voracious bacterium; breast sprinkled in the same yellow microbe and not by the cool sea.

He knew now that time was short. His left arm had gone and his right was a mere stub; his feet were being gradually eaten away; holes began to appear in his chest where the lemon scum touched him. He surveyed, quickly, the surroundings — the residue of the Pandora which was still being disposed of according to Box2's desires — Box2 itself, the millions of tonnes of discarded human waste, moulded into shape by its micro-core computer and subservient agents.

Then he got a surprise. No, it was more of a jolting shock. He stared out across the universe or, at least, the minute part of it between himself and Earth and realised that the mother planet had grown in size until now he could see some detail — vague outline of Africa, spiralling clouds which apparently covered a whole hemisphere. Above the clouds, silhouetted against their whiteness, Henry recognised the huge complex of Earthcomm itself, orbiting slowly.

Damn Earthcomm.

They were nearer. The thought flashed through his registers. But why? Why would Box2 approach anywhere near Earthcomm?

".. everything is automated .. makes humans obsolete .."

Had he had the facilities, Henry would have smiled an ironic smile, but his facial muscles had been eaten away. Earthcomm would succumb to its own flippancy. Millions of tonnes of Box2. Earthcomm would be pulverised.

He was fading fast. He could feel the energy draining from him.

".. everything is automated .. makes humans obsolete .."

Jewel Earth set amid the dark void of the universe. Even now a pleasure to behold. Millions of tonnes of Box2. The thought that occurred to him then would have sent a shiver down his spine if he had been human.

".. everything is automated .. makes humans obsolete .."

Box2 closed in on the human-infested Earth. It would make one hell of a dent in it, was one of Henry's last faint thoughts.

".. everything is automated .. makes humans obsolete .."

As schools computing grows, the micro begins to forsake its familiar function in computer science for new, unexpected roles in other subjects. David Walton reports.

Computer-aided learning leads pupils into new experiments

FOUR YEARS ago, something like five percent of secondary schools had access to a computer. That access might have involved using a terminal connected to a central computer via a telephone line or, more likely, would be a postal service to the computer, with anything up to two weeks before work was returned to the pupils.

Now, however, something like 25 percent of secondary schools have their own microcomputer, and the number is growing rapidly, with some schools now buying their second or third. That explosion of computing power has been financed largely by parent teacher associations, partly because of educational spending cuts, and partly because local education authorities have not been able to react quickly enough to the demands for money in a previously unheard of area.

Difficult time

A school which buys a microcomputer tends to think of using it to support the teaching of computer science, and there has been a corresponding growth in the number of pupils taking CSEs, O levels and A levels in this subject.

Of course, the real growth in this new area has yet to filter through the system, since the time from course initiation to pupils sitting exams is at least two years.

That is a difficult time for schools to introduce new courses, since in some cases, they are being asked to cut existing ones. Also, there are very few teachers with training or experience in the use of computers and many LEAs have virtually abandoned in-service training of teachers on the kind of scale needed.

Economic survival

However, it seems clear that if the U.K. is to survive economically, we must embrace the new technology with all our traditional skills and ingenuity. In 10 years, no-one will want to buy a car which is not made fuel-efficient by an on-board microcomputer — and we will be in a sorry state if we cannot even administer our own taxation system without help from another country.

A much wider use of computers in education is now developing, namely, computer-aided learning, CAL. That

umbrella term covers several ways of using the computer to help the teacher, and two examples will illustrate the variety. Both originate from the Hertfordshire Advisory Unit for Computer-Based Education, and are being used in schools in Hertfordshire and elsewhere.

Route is a computer program which encourages pupils to think about the environmental problems associated with building a motorway. It is based on a real situation — building the AIM link through Hatfield in Hertfordshire — although the principles apply to any such development. Pupils are expected to consider three types of road; tunnels, cuttings, surface roads, and the environmental cost of each of them, in terms of noise, pollution, land grab, safety, etc. They then plan a route through, or around, Hatfield, which minimises environmental cost within a reasonable financial outlay.

The program runs on a microcomputer in the classroom, and while one pupil types in the route, the whole class is able to watch the output on a TV screen. That focuses pupils on the particular situation, and encourages group discussion on a rather nebulous subject.

Obstacle removed

The computer performs reasonably complicated background calculations which would otherwise be an obstacle to the pupils' understanding of the environmental problem. The program is aimed at 14- and 15-year-olds, and is used as part of a coherent environmental studies course.

The Route program, and its associated teacher and pupil materials, is an example of a CAL package. Most subjects contain topics for which a CAL package would be an appropriate teaching aid, and CAL materials already exist in physics, chemistry, biology, geography, history, environmental studies, mathematics, domestic science and economics. However, the CAL packages which exist barely scratch the surface of the microcomputer's classroom potential.

Computer-managed learning sometimes falls under the computer-aided learning umbrella, and involves treating

teachers as classroom managers and offers them support in that role. An example of it is the Hertfordshire computer-managed mathematics project, which was developed under the auspices of the national development programme for computer-aided learning.

It is a complete two-year mathematics course, aimed at 11- and 12-year-olds, which allows individualised learning in a mixed-ability class. It is worksheet-based, and although pupils in a class are all on the same topic, once the topic has begun, pupils can work at their own pace, and the more able are free to progress more deeply into that particular subject.

Management problem

That presents a management problem for the teacher as he or she needs to monitor the progress of each pupil to ensure that they are progressing as well as they can, and that they have not left the rails.

The solution to that used in the maths project is to have a microcomputer mark approximately half of each pupil's work, giving immediate feedback and diagnostics to the pupil, and a regular daily progress report to the teacher. The computer also becomes involved in scheduling pupils, so that pupils who have done badly can be directed to remedial work, whereas those who have done well can be directed to a more demanding worksheet.

Careful monitoring

That system allows the teacher to monitor each pupil more carefully than might otherwise be possible, and frees him or her to help individual pupils or small groups of pupils with whatever difficulties they have. The maths project is running in about 15 schools, mostly in Hertfordshire, although at the moment it is unable to develop further because of lack of finance.

It is worth stressing that neither computer-aided learning nor computer-managed learning are intended to replace the teacher. The computer in the classroom is simply a tool for the teacher and is a sophisticated alternative to the blackboard or the overhead projector.

It will be appropriate in only some

(continued on next page)

(continued from previous page)

teaching situations, and it must be the teacher's job to decide where and when. The case I am making here is for wider availability of the tool, and for a wider range of "attachments" for it, so that the classroom teacher has a real choice.

Sophisticated aid

There are several reasons for using computer-aided learning, not all of which apply to every package. The computer provides the teacher with a sophisticated teaching aid which he or she can use dynamically as appropriate to the particular classroom situation. It provides a focus for pupils, and can put them in the role of decision maker.

The computer can be used to do background calculations which might otherwise cloud the issue. The use of dynamic graphics, which is available on most microcomputers, can provide a visual approach which would otherwise not be available. The computer allows the simulation of science or social science experiments which could not normally be conducted because of problems of time, or danger, or cruelty, or expense.

The use of computer-aided learning also has several advantageous side effects to do with familiarisation of pupils with computers, so that as potential users, or even designers, they can appreciate the considerable variety of possible applications.

There are several problems facing teachers who wish to use computer-aided learning in their classrooms. It is not practicable for the average classroom teacher to produce his or her own CAL packages. A reasonable estimate suggests that a single CAL package, such as Route, takes 150 man-hours to produce, of which only 10 hours is spent producing the program. The rest is passed in defining the problem and the teaching strategy, producing pupil and teacher support materials, documenting the program, and evaluating it in the classroom.

Central agencies

So, it becomes appropriate for central agencies to produce CAL packages, and make them available to classroom teachers. That is starting to happen with the Schools Council, ILEA, Hertfordshire, Devon, Birmingham, Durham and other centres already producing CAL packages, both for local and national use.

Computer-aided learning materials require a reasonably sophisticated distribution service, since a package consists of printed materials, and programs in computer-readable form. At the moment, the computer-readable items tend to be sent on cassette or floppy disc, but as the number of packages, and the number of users increases, that method will become less and less practicable.

What will be needed is distribution by telephone, using Prestel or a similar

system, so that users would have immediate access to a library of programs, and could transfer the version of the program which is suitable for their particular microcomputer.

Such a system needs to be developed nationally, and should include assessment of the package, perhaps along the lines of the Consumers' Association, since the classroom teacher does not have sufficient time to obtain a range of CAL packages and evaluate them.

Comprehensive catalogue

Instead, he or she needs a comprehensive, subject-based catalogue of CAL packages, which includes an independent assessment of the aspects of each package, and an easy system to find the software, and printed material. Already, a start has been made in that direction, with several LEAs using their central computer as a software distribution service, and the Council for Educational Technology is involved in setting-up a similar software-distribution service on Prestel.

However, these are still early days for computer-aided learning. To develop its full potential, we need to invest a considerable amount of manpower and that must be done by educationalists, rather than computer manufacturers. Let us hope that the Government microelectronics programme acts as a suitable pump primer for a national development in this direction. □

We're showing off again in Cambridge!

- ⊙ TRS-80 Model I & II
- ⊙ Apple II & III
- ⊙ North-Star Horizon
- ⊙ Communicator
- ⊙ Commodore Pet
- ⊙ Daisy-wheel printers
- ⊙ Computer books

- ⊙ Acorn Atom
- ⊙ Hewlett-Packard HP85
- ⊙ UK101 kit computer
- ⊙ Sharp pocket computer
- ⊙ Wordstar/Datastar
- ⊙ Plotters/digitisers
- ⊙ Electronic components

First time buyer or experienced user? See what's best in microcomputers today — a comprehensive selection from £100 to £10,000, all generally on demonstration and available from stock. Take this opportunity to choose your ideal system, with the active help of our team of computer professionals.

Interested in microcomputers? — then we've got the Show for you at:

Cambridge Computer Store

1 Emmanuel Street Cambridge CB1 1NE
Telephone: (0223) 65334/5

Mon.—Fri: 9.00 to 12.30, 1.15 to 5.30. Sat: 9.00 to 5.30

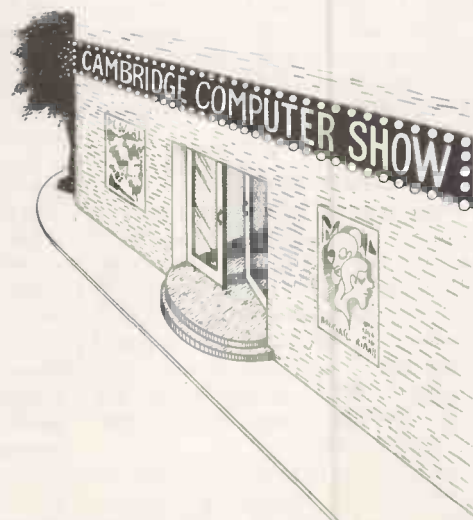

• Circle No. 164

Micros' flexibility offered best solution for PAYE system

The coveted contract for the supply of PAYE systems to the Inland Revenue was settled some months ago in favour of ICL. However this paper by John Butcher MP and Philip Virgo MP sheds some interesting light on the whole question of computing in government.

BEHIND THE fuss as to who should win what equipment orders is a growing feeling of unease in the computer industry that the stage is being set for another Swansea — the Vehicle Licensing Centre fiasco. Equipment and suppliers will eventually be blamed for the result of decisions taken by a naive and inexperienced user more interested in what is politic, in departmental terms, than in what is practicable.

The Inland Revenue officials involved appear to have been more concerned to seek an alibi against responsibility for failure than to consider what is practicable to implement in a reasonable time-scale with a limited number of low-grade computer staff. After sharp criticism from parts of the British software industry, they called in expensive U.S. consultants to back-up an unnecessarily complex and grandiose proposal.

Complex and risky

The consequence was a tender requirement written to dictate an unprecedentedly complex, risky and oversized on-line, networking, database system at considerably greater equipment cost, and many times more accommodation, communications and systems expense, than a basic, reliable mixed system using experience gained from British systems.

Despite the officials' eagerness to avoid a subsequent Public Accounts Committee enquiry by taking U.S. advice, they have ignored the lessons of the 175 reports to Congress by the Comptroller General of the United States, some of which detail wastage and incompetence on a scale which makes Swansea look cost-effective and efficient.

They have also ignored the lessons of the Italian attempt to computerise tax assessment, using U.S. equipment and expertise, which collapsed after four years and had to be rescued by an Italian software house using largely Japanese equipment.

- The high turnover of Civil Service systems staff under a career and salary structure which values technical or managerial competence below political sophistication.

- Political inconsistency of the type which halted PAYE computerisation in the mid-1970s because of the possible change to subsequently-dropped tax credits and which may cause major changes at short notice.
- The probable inability of the Property Services Agency to construct new accommodation, at short notice, even in the middle of a slump in the construction industry.
- The frequent inability of the Post Office, British Telecoms, to commission new communications links at reasonable notice, whether to new or existing buildings and the questionable reliability of many links they do commission.
- The British paranoia over their tax affairs which will require far higher standards of privacy for this system than, for instance, manually held medical records.
- Staff opposition to a system which will be perceived, probably wrongly, to threaten their livelihood.

There are many ways to tackle the underlying requirement ranging from a totally centralised system on a single site to a microcomputer on every desk. The five main solutions — given that a single site would be administratively unworkable and a machine on every desk is unnecessary — are:

- **One microcomputer per administrative unit:** Instead of having a bank of filing cards containing the details of about 2,000 taxpayers, each allocation officer and his assistants would have a microcomputer with screen, a two to five million character fixed disc holding the records, a printer and a floppy disc drive for reading or writing data discs for record transfer, archiving, etc.
- The equipment, mounted on a small trolley for plugging into a wall socket adjacent to the desk of whoever is using it, would cost less than £5,000 in the volume required so that, adding the cost of a central index-computer, containing information as to which unit currently handles which tax payers, the national cost would be less than £60 million.

Except for the central index machine — probably a contents-addressable file store, CAFS, computer like that being tested by the Post Office for directory enquiries — the only accommodation cost would be to check the fuses and earthing of the electricity mains in each office lest any power surge burn out the equipment.

Data transfer, including copies to update the central index, would be handled by an overnight mail service for floppy discs, while inter-site enquiries would be handled by a call to the index centre, where the operator would use a screen to interrogate the file to identify where the record is held, followed by a call to the site holding the record.

Tax tables, code changes, programme changes, etc., would be distributed on floppy discs, produced centrally, as for commercial microcomputers or word processors.

Standardisation

While there would be cost and organisational advantages in having equipment standardisation, it is not essential. For example, Peterborough Data Processing, whose Unipay system is used to pay one in five of the working population of Britain, annually alters the systems run on 100s of their customers' ICL, IBM, Univac and Honeywell computers at only one to two months' notice when tax, national insurance or pension legislation changes with the budget.

That operation is much more complex than is likely for PAYE since, while the Unipay system is standard, any given manufacturer may have a variety of ranges and some manufacturers have a variety of operating systems on the same range, each of which can require variations on the Unipay programs.

Implementation could be very rapid, with no delays for constructions, communications line laying, exchange installation, complex network testing etc.

- **One computer per site:** There are 200 sites housing anything from a single tax district for a few 1,000 taxpayers to 30 or 40 for a million. A modern British-

(continued on next page)

(continued from previous page)

designed and built small business system, like the ICL ME29 Burroughs B90 or Redifon 8000, could support anything from six screens and 10 million characters of storage — for a small, isolated district — to 100 screens and a few 100 million characters of storage, for a medium-to-large site with 50,000 to 100,000 taxpayers. Only the handful of big centres, like Bootle or East Kilbride, would require larger computers with expensive purpose-built accommodation.

Equipment costs would range from less than £40,000 for the small office, up to £250,000 for the medium-to-large office, and, allowing for the big centres, one of which would also house the CAFS central index, the total cost would be a little less than £50 million.

The main accommodation cost would be wall-mounted dust extraction and air conditioning for sites using exchangeable disc drives — perhaps £10,000 per site — and wiring to connect screens and work stations to the computer room, which would normally be a conversion of a small office.

Rapid implementation

As with the micro solution, implementation could be rapid since only limited accommodation work would be necessary and the systems could be quite straightforward.

The advantages over the micro option are primarily in eliminating the need to pass data discs between adjacent districts in the same building or cluster of buildings. However, with the availability of inexpensive local networking facilities, these may soon lose significance.

● **One computer per group of sites:** Frequently, a number of small offices are clustered in the suburbs of a city with a large site handling a number of districts in the centre. Sometimes, the offices may be only a few 100yd. from each other. However, the communications facilities available from the Post Office, British Telecoms, vary widely from place to place.

In some cities, the network is reliable and efficient and high-capacity lines are available at short notice. In other cities, the exchanges are overloaded and traffic vibration has collapsed chambers and concertinaed cables so that it can take years to install a new line and weeks to access an existing line for repair.

Thus, while it may be theoretically cheaper and more efficient to group adjacent offices, such grouping should be dictated more by the services available in practice from British Telecoms rather than distance. Such grouping would save several million pounds over the previous option and would often remove the need to transfer data physically between offices serving neighbouring towns or suburbs.

Implementation would be delayed by as long a delay in line availability as is

acceptable rather than have an additional computer. The additional accommodation work for communications equipment is, by comparison, negligible.

● **Regional centres:** Theoretically, the cheapest solution, at a cost of around £36million, is to provide 12 centres servicing one workstation per 2,000 tax records, sited in local tax offices for on-line entry and validation of data and enquiry purposes. However, at least as much expense again is likely to be required for the construction of purpose-built accommodation, since existing accommodation is only rarely likely to be adequate.

The delay while communications links are installed could be considerable in four of the cities being considered for such centres, while the subsequent vulnerability to disruption also needs consideration.

Moreover, some regions have little geographic cohesion and any attempt to centralise, for example, eastern counties on Peterborough, could prove as problematical as the attempt to centralise the computing of the Anglian Water Authority on Huntingdon.

● **A national network:** The salesman-favoured option with communications processors and many more workstations added to the regional centres of the last option. Its main advantage is the easy transfer of data anywhere in the country. Its disadvantages spring from its complexity and consequent vulnerability.

Exponential increase

Reliable implementation cannot be tested until the last site is commissioned since traffic on a decentralised network rises exponentially with the number of sites linked and a network adequate for 11 sites could be swamped by the 12th. Therefore, it is easily the longest to implement and the most vulnerable to construction or communications delay. A centrally-controlled network would be easier to implement but subsequently more vulnerable to disruption.

The vulnerability to illicit access will dictate rigorous security which will, in the nature of security systems, inhibit, delay and increase the cost of legitimate access.

It is also likely to be the most expensive since, in addition to the £30million for the centres and £30million for the network concentrators and workstations, the purpose-built accommodation and high capacity landlines must be added on a greater scale than for the stand-alone regional centres.

● **The recommended approach:** Given the prime objective of the successful implementation in a reasonable timescale, of a cost-effective system capable of subsequently facilitating radical changes to the tax system, the key to a practicable approach is flexibility.

The system must use existing staff, buildings and communications as much as possible while retaining the capability of

subsequent growth into either a centralised or a decentralised network as changes in organisation, tax structure, communications facilities or technology make that economic and/or desirable.

Therefore, we recommend a solution based primarily on small business computers or possibly linked micros for each site using shared larger machines only where existing accommodation and reliable communications links make installation in a short time-scale relatively easy. That also reduces the vulnerability of the operation to disruption from whatever cause.

We also recommend that the initial system be straightforward and robust enough for currently-available computer staff to develop and implement nationally, and user staff to learn to operate, before the end of the Government's first term of office.

Key to success

The key to successful implementation and development is to get a simple mark 1 system working in two tax offices as soon as possible, remove the bugs and implement it throughout the country. Then, with the basic data on computer file, and the experience gained from using the system operationally, it will be possible to develop a more sophisticated mark 2 system to cater for whatever, hopefully more rational, personal tax system the Government chooses in its second term of office. The attempt to jump straight to a sophisticated system entails unacceptable risks, given the staff and experience available.

The system should be:

- Capable of being installed in existing buildings using existing communications facilities or those available at six months' notice from British Telecoms.
- Capable of being operated by existing staff with minimum change or re-training.
- At least as secure, rapid and reliable as existing manual systems.
- Capable of easy change at no more than three months' notice for rates and/or allowances or 18 months for a fundamental change, e.g., tax credits.
- Capable of subsequent evolution into either a decentralised or a centralised network if either proves cost-effective.

All existing staff should receive guarantees of no compulsory redundancy but establishment numbers should not be guaranteed. Any staff found surplus to requirements after implementation should be re-trained to enable them to move voluntarily to better jobs.

The scope for early staff reduction should not be exaggerated, since experience shows that the correction of the many long-standing errors and anomalies uncovered when a manual system is computerised can be extremely labour-intensive. □



NASCOM 1 & 2

****SPECIAL OFFER !!!****

For 1 month deduct 25% from all program prices (except Wordease).

WORDEASE — WORD PROCESSOR (MC)

Professionally written 4K word processor: 14 line window on text buffer & extensive on-screen editing facilities. Insert & delete characters, lines & paragraphs. Text manipulation — copy from one section of text to another, or read in additional material from tape to any point in the text. FIND & REPLACE facility. Text buffer size according to available memory.

Exceptionally formatting capability: — commands embedded in text allow complete flexibility e.g. variable tab position, indent, line length & page length. Use of up to 10 'MACROS' permits automatic inclusion of headings, footings & other 'text repeats', & also automatic page numbering.

Output to printer — can vary character delay, inhibit line feeds & force upper case if required.

An extensive manual is supplied (itself prepared on Wordease), £25.00 (MANUAL ONLY — £1/refundable against program order).

DRAUGHTS (B/G) — By a County Player & member of English & American Associations, this program plays the standard E.D.A. rules & employs advanced end-game tactics. 6 levels & large clear graphics mean real value for beginners & experts. Hints/instructions included. State if games graphics ROM version required. £9.95.

BACKGAMMON (16K/B) — 5 levels of play are offered in this game, played to the standard rules. Program includes instructions. Available to run on its own, or excellently presented using our special games graphics ROM. £9.95.

Written any programs?
We pay handsome royalties

Please add 55p/order P & P + VAT
15% Sae for FULL CATALOGUE
(Now over 50 items!)

PROGRAM POWER

5 Wensley Road, Leeds LS7 2LX
Telephone (0532) 683186

LUNAR LANDER SUPREME (16K/G/B) — classic spacecraft landing simulation. Short, medium & longrange scans show planet surface in varying detail. Continuously updated STATUS REPORT gives vertical, horizontal & relative velocity, altitude, fuel level, G factor & surface scan for suitable landing site. 8 skill selections. Brilliant graphics. £13.95.

STARTREK II (32K/G/B) — enthralling, real-time version from our Invasion Earth author, using M/C code sub-routines to great effect. Special features include larger galaxy, shielded homing warheads (fired by Klingons), time slots & non stop action. £13.95.

INVASION EARTH (MC/G) — New improved version! 4 complexity ratings, 10 overall speeds. Variable shot speeds & alien descent rate. 4 invader types. Intelligent homing, exploding, angled, direct, multiple warhead & radio-jamming missiles. £10.95.

INVASION EARTH (MC/G) — as above with SOUND EFFECTS using AY-3-8910 CHIP. £12.95.

"NASCOUNT" — PERSONAL FINANCE (16K/MC) — Make life simpler with this finance planner. Budget income/expenses month by month and highlight likely surpluses & deficits. Can be used to check bank account & record past income/expenses. 50 entries each period. Five digit codes with analysis by code & sub-code. Calculate cumulative cash flow to specified month end. Output to cassette & printer. £12.95.

CONSTELLATION (16K/B) — Turn your screen into a telescope & view the stars from any point in the Northern Hemisphere at any time & date. Display stars by magnitude, identifying number or constellation. The telescope can be raised & lowered, zoomed in & out. Also output of star map to printer. £8.95.

**NASCOM 1 — COTTIS BLANDFORD cassette interface for N2 format, reliability & fast load. £14.50 or £11.50 with program order.
B = Nascom BASIC (State Tape BASIC if required). MC = Machine Code. G = Nascom Graphics. 8k RAM required unless otherwise stated. Ask for NAS-SYS or T4 versions.
ALL PROGRAMS SUPPLIED ON CASSETTE IN CUTS/
KANSAS CITY FORMAT.

MUSIC BOX

Now you can make music with NASCOM. Easy to follow program allows you to key in old favourites or have fun composing your own tunes. 7 octave range with staccato option, 9 tempos. Set note duration or tap in rhythm as required. Comprehensive editing. Delete, insert or amend notes. Single-step forwards and backwards through tune. Add new lines within declared array size. The program includes tape generating and playback routines and is supplied with 2 demonstration melodies and instructions for connecting your Nascom to an amplifier/speaker such as our unit below. Min. 16K required — please state T4 or Nas sys/2 or 4 MHZ. **Only £13.95**

AUDIO INTERFACE BOARD/SPEAKER

Compact and ready assembled, suitable for use with "Music Box" and other 'sound effects' programs. 3 simple connections. Complete with instructions on programming for sounds. £9.75

AY-3-8910 SOUND CHIP

Program up to three independent channels with music & sound effects! Supplied with detailed write-up. £8.50

SOUND CHIP INTERFACE BOARD — Using the PIO, program up to four sound chips at once, i.e. 12 separate programmable sounds. Each board contains an interface allowing a further board to be attached. Only simple link changes required. Connect to amplifier/speaker such as our unit above. £13.50

SOUND CHIP DEMO PROGRAM — First mode gives direct entry to chip registers, making experimentation simple & thus rapid appreciation of chip's potential. Second mode turns keyboard into 7 octave 'piano', displaying state of registers & notes (up to 3) being played. £6.95

GAMES GRAPHICS ROM

Contains graphics characters for NAS-CHESS, DRAUGHTS, BACKGAMMON, DICE & a number of other useful characters. Uses NAS-GRA ROM socket. £15.00

GAMES ROM ADAPTOR — allows switching between NAS-GRA ROM & GAMES GRAPHICS ROM. £5.90
COMBINED ROM & ADAPTOR £18.90

Super Startrek (16K/B)	£9.95
Alien Labyrinth (16K/B/G)	£8.95
Super LIFE (MC/G)	£8.95
Cliff Invasion (B/G)	£8.95
Space Fighter (B/G)	£7.95
Cowboy Shoot-out (MC/G)	£6.95
Musical Break-out (MC/G)	£6.95
Driver (B/G)	£6.95
Labyrinth (B/G)	£6.95
Death Run (B/G)	£6.95

• Circle No. 165

video genie



— It Only Needs A Plug

BRITAIN'S BEST BUY IN PERSONAL COMPUTERS?

- * 16K Ram. — 12k Microsoft Basic in Rom
- * TRS-80 Level II Compatible
- * 100's of Programs Available
- * Self-Contained Power Supply
- * Integral Cassette. Plus into TV or Monitor
- * Ideal for Business, Education, + Leisure
- * Includes Demo Cassette with 5 Programs. + 3 Manuals and Leads

Options.

Sound Unit fitted when ordering £15 + VAT

Lower Case Characters fitted when ordering £55 + VAT



VG System Expansion

Expansion Box	£150
Floppy Tape	£165
Disc Drive	£250
Sound Synthesiser	£ 55
Colour Graphics	THA
Eight pen	£16.50
Epson TX 80B Printer	£349
Printer Interface	£ 35
S100 Ram Card 16K	£135
S100 Ram Card 32K	£175
Monitor 9" B/W Professional Quality	£ 79

Programs

Space Invaders (Cassette) with Sound	£13.00
Othello Game (Cassette)	£ 9.25
Music Master (Cassette)	£14.95
Stock Control	£17.00
Tect Edit Word Processor (Cassette)	£15.00

Memory Bargains

2708 Eproms	£ 3.50
2716 Eproms	£ 7.95
2732 Eproms	£18.50
2532 Eproms	£18.50
2114 Rams 300ns	£ 2.70
4116 Rams 200ns	£ 2.95

Books

TRS-80 Machine Language from the ground up	£ 8.50
The Easy Way to Programming In Basic	£ 5.00
Eprom Erasers	
Low Cost	£34.00
High Speed	£89.00

All + VAT



Q-Tek Systems Ltd

2 DALTRY CLOSE, OLD TOWN, STEVENAGE
HERTS
Tel: (0438) 65385

24-hour Despatch
Stock Permitting

• Circle No. 166

IN BUILDING a microprocessor betting system, there are two distinct stages. Firstly, one must analyse the strengths and weaknesses of the various bets available. Would one be better off betting on the races, the football pools, roulette or staying at home? Secondly, having decided on the most advantageous type of bet, you must determine which factors and in what combination will best predict the winning alternatives. I shall show you how to manage both stages and I provide a detailed analysis program for the football pools — a program which can be adapted easily for any other type of bet.

The essence of any bet is that all the punters place money on the various alternatives. When the gamble is over, the money will be redistributed to those punters who chose the correct alternatives minus a certain percentage which the administering organisation retains as profit.

A betting shop retains 10-15 percent, the football pools firms about 30 percent, whereas the house only retains 2.5 percent if you are playing roulette with only one

by Gavin Potter

zero. To win, you must be able to predict the correct alternatives more often than the rest of the punters. The better you are at that, the more you are likely to win.

What advantages does a micro-based system have? — its ability to handle large amounts of data. To capitalise on that strength, it is necessary to find a bet where there is a large amount of readily-available data which the average punter is not going to bother to analyse. Of the bets I investigated, the football pools stand out as the paradigm.

A quick survey of the literature on football soon reveals several possible factors which might help predict the results of a match: the home team's league points, the away team's league points, the number of draws either side had produced in the last few games, the number of draws that that particular clash had produced in the last five years, and several extraneous factors such as the buying and selling of players.

The problem was to decide which of factors were relevant and in what combination they should be linked. I devised the program to help me resolve those questions.

The end-product of any micro-based pools system is a list of matches with a value attached to each of them which one hopes in some way will predict the result. To take a very simple example: one might suppose that the difference between the two teams' league positions would provide some predictive value of the result.

If that were the only factor which need be taken into account, all those matches with a difference less than a certain value would be a draw and all those with a

Striking it rich with drawn matches

difference above a certain value would be non-draws.

The world being what it is, that, of course, does not happen quite as neatly as one might hope. Indeed, if it did, there would be little point in gambling at all because everyone would soon discover such a simple system.

What, in fact, happens is that there is considerable overlap, some matches with large differences between the two teams' league positions end in draws whereas others with very little difference end in wins for one or other side. The greater that overlap, the worse the predictive measure one is using is at predicting the possibility of a draw.

What the program does is to provide a measure of that overlap so that it is possible to compare directly the predictive value of various combinations of factors. That way, it is very easy to decide on the ideal combination of factors and to reject quickly any which fail to provide a predictive value. The only other method is to wait until the end of the season and see whether you are out of pocket or not.

The way the program calculates that is reasonably simple. There are two ways in which the overlap can increase or decrease. Firstly, the mean value of the draws can be closer or further from the non-draws — see figure 1. Secondly, the spread of values of the draws and non-draws can increase or decrease, see figure 2. The principle becomes much clearer once you look at the figures.

Statistical decision theory provides a method whereby those two effects are taken into account and a value of the

Figure 2. As the variability of the results grows larger, it again becomes more difficult to find a value above which all the matches will be non-draws and all those below it draws, even though the mean value of the draws and the mean value of the non-draws remains the same. This is the second way in which overlap can increase or decrease.

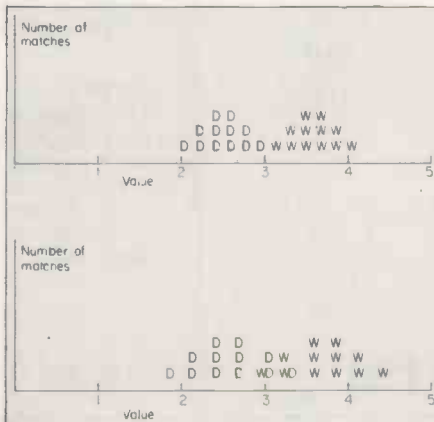

overlap — usually called prime — is produced. The larger the overlap value, the greater the predictive value of that combination of factors. For the mathematically-minded, d prime can be expressed as

$$d' = \frac{\mu_D - \mu_{ND}}{\sqrt{\sigma_D^2 + \sigma_{ND}^2}}$$

where μ_D = the mean value of the distribution of draws

μ_{ND} = the mean value of the distribution of non-draws

σ_D^2 = the variance of the distribution of draws

σ_{ND}^2 = the variance of the distribution of non-draws

For the non-mathematically-minded, what that means is that in terms of the spread of the results, the larger the difference between the average value of a drawn match and the average value of a non-drawn match the better. The smaller the overlap will be and so the greater the predictive value.

The first possibility I decided to investigate was the predictive value of the two teams' league positions. The first prompt the program gives you is for the number of factors you are going to investigate. In this case, the answer was of course two. The first factor being the home team's league position and the second the away team's league position.

You then have to input each of those factors for every match. It is much easier if you first write them on a sheet rather than attempt to read them straight from a newspaper. If you make a mistake entering them, you will be given a chance to correct it at the end. When you have finished typing any corrections, you must type —1.

The program then provides a menu of alternatives. As, in this case, we are trying to analyse the use of home and away league positions to predict draws, we must first input the numbers of those matches which were draws. If we were interested in home or away predictions, we would type those instead. Again, when you have finished, you should type —1. That will return you to the menu.

We are then ready to start the analysis proper. After entering the analysis section from the menu, the first thing the program will do is to ask you whether you are interested in the highest scores, the lowest scores or the absolute scores — the ones nearest to zero. If you are considering the predictive value of the home team's league position and the away

team's league position in predicting draws, it would be reasonable to be most interested in those scores which are nearest to zero.

If, however, you were considering the number of previous draws in the last five matches, you might expect those matches with the highest value to be most likely to be draws. In this case, you would, of course, choose the high-score option.

The program then asks for the weights you want to attach to the various factors. If you want to know the predictive value of the home team's league position and away team's league position, you would type 1 for factor 1 and -1 for factor 2. If you wanted to look at some other combination, i.e., just the predictive value of the away team's position, you can type some different weights — in our example, 0 followed by 1.

The program then analyses the data and prints out a value of d prime. As a rough guide, if your value of d prime is greater than 0.3 or less than -0.3, that combination of factors has a significant predictive value. If d prime is negative, you should choose those matches with the lowest score. If d prime is positive, you should choose those matches with the highest score.

You will then be returned to the menu. If you want to try different combinations of factors, all you have to do is to re-select the analysis option. There is no need to

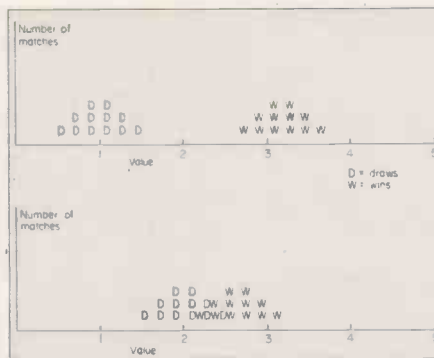

Figure 1. As the average difference between the matches which are draws and those that are not, grows smaller and smaller, it becomes progressively difficult to find a number above which all the matches will be non-draws and all below it, draws. That is one way in which the overlap can increase.

type those matches which were draws, as the program already has that data. The best way I have found to use the program is to type all the factors you wish to consider, and then try them in various combinations. If you do not want to consider a certain factor in that combination, you have only to type 0 in response to a request for its weight.

The only option not yet mentioned is the prediction option. You can use it to predict which matches will be draws as decided by your combination of factors. All you have to do is to enter next week's

data, choose the prediction option and state the kind of score you are interested in — highest, lowest, etc — and the weights of the various factors. The program will then sort, by a bubble sort, the matches into order and output any number you require.

When you have finished, you can exit from the program by choosing the exit option. It is not complicated, as the program will prompt you at all the required places.

The program is written in modular form and so should be very easy to understand.

100-140	Sets-up program
200-330	Inputs data
400-490	Error trap for data
600-690	Menu
700-820	Inputs results of matches
900-1060	Requests weights and scores
1100-1250	Calculates values of matches
1300-1480	Calculates d prime
1500-1630	Prints out d prime
1700-1960	Bubble sort of matches and printout of those you require

The program was written in Microsoft Basic for the Ohio Superboard II and so should need minimal adaptation to run on other machines. The only things which must be watched are that "?" is used as an abbreviation for print and that ":" is used as a delimiter. The only other line which might need watching is line 5000. That is used to scroll the screen clear and so the value of the loop might need to be changed depending on the amount of lines your processor displays.

```

100 REM PREDICTION
101 REM VERSION 3.1
102 REM C GAVIN POTTER
110 DIM RE(55)
120 DIM SC(55)
130 DIM P(55)
140 DEF FNA(A)=INT(100*A)/A
200 REM DATA INPUT
210 GOSUB 5000
220 PRINT"DATA INPUT":PRINT:PRINT
230 PRINT"INPUT NUMBER OF FACTORS"
240 INPUT F
250 GOSUB 5000
260 DIM R(55,F):DIM W(F)
270 FOR I=1TO55
280 FOR J=1TOF
290 PRINT"MATCH":I;" /FACTOR":J
300 INPUT R(I,J)
310 PRINT
320 NEXT J
330 NEXT I
400 REM ERRORS
405 GOSUB 5000
410 PRINT"IF ANY WERE MISTAKES":PRINT
420 PRINT"TYPE IN THEIR NUMBERS":PRINT
430 PRINT"END CORRECTIONS BY":PRINT
435 PRINT" TYPING -1":PRINT
440 INPUT CH:PRINT
450 IF CH=-1THEN GOTO 600
460 FOR I=1TOF
470 PRINT"DATA":CH;" /FACTOR":I
480 INPUT R(CH,I)
490 PRINT:PRINT
500 NEXT I
510 PRINT"NEXT ONE":GOTO 440
600 REM MENU
610 GOSUB 5000
620 PRINT" MENU"
630 PRINT:PRINT:PRINT
640 PRINT"(1) INPUT RESULTS":PRINT
650 PRINT"(2) PREDICTIONS":PRINT
660 PRINT"(3) ANALYSIS":PRINT
670 PRINT"(4) EXIT":PRINT
680 INPUT Q1
690 ON Q1 GOTO 700,800,900,6000
700 REM RESULTS
710 GOSUB 5000
720 FOR I=1TO55:RE(I)=0:NEXT I
725 PRINT"RESULTS INPUT":PRINT:PRINT
730 PRINT"TYPE IN THE NUMBERS OF":PRINT
740 PRINT"THE RESULTS OF INTEREST":PRINT
750 PRINT" IE HOMES, ALWAYS OR DRAMS":PRINT
760 PRINT"END BY TYPING -1":PRINT
770 INPUT S2
780 PRINT
790 IF S2=-1 THEN 600
800 IF S2>0ANDS2<56 THEN 810
805 PRINT"DO NOT UNDERSTAND":PRINT:GOTO 770
810 RE(S2)=1
820 GOTO 770
900 REM ABSOLUTE VALUES
905 GOSUB 5000
910 PRINT"SHOULD YOUR PREDICTIONS":PRINT
915 PRINT"BE.....":PRINT
920 PRINT"(1) THE HIGHEST SCORES":PRINT
930 PRINT"(2) THE LOWEST SCORES":PRINT
940 PRINT"(3) THE NEAREST TO ZERO":PRINT
950 PRINT"ENTER 1,2 OR 3":PRINT
960 INPUT Q2
1000 REM WEIGHTS
1010 GOSUB 5000
1020 PRINT"WEIGHTS":PRINT:PRINT
1025 FOR I=1TOF
1030 PRINT"FACTOR":I;"WEIGHT ?":PRINT
1040 INPUT W(I)
1050 PRINT

```

(continued on next page)

(continued from previous page)

```

1060 NEXT I
1100 REM CALCULATES SCORES
1110 FOR I=1T055:SC(I)=0:NEXTI
1120 FOR I=1T055
1130 FOR J=1TOF
1140 S(I)=S(I)+W(J)*R(I,J)
1150 NEXT J
1160 NEXT I
1200 REM ABSOLUTE VALUES
1210 IF Q2<>3THEN 1250
1220 FOR I=1T055
1230 S(I)=ABS(S(I))
1240 NEXT I
1250 ON Q1 GOTO1700,1300,6000
1300 REM ANALYSIS
1310 F1=0:F2=0:F3=0:F4=0:F5=0:F6=0
1320 FOR I=1T055
1330 IF RE(I)=1THEN 1380
1340 F1=F1+1
1350 F2=F2+SC(I)
1360 F3=F3+SC(I)2
1370 GOTO 1410
1380 F4=F4+1
1390 F5=F5+SC(I)
1400 F6=F6+SC(I)2
1410 NEXT I
1415 U1=0:U2=0:U3=0:U4=0
1420 U1=F2/F1
1430 U2=F3-(F2A2)/F1
1440 U2=SQR(U2/(F1-1))
1450 U3=F5/F4
1460 U4=F6-(F5A2)/F1
1470 U4=SQR(U4/(F4-1))
1480 DP=(U3-U1)/SQR(U2A2+U4A2)
1500 REM PRINTOUT
1510 GOSUB 5000
1520 PRINT" ANALYSIS"
1530 PRINT:PRINT:PRINT:PRINT
1540 FOR I=1TOF
1550 PRINT"FACTOR":I;"WEIGHT":W(I)
1560 NEXT I

```

```

1565 PRINT:PRINT:PRINT:PRINT
1570 PRINT"*****":PRINT
1580 PRINT" D PRIME =";DP:PRINT
1600 PRINT"*****":PRINT
1605 PRINT:PRINT:PRINT:PRINT
1610 PRINT"INPUT ANYTHING TO CONTINUE"
1620 INPUT A$
1630 GOTO 600
1700 REM PREDICTIONS
1710 FOR I=1T055:P(I)=I:NEXTI
1720 FOR I=1T055
1730 J=0
1740 FOR K=1T054
1750 IF SC(K)<=SC(K+1)THEN1800
1760 Y=SC(K):Y1=P(K)
1770 SC(K)=SC(K+1):P(K)=P(K+1)
1780 SC(K+1)=Y:P(K+1)=Y1
1790 J=J+1
1800 NEXT K
1810 IF J=0 THEN 1830
1820 NEXTI
1830 REM PRINTOUT
1840 GOSUB5000
1850 PRINT"HOW MANY PREDICTIONS":PRINT
1855 PRINT"DO YOU REQUIRE ?":PRINT
1860 INPUT LI
1865 GOSUB 5000
1870 ONQ2 GOTO 1910,1880,1880
1880 FOR I=1TOLI
1890 PRINT"MATCH ";P(I);"SCORE":FNA(SC(I))
1895 PRINT
1900 NEXT I:GOTO1940
1910 FOR I=55TO(LI-1)STEP-1
1920 PRINT"MATCH":P(I);"SCORE":SC(I)
1930 PRINT:NEXTI
1940 PRINT:PRINT:PRINT
1950 PRINT"INPUT ANYTHING TO CONTINUE"
1960 INPUT A$:GOTO 600
5000 FOR I=1T025:PRINT:NEXTI
5010 RETURN
6000 END

```

2 new low cost printers.



MPI 88G

- Full dot addressable graphics
- IK buffer standard, 2K optional
- Tractor, Paper roll or single sheet feed
- Bidirectional 100 cps. impact printing
- ASCII, 20m/A loop, RS232, IEEE
- 80, 96 and 132 ch per line
- 96 ch ASCII. Upper, lower case +NLQ 11x7.

40 and 80 column impact matrix printers with sensible price tags – just right for the personal and professional user.

RIL PRINTERS



EATON
LRC 7000+

- Rugged low cost design matrix impact printer
- 40 columns, 1.25 lines per sec.
- Interface cables for PET, TRS80, ATARI, APPLE etc.
- 100 million character head life.

Russet Instruments Ltd

Unit 1 Nimrod Way, Nimrod Industrial Estate,
Reading, Berkshire RG2 0EB, U.K.
Telephone 0734 868147 Telex 849721

• Circle No. 167

A Word Processor, Report Writer, Mailing System, Data Base Manager, and a Computer all for £1995*



Yes, we are offering all this with our SERIES 5000 5" floppy-disc system for the incredibly low price of £1995.*

Not only do you get a powerful Z-80A system on the S-100 bus built to high quality standards by Industrial Microsystems, one of the longest and best-established companies in the microcomputer industry, and supported by Equinox, specialists in microcomputers and multi-user systems.

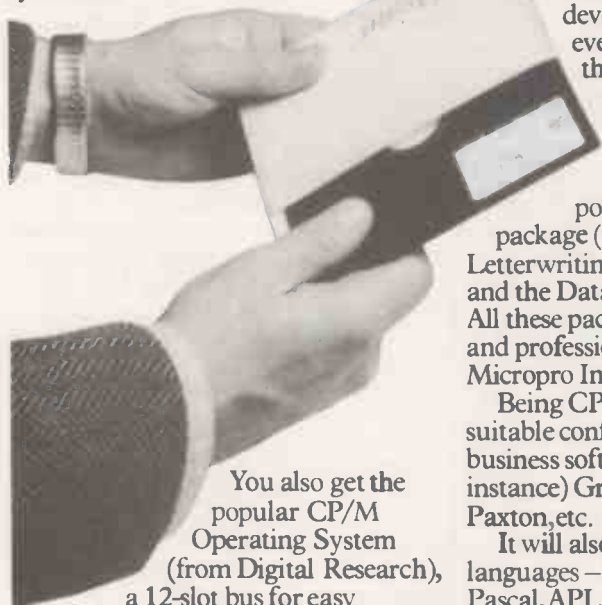

You also get the popular CP/M Operating System (from Digital Research), a 12-slot bus for easy expansion, a Z-80A CPU for powerful performance, 2 serial and one parallel interfaces, 64KB of dynamic RAM with in-built error detection capability,

and dual 5" double-density drives with the option of a third drive (or quad capacity drives in place of double-density) in the same cabinet.

Additionally, there is the Turbocharger option providing both enhanced disc capacity, disc performance and diagnostics. And if even greater storage is required we can supply 8" floppy drives and cartridge disc drives.

A powerful system for the computer-user and system developer — and one with eventual access to OS/2000, the Industrial Microsystems networking system.

And for the office or business user we are including as standard a powerful Word-Processing package (Wordstar), a Mailing and Letterwriting package (Mail-Merge) and the Datastar Data Base Manager. All these packages are widely accepted and professionally written by Micropro International.

Being CP/M based, the system with suitable configuration will also run the business software developed by (for instance) Graffcom, Peachtree, Paxton, etc.

It will also run a wide range of languages — Basic, Cobol, Fortran, Pascal, APL, Algol, C.Lisp, and Forth and will support a wide range of add-on S-100 devices, such as floating point processors, Prestel interfaces, speech synthesisers, digitisers and plotters, etc.

And just to make certain that you get full use out of your system, nationwide field service support is available at a modest extra cost.

*add VAT and the terminal and printer of your choice at the costs shown.

Series 5000 with 64KB Dynamic RAM, dual 5" double density drives, CP/M Operating System, Wordstar, Mail-Merge and Datastar £1995

The same system with quad drives in place of the double density drives £2230

Add-on double density drive £290

Add-on quad drive £405

Peripherals:
Televideo 912C VDU £595

Elbit 1920X VDU with Wordstar keyboard £895

OKI Microline 80 printer £595

Texas 810 150cps printer £1450

NEC Spinwriter RO Word processing printer £1850

All prices exclude VAT, carriage, training and installation and are subject to our standard terms and conditions.

OEM dealer and educational enquiries welcome.

EQUINOX

COMPUTER SYSTEMS LIMITED

Kleeman House, 16 Anning Street,
New Inn Yard, London EC2A 3HB
Tel: 01-739 2387/9 & 01-729 4460

• Circle No. 168

SOME MONTHS ago I bought a Pet. Fellow Petaholics may well decide to skip the next few paragraphs — the classic symptoms will be all too familiar. Having brought the beast home and installed it in place in the back lounge, I could begin to consider the question of its diet. Like all domestic animals, the Pet thrives on a varied menu of Pet food.

My early efforts at programming included the various ideas I had held for some time — a calendar, fortune telling, etc., but none of them was really what I was looking for. I needed inspiration — perhaps a holiday would help to clear the mind.

So, in mid-August, our family bid a temporary farewell to the Pet and headed for a cottage in the depths of rural France. There we could look forward to lazing on sandy beaches and so I armed myself with

by Bob Merry

a pile of science fiction novels and also a game I had bought recently — the mini version of Waddingtons Black Box.

Like many other games of deduction, Black Box is most fun for the person seeking the answer and one has to rely on the patience of one's opponent as you try to discover the logic behind the various replies. How much better it would be, I mused as I spent my turn as setter, if the patterns could be generated randomly and the answers supplied automatically. At last — a project worthy of the Pet.

The object of Black Box is to deduce the position of a number of atoms placed on an eight-by-eight grid. Normally, there are four or five atoms in the molecule. You find the atoms by shooting rays into the box. Three things can happen to a ray — figure 1.

A ray which goes directly into an atom is absorbed, as has happened to the rays starting from points 12 and 19. A ray is deflected at right angles by an atom in the next row to its path. The ray from point five is deflected three times before emerging from 26.

A ray can also be reflected back on itself and that can happen in one of two ways; a reflection can happen as the result of two simultaneous deflections, as happens to the ray from point seven. Alternatively, a ray will be reflected if there is an atom on the edge of the grid, next to the point of entry. That happens to the ray entering at point 22 in the diagram.

The score against you depends on the result of each ray: deflections count two points, reflections and absorptions one point each. In addition, there is a five-point penalty for each atom you have guessed wrongly when the final molecule is revealed.

The average score for a four-atom game is 13 points. Occasionally, one atom may be hidden by the others and its position may be ambiguous. In those cases, the technique is to know when it is better to

BLACK BOX

accept a five-point penalty for an incorrect guess.

My usual method of programming is to divide the problem into several short routines. They are then entered in what I consider a logical order and the various patches in the form of IF THEN and GOTOs are added.

Most of the routines are first sketched in the form of rough notes and then the program is formed on the screen. Wherever possible, I run short sections to test their action. Gradually, the program is developed into one which works.

At that stage, I will see how it can be improved and whether, in fact, the routines are foolproof. Usually, there are a few special cases which are not accounted for and the program has to be edited.

The Black Box program was no exception to the rule and I started by deciding on the various building blocks I would need. The first element was the mode in which I would store the game. The game board, figure 1, is an eight-by-eight grid, surrounded by the numbers 1-32, which are used to identify the rays.

The obvious way to represent that in the computer was to use an array, P(X, Y), where X and Y lie from 0 to 9 inclusive. The elements P(0, n), P(9, n), P(n, 0) and P(n, 9), where n = 1 to 8, will be used to store the ray numbers and the remainder of the ray will be set to zero. The program asks the player to select a number of atoms, Z, which are placed randomly in the array, using 99 to represent an atom.

Having decided how to represent the game for the computer, I now turned to how I would display it to the player. I decided I would keep the board on the screen all the time, making modifications as the game progressed.

There would be space under the board for inputs to be called and error messages to be added, while I could use the area to the right of the board for a score read-out. The modifications to the display could be placed into the appropriate area of screen by using Poke commands, but I have a bias against that because of the burst of snow which accompanies them on most Pets.

Instead, I decided to use two strings, A\$ and D\$, which contain, respectively, 39 cursor-right and 24 cursor-down commands. Now, using LEFT\$(A\$, x) and LEFT\$(D\$, y), I could move the cursor to any point x, y on the screen. The only special case to be taken into account is when either x or y = 0, since LEFT\$(A\$, 0) is not acceptable to the Pet.

The skeleton of the Black Box board is reasonably straight-forward and a little study shows that some elements are

repeated several times. I therefore defined two graphics strings, L\$ and M\$, to cover those repeated elements. L\$ is two spaces followed by a vertical line, centrally placed — the shifted right-hand square bracket key. M\$ is two horizontal lines, centrally placed — shifted @ — followed by a cross — shifted left-hand square bracket.

When rays emerge from the board we need to label both ends of the ray in a way which distinguishes it from other emergent rays. Since the ray entry points are already marked by numbers, I have used letters for emergent ray labels and they are contained in the string, B\$.

The pointer used to select the labels in turn is the variable, B, and we will select our label with the command MID\$(B\$, B, 1).

Lines 170-220 initialise the program, and as well as those variables, we also have RT for the running total for all the games played, GT for the number of games played and S for the score in the current game.

Array elements

Lines 230-260 set all elements of the array to zero, 240, and then put the ray entry points into the appropriate elements, 250. During the instruction sequence, 90-160, the player entered the number of atoms he wanted, Z. The sequence 270-310 generates random coordinates, RX(I) and RY(I), for I = 1 to Z. Line 300 checks to see if the selected element is clear and if it is, the element is loaded with 99.

Now we are ready for the display to be printed. I decided it would look better if the whole board appeared on the screen in its completed state, so I used POKE 59409,52 to blank the display until it was finished. The board consists of 19 lines of print. The first 18 alternate between a line of vertical bars and a line of horizontal bars and cross-points. The 19th line is another row of vertical bars.

Each row of vertical bars consists of nine repetitions of L\$, followed by a carriage return, while each horizontal row consists of nine repetitions of M\$, followed by two horizontal lines, centrally placed. Lines 360 and 370 print the first 18 lines, with I as the counter for the pairs of lines and J counting the repetitions of the graphic strings. Line 380 prints the final line of vertical bars. The next three lines enter the ray entry numbers.

In line 390, we start by moving the cursor 'HOME', then one space to the right — since the first set of numbers are single-digit numbers — two spaces down to reach the position for ray 1, and there

we print 1. The cursor is then moved one space left and two down to print 2, and so on until we have printed 1-8.

After 8, we move two down and two right and print 9; the numbers 10 to 16 are all preceded by a single cursor right. That has now printed the numbers 1 to 8 down the left-hand edge of the board, and 9 to 16 along the bottom of the board.

Line 400 prints 32 down to 25 along the top edge of the board. After HOME, are three cursor-rights followed by 32; the remaining numbers in the row have a single cursor right in front of them. The numbers to the right of the board are printed by 410. That uses A\$ to position the cursor to the 28th column. Then we go down two and print the first number; each number is then preceded by two cursor downs and two cursor lefts.

Hidden atoms

The final two cursor downs move the cursor clear of the board before any carriage return. Now the board is ready, the atoms are hidden in the array, so we can reveal all with POKE 59409,60, and we are ready to start the game.

While it would be possible to include a routine to enter guesses and have the computer check them — there is about 2K of memory left on an 8K Pet — I decided to leave the checking of the final answer to the player.

That brings the options for the player down to two; input a ray, or look at the answer. Lines 430-490 offer this option, check to see that the player has answered correctly and then branches to the appropriate part of the program. At that stage, we will assume a ray is to be entered and so the program goes on to the section covered by lines 500-540.

Line 510 calls for the entry of ray number G which is first checked to see that it is in the range 1-32. Then we need to decide on which side of the board the input point is located, since it will determine the initial direction of the ray. That is provided by N which returns a number from 1 to 4, and the program can now be directed to the proper area.

The four routines for tracing the ray's movement are essentially the same, so we will assume that G is in the range 1-8, N=1 and the program branches to 560. That is the left-hand side of the board and the ray will move from left to right. The initial values of X and Y are 0 and G, respectively.

The routine operates on a search-ahead basis, since it is atoms in the row ahead of the ray which affect its path. The first check is to look straight ahead (X+1), since an atom there will always absorb the ray, irrespective of other atoms.

If an atom is encountered there, the program is sent immediately to the absorbed ray routine at 960. Next we check for reflection; there are two possibilities for that — one in the middle of the board and one in an edge position.

Lines 580-600 check all the possibilities for reflection, and divert the program to the routine at 1050 if required.

We can check for deflection; if there is an atom ahead of and above the ray, the ray will be deflected downwards, while an atom ahead of and below the ray will deflect it upwards. The GOTOS in lines 610-620 divert the program to the appropriate points in the other routines.

If the look-ahead has failed to reveal any atoms, the ray is advanced one space and checked to see if it has reached the right-hand edge. If it has not, we return to 570 and start another step forward. When we reach an edge, the ray has emerged and we can go on to mark the two ends of the ray in 1120-1240.

Each of the four routines in 550-640, 650-740, 750-840 and 850-940 are similarly structured, differing in the way that the ray input, G, is converted to the form

	32	31	30	29	28	27	26	25	
1									24
2		•							23
3									22
4									21
5									20
6					•				19
7									18
8									17
	9	10	11	12	13	14	15	16	

Figure 1. The game board.

P(X, Y) at the start of each routine and in the direction of look-ahead and movement.

Once the ray has exited the board, the result can be marked on the display. The first alternative is absorption covered by 950-1030. The score, S, is increased by one and is printed on the screen to the right of the board using the subroutine at 1380.

The cursor is moved down the screen and the message "Ray was absorbed" printed. Since the only point to be marked is the entry point, we can use the values of N and G to determine the place to print a marker.

N tells us to which side of the board to go, and G can form the basis of the length of A\$ or D\$ to use to reach the proper point on the screen. We shall replace the ray number with a reversed diamond symbol, but because most of the rays are two-digit numbers, we also include a space in the printout.

Lines 980-1010 deal with the four sides, as addressed by N. Line 1020 gives you time to read the result before the subroutine at 1350 clears five lines at the bottom of the screen and the program returns for another choice of input.

The routine to mark a reflection is virtually the same as that for absorption,

apart from the symbol used — a reversed star. Lines 1120-1240 are the routine for an emergent ray. We need to mark both ends of the ray, so, although we can mark its start in a similar way to that used before, we use a slightly different technique for the end of the ray.

The end of the ray is, of course, given by the value of X and Y, since P(X, Y) is the output point. We can use the values of X and Y in A\$ and D\$, unless X or Y is zero, which occurs when a ray emerges at the top or on the left. In those cases, only the non-zero value is used. Line 1160 covers the right-hand and bottom edges; 1170 the left-hand edge and 1180 the top. Lines 1190-1230 use the same technique for the beginning of the ray as was used for reflection and absorption. 1240 gives you time to read the result before returning for another input.

Confession of errors

Eventually, you will be ready to guess the answer and the choice in lines 430-490 will lead the program to the routine starting at 1250. The positions of the Z atoms are still stored in RX(I) and RY(I), for I = 1 to Z, and they are now printed on to the board.

You are asked to confess your errors and the penalty of five points per atom is added to your score. RT and GT are also updated before you are given the chance to play again, with a new value of Z if required.

Lines 1340-1380 contain the two sub-routines we have used. The first moves the cursor to the 20th line on the screen and then blanks five lines by printing 200 spaces. The second prints the score at a position to the right of the board.

If the player has decided to end play, lines 1390-1490 calculate his average score for the number of games played and gives its own assessment of the standard of play.

Those assessments are purely arbitrary and for example, take no account of the number of atoms. However, 13 is a normal score for four atoms — do not forget that anyone could score 20 by four wrong guesses earning five-point penalties. A consistent score of less than 10 would verge on extra sensory perception.

Most of the routines should be easy to adapt for other systems which very few virtually changes, although the graphics of the display may require more thought. One can achieve a good deal of satisfaction by indulging in a little home cooking. There is no need to confine your Pet's diet to prepacked offerings.

Black Box was invented by Dr Eric Solomon and is marketed by Waddingtons House of Games in two versions; the standard version and a mini pocket version. The author is grateful for Waddingtons' permission to use its game for the program.

(continued on page 97)

EXPLORER-85 COMPLETE BUSINESS SYSTEM AT A FANTASTIC PRICE



**64K COMPUTER — VDU —
TWO 8" DRIVES —
PRINTER — CP/M 2.2 —
EXTENDED MBASIC**

£2900.00

All you need to run your business

We can supply software to suit your particular requirements

EXPLORER-85 COMPUTER Kits Start at £85

**8085A cpu — S100 Based System
Designed for maximum Flexibility**

PROBABLY THE MOST EXPANDABLE KIT ON THE MARKET TODAY.

A COMPUTER FOR YOUR REQUIREMENTS TODAY AND TOMORROW BE IT BEGINNERS KIT:

OEM CONTROLLER: OR FULL DISC DRIVE SYSTEM EXPLORER-85.

NOT THE CHEAPEST JUST THE BEST.

8085A cpu — S100 slots (expandable to 6) — Powerful 2k Monitor — 4K RAM (expandable to 64K) — 8k Microsoft Basic — Speed 3.1MHz — 4, 8bit I/O Ports — 1, 6bit Port — 14bit Binary counter — All programmable — Stand alone Keyboard Terminal — 64/32 characters 16 lines — upper & lower case — Full cursor control — Power supply unit — NO EXTRAS NEEDED

4K system complet kit..... £327.00
16K system complet kit..... £410.00

Limited Budget? You can purchase explorer 85 in sub kits starting from £85 for the Motherboard Level 'A'.

EXPAND YOUR SYSTEM WITH 8" DRIVES

8" Control Data Corp Professional Drive
* LSI Controller * Write protect * Single or Double density * Capacity 400K Bytes (SD) 800K Bytes (DD) unformatted * Access time 25ns. Price £350
DISC CONTROLLER I/O BOARD
Controls up to 4 Drives * 1771 ALSI (SD) floppy disc controller * On board data separator (IBM compatible) * 2716 PROM socket included for use in custom applications * On board crystal controlled * On board I/O baud rate * Two serial I/O ports * Autoboot to disc system when system reset * Generators to 9600 baud * Double sided PC board (glass epoxy). Price £150
DISC DRIVE CABINET WITH POWER SUPPLY
De Luxe steel cabinet to house single drive with power supply unit to ensure maximum reliability and stability. Price £79
DRIVE CABLE SET UP FOR TWO DRIVES Price £19.00

64K 'JAWS' S100 DYNAMIC RAM CARD

We offer you ... Hidden refresh ... fast performance ... lower power consumption ... latched data outputs ... 200ns 4116 RAM's ... on board crystal ... 8K bank selectable ... fully socketed ... solder mask on both side of the board. Designed for 8080, 8085 and Z80 bus signals ... works in Explorer/85, Tuscan, Horizon, Sol, as well as all other well-designed S100 computers. **ATTS WIRED & TESTED**

16K	£149	£169
32K	194	214
48K	239	259
64K	284	304
16K upgrade kits £45		

SOFTWARE — CP/M 1.4 £75 — CP/M 2.2 £98.00
Microsoft extended MBasic £155

THE ELF11

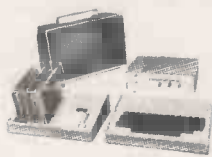

IF YOU REALLY WANT TO UNDERSTAND COMPUTERS THEN ELF11 for YOU

Basic Specification
RCA COSMAC 1802 cpu — ¼ K RAM expandable to 64K — DAM — Interrupt — 16 registers — Fully Decoded Hex Keypad — Dual 7 segment display — Crystal clock — Onboard regulation — 1861 Graphic Chip — 5 slot expansion bus — Double sided plated through PC Board.

Basic KIT ONLY £49.95

ELF11 is Ideal for Beginners — Engineers — Industry — Scientific and Educational purposes

You will LEARN to program in Machine code and really understand computers, from there you can expand it to meet your requirements upto 64K RAM working in Basic level 111
Suggested Starters Pack: — ELF11 kit + RF Modulator + T. Pitmans Short Course for £56.70

ELF11 EXPANSION. We carry a full range of expansion kits — HARDWARE — FIRMWARE — SOFTWARE — MANUALS. Send S.A.E. for brochures
NOW AVAILABLE — FULL BASIC LEVEL 111 + RPN Maths package COMING VERY SHORTLY — EPROM BURNER

10" MONITOR £79.95

IDEAL FOR APPLE NASCOM
U.K. 101, ETC.

- Designed for monitoring computers, closed circuit TV and Video Tape Recorders
 - 10" black and white video monitor
 - 10 MHz band width
 - High-quality metallic cabinet
 - Dimensions: 9" x 9" x 9 1/2"
- Trade Enquiries Welcome



Oki Microline 80



Small, light, quiet matrix printer.

40, 80 or 132 cols.
6 or 8 lines per inch.
96 ASC II + 64 graphics character set
with Centronics compatible interface
RS232 Optional Extra £299

SEND SAE FOR COMPREHENSIVE BROCHURE

Please add VAT to all prices. P&P extra. Please make cheques and postal orders payable to NEWTRONICS or phone your order quoting BARCLAYCARD. ACCESS number.

We are open for demonstrations and Sales Monday-Saturday, 9 30 a.m - 6 30 p.m
Near Highgate Underground on main A1 into London

Newtronics

255 ARCHWAY ROAD,
LONDON, N.6 TEL. 01-348 3325



• Circle No. 169

(continued from page 95)

```

READY.
10 REM*****BLACK BOX*****
20 REM**      **
30 REM**PROGRAMMED BY**
40 REM**      **
50 REM*****R.C. MERRY*****
60 REM**      **
70 REM*****SEPT 1979*****
80 REM*****
90 REM**INSTRUCTIONS**
100 PRINT"Q          [BLACK] [BOX]"
110 PRINT"THIS IS THE GAME OF BLACK BOX, THE GAME"
120 PRINT"OF DEDUCTION BY WADDINGTONS, YOU WILL"
130 PRINT"NEED THE STANDARD RULES OF BLACK BOX"
140 PRINT"TO PLAY, THE COMPUTER GENERATES RANDOM"
150 PRINT"PATTERNS OF ATOMS, HOW MANY ATOMS"
160 INPUT"WOULD YOU LIKE IN THE FIRST GAME";Z
170 REM**INITIALIZE**
180 A$="#####"
190 D$="#####"
200 L$=" |":M$="—+":RT=0:GT=0
210 B$="ABCDEFGHIJKLMN0P":DIM P(9,9)
220 S=0:B=0
230 REM**CLEAR ARRAY,LOAD RAY NUMBERS**
240 FORX=0TO9:FORY=0TO9:P(X,Y)=0:NEXTY,X
250 FORY=1TO8:P(0,Y)=Y:P(9,Y)=25-Y:NEXT
260 FORX=1TO8:P(X,0)=33-X:P(X,9)=X+8:NEXT
270 REM**PLACE RANDOM ATOMS**
280 FORI=1TOZ
290 RX(I)=INT(8*RND(1)+1):RY(I)=INT(8*RND(1)+1)
300 IFP(RX(I),RY(I))<>0THEN290
310 P(RX(I),RY(I))=99:NEXT
320 REM*PRINT DISPLAY DURING BLANKING*
330 POKE59409,52
340 PRINT"Q";
350 FORI=1TO9
360 FORJ=1TO9:PRINTL$;:NEXT:PRINT
370 FORJ=1TO9:PRINTM$;:NEXT:PRINT"—":NEXT
380 FORJ=1TO9:PRINTL$;:NEXT
390 PRINT"#####1#####2#####3#####4#####5#####6#####7#####8#####9#####10#####11#####12#####13#####14#####15#####16"
400 PRINT"#####32#####31#####29#####27#####26#####25"
410 PRINT"#####";LEFT$(A$,27);"#####24#####23#####22#####21#####20#####19#####18#####17#####"
420 POKE59409,60
430 REM**INPUT OPTION**
440 PRINT"#####";LEFT$(D$,20);"DO YOU WANT TO 1)INPUT A RAY"
450 INPUT"                2)SEE THE ANSWER";R
460 IFR=1ORR=2THEN480
470 PRINT"PLEASE ENTER 1 OR 2";GOTO440
480 GOSUB1350
490 ONR GOTO500,1250
500 REM**INPUT RAY NUMBER**
510 PRINT"#####";LEFT$(D$,20);:INPUT"RAY NUMBER";G
520 IFG<1ORG>32THENPRINT"NOT A VALID RAY":GOSUB1350:GOTO510
530 N=INT((G-1)/8)+1
540 ONN GOTO560,660,760,860
550 REM**LEFT TO RIGHT**
560 X=0:Y=0
570 IFP(X+1,Y)=99THEN960
580 IFP(X+1,Y-1)=99ANDP(X+1,Y+1)=99THEN1050
590 IFP(X+1,Y-1)=99ANDX=0THEN1050
600 IFP(X+1,Y+1)=99ANDX=0THEN1050

```

(continued on page 99)

MAKING THE RIGHT PRINTER IS ONLY HALF THE STORY...

Come and see us at
Computemarket '81.
We are exhibiting
at all venues.



To complete the picture you need a strong organisation to provide application and aftersales support.

Our new headquarters in Hampshire plus our comprehensive network of U.K. and European suppliers and service outlets give that essential extra.

Anadex printers provide low initial cost, long operating life and peace of mind – ask any of our 25,000 customers and you'll begin to see the other half of the picture.

- DP-8000 series, 80-column, alphanumerics, adjustable character widths; from **£495**
 - DP-9000 series, 80-132 column, alphanumerics plus graphics; from **£795**
 - DP-9500 series, 132-220 column, alphanumerics plus graphics; from **£895**
- For OEM quantities the above prices are subject to substantial discount.

 **Anadex Ltd.**

Details from Anadex Limited, Weaver House,
Station Road, Hook, Basingstoke, Hants.
Tel: Hook (025672) 3401 Telex: 848762 Anadex G

ANADEX OVERSEAS DISTRIBUTORS

AUSTRIA Fa. William E. Hayward Tel: (06222) 20026 Telex: 633336 BELGIUM Telerex NV SA Tel: (031) 833350 Telex: 33511 DENMARK Instrutek Tel: (05) 611100 Telex: 61656
GERMANY Neumuller Messtechnik Tel: (089) 61181 Telex: 522106 EIRE Kode Services Ltd Tel: 01 802797 FINLAND Jertec Oy Tel: (90) 585 133 Telex: 123265 FRANCE Euroterminal Tel: (1) 665 7340
Schwind Datentechnik GmbH Tel: (089) 8349716 Telex: 213097 ISRAEL SDSI Ltd Tel: (04) 667942 Telex: 4633 667948
ITALY Transport SpA Tel: (02) 20 42 541 Telex: 331410 NETHERLANDS Telerex Nederland BV Tel: (04998) 4295 Telex: 59455 NORWAY A/S Kjell Bakke Tel: (02) 711872/715330 Telex: 19407
SOUTH AFRICA Bell & Howell SA (Pty) Ltd Tel: (011) 724 9361 Telex: 80428 SPAIN Data Dynamics Espana SA Tel: (91) 408 00 00 Telex: 23534
SWEDEN Lagercrantz Elektronik AB Tel: (0760) 86120 Telex: 11275 SWITZERLAND EM Electronic Marketing AG Tel: (061) 35 36 37 Telex: 64861

**AVON**

CSS Ltd Tel: 0272 779452
 Wilkes Computing Ltd Tel: 0272 290651
 Computerama Ltd Tel: 0225 333232

BERKSHIRE

Riva Terminals Ltd Tel: 03447 5193
 Computershop Limited Tel: 0734 481555

CAMBS

Comart Ltd Tel: 0480 215005

CORNWALL

Exleigh Business Machines Ltd Tel: 0736 62616

DERBYSHIRE

Midlectron Ltd Tel: 077 382 6811

DEVON

ACSystems Ltd Tel: 0392 71718
 JAD Ltd Tel: 0752 62616

DUMBARTONSHIRE

Kode Services Ltd Tel: 0342 22766

FIFE

CS Scotland Ltd Tel: 0592 773710

GLAMORGAN

Computer Centre Ltd Tel: 0792 460023

HAMPSHIRE

Microchips Ltd Tel: 0962 62208
 Business Electronics Ltd Tel: 0703 738248

HERTFORDSHIRE

Orchard Electronics Ltd Tel: 0491 35529
 Electroplan Ltd Tel: 0763 41171

HEREFORDSHIRE

Farmplan Ltd Tel: 0983 4321

ISLE OF WIGHT

Zeta Dynamics Ltd Tel: 0983 527725

LANCASHIRE

Keytech Eng Ltd Tel: 0618349244
 Preston Computer Centre Ltd Tel: 0772 57684
 Stack Computer Services Ltd Tel: 051933 5511

LONDON

Compshop Ltd Tel: 01 441 2922
 DDT Ltd Tel: 01 207 1717
 Capital Computer Systems Ltd Tel: 01 637 5551
 CSS Ltd Tel: 01 254 9293
 Euro Calc Ltd Tel: 01 729 4555
 Interam Ltd Tel: 01 834 0261
 London Computer Centre Ltd Tel: 01 338 5721
 Sumlock Bondain Ltd Tel: 01 250 0505
 Small Systems Eng Ltd Tel: 01 328 7145

MIDLOTHIAN

Microcentre Ltd Tel: 031 5567354

NOTTINGHAMSHIRE

Keen ComPuter Ltd Tel: 0602 583254

SOUTH GLAMORGAN

Data Type Ltd Tel: 063 33 65307

SURREY

Peripheral Hardware Ltd Tel: 01941 4806
 AERCO Gemsoft Ltd Tel: 048 62 22881

STRATHCLYDE

Robox Ltd Tel: 041 221 5402

WARWICKSHIRE

Linbrac Computer Services Ltd
 Tel: 092 68 14539
 Taylor Wilson Systems Ltd Tel: 05645 6192

WILTSHIRE

Kode Services Ltd Tel: 0249 813771

(continued from page 97)

```

610 IFP(X+1,Y-1)=99THEN870
620 IFP(X+1,Y+1)=99THEN670
630 X=X+1:IFX<>9THEN570
640 GOTO1120
650 REM***BOTTOM TO TOP***
660 X=G-8:Y=9
670 IFP(X,Y-1)=99THEN960
680 IFP(X-1,Y-1)=99ANDP(X+1,Y-1)=99THEN1050
690 IFP(X-1,Y-1)=99ANDY=9THEN1050
700 IFP(X+1,Y-1)=99ANDY=9THEN1050
710 IFP(X-1,Y-1)=99THEN570
720 IFP(X+1,Y-1)=99THEN770
730 Y=Y-1:IFY<>0THEN670
740 GOTO1120
750 REM***RIGHT TO LEFT***
760 X=9:Y=25-G
770 IFP(X-1,Y)=99THEN960
780 IFP(X-1,Y-1)=99ANDP(X-1,Y+1)=99THEN1050
790 IFP(X-1,Y-1)=99ANDX=9THEN1050
800 IFP(X-1,Y+1)=99ANDX=9THEN1050
810 IFP(X-1,Y-1)=99THEN870
820 IFP(X-1,Y+1)=99THEN670
830 X=X-1:IFX<>0THEN770
840 GOTO1120
850 REM***TOP TO BOTTOM***
860 X=39-G:Y=0
870 IFP(X,Y+1)=99THEN960
880 IFP(X-1,Y+1)=99ANDP(X+1,Y+1)=99THEN1050
890 IFP(X-1,Y+1)=99ANDY=0THEN1050
900 IFP(X+1,Y+1)=99ANDY=0THEN1050
910 IFP(X-1,Y+1)=99THEN570
920 IFP(X+1,Y+1)=99THEN770
930 Y=Y+1:IFY<>9THEN870
940 GOTO1120
950 REM***ABSORBED RAY***
960 S=S+1:GOSUB1380:PRINT"R";LEFT$(D$,20);"RAY WAS ABSORBED"
970 ONNGOTO980,990,1000,1010
980 PRINT"R";LEFT$(D$,2*G);"  R";GOTO1020
990 PRINT"R";LEFT$(D$,18);LEFT$(A$,3*(G-8));"  R";GOTO1020
1000 PRINT"R";LEFT$(D$,2*(25-G));LEFT$(A$,27);"  R";GOTO1020
1010 PRINT"R";LEFT$(A$,3*(33-G));"  R"
1020 FORI=1TO3000:NEXT
1030 GOSUB1350:GOTO430
1040 REM***REFLECTED RAY***
1050 S=S+1:GOSUB1380:PRINT"R";LEFT$(D$,20);"RAY WAS REFLECTED"
1060 ONNGOTO1070,1080,1090,1100
1070 PRINT"R";LEFT$(D$,2*G);"  R";GOTO1110
1080 PRINT"R";LEFT$(D$,18);LEFT$(A$,3*(G-8));"  R";GOTO1110
1090 PRINT"R";LEFT$(D$,2*(25-G));LEFT$(A$,27);"  R";GOTO1110
1100 PRINT"R";LEFT$(A$,3*(33-G));"  R"
1110 FORI=1TO3000:NEXT:GOSUB1350:GOTO430
1120 REM***RAY EMERGES***
1130 S=S+2:B=B+1:GOSUB1380:PRINT"R";LEFT$(D$,20);"RAY EMERGED
AT ";P(X,Y)
1140 IFX=0THEN1170
1150 IFY=0THEN1180
1160 PRINT"R";LEFT$(A$,3*X);LEFT$(D$,2*Y);"  ";MID$(B$,B,1):GOTO1190
1170 PRINT"R";LEFT$(D$,2*Y);"  ";MID$(B$,B,1):GOTO1190
1180 PRINT"R";LEFT$(A$,3*X);"  ";MID$(B$,B,1)
1190 ONNGOTO1200,1210,1220,1230
1200 PRINT"R";LEFT$(D$,2*G);"  ";MID$(B$,B,1):GOTO1240
1210 PRINT"R";LEFT$(D$,18);LEFT$(A$,3*(G-8));"  ";MID$(B$,B,1):GOTO1240
1220 PRINT"R";LEFT$(D$,2*(25-G));LEFT$(A$,27);"  ";MID$(B$,B,1):GOTO1240
1230 PRINT"R";LEFT$(A$,3*(33-G));"  ";MID$(B$,B,1)
1240 FORI=1TO3000:NEXT:GOSUB1350:GOTO430
1250 REM***PRINT ANSWER,FINAL SCORE***
1260 FORI=1TO2:PRINT"R";LEFT$(A$,RX(I)*3);LEFT$(D$,RY(I)*2);"  ":NEXT
1270 PRINT"R";LEFT$(D$,20);"HOW MANY DID YOU GET WRONG";
1280 INPUT
1290 S=S+5*W:GOSUB1350
1300 PRINT"R";LEFT$(D$,20);"YOUR FINAL SCORE WAS ";S:RT=RT+S:GT=GT+1
1310 INPUT"R";"ANOTHER GAME (Y/N)";R$
1320 IFLEFT$(R$,1)="N"THEN1390
1330 INPUT"R";"HOW MANY ATOMS";Z:GOTO220
1340 REM***CLEAR BOTTOM OF SCREEN***
1350 PRINT"R";LEFT$(D$,19);
1360 FORI=1TO200:PRINT"  ":NEXT:RETURN
1370 REM***PRINT SCORE***
1380 PRINT"R";LEFT$(A$,30);LEFT$(D$,5);"  SCORE=";S:RETURN
1390 REM***WORK OUT FINAL AVERAGE***
1400 AV=RT/GT
1410 PRINT"R";"YOUR MEAN SCORE WAS:";AV
1420 PRINT"R";"YOU PLAYED:";GT;"GAMES"
1430 IFAV>20THENG$="POOR!!"
1440 IFAV<20THENG$="FAIR"
1450 IFAV<15THENG$="ABOUT AVERAGE"
1460 IFAV<13THENG$="GOOD"
1470 IFAV<10THENG$="EXCELLENT!!"
1480 PRINT"R";"YOUR PERFORMANCE WAS ";G$
1490 END
READY.

```

Even friends of the famous have to pay VAT

FEW COMPUTER owners can boast that their keyboards have recently felt the touch of the impressive and highly-paid hand of superstar Kate Bush. Yet the computer at London Features International, LFI, were it to have any feelings at all, would probably be extremely blasé about the procession of famous rock stars who have admired their reflections in its screen.

LFI is a photographic agency which specialises in providing action, studio and glamour shots of musicians to record companies, magazines and newspapers worldwide. Its computer is an all-British starlet in its own right, the Transam Tuscan, and all its software — including ledgers and a rental management system for its photographs — is being written by a self-taught programmer, Adrian Boot, who happens to be one of the LFI agency photographers.

Boot had had little experience of computing when he bought his 4K Triton board from Transam. True, about 10 years ago he had done a degree in physical chemistry at London University: "I did a one-year option in computing there, but it was all mainframes in those days".

He used the computer to help him in his final thesis, an opus with the snappy title, *The Disassociation of Constants of Picric Acid*: "but I did very little of the programming myself".

New world

After university, Boot went a long way from London, to Jamaica, and left the world of picric acid and computers well behind him: "I went to Jamaica to teach, but at college, my photography had always been of a semi-professional standard, and it didn't really take me long to establish myself as a photo-journalist in the Caribbean".

That must have been more fun than teaching, and as it happened Adrian Boot and his camera were in the right place at the right time: "Reggae was becoming more popular and I sold quite a few pictures of reggae musicians to European magazines". He also took some photographs for the Rolling Stones who recorded the *Goat's Head Soup* album in Jamaica.

On his return to England eight years ago, he became a full-time freelance photographer with a speciality in rock music and a *Melody Maker* contract. He also set up his own photographic library and his work started to be syndicated across the world.

Now he is very near the top of his profession, but despite the fact that in the few weeks before we visited him, he had photographed a spectrum of rock musicians from Gary Numan and the Professionals to Kate Bush and Status Quo,

he is emphatic that his life is not entirely composed of glamour.

"A good 30 percent of my time at home is spent on administration. My wife and I are often forced to spend cosy evenings battling with the VAT return, and believe me, doing administration goes against the very nature of what makes a good photographer".

His administrative work is split between the basic business accountancy — his business is turning over about £15,000 a year at the moment — and running his

by Cathy Lane

library of several 1,000 transparencies. "Coping with all that is hell. LFI and I find that only about 60 percent of the pictures we loan are returned".

Thanks to his academic background, Boot has become an avid reader of scientific magazines like *Scientific American* and *New Scientist*, so he was not unaware of the micro boom: "Something like four years ago, I began to think that this might be the answer to my VAT problems" — a farsighted conclusion at a time when few commercial applications were being put on to the new microcomputers.

He went to some personal computer exhibitions in the States and encountered a micro in a recording studio over there: "As well as the business functions, they were trying to link it to their studio console — I was intrigued".

Boot looked round and decided that there was no way that he was going to be able to buy software which could run his business. It was early days for the small business system, and the standard, and availability, of low-cost cassette programs was, frankly, poor.

His conclusion was that he would have to program any machine himself and decided that the best way to learn how a computer works was to build one himself from a kit.

So he bought the Triton board from Transam. Why Transam? "I liked their attitude", he says. "There's a kind of snobbishness about microcomputers; if you're in the know, everything is fine and you're a member of the club. If you aren't, it's really difficult to learn anything. That turned out to be a real contrast to the States — everyone there was enthusiastic about micros and helpful to novices like me".

After receiving short shrift from a computer shop that had no patience for his beginner's questions, he tried Transam and: "They answered even my most stupid

questions patiently and very helpfully".

Boot initially bought a 4K Triton board to plug into his own television set. It took him three days of solid effort to build the computer — albeit with plenty of help from Transam. The hiccups were split evenly between his own soldering errors and faulty parts. He takes a phlegmatic attitude to that somewhat staccato progress: "I don't think anyone can really expect to plug in and go with one of those things, not unless you happen to earn a living as an electrical engineer, but it wasn't really too difficult for me".

The first program that Adrian wrote was a routine for solving his VAT problems. They can be complicated because of the vast number of small transactions involved. At first his system did not have a printer, so the computer was acting just as a sophisticated calculator and everything which appeared on the screen was copied by hand into a ledger.

Boot is constantly re-writing that program as he upgrades his system and as Transam releases bigger and better versions of the Basic programming language. He started with the compact, economical and generally neat Tiny Basic implementation — ideal for a small beginner's system and as an introduction to the programming language, but nobody's idea of the kind of function-filled language required for business uses.

Upgraded Basic

The upgraded Basic he uses now is running on a system that has grown into 32K of memory, a single 8in. floppy disc drive, keyboard and screen, and a Teletype as its printer. All this is worth around £1,000; his original outlay was nearer £200.

Doing the VAT used to take two people five brain-numbing hours one evening each month. With the latest version of the VAT program on the computer, it takes just 20 minutes.

Having solved the immediate problems, Adrian slowed down: "We had the computer in the corner of the sitting room, which made a marvellous conversation piece — it was used a good deal for games, but computer games can become boring. Either they are too simple, or the computer wins all the time. It even cheats sometimes, and it's certainly not a good drinking partner".

However, more computing activity was around the corner. About this time, Boot had started to talk to LFI about its acquiring a computer. "We had, in fact, been thinking for some time of computerising the photo library", says John



London Features International photographer Adrian Boot's self-portrait.

Halsall, one of the two company directors of LFI. "Three years ago we had spoken to IBM. It was all much too expensive, though. They were quoting about £15,000 for the hardware, and I realised even then that prices were going to fall".

As a result of Adrian Boot's good experiences with Transam, LFI bought a Tuscan from the company. This Z-80-based microcomputer was then a new product, but it represented a hardware upgrade from the Triton and used the same software. The LFI configuration had double-density disc drives, a fast — 120 cps — matrix printer, 48K memory, and a price tag around the £4,000 mark.

First objective

The first objective for the Tuscan was to computerise the LFI address book. That would then form the basis of the customer file for the photographic library and would provide a mailing list divided into about 50 category codes. Adrian Boot had already started to develop a mailing-list program on his Triton, and the software on Transam computers is helpfully interchangeable.

It took Boot two months to have the mailing list up and running, and he also produced a program which runs the photographic library — it is similar to the standard mailing list, except that everything is categorised as a subject record.

Under each subject record, there are details about the number of different photographic sessions available, the number of transparencies from each session, the code for the photographer who took them and an indication of exactly which transparencies have been taken out and the customer number of the recipient — which refers back to the customer number of the mailing list.

Adrian Boot is working on programs to handle LFI's invoicing and which will also produce statements and a sales ledger.

The long-term plan is to market the programs when they are all completed. "I've deliberately written them all in little modules", says Boot, "but they all interface to each other so that the invoicing file can access the mailing list and so on".

There is also scope for further sophistication: "At the moment when John wants to check on where a particular

photograph is, he has to look through the customer ledger, page by page. Or he could blanket-Telex everyone, which is expensive. We might well be missing many sales of rights because of this".

Boot reckons he would not have been able to write such clever programs were it not for the fact that he had built a computer himself: "Building your own certainly isn't the quickest way of doing it. It probably isn't the cheapest either, but it certainly helps you understand how the thing works".

Future expansion

John Halsall is a little more sceptical about computing, but when all systems are go he intends to capitalise on it — maintaining larger files and handling more pictures. "We want to expand our subject matter — I'm not sure into what areas, but you can sell photographs of anything. Like there's a man who spends all his time at Heathrow just photographing aeroplanes. He doesn't sell that many — but believe me, every time there's a plane crash and the papers want a shot of the exact model, he makes a bomb".

Clear data coding unlocks door to information analysis

ONE ASPECT of statistics is to analyse data to try to determine if it is in agreement with some given hypothesis, and to try to determine the probability that any apparent agreement is real. Such analyses can be conducted with only a limited amount of data available, though the reliability of the analysis increases with the amount of data used, up to a certain point.

The other aspect of statistics is the collection, tabulation and summarising of large quantities of data. Information

by Owen Bishop

collected during censuses, market research, or from, say, the customer records of a large insurance company, may be used to provide summary information on which future action will be based.

Microprocessors are ideal for processing that kind of data in very large quantities. A small system may have some limitation because of its restricted memory space, but with a suitable method of recording the data on tape or disc, that disadvantage can be overcome.

As an example of how a small micro-computer can be used for data-handling we will follow the analysis of the reader-

ship survey, Tell us about you, which was published in the August 1979 issue of *Practical Computing*. The principles involved can, however, be applied equally well to most other kinds of data, such as customer files, library catalogues, and information gathered in surveys.

All information is codable, but it is worthwhile when collecting information to do so in a way that lends itself to subsequent coding. In our survey, the division of readers into four age-groups was ideal, for the four groups can readily be coded as a two-digit binary number. The division of system-cost and future-system-purchase-costs into nine bands each was not ideal, for that took four-digits in coding, whereas, with an eight-band division, almost as much information could have been contained in a three-digit code.

Users of large systems may be prodigal with memory space but, for the user of the small system, the motto is: Take care of the bits, and the bytes will take care of themselves. It may be possible to record additional information without requiring additional bits, and that should be considered during the planning stage. For example, the coding of occupations required six bits, and it would have been possible to code for three additional

occupations and a third category of business within a six-bit code.

It is easy to find fault with the planning after the information has been gathered, for it is notoriously difficult to prepare a perfectly satisfactory questionnaire. If a good deal of time and effort are to be spent on a survey, it is advisable to run a pilot survey first to discover just where the pitfalls lie.

If we want to correlate certain items of information, those items must be coded as a unit for each individual. For example, if we wish to know how many school teachers read *Practical Computing*, run through the questionnaires and count how many people circled 38.

Similarly, we can run through again and discover how many circled 72, to indicate they want a Pascal course. Yet if we want to know how many school teachers want a Pascal course, we must include both items of information in one unit of code. Figure 1 shows several items of information, all contained within a double-byte code group.

Mutually exclusive

The example shows a reader aged 21-40, teaching and researching in a college or university, who uses a computer for amusement only, writes programs, wants a Pascal course, and uses the *Practical Computing* program listings. Note that the coding must take into account whether, in certain groups, the responses are mutually exclusive — age, program writing, Pascal, business use — or whether it may be legitimate for two or more responses within the same group to be circled.

In occupations, a person may be a teacher and in research, or be a computer professional and in a big business. Similarly, problems in operating computers may be due to hardware, software, or both; and there must also be a code for neither.

The example covers most of the essential facts about a reader and enables us to discover how many of our readers are school teachers less than 16 years old — code 00XX — and how many computer professionals above the age of 40 use computers for amusement only and do not write programs — code EOAX. Such code groups did not appear in our survey.

Even without further analysis, the conversion of information into compact code form allows the data to be inspected by eye and broad features can be picked out easily. For example, the group A0XX appears often in the listing indicating that a significant proportion of readers are

Figure 1. Data coding.

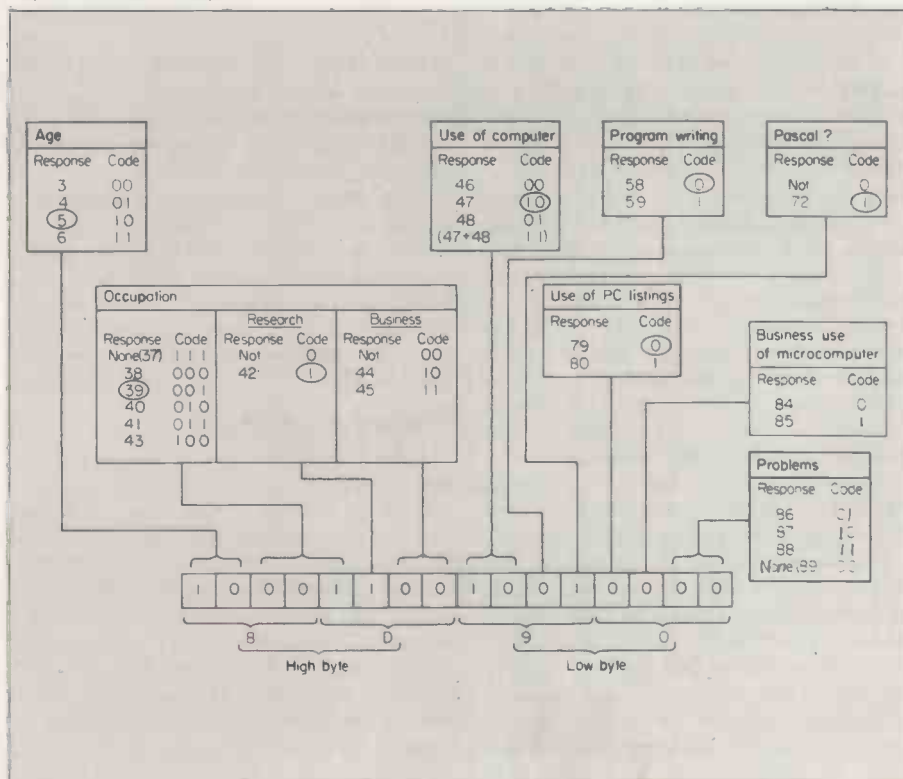

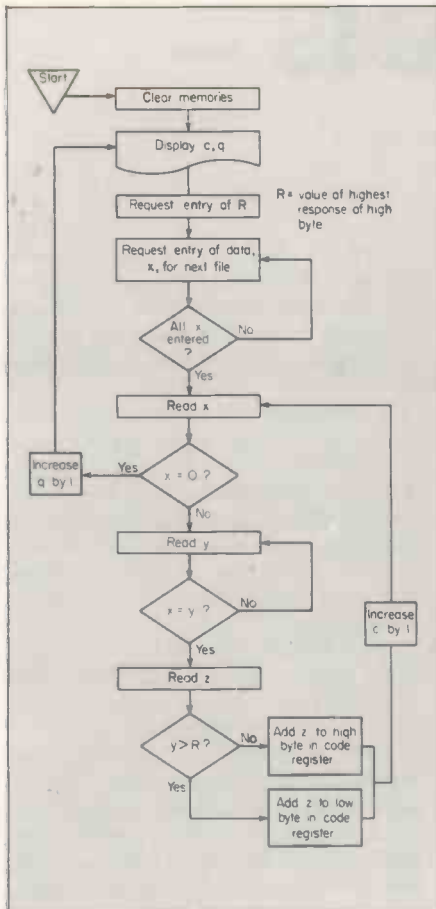

Figure 2. Program flowchart.

computer professionals in the 21-40 age group. Another common group is 82XX — businesses with fewer than 50 employees, aged 21-40 — while the group 10XX — school student, less than 16 — is distinctive but rare.

However, it is extremely rare to find two double-byte groups which are identical, indicating the wide variety found among our readers. To extract the detailed information, the code groups must be analysed systematically.

A program for producing the kind of code shown in figure 1 is described by the flowcharts of figures 2 and 3. The reader is left to write a listing for his own system. The system need not be a large one, for

OFB2	03	04	05	06	37	38	39	40
OFBA	41	42	43	44	45	46	47	48
OFC2	58	59	72	79	80	84	85	86
OFCA	87	88	89					

Figure 4. Response table for data coding program, for items shown in figure 1.

the program was run in machine code on an MK-14, leaving enough memory to hold 100 double-bytes of coded data. Data is entered by typing in the ringed numbers from a questionnaire or file.

For the coding of information shown in figure 1, the number 37 was entered if no occupation number had been circled, and 89 to indicate no problems. That made it possible to distinguish later between a genuine no ring response and an omission on the part of the operator to enter a

response which had, in fact, been ringed.

All possible responses are listed in a response table in the program — figure 4. When data has all been entered, the program reads each item, *x*, in turn and runs through the response table, *y*, until it finds a match. It then finds the corresponding code from the code table, also in the program — figure 5 — and arithmetically adds it to the appropriate register in the code register table.

When coding is complete, the program displays the number of items entered, *c*, as a check that none has been accidentally omitted.

It also displays *q*, the number of files or questionnaires coded, as a check against such errors as turning over two sheets together or entering the same set of data twice. It also indicates when memory is full.

Correlation

If we wish to correlate more information, we need more bytes in the code group. For certain types of information, the number of bits required is relatively large. There were 16 newspapers listed in the questionnaire and since an individual can ring any number and combination of newspapers, we need 16 bits to cover all possibilities. So the addition of newspaper information means that we need a quadruple-byte code.

It is easy to modify the program to deal with quadruple-bytes, but if memory space is limited, the number of questionnaires processed in one run is now halved. To cover all the information on the questionnaire sheet requires 12 bytes in each unit. If it is necessary to be able to correlate any item of information with any other item, the complete questionnaire must be encoded in 12 bytes.

For a small system, this makes the program so long that memory space to store the results is very limited — especially since it requires 12 bytes to store the code of each questionnaire.

Manual process

In the good old days, when analyses were done by hand on paper with perhaps the help of a mechanical calculating machine, a statistical analysis could take several hours. Nowadays, it can be done in microseconds, yet is that speed entirely beneficial? Although calculating results by hand was certainly exacting and often tedious, the analyst had the feeling of really being in contact with the analysis.

As the results gradually grew on the page, he could see how things were developing, to ponder and to anticipate, to think what it all meant in terms of real events.

That opportunity to work with the computation is lost when everything is done in a flash. A computer has no feel for an analysis and it is doubtful if it could be programmed to behave as if it had one. It cannot see how the results are emerging and develop a hunch as to what type of

analysis to try next — or perhaps decide that the whole thing is a waste of time.

Certainly if there is a mass of data which need processing according to some well-tryed routine, a large computer has all the advantages of speed and freedom from error. Yet in many applications, where the analysis itself is of an explor-

OFD4	00	40	80	C0	38	00	08	10
OFDC	18	04	20	02	03	00	80	40
OFE4	00	20	10	00	08	00	04	01
OFEC	02	03	00					

Figure 5. Code table from data coding program, for codings shown in figure 1.

atory nature, much can be lost if the analyst loses contact with the analysis. That is where a small system is best.

If cannot do everything for itself, so it needs to be used intelligently, and needs programming specially for the work in hand. The programming should preferably be done by the analyst, who will know exactly what the machine is doing on his behalf.

The program should allow scope for examining the computations at several stages along the line — for example, it is useful for the analyst to be able to look through the code groups before they are processed further. So, use a system slightly smaller than you think you need and keep in contact with the data. M

Figure 3. User flowchart.

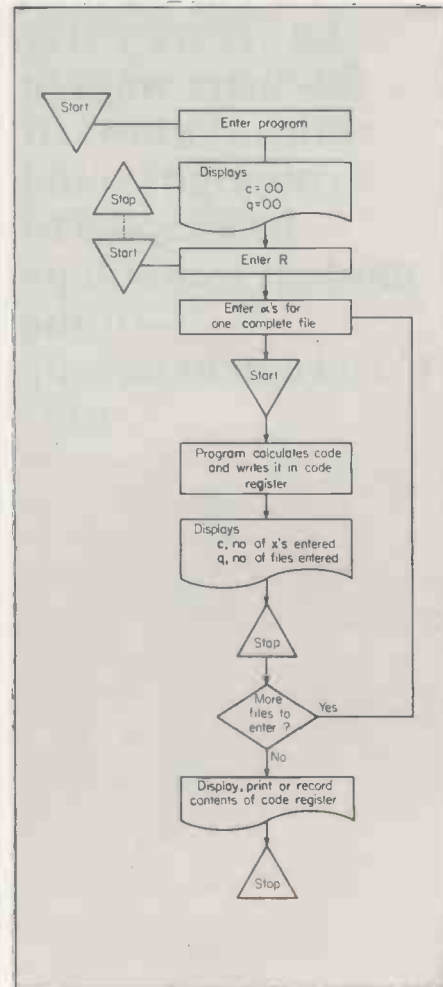

COMPUTER PROGRAMS — ART OR SCIENCE?

There has yet to be a definitive ruling in the courts to decide if computer programs can be copyrighted or patented or whether there is some other legal way to prevent the pirating of original software. In this paper, which was presented to the Chartered Institute of Patent Agents, Lawrence Perry discusses ways in which the laws of copyright could be adapted to modern technology — if the Government has the will.

SECTION 1, sub-section (2) (c) of the Patents Act 1977 declares that, for the purposes of the Act, a program for a computer is not an invention. An identical clause is found at Article 52 (2) (c) of the European Patent Convention. The inclusion of a similar clause in the 1949 Act was not given a moment's thought.

By 1949, hardly more than two or three computers had been built and were operating successfully. The Automatic Sequence Controlled Calculator was completed in 1944. It was a machine constructed of electric relays and controlled

by Lawrence Perry

by punched paper-tape. The first electronic computer, the ENIAC, was completed in 1946 and was controlled by plug-boards so that changing from one computation to another was an arduous task.

It was only in 1945 that von Neumann and his group at the Moore School of Electrical Engineering in Philadelphia, first articulated the idea of the stored-program digital computer. Essentially, it was proposed that the controlling information — the instructions to the machine — should be coded and stored in the machine together with the data on which the machine was to operate.

Yet even in 1945, at the end of a decade in which the electronics industry had made great progress, the von Neumann proposals were ahead of their time. What was lacking was a suitable storage device. The development of the modern computer depended on the discovery of the magnetic core, the transistor, and especially, integrated circuitry.

First success

The first British computer to operate successfully did so at Manchester in June 1948. At Cambridge University, Dr M V Wilkes' EDSAC, Electronic Delay Storage Automatic Calculator, performed its first fully-automatic calculation in May 1949.

So, it is not surprising that the drafters of the 1949 Act, if they had heard at all about computers, saw no reason to make mention of them — still less were they aware of computer programs.

It is difficult to identify any single reason for treating computer programs as non-inventions, although, insofar as the U.K. is concerned, the governing motive was the desire to unify European Patent Law.

Since the European Convention had excluded computer programs, the British were obliged to follow suit in their

domestic law. Yet why exclude computer programs anyway? Although one can never know for certain what advice was sought and tendered, perhaps the following considerations were taken into account.

- The computer was viewed, rather simplistically, as a calculating machine, and the computer program as a mere expression of calculations. Just as a method of solving an equation was not patentable, so, it was argued, should the mere expression of such a method as a set of instructions be excluded from patentability.
- It was thought that an activity associated rather with the study than with the laboratory was not appropriate to patents, which were, traditionally, granted for technological rather than merely intellectual achievement. Writing a program is like playing chess. If the thought processes are accurate, the game will not be lost and the program will not fail. In the laboratory, the technologist is seeking to master the physical world and may fail for reasons beyond his control.
- In the late 1950s, early 1960s, when the problem was under close discussion, the Patent Offices of the world were under extreme pressure. They took a significant proportion of the technologically-qualified personnel of a country and were demanding more as the arrears of unexamined applications mounted to beyond acceptable levels. The introduction of a new class of patentable material — computer programs — would only increase the pressure. Further, the difficulty of establishing the novelty of a computer program would lead to the grant of invalid patents, leading the patent system into yet more disrepute.
- In 1966, in the U.S. the President's Commission recommended that computer programs be excluded from patentability. At least one European country, France, was extremely unwilling to grant U.S. applicants what foreign applicants, it seemed, would not be granted in the States — namely, patents for computer programs. France was, in 1968, the first country to legislate the exclusion of computer programs, and rather jumped the gun, because, even in 1980, the question is not decided in the States.

The third and fourth of these reasons are questions of high politics and I do not propose to touch further on them. It is sufficient to remark that high politics is subject to the whims of fashion rather

more than low technology and that, in the future, it is conceivable that the Patent Office may be used to mop up a large pool of unemployed graduates.

The second reason represents nothing more than the prejudice that patents should only be granted to those with oil in their fingernails. It is the first reason, that the computer program is the expression of a calculation, which has had the most widespread influence and needs the most careful examination.

Cyclical operation

A typical stored program computer is a machine which is designed to operate cyclically as follows:

- 1 Get the next instruction;
- 2 Get the data specified by the instruction;
- 3 Perform the operation specified by the instruction;
- 4 Store the result of the operation;
- 5 Indicate which is the next instruction;
- 6 Repeat steps 1 to 6.

An instruction, therefore, selects the operation to be performed on specified data. A computer program is a set of instructions designed to cause the computer to execute some task. In other words a computer program is the means whereby a computer is caused to perform some function.

Yet the same function could be implemented equally well in electronic circuitry. The design of a computer involves the decision as to how many of the computer functions will be implemented as programs rather than as electronic circuitry. The IBM System/360 announced in 1964 is an interesting example of that.

Although all machines in the range were designed to have the same instruction sets, i.e., the same repertoire of instructions, the manner in which the instructions were implemented differed in different machines of the range. At the low end and middle of the range, the computers were provided with read-only storage containing microprograms. They are computer programs which perform the operations defined by the same instruction set and were effected directly by electronic circuitry. In general, appropriately-designed electronic circuitry will effect a given operation more quickly, at rather higher capital cost, than a computer program driving simpler circuitry of more general application.

Intellectual property

To demonstrate the equivalence of computer programs and electronic circuitry is not to establish that they are identical, and it does not necessarily follow that they should be deserving of the same protection, viewed as intellectual property. However, if the universality of computer programs is considered, serious questions arise as to the wisdom of declaring that a computer program is not an invention.

In the early days of computers, the universality of the machine referred to its

capability of solving any problem which could be presented as a finite series of steps. In the practical world of applied science, that means the computer can solve virtually any problem, can perform any regulatory function. To that universality of application, modern technology has added an extra dimension of patentability. A computer of equivalent power to that which once filled a room can be held in the palm of the hand.

While in the past, the computer has always been capable of calculating appropriate fuel/air mixtures, it is now possible to install the machine beneath the bonnet of a car where it can form part of the engine-control system.

A glance through the pages of the patent abridgement volumes will show that the programmed computer is being used in almost every conceivable application. The programmed computer can be an element in an inventive combination.

Judicial recognition

Perhaps the clearest judicial recognition of the modern facts of life was given by the United States Court of Customs and Patent Appeals in allowing Johnson's application for a patent, reported at 200 USPQ on page 210:

"Very simply our decision today recognises that modern technology has fostered a class of inventions which are most accurately described as computer-implemented processes. Such processes are encompassed within 35 USC 101 under the same principles as other machine-implemented processes, subject to judicially-determined exceptions, *inter alia*, mathematical formulae, methods of calculation, and mere ideas. The over-broad analysis of the PTO, Patent and Trade Mark Office, errs in failing to differentiate between a computer program, i.e., sets of instructions within a computer and computer-implemented processes whereby a computer or other automated machine performs one or more of the recited process steps. This distinction must not be overlooked because there is no reason for treating a computer differently from any other apparatus employed to perform a recited process step".

Perhaps by the time those words are delivered, the CCPA will have been firmly stamped on by the United States Supreme Court, for the Patent and Trade Mark Office has appealed most aggressively against several CCPA decisions which have interpreted Supreme Court utterances narrowly. That will not detract from the obvious good sense of the quotation, but U.S. law and practice do not help us in Europe, faced with Article 52 (2) (c) of the Convention. There is, of course, the mysterious Article 52 (3):

"The provisions of paragraph 2 shall exclude patentability of the subject matter ... referred to in that provision ... only to the extent to which (an application or patent) relates to such subject matter as such".

The guidelines firmly avoid discussion of this Article and my expository task would be easier if the wording mentioned claims or scope of protection. It is true that the German verb, *sich beziehen*, besides meaning to relate to also means to cover, but it also means to cloud over and,

regretfully, the life-line offered by this reading must be rejected.

What is a computer program "as such"? It is the program *per se*, the list of coded instructions set apart from any technical context. Patentability of such a list is excluded by Article 52 (3). Consider again Article 52 (2) (c).

Apparatus or system

It states that schemes, rules and methods of playing games are not inventions. That does not mean that a new and inventive game cannot be patented. Provision is made in the international classification A63F for board-games such as chess or geographical games. What is protected is the scheme, rule and method as implemented in the board and playing pieces.

Applying this to computer programs, it could be argued that, as long as the program of itself is not claimed, a patent can be obtained to an apparatus or system which implements the scheme underlying the program. There must be some validity in the argument for the computer program exclusion was, in the drafting of the Convention, deliberately placed in the "schemes and plans" section of Article 52 — but this argument alone will not do.

A new board-game necessarily involves new apparatus. A new program can be implemented on old apparatus. I have little sympathy with those who claim that, during its execution, a new program changes the old computer into a new machine. A typewriter tapping out a new poem does not change its intended function. The same keys are used sequentially as would be used in copying Tennyson.

Accurate analogy

The analogy between the typewriter keys and the instruction set of a computer is quite accurate. To claim a computer program as apparatus, in the form required by Rule 29, implies that the claim would have a characterising portion something like, "characterised by a machine-readable medium bearing control data such that the computer is caused to perform the following operations". Such claim would be refused under Article 52. Is that the limit of the scope of Article 52?

There are two computers A and B, of which B is subservient to A. The invention is that, at fixed intervals, A checks whether B wants to transmit or receive information to or from A. The invention could be implemented in electronic circuitry or in a computer program, or rather two programs, one in each machine.

A deliberate infringer is likely to choose the program alternative as that is the quickest and cheapest to implement. Assume that two computers connected together are known. The invention does not reside in the program as such and it is unnecessary to refer to the program in the claims.

(continued on next page)

In theory, the claims could be based on a description including only a single embodiment — program or circuitry — but that would be a risky practice and both embodiments should be mentioned, or at least a general statement about the equivalence of programs and electronic circuitry should be included. All this looks rather like subterfuge but is merely compliance with the implications of Article 52.

The patentee is rather more interested in the question of whether a computer program implementation infringes the claims to the invention. The infringer's defence is, of course, that a patent claim cannot cover what is unpatentable. However, this argument depends on splitting the claim into notional implementations and excluding some while including others. This is impermissible.

Business scheme

The patent is granted to an invention, Article 52 (1). The question is, has the infringer taken the invention? The program implementation is not the attempted patenting of a program as such, but a means of achieving the invention, which does not lie in the program. This approach does not permit the covert protection of what would otherwise be unpatentable.

If the invention is a business scheme or a mathematical method, it will be apparent from the specification and will not be hidden in a cloud of words, such as a computer programmed to perform a given function, or other evasions practised under the British 1949 Act.

If we turn to another class of invention, characterised by the use of microprocessors in technological applications, the problem is simpler. The microprocessor is integrated so intimately in its technological environment that inventions usually involve a change in the environment and the characterising clause will include that change.

Easy conversion

If, for example, an improvement is made to a microprocessor-controlled system by increasing the number of parameters to which the system responds, the characterising clause will include means for sensing the extra parameters and the invention cannot be said to be a computer program as such. If the improvement resides merely in an improved program, it is probably best to avoid protection by means of patents and to rely on secrecy and copyright.

It is to copyright that I now turn. In the case of most programs now on the market, the owner does not mind if a competitor invests time and money in developing a similar program independently. His investment is protected by the necessity, as in a poker game, for a com-

petitor to equal it to stay in the game.

What is strongly contested is the unauthorised use of his program to develop a competitive program. That is why a copyright-like type of protection is favoured so strongly and why the possible gaps in such protection are subject to increasingly-critical examination.

Briefly, to summarise the relevant provisions of the 1956 Copyright Act, copyright resides in original literary, dramatic, or musical or artistic works. Original means simply originating with an author and having required sufficient skill and labour.

It can be taken that any computer program worth protecting possesses originality. A computer program is not a dramatic work, nor is it a musical or artistic work. The program may generate such works but does not itself fall in any of these classifications.

By elimination, it is a literary work, which according to Section 48 (1) includes any written table or compilation. In relation to a work having copyright, there are certain acts which require authorisation of the copyright owner before they may be performed. The acts in respect of literary works requiring authorisation include:

- Reproducing the work in any material form;
- Publishing the work;
- Making any adaptation of the work; and,
- Doing, in relation to an adaptation of the work, any of the acts requiring authorisation. Adaptation means, *inter alia*, a translation of the work.

On the precedents, as I understand the authorities, there is nothing in the technological nature of the computer program to deny it copyright. The qualification "literary" has been understood as going to the form and not the content of the work.

Characterising clause

It follows that copyright subsists in a printed or written program. The nature of programs is such that the same program can be expressed in many different program languages and codes with relatively little investment required to convert from one language or code to the other. Different codes are required for different machine designs. The format of instruction word will, in general, differ with different machine manufacturers.

Different languages arise because the spread of computers has depended on making them easy to program, not in the sense of making programming easy, but in allowing the scientist, the mathematician and the businessman to concentrate on the problem he is solving without worrying too much about the complex machine he is using. Languages have been developed, such as Cobol, Basic, PL/1 and Algol, which enable the task to be performed by the computer to be expressed relatively simply.

In the view of the Whitford Committee, the wording of the 1956 Copyright Act is

adequate to cover using a program to develop essentially the same program in a different language or code, and such an act requires authorisation as a translation of the literary work.

That view is not accepted universally and Alistair Kelman, a barrister, has felt the need to propose amendments to the Copyright Act to cover the situation. His proposal is to use the word transmutation to mean changes in the form or expression of a computer program. In particular, he proposes the term "cross-transmutation" to mean a change of code or language. I have two objections to the proposal.

Established precedents

I take it as axiomatic, that, wherever possible, computer programs should be fitted into the Copyright Act without modifying the language of the Act — then advantage can be taken of the established precedents. I see no objection to the use of the term "translation" to mean changing a program from one code or language to another. A translator converts a text from a form in which it is expressed according to one set of rules of grammar and syntax to a form in which it is expressed according to a different set of such rules. The last sentence defines precisely what is done in changing programs.

My second objection is to the use of the word "transmutation", which implies a change in the nature of a substance. Uranium is transmuted atomically into lead. The two substances are essentially different. The changed program should be essentially the same as the original.

Machine-readable

Next must be considered whether copyright subsists in computer programs expressed in machine-readable form. E P Skone-James in the 11th edition of Copinger and Skone-James on Copyright argues as follows:

Writing is defined by the Copyright Act as including any form of notation, whether by hand, printing, typewriting or any similar process. A literary work is defined as including any written table or compilation. From this and the precedents, he deduces that some form of notation is essential but that any form of notation is sufficient. Turning to the Shorter Oxford English Dictionary, he finds "notation" defined as "the process or method of representing numbers, quantities, etc., by a system of signs, and concludes "there seems no reason why ... punched cards, punched tapes, magnetic tapes and even magnetic cores should not be protectable as literary works".

The only weakness in the chain of reasoning is in the last link which relies on calling a magnetic disturbance of a magnetic medium, or a microscopically small connection in a read-only store — a sign. I have no doubt that a defendant faced with this argument will produce the

submission that a sign should be sensible to a human observer. Copyright subsists in Braille documents, which are essentially sensible by touch. It was this kind of difficulty that caused Kelman to initiate public discussion of the problem of computer programs and copyright, for which he is to be applauded.

If copyright does not subsist in computer programs expressed in insensible signs, there is an odd asymmetry in the Act. For it is undoubtedly true that reproducing a printed program on a magnetic medium is reproduction in a material form and requires authorisation. However, reproducing a program recorded on one magnetic disc on another disc does not require authorisation.

Printed copy

In practice, the problem is avoided by retaining a printed copy of the program. Disc-to-disc reproduction is as much a reproduction of the printed original as a direct copy would be.

The problems which arise in determining the ownership of copyright in the output of computer programs are interesting logical exercises. They do not, however, present any essential difficulties and can be solved using the principles as precedents established by the Copyright Act.

Is the protection afforded by the Copy-

right Act sufficient? The essential purpose of a computer program is not to provide a work of study or reference as would a book or compilation. It is to control the operation of a computer. The Act does not envisage a literary work as a tool.

Authorisation

A person may obtain a machine-readable copy of a program and use it, thus depriving the copyright owner of a return on his labour for that use. During execution of the program, each instruction is copied into computer storage. It can be argued that use necessarily involves reproduction in a material form and thus requires authorisation. Yet the reproduction is of so transient a nature that a court might feel it does not qualify as a reproduction at all.

This difficulty was recognised by the Whitford Committee, Stationery Office, 1977, Command 6732, which recommended that, for the avoidance of doubt, the storage of computer programs, or of any other copyright material, in a computer store should be a restricted act, i.e., an act requiring authorisation.

Restricted act

The Committee went on to consider whether use of a computer program should be a restricted act. A minority of

the Committee did not support the recommendation that this should be so.

There are two possible reasons for dissent with the recommendation. First, that it is unnecessary. Usage necessarily involves some kind of storage and thus involves a restricted act.

Second, that the concept of use of a literary work so modifies the philosophy of copyright as to change its nature. One has sympathy with these views while feeling that copyright has proved adaptable to modern technology in such fields as sound recordings and cinematograph films without losing sight of its essential character.

Postscript

Lawrence Perry died in August, 1980. It would have been uncharacteristic of him to reach this stage of an argument without having his conclusion clearly in mind. In essence, the question is whether this last extension of the restricted acts would stretch the links between Copyright Law and its philosophical foundations beyond breaking point, and perhaps unnecessarily.

After all, the author of a cookery book cannot reasonably expect a royalty each time a recipe is used. On the other hand, it does not seem unreasonable for the owner of a program to look to copyright to help obtain a fair return on its use.

Although I suspect I know the direction in which Lawrence Perry was moving, I shall not seek to articulate his conclusion for him. Rather, I shall enjoy, as I am sure he would have enjoyed, the discussion provoked by this and the other issues he addressed. Neil Killgren □

Mailing Floppy Disks?

Use Swan Disk Mailers — and get Safety in the Mail

Now used by over 1,000 computer companies, Swan Disk Mailers provide outstanding postal security at economical prices.

Combining great strength with simplicity of use, Swan Disk Mailers are manufactured from rigid white corrugated, holding up to four disks.

There are two sizes available: 8.75" X 8.75" & 6" X 6"



ring
01 609 1746
for Free samples
and prices

• Circle No. 171

Write off your Computer Supplies problem now.

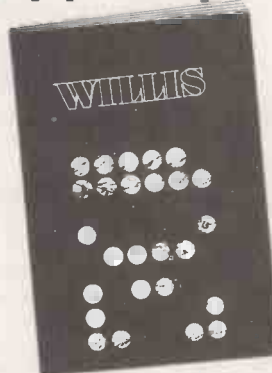

Flexible Disks
Digital Cassettes
Printwheels
Binders
Disk & Tape Storage
Magnetic Tape
Cartridges
Ribbons
Continuous Stationery
Filing Systems
Fire Resistant
Cabinets
Disk packs

Please send me your latest catalogue.

Name _____

Company _____

Address _____

PC 4/81

WILLIS
Computer Supplies
for people who know better

Post to: Willis Computer Supplies Limited, P.O. Box 10, Southmill Road, Bishop's Stortford, Herts CM23 3DN or Tel: Bishop's Stortford (0279) 506491.

• Circle No. 172

Step-by-step approach to programming fundamentals

THIS IS not yet another of those endless series of articles which promise to explain everything — next month. I believe there are many new and not-so-new micro owners who have been left behind. There are a mass of articles levelled at the middling-to-confident programmer. I don't criticise that, but they have left the breeding ground and are off over the hill. For the inexperienced, it is a confusing jungle and they are left in the dark — and are likely to stay there.

From now on, I will assume very little about you, except that you have the use of one of the many microprocessors running Microsoft or a similar Basic. As a word of encouragement, the only really bug-free program I have ever seen is:

10 NEW

That causes few problems and runs on just about all machines. Variables used are zero and you are always returned to the command (READY) mode when the run is complete. However, it brings me to a point on program differences between machines. My micro is a TRS-80 but I have the use of a Pet 2001 and an Ohio, and even on that small selection, there are a surprising number of differences, particularly with the graphics handling. So we will keep our Basic general and if I have to resort to a specialised type of command, I will provide the decode for other machines.

Correct alignment

This month's problem is: using only the following commands, Print/For-Next/If-Then/CLS (Cursor Home), print the numbers 1 to 100 in lines of 10 with all the 10s and units correctly aligned.

I have seen, quite literally, a 100 different ways of achieving that. Some are better than others — but they all work — and, to begin with, that is the most important thing. You probably do not know how to start. Well, let's go through it byte by byte. If I said to you — print the numbers 1 to 100 on the screen — there would be smoke drifting from the keyboard, as you typed:

- 10 CLS: 'The ':' is to indicate a REM(ARK) and is not run by the computer.
- 20 FOR X = 1 TO 100 : ' poor old X, always busy in a loop.
- 30 PRINT X : ' The X is not in quotes so the value will be printed.
- 40 NEXT X : ' It is not vital to add the loop variable to the 'NEXT' statement, but it can help.

Try adding either a comma or semicolon to the end of the print statement in line 30. You will find that if there is no print limiter, the numbers will all be printed down the left-hand side of the

screen. The reason for this apparently perverse piece of behaviour is that in the absence of any command to do otherwise, the cursor will always return to the beginning of the next line.

The simple, but much misused, semicolon and comma are known as print limiters, because they limit the movement of the print cursor. The semicolon holds it at the next available print position and the comma usually allows the cursor to advance to the next screen tabulator — just like a typewriter's tabulator function — except the computer screen tabulators are pre-set.

So you have now managed to arrange the numbers 1 to 100 in two shabby-looking lines across the screen. We now

by Ken Smith

need to arrange them into lines of 10. If they were, what would the numbers on the right-hand side of the screen be?

If you didn't say — 10/20/30/40/50/60/70/80/90/100, you should re-learn your 10 times table. So what is special about those numbers? They are all multiples of 10. Put another way — when you divide them by 10 you always obtain an integer result — integers are whole numbers. 1 is an integer but 1.5 and 3.764 are not.

Well, perhaps we can exploit that fact to help use with our problem. Micros, unless you specify otherwise, will usually perform what is known as single-precision arithmetic. That is, they will always work to around seven digits of accuracy. Thus, if you ask the machine for the answer to 23/10 you will always obtain the answer 2.3 — trailing zeros are not displayed. Now ask for the integer answer to that sum. Type:

```
PRINT INT(23/10)
```

You should now have the answer 2.

So, when will the machine generate identical answers to the problems X/10 and INT(X/10)? Only when X is an exact multiple of 10. Now, we are making progress. We have found a method of making the computer recognise when X is the correct value to start another line. How do we start another line? It couldn't be simpler — just tell it to print and leave out

the print limiter. So we can add another line to our program.

```
35 IF X/10 = INT(X/10) THEN PRINT
```

Now run that. Isn't programming easy? Just look at those numbers lining up in lines of 10 — if yours didn't, you have forgotten the semicolon on the end of the print statement on line 30.

My screen display still looks rather tatty. None of the 10s and units lines up, and the lines are of unequal length. What can be done? Once again, let us resort to English.

It is perhaps a good time to introduce Ken's rules. They are a selection of sayings/proverbs/nonsenses, etc. which have been stolen/invented/dreamed and which I have plastered all over the wall above my VDU. They are a source of great inspiration and provide something to read when I am completely stuck.

KROT # 1 = if it will not code in Basic — try English.

Minor detour

After that little excursion from the main event, your brains should have had time to unwind. The problem is that the top line contains too few digits. We need to insert either a leading space or 0 when there is only one digit to print. So in English, if there is only a single digit, insert a leading blank. Now expressed that way the required basic code is easy:

```
25 IF X < 10 THEN PRINT " ";
```

Note that we need this line to operate before the main print sequence, otherwise the leading blanks would end up as trailing. I hope that an explanation of the semicolon is not required by now. Now the 100 is sticking out a little — a small amount of tidying is needed. I will let you work out that one for yourselves.

For something to while away the long nights, try the same problem with the numbers 1 to 64 in lines of eight and use leading zeros to format the screen neatly. TRS-80 owners may like to key the following. Other micro owners will need a little thought before they attempt it.

Here is the listing for mousetrap — my compliments to a Leeds school and an unnamed pupil.

```
10 CLS:PRINT@10,CHR$(23):"***** MOUSETRAP *****"  
15 FOR I=1 TO 1000:NEXT I  
16 PRINT@896,"DO YOU WANT INSTRUCTIONS?"  
20 M$=INKEY$:IF M$=""THEN20  
30 IF M$="Y" GOSUB 370 ELSE IF M$<>"N" THEN 16  
40 DEFINT A-Z:W=9999
```



```

50 R=0:CLS:V=0: FOR X=0 TO 127:SET(X,0):SET(X,47):NEXT X
60 FOR Y=0 TO 47:SET(0,Y):SET(127,Y):NEXT Y
70 FOR X=0 TO 8:SET(X,5):NEXT X
80 X=RND(126):Y=RND(46):A=1:B=1:M=RND(126):N=RND(46)
:SET(M,N):Z=126:D=46
90 P=X:Q=Y
100 IF X>9 OR Y>5 THEN J=0 ELSE J=J+1:IF J=25 THEN 280
110 G=PEEK(14400):IF G AND 121 THEN 220
120 V=V+1:PRINT@120;V:SET(X,Y):IF POINT(X+A,Y+B) THEN 130 ELSE
X=X+A:Y=Y+B:RESET(P,Q):SET(X,Y):GOTO90
130 A1=A:A2=B:RESET(X,Y):IF POINT(X,Y+B) THEN B=-B
140 IF POINT(X+A,Y) THEN A=-A
150 IF NOT POINT(X+A,Y+B) THEN 100
160 A=-A1:B=-A2:IF NOT POINT(X+A,Y+B) THEN 100
170 A=A1:B=A2:IF NOT POINT(X+A,Y) THEN X=X+A:GOTO100
180 IF NOT POINT(X,Y+B) THEN Y=Y+B:GOTO100
190 IF NOT POINT(X-A,Y) THEN X=X-A:GOTO100
200 IF NOT POINT(X,Y-B) THEN Y=Y-B:GOTO100
210 R=1:GOTO280
220 IF G AND 64 THEN IF M<Z THEN M=M+1:SET(M,N):GOTO260
230 IF G AND 16 THEN IF N<D THEN N=N+1:SET(M,N):GOTO260
240 IF G AND 8 THEN IF N>1 THEN N=N-1:SET(M,N):GOTO260
250 IF G AND 32 THEN IF M>1 THEN M=M-1:SET(M,N)
260 IF G AND 128 THEN RESET(M,N)
270 GOTO120
280 FOR B=1 TO 8
290 PRINT@800,"--GAME OVER--":FOR X=1 TO 200:NEXT X
300 PRINT@801," ";:FOR X=1 TO 200:NEXT X:NEXT B
310 CLS:PRINT@10,CHR$(23);"***** MOUSE TRAP *****";
320 IF R=1 THEN PRINT@132,"BOUNCING DOT COULD NOT MOVE! -2000
PTS PENALTY":V=V+2000
330 PRINT@458,"YOUR SCORE";V:PRINT@522,"BEST SCORE";
340 IF V<W PRINT" YOURS":W=V ELSE PRINTW;
350 PRINT@980,"PRESS ENTER TO CONTINUE"
360 IF PEEK(14400) AND 1 THEN 50 ELSE 360
370 CLS:PRINT@21,"***** MOUSE TRAP *****":PRINT
380 PRINT"THE OBJECT OF THE GAME IS TO TRAP THE BOUNCING DOT
IN THE TOP LEFT HAND CORNER OF THE SCREEN"
390 PRINT"IF THE DOT HITS A WHITE LINE IT WILL BOUNCE
OFF IT. TO DRAW THE LINES USE THE FOUR KEYS MARKE
D [":CHR$(92):CHR$(93):CHR$(94);
400 PRINT"THESE KEYS WILL DRAW A LINE IN THE DIRECTION
INDICATED ON THE KEYS"
410 PRINT"IF THE DOT CANNOT MOVE THE GAME WILL END AND YOU
WILL RECEIVE A PENALTY OF 2000 POINTS. "
420 PRINT"TO ERASE A LINE OR MOVE WITHOUT DRAWING A LINE HOLD
DOWN THE SPACE BAR & AT THE SAME TIME PRESS THE
APPROPRIATE ARROW KEY. "
430 PRINT"THE STATIONARY DOT WHICH APPEARS IN A RANDOM PLACE
ON THE SCREEN AT THE START OF PLAY INDICATES THE STARTING
POSITION OF YOUR LINE. "
440 PRINT@980,"PRESS ENTER TO PLAY";
450 IF PEEK(14400) AND 1 THEN RETURN ELSE 450

```

Microcomputers for every type of business.

INTERNATIONAL MICROCOMPUTER EXHIBITION with Associated Seminars.



Wembley Conference Centre, London.

The huge success of the 1980 show with visitors packing the exhibition over 3 days has created an early demand for exhibition space; consequently, twice the exhibition area has been made available for the next show. As the number of overseas visitors is likely to be even higher for the 1981 event, there will be a keen awareness of the needs of buyers from abroad, as well as the current trends within the UK market.

Exhibition space is being taken very quickly — exhibitors are advised to contact Jane Windeler at the Online offices, who will make a provisional booking awaiting your written confirmation.

This was a very professionally handled and managed event and I was extremely pleased with the turn-out.

J. D. Hartmann, Manager, Customer Services Dept., Tandy Corporation.

We were not only delighted with the large numbers that attended the Show, but also with the quality of the visitors, which has generated a lot of new business for our company.

Colin Stanley, Joint Managing Director, H B Computers.



The customers we met at the Show had the highest level of appreciation and expertise on microcomputing that we have yet encountered.

Tim Moore, General Manager, Newbury Laboratories.

For further information, exhibitors may send their business cards to:
**Online Conferences Limited,
Argyle House, Northwood Hills,
Middlesex, HA6 1TS, England.
Tel: (09274) 28211. Telex: 923498**



• Circle No. 173

Labour-saving solution

JERRY HUDSON'S piece — January 1981 — giving a machine-language method of defining inverse-field characters for the Sorcerer, states that this facility "can be achieved ... by laboriously defining each user-defined key with its inverse field counterpart". I suggest that the following Basic solution is far from laborious, and is more easily integrated into a Basic program writes Tom Baldwin of Le Chesnay, France.

To invert the standard graphics on the user-defined graphics keys:

```
10 FOR I = -1024 TO -513:POKE I + 512, 255-PEEK(I):NEXT
```

To invert the upper-case alphabet on the user-defined graphics keys:

```
10 A$ = "A*B*C*D*E*F*G*H*I*J*K*L*M*
N*O*P*Q*R*S*T*U*V*W*X*Y*Z*"
20 FOR I = 1 TO LEN(A$) - 1 STEP 2
30 A = ASC(MID$(A$, I + 1)) * 8 - 2048 :
B = ASC(MID$(A$, I)) * 8 - 2048
40 FOR J = 0 TO 7 : POKE A + J, 255 - PEEK
(B + J) : NEXT : NEXT
```

A word of explanation: the string A\$ consists of pairs of characters. The first of each pair is the character to be inverted, the second to each pair — * in the example — is the graphic character which will display the inverted character. This method is very flexible. A\$ can be filled with any combination of characters to give any inverted character on any key.

A further example — to invert the digits 0 to 9:

```
10 A$ = "0*1*2*3*4*5*6*7*8*9"
```

Shorter converter

I WAS reading the January 1981 issue of *Practical Computing* when I discovered the Decimal to Hex converter on page 114, writes Roger Moffatt of Belfast.

I would like to submit this much shorter version which was written for a RML 380-Z, and should run on any machine with good string handling.

```
999 REM***DECIMAL TO HEX SUB-
ROUTINE BY R.MOFFATT
1000 FOR N = 1 TO 4
1010 H = D - 16 * INT(D/16)
1020 D = INT(D/16)
1030 HEX$ = MID$( "0123456789ABCDEF
", H + 1, 1)
1040 TOTAL$ = HEX$ + TOTAL$
1050 NEXT N
1060 RETURN
```

In the subroutine the decimal number to be converted is put into D before the routine is called; the result is outputted in TOTAL\$, e.g.,

```
10 INPUT "DECIMAL NUMBER TO BE
CONVERTED (0-65535)";D
```

For all users of systems based on the Z-80 chip, Z-80 Zodiac offers an opportunity to have programs and ideas published. We pay at least £5 for each contribution used.

```
20 GOSUB 1000
30 PRINT "HEX EQUIVALENT IS...";
TOTAL$
40 END
```

Multiplication routine

FOLLOWING the note from Dominic Dunlop, January 1981, I developed this multiplication routine, writes G A Wooster of Cambridge. It takes an unsigned 16-bit number in the BC register-pair and multiplies it by an eight-bit unsigned number in the A register. The 24-bit product is left in H,L&D; the carry problem is avoided. The listing is at the foot of this page.

Using ZEAP 1.1 on my Nascom 2, I cannot assemble listings containing relative jumps to a named routine as shown in Dunlop's program. Am I doing something wrongly or is the ZEAP incomplete? For example, if in line 90 of my program, JR NC SHIFT is written, it gives "Error 23" "Truncation Error" or assembly.

Automatic pilot

IF YOU have ever wanted to switch-on your computer, press the cassette-play button and let the machine continue by itself, assuming you do not have a disc drive, then this is the program for you writes L D Howe of Bristol.

More realistically, it allows any beginner to operate the computer, for instance, to run a games or teaching program, unsupervised and without first learning the commands and other details necessary to have the program up and running from switch-on.

It can be incorporated within any other program by starting the main program at line 1000. The whole program is then saved by typing 'RUN', starting the cassette recorder, in record mode, and then hitting return.

On completion, the VDU announces, "Break in 240", the recording is then stopped. The program records on to the tape, not only the file itself, but also the commands necessary to initialise the computer, load the file and run the program, starting at line 1000. The only instructions

that have to be given to a complete beginner are to switch-on and press the cassette play button.

The program can then give any other instructions necessary as and when they are required. Of course, the computer must be able to accept a tape input on switch-on for the program to work.

The program is written in Nascom ROM Basic, version 4.7, a dialect of Microsoft, and runs on a Nascom 2, using the Nas-Sys 1 monitor. As written, it occupies less than 800 bytes. Table 1 lists the variables used and table 2 the routine/subroutine index of first lines.

PR\$ is included to ensure that each command starts a new line, allowing sufficient time for a return to be executed and any error messages etc. The following notes on the listing will be helpful, particularly to those with other types of machine.

10 — string space of 100 characters is sufficient.

20 — allows variables to be dimensioned, unnecessary here, but good practice after CLEAR.

110 — 'J' is the Nas-Sys command for a Basic cold-start. If your machine cold-starts in Basic on switch-on, then lines 110-120 may be omitted.

140 — extra delay to allow the machine to reach Basic command level.

170 — the file identity, "A", may be changed or omitted, but if included, it must match line 190.

600 — sends the decimal number 13, ASCII code for RETURN, to port 1.

Different machines use differing instructions for this operation.

610 — delay suitable for 1,200 baud operation with a 4MHz clock. Adjust to suit your system, e.g., — 300 baud/2MHz — FOR I = 0 TO 800.

830 — see 600, but substitute X for 13.

840 — see 610.

1000 — this sets the print-head to column 20, line 7. Other machines use different commands for this.

1040 — clears screen. PRINT CHR\$(12) works here on most machines.

1050 — in a real program, this would be the start.

(continued on next page)

Multiplication routine		IC1A CB3F 0080 LOOP2		SRL A ;
IC0B 3E64 0010	LD A 100 ; MULTIPLIER	IC1C D2201C 0090	JP NC SHIFT ; TEST LSB	
IC0D 011027 0020	LD BC 10000 ; MULTIPLI-			
	CAND	IC1F 09 0100	ADD HL BC ; AND IF	
IC10 CD141C 0030	CALL DBMULT ; DOUBLE			
	BYTE MULTIPLY	IC20 CB1C 0110 SHIFT	RR H ; MOVE	
IC13 E7 0040	RST #20 ; TO DISPLAY			
	RESULT (ON NASCOM)	IC22 CB1D 0120	RR L ; RIGHT IN	
IC14 210000 0050 DBMULT	LD HL 0 ; ZERO			
	REGISTERS (WITH NASSYS)	IC24 CB1A 0130	RR D ; NEXT LOOP	
IC17 54 0060	LD DH ;	IC26 1D 0140	DEC E	
IC18 1E08 0070	LD E 8 ; SET NUMBER	IC27 C21A1C 0150	JP NZ LOOP2 ; LAST TIME?	
	OF LOOPS	IC2A C9 0160	RET	

(continued from previous page)

Lines 1000 — 1040 are just one simple method of instruction the operator.

Table 1 — variables used.

OP\$ — output string for writing to tape.
 PR\$ — pre-string header.
 PP\$ — clear screen string.
 X — numerical value of current character being written.
 I, J — loop counters.

Table 2. Routines/subroutines.

10 — initialisation.
 100 — dump; saves the file and commands.
 400 — set variables.
 600 — return and delay: prints 'RETURN' and allows time to process this.
 700 — output string and clear screen.
 800 — output string: writes command to tape.

```

9 REM *** program name ***
10 CLEAR 100
20 RUN 100
99 REM *** dump ***
100 GOSUB 400
110 OP$ = "J"
120 GOSUB 800
130 GOSUB 600
140 GOSUB 600
150 OP$ = CHR$(0)
160 GOSUB 700
170 OP$ = "CLOAD" + CHR$(34) +
    "A" + CHR$(34)
180 GOSUB 700
190 CSAVE "A"
200 OP$ = PP$
210 GOSUB 700
220 OP$ = "RUN 1000"
230 GOSUB 700
240 STOP
399 REM *** set variables ***
400 PR$ = CHR$(13)
410 FOR I = 1 TO 8
420 PR$ = PR$ + CHR$(0)
430 NEXT
440 PP$ = CHR$(12)
450 RETURN
599 REM *** return & delay ***
600 OUT 1,13
610 FOR I = 0 TO 400
620 NEXT
630 RETURN
699 REM *** O/P & CLS ***
700 GOSUB 800
710 OP$ = PP$
720 GOSUB 800
730 RETURN
799 REM *** output string ***
800 OP$ = PR$ + OP$
810 FOR I = 1 TO LEN(OP$)
820 X = ASC(MID$(OP$,I))
830 OUT I,X
840 FOR J = 0 TO 10
850 NEXT
860 NEXT
870 GOSUB 600
880 RETURN
999 REM *** main program ***
1000 SCREEN 20,7
1010 PRINT "Stop tape."
1020 FOR I = 0 TO 5000
1030 NEXT
1040 CLS
1050 END
    
```

Ticker tape

I HAVE been working on a control and display problem, writes Jeff Tock of Bishop Auckland, County Durham. In the course of that work, I wrote a little program to display some information ticker-tape style, i.e., with the string of characters apparently moving on a closed, endless track.

The program is for a Nascom 2 and the program will obviously translate easily to other equipment with memory-mapped displays. To save memory space in working programs, I do not document sub-

routines, relying on the filed sample routine being available.

Here is also a dump of the machine-code routine which was generated by the Poke and Doke instructions.

```

20 REM 'TICKER TAPE'
30 REM routine for T.U. display
40 REM NASCOM 2
60 REM J.TOCK 29/12/80
110 REM demonstration program
120 REM using ticker tape routine
140 PRINT CHR$(12):REM clear screen
141 C=17:REM set column
142 R=4:REM set row
150 PRINT "Input a string of characters"
160 INPUT "of your choice":N$
170 SCREEN C,R
171 PRINT N$
172 GOSUB 200
173 GOSUB 500
180 Z=USR(0)
190 GOTO 180:REM infinite loop
200 L=1993+C+(64*):REM calc. memory location
210 R=L+LEN(N$):REM take length into account
220 S=200:REM controls speed
230 RETURN
510 REM USRLOC address
530 DOKE 4100,3200
910 REM USR routine
1000 POKE 3200,33
1010 DOKE 3201,L
1020 DOKE 3203,12926
1030 DOKE 3205,3237
1040 POKE 3207,14
1050 POKE 3208,(R-L)
1060 DOKE 3209,32291
1070 DOKE 3211,30507
1080 DOKE 3213,8995
1090 DOKE 3215,-15859
1100 DOKE 3217,3210
1110 DOKE 3219,-23238
1120 DOKE 3221,11020
1130 POKE 3223,119
1140 POKE 3224,6
1150 POKE 3225,8
1160 POKE 3226,14
1170 POKE 3227,8
1180 DOKE 3228,-15859
1190 DOKE 3230,3228
1200 DOKE 3232,-15867
1210 DOKE 3234,3226
1220 POKE 3236,201
1230 RETURN
1300 REM T 0080 00A5
1310 REM 0080 21 DA 08 7E 32 A5 00 0E
1311 REM 0088 06 23 7E 2B 77 23 23 00
1312 REM 0090 C2 8A 0C 3A A5 0C 2B 77
1313 REM 0098 06 C8 0E C8 0D C2 9C 0C
1314 REM 00A0 05 C2 9A 0C C9 20 00 00
    
```

Making music

THIS PROGRAM allows the user to produce music using the ZX-80, writes David Harris of Pinner, Middlesex. There is no need for any extra hardware as the sound can be amplified by plugging a cassette recorder or amplifier into the SAVE socket. Users will be familiar with the supercharged bumble-bee sound programs make. That can be organised by a machine-code routine to produce a steady note.

The subroutine listed must be GOSUBed at the very first line of your program. Any time after that, two pieces of information need to be provided before the machine code which has been set-up can be used. The first is the number of cycles the note lasts. The bigger the number, the longer the note lasts.

The second is a delay between each peak of the wave. The bigger that is, the longer the wave length, the longer the time between peaks and the lower the pitch of the note. The program is capable of playing a limitless number of notes one after another. It is possible to make it play one note, return to Basic, set-up another note and return to the machine-code routine. However, the long time taken by Basic produces a click and sounds terrible. Therefore, many notes can be placed one after the other in the array B as follows.

```
B(0) Length of first note
B(1) Frequency of first note
B(2) Length of second note
B(3) Frequency of second note
...
```

B(n) Dummy length of 0 to terminate routine
B should be DIMensioned at line 1010 to accept the maximum number of notes you will put in it. Remember the dummy last note when you do it.

As a rough guide, frequency of 255 gives a real frequency of 500Hertz. Be careful not to make the length 0 or very high as you will have to wait a long time — the routine cannot be stopped by BREAK.

I have found that if the television is plugged-in, there is a loud humming on top of the music. If you have that problem, it can be cured by half pulling-out the connection at the back of the computer, so that the signal line is connected but the screening is not.

The Basic routine at 1000 returns the address to use in the USR command in P. Therefore, to produce a note, use the command USR(P) as shown. Here is the routine to include in your program and call on the first line:

```
1000 DIM A(23)
1010 DIM B(However much you need)
1020 LET P=2+PEEK(16392)+PEEK
(16393)*256
1030 LET A(0)=2090
1040 LET A(1)=4416
1050 LET A(2)=26
1060 LET A(3)=6425
1070 LET A(4)=6891
1080 LET A(5)=4975
1090 LET A(6)=26394
1100 LET A(7)=-14155
1110 LET A(8)=6675
```

```
1120 LET A(9)=7730
1130 LET A(10)=4928
1140 LET A(11)=12826
1150 LET A(12)=16415
1160 LET A(13)=-194
1170 LET A(14)=-45
1180 LET A(15)=19437
1190 LET A(16)=16414
1200 LET A(17)=30731
1210 LET A(18)=8369
1220 LET A(19)=11259
1230 LET A(20)=-19076
1240 LET A(21)=-4064
1250 LET A(22)=6163
1260 LET A(23)=218
1270 RETURN
```

Here is an example to produce two different notes:

```
10 GOSUB 1000
20 LET B(0)=255 ; Length first note
30 LET B(1)=100 ; Frequency, reasonably
high
40 LET B(2)=1000 ; Length of second note
50 LET B(3)=200 ; Frequency of second
note — lower than first
60 LET B(4)=0 ; Dummy to return to
Basic
70 LET Z=USR(P); Call routine — Z is not
used but makes the
syntax correct
80 GO TO 70 ; Repeat
```

Simpler inverse graphics

AN EASY method for obtaining inverse graphics or text in print statements has been written by David Bailey of Leeds, West Yorkshire. It is quite simple, he writes, and slightly less tedious to enter than the method given in February 1981 by Richard Wildash.

```
10 PRINT "ANY TEXT GRAPHICS OR
SPACES" rest of program
999 STOP
1000 FOR A = 16428 TO 16454
1010 POKE A,PEEK(A)+128
1020 NEXT A
```

Run the program by RUN 1000. That should result in a blank screen with 0/1020. If the listing is returned to the screen the text in line 10 will be in inverse characters.

The routine can be easily modified to cope with longer print statements by counting the number of characters and spaces between the quotes in the print statement and extending the FOR — NEXT loop to suit. Remember that 16428 is the location in RAM of the first character after the quote in the print statement.

The print statement to be modified must always be the first line in the program but, of course, by editing, the whole line can be re-numbered and the whole line or parts of it can be used elsewhere in the program. After use, lines 1000 to 1020 should be deleted.

Cricket computer

WHEN YOU run this cricket program, the computer tells you the name of the game and who is battling, writes Sean Clark of Wormshill, Kent. You tell it to bowl by pressing New line. By this time, the computer has prepared your score and decided how many runs you are going to have this bowl. It is now waiting for an input (A\$).

When you press New-line, the screen



will go blank for a certain length of time — while the computer goes through loop D. When the screen goes back on, nothing will appear to have changed but you are being timed.

You must wait about one second before pressing New-line. If you wait more than 1.3 seconds, you will automatically be out. If you take between 0.9 and 0.8, you will win two runs, if you take between 0.8 and 0.7, you will hit 1 run and if you take less than 0.7, you will win no runs.

If you have been caught or stumped, you will obviously be out. The computer will tell you how many runs you have unless you were out — in which case it will have told you — and your score. Again it is waiting for an input (A\$).

If you are still in, it will return to the beginning. On that input, you may also retire by pressing S and New-line. If you are out, the computer will tell you that it is batting, and ask you to bowl. When you press New-line the computer goes through loop F, and tells you the result of the game.

```
5 REM CRICKET
10 PRINT "THIS IS CRICKET."
20 PRINT
30 PRINT
40 LET V=0
50 LET I$="FOR ME"
60 LET H$="YOU ARE"
70 LET Z=-1
80 LET X=RND(8)
90 PRINT H$;"IN BAT"
100 PRINT "PRESS NL.":I$;"TO BOWL"
110 INPUT A$
120 IF Z>-1 THEN GOTO 600
130 FOR D=1 TO RND(2000)
140 NEXT D
150 POKE 16414,0
160 POKE 16415,0
170 INPUT A$
180 CLS
190 LET A=PEEK(16414)
200 LET B=PEEK(16415)
210 LET C=(B*256+A-4)*20
220 IF C>1300 THEN GOTO 500
230 IF X>6 THEN GOTO 500
240 IF C<900 THEN LET X=2
250 IF C<800 THEN LET X=1
260 IF C<700 THEN LET X=0
270 PRINT X;"RUNS"
```

(continued on next page)

(continued from previous page)

```

280 LET Y=Y+X
300 GOTO 550
500 PRINT "YOU'RE OUT."
510 LET H$="I AM"
520 LET I$=""
530 LET Z=Z+1
550 PRINT "SCORE: ";Y
560 INPUT A$
570 IF A$="S" THEN GOTO 510
580 IF H$="I AM" THEN GOTO 90
590 GOTO 80
600 FOR F=1 TO 100
610 LET G=RND(?)
620 IF G=7 THEN GOTO 645
630 LET Z=Z+G
640 NEXT F
645 CLS
646 IF Z>Y THEN LET J$="I WIN"
647 IF Z=Y THEN LET J$="A DRAW"
650 IF Z<Y THEN LET J$="YOU WIN"
660 PRINT "I HAVE";Z;"RUNS"
670 PRINT "YOU HAVE";Y;"RUNS"
680 PRINT J$
    
```

Task master

THIS program gives a test on any information, such as French verbs, vocabulary, historical dates, multiplication tables, etc., which can be set out in two parallel columns, writes D M Bennion of Wolsey Bridge near Stafford.

It achieves considerable economy by using dummy string variables, which are POKEd to their correct values. Taking as an example the French prepositions *de*, *of*, *par*, *by*, *sous*, *under*, *sur*, *on*, *avant*, *before*, the program works like this:

On being RUN, it asks first for the number of entries, in this case 10. The words are then typed in the order shown. The screen then displays the words in two columns. Type a number, and the computer gives a test, choosing words from the first column at random — but choosing each only once.

A correct answer gives the response right, a wrong one, try again. If a second wrong answer is given, the correct answer is displayed. At the end, a score is given. The test can be saved on tape, and started again by GOTO 20.

Even in 1K of RAM, a reasonable amount of space is available for data. About 185 characters can be typed in 12 entries, decreasing by about six per two extra entries, to about 150 in 24 entries.

If the shorter version of lines 45 to 64 is used, those figures are increased by about 25. Should the screen not show all the data, space may be made for about 50 more letters in the following way. Delete lines 1 to 14, correct line 22 to 'PRINT A\$;' and subtract 104 from each of the addresses in lines 24, 25, 28, 45, 46 and 47.

The resulting program can be saved in the normal way, but must always be started by GO TO 20, never RUN. The program must be entered exactly as listed.

```

1 PRINT "NO OF ENTRIES"
2 INPUT E
3 IF E > 24 THEN GO TO 2
4 DIM U(E/2)
5 CLS
10 FOR J=1 TO E
11 INPUT A$
12 POKE 16485, PEEK(16485)+1
13 NEXT J
14 POKE 16485, 38
20 FOR J=1 TO E/2
    
```

```

21 LET U(J)=1
22 PRINT A$;
23 LET P=PEEK(16552)
24 POKE 16552, P+2
25 POKE 16606, P+1
26 PRINT " ";A$
27 NEXT J
28 POKE 16552, 38
30 INPUT Z
31 LET N=0
32 LET R=0
40 CLS
41 LET Q=RND(E/2)*2-1
42 IF U(Q/2+1)≠0 THEN GO TO 41
43 LET U(Q/2+1)=0
44 LET N=N+1
45 POKE 16766, Q+37
46 POKE 16787, Q+38
47 POKE 16821, Q+38
48 LET T=0
49 PRINT N;" ";A$
50 INPUT Y$
51 PRINT Y$
52 IF Y$=A$ THEN GO TO 59
53 IF T=0 THEN GO TO 56
54 PRINT "NO,IT WAS ";A$
55 GO TO 61
56 PRINT "TRY AGAIN"
57 LET T=1
58 GO TO 50
59 PRINT "RIGHT"
60 LET R=R+1
61 INPUT Z$
62 IF N=E/2 THEN GO TO 64
63 GO TO 40
64 PRINT R;" OUT OF ";N
    
```

Here is an alternative version of lines 45 to 64, allowing no second attempt at a wrong answer.

```

45 POKE 16759, Q+37
46 POKE 16780, Q+38
47 POKE 16803, Q+38
Omit lines 48, 53, 56, 57, and 58 from the program.
    
```

If space for data is not at a premium, some lines might be added to give an opinion of the score, such as:

```

65 IF R=N THEN PRINT "EXCELLENT"
66 IF R<N AND R>N-3 THEN PRINT "VERY GOOD"
67 IF R<N-2 AND R>N/2 THEN PRINT "NOT BAD"
    
```

I have not included them, because individual opinions of what is good, bad, or indifferent will vary. Their inclusion does not affect any of the addresses PEEKed or POKEd in the main program.

Free movement

AS ON the ZX-80 you cannot move anything, this program enables you to move in any direction and print anything you wish, writes M Dhanda of Slough, Berkshire. First, type-in the direction. They are marked over 5,6,7 and 8.

You do not have to shift and then press those letters — just type 5 for left, 6 for down, 7 for up and 8 for right. Then you type in the code number. This could be any code number which is for graphics.

```

10 LET A=8
20 LET B=1
30 LET W=0
40 LET H=0
50 LET P=0
60 FOR N=1 TO 512
70 PRINT CHR$(128)
80 NEXT N
90 GOSUB 280
100 POKE W+232, 20
110 INPUT C
120 IF C=-1 THEN GOTO 320
130 INPUT D
140 GOSUB 280
150 LET H=W+(A-1)*33+B
160 POKE H,D
170 IF C=6 AND A<11 OR C=7 AND A>1 THEN LET A=A+2*C+13
180 IF C=8 THEN LET B=B+1
190 IF C=5 THEN LET B=B-1
200 LET H=W+(A-1)*33+B
210 POKE H,20
220 IF B=32 THEN GOTO 240
230 GOTO 110
240 PRINT "DO YOU WANT ANOTHER GO?"
    
```

```

250 INPUT A$
260 IF A$="YES" THEN GOTO 10
270 STOP
280 LET P=PEEK(16397)
290 IF P>127 THEN LET P=P-256
300 LET W=PEEK(16396)+P*256
310 RETURN
320 CLEAR
330 LIST
340 STOP
    
```

Useful oddity

I FEEL that the following oddity might be of some interest to ZX-80 users, writes S McCallum of Watford, Hertfordshire. I discovered that the statement:

LET X=Y=Z

was accepted, as long as Y and Z — which can be expressions, too — had been previously defined. The interesting feature is that the value assigned to X by the expression is:

-1 if Y=Z

and

0 if Y≠Z

i.e., X could then be used in a Boolean-type expression, e.g., if X then goto 1000. Taking the case one step further, I discovered that the statement

LET X=Y=Z=A

was also accepted as a valid statement as long as Y, Z and A were defined previously. However, this time, the values assigned to X are:

-1 if Y=Z AND A=-1

or if Y≠Z and A=0

and 0 if Y=Z AND A≠-1

or if Y≠Z AND A≠0

i.e., A could be a control switch. Again, expressions can be substituted for Y and Z — and A.

Running percentage

ANDREW JONES of Loughborough, Leicestershire has sent us some additions to the program, ZX-80 as a mathematician contributed by Dave Sampson, December 1980. It allows a running percentage to be kept as the program proceeds and allows for an adjustment of difficulty for all ages, he writes.

92 PRINT "HARDNESS 1 TO 10"

94 INPUT E

96 CLS

100 LET R=RND(40*E)-(30*(10*E))

290 PRINT "SCORE = ";(W*100)/X;

"PERCENT"

310 DELETE

I would like to submit a pattern-generation program similar to that seen in the ZX-80 brochure. It will fit easily on to the 1K model:

```

10 PRINT "PATTERN GENERATION BY
ANDREW JONES 10/12/80"
20 LET Z=RND(5)
30 IF Z=1 THEN PRINT "THIRTY TWO
DIFFERENT GRAPHIC SYMBOLS"
40 IF Z=2 THEN PRINT "ANOTHER
THIRTY TWO DIFFERENT SYMBOLS"
50 IF Z=3 THEN PRINT "ANOTHER
THIRTY TWO DIFFERENT SYMBOLS"
60 IF Z=4 THEN PRINT "ANOTHER
THIRTY TWO DIFFERENT SYMBOLS"
70 IF Z=5 THEN PRINT "ANOTHER
THIRTY TWO DIFFERENT SYMBOLS"
80 GO TO 20
90 STOP
    
```

It is also possible to use numbers and letters instead of graphic symbols. If letters are used, it is possible to produce hidden words which must be found, and similarly with numbers.

New-found characters

THOSE WHO have had the lower-case modification installed by Tandy may be interested by the following, writes James Bamber of Doncaster, South Yorkshire. First type in the following program, which runs with or without the upper- lower-case driver program loaded.

```
10 CLS
20 DATA 96, 123, 124, 125, 126, 127
30 A = 15371
40 FOR B = 1 TO 6
50 READ C
60 PRINT "CODE"; C; "="; POKE A,C
70 A = A + 64
80 NEXT
```

You should see on the VDU screen six characters which are not on the keyboard — the most useful is the £. Not only are they not available via the keyboard but they cannot be accessed by using CHR\$ — try it.

To make use of our new-found characters we first have to find the video memory address of the cursor. That is stored in bytes 16416, least significant byte, and 16417, most significant byte.

By converting these bytes from Hex to a single decimal number, we arrive at the address of the cursor. The rest is easy; move the cursor forward a space out of the way, and then poke the code number of the character required into the address we have found.

This subroutine should do the trick.

```
1000 END
1010 REM *SPECIAL CHARACTER POKE
SUBROUTINE
1020 REM *USES Q1 INTERNALLY —
INPUT Q
1030 Q1 = PEEK(16417) * 256 + PEEK
(16416)
1040 PRINT "1 space";
1050 POKE Q1, Q
1060 RETURN

1030 'FINDS CURSOR AND CONVERTS
TO DECIMAL
1040 'MOVES CURSOR ONE SPACE
1050 'PRINTS CHARACTER
```

To use, initialise variable Q with the code number of the character required. Early in the program, if only one character such as £ is to be used, at the point of use, several characters will be called. Then GOSUB when required, e.g.,

```
10 PRINT "This year's profits are "; Q = 96
: GOSUB 1030 : PRINT "100,000. But
are expected to fall next year by about "
: GOSUB 1030 : PRINT "10,000, owing
to the recession."
```

Trial and error

AS A NEW user of the Aculab floppy tape unit, I found I could not use the Tandy re-number program for programs loaded from the unit writes P Errington of Cardiff. Having little knowledge of systems tapes and much less about the machine language involved, it took me some time to think through the problem.

Eventually, after reading the Aculab manual again, I realised that the start address for programs would be altered as the Aculab occupies some of the TRS-80 memory. The manual showed that the

TANDY FORUM is devoted to the Tandy TRS-80. Sometimes we will use it to pass on news about the TRS-80 but, above all, it is for users, and would-be users, of the well-established model I and now the new model II. With your tips, queries, moans and comments, this page can become a market-place for TRS-80 information.

new start number was decimal 18437 or 4801H compared to the normal start number of decimal 17129 or 42E9H.

I then devised a short program to Peek the contents of locations 31820 to 32766, which is where the re-number routine is stored, to find those locations which contained the elements of the old start address — the equivalent decimal numbers of 42E9 are 66 and 233.

The short program prints-out those locations where those two numbers are in adjacent locations and also showed me which of the two elements was contained in the lower location number.

```
10 FOR X = 31820 TO 32766
20 IF PEEK (X) = 66 THEN PRINT X,
PEEK (X), PEEK (X + 1), PEEK (X - 1)
30 NEXT
```

The program showed that the two bytes of the start address are stored at location numbers 31909, 31910, 31999, 32000, 32427 and 32428, and so now all that was necessary was to Poke the new start address numbers which I calculated as 1 and 72 into these locations, as follows:

```
POKE 31909,1
POKE 31910,72
POKE 31999,1
POKE 32000,72
POKE 32427,1
POKE 32428,72
```

With those Pokes complete, I found that the re-number routine, as amended, would deal with programs loaded from the Aculab. Much of this may seem obvious to more experienced programmers, particularly those with a knowledge of machine language, but in my case, it was very definitely a case of trial and error.

Efficient conversion

YOU MAY find the following a little more efficient for conversion of decimal to hexadecimal, writes Nigel Dibben of Poynton, Cheshire, than the routine given in the January 1981 issue:

```
10 INPUT "ENTER POSITIVE DECIMAL
NUMBER";A
20 AS=""
30 B=INT(A/16):C=A-16*B
40 IF C>9 THEN C=C+7
50 AS=CHR$(C+4B)+AS
60 IF B>0 THEN A=B:GOTO 30
70 END
```

It is similar to the usual machine-code technique and it is rather more compact than some of the other versions that I have seen.

It is good to see someone publicising the method of using an integer array to store machine code for use in a Basic program, instead of the often-seen technique of pushing the data into a string — a method which is so confusing. Programs containing such strings are not only difficult

to understand but can be easily damaged by editing. In addition, the technique is no bar to copying programs.

Talking of copying programs, there seems to be a misapprehension about the meaning of the term back-up. In my opinion, the buyer of software should be able to make as many back-ups of his purchase as he needs — after all, if the original is only able to spawn one copy of itself, it ceases to be an original thereafter. I always keep three copies of regularly-used software:

- Master — the original which is never modified or changed in any way.
- Back-up — a copy of the current version in case that is damaged.
- Current — the day-to-day version.

In one or two cases, I have grouped original versions on a protected master disc to release a spare disc, but only when I know I have back-up copies to hand.

To change the subject, anyone having overheating problems with a TRS-80 could take a hint from the users' group and run their computer and expansion interface on a reduced voltage. Mine now runs at a low temperature on about 160 V AC — two-thirds of the rated supply — from a scrap radio transformer. It is important, by the way, not to reduce the voltage to the video display.

There is a dormant function in TRS-80 DOS Basic which is available in Model 2 and MBasic as INPUT\$(n,f) — INPUT-dollar. That inputs a string of n characters from file f — or keyboard if f is unspecified, there is no echo to the video in that case — into a string variable, e.g.,

```
AS = INPUT$(20, #1) # is optional
```

That cannot be implemented in Model 1 with INPUT but can be by using INSTR instead. The following changes need to be made to the NewDOS version of Basic/CMD with a program such as Prozap or Superzap:

```
Relative file sector OOH, from byte 58H
onwards, address 4DFCH, to: 8B 5D.
Relative file sector OCH, from byte BOH
onwards, address 5D8BH, to:
D7 FE 24 C2 30 58 C3 97 61.
```

Do not make these changes unless you have a spare copy of Basic/CMD available. You may then type a Basic statement such as PA\$=INSTR\$(6) to input a six-character password from the keyboard.

Finally, using apostrophes in TRS-80 Basic is not shorthand. Each apostrophe generates three bytes, wherever it is used: 3AH 93H FBH — 93H is the REM token, 3AH is a colon. Each REM uses one byte at the start of a line or two if following a colon at the end of the line. □

Random numbers

MANY applications of a computer require it to respond in an unpredictable manner, writes Christopher Willmot of Durham. Often games require an element of surprise or chance, and more serious use in simulations or teaching programs can be enhanced greatly by an element of randomness.

By their nature, random numbers have no pattern. If two random numbers are added together, the result must also be a random number. This algorithm will generate either decimal or Hex numbers depending on whether the decimal flag is set when the subroutine is called. Single characters are maintained by masking the result of the addition with 0F, but random numbers up to 99 or FF can be generated by calling the subroutine twice, shifting one result and combining both using ORA.

The program should be completely portable between 6502 machines and can be located anywhere in memory by modifying the addresses of the random number store, RNDSTO, and the start of the generation table, RNDTAB.

Saving and restoring the registers is included in the subroutine which means that the subroutine can be called at any convenient point in the main program prior to loading RNDSTO into accumulator, X or Y registers.

```

100 48 PHA
101 8A TXA
102 48 PHA
103 AE 1D 01 LDX
    RNDSTO,X
106 D0 03 BNE PASS
108 EE 1D 01 INC
    RNDSTO
10B BD 1E 01 (PASS)LDA
    RNDTAB,X
10E 6D 1D 01 ADC
    RNDSTO
111 29 0F AND %0F
113 8D 1D 01 STA
    RNDSTO
116 9D 1E 01 STA
    RNDTAB,X
119 68 PLA
11A AA TAX
11B 68 PLA
11C 60 RTS
11D RNDSTO
11E-12D RNDTAB
    
```

On calling the subroutine, the registers are saved on the stack. The result of the previous run is then loaded into the X register and used to index the loading of another number from the table — line 10B. Both numbers are then added and masked so that selection is limited within the table.

The new result is stored in RNDSTO for later access, and in the used position within the table, thus constantly renewing it. No numbers need be loaded into the store or table initially as a brief run will liberally sprinkle appropriate values in a random fashion.

Observant readers may be tempted to eliminate lines 106 and 108. The precaution was introduced to avoid the possibility of becoming stuck, as would happen otherwise if two 0s were selected

THE 6502 SPECIAL is dedicated exclusively to the exchange of information between 6502 users. It is up to you, the reader, to help establish this page with your ideas, problems and guidance for other 6502 users. Please mark your letters 6502 Special. We pay £5 for each contribution published.

consecutively. After many hours of test running, I feel happy to guarantee the effectiveness of this trusty subroutine.

Space savings

IN MOST home micros, memory is limited, writes A H Whitfield of Maidenhead, Berkshire. Here are two ways of saving space in the UK 101 and AIM 65 when PRINTing. It probably applies to most 6502 Microsoft Basics. Quotation marks are unnecessary when followed by RETURN.

A semicolon is necessary only: if the cursor is not to move at the end of a PRINT statement; if two variable labels need separating for identification. So RUNNING the following prints two identical lines:

```

10 A=1: B=2: C$="X"
20 PRINT "This is a test";CHR$(A);A;B;
   C$;A;"OK?"
30 PRINT "This is a test"CHR$(A)A;B;
   C$A"OK?"
    
```

Superboard ideas

AT THE END of each line on the screen of the Superboard II, characters are lost, writes Phil Ogden of Halifax, West Yorkshire. The PRINT routine takes care of that automatically, but with POKE, the problem can become more acute — the most common manifestation being the invaders hiding in the undisplayed memory. I suggest two methods to detect that.

```

DEF FNA(X) = SGN((X - 37 - 32 * INT
((X - 37)/32) + 8) AND 32)
    
```

defines a function FNA(X) where X is either a constant or a variable to be tested and is the memory address of the character in question in decimal. If FNA(X) = 0, the character can be seen on the screen. If, however, FNA(X) = 1, the character is not visible, and appropriate action can be taken to bring the character back into sight.

A similar technique is to add guard bands of an invisible character; on the Superboard II, the space code is 32 but the machine also supports another space character with code 96. While both look identical to the observer, the machine knows differently. So, if the routine:

```

FOR I = 53252 TO 54244 STEP 32: POKE I,
96: POKE I + 25,96: NEXT
    
```

is executed. Providing there are no further screen scrolls, by testing the intended position before moving the character by Peeking the intended location for 96, the visibility of the character can easily be determined. That method also has the

advantage that a similar test could be made for detecting the top and bottom of the screen.

It is useful to be able to convert the address of a character to the X and Y co-ordinates from the cursor HOME position (54117) and vice versa. These routines do that.

```

DEF FNX(X) = X - 37 - 32 * INT((X -
37)/32)
    
```

FNX(X) returns the X co-ordinate of the location given as the argument of the function.

```

DEF FNY(Y) = INT((54114 - Y)/32) + 1
    
```

FNY(Y) returns the Y co-ordinate of the location given as the argument of the function.

```

DEF FNP(P) = 54117 + X - (32 * Y)
    
```

FNP(P) returns the location of the character, having stored co-ordinates in variables X and Y. Those variables should not otherwise be used by the program, and the argument P is a dummy argument — not used by the function, FNP(0) would work.

Sometimes it would be useful to turn off the display while drawing a picture or a gaming board, and flash the completed board when ready. This machine-code routine will copy a picture drawn in the last 1K of RAM in an 8K system — it will modify easily for other systems — to the screen in an instant. The last 1K must be protected by answering the D/C/W/M ? prompt with 7168.

If, in program development, you use a reference for all pokes to screen, i.e., POKE REF + 287,240, all that needs to be done to draw the picture in the last 1K rather than in the video RAM is to re-define the reference as the original reference minus 46080 and use this routine:

```

0276 A2 00 LDX £00
0278 8D 00 1C LDA 1C00,X
027B 9D 00 D0 STA D000,X
027E BD 00 1D LDA 1D00,X
0281 9D 00 D1 STA D100,X
0284 BD 00 1E LDA 1E00,X
0287 9D 00 D2 STA D200,X
028A BD 00 1F LDA 1F00,X
028D 9D 00 D3 STA D300,X
0290 CA DEX
0291 D0 E5 BNE 0278
0293 60 RTS
    
```

To use, make sure that the last 1K contains space characters — a FOR/NEXT loop should ensure that, draw the required display in the memory. To copy the display to the screen use:

```

POKE11,118:POKE12,2:X = USR(X)
    
```

the machine code is stored in the spare memory locations before the start of the Basic program and is not affected by reset.

Using a similar routine, it is possible to exchange the screen and the bottom 1K —

that gives instant screen change, and is useful for creating explosions by filling one screenful of the standard display, and the other of just white blocks, 161. By exchanging rapidly between the two at the critical moment, a good explosion effect can be achieved with only a minimal amount of machine-code programming.

Again the last 1K of memory must be protected by replying 7168 to the D/C/W/M ? prompt, and the code is stored in the spare memory. The routine is accessed by using:

POKE11,149:POKE12,2:X =USR(X)

Here is the program:

```
0294
0295 A2 00      LDX E00
0297 BD 00 1C  LDA 1C00,X
029A 8D 94 02  STA 0294
029D BD 00 D0  LDA D000,X
02A0 9D 00 1C  STA 1C00,X
02A3 AD 94 02  LDA 0294
02A6 9D 00 D0  STA D000,X
02A9 BD 00 1D  LDA 1D00,X
02AC 8D 94 02  STA 0294
02AF BD 00 D1  LDA D100,X
02B2 9D 00 1D  STA 1D00,X
02B5 AD 94 02  LDA 0294
02B8 9D 00 D1  STA D100,X
02BB BD 00 1E  LDA 1E00,X
02BE 8D 94 02  STA 0294
02C1 BD 00 D2  LDA D200,X
02C4 9D 00 1E  STA 1E00,X
02C7 AD 94 02  LDA 0294
02CA 9D 00 D2  STA D200,X
02CD BD 00 1F  LDA 1F00,X
02D0 8D 94 02  STA 0294
02D3 BD 00 D3  LDA D300,X
02D6 9D 00 1F  STA 1F00,X
02D9 AD 94 02  LDA 0294
02DC 9D 00 D3  STA D300,X
02DF CA      DEX
02E0 D0 B5    BNE 0297
02E2 60      RTS
```

Missing points

A FEW points to help Superboard users which Ohio neglected to mention in its manuals, writes C Boyle of Bradford, West Yorkshire.

If the machines crashes, i.e., no response to BREAK W, try Break M G. If that fails, try BREAK M.A.274G.

The key sequence BREAK C A gives you the Basic author's name. A one-line special program — it only fits if PRINT is entered as?

```
10 FOR 2=1TO7:FORX=1TO2:PRINT:
PRINTTAB(20-X):FORY=1TO2*X:
PRINT CHR$(42);:NEXTY,X,Z
```

That will obviously work on almost any machine, CHR\$(42) produces a star.

Memory test

THIS program is used to check that the memory on an Acorn system one is working correctly, writes Tony Edgecombe of Abingdon, Oxfordshire. The program checks every bit of each location to make sure that it is not permanently one or nought.

The program is executed from 0040H. It will request the first address of the ram to be tested. That should be entered and terminated with any command key. The end address should then be entered

and again terminated with a command key.

If there is a fault in the RAM, the computer will display the message fail otherwise it will display the message pass.

```
0030 00 00 73 77 6D 6D 00 00 'PASS'
0038 00 00 71 77 06 38 00 00 'FAIL'
0040 A2 20      LDX $20
0042 20 88 FE   JSR QDATFET
0045 A2 22      LDX $22
0047 20 88 FE   JSR QDATFET
004A A0 00      LDY $00
004C A9 FF      LDA $FF
004E 91 20      STA (20).Y
0050 B1 20      LDA (20).Y
0052 C9 FF      CMP $FF
0054 F0 03      BEQ 03
0056 4C 7A 00   JMP $007A
0059 A9 00      LDA $00
005B 91 20      STA (20).Y
005D B1 20      LDA (20).Y
005F F0 03      BEQ 03
0061 4C 7A 00   JMP $007A
0064 A2 1A      LDX $1A
0066 20 A0 FE   JSR COM16
0069 F0 03      BEQ 03
006B 4C 4A 00   JMP $004A
006E A2 07      LDX $07
0070 B5 30      LDA Z X.30
0072 95 10      STA Z X.10
0074 CA      DEX
0075 10 F9      BPL F9
0077 4C 04 FF   JMP RESTART
007A A2 07      LDX $07
007C B5 38      LDA Z X.38
007E 95 10      STA Z X.10
0080 CA      DEX
0081 10 F9      BPL F9
0083 4C 04 FF   JMP RESTART
```

Load routine

THE FOLLOWING routine occupies an essentially free and protected area of RAM from 0235 — 02CD, writes A J Jameson of Muir of Ord, Ross-Shire, and provides the facilities of:

- Preview of tape contents.
- Loading from tape to memory.
- Auto LIST, RUN or STOP at the end of a listing.
- No character masking, therefore, the total range of characters may be loaded — with the exception of the control characters CR/LF.

The program is entered by POKE536,53: POKE537,2. The contents of a cassette may now be previewed. The preview mode is indicated by the presence of a white block in the top right-hand corner of the screen.

If Key 'L' is now pressed, the program will be loaded; Key 'O' will exit the routine at any time. Prior to operating the given POKES, the following instruction must be entered:

- 1) POKE717,0 Auto RUN
- 2) POKE717,64 Auto LIST
- 3) POKE717,26 Auto STOP

The automatic Run, List or Stop at the end of a program Load is dependent on the presence of the OK provided by the UK101 after a SAVE operation, which normally results in the irritating syntax error message. Alternatively, the routine searches for Run which may be produced by an additional software 'patch' when SAVEing programs.

```
0235 JSR 20 B802      Set up key-board address
```

```
0238 LDA AD 00DF      Keyboard port
023B CMP C9 BF
023D BEQ F0 16 (0255) 'L' key, load ?
023F CMP C9 DF
0241 BEQ F0 62 (02A5) 'O' key, out ?
0243 JSR 20 BE02      Test cassette port
0246 BCC 90 F0 (0238) Data ready ?
0248 LDA AD 01F0      Get data
024B JSR 20 2DBF      Display data
024E LDA A9 A1
0250 STA 8D 36D0      Display block
      indicates preview
0253 BNE D0 E0 (0235) Branch always
0255 LDA A9 5F
0257 STA 8D 1802      Set input vector for load mode
025A JMP 4C 74A2      Basic warm-start
025D LDY A0 01      Set OK/Run flag
025F JSR 20 B802      Set-up key-board address
      Keyboard port
0262 LDA AD 00DF
0265 CMP C9 DF
0267 BEQ F0 3C (02A5) 'O' key, out ?
0269 JSR 20 BE02      Test cassette port
026C BCC 90 F4 (0262) Data ready ?
026E LDA AD 01F0      Get data
0271 CMP C9 0A
0273 BEQ F0 E8 (025D) LF ?
0275 CMP C9 00
0277 BEQ F0 E9 (0262) NULL ?
0279 CMP C9 0D
027B BEQ F0 0C (0289) CR ?
027D DEY 88
027E BEQ F0 0A (028A) 'OK/Run' Flag set ?
0280 JSR 20 C302      Display and store data
0283 CPX E0 47
0285 BNE D0 DB (0262) Maximum line length ?
0287 LDA A9 0D
0289 RTS 60
028A CMP C9 4F
028C BEQ F0 04 (0292) 'O' ?K
028E CMP C9 52
0290 BNE D0 EE (0280) 'R' ?UN
0292 LDY AC CD02      Load message pointer
0295 LDA B9 A5A0      Get character
0298 BMI 30 06 (02A0) MSB set ?
029A JSR 20 C302      Display and store character
029D INY C8
029E BNE D0 F5 (0295) Get next character
02A0 AND 29 7F      Clear MSB
02A2 JSR 20 C302      Display and store character
      Keyboard port
02A5 LDA AD 00DF
02A8 CMP C9 DF
02AABEQ F0 F9 (02A5) 'O' key still closed ?
02ACLDA A9 BA
02AESTA 8D 1802      Re-set input vector
02B1 LDA A9 FF
02B3 STA 8D 1902      Re-set input vector
02B6 BNE D0 CF (0287) Branch always
02B8 LDA A9 DF      Set keyboard row address
02BA STA 8D 00DF      Keyboard port
02BD RTS 60
02BE LDA AD 00F0      Test cassette port
02C1 ROR 6A
02C2 RTS 60
02C3 STA 9D CDD3      Display data
02C6 STA 95 13      Store data in input buffer
02C8 INC EE 0002      Cursor position
02CB INX E8          Cursor pointer
02CC RTS 60
02CD REM
Message pointer $00 = RUN — POKE717,0
          $40 = LIST — POKE717,64
          $1A = STOP — POKE 717,26
```

Character input

THE PROGRAM by Jeremy McGhee to input a single line of text from the keyboard contains a clever idea to do something useful, *Practical Computing* February 1981, but is unnecessary, writes Tim Scratcher of Darlington.

I resort to machine code/Basic hybrids only when I require to do something which is either too slow or impossible in Basic, and there is a way of inputting any characters into a string using GET\$. In its simplest version, the subroutine is:

```
10 PRINT " ";
20 B$=""
30 GET A$:IF A$="" THEN 30
40 A=ASC(A$)
50 IF (A=13 OR A=20) AND B$="" THEN 30
60 IF A=13 THEN 130
70 PRINT A$;
80 IF A > 20 THEN 110
90 B$=LEFT$(B$,LEN(B$)-1)
100 GOTO 30
110 B$=B$+A$
120 GOTO 30
130 PRINT
```

Text is returned in B\$ and the subroutine uses A\$ and A as local variables which could be used elsewhere as much.

Line 10 contains an empty string which could be replaced by any kind of query or request for information, with or without a question mark. The character delete works in the usual way, but any other character — text, graphics or control — will be included in the string.

Line 50 disallows a null string or an attempt to delete from a null string. Lines 80-90, having detected a character delete, reduce the string by that character and obtain the next character.

The subroutine has many advantages over input and other uses. Because the cursor control characters can be incorporated into B\$, you can draw a little picture on the screen and reproduce it any time very simply by printing B\$. Superimposition of a set of subscripted B\$ will then give simple animation.

Any characters can be excluded from the string by inserting a line or lines between lines 50 and 60 of the kind:

```
55 IF A = OR A = ..... THEN 30
```

Those of us with old ROMs can use a

routine like this to make the keyboard function in the correct typewriter manner, that is, with capitals appearing when the shift key is depressed, and with the string remaining correct. That is done by adding 64 to A to change upper-case to lower, and subtracting 64 from A to change lower-case to upper, and adding those values to B\$. Remove line 70 and put it at 85:

```
85 PRINT A$;
Remove line 110 and substitute:
110 IF A > 64 AND A < 91 THEN A = A + 64
112 IF A > 128 AND A < 155 THEN A = A - 64
114 PRINT CHR$(A);
116 B$=B$+CHR$(A)
```

Even when you have put the awkward characters into B\$, there are still problems saving the string in a data file on cassette. If B\$ contains a comma or quotation marks, when printing to a file, B\$ will be saved up to the comma, and then you will have an extra ignored error.

The solution is to substitute into the string some other arbitrary character whenever awkward punctuation is encountered. That is done in a similar manner to changing upper- and lower-case. Remove line 70 and put it at 85 as shown, then remove line 110 and substitute:

```
110 PRINT A$;
112 IF A = 34 THEN A = 42
114 IF A = 44 THEN A = 43
116 B$=B$+CHR$(A)
```

That will appear on the screen as usual, but B\$ will contain an asterisk in place of quotes and a plus in place of a comma. B\$ can then be saved on a data file in the usual way. Of course, when the data file is read, they will have to be changed back to their correct characters, as for example:

```
5 A$=""
10 FOR I=1 TO LEN(B$)
20 A=ASC(MID$(B$,I,1))
30 IF A=43 THEN A=44
40 IF A=42 THEN A=34
50 A$=A$+CHR$(A)
60 NEXT I
70 B$=A$
```

When using a set of subscripted B\$, that may take some time, but I find that a small price to pay for a simple, trouble-free method. In use 1, you are of course limited to 255 characters to a string.

I see only one disadvantage with this method of inputting and that is that you lose the cursor. I suppose you could get it back with:

```
30 GET(A$)
32 PRINT CHR$(160)CURSOR LEFT CHR$(32)CURSOR LEFT;
34 IF A$="" THEN 30
```

but that is bound to play havoc with the length of B\$, and there must be a better way.

Word of warning

JONATHAN Dick's routine for dumping the contents of the Pet screen on to the 3022 printer *Practical Computing* October 1980, calls, I feel, for the following warning to be made, writes JM Round of London.

Page 34 of the 3022 manual warns clearly that not more than five lines should be printed in reverse field without the print-head having time to cool. This routine does not take into account the number of reverse-field characters counted in any one line. The user, therefore, should take great care in using it as a burnt-out print-head could easily be the result should a large proportion of the screen happen to be in reverse field.

Graphplot for equations

ONE OF my most-used programs for the Pet is called Graphplot and enables you to plot a graph of any equation you can express in Basic writes Ian Mercer of Loughborough, Leicestershire.

It uses the maximum available resolution — 80 by 50. The program is in two sections. The first inputs the function, checks it for errors then enters it into the program as line 100. The second section from line 100 onwards plots the function over any desired range scaling it automatically to fit on the screen.

The user can then have axes if desired or change the range or start again with a new function. The conversion for old-ROM Pets is included as a REM statement at line 71 to use it convert line 70 to read POKE 525,2:POKE 527,13: POKE 528,13.

```
8 PRINT "GRAPH PLOT"
9 PRINT "BY I.MERCER"
10 PRINT "TYPE IN THE EQUATION"
11 OPEN "O":PRINT "Y=";INPUT B1;A$=CLOSE:PRINT
22 C$="(X)+=/*-^/,%ABCEGILNOPQRST0123456789"
23 O=0:FOR H=1 TO LEN(A$):H$=MID$(A$,H,1):I$=MID$(A$,H,3)
24 FOR L=1 TO 33:IF H$=MID$(C$,L,1) THEN 26
25 NEXT L:GOTO 34
26 IF H$="( " THEN O=1:IF O=C THEN 32
27 IF H$=")" THEN O=1:IF O=C THEN 32
28 IF (I$="SIN" OR I$="COS" OR I$="TAN" OR I$="LOG") AND MID$(A$,H+3,1) < "<" THEN 33
29 IF (I$="EXP" OR I$="ABS" OR I$="ATN" OR I$="SQR") AND MID$(A$,H+3,1) < "<" THEN 33
30 NEXT H
31 IF O=0 THEN 40
32 PRINT "BRACKETS MISMATCH PLEASE RETYPE EQUATION":GOTO 12
33 PRINT "IF I$ MUST HAVE ITS ARGUMENT IN BRACKETS":GOTO 12
34 PRINT "ILLEGAL CHARACTER -> "H$": PLEASE RETYPE":GOTO 12
40 PRINT "WHEN THE GRAPH HAS BEEN DRAWN, PRESS "
41 PRINT "C" TO CHANGE THE EQUATION."
42 PRINT "R" TO CHANGE THE RANGE."
43 PRINT "E" TO END."
44 PRINT "F" FOR AXES."
45 PRINT "K" PRESS ANY KEY WHEN YOU ARE READY"
46 GET R:IF R$="" THEN 46
47 POKE 59409,52
50 PRINT "00000 DEFFN(X)="A$
60 PRINT "R11000"
70 POKE 158,2:POKE 623,13:POKE 624,13
71 REM FOR OLD PETS USE 525,527,528
80 END
100 DEFFN(X)=SIN(X)
101 POKE 59409,60
105 DIM O(80)
110 DIM Z%(15):FOR G=0 TO 15:READ Z%(G):NEXT G
120 DATA 32,123,108,98,126,97,127,252,124,255,225,254,226,236,251,160
130 INPUT "STARTING VALUE FOR X":SX
140 INPUT "FINISHING VALUE FOR X":EX
150 X=X-ABS(EX-SX)/79
160 SF=79/ABS(EX-SX)
165 PRINT "PLEASE WAIT A MINUTE"
170 M=0:B=0:FOR X=SXTD EXSTEPXX:Z=FNA(X):O(B)=Z:B=B+1
171 IF NDZ THEN 172
172 IF MZ THEN 172
173 NEXT X:SY=477*(X-N)
180 VF=ABS(INT(SY/N))
190 PRINT "J"
200 FOR A=0 TO 79
210 Y=O(A)*SY+VF:X=A:GOSUB 10000
220 NEXT A
230 GET R:IF R$="" THEN 230
240 IF R$="R" THEN RUN 100
250 IF R$="S" THEN PRINT "J":END
260 IF R$="C" THEN RUN
270 IF R$="A" THEN 500
280 PRINT "PRESS R TO ALTER RANGE, E TO END, C TO CHANGE THE EQUATION, F FOR A
YES"
290 GOTO 230
500 IF SX=0 OR EX=0 THEN 600
510 X=X-SX*SF:FOR Y=0 TO 49:GOSUB 10000:NEXT Y
600 IF ND OR MZ THEN 700
610 Y=VF:FOR X=0 TO 79:GOSUB 10000:NEXT X
700 GOTO 230
10000 X2=Y:Y2=Y
10005 SC=32768*(X2/2)+INT((24-Y2/2)*40)
10010 DDZ=(C*(X2*ND1)+1)*((1-(Y2*ND1))*3+1)
10020 OZ=PEEK(SC)
10030 FOR JJ=0 TO 15:IF OZ=ZZZ(JJ) THEN 10050
10040 NEXT JJ:B=0
10050 POKE SC,ZZZ(JJ)OR DDZ
10060 RETURN
READY.
```

Determinant evaluation

I AM an electrical engineer and an Apple user writes John Suzin of Paddington, London. Although you have published many useful programs and various tips, the lack of practical mathematical programs has prompted me to submit this short, but nonetheless, fundamental mathematical program for evaluating the numerical value of a determinant.

As that is related closely to a more complex matrix algebra applied to digital computation, it is the matrix algebra which is the basis of numerical solutions of algebraic and differential equations, solutions of networks and so on, and because of shortcomings of micro Basic, the knowledge of the technique of matrix manipulation is indispensable.

The program occupies 4.5Kbyte of memory; line 90 reserves computer memory for a 15 by 15 determinant; lines 160 to 390 will require inputting the order of determinant and its elements and will print the determinant (A,J) in matrix form. For ease of entry and to avoid any mistakes, the rows and columns are indicated in the program.

The evaluation, based on the old, established method of Chio, begins in line 410 which sets in the indices. Since the method begins by division by the element A(1,1), lines 420 to 510 ensure that the element A(1,1) is not 0 even if it is.

If A(1,1) > 0, the program proceeds normally to line 530. If the element A(1,1)=0, the program branches to line 450 where the second row is subtracted from the first. It depends on the positions of the zeros. There is almost no end to the various precautions one might take to prevent division by zero errors, but they would involve a very much longer program.

Having taken some of the precautions, the loop in line 560 to line 610 will multiply the first row by the first element of the second row and subtract the resultant first row from the second row and repeat it with the second row up to the Nth row of the determinant.

It must be remembered that each operation takes place in a loop and, therefore, the number of successive multiplications and subtraction will be determined by the order of the determinant.

Statements in lines 620 to 640 increase the indices and after repeating the whole process of reduction, the determinant is reduced to a lower order. In line 640, if the last operated element is not the last row element, the whole process is repeated again until L=R, in which case the value of the determinant is given in line 660.

```

30 ? "DETERMINANT EVALUATION"
40 ?
50 ? "COPYRIGHT 1978"
60 ? "BY J.B.SUZIN"

90 DIM A(15,15)
100 ?
160 ? "ENTER ORDER OF
    DETERMINANT";

```

This section is open to the Apple user. In every issue we hope to print ideas, hints and comments about the Apple and its suppliers. They must come from you, so write and tell us what you know.

```

170 INPUT R
180 IF R = 0 THEN END
190 ?
200 ? "ENTER THE ELEMENTS"
210 ?
220 FOR I = 1 TO R
230 ? "ROW";I
240 FOR J = 1 TO R
250 ? "COLUMN ";J;
260 INPUT A(I,J)
270 NEXT J
280 NEXT I
290 ?
300 HOME:VTAB 5
310 ? "DETERMINANT A(“;R;”“;R;”)”
320 ?
330 FOR I = 1 TO R
340 ?
350 FOR J = 1 TO R
360 ? TAB(5);A(I,J);“ ”;
370 NEXT J
380 ?
390 NEXT I
400 ?
410 L = 1;K = 2;D = 1
420 D1 = A(L,L) : D2 = A (K,L)
430 IF D1 < > 0 THEN 530
440 IF D1 = 0 AND D2 = 0 THEN 490
450 FOR J = 1 TO R
460 A(L,J) = A(L,J) - A(K,J)
470 NEXT J
480 GOTO 520
490 FOR I = 1 TO R
500 A(I,L) = A(I,L) + A(I,K)
510 NEXT I
520 D1 = A(L,L)
530 FOR J = L TO R
540 A(L,J) = A(L,J)/D1
550 NEXT J
560 FOR I = K TO R
570 X = A(I,L)
580 FOR J = L TO R
590 A(I,J) = A(I,J) - A(L,J)*X
600 NEXT J
610 NEXT I
620 L = L + 1;K = K + 1
630 D = D*D1
640 IF L < R THEN 440
650 D = D * A (R,R)
660 ? "DETERMINANT VALUE = ";INT
    (D * 1E3 + .5)/1E3

```

Calendar routine

THIS CALENDAR routine for Apple I and ITT 2020 has been sent to us by Gavin Haines of Hastings, East Sussex. As he points out in the program, if you use it with one of your own routines, be careful to initialise data pointers. If your program has READ statements, it could read the wrong data.

```

100 REM
    INITIALIZE
110 SPEED = 255; TEXT : HOME : NORMAL
120 REM

    DIMENSION ARRAYS
130 DIM M$(12),MX(12),J(12),YX(12),Y1X(12),Y
    2X(12),Y3X(12),SX(12)
140 REM M$=MONTHS MX=MONTH CODE J=NO.OF DAYS
    YX-TOTALS SX=HTAB VARIABLE
150 REM

    MODULO
160 DEF FN A(X) = INT (A / B - INT (A /
    B)) * B + .05) * SGN (A / B)
170 REM

    READ IN STRINGS
180 M$ = "SUN MON TUE WED THU FRI SAT"
190 C$ = " CALENDAR FOR THE YEAR "
200 FOR I = 1 TO 12: READ M$(I),MX(I),J(I):
    NEXT
210 DATA JANUARY,0,31,FEBRUARY,3,28,MARCH,
    3,31,APRIL,6,30,MAY,1,31,JUNE,4,30,JULY,6,31,
    AUGUST,2,31,SEPTEMBER,5,30,OCTOBER,0,31,NOVEM

```

```

BFR,3,30,DECEMBER,5,31
220 REM

    SET UP FIELDS
230 FOR I = 0 TO 6: READ T(I): NEXT
240 DATA 32,8,12,16,20,24,28
250 REM

    MENU
260 HOME
270 PRINT "CALENDAR IC"
280 VTAB 4: PRINT "WOULD YOU LIKE TO:-"
290 PRINT : PRINT
300 PRINT TAB (8)"1. LOOK AT A CALENDAR"
310 PRINT : PRINT TAB (8)"2. YOUR OWN SUBRO
    ULINE"
320 PRINT : PRINT TAB (8)"3. END PROGRAM"
330 VTAB 23: HTAB 30: PRINT "WHICH?": GET A
    $
340 IF VAL (A$) > 3 OR NOT VAL (A$) THEN
350 IF A$ = "2" THEN S1 = 1
360 IF A$ = "3" THEN HOME : PRINT "BYE!": G
    O 1000
370 REM

    START
380 HOME : PRINT " ";C$;
390 INPUT Y$
400 IF NOT VAL (Y$) THEN 380
410 Y = VAL (Y$)
420 IF Y < 1582 OR Y > 9999 THEN 380
430 HOME : PRINT " ";C$;Y$
440 REM

    CENTURY AND DECADE
450 CX = VAL ( LEFT$ (Y$,2))
460 DX = VAL ( RIGHT$ (Y$,2))
470 IF Z THEN 520: REM LAST YEAR
480 I = 0
490 I = I + 1
500 REM

    LEAP YEAR?
510 IF Y / 400 < > INT (Y / 400) THEN 530
520 IF Y / 4 = INT (Y / 4) THEN MX(1) = 6:M
    X(2) = 2:J(2) = 29
530 REM

    1ST DAY OF THE MONTH
540 YX(I) = Y + (Y / 4)
550 YX(I) = YX(I) + (CX * 6)
560 YX(I) = YX(I) + (CX / 4)
570 YX(I) = YX(I) + MX(I) + 1
580 Y2X(I) = YX(I) / 7
590 Y3X(I) = Y2X(I) * 7
600 SX(I) = YX(I) - Y3X(I)
610 REM

    PRINT HEADINGS
620 VTAB 4: HTAB 20: CALL - 958: INVERSE :
    PRINT M$(I): NORMAL
630 PRINT : PRINT : PRINT TAB (10)W$: PRINT

640 HTAB T(SX(I))
650 REM

    PRINT CALENDAR
660 FOR L = 1 TO J(I)
670 IF POS (0) > = 33 THEN PRINT : PRINT
    : HTAB 8
680 IF L = 1 THEN VTAB 9
690 IF L < 9 THEN S$ = " "
700 IF L > 9 THEN S$ = " "
710 PRINT S$:L:; NEXT L
720 REM

    GO ON A MONTH
730 PRINT : PRINT
740 VTAB 23: HTAB 10: IF I = 1 THEN INVERSE
    : PRINT "PRESS ANY KEY FOR NEXT MONTH"
750 IF I = 2 THEN INVERSE : PRINT "PRESS 'R
    ETURN' FOR LAST MONTH"
760 IF I = 3 THEN INVERSE : PRINT "PRESS 'E
    SC' KEY TO END"
770 NORMAL
780 GET A$
790 IF ASC (A$) = 27 THEN 250
800 REM

    GO BACK A MONTH
810 Z = 0: X = FRE (0)
820 IF ASC (A$) = 13 THEN I = I - 2:MX(1) =
    0:MX(2) = 3:J(2) = 28: IF I < 0 THEN I = 12:
    Y$ = STR$ (Y - 1):Z = 1: GOTO 410
830 REM

    END OF YEAR?
840 IF I < 12 THEN 490
850 REM

    GO ON A YEAR
860 Y$ = STR$ (Y + 1):MX(1) = 0:MX(2) = 3:J(
    2) = 28
870 GOTO 410
880 REM

1000 D$ = CHR$ (4): PRINT : PRINT D$ "RUN MEN
    U"
2000 REM

2010 REM IF YOU USE THIS CALENDAR ROUTINE
    WITH ONE OF YOUR OWN PROGRAMS, BE CAREFUL TO
    INITIALIZE DATA POINTERS.
2020 REM IF YOUR PROGRAM ALSO HAS READ STA
    TEMENTS, IT COULD READ THE WRONG DATA.
2030 REM

```

THE FASTEST and most impressive mouse at last year's finals was undoubtedly Brainy Bricks. Pete Gissing designed the circuit shown in figure 1 to interface each of a pair of Lego motors and battery boxes to a Kim single-board computer mounted on top.

The circuit has three special features: firstly, it checks the data from the output port to stop the motor from trying to go forwards and backwards simultaneously — that tends to explode transistors. Secondly, it reverses the power supply automatically to the motors for a short time when a drive signal is removed — the 1K pre-sets should be adjusted until the motors stop dead but do not reverse.

Thirdly, the opto-isolator separates the computer power supply completely from the motor supply. That is good design practice as it eliminates a major cause of computer problems. Unfortunately, it also means the circuit will not work using CMOS chips unless a transistor buffer is used on the input to the opto-isolator, as CMOS chips will not sink enough current.

I am told the circuit can handle enough current to drive a small bus — two to three amps — and is, therefore, ideal for small robots of all kinds. The auto-stop facility has, however, some disadvantages. The motors always go at full speed or are stopped. That means that there is little or no possibility of speed control. Brainy Bricks ran better, although more

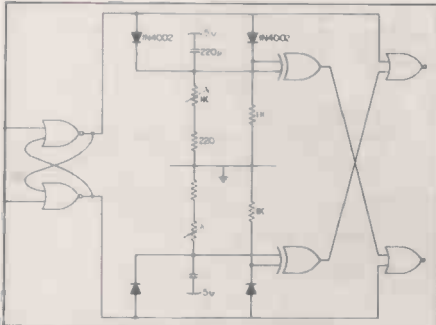

My interpretations of the control bit.

slowly, with used batteries because there was a tendency for wheel spin with new batteries. No speed control also means that steering is more difficult.

Phil Yeardley — who wrote the Brainy Bricks software — overcame the problem with what he called a nudge routine. Broadly, the idea is full speed ahead on both motors until the sensors indicate impending doom then the nudge routine takes over, stopping the motors and then jiggling the wheels until the sensors indicate it is safe to continue.

For example, in the competition, Brainy Bricks tended to veer to the left. When it hit the left-hand wall, it then stopped. The nudge routine then reversed the right wheel until it was safe to continue, then off it went again. Apparently, there are seven different types of nudge guaranteed to help a mouse out of all kinds of trouble. The danger of a nudge routine is that your mouse might move from one square to

What makes Brainy Bricks run?

another, or turn through 90 degrees, without the main control program noticing.

The only other problem with normal electric motors is that if you switch them on and then off, you do not know how far they have moved — even if they stop

by Nick Smith

instantly. To solve that problem, you need to count wheel revolutions, or parts of revolutions by some other method.

The normal solution is a slotted or banded disc, together with optical sensors. The control program then counts pulses of light or changes from light to dark bands, but beware — the control program must check the sensor more often than it can change, or changes, and therefore distance, will be lost. If the distance sensor is connected to an undriven wheel, most skidding problems will be eliminated.

If you do not like that approach, you could use two of my circuits — see *Practical Computing*, Micromouse March 1981 — to control each motor. Motor speed can then be controlled by switching the power supply to the motors on and off. The greater the percentage of time power is supplied, the faster the motors go. Stopping is another problem, of course. If your mouse does not stop quickly enough, you could program your micro to reverse the current to the motors like Brainy Bricks. Do not forget, though, it is easier to adjust a variable resistor than it is to re-program an EPROM. You will of course, still, need a distance sensor and so you could monitor that to discover when you have stopped.

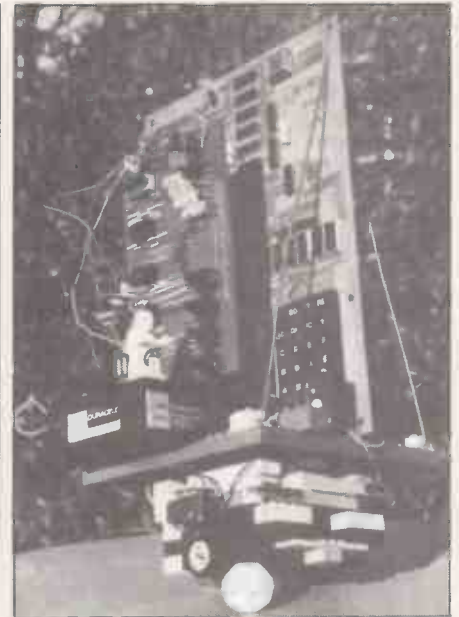

Brainy Bricks

To summarise the major differences: ordinary motors are faster than steppers and/or use much less current. Stepper motors travel in known, fixed increments of distance — if your mouse has not crashed — and do not, therefore, require extra circuitry to calculate distance. Stepper motors need more software to move at all — ordinary motors do not need any — but stepper motors then need less software for steering.

If you have a different approach to motor control, send it to the Micromouse page. It is fascinating to see how different people approach the problem of trading off electronic complexity with software sophistication.

Figure 1.

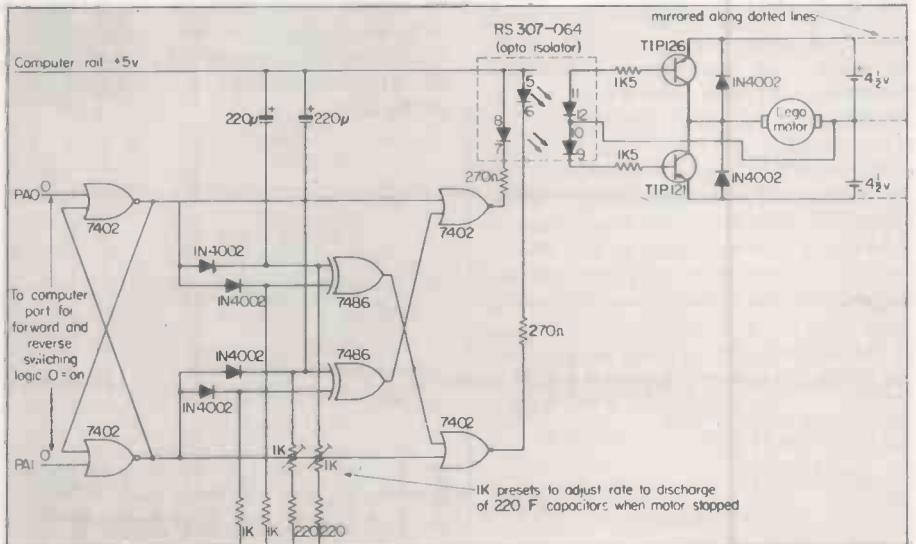

30 programs for the Sinclair ZX-80-1K

111 pages paperback, spiral bound. Price £6.95 plus postage and packing 50p. Available from Melbourne House Publishers, 131 Trafalgar Road, Greenwich SE10, ISBN 0 86161 100 4.

THE 30 programs are a mixture of 15 games, five programming subroutines, three demonstration programs, three mathematics programs and four teaching programs.

It is difficult to establish at what readership this collection is aimed. The documentation of even the simpler programs is insufficient to enable a complete beginner to enter the program and run it without difficulty.

For example, entering data into an array is simple when you know how, but faced, as in Lunar Lander, with the command: "Enter following values", with no other instructions, results in a string of error messages until the correct procedure is found. The use of I as a variable also is a potential source of confusion — with 1.

Whatever the intended readership, one thing above all is essential in a book of programs and that is accuracy. Of 10 of the shorter programs tested, five either resulted in error codes or produced an erroneous result. For example, in Noughts and Crosses, lines 230-250 produce a subscript outside the range of line 100, and line 130 produces values outside the required range of 29-37.

That subscript failure also occurs in other programs such as Nim. The Chinese Remainder algorithm produces erroneous results for inputs of 315 and 316, which are within the stated limits of the program. Prime Numbers outputs numbers which are not prime — the test on line 150 is the wrong way round. Results like these deterred us from testing the longer programs.

Having pointed-out the pitfalls, it must be said that this book is still a valuable item in the library of ZX-80 users, as it leads to a greater appreciation of the potential programming capabilities of its 1K Basic. The programs included illustrate space compression, the use of Peeks and Pokes,

and the use of the USR function to determine how much memory is still available.

It is to be hoped that further volumes of ZX-80 programs will be published, and it would be very interesting, in view of the relatively low cost of additional memory units, to see the volumes extended to cover 2K and upwards applications. It is to be hoped that, in future volumes, care will be taken to check the accuracy of the published program listings.

Conclusions

- A source book of programming ideas for those users of the ZX-80 who already have a good working knowledge of Basic.

- Not recommended for beginners who are unwilling, or unable, to debug the programs.

L C Thomas

Computer graphics: Infotech state of the art report.

Series 8 number 5, 1980, Charles White, editor, two volumes — invited papers and analysis — 548 pages hardback. £120. Available from Infotech, Nicholson House, Maidenhead, Berkshire. ISBN 8553 9660 1 both volumes.

INFOTECH state of the art reports are too expensive to be bought for most private bookshelves, but they can be found in public libraries and are within the budget of most companies, so it is worth knowing the kind of information they contain.

State of the art reports are always in two volumes. The invited papers are papers given at a recent state of the art conference — since attendance at these conferences costs more than £100 a day, the reports begin to seem good value.

The conference papers are usually supplemented by a number of specially-commissioned papers from authorities on particular topics which, for one reason or another, were not covered adequately at the conference.

Since Infotech has smaller publishing delays than many of the specialised technical journals where these papers might otherwise appear, the invited papers can represent as up-to-date a picture of current

work in a particular field as you can obtain anywhere. On the debit side, the papers are still, typically, 12 months old and they will not have been refereed as critically as papers in technical journals, so they may be lower in quality.

The second volume, analysis, is the work of the report editor. It is an introduction to the subject area, and a review and analysis of current experience, problems and solutions. Analysis is constructed by the editor as a discussion between various authors, by extracting relevant paragraphs from the papers in the other volume, supplemented by other material referenced in the bibliography. The editor writes text which links the extracts into a comprehensive whole.

The result, if the editor knows the subject and has the necessary writing skills, is a readable and informative volume arranged so that all the relevant information on each topic can be extracted with minimum effort by the reader. The volume is completed by an annotated bibliography, i.e., references and associated abstracts, and an index.

In general, then, Infotech state of the art reports are a valuable source of information about specialised topics, providing a convenient way of finding your bearings in the subject and extensive papers and references to follow up.

What of this specific report, computer graphics? It is a typical example of the series, competently commissioned and edited. The invited papers cover data management, image processing, standardisation, computer animation, trends, cost-effectiveness, hardware, communications and management. They include the users' views as well as the designers'.

The analysis contains an introduction to the whole subject, and chapters on man/machine interfaces, hardware, software, and applications. There is the usual, excellent bibliography.

Inevitably, the report is a snapshot, a collection of papers reflecting the views, interests, and current activities of 24 individuals early in 1980. Nevertheless, it is a good introduction to computer graphics and although far too expensive for most individuals, it is

readily available — free — through your local library.

Conclusions

- The Infotech state of the art reports are worth investigating if you have an interest in one of their special subject areas — the 1980 series included data communications, microelectronics, office automation, data design, computer graphics, factory automation, life-cycle management, and computer audit and control.

- This particular report is up to standard, and is recommended to anyone seeking a picture of current thinking and activity in the field of computer graphics worldwide.

Martyn Thomas

Infotech state of the art report. Microcomputer Software

Volume 1: analysis and bibliography and Volume 2: invited papers.

TAKEN together, the two volumes comprise approximately 500 pages of text. The first volume, which is slightly shorter than the second, is an edited discussion among microcomputer software experts annotated by the editor, R Dowsing who is a senior lecturer in computing studies at the University of East Anglia.

The discussion is topical and ranges from a review of the current state of microprocessor software to a detailed discussion of microcomputer software development to a look at future trends. The bibliography consists of 20 pages of useful references with short abstracts included for over half of the items listed.

The second volume contains 15 invited papers. Material used in the discussion volume has sometimes been extracted directly from the invited papers. While that makes for some replication of material, it also enables the reader to gain a fuller appreciation of the context in which the original point was made.

Most of the papers are short — only two are more than 20 pages. While brevity alone does not command a paper, it means that people with little time for reading through the volume can easily assess its

(continued on next page)

(continued from previous page)

usefulness. Most of the papers are either survey papers or papers of a tutorial nature; and most authors have included references although the quality of these is sometimes uneven.

To give prospective readers a flavour of the second volumes, the topics covered may be summarised as follows: Surveys of: techniques for software validation, micro-computer database systems, microprogram assemblers for bit-slice processors, microcomputer architectures related to software.

Tutorials on: Structuring Basic software for commercial applications, A simple microprocessor task monitor, Communicating sequential processes, Forth, BCPL, Measures of programmer productivity.

Assessments of: Portability achieved with MicroCobol, Automatic assembler generation, Software used in two Post Office Microprocessor applications, Present micro software and future trends.

Conclusions

- For those with some knowledge of the field, the first volume represents a useful distillation of microprocessor software folklore and experience.

- For such people, the surveys and tutorials of the second volume may be of less relevance.

- For the novice prepared to work and follow up the many references, both volumes should be good source books even though some of the material is already becoming dated.

- Infotech reports are notoriously expensive; while anyone seriously interested in the development of micro-computer software may wish to consult these volumes for reference, their uneven quality makes the case for individual rather than institutional purchase dubious.

Cornelia Boldyreff

Computer consciousness: surviving the automated 80s

By H D Covvey and N H McAlister. Published by Addison-Wesley. 212 pages paperback. Price £3.85. Available from any bookseller. ISBN 0 201 01939 6.

THIS BOOK is intended for intelligent readers, possibly professionals in medicine, law or business, who want to learn about computers and automation but who have no desire to enter the computer industry or to learn how to program.

As computer systems become increasingly widely used, an increasing number of people need to understand what the new technology is about — this book should help them.

Without that understanding, people risk being overtaken by more enlightened competitors; they may be exploited by unscrupulous salesmen or ruined by incompetent consultants; they may feel threatened and not know how to fight back.

Knowledge is power, whether you are struggling to retain your company's share in a diminishing market or arguing with the accounts department of a local bureaucracy.

Computer consciousness is an attempt to explain what computers are, how they work and what they can do, in simple terms. The authors are researchers in medical computing, working at the University of Toronto, Canada, and Toronto General Hospital.

This book is not another set of predictions of the likely impact of microprocessors on society — it is more useful than that. It is a genuine overview of computers, computer systems, software and communications for the interested and intelligent outsider.

Reading the book will not make anyone a computing expert, but it will certainly help the layman to understand the potential of computer systems and their limitations, the possible benefits and the likely costs.

Also, and importantly, the reader will learn about the jargon which can be so intimidating until you realise how trivial and ill-formed most of it is.

Much of the ground covered by the book is included in computer awareness courses in enlightened secondary schools. Nevertheless many teachers, faced with the imminent arrival of a microcomputer, will find a valuable and inexpensive introduction to what may be an unknown subject.

The business user too, will

find the book a useful alternative to the wide range of material published. There are omissions, inevitably, and the emphasis is almost wholly on computers as free-standing systems rather than as embedded components providing flexible control elements in automatic machines and instruments.

Even so, *Computer consciousness* provides a useful, readable and inexpensive overview, just as the authors intended. Readers looking for a more radical and polemical introduction to the subject, are strongly recommended Theodor Nelson's book *Computer lib*, ISBN 0 89347 002 3.

Conclusions

- Recommended to complete newcomers to computing who want an overview of computer systems, hardware and software, communications, applications, risks and benefits.

Martyn Thomas

Pascal programming structures: an introduction to systematic programming.

By George W Cherry. Published by Reston Publishing Company, Inc, a Prentice-Hall Company, at \$8.40 paperback, \$11 cloth, 1980.

IT IS an excellent introductory textbook on Pascal programming written by psychologist and computer scientist, George W Cherry. The constructs of the Pascal language are nicely developed by Cherry as a vehicle for his introduction to systematic programming.

The text which is devoted to presenting the language is very clearly written and Cherry takes great pains to equip the reader with a carefully-developed model of how the language is compiled and programs are executed.

His explication of Pascal syntax is particularly thorough. Cherry points out in his preface:

It is gratuitous frustration for a student to wrestle with a malfunctioning program because his textbook failed to elucidate some syntactical banana peel it's easy to slip on.

The author appeals to both the proposed British Standards Institution/International Standards Organisation draft standard and the *de facto*

standard of Jensen and Wirth. In asides, he interjects comparisons with the U.S. Department of Defence-sponsored language, Ada.

In the programming sections, Cherry warns against the dangers of "side-effects", advocates "information hiding" and shows how to control "power of access". The programming examples derive from problems in fields as diverse as chemistry, psychiatry, information theory and typesetting. In fact, the author prepared the book himself on his personal micro-computer.

Occasionally, the author's style jars; for example, consider:

Before we describe these new facilities, let's motivate their introduction.

My only major criticism of the book is that in some of the example programs, the rigour advocated in the text is not apparent. For example, Cherry's use of subrange data types does not always reflect characteristics of the data.

Cherry is better at describing the syntax of Pascal with the aid of Extended Backus Naur Form than the semantics. He confuses pragmatic issues with semantic ones. Lay-out of programs may make the semantics clearer but it is certainly not a semantic issue. Perhaps it is because we are still lacking in a popular, widely-known and conveniently-used notation for describing semantics that the book fails in this area.

Those are small points and in no way would I wish to deter readers from what is one of the most accessible books on Pascal.

Conclusions

- An excellent text on Pascal programming which gives readers a firm grounding in principles.

- The book is an ideal introduction to the more advanced textbooks written on programming by Wirth, the inventor of Pascal.

- Highly recommended for self-study by the hobbyist who wishes to learn Pascal for "cultural reasons" and who should find its informal style a welcome relief from the more academically-orientated textbooks. Cornelia Boldyreff

WOULDN'T YOU LIKE AN OSCAR FOR A SUPERB PERFORMANCE



To a casual glance, we must admit that there are several other computers which superficially resemble OSCAR. However, if you peek under the stylish structural foam housing, with its separate keyboard for better ergonomics, you'll notice the differences.

S100 SYSTEM

OSCAR has a 6-slot motherboard, housed inside the VDU housing, with proven IDS S100 cards to international standards for a flexible, easily maintained, system.

4MHz Z80A PROCESSOR CHIP

Possibly the most powerful m.p.u. chip in its class, running at full speed, makes OSCAR more powerful than many mini-computers.

64K DYNAMIC MEMORY

A full sized system for your full sized applications.

DISKETTE OR HARD DISK

The options are yours, starting with twin floppies at 400KBytes per drive or an 11MBytes Winchester located inside the VDU housing.

Maximum size? We're not saying, as we keep on increasing it, but it's unlikely to be too small.

CP/M™ OPERATING SYSTEM

Use of the industry standard CP/M™ Operating System means that a wealth of applications software will run on your OSCAR.

VISUAL DISPLAY UNIT

With the green phosphor recommended by opticians for low eyestrain, the VDU also has a bonded face-plate for extra safety. There is a full character set with real descenders on the lower-case letters. There are 24 lines each of 80 characters.

KEYBOARD

Separate keyboard with full QWERTY and numeric pad for fast entry.

PRINTER OPTIONS

A range of printers is available. Your dealer can help you select the appropriate one for your requirements.

APPLICATION PROGRAMS FREE

Sales, Purchase and Nominal Ledgers plus Stock Control and Payroll are available from your dealer and to avoid the problems of pirating, all you have to pay for are the manuals and the media. If these packages do not suit, your dealer will be able to offer alternatives, although, these are unlikely to be free!

NATIONAL SERVICE NETWORK

It's no good owning the best system if you can't get it mended, so IDS have arranged for a National Service Network to offer maintenance contracts on your OSCAR.

PRICE

An OSCAR with twin floppies costs from £2,495.00 (excluding VAT and printer)

NOW

Cut along this line, complete and post for further details.

Designed and manufactured in the United Kingdom by:-

INTERACTIVE DATA SYSTEMS LTD.

14 Heathfield, Stacey Bushes, Milton Keynes MK12 6HP
Buckinghamshire, England
Telephone (0908) 313997

Please send details of OSCAR and your other S100 products to:

Name _____

Position _____

Address _____

Company _____

PC4/81

• Circle No. 174

**Comart Approved
Dealers**

Belfast

O & M Systems
95 Dublin Road
Tel: 0232 49440

Birmingham

Byteshop Computerland Ltd
94/96 Hurst St, B5 4TD
Tel: 021 622 7149

Cambridge

Cambridge Computer Stores
1 Emmanuel St, CB1 1NE
Tel: 0223 68155

Cornwall

Benchmark Computer
Systems Ltd
Tremena Manor
Tremena Road
St Austell, PL25 5GG
Tel: 0726 610000

Dublin

Lendac Data Systems Ltd
8 Dawson St
Tel: 0001 372052

Glasgow

Byteshop Computerland Ltd
Magnet House
61 Waterloo St, G2 7BP
Tel: 041 221 7409

Leeds

Holdene Ltd
Manchester Unity House
11/12 Rampart Road
Woodhouse St
Tel: 0532 459459

London

Byteshop Computerland Ltd
324 Euston Road
London W1
Tel: 01-387 0505

Digitus

9 Macklin Street
Covent Garden WC2
Tel: 01-405 6761

Jarrogate

67 Tulsemere Road,
West Norwood,
London SE17
Tel: 01-670 3674

Manchester

Byteshop Computerland Ltd
11 Gateway House
Piccadilly Station Approach
Tel: 061 236 4737

NSC Computers

29 Hanging Ditch
Tel: 061 832 2269

Newbury

Newbear Computing Store
40 Bartholomew St
Tel: 0635 30505

Nottingham

Byteshop Computerland Ltd
92A Upper Parliament St,
NG1 6LF
Tel: 0602 40576

Sheffield

Hallam Computer Systems
451 Eccleshall Road, S11 9PN
Tel: 0742 663125

Southampton

Xitan Systems
23 Cumberland Place,
SO1 2BB
Tel: 0703 38740

Sudbury

Eurotec Consultants
Holbrook Hall
Little Waldingford
Tel: 0206 262319

Warwicks

Business & Leisure
Microcomputers
16 The Square
Kenilworth
Tel: 0926 512127

Watford

Lux Computer Services
108 The Parade
High Street
Watford WD11 2AW
Tel: 0923 29513

Comart Microcomputer dealers
are located strategically
throughout the country to give
support, guidance and
assistance. In the event of
difficulty contact Comart direct.

 **Cromemco**



Flexibility + Versatility

System Flexibility

Cromemco give you the high performance, reliable computer power you need now, with the in-built capability for future expansion and adaption as demands and requirements change.

The choice is wide. Cromemco's S-100 bus construction provides for expandable memory capability and the widest choice and future options in peripheral support.

Now there is the exciting range of Cromemco High Resolution Colour Graphics Systems.

Applicational Versatility

Cromemco's CDOS Operating System supports proven, well documented Software for Business, Industry, Science, Research and Education; COBOL, RPG II, Macro Assembler, 16K and 32 BASIC, FORTRAN IV, LISP, RATFOR, Word Processing and Data Base, are all included in the range.

Now, there is the new CDOS compatible, Cromix Multi-user Multitasking Operating System which opens up new avenues in application and performance for Cromemco System Users.

The U.K. Leaders in Microcomputer
Development, Application and Support.

comart

St Neots HUNTINGDON Cambs PE19 2AF
Tel (0480) 215005 Telex: 32514 Comart G.

• Circle No. 175

SUN

NOW THE INTEGRAL SYSTEM WITH PERFORMANCE, QUALITY, EXPANDABILITY & RELIABILITY; ESSENTIAL FOR A BUSINESS SYSTEM.

FULL 12 MONTHS WARRANTY



ABC 24:— 620K BYTES ON DUAL MINI FLOPPY DISKS

ABC 26:— 2.3 MBYTES ON DUAL 8 INCH FLOPPY DISKS

LOOK AT THESE STANDARD A1 FEATURES, INCLUDED IN THE PRICE:

- * DOSKET OPERATING SYSTEM
- * FORTRAN IV
- * UTILITIES
- * DIAGNOSTICS
- * BASIC INTERPRETER/COMPILER
- * Z80 ASSEMBLER
- * LIBRARY
- * EDIT (& MORE)

HARDWARE

- * 64K BYTES RAM
- * REAL-TIME CLOCK (INTERVAL TIMER)
- * GREEN SCREEN
- * SEPARATE KEYBOARD
- * SECURITY LOCK
- * HARD DISK AVAILABLE
- * MULTI USER HARD DISK AVAILABLE SOON
- * SEPARATE SCREEN BUFFER
- * IEEE 488 INTERFACE BUS
- * LARGE GRAPHICS SET
- * 12 FULL RS232 PORTS
- * 16 SEPARATE USER DEFINABLE KEYS
- * DMA FOR HARD DISK ATTACHMENT

A1 ELECTRONICS ABC 26 £4750 A1 ELECTRONICS ABC 24 £3350

OPTIONAL SOFTWARE

- * CP/M £150
- * SALES LEDGER £200
- * PURCHASE LEDGER £200
- * NOMINAL LEDGER £200
- * STOCK CONTROL £200
- * WAGES/SALARIES £200
- * ABOVE INTEGRATED PACKAGES £800
- * WORDSTAR & MAILMERGE £350
- * ISR DATABASE £400

ALL WITH SUPPORTING DOCUMENTATION AND LICENSING AGREEMENTS.

ALL PRICES EXCLUDE VAT

BY APRIL 1981, A NATIONAL DEALERSHIP NETWORK, WILL BE OPERATIVE FOR THIS POWERFUL MACHINE. IF YOU ARE AN ESTABLISHED & PROFESSIONAL DEALER, WISHING TO APPLY, PLEASE CONTACT:

SUN Computing Services Ltd

138 Chalmers Way
North Feltham Trading Estate

Feltham
Middlesex

TEL. 01-751 5044 TWX 8954428 SUNCOM 6

ONYX



ONYX C8000 SERIES

Onyx Distribution Limited
Unit 58, Suttons Park Avenue,
Earley, Reading,
Berks RG6 1A7
Tel: (0734) 664343/4/5/6

ONYX Distribution Limited

Description

The C8000 range are a powerful Z-80*/Z-8000* based microcomputer systems which incorporates a high performance rigid disk, advanced processor and memory design, and high density cartridge tape drive in a contemporary low profile enclosure designed for the office environment.

The C8000 range will simultaneously support a full range of standard peripherals, including a systems console, serial and parallel printers and most modems.

Features

C8001/C8001 MU

4MHz Z80A* CPU with 158 instructions including memory block transfer, I/O block transfer and 16 bit arithmetic.

The C8001 supports 64Kbytes and the C8001 MU 128 or 256Kbytes of dynamic RAM using 16k chips with parity to ensure data integrity. The C8001 MU is addressable in 64k arrays comprised of 4 16k segments selected through a unique design which predefines the most common combinations of shared and independent memory banks. Boot strap and self test diagnostics reside in ROM which is mapped out after initialisation.

Two full duplex RS232 ports are provided on the C8001 and five on the C8001 MU, all ports are fully programmable from 50 to 35.4 Kbaud.

An alternate modem port is capable of supporting most synchronous and asynchronous modems. Baud rate is programmable and synchronisation mode selectable.

8bit bidirectional port with 6 handshake lines. Which can be configured as an industry standard (Centronics) printer or a high speed DMA channel.

General purpose DMA controller speeds disk transfers to memory and through the parallel port.

C8002

Z8002* advanced 16bit processor features more than 100 distinct instructions, 8 addressing modes and 7 data types including BCD, string and long word (32bits). Other features include general purpose registers separate instruction and data spaces, privileged instructions and 3 types of interrupt modes.

Memory management controller enables the C8002 to perform address translation, memory block protection and separation of instruction and data spaces. The MMC generates a 20bit address allowing the C8002 to address 1Mbyte of RAM.

A special purpose DMA channel transfers data from main memory to the mass storage controller, and may also be used for memory to memory and I/O transfers.

Hardware floating point processor accessible by the Z8002* is capable of 64bit floating or fixed point arithmetic. The mass storage controller increases throughput by relieving the main processor of all disk and tape control functions. The controller is built around a Z80A*, 64Kbytes of RAM, disk and tape control circuitry, and a DMA channel.

DISK

Eight-inch disk drive with a capacity of 10 or 18 Mbytes expandable to 76 Mbytes. All disk components operate in a sealed enclosure making the drive impervious to the external environment and eliminating the necessity of preventative maintenance. The high performance servo mechanism performs one-track seeks in less than 8ms. Average access time is 35ms and average rotational latency is 8.3ms. Data transfer rates from the drive to the mass storage controller are accomplished by DMA at a rate exceeding 640Kbytes per second.

TAPE

The cartridge tape drive can back up more than 8 Mbytes in less than 15 minutes. The drive employs read after write and CRC checks to ensure data integrity.

OPERATING SYSTEMS AND SOFTWARE

C8002

Version 7 of Bell Labs UNIX* operating system has been adapted for the C8002 and renamed ONYX. Except for a rewritten nucleus and several new compilers, ONYX is exactly the same as Western Electric licenses for sale on the DEC PDP 11 family. ONYX is simple, flexible and easy to use.

All of the Version 7 UNIX* utilities as well as ONYX developed utilities are supplied in binary form. These include:

The shell, or command language interpreter.

C compiler and debugger
Line orientated Text Editor
Screen Editor
NROFF/TROFF
Z8000 Assembler
Compiler Compiler (YACC)
Sort/Merge

Available on ONYX are the most widely available programming languages:

CBASIC 2*
COBOL (ANSI 74, LEVEL 2)
FORTRAN (ANSI 77)
UCSD PASCAL*
MUMPS

C8001/C8001 MU

The C8001 is available with either OASIS*, CP/M* or MP/M* operating as well as a variety of industry-standard language products.

OASIS* features re-entrant NUCLEUS, SPOOLER, ISAM files and editor as well as numerous system utilities, linking loader and macro assembler. A BASIC compiler capable of interactive interpretive debugging and fast compiled operation is also part of the package. Compiled programs may share the same re-entrant run time package allowing for shared file access, record lock and efficient process synchronisation.

CP/M* is the industry standard 8-bit operating system enhanced to take advantage of the high performance characteristics of the C8001.

MP/M* supports the same operating system functions as CP/M in a multiuser environment. Memory may be partitioned and completely separate and independent processes may run, sharing the processor resource as well as the disk and tape.

Onyx Distribution Limited
Unit 58, Suttons Park Avenue,
Earley, Reading,
Berks RG6 1A7
Tel: (0734) 664343/4/5/6

*Z8002 and Z80 are trademarks of Zilog Inc. CBASIC 2 is a trademark of Compiler Systems. UCSD PASCAL is a trademark of Softech Microsystems. OASIS is a trade mark of Phase One Systems Inc. CP/M and MP/M are trademarks of Digital Research Inc. PDP-11 and DEC are trademarks of Digital Equipment Corporation. UNIX is a trademark of Western Electric.

BUILDING RAMS?

Why waste time hand-wiring RAMs? This 5.3 x 2.5 inch professional plated thru PCB mounts on your prototyping board, looking like an 8K byte TTL compatible static RAM. 13 address lines, 8 data I/O, write enable, 2 neg and 1 positive card selects.

Assembled with sockets, pins and caps, just plug in 16 2114's and 1 74LS138 £21. Bare board £15, no VAT, post paid.

Ibix Electronic Design,
56H Norris Hill Drive,
Heaton Norris,
Stockport,
Cheshire.

• Circle No. 178

PAPER

at less than half other prices!!!

11" x 9 1/2" £17.00

for minimum of 2000 sheets

(Price includes VAT and P(P))

TR Computer Systems

5 Grasmere Grove
Burlish Park Estate
Stourport-on-Severn
Hereford & Worcs. Tel: (029 93) 78146
(Terms strictly cash with order)

• Circle No. 179

TRS-80 LII Tape Software

Duplicate copies and improves any LII program

It actually improves copies and makes unreliable tapes load perfectly

Copies any length program, even on a 4K machine

Make back-up copies of adventure etc.

£9.50

from

ALBION SOFTWARE
LAMMAS ROAD, LONDON E10
or SAE for more details

• Circle No. 180

APPLE II/ITT 2020

VISICALC BACK-UP

A specially formatted Disk to enable you to take a back-up copy of your Visicalc Master Disk. Can also be used to store formats/worksheets £16.00

AUTO-INDEX

Master Catalog Program featuring fully automatic updating facility and comprehensive edit and search routines requires 48K and one Disk drive £18.00

DATABASE

Database System using specially formatted Disks and custom-written routines to give fast search and retrieval and offering similar facilities to systems costing around a hundred pounds. Introductory price £39.95

RELOCATED INTEGER

Enables any Integer Program to run without an Integer Card. Includes mini-assembler and now DOS 3.3 compatible. Specify memory size when ordering.

Cassette Systems £12.00 Disk Systems £14.00

*** TRADE ENQUIRIES INVITED ***

D. J. BOLTON

1 Branch Road, Park Street, St Albans
Tel: Park Street (0727) 72917

• Circle No. 181

Solutions which reveal elegant face of recursion

NO DOUBT the title of Boris Allan's article about recursion, *Recursion is highly wasteful and seldom truly needed*, in the December 1980 issue was intended to be inflammatory, and I certainly found it so as an admirer of recursive algorithms.

I thought, however, that I would have to concede that recursion is wasteful in

recursive and thinks that it is seldom needed.

I intend to show that this example program belongs to a special class or

by Ian Glendinning

recursive routines which is in no way general. Consider procedures with the general form:

```
PROCEDURE A(N: INTEGER; ...);
BEGIN
  IF N=0 THEN
    ...
  ELSE
    BEGIN
      A(N-1, ...);
      A(N-1, ...);
    ...
  (* R RECURSIVE CALLS *)
  END
END;
```

Consulting the recursive solution of the Towers of Hanoi that I provide, you can see that it falls into this class and contains two recursive calls. The structure of the calls on execution can be represented on a tree diagram as shown in figure 1 for N=3.

This is a binary tree because R=2 for the Hanoi problem, and if each left and right branch is labelled 1 and 0 respectively, each terminal node at the bottom is identified by a three-digit binary number which consists of the digits passed on traversing the tree to arrive there. Notice that the binary numbers at the terminal nodes increase by one from right to left — in the order of execution of the calls. Each level of the tree represents another recursive call and, taking the left or right branch, indicates which of the two calls in the procedure is then taken.

Hence, what has happened is that in this special case, the stack of return

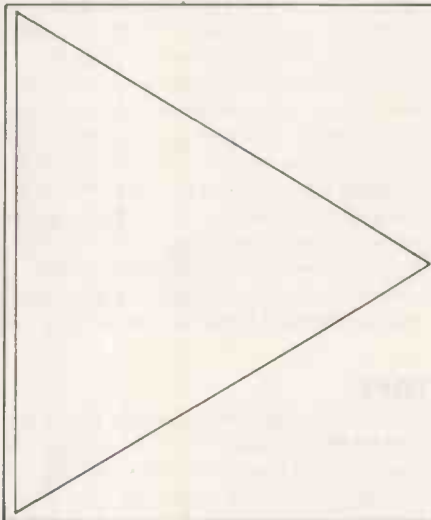
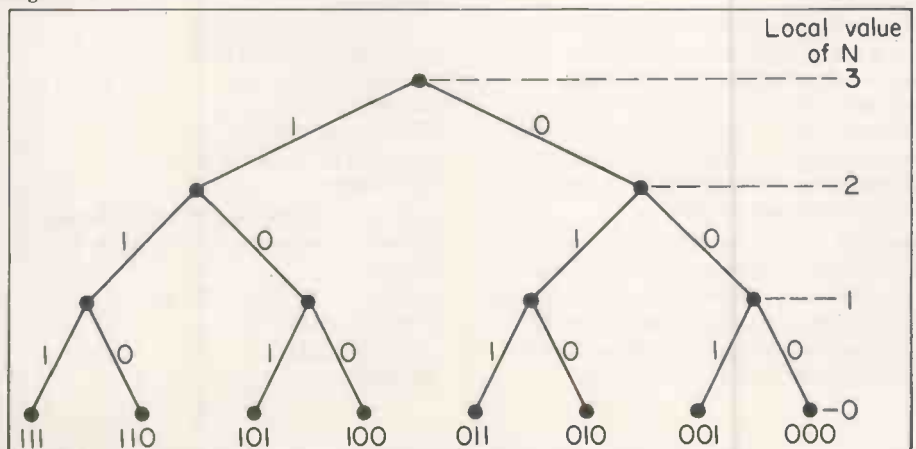

Figure 2.

some cases if a large stack is generated, but his most ingenious algorithm for the Towers of Hanoi problem made me think and do some tests which showed this not to be the case in realistic situations. I now stand an even firmer advocate of recursion.

Recursion is implemented by pushing return address and local variables on to a stack, so it can always be implemented in Basic using an array and some statement such as GOTO N where N is a variable or ON I GOTO for the return. I take it that Allan classes this kind of solution as

Figure 1.



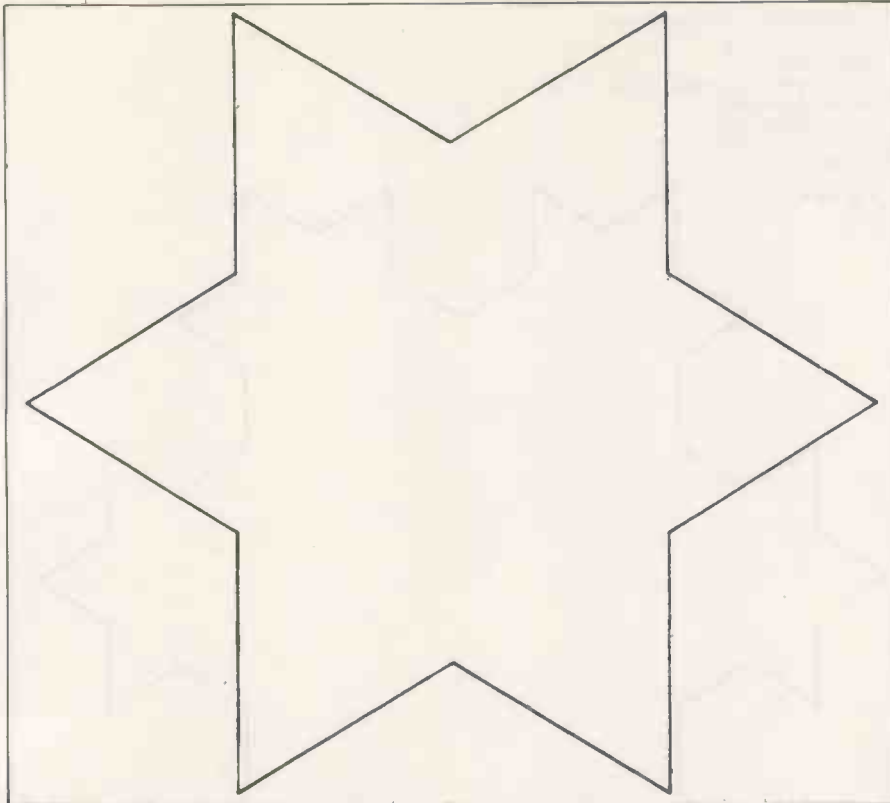

Figure 3.

addresses may be represented by a binary number. If a procedure has R recursive calls, its tree will have R branches at each node, so its stack can be represented by a number to base R. Each digit position refers to the depth of call and the digit at that position refers to the call active at that level. Notice that the depth of recursion, i.e., the number of levels of the tree or the number of digits in the base R number, cannot exceed the value of N in the initial call. So, if N is small, a large stack will not be generated. This is usually the case.

Iterative method

Using these ideas, it is possible to re-write simple recursive programs iteratively. The listing is a recursive Snowflake-drawing program together with example plots, figures 2 to 7, and there are two slightly different iterative solutions — one a little less efficient than the other.

I have run the programs on the University of Manchester Regional Computing Centre UMRCC, CDC Cyber 170/720 and obtained the following results for fifth-order curves.

	Compile time/s	Run time/s	Core used/Octal words
Flake 1	0.755	3.083	13772
Flake 2	0.982	3.353	14124
Flake 3	0.988	5.146	14130

Flake 3 is programmed less efficiently, but comparing 1 and 2, we see that the recursive version, 1, is faster in execution. Compile time and core comparisons are slightly unfair because an extra routine to perform $4^{**}N$ was included in Flake 2 due to the lack of exponentiation in standard Pascal, but this certainly shows the insignificant size of the stack in Flake 1.

I think I have shown that recursion is not highly wasteful and that, unless Allan can produce some more general iterative solutions, recursion is not seldom needed. I would certainly be interested to see him write an iterative treatment of a program to deal with data that is itself recursively defined, a parser, syntax analyser, for the language Pascal for instance.

Such matters aside, I still think recursion is highly elegant and much more comprehensible and transparent once one is familiar with it. Writing programs this way is not only satisfying to one's self, but to those others who have to understand them.

```

00100 PROGRAM HANOI (INPUT/.OUTPUT.);
00110 TYPE PEG=0..2;
00120 VAR N : INTEGER;
00130 PROCEDURE MOVEDISCS(N: INTEGER; FROM,ONTO: PEG);
00140 BEGIN
00150 IF N=1 THEN
00160 WRITELN('MOVE TOP DISC FROM PEG ',FROM:1,' ONTO PEG ',ONTO:1);
00170 ELSE
00180 BEGIN
00190 MOVEDISCS(N-1,FROM,3-ONTO-FROM (*OTHER PEG*));
00200 WRITELN('MOVE TOP DISC FROM PEG ',FROM:1,' ONTO PEG ',ONTO:1);
00210 MOVEDISCS(N-1,3-ONTO-FROM,ONTO);
00220 END
    
```

(continued on next page)

Super
Machine
Code
Word
Processor
£35 + VAT



All you'd expect in a £75-£150 program, PLUS redefine keyboard, auto repeat, tape or disk files, old & new ROMs, PET or ASCII printer, AND 80 column PETS. No need to change when you upgrade. We didn't believe it either! £35 tape can be saved to disk, has 80-column mod listing. £37 disk includes sample files plus full 80-column version.

LIGHT PEN + SOFTWARE — plugs in. £22

PROGRAMMER'S TOOLKIT — 16/32K new ROM: makes programming less like work! £29

ADVENTURE 1 & 2: authentic Scott Adams 24K classic games. Each £7 (both, £13)

FANTASTIC MUSIC MACHINE: hardware + software to write music on your PET and see it play. Add small speaker or play through hi-fi. 4 voices. Transpose, change tempo, repeat segments etc just by typing a row of characters. Save music to disk or tape. Beautifully simple: write tunes within minutes! Old & new ROMs, 8-32K. £37 complete.

Add VAT to all prices please, but post/insurance included. Unconditional Instant Refund Guarantee on hardware, also software if not up to description. Write for more details, more items.

SIMPLE SOFTWARE LTD
15 HAVELOCK ROAD
BRIGHTON, SUSSEX BN1 6GL
(0273) 504879



• Circle No. 182

MICROCASE "turns a board into a real computer"
For NASCOM 2
COMPUKIT
SUPERBOARD
ALSO UNCUT FOR NASCOM 1
ETC.

Direct from us or from your dealer —
but make sure you see a
GENUINE MICROCASE

SIMPLE SOFTWARE LTD
15 HAVELOCK ROAD
BRIGHTON, SUSSEX BN1 6GL
(0273) 504879



• Circle No. 183

SUPERBOARD II

STILL the best value in home computers. Just compare the features:

- 8K floating point BASIC in ROM
- Full ASCII keyboard
- Standard cassette/TV interface
- RS232 printer interface
- 4K user RAM
- Expandable to 32K and dual mini-floppy
- Full range of OHIO Computers carried.

AVAILABLE NOW FROM:
C.T.S.

31/33 Church Street
Littleborough
Lancs OL15 8DA

PLEASE RING OR WRITE FOR
LATEST PRICES

Tel: Littleborough (0706) 74342
or 79332 any time

• Circle No. 184

NASCOM GRAPHICS

THE 10 GRAPHICS BOARD

VERY HIGH RESOLUTION FOR NASCOM 2

380 x 220 individually addressable points

FEATURES:

- fully bit mapped from dynamic RAM
- software controlled
- software supplied for point-plot, line-draw, block-shading and display control
- mixed text and graphics
- real time plotting from ASSEMBLER
- real time plotting from BASIC with NAS-SYS-3
- BASIC plot-then-display with other monitors
- display size variable to suite memory available (approx 10k reqd for full screen)
- professional double-sided PDB
- built & fully tested with plug, socket and cable
- comprehensive documentation with full instructions for simple installation

Price

£55

+ 15% VAT (post free)

Send SAE for free data sheet

AVAILABLE NOW direct from:

IO SYSTEMS LTD

6 LALEHAM AVE., MILL HILL
LONDON NW7 3HL Tel: 01-959 0106

• Circle No. 185

AT LAST FUNCTIONAL TRS 80 BUSINESS PROGRAMES 16K.LII

for cassette

"Most Impressive" is the report of users. In use by many businesses & University Authorities.

Some Examples

BANK A/C PROGRAMME

22 Column analysis, self totaling on all columns. Keeps full alpha & numeric records. At command shows 17 monthly & yearly Totals to date, including Partners drawings, Total O'heads etc. £21.95

Sales Ledger

Full record up to 17 entries for each invoice. Totals 8 columns, searches & totals Individual accounts at will, also weeks sales, months individual heading totals, agents sales & displays entire records page by page. £21.95

MAILING LIST

Searches by Name, Town, County & code no. which can be used to create your own reference system. Search by name Does Not Require Exact Spelling To Find. £9.95 All programs are menu driven needing no operator expertise. Most responses require only single keystrokes. Operator errors are correctable. Custom Software. NEW! New range of terrific animated Games, Not Imported. P&P Inclusive.

ACCESS COMPUTERS 2 Rose Yard, Maidstone, Kent ME14 1HN. Tel: Maid. (0622) 58356

• Circle No. 186

BOOK-KEEPING for ACCOUNTANTS & TRADERS

Purchases Day Book, Sales & VAT to run on a 32K PET.

Neat, Clear and Comprehensive Printouts. Error-proof, Fast & Easy to operate.

Computes all NINE Retailer Special VAT Schemes.

Box 11 & 12 amounts and End of Year adjustments, etc.

100 Expense analysis + Goods at Zero and Std. Rates.

100 Supplier analysis.

Approved by Customs and Excise.

Only **£250**

For further details and sample printout

E. Stanton MBIM, 86 Bracken Drive, CHIGWELL, Essex IG7 5RD

Tel. 01-500 4318 or 01-505 7830

• Circle No. 187

(continued from previous page)

```
00230 END;
00240 BEGIN
00250 WRITELN('HOW MANY DISCS');
00260 READLN;
00270 READ(N);
00280 MOVE(N*0.1)
00290 END.
```

Figure 4.

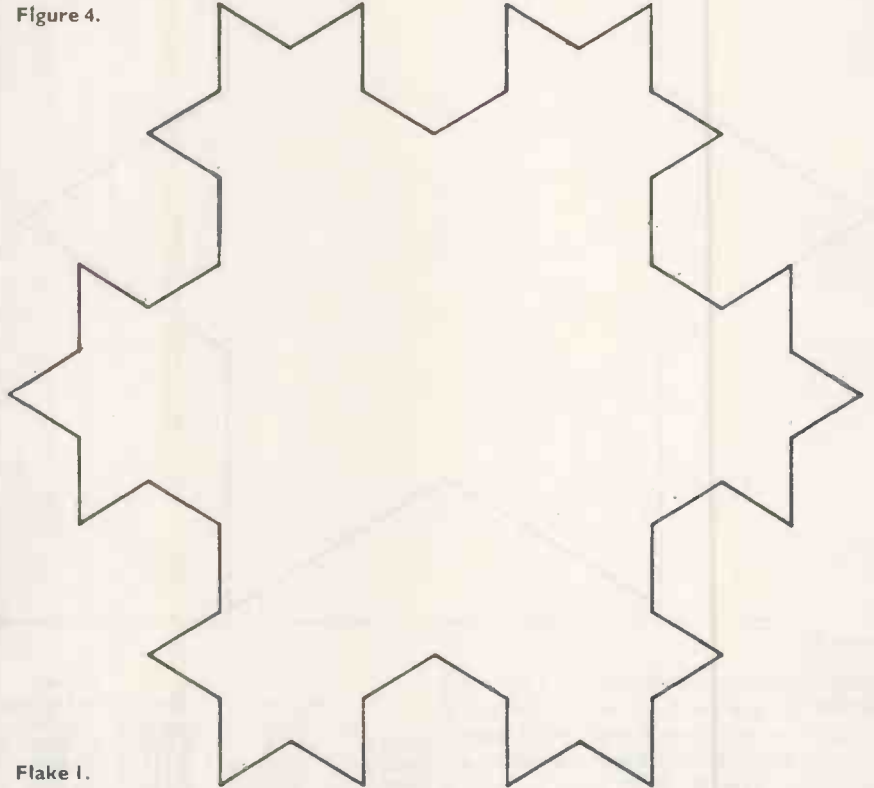

Flake 1.

```
00100 (*$w10000*)
00110 PROGRAM FLAKE(INPUT,OUTPUT);
00120 CONST PICWID=184; (* SCREEN WIDTH *)
00130 PICHIG=140; (* SCREEN HEIGHT *)
00140 MAXORDER=5; (* MAXIMUM CURVE ORDER *)
00150 VAR ORDER: INTEGER;
00160 INC,X,Y,INITX,INITY,PI: REAL;
00170 (* GINO GRAPHICS DECLARATIONS *)
00180 PROCEDURE T4010: FORTRAN; (* DEVICE IS TEKTRONIX 4010 *)
00190 PROCEDURE PICCLE: FORTRAN; (* CLFANS SCREEN *)
00200 PROCEDURE MOVTO2(X,Y: REAL); FORTRAN; (* ABSOLUTE MOVE *)
00210 PROCEDURE LINTO2(X,Y: REAL); FORTRAN; (* ABSOLUTE DRAW *)
00220 PROCEDURE CURVEF(CH: CHAR); FORTRAN;
00230 PROCEDURE CURSOR(I: INTEGER); FORTRAN;
00240 PROCEDURE DEVEND: FORTRAN; (* END DRAWING *)
00250 (* PROCEDURE TO DRAW A KOCH CURVE OF GIVEN ORDER
00260 AT A GIVEN ANGLE TO THE HORIZONTAL *)
00270 PROCEDURE KOCH(ORDER: INTEGER; ANGLE: REAL);
00280 BEGIN
00290 IF ORDER>0 THEN
00300 BEGIN
00310 KOCH(ORDER-1,ANGLE);
00320 KOCH(ORDER-1,ANGLE+60);
00330 KOCH(ORDER-1,ANGLE-60);
00340 KOCH(ORDER-1,ANGLE)
00350 END
00360 ELSE
00370 BEGIN
00380 X:=X+INC*COS(ANGLE*PI/180);
00390 Y:=Y+INC*SIN(ANGLE*PI/180);
00400 LINTO2(X,Y)
00410 END
00420 END;
00430 BEGIN
00440 PI:=4*ARCTAN(1);
00450 WRITELN('ORDER OF CURVE (0..MAXORDER:1..)');
00460 READLN;
00470 READ(ORDER);
00480 IF ORDER<0 THEN ORDER:=0;
00490 IF ORDER>MAXORDER THEN ORDER:=MAXORDER;
00500 INC:=3*PICHIG/(2*SQRT(3));
00510 INITX:=(PICWID-INC)/2;
00520 INITY:=PICHIG/4;
00530 INC:=INC/EXP(ORDER*LN(3)); (* IE INC/3**ORDER *)
```



```

00540 T4010;
00550 PICCLE;
00560 X:=INITX; Y:=INITY;
00570 MOVTO2(X,Y);
00580 (* DRAW TRIADIC KOCH ISLAND *)
00590 KOCH(ORDER,60); KOCH(ORDER,-60); KOCH(ORDER,180);
00600 CURDEF('A');
00610 CURSOR(ORDER); (* DUMMY CALL TO PAUSE FOR HARD COPY *)
00620 DEVEND
00630 END.
    
```

Figure 5.

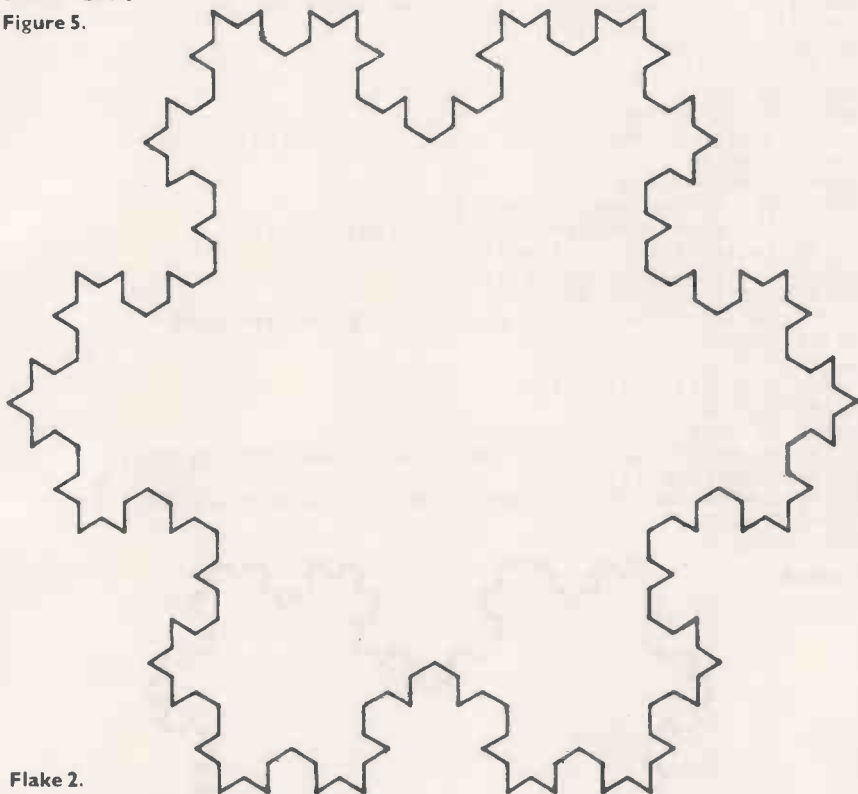

Flake 2.

```

00100 (*$W10000*)
00110 PROGRAM FLAKE(INPUT/.OUTPUT.);
00120 CONST PICWID=184; (* SCREEN WIDTH *)
00130 PICHIG=140; (* SCREEN HEIGHT *)
00140 MAXORDER=5; (* MAXIMUM CURVE ORDER *)
00150 VAR ORDER : INTEGER;
00160 INC,X,Y,INITX,INITY,PI : REAL;
00170 (* GINO GRAPHICS DECLARATIONS *)
00180 PROCEDURE T4010; FORTRAN: (* DEVICE IS TEKTRONIX 4010 *)
00190 PROCEDURE PICCLE; FORTRAN: (* CLEARS SCREEN *)
00200 PROCEDURE MOVTO2(X,Y: REAL); FORTRAN: (* ABSOLUTE MOVE *)
00210 PROCEDURE LINTO2(X,Y: REAL); FORTRAN: (* ABSOLUTE DRAW *)
00220 PROCEDURE CURDEF(CH: CHAR); FORTRAN:
00230 PROCEDURE CURSOR(I: INTEGER); FORTRAN:
00240 PROCEDURE DEVEND; FORTRAN: (* END DRAWING *)
00250 (* PROCEDURE TO DRAW A KOCH CURVE OF GIVEN ORDER
00260 AT A GIVEN ANGLE TO THE HORIZONTAL *)
00270 PROCEDURE KOCH(ORDER: INTEGER; ANGLE: REAL);
00280 VAR MOVE,DIGIT : INTEGER;
00290 THETA : REAL;
00300 FUNCTION FOUR(I : INTEGER): INTEGER; (* EXPONENTIATION
    NOT ALLOWED IN PASCAL *)
00310 VAR F : INTEGER;
00320 BEGIN
00330 F:=1;
00340 WHILE I>0 DO
00350 BEGIN
00360 F:=F*4;
00370 I:=I-1;
00380 END;
00390 FOUR:=F;
00400 END;
00410 BEGIN
00420 X:=X+INC*COS(ANGLE*PI/180);
00430 Y:=Y+INC*SIN(ANGLE*PI/180);
00440 LINTO2(X,Y);
00450 FOR MOVE:=1 TO FOUR(ORDER)-1 DO
00460 BEGIN
00470 THETA:=0;
    
```

(continued on next page)

Pet Owners.

Do You Gamble? YES!

Settle your bets correctly with "Settler". The program written for you by Bookmakers. Single, Double, Treble, Yankee, Canadian, Heinz, etc (win or place). 8K version £8.75 inc p&p. 32K professional version £19.50 inc p&p.

HURST COMPUTER SERVICES,
46 GUILDHALL STREET,
FOLKESTONE, KENT.
TEL FOLKESTONE (0303) 54653.

• Circle No. 188

apfelddeutsch

A Complete New Computer-Driven Home Study Course in German

9 Apple/ITT Diskettes 6 Audio Cassettes
Textbook with illustrations (206 pages)
Workbook - 250 pages Beginners to post O-Level.
Introductory Offer (till 30 June)
£99 excl. VAT

Classroom version (full sets of textbooks) also available. Try us for single disks of testing routines. Send for Details to:

WIDA Software
2 Nicholas Gardens, London W5 5HY
(01)-567-6941 or (062)-882-5206

• Circle No. 189

COLCHESTER

APPLE
NEWBRAIN - UK sale
SHARP &
TANDY PKT, I, II hire
VIDEO GENIE

Printers and Accessories
Electronic Components
Secondhand Computers etc
eg Centronics 702 £450
Ample parking

EMPRISE
(0206) 865926

58 EAST STREET
COLCHESTER
near ROSE & CROWN

• Circle No. 190

LINCOLNSHIRE APPLE DISTRIBUTORS

Stocks of Apples and most accessories Texas, Qume & Paper Tiger Printers 8" Discs, Corvus Disks for Apples.

SOFTWARE

Financial Planning Databases Mailing Visicalc Accounts Word Processing. Also the well known "Estate Computer Systems" Estate Agents Package in use throughout the U.K.

ESTATE COMPUTER SYSTEMS
30 Carre St., Sleaford, Lincs.
Tel: (0529-305637)

• Circle No. 191

ZX80

LEARN QUICKLY WITH

PROGRAM INTERCHANGE CLUB

£1.00 tape and 50p manuscript exchange. Increase your program library fast, by joining P.I.C. Tape or manuscript program interchange service — programming aids — binders — indexes — free competitions for Club members.

Send cheque/postal order £5.00 annual membership — rules — full details and free samples — payable to:-

PROGRAM INTERCHANGE CLUB



2 NEWTOWN
CHICHESTER
WEST SUSSEX PO19 1UG
DEPT 093

• Circle No. 192



Microcomputers are coming — ride the wave! Learn to program with a new course written for the beginner. Learn BASIC — the language of the small computer and the most easy-to-learn computer language in widespread use. A self-instruction course which takes you from complete ignorance step-by-step to real proficiency with a unique style of graded hints. 60 illustrated lessons teach the five essentials of good programming: problem definition, flow-charting, coding the program, debugging, clear documentation. And you don't even need a computer!

PRICE £10.00 (inc. P&P)

Send cheque with order to Cambridge Learning Limited, Unit 61 Rivermill Site, FREEPOST, St. Ives, Huntingdon, Cambs. OR phone 0480-67446 with Access, Barclaycard, or other credit card details.

Cambridge Learning Limited

• Circle No. 193

UK101/SUPERBOARD EXTRAS

48 x 30 VIDEO DISPLAY. ONLY £15
2K VIDEO RAM. COMPLETE KIT, INSTRUCTIONS ETC. CEGMON MONITOR FOR ABOVE £29.50 OR BOTH £40

16K MEMORY EXPANSION KIT.

8K. RAM + 8K. EPROM COMPLETE KIT WITH 4K RAM £40

2114L 450NS £2.15 2716 5v £6

48 x 30 SOFTWARE. SAE FOR FREE PROGRAMME.

NEW SUPERBOARDS at LOWEST PRICES.

CONTACT US NOW. TEL. HOLMFIRTH (0484 89) 2062

NORTHERN MICRO

29 Moorcroft Park, New Mill, Huddersfield.
PLEASE ADD 15% VAT + 40p P+P

• Circle No. 194

(continued from previous page)

```

00480     FOR DIGIT:=0 TO ORDER-1 DO
00490         CASE (MOVE DIV FOUR(DIGIT))MOD 4 OF
00500             0:
00510                 1: THETA:=THETA+60;
00520                 2: THETA:=THETA-60;
00530                 3:
00540                     END;
00550             X:=X+INC*COS((ANGLE+THETA)*PI/180);
00560             Y:=Y+INC*STN((ANGLE+THETA)*PI/180);
00570             LINTO2(X,Y)
00580         END
00590     END;
00600 BEGIN
00610     PI:=4*ARCTAN(1);
00620     WRITELN('ORDER OF CURVE (0..',MAXORDER:1,')');
00630     READLN;
00640     READ(ORDER);
00650     IF ORDER<0 THEN ORDER:=0;
00660     IF ORDER>MAXORDER THEN ORDER:=MAXORDER;
00670     INC:=3*PICHIG/(2*SQRT(3));
00680     INITX:=(PICWID-INC)/2;
00690     INITY:=PICHIG/4;
00700     INC:=INC/EXP(ORDER*LN(3)); (* IE INC/3**ORDER *)
00710     T4010;
00720     PICCLE;
00730     X:=INITX; Y:=INITY;
00740     MOVT02(X,Y);
00750     (* DRAW TRIANGIC KOCH ISLAND *)
00760     KUCH(ORDER,60); KUCH(ORDER,-60); KUCH(ORDER,180);
00770     CURDEF('A');
00780     CURSOR(ORDER); (* DUMMY CALL TO PAUSE FOR HARD COPY *)
00790     DEVEND
00800 END.
    
```

Figure 6.

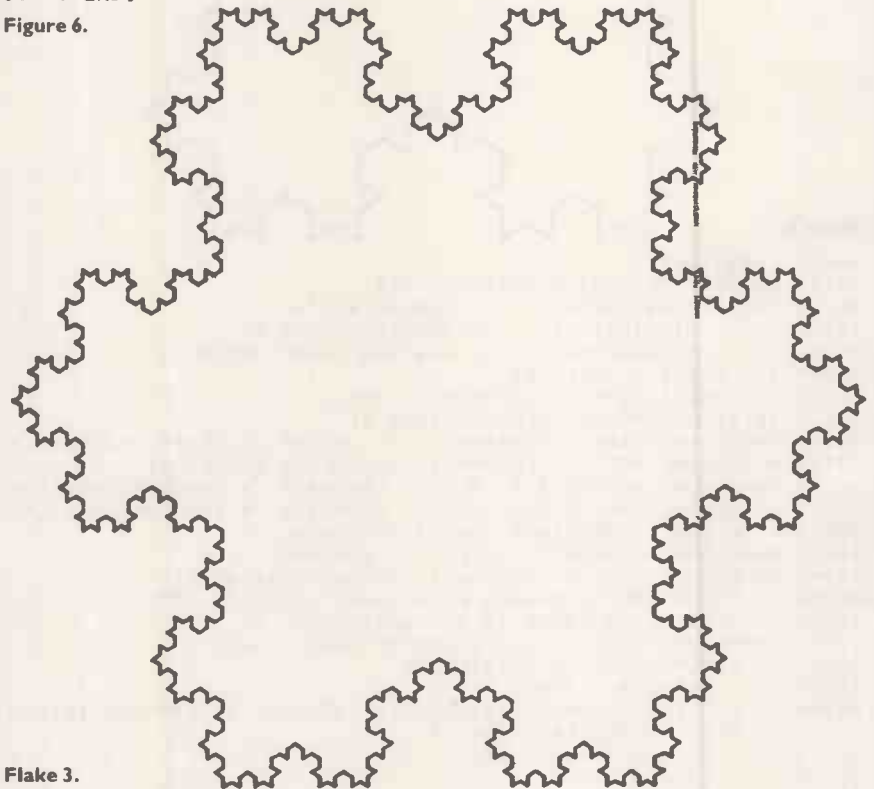

Flake 3.

```

00100 (*%W10000*)
00110 PROGRAM FLAKE (INPUT/,OUTPUT+);
00120 CONST PICWID=184; (* SCREEN WIDTH *)
00130     PICHIG=140; (* SCREEN HEIGHT *)
00140     MAXORDER=5; (* MAXIMUM CURVE ORDER *)
00150 VAR ORDER : INTEGER;
00160     INC,X,Y,INITX,INITY,PI : REAL;
00170 (* GINO GRAPHICS DECLARATIONS *)
00180 PROCEDURE T4010; FORTRAN; (* DEVICE IS TEKTRONIX 4010 *)
00190 PROCEDURE PICCLE; FORTRAN; (* CLEARS SCREEN *)
00200 PROCEDURE MOVT02(X,Y: REAL); FORTRAN; (* ABSOLUTE MOVE *)
00210 PROCEDURE LINTO2(X,Y: REAL); FORTRAN; (* ABSOLUTE DRAW *)
00220 PROCEDURE CURDEF(CH: CHAR); FORTRAN;
00230 PROCEDURE CURSOR(I: INTEGER); FORTRAN;
00240 PROCEDURE DEVEND; FORTRAN; (* END DRAWING *)
00250 (* PROCEDURE TO DRAW A KOCH CURVE OF GIVEN ORDER
00260     AT A GIVEN ANGLE TO THE HORIZONTAL *)
    
```



```

00270 PROCEDURE KOCH(ORDER: INTEGER; ANGLE: REAL);
00280   VAR MOVE,DIGIT,VAL : INTEGER;
00290   FUNCTION FOUR(I : INTEGER): INTEGER; (* EXPONENTIATION
      NOT ALLOWED IN PASCAL *)
00300     VAR F : INTEGER;
00310     BEGIN
00320       F:=1;
00330       WHILE I>0 DO
00340         BEGIN
00350           F:=F*4;
00360           I:=I-1
00370         END;
00380       FOUR:=F
00390     END;
00400   BEGIN
00410     X:=X+INC*COS(ANGLE*PI/180);
00420     Y:=Y+INC*SIN(ANGLE*PI/180);
00430     LINTO2(X,Y);
00440     FOR MOVE:=1 TO FOUR(ORDER)-1 DO
00450       BEGIN
00460         DIGIT:=0;
00470         REPEAT
00480           VAL:=(MOVE DIV FOUR(DIGIT))MOD 4; (* SELECT BASE 4 DIGIT *)
00490           DIGIT:=DIGIT+1
00500         UNTIL VAL<>0;
00510         CASE VAL OF
00520           1: ANGLE:=ANGLE+60;
00530           2: ANGLE:=ANGLE-120;
00540           3: ANGLE:=ANGLE+60
00550         END;
00560         X:=X+INC*COS(ANGLE*PI/180);
00570         Y:=Y+INC*SIN(ANGLE*PI/180);
00580         LINTO2(X,Y)
00590       END
00600     END;
00610   BEGIN
00620     PI:=4*ARCTAN(1);
00630     WRITELN('ORDER OF CURVE [0..',MAXORDER:1,']');
00640     READLN;
00650     READ(ORDER);
00660     IF ORDER<0 THEN ORDER:=0;
00670     IF ORDER>MAXORDER THEN ORDER:=MAXORDER;
00680     INC:=3*PICHIG/(2*SURT(3));
00690     INITX:=(PICWID-INC)/2;
00700     INITY:=PICHIG/4;
00710     INC:=INC/EXP(ORDER*LN(3)); (* IE INC/3**ORDER *)
00720     T4010;
00730     PICCLE;
00740     X:=INITX; Y:=INITY;
00750     MOVTO2(X,Y);
00760     (* DRAW TRIADIC KOCH ISLAND *)
00770     KOCH(ORDER+60); KOCH(ORDER,-60); KOCH(ORDER,180);
00780     CURDEF('A');
00790     CURSOR(ORDER); (* DUMMY CALL TO PAUSE FOR HARD COPY *)
00800     DEVEND
00810   END.
  
```

Figure 7.

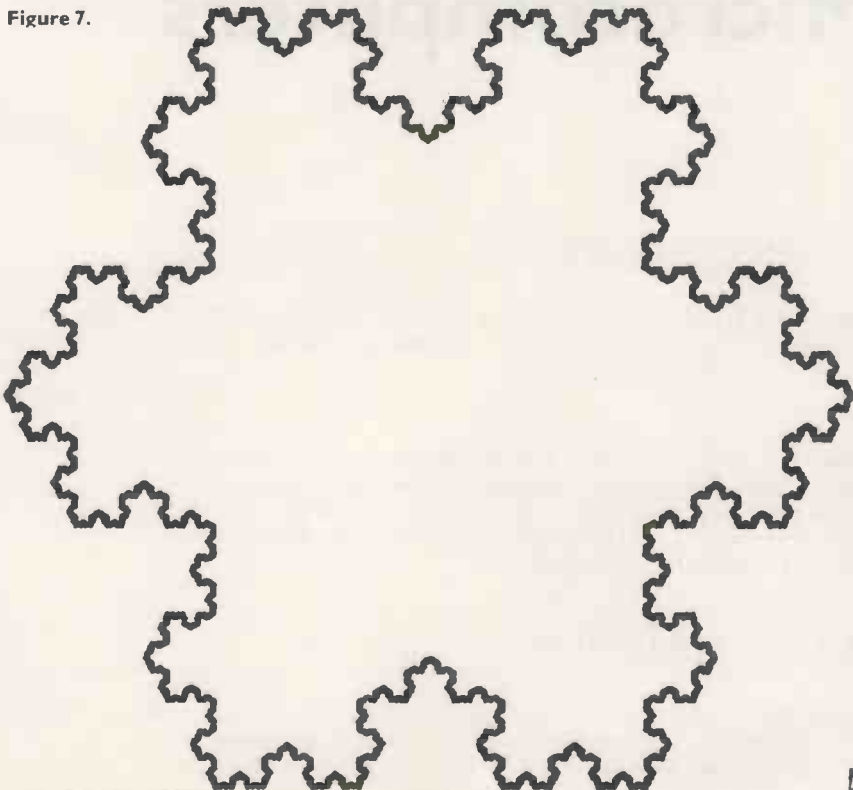

Apple-II in Scotland Core Data Systems Ltd

Suppliers of APPLE hardware and software.

We offer advice on the use of micro-computer systems, and undertake the design of systems to client's specifications.

Specialists in UCSD Pascal.

Now in new premises at:

101 COLINTON ROAD
EDINBURGH EH14 1AL

Phone 031-443 8710
Authorised APPLE Service Centre

• Circle No. 195



for



Lots of **MZ-80K**s and
PC1211s for **IMMEDIATE**
delivery. We try to match
best prices anywhere!!!

King Pin Computers

PO BOX 40 — STEVENAGE —
HERTS SG1 2NA
TEL: STEVENAGE (0438) 59677

• Circle No. 196

TOP QUALITY FLOPPIES Verbatim

Ex: Single Side Single Density Diskettes

	Unit Price	Box Price inc. VAT
8"	£2.27	£27.37
5 1/4"	£1.79	£21.90

Always Quote Your Machine Type When Ordering

- Many other Types Available
- We Can Quote for Your Machine
- Quantity Discount For 50+

Please Give Us A Ring



BUSINESS SYSTEMS LTD.

48 HEDLEY STREET, MAIDSTONE, KENT ME14 5AD
Tel. Maidstone 679 595 MAIL ORDER ONLY

• Circle No. 197

MAINS BORNE INTERFERENCE

Protect your
small computer
system or terminal
with the BLL Mains
Interference Suppressor

only £20 inc VAT, p&tp from



BEYTS
LOGIC

Planer Building
Windmill Road
Sunbury, Middx.
(09327) 86262

• Circle No. 198

LOOK

The latest version of the famous
EPSON TX-80
The TOPPER with GRAFTRAX



This unique option from DATAPLUS gives the TX-80 a FULL HI-DEF GRAPHICS capability. When the bit plot mode is invoked, each bit arriving via the parallel interface individually controls one of the 7 print head needles.

Additional facilities include software control of line feeds in .007" increments, and many others. You have NEVER been offered a better deal than this.

TX-80 with parallel interface £355 + VAT
GRAFTRAX option £4.50 + VAT
Apple, PET, Sharp, Tandy
RS.232 Interfaces £ 40 + VAT
Cash or Credit Cards accepted.

DATAPLUS LTD.

39-49 Roman Road, Cheltenham.
0242-30030 or 37373.

• Circle No. 199

PROJECT COSTING

- Full time and expense recording by employee and job costing
- Sales and purchase ledger with account costing
- Available for APPLE II and most micro's
- Single package £250
- Integrated systems

DELTIC COMPUTING

May Place House, May Place,
Basingstoke, Hants. RG21 1NX
(0256) 59715 Telex: 858151

• Circle No. 200

BASIC Software

for **nan/com-2**

NEED 8K UNLESS OTHERWISE STATED.

BIORHYTHM CHART PRINTER £5.00

Enter birthdate and month reqd. S.A.E. for sample printout.

ARITHMETIC TEST FOR 8-10 YR. OLDS. £5.00

Great fun for all the family. Good use of screen layout

and interactive operation.

HEAT GAINS CALCULATOR for H & V. £50.00

Engineers (32k + Printer). Allows repeated looping

through calculation to see results alter.

(Can be used without printer if reqd.)

HOME SHOPPING CLUB AGENT. £10.00

Save time for the lady in your life!

Calculates weekly deductions with running totals,

adds on goods, calculates commission + more.

PAYROLL: — calculates taxable pay based on tax

code, calculates on N.H.S. on codes A, B&C,

allows 3 rates of overtime, prints wages slip

followed by deduction details plus coin analysis

including total for bank Needs 32k plus printer.

£35.00

+ MORE TO COME!

NEW WEYFRINGE

CENTURY ENHANCED

ONLY £950.00

ALL PRICES INCLUDE P&P AND V.A.T.

AYRLECT Technical Products

COMPLETE SMALL BUSINESS SYSTEMS

Unit 18 Central Trading Estate, Staines,

Middlesex TW18 4XE

Telephone Staines (0784) 62142/3/4

• Circle No. 201

BUYERS' GUIDE

The Buyers' Guide is a summary of low-cost computers available in the U.K. It appears every third month; we add new computers and amend existing information, as required, to keep it up-to-date. Systems are listed by manufacturer.

Microcomputers

ACORN COMPUTERS

Systems 1.2.3: 6502-based, 1-8K RAM, COS or DOS, Hex or full keyboard, TV interface, Acorn bus. Personal or scientific use. Reviewed September 1979.

From £65 for System 1 kit; £285 for System 2 kit; £670 for System 3 kit

Atom: 6502, 2-12K RAM, up to 40K external memory, full keyboard, Basic in ROM, high-resolution graphics, cassette and TV interface, parallel port, I/O lines. Should eventually be able to link into a ring. Acorn Computers Ltd, 4a Market Hill, Cambridge CB2 3NJ (0223) 312772. Reviewed November 1980.

From £130

ALAN PEARMAN LTD

Maple: Z-80A, 16-64K RAM, S-100 bus, CP/M, 8in. discs, RS232 serial and parallel. Sold mainly as Micro-APL system. Alan Pearman Ltd, Maple House, Mortlake Crescent, Chester CH3 5UR. (0244) 46024.

From £1,510



ALPHA MICRO

AM-1010, AM-1051: WD-16, 64K-16MB RAM, S-100, four 8in. up to 90MB hard discs, RS232 up to 20 ports. Alpha Micro, 13 Brunswick Place, London N1 6ED. (01) 250 1616. *From £7,500*

APPLE COMPUTERS

Apple II Plus: 6502, 16-48K RAM, 8K ROM, colour graphics, 5¼in. discs, general use. Own bus. Reviewed October 1979. *From £695*

Apple III: 6502A with supporting chips, giving it a superset of 6502 instruction set. 96-128K RAM, colour graphics, integral 5¼in., RS232, four 50-pin expansion slots. Microsense, Finway House, Hemel Hempstead, Hertfordshire HP2 7PS. (0442) 48151. *P.O.A.*

ATTACHE

Attache: 8080, 64K RAM, S-100, parallel port, 8in. discs, business system. Friargrove Systems Ltd, 494 Great West Road, Hounslow, Middlesex (01) 572 3784. *From £1,737 to £7,000*

BASF

System 7100: Z-80A, 64K RAM, RS232, 5¼in. discs, business systems. MPR, 293 Grays Inn Road, London WC2. (01) 837 6332. *From £4,937*

BILLINGS

BMS: Z-80A, 64K RAM, 8in. 200MB hard discs, business system. Mitech Data Systems, 8 Guildford Road, Woking, Surrey. (04862) 23131. *From £4,295*

B L MICROELECTRONICS

Biproc: Z-80 or TMS9980 kit, 1K RAM, 2K monitor, RS232, cassette, TV. BLM, 1 Willow Way, Loudwater, High Wycombe, Buckinghamshire HP11 1JR. (0494) 443073. *From £150*

BLEASDALE COMPUTER SYSTEMS

UDS: 8080, Z-80, 6809, 32K-1MB, Multibus, CP/M, 5¼in., 8in., hard, RS232, four parallel ports, IEEE 488, development system. Bleasdale Computer Systems, Francis House, Francis Street, London SW1. (01) 828 6661. *P.O.A.*

BRUTECH ELECTRONICS

BEM: Single-board processor with 6502 and no RAM. Data Precision Equipment, 81 Goldsworth Road, Woking, Surrey GU21 1LJ. (04862) 67420. *From £133*

BYTRONIX MICROCOMPUTERS

Megamicro: 8080/Z-80, 64K RAM, 8in. discs, CP/M. Business and university use. Bytronix, 83 West Street, Farnham, Surrey GU9 7EN. (0252) 726814. *From £6,080*

The Dream Machine

Fantasy, fact and fiction
with the

ISC 36XX

Micro system with 64 colour combinations

Prices from £1200 with micro floppy

COPERNICUS (0428) 52888
7 Wey Hill, Haslemere, Surrey.

• Circle No. 202

VISIMAP

A MUST FOR VISICALC USERS

THIS PROGRAM WILL PRINT THE
FORMULAE HELD IN VISICALC
DATA FILES IN A FORMAT
SIMILAR TO SCREEN DISPLAY
AVAILABLE TO APPLE USERS ON DISK

ONLY £10.00 inc VAT

ACTION COMPUTER SERVICES

01-502 1311

28 CHURCH HILL, LOUGHTON, ESSEX

• Circle No. 203

apple II in sussex

oval computer systems

Elm Park, Ferring, Worthing, West Sussex tel: 0903 44831
198 Church Road, Hove, East Sussex tel: 0273 558299

• Circle No. 204



**Education
with Pleasure**

GRAPHICS

TWENTY-FIVE FASCINATING ORIGINAL PSYCHEDELIC PRESENTATIONS CHAINED TOGETHER TO PROVIDE A CONTINUOUS PROGRAMME OF DAZZLING MULTI-COLOURED BRILLIANCE (OR EVEN LIVING BLACK AND WHITE) TO GO WITH YOUR APPLE OR ITT 2020 (STATE WHICH WHEN ORDERING). AS DEVELOPED BY US FOR OUR RESIDENTIAL MICROCOMPUTER TRAINING COURSES IN THE CHANNEL ISLANDS. SEND £9.50 NOW FOR YOUR COPY OF THE GRAPHICS DEMO DISC (STATE TAPE IF REQUIRED) PLUS DETAILS OF OUR COURSES, PRICE LISTS OF HARDWARE, AS WELL AS OTHER EDUCATIONAL SOFTWARE POSTAGE INCLUDED.

MicroSystems Ltd.

LE FOULON, ST. PETER PORT,
GUERNSEY, CHANNEL ISLANDS.
EUROPE - GR

Telephone
(0481) 27181
Telex 4191130

• Circle No. 205

SHOP WINDOW



in Avon & Bristol

with full Software Support for business and professional use, including Invoicing, Ledgers, Stock Control, Word Processing, Hotel Systems, Petrol Station Management, Data Base, Mailing Lists and many other applications. Dataforce (U.K.) Limited, Bush House, Prince Street, Bristol BS1 4HU. Tel: 279016.

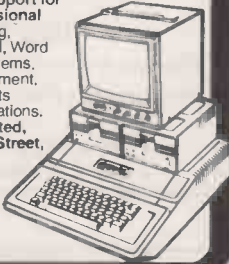

• Circle No. 206

APPLE & ITT2020 BUSINESS SOFTWARE

Professionally written packages now available with comprehensive manuals, built-in validity checks, interactive enquiry facilities, user options, satisfying accountancy, Inland Revenue and Customs & Excise requirements. On diskette under DOS 3.2. in Applesoft with SPACE utility. Not adaptations. Written for Apple System. Support all printer interfaces. Sales, Purchases and General Ledgers £295-00 each.

Manual only £3.
Payroll £375. Manual only £4.
General Ledger supports Incomplete Records, Job Costing, Branch and Consolidated Accounts etc.
General Ledger Applications Manual £10.
Prices exclusive of V.A.T. From our shop or your nearest stockist.

COMPUTECH SYSTEMS
168, Flatchley Road, London, N.W.3.
Tel: 01-794 0202

• Circle No. 207

BIG EARS

SPEECH INPUT FOR YOUR COMPUTER!



BIG EARS opens the door to direct man-machine communication. The system comprises analogue frequency separation filters, preamps and signal conversion, together with a quality microphone and extensive software.

Words, in any language, are stored as "voice-prints" by simply repeating them a few times in "learn" mode. Using keyword selection techniques, large vocabularies can be constructed.

Use BIG EARS as a front end for any application: data enquiry, robot control, starwars — the possibilities are unlimited.

BUILT, TESTED & GUARANTEED ONLY £45!
PRICE INCLUDES POSTAGE & PACKING PLEASE ADD VAT AT 15%
PLEASE STATE COMPUTER UK101, SUPERBOARD, NASCOM2, PET, TRS80, ETC.

MICROGRAPHICS

Colour Conversion for UK101/NASCOM 1 & 2/ Superboard. (Modulator included)

KIT £45
BUILT £60

COLOUR MODULATOR

RGB in. PAL/UHF out

KIT £12
BUILT £18

Please add VAT at 15% to all prices
Barclay/Access orders accepted on telephone

WILLIAM STUART SYSTEMS LTD

Dower House, Billericay Road, Herongate, Brentwood, Essex CM13 3SD.
Telephone: Brentwood (0277) 810244

• Circle No. 208

CANON BUSINESS MACHINES

Canon BX-1/BX-1d: 6800, 64K RAM, 5¼in. integral, RS232, V24 ports, business use. Canon Business Machines, Wadden House, Stafford Road, Croydon, Surrey. (01) 680 7700.

From £3,250

COMMODORE BUSINESS MACHINES

Pet: 6502, 8-32K RAM, IEEE ports, integral 9in. screen, personal and general use. Reviewed August 1979.

From £460

8000 Series — SuperPet: Upgrade of original Pet. 12in. screen, 5¼in. discs, business and general use. Reviewed October 1980.

From £895

Kim-1: 6502, LED six-digit display, 1K RAM, cassette and Teletype interface, evaluation board for 6502 chip. Commodore Business Machines, 818 Leigh Road, Slough Industrial Estate, Slough, Berkshire. (75) 74111. Reviewed November 1978.

From £99.95

COMPSHOP

UK101: 6502, 4-8K RAM, TV interface, RS232, full keyboard, single-board, personal use, similar to Ohio Superboard. Compshop, 14 Station Road, New Barnet, Hertfordshire EN5 1QW. (01) 441 2922. Reviewed May 1980.

From £199 for kit

COMPUCOLOR

Compucolor II: Z-80, 8-32K RAM, 5¼in. integral discs, 13in. colour VDU; RS232. General use. Dyad Developments, The Priory, Great Milton, Oxfordshire OX9 7PB. (08446) 729. Reviewed June 1979.

From £998

Copernicolor II: 8080A, 8-32K RAM, 5¼in., 8in. and Winchester available, VDU, RS232 bus, standard ASCII keyboard with optional keyboards available, graphics 128 by 128, Basic, assembler, Fortran. Based on Compucolor II, wide range of software. General use. Copernicus Ltd, 7 Wey Hill, Haselmer, Surrey. (0428) 52888.

From £1,200

COMPUCORP

655-675: Z-80, 60K RAM own OS but will run CP/M with modifications, RS232, IEEE and others optional. 1-4 5¼in. discs, 16by80 VDU. Business use. Barnet House, 120 High Street, Edgware, Middlesex. (01) 952 7860.

From £2,595 to £4,750

COMPUTER CENTRE

Minikit: Z-80, 16K RAM, serial and parallel, 5¼in., CP/M, S-100.

From £800

Maxikit: Z-80, 16K RAM, serial and parallel, 8in., CP/M S-100. Computer Centre, 9 De la Beche Street, Swansea SA1 3EX.

From £911

COMPUTERMART LTD

Computermart 2000 range: Z-80A, single/multiple, 16-256K, CP/M, S-100 bus, graphics, 8in. single-density double-sided, 180MB hard disc, general/business use. Computermart, 60 St. Faiths Lane, Norwich, Norfolk. Norwich 615089.

From £6,000



COMPUTHINK

Act System 800: 6502, 48K RAM, full keyboard, graphics, 5¼ or 8in. discs, 12in. VDU integral. Business system. Act, 66-68 Hagley Road, Edgbaston, Birmingham B16 8PF. (021) 455 8686. Reviewed February 1980. *From £4,000*

CROMEMCO

Single Card Computer: Z-80, S-100, 1K RAM, 20mA/RS232. OEM and industrial use. *From £273*

Z2: Z-80, 31A power supply, motherboard, 21 sockets, serious hobbyist and OEM use. Reviewed February 1979. *From £573*

Z2-H: Z-80A, 64-512K RAM, S-100 bus, CDOS, 10MB formatted fixed disc, two 5¼in. discs, hard discs up to 70MB. *From £5,373*

System 2: Z-80A, 64-512K RAM, S-100 21 slots, CP/M, VDU, two 5¼in. discs, hard discs up to 70MB. Multi-channel interface available. General/business use. *From £2,095 to £6,408 for seven users*

System 3: Z-80A, 64-512K RAM, S-100, CP/M, two or four 8in. discs, hard discs up to 70MB, general/business use. Datron Microcentre, 2 Abbeydale Road, Sheffield S7 1FD. (0742) 585490. Microcentre, 30 Dundas Street, Edinburgh EH3 6JN (031) 556 7354. Comart, PO Box 2, St Neots, Huntingdon, Cambridgeshire PE19 4NY. (0480) 215005. *From £3,568 to £8,304 for seven users*

DATA APPLICATIONS

DAI Personal Computer: 8080, 8-48K RAM, colour graphics, 20 Eurocard industrial interface modules, RS232, industrial use. Data Applications, 168 Dyer Street, Cirencester, Gloucestershire GL7 2PF. (0285) 2588. Reviewed February 1981. *From £998*

DIGITAL DATA ELECTRONICS

SPC/1: 8085, 32-48K RAM, own OS, COMAL, Assembler and Pascal, graphics, up to three 5¼in. drives, up to four 8in. drives, 10MB Winchester, up to four 20MB cartridge, many ports. DDE, Clark House, Pump Lane, Hayes, Middlesex. 01-573 8991. *From £1,995*

DIGITAL MICROSYSTEMS

DSC-3: Z-80, 64K RAM, CP/M, 8in. discs, hard discs up to 28MB, RS232/V24, business and general use. *From £3,445*

DSC-4: Z-80, 128-512K RAM, CP/M, 8in. discs, hard discs up to 28MB, RS232, RS422, business and general use. *From £3,995*

Hex-29: AMD 2900 16-bit, 64K-1,024K RAM, Hex bus, 8in. discs, hard discs up to 28MB. Eight to 32 ports, RS232. Modata, 30 St Johns Road, Tunbridge Wells, Kent TN4 9NT. (0892) 41555. *From £6,445*

DURANGO

F85: 8085, 64K RAM, own bus and OS, graphics, four RS232 ports, integral 9in. VDU, 9 x 9 printer, keyboard and two 5¼in. disc drives. General use. Comp Ancillaries, 64 High Street, Egham, Surrey. (07843) 6455. *From £7,500*

DYLE HOUSE

System 2000: Z-80, 64K RAM, dual 8in. discs, own OS, business use. Dyle House, 36 Abbot Way, Wellingborough, Northamptonshire. (0933) 79135. *P.O.A.*



IN CARDIFF

COMPLETE APPLE II SYSTEMS,
STANDARD & TAILOR-MADE
PROGRAMS — FEASIBILITY
STUDIES & DEMONSTRATIONS

CARDIFF MICRO COMPUTERS LTD

46 CHARLES ST., CARDIFF.
TEL: CARDIFF (0222) 64171

• Circle No. 209

PET REPAIRS

FAST EFFICIENT SERVICE ON
COMMODORE,
computhink, ANADIX
DOLPHIN AND N.E.C.
COMPUTERS, DISKS AND
PRINTERS

FIELD SERVICE TEAM THROUGH-
OUT LONDON, HERTS, BEDS,
ESSEX AND MIDDLESEX

ELECTRONIC AND GENERAL SERVICES

89, RAILWAY STREET, HERTFORD
TELEPHONE (0992) 57423

• Circle No. 210

DISKS ON NASCOM

A single 3" x 8" DIOM-1 board gives:-

- Interface up to 4 8" drives
- Parallel printer interface
- 32k Bytes extra memory
- Plugs in to NASBUS

Basic Board incl. Disk Controller
& Printer Interface £298
as above plus 16k RAM £338
as above plus 32k RAM £369
Dealer Enquiries Welcome + VAT

IMAGE COMPUTER SYSTEMS
1, Pinehurst Road, West Moors, Wimborne,
Dorset. BH22 0AH Tel. (0202) 876548

• Circle No. 211

DISKWISE



THE Apple Agents
in Devon & Cornwall
Present

Quality Software direct or from your
local Apple Dealer.

HOTEL PLAN — Hotel Management system
inc. booking & guest billing £475
TV RENTAL MANAGEMENT £395

TRADE ENQUIRIES WELCOME
DISKWISE

25 Fore St., Callington, Cornwall
Tel. 05793 3780

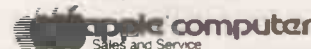

• Circle No. 212

C.C. MICRO SYSTEMS APPLE II Software Specialists

MANAGEMENT INFORMATION SYSTEM
BASIC PRICE £126

- File update
- Field Search
- Report Generating

ARITHMETIC CAPABILITY £156

- Sum any Field
- Powerful Equation facility

- Free Demonstration
- Consultancy Services
- Comprehensive After Sales Back-up

For further details Contact:-

C.C.M.S.

48 Melrose Avenue, Penylan, Cardiff.
Telephone:— 0222 495257

• Circle No. 213

SPECIALS for PET

Programmer's Toolkit.....	£39
Light Pen (+ Software).....	£25
Word Processor (M/Code).....	£35
Music System Complete.....	£37
Adventures 1 & 2 each.....	£ 7

(ALL + VAT BUT INCL. POSTAGE)
Send for details — state model

SIMPLE SOFTWARE LTD
15 HAVELOCK ROAD
BRIGHTON, SUSSEX BN1 8GL
(0273) 504879



• Circle No. 214

TRS-80 I, II & III DISK SOFTWARE

THE SPOOLER gives your Model I/II/III the same performance edge bigger computers have had for years, with the SPOOLER installed CPU time ordinarily spent waiting for disk and printer operations to complete is made available for useful work. Performs much better and is easier to use than those supplied with NEWDOS/80 and TRSDOS 2.0. Installation is simple and requires no changes to your programs. £45.00

MODEL II EXTENDED BASIC adds command abbreviations and additional commands for variable/line number cross referencing, re-numbering with block relocation, dynamic dump of variable contents, locate/replace strings and commands in program text and compress your BASIC programs to an absolute minimum — and more! — a must for every programmer. £87.50

Other MODEL II Software includes remote data entry, Model II to Model II file transfers, convert "V" to "F" format files, convert Model I Basic to Model II, output simultaneously and separately to parallel and serial printers, true proportional spacing for the Electric Pencil, Structured BASIC, powerful multivariate sort and other BASIC extensions, disk intermediate spoolers etc.

All Model II disks contain DOSFIX, a collection of patches to TRSDOS and BASIC to enhance their usability and function. Includes removing 'break' to CTRL6, disable verify detect (speeds disks by 30%) and change disk stopping rate from to to 12 ms — 80% faster!

Most products now available for TRSDOS 2.0 and the Model III.

Prices exclude VAT. Write or call for details.

SYSTEM SOFT

49, DUNVEGAN DRIVE, RISE PARK,
NOTTINGHAM NG5 5DX. TEL (0602) 275559

• Circle No. 215

DYNABYTE

Dynabyte 5000: Z-80, 32-64K RAM, S-100, CP/M, MP/M, CP/Net, RS232, 5¼ or 8in. discs, hard discs up to 96MB, expands to multi-task/user system. Business use. Microtech Ltd, Waterloo Road, Uxbridge, Middlesex, UB8 2YW. (0895) 57780.

From £1,600 to
£12,000

EACA

Video Genie EG3003: Z-80, 16-48K RAM, S-100, CP/M, 5¼in. discs, RS232, personal and general use. Lowe Electronics, Bentley Bridge, Chesterfield Road, Matlock, Derbyshire DE4 5LE. (0629) 2430. Reviewed February 1980.

From £369

ECS MICROSYSTEMS INC

Aristocrat: Z-80A, 32-180K RAM, 12K PROM, dual 5¼in. drives, 946K. Three RS232 and one parallel port, CP/M, wide range of protocols, business and general use. Telecomputing Systems Ltd., Seacourt Tower, Westway, Oxford. (0865) 723621.

From £3,950

EQUINOX

200: Z-80, 64-512 RAM, S-100 bus, CP/M, Omnix, MicroCobol, MVT FAMOS, cartridge disc, six serial and one parallel port, business use.

From £7,500

300: WD-16, 64-256K RAM, S-100 bus, CP/M, Omnix, MicroCobol, MVT FAMOS, cartridge disc drive, six serial ports, business use. Equinox, 16 Anning Street, New Inn Yard, London EC2A 3HB. (01) 729 4460/(01) 739 2387.

From £10,500

EUROCALC

Euroc: 8080, 64K RAM, 8in. discs, 15in. VDU, CP/M, business use. Eurocalc, 55/56 High Holborn, London WC1. (01) 405 3113.

From £8,000

EXIDY

Sorcerer: Z-80, 16-48K RAM, S-100, RS232, CP/M, 5¼in. discs. Plug-in ROM pack programs. Liveport, The Ivory Works, St Ives, Cornwall TR26 2HF. (0736) 798157. Reviewed May 1979.

From £749

GNAT

System 10: Z-80, 65K RAM, own bus, CP/M, graphics, 5¼in. discs, RS232, RS449, 12in. VDU, full keyboard, optional IEEE. Business use. Millbank Computers, 98 Lower Richmond Road, London SW16. (01) 788 1083. Reviewed December 1980.

From £2,995

HAYWOOD

Systems 1000-8000: Z-80, 32-65K RAM, 6000 is S-100, 3000 single-board, CP/M, graphics, 5¼in. discs, three serial and parallel ports. Business, scientific and general use. Haywood Electronics Assoc., 11 Station Approach, Northwood, Middlesex. (01) 428 9831.

From £2,359



HEATH/ZENITH

- H8:** Single-board WH8 assembled, 8080, 16K-65K RAM. Heathbus nine slots, cassette interface, nine-digit LED. *From £321*
- Z89:** Z-80, 16-48K RAM, CP/M, integral 5¼ in. drive, optional dual external, two RS232, full keyboard, 12in. VDU. *From £1,570*
- WH-11A:** LSI-II, 16-bit, 16-32K RAM, own bus and OS, optional dual 8in. drives, serial and parallel ports. Heath Ltd, 11b Bristol Road, Gloucester GL2 6EE. (0452) 29451. (01) 636 7349. *From £250*

HEWART

- 6800Mk II:** 6800 single-board, 1K monitor, 1K user RAM, 1K VDU RAM, 128byte scratchpad, education and home user. S-50 bus. *From £155*
- 6800S:** 6800, 16K monitor, 8K Basic in ROM, graphics, 5¼in. drive. Hewart, 95 Blakelow Road, Macclesfield, Cheshire. (0625) 22030. *From £229*

HEWLETT-PACKARD

- 85A:** 16-32K RAM, 32K ROM, IEEE 488, RS232, graphics, 5¼in. drives, integral 32 by 16 VDU, integral thermal printer, QWERTY and numeric keypad. Scientific use. Hewlett-Packard, King Street Lane, Winnersh, Workingham, Berkshire. (0734) 784774. *From £1,830*

HYTEC MICROSYSTEMS

- H-3000:** Z-80A, 4MHz, 32-128K RAM, two minifloppy discs, standard I/O, two parallel, three serial ports, single board. *From £2,381-£2,640*
- H-4500:** Z-80, 64-208K, two minifloppy discs, standard I/O, two parallel, three serial ports, 4MHz option. *From £3,110*
- H-7000:** Z-80A, 4MHz, 32-128K, two 8in. floppy discs, standard I/O, two parallel, three serial ports. *£3,350*

IMAGE DATA PRODUCTS LTD

- Image Data Eight:** 6802, 4-40K RAM, 43-way bus, own OS, Basic assembler and editor, viewdata-style graphics, up to four 5¼in. discs, up to 12 RS232 ports. Image Data Products, 1-4 Portland Square, Bristol, BS2 8RR (0272) 40248. *£500-£4,000*

INDUSTRIAL MICROSYSTEMS

- Series 5000:** Z-80, 16-56K RAM, CP/M, S-100, two or three 5¼in. discs, two serial and one parallel port, desk unit, business and general use. *From £1,500*
- Series 8000:** Z-80, 64-256K RAM, S-100, CP/M, MicroCobol, MVT FAMOS, Omnix, two, three or four 8in. disc drives, two serial and one parallel port, desk unit, business and general use. Equinox, 16 Anning Street, New Inn Yard, London EC2A 3HB. (01) 739 2387/(01) 729 4460. *From £2,500*

INSTAR

- Omega:** 16-bit, 48-256K RAM, dual floppies, hard discs, up to 12 simultaneous users, business use. *From £7,500*
- Asatayd:** Z-80, 16-56K RAM, dual floppies, CP/M, S-100 bus, business use, Instar, 61 High Street, Croydon, Surrey CR0 1QD. (01) 680 5330. *From £4,950*

CRAE

A co-resident Applesoft Editor for Applesoft programmers. Perform global changes & finds to anything in your Applesoft program. Quote (copy) a range of lines from one part of your program to another. Append Applesoft programs on disk to program in memory. Formatted memory dump to aid debugging. Powerful renumber is five times faster than most available renumber routines. CRAE need be loaded only once and changes your program right in memory. 48K APPLE II or PLUS & Applesoft Rom & Disk.

MCAT

MCAT is a binary program which creates a Master Catalog Report. The first list is sorted by file names and the second by volume number with sectors used indicated.

CRAE on disk with 16 page manual — **14.95**
 CRAE & MCAT on one disk with manuals — **19.95**

Manuals only — **1.00** each
 Add 15% V. A. T. Postage & Packing Free
 Contact:

S. B. D. SOFTWARE

15 Jocelyn Road
 Richmond TW9 2TJ
 Tel: 01-948 0461
 Telex: 22861

• Circle No. 216

mid-herts micros

ITT 2020 SYSTEMS

IN HERTFORDSHIRE!!

- * Consult Kathy and David Price
- * Personal Service for Small Business & Leisure Applications
- * Write or Phone stating your Sphere of interest to:

13 HOMESTEAD ROAD, HATFIELD,
 HERTS. AL10 0QJ
 Telephone: Hatfield (07072) 61733

• Circle No. 217

BROKEN COMPUTERS MENDED

Fast reliable service by professional computer engineers. All models catered for.

For further details please contact:
BYRD ASSOCIATES on Bedford (0234) 214785 (24 hour answering service) or write to us at 43 Ashburnham Road, Bedford.

• Circle No. 218



IMPETUS INPET INTERFACE

Impetus have introduced a new interface — the Impetus Inpet — which has eliminated the problems of trailing leads. The new interface permits the Pet computer to use a wide range of printers having the RS232 communications mode.

Full bi-directional, it allows the Pet to be slowed down to wait for the speed of the printer if need be.

All baud rates from 110 to 9600 are available and the interface can be addressed to the IEEE bus as any device number between 1 and 15. There is also a facility for automatic conversion from lower case in the Pet to true Ascii lower case.

With the Inpet interface, the Pet can also communicate either directly or over the telephone with other, much larger computers and may be driven either from Basic or machine code — unlike certain other new products currently available.

What makes the new Impetus Inpet special however is its overriding feature of being able to fit wholly within the Pet (hence the lack of trailing wires!)

The RS232 port is attached to the side of the Pet without requiring any drilling and the interface may be installed by a non-expert in about ten minutes.

Versions of the Impetus Inpet are available for all types of Pet from the old 8k small keyboard versions up to the new 8,000 series machine. In fact the new interface actually gives the Pet an internal RS232 capability which it previously did not have.

R.R.P. for the 'Interface' complete is £185 plus V.A.T. Available from Impetus or from your local Commodore dealer.

Impetus Computer Systems
Classic Offices, Hendon Central, London NW4 3NN
Tel. 01-202 2726 / 01-202 9630 (24hr. service)

• Circle No. 219

S100

- BOARDS —
- CABINETS —
- DISC DRIVES —
- MOTHERBOARDS —
- COMPLETE SYSTEMS —
- ASSEMBLED AND TESTED
- SOFTWARE —
- LOW PRICES —

PHONE OR WRITE FOR CATALOGUE

RATIONAL SYSTEMS

Cedar House, Union Street
Newport Pagnell,
Bucks MK16 8ET
Tel: 0908 613209

• Circle No. 220

INTERTEC

Superbrain: Z-80, 64K RAM, 256 static RAM, dual Shugart, optional hard disc, CP/M, S-100 bus, business and general use. Encotel, Succombs Hill, Upper Warmingham, Surrey. (820) 5701. Sun, 138 Chalmers Way, North Feltham Trading Estate, North Feltham, Middlesex. (01) 751 6695. KGB, 88 High Street, Slough, Berkshire. (75) 38581. Icarus Computer Systems Ltd, 27 Greenwood Place, London NW5 1NN. 01-485 5574. Reviewed April 1980.

From £1,495

ITHACA INTERSYSTEMS

Pascal Micro DPS1: Z-80, 64K-1MB RAM, full IEEE S-100 bus, CP/M version 2.2, graphics 8in. and hard discs, RS232, four parallel and two serial ports per S-100 board. Ithaca Intersystems, 58 Crouch Hall Road, London N8 8HG. (01) 341 2447.

From £4,258

ITT

2020: Built under licence from Apple. See entry under Apple II. ITT, Star House, Mutton Lane, Potters Bar. (77) 51177.

From £827

KEMITRON ELECTRONICS

UDS 3000: Z-80, 1-64K RAM, Kbus, own OS, CP/M, 8in. and hard discs, ports up to 256. Kemitron Electronics, (0244) 21817.

From £640 to £4,000

LOGABAX

LX-500: Z-80, 32K RAM, S-100, CP/M dual 5¼in. drives, business use. LogAbax Ltd., 1-7 Wesley Avenue, London NW10. (01) 965 0061.

From £3,000

LSI COMPUTERS

M-One: 8080, 8-16K RAM, own OS, dual Shugart 8in. drives, two serial and one parallel port, 12in. VDU and full keyboard. Business use.

From £5,995 with software package

M-Two: 8085, 64K RAM and 4K EPROM. Launched in December 1980. LSI Computers, Copse Road, St Johns, Woking, Surrey GU21 1SX. (04862) 23411.

P.O.A.

LUXOR

ABC 80: Z-80, 16-40K RAM, 12in. VDU, IEEE 488, RS232, 5¼in. drives, loudspeaker, personal and education use. CCS Microsales, 7 The Arcade, Letchworth, Hertfordshire ST6 3ET. (04626) 73301.

From £795

MICRO V

Microstar: 8085, 64K RAM, three RS232, serial inputs, StarDOS, twin 8in. drives, general use. Data Efficiency Ltd, Maxted Road, Maylands Avenue, Hemel Hempstead, Hertfordshire. (0442) 63561.

From £4,950



MICROMATION

Z-Plus: Z-80, 64K RAM, S-100 bus, CP/M (3), MP/M two serial and six parallel ports, business use. Rostronics, 115-117 Wandsworth High Street, London SW18 4HY. (01) 874 1171. Reviewed May 1980.

From £3,950 to £8,550

MICRONEX

MX-100: Z-80A, 64K RAM, S-100 bus, RS232, CP/M, Pixel graphics display system, twin 8in. drives. Micronex, Harford Square, Bristol BS18 8RA. (027) 589 3042.

From £3,485

MIDWEST SCIENTIFIC INSTRUMENTS

MSI 6800: 6800, 16K-56K RAM, 5¼ or 8in. or hard discs up to 10MB. Systems 1,2,7 and 10. System 7 runs Flex, MSI, DOS and SDOS, RS232. System 10 is System 7 with hard disc. Business use. Strumech (SEED), Portland House, Coppice Side, Brownhills, Walsall, West Midlands. (279) 4321. Reviewed March 1980.

From £1,100 to £12,000

MODULAR BUSINESS SYSTEMS

Tutor: 8085, 32-64K RAM, Intel Multibus, CP/M, optional graphics, twin 5¼in. drives or four 8in., two RS232 serial ports.

From £2,500

Elite: 8085, 32-256K RAM, Intel Multibus, CP/M, 5¼in. to 24MB hard discs, RS232, 24-bit TTL programmable port. Modular Business Systems, 21 Chappel Lane, Yeadon, Leeds LS19 7NX.

From £5,400 to £25,000

NASCOM

Nascom 1: Z-80, 2-64K RAM, serial and up to 16 parallel ports, 8K Microsoft Basic, 1K monitor in EPROM. Personal use. Reviewed January 1979.

From £125

Nascom 2: Z-80, 1K RAM expandable to 256 with Nascom System 80 case. Nasbus, 8K Basic, 2K monitor and 2K character generator, low/high-resolution graphics and colour. 5¼in. single or twin floppy discs, RS232, parallel port, Kansas City cassette port. Nascom Microcomputers, 92 Broad Street, Chesham, Buckinghamshire. (02405) 75151. Reviewed April 1980.

From £295

NATIONAL MULTIPLEX

Pegasus: Z-80, 48K RAM, S-100 bus, 5¼in., 8in. drives, CP/M, 12in. VDU, business use. London Computer Store, 43 Grafton Way, London W1. (01) 388 5721.

From £2,700

NEWBURY LABORATORIES

7768: CPU board, 4K RAM, cassette and VDU interface, up to 64K RAM, kit only.

From £45

NewBrain: Z-80A, 2K static RAM plus 4K static or 16K dynamic, RS232 ports, 16-character, LED display, hand-held. Newbury Laboratories, King Street, Odiham, Hampshire. (025) 671 2910.

From £155 for model without LED

FORMS!

1000 PRINTED from £38-66

Tel: Weybridge (0932) 48218

See our ad. on pg. 43

• Circle No. 221

6809 FLEX USERS

YOUR SYSTEM CAN'T BE COMPLETE WITHOUT THESE 4 COMMANDS

DO.CMD A complete language that replaces EXEC. CMD. Conditional branching, ten user parameters, parameter testing, ten number registers, timed wait, timed question, file handling, screen addressing and other exclusive features to enable programmes to be written and run in FLEX.

IX.CMD The ultimate file listing command. Gives disc format and full file information. Four search modes for file matching. Displays information entered with INF.CMD.

INF.CMD Allows 31 words of information to be linked to a file, this can be recalled using either INF or IX. This is invaluable for word processing applications.

DRIVER.CMD Create your own terminal independent programmes using this configurable terminal driver. Price £45.00 inclusive of VAT, postage and media. Please state disk size.

Data Base 169 High Street, Cheveley, Newmarket, Suffolk. 0638 730625

• Circle No. 222

APPLE

WITH



Sales and Service for Business Systems in Hampshire & Sussex

ACCESS CONTROL SYSTEMS LTD

72 WINCHESTER ROAD PETERSFIELD, HANTS.
TEL: 0730 5274

• Circle No. 223

CARDIFF MICRO CENTRE

APPLES + PETS
+
SHARP MZ-80s
+
HEWLETT PACKARD
+
COMPUTER BOOKS
+
DEMONSTRATIONS

SIGMA SYSTEMS

54 PARK PLACE
CARDIFF CF11 5JG

• Circle No. 224

SHOP WINDOW

STOKE on TRENT

for
TUSCAN
and
TANGERINE
and
VIDEO GENIE + SOFTWARE
and
BOOKS

MICRO-PRINT Ltd.,
59, Church Street, Stoke on Trent.
(0782) 48348. Barclaycard and Access

• Circle No. 225

TRS-80™ Computers

Pan American Electronics Incorporated

1117 Conway
Mission, Texas 78572 U.S.A.

is looking for qualified companies to
help sell these systems in England
and Europe.

Telex 767339

Telephone (512) 581-2765

** Registered Trademark of Tandy Co.

• Circle No. 226

S Software for TRS80®

see
how they
run!

Another
Cheap
Advertising
Gimmick From
Southern



SEND JUST £1.00 for a cassette of THREE BLIND MICE, a ridiculous new game from SOUTHERN. Can you cut out the tails of all three mice before one of them kills you? The tape contains two copies of the game:
1) In source BASIC See how slowly it runs!
2) The same program compiled by ACCEL2, Southern's new compiler for Disk BASIC. See how Fast it runs!

Compare the two versions, and then think what ACCEL or ACCEL 2 could do for your BASIC programs.

ACCEL Compiler for Level 2 BASIC £19.95
ACCEL2 Compiler for Disk BASIC £39.95

SOUTHERN SOFTWARE, P.O. Box 39
Eastleigh, Hants. SO5 5WQ

• Circle No. 227

NEWTRONICS

Elf II: Single-board on 1802, 256bytes to 64K RAM, Hex keypad, RS232 I/O and VDU interface, option keyboard, machine code or Tiny Basic, educational.

From £39 for kit

Explorer 85: 8085, 4-64K RAM, S-100 bus, RS232, VDU interface, 8080 and Z-80 software, hobbyists and OEM use. Newtronics, 255 Archway Road, London N6. (01) 348 3325.

From £299

NORTH STAR

Horizon: Z-80A, 16-56K RAM, 5¼in. twin drives, S-100 bus, own OS, business, educational or scientific use. Comart, PO Box 2, St Neots, Huntingdon, Cambridgeshire PE19 4NY. (0480) 215005. Equinox, Kleeman House 16 Anning Street, New Inn Yard, London EC2A 3HB. (01) 729 4460. Reviewed April 1979.

From £995 to £2,500

OHIO SCIENTIFIC

Ohio Superboard and Challenger I: 6502, 8K Basic in ROM, 2K monitor, 4K RAM, full keyboard and VDU interface. Hobbyist use. Reviewed June 1979.

From £160

Challenger 2: 6502, 48K RAM, dual 8in. drives, serial port, low-cost business use.

From £1,500

Challenger 3: 6502, Z-80 and 6800, 48-56K RAM, OSI 48-pin bus, serial port for VDU, CP/M, expands to eight users, 10, 20 and 75MB hard disc, business use.

From £2,300

Challenger 4: Similar to Challenger I but 64 by 32 display, colour and sound option. U-Microcomputers, Winstanley Industrial Estate, Long Lane, Warrington, Cheshire WA2 8PR (0925) 54117/8. CTS (0706) 79332. Millbank, 98 Lower Richmond Road, London SW16. (01) 788 1083. Reviewed September 1979. Mutek, Quarry Hill, Bath, Wiltshire. (0225) 743289.

From £450

PANASONIC

Panasonic: 8085, 56K RAM, full keyboard, integral 24 by 80 VDU, integral twin 5¼ or 8in. floppy drives. Three RS232, business use. Panasonic Business Systems, 9 Connaught Street, London W2. (01) 261 3121. Reviewed June 1979.

From £4,150

PROCESSOR TECHNOLOGY

Sol: 8080, 16K RAM, S-100 bus, 5¼in. drives, VDU integral, business system. Comart, PO Box 2, St Neots, Huntingdon, Cambridgeshire PE19 4NY. (0480) 215005. Reviewed July 1979.

From £1,750

RAIR

Black Box: 8085, 32-256K RAM, dual mini-floppy discs, eight programmable serial ports, RS232, CP/M, hard discs to 10MB, general and business use. Rair, 30-32 Neal Street, London WC2H 9PS. (01) 836 4663. Reviewed November 1979 and August 1980.

From £2,300

RCA

Cosmac: 1802 micro with Hex pad and TV interface. Machine-code programming with Tiny Basic option. HL Audio, 255 Archway Road, London N6 5BS. (01) 348 3325.

From £79 for kit

RESEARCH MACHINES

380-Z: Z-80, 4-56K RAM, RS232, CP/M, twin 5¼ or 8in. discs, high-resolution graphics. Sold principally to higher and secondary education.

From £830 to £3,500

280-Z: Board version of 380-Z. Research Machines, PO Box 75, Mill Street, Oxford. (0865) 49791.

From £722 for 4K version

ROCKWELL

Aim-65: 6502, 1-4K RAM, full keyboard, RS232, discs, hobby use, Portable Microsystems, Forby House, 18 Market Place, Brackley, Northamptonshire NN13 5SF. (0280) 702017. Reviewed July 1979.

From £250

SATTCO AB

Databoard 4680: Z-80, 16-64K RAM, own bus, full-colour graphics, 5¼in., 8in. and hard discs up to 10MB, 64 interface units. General use. Microsystems Technology, PO Box 5, Knutsford, Cheshire, WA16 9DU. (0565) 52911.

P.O.A.

SCIENCE OF CAMBRIDGE

MK-14: 8060, 256bytes user memory to which ¼K RAM can be added, Hex pad, cassette interface, seven-digit LED, single-board. Reviewed May 1979.

From £39

ZX-80: Z-80A, 1-16K RAM, 4K Basic in ROM, cassette and TV interface, touch-sensitive keyboard, educational use. 22 graphics. Science of Cambridge, 6 Kings Parade, Cambridge CB2 1SN. (0223) 311488/312919. Reviewed July 1980.

From £79 for kit

SD SYSTEMS INC

SBC-100: Z-80, 1-48K, S-100 bus, Basic in 8K ROM, four ROM sockets, optional 5¼in. drives, RS232 serial and parallel, single-board. Reviewed January 1981.

From £155

SD-100/200: Z-80, 64-256K RAM, 8K PROM, S-100 bus, RS232, CP/M, 12in. VDU, twin 8in. drives, business, industrial and general use. Airamco, Unit A2, 9 Longford Avenue, Kilwinning Industrial Estate, Kilwinning, Ayrshire KA13 6EX. (0294) 65533. Barcellos, Kimberley House, Vaughan Way, Leicester. (0533) 26584.

From £3,750

SEN ELECTRONICS

Organiser: Intel 8085, 64K RAM, multi-user Basic, 8in. drives or 20MB hard discs, three RS232, business use. SEN, 5 London Street, Chertsey, Surrey KT16 8AP. (09328) 66744.

From £7,500



OVERPRICED COMPUTERS INADEQUATE PERSONAL MICROS?

Modata supply Dealers and OEMs with Digital Microsystems competitively priced Single and Multi-User computers which include Reliable Floppy and Hard Disk storage.

ie DSC-2: Z80 at 4MHz + 64Kb +
2 x SSDD 8" Floppies for 1Mb + CP/M
- £3525 E.U.

**WHY NOT FINDOUT MORE?
0892 41555**

Modata Ltd. 30 St. Johns Road,
Tunbridge Wells, Kent TN4 9NT

• Circle No. 228

MICROCASE

"turns a board into a real computer"

For NASCOM 2

COMPUKIT

SUPERBOARD

ALSO UNCUT FOR NASCOM 1 ETC.

Direct from us or from your dealer —

but make sure you see a
GENUINE MICROCASE
about £30

SIMPLE SOFTWARE LTD
15 HAVELOCK ROAD
BRIGHTON, SUSSEX BN1 6GL
(0273) 504879



• Circle No. 229

TANDY

COMPUTER CENTER

— FOR BUSINESS AND PLEASURE —
FULL RANGE OF TRS 80 COMPUTERS
DISC DRIVES, SOFTWARE, PRINTERS.
OTHER MAKES ALSO AVAILABLE



EXPERT FRIENDLY ADVICE



PJ EQUIPMENT
3 BRIDGE STREET (0483)
GUILDFORD, SURREY 504801

• Circle No. 230

CP/M SOFTWARE

FOR MANUFACTURING &
GENERAL BUSINESS.

- BILL OF MATERIALS
- STOCK/WIP CONTROL
- PIECE-WORK AND PAYROLL
- ACCOUNTING

ALSO SUPPLIERS OF:—

VECTOR GRAPHIC HARDWARE

TAYLOR MICRO SYSTEMS

HAMSTEAD INDUSTRIAL ESTATE
OLD WALSALL ROAD, GREAT BARR,
BIRMINGHAM B42 1DF 021-358 2436

• Circle No. 231

SHOP WINDOW

COMPUTING? START HERE!

Are you thinking of buying a small business computer system, or home computer?
Are you interested in computing but don't know where to start?

A Two-Day Course for beginners in Computing has been arranged at the delightful 'Bear of Rodborough' Hotel, in the heart of the Cotswolds, on 4/5 April 1981. The course will give you the knowledge to select the best system for your needs, and teach you enough about programming for you to write your own programs in BASIC.

Cost is £45, including lecture notes, coffee, lunch and tea. Accommodation extra if required.

Further details from

STROUD MICROCOMPUTERS
25 High Street, Stroud, Glos.

• Circle No. 232

CUSTOM CONSOLES

If you require a special desk or console to accommodate your system, Sound Woodworking can help. Please send details of your specific requirements to:

Ted Henry

Fairlight, Kings Drive, Greenside,
Ryton on Tyne NE40 4RW

Tel: 0894 22 5803

(A small selection of basic designs are available on receipt of an SAE).

• Circle No. 233

SHARP MZ-80K software

- £5 MOONLAND — Complex real time lander. Superlative graphics/sound. (10K RAM).
- £4 COMPOSER — Play times via the keyboard. Replay your compositions. Print music strings for future use.
- £5 BANK ACCOUNT — Input your regular income/outgoings. See the year's cash flow in monthly statements.
- £5 CHASE — Excellent real time chase. Steal the gems but avoid the vicious dog!
- £7 BACKGAMMON — Outstanding. Available only from US. Superb Graphics & play.
- £5 MANIAC — Exhausting real time maniac drive. Run down strays, but don't crash. 81 skills!
- £4 each — BIORHYTHMS, MASTERMIND, FOX & GEESE, ADDRESS BOOK. £3 — REACTION TESTER.
- £7 BACKGAMMON. Outstanding. Available only from us. Superb graphics and play.

Write or phone for full catalogue.

Cash with order. All prices include P&P etc.

"These programs are of a very high standard indeed, with excellent graphics" — SE User Group.

HIGHLIGHT SOFTWARE

76 St. Cyrus Road, Colchester CO4 4LR
Telephone (0206) 64437

• Circle No. 234

UNBIASED commercial system studies and recommendations.

HARDWARE and SOFTWARE design using Z80 and MC6800.

WORD PROCESSING plus selective mailing list printing.

PROM PROGRAMMING for 2708, 2716 and fusible-links.

Details from John Gaeth at:

KEY MICRO SYSTEMS LTD

30 Baker St, London W1M 2DS
Tel: (01)-864-7037 (24 hours).

• Circle No. 235

SGS-ATES

Nanocomputer: Z-80, 6-64K RAM, Gamma bus, 2K NC-2 monitor in ROM, Basic as option, RS232, cassette interface, Hex keypad. Midwich, Hewitt House, Northgate Street, Bury St Edmonds, Suffolk, IP33 1HQ. Reviewed October 1979.

From £350

SHARP ELECTRONICS

MZ-80K: Z-80, 16-48K RAM, 10in. integral VDU, integral cassette, loudspeaker, 5¼in. disc optional, general use.

From £480

PC-1211: Pocket computer. Programmable in Basic with cassette interface. Sharp Electronics, Sharp House, Thorp Road, Newton Heath, Manchester M10 9BE. (061) 205 2333. Reviewed July 1980.

From £85

SINTROM ELECTRONICS

Periflex 630/48: Z-80A, 32-48K RAM, S-100, CP/M, twin Micropolis 5¼in. discs, two serial and three parallel ports.

From £1,995

Periflex 1024/64: Z-80, 64K, S-100, CP/M, dual 8in. discs, two serial and three parallel. Sintrom Electronics, Arkwright Road, Reading, Berkshire RG2 0LS (0734) 85464.

From £2,750

SIRTON COMPUTERS

Midas Range: Z-80, from 8K RAM, S-100 or IEEE bus, CP/M, MP/M, graphics, up to four 5¼in. or 8in. drives, hard disc, RS232, 8-bit parallel, IEEE 488. Sirton Computers, 76 Godstone Road, Kenley, Surrey CR2 5AA. 01-668 0761.

£785-£2,150

SMOKE SIGNAL

Chieftain 511-821: 6800/6809, 32-64K RAM, S-50 bus, Flex DOS68/68d/69 dual 5¼in., 8in., dual RS232, video board, wide range of options, general use. Windrush Micro Designs, Gaymers Way, North Walsham, Norfolk. (069) 245189.

From £1,807

SOLID STATE TECHNOLOGY

Athena: 8085, integral dual mini-floppies and mini-cassette, and matrix printer, can be expanded with 10 micros beyond CPU. Memory to 1.2GB. Claims performance similar to DEC PDP-11/34. Butel-Comco, 50 Oxford Street, Southampton, Hampshire SO1 1DL. (0703) 39890.

From £3,000

SORD COMPUTER SYSTEMS INC

M200 Range: Z-80A, 64K RAM, S-100 bus, Sord OS, graphics, 5¼ 8in. or hard discs, two RS232, integral 80 × 24 VDU. Business use. Midas Computer Services Ltd, 2 High Street, Steyning, Sussex (0903) 814523.

From £1,850 to £6,950

SOUTHWEST TECHNICAL PRODUCTS

C/09: 6800, 56K RAM, Flex OS, 5¼in, 8in. or 15MB hard discs, business, educational and scientific packages.

S/09: 6800, 128K RAM-380K RAM., Uniflex OS, support up to 16 users in foreground and background mode. Southwest Technical Products, 38 Dover Street, London W1X 3RB. (01) 491 7507.

From £3,000 to £10,000



SPENCER JOHNSTON LTD

SJL 8000: Z-80A, 64-208K RAM, integrated database system to user specifications, 8in. discs to 4MB Winchester to 80MB. Sun Computer Services, 60 Broad Lane, Hampton, Middlesex. (01) 979 9824. *From £8,000*

SYNERTEC

Sym-1: 6502, 4K-64K RAM, port-expansion kit, TV interface, Kim software, hobbyist use. Newbear, 40 Bartholomew Street, Newbury, Berkshire. (0635) 30505. *From £160*

TANDBERG DATA

TDV Series: 8080A, 32-64K RAM, Intel bus, 4K Basic discs system in ROM, one plus three 8in. discs, or 2.5MB disc cartridge, eight ports, semi-graphics, CP/M version available, educational use. Tandberg Data, 81 Kirkstall Road, Leeds, LS3 1HR. (0532) 35111. *From £4,000*

TANDY CORPORATION

Model 1: Z-80, 4-48K RAM, RS232, Level I and Level II Basic in ROM, separate keyboard and 12in. VDU, small business and personal use. Reviewed November 1978. *From £349*

Model 2: Z-80, 64K RAM, integral 8in. disc, integral 12in. VDU, detachable keyboard, CP/M serial and parallel ports, Level III Basic, business use. Tandy, TRS-80 Division, Bilston Road, Wednesbury, West Midlands, WS10 7JN. (021) 556 6101. Reviewed March 1980. *From £1,995*

TANGERINE COMPUTER SYSTEMS

Microtan 65: 6502, 1-48K RAM, Tanbus, IEEE 488, Tanbug in ROM (1K), Pixel graphics, 5¼in. discs, 32 I/O lines and three serial ports, from single-board upwards. Tangerine Computer Systems, Forehill, Ely, Cambridgeshire. (0353) 3633. *From £69*

TECHNALOGICS

TECS: 6800, 56K RAM, Basic and Prestel terminal software, RS232, two cassette ports, two parallel ports, 5¼in. discs. Technalogs, Windmill Works, Station Road, Swinton, Manchester M27 2BU. (061) 793 6323. Reviewed November 1979. *From £895 per kit*

TERODEC MICROCOMPUTER SYSTEMS

TMZ-80: Z-80, 64K RAM, CP/M, MP/M, CP/Net, twin 8in., up to 32MB hard discs, multi-user business use. Terodec, 17 The Gallop, Yately, Camberley, Surrey. (0252) 874790. *From £3,000*

TEXAS ELECTRONIC INSTRUMENTS (TEI)

PT-208/PT-212: 8080, Z-80, 8085, 32-60K RAM, S-100, CP/M, 5¼in., 8in. and hard discs, three RS232 and three 8-bit ports, integral VDU, business use. Abacus Data-type, 62 New Cavendish Street, London W1. (01) 580 8841. Reviewed January 1980. *From £3,500*

ZX80 SOFTWARE ON CASSETTE

1K: KALA our best selling game only £2
LUNAR LANDER + SPACE DOCKING +
STOPWATCH + CLOCK only £3.75
HANGMAN + SPIDER + DIARY £3.75
DECIMAL SUBROUTINES our BASIC routines
get your divisions right! ADDITION/
SUBTRACTION + MULTIPLICATION + DIVISION
£3.75

ZX80

2K: SUPERKALA £3.00 SUPER HANGMAN +
CALENDAR £3.75
C12 cassettes only £2.75 for 5
HINTS & TIPS for the ZX80 £3.50

Send order to: Hewson Consultants,
7 Grahame Close, Blewbury, Oxon OX11 9QE
or enclose sae for full catalogue.

• Circle No. 236

ADD FULL GRAPHICS TO YOUR VDU!

Does your VDU Home Computer use the Thomson SFF96364 VDU chip? (eg. Triton, Elek-terminal) And do you want FULL GRAPHICS and LOWER CASE CHARACTERS? Then you need the AUTO ELECTRONICS 96364G GRAPHICS MODULE. When used in conjunction with the SFF96364 it gives access to the full 8 x 12 dot matrix per character not just 7 x 5. This allows ANY customised character set to be used (eg. Arabic) or graphics set or even high definition graphics. Character information is stored in EPROM (or even RAM) which completes the circuit. The module measures 4 x 4 x 1.3 cms. and consumes 20 mA at 5 volts. 96364G Graphics Module (with full data) £12.65

96364GP Ready Build PCB with Graphics Module and socket for 2716/2708 EPROM (with full data) £23.00
2716 (5 volt) Custom Programmed with ASCII Character set £11.50

Prices include VAT and Postage.
Write or phone for data.

AUTO ELECTRONICS,
MOOREND GROVE,
CHELTENHAM, GLOS GL53 0EX
(0242) 515133 (after 6pm)

• Circle No. 237

PET, SORCERER APPLE, TRS-80

Pascal (16/32K PET, cassette)	£29.00
Battleship Commander (32K Apple)	£11.95
Dungeon Campaign (48K Apple)	£10.95
Wilderness Campaign (32K Apple)	£10.95
Temple of Apsah (16K L2 TRS-80)	£16.95
Screen Editor (Sorcerer)	£ 8.95
Martian Invaders (Sorcerer)	£11.95
Starbase Hyperion (16K Sorcerer)	£13.50
Courtball (16K L2 TRS-80)	£ 5.95
The Book: Volume 1 (TRS-80)	£ 8.95
Supermap (TRS-80)	£ 7.95

Many more programs available. Send for our free catalogue. Cheque or p.o. to

SAPPHIRE SOFTWARE LTD.
PO BOX 244
MILTON KEYNES MK14 7BQ

• Circle No. 238

TRS-80 System

All items stocked, Barclaycard, Access & American Express are welcome, or apply for your own RADIO SHACK Charge Card. U.K. Delivery by Securicor. Direct and Personal Exports.

RADIO SHACK LTD.
188 Broadhurst Gardens,
London NW6 3AY.

Tel: 01-624 7174 Telex 23718

• Circle No. 239

TANDY TRS-80 TEXAS TI-99/4 in Bedfordshire

ELECTRON SYSTEMS
6, PARK ROAD, SANDY
Telephone 0767-81195

• Circle No. 240

ZX80 SOFTWARE

G.C.E. "O" LEVEL tuition in mathematics.
4 programs on cassette (4K) £4.50

JUNIOR SCHOOL COACHING (suitable up to age 13 years). English, maths, general knowledge and reasoning.
10 programs on cassette (4K) £4.50

4 GAMES: Random no. guessing, memory test, reaction speed game and hangman. (4K) £4.50

4 GAMES: Chase the letter, snap, reaction test and scissors-paper-stone (1K) £2.00

Cheque with order, or SAE for more details to:

ROSE CASSETTES

148 Widney Lane, Solihull, West Midlands B91 3LH

• Circle No. 241

MICRO ADS

are accepted from private readers only, pre-paid and in writing, 20p per word, minimum charge £2.
Please make cheques payable to Practical Computing and send to Room L311, Quadrant House, The Quadrant, Sutton, Surrey SM2 5AS.

SHARP MZ80K PROGRAMS: Backgammon; Startrek; Biorhythms + Life Expectancy; Pontoon; Mastermind + Hangman + Noughts & Crosses; Alien Attackers + Dictator. All £6 each. T. Garden, 23 Whitehill Court, Berkhamsted, Herts.

PET. UPGRADING TO 32K selling 8K. Integral cassette; Old Roms; Calculator keyboard; White screen; £250 no offers. To see and test phone 01-582 7766 any time.

CROMEMCO SYSTEM 3, 3102 Terminal, Anadex DP9500 Printer. Quick Sale. Offers. S. Gimblett, 79 Calderwood Crescent, Gateshead, Tyne & Wear. (0632) 876645.

ZX80 FOR SALE. Includes 16K RAM pack, Mains Transformer. Not used. £80 o.n.o. Telephone Castleford 554105.

SUPERBOARD II Cased and P.S.U. Two months old. Tapes etc. £240. Phone Wakefield 270584.

11 1KZX80 PROGRAMS; Formulal, Shove ha' penny, Cryptogram, Connect 4, Maze, Lunar, Hurtle 1&2, Snap, Acey Deucey, Maths. Only £4. N. Tingle, 234 Penns Lane, Sutton Coldfield, Birmingham.

PET 8K with Expandamem to 32k, 3040-disk drive and disks. Best offer secures. Ring 01-950 4209.

NASCOM BASIC Renumberer programme. £3.50 cassette. N. Nazoa, 14 Barham Rd., Wimbledon, London SW20.

ZX80 CHEAP software, 6 programs - Lunar Lander, Sky Diver (both with graphics). The numbers game (strategy game - hard to beat the machine), Mastermind, Simon, Utilities package (contains 4 subroutines). All fully documented. Cassette £3.50. Send cheque to - Bramfit, 8 Milton Drive, Sale, Cheshire, M33 1LJ or phone 061-969 7583 for details.

TEXAS INSTRUMENTS

TI-99/4: 990 16-bit, 16K RAM, Basic in 26K ROM, high-resolution, colour graphics, up to three 5¼in. discs, joystick, cassette and other ports, RS232, personal use. Texas Instruments Ltd., Manton Lane, Bedford, MK41 7PU. (0234) 67466. Reviewed August 1980.

From £950

TRANSAM COMPONENTS

Triton: 8080, 32K RAM, CP/M, 1K TB10S in ROM, up to three. 5¼in. discs, or four 8in., serial and parallel ports. Reviewed December 1979.

From £296

Tuscan: Z-80, 8-64K RAM, S-100 bus, CP/M, RS232, TV and cassette interface, from single-board, personal use to full business system. Transam, 59 Theobalds Road, London WC1. (01) 405 5240.

From £150

ULBRICH AUTOMATION

Powerhouse II: Z-80, 16-32K RAM, RS232, 5in. internal VDU, integral mini-cassette, 2K monitor, IEEE, 14K Basic DOS, OEM users. Powerhouse Microprocessors, 5 Alexander Road, Hemel Hempstead, Hertfordshire HP2 5BS. (0442) 42002.

From £1,200

VECTOR GRAPHIC

MZ: Z-80, 48K-64K RAM, CP/M, 5¼in. discs, optional graphics, serial and parallel ports. Business and general use. Almarc Data Systems, 906 Woodborough Road, Nottingham (0602) 625035. Reviewed October 1980.

From £2,300

WESTERN DIGITAL

Pascal Microengine: MCP1600, executes P-code directly, 64K RAM, own bus, 5¼in., 8in. or hard discs up to 18MB, two RS232, two parallel ports. Pronto Electronics Systems, 466-478 Cranbrook Road, Gants Hill, Ilford, Essex IG2 6LE. (01) 554 6222.

From £2,295

ZENTEC

ZMS-70: 8080A-1, 32/64K RAM, up to 12K ROM, dual integral 5¼in. discs, 600MB, RS232, integral 15in. VDU, 16 function keys. Zigal Dynamics Ltd., Bank Chambers, 13 High Street, Chesham, Buckinghamshire. (02405) 75681.

From £4,000

ZILOG

MCZ Series: Z-80, 64K RAM, RIO OS, Zilog bus, optional graphics, 8in. discs, and hard discs, four RS232, one parallel, stand-alone or networking. Zilog (U.K.) Ltd, Babbage House, King Street, Maidenhead, Berkshire. (0628) 36131.

From £3,000

INNOVATIVE

TRS-80 SOFTWARE

FROM THE PROFESSIONALS

INSTANT SORT/SEARCH DATABASE

Everything in electronics takes a finite time, consequently nothing can be instantaneous. However a database that will search 500 records and sort the names into alphabetical order in 1½ seconds, that will go on to do the same thing with 1,000 names in only 2½ seconds, is fast. If you add that ability to search 500 or 1,000 records for a specific range of names or ages or sexes or whatever, in such a small amount of time that it is not worth timing it, then the program deserves to be described as instantaneous. Especially as these times are attained on a standard Level II TRS-80.

These results are achieved, obviously, by some very clever machine language coding. This however is not enough. After all GSF from Racet will sort 1,000 arrays in about 11 seconds and that is indeed a clever program. No, in order to achieve the results required from this program it is necessary to change one's entire overview of database.

There are many databases available for the TRS-80 now. All of them have been designed to store as much data as possible, as easily as possible. Not as an afterthought, but nor as a prime design requirement, they have also incorporated as fast a sort as was practicable. This program was designed from the outset to achieve unbelievably fast sort and search times. Indeed we do not recommend this database for application in which fast searching or sorting is not a prime requirement. And what are the applications? It's a hackneyed phrase to say that they are limited only by the user's imagination, but that's about it. Let's take an example. Suppose you are running a marriage or data bureau. An ordinary database will file all the names and addresses away together with the necessary information as to sex, age and so on and with some you would be able to sort the list, so that only people with similar characteristics were eventually obtained. With this database you could, for instance, file the name, sex, age, category of hobby, category of chief interest, vital statistics and other data so that at the touch of a button you could instantaneously display on the screen all women of a certain age with certain vital statistics, living in a certain area. You could also display men with similar (excluding the vital statistics!) data that fall into similar categories. And all of this almost instantaneously. Not everybody runs a marriage bureau, but other applications are not hard to think of. Estate agents can file details of property away so that they can instantaneously obtain data on houses in a certain area or of a certain size. Doctors can reach information as to patients with similar diseases, ages or whatever immediately. In the home, a record library can be stored and every record by a certain composer written in a certain year can be accessed without delay. The list of applications is endless. For any use where it is important to extract information within a certain range or it is important to sort information, this database will find a use.

The prime commands and features of this program are as follows:

Datafile creation		Sort/Search	
1.	Create a file.	1.	Sort up or down.
2.	Add a record.	2.	Page forward or backward.
3.	Delete a record.	3.	Select a range for search.
4.	Display a record.	4.	Select or exclude a category.
5.	Tape a file.	5.	Select or exclude on initial letter.
6.	Amend a record.	6.	Resort records in a sort.
7.	Display the file data.	7.	New sort all records.
8.	Load a tape.	8.	Extended sort.
		9.	Arithmetic.
		10.	Display file data.
		11.	Load a tape.
		12.	Printout sorted data.

The data is displayed in columnar form and the data may be alphabetical, alphanumeric, integer or decimal. The number of columns is from 2 to 10 and the records may contain a maximum 44 - 60 characters depending upon the number of columns used. Columns may be of any width within the screen capacity but integer or decimal columns more than five and six characters wide respectively will not have the option of searching within a range.

The program consists of two parts. The first is used for entering the data and the second for the sort or search. The second part overlays the first when it is loaded so only 4K of memory is used by the entire program. The remainder of your memory space is available for data. The amount of data that can be contained will of course depend upon the amount of memory available, but as a rough guide a 16K user will be able to manipulate at one time 250 records of 39 characters each or 514 records of 17 characters each. As a further rough guide on sorting speed, the time to sort 1,000 records on fields of random strings of random length, or of random number between 1 and 99,999, averages under 2½ seconds.

Numeric columns either integer or decimal may be arithmetically manipulated almost instantaneously. A total may be cast or an average taken for any numeric column up to five digits. This is so fast that when adding 1,000 numbers totalling over 50 million, only a slight hesitation can be noticed before the total is given.

In summary therefore this program is ideal for any application concerning the manipulation of information whether it be business, personal or hobby which can be comfortably displayed as one record per line upon the screen and in respect of which it is required that super fast searches or sorts be carried out. The program is supplied on cassette. At this time it is not compatible with disk systems. A disk version is in the course of preparation. The cassette includes a set of data randomly generated which can be fed into part 2 of the program to demonstrate the fantastically fast sort and search features.

Tape for 16K TRS-80 or video genie £19.50

All prices exclusive of VAT which should be added at the prevailing rate. Postage and packing including VAT 75p regardless of the number of programs ordered.

Send large SAE (44p) for our current Catalogue of TRS-80 software. Add £1.85 for a binder.



A.J.HARDING (MOLIMERX)

MOLIMERX LTD.

28 COLLINGTON AVENUE, BEXHILL-ON-SEA, E.SUSSEX.

TEL: (0424) 220391

TELEX 86736 SOTEX G



• Circle No. 263

Son of Hexadecimal Kid

Samson Synapse discovers the strange effects he can have on living things when some apple trees he planted bear floppy discs as fruit. He knows that in a world dominated by the fanatical Nullards, he dare not tell anybody about it but even so, little does he realise — in his first flush of enthusiasm for computers — just how dangerous his mysterious gift will prove.

Samson gave himself up to the subtle seductiveness of software completely. His secret night-time visits to the cedar wood where Bootstrap had hidden the moonshine micro became more frequent. Thanks to Bootstrap's acquisitiveness and his own green fingers, he possessed the finest micro laboratory in the world.

There he taught himself Basic and several assemblers, and there he spent many happy hours entranced by the musical whirr of discs in their drives or devouring back issues of the CP/M User Group Newsletter — otherwise known as the Gary Kildall Fan Club Magazine.

The brilliant flame of forbidden knowledge shone into the crevices of his mind like the glare from an atomic explosion. It took him over. Computing became the focal point of his life. Programming was his opium: if a day went by without a line of coding, his hands would tremble and his limbs begin to twitch. He even started constructing simple microcircuits from some plans Bootstrap had left behind, though he was hampered by a shortage of solder.

Meanwhile, his behaviour at home became increasingly eccentric. His mother was worried and Johnny McNull grew deeply suspicious. Samson's nocturnal outings took their toll — there were black bags under his eyes, and his conversation was absent-minded to the point of idiocy. Sometimes he dozed-off at the table in the middle of a meal from sheer tiredness.

Preoccupied with the mental dance of registers and stack-pointers, he became lazy in his work on the family plot, where before he had been an energetic and eager little boy. His relations with the rest of the household took a turn for the worse. McNull in particular was angered by the change that had come over him.

His home life would have been under strain anyway at that time, for his mother was pregnant once more. Her relationship with McNull, who now spent virtually all his time with them, had ripened over the years in an unspectacular fashion. Though nothing had ever been said, it was accepted that he was the man about the house and, in effect, Samson's stepfather.

The imminent arrival of a new baby, combined with his own erratic behaviour, distanced him from his mother; and his relationship with McNull deteriorated badly. He had never had much truck with Piltown 2, so that left only Lambda to talk to.

"Aunt Lambda", he enquired one day,

trying to sound off-hand, "you know when you have a PIO attached to the interrupt line of a Z-80 processor"?

"Yes", she answered guardedly, giving him a quizzical look.

"Well, how do you make it hold the signal on the second channel if it's already busy with the first one"?

"Now why should you want to know a thing like that"?' she replied with a wry smile, and the conversation was at an end.

During the period leading up to the birth, he kept up his experiments in vegetable cultivation on a small scale. He had his own little plantation at a discreet distance, well concealed from the house. He was not really worried that it would be discovered.

His main concern was that he would inadvertently affect some of his mother's vegetables and give the game away. That happened only once, when a row of runner beans started sprouting RS232 interfaces and he was forced to take the blame for the destruction of their entire bean crop.

In his own patch, there was nothing as dramatic as his first effort with the apple trees, though one myrtle bush surprised him by growing a plastic leaf with straight edges which was to prove useful later. On one side, it had the words, American Express, embossed in blue lettering with his own name underneath. On the reverse, it bore the legend, I promise to provide the bearer, on demand, anything he can credit.

Not knowing what to do with it, he popped it in his back pocket and kept it for luck. It had a reassuring feel to it, and when he brought it out and waved it about he felt oddly self-confident.

On one plant he lavished particular affection. It grew from a cutting he saved when he had to uproot his original apple orchard. He put it in a pot and kept it on the window ledge of his bedroom. Sometimes, he would sit gazing abstractedly at the delicate tracery of its branches spreading outwards and upwards from the smooth green surface of moss at its base. On one of these occasions McNull barged in.

"Wherefore doest thou waste time sitting up here"?' he demanded. "If thou wouldst do something of value the potato beds need weeding".

"This is the Binary Tree of Knowledge", declared Samson, still half in his reverie.

"Talk not of such things", warned McNull, "for fear the Nullards hear of it; and if they take thee this time, I shall not try to save thee".

"You didn't save me last time".

"I said I shall not try", answered McNull. Then he turned and swept out of the room.

Samson waited until his footsteps faded, then rushed to his bed and lifted the mattress to reveal a few precious sheets of note-paper. Looking at the branching of his tree had suddenly given him an idea for a new sorting procedure.

So busy was he with his tree-sort routine that he did not notice the rumpus downstairs which started a few minutes later, nor the fact that McNull had returned.

McNull took one look at what he was doing and snatched the papers away. "Hey", he expostulated. "I need those". "Others have needs greater than thine", replied McNull. "Hasten to thy mother's side. Do as thine aunt commands, for the child is shortly to be born". Cleo's labour had begun.

"What about my subroutine"?' Samson demanded.

McNull turned to face him and, very deliberately, tore it to shreds in front of his eyes. Something in Samson's head clicked at that moment. He looked up at his stepfather and saw an enemy. Grudgingly, Samson slouched downstairs.

Soon both he and McNull were scurrying about under Lambda's direction, fetching water, heating up pails, rushing about with clean linen and bumping into one another.

The baby was born late at night. It was a little girl. McNull held her up and made a long speech no one could understand while Lambda looked on beaming. Cleo sat propped up by pillows looking somewhat stupefied. Samson was left to do most of the clearing-up. There seemed to be an awful amount of blood. He did not like any of it — the blood, his mother's moans, McNull's speechifying.

Lambda swaddled the baby and put it in its cot. It slept at once and the whole household settled down to rest, but Samson could not sleep. A strange hunger gnawed at his entrails. After what seemed like hours of restless tossing and turning, he crept downstairs.

He peered at the little infant, sleeping so peacefully by candlelight. Only its head and one plump shoulder were showing from its wrappings. Samson licked his lips. He stared at one tiny blue vein in its neck, trembling like a butterfly's wing.

An animal compulsion took hold of him. He bared his teeth and bent down, his eyes feasting on the succulent newborn flesh. Has Dracula risen from the grave? □

The *SENSATIONAL* CROFTON Offer



9" metal cased monitor at lowest ever price — £48.50 plus VAT — £55.77 total plus carriage.

S100 Television camera interface board (frame grabber).
Resolution 256 x 256 point mode, 128 x 128 16 level, grey scale.
Full D.M.A. transfer into main memory.
Send for full details.

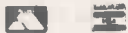
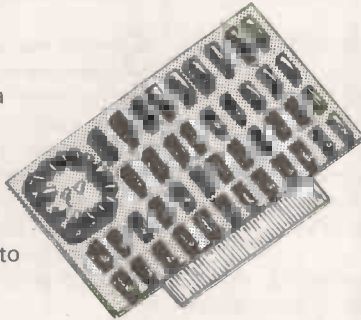

Ask for Crofton Mail
All major credit cards accepted. Order Catalogue.

All items subject to availability. The above prices include VAT. Carriage will be charged at cost.

Phone or write to

CROFTON ELECTRONICS LIMITED
35 Grosvenor Road, Twickenham, Middx TW1 4AD.
Tel: 01-891 1923/1513

• Circle No. 264

THE BUSINESS SOLUTION TERODEC

1 to 4 MBytes 8" floppy discs
64K RAM as standard fitting
CPM OPERATING SYSTEM
4 M Hz Z80 CPU

All built into a polished wooden desk.

TMZ 80 1 MByte	£3995
TMZ 80 2 MByte	£4295
TMZ 80 4 MByte	£5595

Prices exclude VAT.

LANGUAGES AVAILABLE
Fortran, Cobol, Pascal, Basic.

GRAHAM DORIAN SOFTWARE

Job Costing	£500	Order Entry & Inv.	£500
Nominal Ledger	£500	Purchase Ledger	£500
Sales Ledger	£500	Payroll	£500

HIBBERD ELECTRONICS LTD.

2 Sarsen Close. SWINDON. Wiltshire.
Tel. Number 0793-31404/35377
(24 HOUR ANSWERING SERVICE ON 31404)

• Circle No. 266

Lowest Prices Yet! Memory Chips

Guaranteed quality — Any faulty chips should be returned to us within 12 months of purchase with proof of purchase for replacement by return of post.

4116 and 2114 chips at the same price

4116 dynamic memory chips guaranteed to 200 nanoseconds full cycle time. Suitable for Apple, TRS 80, Nascom, Exidy Sorcerer, Sharp MZ 80K etc (8 chips give 16k bytes of memory).

2114 static memory chips guaranteed to 300 nanoseconds full cycle time. Low power, suitable for Superboard Compukit, Atom, ZX 80 etc. (2 chips give 1K byte of memory).

No. of Chips	Unit Price	Total Price		
		Nett	Vat	Total
2	1.80	3.60	.54	4.14
8	1.70	13.60	2.04	15.64
24	1.60	38.40	5.76	44.16
100	1.40	140.00	21.00	161.00
500	1.30	650.00	97.50	747.50
1000	1.25	1250.00	187.50	1437.50

Official orders welcome. Post and Packing free:
24 Hr Telephone Credit Card Orders 051-236 0707



Mail orders to:
MICRODIGITAL LIMITED
FREEPOST (No stamp required)
LIVERPOOL L2 2AB

LASKYS
COMPANY

Retail Premises at:
25 BRUNSWICK STREET,
LIVERPOOL L2 0PJ.
Tel: 051-227 2535/6/7

MICRODIGITAL

• Circle No. 265

BEAVER
SYSTEMS



Norlett House
Dormer Road
Thame
Oxon OX9 3UC
Telephone: Thame
(084421) 5020 (24 hr)

YOUR COMPLETE OHIO SCIENTIFIC SERVICE

HERE ARE FIVE VERY GOOD REASONS FOR CALLING US —

- O.S.I. SYSTEMS**
— including the popular SUPERBOARD II and CHALLENGER 4P as either cassette or disc based systems.
- O.S.I. SOFTWARE**
— cassette and disk based software covering a broad spectrum of uses. Some of the cassette based software can also be run on the U.K.101.
- BEAVER SOFTWARE**
— Business, educational and entertainment software — professional programs with full listings and documentation. Also available for other systems — especially the U.K.101.
- BEAVER PROGRAMMING AIDS**
— including Video Workpads, BASIC workpads, Machine Code Workpads, Cassette Index cards and labels and Blank Cassettes, all available for OSI, U.K.101, and TRS-80.
- BEAVER EXPANSION**
— Economy memory expansion using motherboard and slot-in 8K RAM boards, 8K EPROM boards, floppy control board & shortly, PROM Programmer board. Buy as much as you need when you need it.



CALL OR WRITE... NOW!



• Circle No. 267

KNIGHT'S T.V. & COMPUTERS

ROCK BOTTOM PRICES FROM SHARP'S BIG DEALER 48K memory MZ-80K £439



Dear Microfans,

Ring, write or telex for details of our ROCK BOTTOM PRICES on Sharp e.g. 24K MZ-80K micro £389, 48K MZ-80K £439, MZ-80P3 printer £389, MZ-80FD dual floppy £579. Send for the list of our 150 programs for the MZ-80K KAMIKAZE PILOT; LINEAR, LOG, EXPONENTIAL, and POWER CURVE FITTING; STOCK CONTROL AND MAILING LIST. Our 'KNIGHT COMMANDER', which adds dozens of new commands (AUTO LINE NUMBER, APPEND, DUMP, RENUMBER, TRACE etc.) to Sharp's already mathematically excellent Basic, is so good that Sharp themselves are now selling it overseas. The 'KNIGHT COMMANDER' takes no extra memory and is only available in the UK from us — it costs £40. We run the International Sharp User Group which now has 1,000 members in 30 countries — membership is free when you buy your micro from us but costs £3 if you bought elsewhere. The latest issue details the new PC3201 and the Super Sharp is now available at £1,500, VDU £250, printer £450, Disks £795. The complete system with four DISK drives and 2½ Megabytes of store is £5,190 — SALES, PURCHASE, INVOICING, NOMINAL ledgers, STATISTICS, and EDUCATIONAL PROGRAMS are now available.

One of our customers — Mr Weller from Cornwall (he invented the language CORAL) was so pleased with his MZ-80K that he drove to Aberdeen to collect his disks and printer and meet the people who know so much about Sharp micros.

Happy computing, 10-10, 73, 88, Graham Knight

P.S. You don't have to be like Mr Weller and drive 600 miles to collect your SHARP we will be happy to send it to arrive anywhere in the UK within 24 hours.

P.P.S. PLEASE ADD V.A.T. TO ABOVE PRICES

KNIGHTS TV AND COMPUTERS

108 ROSEMOUNT PLACE, ABERDEEN.

TEL: (0224) 630526. TELEX: 739169.

• Circle No. 268



• Circle No. 269

THE ZX80 COMPANION



(SECOND EDITION)

LINSAC

THE MONITOR REVEALED

OVER 40 PROGRAMS AND ROUTINES
HOW TO PRODUCE MOVING DISPLAYS
COMPLETE ANALYSIS OF ZX80 MONITOR

NOW ONLY

£7.95
INCL
UK P&P

THE ZX80 COMPANION

Second Edition. ISBN 0 907211 00 3.

This best-selling manual on the Sinclair ZX80 covers ZX80 BASIC, hardware, programs, and the ZX80 Monitor, with a detailed explanation of monitor routines and entry points.

'An invaluable asset for ZX80 owners' — Micro Forecast.

'A very detailed and carefully written guide to the machine' — Education Equipment.

For an accompanying cassette of ten programs add £4.95.

Send SAE for catalogue of Sinclair-tested software and other literature.

LINSAC (PC) 68 Barker Road, Linthorpe, Middlesbrough TS5 5ES

• Circle No. 270

Old tricks for new Pets...

COMMAND-0 is a FOUR KILOBYTE Rom for the 4000/8000 Basic 4 Pets with all the "Toolkit" commands RENUMBER (improved), AUTO, DUMP, DELETE, FIND (improved), HELP, TRACE (improved & includes STEP), and OFF - plus PRINT USING - plus four extra disk commands INITIALIZE, MERGE, EXECUTE, and SEND - plus extra editing commands SCROLL, MOVE, OUT, BEEP, and KILL - plus SET user-definable soft key, 80 characters - plus program scroll up and down - plus 8032 control characters on key - Ask for Model CO-80N for the 8032 or CO-40N for the 4016/4032. £50.00 plus Vat

New tricks for old Pets...

DISK-O-PRO is a FOUR KILOBYTE Rom that upgrades 2000/3000 Pets, but lets you keep all your old software - including Toolkit. As well as REPEAT KEYS and PRINT USING, you get all the Basic 4 disk commands CONCAT, DOPEN, DCLOSE, RECORD, HEADER, COLLECT, BACKUP, COPY, APPEND, DSAVE, DLOAD, CATALOG, RENAME, SCRATCH and DIRECTORY - plus extra disk commands INITIALIZE, MERGE, EXECUTE and SEND - plus extra editing commands SCROLL, MOVE, OUT, BEEP and KILL - plus SET user definable soft-key, 80 characters - plus program scroll-up and scroll-down. We recommend the 4040 disk or upgraded 3040 for full benefit of disk commands. Ask for Model ODP-16N for new Pets 2001-3032, and 2001-8 with retrofit Roms & TK160P Toolkit. £50.00 plus Vat, other models available.

PRONTO-PET hard/soft reset switch for the 3000/4000 Pets. We don't think you'll "crash" your Pet using our software, but if you do the Pronto-Pet will get you out! Also clears the Pet for the next job, without that nasty off/on power surge. £9.99 + Vat

and no tricks missed!

KRAM Keyed Random Access Method. Kid your Pet it's an IBM VSAM disk handling for 3032/4032/8032 Pets with 3040/4040/8050 disks means you retrieve your data FAST, by NAME - no tracks, sectors or blocks to worry about. Over 2,500 users worldwide have joined the "Klub"! Now you can too, at the 1981 price, £75.00 plus Vat.

SPACEMAKER All our Rom products are compatible with each other, but should you want, say, Wordpro with Kram, or Disk-o-pro with Visicalc, then SPACEMAKER will allow both Roms to address one Rom socket, with just the flip of a switch, for £22.50 plus Vat.

We are sole UK distributors for all these fine products. If your CSM dealer is out of stock, they are available by mail from us, by cheque/Access/Barclaycard (UK post paid) or send for details.

Calco Software

Lakeside House Kingston Hill Surrey KT2 9QT Tel 01-546-7256

• Circle No. 271



L&J COMPUTERS

3 CRUNDALE AVENUE, KINGSBURY NW9 9PJ 01-204 7525

THE "PET" SPECIALISTS



NEW LOW, LOW, 'PET' PRICES!!

Pet 8K (Large keys)	£420*
16K	£499*
32K	£630*
Ext cassette decks (+ counter)	£ 55*
PET Friction Feed printers	£350*
AVAILABLE FROM STOCK + VAT	
Printers/Disc Drives	Sundries
PET 3023	PET 3040
PET 3022	Compu 400K
Centronic 779	Compu 800K
Spinwriter	Interfaces

TRY US!
YOU WILL NOT BE
DISAPPOINTED

SUPERPETS NOW EX-STOCK!

Tool kits: library cases
Disks: C12 Cassettes
Paper (roll & tractor feed)
Labels: Dust covers

SPECIALS FOR THIS MONTH:

PETMASTER SUPERCHIPS — UPGRADE YOUR PET EVEN MORE!

A FEW ONLY: Brand New CENTRONIC 779 t/f printers £590*
Brand New PET 2023 f/f printers £320*

THE "MUPETS" ARE HERE!

3 TO 8 PETS ONLY NEED 1 DISK DRIVE...
Daily demonstrations: Ring for details.



COMPLETE SYSTEMS FROM £1700!!

THE SYSTEMS WE SUPPLY & INSTALL ARE COMPLETE:
ESTIMATES GIVEN FREE WITH NO HIDDEN EXTRAS:
FULL BACK-UP: GUARANTEED EXPERTISE.

* PRICES DO NOT INCLUDE VAT

PERSONAL SHOPPERS WELCOME
Phone & Mail Orders accepted.

SOFTWARE

As well as a full range of Petsoft and Commodore Software, we have some highly reliable "Home-Brewed" programs available.

STOCK CONTROL & INVOICING £60
(Handles up to 500 items — 32K) (180 on 16K). Stock depleted on invoicing, search etc. Cassette, disk (& print option).

CASH BOOK £90
Enter daily/weekly amounts — printout and totals, weekly/monthly analysis, totals and balances.

MACHINE HIRE Typewriter & Plant Hire Firms. £420

STOCK TAKING Cuts out all the hard work £230

OUTSIDE SERVICES (For Mini-Cabs Etc) £220

See for free software booklet

Specialists in:

Commodore Business Programs
Bristol Trader, Item & Monitor
Superpay Word Processing

SPECIALISED SOFTWARE APPLICATIONS
UNDERTAKEN. RING FOR DETAILS

2 FOR JUST OVER THE PRICE FOR 1!

We now have limited stock of NEW
CASSETTE DECKS, with built-in
COUNTER + SOUND BOX FOR PETS.
AT ONLY £65* EACH.
Orders dealt with in strict rotation

ALL GOODS SENT SAME DAY WHEREVER POSSIBLE
LARGE S.A.E. FOR LISTS ETC.



• Circle No. 272

LET'S GET IT CLEAR!

A poor video display is a serious weakness in any computer system. Illegible characters on a glaring screen don't do much for a VDU operator's eyes - or for productivity.

You need a display terminal which suits your operator as well as your system.

The TAB 132/15 does both, with many extra features; and at a price comparable to inferior 12ins terminals.

A 15ins screen, superior resolution from 392 scan lines (50% more than other models) and large, crisp letters formed within a 9x16 cell size to ensure maximum screen clarity.

VDU operator efficiency will also benefit from the 24 data lines carrying 80 or 132 characters, and the horizontal scrolling facility which prevents text from being lost while changing from one format to the other.

Eight screen-labelled soft keys provide the flexibility to handle current and future applications, without the need to memorise function codes and positions.

The TAB 132/15 has full communications capability, too.



- High resolution, 15ins screen, green or white phosphor
- 80 and 132 characters per line, with horizontal scrolling
- Separate, movable keyboard and tilting screen
- Communications capability to 19200 baud, full or half duplex
- Standard reverse video facility
- Programmable, screen-labelled soft keys
- Durable, reliable keyboard resistant to dust and 'coffee proof'.

We've made it as clear as we can. But if you want to know why the TAB 132/15 terminal is a better choice for your system, ask for a demonstration and see for yourself.

PHL

PERIPHERAL HARDWARE LIMITED
Armfield Close West Molesey Surrey
Telex 922175

SOUTH
01-941 4806

NORTH
Harrogate 501263/4

IRELAND
Dublin 952316

A member of the VOLLWOOD Organisation

• Circle No. 273

NEW SEIKOSHA

The lowest cost, smallest size, 80 column impact dot graphic printer in the world.



GP80A

Suitable for home, educational and business use, the Seikosh GP80A features include:— Plain paper. 80 column width. 30 cps. Full ASCII character set. Graphics facility. 5 x 7 dot matrix. Double width characters. Pin feed. Centronics interface standard.

Other interface and cables available:— IEEE/488, PET, TANDY, APPLE, RS/232C.

Ring the Master Distributor, DRG Business Machines, (Supplies and Peripherals Division).

Weston-Super-Mare, (0934) 416392 or your nearest dealer:

Chromasonic Electronics	London	(01) 263 9493
Computerama	Bath	(0225) 333232
Datalink	Bristol	(0272) 213427
Electronic Brokers	London	(01) 278 3461
Microdigital	Liverpool	(051) 227 2535
Sigma Systems	Cardiff	(0222) 21515
Watford Electronics	Watford	(0923) 40588

DRG BUSINESS MACHINES

Unit 8, Lynx Crescent,
Winterstoke Road, Weston-Super-Mare,
Avon BS24 9DN Tel: (0934) 416392

THE FINEST WORLDWIDE SUPPORTED NATIONWIDE

• Circle No. 274

SOFTWARE FOR CPM MACHINES

Production Planning & Control

- Job/Project Costing & Control * * * * *
- Standard Costing * SOURCE *
- Bill of Materials * LISTINGS *
- Material Requirements Planning * AVAILABLE *
- Capacity Planning * * * * *

From **£350**

Accounting & Stock Control

- Purchase Ledger * * * * *
- Sales Ledger } Integrated * SOURCE *
- Nominal Ledger } £300 * LISTINGS *
- Payroll £125 * AVAILABLE *
- Stock Control £125 * * * * *

SMIS SHEFFIELD
MICRO
INFORMATION
SYSTEMS

Weston House, West Bar Green, Sheffield S1 2DA
Tel: (0742) 20224 Telex: 54453

• Circle No. 275

SEE THE VERY LATEST

SHARP-PC3200

MZ-80K

BUSINESS SYSTEM

48K — £1720 + VAT

FULL SOFTWARE SUPPORT

NASCOM NORTH STAR

PC1211 + PRINTER NOW IN STOCK!

**BOOKS — SOFTWARE —
GAMES**

PHONE

**CHRIS ROBINSON
IPSWICH (0473) 50152**

MICROTEK LTD.

15 LOWER BROOK ST.,
IPSWICH

• Circle No. 276



Pete & Pam Computers

Microcomputer hardware & software

Specialists in Applefare

Peter & Pam Fisher

WE DISTRIBUTE FOR MICROSOFT, HIGH TECHNOLOGY, STONEWARE COMPUTER STATION, CALIFORNIA PACIFIC, DAKINS, BRODERBUND, STARCRAFT, SUB LOGIC AND MIR ENTERPRISES. DEALER ENQUIRIES WELCOMED.

HAVE YOU BEEN WATCHING OUR ADVERTISEMENTS?

Spend time reading through this one to find out how you can make more use of your APPLE II.

M & R ENTERPRISES

SUP-R TERMINAL An 80 column by 24 line plug-in compatible board for APPLE II. 128 ASCII chrs. Upper and lower case — with descenders. Shift lock feature. Synchronous operation with APPLE. Incorporates PASCAL and BASIC control characters. £195.00

MICROSOFT

Z-80 SOFTCARD. A true Z80 microprocessor plug-in board to allow you to run CP/M software. Includes MICROSOFT'S BASIC 5.0. £175.00

RAMCARD 16K Expansion card for APPLE. Requires 16 Sector System (DOS 3-3) £110.95

RAMCARD + DOS 3.3 together, Special Price £139.95

FORTRAN for SOFTCARD. Has a strong advantage over APPLE Fortran. 4 to 6 times faster because it generates true machine code rather than "P" code. Feature-wise, the two are essentially the same. £99.95

COBOL for SOFTCARD. The only COBOL available for APPLE. Ask for more information. Special Price was £359.95 — Now £299.00

BASIC COMPILER for SOFTCARD. Get fast program execution times without giving up BASIC. 3-10 times faster than interpreted BASIC. £192.95

OLYMPIC DECATHALON. Latest game from MICROSOFT. 10 events presented in extraordinary graphics. 1-8 players can play. £14.95

ADVENTURE. Yes, this is the original written for the PDP11, and played during many a lunch hour on expensive main frames! £14.95

TYPING TUTOR. Runs in INTEGER (incl. relocated) It works! £8.95

Now available on disk Applesoft. £10.95

PERSONAL SOFTWARE

VISICALC. Yes, the one sold elsewhere for £125. Our price £75.00

PET VISICALC. Complete, sealed package. £99.95

CCA DATA MANAGEMENT. Our price just £49.95

DESKTOP PLAN. Develop your own large business model. £49.95

HIGH TECHNOLOGY

INFORMATION MASTER. The latest data management system from High Tech. We use it for all our book-keeping up to trial balance and for our price lists. Can be user tailored for many uses. £73.95

DATA BASE MANAGEMENT SYSTEM. High Tech.'s original system. Not as many features as Info. Master, but is user oriented with lots of error trapping. £49.95

DATA MASTER A utility for use with both Info. master and D.B.M.S. allows you to re-define field types, transfer data from one system to another, using a wide set of parameters. We use this too. £49.95

STONEWARE

D.B. MASTER Up to 1020 Bytes per record. Up to 100 fields per record. Up to 9 Screen Pages per record. Up to 4 fields in primary ISAM Key. Supports Multi-diskette files. Automatic "Data Packing" for increased disk capacity. A great Data Base Manager for big applications. £109.95

GAMES

TRANQUILITY BASE. Try to land a HIREs spacecraft. £13.95

BLOODY MURDER. Like playing with knives? (Integer) Disk. £9.95

MICROLEAGUE BASE BALL with real HIREs little people. £11.95

EDUCATIONAL

ARISTOTLES APPLE. Tutorial Pride. £17.95

PERIPHERALS PLUS

VERSAWRITER A low cost graphics tablet for APPLE £124.95

JOYSTICK T.G. Products robust joystick — self centering. £34.95

COMPUTER STATION

PASCAL GRAPHICS DUMP PROGRAM for Paper tiger 440G, 445G, 460G, 560G £22.95

NEC Spinwriter and Anadex 9501. £22.95

ENHANCED GRAPHICS DUMP PROGRAM also available for above. £22.95

VISILIST lists out the grid location and formulas of any Visicalc fil. £10.95

MACRO SCREEN EDITOR Cursor oriented editing tool. £19.95

APPLEWRITER GRAPHICS. Links with Applewriter and any of the 28 character sets supplied in APPLE'S "Dos Tool Kit" to provide word processing with a difference! Tiger 4406/4456 & Silentype. £17.95

CALIFORNIA PACIFIC GAMES

AKALABETH Latest Adventure type game. £16.95

TRILOGY £15.95. **TRANQUILITY BASE** £13.95

HEAD-ON Fram Japan £13.95

BILL BUDGE'S SPACE ALBUM £20.95

CONTINENTAL SOFTWARE

LOS ANGELES MONOPOLY. Define your own street names or take a trip round the streets of L.A. Allows you change the rules! £15.95

HYPERSPACE WARS £15.95

VARIOUS

DAN PAYMAR LOWER CASE ADAPTOR Produces upper and lower case, state revision 7 or earlier. £29.95

BASF 5.25 IN DISKS FOR APPLE. At a good price. 10 for £18.50

DAKINS. Find your way around the new APPLE DOS with Programming Aids 3-3. 12 Utility programs on one Diskette. (16 sector) Well documented. £49.95

STARCRAFT (Tokyo)

APPLE GALAXIAN. The best 'Invader' game we've seen bar none. We mean it! £13.95

GALAXY WARS. Another arcade game beautifully implemented on APPLE. £13.95

BRODERBUND. Do you like Starrek adventures? 4 GALACTIC SAGA's from Broderbund, provide a level of complexity and sophistication not seen before.

GALACTIC EMPIRE, TRADER AND REVOLUTION (3 separate DIsks) £13.95 each

TAWALA'S LAST REDOUBT £16.95

PLEASE ADD 15% VAT TO YOUR ORDER

POSTAGE AND PACKING FREE

ASK FOR OUR FULL CATALOG

IF YOU KNOW WHAT YOU WANT AND DON'T WANT TO PAY

AN INFLATED PRICE

GIVE US A CALL — WE SELL ALL SORTS OF THINGS FOR APPLE

TEL 01-677-2052 (24HRS) 7 DAYS A WEEK

98 MOYSER ROAD LONDON SW16 6SH

POST OFFICE GIRO NO. 585 6450

• Circle No. 277

**THE COMPLETE DATA ENTRY
RETRIEVAL AND UPDATE SYSTEM
FOR YOUR MICRO**



DataStar™

**Takes the drudgery of out
data-entry programming!**

Use DataStar to generate screen layouts, validate data input and update files.

DataStar has horizontal and vertical scrolling facilities for large forms, and performs search/retrieval and arithmetic operations. Produced by MicroPro International, the company that created the famous WordStar word-processing software.

DataStar is the complete data entry and retrieval package for £180; manual available for £29, refundable against purchase of software. Runs on Z80/8080/8085 micros under CP/M or CP/M compatible operating systems.

CONTACT US TODAY!

HELISTAR SYSTEMS LTD.

150 WESTON ROAD, ASTON CLINTON,
AYLESBURY, BUCKS HP22 5EP.
TEL: AYLESBURY (0296) 630364

• Circle No. 278



HEWART MICROELECTRONICS



**BRITISH SS50 SYSTEMS FOR RESEARCH
CONTROL AND EDUCATION**

The SS50 with the 6800 processor is by far the best system for machine code training and control systems. Plug in a 6809 and you then have the world's best 8 bit chip for more advanced applications. Illustrated above is trainer 2 — a single disc 32K computer for about £1,000.

We also supply the Apple II and the Video Genie to cover 6502 and Z80 programming applications.

SAE for leaflets.

**95 BLACKLEW ROAD, MACCLESFIELD,
CHESHIRE SK11 7ED**

• Circle No. 279



**BLACK WHITE
OR
GREEN
THE CHOICE IS
YOURS.**

Black & White model £85.00 + VAT + £4.50 car.

Green model £95.00 + VAT + £4.50 car.

OVM Video Monitors:—

**Precision engineered Video
Monitors, with a 9" screen,
accepting standard 1.4V P-P
inputs at 75 ohms or high
impedance.**

**Metal cased, solid state and
reliable, white or green.**

The choice is yours.

LOWE ELECTRONICS

CHESTERFIELD ROAD, MATLOCK, DERBYSHIRE DE4 5LE TEL 0629 4995

TRADE ENQUIRIES WELCOME



• Circle No. 280

BITS + PCS

COMPUTER PRODUCTS LTD

4 Westgate, Wetherby, West Yorks, LS22 4LL
Telephone (0937) 63744/63774

THE NORTH'S LEADING NASCOM SPECIALIST



PROGRAMMABLE CHARACTER GENERATOR FOR NASCOM 2
8192 Programmable dots Memory mapped with demo software and free game £60.00

NEW PRODUCTS FOR NASCOM:

DISCS:

Single drive £380.00
Double drive with CPM & EBASIC £640.00
Ask for details
Professional designed for your NASCOM

KENILWORTH CASE

A high quality case made from stelvete coated steel and solid mahogany £49.50
Mounting Kit for two cards £350
Mounting Kit for five cards £19.00

SARGON CHESS PACK

This pack includes the book and a tape with Sargon prepared to run under NAS-SYS. Also included in a special graphics rom and a PCB giving your NASCOM the ability to switch between two graphics ROMs, your original and the chess ROM. All the above for only £35.00

EPROM PROGRAMMER

This unit allows the NASCOM user to programme both 2708 2716 EPROMS complete with operating software £25.95

EPROM ERASER

Erasers 28 roms in 20 minutes £34.00

INTERFACE EPROM BOARD

Provides sockets for both 2708 and 2716 EPROMs (up to 16 EPROMs) and also provides a fully decoded socket for the NASCOM 8K BASIC ROM. This board is produced to full NASBUS specification and can be used in "page mode" together with the new NASCOM RAM B. Wait states may be generated on board to allow a NASCOM 1 to run at 4MHz in BASIC. The complete Kit at only £55.00

CASTLE INTERFACE

Gives the following features: — Auto tape drive * Auto cassette muting * Auto serial printer muting * 2400/1200/300 BAUD cassette. This interface built and tested complete with documentation at only £17.50

ASTEC 10" B/W MONITOR

A Professional Cased 10 inch Monitor giving superb resolution, only £80

ANALOGUE TO DIGITAL CONVERTER

This unit gives 4 Channels with an Input Range of 0 to 120mV up to 0 to 24V. Conversion time (average) 0.5mSec. Supplied built and tested at only £49.50

DUAL MONITOR

This Kit allows switching between two monitors on a NASCOM 1 e.g. T4 and NAS-SYS £6.50

PORT PROBE

A very useful device for testing and evaluating ports and peripheral software with improved documentation £17.50

HEX AND CONTROL KEY PADS

Our popular range of add on key boards for the NASCOM micros
HEX for NASCOM 2 £34.00
HEX & CONTROL KEYS for NASCOM 1 £40.50

PROGRAMMERS AID

In 2 2708 EPROM gives the NASCOM ROM BASIC many extra commands: AUTO, RENU, DELE, DUMP, FIND HEX, APND, HELP ... etc. £28.00

BITS & PC'S GAMES TAPE 1

Good value — ten excellent games £8.00

BOOKS

Full range including INMC mags

Epson MX80 £360.00
Eikosho GP80 £250.00
Software interface details supplied for Nascom users

PRINTERS

SHARP
MZ-80K 48K RAM £450.00
PC12 Pocket Computer £82.00
PC12 11 Cassette Interface £13.00
PC12 11 Printer £85.00

TEXAS T199/4 SPECIAL OFFER 3 only

Complete with accessories normal price £950.00
including B & W Monitor OUR PRICE £480.00

BUILT SYSTEMS REPAIRS MAIL ORDER and ADVICE

are our SPECIALITY
FULL RANGE OF NASCOM PRODUCTS
SAE FOR DETAILS. PRICES EXCLUDE VAT AND
POSTAGE/PACKAGE

Access & Barclaycard Welcome

FREE BASIC TRAINING COURSE WITH EVERY

SHARP MZ-80K

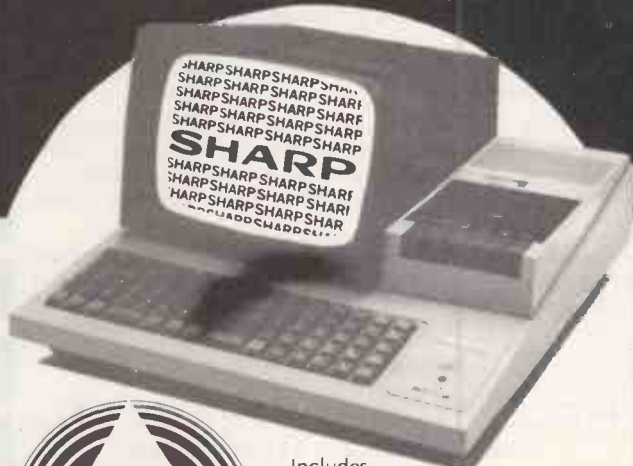

Includes

- * 20K RAM
- * One day BASIC course
- * BASIC Cassette & Manual
- * 12 months guarantee
- * Many options & programmes available

	NETT	VAT	TOTAL
MZ-80 Computer 48K	£478.00	£71.70	£549.70
MZ-80K 28K UPGRADE	£87.00	£13.03	£100.05
MZ-80 I/O Interface Unit	£62.00	£6.30	£48.30
MZ-80 FD Dual Disk Drive	£693.00	£103.95	£796.95
MZ-80 FDK Additional MZ-80FD	£616.00	£92.40	£708.40
MZ-80 RS232 Interface	£110.00	£16.50	£126.50
MZ-80 P3 Matrix Printer	£430.00	£64.50	£494.50
CP/M Operating System	£196.00	£29.40	£225.40
PC-1211 Pocket Computer	£91.00	£13.65	£104.65
CE-121 Cassette Interface	£12.60	£1.89	£14.95
RP1600 Daisywheel Printer	£1450.00	£217.50	£1667.50
Ledger and stock control packages free with computer systems			

Please send me

Name

Address

I enclose cheque/P.O. for £..... (£10 P & P)

Butel-Comco Limited
Garrick Industrial Centre
Garrick Road Hendon
London England NW9 6AQ
Telephone 01-202 0262
Telex 47523

Barclaycard

Access

Signed

Technology for business

INSTANT H.P. CREDIT AVAILABLE

PC4/81

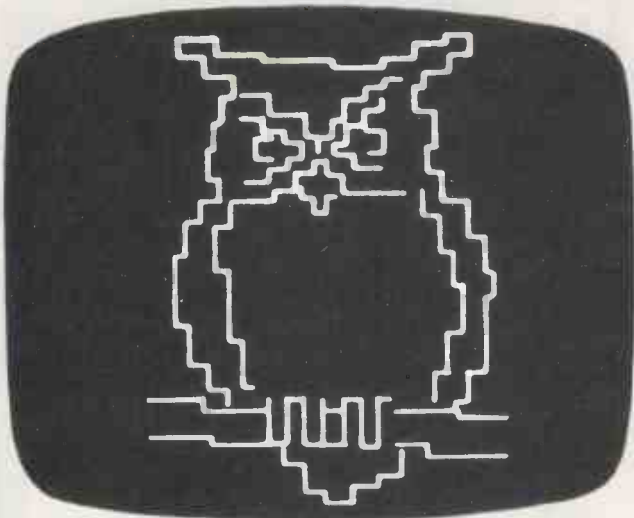

You lucky Apple II owners— by adding **Appletel** you can have the only **PO approved** computer connection

With Appletel you can link your present Apple II computer direct to Prestel for just £595 plus VAT - which is a major cost saving for a start. Add in these other major advantages and you'll really appreciate what the complete Owl Computer package can do for you!

- ★ Save on telephone bills by storing pages from Prestel on a floppy disc - screen them up on Apple II when you're ready.
- ★ Programme the unit to automatically call up a sequence of pages, and store them for later examination.
- ★ Write your own BASIC programs to process Prestel data as well as send commands to Prestel.
- ★ The full keyboard means you can use Prestel to maximum advantage for sending messages.
- ★ Appletel is now available in colour

For full details on what Appletel can do for you, and the name of your nearest dealer, please phone or write.

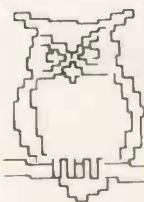

Owl Computers

18 Hadham Road, Bishop's Stortford
Herts CM23 2QR
Tel: Bishop's Stortford (0279) 52682

• Circle No. 283

PRACTICAL COMPUTING BACK NUMBERS & BINDERS



BINDERS

UK — £4.60 including packing, postage and VAT
Overseas — £5.75 including packing and postage
Please make all cheques payable to *Practical Computing* and sent to the General Sales Dept.

BACK NUMBERS

Fill in the coupon in every issue and return it with your remittance to *Practical Computing*, General Sales Dept. Room 205, Quadrant House, The Quadrant, Sutton, Surrey SM2 5AS.

SONY® Hi-Speed cassette duplicator



Duplicate computer data at 8 times normal speed! The CCP-11 Cassette-to-Cassette duplicator will copy both sides of a C-60 cassette simultaneously in less than 4 minutes. The CCP-13A with slave units can produce up to 43 copies at a time.

Write now for full details of our range including slave units and open reel master recorder.

FORCE 10

THE FORCE TEN CO LTD,
Audio-Visual Centre,
183, Boundary Road, Woking, Surrey.
Tel: Woking (04862) 62711

• Circle No. 284

LONDON COMPUTER CENTRE

NEW!

**Revolutionary! Epson MX80F/ T
the PRINTER with FRICTION &
ADJUSTABLE Removeable TRACTOR FEED**

£425

Dual print modes letter quality & standard dot matrix



ULTRA QUIET.

LOWER CASE DECENDERS
BI DIRECTIONAL, LOGIC SEEKING PRINT HEAD
40,80,66,132 Columns per line
UNIQUE BOLDING (BUILT IN FEATURE)
64 Graphic Characters (TRS 80 & Prestel)
9 x 9 PRINT MATRIX. £ sign.

Forms Handling; Top of Form
Horizontal and Vertical Tabs.

Centronics parallel interface standard.

Optional extra Serial, PET & APPLE interfaces.

Easily replaceable head.

After 50,000,000 to *100,000,000 characters
the head can be replaced without technical
knowledge or assistance for £15.00

* Approx. 38,000 copies of A4 letters.

For a Demonstration call into:

**43 GRAFTON WAY, LONDON W1P 5LA (Opposite Maples)
Tel: 388 6991/ 2 OPENING HOURS: 11-7 MON-FRI 12-4 SAT
24 hour answer phone: 01-388 5721**

• Circle No. 285

Have we got a Program for you!

APPLE TRS 80 VIDEO GENIE ZX 80

Excellent quality programs chosen for their superb graphics and smooth action

ATTACK FORCE

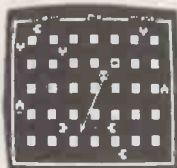

WITH SOUND!

Dodge the alien Ramships and fire missiles to destroy them before they get you. The alien Flagship uses his deadly laser bolt to transfer a Ramship into another Flagship, or into your ship's double. Look out!! Destroy your double and you could destroy yourself. Hours of exciting fun.

TRS80 LEVEL I or II. 16K Tape **£10**

NEW

ASTEROID NOVA



For the first time the amazingly popular ASTEROIDS pub game is now available for your microcomputer. Huge asteroids have invaded the galaxy. Your mission is to destroy them and the alien saucers before they destroy you. But beware, big asteroids break up into smaller ones.

TRS 80 LEVELS I & II. 16K Tape **£10**
VIDEO GENIE. 16K Tape **£10**
APPLE II & II+, 32K Disk **£15**

GALAXY INVASION



WITH SOUND!

The newest and most exciting invaders type game yet! Cruel and crafty aliens attack Earth. You are the sole defender. As you fire your laser at the aliens they swoop down and bomb you. Exciting use of graphics! Must be seen.

TRS 80 LEVEL I & II. 16K Tape **£10**
VIDEO GENIE: 16K Tape **£10**

NEW
VISICALC for TRS 80
32K DISK ONLY
£75

**SEE OUR COMPLETE
RANGE
SEND STAMPED ADDRESSED
ENVELOPE FOR FREE
CATALOGUE**

THE ESSENTIAL SOFTWARE COMPANY (VISCINTI LTD.)

47 BRUNSWICK CENTRE, LONDON WC1N 1AF

I have a microcomputer
 Please send me your software catalogue. I enclose a stamped self addressed envelope.

Please send me

I enclose a cheque/postal order for £ (plus 50p post & packing)

Signature

Name

Address

..... Postcode

PC4/81

• Circle No. 286

New from Millbank!

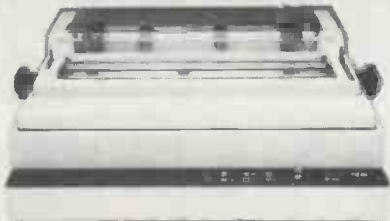

UNBEATABLE DAISYWHEEL VALUE!

The Olivetti PR 430 brings a new level of reliability, quality and value to daisywheel printing. Attractive trade and OEM prices (RRP: £1275).

PLUS

Don't forget to ask about the fabulous Millbank System 10 the new fully integrated microcomputer—ideal for mainframe communications and preprocessing and all commercial computing applications.

Trade and OEM enquiries welcome.

**MILLBANK
COMPUTERS**

MILLBANK COMPUTERS LIMITED · 98 LOWER RICHMOND ROAD
LONDON SW15 1LN · TELEPHONE: 01-788 1083

• Circle No. 287

THE WESTFARTHING SMALL BUSINESS SYSTEM

for Apple/ITT 2020 micros

Designed from first principles for the family business, it will pay for itself by keeping the accounts in good order, saving management time on paperwork, and accountants fees.

FUNCTIONS: (in short, everything you need)

- Invoicing (+ discounts, quotations, delivery notes)
- Customer accounts and shop sales
- Bank and cash balances calculated weekly
- Sales and overheads (30 categories) totalled weekly
- VAT return calculated (while you have lunch)

SPECIAL FEATURES FOR OWNER-MANAGERS:

- VAT-inclusive bills split automatically
- Messages can be printed on invoices
- Automatic payment entry when customer pays on the spot
- Uses plain fan-fold paper, prints your heading
- S/A customer address labels printed
- User's Manual (50 pages) in clear, non-technical style
- Designed to be user-modifiable

Requires 48K RAM, Applesoft in ROM, 1 or 2 disc drives, printer, Program lives in core. Includes pages of program information, hundreds of REMs, disc map, etc.

Cost: £750 + VAT (£750 only to non-regd trader). For information, send £1 for 10 page description or £10 for User's Manual.

Westfarthing Computer Services Ltd., 21 Wendron St., Helston, Cornwall. Phone Helston (03265) 4098.

• Circle No. 288

TOMORROW TODAY at Birmingham Computer Centre

Commodore official distributors



4008/16/32 8032 — 8050

NEW DAISYWHEEL PRINTER IN STOCK
NEW MATRIX PRINTER NOW IN STOCK
THE RELIABLE VALUE FOR MONEY SYSTEM
WITH FULL AFTER SALES SUPPORT.



Apple authorised distributors

The sophisticated quality system with a reputation for advanced design and innovation.

SHARP Z80K



The incredible computer system now available ex-stock including the New Duel Drive Double Sided Floppy Disk.

THE ULTIMATE IN DAISYWHEEL PRINTERS
RICOH.RP 1600

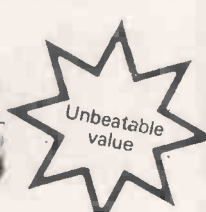
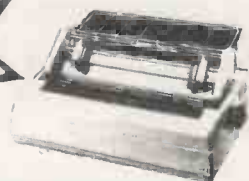

THE BEST WORDPROCESSOR.PRINTER.AVAILABLE
DEALER ENQUIRIES WELCOME

CAMDEN ELECTRONICS LTD
MICROCOMPUTER SYSTEMS

462 COVENTRY ROAD • SMALL HEATH • BIRMINGHAM B10 0UG
Telephone: 021-773 8240 or 021-772 5718 • Telex: 335909 (Camden G)

• Circle No. 289

CASH AND CARRY SUPERDEALS

SUPERBRAIN 64K £1650

**QUAD DENSITY
SUPERBRAIN** £2250

NEC SPINWRITER £1600

DIABLO 630 £1600

CROMENCO – (All hardware and software in stock for immediate delivery)

MATRIX PRINTERS

**ANADEK
OKIDATA
EPSON** The quietest, most reliable printers available – 40, 80 or 132 characters per line with graphics

Telephone: 01-840-1926

MICROPRO

WORDSTAR
The Ultimate Word Processing Package **£250**

DATASTAR
Forms Generation, Data Capture, Validation and Retrieval **£180**

MAILMERGE
Mailing List, Standard Letters, etc. **£80**

SUPERSORT
Search, Sort and Select **£125**

PASCAL, BASIC FORTRAN, PL/I and other CP/M software

Dealers: Best Discounts

Call for Details
Telephone: 01-840-1926

• Circle No. 290

Mini-Digital Cassette Recorder

AN ALTERNATIVE TO DISC FOR PROGRAM AND DATA STORAGE

FEATURES

- THE PHILIPS MDCR 220 MECHANISM OF PROVEN RELIABILITY
- HOLDS UP TO 120K BYTES/CASSETTE WITH FAST DATA TRANSFER
- EXTRA MEMORY BOARD WITH RAM AND ROM TO HOLD OPERATING SOFTWARE
- WILL READ AND WRITE (IN BLOCKS FROM 256 BYTES TO 60K BYTES), BACKSPACE AND SEARCH FOR END OF DATA ON TAPE
- COMPATIBLE WITH 6502 BASED SYSTEMS IE PET, AIM65, OHIO, KIM, COMPUKIT ETC.
- BUILT AND TESTED UNIT AVAILABLE TILL THE END OF APRIL REDUCED FROM £245 TO £195.



PRICES (INCLUDING MANUAL)
MINI RECORDER MECHANISM £95.00
INTERFACING BOARD (TYPE A) £42.50
MEMORY BOARD (WITH ROMS FOR 6502) £55.00
CASSETTES (BOX OF 6) £15.90
CARRIAGE £2.25
PRICES EXCLUSIVE OF VAT 15%

CURRAH COMPUTER COMPONENTS

UNIT 7, HARTLEPOOL WORKSHOPS
SANDGATE INDUS EST, HARTLEPOOL
CLEVELAND (0429) 72996

• Circle No. 291

INTEGRATED SMALL BUSINESS SOFTWARE

ISBS

ISBS - F

A totally Integrated Small Business System designed for single user floppy disk based systems. ISBS-F is already being used by many Businesses and Professions throughout the UK. Each package can be used as standalone or can be built into an integrated system depending on user requirements. All packages are fully supported and maintained, and are supplied with easy to follow Reference Manuals. ISBS-F is easy to install and ideal for the first time small Business user with no previous computer experience.

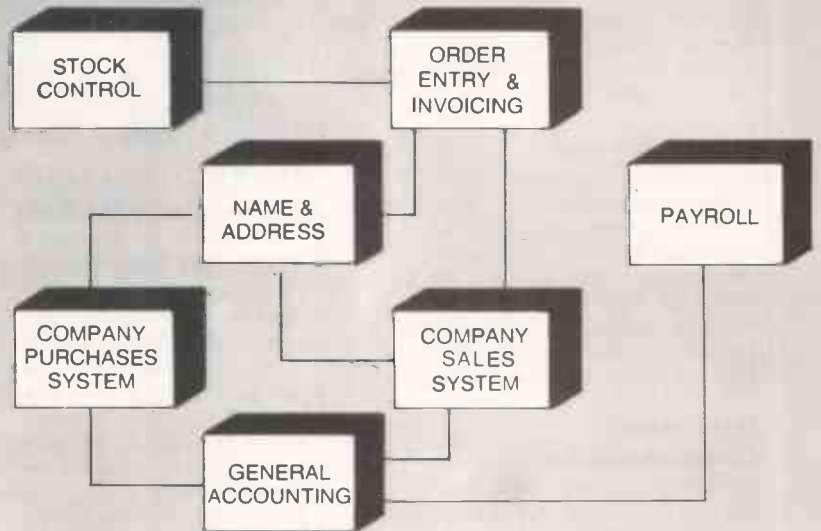

ISBS - W

A Hard disk or Winchester disk based Integrated Business Software system which is upwards compatible with ISBS-F. This system is ideal for the small to medium size user where data storage and processing speed exceeds the capabilities of floppy disk based systems. Choose from any combination of modules and add others at a later stage if required. The system features many facilities found in minicomputer and mainframe business packages. All modules are fully supported and maintained and comprehensive documentation is supplied with each installation.

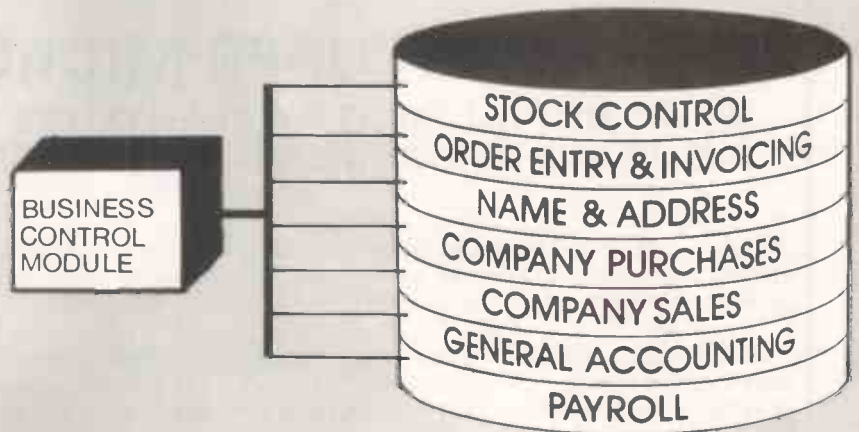

SYSTEM REQUIREMENTS

ISBS has been designed for most popular 8080/Z80 Microcomputer disk systems running under CP/M*
 ISBS-F: 48k & 2 floppy disk system, VDU, 132 col printer, CP/M* 1.4 or 2.x
 ISBS-W: 64k & Hard disk(s) system, VDU, 132 col printer CP/M* 2.x or MP/M*
 Current installations on Rair Black Box, Northstar, Heath, Cromemco, Altos, Superbrain, IMS 5000/8000, Dynabyte, Micromation.

For further details and prices contact your nearest dealer or call us direct.

*CP/M, MP/M trademarks Digital Research.

GRAFFCOM
SYSTEMS GROUP

52 Shaftesbury Avenue London W1 01-734 5970

NOT JUST ANOTHER MICRO

THE 4000 SERIES HAS MAINFRAME COMMS AS WELL

The H4500

The H4500 is the information station for the business professional. The H4500 is both a powerful independent desk top data processing system and an advanced intelligent terminal attachable to host computers. Designed for the user who has to rely on it to support business operations the H4500 is first and foremost **RELIABLE** and will stand constant use over lengthy periods of time.

Multifunctional

In use the H4500 is versatile. It may be used for a single function but in general users take full advantage of the multifunctional capabilities of the system. A wide range of software is available for instant use on the H4500 including Word Processing, Accounting, High Level Languages as well as specific commercial applications e.g. recruitment, solicitors, etc.

Mainframe Communications

The H4500 may be used in conjunction with HOST COMPUTERS either as an advanced intelligent terminal, as a data collection device or as a distributed processor. Protocols include: I.C.L. — BURROUGHS — DEC — I.B.M.



The 4500 talks to ICL, Burroughs, IBM, DEC, etc.

Technical Specification

Computer

Z80 processor/158 instructions 64K memory addressability plus 16K switch in blocks. Microbus for easy expansion — data, address, interrupt, control and timing.

Disk

493 kilobytes per drive (formatted). Soft sector (493 kilobytes each side) microfloppy disks industry standard, addressing and CRC checks.

Keyboard

Typewriter array plus editing, numeric and special function groups. All key sites programmable.

The H4000

Modern microcomputer technology in the H4000 provides an attractive alternative to the ICL 7181 or the 7500 system (including its replacement the 7800). Attractive in terms of performance, system resilience and cost.

The Microcomputer

Each H4000 has its own powerful Z80A processor with 16K bytes of memory. The use of the Z80A eliminates any need for a central cluster controller. The 'senior' H4000 on the line performs this function. If it is not on line the next takes over.

Support

A high level of support is provided as demanded by the business user. Our engineering staff have worked on the H range since its design days and our software staff provide a comprehensive service covering all of the software which we supply.

HYTEC

Hytec Microsystems Limited,
St. Georges Place, Oxford OX1 2BL.
Telephone (0865) 726644/5/6

• Circle No. 293

MULTI USER MICRO SYSTEM!

NO IT'S NOT A JOKE, IT'S A REALITY! IT'S CALLED MVT-FAMOS, AND IT'S UP AND RUNNING ON OUR IMS RANGE AT THIS VERY MOMENT

That's right, it's not 'Coming Shortly', it's not 'Available in the near future', and it's certainly not 'Soon to be released'. It's available now, and we can demonstrate it at your convenience.

MVT-FAMOS is a full multi-user, multi-tasking Z 80 based operating system, which means that you can have several terminals running many different types of systems, such as stock control, accounting and payroll, all at the same time. Or you may wish to have several people all accessing the same system, MVT-FAMOS doesn't mind, it's entirely up to you.

You don't have to spend a lot of money to get started with FAMOS either, a 2 drive floppy based system with 64K of RAM storage, VDU and printer sells for as little as £3,500 (Three Thousand Five Hundred). But once you start there's no stopping, because you can increase the number of terminals, the amount of RAM memory, and even add multiple hard disk drives, giving you millions of bytes of data storage.

So if you would like to arrange for a demonstration of this extremely advanced and versatile system, or even just to get some more information, contact: —

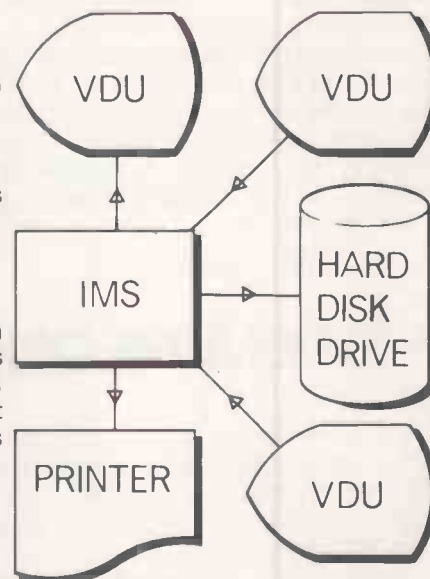

MICROTEK COMPUTER SERVICES

50 Chislehurst Road, Orpington, Kent, BR5 0DJ. Tel: Orpington 26803

• Circle No. 294

CHROMASONIC electronics

48 JUNCTION ROAD, ARCHWAY, LONDON N19 5RD 50yds FROM ARCHWAY STATION & 9 BUS ROUTES
 TELEPHONE 01-263 9493 263 9495

YOUR SOUNDEST CONNECTION IN THE WORLD OF COMPONENTS AND COMPUTERS

PETS & SYSTEMS

- 8N 8K RAM £399
- 16N 26K RAM £499
- 32N 32K RAM £599
- CASSETTE DECK £55

343K Twin Floppy Disk
 £695

NEW 32K with 80 col Screen £825
 Twin Disk Drive 950K £895

All with new keyboard
 and green screen
 Friction Feed Printer
 £375
 Tractor Feed Printer
 £425

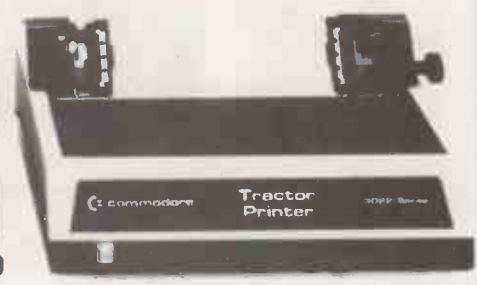

COMPLETE 32K SYSTEM £1789

MEMORY EXPANSION KIT

Suitable for UK101. Superboard expansion using 2114's each board has 16K ram capacity kit contains:

- ★ On board power supply
- ★ 4K Eprom expansion
- ★ Fully buffered for easy expansion via 40-pin socket
- ★ 8K kit £79.95
- ★ 16K kit £106.95
- Printed Circuit Board £29.95
- 40 pin - 40 pin header plug £8.50



NEW SHOP

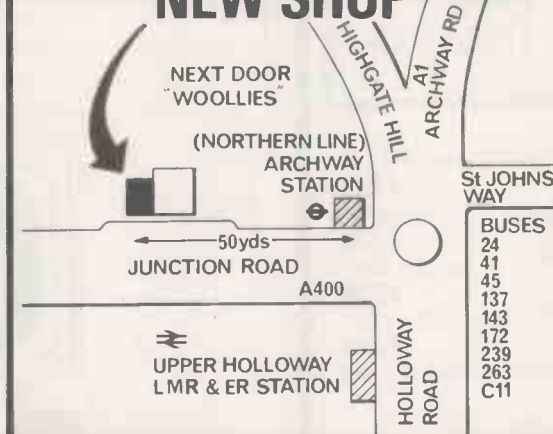

VIDEO GENIE based on TRS80



Utilises Z80, 12k level II Basic, Integral Cassette Deck, UHF O/I.P. 16k RAM, all TRS80 features

£289

CASES

Available for U.K. 101, Superboard Nascom, Appx. DIM. 17" x 15" 435 x 384 mm

PRICE £24.50

Post & Packing £1.50

UK101 P.P.I.

BUILT & TESTED. INTERFACES TX80 PRINTER DIRECT, CAN BE PROGRAMMED TO OPERATE RELAYS, MOTORS, VARIOUS OTHER PERIPHERALS 'CENTRONICS COMPATIBLE' PLUS INTO IC SOCKET. RED!!!!!! DISPLAY LED BINARY DISPLAY FULL DOCUMENTED £29.95

UK101

£179 IN KIT FORM
 £229 READY BUILT

& TESTED
 £255 COMPLETE IN CASE

4K EXPANSION (8 x 2114) now only **£14.00**

- No extras required
- ★ Free sampler tape
 - ★ Full Qwerty keyboard
 - ★ 8K basic
 - ★ Ram expandable to 8K on board (4K inc)
 - ★ Kansas City tape interface
 - ★ NEW MONITOR ALLOWS FULL EDITING & CURSOR CONTROL



£22.00

PRINTERS



EPSON TX-80 £295
MX80 £350

Dot-matrix printer with Pet graphics interface: Centronics parallel, options: PET, Apple and serial.



Please add VAT 15% to all prices. Postage on computers, printers and cassette decks charged at cost, all other items P&P 30p. Place your order using your Access or Barclaycard. (Min. tel order £5). Trade and export enquiries welcome, credit facilities arranged.



• Circle No. 295

odp Flexible Diskettes

OFFICE DATA PRODUCTS

Quality Floppy Discs from the World's Largest Manufacturer of this type of Product. Fully Guaranteed.



With New Extra Longlife Coating Technology

- Single Sided Single Density 5 1/4" Diskette 40 Track Certified **£1.75**
- Double Sided Double Density 5 1/4" Diskette 40 Track Certified **£2.49**
- Single Sided Single Density 8" Diskette 26 Sectors, 128 Bytes/Sector **£2.29**
- Double Sided Double Density 8" Diskette Certified **£3.64**

These prices are for small quantities and do not include v.a.t.

DISCOUNTS FOR LARGER QUANTITIES.

Full range of other configurations available from stock.

Other products include: —

- Floppy Disc Head Cleaning Kits.
- Floppy Disc Storage. Fire Protection.
- Printer Ribbons etc.

Full range of media and Accessories also available for the larger Computer.

TRADE ENQUIRIES WELCOMED.

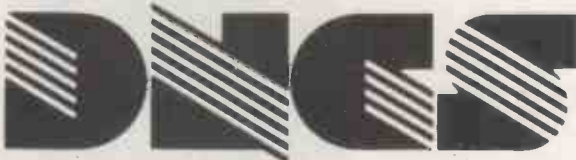

**D.N. COMPUTER SERVICES LTD.,
WEST CROFT INDUSTRIAL ESTATE,
MANCHESTER OLD ROAD, MIDDLETON,
GREATER MANCHESTER.**

Tel: 061-643 0016 Telex: 635091

• Circle No. 296

Erase Eproms in 8 minutes for under £100

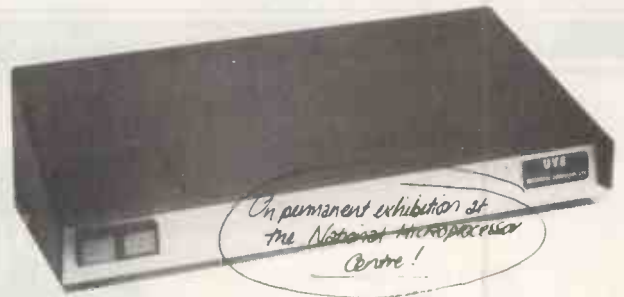

The high speed, high capacity model UV8 sets new performance and price standards.

- Cuts typical erasure times by a factor of 5
- 8 MINUTE SOLID STATE TIMER
- Capacity up to 14 EPROMS
- 2708 type erased in 4 to 7 minutes
- High intensity 254 NM UV source
- Safety interlock automatically starts timing sequence
- Audio tone signals erasure cycle complete
- Internal switch to extend erase time.

MICRODATA Computers Ltd, Belvedere Works, Bilton Way, Pump Lane Industrial Estate, Hayes, Middlesex.

Telephone (01) 848 9871 (6 lines) Telex 934110

• Circle No. 297

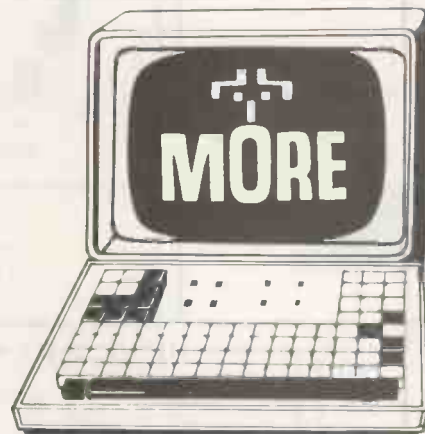

If your PET is hungry for 5 1/4" flexible disks, we can feed him.

Control Dataset high quality 5 1/4" flexible disks are readily available at major office equipment suppliers. Or you can order them direct from us.

For a list of stockists, or details of our mail order service, contact us at Control Dataset Ltd., P.O. Box 16, Argyle Way, Stevenage SG1 2AB, Herts. (Tel: 0438-3399)

CONTROL DATASET

CONTROL DATA

• Circle No. 298

FACTORY FRESH BRAND NAME

5 1/4" MINI DISKS

FREE PLASTIC LIBRARY BOX WITH EVERY TEN-PACK ORDERED

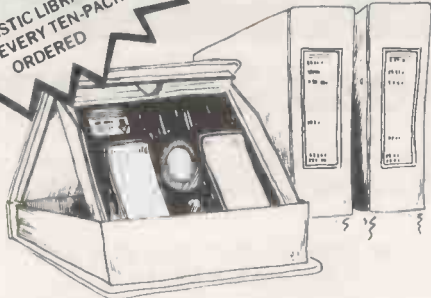

DISCOUNT PRICES PER TEN-PACK

All Disks are Factory Fresh, and incorporate latest manufacturers mods.

	NET	VAT	TOTAL
MEMOREX : The Ultimate in Memory Excellence			
MEM 1 S/Sided, Soft* Sector, S/Density	£16-48	£2-47	£18-95
MEM 1D S/Sided, Soft* Sector, D/Density	20-39	£3-06	£23-45
MEM 2D D/Sided, Soft* Sector, D/Density	£23-44	£3-52	£26-96
Verbatim : New Datalife Brand, with hub ring reinforcement			
MD525 S/Sided, Soft* Sector, 35/40-Track	£17-35	£2-60	£19-95
MD550 D/Sided, Soft* Sector, 35/40-Track	£26-04	£3-91	£29-95
MD577 S/Sided, Soft* Sector, 77-Track	£27-50	£4-13	£31-63
BASF : Typical West German Precision			
BASF 1 S/Sided, Soft* Sector, S/Density	£19-96	£2-99	£22-95
BASF 1D S/Sided, Soft* Sector, D/Density	£22-50	£3-38	£25-88
BASF 2D D/Sided, Soft* Sector, D/Density	£25-61	£3-84	£29-45

* All the above, are available in 10 or 16 Hard Sector at the same price, so please specify clearly when ordering, whether soft, 10 or 16 hard sector, and if in doubt, telephone us or name your computer on your order.

EUROPHONIC

Disk Drive Head Cleaning Kit		£18-00	£2-70	£20-70
Disk Directories	(Each)	-83	-12	-95
Disk Directories	(Per dozen; post free)	£8-65	£1-30	£9-95
DiskWriter 'writes with minimum pressure'	(Each)	-40	-06	-46
DiskWriter	(Per dozen; post free)	£4-00	-60	£4-60
Plastic Library Boxes	(Each)	£1-70	-25	£1-95
SuperLuxe Disk Library 'holds twenty disks'	(Each)	£8-65	£1-30	£9-95

If Order Form has been cut, send your cheque, payable to Cash with order only please.

EUROPHONIC

FREEPOST, Liphook, Hants, GU3 7BR. Tel: 0428 722563.



Order 2 or more Ten-Packs, and we will also give you a free EUROPHONIC Disk Directory and DiskWriter with every pack, so you need never wonder what's on your disks again.

SPECIAL BONUS

FREE Brushed chrome Paper Mate Ballpoint, with 5 - 9 Ten-Packs. 10 or more Ten-Packs, A GOLD Plated Paper Mate Ballpoint.

SPECIAL BONUS

ORDERING INFORMATION

U.K. DELIVERY, PACKING & INSURANCE (parcel post)	INC. VAT
Disk Drive Head Cleaning Kits	-75p
Mini-Disks (1-5 Ten-Packs)	each Ten-Pack -95p
Mini-Disks (6 plus Ten-Packs)	each Ten-Pack -65p
Disk Directories	(post free with disks) -25p
DiskWriters	(post free with disks) -25p
Plastic Library Boxes	(post free with disks) 45p
Superluxe Disk Library	-95p

URGENT DELIVERY, PKG. & INS. (first class post)	Ten-Pack	Ten-Packs
Mini-Disks first	£1-80	
Mini-Disks second & subsequent		£1-30

We accept BARCLAYCARD & ACCESS CARD, and make a small surcharge of 6%, on the total order value.
 If your order is urgent, you may telephone your card number to us, and we can ship from stock the same day.
 Please remember to state clearly, your card number, the holder's name & address, and where you want us to send the goods, & who to invoice.
 Payment by Cheque
URGENT ORDERS: Send your order, with a first class stamp on the envelope, and for us to return your goods FIRST CLASS, see the First Class postal rates above. Please mark your order URGENT.
NORMAL ORDERS: Cheques with order, payable to EUROPHONIC Please. If you are a large establishment, and can not raise cheques without an invoice, please post or telephone us your order, and we will return a pro-forma invoice, for your accounts department to pay against.

ORDER FORM

To: **EUROPHONIC**

FREEPOST, Liphook, Hants, GU3 7BR. No stamp required.

Please send me:	Qty	Total
MEM 1 Ten-Pack at £18-95		
MEM 1D Ten-Pack at £23-45		
MEM 2D Ten-Pack at £26-96		
Verb 525 Ten-Pack at £19-95		
Verb 550 Ten-Pack at £29-95		
Verb 577 Ten-Pack at £31-63		
BASF 1 Ten-Pack at £22-95		
BASF1D Ten-Pack at £25-88		
BASF2D Ten-Pack at £29-45		
Cleaning Kit at £20-70		
SuperLuxe Library at £9-95		
Disk Directories at 95		
DiskWriters at -46		
Please add delivery & insurance		
TOTAL Value of Cheque enclosed		£

Please make cheques payable to **'EUROPHONIC'**
 Name: _____
 Address: _____

What you say about us:
 "Just received your 100 Verbatim Mini Disks, please send another 100."
 "Your urgent deliveries to us, have saved us from many problems, please find enclosed a cheque for our third order of 100 BASF disks, we are delighted."
 "Another 20 BASF please, and thank you for the sheer speed of service in settling impossible deadlines."
 "Dear Sir, Please find enclosed cheque for yet another Ten-Pack, and thank you for your most courteous service."
 "There must be something wrong with your disks, your prices are too low!"

The Co-Operative Society, Nuneaton.
 Carlton Computers, Great Yarmouth.
 A. T. Grant, Sevenoaks.
 R. Pool, Reading.
 anonymous & sceptical telephone enquirer.
• Circle No. 299

KEMITRON ELECTRONICS LTD

The Complete Business System

The KEMITRON K3000 Disk Based System is an all BRITISH microcomputer suitable for all Business and Educational applications. The basic unit consists of two 8" floppy disk drives, processor (Z80A), RAM, communications interface and supporting hardware.

Its unique modular design allows the simple addition of more memory or input/output interfaces as and when required. This powerful facility can also be applied to the addition of extra disks (up to four).

The computer is supported by the CP/M disk operating system which provides all communication between the disks, terminal and printer and includes several utility programs. CP/M is the industry standard and as such can utilise a wide variety of well supported software which is both readily available and reasonably priced.

APPLICATIONS

- * WORD PROCESSING
- * FINANCIAL PACKAGES
- * STOCK CONTROL
- * INVOICING
- * PAYROLL
- * ASSEMBLY LANGUAGE DEVELOPMENT
- * EDUCATIONAL & LABORATORY COMPUTER
- * PROGRAM DEVELOPMENT

TECHNICAL DETAILS

- * Z80A Based — runs at 4 MHz
- * 32-48 or 64K RAM — Dynamic
- * Twin RS232 ports — more if required
- * Twin 8" single sided single density disk drives
- * Supports CP/M

from £2,300+ VAT

**CHESTER
COMPUTING
CENTRE**

— Ring or write for further details

**21-23 CHARLES STREET
HOOLE, CHESTER CH2 3AY
TEL: (0244) 21817**

• Circle No. 300

3D

Digital Design and Development
18/19 Warren Street London W1P 5DB Tel 01 367 7368

**Scientific and Industrial
Interface Specialists.**

SHARP MZ-80K CBM PET

**Specialist Suppliers of Complete
Systems for Industrial and
Laboratory Monitoring and Control.**

SHARP MZ-80K INTERFACES

- Parallel Printer Interface £110
- Serial Printer Interface £150
- Bi-Directional Serial Interface £210
- 16-Channel A/D Converter Unit £280
- Fast Data Acquisition System —
40,000 readings/sec. 4 analog channels
channels IN and 4 channels OUT. £1200

PET INTERFACES

IEEE-488 Compatible Units

- 16 Channel 8-Bit A/D Converter £300
- 8 Channel 8-Bit D/A Converter £350
- 8 Channel 12-Bit A/D Converter £600
- 12-Bit D/A Converter £695
- X-Y Analog Plotter Interface £200
- Digital Data Input Unit, 64 Bits £400
- Digital Data Output Unit, 64 Bits £350
- 16 Channel Relay Unit £350

Also...

- USER Port Converter A/D plus D/A £200
- Fast Data Acquisition System
40,000 readings per sec. 4 A/D + 4 D/A £1200

All units boxed complete with IEEE-488 address internally selectable, with integral power supply, cables, switch, fuse, indicators and illustrative BASIC software.

TERMS: All prices Ex-VAT. P&P extra.
Cheques should be made payable to
3D Digital Design & Development.
All goods supplied under 90 days warranty.
CUSTOM DESIGN UNDERTAKEN.

• Circle No. 301

SIRTON COMPUTERS



76 Godstone Road, Kenley (Nr Croydon) Surrey CR2 5AA
Tel: 01-668 0761/2

NOW WITH MP/M

MIDAS S.100 SYSTEMS

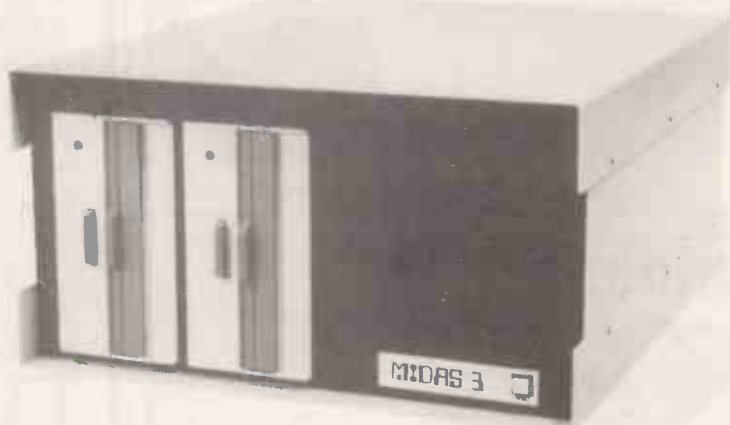

MIDAS 1: From £750
MIDAS 2: From £1580
MIDAS 3: From £2150
MIDAS 4: From £5900
ITHACA-DPS 1: From £1075

- Our versatile Z80 Microcomputers are available as standard units or custom configured to your exact specification from a comprehensive range of stocked S100 boards.
- Disc storage capacity of the MIDAS 3 can be 2M Bytes, expandable to over 20M Bytes with a Winchester Hard Disc Unit in our MIDAS 4 range.
- MIDAS runs CP/M and MP/M is also available. Other Software includes M-BASIC, C-BASIC, FORTRAN, COBOL, CIS-COBOL, PASCAL and Word Processing.
- **A MIDAS 3, with 64K RAM and 2M Bytes storage on two 8" drives with two Serial I/O Ports and CP/M 2 only £2835.**
- Multi-User System (four users) — MIDAS 3 with four 48K blocks of RAM, 1 MByte disc storage on two 8" drives and four Serial I/O Ports, and CP/M 2 + MP/M — **£3850.**
- Printers, VDUs and other peripherals stocked to give complete package systems at keen prices.
- Business Packages include Accounts, Stock Control, Purchase Ledger etc etc.

Boards stocked from Ithaca, Godbout, SSM, S D Systems, Vector, Micromation, Mullen, Mountain Hardware, Hi-Tech, Video Vector, Pickles & Trout, Central Data, Cromemco, Thinker Toys — Send for full Price List (many available in kit form).

Processor		RAM	
Z80 Starter Kit	£188	Dynamic RAM 16K-64K	from £205
SBC100	£208	Static RAM 8K-64K	from £95
8085/88 CPU	£237	Memory Manager	£52
Z80 CPU 4 MHz	from £130	I/O	
EPROM		2S/4P prov 4K RAM/4K ROM	£169
2708 EPROM (16K)	£60	2S/2P or 2S/4P or 3P/1S or 4S/2P	from £135
2708/2716 Programmer	from £134	Analogue 8 or 12 bit	from £287
Video		Optically isolated I/O	£114
16 lines, 32/64 ch	from £104	IEEE 488 Interface	£350
24 lines, 84 ch	from £265	Miscellaneous	
Disc Controllers		Real Time Clock	£180
Versafloppy S/D	£198	High Dens Graph/8K RAM	£333
Doubler D/D	£280	Hi-Tech Colour	£295
Mainframes		Motherboards — various from	£34
We are the sole UK Distributor for Integrand Mainframes and Disc Enclosures, available in nine models including Desk Top and Rack Mounting, with or without provision for Disc Drives. All units totally enclosed, painted on all external surfaces and complete with power supply etc.		Extender Board/logic probe	£39
Software		Maths Board AMD 9511	£330
CP/M 1 & 2, MP/M, PL/1, C-BASIC 2, M-BASIC V5, XYBASIC, FORTRAN 80, COBOL 80, CIS-COBOL, PASCAL/Z, PASCAL (UCSD), PASCAL M/T, Forth, MAC, ZSID, Disassembler, Wordstar, Datastar, Magic Wand, Wordmaster, Supersort etc etc.			

WRITE OR PHONE FOR CATALOGUE
PRICES EXCLUSIVE OF VAT

• Circle No. 302

peripherals from
Penny & Giles

Now there are two Lear Siegler Dumb Terminals. The same reliable ADM-3A with loads of dependable features - 12in screen, full/half duplex, 11 selectable data rates, 1920 characters in 24 rows of 80 letters, RS232C port and direct cursor addressing. And the new reliable ADM-3A+ for those who need something extra, like, numeric pad with full point, comma, tab, minus and return, upper and lower case caps lock, programme mode key and separate cursor control key. Both on immediate delivery.



printers



Penny & Giles hard copier
An electro-static, micro processor controlled, line or message printer, with graphics facility, serial or parallel interfacing, re-programmable character generator and add-on user programmable options.

Penny & Giles matrix printers

A plain paper, programmable printer with 8080 intelligence, 80 columns, bi-directional print speed of 55 to 1000 lines per minute depending on format, multiple character set and a graphics option.



data stores



Penny & Giles minifile is the compact floppy disc data store with all the performance you will need:
rapid access to 600 files per disc
up to 162 thousand stored characters
full integral disc management

up to 7200 baud transfer rate
automatic error handling
RS232/tele type compatible interface
auxiliary modem port

And it has dual disc expandability and full edit too, if you need it.

Get full technical details on all the peripherals from Penny & Giles by ringing the reader service number.

Penny & Giles
Data Recorders Ltd



Mudford Christchurch Dorset BH23 4AT
Tel: Highcliffe (042 52) 71511 Telex: 41266

• Circle No. 303

ITT2020 SOFTWARE APPLE II

DATABASE is a program that writes a program. DATABASE can create a flexible record-keeping system custom designed to YOUR specification.

HUNDREDS OF MEMBERSHIP DETAILS OF MEDICAL RECORDS APPLICATIONS MAILING LISTS, ETC a direct replacement for the CARD INDEX

Simply draw the format you require on the screen maximum using the editor. Then let the computer do the rest! Easy to use. FEATURES: protected screen editing automatic date and number checking comprehensive search & print functions £120+V.A.T. for the complete system!

Phone 01-242-7394 or write for details

DISK DEAN LTD
23 BEDFORD ROW, LONDON WC1R 4EB

• Circle No. 304

SPIDER SOFTWARE

CUSTOMISED SOFTWARE

Apple II/ITT 2020 software written to your own specifications. The largest user of postal services in the world uses a Spider Software bespoke mailing-list. Firm quotation given on receipt of program requirements. Please write or phone for details of our services.

PACKAGED SOFTWARE

Write or phone for a copy of our FREE catalogue of Apple/ITT software. Includes:

D/DATABASE

D/DATABASE uses advanced programming techniques and unique data storage and retrieval routines. A special high-speed disk I/O controls the data held on disk, searching and evaluating information at many times the rate achieved by the standard DOS's random access capabilities. Every possible byte on a disk is available for data storage on a DDA formatted disk. D/DATABASE is not operated using limited numbered indexes. All 'conversation' with the system is in the form of logical statements, similar to BASIC statements.

10 databases per disk maximum - 128 characters maximum record size.
9 character field names - 909 (DOS 3.2) or 1119 (DOS 3.3) useable files per disk.
9 user named fields per record - 27 characters maximum per field within total limit.
16 character index files - D/DATABASE is VERY user-friendly.
£39.95. BASIC and machine-code. Requires 48K. Specify DOS 3.2 or 3.3 when ordering.

MYSTERY HOUSE

In this hi-res adventure you are transported to the front yard of an old Victorian house. Your friends are being murdered one-by-one and you must find out why, and who the killer is. Over 100 hi-res pictures and an extensive vocabulary of 300 words.
£24.95 on disk only. Machine-code. Requires 48K.

THE WIZARD AND THE PRINCESS

Fantastic hi-res adventure with hundreds of pictures in 21 different colours. Do battle against the evil wizard in order to save the princess's life. The graphics on this game have to be seen to be believed.
£29.95 on disk only. Machine-code. Requires 48K.

OLDORF'S REVENGE

An exciting hi-res game using over 100 pictures. As you explore the caverns and castles looking for treasure you must battle the one-eyed, two-thumbed Torkie; find the Grezzlerip's sword; visit the Snotgurgle's palace and journey through the domain of the three-nosed lckypup.
£14.95 on disk only. Requires Applesoft ROM and 48K.

TARTURIAN

Explore 160 rooms (each in hi-res) gathering weapons and treasure that will prepare you for the final battle against the Tarturian. You will encounter deadly Krolls, battle the Minotaur, try and get by Count Snootwecker, decipher the Yummy Yakky's secret and avoid ghouls.
£19.95 on disk only. Requires Applesoft ROM and 48K.

Prices are inclusive but add 50p P+P for orders under £30.00 totally.

SPIDER SOFTWARE

44 LENHAM ROAD, SUTTON, SURREY
Tel: 01-661 2365 01-680 0267 (after 6 p.m.)

• Circle No. 305



Number one for PET in London.

01-579 5845

The news is travelling fast amongst the professionals that Adda are the Number One people to go to for Commodore PET microcomputer systems.

Commodore's new generation of desk-top computers and software - including packages for accountants, solicitors and doctors - can be made to realise their full potential with professional advice from Adda. This, together with exceptional standards of service back-up, will help you stay on top and in complete control of the latest advances in microcomputing.

WORD PROCESSING FROM AS LITTLE AS £2900

With the WORDCRAFT 80 programme, Adda can show you how to make use of a Commodore Business System in the dual role of a fully fledged word processor. There's capacity for 250-300 pages of text, the functions you'll find on very much more expensive word processors, and a wide choice of output printers including daisy-wheel. Add on the DMS file management programme for £195 and you can access several thousand names and addresses for personalised mailing. Mu-Pet enables you to build up a multi-terminal word

processing system linking from three to eight microcomputers to one Commodore disc drive and printer for as little as £595.

CALCULATOR, PEN AND PAPER - ALL IN ONE - WITH VISICALC

When you need to work things out on paper, using a calculator, the VisiCalc programme can do it so much easier and quicker on computer - and instantly display the answers you are looking for. And you can get a hard printout later. The applications are numerate and innumerable - get Adda to show you.

MEDICOM PRACTICE MANAGER - JUST WHAT THE DOCTOR ORDERED

Medicom Practice Manager provides the information needed

to ease the clerical workload and aid the running of an efficient practice. Designed by doctors in general practice, this practical computing system controls and prints repeat prescriptions, maintains the age/sex register and monitors patient care - in a complete package costing less than £3000. A pharmacy stock control system can be added for just £400.

Find out more about how these developments can best be employed in the professions - with professional advice from Adda.

Phone 01-579 5845 today.

adda

Adda Computers
14 Broadway
West Ealing
London W13 0SR
Entrance in
Kirchen Road
01-579 5845



we add up to a great deal.

• Circle No. 306

MicroStyle

9 St. Peters Terrace,
Lower Bristol Rd.
Bath, BA2 3BT.
Telex: 44371 (KEMP-G)

ANOTHER FIRST FOR MICROSTYLE, THE
DAI PERSONAL COMPUTER **THE SECOND GENERATION**
PERSONAL COMPUTER
*** HIGHEST PERFORMANCE * LOWEST PRICE**

- * 48K (8080A)
- * 16 Colours or shades of Grey
- * Multiple High Resolution Graphics Modes (64 x 71, 129 x 159, 255 x 335)
- * Character mode (60 x 24)
- * Split Screen Modes
- * Full ASCII Upper & Lower Character Set
- * Unique graphical — Sound Commands for Smooth Music, random frequencies & enveloped sound!



* RS232 I/F

All as Standard

at only **£595** + VAT

ACULAB FLOPPY TAPE

The ideal graduation from Cassettes for all TRS.80 and Video Genie owners

TRS.80 Version £165:

Video Genie £174

COMPUTERS

PET 8K	£415
PET 16K	£525
PET 32K	£650
PET 8032	£895
OHIO CI-P	£220
OHIO CI-E	£255
SUPERBOARD	£160
SUPERBOARD 'E'	£195
VIDEO GENIE	£330
SHARP MZ80K	£480
APPLE II	£695

SUPERBRAIN

SuperBrain's CP/M operating system boasts an overwhelming amount of available software in BASIC, FORTRAN, COBOL, and APL. Whatever your application. . . General Ledger, Accounts Receivable, Payroll, Inventory or Word Processing, SuperBrain is tops in its class.

320K £1850 700K £2400
1.5Mb £2750

DISC DRIVES

COMPU/THINK

400K	£795
800K	£995

COMMODORE

CBM 30/40	£695
-----------	------

PRINTERS

EPSON TX80B (inc. I/F & cable)	£359
EPSON MX80	£425
ANADIX DP8000	£495
ANADIX DP9500	£895
ANADIX DP9501	£995
PAPER TIGER	£585
MICROLINE 80	£359
IBM GOLFBALL	£595
CENTRONICS 737	£425
NEXOS PETAL	£1195

VIDEO MONITORS

10" BLACK & WHITE	£85
10" GREEN SCREEN	£95

PLEASE ADD
.15% VAT
ON ALL PRICES

TEL: BATH (0225) 334659
AFTER HOURS (0761) 33283

• Circle No. 307

REAL-TIME SPECTRUM ANALYZER
£340

You can now buy, for about one-sixth the price of current products, a third-octave spectrum analyzer with more features and capabilities than were previously available at any price. What's the catch?

If you don't already own a Commodore PET computer, a Radio Shack TRS-80 or Apple, you'll have to get one. This will raise the price to somewhat under one-half the price of competing products, but of course you'll also have a COMPUTER!

The THS 224 REAL-TIME FREQUENCY ANALYZER comprises a single circuit board which installs inside the PET. This board contains a set of 31 analog third-octave filters (20 Hz to 20 kHz), detectors, an analog-to-digital converter, a 1K Read Only Memory containing machine language routines which allows the PET processor to interface with the Analyzer, and the peripheral circuitry necessary to transfer analog data into the PET memory. The simplest BASIC program required to turn the PET into an analyzer is only three statements long! Much longer programs can be written to allow complete user interaction with the analyzer, including many new forms of statistical signal processing, curve weighting, voice recognition etc.

• COUNTLESS EDUCATIONAL APPLICATIONS



EXPANSION MEMORY

with space for eprom

Price
break-
through

24k
£280

32k
£325

All items can
be seen and
demonstrated at
our London showroom.
Orders accepted by
mail, phone or in person.

PETS 8k inc. cassette
from £380

PET IS A TRADEMARK OF
COMMODORE BUSINESS SYSTEMS

Prices exclude VAT. Send or phone
for further details and brochure.

Access, Barclaycard, and Trustcard accepted.



UK Distributors
Feldon Audio Ltd.,

126 Great Portland Street, London W1 Tel 01-580 4314 Telex London 28668

• Circle No. 308



Computer Hardware at Cash & Carry Prices.

SHARP EQUIPMENT

Model	User Ram	exc.VAT	inc.VAT
Sharp MZ80K	20K RAM	375	431.25
Sharp MZ80K	36K RAM	420	483.00
Sharp MZ80K	48K RAM	460	529.00
Sharp MZ80FD	Floppy Disk	576	662.40
Sharp MZ80P	Printer	372	427.80
Sharp MZ80I/O	Input/Output Unit	87	100.05

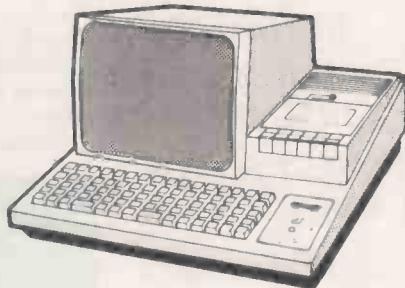

FREE LEDGER & STOCK CONTROL PROGRAMME WITH EVERY COMPLETE SHARP SYSTEM, i.e. 48K Sharp, Twin Floppy Disk, Printer and I/O Unit

COMMODORE EQUIPMENT

Model	User Ram	exc.VAT	inc.VAT
3008 (4008)	40 Col. PET 8K Mem.	378	434.70
3016 (4016)	40 Col. PET 16K Mem.	462	531.30
3032 (4032)	40 Col. PET 32K Mem.	585	672.75
8032	80 Col. PET 32K Mem.	755	868.25
3040 (4040)	347K Disk	585	672.75
8050	1M Byte Disk	755	868.25
4022	Printer	357	410.55
8024	Printer	975	1121.25
C2N	Cassette	47	54.05

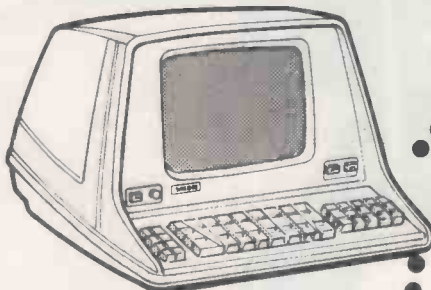
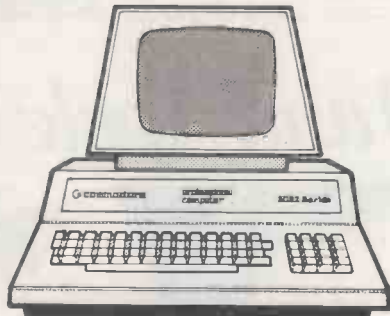

Every machine sold by Computer Supermarket is fully tested before despatch and is absolutely complete with instruction manual and tape, including free 13 amp plug fitted on mains lead.

All goods sold with full manufacturer's warranty and subject to conditions of sale. Copy available on request. All machines sold are full U.K. Standard.

All prices exclude VAT and delivery. Delivery anywhere in U.K. an additional £12.50 plus VAT.

COMPUTER SUPERMARKET

3rd Floor
Douglas House
Queens Square
Corby Northamptonshire
Telephone (05366) 62571
Telex COMPSU 341543/4



• Circle No. 309

NewBear

Computing Store Ltd



**BETTER PRICES!
BETTER DELIVERY!
WIDEST RANGE OF
SOFTWARE**

For the best deal
from the largest
sharp dealer
phone Newbear
(0635) 30505



MZ-80K

Many unique products
Zen/Listings/Word Proc.

Apple
II plus



For ex-stock delivery
12 months warranty

**ACORN
PROM PROGRAMMERS
PROM ERASERS
KEYBOARDS
5 1/4 AND 8"
DISC DRIVES**

**WIDEST RANGE
OF BOOKS IN U.K.**

**and Bear care
Bear Bargains**

**NORTH
STAR**



★ **HORIZON**

Installed on your site with full field
service anywhere in U.K. fully C.P.M.
compatible. Chosen by Newbear for
its reliability and performance.

64K Dual Drive Quad	£1995.00
North Star Horizon	
Newbury Laboratory 7009 terminal	£795.00
Citoh8300 R.M. Printer	£499.00
CPIM 2.2.	£95.00

Please send urgently:

Sharp A
 North Star Horizon Cat.
 Booklist Citoh N.L. Terminals
 Please contact me Phone No.
 Name
 Address

PC4/81

NEWBEAR COMPUTING STORE LTD. (HEAD OFFICE)
 40 BARTHOLOMEW STREET, NEWBURY, BERKS
 TEL. (0635) 30505 TELEX 848507 NCS
FIRST FLOOR OFFICES, TIVOLI CENTRE, COVENTRY ROAD,
 BIRMINGHAM. TEL. 021 707 7170
 220-222 STOCKPORT ROAD, CHEADLE HEATH, STOCKPORT.
 TEL. 061-4912290

• Circle No. 310

...for ITT 2020 and Apple Computers

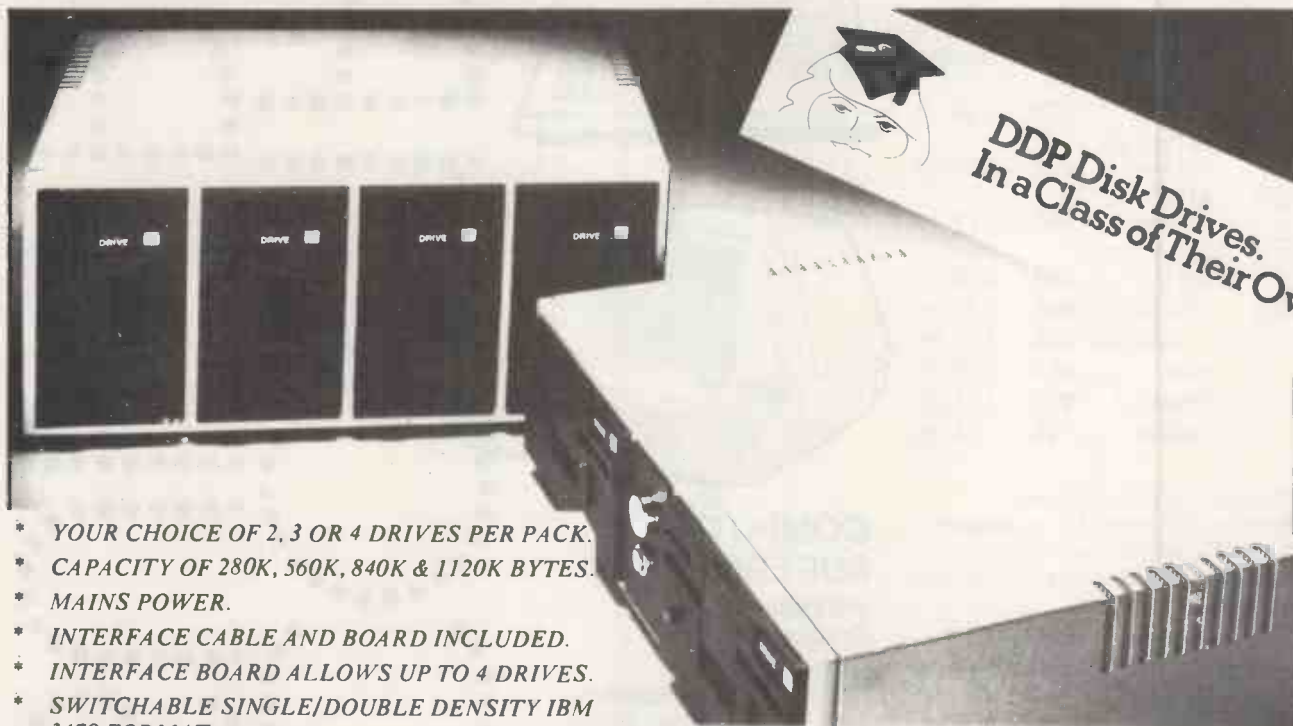

- * YOUR CHOICE OF 2, 3 OR 4 DRIVES PER PACK.
- * CAPACITY OF 280K, 560K, 840K & 1120K BYTES.
- * MAINS POWER.
- * INTERFACE CABLE AND BOARD INCLUDED.
- * INTERFACE BOARD ALLOWS UP TO 4 DRIVES.
- * SWITCHABLE SINGLE/DOUBLE DENSITY IBM 3470 FORMAT.
- * 2 & 3 PACK HAVE LOCKABLE POWER SUPPLY FOR SECURITY WITH LED POWER INDICATORS.



DISTRIBUTED DATA PROCESSING LTD.,
 36 Nobel Sq., Basildon, Essex. SS13 1LT.
 Tel. Basildon (0268) 728484

• Circle No. 311

NASBUS NEWS

More great deals from 6 Nascom Dealers

A NASCOM-2 BASED SYSTEM FOR £1499 + VAT

The proven Nascom-2 microcomputer can now be bought as a complete system from £1499 + VAT. For this price you get the Nascom-2 kit, 16K RAM board kit, Kenilworth case with 2 card frame, Centronics 737 printer, 10 inch monitor, and the

Gemini Dual Drive Floppy Disk System. The CPU and RAM boards are also available built - the additional cost is available on application.



GEMINI G805 FLOPPY DISK SYSTEM FOR NASCOM-1 & 2

It's here at last. A floppy disk system and CP/M.

CP/M SYSTEM. The disk unit comes fully assembled complete with one or two 5 1/4" drives (FD250 double sided, single density) giving 160K per drive, controller card, power supply, interconnects from Nascom-1 or 2 to the FDC card and a second interconnect from the FDC card to two drives, CP/M 1.4 on diskette plus manual, a BIOS EPROM and new N2MD PROM. All in a stylish enclosure.

Nascom-2 Single drive system. **£450 + VAT**
 Nascom-2 Double drive system **£640 + VAT**
 Nascom-1 Single drive system. **£460 + VAT**
 Nascom-1 Double drive system **£650 + VAT**
 Additional FD250 drives **£205 + VAT**

D-DOS SYSTEM. The disk unit is also available without CP/M to enable existing Nas-Sys software to be used. Simple read, write routines are supplied in EPROM. The unit plugs straight into the Nascom PIO.

Single drive system **£395 + VAT**
 (please state which Nascom the unit is for)
 Certain parts of the CP/M and D-DOS disk systems are available in kit form.
 Details available on request.

KENILWORTH CASE FOR NASCOM-2

The Kenilworth case is a professional case designed specifically for the Nascom-2 and up to four additional 8" x 8" cards. It has hardwood side panels and a plastic coated steel base and cover. A fully cut back panel will accept a fan, UHF and video connectors and up to 8 D-type connectors. The basic case accepts the N2 board, PSU and keyboard. Optional support kits are available for 2 and 5 card expansion.

Kenilworth case **£49.50 + VAT**
 2-card support kit **£7.50 + VAT**
 5-card support kit **£19.50 + VAT**

GEMINI EPROM BOARD

The Nasbus compatible EPROM board accepts up to 16, 2716 or 16,2708 EPROMs. It has a separate socket for the MK36271 8K BASIC ROM for the benefit of Nascom-1 users. And for Nascom-2 users, a wait state for slower EPROMs. The board also supports the Nascom Page Mode Scheme.

EPROM Board (kit) **£55 + VAT**
 EPROM Board (built & tested) **£70 + VAT**

CASSETTE ENHANCING UNIT

The Castle interface is a built and tested add-on unit which lifts the Nascom-2 into the class of the fully professional computer. It mutes spurious output from cassette recorder switching, adds motor control facilities, automatically switches output between cassette and printer, simplifies 2400 baud cassette operating and provides true RS232 handshake.

Castle interface Unit **£17.50 + VAT**

A-D CONVERTER

For really interesting and useful interactions with the 'outside world' the Milham analogue to digital converter is a must. This 8-bit converter is multiplexed between four channels - all software selectable. Sampling rate is 4KHz. Sensitivity is adjustable. Typical applications include temperature measurement, voice analysis, joystick tracking and voltage measurement. It is supplied built and tested with extensive software and easy connection to the Nascom PIO.

Milham A-D Converter (built and tested) **£49.50 + VAT**

PROGRAMMER'S AID

For Nascom ROM BASIC running under Nas-Sys. Supplied in 2 x 2708 EPROMs. Features include: auto line numbering; intelligent renumbering; program appending; line deletion; hexadecimal conversion; recompression of reserved words; auto repeat; and printer handshake routines. When ordering please state whether this is to be used with Nas-Sys 1 or 3. **Price £28 + VAT.**

DUAL MONITOR BOARD

A piggy-back board that allows N1 users to switch rapidly between two separate operating systems. **Price (kit) £6.50 + VAT.**

NASCOM-2 Microcomputer Kit **£225 + VAT**
 NASCOM-1 Microcomputer Kit **£125 + VAT**
 Built & tested **£140 + VAT**
 IMP Printer. Built & tested **£325 + VAT**

CENTRONICS 737 MICRO PRINTER

A high performance, low price, dot-matrix printer that runs at 80cps (proportional) and 50cps (monospaced). This new printer gives text processing quality print. And can print subscripts and superscripts. It has 3-way paper handling and parallel interface as standard. Serial interface is optional. **Price £425 + VAT.** Fanfold paper (2000 sheets) **£18 + VAT.**

GEMINI 'SUPERMUM'

12 x 8 piggy-back board for Nascom-1 offering five-slot motherboard, quality 5A power supply and reliable buffering with reset jump facility. **Price £85 + VAT.**

BITS & PC'S PCG

5 x 4 board which plugs straight into Nascom-2. Operates on cell structure of 128 dots, producing 64 different cells. Once defined, each cell may be placed anywhere, any number of times on screen simultaneously. Max screen capacity: 768 cells. Dot resolution: 384 x 256 = 98304. Many other features including intermixing of alpha-numeric characters and pixels. **Price (kit) £60 + VAT.**

GEMINI 64K RAM BOARD

Newly developed Nasbus compatible board that can accommodate up to 64K of RAM with optional Page Mode facility. **Prices: £90 (16K), £110 (32K), £130 (48K), £150 (64K). Add VAT to all prices.**

All prices are correct at time of going to press.

DISKPEN

The powerful text editor written for the Nascom is now available on a 5 1/4 inch floppy disk with a number of new features. **Price £43.25 + VAT.**

PORT PROBE

Allows monitoring of input and output of Nascom PIO. This board can generate interrupts and simulate handshake control. **Price (kit) £17.50 + VAT.**

HEX & CONTROL KEYPADS

Hexadecimal scratchpad keyboard kit for N1/2. **Price £34 + VAT.**
 As above but including (on the same board) a control keypad kit to add N2 control keys to N1. **Price £40.50 + VAT.**

BASIC PROGRAMMER'S AID

Supplied on tape for N1/2 running Nas-Sys and Nascom ROM BASIC. Features include auto line number, full cross-reference listing, delete lines, find, compacting command, plus a comprehensive line re-numbering facility. **Price £13 + VAT.**

PROM-PROG

2708 (multi-rail) and 2716 (single-rail) EPROM programmer kit controlled by N1/2 PIO. Supplied with comprehensive software for use with Nas-Sys. **Price £25.95 + VAT.**



All the products are available while stocks last from the Nascom dealers below. (Mail order enquirers should telephone for delivery dates and post and packing costs.) Access & Barclaycard welcome.

BITS & PC'S
 4 Westgate, Wetherby, W. Yorks.
 Tel: (0937) 63774.

BUSINESS & LEISURE MICROCOMPUTERS
 16 The Square, Kenilworth, Warks.
 Tel: (0926) 512127.

ELECTROVALUE LTD.
 680 Bumage Lane, Bumage,
 Manchester M19 1NA.
 Tel: (061) 432 4945.

28 St. Judes, Englefield Green,
 Egham, Surrey TW20 0HB.
 Tel: (0784) 33603. Tlx: 264475.

TARGET ELECTRONICS
 16 Cherry Lane, Bristol BS1 3NG.
 Tel: (0272) 421196.

INTERFACE COMPONENTS LTD.
 Oakfield Corner, Sycamore Road,
 Amersham, Bucks.
 Tel: (02403) 22307. Tlx: 837788.

HENRY'S RADIO
 404 Edgware Road, London W2.
 Tel: (01) 402 6822.
 Tlx: 262284 (quote ref: 1400).



CRACK IT WITH MIKE!

Most people have seen, and wondered at the intricacies of the machine language programming of the 'Invaders' programs, but now, the creator of the best selling Kansas Arcade Invaders has produced a booklet solely for Kansas, explaining at last those first steps in machine language programming for the Tandy TRS-80 and Video Genie.

'Getting Started' fills in the 'missing link' at last — the very first part of machine language programming — and will get you started quickly and easily into its mysteries.

For not only does the booklet explain the commands of the Editor, Assembler and Debugger, but goes on to take you step by step through writing an actual program, explaining all as it goes along.

Alas, 'Getting Started' is not for sale!

It is however provided with the Kansas Editor, Assembler and Debugger as part of the combined package including the instruction manual.

This full feature Editor, Assembler and Debugger gives all the facilities which are needed for creating, copying and debugging machine language programs and 'Getting Started' is actually based on this program, in conjunction with its instruction manual.

If you know absolutely nothing at all about machine language, we guarantee this will get you started. And it works on the early Genies!

The complete package — £19.50

Kansas

All prices are Vat paid and post free. Return first class post service. Barclaycard Visa orders sent same day if phoned in by 3pm. Answering machine ordering service after 6pm and Sundays to allow use of cheap rate. Catalogue available upon request.

Kansas City Systems, Unit 3, Sutton Springs Wood, Chesterfield, S44 5XF. Tel. 0246 850357

TRS-80 + VIDEO GENIE = MICRO 80 AN EQUATION THAT SOLVES YOUR MICRO PROBLEMS

More and more owners of these two computers are finding that a subscription to MICRO-80 helps them to get the best out of their equipment. MICRO-80 is a specialist magazine devoted solely to these systems. It is full of programs, hardware hints, problem solving and other articles on the TRS-80 and Video Genie.

Find out what you have been missing by completing the coupon and sending with your remittance.

TO: — MICRO-80 (U.K. SUB DEPT.)
24 WOODHILL PARK
PEMBURY
TUNBRIDGE WELLS
KENT TN2 4NW

PLEASE SEND ME A SAMPLE COPY
OF MICRO-80. I ENCLOSE MY
CHEQUE/P.O. FOR £1.50

NAME

ADDRESS

PC4/81

• Circle No. 313

Microtrend software and the Adler Alphatronic NOW YOU'RE TALKING BUSINESS

Microtrend Ltd., has software now for the microcomputer with a future. This wide range of well-specified, user-friendly and professionally-packaged products includes five accounting systems, two word processors (plus an inter-micro communications system for electronic mail and other data transfer operations).

Adler Business Systems provide Microtrend's Trendisk/1 Data Management System free of charge with each Alphatronic.

Combine our excellent software with the superb Alphatronic and you are really talking business. Microtrend products are available off the shelf from your local dealer or distributor.

Call 0423-711878 or write to
Microtrend Ltd.,
P.O. Box 51,
Pateley Bridge,
Harrogate, HG3 5DP.,
for more details.



microtrend

Professional Software for Microcomputers

• Circle No. 314

it's time you had ... a Bit Pad!

An easy to use digitizer that makes any form of graphics entry simple. It can be used as a menu device or data entry or even for games.

- Bit Pad will interface with almost any micro-computer.
- Bit Pad is a 15sqin digitizer tablet (an 11sqin active area) and a stylus.
- The Bit Pad price includes an RS232 interface (or IEEE 488 or parallel).
- Bit Pad only costs £399 (excluding VAT) Power Supply Optional.

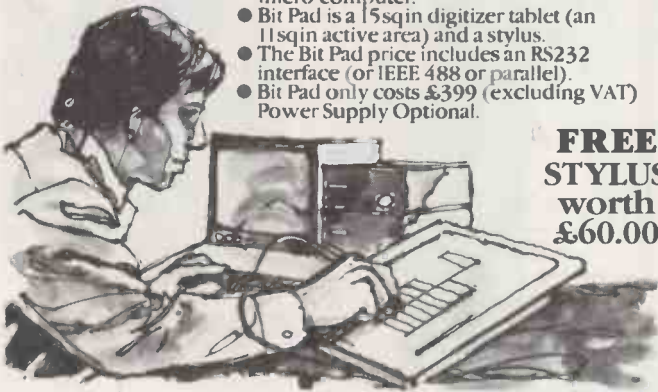

**FREE
STYLUS
worth
£60.00**

Give your computer the flexibility you need, fill in the coupon for more information, or make the coupon into an order, attach a cheque for £459 (including VAT) - it's time you had a Bit Pad!

Summagraphics

Bit Pad

tds

GRAPHICS

Our Technology...your Success.

For immediate details ring our Action

Desk on 0254 676921



£399

(excluding VAT)

tds

GRAPHICS

Please send me more details/_____ Bit Pads
@ £459 (including VAT)*

Name

Address

*Please delete as applicable.

Send to: TDS Ltd, Philips Road, Whitebirk Estate, Blackburn, Lancs. BB1 5TH.

• Circle No. 315

INDEPENDENT COMPUTER ENGINEERING LTD

CROMEMCO SYSTEMS & SOFTWARE

CP/M 2.2 FOR CROMEMCO — £95

S100 Peripherals:

Dump your hard disk to 'reel'
tape in 10 minutes —

½" 9-track 1600 BPI IBM/ANSI
compatible tape drive

+ controller + software — £2500

Hard Disk Systems — from £2500

Cartridge Disk — from £3950

CALIFORNIA COMPUTER SYSTEMS

S100 Boards and Systems

64K Dynamic RAM (bank select) — £350

ALL PRICES EXCLUDE VAT

Further details, please contact:

ICE Independent Computer Engineering
16/18 Littleton Road, Ashford,
Middlesex TW15 1UQ

TELEPHONE: ASHFORD (STD 07842) 47171

TELEX: 8952042 (DPCUST G)



EPSON MX80 SERIES DOT MATRIX PRINTERS

- * 9 x 9 matrix (true descenders lower case)
- * 80cps bidirectional printing, with logical seeking print head
- * 96 ASCII character set, plus 64 graphics incorporating 4 switch selectable European language options
- * Programmable forms handling
- * 12 different print modes, up to 132 characters per line
- * Operator controls & indicators, self test
- * Options — high resolution graphics, dual friction/tractor feed unit
- * £395 with standard parallel interface (interface options = RS232, Pet, TRS80, MZ80, Apple)

COMPUTER SOLUTIONS TO BUSINESS PROBLEMS — SOFTWARE PACKAGES / HARDWARE
MAINTENANCE / HARDWARE CONFIGURATION & DESIGN

• Circle No. 316

FROM ANPAC SYSTEMS

P — PROFESSIONAL

A — ADVANCED

C — COMPUTER

S — SOFTWARE

£100

+ VAT P/P

SUPERBRAIN * CROMEMCO

- 1. SALPAC** — INVOICING & SALES LEDGER
- 2. PURPAC** — PURCHASE LEDGER
- 3. NOMPAC** — NOMINAL LEDGER (INCLUDING ACCRUALS & PREPAYMENTS)
- 4. STOKPAC** — STOCK RECORDING
- 5. INCPAC** — INCOMPLETE RECORDS ACCOUNTING — LINKS TO WORDSTAR
- 6. PROPAC** — PROFESSIONAL OFFICE COST RECORDING
- 7. FINPAC** — FINANCE HOUSE (HIRE PURCHASE) ACCOUNT CONTROL
- 8. PAYPAC** — HOURLY, WEEKLY, MONTHLY PAYROLL

All PACS soon available on APPLE + SHARP. We specialise in customised software — Ask for further details.

COMPLETE SYSTEMS AVAILABLE: —

BUSINESS SYSTEM — S/brain, printer, SAL, PUR, NOM, STOK —
£2,295 + VAT

PROFESSIONAL ACCOUNTANTS SYSTEM — S/brain, printer, INC,
PRO, WORDSTAR — **£2,295 + VAT**

PLUS MANY MORE AT COMPETITIVE PRICES

**WE ARE THE EXPERTS IN MICRO SOFTWARE: FOR ALL YOUR
MICRO REQUIREMENTS INCLUDING DISKS, CASSETTES, ETC.,
CONTACT:**

MARTIN HOUSE,
MARTIN ST,
BRIGHOUSE

ANPAC SYSTEMS
0924 826236

92 CANAL LANE,
LOFTHOUSE GATE
WAKEFIELD

• Circle No. 317

CENTRALEX-LONDON LTD
 8-12 Lee High Rd, London SE13
 Tel: 01-318 4213/4/5/6/7
 9.30 am - 5 pm Mon to Fri -
 Evenings and weekends by
 appointment



centralex

A comprehensive range of Microcomputers Equipment, Peripherals, Software and Services for those who value Professional Standards, Guidance and Continuing Support for Hardware and Software.

APPLE
 TEXAS
 MICROPOLIS
 DIABLO
 MICROLINE

PET
 OHIO SCIENTIFIC
 CENTRONICS
 QUME
 HITACHI

ITT 2020
 CROMEMCO
 ANADEX
 DEC
 LEXICON

EXIDY
 MICROSTAR
 INTEGRAL
 DATA GENERAL
 ETC. ETC.

HORIZON
 SHUGART
 TELETYPE
 EPSON

INFORMEX-80 Printer

£399+VAT

Special offer - for a limited period

For PET, APPLE, EXIDY, TRS80, ETC
 A high quality, high speed printer
 (125 cps) Upper and lower case letters
 plus graphics as standard
 Interface and cable for TRS80, PET,
 APPLE or RS 232 £69 + VAT
 Tractor feed option only £39

ALSO Training, Consultancy, Systems Design,
 Programming and Software

PAYROLL - INVOICING - STOCK CONTROL -
 SALES/PURCHASE LEDGER - VAT - MEDICAL
 RECORDS - EDUCATIONAL & ENGINEERING
 PROGRAMMES - HOTEL RESERVATION - ESTATE
 AGENTS - BUILDING MAINTENANCE - COBOL -
 FORTRAN - ETC.

Maintenance Contracts including stand-by equipment during repair
 periods - Free Delivery Nationwide - Terms arranged - Credit Cards and
 official orders accepted.



• Circle No. 318

The Rohan Computing Collection.....

Rohan computing, in addition to their normal software and systems consultancy services, now offer the following range of computer equipment for sale. As far as possible Rohan computing try to hold these items in stock ready for immediate delivery. Nationwide on site maintenance for all Rohan computing equipment.

Qume The Qume is ideal as a general purpose printer or for adding word processing facilities to an existing micro-computer. Print only and keyboard versions available. The keyboard version can double as a spare typewriter. RS232 interface adaptable for the PET, APPLE, etc. XON/XOFF protocol available. Word processing package/driver available for CP/M based systems. Other versions in preparation.

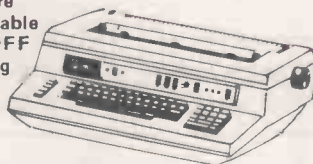

Digital Decwriter IV. The best desk top matrix printing terminal available. Typewriter styling. 10,12,13,2,16.5 characters per inch. All sizes very legible. 2,3,4,6,8,12 lines per inch. Optional tractor feed and numeric keypad. RS 232 interface.



PET Commodore PET microcomputers. The PET is the ideal low cost computer for teaching yourself programming, educational use and time consuming calculations in science, industry and commerce. Graphic display excellent for histograms etc.
 *8k PET with integral cassette and minikeyboard
 *16 & 32k PET's with full sized professional keyboards.
 *2022 matrix printers
 *2040 floppy disc units.



CIFER Cifer 2600 Series VDU's. Superbly engineered and made in Britain. *12 inch screen.
 *7 x 11 character matrix
 *9 x 12 matrix for graphic characters
 *62 or 100 key detachable keyboards
 *Printer port
 *VT52 emulation
 *Line drawing set

RAIR Blackbox, Teletype 43s, Tally high speed matrix printers also available.

Rohan

Phone Richard on SOUTHAM (092681) 3541 for prices and delivery.
 Rohan Computing, B.A.S.S. (Engineers) Sales Limited, Kineton Road, Southam, Warwickshire CV33 0DQ
 52 Coventry Street, Southam, Warwickshire CV3 0EP Tel: 092 6814045

• Circle No. 319

ASSOCIATION OF LONDON COMPUTER CLUBS

Proudly presents

THE SECOND
LONDON
COMPUTER
FAIR

APRIL 14th 15th & 16th 1981 10am - 6pm
[7pm 15th]

Including: Retail Exhibitors • Hobbyists
Club Stands • Seminars • Workshops
Bring and Buy Sale

Admission 75p

POLYTECHNIC OF NORTH LONDON
THEATRE

⊖ Opposite Holloway Rd. tube station ⊖

SPONSORED BY EDUCATIONAL COMPUTING and
PRACTICAL COMPUTING

• Circle No. 320

NEW

TRS 80 MODEL III



The Model III has arrived in the U.K.

★ **NEW FEATURES AVAILABLE** ★

★ Upper and Lower Case characters (standard) ★ Real Time Clock ★ 500 or 1500 Baud Cassette ★ Parallel Printer Interface (standard) ★ Auto Repeat keys ★ Flashing Cursor ★ New Characters, Greek, Japanese Kana ★ Numeric Keypad ★ 16, 32 or 48K ★ Room for two D.D. Disc Drives & Interface ★ 12" VDU ★ All in stylish cabinet.

16K **£649** INCLUSIVE

S a e Enquiries Delivery 4-6 weeks



N.I.C.

Unit 7, 61 Broad Lane, London N15 4DJ
Daytime 01-808 0377 Evenings 01-889 9736



• Circle No. 321

Basic Principles and Practice of Microprocessors

D.E. Heffer, G.A. King and D. Keith

A text describing how computer technology is implemented in microprocessors. Basic principles of computing and programming are followed by an examination of the component parts of a microcomputer system. There are many examples of general procedures and their applications to specific machines.

£5.95 paper 208 pages 80 line drawings
ISBN 0 7131 3426 7



Edward Arnold

41 Bedford Square, London WC1B 3DQ

• Circle No. 322

ELECTRONIC GAMES

ATARI

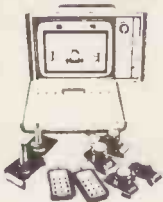

SPECIAL PRICE
£86 + VAT

INTELLIVISION MATTEL

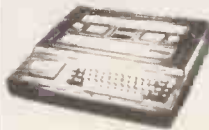

£173.87 + VAT

Available August 1980
This is the most advanced TV game in the world. Expandable next year into a full microcomputer.
COLOUR CATALOGUE AVAILABLE WITH DETAILS ON ALL THE CARTRIDGES

CHESS



Send for further details.

COMPUTERS

NEW RANGE AVAILABLE AUGUST 1980
We specialise in computer chess machines & stock over 13 different models from £20 to £300

TELETEXT



RADDFIN
TELETEXT
Add on Adaptor

£199 + VAT

BRIDGE

COMPUTER



- ★ Plays 1/2/3 or 4 Hands
- ★ Problem Mode
- ★ Audio Feedback
- ★ Instant Response
- ★ Auto scorekeeping

BACKGAMMON



From £38 to £108. Send for further details.

COMPUTERS

OMAR 1
OMAR 2
CHALLENGER
GAMMONMASTER

**27 TUNE
DOOR
BELL
£17.13**

+ VAT



SPACE INVADERS



HAND HELDS + CARTRIDGES
ATARI - ACETRONIC
PRINTRONIC
RADDFIN - DATABASE etc.
We keep a full range!
Send for cartridge lists stating which machine you own.

DRAUGHTS

COMPUTER



- ★ Solves Problems
- ★ Rejects illegal moves
- 2 level machine £43 + VAT
- 4 level machine £77.78 + VAT

LEISURE

- ★ CHEAP TV GAMES
- ★ TELEPHONE ANSWERING MACHINES
- ★ AUTO DIALERS
- ★ CALCULATORS
- ★ DIGITAL WATCHES
- ★ PRESTEL
- ★ HAND HELD GAMES

SILICA SHOP

SILICA SHOP LTD.,
1/4 The Mews, Hatherley Rd., Sidcup
Kent DA14 4DX
Tel: 01-301 1111

**FREE
CATALOGUE**

For a free copy of our 32 page catalogue, send a 12p stamp to Silica Shop Ltd or Telephone 01-301 1111

MAIL ORDER SERVICE — Free postage & Packing
TELEPHONE & MAIL ORDERS — accepted on:
Access * Barclaycard * American Express * Diners Club * Credit Facilities arranged
CALLERS WELCOME — at our shop in Sidcup — Demonstrations daily
Open from 9am-5.30pm mon-Sat (9am-1pm Thurs)
GUARANTEE — Full 12 months + After Sales Support

We have comprehensive brochures on all products. Please let us know what you are interested in and we will send you detailed brochures AND our own 32 page catalogue covering most games on the market.

COMPUTECH for apple

COMPUTECH for ITT

Well proven software for business applications on the
ITT 2020 and Apple microcomputers.

Prices excluding V.A.T. for cash with order, F.O.B. London NW3

PAYROLL	(300+ Employees, 100 Departments, hourly, weekly, monthly. Very powerful but easy to use).	£375
SALES LEDGER	(500+ Accounts, 100 Departments).	£295
PURCHASES LEDGER	(500+ Accounts, 100 Departments).	£295
GENERAL (OR NOMINAL) LEDGER	(1000 Accounts, 100 Analyses, multi-purpose package). Job costing etc.	£295
UTILITIES DISK 1	(Diskette patch, slot to slot copy, zap etc).	£20
APPLEWRITER	(Word Processing, see below for U/L case).	£42
VISICALC	(Financial Modelling, Costing, Analysis).	£95
CAI	(Converts Apple pictures for ITT display).	£10

Over 500 packages in use, fully supported by us.

AND NOW HARDWARE!

LOWER & UPPER CASE CHARACTER GENERATOR £50
Replaces character generator to display upper and lower case characters on screen, includes patches to work with Applewriter, supplies the missing link! Specify Apple or ITT.

COMPUTECH DIPLOMAT H/S SERIAL INTERFACE £80
This card has been designed and built to the same professional standards that have resulted in the success of our software. The DIPLOMAT observes the proper "handshaking" protocol so that you can drive fast printers and send and receive data from other peripherals at high speeds without loss of data. Switch (& software) selectable baud rates to 19200 and many other options. Plug compatible with 'terminal' or 'modem' wired peripherals. Guaranteed.

MICROLINE M80 PRINTER £425
This neat, reliable machine prints at 10 characters per inch, 80 characters on an 8 inch line, or 40 expanded characters, or 132 very readable characters, upper and lower case and graphics, 9 x 7 dot matrix, 6 or 8 lines per inch. Parallel interface is standard, serial optional. Both friction and sprocket feed are standard, tractor optional. We can also supply the parallel interface card for Apple System computers for £80 and a driver to enable both text and graphics to be used. Optional custom colour matching for Apple or ITT. Optional character sets. *Trade supplied at very generous discounts for modest quantities.*

THE FABULOUS MICROMUX 8000 from £800
This is a brand new product, an asynchronous serial multiplexor with up to 16 ports, any one of which may communicate with any other independently, like a 'telephone exchange' for data! Built in test function. Firmware may be customised for special applications. Available in multiples of 4 ports up to 16.

COMPUTECH SYSTEMS

168, Finchley Road, London NW3 6HP. Tel: 01-794 0202

AGENTS THROUGHOUT THE UK AND OVERSEAS

• Circle No. 324

IBM SELECTRIC GOLFGALL PRINTERS AND INPUT, OUTPUT 735 TYPEWRITERS

PRINTERS FROM	£195.00
735 TYPEWRITERS FROM	£245.00
WIRING AND COMMISSION TO SUIT	
ACULAB INTERFACE	£ 48.00
ACULAB INTERFACES EX STOCK	£155.00

ALSO AVAILABLE IBM 71, 72, 82 typewriters
Full workshop facilities for rebuilds and servicing.
Keyboard ASCID-ASCII, 10-12 pitch, language conversions undertaken.
11", 13", 15" platen lengths, split platens pin feed platens. Operational keylever repeats fitted on request.
Full IBM range of 10-12* pitch heads including language, symbol and metric.
Language keybuttons blue or grey.

WE BUY SELL OR EXCHANGE ALL IBM SELECTRIC TYPEWRITER MODELS
FOR FURTHER DETAILS PHONE **STUART KIRBY OR LOUIS BAKER**

KEYTRONICS

SAUL LODGE SAUL GLOUCESTER GL2 7JE
TEL. 0452 740 612

PRICES EXCL VAT @ 15%
& CARRIAGE & PACKING
CALLERS BY APPT ONLY PLEASE

• Circle No. 325

INTELLIGENT ARTEFACTS LTD



**BEST VALUE
BEST SERVICE
1 YEAR GUARANTEE**

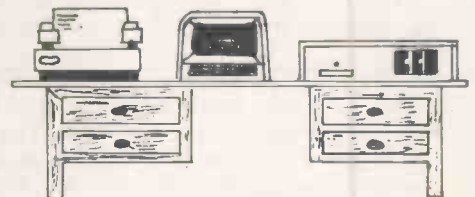

PROFESSIONAL COMPUTERS

Acorn Atom	150
Pet 8K 4008	359
Pet 16K 4016	459
Pet 32K 4032	559
Superpet 32K 8032	799
Pet Cassette	39
Toolkits	24
Disks	
Pet 8050	799
Pet 4040	575
Disk Debug/Concat	14.95
FORTH on Pet Disk	90
TI Disk + Controller	399
Printers	
Epson MX80B + IEE	359
Coosel	299
Centronics 737	399

Superbrain	
32K + 320K Disk	1299
64K + 320K Disk	1399
64K + 688K QD Disk	1699
North Star Horizon	
32K - DD - dual drive	1399
32K - QD - dual drive	1549
48K - DD - dual drive	1549
48K - QD - dual drive	1799
Expansion boards from	199
Speed I/O from	249
Printers	
Sprinwriter	1399
Diablo	1199
IA Software for Superbrain + NSH	
Accounts	499
PAYE	49
Job Costing or Parts Listing from	199
Also Word Star and Mailmerge	249

SOFTWARE WRITTEN TO SPECIFICATION
PRICES EX VAT

INTELLIGENT ARTEFACTS LIMITED
DISCOUNT HARDWARE AND SOFTWARE

Cambridge Road, Orwell, Royston, Herts.
Telephone: ARRINGTON (022 020) 689

• Circle No. 326

After the best selling 'Pet Revealed' and 'Library of Pet Subroutines' comes another book from Nick Hampshire **PET GRAPHICS**



The way information is displayed on the screen can make or ruin any program whatever the application. This book shows how you can fully exploit the graphics possibilities of the PET, essential reading for anyone wishing to write good useful programs. The book contains dozens of example programs including a comprehensive graphics package written in machine code (resides in the top 2K of memory). The contents of 'PET Graphics' include: How the PET display works — designing a display format — cursor control in PRINT — using POKE — an introduction to the machine code graphics package (you don't need a knowledge of machine code to use this package, but the full source code listings are given for those interested), among the packages over 30 routines are those to draw — bars, borders, character blocks, reverse field blocks, double density point and line plot, fine density bar plot, block scrolling, scrolled multiple page screen, repeat key and protected screen areas, multiple page displays, macro character generator, etc. — Other sections of the book cover — interactive graphics, with full circuit designs and comprehensive support software for adding a light pen to the PET — simple switch and joystick input devices — a review of add on hardware to give the PET high resolution graphics capability.

Price £10.00

All the programs in 'PET Graphics' are available on CBM format disk price £10.00

Cheques payable to Computabits Ltd.

COMPUTABITS LTD

P.O. BOX 13, YEOVIL; SOMERSET.



• Circle No. 327

aculab floppy tape,

The tape that behaves like a disc,
For TRS-80 LEVEL II and Video Genie.

Connects directly to TRS-80 Level 2 Keyboard. Operating and file handling software in ROM. 8 commands add 12 powerful functions to Level 2 BASIC. No buttons, switches or volume controls. Full control of all functions from Keyboard or program. Daisy chain multiple drives. Certified digital tape in endless loop cartridges. Reads and writes in FM format at 9000 Baud. Soft sectored with parity and checksum error detection for highly reliable operation—just like discs. Maintains directory with up to 32 files on each tape, tapes may be write-protected. Supports Basic and machine-language program files, memory image and random access data files. 12 character filespecs—: "FILENAME/EXT:d" (d is drive no. 0-7). Automatic keyboard debounce. Full manual with programming examples and useful file-handling routines.

COMMANDS (usually followed with a filespec and possible parameter list).

@SAVE, @LOAD, @RUN —for BASIC programs, machine language programs and memory image files. **@GET, @PUT** —moves a 256-byte record between a random access file and BASIC's data buffer. **@KILL** —removes a file from the directory and releases tape sectors for immediate re-use. **@LIST** —displays file directory along with sector allocation and free sectors. **@NEW** —formats tape and creates a blank directory.

Master drive with PSU, Manual and a selection of tapes.

For TRS-80 £169-00, for Video Genie £174-00.

Slave drives £125-00. (add £2-00 p.p. + vat).

(Export orders pp charged at cost)



For further information,
Telephone
0525 371393

aculab Ltd.
24 Heath Road,
Leighton Buzzard,
Beds. LU7 8AB

• Circle No. 328

ELECTRONIC BROKERS LTD VDU PRICES SHATTERED



Hazeltine 1000

The low, low priced teletypewriter—compatible video display terminal with 12" screen (12 x 80) 64 ASCII alphanumeric and symbols. Full/Half Duplex. RS232.

£199

All equipment reconditioned, unless otherwise stated.



BRAND NEW
GP80 GRAPHICS PRINTER



Hazeltine 2000

The world's largest-selling teletypewriter—compatible video display terminal. Features include: 12" screen (74 x 27) 64 alphanumeric and symbols. 32 ASCII control codes. Switch-selectable transmission rates to 9600 baud. Three switch-selectable operating modes full-duplex, half-duplex or batch. Direct cursor addressability. Dual-intensity video. Tabulation. Powerful editing capability. Remote keyboard. Selective or automatic roll-up. RS232.

£299

Low cost matrix printer.

Ideal for Microprocessor users such as Hobbyists & Educationalists or for any low-budget application.

* Full upper/lower case ASCII PLUS GRAPHICS Mode.

* 80-column printing with adjustable tractor feed.

* 30 cps print-speed with 1-line buffer.



Modular one basic

Now with Upper & Lower Case. 12" screen (24 x 80). XY cursor addressing 64 ASCII alphanumeric & symbols. Dual intensity detachable keyboard. Choice of 8 transmission rates up to 9600 baud. RS232. Range of options including printer port (£70.00).

£399

Modular one edit

All the above plus full edit capability, tabulation, 8 special function keys + many other features. **£695.00**
POLLING MODELS also available—P.O.A.

* Standard and Double-width characters (12 cpi and 6 cpi)

* Standard parallel (Centronics-type) interface.

* Optional Interfaces available for RS 232, IEEE 488, Tandy, PET, Apple II

ONLY £199 plus carriage & VAT (mail order total £240.35).

Electronic Brokers Ltd., 61/65 Kings Cross Road, London WC1X 9LN. Tel-01-278 3461. Telex 298694

• Circle No. 329

**Ask for details
about Almarc
Hard Disc
Systems**

Almarc + Vector Graphic

The complete partnership
in Microcomputing

Almarc DATA SYSTEMS

System VIP

- * Vector 3 terminal with 6-slot S100 bus.
- * Fast (4 MHz) CPU using the powerful Z80.
- * 56K of user RAM.
- * Serial RS232 port (110-9600 baud selectable), 3 8-bit parallel ports.

- * 80 x 24 display using 8 x 10 matrix.
 - * Full QWERTY keyboard plus separate numeric keypad and capacitance keys.
 - * UNISTOR disc drive giving 315K bytes of storage.
- PLUS CP/M 2, Microsoft BASIC 80, SCOPE (text editor) and RAID (simulator debugger).



System B

- * Vector mindless terminal.
- * Z80 CPU with fast 4 MHz clock.
- * 64K bank-selectable RAM (56K user RAM).
- * 4 serial ports (all switch-selectable 110-9600 baud), 5 parallel ports.
- * Flashwriter II video board (80 x 24).

- * Interrupt handling on I/O board.
- * Twin disc drives - 630K capacity.
- * CP/M 2.2 operating system.

PLUS
Microsoft BASIC 80, SCOPE (screen-oriented program editor), RAID (full screen dynamic simulating debugger), ZSM Z80 Assembler.



System 2800

- * Vector 3 console chassis with 12 inch CRT and capacitance keyboard.
- * Z80 based single board computer with serial port, 3 8-bit parallel ports, 3 PROM slots and 1K RAM.
- * 64K dynamic memory board and disc controller.

- * Flashwriter II video board (80 x 24)
- * 6 slot S100 motherboard
- * Switch-selectable asynchronous baud rates (110-9600 bits/sec).
- * IBM-compatible DUALSTOR twin 8 inch double density disc drives, giving 2M-bytes capacity.



At ALMARC Data Systems, you can be sure of our experience of hundreds of Vector Graphic systems installed throughout the U.K. - all with 12-month warranty and the back-up of full service facilities carried out by experienced staff.

ALMARC are the specialists in Vector Graphic equipment with applications in word processing, business

systems, laboratories, research, schools, colleges, universities and industry. Plus an ever-growing list of compatible software - Pascal, Fortran, Cobol, APL, Algol, Basic Compiler and others.

We will be pleased to demonstrate how ALMARC + VECTOR GRAPHIC Systems equals The Complete Partnership in microcomputing.

906 Woodborough Road, Nottingham NG5 5QS. Telephone: (0602) 625035.

• Circle No. 330

BUTEL-ATHENA

The Ideal Small Business System

The ATHENA is just what your growing business needs. The high performance ATHENA can deal with all your accounting, stock control, word processing and other requirements. It is simple to use, has only a single power lead and can be expanded with multiple terminals and more storage.

Prices start at £5694. Write or call for details.

ATHENA Dealerships
Available.

BUTEL
Technology for business

Butel-Comco Limited
Garrick Industrial Centre
Garrick Road Hendon
London England NW9 6AQ
Telephone 01-202 0262
Telex 47523



• Circle No. 331

Printed Continuous Stationery

we can supply printed continuous forms with your company name and logo plus ex-stock single part listing paper in the following sizes:-

depth x width	(in inches)	depth x width
11 x 9¼		13 x 9¼
11 x 9½		8½ x 11½
11 x 10¾		12 x 8½
11 x 9⅞		12 x 9¼ 60 gsm
11 x 8½	NEW	12 x 9¼ 70 gsm
11 x 12		12 x 9¼ 85 gsm
8½ x 12		

multiples in OTC or NCR are available for prices and details telephone:-

David Richards 01-520 8624

David Richards (Printers & Distributors) Ltd 61/63, Hoe Street London E17 4SA

• Circle No. 332

Intex DATALOG LTD COMPUTERS

MICROPAY-200 £195.00 + VAT

Micropay-200 is a complete payroll System designed to run on a COMMODORE 32K PET microcomputer, interfaced to dual floppy disk drives and a printer.

The System provides:

1. Weekly/monthly payslips
2. Summary page of all payments and deductions that month
3. Summary page of all payments and deductions for the tax year to date
4. Weekly/monthly cash analysis slip for all cash payments made
5. Monthly summary of all payments and deductions
6. Year end summary of all payments and deductions

STOCK CONTROL 3750

Stock Control 3750 is a complete stock control system designed and written to meet the needs of a small business.

It will accommodate up to 3747 stock items and runs on a COMMODORE PET micro-computer interfaced to a printer and COMPU/THINK disk drives.

The System incorporates programs to:

1. Set up a Supplier file.
2. Set up Stock files.
3. Copy Data files.
4. Insert/delete stock records.
5. Insert/delete supplier records.
6. Update/display stock file.
7. Update/display supplier file.
8. Print stock list.
9. Print supplier list.
10. Print reorder report.
11. Print stock movement report.
12. Print stock valuation report.

And perform other useful routines.

Stock Control 3750 is fully protected from misuse and can easily be used by someone with no knowledge of computers or their operation.

The System costs £195.00 + V.A.T. and this price includes a full back-up and advisory service from INTEX DATALOG.

FOR FULL SPECIFICATION WRITE TO:
INTEX DATALOG LTD, DEPT PC1280
EAGLESCLIFFE IND. EST., EAGLESCLIFFE
CLEVELAND TS16 0PW. TEL: 0642 781193

MAIL ORDER SERVICE

BARCLAYCARD - MAIL ORDER - ACCESS

ITEM	PRICE	TOT. INC. VAT
*** DUSTCOVERS		
PET - ALL MODELS	5.75	6.90
T/743 PRINTER	5.75	6.90
ANADEX DP8000	3.50	4.35
CBM 3040 DISK	3.50	4.35
CBM 3022 PRINTER	3.99	4.80
COMPUTHINK DISK	3.00	3.75
ACCOUSTIC COVER FOR		
CBM 3022 PRINTER	49.00	62.00
*** D/D DISKETTES IN FREE CASE		
BASF	35.00	40.83
ACCUTRACK	30.00	35.08
LIBRARY CASE	3.50	4.60
*** BLANK CASSETTES		
C15 (PER 10)	4.00	5.75
C60 (PER 10)	6.00	8.05
*** CONNECTORS		
USERIEEE PORT	1.30	1.78
CASSETTE PORT	.99	1.43
USERPORT COVER	2.50	3.16
MALE 'D' PLUGS	2.40	3.16
FEMALE 'D' SOCKETS	3.50	4.31
'D' CONNECTOR COVERS	2.50	3.16
*** RIBBONS		
TELETYPE 43	7.72	9.17
ANADEX DP8000	2.75	3.45
ANADEX DP9500/1	15.00	18.40
CBM 3022	2.75	3.45
QUME (FABRIC)	4.25	5.18
QUME (CARBON M. SI)	4.50	5.46
QUME (CARBON S/S)	5.00	6.04
DAISY WHEELS		
QUME SPRINT 5	6.50	7.76
*** PROGRAMMERS TOOLKIT		
*** SPECIAL OFFER		
OLD ROMS 8K	65.00	75.90
NEW ROMS 8K	65.00	75.90
NEW ROMS 8/16/32K	45.00	52.90

PROKIT 1

PROKIT 1:- PROGRAMMERS AID.
ADDS THAT TOUCH OF PROFESSIONALISM TO EVERY PROGRAM YOU WRITE.
NUMERIC INPUT ROUTINES:- AUTOMATICALLY ADD LEADING AND TRAILING ZERO'S AND RESPOND ONLY TO NUMERIC KEYS AND DECIMAL POINT.
GENERAL INPUT ROUTINES:- SET THE LENGTH OF FIELD REQUIRED, SPECIFY WHICH CHARACTERS YOU WANT PET TO RESPOND TO AND ALL OTHERS WILL BE IGNORED.
DATE INPUT ROUTINE:- THE PROGRAM WILL NOT CONTINUE UNTIL YOU HAVE ENTERED A VALID DATE.
STRING SEARCH ROUTINE:- FINDS A MATCHING SUBSTRING WITHIN A STRING ENABLES YOU TO USE ON GOTO WITH ANY CHARACTERS, NOT JUST NUMBERS.
SCREEN ROUTINES:- CAN STORE SCREEN DISPLAYS IN MEMORY AND RETRIEVE THEM IN A FLASH:- SUPER FOR MENUS AND GAMES!
PROKIT 1, DEFINITELY THE BEST THING FOR PROGRAMMERS SINCE THAT OTHER KIT! AVAILABLE ON DISK OR TAPE, READY TO INCORPORATE IN YOUR OWN PROGRAMS.
PRICE £40.25 INC. VAT AND POSTAGE

Intex

• Circle No. 333

PRODUCTION CONTROL & JOB COSTING

CPM MACHINES

A JOBBING

DEFINE : Estimated Resource - Material, Labour
Requirements - Subcontract, Overheads
: Shop Floor Route - Operations, Time

ENQUIRE : Job Status - Sub-Assemblies
- Variance Analysis
- Profitability
: Labour - Employee Cost/
Contribution

REPORT : Job Profitability - Work in Progress
- Completed Jobs

QUOTE : Use Historical Job Data

OTHER MODULES : Capacity Planning/scheduling
Employee Productivity, Invoicing.

B BATCH PRODUCTION (BILL OF MATERIALS)

DEFINE : Components, Product Structure
Route & Operations (Set Up,
Operational Times & Costs)

REPORT : Component Utilisation
: Product Manufacturing Costs
: Product Profitability

OTHER MODULES : Order Entry - Component/Operational
Requirements
: Stock Control - Raw Materials,
Components Part
Assemblies

THE SYSTEMS CAN BE TAILORED TO MEET YOUR
REQUIREMENTS

COSTS : Software from £1,500
(Hardware from £5,000)

SMIS

**SHEFFIELD
MICRO
INFORMATION
SYSTEMS**

**CONTACT: SMIS Limited,
Weston House, West Bar Green,
Sheffield S1 2DA
Tel: (0742) 20224**

• Circle No. 334

COMPUTERS

Decisions! Decisions! Who do you turn to?

Up to now there hasn't been anybody willing enough to give you impartial advice, on which type of microcomputer and/or wordprocessing system is right for your business. We at Petalect have made it our business to give you that help. A study of the market has meant that we can offer you a wide selection of systems to meet most applications, at a cost that is not going to burn a hole in your pocket.

They range between £1,000 - £15,000 and include the best known names — Commodore, Sharp, ACT, Hewlett-Packard and Apple. All backed by our reliable after-sales service. So before you make a decision, chat with us first.



Make the right choice, right from the start.

32, (P), Chertsey Road, Woking, Surrey GU21 5JE Tel: Woking 69032/21776

• Circle No. 335

BUSINESS SOFTWARE for OHIO SCIENTIFIC DISK BASED SYSTEMS

Now available

- * Sales and Purchase Ledger
- * Stock Control: Payroll
- * Monthly P & L report
- * Comparison with budgets
- * Fully integrated system
- * Menu driven — manual virtually unnecessary
- * No obscure commands to learn
- * Customising for your business

Available only from:

RESOLUX LIMITED

Alpha House, Beech Lane,
MACCLESFIELD, Cheshire
Tel: (0625) 28220 & 615621

• Circle No. 336

small systems engineering limited

2-4 Canfield Place · London · NW6 3BT · Telephone 01-328 7145/6

IEEE-488 INTERFACES

B200	Bi-directional RS232C Serial	£186.00
Type C	Unidirectional RS232C Serial	£120.00
AP	Addressable parallel for Centronics or Anadex printers	£106.00
GPI AP	Micro based bi-directional serial interface with buffering Custom GPI software development for special interfacing requirements	£249.00

All serial interfaces incorporate

- Software or switched Baud rate selection with 16 different rates selectable
- Crystal controlled Baud rate
- Full RS232C handshake
- 20mA Current loop I.O. capability

All the above interfaces have two modes of code conversion to match print out to the PET screen for either display mode.

Non Addressable parallel	£45.00
TV/Video interface	£35.00

We also stock a range of PET connectors.



PET SOFTWARE

NEW★★INTERCOMM★★

- General purpose asynchronous communications package	
● Emulates a wide range of terminals	
● Data and program file transfer capability.	
● Permits communication with mainframes, networks, other micros, other PETs	
WORDCRAFT 80	£350.00
OXFORD COMPUTER SYSTEMS	£325.00
BASIC COMPILER	£200.00
TCL PASCAL	£120.00

S100 HARDWARE and SOFTWARE

P & T S100 IEEE controller board with CP/M, NORTH STAR or Custom software	£350.00
Measurement Systems high quality dynamic memory boards.	
A range of cross assemblers for most popular micros	£85.00
Prom simulator development board	£249.00
8048 development card	£395.00

PRINTERS ... PRINTERS ...

RP1600 DAISY WHEEL PRINTER	
60 cps PET, centronics, RS232 interfaces	£1450.00
Centronics 737	
80 cps proportionally spaced complete with non-addressable interface for PET or addressable interface	£395.00 £445.00

New ... HEWLETT PACKARD HP-85 PERSONAL COMPUTER

For professional scientific and engineering applications.

- Display with powerful graphics capability
- Fast, quiet internal printer
- Integral Tape Cartridge 200K bytes capacity
- Flexible I.O.: HPIB, RS232, BCD, GPIO
- Extended Basic with advanced graphics statements
- HP quality and reliability

As IEEE-488 interfacing specialists we can provide full technical support and advice on HP-85 applications.

• Circle No. 337

DATA LINK

Calling all serious
 **apple® users!**

Announcing Applied Analytics

ASPEED

The microspeed language system

- Runs six to sixty times faster than Basic.
- Programming capabilities well beyond Applesoft.
- Auxiliary Processor (Am 9511) for fast floating point.
- High-speed, extended high resolution graphics.
- Software development time cut in half.
- Exceptionally compact, compiled code.
- Extensible, structured language to meet your needs.
- Bonus: increased speed Applesoft functions.
- Requires 48K Apple 11 or 11+, single disk.

Sole distributors for UK and Europe
Retailer enquiries welcome

DATA LINK

10, Waring House Redcliffe Hill
BRISTOL BS1 6TB Tel: (0272) 213427

To: Datalink Microcomputer Systems Limited.

Please send Complete System £265 + VAT
 Detailed information

Name

Address

Tel No:

PC4'81

• Circle No. 338



**CRYSTAL ELECTRONICS
CC ELECTRONICS**

**THE SKY'S THE LIMIT
FOR YOUR SHARP MZ80K with
SHARP CP/M 2.21 (XTAL)**

CP/M is the trade mark of Digital Research.

**This sophisticated interactive program
development system will give your home computer
BUSINESS/INDUSTRIAL potential.**

Basic CP/M facilities include:

- Dynamic file management
- General purpose editor
- Fast assembler
- Advanced debugging utility

YOUR SHARP CP/M 2.21 (XTAL) PACKAGE INCLUDES

- Hardware modification (if fitted by a SHARP dealer does NOT break the guarantee)
- SHARP CP/M 2.21 (latest version) on disc
- XTAL Monitor and Operating system
- 7 Digital Research manuals
- CP/M Handbook (by RODNAY ZAKS)
- 12 months guarantee and up-dates

IF YOU ARE A SHARP MZ80K OWNER, CP/M 2.21 (XTAL)

IS A MUST FROM £200.00

Ask your SHARP dealer for further details or contact

CRYSTAL ELECTRONICS

**CP/M SOFTWARE HOUSES—XTAL CAN HELP YOU
ESTABLISH YOUR SOFTWARE ON THE SHARP**

Members of Computer Retailers Association & Apple Dealers Association

Shop open 0930-1730 except Saturday & Sunday

40 Magdalene Road, Torquay, Devon, England. Tel: 0803 22699

Telex 42507 XTAL G

Access and Barclaycard welcome.



• Circle No. 339

**Switch this
data terminal
off-line...**



**...and you've got
a daisy wheel
typewriter.**

**SCRIPTA £998 + VAT
(RO Version £836 + VAT)**

Manufactured in W. Germany by **OLYMPIA INTERNATIONAL**

SOLE UK DISTRIBUTOR: **DATAPLUS LTD.**

DATAPLUS 39-49 Roman Road, Cheltenham GL51 8QQ.
Telephone 0242-30030 or 37373. Telex 43594

• Circle No. 340

SOFTWARE FOR CP/M®

HIGH QUALITY SOFTWARE - WITH HIGH QUALITY SERVICE

**★ WORDSTAR
ENHANCEMENTS**

- VDU with Customised keys £645
- Daisywheel printer 60cps £1290
- I/O Master interface board for S100 systems from £100

WORDSTAR - Professional word processing software. On-screen formatting, wordwrap, pagination, line and character count on view. Micro-justification on daisy-wheel printer. Search and replace. Block/paragraph manipulation. External file read/write. Background printing during editing etc.	£250	MICROSOFT BASIC COMPILER	£195
MAIL-MERGE - Powerful Wordstar enhancement for file merging and document personalisation.	£65	MICROSOFT FORTRAN COMPILER	£270
DATASTAR Screen orientated system for Data Entry, Retrieval and Updating.	£175	MAGSAM - Versatile easy to use Keyed File Management System for Microsoft Basic or CBASIC.	£130
SUPERSQRT - Sort, merge and selection program.	£125	CIS - COBOL - ANSI' 74 implementation to full level 1 standard. Supports random, indexed and sequential files, features for conversational working, screen control, interactive debugging, program segmentation etc.	£425
CONFIGURABLE BUSINESS SYSTEM (CBS) - Unique information management system with user definable files, powerful report generator, menu-driven for ease of use. No programming experience necessary!	£225	FORMS-2 - Automatic COBOL code generator for screen formats.	£100
ACCOUNTING PACKAGES by Median - Tec: PAYROLL, SALES, PURCHASE,	£500	PASCAL-Z	£235
NOMINAL Specially developed by UK software house to exacting specifications. Written in Microsoft Basic each package may be customised by end user, all are widely used. Ledgers are open item. Payroll caters for weekly and monthly pay.	each	STRUCTURED BASIC - Relocatable compiler	£140
PROJECT COST CONTROL/JOB ACCOUNTING - A comprehensive set of programs to monitor budgets, account for expenditure and project completion etc. Ideally suited for contractors. Written in CBASIC-2.	£150	CBASIC-2 - Extended Disk Basic pseudo compiler and run-time interpreter.	£75
STATISTICS PACKAGE - Over 25 routines including Regression & ANOVA	£100	SELECTOR III - C2 - Information management system written in CBASIC-2. Maintains multi-key data base files and produces sorted formatted reports. Package includes simple application programs.	£185
MATHS PACKAGE - Over 40 easily used routines.	£100	SELECTOR IV - Upward compatible version of III with enhanced reporting.	£300
IBM - CP/M COMPATIBILITY - Powerful utility to transfer data to/from IBM machines in standard disk format.	£110	BSTAM - Telecomms facility for exchanging files between CP/M computers.	£75
MICROSOFT BASIC INTERPRETER	£155	ASCAM - Facility for communicating with other computers.	£99
		MACRO 80 - Macro Assembler	£99
		CP/M 2.2 - Standard Version B" Single Density.	£99
		Please contact us for availability of other products All orders must be PREPAID. Add £1 per item P & P (Minimum £1.50) and VAT CP/M is trade mark of Digital Research	



TELESYSTEMS LTD

P.O. Box 12, GREAT MISSENDEN, BUCKS, HP16 9DD

Telephone (02406) 5314



• Circle No. 341

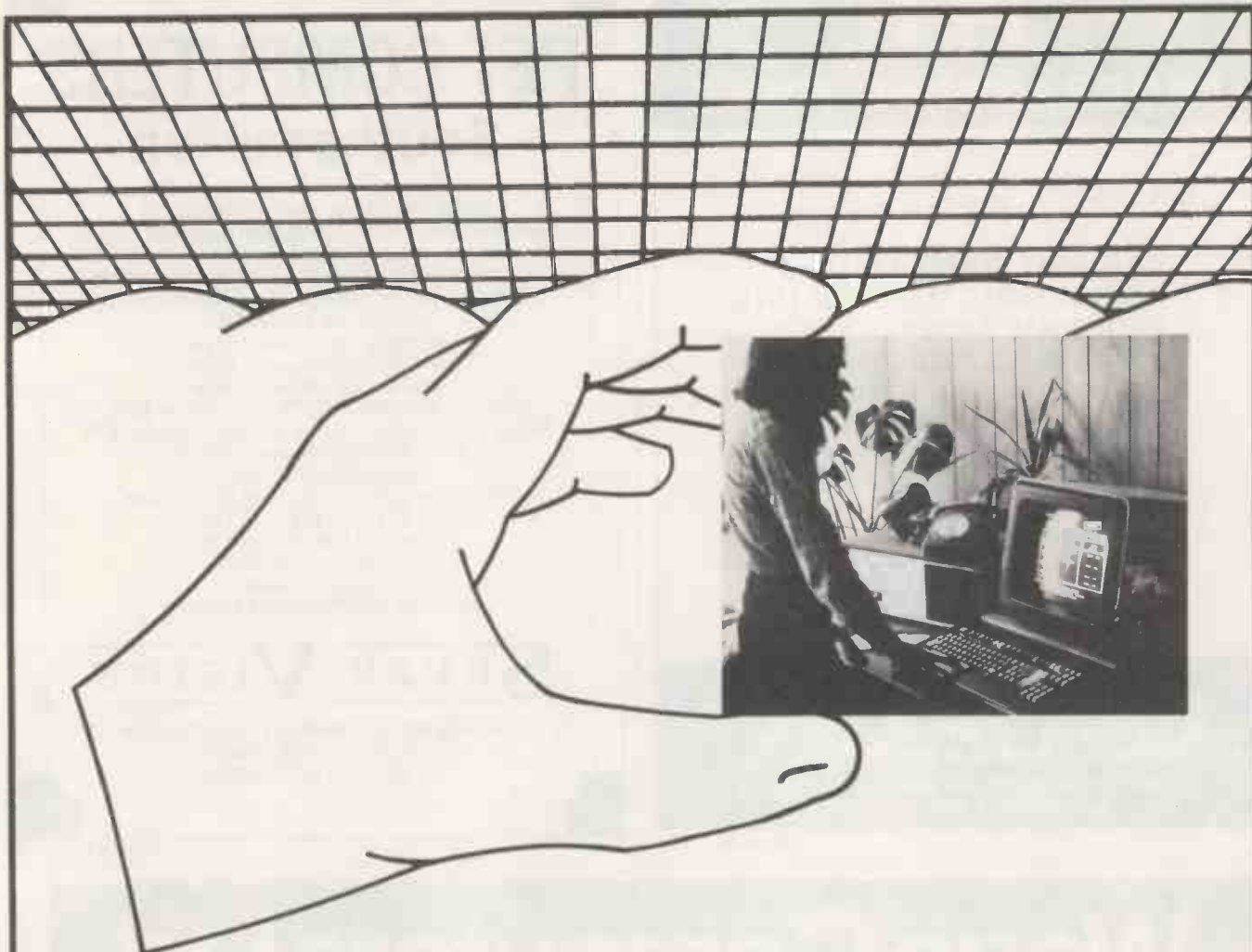

S100 COLOUR VIEWDATA DISPLAY CARD-UHF	£295
S100 COLOUR VIEWDATA DISPLAY CARD~RGB	£244
S100 PRESTEL AUTODIAL MODEM (2 CARDS)	£300
14" COLOUR VIEWDATA MONITOR (RGB)	£325

PRICES DO NOT INCLUDE VAT

**FULL RANGE OF VIEWDATA ITEMS SUPPLIED
CALL FOR DETAILS**

HI·TECH ELECTRONICS

54 HIGH ROAD, SWAYTHLING, SOUTHAMPTON SO2 2JF
TEL 0703 581555 TELEX NO. 47388 HTEL

• Circle No. 342

PET PROGRAMMING TOOLS

Quality Programs for software development on 8/16/32K PETs + 3040 CBM disk.

**VARIABLE NAME LISTING
GOSUB/GOTO/THEN LISTING
PROGRAM APPEND
VARIABLE NAME CHANGER
SELECTIVE LINE RENUMBER
PROGRAM 'UN-APPEND'
CORRUPTED DISK COPIER**

Programs supplied on disk with full instructions
Prices £20 for any one, £15 for each additional program
(in same order).

Includes VAT, post and packing.
SAE please for further details.

Comana Ltd.

FIRST FLOOR, 10 GRAHAM ROAD, MALVERN,
WORCS WR14 2HN (06845) 4862

• Circle No. 343

PET COMPUTERS Southampton

SALE of ex-hire, second hand and demonstration PET's (2000 3000 and 4000 series)

Prices from:

8K small keyboard £275 16K small keyboard £425
16K large keyboard £450 32K large keyboard £550

ALSO NEW MACHINES

4008N large keyboard £425

4016N large keyboard £510

4032N large keyboard £625

4040 Disk Unit £640 4022 Tractor Printer £405

Tensai Cassette Deck (inc sound and counter) £70

Commodore Software stocked

6550 RAMs £10 each

HIRE Commodore equipment by the week

8K £23 16K £26 32K £30

Disk Unit £30 Printer £30

All prices exclude VAT

Above subject to availability

OFFICIAL COMMODORE DEALER

SUPER-VISION

13 ST JAMES ROAD, SHIRLEY, SOUTHAMPTON

Telephone (0703) 774023

After hours (0703) 55488

• Circle No. 344

Wego Computers Ltd



CBM approved
£75.00 + VAT

Wego Sequential Switching Unit

Allows up to 5 devices to be connected to the mains, and with one switching operation power up and down all the devices, in the correct sequence.



£89.50 + VAT

Numeric Key Pad for the Apple.

A 13 digit Key pad (0-9, -, ., ENTER) to run in parallel with the numeric section of the APPLE Keyboard. Supplied with connecting cable, plugs and sockets.



CBM approved
Prices from £620 + VAT

Mark Sense Card Reader

"A pencil, a card, and this low-cost reader. . . it's the new, fast way to enter data into your microcomputer." Versions available able to communicate with PET, APPLE, TRS-80, or any S100 or RS232 bus. Ideal for business and education applications.

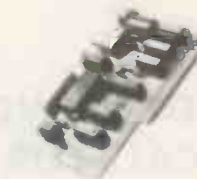

Sole UK Distributors

California Computer Systems Cards for the Apple

Synch Serial Card	£119.97 + VAT
Asynch Serial Card	£106.37 + VAT
Parallel Card	£ 79.97 + VAT
Arithmetic Proc. Unit	£265.97 + VAT
Programmable Timer	£106.37 + VAT
IEEE GPIB	£199.50 + VAT
A/D Converter	£ 99.72 + VAT
ROM/PROM Module	£ 70.89 + VAT
Clock Card	£ 83.33 + VAT
Centronics Card	£ 79.97 + VAT

Available from your local dealers, or direct from Wego Computers Ltd., 22A, High Street, Caterham, Surrey CR3 5UA. Tel: (0883) 49235 Telex: 933660

Authorised COMMODORE and APPLE Dealers

• Circle No. 345

OHIO IS NOW IN BERKSHIRE

Which will upset geographers but delight OEM systems designers.

Ohio Scientific, you don't need telling, are one of the largest microcomputer manufacturers in the States.

From our new full-service base in Berks, OS (UK) now supply all the low-priced high-production state-of-the-art value-for-money equipment you need:

Hardware. Software. Pre-tested. Burned-in. Ready-to-go. Backed-to-the-hilt with the sort of quality control and service back-up that made them third largest in five years.

For example, Ohio Scientific's C2-OEM is designed to be the cost effective solution to business and industrial applications which can effectively utilize typical microcomputer execution speed. The C2-OEM benefits from Ohio Scientific's years of volume microcomputer

production experience yielding an extremely competitively priced medium performance microcomputer. The C2-OEM utilizes the popular 6502 microprocessor operated at 1Mhz clock speed in conjunction with 48K of 450 NS Dynamic RAM memory.

The C3-D mates the electronics of the popular Challenger III triple processor microcomputer system with the cost effective 8" Winchester disk. The C3-D features the three most popular microprocessors – the 6502A, 68B00 and the Z80A. When operated in the 6502 processor mode, the machine executes instructions approximately twice as fast as competitive microcomputer systems. The C3-D incorporates 52K high speed static RAM, serial I/O port, bootstrap and diagnostic firmware, 8" floppy disk for transport and backup as well as an 8" Winchester. The C3-D comes complete with OS-65U disk operating system which is optimized for use with the Winchester hard disk and includes a fast 9-digit BASIC by Microsoft.

The C3C is one of the most economically priced 36 megabyte hard disk systems available in the UK. C3C qualities include three processors, 6502, 6800, and Z80A with software control and full multi user and multi tasking facilities, with floppy disk or Alloy Engineering tape drives. C3C is 'state of the art' in microcomputing.

All systems come with fully operational software and languages include BASIC, FORTRAN, AND PASCAL with CP/M (R) on C3 series machines. Complete application software also available.

For details, put in a short-distance call to Ohio on Slough (0753) 75915.

OHIO SCIENTIFIC
(UK) Ltd*

Middlegreen Estate,
Middlegreen Road,
Langley, Berkshire.
Telephone: Slough
(0753) 75915



* Ohio Scientific (UK) Ltd is a wholly owned subsidiary of American Data Home & Office Computers Inc

• Circle No. 346

Atom Explosion in Cambridge!

See the sensational Acorn Atom on demonstration at Cambridge Computer Store. Also the Acorn kit systems and the UK101: all available off-the-shelf or on short delivery.

We have low-power 2114 RAM at competitive prices and the stock in our Electronics Department includes a huge range of IC's and components.

Cambridge Computer Store

1 Emmanuel Street
Cambridge CB1 1NE
Phone (0223) 65334/5

• Circle No. 347

THE SHARP MZ-80 COMPUTER SYSTEM

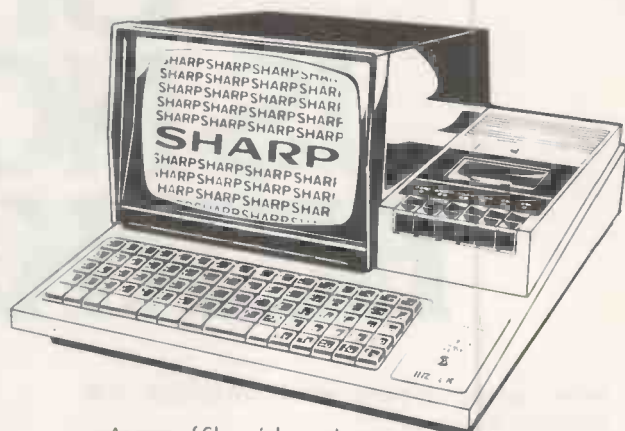

As one of Sharp's largest systems dealers we supply complete MZ-80 systems including FLOPPY DISCS and PRINTERS.

We have considerable experience in implementing SALES, PURCHASE and NOMINAL LEDGERS, PAYROLL, STOCK CONTROL, FOREIGN EXCHANGE and FINANCIAL PROGRAMMES.

Contact us now for details on 01-247 8506.

SCOPE

Stone House, Houndsditch Entrance
128-140 Bishopsgate
London EC 2M 4HX



• Circle No. 348

MICROPROCESSORS

AN INTRODUCTION FOR THE PROFESSIONAL LAYMAN

by Paul Kimberley B.Sc., C.Eng., M.I.Prod. Eng.

CAN YOUR BUSINESS AFFORD TO BE WITHOUT IT?

This book provides the much needed introduction to the principles and jargon involved in the modern microelectronic and computer systems that can and will rapidly transform business and industry. If the microelectronic revolution isn't going to pass you by, here's all you need to know about:

- ▲ The principles of the computer and the development of the related technology over the past 30 years
- ▲ Current market trends and the ever-widening range of applications
- ▲ Microelectronics: the components that make up a modern microprocessor
- ▲ Practical applications: two case studies, one industrial, one administrative, which provide a step-by-step guide to applying the technology

- ▲ Additional hardware surrounding the microprocessor
- ▲ Glossary: over 1000 of the most commonly used terms in the world of microelectronics

Planned as a businessman's self-defence kit against the secret language of the technocrats, this is a book that every manager needs.

Please supply . . . copies of MICROPROCESSORS by Paul Kimberley at £7.95 plus 85p. postage and packing (overseas orders: allow £1.20 p & p).

I enclose a cheque payable to Hayes Kennedy Ltd. for £ . . .

NAME: _____

ADDRESS: _____

Hayes Kennedy Ltd, 103 High Street, Thame,
Oxfordshire OX9 3DZ Please allow 28 days for delivery.
Also obtainable from your local bookseller.

PC4/81

• Circle No. 349

MICROS

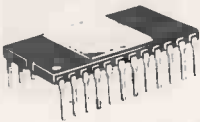

Micros, memory and support

MC1489	86	74S287	2.60
MC1488	86	74S288	2.60
MC14411	11.96	74S471	4.96
MC14412	11.96	74S472	11.96
1702	6.96	74S474	11.96
2101	2.99	8T26	1.80
2102	99	8T28	1.80
2111	2.32	8T95	1.80
2112	2.32	8T97	1.80
2114	3.46	8T98	1.80
2114L	3.75	SC/MP2	9.96
2142	10.40	8080	6.49
2376	11.60	8085	11.96
2513	6.60	8086	89.00
2516(5v)	13.95	8154	11.60
2532	29.00	8155	12.60
2708	6.60	81LS95	1.30
4027	2.96	81LS96	1.30
4116	4.96	81LS97	1.30
4118	14.96	81LS98	1.30
5204	7.96	8212	2.46
57109	12.43	8216	2.60
57161	9.96	8224	2.60
6011	4.96	8228	4.20
6402	4.96	8251	4.96
6502	7.96	8253	10.96
6520	4.60	8255	4.96
6522	7.96	8257	10.96
6532	8.60	8259	11.96
6545	17.60	8678	12.96
6576	14.96	86C2	2.20
6800	7.96	96364	10.96
6802	12.49	Z80-2MHz	7.50
6809	19.96	Z80-PID	6.96
6810	3.96	Z80-CTC	6.96
6821	4.60	Z80-4MHz	8.96
6845	19.60	Z80-PID	7.60
6860	3.96	Z80-CTC	7.60
6862	6.96	Z8000	120.00
74500	59	ADC0817	14.47
74504	66	DG300	3.80
745201	3.96	F8	9.96
745188	2.60	F8SMI	9.96
745262	9.96		

74LS00

LS00	13	LS366	86	
LS01	13	LS367	86	
LS02	15	LS368	86	
LS03	15	LS373	180	
LS04	20	LS374	180	
LS05	23	LS375	180	
LS08	23	LS377	199	
LS09	23	LS378	185	
LS10	20	LS379	215	
LS11	32	LS386	86	
LS12	32	LS390	140	
LS13	40	LS393	140	
LS14	76	LS395	210	
LS15	40	LS396	189	
LS20	24	LS398	275	
LS21	32	LS399	230	
LS22	40	LS445	140	
LS26	46	LS447	186	
LS27	48	LS480	180	
LS28	49	LS668	106	
LS30	24	LS669	106	
LS32	30	LS670	270	
LS33	39			
LS37	39	CMOS	18	
LS38	39	4001	18	
LS40	28	4002	24	
LS42	86	4006	32	
LS47	86	4007	32	
LS48	120	4008	82	
LS49	120	4009	40	
LS51	26	4010	48	
LS54	30	4011	24	
LS55	70	4012	24	
LS563	160	4013	46	
LS73	40	4014	86	
LS74	40	4015	86	
LS75	48	4016	42	
LS76	48	4017	82	
LS78	45	4018	28	
LS83	106	4019	48	
LS85	106	4020	98	
LS86	46	4021	106	
LS90	60	4022	96	
LS91	126	4023	26	
LS93	78	4024	76	
LS96	116	4025	26	
LS96	180	4026	180	
LS107	46	4027	48	
LS109	76	4028	82	
LS112	80	4029	106	
LS113	86	4030	80	
LS114	49	4033	176	
LS122	70	4034	210	
LS123	96	4035	126	
LS124	180	4040	106	
LS125	80	4041	80	
LS126	80	4042	80	
LS132	96	4043	96	
LS133	30	4044	96	
LS136	66	4046	130	
LS138	70	4047	96	
LS139	90	4049	46	
LS145	120	4050	48	
LS148	176	4051	80	
LS151	96	4052	80	
LS153	86	4053	80	
LS155	96	4054	130	
LS156	96	4055	136	
LS157	78	4056	28	
LS158	86	4059	26	
LS160	120	4070	26	
LS161	96	4071	26	
LS162	110	4072	26	
LS163	100	4073	26	
LS164	116	4074	26	
LS165	166	4075	26	
LS166	176	4076	30	
LS168	210	4081	28	
LS169	210	4093	89	
LS170	288	4502	126	
LS171	106	4507	80	
LS174	147	4508	326	
LS175	110	4510	98	
LS181	296	4511	150	
LS190	120	4512	65	
LS191	120	4514	195	
LS192	126	4515	298	
LS193	126	4516	120	
LS194	126	4518	106	
LS195	126	4519	70	
LS196	120	4520	116	
LS202	346	4521	260	
LS221	120	4510	98	
LS240	226	4522	160	
LS241	226	4525	160	
LS242	232	4527	180	
LS243	232	4528	180	
LS244	226			
LS245	360	REGS	103	
LS247	136	+ve	7805	146
LS248	136		7812	146
LS249	136		7815	146
LS251	130		7818	146
LS253	130		7905	220
LS257	116		7912	220
LS258	120		7912	220
LS259	180		10220	pleat
LS261	460		7805	80
LS266	76		7812	80
LS273	180		7815	80
LS275	320		7818	80
LS279	88		7824	80
LS280	260		7905	80
LS283	180		7912	80
LS290	130		7915	80
LS293	130		7918	80
LS295	216			
LS296	216			
LS299	420			
LS324	230			
LS325	320			
LS326	330			
LS327	316			
LS352	186			
LS359	186			
LS355	86			

WE HAVE MOVED

TO OUR NEW CENTRAL LONDON SHOWROOM
59/61 THEOBALDS RD, WC1 TUBE HOLBORN.

FLOPPY DISK DRIVES

We sell all you need cased or uncased Cables & connectors Brand new fully guaranteed Price

Single 5 1/4" Drive	£195
Single 8" SA800	£395
Dual 5 1/4" PSU	£59
Dual 8" PSU	£76
Dual Cabinet & PSU 1x8"	£565
Dual 8" Drive Unit	£945
Dual 5 1/4" Drive Unit	£440

TUSCAN S100

A Z80 based S100 Computer

Single board will hold up to 8K RAM, 8K ROM, Video interface Z80 processor - I/O and cassette interface 5 spare S100 expansion sockets for memory/disc expansion System monitor, resident BASIC or CP/M system option All components available separately or ready-built

NEW LOW PRICES
TUSCAN MAIN BOARD KIT ONLY £235 + VAT
SAE FOR DETAILS

VIDEO TERMINAL

24x80 display Pentland Video Terminal full features professional terminal Full details on request Price £596

TRITON

SINGLE BOARD PERSONAL COMPUTER

8080 BASED SINGLE BOARD system with EUROCARD EXPANSION

Complete Kit incl PSU/Case/Keybd	£286
Expansion Motherboard Kit	£ 50
8K (2114) RAM Card Kit	£ 97
8K (12708) ROM Card Kit	£ 97

Expandable up to CP/M Disc System SAE for details

S100 CARDS

NEW LOW PRICES

16K STATIC KIT ASSM with no RAM (2114)	£ 62	£ 82
- 8K RAM	£ 109	£ 130
- 16K RAM	£ 157	£ 178
8K static (16x2114 chips)	£ 48	
64K DYNAMIC (4116) with 16K RAM	£ 149	£ 165
with 32K RAM	£ 189	£ 205
with 48K RAM	£ 229	£ 245
with 64K RAM	£ 269	£ 285
16k upgrade 8x4116	£ 40	
16/32K EPROM CARD Without EPROMs		
2708/2516	£ 63	£ 89
FDC DOUBLE DENSITY Double Density for 5 1/4" or 8" Drives	£ -	£ 195

TCL PASCAL

FOR PET & CP/M systems

Put Pascal on your PET now Pascal conversion ROM £ 20 Pascal manual £ 9 Complete package including compiler £ 120

VAT

ALL OUR PRICES EXCLUDE VAT & P/P

CENTRONICS 737 PRINTER

LETTER QUALITY FOR £ 425

Uses any paper roll, fanfold, single sheets, 96 character ASCII, 7 x 7 dot matrix, 50 CPS, RS232 or parallel I/O

Edge Connectors S100

£4.00

DIP Switches		Zero Insertion Force Sockets		Insulation/Piercing Ribbon/Cables PLUG	
4 way	£ 1.20	16 way	£ 4.95	10 way	£ 1.60
7 way	£ 1.75	24 way	£ 6.00	20 way	£ 2.30
8 way	£ 1.80	40 way	£ 9.50	26 way	£ 4.00
		D-Types		34 way	£ 4.80
		25W Male £ 2.80		40 way	£ 3.75
		25W Female £ 3.80		50 way	£ 6.00
		25W Cover £ 1.80		60 way	£ 6.50
				14 way	£ 3.60
				40 way	£ 5.30
				50 way	£ 6.00
				24 way	£ 4.60
				16 way	£ 1.50
				24 way	£ 2.80
				10 way	£ 1.10
				14 way	£ 1.40
				16 way	£ 1.60
				20 way	£ 2.40
				22 way	£ 2.80
				24 way	£ 3.20
				26 way	£ 3.60
				30 way	£ 4.00
				34 way	£ 4.40
				40 way	£ 5.00
				60 way	£ 6.50

SOFTWARE

CP/M*

DISK WITH /MAN MANUAL Available on 8" IBM format & 5 1/4" for TUSCAN & TRITON

TCL SOFTWARE

TCL Disc Basic £55/£9
TCL Pascal £120/£9

MICROSOFT

Basic-80 £155/£15
Basic Compiler £195/£15
Fortran-80 £205/£15
Cobol-80 £325/£15
Edi 80 £45/£10
Macro 80 £75/£10

MICROPRO

Word Star £255/£15
Word-Star/Mail-Merge £315/£15
Data Star £195/£25
Word-Master £75/£15

DIGITAL RESEARCH

CP/M 1-4 £75/£18
CP/M 2-2 £95/£18
MAC £55/£10
SID £45/£10

OTHERS

KISS £190/£15
SUPER SORT I £125/£15
C BASIC 2 £75/£10
Z80 Dev Pack £50/£12
ZSID £60/£7
POSTMASTER £85/£10

MEDIA

5 1/4" S/Sided D/D £3.50
* per 10 £29.50
8" S/Sided D/D £4.50
* per 10 £35.00
C12 Data Cassettes 50p

MAIL ORDER

TEL & MAIL ORDERS ACCEPTED

BARCLAYCARD VISA

OK TOOLS

Full range of wire wrapping accessories & boards & dip jumpers etc Visit our showroom or send for our catalogue

VERO

S100 prototyping boards and full range of accessories.

BOOKS

Complete range of microcomputer books and magazines on sale in our showroom

CATALOGUE AVAILABLE

Catalogue available. Send 50p & S.A.E. (A4 size).

TRANSAM

59/61 THEOBALDS RD
LONDON WC1
TEL: 405 5240/2113
TELEX 444198.

TRANSAM

ANGLIA COMPUTER CENTRE
**MICROCOMPUTERS FOR BUSINESS,
 EDUCATION AND HOME**

**FOR ALL YOUR BUSINESS, EDUCATION
 & LEISURE COMPUTER REQUIREMENTS!!!**

ACORN ATOM
 APPLE II
 TRS-80
 SHARP
 NORTH STAR
 HORIZON
 TANGERINE
 U.K. 101
 NASCOM
 VIDEO GENIE

+ PRINTERS &
 OTHER PERIPHERALS.
 BOOKS**
 SOFTWARE*
 MAGAZINES**
 STATIONERY***
 BUSINESS &
 INDUSTRIAL
 CONTROL

WE ARE HERE!!!
 88 St. Benedict's Street
 NORWICH NR2 4AB
 Tel. (0603) 29652
 24hr. Answering Service.

• Circle No. 351

**THE ONE STOP
 COMPUTER SHOP**

BUSS STOP

We Supply Systems for Business, Education and Industry —
 And We Support Them With Service and Software!

Commodore

2001-8	£379.00	8032	£895.00	KIM1	£93.00
3008	£398.00	8050	£895.00	KIM3B	£96.95
3016	£495.00	8024	£1160.00	KIM4	£65.00
3032	£625.00	8010	£220.00	Toolkit, SuperChip,	
3022	£383.00	Pet Lead	p18.75	Soundbox, Parallel	
3023	£337.00	IEEE Lead	£23.44	and Serial Interfaces	
3040	£625.00	C2N Cass	£49.50	All Ex-Stock.	

Now on demonstration — The NEW PET MODEM, with Supporting Software.

VIDEO GENIE — EG3003 16K RAM, 12K LEVEL II BASIC IN ROM.
 TRS80 Compatible **£289.50**

NASCOM — Phone for latest Details/Prices.
 Dolphin Printers — The Superb BD30P now 80/132, chrs/line.
 Down to £450.00 While Stocks Last.
 The New BD136, The Ultimate Intelligent Matrix Printer — Prints
 at 240 Chrs/Sec. **£1200.00**

RICOH, QUME, NEC Spinwriter etc. Also Available, Please phone
 for Prices.

CONSUMABLES C15's Only £4.00 for 10. 10 Verbatim 5¼" Disks
 — 35 Track £19.95 — for CBM 3040. 10 Verbatim 5¼" Disks —
 77 Track £36.50 — for CBM 8050.
 Wide range of Continuous Stationary in stock — Paper, Labels etc.

SOFTWARE — We Sell Only The Best — Wordpro, Wordcraft,
 OZZ, Communicator, Medicom — and much more! Plus — A Wide
 Range of Books and Manuals for all Machines.

Please phone for carriage charges, all prices + VAT
 Photo Acoustics Ltd, BUSS STOP Computer Division
 255a St. Albans Road, Watford, Herts. (entrance in Judge Street)
 Phone: Watford 40698 or Newport Pagnell 610625

• Circle No. 353



The best cash, leasing and H.P. deals around.
 For more details of our offers on the "Apple"
 contact us today.

Microsolve

Solving business problems is our business

Microsolve Computer Services Limited
 Middlesex House, 29-45 High Street, Edgware,
 Middlesex, HA8 7XF
 Telephone 01-951 0218/9/0

• Circle No. 352

Pet Software

* DSL WORD PROCESSOR *

A low cost but very powerful word processor suitable for
 preparation of a wide range of documents (letters, reports
 etc.). Please state make and type of printer/interface. Cassette
 Cassette + full documentation, £20.00

* DSL BASIC MANAGER *

Relocate up to 9 programs (games, utilities etc.) in RAM —
 CALL & RUN under menu control whilst retaining normal
 BASIC operation in remaining RAM.
 Cassette + full documentation, £12.50

* DSL MINI-BASIC COMPILER *

Speed execution of your BASIC floating point arithmetic sub-
 routines — compile to fast machine code. Compiler locates in
 top RAM using MANAGER (supplied). Source code (written
 in a sub-set of BASIC entered from tape/dis/keyboard.
 Cassette + full documentation, £25.00

Please state if new or old ROM machine
 (above prices include VAT & postage)

DRAGON SYSTEMS LTD
 54 Mansel Street, Swansea, W. Glam.
 Tel: (0792-794786)

• Circle No. 354

NOW £1550 CAN BUY YOU A LOT OF COMPUTER.



Alpatronic printers guarantee highest print quality.

12" professional size screen with easy-to-read characters.

Alpatronic is from Adler—reliability and nationwide dealer service is assured.

Central processor big enough to handle the most sophisticated programs.

NEW ADLER ALPHATRONIC.

The new Alpatronic—everything you'd look for in a micro with one important difference. It has the Adler reputation for reliability and the network of Adler dealers to give an unrivalled back-up service.

Compare the features Alpatronic gives with others at a higher price and we think you'll agree—Alpatronic is a lot of computer for the money.

- ★ Two double density floppy disk drives—160 KBytes each for program and data storage.
- ★ 48 KBytes Random Access Memory.
- ★ An impressive baud rate of 4800.
- ★ High resolution screen giving 24 lines of 80 characters.
- ★ A dot matrix printer that produces 80 characters per second.
- ★ Languages that include Basic, Basic Compiler, with Fortran and Pascal to come, as well as a CP/M† disk with Assembler and text editor.
- ★ An extensive software library.
- ★ Conventional typewriter format keyboard for easy use.
- ★ Input/output interfaces for future expansion of system.

What do you get for your money?

Alpatronic P1 is £1550* and includes a 2000 character screen, keyboard and integral double density floppy disk unit. You can easily add to your Alpatronic. For example, the P2 includes a 2000 character screen, keyboard, two integral double density floppy disk units together with a dot matrix printer, CP/M† disk and manual, and costs just £2345*.

*Prices exclusive of VAT. †Trade mark of Digital Research Inc.

FREE

With Model P1, a two disk basic teach-in course, worth £85.
With Model P2, a two disk data retrieval program, worth £120.



The Adler Alpatronic from £1550. Brilliantly simple.

Alpatronic Division, Adler Business Systems Ltd., 27 Goswell Road, London EC1M 7AJ. The UK subsidiary of Triumph-Adler.
Tel: 01-250 1717. (Alpatronic Division)

Please send me further information on the Alpatronic computer and the name and address of my nearest Alpatronic dealer.

Name

Company

Address

Telephone

PC4/81

• Circle No. 355

DO YOU REQUIRE PERSONAL & PROFESSIONAL SERVICE?

HARDWARE

Apple 16K	695.00
Disk Drives	299.00
Controller 3.3	84.00
16K Add-on RAM	56.00
Full Colour System	435.00
9" High Res B/W Monitor	148.00
9" Black/White Monitor	127.00
12" Black/White Monitor	189.00
Cable for Monitor	9.00
12" Green/Black Cable	166.00

ACCESSORIES

Speech Lab	122.00
Speechlink 2000	168.00
Pascal Language	299.00
Applesoft Card	116.00
Integer Card	116.00
80 Col Card	162.00
Apple Juice	157.00
Black/White Modulator	14.00
Clock/Calendar Card	168.00
Supertalker	179.00
Rom-Plus Board	127.89
Romwriter	106.00
Copypius Rom	30.00
Music System - Complete	312.00
Apple Pilot	104.00

INTERFACE CARDS

Prototype Cards	15.00
Parallel Printer Card	104.00
Comms Card	130.00
Serial Card	113.00
Centronics Card	130.00
Controller Card	45.00
Eurocolour Card	113.00
IEEE Interface	212.00

BUSINESS SOFTWARE

Visicalc	125.00
Desk Top Plan	75.00
CCA Database	75.00
DMBS Database	100.00
Information Master	100.00
Data Master	100.00
Stock Systems from	100.00
Integrated Ledgers	855.00
Invoicer	140.00
Payroll	375.00
Word Processing from	42.00
Apple Post	27.00
Mailing List	70.00

MISCELLANEOUS

DOS Tool Kit 3.3	42.00
Animation Pack	42.00
Versewriter	149.00
Graphics Tablet	462.00
Joy Stick	44.00
Revolving Tables	42.00



GAMES

6 GAME DISC PACK

23 Bricks
Othello
Sevens

Yahtzee
Pinball
Hammurabi

£15

10 GAME DISC PACK

Towers of
Hanoi
Blackjack
Catch
Chaser
Animals

Intercept
Mastermind
Sink that Ship
Mission
U-Boat
Biorhythm

£20

WAR

Bismark	29.95
Ambush	29.95
Napoleonics	29.95
Conflict	29.00
Air Combat	22.00
Galactic Trader	22.00
Galactic Revolution	22.00
Galactic Empire	22.00
Flight Simulator	22.00
Cassette or Disk	29.95

OTHER

Monopoly	12.00
Olympic Decathlon	20.00
Apple Bowl	9.00
Tranquility Base	20.00
Trilogy	26.00
Head-On (Car racing)	22.00
Typing Tutor (Cassette)	14.00
Gammon Gambler	15.00
Bridge Partner	14.00
Baseball	16.00
Sargon Chess	30.00
Animation Package	44.00

ADVENTURE

Invasion Orion	18.00
Star Fleet Orion	18.00
Temple of Apshai	22.95
Apple Invaders	12.00
Moorlocks Tower	18.00
Adventure	24.00
Asteroids in Space	15.00
Akalabeth	24.00
Hell Fire Warrior	22.95
Oatstones of Ryn	18.00

SHOOTING

Wild Western Gunfighter	16.00
Battleship Commander	16.00
Bill Budge Space Album	34.00
Super Star Base Gunner	18.00
Super Space Invaders	22.00
Star Cruiser	22.00
Bloody Murder (Knife Throwing)	14.00
Hyper Space War	23.00

BOOKS AND MANUALS

Apple II Ref Manual	11.00
6502 Hardware Manual	9.00
6502 Software Manual	9.00
Apple II Basic Program	6.00
Applesoft II Ref Manual	6.00
DOS 3.2 Manual	6.00
Pascal Reference Manual	6.00
Pascal Reference Manual	8.50
Apple II Basic Tutorial	6.00
Autostart ROM Manual	4.50
DOS 3.3 Manual	4.80

**SUBSTANTIAL DISCOUNTS FOR CASH PURCHASERS
WE NOW OFFER ONE FULL YEARS WARRANTY ON ALL APPLE EQUIPMENT**

Professional Data Systems.

CARNE HOUSE, MARKLAND HILL, CHORLEY NEW RD, BOLTON.

ALL PRICES CORRECT AT THE TIME OF GOING TO PRESS
(ALL PRICES SUBJECT TO VAT)



0204
493816



• Circle No: 356

Micro General

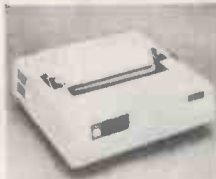

MATRIX PRINTERS — FROM £295

Choose from our selection of Matrix Printers for all your low cost printer requirements. There is a model to suit your budget. Printer prices include FREE DELIVERY to U.K. Mainland plus 90 day parts and labour warranty.

MICROLINE PRINTERS

MICROLINE 80 — 80 cps uni-directional printing with Parallel Centronics Interface
— Serial RS 232 Interface and Tractor Feed Options available. **£295** plus VAT

MICROLINE 82 & 83

- Head life of 200,000,000 characters
- Bi-directional printing with short line seeking
- Centronics Parallel and RS 232 Serial Interface
- 96 ASCII characters and 64 block graphic shapes
- Programmable selection of 4 character sizes
- Programmable vertical forms and tab control
- Self test
- Optional High Speed Serial Interfaces with various communications protocols and buffer sizes

MICROLINE 82 80 cps. Pin and Friction Feed **£510** plus VAT

MICROLINE 83 120 cps. Tractor and Friction Feed. Takes up to 16 inch paper. **£799** plus VAT

EPSON MATRIX PRINTER

MX 80 PRINTER — 80 cps bi-directional printing
— 4 print sizes, bold and emphasised
— Upper and Lower case with true decenders
— Vertical and horizontal tabulation
— Interface boards for PET/APPLE/TRS 80 and RS 232 available. **£345** plus VAT

APPLE & IIT 2020 SALES AND SERVICE | **PRINTER PAPER** **£18** plus VAT
Extra 32K RAM supplied free with every system purchased. 11 x 9 1/2 Plain with side perf. 2000 sheets

INTERFACE CABLES Serial: £17.00 Parallel: £27.00 + VAT
Educational discounts on request.
Remittance plus VAT please to: —
MICRO GENERAL, 6 The Birchwoods, Tilehurst, Reading, Berks RG3 5UH.
Tel: 0734 25226

• Circle No. 357

6809 SWTP/ GIMIX

UNIX on a MICRO

- * The new standard DEC/PDP operating system is now available on 6809 micros.
- * UNIFLEX is a MULTI-USER/MULTI-TASKING system for up to 12 users.
- * RRL provide the complete system with from 128k to 768k RAM.
- * 2.5 Megabyte floppy disk drives and 16 Megabyte fixed disks.
- * Full range of VDU's, terminals, printers, interfaces etc.

MOTOROLA 6809 COMPUTERS

- * RRL specialises in the EDUCATIONAL and SCIENTIFIC applications.
- * Small systems from 32k with 5" disk drives upwards.
- * PASCAL, FORTRAN, PILOT, BASIC Compiler, LAB-BASIC, Statistical Analysis etc.
- * D-A, A-D converters and special interfaces to solve your problem.

PET & CP/M STATISTICS SOFTWARE

RESEARCH RESOURCES LTD, P.O. Box 160
Welwyn Garden City, Herts. England
Tel: (07073) 26633

• Circle No. 358

Z-80 Books at Microdigital

Programming the Z-80 — R. Zaks

Another in the highly successful Sybex Series by Rodney Zaks. This book combines the function of a teaching text, that Sybex do so well, with an extensive reference section. The book is much more than an introduction to the Assembly Language syntax of the Z-80. **9.70**

Practical Microcomputer Programming with the Z-80 — Weller

18 chapters of solid accurate programming information. Debugging techniques, interrupt modes, array and table handling, number base conversation, floating point arithmetic, programmed input/output stackpointer usage. The book includes an editor assembler listing for Z-80 and 8080. If you return the coupon at the back of the book you receive either paper tape or TRS 80 cassette of the object code for the assembler. **19.50**

Z-80 Assembly Language Programming

Instruction set plus examples plus algorithms. An accurate and reliable textbook. **10.45**

Z-80 Programming for Logic Design — A. Osborne

These books describe the implementation of sequential and combinational logic using assembly language. They describe the meeting ground of the programmer and the logic designer and are written for readers in both fields. **6.25**

Z-80 Microprocessor Programming and Interfacing Volume 1 — Nichols and Rony

This book is the first of a two volume series on the Z-80. It covers programming at the assembly and machine language level for the Z-80. Book 2 will cover interfacing. The books are laboratory orientated texts. The strong emphasis is on learning through experiment. This book requires no background in computers. **7.70**

Z-80 Programming and Interfacing Book 2 — Nichols and Rony

Address interfacing digital circuits with the Z-80 CPU, P10 and CTC chip and progresses on from Book 1 (Interfacing assuming the reader is familiar with the topics covered in Book 1). **8.45**

Instruction Handbook (Z-80)

This slim volume constitutes a powerful and comprehensive guide. About seven hundred instruction codes are obtainable from the basic instructions. **3.05**

Z-80 Microcomputer Design Projects — W. Barden Jr.

A solid introduction to the Z-80 microcomputer and the EZ-80 chip. Simple construction of the EZ-80 microcomputer and several applications. **9.10**

Z-80 Microcomputer Handbook — W. Barden Jr.

This book provides essential information on Z-80 technology and is organised into three sections: Hardware, software and microcomputers built around the Z-80. **6.90**

Post and Packing free. No VAT on Books. Bona Fide official orders welcome.

I enclose cheque/P.O. for: _____

Name _____

Address: _____

Post Code _____

Goods required _____

PC4/81



24 Hr Telephone Credit
Card Orders 051-236 0707



Mail Orders to:
MICRODIGITAL LIMITED
FREEPOST (No Stamp required)
LIVERPOOL L2 2AB



Retail Premises at:
25 BRUNSWICK STREET
LIVERPOOL L2 0PJ
Tel: 051-227 2535/6/7

MICRODIGITAL

• Circle No. 359

COMPUTERAMA

All we discount is the price!

Computers

Pet, 40 col, new ROMS green screen, large keyboard	8K	£399
	16K	£499
	32K	£599
Pet, 80 col, new DOS	32K	£840
	64K	POA
TRS-80 system, includes VDU, cassette recorder & P.S.U.	4KLI	£320
	16KLI	£475
TRS-80 CPU, includes UHF TV modulator & P.S.U.	4KLI	£250
	16KLI	£375
TRS-80 expansion interface	32K	£275
Apple II includes BASIC interpreter	16K	£599
	32K	£625
	48K	£649
Colour monitor system		£399
Video Genie includes on-board cassette recorder, output to VDU or UHF TV (TRS-80 BASIC)	16K	£299
Video Genie expansion bus box	S100	£245



Dear Customer,
Our computer products are the best possible value for money. The price you pay is low because we import direct, and sell direct, thus cutting out the retailer. We look after you, our customer with a full year guarantee and after-guarantee servicing. We can give you unbiased advice and take orders with most credit cards over the telephone for despatch the same day. We also do personal financing and company leasing or lease-purchase. You can't get a better deal elsewhere—scan the pages of this magazine and see. Why not order from us now—you'll be glad you did, I promise you.

*Alan Brook
Computerama*

Disc drives

Pet compatible	
Commodore Dual	£655
Computhink 400K	£595
Dual 800K	£795
1.6Mb	£1195
TRS-80 compatible, all with case & P.S.U.	
Teac 40 track single	£225
Dual	£399
Quad	£775
77 track single	£325
Dual	£595
Quad	£1155
Shugart SA 400 Single	£229
Apple 11 twin-drive	£456
Controller card	£49

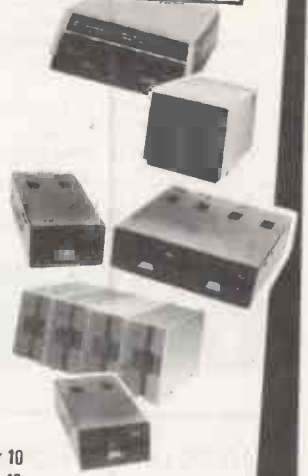

Diskettes 5 1/4" double sided double density £32 for 10
8 1/2" " " " " £36 for 10

Printers

Electrosensitive Type Quick Printer II (33 col) (TRS-80, serial & parallel inputs)	£129
Thermal Type Phantom 400 (40 col) (with dot graphics)	£229
800 (80 col)	£329
Impact Dot-Matrix Commodore Tractor 80 col (for Pet) all Pet graphics	£375
Epson Tractor 80 col Pet graphics	£325
Epson Tractor 80 col High Res. graphics	£399
Anadex DP8000	£425
Anadex DP9500	£825
Paper Tiger with 8 char. sizes & High Res. graphics	£595



List of programmes
available on request.

Monitors

12"	£69
12" (green screen)	£79

Cables

Pet/IEEE	£20	C12
IEEE/IEEE	£25	Blank
RS232 Plug to socket	£25	Cassettes
RS232 Plug to plug	£25	10 for £4
For others please ring		100 for £35

Paper

Electrosensitive for QPII	£3.50 per 2 roll pack
Thermal for Phantom 400, TCM 100	£4.10 per 2 roll pack
Phantom 800, TCM 200	£3.90 per roll pack
Impact, single part sprocket punched 9 1/2 x 11 for Commodore, Epson, Anadex Dolphin & Paper Tiger, taffold strippable	£9.50 per box 2000 sheets

Interfaces

Pet/TRS-80 to UHF TV	£25
Pet/TRS-80 to RS232 output	£65
Pet to RS232 in/out	£90
Pet to RS232 decoded output	£150
Pet to RS232 decoded in/out	£175
Pet multiplexer for networking up to 20 Pets	£350
Pet/TRS-80 to S100, 4 slot	£112
Pet/TRS-80 to Centronics	£45
Pet to Centronics decoded	£69



Please add £10 Securicor delivery
on computers etc.,
Plus 15% V.A.T. on all prices.

TEL: BATH (0225)
333232

- Personal credit (same day)
- Company credit
- Full year guarantee
- After-sales service
- Mail order
- Export (most countries)



Computerama Ltd.
5 Cleveland Place, East,
London Road, Bath, BA1 5DJ

• Circle No. 360

PROFESSIONAL SUPERBRAIN SOFTWARE

COMPILERS & UTILITIES

Microfocus CIS COBOL:

- Standard compiler £425
- Forms-2 utility £100

NB We are the sole UK distributors of Microfocus products on the SUPERBRAIN.

Microsoft:

- MBASIC interpreter £155
- BASIC 80 compiler £200
- COBOL 80 compiler £390
- FORTRAN 80 compiler £260
- MACRO 80 assembler £ 85

Micropro:

- WORDSTAR (word-processing) ... £230
- Mailing list merge for above £ 65
- DATASTAR (data management) .. £160
- SUPERSORT £130

The Micro Solution Ltd:

- REPORT GENERATOR £100

(this superb data management tool allows you to produce interactively a COBOL program to select records from a file and print them in your layout)

CP/M 'SPECIALS' AVAILABLE P.O.A.

APPLICATIONS SOFTWARE

The Micro Solution Ltd:

- Integrated Accounting System £750
- Stock Control System £400
- Bill of Materials System £400

These three modules interlock as required to make a superb total business system.

Half day free training is included in the above price for each module.

The Accounting system includes:

- Sales/Purchase/Nominal Ledgers + VAT
- Final Accounts/Profit & Loss/Bal sheet
- Invoicing
- Open Item or Balance Forward

The Stock Control system includes:

- Order processing/Auto. Reordering
- Picking List production

Others:

- Television Rental system £800
- Estate Agents' system £475
- BSTAM (inter m/c transfer) £ 75

SUPERBRAINS AVAILABLE FROM STOCK,

FROM **£1450**

ADD VAT AT STD. RATE TO ALL ABOVE PRICES
POSTAGE AND PACKING WILL BE ADDED
DELIVERY NEXT DAY FOR STOCK ITEMS

**** CASH WITH ORDER — POSTAGE/PACKING FREE ****

DEALER ENQUIRIES WELCOME



Contact:



Park Farm House
Heythrop
Chipping Norton
OXFORDSHIRE
OX7 5TW

telephone:
CHIPPING NORTON (0608) 3256
ask for: Bill Whaley
or
Bede Dunlop

• Circle No. 361

V. & T. ELECTRONICS

	KIT	BUILT	
NASCOM 2 16K RAMB BOARD V & T ASSEMBLER	330	385	RAM DOWN! 1 x 4116 < £2 SEE BELOW
			Z80A 81C BASIC 2K MONITOR EASY + CHEAP TO EXPAND * BRITISH *
NASCOM 2 16K RAMB BOARD 3 AMP POWER SUPPLY GRAPHICS ROM 8 x 4116s TO 32K V & T ASSEMBLER ON TAPE + DOCS VERO 19" FRAME/OR MICROCASE 77 WAY MOTHERBOARD DISCOUNT IF BOUGHT COMPLETE	210 130 32.50 12.50 27.50 5.50	250 150 37.50 15 15 12.50 27.50 5.50	NEW FOR NASCOM 2 HIGH RESOLUTION BOARD. 380 x 220 BIT MAPPED FROM RAM — NEEDS 10K. REAL TIME PLOTTING FROM ASSEMBLER & BASIC (NEEDS NAS SYS 3). FULL SOFTWARE SUPPLIED BUILT & TESTED £55
I/O BOARD EPROM BOARD, UP TO 32K NASCOM IMP PRINTER 80 CPS NEW! AY-38910 SOUND CHIP 64K EPROM + RAM POA	45 55 45	55 67.50 325 5	V & T ASSEMBLER: FULLY RELOCATABLE ON TAPE. STATS MONITOR. £12.50 PIO OPTION £12 ZEAP EPROM £50 VART OPTION £16 TAPE £30 CTC OPTION £14 NAS DIS £37.50 NAS SYS 3 £40 NASPEN £30 NASPEN £30
		450	MEMORY
			8 x 4116 200 ns DRAM £16.00 TRS80 U/GRADE KIT £17.00 1 x 2114 300 ns SRAM 1.75 1 x 4118 250 ns SRAM 1K 8 1 x 2708 x 1K x 8 EPROM 3.25 1 x 2716 5V 2K x 8 EPROM 5 1 x 2532 5V 4K x 8 EPROM 12

PLEASE ADD V.A.T. AT 15%

82 CHESTER RD LONDON N19 5BZ TEL (01) 263 2643

• Circle No. 362

Datron of Sheffield for Cromemco

— the ultimate name in micros

- * Datron import
- * Datron supply
- * Datron stock

DIRECT FROM
CROMEMCO

AND SUPPORT
NATIONALLY

CROMEMCO SYSTEMS,
CARDS & SOFTWARE



Datron Prices

Unit	RAM	ROM	Disc	
System Zero/D	64K	4K	2 x 390K	£2,450
System 2	64K	4K	2 x 390K	£2,526
System 3	64K	4K	2 x 1.2M	£4,050
Hard Disc Z2-H	64K	4K	10M + 2 x 390K	£5,373
Z2H Colour Graphics	64K	4K	10M + 2 x 390K	£7,800†

Prices include Interfaces for VDU, dot matrix and letter quality printers, documentation and systems familiarization.

† also includes 13" RGB Monitor and 2 x 48K graphic memory cards.



Wide range of languages,
16K and 32K Basic,
Cobol, Rational Fortran
and Fortran IV, Lisp,
RPG etc. Operating systems
— Cromemco CDOS, CP/M
Compatible or Cromix
for Multi-User



Write or 'phone for free advice
and catalogue or call in for a
demonstration.

DEMONSTRATIONS 9am-5pm
MONDAY-SATURDAY

DATRON MICRO CENTRE
DATRON INTERFORM LTD

2 Abbeydale Road, Sheffield S7 1FD.
Telephone 0742-585490 / 585400.
Telex 547151.

• Circle No. 363

'TUSCAN' FROM TRANSAM



Take a step up to your next Computer!

THE CONCEPT

How many ways are there to build an S100 system? Not many, and all expensive. TUSCAN changes all that.

Five S100 boards on one single board — just for starters. Plus five extra slots for future expansion.

What a combination! Z80 and S100 with the TRANSAM total package of system and applications software.

THE PRICE RANGE

From £235 for complete main board kit to £1481 for 48K assembled with 2 x 5¼" drives.

THE HARDWARE

The first Z80 single board computer with integral S100 expansion. British designed to the new IEEE (8 BIT) S100 specification, the TUSCAN offers total system flexibility. A flexibility available now.

The board holds the equivalent of a Z80 cpu card, 8k ram, 8k rom video and I/O cards with 5 spare S100 expansion slots and offers a price/performance ratio which is hard to beat.

Just compare our price with a commercial S100 ten slot motherboard with this specification.

THE SOFTWARE

TUSCAN offers the user the choice of system monitor, editor, resident 8k basic, resident Pascal compiler or full CP/M disk operating system. All options are upwards

compatible and fully supported with applications software. Both 5¼" and 8" drives are supported in double density.

THE PACKAGE

TUSCAN is available in kit form or assembled. With several hardware and software options to suit your requirements and budget. Attractive desk top case also available holds 2 x 5¼" Drives.

TRANSAM

NOBODY DOES IT BETTER!

Send to Transam Components Ltd., 59/61 Theobald's Road, London WC1.

I am interested in the TUSCAN Z80 based single board computer
NEW LOW PRICES, send S.A.E. for further details.

Name _____

Address _____

Telephone _____

PC4/81

TRANSAM COMPONENTS LTD., 59/61 THEOBALD'S ROAD, LONDON WC1. TEL: 01-405 5240/2113

• Circle No. 364

KGB MICROS LIMITED

THE PROFESSIONAL ORGANISATION OFFERING
HARDWARE AND SOFTWARE PLUS FULL CLIENT SUPPORT
WHO WISH TO MAKE YOUR BUSINESS OUR BUSINESS

SUPERBRAIN™



THE MICRO COMPUTER THAT HAS
THE BEST PRICE/PERFORMANCE
RATIO.

£1495 (64K RAM)

MICROLINE 80



THE EFFICIENT BUSINESS SYSTEM
SUPERBRAIN

+

MICROLINE 80 PRINTER

£1795

INDIVIDUAL PRICE £500.00

DIABLO 630

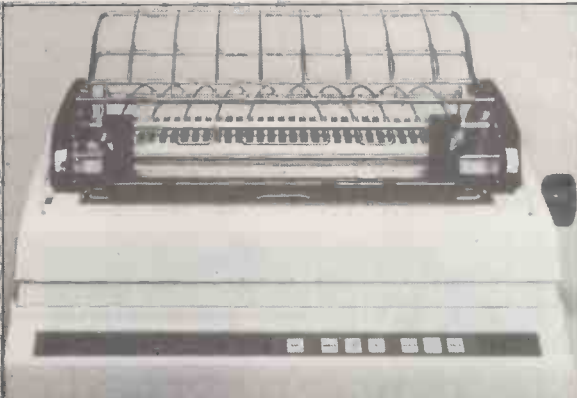

THE COMPLETE WORD PROCESSING
SYSTEM

SUPERBRAIN

+

DIABOLO 630 PRINTER

+

THE PROVEN 'WORD STAR' PACKAGE

£2995

INDIVIDUAL PRICE £1675.00

SOFTWARE SUPPORT

- * KGB offer a wide range of standard software — FORTRAN, COBOL, BASIC, PASCAL.
- * KGB will customise our software packages to meet your unique requirements — Invoicing £95, Sales Ledger £235, Purchase Ledger £235, Nominal Ledger £235, Payroll £335.
- * KGB will design and implement software to suit your business needs.

**KGB Micros Ltd., 88 High Street, Slough, Berkshire.
Tel: Slough 38581/38319**

Superbrain is the registered trademark of Intertec Data Systems. Prices exc. VAT.

• Circle No. 365

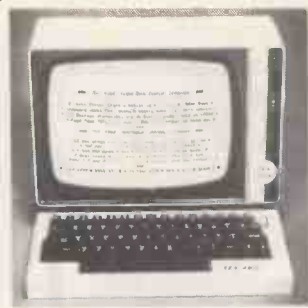

VIDEO DISPLAY UNIT
TEX VT64 - £299

★
UNIVERSAL KEYBOARD
TEX KB62 - £99

★
VT64 & KB62 - £389

- 16 x 64 FULL SCREEN REWRITE IN 0.5 SECONDS.
- 128 CHARACTER U/L SET + FULL CURSOR/SCREEN CONTROLS.
- FOUR-TONE 'BEL'. V24/20mA. 50-19200 BAUD.
- KEYBOARD INPUT PORT ACCEPTS & POWERS MOST TYPES.
- UPGRADEABLE TO 24 x 80 VT80 DURING 1981.
- KB62 HAS 464 x 8-BIT KEYCODES IN EPROM.
- 62 KEYS WITH DEDICATED CURSOR & USER FUNCTIONS.
- QUALITY 'FEEL'. ALPHA-LOCK. AUTO-REPEAT.
- QUAD-MODE ENCODING. 2/N-KEY ROLLOVER/LOCKOUT.
- LATCHED DATA. ± STROBE. CONTACTS OF USER KEY.
- KB16 SEPARATE ADD-ON NUMERIC PAD DURING 1981.

TEX EPROMPT ERASER - £39 inclusive



- SIMPLE 32-CHIP ½ HOUR PROCESS ON 200-250V A.C.
- TUBE RUNS COOL AT EXACT WAVELENGTH FOR EPROMS.
- 16-CHIP INTERLOCKED-DRAWER 'GT' MODEL £45 INCL.
- SOLID-STATE 30-MINUTE TIMER UNIT £15 INCL.

VT64/KB62 prices exclude shipping and value added tax
Terms C.W.O.C.O.O. or trade references for credit

Trade enquiries invited for substantial discounts.
O.E.M. quantities available with custom trim.

All orders and enquiries post-free to:—

TEX MICROSYSTEMS LTD. FREEPOST
ST. ALBANS, HERTS. AL1 1BR TRING 4797/ST. ALBANS 64077 (DAY/NIGHT)

• Circle No. 366

NEWDOS80 — APPARAT'S DOS FOR THE 80's

- * Up to 4095 bytes per record on disc files
- * Variable — length records
- * 5 or 8 inch disc drives of 35, 40, 80 tracks may be mixed
- * DOS and BASIC command changing
- * Print Spooler provided for concurrent printing and other processing
- * NEWDOS and TRSDOS compatible
- * PLUS MUCH MORE !!!

£65 including detailed manual BUSINESS SOFTWARE

Contact us to discuss your application

UDMS INFORMATION MANAGEMENT FOR THE NON-PROGRAMMER

- * Powerful, easy-to-use facilities for data storage, update, and reporting
- * Ideal for business applications
- * Extremely flexible
- * Save £££'s on software costs!
- * Versions for TRS80 I and II
- * Comprehensive users manual

Basic Version £75 Full Version £150 Manual only £6.00

MICROLINE-80 PRINTER

Phone for lowest price
Prices exclude V.A.T. and Postage.

CLEARTONE COMPUTER CONSULTANTS LTD.
PRINCE OF WALES INDUSTRIAL ESTATE
ABERCARN, GWENT NP1 5RJ Tel: (0495) 244555

CLEARTONE

• Circle No. 367

new practical computing books

prentice-hall books

Michael P. Zabinski

Introduction to TRS-80 LEVEL II BASIC and Computer Programming

With step-by-step instructions, this practical book shows how to use the TRS-80 for a wide range of applications from multiplication tables to computer graphics and video games.

£7.10 pb 186 pages 13-499962-2

Hubert S. Howe, Jr.

TRS-80 Assembly Language

For the first-time user as well as experienced users of the TRS-80, this book covers introductory concepts, practical programming applications, ROM and RAM usage, and disk operating systems.

£6.45 pb 186 pages 13-931121-1

Lance A. Leventhal

Microcomputer Experimentation with the Motorola MEK6800D2

A complete introduction, this new book stresses practical applications of microprocessors in such areas as instrumentations, communications, test equipment, and industrial and process control.

£11.00 pb 368 pages 13-580761-1

Lance A. Leventhal and Colin Walsh

Microcomputer Experimentation with the Intel SDK-85

A series of laboratory experiments with over 70 fully documented programs are provided that cover all the basic aspects of using microprocessors in engineering systems design.

£10.35 pb 384 pages 13-580860-X



Prentice-Hall International

Prices are correct at the time of going to press but may be subject to change

sams books

Stephen M. Murtha and Mitchell Waite

CP/M™ Primer

Illustrated throughout with diagrams and photographs, this book gives clear instructions on how to use and work with the CP/M™ disk operating system which is very popular for the 8080, 8085 and Z80 microcomputers.

£7.75 pb 92 pages 672-21791-0

Howard M. Berlin

Circuit Design Programs for the TRS-80

This book provides a variety of useful BASIC programs that will greatly simplify the design and analysis of common circuit problems.

£5.80 pb 140 pages 672-21741-4

Howard Berenbon

Mostly BASIC Applications for Your Apple II

£7.10 pb 152 pages 672-21789-9

Howard Berenbon

Mostly BASIC Applications for Your PET

£7.10 pb 160 pages 672-21790-2

Howard Berenbon

Mostly BASIC Applications for Your TRS-80

£7.10 pb 168 pages 672-21788-0

book orders

These books can be ordered from your bookseller or in case of difficulty from Department 30,

Prentice-Hall International, 66 Wood Lane End, Hemel Hempstead, Hertfordshire, HP2 4RG, England.

Please mark the number of books you wish to order in the boxes beside each title and return the advertisement to the address above with your payment.

Name _____

Address _____

I enclose a cheque/P.O. for £ _____

Please add 55p per book for postage and packing. Payment should be made out to International Book Distributors.

Please allow 28 days for delivery. PC

• Circle No. 368

THE PETMASTER SUPERCHIP

It doesn't matter how long you've had your PET or CBM microcomputer, there's something that the SUPERCHIP can do for you. Quite a few things in fact, like the auto-repeat facility (which you can adjust to your requirements), or the single key entry of 26 Basic words. You can manipulate the screen in much the same way as on the new 8032 Superpets - at a fraction of the cost - or perhaps use the built-in SHRINK routine to save valuable memory. Over 500 users in the U.K. have installed SUPERCHIP, and this British product has been sold to owners in nearly twenty countries! £45 plus VAT for 2001/3000/4000 models. A 28-page extract from the manual is available free on request.

FREE CATALOGUE

Our new 1981 Catalogue has dozens of programs which will LOAD (we don't bulk duplicate our cassettes and disks) and RUN. Some of the new programs in the catalogue are CATACOMBS, MASTER DIRECTORY, SPEEDSORT, DISK MERGE, P.E.P., PAPERMATE (low-priced word processor), WORDPRO, VISICALC, and ANIMATION. We also offer an extensive range of supplies and accessories - VERBATIM disks are £18 for 10, CBM printer ribbons £1.80 each - and our other prices are equally competitive. We've got PRESTO DIGITIZERS at £18 (down from £42) and DUST COVERS at just £2.75 each! We sell music boards, sound chips, EPROMS, memory chips, cassette and IEEE connectors, 2-metre IEEE cables - there isn't room to mention everything here! Write for your free catalogue today.

OFFICIAL ORDERS
FROM SCHOOLS AND
COLLEGES WELCOMED!



SUPERSOFT

28 Burwood Avenue, Eastcote, Pinner,
Middlesex. Phone 01-866 3326 anytime

• Circle No. 369

GATE MICROSYSTEMS LIMITED

MICROCOMPUTER SALES + SUPPORT NOW IN DUNDEE + GLASGOW



Announce: —

THE MICROSOFT Z80 SOFTCARD FOR YOUR APPLE II PLUS

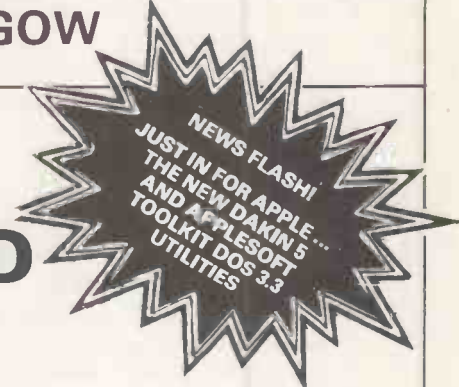

- * Z80 Softcard is a circuit board with a Microprocessor and I/O Circuitry which plugs into any slot (except 0 in your APPLE.
- * Z80 Softcard allows you to run CP/M, CP/M based languages and CP/M application programs on your APPLE.

- * Z80 Softcard enables you to switch your APPLE back and forth from 6502 processing to Z80 processing via a single instruction.
- * Z80 Softcard gives you Microsoft Basic 5.0 on your APPLE.

PRICE **£200.00** EX VAT

GATE MICROSYSTEMS LTD
THE NETHERGATE CENTRE
66, NETHERGATE, DUNDEE DD1 4ER (0382) 28194

GATE MICROSYSTEMS LTD
ABBAY HOUSE, 10 BOTHWELL STREET
GLASGOW G2 6NU 041-221-9372

• Circle No. 370

SYSTEM 4000 EPROM EMULATOR/PROGRAMMERS



P4000 PRODUCTION EPROM PROGRAMMER

This unit provides 'simple, reliable' programming of up to 8 EPROMs. It has been designed for ease of operator use — a single 'program' key starts the blank check — program — verify sequence. Independent blank check and verify controls are provided along with mode, pass/fail indicators for each copy socket and a sounder to signal a correct key command and the end of a programming run. Any of the 2704/2708/2716 (3 rail) and 2508/2758/2516/2716/2532/2732 EPROMs may be selected without hardware or personality card changes. 2 year warranty. Price **£545 + VAT**:

VM10 VIDEO MONITOR

This compact, lightweight Video Monitor gives a clean crisp picture on its 10" screen. Suitable for use with the EP4000, SOFTY and other systems. 12 month warranty. Price **£88 + VAT, carriage paid**.

MODEL 14 EPROM ERASERS



MODEL UV140 EPROM ERASER

Similar to model UV141 but without timer. Low price at **£61.50 + VAT, postage paid**.

EP4000 EPROM EMULATOR/PROGRAMMER

The microprocessor based EP4000 has been designed as a flexible, low cost, high quality unit for emulating and programming all the popular NMOS EPROMs without the need for personality cards, modules or hardware changes. Its software intensive design permits selection of the 2704/2708/2716 triple rail EPROMs and the 2508/2758/2516/2716/2532/2732 single rail EPROMs for both the programming and emulating modes.

The video output (T.V. or monitor) for memory map display in addition to the built-in Hex LED display, for stand alone use, is unique in this type of system. This, with the double function 28 key keypad, powerful editing features, powered down programming socket, buffered tri-state simulator cable and 4k x 8 data RAM gives you the most comprehensive, flexible and compact systems available today.

2 year warranty. Price **£545 + VAT**:

MODEL UV141 EPROM ERASER

- 14 EPROM capacity
- Fast erase time
- Built-in 5-50-minute timer
- Safety interlocked to prevent eye and skin damage
- Convenient slide-tray loading of devices
- Available Ex-Stock at **£78 + VAT Postage Paid**
- Add **£6** to order total for next day delivery by DATAPOST.

EX-STOCK

PLEASE NOTE OUR NEW ADDRESS/TELEPHONE NUMBER

GP INDUSTRIAL ELECTRONICS LTD,
UNIT 6, BURKE ROAD, TOTNES INDUSTRIAL ESTATE,
TOTNES, DEVON.

TELEPHONE: TOTNES (0803) 863360 (Sales) / 863380 (Technical Service)
DISTRIBUTORS REQUIRED — EXPORT ENQUIRIES WELCOME

SOFTY SYSTEM

EX-STOCK

Low cost card 2704/2708 emulator/programmer features:

- Direct output to T.V.
 - High speed cassette interface
 - On card EPROM programmer
 - Multifunction Keypad
 - 1K monitor in 2708
 - 1K RAM
 - 128 byte scratchpad RAM
 - 22 in/out ports
 - Access at card edge to all buses
 - 1K EPROM EMULATION
 - Direct memory access for fast data transfers
 - Editing facilities, including — data entry/deletion, block shift, block store, match byte, displacement calculation
 - Supplied with Zif socket, simulator cable and comprehensive manual
- SOFTY Kit of parts **£100 + VAT**
SOFTY Built & tested **£120 + VAT**
SOFTY Built power supply **£20 + VAT**

P&P IS INCLUDED IN ALL PRICES
Add **£6** to order total for next day delivery by DATAPOST.



SOFTY CONVERSION CARD

Enables SOFTY to program the single rail EPROMs, 2508/2758/2516/2532. Selection of device type and 1K block are by pcb slide switches. Programming socket is zero insertion force. Easy connection to SOFTY with the DEP Jumper supplied. Built and tested: **£40 + VAT, postage paid**.

SOFTY PRINTER

- 40 column electro-sensitive printer
 - 5 x 7 dot matrix
 - print sizes
 - Push button hex print-out of SOFTYs RAM, EPROM or inter-cursor contents
 - On card PSU
 - Selection of bytes per line.
- Built and tested **£145 + VAT, postage paid**.

EX-STOCK EPROMS

	1-9	10-24	25 up
2716 (single rail)	6-95	6-50	5-95
2708	4-00	3-80	3-60
2532	23-40		
2732	21-00		

ADD VAT AT 15% — POSTAGE PAID

WRITE OR TELEPHONE FOR DETAILS
ON ANY OF OUR PRODUCTS

• Circle No. 371

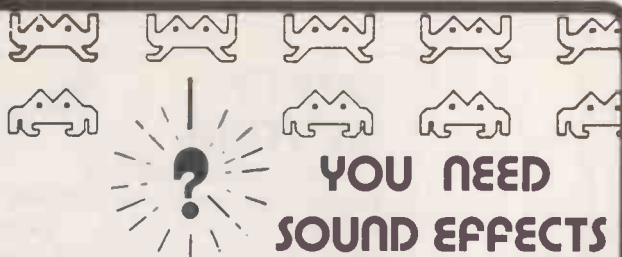

YOU NEED SOUND EFFECTS

FOR PET, SUPERBOARD, UK101, NASCOM.

- COMPLEX EFFECTS AND MUSIC
- USES INCREDIBLE AY-3-8910
- COMPLETELY BUILT, SIMPLY PLUGS IN
- BASIC OR MACHINE CODE
- BUILT IN AMP & SPEAKER + STEREO
- INCLUDES 2 8 BIT I/O PORTS
- COMPATIBLE WITH OTHER EXPANSIONS
- FREE DEMO PROGRAM + INSTRUCTIONS

Send for free information leaflets.

£43

N.B. 8T28 buffers (Superboard/UK101) next 6502 @ £3.00 per pair if required. + VAT
EX STOCK

**SOON
AVAILABLE!!**
PHONE, WRITE FOR DETAILS.

EPROM Programmer for Superboard/UK101.

Peripheral board 24 I/O lines for relay driving
etc., etc.

SUPERBOARD II 50Hz → £159 + VAT

610 EXPANSION £159 + VAT

CD3P FLOPPY DISC £285 + VAT

BASE 2 800Mst PRINTER £359 + VAT

Microcases £26 2114L 300ns RAM 8 for 22 4116 300ns 8 for £22 50 5V 3A power supply for Superboard £15 Vision Modulator, high quality, £4 50 Sound Modulator to match £3 75 40pin ribbon cable, 40pin DIP 40pin PCB suit Breadboard £4 50 Prototype Breadboard for Superboard/UK101 comprehensive, labeled bus £5 50 Bus extender to take 610 8 peripherals £4 25 Header plugs, 40pin £2 50 40pin sockets £0 40 8T28 buffers £1 50 ex AY-3-8910 sound chip £8 25 Joystick mechanisms £9 95 Blank DATA cassettes £5 25 for 10 Black discs 5" £3 25 PLEASE ADD VAT TO THE ABOVE PRICES ORDERS UNDER £10 ADD 50p p&p Trade enquiries welcome.

Easicomp

57 PARANA COURT, SPROWSTON,
NORWICH NR7 8BH
0603 416352



• Circle No. 372



**CRYSTAL ELECTRONICS
CC ELECTRONICS**

SHARP MZ80K

**For the latest competitive
PRICE**

Contact us

Before you accept discounts elsewhere.

GIVE US A TRY

**CRYSTAL ELECTRONICS is the home of XTAL BASIC
ACCLAIMED BY MANY**

Bi-directional serial board for your SHARP RS232
compatible < 150 Baud to > 2400 Baud adjustable.
5,6,7,8 Bit words, plugs into MZ80 I/O £99.50 plus VAT

**MZ80K owners — are you XTAL followers?
NO! Then please read on.
XTAL BASIC (SHARP)**

Takes 5K less memory, has all the features of SHARP BASIC
PLUS Multi dim strings, error trapping, logical operators,
machine code monitor, more flexible peripheral handling,
improved screen control, increased list control, auto run, if..
then.. else — and it doesn't stop there — it grows. You can
extend the commands and functions at will — 10K, 12K, 16K,
BASIC?

SHARP to XTAL BASIC conversion program is included.
£40 plus VAT

Members of Computer Retailers Association & Apple Dealers Association

Shop open 0930-1730 except Saturday & Sunday

40 Magdalene Road, Torquay, Devon, England. Tel: 0803 22699

Telex 42507 XTAL G

Access and Barclaycard welcome.



• Circle No. 373

AIM 65 DANCES TO A NEW DISK

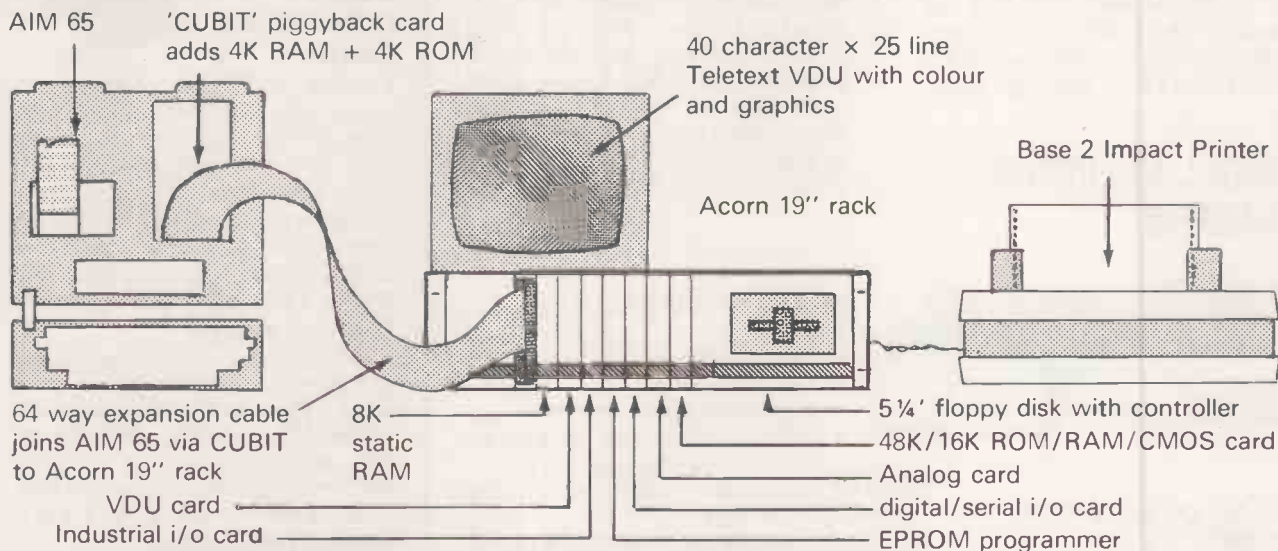

£600 buys a complete single disk extension to the AIM 65

This is the first conveniently packaged AIM 65 disk system to be available, and in the same sensible Eurocard presentation it offers memory expansion, impact printer interface, colour VDU, EPROM programmer, digital and analog i/o, and more. In addition, the owner of this hardware can run Acorn software, which includes BASIC, disk assembler, word processor and business accounting, and can run a 6809 microprocessor card in the same rack.

CONTROL — ALL ROCKWELL SYSTEMS
UNIVERSAL — ALL ACORN SYSTEMS
LTD SUPPLY — EXTENSIONS TO BOTH

Control Universal Ltd.
11-15 Bush House,
Bush Fair, Harlow, Essex
Tel: 0279 31604

• Circle No. 374

Stack-Apple announce their APPLE-SHOP

● fast delivery ● one year warranty ● full technical support

If you have any queries on these or any other Apple product call 051-933 5511 Paul Fullwood, Carl Phillips or Fiona McKendrick

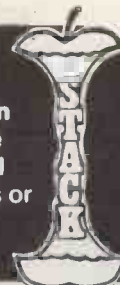

At last! A source where you can get any Apple-orientated product quickly, at a fair price and, most importantly, with the service and support that have made STACK-APPLE Britains' number one Apple supplier!

MICROSOFT Z-80 SOFTCARD

Microsofts innovative peripheral card turns Apple into one of the most flexible CP/M based systems you can buy. The Softcard actually contains a Z-80 processor and lets you switch between the Apples' 6502 and Z-80 with simple commands, so you can use software written for either processor. The Softcard gives you the two software standards-CP/M 2.2 and Microsoft 5.0 Basic with PRINT... USING, 16 Digit precision, CALL, CHAIN, COMMON, powerful file handling. Applesoft's graphics extensions are also supported. Softcard allows you to run almost any CP/M based language or applications package.

Nett	VAT	Total
£170.00	£25.50	£195.50

M & R ENTERPRISES SUP-R-TERMINAL

This is the best of the 80 col. boards. 80 x 24 Upper lower case, user defined character sets in RAM. The Z-80 softcard and super-r-terminal work perfectly together. If you are planning to use existing CP/M packages written for an 80 column terminal they should be compatible with this combination. The softcard B10S allow you to emulate any common VDU or terminal using the Apple keyboard and Super'R' Terminal.

Nett	VAT	Total
£245.00	£36.75	£281.75

SPECIAL

Z-80 Softcard and Super'R' Terminal Combo.

Nett	VAT	Total
£370.00	55.50	£425.50

ANADEX GRAPHICS CARD

Our own printer card designed specifically for the Anadex DP9500/1 and new DP9000/1 printers. The card behaves as a normal Apple centronics interface but also includes powerful graphics dump software on the ROM permitting dot-for-dot reproduction of a hi-res image on the printer with almost any imaginable format - either hi-res, page, normal or inverse, expanded in X or Y directions with varying scale factors, left, right or centre justified across page.

Nett	VAT	Total
£140.00	£21.00	£161.00

CCS ASYNCHRONOUS SERIAL

This is the serial card that goes where Apples' fears to tread! SWITCH-SELECTABLE board rates from 50 to 19.2K baud. On-board crystal, supports hardware handshaking with RTS, CTS, DTE, DTR. Recommended for use with Apple Pascal, softcard, daisy-wheel printers, modem control etc.

Nett	VAT	Total
£113.00	£16.95	£129.95

VERSAWRITER

Versawriter is a highly versatile graphics tablet of robust construction that is a tremendous aid in using Apples' high resolution graphics. Cursor movement with simultaneous display of X Y co-ordinates and independent control of drawing size and scale. Use defined shapes can be created, stored, positioned, rotated, even coloured (Up to 106 colours are available!). Apple with versawriter and printer can form quite an effective computer Aided Design at a fraction of the cost of conventional systems.

Nett	VAT	Total
£117.00	£17.55	£134.55

APPLE COMPUTER CARDS

Nett	High Speed Serial	VAT	Total
£113.00		£16.95	£129.95

Nett	Communications	VAT	Total
£130.00		£19.50	£149.50

Nett	Centronics Parallel	VAT	Total
£130.00		£19.50	£149.50

Nett	Parallel Printer	VAT	Total
£113.00		£16.95	£129.95

Nett	Pascal Language Systems	VAT	Total
£299.00		£44.85	£343.85

Nett	Apple Fortran	VAT	Total
£120.00		£18.00	£138.00

Nett	DOS 3.3	VAT	Total
£39.00		£5.85	£44.85

Nett	Eurocolour	VAT	Total
£113.00		£15.95	£129.95

Nett	Proto-Typing Card	VAT	Total
£15.00		£2.25	£17.25

STACK-APPLE No 1 for Apple Products

MOUNTAIN HARDWARE

Nett	Clock Calendar	VAT	Total
£168.00		£25.20	£193.20

Nett	Music System	VAT	Total
£312.00		£46.80	£358.80

Nett	Rom Writer	VAT	Total
£106.05		£15.91	£121.96

Nett	Rom Plus	VAT	Total
£128.89		£19.33	£148.22

Nett	Copy Rom Superb disk copy utility on ROM for ROM-PLUS	VAT	Total
£30.00		£4.50	£34.50

CALIFORNIA COMPUTER SYSTEMS

Nett	Centronics Card (new)	VAT	Total
£95.00		£14.25	£109.25

Nett	IEEE-488 GPIB (Revised firmware)	VAT	Total
£212.00		£31.08	£243.80

Nett	Synchronous Serial RS232	VAT	Total
£113.00		£16.95	£129.95

Nett	Asynchronous Serial	VAT	Total
£113.00		£16.95	£129.95

Nett	Clock Calendar (new)	VAT	Total
£99.00		£14.85	£113.85

Nett	Programmable Timer	VAT	Total
£84.00		£12.60	£96.60

Nett	PIA (uses 6821 16 I/O lines)	VAT	Total
£84.00		£12.60	£96.60

Nett	12K PROM/ROM/RAM card	VAT	Total
£75.00		£11.25	£86.25

Nett	Arithmetic processor	VAT	Total
£240.00		£36.00	£276.00

Nett	3 1/2 digit BCD A/D unit	VAT	Total
£120.00		£18.00	£138.00

Please send me: _____

Cheque/P.O. enclosed for: £ _____

Name _____

Address _____

Prices include delivery.

Official orders welcome.

STACK-APPLE 290-298 Derby Road,
Bootle, Liverpool 20.
Telephone: 051-933 5511.

PC4/81

● Circle No. 375

DATA LINK

Microcomputer Systems Limited

Systems software for business, industrial and scientific applications

APPLE SYSTEMS

Apple II Plus	£695.00
1 MB 8" Disk Drives	£1550.00
Disk Drive with controller card 3.3 DOS	£382.00
Disk Drive without controller card	£299.00
16K Add-ons RAM	£69.00

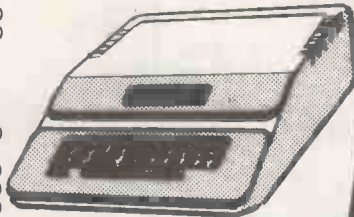

FULL RANGE OF ACCESSORIES

including:	
Visicalc	£95.00
A1-02 Data Acquisition Card	£180.00
Clock Card	£160.00
ROM Plus Board	£116.00

ALL PRICES EX VAT

APPLE SYSTEM — Latest Additions

DOS 3.3 (23% extra disc space)	£39.00
H.S. RS232/Bi-directional parallel Combined Interface	£120.00
Desktop Plan (from Visicalc people)	£64.00
Language Card with Pascal	£299.00
Fortran Addition	£120.00
Pilot addition	P.O.A.
Appletel (for Prestel)	£595.00
Apple juice reserve power supply	£148.00
IEEE Interface	£212.00
Datalink Programmable Timer Card	£110.00
Z-80 Softcard	£175.00

Printers

Centronics 737	£425.00
Paper Tiger from	£545.00

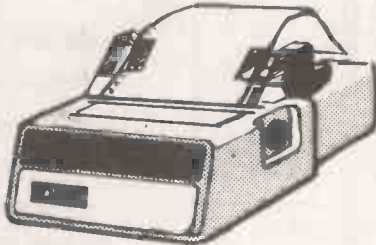

NEW!!!!

SEIKOSHA GP80

Dot-matrix with Full graphics £250.00

C.ITOH Daisy-Wheel Printer £1,085.00

Consultancy Service

If the computer you buy is really going to do the job you want it to do — run your accounts, control your stock, solve your problem, or you name it . . . the selection of the computer system and the programs to run it must be made with the utmost care. Otherwise, grief, hassle and costly frustration may well be your unhappy lot.

As always, the answer is to consult an expert.

We have on tap a team of friendly experts who will happily analyse your problem, discuss with you your hopes and ambitions, and advise you on the feasibility of a computer solution. If the situation is on-going, they will then specify your software requirements and recommend a particular computer system.

Finally, they will cost the whole exercise.

Fortune smiles upon he who . . .

DISKETTES ETC

BASF Top Quality Unconditional 12 Month Guarantee

5.25" Mini Single Sided Soft Sector/Single Density	£25.00 (Box of 10)
5.25" Mini Single Sided Hard Sector/Single Density	£25.00 (Box of 10)
5.25" Mini Single Sided Soft Sector/Double Density	£26.00 (Box of 10)
5.25" Mini Double Sided Soft Sector/Double Density	£30.00 (Box of 10)
8" Single Sided Soft Sector/Single Density	£26.50 (Box of 10)
8" Single sided Soft Sector/Double Density	£27.50 (Box of 10)
8" Double Sided Soft Sector/Single Density	£40.00 (Box of 10)
8" Double Sided Soft Sector/Double Density	£40.00 (Box of 10)

DISKETTE LIBRARY CASES

5.25" Mini Diskette Library Case for 10 Diskettes	£2.50
8" Diskette Library Case for 10 Diskettes	£3.00

DISKETTE TRAY WITH LOCKABLE LID

A6 5.25" Mini Diskette Tray with Lockable Lid:	30-40 capacity £18.00	60-80 capacity £20.00
--	-----------------------	-----------------------

A5 8" Diskette Tray with Lockable Lid:	30-40 capacity £25.00	60-80 capacity £28.00
--	-----------------------	-----------------------

9" Plain Listing Paper (per 2,000 sheets)	£16.00
---	--------

10% EDUCATIONAL DISCOUNT

STOP PRESS

Micro-SPEED Language System

Developed by a USA-based companion company of Datalink, the u-SPEED card is a brand new enhancement which will go far to make the Apple the market leader.

By using a version of FORTH and a high speed maths chip u-SPEED facilitates high-speed plotting of graphics, high-speed text-writing and maths, etc., etc., increasing running speed by approximately a factor of ten (over Applesoft).

A detailed spec. is available on request.

Price £265.00

SPECIAL OFFER 5.25" BASF diskettes £20 (box of 10)

WE CAN NOW ARRANGE INSURANCE FOR YOUR COMPUTER

We also stock an extremely comprehensive range of computer books

DATA LINK

10 Waring House, Redcliffe Hill, Bristol BS16TB
Telephone: Bristol (0272) 213427

Karadawn Ltd.

Micro Computer Systems & Software

2 Forrest Way, Gatewath Industrial Estate, Warrington, Cheshire.

Tel: 0925-572668. Telex: 628269

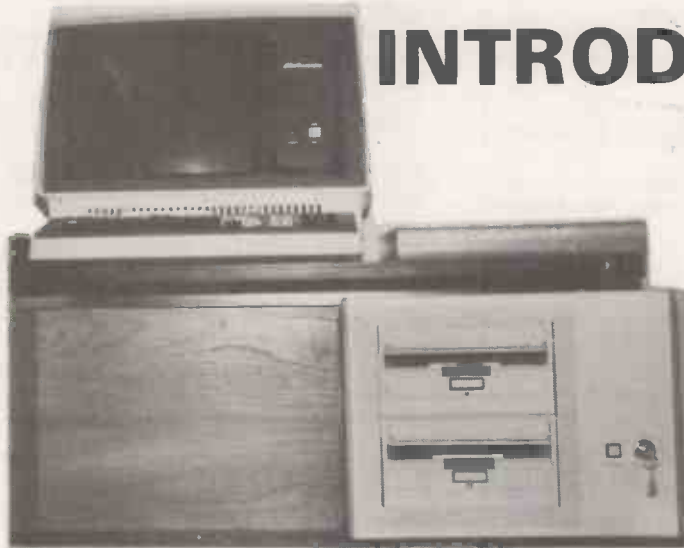

INTRODUCE THE KD-200

MANUFACTURED TO KARADAWN'S OWN SPECIFICATION IN CALIFORNIA, U.S.A. THE EXCITING NEW K D GENERATION OF ADVANCED HIGH RELIABILITY BUSINESS COMPUTERS.

FOR THE TECHNICAL

2 MEGABYTE STORAGE CAPACITY ON 2 DOUBLE SIDED DOUBLE DENSITY 8" MITSUBISHI FLOPPY DRIVES WITH TRACK TO TRACK ACCESS TIME OF 3m.s.
64K RAM
Z-80A CPU running at 4mhz
2 RS232 Serial & 2 Parallel Ports.
Industry Standard CP/M operating System 2.2. included in the price
15" V.D.U. by Elbit with tinted green screen, easily expandable to hard disk, up to 66 meg. and MP/M
Data Communications via direct connection or telephone/satellite available.
Reversed flow ventilation and heavy duty power supply
8" Winchester Hard Disks available up to 34 megabytes off the shelf that work comes with custom made systems desk.

FOR THE NOT SO TECHNICAL

Up to 2,000,000 characters of information or data can be reliably stored on two 8" sized floppy disks.
Plenty of memory.
Uses the famous Z-80 micro chip.
Can run a printer and talk to another computer at the same time.
No hidden extras.
Pleasant, easy viewing; no magnifying glasses needed.
When you need more storage or more add-on terminals you don't have to buy the "next model up". It can talk to its friends overseas, or in your other branches.
Electronic Mail ???
Keeps its head cool when all around are losing theirs.
Reliable storage of up to 34 million characters.
Complete in attractive desk. No trailing wires and separate "modules".

Prices start at **£4,750** for KD-100 (1 mg System)
£5,250 for KD-200 (2 mg System)
£7,950 for 1 KD-1000 (10 mg System)
£10,250 for KD-3400 (34 mg System)

For Multi User add £1,000 to above, and £1,500 for each extra terminal.

FULL SELECTION OF SOFTWARE, WORD PROCESSING, BUSINESS PACKAGES, LANGUAGES ETC. AVAILABLE

U.K. AND EUROPEAN DEALER/EXPORT ENQUIRIES INVITED. CP/M IS A REGISTERED TRADE MARK OF DIGITAL RESEARCH.

*ALL SYSTEMS CAN BE SUPPLIED WITH INDIVIDUALLY WRITTEN SOFTWARE
TAILORED TO YOUR EXACT SPECIFICATIONS BY OUR OWN PROGRAMMERS.
ALL OUR SOFTWARE IS FULLY SUPPORTED.*

• Circle No. 377

XITAN SYSTEMS LTD

The South's CROMEMCO experts

Need a Hard Disk System with FAST RELIABLE Backup?

Xitan now have the answer with the Z-2H plus DC300 Tape cartridge BACKUP system (\$100 controller, drive, psu & software).

The Cartridge BACKUP system is available separately for existing Z-2H users (13.4 Megabyte capacity — 1 Megabyte per 5 minutes).

Utilities/Software for CROMEMCO Systems.

Tired of XFER — use FCOPY or DFCOPY. Single sided 8" copy in 54 seconds, Double sided 8" copy in 104 seconds. £50.00 each.

Need to build Assembler libraries — try LIBR at £50.00.

CP/M 2.2 and MP/M 1.1 available for System 3 and Z-2H systems.

EASYFORM. For creation/Editing of forms on the 3102 VDU with structured Basic. Forms useable from Cobol, Basic, Fortran etc. £160.00.

BUSINESS SOFTWARE.

CROMEMCO systems — a complete Business system based on

the system 3 from CAP-CPP. Phone for an appointment to see it running.

For the smaller customer, we have an integrated Sales, Purchase and Nominal system for the North Star Horizon. Nothing fancy — but installed and running for over 7 months. IT WORKS! WHATIF! Cash Flow, Accounts budgetting utility. Just released. Incredible value at £95.00.

Also available an Incomplete Records system for the Horizon.

SPECIALS.

Real Time Clock — \$100 — 100 microseconds up to 99,999 days £185.00 Hi-Tech \$100 PAL colour card, 24 x 40 Prestel format £295.00 Video Vector Fastlib £495.00.

Dual Tandon Double/sided 40 track minifloppy subsystem £625.00.

INTEGRATED SPECIALIST SYSTEMS.

MEDIDATA 32,000 patient Doctors' system. Installed and running. Prices from £7,500.00.

RETURNED ALE. Run a brewery? Keep track of returned ale and reclaim Excise Duty. Track down production and storage problems. Copes with 10,000+ barrels. Prices from £8,500.00.

Xitan Systems also supplies and stocks vdu's, printers, NORTH STAR HORIZON computers, Commodore Business Machines PETs, S100 boards, and books. We are here to demonstrate the range of quality microcomputer systems available for use today. Ring up for an appointment now! You'll not be disappointed. We have Osborne's Sales Ledger and Payable Ledger in source form for use on Cromemco System 3 with CBASIC2, and we can offer a customising service on these programs. Additional software includes Microsoft Basic Interpreter and Compilers, Cbasic, Macro80, and CP/M for the North Star Horizon.

XITAN SYSTEMS LIMITED

23 Cumberland Place, Southampton SO1 2BB

Telephone (0703) 38740. Hours Monday — Friday 9.30am to 5.30pm



• Circle No. 378

ADVANCED COMPUTER EQUIPMENT (LEEDS) LTD

95 MEADOW LANE LEEDS 11 TEL 0532 446960

NEW MICROCOMPUTER STORE

NOW OPEN

PRICES SHATTERED

COMMODORE PET

ALL WITH 12 MONTHS WARRANTY

32K PROFESSIONAL KEYBOARD	£575
DUAL DISK DRIVE 347K	£625
CASSETTE DECK C2N	£ 50
PRINTER 3022 MATRIX TRACTOR	£375

SHARP Z-80

ALL WITH 12 MONTHS WARRANTY

48K WITH 34K USER RAM	£474
36K WITH 22K USER RAM	£422
20K WITH 6K USER RAM	£380
DISK DRIVES, PRINTERS ETC.	

PRINTERS

BD80/132 BI DIRECTIONAL MATRIX	£425
IEEE PARALLEL OR RS232 INTERFACE	
RICHO — RP1600 DAISYWHEEL	
SPECIAL PRICE	£1,150

APPLE II PLUS

12 MONTHS WARRANTY

48K AUTO START	£695
DISK WITH CONTROLLER	£345
DISK WITHOUT CONTROLLER	£295
9" MONITOR B/W	£ 80

SUPERBRAIN

64K WITH SINGLE DENSITY 320K DISK	£1,550
64K WITH DOUBLE DENSITY 700K DISK ...	£2,150
FULLY INTEGRATED ACCOUNTS PACKAGE .	£950
OPERATING SYSTEM * MBASIC *	
COBOL * FORTRAN	

SUNDRIES

DATA TAPES SUPER QUALITY (10)	£ 4.35
5 1/4" CERTIFIED VERBATIM (10)	£27.00
PLAIN LISTING PAPER 2000 SHEETS	£12.50
BOOKS * GAMES * PROGRAMS * GALORE	
VISICALC * DESKTOP PLANNER	
SPECIAL OFFER	

PLEASE ADD VAT TO ALL GOODS EXCEPT BOOKS — CASH AND CARRY OR 24HR DELIVERY — YOUR CHOICE
ALL EQUIPMENT IS FACTORY FRESH AND FULLY TESTED IN OUR OWN WORKSHOPS

STANDARD CONDITIONS OF SALE APPLIES TO ALL PRODUCTS

• Circle No. 379

FLOPPY DISK DRIVES FOR TRS 80 AND VIDEO GENIE

DUAL DISK UNITS

2 x 40 TRACK DRIVES

£440

2 x 80 TRACK DRIVES

£595

SINGLE DISK UNITS

1 x 40 TRACK DRIVE

£236

1 x 80 TRACK DRIVE

£315

DISK DRIVE CABLES

2 DRIVE CABLE

£19

4 DRIVE CABLE

£30



PERCOM DATA SEPARATORS

£20

Plugs into the TRS 80 expansion interface and corrects 'READ/VERIFY' and 'CRC ERROR! TRACK LOCKED OUT!' problems on the inside tracks of any floppy disk system. Comes with full installation instructions — NO SOLDERING, NO CUTTING, JUST PLUGS INTO THE EXPANSION INTERFACE.

Call your nearest dealer for a demonstration:

RADIO SHACK LTD.,
188, Broadhurst Gardens,
London NW6
Tel: 01-624-7174

COMPESHOP LTD., 14, Station
Road, New Barnet, Herts.
Tel: 01-441-2922

COMPESHOP LTD.,
311, Edgware Road,
London W2. Tel: 01-262-0387

MICRO-CONTROL LTD.,
224, Edgware Road,
London W2. Tel: 01-402-8842

**LONDON COMPUTER
CENTRE**, 43 Grafton Way,
London W1. Tel: 01-388-5721

**TRANSAM COMPONENTS
LTD.**, 59-61, Theobalds Road,
London WC1.
Tel: 01-405-5240

N.I.C. 61, Broad Lane,
Tottenham, London N15
Tel: 01-808-0377

ZERO ONE ELECTRONICS,
36, Oaklands Avenue,
THORNTON HEATH,
Surrey
Tel: 01-689-7924

P & J EQUIPMENT LTD.,
3 Bridge Street,
GUILDFORD
Tel: 0483-504801

SEVET TRADING, 14, St.
Paul's Street, Bristol 2
Tel: 0272-697757

PARWEST LTD., 58, Market
Place, Chippenham.
Tel: 0249-2131

COMPUTERAMA LTD.,
5, Cleveland Place East,
London Road, Bath.
Tel: 0225-333232

ENSIGN, 13-19, Milford
Street, Swindon, Wilts.
Tel: 0793-42615

H.C. COMPUTERS LTD.,
541, Durham Road,
Low Fell, Gateshead.
Tel: 0632-821924

**CAMBRIDGE COMPUTER
STORE**, 1, Emmanuel Street,
Cambridge. Tel: 0223-65334

**PORTABLE MICRO-
SYSTEMS**, 18, Market Place,
Brackley, Northants
Tel: 0280-702017

I.C. ELECTRONICS,
Flagstones, Stede Quarter,
Biddenden, Kent.
Tel: 0580-291816

MICRO CHIP SHOP,
190, Lord Street, Fleetwood,
Lancs. Tel: 03917-79511

MICRO CHIP SHOP,
197, Waterloo Road, Blackpool.
Tel: 0253-403122

MICRO CHIP SHOP,
93, Friargate, Preston, Lancs.
Tel: 0772-22669

HARDEN MICROSYSTEMS,
28-30, Back Lord Street,
Blackpool. Tel: 0253-27590

**NORTH WEST COMPUTER
CONSULTANTS LTD.**,
241, Market Street, HYDE,
Cheshire
Tel: 061-366-8624

**HEWART MICRO-
ELECTRONICS**, 95, Blakelow
Road, Macclesfield.
Tel: 0625-22030

KARADAWN LTD.,
2 Forrest Way, Warrington
Tel: 0925-572668

PHOTO ELECTRICS,
459, London Road,
Sheffield
Tel: 0742-53865

GNOMIC LTD.,
46, Middle Street,
Blackhall, Hartlepool
Tel: 0783-863871

EWL COMPUTERS LTD.,
8, Royal Crescent, Glasgow.
Tel: 041-332-7642

CUMANA LTD 35 Walnut Tree Close, Guildford, Surrey, GU1 4UN.
Telephone: (0483) 503121.

Please add VAT to all prices.

*Delivery at cost will be advised
at time of order.*

• Circle No. 380

Clenlo Computing Systems

**Complete Systems
Complete Backup
Complete Service**

Software:

PEARL 

Product of:
Computer Pathways Unlimited, Inc.

A Powerful Application Generator Produces Error-Free Automatic Rapid Logic Generates C BASIC 2 Programs and Compiles Them

Automatically Produces Programs For:

Menu Selection
File Update/ Edit

Report Generator
Indexed File Reorganisation / Indexed Access

Hardware:

THE CLENLO CONQUEROR

A Z-80 Microcomputer in an attractive Metal Cabinet, containing a 12 slot motherboard. Two serial and two parallel I/O ports. Will accept a variety of S-100 compatible floppy and hard disc drives.

Normally configured with 64K RAM and dual 8" double-density floppy disk drives giving total of 1.2 megabytes of data storage uses CP/M version 2.2 operating systems. Optional extras attractive desk unit to house microcomputer and drive.

64K Word Processing System together with VDU and Daisywheel Printer £4,000.

Peripherals:

The Morrow Designs Discus M26

**Morrow Designs Discus M26 offers 26 Megabytes of Data Storage
Morrow Design Discus M10 offers 10 Megabytes of Data Storage**

Each subsystem is backed with fully tested software. INSTALL software allows you to attach any Morrow disk system CP/M system operating under CP/M.

Morrow Designs disk drive, hard or floppy can be mixed and matched through Morrow Designs standard software, all necessary hardware, software and firmware is included with each system.

A growing list of tools to expand the apple.

7440A Programmable Interrupt Timer module, 7720A Parallel Interface, 7811B Arithmetic Processor, 7710A Asynchronous Serial Interface, 7470A 3 $\frac{1}{2}$ BCD A/D Converter, 7490A GPIB IEEE 488 Interface, 7114A Prom Module, 7500 A wire wrap board, 7510A solder board, 7590A Extender board, 7016A 16K Dynamic Memory Add-on.

Contact us for prices and further details of the range of products and services we offer.

**Clenlo Computing
Systems Ltd.**

Crown House
18 Gypsy Hill
London SE19 1NL
01-670 4202

• Circle No. 381

Wilkes Computing for DEC[™] Terminals

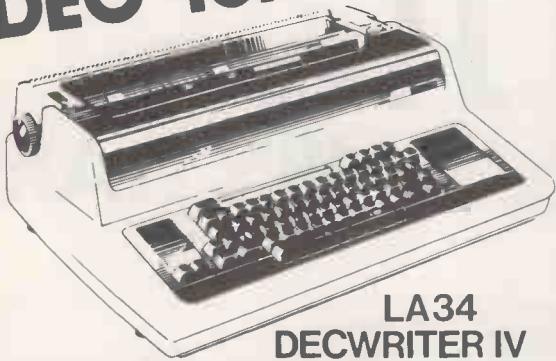

LA34
DECWRITER IV

- Desk Top ● 30 cps
- Full 128 ASC11 Character Set
- 4 Character pitches
- 6 different line spacings
- Left and right margins
- Optional forms control
- LOW PRICE

© Digital Equipment Company Ltd.

Wilkes Computing

Bush House, 72 Prince Street, Bristol BS1 4HU
Tel. (0272) 25921 Telex. 449205

Wilkes Computing Announce The VISUAL 200

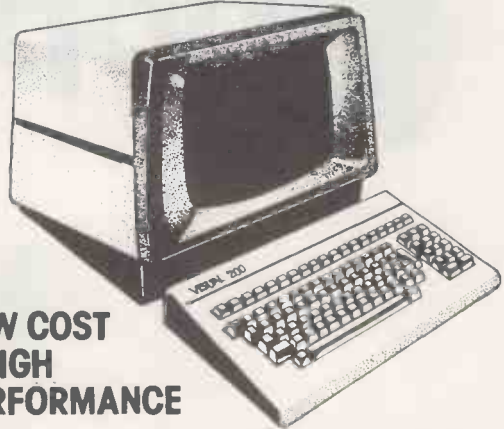

LOW COST — HIGH PERFORMANCE

- Detachable keyboard
- Numerical pad
- Upper & lower case
- Editing
- Smooth scroll
- Cursor addressing
- Printer port
- Many more standard features and options
- Switchable emulations
DEC VT52
Hazeltine 1500
Lear Siegler ADM3A
ADDS 520

Wilkes Computing

Bush House, 72 Prince Street, Bristol BS1 4HU
Tel. (0272) 25921 Telex. 449205

Wilkes Computing Present

the Anadex DP9500

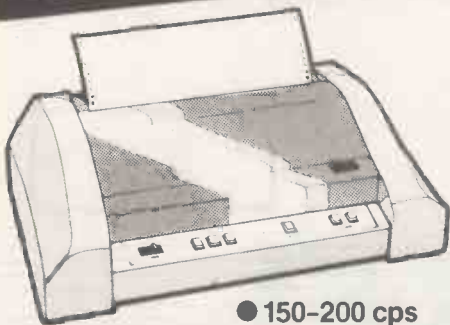

- 150-200 cps
- Bi directional smart printing
- 132-176 columns ● Complete forms control
- Horizontal and vertical tabs
- Double width printing ● 9 wire print head
- High density graphics ● Up to 9600 Baud

Wilkes Computing

Bush House, 72 Prince Street, Bristol BS1 4HU
Tel. (0272) 25921 Telex. 449205

Wilkes Computing Announce

DIABLO 630

DAISY WHEEL PRINTER

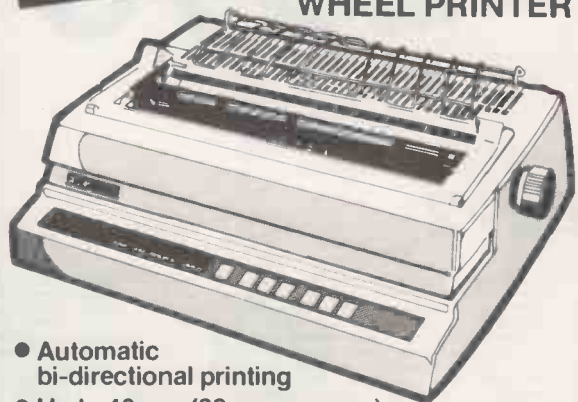

- Automatic bi-directional printing
- Up to 40 cps (32 cps average)
- Interchangeable metal/plastic print wheels
- RS232-c or 20 mA interface
- Word processing options
- Optional tractors ● Optional cut sheet feeder

Wilkes Computing

Bush House, 72 Prince Street, Bristol BS1 4HU
Tel. (0272) 25921 Telex. 449205

● Circle No. 382

apple®][PLUS **48K RAM**

© Apple is a trade mark of Apple Computer Inc., Cupertino, CA. USA.



£595

(subject to availability)

Send cheque or money order for

£692 (including VAT & Delivery in the UK) to:

Trade Enquiries
Welcome

QUEST LIMITED

at our new address:

15 Grand Parade, Brighton, Sussex, BN2 2QB.
Telephone: 0273-695264

• Circle No. 383

NEW SUPERBOARD SERIES II

New from OSI - Series II. Everything series I had but with more on a single board. Ideal for the beginner or experienced engineer alike. It needs only a 5V 3A power supply to be up and running. Fully expandable to a Floppy Disc and small business system.



STILL ONLY £149

+ P&P £3.50 + VAT

- 625 lines jitter free Display.
- Memory Mapped Video Display with upper/lower case graphics and gaming characters.
- Software selectable Display 24 x 24 48 x 12
- Uses the ultra powerful 6502 Micro.
- 8K Microsoft Basic in Rom.
- Full feature Basic runs faster than currently available computers and all 8080 based business computers.
- 4K static Ram on board expandable to 8K.
- Full 53 Keyboard with upper/lower case and user programmability.
- Power on reset-standard.
- 2 second action break key.
- Kansas City standard Audio cassette interface for high reliability.

- 6 latch outputs available for control purposes.
- 8 bit Digital to Analogue converter.
- Full machine code monitor and I/O utilities in Rom.

Superboard II Series II £149.00 + VAT
 Black ABS case £ 24.50 + VAT
 Extra 4K Ram £ 16.95 + VAT
 PSU 5A Ready Built £ 19.95 + VAT
 Numeric Key Pad Kit £ 11.95 + VAT
 610 Expansion Board with 8K fitted (expandable to 24K) £150.00 + VAT
 CD3P Floppy Disc £269.00 + VAT

Series 2 User's Manual The best single source of information £6.95, no VAT

Video swap tape & UHF modulator FREE!

SEIKOSHA GP80A



This Unihammer dot Matrix Printer gives Normal and Double Width Characters as well as Dot resolution Graphics.

- Printing Speed 30 cps
- Character Set 5 x 7 Matrix
- Print Density 12 CPI at 80 CPL
- Paper Feed 8" Matrix
- Parallel Interface Standard

Other Interfaces
 RS 232 £49 + VAT
 IEE 488 or Apple £29 + VAT
 Pet £29 + VAT

£225
 P & P £4.50 - VAT

500 Sheets of paper FREE!

EPSON TX80

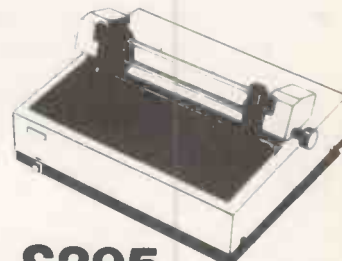

A complete 80 column dot matrix printer, available in tractor or friction feed versions.

- Speed: 125cps.
- Unidirectional print
- PET compatible graphics.

£295

P & P £4.50 + VAT

Various Interfaces available from £45

500 Sheets of paper FREE!

PETS

CASSETTE
£55

8K
 16K
 32K

£399
£499
£599

SOFTY

The complete microprocessor development system for the engineer and beginner alike.

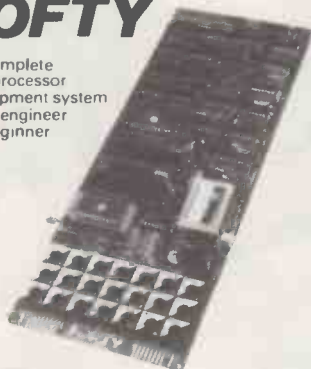

- Displays memory contents on standard UHF TV.
- Can replace monitor Rom to test and develop programs.
- Ideal training aid.
- Two 8-bit I/O ports.
- Fast cassette interface.
- On-board Eprom programmer.
- Copies software.
- Simple modification for single rail.

Price: Kit.....£ 99.00 + VAT
 Ready built.....£120.00 + VAT
 PSU.....£ 20.00 + VAT
 P & P.....£ 1.50 + VAT

FREE 2716 with each Softy

STAKPAK

Unique filing system comprising stackable drawers, each containing 2 digital quality C12 cassettes. Complete with index cards & blank labels.



5 Stakpaks (10 cassettes)
£5.50 P&P 75p + VAT

SUPERPRINT 800



This rugged and reliable printer offers more features and flexibility than competitive units but at a new Special Offer price

£299

P & P £4.50 + VAT

500 Sheets of paper FREE!

- 64, 72, 80, 96, 120, or 132 characters/line.
- RS-232, 20ma, 1EEE-488 and Centronics
- Self-test switch.
- I/O fitted as standard.
- 16 baud rates to 19,200.
- Tractor and Friction Feed
- 60 lines per minute.
- Multiple character sets facility.

VIDEO GENIE

A complete Computer System

- 16K User Ram
- 12 K Microsoft Basic in Rom.
- 64 x 16 line Display
- 128 x 48 dot graphics resolution.
- Software compatible with TRS80 level II.
- Built in Cassette Recorder.
- Output and Control for Second Cassette.
- Full expansion via Expansion box to Disc-Printer



£290

P & P £5 + VAT

A Z80 based computer system with Full Keyboard and built in Cassette recorder plus outputs for Monitor and/or TV Parallel Printer Interface £35 + VAT

ACCESSORIES

TEX Eprom Eraser	£33
6Mhz Modulators	£2.80
8Mhz Modulators	£4.50
Cassette Recorders	£13.95
8" Fan-Fold Paper 500 sheets	£5.95
9 1/2" Fan-Fold Paper 500 sheets	£5.95
TVM 10 Monitor, 9" B&W	£95
HEX PAD	£3.50
ASCII Keyboard 756	£40
CEGMON any version	£29.50
Space Invaders 8K	£4.60
BASF Floppy Discs - each	£2.85

33/35 CARDIFF ROAD,
WATFORD, HERTS. Telephone 40588

TTL 74 (TEXAS) Series		74LS Series		LS173 Series		74S Series
7400 11	74123 65	LS00 13		LS174 110		74S04 73
7401 11	74125 50	LS01 13		LS175 110		74S132 138
7402 11	74126 45	LS02 15		LS181 295		74S138 240
7403 14	74132 55	LS03 15		LS183 295		74S158 240
7404 14	74136 55	LS04 16		LS189 128		74S198 210
7405 18	74141 75	LS05 23		LS190 95		74S189 158
7406 36	74142 185	LS08 22		LS191 95		74S194 360
7407 36	74143 250	LS10 20		LS192 95		74S241 540
7408 17	74144 250	LS11 32		LS193 99		74S262 850
7409 20	74145 90	LS12 32		LS194 125		74S287 325
7410 17	74147 150	LS14 60		LS195 130		74S470 325
7411 25	74148 125	LS15 40		LS196 120		74S472 1150
7412 20	74150 130	LS20 21		LS197 85		74S475 825
7413 32	74151 70	LS21 32		LS200 345		
7414 38	74153 70	LS22 32		LS202 345		
7416 30	74154 120	LS23 35		LS221 120		
7417 30	74155 75	LS24 44		LS240 165		
7420 19	74156 75	LS27 35		LS241 165		
7421 38	74157 70	LS28 35		LS242 165		
7422 25	74159 165	LS32 25		LS243 165		
7423 28	74160 99	LS33 35		LS244 195		
7425 58	74161 99	LS37 30		LS247 135		
7426 43	74162 99	LS38 35		LS248 135		
7427 32	74163 99	LS42 66		LS249 135		
7428 35	74164 120	LS47 85		LS251 130		
7430 19	74165 120	LS48 105		LS253 95		
7432 27	74166 130	LS49 105		LS257 95		
7433 36	74167 205	LS54 30		LS258 120		
7437 35	74170 205	LS55 30		LS259 160		
7438 32	74172 375	LS56 30		LS261 450		
7440 20	74173 110	LS57 45		LS266 75		
7441 68	74174 100	LS58 45		LS273 180		
7442 58	74175 82	LS59 125		LS275 320		
7443 120	74176 80	LS63 60		LS277 35		
7444 116	74177 85	LS68 38		LS279 88		
7445 105	74178 110	LS76 45		LS280 250		
7446 75	74179 150	LS82 75		LS283 90		
7447 72	74180 90	LS86 38		LS289 420		
7448 75	74181 280	LS90 50		LS291 215		
7450 20	74182 85	LS91 125		LS292 215		
7451 20	74184 130	LS92 75		LS293 130		
7452 20	74185 130	LS93 60		LS295 215		
7454 20	74188 310	LS95 115		LS298 215		
7460 20	74190 130	LS96 120		LS299 420		
7470 40	74191 120	LS107 45		LS300 175		
7472 38	74192 120	LS109 75		LS302 175		
7473 35	74193 120	LS112 40		LS323 270		
7474 34	74194 102	LS113 75		LS324 200		
7475 56	74195 75	LS114 40		LS325 200		
7476 40	74196 99	LS122 70		LS326 200		
7480 52	74197 88	LS124 180		LS327 315		
7481 120	74198 160	LS125 45		LS346 185		
7482 75	74199 160	LS126 45		LS347 150		
7483 90	74201 150	LS127 75		LS348 190		
7484 99	74202 150	LS132 60		LS352 185		
7485 105	74203 150	LS133 60		LS353 185		
7486 33	74204 185	LS136 55		LS365 65		
7489 205	74209 189	LS138 70		LS366 65		
7490 42	74251 110	LS139 70		LS367 65		
7491 84	74265 66	LS145 120		LS368 90		
7492 50	74273 267	LS147 210		LS373 150		
7493 57	74278 249	LS151 90		LS374 150		
7494 85	74279 99	LS153 85		LS375 150		
7495 70	74283 149	LS155 75		LS377 199		
7496 80	74284 350	LS156 85		LS378 140		
7497 170	74285 350	LS157 70		LS379 215		
74100 130	74290 107	LS158 70		LS384 250		
74104 62	74293 135	LS160 90		LS385 420		
74105 62	74297 185	LS161 98		LS386 85		
74107 34	74298 165	LS162 110		LS390 140		
74109 60	74365 95	LS163 95		LS393 140		
74110 54	74366 95	LS164 115		LS395 210		
74111 68	74367 95	LS165 145		LS396 199		
74112 170	74368 95	LS166 175		LS398 275		
74116 170	74390 185	LS168 210		LS399 230		
74118 85	74393 185	LS169 210		LS445 140		
74119 120	74490 185	LS170 288		LS447 195		
74120 75				LS490 245		
74121 35				LS498 105		
74122 50				LS569 105		
				LS670 270		
				LS673 750		
				LS674 850		

The above is just a selection of our vast stocks of brand new, full spec, electronic components.
To Order: Please add 15% VAT to all orders unless stated. On orders of less than £10 add 40p P&P.
Terms of Business: Cash/Cheque/P.O.'s or Bankers Draft with order.
Access Orders: Minimum £10 please.
JUST PHONE IN YOUR ORDER WE DO THE REST.



• Circle No. 386

INFRA COMPUTER COMPONENTS LIMITED

PENDORRICK HOUSE, 7 WESTFIELD ROAD,
GREAT SHELFORD; CAMBRIDGE CB2 5JW.

Telephone: (0223) 841728/843953.
Ring between 9.30 am 12 or 1 to 6.00

EPROMS		MEMORIES	
1702A.....	£4.50p	2114 450 ns.....	£1.90p
2708K.....	£3.60p	2114 200 ns.....	£2.65p
2716K (+5v) 450 ns.....	£4.80p	4116 200 ns.....	£2.25p
2716-1 350 ns.....	£6.50p	4116 150 ns.....	£3.65p
253K.....	£13.50	2114 450 ns 100 off.....	£1.60p
2732 (Intl).....	£15.50	2114 200 ns 100 off.....	£1.75p

Z80 CPU 2.4MHz.....	£7.00 each	6845.....	£10.00 each
ZX80 ACPU 4MHz.....	£7.50 each	6809.....	£12.50 each
MC6847.....	£10.50 each	6802.....	£7.50 each
		6502.....	£5.50 each

LS SERIES PRICES SLASHED CHEAPEST IN THE BRITISH ISLES SOME AT A GLANCE

LS 245	£1.70p each	LS 242	£1.20p each
LS 240	£1.40p each	LS 241	£1.20p each
LS 244	£1.15p each	LS 157	50p each

WE WELCOME INQUIRIES FOR BULK PURCHASES
Please add 50p. for postage/packing, and 15% Vat.

• Circle No. 387

SPECIAL OFFER
SAVE UP TO £300

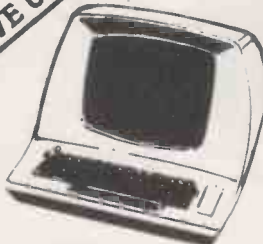

Data Efficiency Ltd is currently offering the popular and reliable Lear Siegler ADM-3A and ADM-31 VDU's at amazingly low prices.

The ADM-3A features 1920 easy to read characters, complete cursor control, a wide range of speed and word formats and dual interface. Price £395 (R.R.P. £545).

The ADM-31 offers two page display, full editing features, upper and lower case characters, dual intensity and printer port. Price £495 (R.R.P. £795).

All prices quoted are exclusive of V.A.T. but inclusive of a three month warranty by Systems Reliability Ltd. Delivery is ex-stock and free within the U.K.

To take advantage of this special offer or for further details please ring Hugh Chappell.

DE DATA EFFICIENCY LTD
Maxted Road,
Maylands Avenue,
Hemel Hempstead, Herts.
Tel: (0442) 63561
Telex 825554 DATEFF G

• Circle No. 388

£1150
+ VAT

VISUAL 100



The VISUAL 100 is a new microprocessor based video display terminal that offers total compatibility with the DEC VT100* from both a software and operator point of view.

For the operator, the detached solid-state keyboard has been customized so that all key positions and LED indicators are in identical location to that of the VT100.

For the software, all codes and features have been implemented in a manner identical to the VT100 assuring plug-to-plug compatibility. The big difference between the VISUAL 100 and the DEC VT100 is that the VISUAL 100 offers features not available on the VT100, or available only as extra-cost options. These added features include:

- ETCHED NON-GLARE FACEPLATE
Your operator will appreciate viewing characters through an etched non-glare faceplate. This feature assures crisp, sharp character resolution even in the brightest office environ-

ments. Further, the tilt screen feature allows an adjustable viewing angle, 10° to 15°, for optimal viewing comfort.

- ADVANCED VIDEO PACKAGE IS STANDARD
Blink, bold, reverse video, and underline video attributes which can be used alone or in any combination for enhanced video presentations
- CURRENT LOOP INTERFACE IS STANDARD
A 20mA current loop interface as well as an EIA RS232C interface.
- BUFFERED PRINTER INTERFACE OPTION
This option allows independent print/communication baud rates and independent parity. The printer option also allows the VISUAL 100 to function as a controller between host and printer, using "XON XOFF" protocol. Printer busy can also be monitored using XON XOFF, or control line.

Seeing is believing, so see for yourself. For a demonstration and a pleasant surprise on quantity pricing of the VISUAL 100, call or write us today.

£675
+ VAT

VISUAL 200



The VISUAL 200 is a new, low cost, microprocessor based video display terminal which truly stands above competitive teletype compatible terminals in its price range.

In addition to the most popular features available (or partially available) on competitive terminals, such as numeric pad, upper/lower case, editing, current loop, cursor addressing, columnar and field tab, etc., standard features which set the VISUAL 200 apart and reach the optimum in human engineering and operator comfort include:

- Detachable Keyboard
- Smooth Scroll
- Tilt Screen (10° to 15° viewing angle)
- Large 7 x 9 Dot Matrix Characters

Perhaps the most distinctive feature of the VISUAL 200 is the Switchable Emulation capability. A switch on the rear panel programs the terminal for code-for-code emulation of a Hazeltine 1500, ADDS 520, Lear Siegler ADM-3A or DEC VT-52. To an O.E.M. customer it means no change in software to displace the older, less powerful terminals in his product line with the new, reliable and low cost VISUAL 200. To a Distributor it means offering a single modern terminal which is compatible with all the software his customers have written for the older terminals. And you're not limited to merely emulating these older terminals; you can outperform them at the same time by taking advantage of the additional features of the VISUAL 200.

Reliability designed into the VISUAL 200 is evidenced by its solid state keyboard, single P.C. Board and self test diagnostics on power up.

Seeing is believing, so see for yourself. For a demonstration and a pleasant surprise on quantity pricing of the powerful, easy to use and reliable VISUAL 200, call or write us today.

Standard Features

- 24 x 80 Screen Format
- 7 x 9 Dot Matrix
- Upper/Lower Case
- Numeric Pad
- Background/Foreground
- Blink Line
- Insert/Delete Line & Character
- Columnar and Field Tab
- Set/Clear Tab
- Security Mode (non-display)
- Clear End Line, Field & Page
- Clear Line
- Clear Screen
- Line Drawing
- Current Loop or RS-232 Interface
- Secondary Channel
- Composite Video
- Serial Copy Port
- Hold Screen
- Baud Rates to 19,200
- Self Test
- Cursor Addressing
- Cursor Control Keys
- Read Cursor Address
- Typamatic Keys
- Smooth Scroll
- Microprocessor
- Detachable Keyboard
- Solid State Keyboard
- Read Terminal Status
- Tilt Screen
- Switchable Emulations

THE FIRST MICROCOMPUTER WHOLESALER

Σ Sigma
(UK)

We offer products from many manufacturers including:

Altos
Centronics
Century Data
Control Data
Datasouth
Dyna Byte
Hazeltine
Impact Data

Industrial Micro
Integral Data
Intertec
Konan
M, S, & C.
Malibu
Micro Peripherals
N.E.C.

North Star
Onyx
PerSci
Qume
Soroc
Televideo
Texas Instruments
Visual Technology

SIGMA (U.K.)
6, THE JAYS;
BURGESS HILL,
SUSSEX.

CATREI COMPUTERS
John F. Kennedy Avenue,
Dublin 12,
Ireland.

Telephone: 04446-44159

Telephone: Dublin 509714

DATASOUTH DS180 HIGH SPEED MATRIX PRINTER

£1490
+ VAT

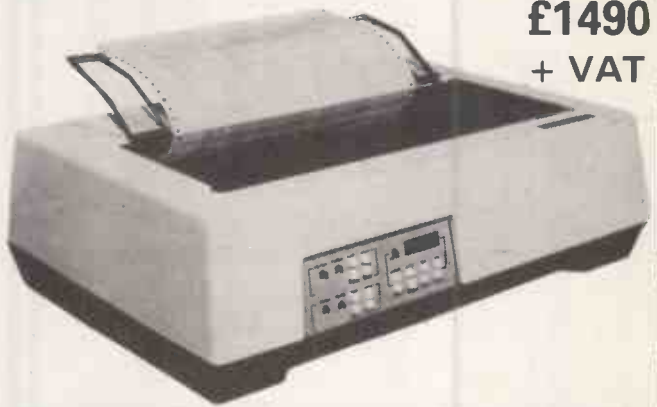

The Datasouth DS180 is a dot-matrix serial impact printer designed for high performance at an economical price. Application flexibility and a long list of standard features make the DS180 an ideal device for small business systems, distributed communications networks and intelligent terminals.

HIGH SPEED PRINTING

Utilizing 180 cps optimized bidirectional printing, the DS180 offers higher throughput than any printer in its class. Its 9-wire printhead produces highly legible 9x7 characters with descenders for lower case letters and true underlining. All 96 ASCII characters may be printed across a 132 column line at 10 characters per inch. Expanded characters (5 cpi) may be selected for highlighting portions of the text.

USER PROGRAMMABLE

The DS180 offers a large number of user programmable features, yet is easy to operate. A unique programming keypad with a non-volatile memory makes printer set-up quick and simple. Top of form, horizontal and vertical tabs, perforation skip-over and auto line feed are just a few of the features the user may select. Communications status may also be programmed and monitored using the indicator panel lights and LED display.

ATTRACTIVE DESIGN

Compact, desk-top packaging allows the DS180 to fit into almost any installation. Its noise dampening cover makes it suitable for use in a quiet office environment. The cartridge ribbon makes routine changes clean, fast and convenient.

MICROPROCESSOR ELECTRONICS

Through the use of state-of-the-art microprocessor electronics, reliability and maintainability have been greatly improved. The simple modular design of the DS180 provides easy access to all major components. A single printed circuit board contains both

the power supply electronics and digital controller for the printer. A self-test feature and diagnostic display panel help the user verify proper operation of the unit and isolate problems should they occur.

COMMUNICATIONS

Interfaces on the DS180 include RS232 and 20mA current loop serial interfaces, and a Centronics compatible parallel interface. Baud rates from 110-9600 and parity selection may be keyed in by the user for his specific application.

FORMS HANDLING

Adjustable tractor accommodates forms from 3-15 inches wide. A head-to-platen gap adjustment ensures optimum print quality on up to 6-part forms. Fanfold paper may be fed from the front or bottom of the DS180. A paper out sensor may be programmed to send a stop transmission character and sound an audible alarm.

QUALITY MANUFACTURING

Reliable performance is ensured by a stringent quality control program. Datasouth uses preselected, high reliability parts from leading manufacturers. Multiple tests are performed on sub-assemblies during each stage of production, with each completed unit undergoing a final 24 hour print test and burn-in. The DS180 carries a 90 day warranty on materials and workmanship.

• Circle No. 389

OUTSTANDING HARDWARE AND SOFTWARE

FROM Computerpower

Fast, multi-user 16-bit S-100 systems
 M9900 CPU (includes complete disc operating & file system, & word processing software) **£400**
 64K RAM, fast 16-bit memory **£600**
 PROM/RAM monitor & r.t. clock **£200**
 QUAD I/O 4 RS232 ports **£200**
 FDCII 2S/2D disc controller **£225**
 . Complete system as above, plus Paper Tiger printer, TVI920C vdu, 2MB 8" floppy disks, multi-user Unix-like operating system, word processor & database management system **£4980**
 Hard disk system, as above plus 31MB Winchester disk, 15" vdu, NEC Spinwriter **£9980**

High-quality software for CP/M & M9900

DATEBOOK office appointments program for professional offices

£145(20)

PROFESSIONAL TIME ACCOUNTING

£300(25)

APPLICATIONS DEVELOPMENT

UTILITIES shortcut to reliable CBASIC programs with screen & print formatter, file creation, indexing, etc **£275(25)**

PL/1 powerful mainframe language, now for 8080s and Z80s **£275(30)**

MICRO B + ultra-fast keyed file access, searches 10,000 key values in under one second **£120**

VAT MUST BE ADDED TO ALL PRICES EXCEPT FOR SOFTWARE MANUALS (IN BRACKETS).

Ring or write for more details, or a complete list of hardware and software

Computerpower 47 Red Lion Street, London, WC1R 4PF Tel: 01-405 7780

• Circle No. 390

Advertisement Index

A							
Adda	169	DRG Business Machines	153	Lionhouse Micros	45	Printout	37
Adler	197	E		Liveport	52	Program Power	89
Acorn Computers	36	Esasicomp	208	L & J Computer Centre	18, 158	Purley Computing	32
Aculab	184	Edward Arnold	180	London Computer Fair	179	Q	
AF Business Machines	21	Electronic Brokers	184	Lowe Electronics	155	Q Tek	89
AJD Direct Supplies	180	Elektor	38	LP Enterprises	8, 9	R	
AJ Harding (Molimerx)	148	EMG	147	M		Rair	53
Almarc	21, 23, 185	Equinox	93	Merchant Systems		Research Resources	199
Anadex	98, 99	Europhonics	165	Micro 80	28	Resolux	188
Anglia Consultants	196	F		Micro Business Centre	174	Rohan	178
Anpac	177	Feldon Audio	170	Micro Age	38	Russett	92
A-Z Computer Systems	150	Force 10	157	Bicro Byte	151	S	
B		G		Micro Computer	33	Science of Cambridge	72, 73
Beaver Systems	150	Gate	206	Micro Data	30, 54	Scope	194
Bits and PC's	156	GP Industrial Electronics	207	Micro Digital	164	Sharp Electronics	25
Business Computer Services	74	Graffcom	161	Micro Faculties	14, 26, 199	Sheffield Micros	187
Business & Leisure Micros	34	Gramma Winter	10, 11	Micro General	20	Shelton	75
Buss Stop	196	Guestel	216	Micrope	199	Sigma UK	220
Butel Comco	156, 186	H		Microperipherals	126	Sirtron Computers	167
C		Hal Computers	43	Micro Solution	39	Small Systems	188
Calco	152	Hayes Kennedy	194	Micro Solve	201	SMI S	154
Calisto	13	Helistar Systems	155	Micro Style	196	Spider Software	168
Cambridge Computer Store	86, 194	Hewart Micro Electronics	155	Microrotek	170	Stack	209
Camden Electronics	159, 212	Hewlett Packard	31	Micro Trend	162	STCS	160
Castle Electronics	34	Hi-Tech	162, 191	Midas	175	Stage One	221
Chromasonic	163	I		Millbank	24	Sumlock Bondaw	35
Clearstone	205	Icarus	48	MMS	159	Sun Computing Services	125
Comanac	192	Independant Computer Engineers	176	N	30	Supersoft	206
Comart	5, 124	Imac	23	Nascom	173	Supervision	192
Commodore	3	Infra	219	Newbear	172	Swan	107, 147
Compshop	222, 223	Intelligent Artifacts	182	Newtronics	96	Systematics International	65
Computech	181	Interactive Data Systems	123	NIC	180	Systemics	21
Computerama	200	Interface Components	12	North Amber	27	T	
Computer Bits	183	Intex Datalog	187	Northern Software	29	Tangerine	16
Computer Sales	26	Ithaca Intersystems	224	O		Telesystems	190
Computer Supermarket	171	K		Ohlo Scientific	193	Technomatic	22
Control Dataset	164	Kansas City Systems	174	Online	110	Terminal Display	176
Control Universal	208	Karadawn	211	Office Computer Techniques	19	Tex Micro Systems	205
Creative Computing	17	Keating Computing	28	Oxford Computer Centre	26	Tim Orr Design	36
Crofton	150	Kemtron	166	Oxford Computer System	217	Transam	195, 203
Crysal	190, 208	Keytronic	182	P		Triac Systems	24
Cumana	213	KGB	204	Paxton Computers	36	Trial	154
Currah Computer Components	160	Knights TV	151	Peripheral Hardware	168	Tridata Micros	217
D		Kram	32	Personal Computers	153	V	
Data Efficiency	219	L		Pete & Pam Computers	51	Vlasak	71
Datalink	189, 210	Landsler	147	Pets	154	Visconti	158
Data Plus	190	Lifeboat Associates	6, 7	Petalact	188	V&T Electronics	202
David Richards	186	Linsac	152	Petsoft	79	W	
Davinci	38			Professional Data Systems	198	Watford	218, 219
Datron Micro Centre	202			Prentice Hall	205	Wego	192
3D Digital Design	166					Westfarthing	159
DDP	172					Wilkes	215
Digitus	40					Willis	197
DN Computer Services	164					X	
Dragon Systems	196					Xitan	212

EXTENDED GUARANTEE BY COMPUKASE

THE NEW ANADEX DP9500 and DP9501

A PROFESSIONAL PRINTER



- Bi-directional printing
- Up to 220 chars/line with 4 print densities
- 500 char buffer
- RS232C and Centronics Parallel interface built in
- Full software control of matrix needles allowing graphics capability
- 200 chars/sec ● Adjustable width tractor feed.

DP9500 — ONLY £795 + VAT
DP9501 — ONLY £845 + VAT

RRP £540

only **£399** + VAT

ANADEX DP8000

Super Quality — Low cost printer. Tractor Feed with full 96 ASCII character set. Accepts RS232C at band rates between 100 and 9600 and Parallel Bit data. Attaches either directly or through interfaces to Pet, Apple, TRS80, Sorcerer, Nascom, CompuKit etc.

EXTENDED GUARANTEE BY COMPUKASE

INTRODUCING

THE NEW & EXCITING TRS80 MODEL III



EXTENDED GUARANTEE BY COMPUKASE

16K £559 + VAT 32K £589 + VAT 48K £619 + VAT

THE ATARI VIDEO COMPUTER GAMES SYSTEM

Atari's Video Computer System now offers more than 1300 different game variations and options in twenty Game Program™ cartridges!

Most Cartridges only £13.90 + VAT

Prices may vary with special editions Basic Maths, Airsea Battle, Black Jack, Breakout, Surround, Spacemar, Video Olympics, Outlaw, Basketball, Hunt & Score*, Space War, Sky Diver, Air Sea Battle, Codebreaker*, Miniature Golf.

Extra Paddle Controllers — £14.90 + VAT *Keyboard Controllers — £16.90 + VAT

SPACE INVADERS NOW IN STOCK £25

£83.00 + VAT

EXTENDED GUARANTEE BY COMPUKASE

WE ARE NOW STOCKING THE AUTOSTART APPLE II AT REDUCED PRICES

16K £549 + VAT
32K £579 + VAT
48K £599 + VAT

EXTENDED GUARANTEE BY COMPUKASE

Getting Started APPLE II is faster, smaller, and more powerful than its predecessors. And it's more fun to use too because of built-in features like:

- BASIC — The Language that Makes Programming Fun.
- High-Resolution Graphics (in a 54,000-Point Array) for Finely-Detailed Displays.
- Sound Capability that Brings Programs to Life.
- Hand Controls for Games and Other Human-Input Applications.
- Internal Memory Capacity of 48K Bytes of RAM, 12K Bytes of ROM; for Big-System Performance in a Small Package.
- Eight Accessory Expansion Slots to let the System Grow With Your Needs.

You don't need to be an expert to enjoy APPLE II. It is a complete, ready-to-run computer. Just connect it to a video display and start using programs (or writing your own) the first day. You'll find that its tutorial manuals help you make it your own personal problem solver.

The Radio Shack TRS-80™ Model III is a ROM-based computer system consisting of:

- A 12-inch screen to display results and other information
- A 65-key console keyboard for inputting programs and data to the Computer
- A Z-80 Microprocessor, the "brains" of the system
- A Real-Time Clock
- Read Only Memory (ROM) containing the Model III BASIC Language (fully compatible with most Model I BASIC programs)
- Random Access Memory (RAM) for storage of programs and data while the Computer is on (amount is expandable from "16K" to "48K", optional extra)
- A Cassette Interface for long-term storage of programs and data (requires a separate cassette recorder, optional/extra)
- A Printer Interface for hard-copy output of programs and data (requires a separate line printer, optional/extra)
- Expansion area for upgrading to a disk-based system (optional/extra)
- Expansion area for an RS-232-C serial communications interface (optional/extra)

All these components are contained in a single moulded case, and all are powered via one power cord.

HITACHI PROFESSIONAL MONITORS

9" — £129 £99.95
12" — £199 £149

- Reliability Solid state circuitry using an IC and silicon transistors ensures high reliability.
- 500 lines horizontal resolution Horizontal resolution in excess of 500 lines is achieved in picture center.
- Stable picture Even played back pictures of VTR can be displayed without jittering.
- Looping video input Video input can be looped through with built-in termination switch.
- External sync operation (available as option for U and C types)
- Compact construction Two monitors are mountable side by side in a standard 19-inch rack.

EXTENDED GUARANTEE BY COMPUKASE

APPLE DISC II 3.3 Dos

Disc with Controller **£349** + VAT

Additional Drives **£299** + VAT

- Powerful Disk Operating Software Supports up to 6 drives
- Name Access to Files for Ease of Use
- BASIC Program Chaining to Link Software Together
- Random or Sequential File Access to Simplify Programming
- Dynamic Disk Space Allocation for Efficient Storage
- Individual File Write-Protection Eliminates Accidental File Alterations
- Loads an 8K Byte Binary Image in 6.5 sec. (1.2 sec. in Pascal)
- Storage Capacity of 116 Kilobytes (143K Bytes with Pascal) on Standard 5 1/4" Diskettes
- Powered Directly From the APPLE (Up to 6 Drives) for Convenience and High Reliability
- Packaged in Heavy-Duty, Colour-Coordinated Steel Cabinet

EXTENDED GUARANTEE BY COMPUKASE

SPECIAL OFFER FOR MODEL III PURCHASERS

We will take keyboards only for TRS80 Model I and Level II in part exchange.

There will be refurbished Model I and Level II keyboards available later in the year — Phone for availability and price.

only **£295** + VAT

Expand your TRS80 by 32K

TRS80 EXPANSION INTERFACE

32K Memory on board. Centronics parallel port. Disk controller card. Real time clock. Requires Level II Basic. Interface for 2 cassette decks. complete with power supply.

EXTENDED GUARANTEE BY COMPUKASE



LOW COST TELEPHONE ANSWERING MACHINE

only **£99.95** + VAT

Microprocessor controlled answering machine. Plug into your phone line. Records any phone call messages. Remote bleeper enables you to listen to your messages from anywhere in the world. Uses standard cassettes. Comes complete with mains adaptor, microphone, remote bleeper, base unit, cassette with 30 sample pre-recorded messages.

EXTENDED GUARANTEE BY COMPUKASE

NEC SPINWRITER

only **£1350** + VAT

NEC's high quality printer uses a print "thimble" that has less diameter and inertia than a daisy wheel, giving a quieter, faster, more reliable printer that can cope with plotting and printing (128 ASCII characters) with up to five copies, friction or tractor fed. The ribbon and thimble can be changed in seconds. 55 characters per second bidirectional printing — with red/black, bold, subscript, superscript, proportional spacing, tabbing, and much, much more.

EXTENDED GUARANTEE BY COMPUKASE

EXTENDED GUARANTEE BY COMPUKASE

We give a full one year's guarantee on all our products, which normally only carry 3 months guarantee.

We have one of the largest collections of Computer Books under one roof, along with racks of software for the PET and TRS80. **Come and see for yourself.**

COMP PRO MIXER

Professional audio mixer that you can build yourself and save over £100.

Only **£99.90** plus VAT for complete kit. Plus FREE power supply valued at £25.00

ACCESSIT AUDIO ADD-ONS



TEAC DISK DRIVES

EXTENDED GUARANTEE BY COMPUKASE

- TEAC FD-50A has 40 tracks giving 125K Bytes unformatted single density capacity.
- The FD-50A can be used in double density recording mode.
- The FD-50A is Shugart SA400 interface compatible.
- Directly compatible with Tandy TRS80 expansion interface.
- Also interfaces with Video Genie, SWTP, Heathkit, North Star Horizon, Superbrain, Nascom, etc., etc.
- Address selection for Daisy chaining up to 4 Disks.
- Disks plus power supply housed in an attractive grey case.

40 TRACK	
Single Disk Drive £225 + VAT	Double Disk Drive £389 + VAT
77 TRACK	
Single Disk Drive £299 + VAT	Double Disk Drive £499 + VAT

THE VIDEO GENIE SYSTEM

Ideal for small businesses, schools, colleges, homes, etc. Suitable for the experienced, inexperienced, hobbyist, teacher, etc.

EG3000 Series

WITH NEW EXTRA KEYS!

16K **£279** + VAT

- 16K user RAM plus extended 12K Microsoft BASIC in ROM
- Fully TRS-80 Level II software compatible
- Huge range of software already available
- Self contained, PSU, UHF modulator, and cassette
- Simply plugs into video monitor or UHF TV
- Full expansion to disks and printer
- Absolutely complete — just fit into mains plug.

The Video Genie is a complete computer system, requiring only connection to a domestic 625 line TV set to be fully operational; or if required a video monitor can be connected to provide the best quality display. 51 key typewriter style keyboard, which features a 10 key rollover. Supplied with the following accessories: ● BASIC demonstration tape; ● Video lead; ● Second cassette lead; ● Users manual; ● BASIC manual; ● Beginners programming manual. Write useful programs in the BASIC computer language yourself.

EXTENDED GUARANTEE BY COMPUKASE

NEW

VIDEO GENIE EXPANSION BOX

Complete with RS232 interface and floppy disc controller. 0 memory. **£225** + VAT.

Memory expansion card (S100) 16K £110 32K £159 + VAT
Further S100 cards available later in the year.

EXTENDED GUARANTEE BY COMPUKASE

NOBODY CAN GET NEAR OUR PRICES EXCEPT OUR CUSTOMERS

NASCOM 2 DISC DRIVES

Add a powerful, double density, mini floppy disc to your Nascom system.

- Disc Controller Card (includes Nasbus 6 S100 interface)
- Will control 4 Drives.
- CPM operating system.
- Extended Disc Basic Compiler.
- Power supply included

One Disc System — £499 + VAT
Additional Disc Unit — £299 + VAT



NASCOM 2 GAMES TAPE

featuring Space Invaders and Android Nim. Re-numbering program and other goodies!

£7.50 + VAT

NEW REDUCED PRICES

8K **£399**
16K **£449**
32K **£499**

RPR £795 for 32K



The PEDIGREE PETS

Very popular for home & business use. 8K Microsoft Basic in ROM. 8K Pet 32K & 16K with new improved keyboard. All with green screen.

Cassette Deck **£55 extra** Full range of software available.

Interface PET IEEE — Centronics Parallel
Decoded **£77.00 + VAT**

SPECIAL SCOOP

GET YOURSELF A NEW MX80 PRINTER AND SAVE A FORTUNE

only **£299 + VAT**

Interface Cards for Apple, Pet, TRS80, Nascom and CompuKit — RS232 Interface Cards not necessary for parallel. **£49 + VAT**

Full TRS80/Genie Graphics including cables. Ready to go. **EX-STOCK.**



COMP POCKET COMPUTER GREATEST BREAKTHROUGH YET

£79.90 + VAT

COMPUTER POWER THAT ONCE FILLED A ROOM CAN NOW BE CARRIED IN YOUR POCKET!

- Programs in BASIC • "QWERTY" Alphabetic Keyboard • 1.9K Random Access Memory
- Long Battery Life.

Computer power that once filled a room can now be carried in your pocket! It's easy to load with ready-to-run software from cassette tape (interface and recorder optional) or program it yourself in easy-to-learn BASIC. 24-character liquid crystal readout displays one line at a time. Special feature is advanced non-volatile memory allows you to power on and off without losing the contents of memory. Note: Memory must be transferred to tape before changing batteries. Automatic statement compaction squeezes every ounce of memory space. Features power-off retention of programs and data. Powerful resident BASIC language includes multiple statements, math functions, editing, strings, arrays and much more. Multiple program loading capability subject to RAM availability. Carrying case and batteries included.



EUROPE'S FASTEST SELLING ONE BOARD COMPUTER.

COMPUKIT UK101

★ 6502 based system — best value for money on the market. ★ Powerful 8K Basic — Fastest around ★ Full Qwerty Keyboard ★ 4K RAM Expandable to 8K on board. ★ Power supply and RF Modulator on board. ★ No Extras needed — Plug-in and go ★ Kansas City Tape Interface on board. ★ Free Sampler Tape including powerful Disassembler and Monitor with each Kit. ★ If you want to learn about Micros, but didn't know which machine to buy then this is the machine for you.

DEALER ENQUIRIES INVITED

Fully assembled **£199.00**

NEW EXTENDED MONITOR IN EPROM — available separately at **£22 + VAT**

Improved BASIC function — revised GARBAGE routine. Allows correct use of STRING ARRAYS. This chip can be sold separately to existing CompuKit and Superboard users.

Build, Understand and Program your own Computer for only a small outlay

KIT ONLY £149 + VAT NO EXTRAS NEEDED

FOR THE COMPUKIT — Assembler Editor **£14.90** Screen Editor Tape **£1.90**
GAME PACKS — 1). Four Games **£5.00** 2). Four Games **£5.00** 3). Three Games 8K only **£5.00**
Super Space Invaders (8K) **£6.50** Space Invaders **£5.00** Chequers **£3.00** Realtime Clock **£3.00**
Case for CompuKit **£29.50** 40 pin Expansion Jumper Cable **£8.50** All Prices exclusive VAT

NEW TV GAME BREAK OUT

Has got to be one of the world's greatest TV games. You really get hooked. As featured in ETI. Has also 4 other pinball games and lots of options. Good kit for up-grading old amusement games.

MINI KIT — PCB, sound & vision modulator, memory chip and de-code chip. Very simple to construct. **£14.90 + VAT**
OR PCB **£2.90** MAIN LSI **£8.50** Both plus VAT



A SELECTION OF APPLE INTERFACES ARE NOW AVAILABLE AT OUR NEW SHOWROOM.

SALE MEMORY UPGRADES

16K (8 x 4116) **£15.90 + VAT**
4K CompuKit (8 x 2114) **£15.90 + VAT**

WHETHER OR NOT YOU PURCHASE YOUR PRODUCTS FROM US OR NOT - OUR STAFF OF HIGHLY TRAINED ENGINEERS WILL BE ONLY TOO PLEASED TO CARRY OUT ANY REPAIRS NECESSARY

NOW OPEN OUR SHOWROOM & SALES CENTRE AT
311 Edgware Road, London W2

8MHz Super Quality Modulators	£4.90
6MHz Standard Modulators	£2.90
C12 Computer Grade Cassettes	10 for £4.00
Anadex Printer Paper — 2000 sheets	£25.00
Floppy Discs 5 1/4" Hard and Soft Sector	£3.50
Floppy Disc Library Case 5 1/4"	£3.50
Verocases for Nascom 1 & 2 etc.	£24.90

SPECIAL OFFER

We will part exchange your Sinclair ZX80 for any of our products.

Refurbished ZX80's } fully } **£69.90 + VAT**
Refurbished MicroAces } guaranteed }

(Supply dependant upon stocks).



ENGLISH COLOUR TV / AMERICAN NTSC COLOUR MONITOR

Suitable for Apple, Atari and Texas 99/4 **£295 + VAT**

FANTASTIC FOR FILE HANDLING ACULAB FLOPPY TAPE

The tape that behaves like a disc, for TRS-80 LEVEL 2. **£169 + VAT**

The Aculab Floppy Tape for the TRS-80 and Video Genie is a highly reliable digital storage system that provides many of the advantages of floppy disks at less cost. Automatic debounce routine for the Level 2 keyboard. Connects directly to TRS-80 Level 2 Keyboard. Operating and file handling software in ROM. 8 commands add 12 powerful functions to Level 2 BASIC.



COOP SHOP

"Europe's Largest Discount Personal Computer Stores"

Delivery is added at cost. Please make cheques and postal orders payable to **COMP SHOP LTD.**, or phone your order quoting **BARCLAYCARD, ACCESS, DINERS CLUB** or **AMERICAN EXPRESS** number.

CREDIT FACILITIES ARRANGED — send S.A.E. for application form.

MAIL ORDER AND SHOP:
14B Station Road, New Barnet, Hertfordshire, EN5 1QW (Close to New Barnet BR Station — Moorgate Line).
Telephone: 01-441 2922 (Sales) 01-449 6596 Telex: 298755 TELCOM G
OPEN (BARNET) — 10am - 7pm — Monday to Saturday

NEW WEST END SHOWROOM:
311 Edgware Road, London W2. Telephone: 01-262 0387
OPEN (LONDON) — 10am - 6pm — Monday to Saturday

- ★ IRELAND: 80 Marlborough Street, Dublin 1. Telephone: Dublin 749933
- ★ COMP SHOP USA, 1348 East Edinger, Santa Ana, California, Zip Code 92705. Telephone: 0101 714 6472526

TELEPHONE SALES OPEN 24 hrs. 7 days a week 01-441 2922

BARCLAYCARD VISA AMERICAN EXPRESS DINERS CLUB INTERNATIONAL Western Union



Outside of the garden you need a computer that can grow.

For the common or garden hobbyist, a high quality personal computer is a real temptation. But let's face it: in the world of business, engineering and scientific applications, you need a system that has been designed from the ground up to allow flexibility and expansion.

Providing flexibility and expandability today allows the micro to move up to and beyond the level of yesterdays mini. Hard disks for big system memory; more peripherals for big system flexibility; more number crunching capability and programming power can all be added when you need them. And without the feeling that you are turning a good natured toytown machine into a disproportionate monster.

The Ithaca InterSystems DPS1 has the power and flexibility of the IEEE 696 S100 bus with 20 slots of expandability for up to 16 individually addressable DMA devices and up to 1 MegaByte direct addressing from our Z80 board with its unique memory management system.

For really serious computing, our optional hardware front-panel provides a powerful diagnostic tool for debugging and development. Among its many features are the ability to deposit into and examine memory and set hardware break-points. Coupled with an oscilloscope, many other activities usually associated with expensive logic analyzers are possible. No wonder it's fast becoming the chosen development system in laboratories everywhere. And the recently announced system without the hardware frontpanel sets new standards for target systems too.

On the subject of standards, Ithaca InterSystems Series II is the most complete line of IEEE 696 S100 boards . . . easily upgradeable to the Z8000 or other 16 bit processors as they become available . . . so you never get locked out of rapid

expansion, or locked into obsolescence, by depending on a single manufacturer.

But beware: IEEE 696 is an 8 bit AND 16 bit standard, not 8 bit only as some would have you believe. True compatibility and later upgrade to 16 bits means you need to stick to the full IEEE 696 S100 standard from the start.

So if you've left the common or garden variety applications behind, come to Ithaca InterSystems and get a system that will grow as big as your next idea. Whether starting out with a basic low cost system or needing a sophisticated full feature multiuser system or anything in between . . . you'll find a solution to your problem with Ithaca InterSystems. With a choice of 5" or 8" drives, hard disks and CP/M or MP/M, and the full range of CP/M compatible software, including the excellent PASCAL/Z native code compiler, we probably have what you need.

Why not contact us to discuss your requirement? Call today for a catalogue of our products which also contains details of the IEEE S100 bus.

Coleridge Lane, Coleridge Road,
London N8 8ED. England.

Telephone: 01-341 2447
Telex: 299568

ITHACA InterSystems (UK) Ltd.

"MAKING MICROCOMPUTERS FOR THE '80s"