

Popular Electronics®

WORLD'S LARGEST-SELLING ELECTRONICS MAGAZINE

NOVEMBER 1978/\$1

**PE Compares Audio "Click & Pop" Suppressors
How to Use Low-Cost Digital Test Equipment**

Special Focus On Personal Computers

"CORONA" 256-COLOR PERIPHERAL + TIC-TAC-TOE PROGRAM

8085 SINGLE-BOARD COMPUTER + 16 BIT Vs. 8 BIT CPUs



140
Popu

680896 KRK B6122R99 9410 DEC78

**Auxman R-1120 AM/FM Stereo Receiver
ioneer CT-F900 Cassette Deck
agnet TK7E Stereo Phono Cartridge**



COBRA RE-INVENTS THE REMOTE CB.

The first remote CBs were nothing more than a CB transceiver that you locked in your trunk and an oversized mike that could barely fit in your hand.

Such was the state of the art when the first remotes were introduced. Which was why Cobra spent till now improving the state of the art.

Introducing the result. The Cobra 62XLR. Small enough to go under the seat or on the firewall as well as in the trunk. Strong enough to take the bounces and jolts those early remotes couldn't. Powerful enough to punch through loud and clear.

The receiver has automatic gain control, switchable noise limiting, plus Dual-Gate Mosfet and Monolithic Crystal Filter to keep interference to a minimum. So the voice you hear always comes through loud and clear.

The streamlined mike puts all the controls at your fingertips. Speaker, channel selector and squelch are built right in. So there's no fiddling around while you're driving around.

And with Cobra's reputation for building them right and our nationwide network of Service Centers making sure they stay that way, you can be pretty sure that nobody's ever going to improve on the 62XLR.

Cobra may not have been the first to make a remote. But we were the first to do it right.



Punches through loud and clear.

Cobra Communications Products
DYNASCAN CORPORATION
6460 W. Cortland St., Chicago, Illinois 60635

Write for color brochure
EXPORTERS: Empire • Plainville, N.Y. • CANADA: Atlas Electronics • Ontario
CIRCLE NO. 10 ON FREE INFORMATION CARD

Unfair Copy

The watch shown here is a copy of the world famous Seiko chronograph alarm. Unfair? You be the judge.

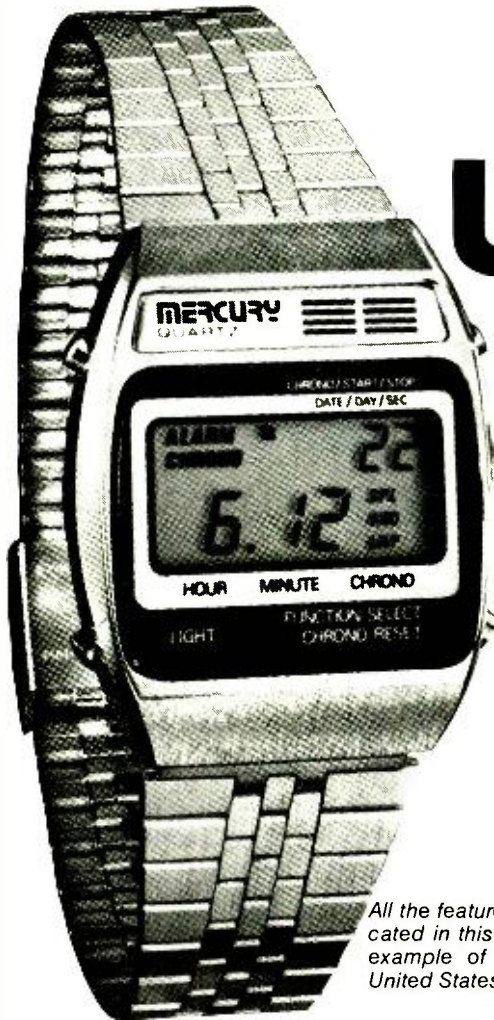

All the features of the Seiko watch are duplicated in this digital watch. It is an excellent example of the fierce competition in the United States.

It's really a shame. The watch shown above is a copy of the Seiko chronograph alarm.

Seiko is one of the world's most respected watchmakers, having literally taken over the quartz watch industry. Their quality is outstanding, and they have produced many great innovations in the digital watch industry.

The Seiko chronograph alarm sells for \$300. The watch costs jewelers \$150. And jewelers love the item, not only because of the excellent reputation of the Seiko brand, but because it's probably America's best-selling new expensive digital watch. And Seiko can't supply enough of them to their dealers.

The Mercury copy shown above looks almost exactly like the Seiko and costs dealers approximately \$50. Most dealers are selling it for \$100, and they're selling them as fast as they get them.

LABOR EXPENSIVE IN JAPAN

Unlike the Seiko watch which is made in Japan, the Mercury is manufactured under special contract in Hong Kong by a prominent American watch manufacturer. The watch uses basically the same components as the Seiko, but the differences lie mainly in the labor. Hong Kong's labor costs are far less than in Japan. An average Japanese watch assembler makes the equivalent of \$75 per day whereas the equivalent employee in Hong Kong makes only a few dollars per day.

The value of the yen has skyrocketed while the Hong Kong dollar has changed little in comparison to the U.S. dollar. So all Seiko products have become even more expensive to export.

BOTH BACKED BY SERVICE

The Seiko is backed by a national network of service centers. The Mercury is backed by a very efficient service-by-mail center. Since the latest crop of space-age digital LC watches require very little service other than battery replacement, which any jeweler can do, service has become less a concern.

Why then would anyone want to buy a copy of the Seiko? For several reasons:

Savings JS&A has obtained sufficient quantities of the Mercury to offer you the item for as low as \$69.95.

Support Mercury is a division of Leisurecraft Industries, a public company that specializes in obtaining the best digital watches and insuring their value with excellent service, support and quality.

Quality You'll be amazed at the excellent quality of the Mercury, especially compared side by side with the Seiko.

Accuracy The Mercury is guaranteed accurate to within 15 seconds per month, although much greater accuracy can be expected.

THE BEST FEATURES

The alarm chronograph has an alarm that really wakes you up. Its chronograph measures time to one hundredth of a second and has three settings: **split** which continues counting the split seconds while you freeze the time for reading, **add** if you want the total time of several periods, and **lap** which starts counting from zero when you press the button.

You have hours, minutes, seconds, day of the week, the month and date. The Mercury

Quartz LC also remembers the days in a month and automatically recycles to the correct first day of the next month.

EXAMINE THE FEATURES

Order the Mercury from JS&A on a trial basis. Compare it feature for feature with the Seiko. Compare its accuracy, its alarm, and its chronograph functions.

If after a truly side-by-side comparison, you aren't convinced that its accuracy, quality, and features make it a truly outstanding value, return it within 30 days for a prompt and courteous refund. We promise to accept the return of your watch with absolutely no questions asked and even refund the \$3.50 postage and handling.

AMERICA'S LARGEST SOURCE

JS&A is America's largest single source of space-age products—further assurance that your modest investment is well protected.

The new crop of digital watches rarely malfunction, but if service is ever required, it is reassuring to know that there is a prompt service-by-mail facility, a one year limited warranty and two substantial companies backing your modest investment.

To order your Mercury Quartz LC, send your check for **\$69.95** for the silver-tone model or **\$79.95** for the gold-tone along with \$3.50 per order for postage and handling (Illinois residents, please add 5% sales tax) to the address shown below or credit card buyers may call our toll-free number below.

Is it unfair to copy a popular expensive watch? America's growth can be traced directly to the principle of open competition. Open competition has not only been the catalyst for innovation, but it is also responsible for bringing better value to a free marketplace. Unfair? Maybe if you were Seiko it would be. But then we're all not that lucky.

Your timing is perfect. Why not order the Mercury LC at no obligation, today.

JS&A NATIONAL SALES GROUP

Dept. PE One JS&A Plaza
Northbrook, Ill. 60062 (312) 564-7000
Call TOLL-FREE 800 323-6400
In Illinois Call (312) 564-7000

©JS&A Group, Inc., 1978

Brand New. LCD Alarm Chronograph



You can't wear a more accurate watch ... With the split second precision of the finest Swiss stopwatch ... Plus a 24-hour alarm & personal reminder system.

This spring and summer, our LCD Alarm Chronograph was a runaway best seller. It's sold out in fact. For this reason, we've improved it. Made it even bolder and more exciting, with extra convenience features and for less money!

How? By placing one of the largest watch orders in our history... and passing the quantity savings along to you.

Truly Extraordinary

This new LCD Alarm Chronograph is truly extraordinary. It does more and does it better than any other watch. With an impressive, dramatic appearance that reflects its uncommon ability.

Remarkable Value

The only thing about it that's not extravagant is its price. It's actually over \$200.00 less than the nationally advertised watch that comes close to its usefulness and accuracy.



Correct time is 6:53.44 on Tuesday

Quartz Crystal Time... The LCD Alarm Chronograph gives you accuracy to ± 60 seconds a year. Quartz crystal accuracy that would have been considered sensational per month in earlier micro-electronic watches. And is still not available in models selling for as much as \$500.00 to \$1000.00.

The Electronic Calendar... So you always have exactly the right time on display—the hours, minutes and running seconds, plus the day of the week. Then, at a touch, you can replace the time with the month and date. Of course, the electronic calendar adjusts automatically for the number of days in the month. Then, so you can see when it's dim or you're in the dark, the face lights up.



Correct date is August 8th

24 Hour Alarm

Of all the features available in digital watches today, an alarm system like this is the one that's most wanted. And no wonder. It will wake you; remind you of your appointments, phone calls and meetings (or break one up that's been going on too long). It's really important enough all by itself to warrant your getting a new watch.

You can set this alarm for any minute of any hour. Day or night. In all, 1440 positions are available—easily and instantly. Then, unless you change or deactivate it, the alarm will sound for a full minute at the same time every day. With an insistent, though pleasant, beep. When the alarm is set, an A appears on the face. To check the time it'll go off, just touch the alarm button.



Set to ring at 11:45 P.M.

The Chronograph System

As to the chronograph, or split-second timer, its precision is so fine, it borders on the infinitesimal. Imagine, it enables you to time an event for up to an hour to one-hundredth of a second... and beyond that, for a full 24 hours, to the second! On top of which, you can time an event in memory, keeping the regular time of display until you need the chronograph readout. Then, as you'll see in the explanation to the far right, the chronograph measures or stops time, in an extraordinary variety of ways.

This exceptional versatility makes the LCD Alarm Chronograph with its highly sophisticated micro-computer chip the ideal instrument for doctors, pilots, motion picture directors and photographers, sound and efficiency engineers, sportsmen of course, and every executive who wants the ability to command time to stand still.

Only \$70

Right now, only the Seiko among nationally advertised brands has all these features. And it regularly sells for \$299.95. Well over two hundred dollars more—even though its chronograph is accurate to only a tenth of a second.

This incomparable value (proved after exhaustive quality control tests) is what really impressed us. And we're one of the oldest and largest mail merchandisers in America.

30 Day Trial

What is more, buying by mail, you can prove all this to your own satisfaction without risking one cent. You have thirty days to put the LCD Alarm Chronograph to the test—to confirm it won't gain or lose five seconds a month, prove the convenience of the alarm, satisfy yourself that the LCD Alarm Chronograph is as useful as it is easy to operate. More, to compare it with any watch at any price, and to send it back for a complete refund if the value is not as great as we say, if it doesn't arouse the admiration and fascination of your friends, win your own pleasure and satisfaction.

Silver-tone or gold plated

So order your LCD Alarm Chronograph today. The price, including shipping, handling, insurance and a handsome gift case is just \$70.00 with chrome case and stainless steel bracelet, or \$80.00 in gold plated case and

bracelet. Your watch comes with a full ONE YEAR Limited Warranty. Remember, too, the printed circuitry eliminates all moving parts and normal servicing, and assures you of years of trouble-free performance

**800-325-6400
OPERATOR #19**

(Missouri residents call 800-342-6600)
In operation 7 days a week

To order by credit card, call the toll free number above. Send your check to Douglas Dunhill at the address below. (New York and Illinois residents add the appropriate sales tax.)

The Multi-Function Chronograph System

No other instrument, at any price, gives you greater precision than the 1/100th of a second accuracy of the new LCD Alarm Chronograph, or greater versatility and flexibility in timing an event from a fraction of a second to 24 hours. Only with the micro-electronic revolution could you have a multi-function chronograph, a chronograph that can be put in memory, in a sleek, thin, superbly styled timepiece like this.



Timed to 54 minutes and 14.85 seconds

#1 Add Time... is the stop watch mode. You'll use it to time everything from a phone call to the length of a meeting. How long your car's been at a parking meter, the time you've been jogging or exercising, even the time it takes a quarterback to set up and throw. With Add Time, you can stop when necessary, like a time out in basketball, and start again when the action begins. Try it the next time you prepare a speech.

#2 Split Time... is the mode you'll use to get the time of each contestant across the finish line, or to get the time for the 1/4 or the 1/2 or any interim. On Split Time the chronograph is actually stopped and running at the same time, so you can use it to figure the time of a pit stop, for example, and still get the over-all time of the race.

#3 Twin Timing... Most extraordinary of all, you can actually combine these functions, using your chronograph as both a stopwatch and split timer. For example, a television producer would start timing a show, he then stops and starts the chronograph to get the time of the commercial, writes down the figure, and starts the chronograph again, which jumps ahead to the total elapsed time. With an ordinary or analog stopwatch, you'd need two sets of hands to do this—and would probably have to pay more for just a stopwatch than for the LCD Alarm Chronograph.

You'll find the chronograph so easy to use, you'll master it in minutes, and in days find innumerable business and personal uses. Take 30 days to prove it to yourself.

Be sure to specify white or gold. You'll have the precise time, absolute control over time, plus ample warning when it's time to do anything. And the pride that comes with wearing a watch that's second to none.

© Douglas Dunhill Inc. 1978



Dept. 81-2321
4225 Frontage Road
Oak Forest, IL 60452

Coming Next Month

- A COMPUTER-VS-YOU CHESS GAME
- SECURITY PROJECTS: AN IR INTRUSION SYSTEM AN ELECTRONIC INTRUDER ALARM
- POPULAR ELECTRONICS ANNUAL EDITORIAL INDEX
- TEST REPORTS: Lafayette AM/FM Stereo Receiver
Dual 819 Cassette Deck
Crown DL-2 Audio Control Center

Cover Art by George Kelvin

POPULAR ELECTRONICS, November 1978, Volume 14, Number 5. Published monthly at One Park Avenue, New York, NY 10016. One year subscription rate for U.S. and Possessions, \$13.00; Canada, \$16.00; all other countries, \$18.00 (cash orders only, payable in U.S. currency). Second Class postage paid at New York, NY and at additional mailing offices. Authorized as second class mail by the Post Office Department, Ottawa, Canada, and for payment of postage in cash.

POPULAR ELECTRONICS including ELECTRONICS WORLD. Trade Mark Registered. Indexed in the Reader's Guide to Periodical Literature. COPYRIGHT © 1978 BY ZIFF-DAVIS PUBLISHING COMPANY. ALL RIGHTS RESERVED. Ziff-Davis also publishes Boating, Car and Driver, Cycle, Flying, Popular Photography, Skiing, Stereo Review, Electronic Experimenter's Handbook, Tape Recording & Buying Guide, Stereo Directory & Buying Guide, and Communications Handbook.

Material in this publication may not be reproduced in any form without permission. Requests for permission should be directed to Jerry Schneider, Rights and Permissions, Ziff-Davis Publishing Co., One Park Ave., New York, NY 10016.

Editorial correspondence: POPULAR ELECTRONICS, 1 Park Ave., New York, NY 10016. Editorial contributions must be accompanied by return postage and will be handled with reasonable care, however, publisher assumes no responsibility for return or safety of manuscripts, art work, or models.

Forms 3579 and all subscription correspondence: POPULAR ELECTRONICS, Circulation Dept., P.O. Box 2774, Boulder, CO 80302. Please allow at least eight weeks for change of address. Include your old address, enclosing, if possible, an address label from a recent issue.

The publisher has no knowledge of any proprietary rights which will be violated by the making or using of any items disclosed in this issue.



Member Audit Bureau of Circulations

Feature Articles

- 22 MICROPROCESSORS IN AUDIO COMPONENTS / Julian Hirsch
- 53 A BASIC GUIDE TO DIGITAL LOGIC PROBES, CLIPS, & PULSERS / Clayton Hallmark
- 64 COMPARING AUDIO "CLICK" AND "POP" SUPPRESSORS / Julian Hirsch
Getting higher fidelity with the new noise-removal audio components.
- 70 DATA PROCESSING QUIZ / Robert P. Balin

Construction Articles

- 71 A PERSONAL MICROWAVE COMMUNICATIONS SYSTEM—
THE MINI-WAVE, PART 2 / Robert B. Cooper, Jr. & S. K. Richey
- 81 ADD A "TICK-TOCK" TO YOUR DIGITAL CLOCK / William D. Kraengel, Jr.
- 83 CONTROL YOUR MODEL RAILROAD WITH AUDIO TAPE / Spencer Bostwick
Let a cassette tape take the place of your train's engineer.
- 106 BUILD A UNITY GAIN INDICATOR / James Barbarello
Inexpensive level detector for audio applications.

Special Focus on Computers

- 87 THE "EXPLORER" 8085-BASED MICROCOMPUTER / Martin Meyer
Expandable, single-board computer is compatible with 8080 software.
- 92 "CORONA" 256-COLOR PERIPHERAL / Jeff Lowenson, Robert Marsh, & James Spann
- 94 A CASSETTE CONTROL SYSTEM FOR COMPUTERS / A. A. Mangieri
- 98 A TIC-TAC-TOE GAME FOR YOUR ELF COMPUTER / Edward M. McCormick
- 101 16-BIT VS 8-BIT MICROPROCESSOR / Gordon Letwin & Hampton Miller
- 104 HOW TO CARE FOR DISKETTES / Leslie Solomon

Columns

- 20 STEREO SCENE / Ralph Hodges
New Maps of Sound.
- 112 EXPERIMENTER'S CORNER / Forrest M. Mims
The 74150 Multiplexer.
- 117 HOBBY SCENE Q & A / John McVeigh
- 119 DX LISTENING / Glenn Hauser
Radio Clarin.
- 122 COMPUTER BITS / Hal Chamberlain
Computer Arithmetic—Floating Point

Julian Hirsch Audio Reports

- 24 PIONEER MODEL CT-F900 STEREO CASSETTE DECK
- 33 LUXMAN MODEL R-1120 AM/FM STEREO RECEIVER
- 44 SIGNET MODEL TK7E STEREO PHONO CARTRIDGE

Electronic Product Test Report

- 118 J.I.L. MINICOM SX-100 SCANNING MONITOR RECEIVER

Departments

- 4 EDITORIAL / Art Salsberg
POPULAR ELECTRONICS at the White House.
- 6 LETTERS
- 8 NEW PRODUCTS
- 14 NEW LITERATURE
- 125 SOFTWARE SOURCES
- 127 ELECTRONICS LIBRARY
- 146 OPERATION ASSIST

JOSEPH E. MESICS
Publisher

ARTHUR P. SALSBERG
Editorial Director

LESLIE SOLOMON
Technical Director

JOHN R. RIGGS
Managing Editor

IVAN BERGER
Senior Editor

ALEXANDER W. BURAWA
Features Editor

EDWARD I. BUXBAUM
Art Director

JOHN McVEIGH
Assistant Technical Editor

ANDRE DUZANT
Technical Illustrator

CLAUDIA TAFARO
Production Editor

RUTH POLSKY
Editorial Assistant

Contributing Editors
**Hal Chamberlin, Lou Garner, Glenn Hauser
Julian Hirsch, Ralph Hodges, Forrest Mims**

CARMEN VELAZQUEZ
Assistant to the Editor

LINDA BLUM
Advertising Service Manager

KATHERINE REINHARDSEN
Executive Assistant

EDGAR W. HOPPER
Publishing Director

ZIFF-DAVIS PUBLISHING COMPANY
Philip B. Korsant, President
Furman Hebb, Executive Vice President
John R. Emery, Sr. Vice President, Finance
Philip T. Heffernan, Sr. Vice President
Edward D. Muhfeld, Sr. Vice President
Philip Sine, Sr. Vice President, Secretary
Lawrence Sporn, Sr. Vice President, Circulation and Marketing
Arthur W. Butzow, Vice President, Production
George Morrissey, Vice President
Sydney H. Rogers, Vice President
Sidney Holtz, Vice President
Albert S. Traina, Vice President
Paul H. Chook, Vice President
Edgar W. Hopper, Vice President
Robert N. Bavie, Jr. Vice President
Selwyn Taubman, Treasurer

W. Bradford Briggs, Vice Chairman

ZIFF CORPORATION
William Ziff, Chairman
I. Martin Pompadur, President
Hershel B. Sarbin, Executive Vice President

ZIFF-DAVIS PUBLISHING COMPANY
Editorial and Executive Offices
One Park Avenue, New York, New York 10016
212-725-3500
Joseph E. Mesics (725-3568)
John J. Corton (725-3578)
Bonnie B. Kaiser (725-3580)

Midwestern Office
Suite 1400, 180 N. Michigan Ave.
Chicago, IL 60601 (312-346-2600)
Midwest Representative: Buzz Vincent

Western Office
9025 Wilshire Boulevard, Beverly Hills, CA 90211
213-273-8050, BRadshaw 2-1161
Western Advertising Manager: Bud Dean
Western Representative: Norm Schindler
Suite 205, 20121 Ventura Blvd
Woodland Hills, CA 91364 (213-999-1414)
Japan: James Yagi, Oji Palace Aoyama,
6-25, Minami Aoyama, 6 Chome, Minato-Ku
Tokyo 407-1930/6821, 582-2851



Editorial

POPULAR ELECTRONICS AT THE WHITE HOUSE

I spent an interesting day at the White House a few weeks ago, together with a small band of other magazine editors. This included a half-hour session with President Jimmy Carter.

The energy problem is clearly one of the uppermost challenges with which the administration is grappling. At this time, though, it appears that a distinct energy substitute for oil is not at hand. Rather, a host of other energy-resource avenues are being explored, solar being one. But solar energy, though glamorous, is costly: about \$81 per equivalent barrel of oil compared to \$14 for fossil fuel and \$25 for other sources.

Our energy crunch—when oil demand exceeds productive capacity—is expected to be reached sometime between 1982 and 1988. Extending this date by conservation and substituting other fuels such as natural gas and coal is a primary goal, giving the U.S. time to fully develop energy alternatives. One alternative, says Jim Bishop, chief spokesman for the energy department, is restoring to service hydroelectric turbines in disuse since the 30s and 40s, when oil was cheap. Moreover, the U.S. is encouraging use of small dams for electric generation, where there's a potential generating capacity of more than 54,000 megawatts.

Walking onto a balcony at the Executive House with Energy Secretary James Schlesinger, I asked him what he thinks I should do when my 25-year-old oil burner passes on. He suggested the possibility of substituting a heat pump, though hesitating to make a firm recommendation for the refrigerant system that uses a reversing valve to provide both heating and cooling. Seems that the pump is advantageous when proper factors are present, such as having a satisfactory duct system, when electric-resistance heating is available, when it doesn't get terribly cold outside, and where electricity costs are not outrageously high. Solar heating, even for hot water only, is not around the corner for me either since I'm living in the North and solar costs are still quite high. Schlesinger pointed out, though, that there will surely be a solar energy tax break bill passed soon and, besides, it will be retroactive to April 20, 1977. He also noted that nuclear breeder reactors are OK, though fusion types are not.

On another subject of interest, I tried to find out what alternatives the U.S. had in the event the rumored "Third World" attempt to take frequencies away from the amateur radio and CB bands does indeed occur at the upcoming WARC meeting in '79. Rick Neustadt of the Domestic Policy Staff was aware of the rumors, saying that our embassy people in each country are trying to persuade the foreign governments that it would be in their own best long-term interests not to do this. He declined to answer my question about the U.S.'s planned posture should the countries decline to follow the industrial nations' lead, however.

There were many more subjects covered at this meeting in Washington, D.C., but the foregoing are of special interest to PE readers, I know.

Reflecting on the energy problem reminded me of an article reprint I read recently in which the author observed that energy alternatives are needed, determined long-range trends, and analyzed available resources and future possibilities that deserve research efforts to forestall the inevitable. Solar radiation, he concluded, would be the great source of energy for the future. The author's name: Charles P. Steinmetz. The date: June 27, 1918.

The Age of Affordable Personal Computing Has Finally Arrived.

Ohio Scientific has made a major breakthrough in small computer technology which dramatically reduces the cost of personal computers. By use of custom LSI micro circuits, we have managed to put a complete ultra high performance computer and all necessary interfaces, including the keyboard and power supply, on a single printed circuit board. This new computer actually has more features and higher performance than some home or personal computers that are selling today for up to \$2000. It is more powerful than computer systems which cost over \$20,000 in the early 1970's.

This new machine can entertain your whole family with spectacular video games and cartoons, made possible by its ultra high resolution graphics and super fast BASIC. It can help you with your personal finances and budget planning, made possible by its decimal arithmetic ability and cassette data storage capabilities. It can assist you in school or industry as an ultra powerful scientific calculator, made possible by its advanced scientific

math functions and built-in "immediate" mode which allows complex problem solving without programming! This computer can actually entertain your children while it educates them in topics ranging from naming the Presidents of the United States to tutoring trigonometry all possible by its fast extended BASIC, graphics and data storage ability.

The machine can be economically expanded to assist in your business, remotely control your home, communicate with other computers and perform many other tasks via the broadest line of expansion accessories in the microcomputer industry.

This machine is super easy to use because it communicates naturally in BASIC, an English-like programming language. So you can easily instruct it or program it to do whatever you want, *but you don't have to*. You don't because it comes with a complete software library on cassette including programs for each application stated above. Ohio Scientific also offers you hundreds of inexpensive programs on ready-to-run cassettes. Program it yourself or just enjoy it; the choice is yours.

Ohio Scientific offers you this remarkable new computer two ways.

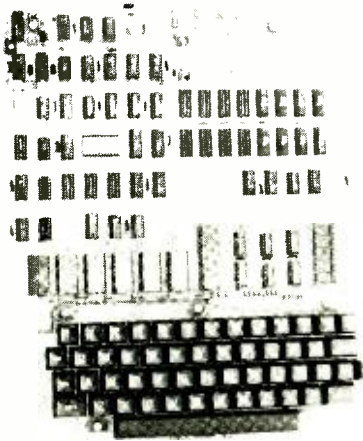

Challenger 1P \$349

Fully packaged with power supply. Just plug in a video monitor or TV through an RF converter to be up and running.

Superboard II \$279

For electronic buffs. Fully assembled and tested. Requires +5V. at 3 Amps and a video monitor or TV with RF converter to be up and running.



Standard Features

- Uses the ultra powerful 6502 microprocessor
- 8K Microsoft BASIC-in-ROM
Full feature BASIC runs faster than currently available personal computers and all 8080-based business computers.
- 4K static RAM on board expandable to 8K
- Full 53-key keyboard with upper/lower case and user programmability
- Kansas City standard audio cassette interface for high reliability
- Full machine code monitor and I/O utilities in ROM
- Direct access video display has 1K of dedicated memory (besides 4K user memory), features upper case, lower case, graphics and gaming characters for an effective screen resolution of up to 256 by 256 points. Normal TV's with overscan display about 24 rows of 24 characters, without overscan up to 30 X 30 characters.

Extras

- Available expander board features 24K static RAM (additional), dual mini-floppy interface, port adapter for printer and modem and an OSI 48 line expansion interface.
- Assembler/editor and extended machine code monitor available.

ORDER FORM

Order direct or from your local Ohio Scientific dealer.

I'm interested. Send me information on your

Personal Computers Business Systems

Send me a Superboard II \$279 enclosed

Send me a Challenger 1P \$349 enclosed

Include 4 more K of RAM (8K Total) \$69 more enclosed

Name _____

Address _____

City _____ State _____ Zip _____

Payment by BAC (VISA) Master Charge Money Order

Credit Card Account # _____

Expires _____ Interbank # (Master Charge) _____
Ohio Residents add 4% Sales Tax

TOTAL CHARGED OR ENCLOSED _____

All orders shipped insured UPS unless otherwise requested. FOB Aurora, OH

Interested in a bigger system? Ohio Scientific offers 15 other models of microcomputer systems ranging from single board units to 74 million byte hard disk systems.

NOVEMBER 1978

CIRCLE NO. 46 ON FREE INFORMATION CARD

5

OHIO SCIENTIFIC
America's Largest Full Line Microcomputer Company
1333 S. Chillicothe Road • Aurora, Ohio 44202 (216) 562-3101



Letters

DX BOOSTER

I can't begin to tell you how much I enjoyed reading Harry Helms' articles on DXing. Be-

ing a DXer myself, I find his articles invaluable. Among my favorites are "Ending that Utility Futility" (July 1977) and "DX Catches from Africa" (July 1978). I would certainly enjoy seeing more articles by Mr. Helms. Incidentally, I am also a Glenn Hauser fan. —David Reed, Jr., WDX4DR, Miami, FL.

CAR STEREO NR & CR0₂

Thanks for "How to Get Hi-Fi Sound in Any Auto" (July 1978). After reading this article, however, two questions came to mind. First, will tapes recorded on one deck with Dolby noise reduction (at home, for example) be properly decoded by another Dolby deck

(such as in a car)? Secondly, why don't the cassette players in car radios have provisions for CrO₂ tapes and why do so few of them have Dolby noise-reduction systems?—Rick Whiting, WOTN, Hopkins, MN.

The answer to your first question is "yes." The tracking of Dolby noise-reduction circuits from deck to deck is quite close. The answer to your second question boils down to a matter of marketing. If manufacturers feel that there are enough people out there who want CrO₂ and other tape formulations besides "standard," they'll likely start producing them. Also, improved tape formulations and the noise-reducing benefits of a Dolby system may not always be justified in an automotive environment, where ambient noise might mask tape noise and other advantages enjoyed at home.—Ed.

SWR CLARIFIED

SWR continues to be misunderstood. In "Build a Low-Cost SWR Tester" (June 1978), there was a chart relating SWR to reflection loss and antenna power. The chart gives the impression that, with 4 watts of transmitter output power, antenna power will be 4 watts if the SWR is 1:1. This would mean that it makes no difference whether one uses a short length of low-loss feedline or a long length of lossy feedline as long as the SWR is 1:1. This is not so. The reflection losses due to the SWR must be added to the losses of the line. SWR is only one of the contributing loss factors.—John J. Duda, Erie, PA.

SERVICE BY MAIL

In "Personal Computers for Small-Business Applications" (August 1978), the statement "... service from manufacturers is obviously not a satisfactory route to take" is open to challenge. In my own experience, I have had excellent service from a computer manufacturer, from initial purchase, to help with programming, to repair and debugging my computer—all conducted by mail. Within a week of placing my order, I had my burned-in computer. After that, I never had to wait more than three days for a response to my letters. This is excellent service from a company located more than 600 miles from where I live.—Art Baldwin, Dallas, TX.

Your experience, though not unique, is not commonplace. Even so, computer down-time for as short a time as one day can be very frustrating (not to mention costly for small businesses).—Ed.

Out of Tune

In "The Versatile Keypad" (August 1978) in Fig. 3, the left side of IC11 was incorrectly labelled 3, 4, 5 from top to bottom. The correct sequence should be 3, 5, 4.

POPULAR ELECTRONICS

WHAT WE KNOW ABOUT COMPUTERS COULD SAVE YOU MONEY

SO YOU WANT TO BUY A COMPUTER

- Finally, an objective look at the top 24 micro systems sold throughout the world
- Honest pros and cons of each system, plus a straightforward look at the micro computer industry as it relates to you!
- Written in plain English for the layman. If you are considering the purchase of a personal computer, this book will save you money!

ONLY \$4.50 PER VOLUME

SAMPLE CONTENTS

- Don't Get Hung up on the Chips • Now, about the hardware • What? No software! • Helpful suggestions before spending money

READ UP ON COMPUTERS BEFORE YOU PUT YOUR MONEY DOWN!

ONLY \$4.50 PER VOLUME

TELEPHONE TOLL FREE: 800-327-6543—

or send this coupon!

SCIENTIFIC RESEARCH

P.O. Box 490099 P Key Biscayne Florida 33149

Please send me (quantity) _____ books I am enclosing \$4.50

per book plus \$1.00 postage and handling charge

Master Charge or Visa Account No. _____

Expiration Date _____

NAME _____

ADDRESS _____

CITY _____ STATE _____ ZIP _____

NEW PRODUCTS

The Model 10 at \$49.95 represents the most outstanding blood pressure computer value.



Blood Pressure Computers



The Model 11 at \$69.95 is one of the most deluxe blood pressure models available.

More Americans are taking their own blood pressure with today's new electronic marvels. Here's a report on two of the newest and lowest priced quality models.

There's a new way to take your blood pressure. Scientists have developed electronic systems that wrap around your arm, require no stethoscope, and don't even require rolling up your sleeve.

When a doctor reads your blood pressure, he uses his skill and a stethoscope to determine your systolic and diastolic readings. Now a computer can do this in the convenience of your home and on a regular basis.

DOCTORS ENCOURAGE USE

It's a good idea to know your own blood pressure. Doctors estimate that 25 million Americans suffer from hypertension and yet only half know about it.

Hypertension is high blood pressure, and high blood pressure usually goes unnoticed until serious symptoms develop—often too late to correct.

Doctors encourage their patients to regularly monitor their blood pressure, and the new electronic models make monitoring easy enough for everyone to do. Even if your health has been perfect, hypertension or high blood pressure can occur at anytime.

EASY TO USE

Taking your blood pressure is quite simple. Just slip your hand through a self-tightening velcro cuff, slide the cuff up your arm, pull the tab, and attach the tab to the velcro material. The tab will stick automatically without loosening. Then squeeze the rubber bulb to inflate the cuff, and read your blood pressure on the dial.

The two units shown above are two of the most advanced models available. The JS&A Model 10 sells for \$49.95 and the Model 11 shown to the right sells for \$69.95.

Both units use three integrated circuits and a microphone transducer. The microphone picks up pulses in your artery, and the integrated circuits measure the pulses and

relay the information to a meter which visually displays your two blood pressure readings. There is no expensive stethoscope required, no guesswork or complicated steps to follow.

The Model 10 has a separate bulb to inflate whereas the Model 11 has the bulb built into the handle making the process a one-handed procedure. The deluxe Model 11 also has a self-bleeding release valve and a more attractive carrying case.

The units shown above also flash an LED signal and an audible tone at the two blood pressure readings to assist the hard-of-hearing or those with poor eyesight.



Both JS&A blood pressure units were designed to easily slip over your arm and tighten with the self-tightening bar and the velcro material. Just pull the flap and press.

Both models represent outstanding value. If you are looking for the lowest priced electronic monitor available, we recommend the Model 10. If you are looking for a more deluxe unit, we recommend the Model 11. In either case, you will own the finest.

SOLIDLY BACKED

The JS&A units are powered by a readily-available 9-volt battery supplied with each

unit. The units use solid-state electronics so service should never be required. But if service is ever required, JS&A's prompt service-by-mail center is as close as your mailbox. JS&A is America's largest single source of space-age products—further assurance that your modest investment is well protected.

We recommend that you at least try a blood pressure computer without obligation for 30 days. Order one. When you receive it, see how easy it is to slip the cuff on your arm, tighten, and inflate. See how easy it is to read and monitor your blood pressure regularly. If, for any reason, you decide that you would rather return your unit within the 30 day trial period, please feel free to do so, and we will be happy to refund your money and even the \$2.50 postage and handling. There is no risk.

To order your blood pressure computer, simply mail your check for **\$49.95** for Model 10 or **\$69.95** for Model 11 plus \$2.50 per order for postage and handling (Illinois residents add 5% sales tax) to the address shown below. Credit card buyers may call our toll-free number to order.

We will promptly ship you your blood pressure computer, batteries, carrying case, complete instructions, and your 90 day limited warranty.

Space-age technology has made it easy to monitor your own blood pressure. Order a JS&A blood pressure computer at no obligation, today.

JS&A NATIONAL SALES GROUP

Dept PE One JS&A Plaza
Northbrook, Ill. 60062 (312) 564-7000
Call TOLL-FREE 800 323-6400
In Illinois Call (312) 564-7000

© JS&A Group, Inc., 1978



New Products

Additional information on new products covered in this section is available from the manufacturers. Either circle the item's code number on the Free Information Card or write to the manufacturer at the address given.

B.I.C. Two-Speed Cassette Deck

B.I.C./Avnet's Model T-3 cassette deck features two speeds—the standard 1 7/8 ips and a new 3 3/4 ips. The higher tape speed is said to improve frequency response, wow and flutter, and S/N. The three-head



unit is claimed to have frequency responses of 25-19,000 Hz \pm 3 dB at 1 7/8 ips and 25-22,000 Hz \pm 3 dB at 3 3/4 ips. Its transport system has primary and secondary capstans and pinch roller assemblies in a closed-loop system. Four separate Dolby circuits allow simultaneous encode and decode of left- and right-channel signals. Wind or rewind time on a C60 tape is 45 seconds. A BIAS switch provides a selection of HI, NORMAL, AND LO; equalizations of 70 or 120 microseconds can also be chosen. Peak-reading meters have an extended range of 45 dB. \$499.95. Address: B. I. C./Avnet, Westbury, NY 11590.

CIRCLE NO 87 ON FREE INFORMATION CARD

OK IC Insertion Tool

The new Model MOS-40 DIP IC insertion tool from OK Machine and Tool Corp. handles all TTL and MOS ICs in standard 36- and 40-pin packages with 0.6" pin-row spacing. This tool also aligns bent-out IC pins. A twist of the handle compresses the pins to the proper 0.6" spacing and locks the IC into the tool. To insert the IC in its socket or directly on a pc board, the user simply places the tool over the appropriate

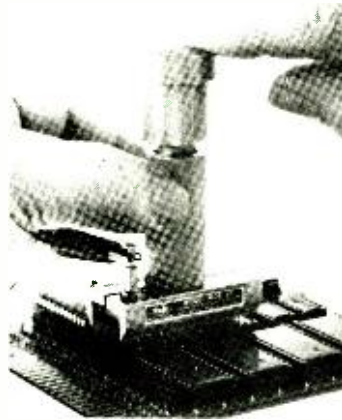

location and presses the plunger. The tool features heavy chrome plating throughout and a terminal lug for attaching a grounding strap for reliable static dissipation and safe handling of MOS devices. \$7.95. Address: OK Machine and Tool Corp., 3455 Conner St., Bronx, NY 10475.

CIRCLE NO 88 ON FREE INFORMATION CARD

JVC Portable SW Receiver

JVC's new Model FR-6600JW portable communication receiver features AM, FM, and four shortwave bands, the last spanning a 1.6-to-30-MHz range. The dual-conversion receiver is designed to operate on ac, D cells, or car batteries. The control complement includes: r-f gain, independent bass and treble tone, audio filter for noise reduction on AM and SW, afc switch,



bfo switch, pitch control, and main-tuning and vernier-type SW-tuning controls. A calibration signal produces a beat sound at 250 kHz. The afc switch doubles as a distant/local switch on AM. The bfo frequency can be adjusted over a \pm 3-dB range. Other features include a built-in 5" (12.7-cm) speaker; jacks for earphones, headphones, recording output, and external dc input; and swivel telescoping and ferrite-core antennas. Size is 12.9"W X 8.4"H X 3.9"D (32.7 X 21.3 X 10 cm) and weight is 6.4 lb (2.9 kg). \$149.95. Address: JVC America Co., 4875 Queens Midtown Expwy., Maspeth, NY 11378.

CIRCLE NO 89 ON FREE INFORMATION CARD

Empire Scientific Record Cleaner

Disco Film from Empire Scientific Corp. is a new record cleaner that forms a peel-off film to remove dirt and grime from record grooves. Disco Film is water-soluble and harmless to vinyl. (It should not be used on old shellac records.) It is applied to the record surface with a built-in sponge applicator. When dry, a flexible film is formed that is easily peeled off with adhesive tape. One container of Disco Film will clean up to 70 vinyl LP record sides. \$29.95. Address: Empire Scientific Corp., 1055 Stewart Ave., Garden City, NY 11530.

CIRCLE NO 91 ON FREE INFORMATION CARD

Pace Mobile CB AM Transceiver

Only 5 1/4 inches deep, for tight installation, the new Pace 8016 CB AM transceiver features a digital LED display with manual



dimming, a front-panel microphone level control, and switchable ANL. Specifications include harmonic suppression of -70 dB at 100% modulation. Other features are an edge-mounted S/r-f meter and switchable PA facilities. Dimensions are 7 1/4" W x 2 3/8" H x 5 1/4" D (19 x 6 x 14 cm). \$99.95. Address: Pathcor, Inc., 24049 S. Framp-ton Ave., Harbor City, CA 90710.

CIRCLE NO 92 ON FREE INFORMATION CARD

Microcomputer Light Pen

A new, low-cost light-pen for microcomputers is available from Esmark. Called the "Vidiet-Stik" (for Video Integrated Electronic Tracking), the light pen is touched to a CRT display screen at any desired point to indicate that point to a computer. Typical applications include hand-drawn computer graphics, interactive games, keyboard substitution, program "menu" selection, and educational drills for pre-schoolers. Designed for virtually all mini/micro systems with at least one parallel I/O line, the light-pen is supplied with software for 8080 and Z80 systems. Only three electrical connections are required: +5V, ground, and a single, TTL-level signal line. The

Osborne & Associates, Inc.

The World Leaders in Microprocessor Books



If you want information on microprocessors, read the Osborne books.

An Introduction to Microcomputers

Volume 0 - The Beginner's Book
 If you're not familiar with computers, but would like to be, then this is the book for you. Computer logic and terminology are introduced in a language the beginner can understand. Computer software, hardware and component parts are described, and simple explanations given for how they work. Text is supplemented with creative illustrations and numerous photographs. 300 pages.

Volume 0 #08-X \$7.95

Volume 1 - Basic Concepts

A must for anyone in the computer field, this best selling text explains hardware and programming concepts common to all microprocessors. Its universal appeal is reflected by its having the greatest yearly sales volume of any computer text. 350 pages.

Volume 1 #02-0 \$8.50

Volume 2 - Some Real Microprocessors
Volume 3 - Some Real Support Devices and update subscriptions

These two books provide complete descriptions of virtually every microprocessor and most support devices. There are no other books like these; they provide detailed part descriptions from an independent source.

To cope with the rapid evolution of microprocessor products, Volumes 2 and 3 have been printed in loose leaf form; each volume has its own series of six bimonthly updates, allowing you to remain current with all parts as soon as they are really available. Updates sold separately.

These two books replace the 1977 edition of Volume II - Some Real Products.

- Volume 2 with binder #14-4 \$20.00
- Volume 3 with binder #17-9 \$20.00
- Volume 2 update only \$25.00/yr.
- Volume 3 update only \$25.00/yr.
- Volume 2 and 3 updates \$40.00/yr.

Program Books Written in BASIC

Payroll with Cost Accounting
Accounts Payable and Accounts Receivable
General Ledger

These books feature complete, quality applications software for small-to-medium sized businesses. Each book includes fully documented program listings, sample printed reports, installation instructions and user's manual. Written in an extended Wang BASIC (write to ask us about our CP/M CBASIC version and other conversions). 375 pages each.

- Payroll #09-8 \$15.00
- AP & AR #13-6 \$15.00
- G. Ledger not yet available, see order form

Some Common BASIC Programs

76 short practical programs, most of which can be used on any microcomputer with any version of BASIC. Complete with program descriptions, listings, remarks and examples. 200 pages.

SCBP #06-3 \$8.50

Assembly Language Programming

8080A/8085 Assembly Language Programming
6800 Assembly Language Programming

These books describe how to program a microcomputer using assembly language. They discuss classical programming techniques, and contain simplified programming examples relevant to today's microcomputer applications. 400 pages each.

- 8080A/8085 #10-1 \$8.50
- 6800 #12-8 \$8.50



Programming for Logic Design

8080 Programming for Logic Design
6800 Programming for Logic Design
Z80 Programming for Logic Design

These books describe the meeting ground of programmers and logic designers; written for both, they provide detailed examples to illustrate effective usage of microprocessors in traditional digital applications. 300 pages each.

- 8080 #04-7 \$8.50
- 6800 #05-5 \$8.50
- Z80 #11-X \$8.50

Osborne & Associates, Inc. P.O. Box 2036, dept. A3 (415) 548-2805 Berkeley, CA 94702 USA TWX 910-366-7277	BOOK # & TITLE	PRICE	QUANTITY	AMOUNT
NAME _____ ADDRESS _____ CITY _____ STATE _____ ZIP _____ PHONE _____				
Please send the following information: <input type="checkbox"/> Becoming an O&A dealer <input type="checkbox"/> School discounts <input type="checkbox"/> List of foreign distributors <input type="checkbox"/> More information on O&A books <input type="checkbox"/> Notice when General Ledger is available	SHIPPING (Shipping for large orders to be arranged) Vol. 2 and Vol. 3 update subscriptions <input type="checkbox"/> All foreign orders \$4.00 per 6-issue subscription for airmail <input type="checkbox"/> No charge in the U.S. 4th class mail ONLY	California residents tax		
Payment in advance must be enclosed for purchases of up to \$70.00. Invoicing U.S. purchases over \$70.00 available upon approval of your account. All foreign orders must be prepaid in U.S. dollars drawn on a U.S. bank.	Books: <input type="checkbox"/> All foreign orders \$3.00 per book for airmail <input type="checkbox"/> \$0.35 per book 4th class (allow 2-3 weeks in the U.S.) <input type="checkbox"/> \$0.75 per book UPS in the U.S. (allow 10 days) <input type="checkbox"/> \$1.50 per book special rush shipment by air in the U.S.	shipping	TOTAL AMOUNT ENCLOSED	Calif. residents add 6% sales tax S.F. BART residents add 6 1/2 % sales tax.

F11



Needle in the hi-fi haystack

Even we were astounded at how difficult it is to find an adequate other-brand replacement stylus for a Shure cartridge. We recently purchased 241 random styli that were not manufactured by Shure, but were being sold as replacements for our cartridges. Only ONE of these 241 styli could pass the same basic production line performance tests that ALL genuine Shure styli must pass. But don't simply accept what we say here. Send for the documented test results we've compiled for you in data booklet # AL548. Insist on a genuine Shure stylus so that your cartridge will retain its original performance capability—and at the same time protect your records.

Shure Brothers Inc.
222 Hartrey Ave., Evanston, IL 60204
In Canada: A.C. Simmonds & Sons Limited

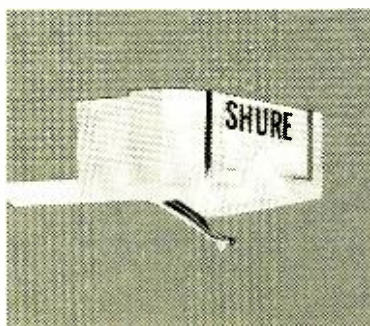

Manufacturers of high fidelity components, microphones, sound systems and related circuitry.
CIRCLE NO. 65 ON FREE INFORMATION CARD

software occupies less than 1K of memory, and is relocatable to any address. \$40, plus \$1.50 postage and handling. Address: Esmark, Inc., 507½ E. McKinley Highway, Mishawaka, IN 46544.

CIRCLE NO. 93 ON FREE INFORMATION CARD

Heath Logic Probe

Heath's new Model IT-7410 (kit)/ST-7410 (wired) logic probe is designed for in-circuit testing of TTL and CMOS integrated circuits. It features switch-selectable thresholds for either TTL or CMOS circuitry and



lamps that turn on when the input voltage crosses the appropriate levels. A memory circuit is incorporated to turn on a LED when either threshold is crossed. The probe is designed to detect pulses as short as 10 ns. Upper frequency limits are 100 MHz for TTL and CMOS devices at 5 volts and 80 MHz for CMOS at 15 volts. Power for the probe is obtained from the circuit under test via a pair of insulated alligator clips. A ground lead is provided for high-frequency operation. The probe is protected for up to 50 volts continuous and 175 volts dc for 5 seconds. Price is \$39.95 kit, \$64.95 assembled. Address: Heath Company, Benton Harbor, MI 49022.

CIRCLE NO. 90 ON FREE INFORMATION CARD

H. H. Scott Integrated Amplifier

H.H. Scott's top-of-the-line Model 480A integrated amplifier, rated at 85 watts continuous power/ch at 0.03% THD, has two independent phono preamplifiers with separate input and record capability. This permits the user to record from any one function while simultaneously listening to any other source. The amplifier also features active subsonic and high filters; base, mid-range, and treble tone controls that can be bypassed for flat response; dual logarithmic dBW power meters; dc OCL power

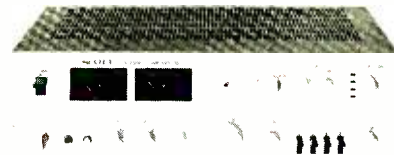

amplifier; and 117/220-volt ac switchable voltage. A switch is provided on the front panel for outboard sound processors. Also provided are impedance and capacitance selectors for cartridge/system compatibility and an electronic protection system to prevent a short circuit from damaging the amplifier or speaker system. \$449.95. Address: H.H. Scott, Inc., 20 Commerce Way, Woburn, MA 01801.

CIRCLE NO. 94 ON FREE INFORMATION CARD

Sylvania Power Microphone

The Sylvania Model SDX-400 power microphone for CB base-station applications has 20-dB gain available and is continuously adjustable via a slide control. The mike's output impedance ranges from 0 to 2500 ohms, and maximum sensitivity is -45 dB. A 9-volt battery powers the mike's transistorized amplifier and an on-the-air LED indicator. There's a built-in compressor circuit in the amplifier for high transmitter modulation levels. The push-to-talk switch has a lock-on position and the mike head can be adjusted for optimum pickup. Address: GTE Sylvania Inc., 1 Stamford Forum, Stamford, CT 06904.

CIRCLE NO. 95 ON FREE INFORMATION CARD

Altec Lansing Model Eighteen Floor-Standing Speaker

Altec Lansing's Model Eighteen, a floor-standing speaker system, utilizes its 604-8H driver combination. The latter con-

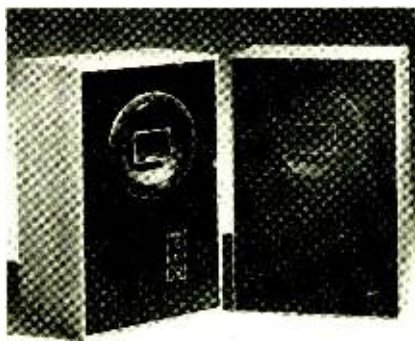

sists of the "Tangerine" phase plug, "Mantaray" horn, and a new dual equalizing network. The phase plug transmits high frequencies beyond 20,000 Hz, while the



**fact:
calling this a “brush”**



is like calling this a “radio”

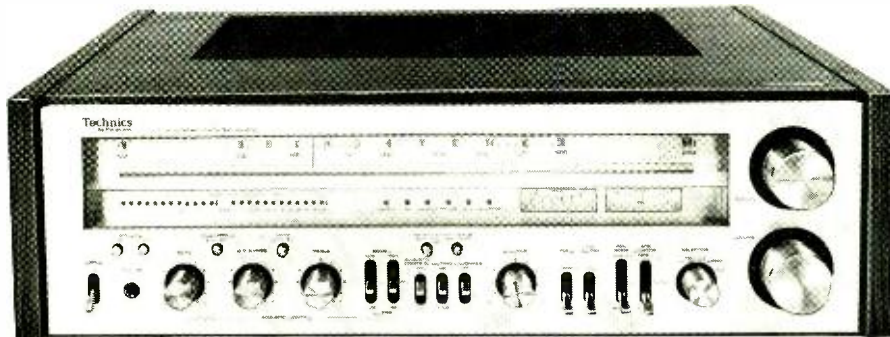

we call it a Dynamic Stabilizer

...critics call it a major innovation

True, the device on the front of a V15 Type IV cartridge bears a superficial resemblance to a cleaning brush.

In reality, it is a complex, exquisitely engineered subassembly which performs several complex functions that measurably enhance the quality of record reproduction!

Each one of its 10,000 conductive carbon fibers is positively grounded to discharge ever-present static electricity from the surface of your records. This eliminates static clicks and pops, as well as the tracking distortion produced by the varying electrostatic attraction between the record surface and the tone arm.

What's more, the Dynamic Stabilizer incorporates Shure-developed viscous damping that results in a uniquely efficient suspension system which maintains precise cartridge-to-record distance and uniform tracking

force—even on severely warped records. The stabilizer also acts as a shock absorber to cushion the stylus in case you accidentally drop the tone arm onto the record.

Finally, the tiny carbon fibers are so fine that 10 of them can fit *inside* a single groove to sweep free minute dust particles.

This integrated approach to pure sound reproduction extends throughout the design of the V15 Type IV. It sets a new standard of high trackability at ultra-low tracking forces—even on records that are warped, dusty, and charged with static.

If faithful reproduction of *all* your recordings is of paramount importance to you, we invite you to audition the V15 Type IV with the Dynamic Stabilizer. Or, write for the complete story (ask for AL569).



V15 Type IV...the stabilized cartridge



Shure Brothers Inc., 222 Hartrey Ave., Evanston, IL 60204, In Canada: A. C. Simmonds & Sons Limited
Manufacturers of high fidelity components, microphones, sound systems and related circuitry.

horn is said to provide improved horizontal dispersion. The Model Eighteen is a tuned, vented enclosure which reproduces more than 100 dB (SPL) from one watt at one meter. It is available in a hand-rubbed oak cabinet with a black semi-transparent grille fabric. Address: Altec Corp., 1515 S. Manchester, Anaheim, CA 92803.

CIRCLE NO 96 ON FREE INFORMATION CARD

Electro Scientific DMM

Electro Scientific's Calcmeter 4100 is a fully CMOS-microprocessor-controlled 3½-digit DMM that sells for less than \$400. It can automatically and directly scale and offset; sort with high/low limits; average noise away; measure dBV directly; display in percent deviation; and troubleshoot by sound. It can measure and hold a million times on a single 9-volt battery, control and



datalog remotely with an accessory printer, and perform math conversions with 11 special keys. It can also store measurements and/or calculations in five different memory locations; operate with autoranging, autozeroing, and autopolarity; and display in scientific, engineering, and fixed-decimal formats. Its ranges are: 10- μ V sensitivity through 1000 V dc, 750 V ac; 10 μ A sensitivity up to 200 mA (20 A with accessory shunt); 0.1-ohm resolution through 20 megohms. Basic accuracy is 0.25% dc V. Address: Electro Scientific Industries, Inc., 13900 N.W. Science Park Dr., Portland, OR 97229.

CIRCLE NO 97 ON FREE INFORMATION CARD

ADC Turntable

The ADC Professional Products Group of BSR(USA) Ltd. has introduced a new series of turntables with resonance-canceling bases and energy-absorbing resonance-tuned suspension feet. Topping the line is the Model 1700DD quartz direct-drive PLL semiautomatic turntable. An electronic phase comparator monitors speed changes and makes immediate cor-



rections. Also featured is an ultra-low-mass professional straight tonearm and a headshell molded of carbon fiber. The tonearm has viscous cueing and facilities for adjusting the antiskating force. Other features include: microswitch electronic controls, electronic speed and pitch controls, die-cast aluminum platter, and a removable hinged dust cover. Address: BSR(USA) Ltd., Rte. 303, Blauvelt, NY 10913.

CIRCLE NO 98 ON FREE INFORMATION CARD

Telequipment Dual-Trace Scope

The Telequipment Model D66A is a 25-MHz dual-trace oscilloscope. Features pushbutton operation for all standard trigger operations, and a TV trigger switch for TV servicing. Calibrated sweep speeds

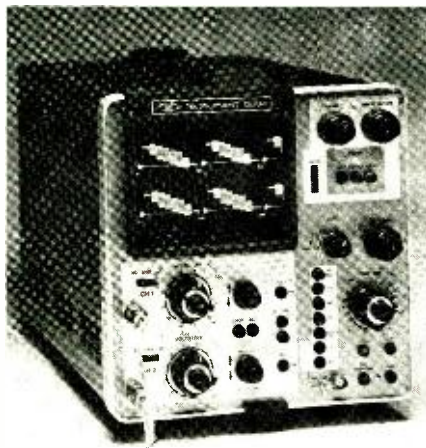

range from 20 ns to 2 s/division; vertical sensitivity ranges from 10 mV to 50 V/division across the 25-MHz bandwidth of the scope. A 1-mV/division sensitivity can be selected, but the bandwidth would then be 15 MHz. Address: Marshall Pryor, 43-000, Tektronix, Inc., P.O. Box 500, Beaverton, OR 97077.

CIRCLE NO 86 ON FREE INFORMATION CARD

Continental Specialties Pulse Generator

The CSC DM-4 Design Mate pulse generator produces a wide range of repeated,

triggered, gated or one-shot pulses. Pulse repetition frequency is continuously variable from 0.5 Hz to 5 MHz, in seven, overlapping decade ranges. Duty cycle, pulse width and pulse spacing are variable over a range of 10⁷:1, from 100 ns on/1 second off to the reverse. Pulse output amplitude is variable from 0.1-10 volts, with sufficient output current for a TTL fanout of 40. Ex-

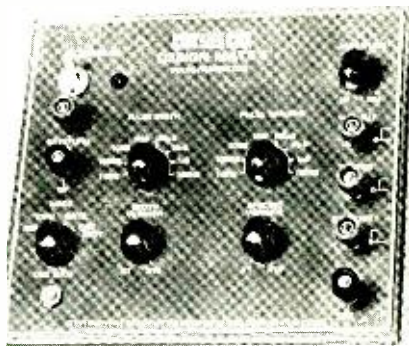

ternal triggering to 10 MHz is accepted, and a push-button is provided for one-shot use. A separate sync output pulse leads the main pulse output by approximately 20 ns. \$130. Address: Continental Specialties, 70 Fulton Terrace, New Haven, CT 06509.

CIRCLE NO 99 ON FREE INFORMATION CARD

Sonus Phono Cartridges

Sonic Research, Inc., has developed two new series of high-definition phono cartridges to suit a wide range of record-playing needs. The premium Sonus Gold series consists of three models with identical



bodies and stylus assemblies. They differ from each other only in their diamond stylus shapes. The \$140 Blue Label is specially designed for discrete 4-channel playback. The \$125 Red Label is fitted with an elliptical stylus. And the \$110 Green Label has a spherical stylus. All three cartridges are designed to track at from ¾ to 1¼ grams. The Sonus Silver series consists of the Silver P (\$75), which is a modestly priced version of the Blue Label, and the Silver E, which has an elliptical stylus. Both are designed to track at between ¾ to 1½ grams. Address: Sonic Research, Inc, 27 Sugar Hollow Rd., Danbury, CT 06810.

CIRCLE NO 100 ON FREE INFORMATION CARD



The priceless gift of learning now has a price: \$599. And a name: the Radio Shack TRS-80™ Microcomputer. And now, at last, your child has a chance to discover Tomorrow on Christmas morning.

"Tomorrow" is an electronic world, based on computers — and it's already here. In it your child can be a number in a machine. A robot. Because he or she does not understand either the number or the machine. Or your child can be pleurably elevated into this brave new world with a gift that has only become affordable in recent months.

Quotes from Fascinated Customers

The Radio Shack personal computer surely ought to be on the gift list of every concerned parent, despite that \$599 — though less than a moped — is costlier than an electric train. A father writes to tell us "this investment is one of the most significant in value to our family and to the future education of our child that we have ever seen."

A Californian, aged 12, writes to tell us that he's "too young to go to work for Radio Shack . . . but maybe we could work a deal where I could write some programs for you." An educator thanks us for "making possible the tapping of human innovation and creativity on an unprecedented scale."

Advice for Parents Who Care

In your lifetime the possibility of owning or giving a computer — up to now — was unthinkable. A computer? That can teach? Remember? Display on its own screen? Play games? Complete with a standard typewriter keyboard? Unthinkable — up to now.

But now the Tomorrow Machine is not only thinkable but practical, affordable and available at every Radio Shack store and participating dealer. The TRS-80 personal computer system? For the kids? For Christmas? Crazy? Like a fox!

Radio Shack®
The biggest name in little computers™

A Division of Tandy Corporation
Fort Worth, Texas 76102



TRS-80 manual, written by an educator, is 232 pages of instruction for a beginner.



TRS-80 system includes everything in this picture and, of course, the manual.



TRS-80 is expandable and can grow in power and utility. Everyone in the family becomes involved, entertained, informed.



FIND!

When you discover A P Products, you've got it made.

To electronics hobbyists, A P Products are a "find" every time. You'll see.

You'll find yourself building and testing your circuits faster and easier than you've been able to before. And with optimum electronic integrity.

Part of it is the practical, sensible, useful design of our solderless,

reusable breadboards and interconnectors and testing devices.

The other part is quality. Superior materials. Superior manufacture. Everything pretested. You can truly depend on A P Products.

Item: Our connectors are molded onto the cable, not just crimped on. They just don't pull loose. Try one and see.

Where? Call (toll-free) 800-321-9668 for the name of your local A P store. And ask for our complete A P catalog, The Faster and Easier Book.



A P PRODUCTS INCORPORATED

Box 110 • 72 Corwin Drive
Painesville, Ohio 44077
Tel. 216/354-2101
TWX: 810-425-2250

Faster and Easier is what we're all about.



New Literature

ITT POMONA TEST ACCESSORY CATALOG

An 86-page test accessory catalog from ITT Pomona Electronics lists products such as molded patch cords, cable assemblies, test socket adaptors, spaced molded accessories, molded test leads, connecting leads and banana and phone plugs. The catalog introduces 23 new products and includes cable and wire description and metric conversion charts. Address: ITT Pomona Electronics, 1500 E. Ninth St., Pomona, CA 91766.

CB INTERFERENCE FLYER

"CB Interference Cures" is a flyer describing common FM, TV, and audio interference problems and cures. Topics covered include ac power lines, stereo speaker leads, phono inputs. For a free copy ask for Flyer CB-1 and enclose a SASE. Address: Electronic Specialists, Box 122, Natick, MA 01760.

WESTINGHOUSE SEMICONDUCTOR MOUNTING DATA

Proper mounting methods of power semiconductors is the topic of new application data from the Westinghouse semiconductor division. The seven-page data sheet gives procedures for applying all types of devices—lead mount stud type, flat base and disc. Thermal resistance considerations, surface requirements, cleaning procedures, optimum mounting pressures, hardware considerations, and heat-sink recommendations are covered. The data sheet, entitled "Mounting Power Semiconductors," includes diagrams and tables. Address: Semiconductor Division, Westinghouse Electric Corporation, Youngwood, PA 15697.

TAB BOOK CATALOG

A new 1978 catalog is available from Tab Books. More than 600 current, new, and forthcoming technical and do-it-yourself titles are listed. The 52-page catalog is fully illustrated. Address: Tab Books, Blue Ridge Summit, PA 17214.

TANDY COMPUTER CATALOG

The Tandy Computers 1978 mail-order catalog lists a full line of popular microcomputers and accessories. Kits as well as assembled microcomputers are described, along with software, literature, and parts. The 52-page, four-color catalog can be obtained by calling (toll free) 1-800-433-1679 or writing to the company. Address: Tandy Computers, Dept. R7, Box 2932, Fort Worth, TX 76101.

B&K-PRECISION's new digital probe

offers more than logic.

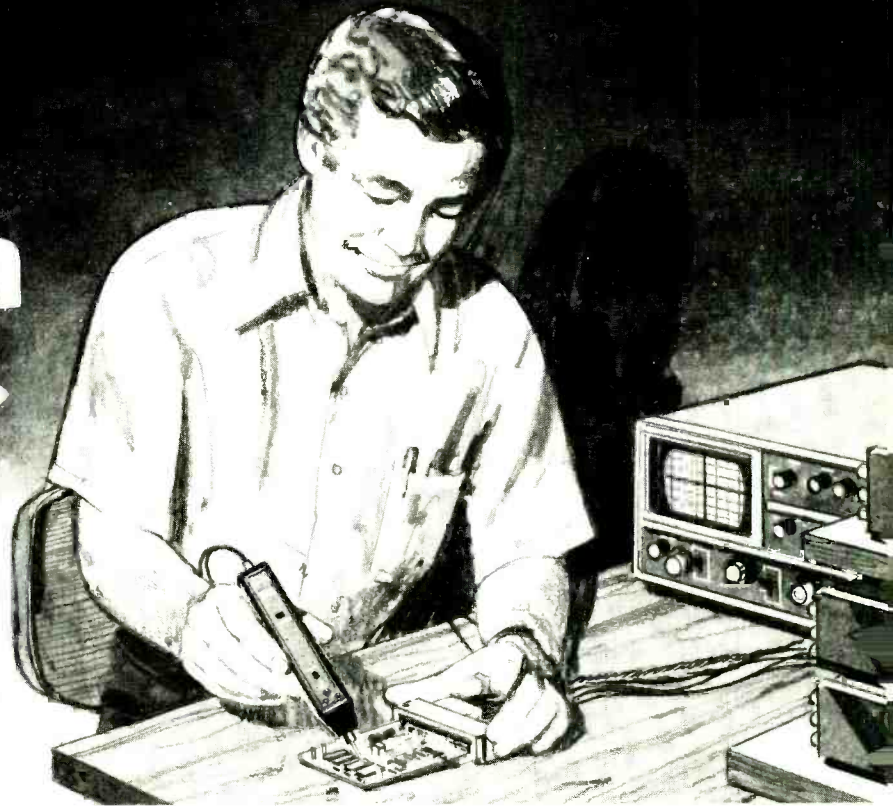

ACTUAL
SIZE



Reveals pulse presence to 50MHz and costs only \$50

Most logic probes do a satisfactory job of indicating logic status, some also display low frequency pulses, but now B&K-PRECISION offers more. The new DP-50 Digital Probe actually displays pulse presence to 50MHz. In addition, the intensity of its PULSE LED is directly proportional to the duty cycle of the signal observed, up to a 10:1 ratio.

For high-speed or intermittent pulses, the DP-50 offers a MEMORY mode to "freeze" and store the pulse display. In the PULSE mode, pulses as short as 10 nanoseconds (typical) are "stretched" for a clear visual indication. A 2-megohm input impedance ensures that the DP-50 will have no effect on the circuit under test. This impedance is significantly higher than ordinary logic probes.

The DP-50 is a multi-family device, compatible with TTL, DTL, RTL, HTL, CMOS, MOS and high-noise immunity logic (HiNIL). As a result, the DP-50 simplifies the analysis and troubleshooting of any digital circuit by clearly displaying in-circuit logic activity. The DP-50 is a compact and lightweight instrument, yet it outperforms conventional logic probes. Like other B&K-PRECISION instruments, the DP-50 is fully overload protected.

At only \$50, the DP-50 is the most cost-effective high-performance digital probe available. All together, the DP-50 offers much more than just logic. But isn't that logical? It's from B&K-PRECISION.

Available from your local electronics distributor.

B&K PRECISION **DYNASCAN CORPORATION**

6460 W. Cortland Street • Chicago, IL 60635 • 312/889-9087

In Canada: Atlas Electronics Ontario
International Sales: Empire Exporters Inc. 270 Newtown Road Plainville, L.I. N.Y. 11803

CIRCLE NO. 7 ON FREE INFORMATION CARD

Now NRI makes it TV/Audio home

Side-by-side equipment comparison of NRI and two other leading schools shows what you get for what you pay.

When you have to pay as much as \$985 more for another school's course, you should carefully consider your tuition investment.

When you sit down and try to pick out the school that's best for you, it gets

to be a problem. Catalogs are radically different and some are not too clear as to what you actually get for your money. So NRI has done a lot of the work for you. And put the prices right up front so you can make your own judgment.

Of course, we can't compare everything. Lesson clarity and content vary. What one covers here, another covers there... or not at all. The material one school breaks down into eight lessons may be four at another. And the qualifications and abilities of instructors are another question.

One Million Students, Over 60 Years' Experience

So we can only tell you what NRI has to offer. We've been in education since 1914, starting as a radio school six years before commercial broadcasting was even on the scene. Since then, we've kept right up with the times, improving techniques, adding material, creating new courses to help people improve their skills and income.

Early on, we learned to keep our lessons compact...thoroughly covering a subject, but not so much that students would be overwhelmed. We call them "bite-size" lessons because they're easy to digest.

Learn by Doing with "Hands-on" Training

And, we pioneered the concept of "hands-on" training. NRI goes far beyond theory and textbooks to give our students actual bench experience and prepare them for the realities of electronic servicing. Every piece of equipment in our Master Course in TV and Audio Servicing is designed for learning. As you assemble the kits we supply, you build a highest-quality, up-to-date 25" (diagonal) color TV, a 4-channel amplifier and tuner with speakers, your own oscilloscope,

	NRI	SCHOOL A	SCHOOL B
COURSE TITLE	Master Course in TV, Audio, and Video System Servicing	Master Course in Color TV Servicing	Electronics Technology and Advanced Troubleshooting I & II
CASH PRICE (terms available)	\$1295	\$1539	\$2280
TV SET	NRI designed-for-learning kit. Dual speaker 25" (diagonal) color TV with cabinet	Heathkit GR-2001 25" (diagonal) color TV (cabinet extra)	Zenith model G-020W 19" (diagonal) color TV (fully assembled)
OSCILLOSCOPE	NRI designed-for-learning kit. 5" (8 x 10 cm) triggered sweep	Heathkit 10-4541 5" (8 x 10 cm) triggered sweep (not given until after graduation)	Heathkit 10-4541 5" (8 x 10 cm) triggered sweep
COLOR BAR GENERATOR	NRI designed-for-learning kit. 10 patterns	Elenco SG-200 (kit) 10 patterns	Elenco SG-200 (fully assembled) 10 patterns
FREQUENCY COUNTER	NRI designed-for-learning kit. Complimentary metal oxide semiconductor digital type		
METER	NRI designed-for-learning kit. Transistorized AC/DC volt-ohm meter	Heathkit (part of TV kit) DC only; 1K Ohm/volt	Private label multimeter
AUDIO	NRI designed-for-learning kit. Four-channel high-fidelity AM, FM tuner with speakers	Private label pocket transistor AM radio kit and AM-FM-SW solid-state portable radio kit	
TRAINER	NRI Discovery Lab	Breadboard	Experimental Electronics Lab
MISCELLANEOUS EQUIPMENT		EICO Digital Logic Probe	

All data as shown in each school's catalog as of September 1, 1978.



Learn as you build with "hands-on" training.

easy to compare study courses.

digital frequency counter, and other instruments you'll use in your course, use later to earn good money as a TV/Audio technician.

The point is, none of this equipment is hobby-kit or commercial assembly line units with lessons "retro-fitted" to what was at hand. NRI has designed each so you get invaluable training and experience you just can't get any other way. As you build, you study operation of circuitry, see how sections interact, perform "power-on" experiments only possible with NRI. This total training is exclusive with NRI...no other school, home study or resident, offers it.

Instructors Who Know Their Business

NRI instructors are thoroughly qualified, with both technical and educational experience. Most of them helped develop NRI courses, lessons, and equipment, so they really know what they're talking about. They're interested in their students, always ready to help with a question, a problem...give good advice to help you reach your goals.

It's instructors and training like this that have made NRI the choice of professional TV servicemen who have taken home study courses. As a national survey shows (summary on request), they recommend NRI by a majority of three to one over any other school.

So how does NRI give you all this and still cost so little? We keep costs down by designing our own training kits, eliminating the middleman's profit on hobby kits or commercial units. And by offering our training by mail only. We have no sales force, no commissions to pay. You make up your mind in your own time, without pressure, let the facts speak for themselves. We pass these savings on to you in the form of lower tuitions, more equipment, carefully designed courses and effective lessons.

Send for Free Catalog, No Salesman Will Call

Send for our free catalog today and get all the details. See every piece of equipment and kit you get...a complete listing of fully described lessons...explanations of each and every experiment you perform. Read about NRI's background and qualifications...career opportunities...what NRI graduates say about their training...costs and monthly payment plans for the courses that interest you. Then compare NRI value and results and make your decision. Like the million that have gone before you, we think you'll choose NRI. Send the card today.



Build and keep 2-meter transceiver, test equipment for a communications career.

Or check out NRI value-training in Computer or Communications/CB Equipment Servicing.

If you're interested in learning how to service and maintain digital computers, check out our NRI course. You learn at home, in your spare time, and actually build a programmable, integrated circuit, digital computer with expanded memory.

Or maybe your interest is CB or the expanding world of communications... mobile radio, microwave,

TV broadcasting, and much more. NRI can help you there, too, as you build and experiment with your own digitally synthesized 2-meter transceiver. For these and other NRI home study courses, just check the postage-paid card and mail today. If card is missing, write to:



NRI Schools
McGraw-Hill Continuing
Education Center
3939 Wisconsin Avenue
Washington, D.C. 20016



Stereo Scene

By Ralph Hodges

NEW MAPS OF SOUND

WHATEVER happened to the great tube vs. transistor debate, the TIM (transient intermodulation distortion) uproar, the showdown between moving-magnet and moving-coil phono cartridges, and all the other provocatively controversial issues that were once ready grist for this column's mill? This was the first question to pop into my mind when I recently reviewed a few years' worth of these columns in search of new directions.

Not many years ago, it was widely believed that new conceptual models for nonlinear phenomena—TIM, for example—and new test techniques for studying them would finally explain what it was that so many seemed able to hear but unable to measure. After all, it appeared certain that these phenomena were being heard, not only by audiophiles but by credentialed engineers. Surely the application of enough intense study to things that were perceptually detectable would ferret out their secrets in time, and give us a means of determining why one amplifier seemed to sound good and another not so good.

Well, the march toward the great sonic truths has not been as orderly or inevitable as it was hoped it would be back then. TIM has been defined and redefined, measured this way and measured that. Yet, a clear-cut correlation between what looks good in the laboratory and sounds good in the listening room eludes us. Moving-coil cartridges continue to measure not especially better nor especially worse than moving-magnet designs—at least according to presently applied tests—and no one can be definite about why some ears seem to prefer them. Several of the original true believers in "esoteric" distortions have actually recanted. Many of those who remain dedicated to the cause are either perplexed by the lack of good ear-instrument correlation or have safely tucked themselves away in a world of abstraction in which they envision future tests that will reveal the whole elephant rather than just its trunk, leg, or tail.

The Whole Elephant. The favorite argument (and it's beginning to sound a little bit like an apology) of researchers who cannot find revealing measurements for what they hear is that all our present-day measurements are dimensionally limited. We plot distortion against frequency or against power output but ignore many time- and phase-related considerations in the measurement. In another test—rise time, perhaps—we'll attack some time-related phenomenon directly, but without relating it in a sophisticated way to the frequency and power output domains. It has long been the view of many researchers that a properly chosen test signal such as an appropriate square wave can enable you to make virtually any significant amplifier measurement you choose. These would include frequency response, effective power output, phase shift, rise time, slew rate, general transient and overload behavior, and—by using modern spectrum-analysis techniques—harmonic and intermodulation distortion. But the problem, according to the critics of present-day measurements, is that we continue to look upon all these amplifier characteristics as separate, independent entities.

What is necessary, the critics further suggest, is an agreed-upon system of mathematical transformations by which all these parameters can be plotted or "mapped" against a set of common (if complex) coordinates, so that their vital interrelationships can be observed. For example, slew rate and high-frequency power output tend to be inversely related; as power output goes up, undistort-

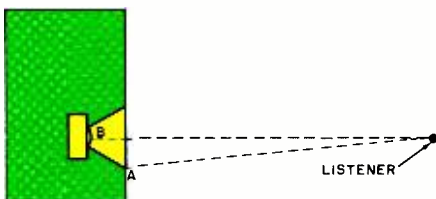

Fig. 1. Due to quick travel through cone, sound from A reaches the listener sooner than from B, where output is supposed to originate.

ed high-frequency response falls off. Something of a trade-off is involved here, and it's presumably important for us to know how much we can balance the requirements of bandwidth and output capability to obtain audible results for most musical material. Present specifications do not even indicate that this critical interrelationship exists. Therefore, we need new "maps," or so the argument goes.

Maps to Where? Speaking before a convention of the Audio Engineering Society in Hamburg, Germany early this year, Henning Møller put forward some practical remarks as to how present specifications for many audio components are deficient. A Dane, but hardly a melancholy one, Møller believes we are now at the point where, with the proper measurements properly interpreted, meaningful correlation between test instruments and ears is just barely possible. Møller (whose connection with Brüel & Kjaer would seem to put him in a position of authority on these matters) proposes six domains of evaluation for an audio system:

(1) 1/3-octave-band steady-state response measurements of the system's acoustical output, taken either in the actual listening environment or in a "standard" room representative of typical environments. Only frequencies from 20 to 2,000 Hz need be considered here.

(2) Free-field (anechoic) evaluations of amplitude and phase performance from 2,000 to 200,000 Hz. This is essentially an examination of the transient behavior of the system, and would reveal aberrations in phase/time coherence.

(3) Amplitude measurements from 200 to 20,000 Hz on varying time bases. "Gating" techniques would be used to examine the system's behavior subsequent to stimulation by a pulse or a tone burst of specific duration. Møller lays particular emphasis on what happens up to 1 millisecond after the cessation of the burst, as well as on spurious "early" reflections that may actually precede the proper output of the system.

(4) Measurements from 2 to 20 Hz, particularly on record players and other program sources involving mechanical operation. This frequency range is the "tonearm resonance, flutter, and rumble domain," and the problems to be expected are time-base fluctuations ("frequency smear") and intermodulation effects extending up into the audio range. Møller is certainly not alone in believing that a turntable flutter measurement is

much more an evaluation of the tone-arm/cartridge combination than an assessment of the platter drive.

(5) Swept two-tone intermodulation measurements from 20 to 20,000 Hz. These are suggested as a more revealing substitute for traditional steady-state THD and IM tests.

(6) Similar swept two-tone tests from 2,000 to 200,000 Hz. These are intended to be revealing of a system's transient performance and its ability to slew with adequate speed.

Rationalizations. It is strongly emphasized that these tests are tentative, awaiting further confirmation of their useful correlation with perceived sound quality. And beyond that will come the business of standardizing procedures, weighting various parameters for their subjective importance and "trade-off" values, and establishing some scheme (if possible) whereby overall "figures of merit" can be awarded. But what, specifically, do these tests have to recommend them?

The first test is a traditional steady-state evaluation of spectrum, with a little more emphasis on interface with the actual listening environment than has been usual. Tests 2 and 3 begin to occupy us seriously with controversial time and phase considerations, which Møller evidently takes quite seriously. For example, he speaks of a situation (Fig. 1) in which the transmission time of an impulse through the material of a speaker cone is so much faster than the speed of sound through air that a spurious "pre-echo" of a transient can actually reach the listener sooner than the signal from the cone's "acoustic center." Compound these effects with (in the case of loudspeakers) the better recognized driver and cabinet resonances as well as diffraction phenomena and we can see that any abrupt impulse a loudspeaker is called upon to reproduce is not likely to be very well defined in time. Møller considers this a very audible fault.

Test 4 gets us into more-or-less steady-state time modulation where we can expect to see distinct spurious frequencies generated as the result of constant infrasonic disturbances in the system. And the remaining two tests look for similar distortion products, this time generated by audible and ultrasonic sig-

nals passing through the system. Møller states that the two-tone swept IM measurements over a 200-kHz bandwidth typically reveal distortion levels of 10 percent in tuners, phono preamplifiers, and tape decks. These distortions frequently consist of difference products that crop up in the audio band, although they are generated by signals well above it in frequency.

One of the arguments that has been repeatedly leveled at wide-band (200-kHz or more) distortion measurements is that there is no reason to believe that frequencies much above 15 kHz ever find their way into an audio system; and if they never get in, there is no point in worrying about just what they might do if present. Lately, however, there has been some evidence to dispute this view. Tuners and tape recorders both make use of ultrasonic signals and, sophisticated filtering notwithstanding, their effects can be clearly heard under the proper conditions (for example, a high-level frequency sweep on a cassette deck can almost always be made to give you a very audible beat with the bias oscillator, descending in frequency as the test signal ascends).

Even record players, traditionally thought to be severely bandwidth-limited, can present some surprising inputs to a phono preamplifier. With a scanning electron microscope, George Alexandrovitch of Pickering/Stanton has measured frequencies higher than 40,000 Hz at levels exceeding 40 centimeters per second on some records! How on earth did such horrendous signals ever get there? It seems unlikely that they have anything directly to do with the music that was being recorded, but they are there nonetheless. Furthermore, since we know that a record player can and often does have a bandwidth exceeding 40,000 Hz (that's what enables CD-4 to work), it is no longer safe to assume that a sound system will merely ignore this sort of recorded information.

Møller presents additional data that persuasively argue for the presence of unexpected levels of ultrasonic energy in phono reproduction. Through the use of a small accelerometer (rather than a test record) B & K has been able to take a closer look at the square-wave responses of various phono cartridges. Figure 2 shows "typical" results for mov-

ing-magnet and moving-coil devices. The rise time for the moving-coil sample is an astonishing 5 microseconds (the moving-magnet achieves a 20-microsecond rating), testifying to an ample bandwidth. The question now arises as to whether the moving-coil cartridge, with its obvious ability to inflict significant amounts of ultrasonic energy upon the phono preamplifier, should really sound better than the moving-magnet device. The question remains to be answered.

Good Enough? Setting aside the interpretive criteria that will have to be applied to this battery of tests, and not even considering how the various results might be brought together into a "multi-dimensional" panorama of overall system performance, we can still ask how well each test seems to meet the requirements others have suggested for good subjective correlation. In this respect, Møller's proposals seem to stack up fairly well. In some respects they may be too stringent. Extending measurements to a bandwidth of 200 kHz (the traditional order of magnitude better than the 20-kHz bandwidth of interest) might just be stretching things a bit for practical power amplifiers. Careful listeners seem satisfied with a usable bandwidth of 80 kHz or so, provided it is free of TIM and related effects. This would make the job of the amplifier designer significantly easier.

Møller's emphasis of time-related performance factors seems to be right on the money. Luckily, now is just the moment for the world to "discover" time-base aberrations in audio equipment because the instrumentation is at last becoming capable of measuring it with real authority. Beyond that, there is one serious practical difficulty that Møller's tests fail to solve: the matter of appropriate performance for individual components, and the problem of interfacing said components. As it stands the program applies itself to the system as a whole, including the listening room. This is undoubtedly the right way to go about the evaluation procedure, but it doesn't suit the marketing realities of high-fidelity equipment in the U.S. very well. It also doesn't address itself directly to the questions that prospective purchasers of audio equipment desperately need answered. Let us hope that someone with resources comparable to Møller's gets excited by these proposals for new test procedures and begins to present the results, tempered by experience, in a form we can truly make use of. ◇

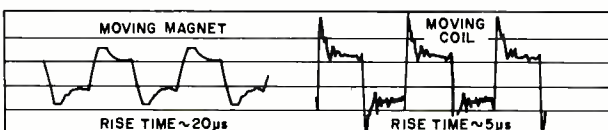

Fig. 2. Responses of moving-magnet (left) and moving-coil cartridges.



Julian Hirsch

Audio Report

Microprocessors in Audio Components

In the few years since it first appeared, the microprocessor—the “computer on a chip”—has made impressive inroads into consumer products. The list of applications grows daily: microwave ovens, automobiles, TV receivers, scanning receivers, video games, CB transceivers, and countless others. High-fidelity components are also a part of that list. Considering the “novelty oriented” nature of many audiophiles, it is surprising that we have not seen even greater use of microprocessors in this popular field.

The range of possible uses for the microprocessor is limited only by one’s imagination. It is as though we have been handed a “universal solution” and merely have to find the problems for it to solve! The first use of a microprocessor in a high-fidelity component was in the ADC Accutrac 4000 turntable. This unit can be programmed to play the various bands of a record in any desired sequence, receiving its inputs from an optical system in the cartridge that counts the blank spaces between recorded bands as the pickup scans the record under motor control. ADC followed up the Accutrac 4000 with the lower priced Accutrac +6, a record changer with many of the same control features. After a considerable delay, it is only now reaching the marketplace. Although the Accutrac players have been available for some time, it is only recently that competitive record-playing products have been announced.

In cassette recorders, the first microprocessor control appeared in the Sharp RT-3388 (and the nearly identical Optonica 6501). Originally, Sharp had a relatively simple feature of counting the quiet spaces between recorded selections on a tape. Thus, it was able to “skip” unwanted selections and go at high speed directly to the desired

program segment. Sharp has now extended this system to include all the tape indexing and counting functions plus real-time tape timing, with its memory rewind and cueing system linked to the digital counter system. Even a quartz-controlled clock is built into the Sharp cassette deck.

The Pioneer CT-F900 cassette deck, tested in this issue, also uses microprocessors, but in a somewhat different way than was used by Sharp. Its capabilities include the various memory indexing and rewind features, but there has been no attempt to include a user-programmable “signal seeking” feature or digital clock. In this regard, it should be noted that even the Sharp decks can only be programmed to scan a tape in one direction (either forward or reverse) looking for a specific selection, but they are not able to be programmed to scan in either direction so as to play sections of a tape in *any* order (as can be done with the Accutrac record players). Pioneer’s most effective use of a microprocessor (so far, unique to its machine) is as an analog-to-digital signal processor for driving the level display tubes.

The Sherwood Micro CPU 100 FM tuner is among the most advanced applications we have seen of a microprocessor in an audio product, with its digitally synthesized tuning and 48 station memory. It also has call letters that appear on the alphanumeric display together with the frequency of each station. In addition, Sherwood’s “on board” computer, by insertion of a special test ROM, can check all its own circuits and those of the tuner section in a matter of seconds. It will identify any incorrectly operating component or semiconductor by circuit symbol number on its alphanumeric display. Considering the complexity of so much of today’s hi-fi equipment, this sort of self-

“It is as though we have been handed a ‘universal solution’ and merely have to find the problems for it to solve!”

\$44.95 KNOW-IT-ALL

CSC's multi-family Logic Probe 1 with memory.
Already the industry standard for performance and value.

This compact, enormously versatile test and troubleshooting aid is like a pencil-sized scope at your fingertips. Simply connect its clip leads to the circuit's power supply, set a switch to the proper logic family, and touch the probe tip to the node under test.

LP-1's unique circuitry does the work of a level detector, pulse detector, pulse stretcher and memory. HI LED indicates logic "1," LO LED, logic "0," and all pulse transitions — positive and negative, as narrow as 50 nanoseconds — are stretched to 1/3 second and displayed on the PULSE LED. One-shot, low-rep-rate narrow pulses — nearly impossible to see even with a fast scope, are easily detectable and visible. And you can indefinitely store single-shot as well as low-rep-rate events.

At frequencies above 1 MHz, there is an additional indication with unsymmetrical pulses: duty cycles of less than 30%, light the LG LED; over 70%, the HI LED. In all modes and circuit states, LP-1's high input impedance virtually eliminates loading problems. The unit also features overvoltage and reverse-polarity protection, interchangeable probe tips, cables and other optional accessories.

Order today. Call 203-624-3103 (East Coast) or 415-421-8872 (West Coast): 9 a.m. - 5 p.m. local time. Major credit cards accepted. Or see your CSC dealer. Prices slightly higher outside USA.

Logic Family Switch — TTL/DTL or CMOS matches Logic "1" and "0" levels; CMOS position also compatible with HTL, HINIL and MOS logic.

PULSE/MEMORY Switch & LED — PULSE position detects and stretches pulses as narrow as 50 nanoseconds to 1/3 sec.; MEMORY stores single-shot and low-rep-rate events indefinitely; HI/LO LED's remain active.

HI/LO LED's — Display level (HI-logic "1" or LO-logic "0") or signal activity.

Interchangeable probe tips — Straight tip supplied; optional alligator clip and insulated quick-connecting clip available. Optional input ground lead.

36" leads — 36" supplied, with alligator clips. Virtually any length leads may be connected via phono jack.

*Metric rec. resole. Slightly higher outside U.S.

© 1973 Continental Specialties Corporation.

Specifications

Input impedance: 100,000Ω

Thresholds (switch selectable)

logic "1" thresholds (HI-LED) 2.25V ± 15%

logic "0" thresholds (LO-LED) 0.60V ± 10%

Min. detectable pulse width 50 nsec. guaranteed

Pulse detector (PULSE LED) in PULSE position of PULSE/MEMORY switch, 1/3-sec pulse stretcher makes high-speed bus stream or single events (+ or - transitions) visible in MEMORY position, first transition lights and activates LED

Operating temperature 0-50°C

Physical size (l x w x d)

5.8 x 1.0 x 0.7" (147 x 25.4 x 17.8mm)

Weight 0.2 oz. (0.065Kg)

Power leads removable 36" (914mm) with color-coded insulated clips; others available

Input protection overload, ± 500V continuous 117 VAC or less than 15 sec.; reverse polarity, 50V; power leads reverse-voltage protected.

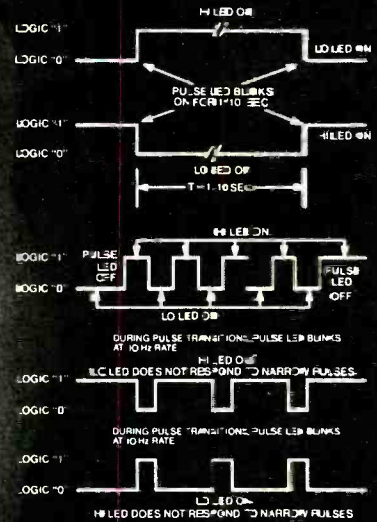

CONTINENTAL SPECIALTIES CORPORATION
CSC

70 Fulton Terrace, Box 1492, New Haven, Ct 06509
203-624-3103 T.V. 710-465-1227

WEST COAST: 351 California St., San Francisco, CA 94104
415-421-8872 T.V. 910-372-7952

GREAT BRITAIN: CSC UK LTD.

Spur Road, North Feltham Trading Estate,
Feltham, Middlesex, England.

01-890-0782 Int'l Telex 851-58-3609

CANADA: Len Finkler Ltd., Ontario

CIRCLE NO 13 ON FREE INFORMATION CARD

NEW LP-1!

checking ability would seem to represent a very healthy trend.

In audio amplifiers, the closest we have seen to a microprocessor-controlled device is the Crown DL-2 preamplifier. It differs from others we have mentioned in that it has no built-in microprocessor. Instead, it has been designed to interface with a computer. (The Sherwood Micro CPU 100 has this potential capability, but there are no connections for the interface. The Crown has the connectors as a standard feature and an interface board will shortly be made available by Crown.) Using this option, the DL-2 can be used to control a sound system, including both program selection and level selection,

completely under computer control.

To do this, its basic operations have been converted to a digital basis. In the case of switching, the change has been relatively simple since switching is inherently digital in nature. The volume adjustment is handled by a reed-relay attenuator system. Volume is normally controlled by a voltage adjusted by a human operator, but it is obviously just as adaptable to a direct computer input.

We have no doubt that many other products will be appearing in the future that employ some of these features and (we hope) many more that can only be guessed at. In the products we have seen so

far, we find a curious mix of genuinely useful features and the other kind—the “solution looking for a problem.” Some of these, to be sure, are obtained “free” when one incorporates a microprocessor. If they are available at the touch of a button, they cost essentially nothing and can add to the appeal of a product. Still, most of the products we have tested so far leave us slightly dissatisfied in their control flexibility. They seem to be able to do so much, yet each of them has some obvious and often irksome limitation. If these are also perceived as drawbacks by the general public, they will likely be corrected in future models, or in competitive products.

audio test reports:

automatic rewind is a control function of the built-in microprocessor



Some interesting new features highlight Pioneer's Model CT-F900 three-head,

two-motor cassette deck. For instance, it has replaced VU meters with fluorescent level indicators; and it has electronic memory controls, a dual-capstan drive system operated through a microprocessor-controlled logic system, and a “double Dolby” system that allows programs to be monitored just as they will sound with noise reduction.

This is a relatively large cassette deck. It measures 16.5”W × 14.5”D × 7.38”H (42 × 36.8 × 18.7 cm) and weighs 24.25 lb (11 kg). An optional rack mounting adapter permits the deck to be installed in a standard 19” (48.3-cm) EIA rack. The suggested retail price of the Pioneer CT-F900 is \$475.

General description. Since the cassette well extends beyond the front panel, the status of the tape on a cassette being played is clearly visible at all

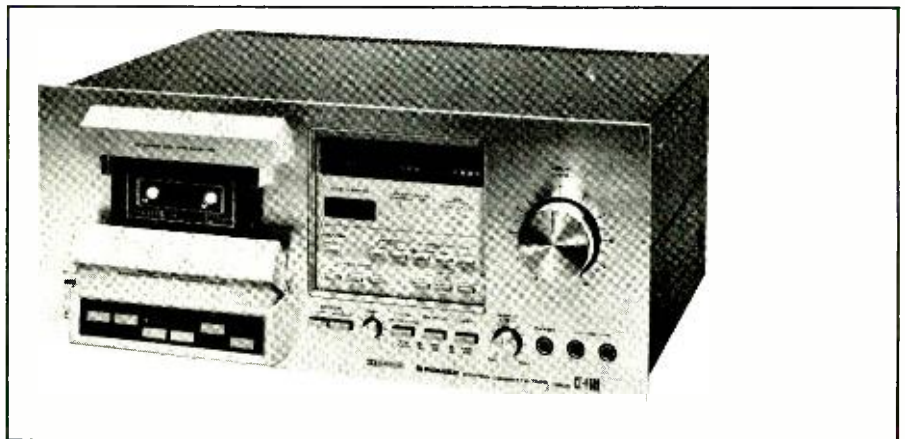

double Dolby, dual-capstan, and fluorescent level indicator in the Pioneer Model CT-F900 stereo cassette deck

times. When it is first inserted, the machine goes into REWIND for an instant, taking up any slack in the tape so that the portion between the two capstans will be under the proper tension. A hinged cover can be swung up to protect the heads and capstans when no cassette is in place.

The tape transport employs a servo-

controlled dc motor for the capstan drive and a mechanical governor-controlled dc motor for the hub drive. The transport is controlled by solenoids that are actuated through a logic system by light-touch buttons located on a black panel below the cassette well. Rectangular transport control buttons are grouped functionally.

TO FULLY APPRECIATE PIONEER'S NEW DIRECT-DRIVE TURNTABLE, YOU HAVE TO TAKE APART THE COMPETITION.

When you compare what goes into most \$175* high-fidelity turntables to what goes into Pioneer's new PL-518, you'll find there's no comparison.

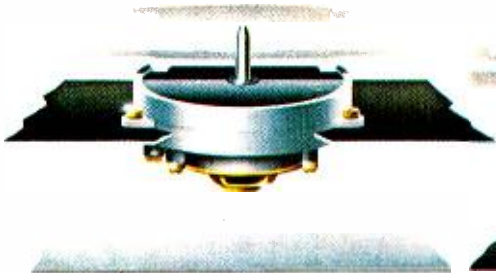

On many turntables, the motor is suspended from the base itself, where the slightest vibration can be picked up by the stylus. The PL-518's direct drive motor is anchored to a metal plate beneath the base, where this is far less likely to happen.

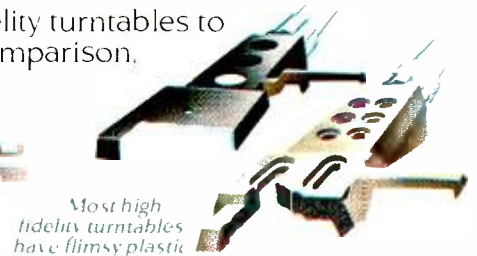
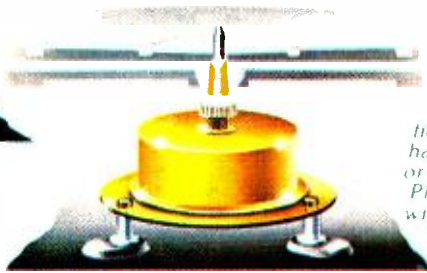

Most high fidelity turntables have flimsy plastic or metal headshells that can distort the music. Pioneer's is made of glass fiber, a substance with far greater mass yet less weight, which is unaffected by resonance.



Many tone arms are mounted on piano wire and cheap plastic casings which vibrate. Instead, ours float on pivot bearings which are immune to vibration.

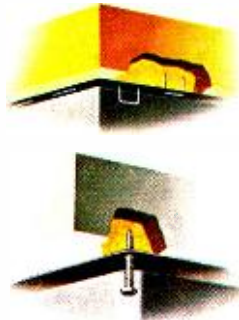

Some turntables are held together by staples, which can work themselves loose. Pioneer uses aluminum screws to seal the base to the base plate.

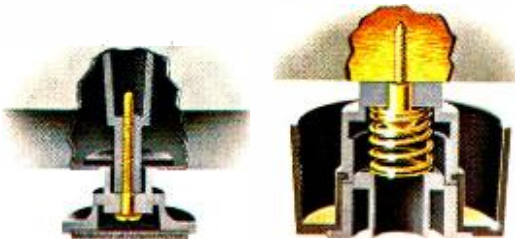

A lot of turntables have skinny plastic legs that merely support the weight of the turntable. The feet of the PL-518 are spring mounted which helps reduce acoustic feedback. So you can play your music loud enough to rattle the walls without rattling the turntable.



Some rely on 3 ball bearings for stability in the tone arm shaft but Pioneer uses 34.

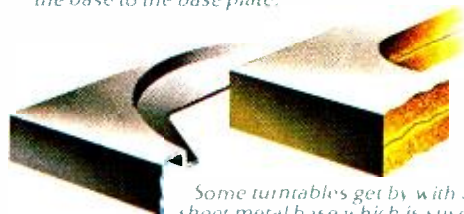

Some turntables get by with a common plastic or sheet metal base which is susceptible to vibration and can cause acoustic feedback. Not the base of the PL-518. It's made of two solid blocks of compressed wood, which when joined eliminate feedback.

What you see here will tell you a lot about Pioneer's PL-518.

It'll not only tell you what kind of care and engineering went into it, but also the kind of exceptional performance you can expect to get out of it. Performance free of audible distortion, acoustic feedback and rumble.

Because at Pioneer, we believe that to get the most out of every piece of music, you've got to get the most out of every part of the turntable.

PIONEER We bring it back a live.

U.S. Pioneer Electronics Corp., High Fidelity Components
85 Oxford Drive, Moonachie, N.J. 07074
*Manufacturer's suggested retail price

CIRCLE NO. 69 ON FREE INFORMATION CARD



At CIE, you get electronics career training from specialists.

If you're interested in learning how to fix air conditioners, service cars or install heating systems – talk to some other school. But if you're serious about electronics, come to CIE –The Electronics Specialists.

John E. Cunningham

**Special Projects Director
Cleveland Institute of Electronics**



My father always told me that there were certain advantages to putting all your eggs in one basket. "John," he said, "learn to do one important thing better than anyone else, and you'll always be in demand."

I believe he was right. Today is the age of specialization. And I think that's a very good thing.

Consider doctors. You wouldn't expect your family doctor to perform open heart surgery or your dentist to set a broken bone, either. Would you?

For these things, you'd want a specialist. And you'd trust him. Because you'd know if he weren't any good, he'd be out of business.

Why trust your education and career future to anything less than a specialist?

You shouldn't. And you certainly don't have to.

FACT: CIE is the largest independent home study school in the world that specializes exclusively in electronics.

We have to be good at it because we put all our eggs in one basket: electronics. If we hadn't done a good job, we'd have closed our doors long ago.

Specialists aren't for everyone.

I'll tell it to you straight. If you think electronics would make a nice hobby, check with other schools.

But if you think you have the cool—and want the training it takes—to make sure that a sound blackout during a prime time TV show will be corrected in seconds—then answer this ad. You'll probably find CIE has a course that's just right for you!

At CIE, we combine theory and practice. You learn the best of both.

Learning electronics is a lot more than memorizing a laundry list of facts about circuits and transistors. Electronics is interesting because it's based on some fairly recent scientific discoveries. It's built on ideas. So, look for a program that starts with ideas—and builds on them.

That's what happens with CIE's Auto-Programmed® Lessons. Each lesson uses world-famous "programmed learning" methods to teach you important principles. You explore them, master them completely... before you start to apply them!

But beyond theory, some of our courses come fully equipped with the electronics gear to actually let you perform hundreds of checking, testing and analyzing projects.

In fact, depending on the course you take, you'll do most of the basic things professionals do every day—things like servicing a beauty of a Zenith color TV set... or studying a variety of screen display patterns with the help of a color bar generator.

Plus there's a professional quality oscilloscope you build and use to "see" and "read" the characteristic waveform patterns of electronic equipment.

You work with experienced specialists.

When you send us a completed lesson, you can be sure it will be reviewed and graded by a trained electronics instructor, backed by a team of technical specialists. If you need specialized help, you get it fast... in writing from the faculty specialists best qualified to handle your question.

People who have known us a long time, think of us as the "FCC License School."

We don't mind. We have a fine record of preparing people to take... and pass... the government-administered FCC License exams. In fact, in continuing surveys nearly 4 out of 5 of our graduates who take

the exams get their Licenses. You may already know that an FCC License is needed for some careers in electronics—and it can be a valuable credential anytime.

Find out more! Mail this card for your FREE CATALOG today!

If the card is gone, cut out and mail the coupon.

I'll send you a copy of CIE's FREE school catalog, along with a complete package of independent home study information.

For your convenience, I'll try to arrange for a CIE representative to contact you to answer any questions you may have.

Remember, if you are serious about learning electronics... or building upon your present skills, your best bet is to go with the electronics specialists—CIE. Mail the card or coupon today or write CIE (and mention the name and date of this magazine), 1776 East 17th Street, Cleveland, Ohio 44114.



Patterns shown on TV and oscilloscope screens are simulated.



CIE Cleveland Institute of Electronics, Inc.

1776 East 17th Street, Cleveland, Ohio 44114
Accredited Member National Home Study Council

YES... John, I want to learn from the specialists in electronics—CIE. Send me my FREE CIE school catalog—including details about troubleshooting courses—plus my FREE package of home study information. PE-77

Print Name _____

Address _____ Apt. _____

City _____

State _____ Zip _____

Age _____ Phone (area code) _____

Check box for G.I. Bill information: Veteran Active Duty

Mail today!



You heard it was coming. You heard right!

(Make sure your Santa hears about it.)



The Prince On-Board Computer. You've read about digital computers being available soon from Detroit. Now the first universal driver-operated automotive computer is available! It's a revolutionary electronic brain that's unquestionably going to be the **ULTIMATE OPTION** for '79.

What it will do for you. The Prince On-Board Computer provides more than two dozen different kinds of information at the touch of a button.



The On-Board Computer measures only 10.5" x 2.8" x 1.7" and mounts easily in any vehicle.

Data such as vehicle location (10/20 to CB'ers). Miles-to-go on a trip. Estimated time of arrival. Miles per gallon and

cost-per-mile. Plus five memories to store mileage points with unique audio alarm reminders — and more!

Test drive one today.

Your new car dealer can arrange for a test ride in a Prince On-Board Computer-equipped car today. Or you can contact your local A.R.A. distributor* for more information. And if you're not in the market for a '79 right now, the POBC can be installed on your present car, van or truck.

Prince™ on-board™ computer

Manufactured by Prince Corporation, Holland, Michigan. Prince and On-Board are trademarks of Prince Corporation. Patents pending.

* Look in the Yellow Pages under Automotive Air Conditioners, or write Mr. Al Brandimarte, A.R.A., P.O. Box 870, 606 Fountain Parkway, Grand Prairie, Texas 75050. Call toll-free 800-527-7914 (U.S.A.) In Texas 214-647-4111.

CIRCLE NO. 57 ON FREE INFORMATION CARD

Product Focus

Although the Pioneer Model CT-F900 is not the first cassette deck to employ a microprocessor for certain of its functions, it is the first to our knowledge to use one as a signal processor for operating a digital level display. The instruction manual for the deck does little more than state that the "brain" of the level indicating system is a 4-bit parallel processing chip. The schematic adds a little more information, and shows that the microprocessor is a 28-pin LSI device

The audio levels, as they appear at the LINE outputs of the recorder, are amplified and detected, and the rectified audio is supplied to the LSI chip, where it is apparently sampled at a high rate (an LC tuned oscillator circuit is connected to the IC); digital equivalents of the instantaneous analog levels are generated. The outputs of the LSI chip go to the many terminals of the Digitron level display tube, a 20-segment device whose square fluorescent "dots" are controlled by the digital signals applied to it.

The on/off nature of the display segments removes the ambiguity that detracts from the accuracy and usefulness of most LED peak level indicators. As the level is increased slowly, there comes a point when the next higher segment, even if only 1 dB above the last one to be illuminated, lights abruptly, with no intermediate state of partial brightness. The selection of either PEAK or AVERAGE response is made before the signals go to the microprocessor by changing the signal circuit's time constant.

Although many of the functions of the Pioneer level display can be done with conventional LED systems, we found the very bright, visible, and unambiguous blue Digitron display to be both more useful and more attractive than any of the LED displays we have seen.

Small, colored indicators near the buttons light when the buttons are actuated.

The logic system makes it possible to operate the controls in any sequence without damage to the tape or the deck. Pressing any control while the tape is in motion momentarily stops the deck before executing the change of mode. The transport shuts off and mechanically disengages when the tape stalls at the end of a cassette, or in the event a tape should break.

At the upper right of the panel is a large recording INPUT level control that consists of two concentric knobs coupled by a slip clutch. Below it are two microphone jacks (for dynamic or electret microphones), a stereo headphone jack for low-impedance phones, and a small concentric knob control for adjusting the

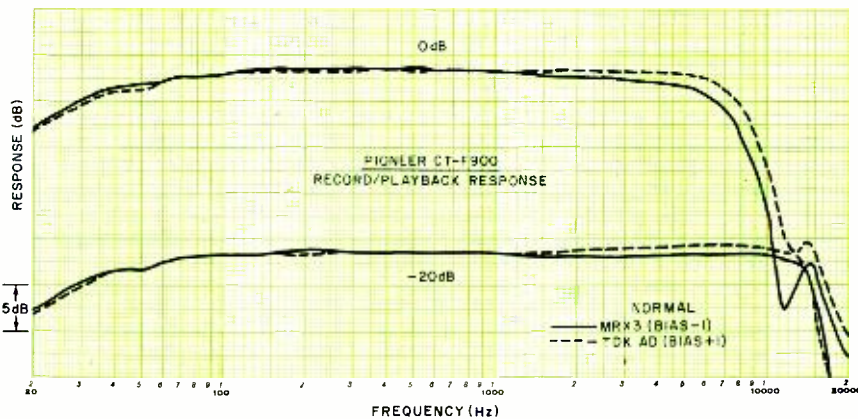

Frequency response at two recording levels for two standard tapes.

playback OUTPUT level. In the lower center of the panel are a number of push-button switches. Two are for selecting the program that appears at the LINE outputs (SOURCE or TAPE playback) in the rear. The recording input can be transferred from the rear LINE jacks to the microphone inputs by one of the buttons (the two sources cannot be mixed, however). One button turns on and off

easy-to-read signal level is shown on a fluorescent vacuum-tube display

the Dolby system, and another selects the recording bias and record/playback equalization. In the AUTO (out) position of this latter button, the recorder automatically selects the bias and equalization for any ferric (STD) or chromium dioxide (CrO₂ or a "chrome equivalent" tape such as TDK SA, Maxell UD-XL II, etc.) tape. This is done by a sensor

that detects the special notch in the back of a chrome cassette.

When the TAPE button is pushed in, the bias and equalization are set for ferrichrome (FeCr) tape. A small BIAS knob near the TAPE button can be used to trim the bias over a limited range to optimize the recorder for any specific brand of tape within the three basic categories.

Some of the most novel features of the Model CT-F900 are contained in a square indicator and control subpanel in the center of the front. Across its top are two horizontal rows of level indicators from a fluorescent Digitron vacuum tube display that creates a row of blue-lighted squares that moves to the right with increasing signal level. There are separate rows of level indicators for the two channels. Between the rows is a calibrated scale that covers a -20-to-+7-dB range. Below the level-indicator display is a large three-digit TAPE COUNTER display made up of 8-mm high Digitron numerals that can be seen easily from a considerable distance.

Twelve small pushbuttons on the sub-panel control the unique operating features of the CT-F900. The deck has a

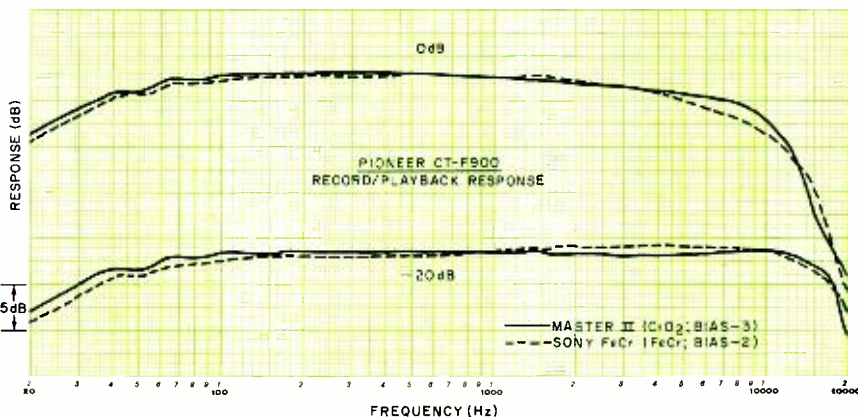

Frequency response at two recording levels for "chrome" and FeCr tapes.

Performance Specifications

Specification	Rating	Measured
Frequency Response		
Standard LH tape: (20-17,000 Hz)	30-15,000 Hz ± 3 dB	Within limits
Chromium dioxide tape: (20-19,000 Hz)	30-17,000 Hz ± 3 dB	Within limits
Ferrichrome Tape: (20-19,000 Hz)	30-17,000 Hz ± 3 dB	Within limits
S/N Ratio: Dolby off	Over 54 dB	55 to 63 dB
Dolby on	Over 64 dB	62 to 68 dB
Harmonic distortion	Less than 1.3% (0 dB)	—
Input sensitivity		
MIC:	0.3 mV	0.22 mV
Line:	60 mV	50 mV
Max. Allowable input/imp.		
MIC:	100 mV/30,000 ohms	150 mV
Line:	25 V/100,000 ohms	—
Max. output level	640 mV into 50,000 ohms	—
Fast winding time (C-60)	Under 85 sec weighted	80 sec
Wow and Flutter	0.05% weighted rms max.	0.06% weighted rms

"memory rewind" like that offered on a number of other tape decks, except that it operates entirely electronically through a special purpose LSI microprocessor that can perform four different memory functions. In the MEMORY STOP mode, pressing the rewind button causes the tape to rewind to the point where the indicator reads 000, and stop. MEMORY PLAY is similar, except that it goes into a normal play mode after stopping. REPEAT END operates automatically when the end of the tape is reached, rewinding the tape to its beginning and replaying it. COUNTER REPEAT operates in a similar fashion, except that the tape rewinds to 000 and starts playing from there.

The deck can be operated from an external clock timer for unattended playback or recording of programs. After the machine has been set up for correct recording conditions, it and the program source are plugged into the clock timer and the TIMER START-REC button is pressed. When power is restored by the timer, the recorder automatically goes into the record mode. For playback only, TIMER START-PLAY is pressed.

external clock
timer can be
set for recording

The level meter is more than merely a nonmechanical voltage indicator. It can be set to read AVERAGE levels, roughly corresponding to a VU meter, or to be a PEAK meter that can accurately follow the shortest musical transients. There is also a PEAK HOLD mode, in which the highest peak level attained is held on the display. A button resets the TAPE COUNTER to 000, and colored indicator lights show the status of the MEMORY, DOLBY, and TAPE BIAS systems.

Laboratory Measurements. No information was supplied on specific tapes for which the bias had been set on the tape deck we tested, so we ran frequency-response curves on a dozen or more tapes, adjusting the BIAS control for flat-test response for each tape. Although our BIAS settings usually did not match the recommendations in the manual, the differences were not large, and perfectly satisfactory results should be obtained with almost any good-quality tape. In the absence of built-in oscillators, the best way to make this adjustment is to record interstation FM tuner hiss at a -20 -dB level and switch between the SOURCE and the TAPE monitor signals while adjusting the BIAS control for the closest audible match between the two.

We selected one of each basic tape type for the balance of our tests. (The selection was partly arbitrary, and partly because these tapes seemed to give the

flattest overall frequency response.) Scotch Master II was used for the "chrome" tape. This is a cobalt-treated ferric tape, designed for chrome bias and $70\text{-}\mu\text{s}$ equalization. Sony Ferrichrome was used for the FeCr tape and Memorex MRX3 for the STD tape.

At a -20 -dB recording level, the frequency response was within the manufacturer's limits of ± 3 dB over a range of 30 to 15,000 Hz for STD tape and 30 to 17,000 Hz for the other two tapes. The low-end response dropped off smoothly below about 60 Hz, with almost no sign of the response "ripples" that are typical of most cassette recorders. The response was, in fact, much flatter than the Pioneer specifications would suggest. With Master II tape, it varied less than ± 0.5 dB from 55 to 14,000 Hz, and the other tapes yielded very nearly as good results.

a rare combination
of listening quality
and operating
versatility

The "tracking" of the Dolby circuits was acceptable at a -20 -dB level, where they changed the overall response by about 2 dB over much of the high-frequency range. It was virtually perfect at -40 dB, where there was no detectable change in response until the frequency exceeded 10,000 Hz. The $120\text{-}\mu\text{s}$ (STD) playback equalization was measured with a TDK AC-337 test tape. The response was an excellent ± 0.5 dB from 60 to 12,500 Hz and was up only 1 dB at 40 Hz. At first, it seemed that we would not be able to measure the $70\text{-}\mu\text{s}$ (CrO₂) equalization, since our test tapes do not have the notch that switches the recorder. However, we found that the FeCr switch setting changed the playback equalization to $70\text{-}\mu\text{s}$. With our Teac 116SP tape we found it to be flat within ± 1 dB over the 40-to-10,000-Hz range of the tape.

A line input of 50 mV or a microphone input of 0.22 mV was needed to produce a 0-dB recording level. The microphone inputs overloaded at 150 mV, the highest figure we have measured on a cassette recorder. The playback output from a 0-dB recording varied somewhat with the tape used, from 0.59 volt with Master II to 0.78 volt with MRX3. The third-harmonic playback distortion with a

1000-Hz input signal was measured with each tape as a function of recording level. The reference 3% distortion level was measured at 0 dB with the Master II tape and at -0.5 dB with Sony FeCr. With Memorex MRX3, we measured only 0.5% up to a +3-dB level and had to record at +7.5 dB to measure 3% distortion in the playback mode.

The playback S/N ratio, referred to the signal level that produced 3% distortion, was about 50 dB in an unweighted measurement with Master II and FeCr tapes. It was a very good 57 dB with MRX3. With A weighting, the S/N was 55 to 56 dB with the first two tapes and 63 dB with MRX3. Finally, with CCIR/ARM weighting and using the Dolby system, the S/N was 62 dB with the first two tapes and 68 dB with MRX3. The noise level increased by 18.5 dB through the microphone inputs at maximum gain and by 5 dB when the gain was set to its center position.

Tape speed in our sample machine was about 0.5% fast. In the fast-speed modes a C60 cassette was moved from end to end in about 80 seconds. The flutter, with a weighted rms (JIS) measurement, was a low 0.06%. Even the weighted peak flutter (DIN) was a very good $\pm 0.08\%$. The playback flutter readings were made with a TDK AC-342 test tape. In a combined record/playback measurement, the flutter was 0.07% wrms and $\pm 0.14\%$ weighted peak. The flutter was principally in the 15-to-20-Hz range, with another peak at 55 Hz.

User Comment. When we recorded interstation FM tuner hiss at a -20-dB level and listened to the playback, we

discovered that all three tapes we had chosen were capable of almost perfect response. In each case, there was only a very slight difference in the playback signal that we were unable to eliminate with the BIAS control. Even though the BIAS adjustment appears to lack the convenience of use that we have seen on some other recorders that have built-in test oscillators for making this adjustment, we believe that by using tuner hiss one can actually come closer to an optimally flat response in most cases.

The fluorescent level "meters" worked very well, being accurate and extremely easy to read. In the AVERAGE mode, they indicated about 1 dB low on 0.3-second tone bursts, which is slightly slower than a standard VU meter but still better than most mechanical meters used on consumer cassette recorders. As PEAK indicators, this indicator is one of the best, with virtually instantaneous response and a slow decay that takes a couple of seconds to descend through its full range.

It is worth noting that shutting off the recorder returns the TAPE COUNTER to 000. If one is recording or playing a tape and interrupts it by shutting off the power the electronically controlled index counter reading is lost, unlike the case with mechanical index counters.

Although the manual does not recommend using high-impedance phones with the Model CT-F900, we found that it produced very comfortable listening levels with 200-ohm phones (most recorders cannot). The various special functions of the machine, such as the MEMORY and REPEAT features and TIMER operation, worked perfectly. The automatic tape sensing system excluded older

chromium-dioxide tapes from use. Although the manual does not mention this, these tapes can be played (but not recorded) by pushing the selector button to its FeCr setting.

We can say unequivocally that the Pioneer Model CT-F900 is a first-rate cassette deck. The sound quality of prerecorded tapes and of tapes we made on this machine was uniformly excellent. There is no longer much excuse for distorted recordings due to excessive signal levels. The PEAK HOLD feature lets one know, after one brief practice run, what maximum level to expect from any program. A convenient feature of this deck is its ability to make "flying-start" recordings. This can also be valuable in editing tapes. While listening to a tape, at any point where one wishes to record another program, holding down both the PLAY and REC buttons places the machine in its recording mode.

As we have often found with cassette decks, the greatest dynamic range is usually obtained with a good ferric tape. The chrome and ferrichrome tapes saturate at a lower level, and cannot be recorded as heavily without excessive distortion. However, they have better high-frequency saturation characteristics. So if the program has strong high-frequency content, these tapes will often give the best results, in spite of their slightly reduced midrange.

The Model CT-F900, which stands second from the top in price among Pioneer's six front-load cassette decks, offers a rare combination of listening quality and operating versatility. Combined with a price that is, by today's standards, moderate, it ranks extremely high among other high-quality decks.

CIRCLE NO. 101 ON FREE INFORMATION CARD

solid and conservative design in a premium product: the Luxman Model R-1120 AM/FM stereo receiver

novel afc
circuit is
especially effective



Several AM/FM stereo receivers were added to Luxman's line recently. The most powerful of these is the Model R-1120. It

is rated to deliver up to 120 watts/channel into 8 ohms from 20 to 20,000 Hz at no more than 0.03% THD. The external design of these new receivers is intended to minimize the visual impact of their less frequently used controls and to give the front panel of the receiver an uncluttered appearance without sacrificing any of the operating and control versatility expected of such a deluxe product.

The Model R-1120 is supplied in a rosewood-veneered wooden cabinet. It measures 19¼"W × 16⅝"D × 7⅛"H (49 × 41.5 × 18 cm) and weighs 37.4 lb (17 kg). Its suggested retail price is \$995. An optional Dolby FM decoder module that plugs into the inside of the receiver and



amplifier output is displayed via LED indicators at six levels

is controlled by a front-panel switch is available for \$55.00.

General Description. The front panel and control knobs of the receiver are finished in a pale bronze tone. The contrasting dark-brown dial section is covered by a clear glass window. Behind the window are the long AM and FM scales, separate tuning meters for relative signal strength on AM and center-channel tuning on FM, and a number of LED indicators. One LED, labelled DOLBY FM, is functional only when the Dolby FM decoder module is installed. When the DOLBY FM button is pressed, the FM tuner's deemphasis is changed to 25 μ s, the Dolby decoder is activated, and the LED indicator comes on. If the Dolby module is not installed, pressing the DOLBY FM button silences the tuner's output (the LED remains off).

Near the Dolby LED is another LED labelled STEREO FM. This LED comes on only when a stereo-FM signal is being received.

In the lower right of the dial area are two horizontal rows of LED's that make up the peak power indicator. Each of the receiver's two channels is assigned six LED's that indicate 0, -6, -9, -12, -15, and -18 dB, relative to the rated 120-watt output of the amplifier. A pushbutton switch on the front panel can be pressed to increase the sensitivity of the display by 12 dB so that the -18-dB LED comes on when the output is only 120 mW. A switch on the rear apron permits the power display to be defeated if desired.

A large tuning knob bisects the lower edge of the dial cutout and operates a very smooth flywheel tuning mechanism. Above the dial scales is a row of small control knobs and pushbutton switches that are inconspicuous because of their sizes and the fact that their brown color blends with the panel's background. They include pushbuttons for the DOLBY FM system, FM MUTING OFF, tape MONITOR, and tape DECK 1/2 select. The last connects the monitoring inputs to either of two tape decks. A small knob switch is provided for interconnecting the tapes for dubbing from one deck to another. A similar control is used to select the receiver's operating mode, for which there are STEREO, MONO, and REVERSED STEREO.

switch provides dubbing capability for two tape decks

Other pushbutton switches are provided for switching in and out LOUDNESS compensation, a SUBSONIC filter, LOW CUT and HIGH CUT filters; changing the sensitivity of the power display; and switching on and off the POWER. When power is first applied, the speaker outputs are silenced and a red LED near the POWER switch flashes on and off for

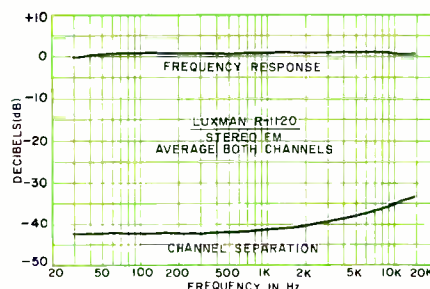

Frequency response and crosstalk averaged for both FM channels.

about 7 seconds. After this stabilization period, the speaker outputs are activated and the LED extinguishes. If an overload or short circuit should occur in the output during operation, the speaker outputs are instantly disabled and the LED commences flashing until the fault is corrected.

The remaining control knobs are in a single row across the bottom of the front panel. The INPUT SELECTOR switch has positions for AM, FM, PHONO 1, PHONO 2, and AUX inputs. The smaller bass and treble TONE CONTROL knobs are continuously adjustable and have center detents. Also, pulling out on the knobs changes the turnover frequencies by one octave. (The bass frequencies are 200 and 400 Hz and the treble are 2000 and 4000 Hz.)

The VOLUME CONTROL is concentric with a center-detented BALANCE ring. The SPEAKERS selector switch can be used to connect either, both, or neither

Product Focus

Although in most respects the Luxman Model R-1120 follows conventional receiver design practice, we found, to our surprise, that it has a novel afc system that is not mentioned as such in the instructions or specifications. Our only clue to its existence came from a study of the functional block diagram in the instruction manual, which showed a connection from the detector output, through a "servo amplifier" block, to the FET r-f amplifier stage. This might have been an amplified afc system, except that the afc function was clearly shown as a separate part of the circuit, and a switch on the "servo amplifier" was identified as "FM Tuning Lock" (This is not a physical switch that can be seen on the receiver, however.) We suspected that this was some form of afc, which should have been shown as going to the local oscillator instead of to the r-f amplifier. A little experimenting confirmed this.

Although this afc system is nondefeatable, and as a rule we consider a non-defeatable afc to be highly undesirable, as used in the Model R-1120, it proves to be a strong "plus" feature. It is actually disabled electronically at all times, except when the receiver is tuned very close to the center of a channel (so that the tuning meter's pointer has entered its center segment). At that point, the afc takes over and imperceptibly pulls the tuning all the way to its correct point. This system prevents the afc from interfering with tuning in a weak signal adjacent to a channel occupied by a strong signal, yet it makes mistuning virtually impossible.



Performance that's easy to handle.

The Motorola[®] System 500 Remote CB. The first full-featured Remote that's easy to handle. It's designed to feel natural. To operate effortlessly. With about as much thought as you give to shifting gears.

But what good is a Remote that fits your hand, if it doesn't fit your needs? The Motorola System 500 Remote features a 2-speed channel selector. A local/distance switch that reduces interference and background noise. A channel 9 emergency switch that puts you in touch with help instantly when you need it.



You also get the CB features you've come to expect from Motorola. Like a phase lock-loop synthesizer. Power mic. Phosphorescent control labels for easy identification. Hot-last channel memory. L.E.D. channel readout. And an optional relay which interrupts radio audio as CB messages are received.

As easy as it is to handle and operate, this CB is tough to steal. The transceiver chassis is compact — easily hidden away in the trunk, under the seat, or mounted on the firewall.

The complete, uncomplicated Motorola System 500 Remote. Because when you're driving, you've got enough to handle.



MOTOROLA
CB

CIRCLE NO. 40 ON FREE INFORMATION CARD

To find the dealer nearest you, write: Market Relations Manager, Motorola, Inc., Automotive Products Division, 1299 East Algonquin Road, Schaumburg, Illinois 60196. Motorola is a registered trademark of Motorola Inc.

FREE

World's biggest and best source of top-quality electronic kits!
Look at what's new in our new just-off-the-press catalog!

NEW

Computerized Weather Monitor



If you need weather information for ANY purpose, the ID-4001 is the way to get it! This microcomputer-based weather instrument displays — time of day in 12 or 24-hour format; wind direction and magnitude; indoor and outdoor temperature; barometric pressure; even wind chill factor! What's more, the computer's memory stores the highest and lowest data for each function so you can recall it for easy and accurate record keeping. Chart recorder and computer outputs provide even more versatility!

NEW

Rack-Mount Stereo Components



Heath has developed an entire new line of sophisticated audio equipment designed to offer the striking good looks and versatility of rack mounting combined with specifications and performance capabilities that are the equal of the finest components available today! The AA-1600 Stereo Power Amplifier features 125 watts, minimum RMS, per channel into 8 ohms, with less than 0.05% total harmonic distortion from 20-20,000 Hz. The AD-1700 provides a graphic LED display of power output to monitor system performance and help prevent overloads. Other components soon to come will be a versatile, low-distortion stereo preamplifier, and a deluxe digital FM-AM Stereo Tuner.

NEW

Digital Readout Car Clock with Trip Timer



Versatile clock/timer for any vehicle shows time in hours and minutes, has 24-hour timer that reads to nearest second. Bright, easy-to-read display, low-power circuit doesn't drain battery.

NEW

Deluxe Dual-Trace Oscilloscope



Low-priced dual-trace scope ideal for audio and TV servicing. Features outstanding sensitivity, extra-bright traces, selectable triggering, 7-position variable time base, DC to 5 MHz bandwidth.

NEW

Hand-Held 2-Meter Transceiver



Superb features specifications and a great low price make the VF-2031 a terrific buy in a hand-held two-meter transceiver. Features 8-channel simplex with ± 600 kHz offset using one crystal per channel, minimum 2 watts out, and 0.5 μ V sensitivity for 20 dB quieting. Includes built-in antenna, nickel-cadmium batteries and battery charger. An optional tone encoder and other accessories also available.

NO PREVIOUS EXPERIENCE NECESSARY

Thousands of people with no electronics experience whatsoever — people who have never handled a soldering iron before — have proved that you can build any Heathkit product you want — and enjoy every moment of it! Simple step-by-step manuals make it easy as 1-2-3, and every Heathkit product you build will be a source of pride and satisfaction for years to come as you say "I built it myself"!



Heath Company, Dept. 010-470
Benton Harbor, Michigan 49022

HEATHKIT ELECTRONIC CENTERS* PROVIDE SALES AND SERVICE



* Units of Schlumberger Products Corporation. Retail prices on some products may be slightly higher.

Opening Soon:
Salt Lake City, Utah; Oklahoma City, Okla.

ARIZONA — Phoenix, 85017, 2727 W. Indian School Rd. 602-279-6247.

CALIFORNIA — Anaheim, 92805, 330 E. Ball Rd. 714-778-9420; El Cerrito, 94530, 6000 Potrero Ave. 415-236-8870; Los Angeles, 90007, 2309 S. Flower St. 213-749-0261; Pomona, 91767, 1555 Orange Grove Ave. N. 714-623-3543; Redwood City, 94063, 2001 Middlefield Rd. 415-365-8155; Sacramento, 95825, 1860 Fulton Ave. 916-486-1575; San Diego, (La Mesa, 92041), 8363 Center Dr. 714-461-0110; San Jose (Campbell, 95008), 2350 S. Bascom Ave. 408-377-8920; Woodland Hills, 91364, 22504 Ventura Blvd. 213-882-0531.

COLORADO — Denver, 80212, 5940 W. 38th Ave. 303-422-3408.

CONNECTICUT — Hartford (Avon, 06001), 395 W. Main St. 303-422-3408.

FLORIDA — Miami (Hialeah, 33012), 4705 W. 16th Ave. 305-823-2280; Tampa, 33614, 4019 West Hillsborough Ave. 813-886-2541.

GEORGIA — Atlanta, 30342, 5285 Roswell Rd. 404-252-4341.

ILLINOIS — Chicago, 60645, 3462-66 W. Devon Ave. 312-583-3920; Chicago (Downers Grove, 60515), 224 Ogden Ave. 312-852-1304.

INDIANA — Indianapolis, 46220, 2112 E. 62nd St. 317-257-4321.

KANSAS — Kansas City (Mission, 66202), 5960 Lamar Ave. 913-362-4486.

KENTUCKY — Louisville, 40243, 12401 Shelbyville Rd. 502-245-7811.

LOUISIANA — New Orleans (Kenner, 70062), 1900 Veterans Memorial Hwy. 504-722-6321.

MARYLAND — Baltimore, 21234, 13, E. Joppa Rd. 301-861-4446; Rockville, 20852, 5542 Nicholson Lane. 301-881-5420.

MASSACHUSETTS — Boston (Peabody, 01960), 242 Andover St. 617-531-9330; Boston (Wellesley, 02181), 165 Worcester Ave. (Rt. 9 just west of Rt. 128) 617-237-1510.

MICHIGAN — Detroit, 48219, 18645 W. Eight Mile Rd. 313-535-6480; E. Detroit, 48021, 18149 E. Eight Mile Rd. 313-772-0416.

MINNESOTA — Minneapolis (Hopkins, 55343), 101 Shady Oak Rd. 612-938-6371; St. Paul, 55106, 1645 White Bear Ave. 612-778-1211.

MISSOURI — St. Louis (Bridgeton) 63044, 3794 McKelvey Rd. 314-291-1850.

NEBRASKA — Omaha, 68134, 9207 Maple St. 402-391-2071.

NEW JERSEY — Fair Lawn, 07410, 35-07 Broadway (Rte. 4) 201-791-6935; Ocean, 07712, 1013 State Hwy. 35. 201-775-1231.

if you want quality...value...and pride of craftsmanship
 get the **NEW HEATHKIT® CHRISTMAS CATALOG!**



COAST-TO-COAST

NEW YORK — Buffalo (Amherst, 14226), 3476 Sheridan Dr. 716-835-3090; Jericho, Long Island, 11753, 35 Jericho Turnpike, 516-334-8181; Rochester, 14623, 837 Jefferson Rd. 716-244-5470; White Plains (North White Plains, 10603), 7 Reservoir Rd. 914-761-7690.

OHIO — Cincinnati (Woodlawn, 45215), 10133 Springfield Pike, 513-771-8850; Cleveland, 44122, 28100 Chagrin Blvd. 216-292-7553; Columbus, 43229, 2500 Morse Rd. 614-475-7200; Toledo, 43615, 48 S. Byrne Rd. 419-537-1887.

PENNSYLVANIA — Philadelphia, 19149, 6318 Roosevelt Blvd. 215-288-0180; Frazer (Chester Co.), 19355, 630 Lancaster Pike (Rt. 30) 215-647-5555; Pittsburgh, 15235, 3482 Wm. Penn Hwy. 412-824-3564.

RHODE ISLAND — Providence (Warwick, 02886), 558 Greenwich Ave. 401-738-5150.

TEXAS — Dallas, 75201, 2715 Ross Ave. 214-826-4053; Houston, 77027, 3705 Westheimer. 713-623-2090; San Antonio, 78216, 7111 Blanco Road. 512-341-8876.

VIRGINIA — Alexandria, 22303, 6201 Richmond Hwy. 703-765-5515; Norfolk (Virginia Beach, 23455), 1055 Independence Blvd. 804-460-0997.

WASHINGTON — Seattle, 98121, 505 8th Ave., N. 206-682-2172.

WISCONSIN — Milwaukee, 53216, 5215 W. Fond du Lac. 414-873-8250.

HEATH Schlumberger	Heath Company, Dept. 010-470 Benton Harbor, Michigan 49022
Please send me my FREE Heathkit Catalog. I am not on your mailing list.	
Name _____	
Address _____	
City _____	State _____
Zip _____	
NOTE: This FREE Catalog Coupon can also be redeemed at any of the Heathkit Electronic Centers* nationwide. (See list at left)	

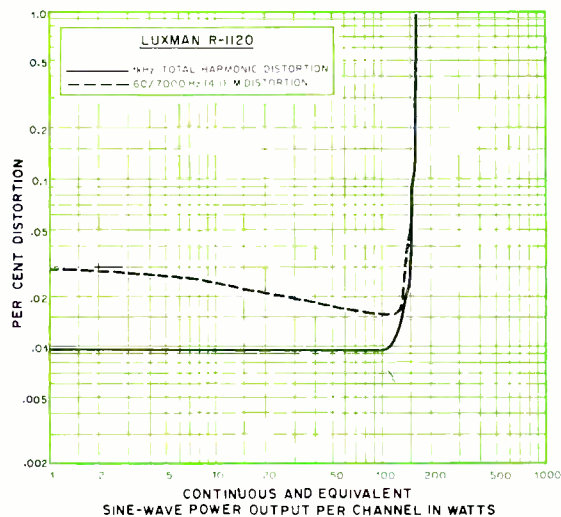

Total harmonic distortion and 60/7000-Hz distortion.

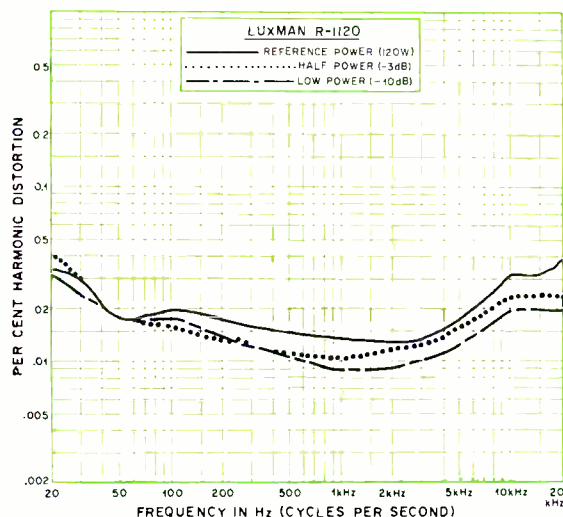

Harmonic distortion at three power levels.

of two speaker systems to the amplifier's outputs and has an additional position for driving a separate pair of electrostatic speaker systems through their own separate output terminals on the rear apron. The labelling for the front-panel switches is on the dial window above the respective knobs. (The fluted metal knobs do not have clearly visible index lines, which is one of the few sacrifices made in the interest of style in the Model R-1120.)

On the receiver's rear apron are insulated connectors for the speaker outputs, two ac convenience outlets (one switched), and the various input and output jacks, including a DIN socket that duplicates the functions of one set of tape connections. In addition to terminals for external antennas, there is a hinged AM ferrite rod antenna and a switch that attenuates the FM antenna input near powerful stations that might overload the front end of the FM tuner.

1000-Hz THD was only 0.011% at rated 120 watts

Laboratory Measurements. The one-hour preconditioning period at one-third power left the top of the receiver above the output section very hot. However, the receiver was comfortable to the touch elsewhere. It delivered a clipping output of 144 watts/channel at 1000 Hz into 8-ohm loads, with both channels driven. (The IHF Clipping Headroom was 0.8 dB.) Into 4- and 16-ohm loads, the output clipped at 159 and

Performance Specifications

Specification	Rating	Measured
Power output (8 ohms, 20-20,000 Hz)	120 W at 0.03% THD	Confirmed
IM distortion	0.03%	Confirmed
Input sensitivity		
Phono	2.5 mV (120 W)	0.22 mV/1 W
Aux	160 mV	15.5 mV/1 W
Phono overload	160 mV	162 mV
S/N		
Phono	72 dB (re 120 W)	61 dB (re 1 W)
Aux	88 dB	61 dB (re 1 W)
Dynamic headroom (20-ms burst at 1000 Hz)	Not specified	2.13 dB
IHF slew factor		2.21
FM Section		
IHF sensitivity		
Mono (across 300 ohms)	10.3 dBf (1.8 μV)	11.0 dBf (1.9 μV)
Stereo " " "	17.2 dBf (4.0 μV)	15.7 dBf (3.3 μV)
50-dB quieting sensitivity		
Mono (across 300 ohms)	14.1 dBf (2.8 μV)	12.8 dBf (2.4 μV)
Stereo " " "	36.8 dBf (38 μV)	38 dBf (44 μV)
Alternate-channel selectivity	80 dB	69 dB
S/N at 65 dBf		
Mono	74 dB	73 dB
Stereo	70 dB	69.5 dB
Frequency response (stereo)		
50-10,000 Hz	+0.2/-1.5 dB	+0.6/-0.3 dB
20-15,000 Hz	+0.2/-1.5 dB	+0.6/-0.9 dB
1-kHz distortion at 65 dBf		
Mono	0.1%	0.09%
Stereo	0.2%	0.19%
Capture ratio at 65 dBf	1.3 dB	1.7 dB
Image rejection	80 dB	86 dB
AM suppression	55 dB	66 dB
Stereo separation:		
100 Hz	45 dB	42 dB
1 kHz	48 dB	41 dB
6 kHz	42 dB	37.5 dB
Subcarrier product ratio	60 dB	78 dB
AM Section		
Frequency response (-6-dB points)	Not specified	250-4500 Hz

We've done the impossible again! **A versatile and superior** **frequency counter kit for only \$89.95**



Now you can forget about price/performance trade-offs when you select a frequency counter. In Sabtronics' Model 8100 you get features you once expected to pay several hundreds of dollars for. But you pay only our low, low price of \$89.95!

Dare to Compare. This frequency counter, using LSI technology, has the performance and input characteristics you demand. Note the specifications: You will see that the frequency range is guaranteed all the way to 100 MHz; and a high or low input impedance allows you to select for high-frequency operation. And you'll see a sensitivity that holds well over the frequency range; convenient selectable gate-time for best resolution; and selectable attenuation; and even an optional pre-scaler. Note the highly accurate time base, and its excellent ageing and temperature characteristics. And a full 8-digit LED display with floating decimal point, leading zero suppression, and overflow indicator.

You would expect to find all these features together only on a much higher-priced instrument. But Sabtronics' advanced digital technology combines with your own skill — you assemble this kit from our easy-to-follow instructions — to make it possible for you to have this fine frequency counter at a fraction of what you would otherwise expect to pay.

Free 10-day trial

Examine the 8100 Frequency Counter Kit for 10 days. If not completely satisfied, return unassembled for full refund of \$89.95 purchase price.

sabtronics 
 INTERNATIONAL INC.

13426 Floyd Circle • Dallas, Texas 75243
 Telephone 214/783-0994

Brief Specifications

- Frequency Range: 20 Hz to 100 MHz guaranteed (10 Hz to 120 MHz typical)
- Sensitivity: 25 mV RMS, 20 Hz to 70 MHz (20 mV typical); 45 mV RMS, 70 MHz to 120 MHz (30 mV typical)
- Selectable Impedance: 1 M Ω at 25 pF, or 50 Ω
- Selectable Attenuation: X1, X10, or X100
- Accuracy: \pm 1 Hz plus time-base accuracy
- Ageing rate: \pm 5 ppm/yr
- Temperature stability: \pm 10 ppm, 0 $^{\circ}$ to 50 $^{\circ}$ C
- Selectable Gate-time: 0.1 sec, 1 sec., or 10 sec.
- 8-digit LED display with floating D.P., overflow indication
- Input: 9-15 VDC, 350 mA (550 mA with optional prescaler)
- Input protection: 150 V RMS, 20 Hz to 10 kHz; 30 V RMS to 2 MHz; and 3 V RMS to 100 MHz
- Optional prescaler extends frequency range to 650 MHz. (Available soon)

To: Sabtronics International, Inc.
13426 Floyd Circle, Dallas, TX 75243

PE 11

Please send me _____ Sabtronics Model 8100
 Frequency Counter Kit(s) at \$89.95 each \$ _____
 Texas Residents add Sales Tax \$ _____
 Shipping and handling, \$5.00 per unit
 (USA only)* \$ _____
 Payment enclosed \$ _____

Charge my Master Charge
 Visa

Account No. _____ Exp. Date _____

Name _____

Street _____

City _____

State _____ Zip _____

*Canada \$6.50. All other countries \$19.00 Airmail.

97.5 watts, respectively. The 1000-Hz THD was less than 0.01% up to 100 watts output, and was only 0.011% at the rated 120 watts and 0.02% at 140 watts. IM distortion was 0.03% at the rated 120 watts and 0.02% at 140 watts. IM distortion was 0.03% at 0.1 watt. It dropped to 0.017% at 100 to 120 watts and was only 0.04% at 150 watts.

The THD at the rated 120-watt/channel output was less than 0.02% from 40 to 6000 Hz. It rose to 0.036% and 0.04%

Muting action of FM tuner was ideal

at 20 and 20,000 Hz, respectively. The distortion at reduced output levels was lower, but followed a similar characteristic. To drive the amplifier to a reference output of 1 watt, as called for in the new IHF-A-202 standard, required an AUX input of 15.5 mV or a PHONO input of 0.22 mV. The A-weighted S/N in both cases was 61 dB, referred to 1 watt. The PHONO input overloaded at a safe 162-mV level at 1000 Hz.

The amplifier's dynamic headroom, when driven by a 20-ms toneburst at 1000 Hz, was 2.13 dB, since it could deliver just shy of 200 watts into 8 ohms under this condition. The amplifier was stable with capacitive loads as great as 2 μ F in parallel with 8 ohms through its normal speaker outputs. We made no measurements through the electrostatic speaker outputs, which are driven through an RC network, presumably to improve the amplifier's stability margin. The IHF slew factor was 2.21.

The peak-power indicators proved to be very accurate, and their instantaneous response made them highly effective indicators of the true peak power output in each channel. The R-1120's tone-control curves were conventional when the 400- and 2000-Hz turnover frequencies were used, but were much more useful with the 200- and 4000-Hz frequencies. These allowed the response to be adjusted at the frequency extremes. This is of importance because here's where this correction is most likely to be needed, without affecting the midrange response or the overall sonic balance.

Audio filters had the desirable 12-dB/octave slopes, with -3-dB response frequencies of 45 and 6000 Hz. They were

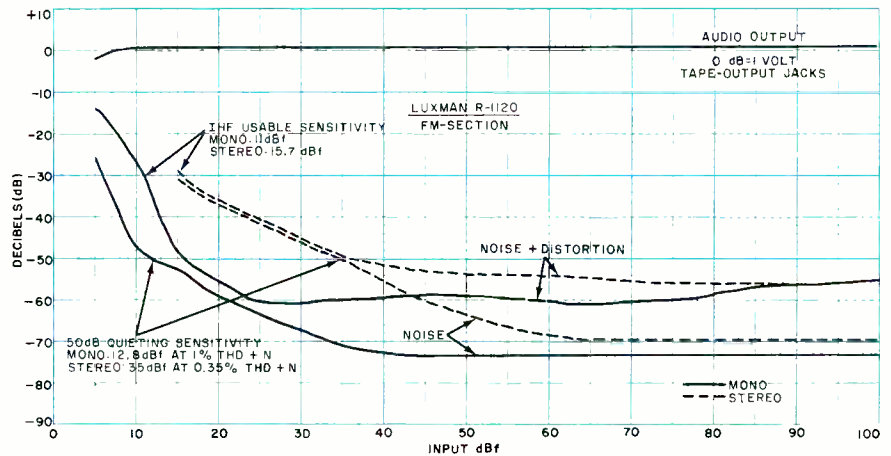

Noise and sensitivity curves for FM section of tuner.

considerably more effective than most filters in their ability to reduce noise without undue loss of program content. The effect of the subsonic filter was below our measurement range, but it reduced the 20-Hz response by only 1 dB. The loudness control boosted both low and high frequencies by an amount we feel was much too heavy-handed. RIAA phono equalization was accurate within +0/-1 dB from 50 to 20,000 Hz. It was down 3 dB at 20 Hz. There was a very slight interaction with the phono cartridge inductance, which boosted the output by about 0.5 dB in the 5000- to 20,000-Hz range.

FM tuner performance ratings and our measurements are shown in the Specifications table. The AM frequency response, reasonably good at high fre-

RIAA phono equalization was accurate within +0/-1 dB from 50 to 20,000 Hz

quencies, was severely reduced at low frequencies for no apparent reason.

User Comment. As the test data shows, the Luxman Model R-1120 receiver met or exceeded virtually all of its specifications. Some of the apparent discrepancies resulted from differences in test conditions, but none of them

affected the usefulness or actual performance of the receiver.

The receiver had the "feel," smoothness of operation, and overall elegant quality that we found to be characteristic of Luxman products we have used in the

operating smoothness, elegant appearance are evident in overall design

past. This is one of the intangibles that one expects to enjoy in any premium-priced product like this Luxman receiver. The muting action of the FM tuner was ideal, with no trace of noise when tuning through a station and a barely perceptible time delay in the unmuting.

The Model R-1120 does not have separate preamplifier outputs and power amplifier inputs, but this was just about the only significant omission among its features. It is easy to forget how versatile this receiver actually is because so many of the controls that contribute to its versatility are small and are designed to blend with their background.

At first glance, the Luxman Model R-1120's price might seem rather high on a watts-per-dollar basis. But considering its performance and features, its styling and flexibility, and the very solid and conservative design and construction that is in evidence throughout it, the R-1120's cost is not at all excessive. Clearly, it's a premium product.

CIRCLE NO 102 ON FREE INFORMATION CARD

(Continued on page 44)

Technics Linear Phase SB-4500A. For people with an ear for waveform fidelity. And an eye for beautiful cabinetry.

If you keep up with the latest in hi-fi successes, you already know about Technics Linear Phase Speaker Systems. The Technics speaker systems with waveform fidelity: The ability to reproduce a musical waveform that's virtually a mirror image of the original. Now you can know Technics Linear Phase Speakers for something else: Beautiful simulated walnut wood cabinetry. Introducing the SB-4500A.

Like our other Linear Phase Speakers, the SB-4500A is capable of achieving not only a wide frequency response, but also flat amplitude and precise linearity.

And if seeing is believing, look at the waveforms. On top is the oscilloscope reading (the fingerprint) of a live piano waveform.

The other, the piano waveform as reproduced by the Technics Linear Phase

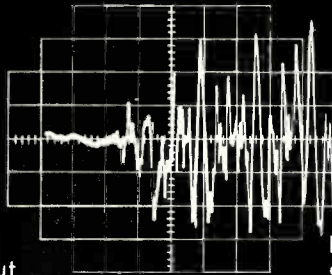

Live Piano Waveform.

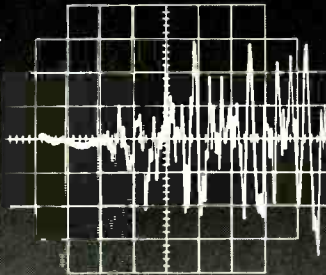

Piano Waveform reproduced by SB-4500A.

SB-4500A. That's waveform fidelity you can see as well as hear. And that sounds better than good. That sounds live.

How did we do it? First by conducting exhaustive amplitude and phase studies in acoustically perfect chambers. Then by developing a unique new phase-controlled crossover network that not only compensates for the time delays caused by different frequencies, but simultaneously corrects any acoustic differences in the drivers. And finally by staggering each driver unit for the optimum acoustic position.

Technics Linear Phase SB-4500A. Your ears will love the way it sounds. Your eyes will love the way it looks.

Technics

Professional Series

CIRCLE NO. 53 ON FREE INFORMATION CARD



frequency response is less dependent on load conditions than other cartridges



Signet phono cartridges are premium-quality products made by a division of Audio-

Technica. The Signet series employs a dual-magnet transducer design. There are two models for stereo and one for CD-4 quadraphonic reproduction. Both of the stereo versions, one of which is the Model TK7E reviewed here, have a tapered aluminum cantilever with a 0.2- \times -0.7-mil elliptical nude diamond stylus. The Model TK7E has a special "Micro-Mass" cantilever and diamond. Its coil windings have minimal inductance and resistance, making the cartridge's frequency response less dependent on external load conditions.

Suggested retail price for the Model TK7E phono cartridge is \$150.

General Information. The typical moving-magnet cartridge has a single magnet on its cantilever. The flux of this magnet is distributed between the pole pieces for the two channels as the stylus moves in the record groove. This generates a voltage in each winding, proportional to the magnitude of the magnet's excursions between the pole pieces. This Audio-Technica dual-magnet design employs two separate magnets mounted on the cantilever at an angle of 90° to each other. The combined mass of the two magnets is claimed to be less than the mass of the single magnet used in typical cartridges. In addition, the moving magnets are located as close as possible to the cantilever's pivot point to reduce their contribution to the effective moving mass at the stylus tip.

The cantilever tube in the Signet series of cartridges is tapered to achieve optimum combination of low mass and high rigidity. The Signet cartridges are normally supplied with styli that have aluminum cantilevers. However, the wide variety of accessory styli available gives the user considerable latitude in choosing the parameters of his stylus. These styli can be ordered from any Audio-Technica dealer and are the same price as the standard replacement styli.

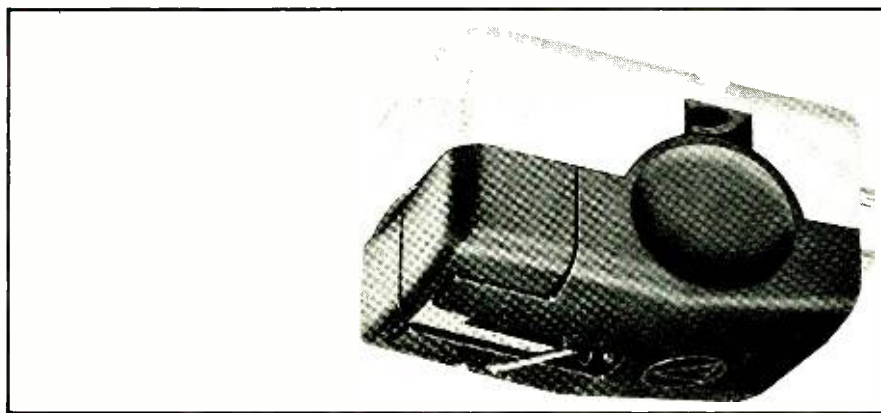

premium-quality, dual-magnet design in the Signet Model TK7E stereo phono cartridge

The styli can be replaced by a user with ease. The Signet stylus itself is a square-shank nude diamond installed through a square hole in the flattened tip of the cantilever tube. This system accurately positions the stylus surfaces relative to the record groove walls. It has a minimum effective mass, owing to its small size and the fact that it is bonded

three stylus shapes are available for greater versatility

to the cantilever instead of being mounted with a metal holder. In the accessory series, each cantilever material is offered with a choice of three stylus shapes: 0.5-mil spherical, 0.2- \times -0.7-mil elliptical, and Shibata. There is also a low-mass aluminum cantilever with a 0.5-mil spherical tip and a heavier aluminum cantilever with a 2.5-mil spherical tip for playing 78-rpm discs.

Laboratory Measurements. We tested the cartridge in the tonearm of a Dual Model 701 record player. The installation instructions did not list a specific load capacitance for the cartridge, but it did suggest keeping the capacitance to a minimum. We loaded the cartridge with 280 pF across the recommended 47,000-ohm load, since this is a typical circuit capacitance in stereo systems. We did, however, check the effect

of load changes on the frequency response.

With a fixed 47,000-ohm load, changing from 190 to 280 pF had negligible effect on the frequency response. An increase to 420 pF produced a peak at 10,000 ohms, after which a rapid drop-off in output was observed. With a fixed 280-pF load, the flattest response was obtained with 47,000 ohms. An increase to 100,000 ohms caused a rise in output beyond 5000 Hz, to a maximum of +4 dB at 20,000 Hz. All basic performance and listening tests were performed with a tracking force of 1.25 grams.

Using the CBS STR100 test record, the cartridge had a response of 40 to 20,000 Hz \pm 1 dB. The high-frequency and midrange output levels were the same, but there was a broad dip in the range between 3000 and 5000 Hz. Channel separation was about 20 dB in the midrange, 18 dB at 10,000 Hz, and 11 to 12 dB at 20,000 Hz.

styli are easily replaceable by the user

The cartridge's output measured 3.65 mV at a 3.54-cm/s velocity, and the channel levels were matched within 0.2 dB. The vertical stylus angle was 22°. The combined low-frequency tonearm/cartridge resonance was about 7 Hz at an amplitude of 8 dB.

(Continued on page 50)

The last word. We thought we'd said it last year. But it turns out we spoke too soon.

The reason for our premature announcement is the Touch K500. It's not just more to say, it's almost a whole new vocabulary in scanners. With totally new words to describe totally new features. For example.

RAM* Scanning: Program in frequency numbers. Enter them into channels. Then scan the channels to hear a call. Simple concept. Monumental capability. Because the Touch K500 gives you 40 channels to scan any of 15,757 different frequencies. You need never even mention the word "crystals".

ROM* Scanning: There are no words or numbers required. Just choose from the three sets of frequencies: police, fire, or marine and weather. Then tap the symbol that corresponds to the set you've chosen. The red light symbol is for police, the flame means fire and the boat will get you marine, weather and mobile phones. Next, get ready. The Touch K500 will promptly scan through every common frequency in the ROM set. So you can actually scan police calls without ever knowing the frequencies, just remember that the red light symbol calls the cops.



Search and Store: With a conventional radio you turn the tuning dial to seek new signals. With ours you search automatically. Besides being easier, our system has some definite performance advantages. Because the Touch K500 not only covers each frequency individually, it also remembers where it heard a call. You can go on searching and enjoying. Then later, you can ask the radio to go back and recall the frequencies it heard. As always, it will respond instantly to your touch.

Et Cetera: There's a lot more to say about our Touch K500: like priority, programmable scan delay, channel activity count, remote equipment switching, Weather Alert[®], and even digital clock with alarm. But enough of our speech. There's something more important you should hear. That is:

The Good Words: Try it. When you go to your Regency retailer, to see the Touch K500, the best thing he can say is: "Try it". Because after just one touch, you'll know you're listening to the scanner from the company that's said it all: Regency.



Last year we introduced the last word in scanners. This year we've got more to say.

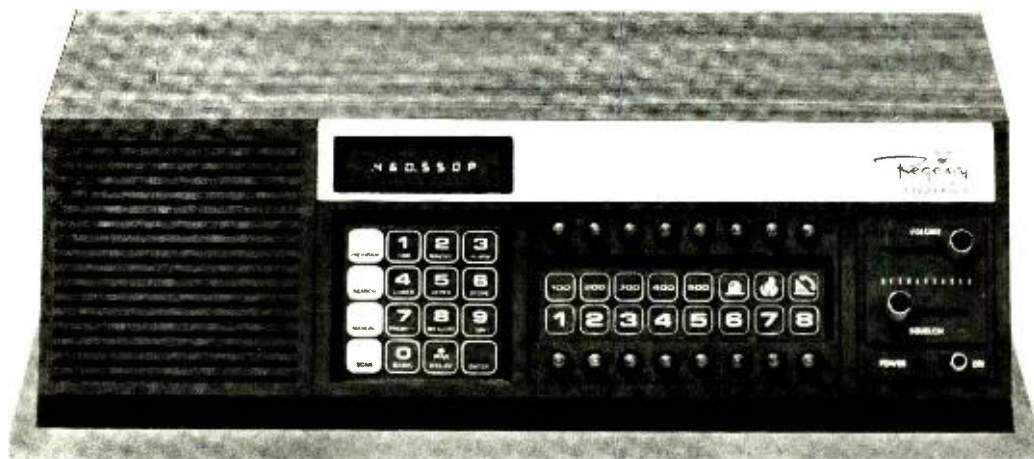

MORE—591 Channels, Search, Store, Time—MORE

Regency Electronics, Inc. • 7707 Records St. Indianapolis, IN 46226

*RAM: Regency Alterable Memory

*ROM: Regency Organized Memory

NOVEMBER 1978

CIRCLE NO. 59 ON FREE INFORMATION CARD

45

ANNOUNCING ... A New CREI Program: Minicomputer & Microprocessor Technology Including A Microprocessor Laboratory

Now you can learn at home
the new technology that is
revolutionizing electronics

The microprocessor has ushered in the age of microtechnology and electronics will never again be the same. The microprocessor has made possible the placing of an entire computer on a silicon chip one quarter inch square. The microprocessor "miracle chip" is in the process of changing the world. Soon all technical personnel in electronics will have to understand and work with the microprocessor. It is invading virtually every area of electronics. And it is profoundly affecting your electronics career.

Brand New Program

CREI has a brand new program to help you learn how to work effectively with this revolutionary electronics development. CREI's new program in Minicomputer and Microprocessor Technology is designed to prepare you for this field by giving you the education and practical experience you need.

The program provides solid preparation in electronics engineering technology with a specialization in minicomputers and microprocessors. In addition, it includes a microprocessor laboratory which features a fully programmable microcomputer which utilizes the Motorola 6802 microprocessor chip. This is an extremely important element of your program.

Programming Essential

As you may well know, you must learn how to *program* the microprocessor in order to design, service or troubleshoot microprocessor electronic systems. There is only one effective way to learn this all-important skill of programming, and that is by actually *doing it*. CREI's new program gives you this opportunity as you work with the exciting microprocessor laboratory.

Programming Is Easy

With CREI's new program, learning the skill of programming is simple. Within a few hours you'll be programming the microprocessor and in a short time you'll learn how to program it in three languages: BASIC, assembly and machine languages. In addition, you will learn how to interface the microprocessor with other systems and to test and debug specialized programs.

Preparation at Home

Wide Choice of Programs

Please note, however, that CREI's new program is only one of 16 state-of-the-art programs in advanced electronic technology offered by CREI. So even if you choose not to specialize in microprocessor technology, CREI has an advanced electronics program to meet your needs.

With CREI, you may choose from any of the following areas of specialization in advanced electronics:

- Microprocessor Technology
- Computer Engineering
- Communications Engineering
- Digital Communications
- Electronic Systems
- Automatic Controls
- Industrial Electronics
- Television Engineering
- Microwave Engineering
- Cable Television
- Radar and Sonar
- Nuclear Instrumentation
- Satellite Communications
- Aeronautical and Navigational
- Solid State Theory
- Nuclear Engineering

Unique Lab Program

An exclusive option available with CREI programs in electronic engineering technology is CREI's unique Electronic Design Laboratory program. It gives you actual experience in designing practical electronic circuits. It also helps you to understand the theories of advanced electronics and gives you extensive experience in such areas as tests and measurements, breadboarding, prototype construction, circuit operation and behavior, characteristics of electronics components and how to apply integrated circuits. Only CREI offers this unique Lab Program.

Practical Engineering

CREI programs give you a practical engineering knowledge of electronics. That is, each part of your training is planned for your "use on the job." By using your training, you reinforce the learning process. And by demonstrating your increased knowledge to your employer, you may qualify for faster career advancement.

Free Book

There isn't room here to give you all of the facts about career opportunities in advanced electronics and how CREI prepares you for them. So we invite you to send for our free catalog. This fully illustrated, 56 page book describes in detail the programs, equipment and services of CREI.

Qualifications

You may be eligible to take a CREI college-level program in electronics if you are a high school graduate (or the true equivalent) and have previous training or experience in electronics. Program arrangements are available depending upon whether you have extensive or minimum experience in electronics.

Send for this FREE Book
describing your opportunities
and CREI college-level
programs in electronics

CREI Home Study Programs In
ELECTRONIC
ENGINEERING TECHNOLOGY

CREI Introduces
Program 680:
MINICOMPUTER &
MICROPROCESSOR
TECHNOLOGY
INCLUDING MICROPROCESSOR
LABORATORY PROGRAM

CAPITOL
RADIO
ENGINEERING
INSTITUTE
McGraw-Hill
Continuing
Education Center
Washington, D.C.
20016

Mail card or write describing qualifications to

CREI **CAPITOL**
RADIO
ENGINEERING
INSTITUTE

McGraw-Hill Continuing Education Center
3939 Wisconsin Avenue Northwest
Washington, D.C. 20016

Accredited Member National Home Study Council

GI Bill

CREI programs are approved for training of veterans and servicemen under the G.I. Bill.



Tracking tests revealed that the cartridge had outstanding tracking abilities over the full audio range. Using the German Hi Fi Institute record, the 60-micron level of the 300-Hz tones could be played at the cartridge's 0.75-gram minimum rated force. At the 1.25-gram force we used, the 90-micron level could be played without audible mistracking (very few cartridges can do as well). At 1.5 grams, the cartridge could play the rec-

ord's 100-micron maximum level. Our other high-level test records could be played at forces from 0.75 to 0.9 gram.

outstanding tracking abilities over the full audio range

We measured tracking distortion with

the Shure TTR102 and TTR103 records. The TTR102 is a conventional IM test record, with frequencies of 400 and 4000 Hz recorded at velocities ranging from about 7 to 27 cm/s. The measured IM distortion was between 0.8% and 0.9% (which we believe to be the residual of the test record) for velocities up to 15 cm/s. It increased smoothly and gradually to 2% at 23 cm/s and 3.5% at 27 cm/s.

With the high-frequency tracking tests of the TTR103 test record, which has shaped 10,800-Hz tone bursts at a 270-Hz repetition rate, the repetition-rate distortion was very nearly as low as we have ever measured. It varied between 0.7% and 1.1% as the velocity increased from 15 to 30 cm/s. These measurements were made at 1.25 grams and clearly illustrate the Model TK7E's very excellent tracking ability. The square-wave response with a CBS STR112 test record revealed a single cycle of ringing, with a small overshoot at a frequency we estimate to be at about 15,000 to 20,000 Hz.

User Comment. Our measurements left little doubt that the Signet Model

Performance Specifications

Specification	Rating	Measured
Frequency response	5-30,000 Hz	40-20,000 Hz \pm 1 dB
Tracking force	0.75-1.75 g	1.25 g
Channel balance	0.75 dB	0.2 dB
Channel separation: 1 kHz	30 dB	20 dB
10 kHz	22 dB	18 dB
Output @ 5 cm/s	2.7 mV	5.1 mV
Stylus tip	0.2 \times 0.7 mil	_____
Vertical tracking angle	20 degrees	22 degrees
Recommended load impedance	47,000 ohms	47,000 ohms/280 pF
Cartridge inductance	370 mH	_____
DC resistance	500 ohms	_____
Cartridge weight	6.8 g	_____

MORE Hobby Electronic Projects from

HEP

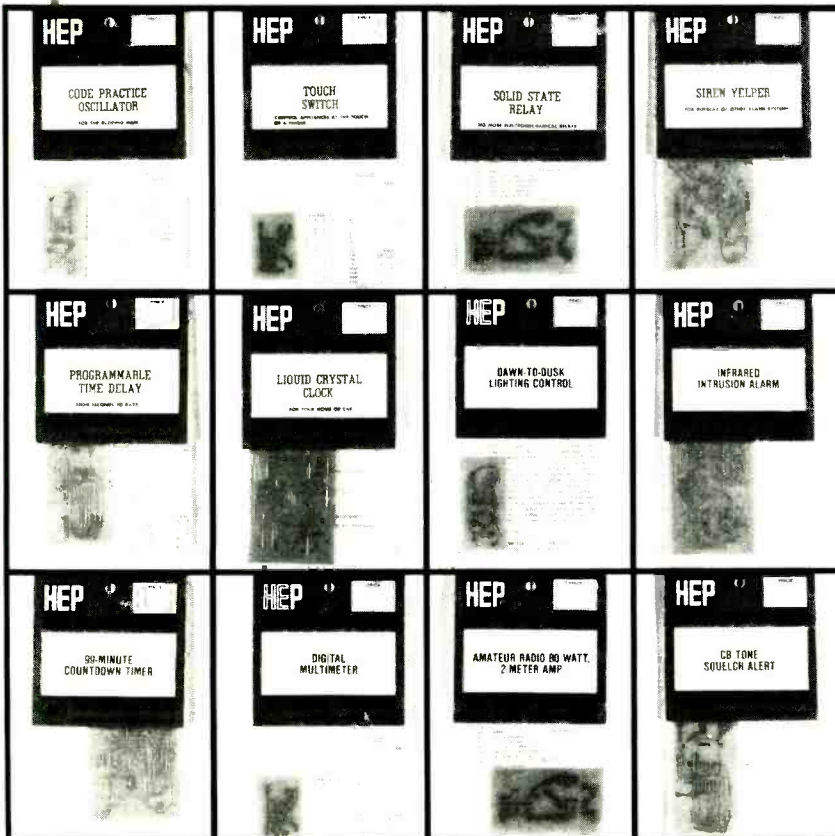

You loved our first six HEP Projects . . . so we've made it an even dozen!

Six more exciting and functional electronic projects for home or lab.

Six more ways to explore tomorrow through superior technology.

More complex.

More challenging.

And HEP Projects give you a big head start by providing a printed circuit board, complete instructions and parts list.

The *new* HEP Projects made easy:

Digital Multimeter

Amateur Radio 80-watt, 2-meter Amp

99-Minute Countdown Timer

Dawn-to-Dusk Lighting Control

Infrared Intrusion Alarm

CB Tone Squelch Alert

And more on the way!!!

Available at your nearest authorized HEP Distributor. For mail order information, write: **Motorola Mail Order Sales**, P.O. Box 27605, Tempe, AZ 85282 or circle reader information card.



MOTOROLA

Semiconductor Products Inc.

HEP

TK7E was an outstanding stereo phono cartridge. Just how outstanding, however, can be determined only by listening. First, we played the Shure Audio Obstacle Course tracking test records. With the older Era III record in this series of records, only a trace of "sandpaper" quality at the highest level of the sibilance test prevented the cartridge from achieving a perfect score. Even this slight mistracking was corrected by increasing the tracking force to 1.75 grams.

Although we have less experience with the newer Era IV test record, it has revealed that it is a much more severe test for high-frequency tracking than the older record, to say nothing of being far more demanding than almost any commercially pressed music disc. In view of

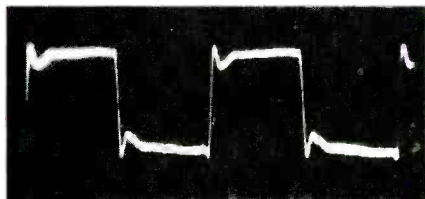

Square-wave response to STR112.

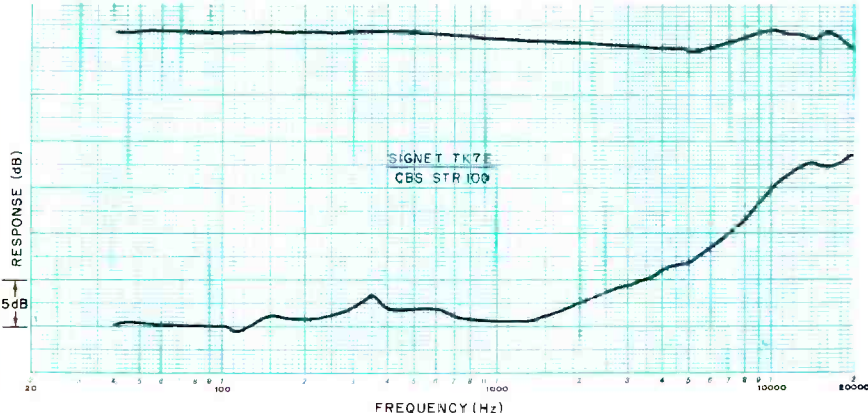

Composite response and crosstalk using CBS STR100 test record.

this, we were most impressed to discover that the Signet cartridge could track everything on the record without audible signs of distress. After this ordeal, listening to conventional records was almost anticlimactic.

Rarely have we heard a cartridge whose sound had such total ease, smoothness, and lack of coloration. Especially noticeable was the silent background. Record hiss was distinctly lower than we have heard from the same records with most other cartridges. Let one get the impression that this cartridge must be heard under the most demanding conditions to be appreciated, we hasten to report that we

were struck with how unstrained the sound was with every record we played.

It is interesting to observe that, with the possible exception of our tracking distortion measurements, there was nothing in our test data that clearly and unequivocally correlated with this cartridge's sound quality. To be sure, all the test data was first rate, but we have used cartridges that "tested" as well as or better than this one, yet did not have the listening quality of the Model TK7E. Only a few moments of listening to it are enough to place this cartridge in its proper place among the very few "finest" on the market today.

CIRCLE NO. 103 ON FREE INFORMATION CARD

CAN YOU OUTSMART OUR COMPUTER?

Don't be too sure. The computer built into Parker Brothers game Code Name: Sector™ is capable of making thousands of calculations per second. It's as powerful as early computers that filled entire rooms and sold for millions of dollars. And, while it gives you clues to track down and sink a hidden electronic submarine, it also helps the sub escape and counter-attack. That's the catch that makes every game a real challenge. Whether you're playing alone or against others, your toughest opponent is the computer. Code Name: Sector™, the electronic board game from Parker Brothers. It's a game with a mind of its own.



PARKER BROTHERS
©1978, Parker Brothers, Beverly, MA

CIRCLE NO. 54 ON FREE INFORMATION CARD



Someday all terminals will be smart.....

- ◆ 128 Functions—software controlled
- ◆ 7 x 12 matrix, upper/lower case letters
- ◆ 50 to 38,400 baud—selectable
- ◆ 82 x 16 or 92 x 22 format—plus graphics
- ◆ Printer output port
- ◆ "CHERRY" keyboard

CT-82 Intelligent Terminal, assembled and tested. \$795.00 ppd in Cont. U.S.

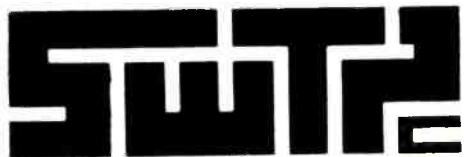

SOUTHWEST TECHNICAL PRODUCTS CORPORATION
 219 W. RHAPSODY
 SAN ANTONIO, TEXAS 78216

A Basic Guide to Digital Logic Probes, & Clips, & Pulsers



Hewlett-Packard Model 548A Logic Clip and 546A Logic Pulser.

How to use low-cost digital test equipment

TROUBLESHOOTING digital logic circuits can often be simplified by the use of low-cost testers especially designed for this purpose. These include logic probes, clips and pulsers. Every modern-day electronics experimenter, designer and service technician should know how to work with these important digital testers, as well as have an understanding of the sundry attributes.

Homebrew Testers. The most commonly used logic testers are the probe and pulser. Very basic versions of these, suitable for building in a test lead, ball-point pen, or spark-plug tester, are shown in Fig. 1.

The logic probe (Fig. 1A) is a state checker. It tells whether an input or output pin of an IC is "high" (logic 1) or "low" (logic 0). The clip lead attaches to the positive supply. The LED comes on when the probe is touched to a point at ground potential (low or logic 0) but remains off for a high state. You could also use a voltmeter, bearing in mind that for TTL, high is greater than 2.4 volts and low is less than 0.8 volt; but it is simpler to use a logic probe. It is also safer because it lets you keep your eye on the IC you are probing to avoid shorting adjacent pins and possibly damaging the IC.

It is generally convenient to trigger a logic circuit manually during troubleshooting, using a logic pulser. To use the one shown in Fig. 1B, clip one end of the capacitor to ground and touch the other end (prod) to the positive bus to charge the capacitor to the bus voltage. Then touch the prod to the input of a gate to be tested; the capacitor will discharge, creating a positive pulse. Now monitor the output of the gate with a logic probe.

The homebrew instruments just described are very crude, of course, but they do illustrate some fundamentals of the commercial instruments. For example, the simple LED state checker gives an unambiguous reading for only one state. The probe's LED lights for the low

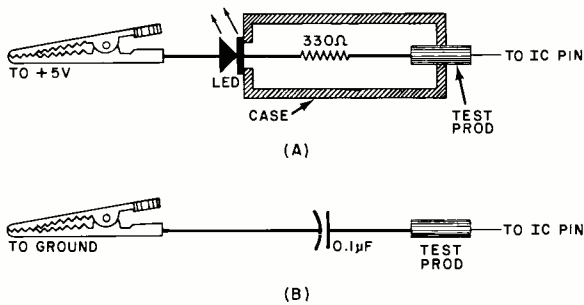

Fig. 1. How to construct your own logic probe (A) and pulser (B).

state and remains off for the high state. Unfortunately, it also remains off in the case of an open in the circuit or IC. A good commercial logic probe, in contrast, gives a positive indication of a low state or high state, as well as detecting bad levels (between high and low), single pulses, and pulse trains.

Logic Probes. A logic probe is much simpler to set up and use than a scope or meter. One simply connects the probe's clip leads to the power supply of the circuit being tested, touches the probe to the circuit point to be tested, and looks for an indication on the probe.

There are a host of different logic probe designs available. Continental Specialties and Kurz-Kasch probes have three indicators (LEDs for CSC and red, white, and blue lamps for Kurz-Kasch) to indicate highs, lows and pulses. AVR probes have two LEDs that indicate highs and lows and flash for pulses. Hewlett-Packard probes have a band of light all around the tip for omnidirectional viewing. The light is at full brilliance for highs, half brilliance for opens or poor levels, and off for lows. Production Devices probes indicate highs and lows with high- and low-frequency audio tones, and a new audio-visual model has LEDs as well.

When the power leads of a logic probe are connected to a circuit's power supply, circuitry inside the probe automatically programs the logic thresholds. For the TTL family, the circuitry sets logic thresholds at about 16% of the supply voltage for lows, and 48% for highs. Hence, a low indication occurs for potentials less than 0.8 volt, and a high indication occurs for potentials greater than 2.4 volts. There's a "no-man's"

land between the thresholds (Fig. 2) where the absence of a light or tone indicates an open circuit or bad level.

Figure 2 shows how the HIGH and Low LEDs indicate negative pulses from a high level or positive pulses from a low level. A probe can also indicate the duty cycle of pulses in a train (percent of time the logic level is high), since this determines the amount of time the LEDs are on (and thus their relative brightness).

Probes sometimes have a PULSE indicator. For continuous trains of pulses within the frequency limits of the probe, the PULSE LED blinks at a steady rate, typically of 3 or 10 Hz. For displaying short single-shot pulses, probes usually have a pulse-stretcher circuit that detects pulses of 200, 50, or even 5 ns, turning the PULSE LED on long enough to make a visible flash.

Probes sometimes even give a rough idea of pulse frequency. For square-wave pulses of 50% duty cycle, the CSC probe, for example, flashes its PULSE LED and turns on both HI and LO state LEDs if the frequency is below 100 kHz, or neither state LED if the frequency is above 100 kHz.

The ability of some probes to detect pulses as short as 5 ns and to handle frequencies of 50 or 100 MHz shames some very expensive oscilloscopes.

Buyer's Guide. In evaluating a probe, consider these capabilities:

Single Pulse. Look for an ability to catch short, intermittent single pulses and detect "glitches" (noise transients). The minimum detectable pulse width of probes varies widely. Some are capable of detecting pulses as narrow as 5 or 10 ns, something that is difficult to do with even a high-performance scope.

Memory. Some probes have a switch-selectable memory mode in which the leading edge of a pulse latches a flip-flop on to keep the PULSE LED lighted. This means you do not miss a short pulse because you blinked or turned your head when the LED flashed. It also means you can clip the probe in place and wait as long as necessary to trap a troublesome glitch. Or you can hang the probe on a backplane, make a change to the circuit under test, and come back to see if anything has happened. Best of all, a probe with memory costs a fraction as much as a memory scope.

Input Impedance. The input impedance of a probe must be high enough not to affect your measurements. For example, a low resistance into a Schottky gate will overload a low-power output in the low state.

Overload Protection. Most probes have input-overload protection that prevents damage even if the probe is plugged into a wall socket for 15 to 30 seconds.

Bad Levels. A probe should be able to detect bad levels between logic high and low. Ideally, it should be able to distinguish between highs, bad levels, and high impedance in three-state logic.

Multifamily Use. Some probes are compatible only with TTL and DTL. Others are compatible with TTL/DTL at one switch setting, and with CMOS and high-threshold families at another setting. Interestingly, the AVR probe requires no switch setting to go from one logic family to another.

When a logic probe is connected to the power supply of a circuit to be tested, circuitry inside the probe automatically sets the thresholds for high and low according to the supply voltage. For TTL, the thresholds for high and low are typically 48% and 16%, respectively, of the supply voltage. For other families they are typically 70% and 30%, although they may be 60% to 70% and 15% to 30%. Figure 3 shows how to connect a probe for various families. Always connect the positive (red) clip to the more positive power-supply terminal and the negative (black) clip to the more negative terminal.

(Continued on page 61)

Fig. 2. Illustration shows the three light-indication possibilities of a logic probe under given circuit conditions.

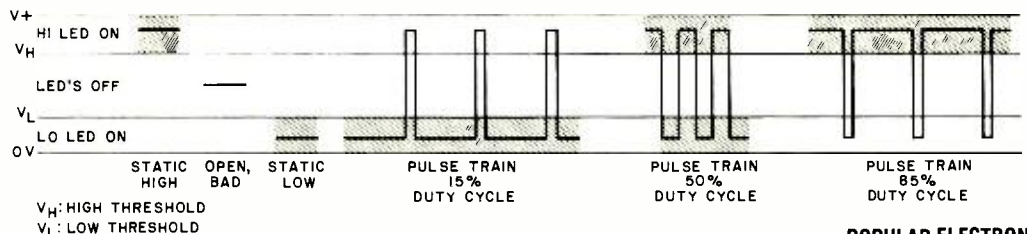

Jim-pakTM

electronic components

One-Stop Component Center

AUTHORIZED DEALERS

ALABAMA

Cropwell
Huntsville
Mobile
ALASKA
Anchorage
ARIZONA
Flagstaff
Fountain Hills
Tempe
Sierra Vista
Yuma

CALIFORNIA

Bellflower
Berkeley
Brea
Cypress
El Monte
Fontana
Fullerton
Glendale
Harbor City
Lake Tahoe, South
Lancaster
Long Beach
Mission Viejo
Modesto
Modesto
Monterey
Morro Bay
Oceanside
Palmdale
Palo Alto
Pasadena
Riverside
Sacramento
Sacramento
San Bernardino
San Carlos
San Diego
San Diego
San Fernando
San Francisco
San Francisco
San Jose
San Jose
San Luis Obispo
San Rafael
Santa Barbara
Santa Cruz
Santa Maria
Santa Monica
Susan City
Sunnyvale
Torrance
Vallejo
Van Nuys
Ventura
Walnut Creek
Westminster
Whittier
Whittier

COLORADO

Aurora
Denver
Steamboat Springs

CONNECTICUT

Bridgewater

FLORIDA

Fort Lauderdale
Gainesville
Lakeland
Orlando
Pensacola
Tampa
Tampa

GEORGIA

Atlanta

HAWAII

Aiea

IDAHO

Boise

ILLINOIS

Carbondale
Evanston
Evanston
Granite City
Growsland
Mount Prospect
Niles
Oak Park
Peoria
Robinson
Rockford
Shelburne

INDIANA

East Chicago

IOWA

Clinton

MAINE

Davenport

Tucker Bros
Industrial Electronic Supply
Lafayette Radio Electronics

Electronics Corp of Alaska
Jim's Audio & Stereo Repair
P & C Communications
Computerworld Inc.
B & S Electronics
Yuma Electronics

Earl's Hobby Shop
Al Lasher Electronics
Century Electronics
SCR Electronics
Kimball & Stark
Fontana Electronics
Orvac Electronics Inc.
Eagle Electronics
Buff's Electronics
CalPine Electronics
Consumer Electronics
Scott Radio Supply Inc.
Tower Electronics Corp
Computer Magic
Pacific Radio
Zackit
Morro Bay Electronics
Electronic Center
Radio Shack A.S.C. Palmdale
Zack Electronics
Dow Radio Inc.
Computer Center
Heathkit Electronic Center
The Radio Place
Zackit
Inland Computer & Electronics
J & H Outlet Store
Radio Shack A.S.C. Mira Mesa
Radio Tronics Inc.
San Fernando Electronics
Zack Electronics
Zenith Distributing Corp
Peninsula Electronic Supply
Gourmet Electronics
Mid State Electronic Supply
Electronics Plus
Lombard Electronics
Santa Cruz Electronics
Cips Electronics
Mission Control
Byte Shop
Sunnyvale Electronics
SE Electronics
Zackit
Thrifty Electronics Supply
Lombard's Electronics Inc.
Byte Shop of Walnut Creek
JK Electronics
D & S Electronics
Whittier Electronics Co

Com Co Electronics
Mt. Com Distributing Co
Norm's TV & Electronics
Bridgewater Computer
Computers For You
Lafayette Radio
Lakeland Specialty Electronics
Altair Computer Center
Gico Electronics Inc.
AMF Radio
Microcomputer Systems
Atlanta Computer Mart
Delcom Hawaii
Integrated Circuit Supply
Custom Electronics
A Gem Supply Inc.
AudioTronics
Lafayette Radio
Itty Betty Machine Co
Tri State Electronic Corp
Computer Systems Center
Mayer Electronics
Tri State Electronic Corp
Computer Land
Spectronics Inc.
Warren Radio Co
Radio Shack
Imperial Computer Systems
Data Domain
Acro Electronics Corp
Meade Electronics
Bridge Elec Computer Center
Computer Store of Davenport

IOWA (Continued)

Des Moines

KANSAS

Manhattan
Wichita
KENTUCKY
Lexington
LOUISIANA
Baton Rouge
Baton Rouge
New Orleans
MARYLAND
Baltimore
Baltimore
Baltimore
La Vale
Rockville
Rockville
Silver Spring
Towson
Towson

MASSACHUSETTS

Medford
North Adams
Waltham
Worcester
MICHIGAN
Ann Arbor
Flint
Grand Rapids
Lansing
Midland
Mt. Clemens
Muskegon

Radio Trade Supply Co
Electronix Limited

Electronic Surplus Sales
Communications Specialties Ltd
Amateur Radio Equipment Company
Radio-Electronic Equipment Co.

Davis Electronics Supply Co.
Menard Electronics Inc.
Wm. B. Allen Supply Co.

Computers Unlimited
Computer Workshop of Baltimore
Everything Electronic
J & M Electronics
Computer Workshop
Heathkit Electronic Center
Computers Etc
Baynesville Electronic Inc.
Computers Etc.

Tufts Electronics
Electronics Supply Center
Computer Mart Inc.
RM Electronics Inc.
Airway Electronic Communications
Hobby Electronic Center
Micro Computer World
Fulton Radio Supply Co.
Computronics Corp
The Computer Store
H R Electronics

NEW YORK (Continued)

Rochester
Troy
Utica
White Plains
Williamsville
NORTH CAROLINA
Durham
Greensboro
Raleigh
NORTH DAKOTA
Fargo
Fargo
OHIO
Bucyrus
Cincinnati
Columbus
Dayton
Reynoldsburg

OKLAHOMA

Guymon

OKLAHOMA

Okahoma City

OREGON

Albany
Beaverton
Cons. Bay
Medford
Ontario
Portland
Salem

PENNSYLVANIA

Draxel Hill
Erie
Hershey
Murrysville
Pittsburgh
Pittsburgh
Pittsburgh
Wilkesbarre
York

RHODE ISLAND

Cranston

SOUTH CAROLINA

North Charleston

TENNESSEE

Chattanooga
Clarksville
Cookeville
Knoxville
Memphis
Memphis
Nashville
Oak Ridge

TEXAS

Amarillo
Dallas
Houston
Houston
Houston
San Antonio
UTAH
Provo
Salt Lake City

VIRGINIA

Alexandria
Alexandria
Charlottesville
Hampton
Norfolk
Richmond
Roanoke
Springfield
Virginia Beach

WASHINGTON

Everett
Kirkland
Langview
Pasco
Richland
Seattle
Seattle
Seattle
Spokane
Tacoma

WEST VIRGINIA

Morgantown
Morgantown
Ripley
Wheeling

CANADA

Alberta (Calgary)
Ontario (Willowdale)
Quebec (Montreal)

PANAMA

Panama City
Panama City
Panama City

FRANCE

Paris
SINGAPORE
SINGAPORE

2001 Microsystems
Trojan Electronics
Am-Com Electronics
The Computer Corner
Hirsch Sales Co.
Futureworld
Byte Shop
Byte Shop of Raleigh
The Computer Company
S & S Electronics

Mead Electronics
Digital Design
Heathkit Electronic Center
Altair Computer Center
Universal Amateur Radio

Sound Service
Bits, Bytes & Microwaves
High Technology

Oregon Ham Sales
Norvac Electronics
Herrick Electronics
Portland Radio Supply
Miller Electronics
Portland Radio Supply
Computer Pathways

Kass Electronic Distributors
Warren Radio
Microcomputer Systems Inc.
Computer Workshop of Pittsburgh
Stevens Electronics

Heathkit Electronic Center
Tydings Company
Hamline Electronics
G.Y.C. Company

Jahbour Electronics City
Jahbour Electronics City
Technical Services Inc.

William's Data Comp Division
Masstronics
Wagon's Stereo Center
Byte Shop
Bluff City Electronics
Sere-Rose & Spence Electronics
Eddie Warner's Parts Co.
Computer Denn

Computer Encounters Inc.
CompuShop
Altair Computer Center
Interactive Computers
Shrman Electronics Supply Inc.
Alpine Electronic Supply Co
Best Distributing

Computer Hardware Store
Computers Plus Inc.
Heathkit Electronic Center
Lafayette Electronics
Lafayette Radio
Awe Electronics Corp
Awe Electronics Corp
Computers To-Go
The Computer Place
Computer Workshop of North Virginia
Heathkit Electronic Center

ABC Communications
C & J Electronics
Progress Electronics
Riverview Electronics
C & J Electronics
ARC Communications
Amateur Radio Supply
C Com
Empire Electronics
Personal Computers
Northwest Radio Supply

The Computer Corner
Electro Distributing Co
Thompson's Radio Shack
Lafayette Radio Assn. Store

The Computer Shop
Home Computer Centre
Wang's Microcenter

Electrotecna S.A.
Sonnet S.A.
Tropico S.A.

Computer Boutique
Inter Trade (PTE) Ltd
Systems Technology Ltd.

New! **Jim-pak** **KITS**
electronic components

- 4 DIGIT (.379 HT.)
- SEQUENTIAL FLASHING COLON
- 12 OR 24 HOUR OPERATION
- EXTRUDED ALUMINUM CASE
- HOURS, MINUTES & HOLD PRESSURE SWITCHES
- INCLUDES ALL COMPONENTS, CASE & WALL TRANSFORMER

JE730 \$14.95

AVAILABLE AT YOUR DEALER TODAY!!

MINNESOTA

Duluth
Eagan
Hopkins
St. Paul

Northwest Radio of Duluth
Computer Room Inc.
Heathkit Electronic Center
Heathkit Electronic Center

MISSOURI

Florissant

Breckman Electronics
Computer County
Computer Workshop of Kansas City

MONTANA

Billings

Conley Radio Supply
Electronic Service & Distributing
Art's Electronics

NEBRASKA

Lincoln

Altair Computer Center
Scott Electronic Supply Inc.
Scott Radio Supply Corp.
Heathkit Electronic Center
Omaha Computer Store

NEVADA

Las Vegas

Century 23

NEW JERSEY

Bayville

A R S Communications Services
Radio Shack Associate Store
The Computer Emporium
Hoboken Computer Works
Alltronics
Computer Corner of New Jersey
Type-tronic Computer Store

NEW YORK

Albany

Fort Orange Electronics
Grylock Electronics
Computer Mart of New York
Com-Tech Electronics

NEW YORK

Kingston

New York

Rensselaer

SEE YOUR LOCAL Jim-pakTM DEALER TODAY!

For Dealer Information, write or phone JIM-PAK[®], 1021 Howard Ave., San Carlos, California 94070 (415) 592-8097

Train with NTS for the MicroComputers, digital the first name

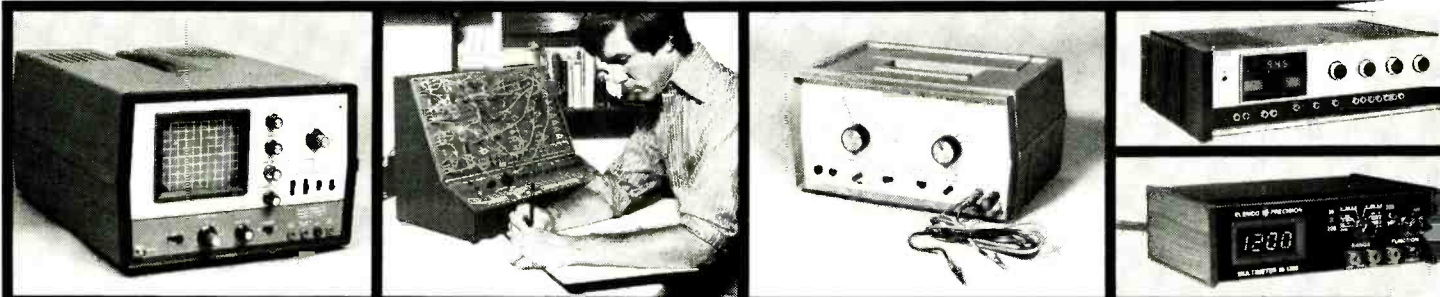

MicroComputers



The world of electronics is daily becoming more challenging. Technology is growing more specialized, and the importance of digital systems increases every day. Test instruments, home entertainment units and industrial control systems are all going digital. And now, NTS training programs include a wider choice of solid-state and digital equipment than ever before offered in any home study course: Advanced NTS/Heath digital color TV (25" diagonal with optional programming capability), NTS/Heath microcomputer, digital test equipment, digital stereo receiver (70 watts per channel), NTS compu-trainer, plus much more state-of-the-art equipment to make your training exciting and relevant.

The equipment you receive with NTS training programs is selected to provide you with a solid

background in electronic systems. Kits and lessons are designed to work together to demonstrate electronic principles and applications. The kit-building not only shows you how electronic hardware functions, but how various circuit designs accomplish different purposes. Your lessons guide you through any number of experiments associated with many projects. This is the Project-Method, and it works. Step-by-step, you learn how and why digital electronics has become a part of our world, and the even bigger role it is sure to play in the future.

Whether you are looking for training in Consumer, Commercial, or Industrial electronics, NTS offers fourteen courses, some basic, many advanced, in several areas of electronics. An all-new full-color NTS catalog shows you what each course covers,

electronics of the future.

systems and more...from
in home study.



and every piece of equipment included.

Send for it today, and see for yourself what's really happening in electronics training technology at NTS. Find out how much has changed, and what new directions the field is taking. You'll probably want to be a part of it.

It's free. Just mail the card or coupon. Today.

**NO OBLIGATION. NO SALESMAN WILL CALL.
APPROVED FOR VETERAN TRAINING.**

NATIONAL TECHNICAL SCHOOLS

TECHNICAL-TRADE TRAINING SINCE 1905
Resident and Home-Study Schools
4000 South Figueroa St., Los Angeles, Calif. 90037

NATIONAL TECHNICAL SCHOOLS Dept. 205-118
4000 South Figueroa Street, Los Angeles, California 90037

Please send FREE Color Catalog and Sample Lesson.

- Color TV Servicing
- B & W TV and Radio Servicing
- FCC License Course
- Electronic Communications
- Electronics Technology
- Audio Electronics Servicing
- Digital Electronics
- MicroComputers/MicroProcessors

Name _____

Address _____

Apartment Number _____ Age _____

City _____

State _____ Zip _____

Check if interested in G.I. Bill information.

Check if interested ONLY in classroom training in Los Angeles.

Two sources of perfection in stereo sound.

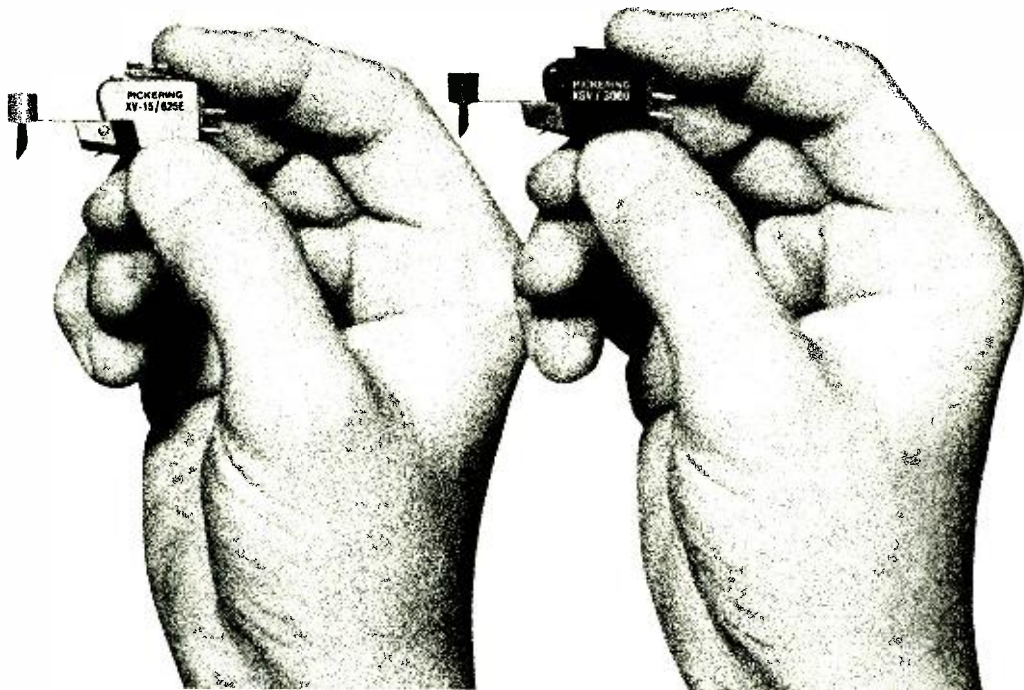

Match one to your equipment...

"The right Pickering Cartridge for your equipment is the best Cartridge money can buy."

We've been saying that for years; and tens of thousands of consumers have profited by applying this principle in assembling their playback systems.

If you have a fine manual turntable, the XSV/3000 is a perfect choice.

If you have a high quality automatic turntable, then installing an XV-15/625E in its tone arm is a perfect choice.

The XSV/3000 is measured and praised in 8 Reviews (the XV-15/625E gets its accolade in one of them) — so we have published all 8 Reviews in a single brochure for you to read and evaluate. Be sure to get your free copy.

Pickering's new XSV/3000 is a remarkable development. It possesses our trade-

marked Stereohedron™ Stylus Tip, designed to assure the least record wear and the longest stylus life achievable in these times with a stereo cartridge. Its frequency response is extraordinarily smooth and flat; its channel separation is exceptional; its transient response affords superb definition. It represents a whole new concept of excellence in stereo cartridges.

Your Pickering dealer has your free copy of the "8 Great Reviews" brochure, Or write to Pickering & Co., Inc. Dept. PE, 101 Sunnyside Blvd. Plainview, New York 11803



FREE!

PICKERING

"for those who can hear the difference"

CIRCLE NO 55 ON FREE INFORMATION CARD

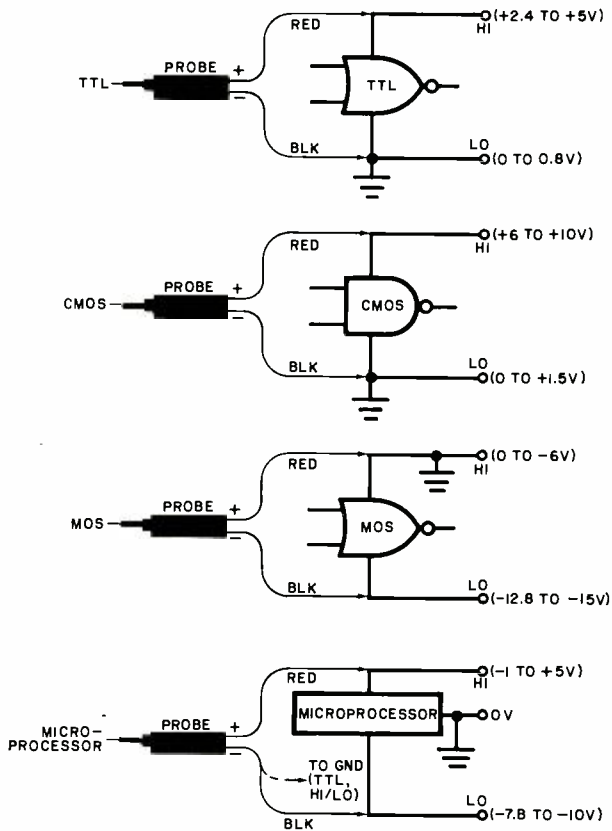
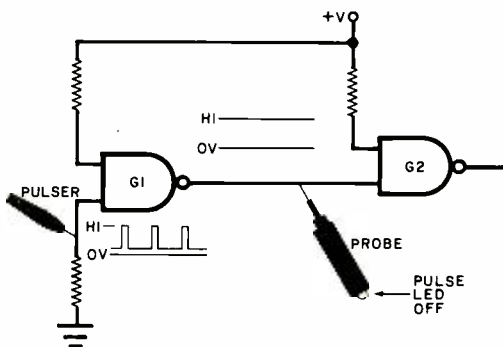
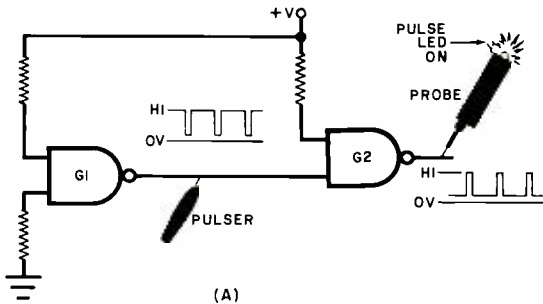

Fig. 3. Probe connections and tester thresholds for various logic families.

Sometimes the thresholds based on the supply voltage of the circuit under test may not be the ones needed. You can redefine the thresholds by connecting the probe's power clips to another power supply whose 70% and 30% points correspond to the desired thresh-



NAND TRUTH TABLE

INPUTS		OUTPUT
0	0	1
0	1	1
1	0	1
1	1	0

(B)

Fig. 4. Using a logic probe and a pulser to test a NAND gate.

olds, connecting the grounds of the two supplies together.

Logic Clip. A logic clip is another easy-to-use digital tester. Unlike the logic probe, it checks a number of points simultaneously. You just clamp it over an IC DIP package and two rows of LEDs instantly indicate the logic states of all pins. There are no controls to set—even even any power leads to connect. The clip's circuitry automatically locates the positive and ground supply pins, whichever way you connect the clip. You cannot connect it incorrectly. In contrast to these advantages, clips do have some relative shortcomings, as follows.

Logic clips cannot test many circuits

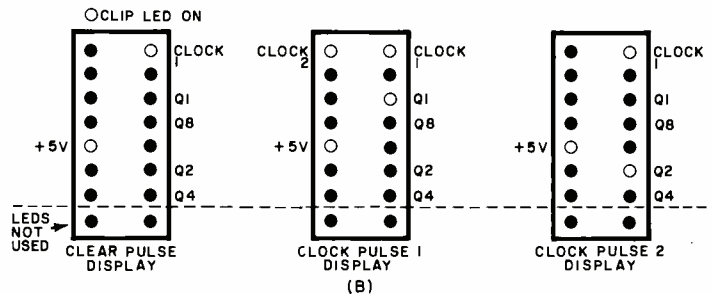
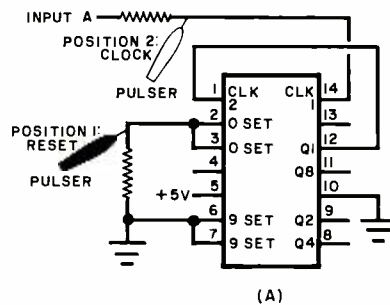

Fig. 5. Checking a 7490 decade counter with a logic clip and pulser. (A) Shows IC pins and pulser signal injection points. (B) Illustrates clip's expected display.

that probes can, though they can give indications faster with static or slow-changing signal conditions (one simply can't monitor many fast-changing LEDs at the same time). Some clips are limited to 7 volts, while others can be used with ICs that have up to 15 or 18 volts between any two pins without suffering damage. Clips operate with positive-voltage logic families (TTL, RTL, DTL, CMOS, etc.), which means that they will not work with some MOS ICs and ICs with three supplies (such as -12 volts, ground, and +5 volts).

A logic clip has a single threshold, for logic high. It does not have a low threshold and, therefore, cannot indicate a bad

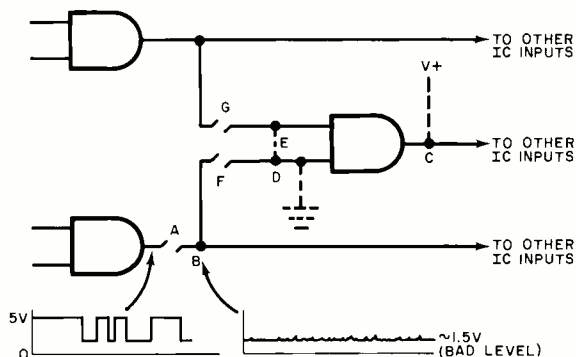

Fig. 6. Five steps to follow in isolating the most common faults in digital logic circuits.

level. The latter shows up as a high state on a clip. A clip also lacks pulse-stretching circuitry, so it cannot indicate narrow single-shot pulses. For viewing these or high-frequency pulses, you *will* need a probe.

Depending on the supply voltage and how many LEDs are on, a logic clip may draw 100 or 200 mA. This can tax some power supplies, especially if the clip is left in continuous operation.

The logic-high threshold of most clips is about 1.5 to 2 volts, which is compatible with TTL and DTL. In comparison, the costlier H-P Model 548A, has a threshold that is 34% to 46% of the supply voltage, and is also compatible with CMOS and other positive-voltage logic families.

A logic clip is usually used with a pulser to check sequential-logic ICs such as flip-flops, latches, counters, shift registers, and adders. A clip is sometimes useful for testing gates, too. For example, if the clip shows that the output pin of a 4-input NAND gate is constantly low and that the NAND gate's inputs are not all high, then as a look at a NAND truth table will reveal, the output must be shorted to ground.

Logic Pulser. A commercial logic pulser is much more than a capacitor in a probe, as in our earlier home brew example. It is (or should be) a high-quality pulse generator with the versatility of a laboratory pulse generator minus the complicated controls. Just clip the pulser's leads to the power supply of the circuit under test, touch the pulser to the point to be stimulated, and press the PULSE button. All circuits connected to that point, outputs as well as inputs, are briefly driven to their opposite state. There is no need to unsolder any pins. Whether the test point is high or low, the pulser drives it to the opposite state each time you press the button. Holding down the button produces a series of pulses. The pulses should be bounceless, safe for the circuit under test, capable of overriding the state of any normal (unshorted) circuit node, and tailored to the logic family being tested.

Usually, the pulser is teamed with a probe for testing logic gates, and either

a probe or clip for testing sequential circuits such as flip-flops and counters. To test a gate, the pulser drives the input while a probe monitors its transmitted pulses at the output. (A probe is required because a clip cannot monitor the pulser's narrow output pulses.)

Assume that the output of NAND gate G1 in Fig. 4A is being held high, causing the output of G2 to be low (refer to the NAND truth table). When its button is held down, the pulser overrides the high output state of G1 and places a train of pulses on the input of G2. Accordingly, a train of narrow logic-high pulses appears at the output of G2. The PULSE LED of the probe flashes, indicating pulse activity and the LOW LED glows continuously to indicate a low that is going high. Although the output of G2 is stuck at a low level, the gate is not defective since it does indeed transmit pulses from the pulser.

Next, assume that the probe and pulser are moved to the positions shown in Fig. 4B. The pulser now applies a series of high pulses to the input of G1. Note that the pulser automatically supplies pulses of the proper polarity with no intervention by the operator. If the PULSE LED of the probe does not respond, gate G1 is defective and is the likely source of the stuck level at the output of G2.

Assume now that a 7490 decade counter sequential circuit is to be checked with a logic clip and pulser (Fig. 5). First, attach the 16-pin clip to the 14-pin IC (Fig. 5A) (the top or bottom two LEDs are not connected). Touch the pulser to the reset input and press the PULSE button once to inject a zero pulse into the IC and zero the outputs (Q1, Q2,

The Kurz-Kasch Model 670 probe has red, white, and blue lamps to indicate logic states. Switches choose logic family and memory.

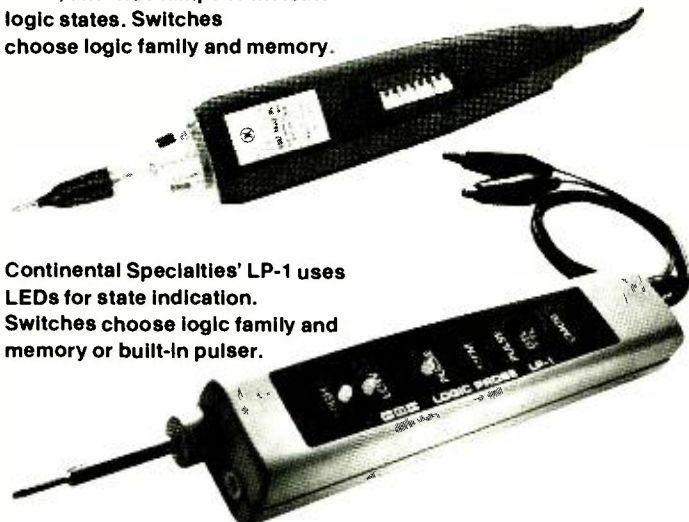

Continental Specialties' LP-1 uses LEDs for state indication. Switches choose logic family and memory or built-in pulser.



In AVR's "Catch -A-Pulse," two LEDs indicate high and low states and flash for pulses.

Q4, Q8). The display should be as shown at the left in Fig. 5B. Next, move the pulser to the clock input and single-step the counter through its decade cycle (0 to 9 decimal, 0000 to 1001 binary). After the first clock pulse, the LED for Q1 lights, indicating a count of 1. After the second clock pulse, the LED for Q2 lights and the LED for Q1 goes out, indicating a count of 2. Continuing this way, you can check the counter over its entire cycle of operation.

A probe is often all you need for testing sequential ICs. The circuit in which the IC is used can provide the pulses. For example, if there is a clock signal on a decade counter and the enabling inputs (usually reset lines) are enabled, the output should be counting. You can check this by monitoring the clock and enable inputs with a probe. If the probe indicates pulse activity on the outputs, you can assume that the IC is operating okay. When ICs fail, they usually do so completely and produce a circuit node stuck at a high, low, or bad level. Usually, it is not necessary to observe the timing relationships of the signals in a circuit under test, which would require an oscilloscope. An indication of pulse activity by a logic probe is normally sufficient evidence of proper operation.

Checking Logic Circuits. The most common defects found in digital circuits are shown in Fig. 6. The following five steps, performed in the sequence shown, will isolate the trouble quickly.

1. Narrow down the area of possible trouble by testing for bad nodes with a probe. A node is simply a circuit junction

point common to two or more gates or other elements. A bad node may be stuck at logic high or low or somewhere in between. Service literature for the equipment under test, or a knowledge of the equipment, will usually suggest points to monitor with a probe.

2. Check for an open bond in the IC driving the failed node. An open output at A in Fig. 6 would cause the node at B to float to a bad level of 1.4 to 1.5 volts. Inputs connected to B would interpret this as a high level, but a logic probe would not be fooled! It would indicate a bad level. The IC driving the node should be replaced.

3. If the node is not at a bad level, then test for a short to V+ (point C) or ground (D). Inject a pulse at the suspect node while monitoring the same node with a probe. The pulser is powerful enough to override even a low-impedance TTL output, but it is not sufficiently powerful to cause a change of state on the V+ or ground bus. Therefore, the absence of a pulse indicates that the node is shorted to V+ if it is high or to ground if it is low.

In case of a short, examine the circuit board for solder bridges, shorted-together pins, etc. If this does not isolate the short, then it is equally likely to be an internal short in any of the ICs attached to the node. Try replacing the IC driving the node and then each of the other ICs until the problem disappears. (Sometimes there may be a shorted capacitor or resistor attached to the node.)

4. Check for a short between two nodes (E in Fig. 6). Pulse one failing node and observe each of the other fail-

ing nodes with a logic probe. If there is a short between the pulsed and probed nodes, the probe will detect the pulse. To verify the short, transpose the probe and pulser and check again. As a further check, you can remove the circuit board from the system and investigate the short with an ohmmeter. The most common short between nodes is a circuit-board short caused by a solder bridge, loose wire, or other visible defect. Only if the two shorted nodes are common to one IC can the failure be inside the IC. If the short is not visible, replace the IC.

5. If you still have not isolated the problem, check for an open input bond (F in Fig. 6), a failure of the internal steering circuitry of the IC, or an open in the circuit outside the IC (G in Fig. 6).

With an open input bond (F), a signal appears at the input pin of the gate, but the gate responds as if a static high were applied. A failure of the steering circuitry will cause the output of an IC to be stuck high or low. In the case of a circuit open, inputs attached to the left side of the break will be driven normally, while inputs to the right will float to a bad level that looks like a static high.

In Conclusion. Logic probes, clips, and pulsers provide a digital answer to digital problems. Many of them cost less than you would pay for a multimeter. There are times, however (especially in complex computer circuitry), when a logic comparator is desirable because it can check out a host of logic levels simultaneously under dynamic conditions. But comparators are costly and require a large inventory of good ICs. ◇

Production Devices' Model 95 Indicates highs and lows with audio tones.



CSC's 16-LED Logic Monitor clip displays states of all IC pins at once.



Micronta three-LED Digital Logic Probe



COMPARING AUDIO "CLICK" AND "POP" SUPPRESSORS



DURING the past year or so, a new type of audio signal processing accessory has made its appearance. Usually called a "click and pop" suppressor, its function is to remove or greatly reduce the audible transient sounds resulting from scratches and blemishes on the surface of a phonograph record. Although nothing can be done to restore to perfect condition a scratched disc, it is possible to greatly reduce the annoyance from the resulting clicks. "Pops" are another form of record noise, which usually result from disc imperfections and the ever-present electrostatic charge (with its attendant crackling sounds) on the disc.

The designer of a noise-reducing accessory must first determine how to recognize noise and to distinguish it from program material. Fortunately, a

record scratch has several unique characteristics that distinguish it from the music: (1) It usually produces a vertical displacement of record material thereby generating an out-of-phase record modulation. (2) It has a very fast attack and decay time. This contrasts with normally slow action of musical sounds (even high-frequency percussive sounds decay slowly, though attack time is fast). (3) The transient will be brief in duration, lasting no more than one or two milliseconds. Musical sounds are always of greater duration. Although commercially available suppressors differ in most of their circuit details, all operate on the same general principles.

Once a transient noise is identified, the next step is to remove it without affecting the program. Though the audio signal can simply be blanked out for the

duration of the noise pulse, this leaves a "hole" in the program that can be just as audible as the "spike" of noise. Hence, each click and pop suppressor has been designed to fill in the holes in the program as unobtrusively as possible. It is necessary, therefore, for each system to pass the program through a time-delay circuit, since a finite time is required for the sensing circuits to determine that a noise pulse is present. Any suppression that occurs must be applied from the beginning of the transient.

The incoming program in suppressors is split into two paths. One path delays the signal for a short time before passing it through a gate or other circuit that is used to remove the transient. The other path passes the signal with no delay to the sensing circuits that control operation of the gate. Each of the competing



The SAE Model 500 impulse noise-reduction system.



Garrard's Model MRM 101



Now you can step up to higher fi with a new breed of record noise-removal audio components

BY JULIAN HIRSCH

suppressors on the market is claimed to use a different method for filling in the hole left by the removal of the noise transient, but the manufacturers are vague about the details of their techniques.

External measurements on a device like a click and pop suppressor (or any dynamic signal processor, for that matter) are at best an incomplete and unsatisfactory method of judging its performance. We chose, therefore, to depend mostly on subjective side-by-side comparisons, using measurements only where they could be truly informative.

Let us take a close look at the presently available click and pop suppressors and compare them on the basis of published specifications (see Table).

SAE Model 5000. The first click and pop suppressor to reach the market was

the SAE Model 5000 impulse noise-reduction system. This compact black box has input and output jacks as well as a second set of tape recorder input and output jacks that duplicate those on the amplifier used for connecting the suppressor into an audio system. INVERT, DEFEAT/NORMAL, and MONITOR switches are at the top of the front panel. The DEFEAT switch bypasses the suppressor circuits entirely, while the MONITOR button has the same function as the monitor button on the amplifier, except that it processes the signals going to the tape recorder through the impulse-noise suppressor circuits to remove transient noises from a disc program being copied onto tape.

The INVERT switch is used with a SENSITIVITY slide control to adjust the operating threshold. When INVERT is en-

gaged, the output from the system consists of only the noise pulses removed. As the SENSITIVITY control is moved up from zero, clicks and pops on the disc will be heard emerging from a silent background. If it is advanced too far, portions of the program will be heard as well. Hence, the correct adjustment point is obtained when only the pops are heard. Then, releasing the INVERT switch allows the program to be heard.

SAE's literature states that portions of program material immediately preceding and following the noise pulse are evaluated and substituted for the chopped-out portions. It also states that since this takes less than a millisecond, the substitution cannot be heard.

Burwen Model TNE 7000. This transient noise eliminator is manufac-



Music Recovery Module.



The Burwen Model TNE 7000 noise eliminator.

CLICKS and POPS

continued

tured by KLH. The design is based on the premise that noise transients last no more than 2 μ s; that they have attack and decay times of 50 to 200 μ s; and that they have high-energy content in the ultrasonic region from 20 to 50 kHz, where there is little or no music.

When the Burwen device senses the presence of impulse noise, using the above criteria, it cuts off the direct program for the duration of the noise pulse. However, instead of a delay of several milliseconds, the Model TNE 7000 has a very short 40- μ s delay in its signal path. It is much faster in operation than the other suppressors and is able to blank the signal for a period as brief as 80 μ s. A smoothing circuit that substitutes a smoothly varying signal for the program is used to fill in the hole instead of the abrupt transition of the noise gate to make the suppression inaudible.

This is a fairly large component. Like the SAE Model 5000, it has no power switch and is meant to be switched on and off by the amplifier's switched convenience outlet or left on continuously (it draws negligible power).

In the center of the front panel are pushbutton DEFEAT and TAPE MONITOR switches. The latter replaces the amplifier's tape monitor switch, since the device connects to the amplifier in the same manner as does the SAE device. The DEFEAT button allows one to bypass the noise-suppression circuit when it is not needed.

A large SENSITIVITY control is at the left of the panel, and next to it is a LED labelled HIGH FREQUENCY CALIBRATION. The control is used to adjust the sensitivity of the suppressor to high-frequency signals (in the vicinity of 30,000 Hz) that are used to actuate the noise-blanking gate. When the control is correctly set with relation to the noise "floor," the LED noticeably dims. At the right of the panel is another control labelled THRESHOLD, accompanied by a LED labelled TRANSIENT NOISE ELIMINATION. As the control is turned clockwise, transient

Test results in Figs. 1-4 are for SAE 5000, Figs. 5-7 are for Burwen 7000. Time base is 1 ms/div., except 1 μ s/div. for Fig. 7. Test signal is 10,000-Hz tone burst on 10,000-Hz sine wave. Fig 1 shows 0.4-ms burst input
(Continued above on following page.)

Fig. 1

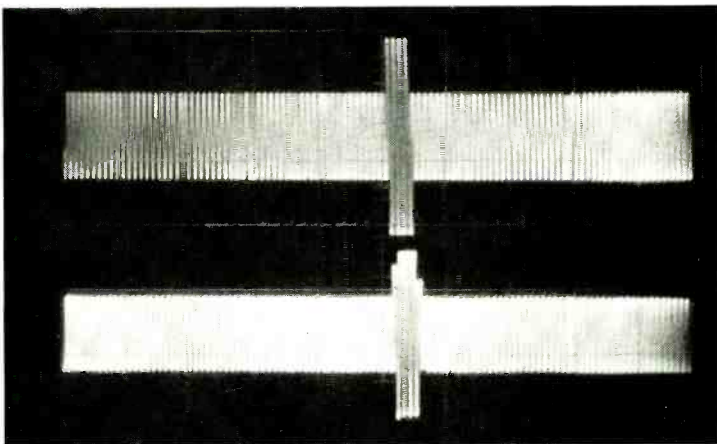

Fig. 2

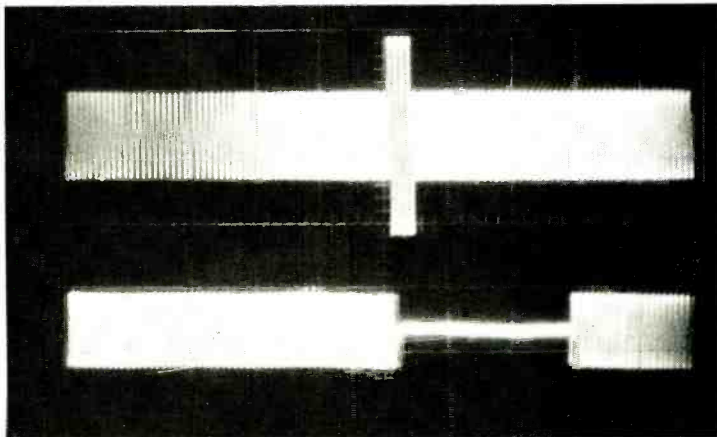

Fig. 3

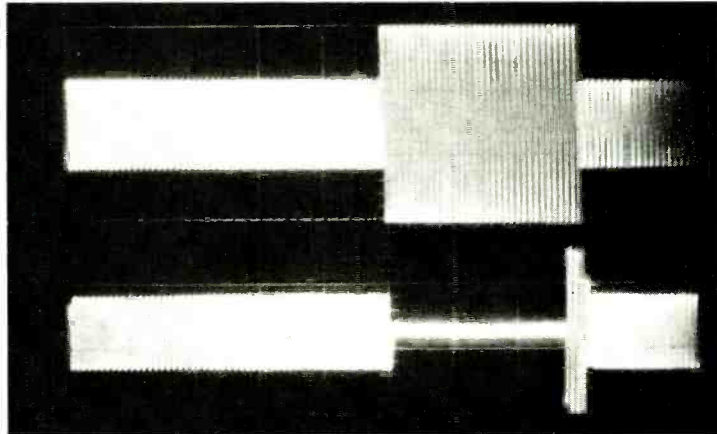
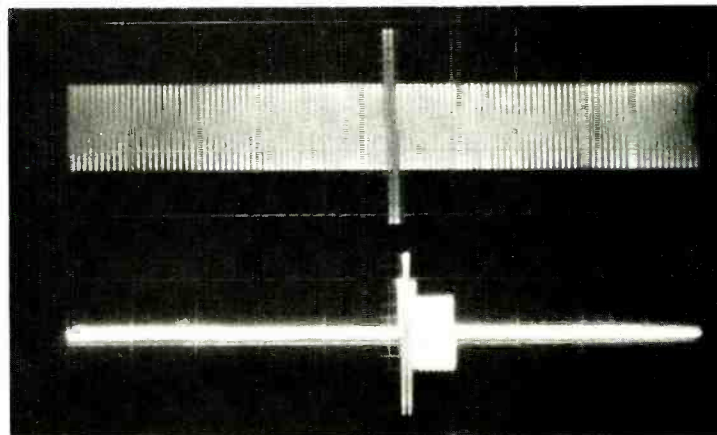

Fig. 4



(Continued from preceding page.)

and output with suppressor defeated. Fig. 2 is same with suppressor in use. In Fig. 3, burst is 3 ms, suppressed for only 2.7 ms. Fig 4 shows output with INVERT switch activated. Figs. 5 and 6 can be compared to Figs. 2 and 3. In Fig. 7, lack of fill-ins is shown when burst is shortened to 100 μ s.

noise causes the LED to flash, which indicates that the noise is being removed from the signal.

Since the Model TNE 7000 uses noise impulse energy in the vicinity of 30,000 Hz to trigger its circuits, it is desirable to use it with a cartridge that has extended high-frequency response. A CD-4 cartridge is ideal, for example, but the system will function properly with any reasonably good cartridge.

Garrard Model MRM 101. Garrard's suppressor is named, somewhat cryptically, a "Music Recovery Module." Unlike the other suppressors, which are designed to connect into an audio system via the amplifier's tape-monitoring loop, where it can be used to remove transient noise impulses from any program source, the Model MRM 101 can be used only on phono sources. It contains its own RIAA-equalized preamplifier, whose output can be connected to a high-level (AUX) input on an amplifier or receiver.

The Model MRM 101 identifies transient noises by using the same criteria employed in the Burwen and SAE systems. The decision time of the Garrard device's logic is 0.4 ms, and a 2.7-ms program delay is used so that the device can suppress a transient from its onset. The program delay is accomplished with a 256-stage "bucket-brigade" IC. Instead of attempting to fill the hole left in the program by the deleted pulse, the pulse is blanked to a depth of 34 dB with a smoothly operating optical attenuator. A LED/photoreistor circuit reduces the gain smoothly and relatively slowly, in contrast to an abrupt cutoff action, while another LED/photoreistor circuit returns the gain to its original level after the transient passes. This cycle of pulse recognition, gain reduction, and gain restoration takes about 2.5 ms and falls within the 2.7-ms program delay period. Because of the smooth change in gain, the action is relatively inaudible.

At the left of the Model MRM 101's front panel is the POWER switch. At the right is the SUPPRESSOR on/off switch; a red LED lights when the suppression circuits are switched in. The remaining control is simply labelled MIN and MAX at its rotation extremes. Near it is a red

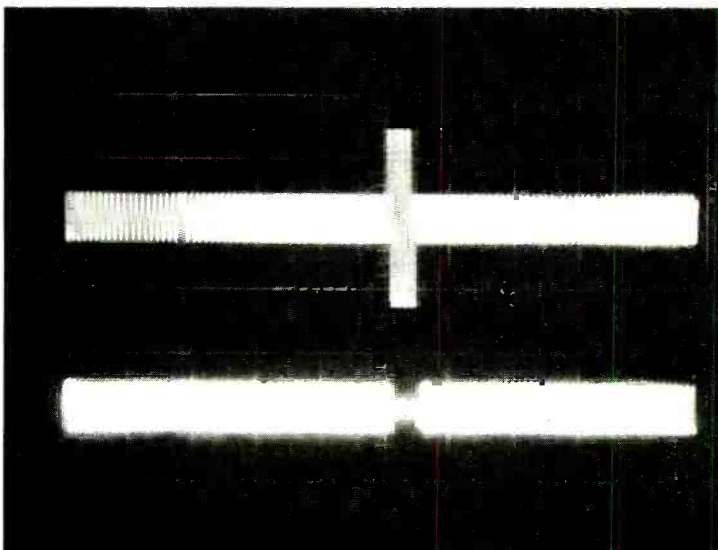

Fig. 5

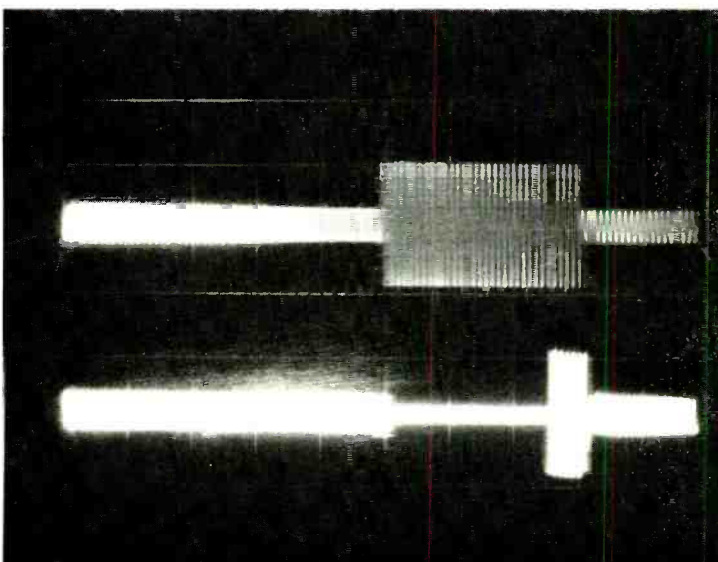

Fig. 6

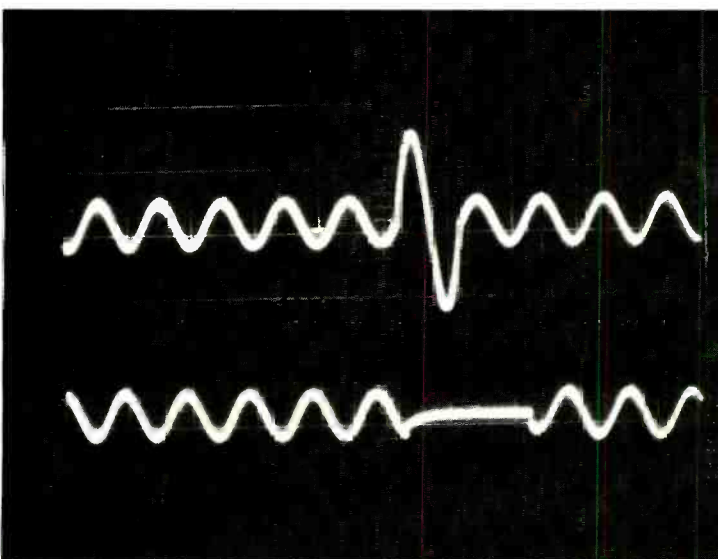

Fig. 7

LED labelled SUPPRESSOR ACTIVITY.

It is not necessary to turn on the suppressor circuits to use the Model MRM 101 solely as a phono preamplifier. If a record has impulse noise, the suppressor circuits can be switched in and the MIN/MAX control advanced clockwise until the SUPPRESSOR ACTIVITY LED begins to flash, indicating that the suppressor is acting on the noise impulses.

Laboratory Tests. Most conventional laboratory performance tests on click and pop suppressors are uninformative. We simply verified the devices' maximum output capabilities, distortion figures, and noise levels. In the case of the Garrard Model MRM 101, we also measured the performance of its phono preamplifier.

The Garrard suppressor's preamplifier was affected considerably by whether or not the noise-elimination circuits were switched in. Without suppression, it overloaded at a safe 135 mV at 1000 Hz and could deliver an 8.8-volt output. With the suppressor switched in, the overload limit was a marginal 47 mV and the maximum output voltage was 2.8 volts. In both cases, a 4.5-mV input was needed to develop the rated 300-mV

output. The unweighted noise level in the output was -66 dB without suppression and -60 dB with suppression, referred to the 300-mV nominal output. Both figures are quite acceptable for a phono preamplifier. (They would be improved by slightly more than 4 dB if referred to the IHF standard output level of 0.5 volt.)

The 1000-Hz THD was very low without the suppressor, measuring only 0.0025% at 1-volt output. It increased to 0.1% when the suppressor was activated. The RIAA phono equalization was accurate to within ± 0.5 dB from 30 to 20,000 Hz without the suppressor, and there was no interaction with cartridge inductance. The suppressor circuit rolled off the response above 10,000 Hz to -6 dB at 20,000 Hz and introduced a rise of about 1.5 dB from 70 to 250 Hz.

It must be remembered that, even if some of the preamplifier specifications deteriorate when the suppressor is used, this condition would exist only when records in substandard condition are being played. There would be no reason to use a transient suppressor when playing a record of high quality.

Aside from the measurements of the phono section of the Model MRM 101,

the only objective tests we made on all three noise suppressors were with simulated transient signals to determine how suppression affected the total signal waveform.

Interpreting Oscilloscope Photos. The oscilloscope photos we took during our tests reveal some significant differences between the Burwen and SAE suppressors. The test signal was a 10,000-Hz sine wave on which was superimposed a 10,000-Hz tone-burst signal of adjustable duration. We adjusted the amplitude of the burst so that it would reliably operate the suppressor circuits. (About 6 dB greater than the steady-state level was a suitable level, although the suppressors could be adjusted to operate over a very wide range of levels.)

On all photos, except that in Fig. 7, the time base is 1 ms/division. In Fig. 1, we see a 0.4-ms burst signal at the top of the photo and below it the same signal at the output of the SAE Model 5000 with the suppressor defeated. Except for the approximately 100 μ s required for the burst to build up and decay, the signal was unmodified by its passage through the SAE system.

In Fig. 2, the suppressor is in use, with the sensitivity adjusted so that the burst is recognized as a "noise." Two things are apparent here: the off time is much longer than the noise pulse by about 2.7 ms and there is no sign of any "fill-in" signal during the off interval. In Fig. 3, the length of the "transient" has been increased to about 3 ms, which is somewhat longer than any real click or pop would last according to the criteria accepted by all three manufacturers. The suppression interval is still only 2.7 ms and about 0.3 ms of the pulse passes through at full amplitude. This suggests that the signal-path time delay in the Model 5000 is about 2.7 ms.

In Fig. 4, we see the output of the Model 5000 with the INVERT switch activated, using a short burst of 200 μ s. As claimed, the signal is suppressed in the output and only the noise pulse is present, which makes it very easy to set the operating threshold. Note, however, that the INVERT output continues after the noise pulse at roughly the steady-state program level for another 0.7 ms. This time remains constant when the duration of the noise pulse is varied over wide limits.

The performance of the Burwen suppressor with the same signals used in Fig. 1 and Fig. 2 for the SAE device is

Performance Specifications—"Click" and "Pop" Suppressors

Specification	SAE 5000	Burwen TNE 7000	Garrard MRM 101
Harmonic distortion (20-20,000 Hz, rated output, unless specified)	0.1%	0.2%	0.01% DIRECT 0.1% SUPPRESSED (1 KHz)
IM Distortion	0.1%	NA	NA
S/N (output V)	90 dB (2.5 V)	96 dB (2.5 V)	100 dB (DIRECT, 8 V) 80 dB (SUPPRESSED, 2.5 V)
Rated output	2.5 V	2.5 V	300 mV
Maximum output	9 V	7 V	8 V (DIRECT) 2.5 V (SUPPRESSED)
Frequency response (20-20,000 Hz)	± 1 dB	± 0.5 dB	± 1.5 dB (from RIAA)
Input impedance	75,000 ohms	40,000 ohms	47,000 ohms
Load impedance	Over 600 ohms	5000 ohms	10,000 ohms
Gain	+0/-1 dB	0.0 dB	NA
Power consumption 120 V	7 W	8 W	7 W
Dimensions (in.) (W x D x H)	10 $\frac{3}{4}$ x 9 $\frac{1}{4}$ x 3	16 $\frac{3}{4}$ x 7 $\frac{5}{8}$ x 2 $\frac{3}{4}$	14 $\frac{7}{8}$ x 11 $\frac{3}{4}$ x 2 $\frac{3}{4}$
Suggested retail price	\$200	\$300	\$200

shown in Fig. 5. In this case, the off time is the same as the duration of the noise pulse. It maintains this relationship until the duration of the pulse exceeds about 2.5 ms, after which the pulse is no longer suppressed (see Fig. 6). To judge how effectively the Burwen device dealt with very short pulses, for which it had supposedly been optimized, we shortened the burst to 100 μ s (one cycle of the 10,000-Hz signal). The result is shown in Fig. 7 on a time scale of 100 μ s/division. It can be seen that the 100- μ s transient causes the program to be suppressed for about 200 μ s. It also appears that, as was the case for the SAE device, it has no visible fill-in action while the signal is interrupted.

We did not test the Garrard Model MRM 101 with this composite signal, because of the manner in which this suppressor is connected to the amplifier.

Listening Comparison. The tone-burst tests are interesting, but they're hardly comprehensive enough to properly evaluate the suppressors. Such tests can be made only by subjective listening comparisons to genuine record clicks and pops. Tone bursts, however, do tell us something about the range of transient durations over which the suppressors can operate, the duration of the signal-blanking interval, and the nature of any "fill-in" signal during the interval. (We found no evidence of a fill-in signal with any of the suppressors.)

Most of our listening evaluation was done with records, since they are the prime source for which these products were designed. Several different phono cartridges were used, including CD-4, low-cost moving-magnet, and some moving-coil cartridges. We found no significant performance differences with different cartridges.

For our listening tests, we made a "demonstration" record by using a razor blade to cut radial "scratches" in a spoke pattern on a record. When we played the record without suppression, the scratches generated a fusillade of loud pops with each revolution. This kind of record makes for a very effective, though potentially misleading, demonstration of a click-and-pop suppressor.

In our judgment, the Garrard and SAE suppressors were very nearly equivalent in their ability to eliminate the audible effects of such "scratches." Depending on the severity of the razor scratches, there might be a complete suppression of the noise, or the "hole" might be heard as a soft low-frequency "thump." Even the

latter was far less objectionable than the original transient in every case.

The Burwen device had almost no effect on the noises from the massive gouges made by the razor blade. At first, we wondered if the system was operating properly, but a telephone call to designer Richard Burwen clarified the matter. The Model TNE 7000 is designed to deal with "real-world" scratches, which are almost invariably much more shallow and produce briefer and less audible transients than the artificially spiked discs. The Burwen circuitry has been designed specifically to suppress these short-duration transients.

We had to ferret out some of our discs with short, sharp ticks to evaluate the Burwen suppressor. Some of these discs produced little more than a crackle in the sound, akin to the sound from dust particles and electrostatic discharges. The SAE suppressor cleaned up the sound fairly well, but tended to leave audible thumps. (This is explainable by the constant duration of its blanking action, which treats all transients alike, regardless of their duration.) The Garrard suppressor removed the ticks fairly well, with little or no trace of residual thump. The Burwen system proved to be by far the most effective of the three suppressors in this situation. The only clue that a transient was present was the flashing of its LED indicator.

We tested the three suppressors with an off-the-air FM program that contained the effects of scratched records. Though the Garrard system cannot do anything about this, the other two systems can, at least potentially. The few times we encountered FM broadcasts of scratched records, we were unable to make any real comparisons between the Burwen and SAE suppressors because the noises did not last long enough and were not under our control. However, we did find that both suppressors could do at least a fair job of removing clicks from FM signals. In addition, the very fast response of the Burwen system made this suppressor surprisingly effective in removing automobile ignition interference to the FM signal.

In Conclusion. The applicability of click-and-pop suppressors for a home music system must be decided on the basis of how many seriously scratched records one has. Of course, one can buy a lot of replacement discs for the \$200 to \$300 cost of a suppressor. If you are engaged in making tape copies of old, scratched discs for which there are no

replacements, a suppressor can certainly be an invaluable accessory.

The Garrard system has the advantage and disadvantage of containing its own phono preamplifier. When its suppressor is in use, its preamplifier is not the equal of those found in moderately priced amplifiers and receivers, and critical listeners might not wish to use it in lieu of an existing preamplifier (although when the suppressor is defeated, the preamplifier in the Garrard system is of very good quality). On the other hand, the Model MRM 101 does provide one with an additional magnetic phono input when it is connected to an amplifier's aux inputs. As we see it, any deficiencies it might have are of little importance when one is faced with the alternatives of listening to a scratched disc "as is" and not playing it at all.

If one decides to keep his present phono preamplifier, the SAE Model 5000 comes close to equalling the performance of the Garrard system in suppressing clicks and pops. Either system will do a very impressive job of suppression with relatively little effect on the program itself. The worse the click, the more effective these systems will be in removing it.

The Burwen Model TNE 7000 is much more refined in its action. If razor gouges are a good approximation of the condition of your discs, this is *not* the system to buy. For dealing with most real, accidentally caused clicks, manufacturing defects, and electrostatic crackles, whether, on your own discs or in FM broadcasts, however, the Burwen system was the most effective of the three we tested.

All three systems were easy to adjust for good suppression without audible distortion, although excessively high settings of the threshold controls on the Burwen and SAE systems could produce an unpleasant "hashy" distortion. Since it is easy to set the controls correctly, this is no cause for concern. We were unable to make the Garrard system produce audible distortion or overload over the entire range of its threshold control.

Keep in mind that none of the devices detailed here will do anything about record hiss, rumble, or any record noise except transient sounds that satisfy their recognition criteria. When used for the intended purpose, they can be effective and useful additions to any music system in which the quality of the records does not match that of the individual playing components. ◇

Data Processing Quiz

DIRECT FROM JAPAN'S BIGGEST ELECTRONICS SUPPLIER
 Any and all components for all Japanese makes

2A42	2584	2585	2586	2587	2588	2589	2590	2591	2592	2593	2594	2595	2596	2597	2598	2599	2600	2601	2602	2603	2604	2605	2606	2607	2608	2609	2610	2611	2612	2613	2614	2615	2616	2617	2618	2619	2620	2621	2622	2623	2624	2625	2626	2627	2628	2629	2630	2631	2632	2633	2634	2635	2636	2637	2638	2639	2640	2641	2642	2643	2644	2645	2646	2647	2648	2649	2650	2651	2652	2653	2654	2655	2656	2657	2658	2659	2660	2661	2662	2663	2664	2665	2666	2667	2668	2669	2670	2671	2672	2673	2674	2675	2676	2677	2678	2679	2680	2681	2682	2683	2684	2685	2686	2687	2688	2689	2690	2691	2692	2693	2694	2695	2696	2697	2698	2699	2700	2701	2702	2703	2704	2705	2706	2707	2708	2709	2710	2711	2712	2713	2714	2715	2716	2717	2718	2719	2720	2721	2722	2723	2724	2725	2726	2727	2728	2729	2730	2731	2732	2733	2734	2735	2736	2737	2738	2739	2740	2741	2742	2743	2744	2745	2746	2747	2748	2749	2750	2751	2752	2753	2754	2755	2756	2757	2758	2759	2760	2761	2762	2763	2764	2765	2766	2767	2768	2769	2770	2771	2772	2773	2774	2775	2776	2777	2778	2779	2780	2781	2782	2783	2784	2785	2786	2787	2788	2789	2790	2791	2792	2793	2794	2795	2796	2797	2798	2799	2800	2801	2802	2803	2804	2805	2806	2807	2808	2809	2810	2811	2812	2813	2814	2815	2816	2817	2818	2819	2820	2821	2822	2823	2824	2825	2826	2827	2828	2829	2830	2831	2832	2833	2834	2835	2836	2837	2838	2839	2840	2841	2842	2843	2844	2845	2846	2847	2848	2849	2850	2851	2852	2853	2854	2855	2856	2857	2858	2859	2860	2861	2862	2863	2864	2865	2866	2867	2868	2869	2870	2871	2872	2873	2874	2875	2876	2877	2878	2879	2880	2881	2882	2883	2884	2885	2886	2887	2888	2889	2890	2891	2892	2893	2894	2895	2896	2897	2898	2899	2900	2901	2902	2903	2904	2905	2906	2907	2908	2909	2910	2911	2912	2913	2914	2915	2916	2917	2918	2919	2920	2921	2922	2923	2924	2925	2926	2927	2928	2929	2930	2931	2932	2933	2934	2935	2936	2937	2938	2939	2940	2941	2942	2943	2944	2945	2946	2947	2948	2949	2950	2951	2952	2953	2954	2955	2956	2957	2958	2959	2960	2961	2962	2963	2964	2965	2966	2967	2968	2969	2970	2971	2972	2973	2974	2975	2976	2977	2978	2979	2980	2981	2982	2983	2984	2985	2986	2987	2988	2989	2990	2991	2992	2993	2994	2995	2996	2997	2998	2999	3000
------	------	------	------	------	------	------	------	------	------	------	------	------	------	------	------	------	------	------	------	------	------	------	------	------	------	------	------	------	------	------	------	------	------	------	------	------	------	------	------	------	------	------	------	------	------	------	------	------	------	------	------	------	------	------	------	------	------	------	------	------	------	------	------	------	------	------	------	------	------	------	------	------	------	------	------	------	------	------	------	------	------	------	------	------	------	------	------	------	------	------	------	------	------	------	------	------	------	------	------	------	------	------	------	------	------	------	------	------	------	------	------	------	------	------	------	------	------	------	------	------	------	------	------	------	------	------	------	------	------	------	------	------	------	------	------	------	------	------	------	------	------	------	------	------	------	------	------	------	------	------	------	------	------	------	------	------	------	------	------	------	------	------	------	------	------	------	------	------	------	------	------	------	------	------	------	------	------	------	------	------	------	------	------	------	------	------	------	------	------	------	------	------	------	------	------	------	------	------	------	------	------	------	------	------	------	------	------	------	------	------	------	------	------	------	------	------	------	------	------	------	------	------	------	------	------	------	------	------	------	------	------	------	------	------	------	------	------	------	------	------	------	------	------	------	------	------	------	------	------	------	------	------	------	------	------	------	------	------	------	------	------	------	------	------	------	------	------	------	------	------	------	------	------	------	------	------	------	------	------	------	------	------	------	------	------	------	------	------	------	------	------	------	------	------	------	------	------	------	------	------	------	------	------	------	------	------	------	------	------	------	------	------	------	------	------	------	------	------	------	------	------	------	------	------	------	------	------	------	------	------	------	------	------	------	------	------	------	------	------	------	------	------	------	------	------	------	------	------	------	------	------	------	------	------	------	------	------	------	------	------	------	------	------	------	------	------	------	------	------	------	------	------	------	------	------	------	------	------	------	------	------	------	------	------	------	------	------	------	------	------	------	------	------	------	------	------	------	------	------	------	------	------	------	------	------	------	------	------	------	------	------	------	------	------	------	------	------

TV, RADIO, STEREO SPARE PARTS KITS (with beautiful fitted case)

DIP IC TEST CLIP 16P \$3.00

EXTRA LENGTH TEST CLIPS \$1.00

TRANSISTOR Set
 A-TYPE (66 species, 123 pcs) \$275.00
 B-TYPE (114 species, 123 pcs) \$275.00
DIODE Set \$150.00
IC Set (27 pcs) \$140.00
CR Set (479 pcs) \$100.00

Most orders shipped same day. Minimum order US\$20.00. Send Postal or bank money order only. Please add US\$3.50 for air shipping and handling per order. Dealer inquiries also invited.

ADD ELECTRONIC INDUSTRIAL CO., LTD.
 1-1-1, Nishi-Shinjyuku 2-chome, Shinjyuku-ku, Tokyo, 163, Japan
 Tel: (03) 232-2301, Telex: NIPONCO TOKYO

BE A LOCKSMITH

\$39.95 COMPLETE COURSE

Kit contains: LOCK PICKER, CAR OPENING TOOL, LOCKS, KEYS & KEYS COURSE COVERS LOCK PICKING, MASTER KEYING, KEY IMPRESSIONING, RE-KEYING

Today a trained Locksmith can just about write his own ticket. Locksmiths average \$15.00 an hour. Learn at home - Earn as you learn. Fast easy course that trains you by doing. All keys, locks, picks, car tools and special equipment supplied. Zooming crime is everywhere, everyone is seeking greater protection. **Cash in at once, train at home - Earn extra \$\$\$ right away.** Send for exciting facts and a Free Lesson - No obligation or Send \$39.95 for complete Kit & \$1.75 shipping & handling. Texas residents add sales tax. C.O.D. accepted. **10 day money back guarantee.**

NATIONAL LOCKSMITH SUPPLY
 8350 PARK LANE, SUITE 265
 DALLAS, TEXAS 75231

SEND COURSE SEND INFORMATION AND FREE LESSON

NAME _____
 ADDRESS _____
 CITY _____
 STATE _____
 ZIP _____

\$39.95 & 1.75 shipping. Texas Residents add 5% Tax. C.O.D. accepted

CIRCLE NO 42 ON FREE INFORMATION CARD

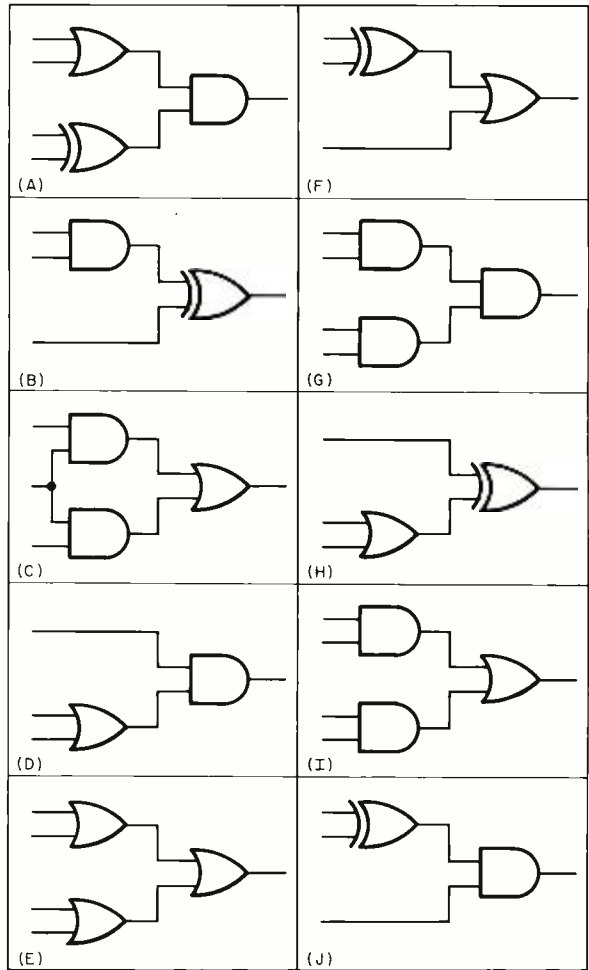

Digital logic circuits are designed to handle the "and" and "or" relationships that exist not only in mathematical processes but in everyday life as well.

To test your ability at understanding logic, see if you can match the following common situations (1 to 10) with the analogous circuits (A to J).

1. To win a prize, you must send in a coupon and also get at least one of the questions right.
2. Today's luncheon special consists of a ham sandwich with either soup or a salad, but not both.
3. You can paint the walls blue or pink, but paint the ceiling white, even if you don't do the walls.
4. A pair of Jacks or a pair of Queens will win the hand.

5. They will rent the apartment to a couple or a single person, but not to both.

6. On this TV set, you can get the sound and picture separately or together on channel 5, but the sound only on channel 8.

7. To get in, you must have either \$4.00 and a discount card, or come up with another dollar.

8. You must attend at least one morning or afternoon session of either day of the conference.

9. If you take a course in Law or Sociology, or both, you must also take one in either English or History, but not both.

10. You can play doubles at tennis there; but if a player on either team fails to show up, the game is called off.

(Answers on page 119)

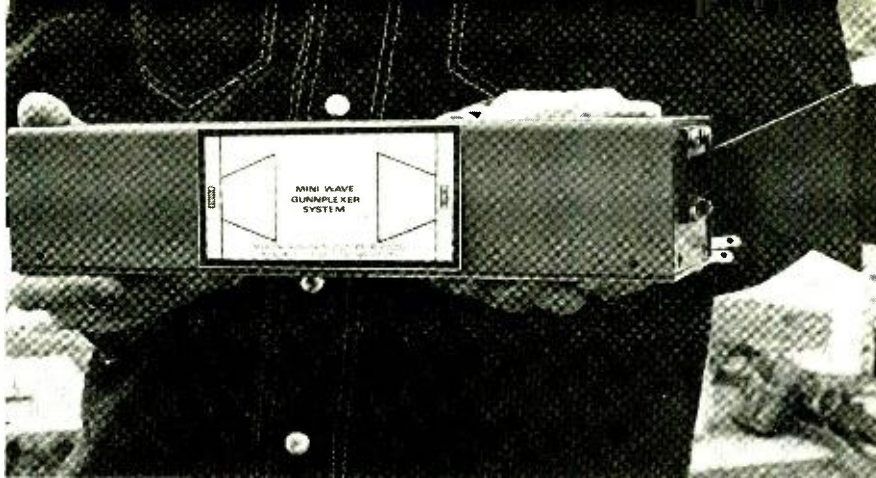

BY ROBERT B. COOPER, JR.,
W5KHT,
AND S. K. RICHEY

PART 2

A PERSONAL MICROWAVE COMMUNICATIONS SYSTEM

THE MINI-WAVE

*Construction,
alignment, and
setup details*

HAVING examined the Gunnplexer microwave module and its transmit and receive support circuits in Part 1, last month, this concluding part will focus on assembly and alignment of Mini-Wave communications gear, selection of antennas, and how this choice affects communications range. Other topics to be discussed are licensing your Mini-Wave system and safety considerations in the use of microwave devices.

Construction. The use of printed-circuit construction techniques is recommended. A carefully designed pc board will minimize instability due to parts placement and lead positioning that can occur in a high-gain, high-frequency stage such as the receiver i-f. Suitable etching and drilling and parts placement guides for the receiver, optional audio subcarrier generator/modulator and demodulator boards are shown in Figs. 5, 6, and 7, respectively. (The transmitter without the optional audio subcarrier generator/modulator is so simple that no circuit board is required.)

The receiver contains a number of hand-wound inductors. Air-core coils can be wound on a pencil, a piece of plastic tubing, or a coil form made speci-

fically for that purpose. Several coils are lengths of very fine (No. 30) enamelled copper wire wound on Ferroxcube ferrite shielding beads. The edges of the beads should be smoothed so that the enamel insulation is not inadvertently scraped off when the coils are wound, either by tumbling the beads in a lapidary tumbler or with a fine grade of sandpaper.

When components are mounted on the printed circuit boards, attention should be paid to the polarity of electrolytic capacitors and diodes and pin basing of transistors and IC's. The minimum amount of heat and solder consistent with good connections should be applied to each solder joint. Also, the boards should be scrutinized for unwanted solder bridges between adjacent foils. Interconnections between the boards, Gunnplexer signal ports, and input and output jacks should be made with small-diameter coaxial cable such as RG-174/U. Hook-up wire can be used for other connections.

The author's prototype transmitter is shown in Fig. 8 with the cover of its enclosure removed. Video and audio level and Varactor tuning voltage controls, input jacks, the power switch and fuseholder are mounted on the rear of the

enclosure. Terminal strips and point-to-point wiring are employed in the power supply and non-audio portions of the transmitter. The Gunnplexer is bolted directly to the front of the enclosure. The entire assembly forms a neat, relatively compact unit that can be mounted on a camera tripod or other support. If it is inconvenient to mount the entire transmitter or receiver at the antenna site, the Gunnplexer alone can be installed there with coaxial lines to other circuits.

The enclosures that come with the Mini-Wave kits are not intended for permanent installation outdoors. The major problem is moisture. One very simple solution to this problem is to cover the entire transmitter or receiver package, including a 17-dB gain horn antenna if used, with a large plastic bag equipped with a downward-pointing plastic tube that will allow "breathing" and the escape of condensed moisture. Of course, adequate measures should be taken to keep the 117-volt ac power line isolated from the environment. Alternatively, low-voltage ac derived from a step-down transformer can be applied to a remote Mini-Wave transmitter or receiver by means of a suitable length of multiconductor cable approved for outdoor use.

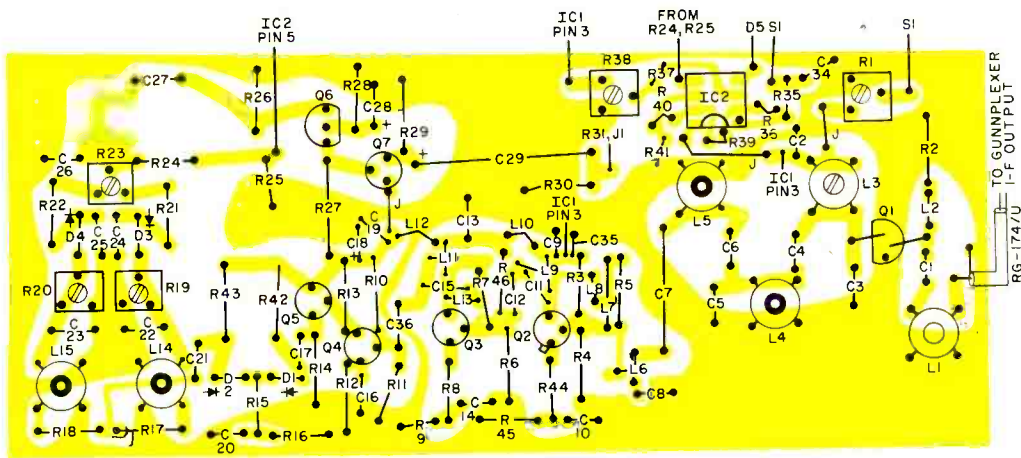
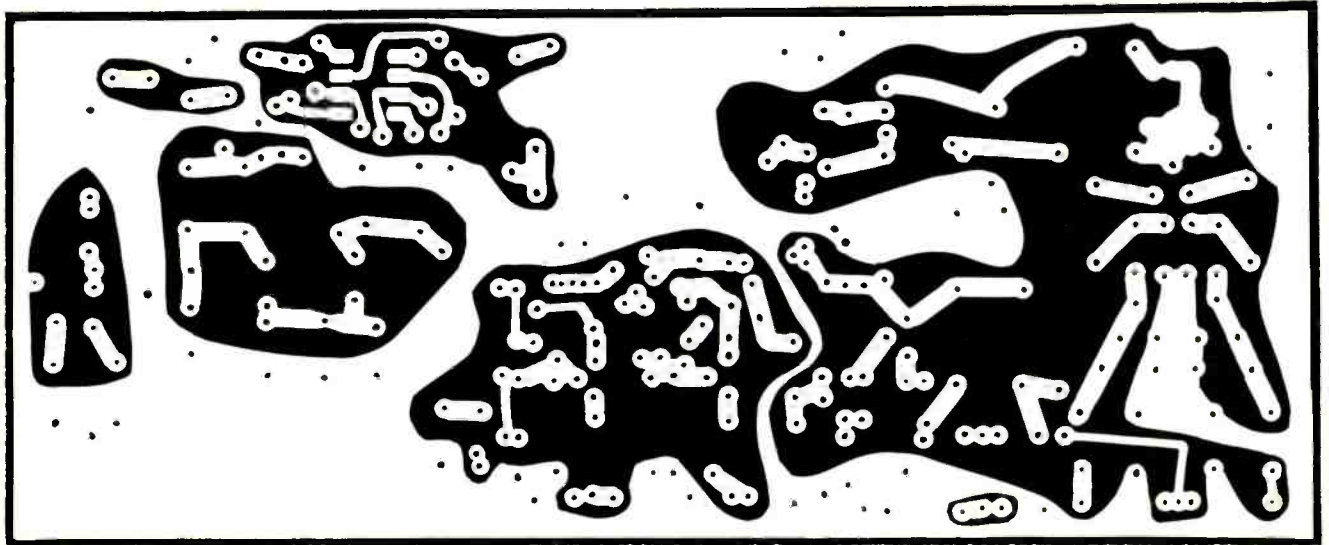

Fig. 5. Etching and drilling guide (below) and parts placement (left) for the receiver board.



Alignment. For best performance, Mini-Wave communications equipment must be properly aligned. This is especially true in the case of the receiver, audio subcarrier generator/modulator and audio subcarrier demodulator. The transmitter, however, requires almost no alignment at all, owing to its simplicity. Instrumentation required includes a voltmeter, an oscilloscope and a frequency-swept signal generator.

Align the receiver in the following manner (see Fig. 9). First, disconnect the coaxial cable running from the Gunnplexer's i-f output to the receiver pc board. This is most easily done by disconnecting the cable from the Gunnplexer rather than from the pc board. Next, couple signals to the coaxial cable from a frequency-swept signal generator via a 100-pF silver mica or disc ceramic capacitor. The generator's controls should be adjusted so that the output signal is at a relatively low level (0 dBm or 1 mV) and sweeps to beyond 60 MHz

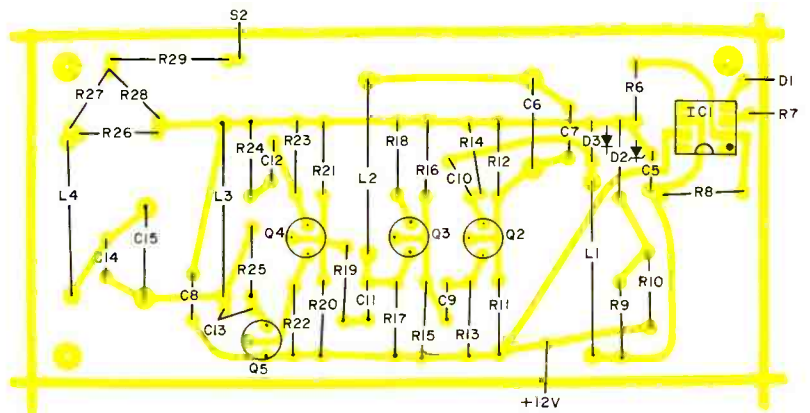
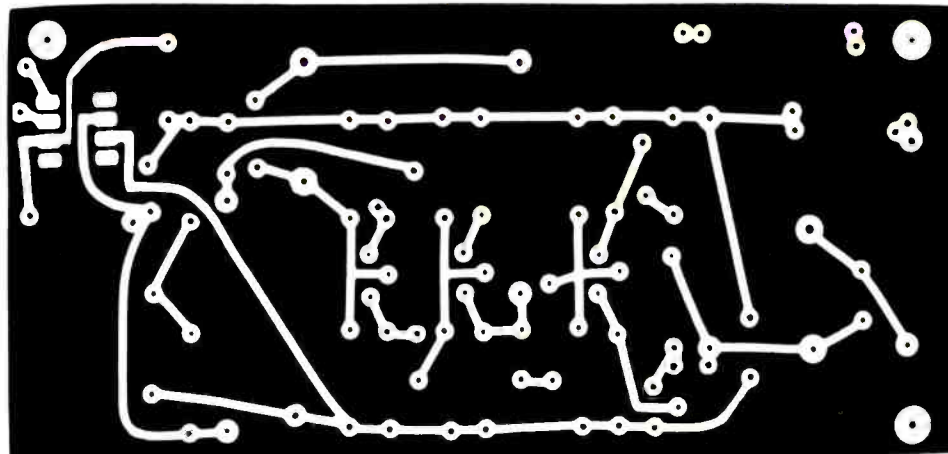

Fig. 6. Etching and drilling and parts placement guides for audio subcarrier generator/modulator.



An Extraordinary Offer to introduce you to the benefits of Membership in

ELECTRONICS BOOK CLUB

take any **4** of these 22 unique electronics books (values to \$65⁸⁰) for only **49¢** each

with a Trial Membership in the Book Club that guarantees to save you 25% to 75% on a wide selection of electronics books

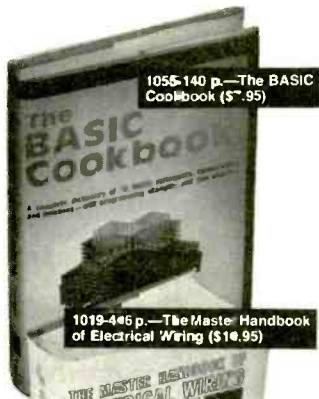

1055-140 p.—The BASIC Cookbook (\$7.95)

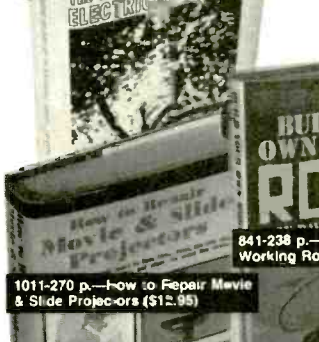

1019-446 p.—The Master Handbook of Electrical Wiring (\$16.95)



1011-270 p.—How to Repair Movie & Slide Projectors (\$12.95)



678-276 p.—Modern Communications Switching Systems (\$17.95)



874-392 p.—Master Handbook of Digital Logic Applications (\$22.95)

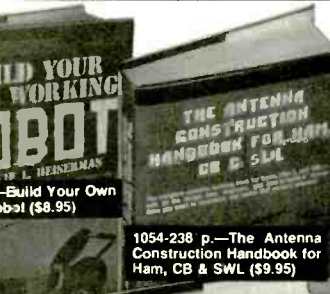

841-238 p.—Build Your Own Working Robot (\$8.95)

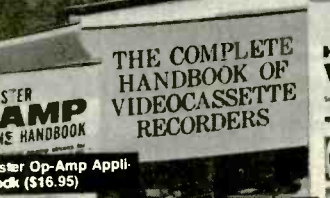

1054-238 p.—The Antenna Construction Handbook for Ham, CB & SWL (\$9.95)



811-280 p.—The Complete Handbook of Videocassette Recorders (\$9.95)

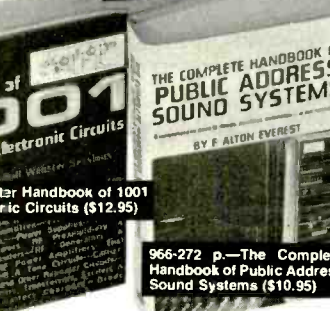

966-272 p.—The Complete Handbook of Public Address Sound Systems (\$10.95)



101-416 p.—Electronic Circuit Design Handbook (\$17.95)



1028-270 p.—How to Repair Video Games (\$9.95)



919-434 p.—Color TV Trouble Factbook (\$9.95)

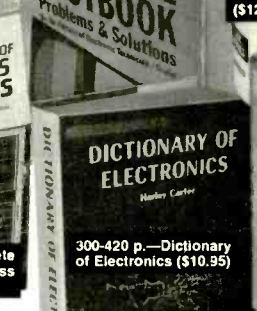

300-420 p.—Dictionary of Electronics (\$10.95)



1070-406 p.—Interfacing with an Analog World (\$12.95)

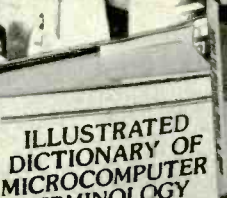

1088-322 p.—Illustrated Dictionary of Microcomputer Terminology (\$12.95)



929-322 p.—Solid-State Motor Controls (\$12.95)



1060-308 p.—303 Dynamic Electronic Circuits (\$9.95)



1064-336 p.—How to Design, Build, & Test Complete Speaker Systems (\$10.95)



1015-308 p.—A Beginner's Guide to Microprocessors (\$9.95)

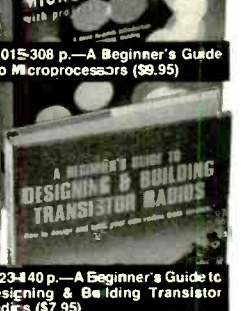

1023-440 p.—A Beginner's Guide to Designing & Building Transistor Radios (\$7.95)

May we lend you your choice of 4 of these practical time-and-money-saving books as part of an unusual offer of a Trial Membership in Electronics Book Club?

Here are quality hardbound volumes, each especially designed to help you increase your know-how, earning power, and enjoyment of electronics. Whatever your interest in electronics, you'll find Electronics Book Club offers practical, quality books that you can put to immediate use and benefit.

This extraordinary offer is intended to prove to you through your own experience, that these very real advantages can be yours... that it is possible to keep up with the literature published in your areas of interest, and to save substantially while so doing. As part of your Trial Membership, you need purchase as few as four books during the coming 12 months. You would probably buy at least this many anyway, without the substantial savings offered through Club Membership.

To start your Membership on these attractive terms, simply fill out and mail the coupon today. You will receive the 4 books of your choice for 10-day inspection. **YOU NEED SEND NO MONEY.** If you're not delighted, return the books within 10 days and your Trial Membership will be cancelled without cost or obligation.

ELECTRONICS BOOK CLUB, Blue Ridge Summit, Pa. 17214

Facts About Club Membership

- The 4 introductory books of your choice carry publisher's retail prices of up to \$65.80. They are yours for only 49¢ each (plus postage/handling) with your Trial Membership.
- You will receive the Club News, describing the current Selection. Alternates and other books, every 4 weeks (13 x a year).
- If you want the Selection, do nothing, it will be sent to you automatically. If you do not wish to receive the Selection, or if you want to order one of the many Alternates offered, you simply give instructions on the reply form (and in the envelope) provided, and return it to us by the date specified. This date allows you at least 10 days in which to return the form. If, because of late mail delivery, you do not have 10 days to make a decision and so receive an unwanted Selection, you may return it at Club expense.
- To complete your Trial Membership, you need buy only four additional monthly Selections or Alternates during the next 12 months. You may cancel your Membership anytime after you purchase these four books.
- All books—including the Introductory Offer—are fully returnable after 10 days if you're not completely satisfied.
- All books are offered at low Member prices, plus a small postage and handling charge.
- **Continuing Bonus:** If you continue after this Trial Membership, you will earn a Dividend Certificate for every book you purchase. Three Certificates plus payment of the nominal sum of \$1.99 will entitle you to a valuable Book Dividend of your choice which you may choose from a list provided Members.

ELECTRONICS BOOK CLUB

Blue Ridge Summit, Pa. 17214

Please open my Trial Membership in ELECTRONICS BOOK CLUB and send me the 4 books circled below. I understand the cost of the books I have selected is only 49¢ each, plus a small shipping charge. If not delighted, I may return the books within 10 days and owe nothing, and have my Trial Membership cancelled. I agree to purchase at least four additional books during the next 12 months, after which I may cancel my membership at any time.

101 300 678 800 811 841 856 874
919 929 966 1011 1015 1019 1023
1028 1054 1055 1060 1064 1070 1088

Name _____ Phone _____

Address _____

City _____

State _____ Zip _____

(Valid for new Members only Foreign and Canada add 10%) PE-118

Professional or not, the Computer the best books in the field...

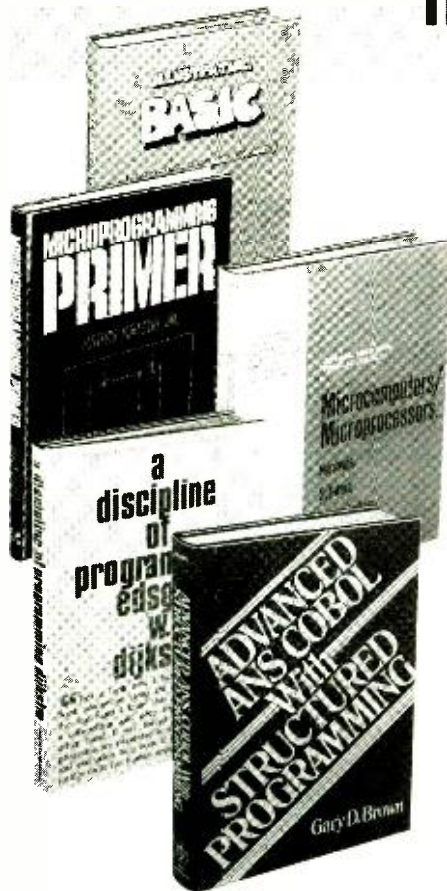

PROGRAMMING LANGUAGES. By Allen B. Tucker, Jr. 439 pp., illus. Gives you not only the principles of design but the applications of six major programming languages so you can decide—among the special features of each—what best suits your operations. Shows you the languages' strengths and weaknesses through demonstrations of their use in solving various representative "benchmark" problems. Also provides programs using a variety of computers so you can evaluate languages and their compilers on a basis of uniform and meaningful criteria.

654/158 Pub. Pr., \$19.95 Club Pr., \$14.95

MICROPROCESSOR PROGRAMMING For Computer Hobbyists. By Neil Graham. 282 pp., with figures, tables, and samples. If you are a personal computer enthusiast or technician, this book will prove to be one of the most valuable and interesting investments you can make. It contains full details on programming—from the very basics to the state-of-the-art capabilities—and yet it is written so simply, and progresses in such a direct and logical manner, that any reader, no matter how inexperienced, can easily follow it.

783/56X Pub. Pr., \$12.95 Club Pr., \$10.95

A DISCIPLINE OF PROGRAMMING. By Edsger W. Dijkstra. 217 pp., with figures. Based on the author's conviction that a carefully chosen separation of concerns is essential for the design of high-quality programs, this book focuses on—and solves with fresh insight and originality—a separate problem of design in each chapter. Rather than choosing one of the existing programming languages to work with, he has designed a mini-language that helps to stress the more fundamental aspects of the task.

770/115 Pub. Pr., \$19.95 Club Pr., \$15.75

This title counts for two premium books

ENCYCLOPEDIA OF COMPUTER SCIENCE.

Edited by Anthony Ralston and C. L. Meek. 1,500 pp., 60 illus., 100 charts, 7 x 10 format. This first and only in-depth coverage of the entire field of computer science in a single volume is utterly comprehensive and completely up to date. An invaluable reference work for specialists, nonspecialists, educators, students, general readers, and librarians, it provides answers to any computer science discipline question in minutes. In addition to covering every aspect of the discipline in five broad areas, each is broken down into some 500 articles, most of them containing bibliographic information to make intensive study of any one subject easier.

769/01X Pub. Pr., \$60.00 Club Pr., \$39.95

THE "COMPULATOR" BOOK: Building Super Calculators and Minicomputer Hardware with Calculator Chips.

By R. P. Haviland. 320 pp., illus. Calculator chips are good for more than calculators—and here's the book to prove it. An imaginative, one-of-a-kind guide, it shows you how to use calculator chips in hundreds of innovative, practical ways, building bigger displays, designing better calculators, and creating exotic functions. Now experimenters can approach the full power of their own desktop minicomputers—multifunctioned, superbrained, and ready to do everything but get up and walk away!

783/578 Pub. Pr., \$10.95 Club Pr., \$9.30

THE 8080A BUGBOOK:

Microcomputer Interfacing and Programming. By Peter R. Rony, David G. Larsen, and Jonathan A. Titus. 416 pp., with figures, charts, and tables, paperbound. Gives you the basic concepts of microcomputer interfacing and the associated microcomputer I/O programming so you can develop your own interfaces to other digital devices. For the 8080 user, this book will be invaluable, because the Intel 8080 is penetrating every facet of life today, creating new industries and threatening old ones, and this book teaches you the fundamental tasks of microcomputer interfacing.

783/845 Pub. Pr., \$9.95 Club Pr., \$8.45

MICROCOMPUTERS/MICROPROCESSORS/

Hardware, Software, and Applications. By John L. Hilburn and Paul N. Julich. 372 pp., illus. This book was expressly created for people involved in the design, use, or maintenance of digital systems using microcomputers. The opening chapters provide needed background in digital logic and present well-organized discussions of number systems, arithmetic operations, and codes employed in microcomputers. The authors then describe the theory and workings behind microprocessor architecture, read-only memory (ROM), random-access memory (RAM), and input/output interfacing methods.

771/499 Pub. Pr., \$22.50 Club Pr., \$16.50

APPLYING MICROPROCESSORS

New Hardware, Software, and Applications. Edited by Laurence Altman and Stephen E. Scrupski. 200 pp., illus., 8 1/2 x 11 format. A follow-up volume to *Electronics* magazine's recently published book, *Microprocessors*, this work takes you into the second- and third-generation devices rolling off semiconductor lines today. The collection of articles here is designed to smooth your way to mastery of new design methods, and it gives you both an overview of the state of the art and a wealth of design ideas, analyses, and applications.

191/603 Pub. Pr., \$16.95 Club Pr., \$13.25

BE SURE TO CONSIDER THESE IMPORTANT TITLES AS WELL—

GRAMMARS FOR PROGRAMMING LANGUAGES. By J. C. Cleaveland & R. C. Uzgalis. 783/594 Pub. Pr., \$15.95 Club Pr., \$12.75

GETTING INVOLVED WITH YOUR OWN COMPUTER A Guide for Beginners. By L. Solomon & S. Veit. 771/952 Pub. Pr., \$9.95 Club Pr., \$8.35

DIGITAL COMPUTER DESIGN. By R. Kline. 784/450 Pub. Pr., \$19.50 Club Pr., \$15.75

MINICOMPUTER SYSTEMS Organization and Programming. By R. H. Eckhouse, Jr. 768/641 Pub. Pr., \$18.95 Club Pr., \$13.95

MICRO-ANALYSIS OF COMPUTER SYSTEM PERFORMANCE. By B. Beizer. 785/058 Pub. Pr., \$22.50 Club Pr., \$17.25

TOP-DOWN STRUCTURED PROGRAMMING TECHNIQUES. By C. L. McGowan & J. R. Kelly. 769/052 Pub. Pr., \$15.95 Club Pr., \$13.50

FUNDAMENTALS OF DATA STRUCTURES. By E. Horowitz & S. Sahni. 770/522 Pub. Pr., \$17.95 Club Pr., \$14.95

COMPUTER ARCHITECTURE. By C. C. Foster. 770/794 Pub. Pr., \$17.95 Club Pr., \$13.95

PROGRAMMING MICROPROCESSORS. By M. W. McMurrin. 770/913 Pub. Pr., \$9.95 Club Pr., \$8.45

MICROPROCESSOR/MICROPROGRAMMING HANDBOOK. By B. Ward. 768/749 Pub. Pr., \$9.95 Club Pr., \$8.45



Professionals' Book Club provides you with (and at great savings, too!)

AUTOMATIC DATA PROCESSING

HANDBOOK. Edited by The Diebold Group 976 pp., 269 illus. Written by a staff of internationally recognized authorities on ADP and sponsored by one of the nation's leading management consulting firms, this utterly comprehensive handbook explains and discusses computer systems, programming and languages, communications processes, and the design and installation of today's computers. 168/075 Pub. Pr., \$34.95 Club Pr., \$23.75

MICROPROGRAMMING PRIMER. By Harry Katzan, Jr. 254 pp., illus. An introductory how-to book that treats microprogramming and emulation topics, this volume assumes that readers are acquainted with basic concepts of computers. Discussions include the complex relationships between programs, computers, and modern methods of implementation. 333/874 Pub. Pr., \$20.95 Club Pr., \$15.70

DATABASE PROCESSING

Fundamentals, Modeling, Applications. By David M. Kroenke. 408 pp., illus. An introduction to database-oriented systems, presenting material that covers the full spectrum of all activities involved. Physical representation, modeling, commercial systems, and implementation are discussed equally with no particular emphasis on one area to the neglect of any other. 769/931 Pub. Pr., \$16.95 Club Pr., \$12.95

MICROPROCESSOR

APPLICATIONS MANUAL. By Motorola Semiconductor Products, Inc. 720 pp., illus., 8 1/2 x 11 format. With a nuts-and-bolts kind of practicality, this manual by the Motorola people (who should know) gives you detailed applications information on microprocessors and assumes no prior knowledge on your part about MPUs. It covers all the systems phases and explores such topics as architecture, the instruction set, addressing modes, interrupt structure, and other vital MPU features. 435/278 Pub. Pr., \$32.50 Club Pr., \$24.00

MINICOMPUTERS: Structure and

Programming. By T. G. Lewis and J. W. Doerr. 282 pp., illus. This valuable handbook makes an outstanding introductory guide to both the hardware and software of today's minicomputers. Its broad coverage includes assembly language, machine architecture, and small machine algorithms. "Timely . . . a nice job on structure and content."—*Data Processing Digest*. 773/009 Pub. Pr., \$13.95 Club Pr., \$11.75

ILLUSTRATING BASIC: A Simple

Programming Language. By Donald Alcock. 134 pp., illus. Completely handwritten by the author in a most unusual way, and containing an abundance of figures, diagrams, and drawings, this book was inspired by the need for a guide that would help readers who have to use computers but are terrified by them. 771/928 Pub. Pr., \$10.95 Club Pr., \$8.95

CHESS AND COMPUTERS By David Levy. 145 pp., illus. All over the world, great human effort and computer resources are being devoted to producing a program that can play chess as well as a master. This first comprehensive book on the subject shows why the project is worthwhile because the techniques employed in writing a strong chess program may be used to help solve other programs. 785/252 Pub. Pr., \$12.95 Club Pr., \$10.50

THE Z-80 MICROCOMPUTER

HANDBOOK. By William Barden, Jr. 304 pp., illus., paperbound. Sooner or later the Z-80 will have a successor. For the time being, this book gives you the entire "state of the art" in microcomputer technology today. Arranged in three convenient and logically developed sections, the book discusses architecture and interface signals, then the powerful interrupt sequences of Z-80 and interfacing examples of I/O memory devices. 784/914 Pub. Pr., \$8.95 Club Pr., \$7.60

ADVANCED ANS COBOL WITH

STRUCTURED PROGRAMMING. By Gary D. Brown. 497 pp., illus. More and more people learn COBOL each year, increasing the number of active COBOL programmers. Having advanced beyond the introductory stages, they need a book that touches only lightly on the basics, and then goes into detail on both advanced programming techniques and advanced COBOL statements. This book begins where the basic manuals leave off. 772/118 Pub. Pr., \$19.95 Club Pr., \$15.95

COMPUTER ARCHITECTURE AND

ORGANIZATION. By John P. Hayes. 512 pp., illus. Assuring you a far deeper understanding of computer design at the systems level, this comprehensive, in-depth volume gives you the broad coverage you need of computer architecture—and in a most rigorous but highly readable manner. It provides all the mathematics needed for analyzing computer performance, plus extensive references for additional reading. 273/634 Pub. Pr., \$21.50 Club Pr., \$16.50



Two Special
premium books
come to you with
your first selection

--- MAIL THIS COUPON TODAY ---

COMPUTER PROFESSIONALS' BOOK CLUB
P.O. Box 582 Princeton Road, Hightstown, New Jersey 08520

Please enroll me as a member and send me the three books indicated. I am to receive the two bonus books at the introductory price of \$2.95 plus my first selection, plus tax, postage, and handling. If not completely satisfied, I may return the books within 10 days and request that my membership be cancelled. If I keep the books, I agree to take a minimum of three additional books during the next two years at special Club prices (guaranteed 15% discount, often more). I will receive the Club Bulletin 13 times a year. If I want to examine the featured selection, I need take no action. It will be shipped automatically. If, however, I want an alternate selection—or no book at all—I simply notify the Club by returning the convenient card always enclosed. I will always have a minimum of 10 days in which to return the card and you will credit my account fully, including postage, if this is not the case. Membership in the Club is continuous but cancellable by me at any time after the four-book purchase requirement has been filled. This order subject to acceptance by McGraw-Hill. Orders from outside the continental U.S. must be prepaid. Company, business or institutional tax exemption status is not applicable to purchases made through individual Club memberships. All prices subject to change without notice. Offer good for new members only. Postage and handling charges are added to all shipments. Members are billed when books arrive.

Write Code # of 1st premium book selection here	Write Code # of 2nd premium book selection here	Write Code # of 1st book selection here.
<input type="text"/>	<input type="text"/>	<input type="text"/>

NAME _____
ADDRESS _____
CITY _____ STATE _____ ZIP _____

EXTRA SAVINGS: Remit in full with your order, plus any local and state tax, and McGraw-Hill will pay all regular postage and handling charges

P39345

COMPUTER PROFESSIONALS' BOOK CLUB saves you both time and money!

Here is a book club designed to meet all of your professional as well as hobbyist needs by providing practical books about computers on a regular basis at below publisher prices. If you're missing out on important technical literature—if today's high cost of reading curbs the growth of your library—here's the solution to your problem.

The Computer Professionals' Book Club was organized for you, to provide an economical reading program that cannot fail to be of value. Administered by the McGraw-Hill Book Company, all books are chosen by qualified editors and consultants. Their understanding of the standards and values of the literature of interest to you guarantees the appropriateness of the selections.

How the club operates: Thirteen times a year you receive free of charge The Computer Professionals' Book Club Bulletin. This announces and describes the Club's featured book as well as alternate selections available at special members' prices. If you want to examine the Club's feature, you do nothing. If you prefer one of the alternate selections—or if you want no book at all—you notify the Club by returning the card enclosed with each Bulletin.

As a Club member, you agree only to the purchase of four books (including your first selection) over a two-year period. Considering the many books published annually, there will surely be at least four you would want to own anyway. By joining the Club, you save both money and the trouble of searching for the best books.

NOVEMBER 1978

CIRCLE NO. 38 ON FREE INFORMATION CARD

R Popular Electronics Reprint series

Many important articles covering a variety of interests in the broad field of electronics are published in POPULAR ELECTRONICS. Reprints of selected articles and test reports are now available in the event that you missed some you would like to have for reference or study purposes—or for projects you wish to build. Reprints are only \$1 each, 75¢ for those marked with an asterisk, \$1.50 for those noted. Minimum order is \$3.

✓ Denotes new reprints available for the first time!

SPECIAL ARTICLES

AUDIO

- 40854 How The New FTC Hi-Fi Rules Affect You
- 40855 How To Evaluate Tape Recording Specs
- 40856 A New Standard For FM Tuner Measurements
- ✓40964 Build The Hi-Fi/TV Audio Minder

COMPUTER

- 40860 How To Select A Microcomputer
- 40861 Ins & Outs Of Computers For Beginners
- ✓40966 Introducing Speechlab—The First Hobbyist Vocal Interface For A Computer —\$1.50

COSMAC "ELF" SERIES

- 40857 Low Cost Experimenter's Microcomputer
- 40858 Experimenter's Microcomputer/With Hardware Improvements & More Programming Details
- 40859 Microcomputer/ How To Expand Memory, Plus More Programs
- 40870 Build The Pixie Graphic Display

COMMUNICATIONS

- 40862 CB Specifications Made Easy
- 40863* How To Choose CB Base Station Antennas
- ✓40965 Build Morse-A-Letter —\$1.50

OTHER

- 40867 How To Design Your Own Power Supplies
- 40868 The Care & Feeding Of NiCd Batteries
- 40869 Build A Gas & Fume Detector
- ✓40963* Six CMOS Circuits For Experimenters
- ✓40967 Programming Calculators For Fun and Games —\$1.50
- ✓40968* Zap New Life Into Dead NiCd Batteries

LEARNING ELECTRONIC THEORY WITH CALCULATORS SERIES

- 40864 Basic Equations and OHM's Law
- 40865 Reactance, Time Constants And AC Calculations
- 40866 RC Coupling, Basic Amplifier Calculations, and RLC Relationship

TEST REPORTS

AUDIO

- 40871 ADC Accutrac 4000 Record Player
- 40872* Empire Model 698 Manual Turntable

- 40873 Kenwood Model 600 Integrated Stereo Amplifier
- 40874* MXR Stereo Graphic Equalizer
- 40875* Nakamichi Model 500 Stereo Cassette Deck
- 40876 Onkyo Model TX-4500 AM/Stereo FM Receiver
- 40877* Ortofon MC20 Moving Coil Phono Cartridge
- 40878* Pickering Model XV-15/625E Stereo Phono Cartridge
- 40879 Pioneer Model CT-F8282 Stereo Cassette Deck
- 40880 Radio Shack "Realistic" Model STA-2000 AM/Stereo FM Receiver
- 40881 Rotel RX-7707 AM/Stereo FM Receiver
- 40882 Sansui Model TU-9900 AM/Stereo FM Tuner
- 40883* Shure Model M24H Stereo Phono Cartridge
- 40884* Sony Model TA-4650 V-FET Stereo Power Amplifier
- 40885* Spectro Acoustics Model 210 Stereo Graphic Equalizer
- 40886* Stanton Model 681EEE Stereo Phono Cartridge
- 40887 Teac Model PC-10 Portable Stereo Cassette Deck
- 40888* Technics Model SB-6000A Linear Phase Speaker System
- 40889* Thorens Model TD-126C Record Player
- ✓40969* Akai Model GX-270D-SS Four-Channel Tape Recorder
- ✓40970 Speakerlab Model S7 Speaker System Kit
- ✓40972* Dual Model 1245 Automatic Turntable
- ✓40973* Burwen Model DNF 1201A Noise Reducer System

COMMUNICATIONS

- 40890* Cobra Model 29XLR 40-Ch. AM CB Mobile Transceiver
- 40891* Drake Model SSR-1 AM/SSB Communications Receiver
- 40892* Kenwood Model TS-820 Amateur Radio Transceiver
- 40893* Kris Model XL-50 40-Ch. AM CB Mobile Transceiver
- 40894* President Model "Washington" 40-Ch. AM/SSB CB Base Station
- 40895 Yaesu Model FRG-7 AM/SSB Communications Receiver
- 40971* General Electric Model 3-5825 AM/SSB CB Transceiver
- 40974* Realistic Model TRC-449 Mobile AM/SSB CB Transceiver

TEST INSTRUMENTS

- 40928* B&K-Precision Model 280 Digital Multimeter
- 40929* B&K-Precision Model 1471B Dual-Trace Scope
- 40930* Ballantine Model 1010A Dual-Trace Scope
- 40931* Fluke Model 8020A Digital Multimeter
- 40932* Hewlett-Packard Model 280 Digital Multimeter
- 40933* Sencore Model DVM-32 Digital Multimeter
- 40934* Sencore Model TF-70 Portable Transistor Tester
- 40935* Triplet Model 60 Analog Multimeter

* REPRINTS ARE \$1 EACH, 75¢ FOR THOSE MARKED WITH ASTERISK, \$1.50 FOR THOSE NOTED, MINIMUM ORDER \$3.00.

POPULAR ELECTRONICS REPRINTS, Dept. C1080
P. O. Box 278, Pratt Station
Brooklyn, New York 11205

Please send the reprints listed.

NUMBER OF REPRINTS ORDERED
@75¢ @\$1.00 @\$1.50

TOTAL ENCLOSED \$
(MINIMUM ORDER \$3.00)

Reprint #	Quan	Reprint #	Quan.

C1180

Print Name _____

Address _____

City _____

State _____ Zip _____

*Residents of CA, CO, DC, FL, IL, MI, MO, NY STATE, TX, and VT add applicable sales tax. Outside U.S.A. add \$1.00 per order.

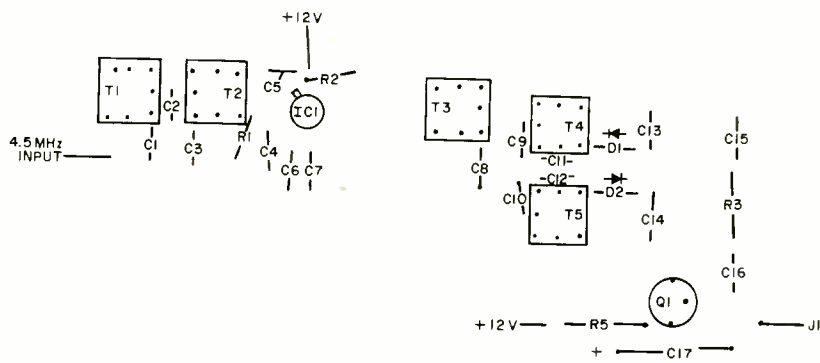
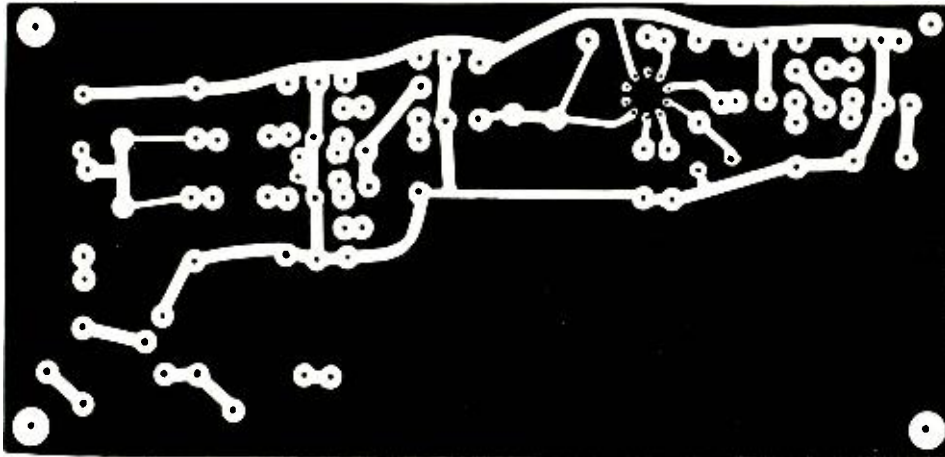

Fig. 7. Etching and drilling and component layout guides for an audio subcarrier demodulator board.



+8 volts dc above ground. Then, place S1 in the AFC OFF position and adjust R1 so that the +4 volts dc appears between the Varactor voltage input of the Gunnplexer and ground. Finally, place S1 in the AFC ON position and adjust R38 so that +4 volts dc appears between the Gunnplexer's Varactor voltage input and ground. This last adjustment should be performed with the transmitter or any other source of 10-GHz microwave radiation turned off.

Only a few adjustments are necessary for transmitter alignment. First, adjust trimmer potentiometer R1 so that +8 volts dc appears between the emitter of Q1 and ground. Then open S2 (if this switch and the audio subcarrier generator/modulator have been included) and adjust R4 for a +4-volt bias between the Gunnplexer's Varactor voltage input and ground. The remaining control, R30, is adjusted while the video source to be used with the transmitter is supplying an input signal to J2. This adjustment can be performed now with the aid of an oscilloscope or "by eye" after the receiver has been aligned. If an oscilloscope is used, monitor the Varactor bias and adjust R30 so that 1 volt peak-to-peak of video rides on the +4-volt dc level. Otherwise, adjust the control after communications between the transmitter and the receiver have been established, varying the setting of R30 for best picture quality.

The audio subcarrier generator/modulator should now be aligned if it has been built into the transmitter. Sample the audio subcarrier at a convenient point (say, the pole of S2) and apply it to a frequency counter. With no audio sig-

with markers at 40, 45 and 50 MHz. Couple signals at the emitter of Q5 to the scope's vertical amplifier input via a 0.001- μ F disc ceramic capacitor and a sweep demodulator probe. The frequency-sweep sawtooth should be applied to the scope's horizontal amplifier input.

Alignment of the receiver i-f involves adjusting L2, L3, L4, L5 and C7 so that a total gain of 50 dB \pm 0.5, \pm 0.5 dB is obtained across the i-f passband. The oscilloscope trace will appear as in Fig. 9B when the i-f section is properly aligned.

Next, the FM detector or discriminator will be aligned. Disconnect the coupling capacitor and oscilloscope probe from the emitter of Q5 and connect the probe to J1, the video output jack, as shown in Fig. 10 A. Inductors L14 and L15 should be slug-tuned to resonate the two legs of the discriminator at 35 and 55 MHz, respectively. Adjust potentiometers R19 and R20 so that an unmodulated carrier at exactly 45 MHz produces a zero-volt output. These adjustments are most easily done with the sweep function of the signal generator disabled.

When the wiper of R23 is at its proper setting, the two legs of the discriminator will cause equal negative- and positive-voltage swings as the carrier is swept from below 35 MHz to above 55 MHz. A

correctly aligned discriminator will generate the S-shape oscilloscope trace shown in Fig. 10B. The 35-MHz marker will be at the bottom of the curve, the 45-MHz marker at the zero-volt center line, and the 55-MHz marker at the top of the curve. Aligning the discriminator for this extended frequency range ensures near-perfect linearity over the actual 40-to-50-MHz i-f passband.

The remaining steps in the alignment of the receiver deal with the bias voltages applied across the Varactor and Gunn diodes in the Gunnplexer. Adjust trimmer R32 so that the emitter of Q8 is

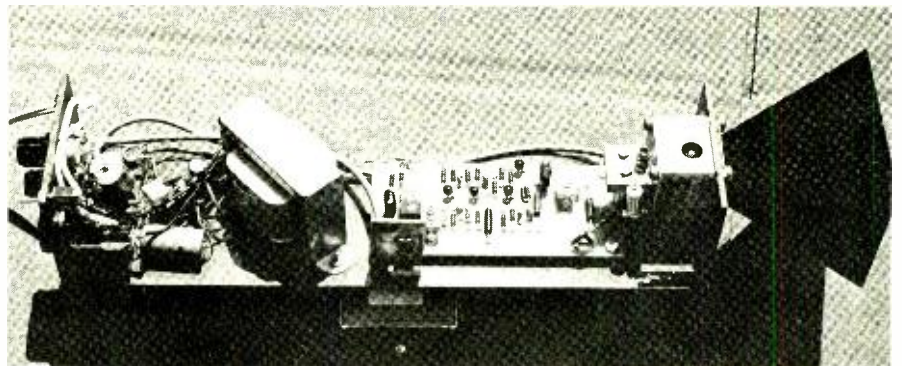

Fig. 8. Photo of Mini-Wave transmitter with case removed. Pc board holds circuit for audio subcarrier generator/modulator.

nal applied to input jack *J1*, adjust trimmer capacitor *C6* so that the subcarrier frequency is exactly 4.500 MHz. Then remove the counter probe, replace it with one from an oscilloscope, and adjust trimmer *C15* for maximum subcarrier amplitude (about 0.1 volt rms).

Level control *R7* should be adjusted so that the audio signal source to be used with the transmitter causes the subcarrier to deviate ± 25 kHz, the optimum amount. This adjustment can be done "by ear." That is, after the audio subcarrier demodulator has been aligned, the audio source can be coupled to the transmitter and level control *R7* adjusted for the best-sounding audio. In practice, an audio source with an output impedance or 10,000 ohms or more and an output level of 50 to 100 millivolts should be used to drive the audio circuit. If your audio source cannot provide that much signal, the gain of audio preamp *IC2* can be increased by replacing feedback resistor *R8* with a higher-value component. As is, this stage has a voltage gain of 10 (20 dB).

Alignment of the audio subcarrier demodulator is similar to that of the receiver. Apply the output of a signal generator operating at 4.5 MHz to the primary of transformer *T1*. Signal level is not critical, but should be approximately 100 millivolts. Couple an oscilloscope probe to the secondary of *T3* and monitor the 4.5-MHz signal. Using an alignment tool, adjust the slug cores of *T1*, *T2* and *T3* for maximum amplitude on the scope.

Next, activate the frequency-sweep function of the signal generator and place markers at 4.450, 4.500 and 4.550 MHz. Remove the oscilloscope probe from the secondary of *T3* and place it at audio output jack *J1*. Adjust the slug of *T4* so that the transformer resonates at 4.450 MHz. Then tune *T5* so that it resonates at 4.550 MHz. The resulting oscilloscope trace will resemble that shown in Fig. 10B when the transformers are properly tuned. The 4.450-MHz marker will appear at the bottom of the S-shaped discriminator characteristic curve, the 4.500-MHz marker will appear at the zero-volt center line, and the 4.550-MHz marker will be at the top of the S-curve. Aligning the audio demodulator for a ± 50 -kHz passband ensures maximum linearity over the actual ± 25 -kHz bandwidth occupied by the frequency-modulated subcarrier.

This completes alignment of the Mini-Wave communications link. There are two screw adjustments built into the Gunnplexer. One varies the characteris-

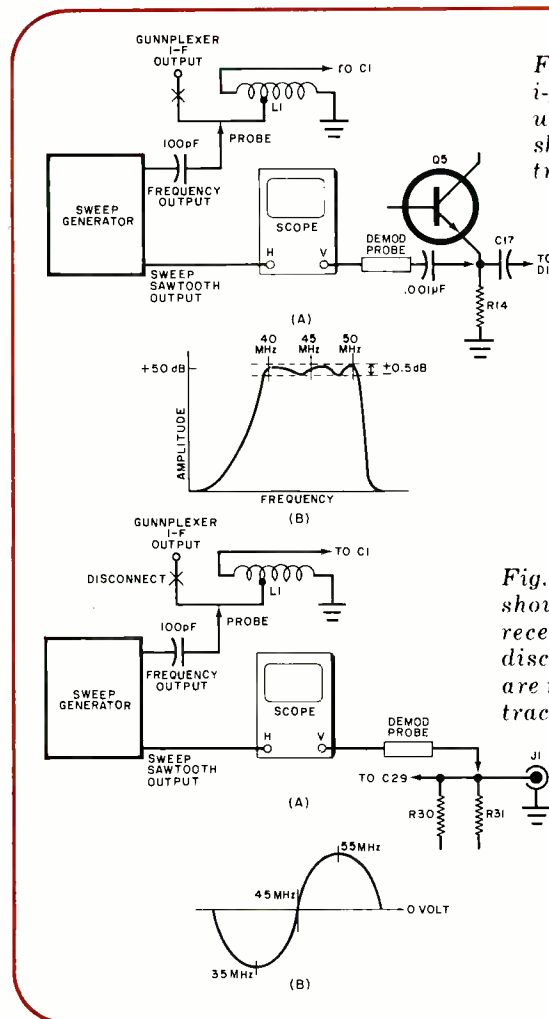

Fig. 9. To align receiver i-f, disconnect input and use sweep and scope as shown at (A) to obtain trace shown at (B).

Fig. 10. Use the circuit shown at (A) to align the receiver FM detector or discriminator. Adjustments are made to obtain trace shown in (B).

tics of the cavity in which the Gunn diode is mounted and thus determines the frequency of oscillation. The other controls the amount of local oscillator output applied to the Schottky mixer diode. This mixer injection control screw is mounted in front of the ferrite circulator and its setting need not be disturbed. If the transmitting and receiving Gunnplexers have been ordered for frequencies establishing the correct 45-MHz offset, the frequency adjust screws should be left at their factory settings.

To communicate with Mini-Wave systems employing Gunnplexers oscillating at other frequencies, either the Varactor bias or the position of the mechanical tuning screw (or both) will have to be changed. Keep in mind, however, the limits of these frequency adjustments (± 100 MHz mechanical, 60 MHz minimum electronic). The Varactor bias should not be varied so much that the composite video signal cannot fully modulate the microwave carrier.

Be sure that you can tune the Gunn oscillator back to the frequency required by your own link before attempting any off-channel operation. Retuning can be

accomplished by one of several means. You can keep one end of your link on-frequency and tune the other off frequency. Then, after communications are complete, adjust the frequency of the off-channel Gunnplexer for best reception at the other end of your link. A frequency counter can also be employed. Couple the two Gunnplexers and sample the i-f output of one, applying it to a frequency counter. The off-channel Gunnplexer can then be retuned to its "home" frequency by monitoring the frequency difference between the two oscillators displayed by the counter. Finally, a locally installed "beacon" Gunnplexer can be used by a number of microwave communicators as a common reference for equipment calibration and frequency setting purposes. \diamond

Editor's Note: In Part 3 of this article, next month, we will conclude with antenna and set-up instructions and information on licenses. In Fig. 2 of Part 1, last month, *D3* should have been shown so that the anode was on the right, the cathode on the left. Also, the shell of *J1* and the junction of *R28*, *R29*, *R30*, and *C28* should have been grounded.

ADD A "TICK-TOCK" TO YOUR DIGITAL CLOCK

Give your modern clock a familiar sound.

BY WILLIAM D. KRAENGEL, JR.

MODERN digital clocks keep very accurate time and make a fine addition to most living rooms. In fact, digital timepieces in the shapes of grandfather clocks are now available. Some of these even have a moving pendulum (made from LED's) to further enhance their appearance. About the only thing missing from these clocks is the familiar "tick-tock" sound.

If your digital clock has a LED pendulum, or a source of 1-Hz logic signals somewhere in its circuit, this project will add a nice touch to its operation.

The inputs to this project are buffered CMOS for negligible circuit loading, and the small amount of power required is easily supplied by the clock's power supply.

The basic circuit, shown in Fig. 1 is for CMOS and TTL approaches.

Circuit Operation. If your clock has a LED pendulum, one LED (usually the leftmost one) is designated the "tick" LED while the one on the right end is the "tock" LED. If the pendulum timing is conventional, these LED's will light alternately at 0.5-second intervals.

The individual tick and tock inputs are buffered by IC1D and IC1E then differentiated by R3C2 and R5C3 to pro-

duce two narrow pulses with the tock pulse a little wider than the tick pulse and lagging by 0.5 second. These alternate pulses are gated into two parallel-connected buffers. IC1A and IC1F, and used to drive transistor Q1. This transistor drives a small loudspeaker. Because of the narrow pulses, the average current through Q1 and the speaker is small. The instantaneous current through Q1 and the speaker is limited by the inductive reactance of the speaker voice coil to fast pulses.

The various alternate positions shown in the schematic, along with IC1B, are used to reverse the polarity of the differentiators and the diodes so that they can respond to either positive- or negative-going input pulses. When IC1C is used with a common 1-Hz input signal, the tick differentiator triggers the high level of the input signal while the tock differentiator triggers the low level.

The resulting output pulses from Q1 sound surprisingly like the familiar tick-tock of an old-fashioned grandfather clock. The volume control (R6) can be used to reduce the level to that of a pocket watch.

Interfacing. The drive signals to the LED's on the electronic pendulum will be

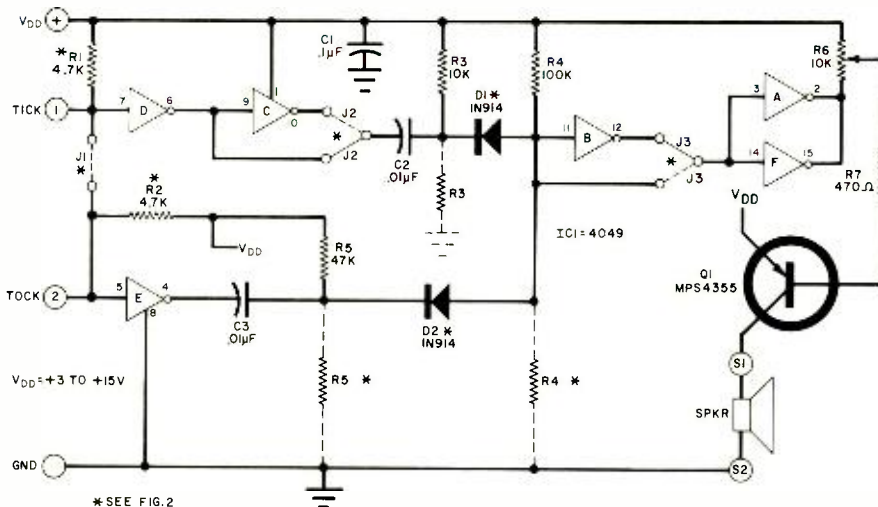
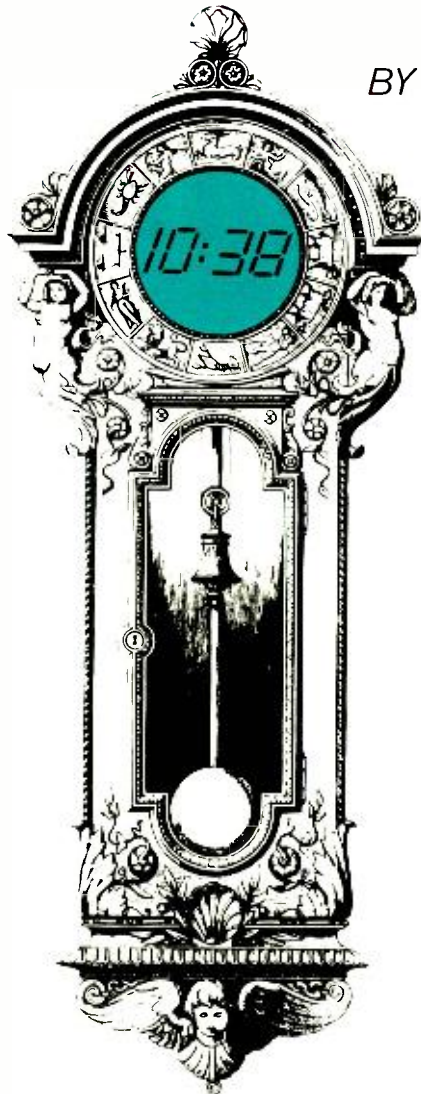

Fig. 1. Schematic of tick-tock circuit also shows alternate connections for different inputs.

PARTS LIST

- C1—0.1- μ F disc ceramic capacitor
- C2, C3—0.01- μ F, disc ceramic capacitor
- D1, D2—1N914
- IC1—4049B hex inverter (CMOS)
- Q1—MPS4355 or similar
- The following are 1/4-watt, 10% resistors unless otherwise noted:
- R1, R2—4700 ohms (see text)
- R3—10,000 ohms
- R4—100,000 ohms
- R5—47,000 ohms
- R6—10,000-ohm trimmer potentiometer (Radio Shack No. 271-218 or similar)
- R7—470 ohms
- SPKR—1 1/2" to 2 1/2" 8-to-10-ohm speaker
- Misc.—Socket (optional), hookup wire, mounting hardware, etc.

Note: The following is available from CM Circuits, 22 Maple Ave., Lakawana, NY 14218; etched and drilled pc board at \$3.00 plus \$0.50 postage and handling. NY state residents, please add sales tax.

Fig. 2. Three approaches to parts usage and wiring for different inputs and clock types.

INPUT WAVEFORMS	FOR TTL CLOCK ONLY	POSITION OF * PARTS
	R1, R2	FIG. 3A
	R1, R2	FIG. 3B
	J1, R2	FIG. 3B + J1

either a 1 or a 0. The tick-tock project will accept either one. If the drive signals are logic 1, use the approach shown in row 1 in Fig. 2. If the signals are logic-0, use approach in row 2 of Fig. 2.

If your clock does not have a pendulum, and you can locate a 1-Hz logic signal in your circuit, use row 3 of Fig. 2.

The input logic signals can vary from +3 to +15 volts as long as the project is powered from the clock supply.

Construction. The actual-size pc board shown in Fig. 3 will accommodate

either of the three variations of construction. Note that jumper *J1* is used only for the approach in row 3, while jumpers *J2* and *J3* are used in accordance with the parts placement guides.

If you have a TTL clock, pull-up resistors *R1* and *R2* are required at the inputs. When *J1* is used with row 3, only *R2* is used. Note the alternate placement of some resistors and diodes and follow Fig. 2 for particular input signals.

If desired, a socket may be used for *IC1*, and any method of construction can be used. ◇

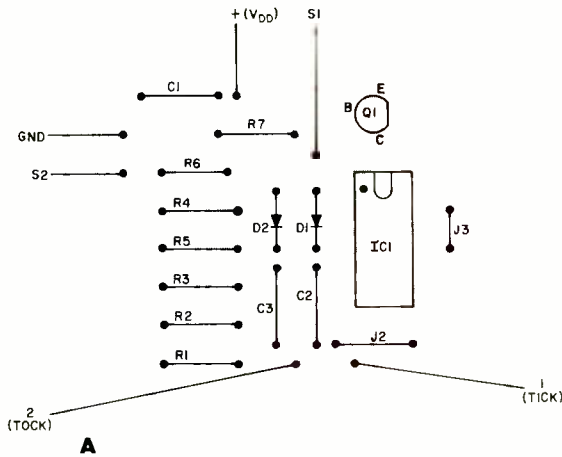
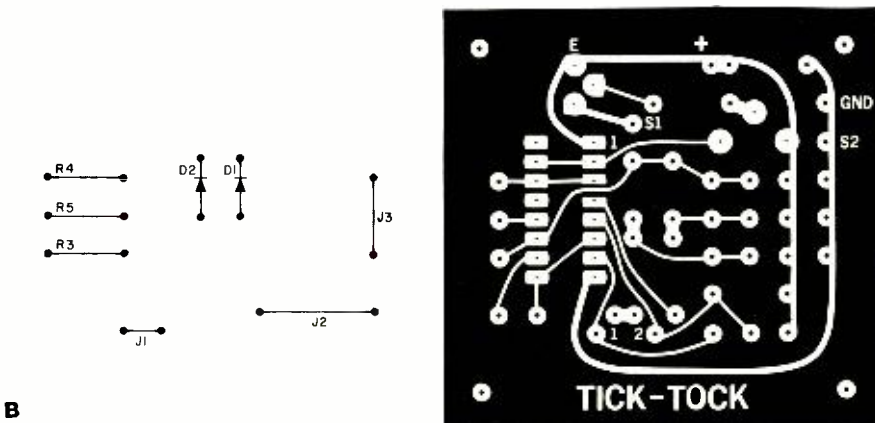

Fig. 3. Etching and drilling guide for pc board is shown below. At (A) is component arrangement for row 1 in Fig. 2. Use (B) for rows 2 and 3 in Fig. 2. Note *J1* is used only for row 3 of Fig. 2.



McIntosh

"A Technological Masterpiece..."



McIntosh C 32

"More Than a Preamplifier"

McIntosh has received peerless acclaim from prominent product testing laboratories and outstanding international recognition! You can learn why the "more than a preamplifier" C 32 has been selected for these unique honors.

Send us your name and address and we'll send you the complete product reviews and data on all McIntosh products, copies of the international awards, and a North American FM directory. You will understand why McIntosh product research and development always has the appearance and technological look to the future.

Keep up to date.
Send now - - -

McIntosh Laboratory Inc.
Box 96 East Side Station
Binghamton, NY 13904

Name _____

Address _____

City _____ State _____ Zip _____

If you are in a hurry for your catalog please send the coupon to McIntosh. For non-rush service send the Reader Service Card to the magazine.

IN RECENT YEARS, the cassette tape recorder has been used in a number of nonaudio applications. A good example of such use is as a mass-storage memory medium in a microcomputer system. Using a similar technique, the cassette recorder can be employed in model railroading. In the "Automatic Model-Railroad Engineer" described here, the cassette recorder serves as a storage system for timed "stop and go" commands. The approach is simple and inexpensive.

System Operation. As shown in the schematic diagram, a pulse generator initiates the command pulses that are fed into a cassette recorder. In operation, the recorder sends the prerecorded pulses to an amplifier that boosts the signal to a level sufficient to operate the relay. In turn, the relay controls the flow of current from the power pack to the model railroad's track.

The system's pulse generator is an inexpensive code-practice oscillator (CPO) that can be obtained from such suppliers as Radio Shack and Lafayette Radio Electronics. The CPO comes fully assembled on a printed circuit board.

Pulse commands are recorded on tape as follows. First, an audio cable, terminated at one end with a phono plug, connects to the output jack on the pulse generator. The other end of this cable must be terminated with a plug designed to mate with the auxiliary (AUX)

Control Your Model Railroad With Audio Tape

Let signals from a cassette tape take the place of your train's engineer

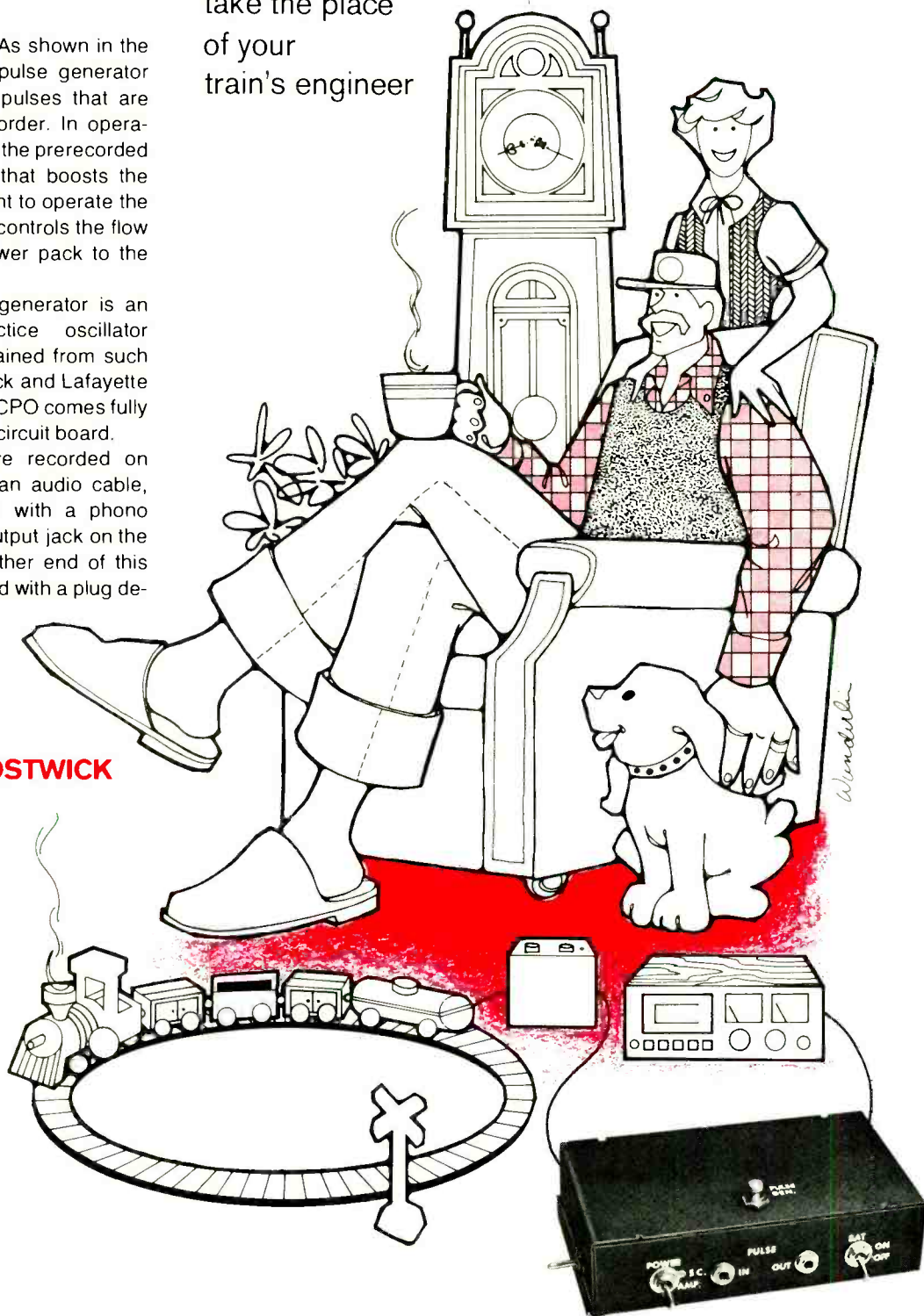

BY SPENCER BOSTWICK

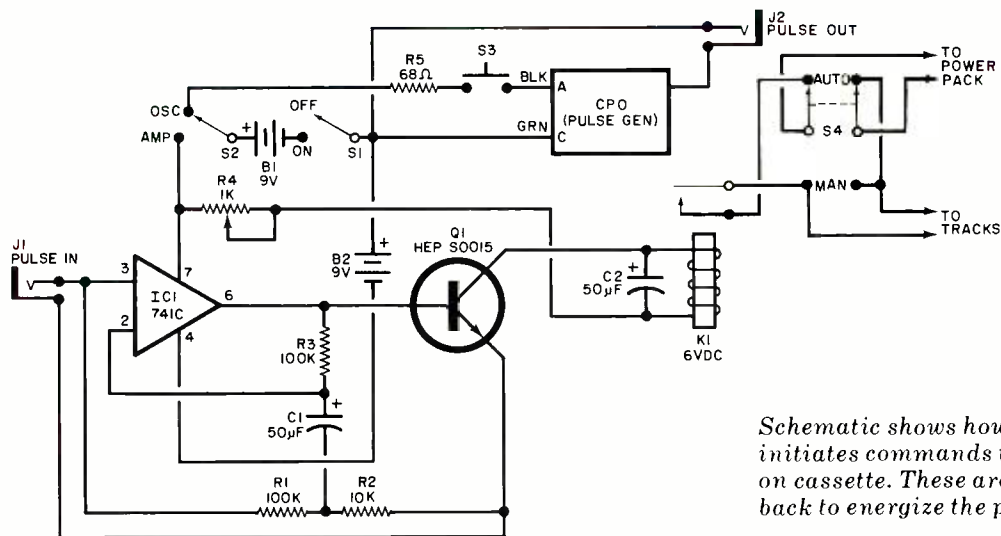

Schematic shows how pulse generator initiates commands that are recorded on cassette. These are later played back to energize the power relay.

PARTS LIST

B1, B2—9-volt battery
 C1, C2—50 μ F, 15-volt electrolytic
 IC1—741 operational amplifier
 J1, J2—Miniature phone jack
 K1—6-volt dc relay (Potter & Brumfield No. RS5D or similar)
 Q1—HEP S0015 (Motorola) transistor

R1, R3—100,000-ohm, 1/4-watt resistor
 R2—10,000-ohm, 1/4-watt resistor
 R4—1000-ohm flat-mount pc potentiometer
 R5—68-ohm, 1/2-watt resistor
 S1, S2—Spst toggle switch
 S3—Spst, normally open pushbutton switch
 S4—Dpdt switch
 Misc.—Printed circuit board or perforated

board and solder clips for amplifier circuit; battery holders and connectors for B1 and B2 (2); code practice oscillator (Radio Shack No. 20-1155 or similar); suitable enclosure; patch cord; connectors for power pack and track (4); rubber grommets (2); spacers; machine hardware; hookup wire; solder; dry-transfer lettering kit; etc.

input jack on your cassette recorder. Then, with the recorder operating in the record mode, the pulse generator can be keyed on and off for the desired run and stop times.

Once the desired run and stop times are recorded on tape, the tape can be rewound and played back through an amplifier that energizes and deenergizes a relay. The relay's contacts open and close the output circuit from the model railroad's power pack to its track, timed according to the blank spaces and pulse trains recorded on the tape. Pre-recorded programs can be as short or as long as the tape's running time.

The amplifier is built around dual high-gain operational amplifier IC1. The op amp drives conventional transistor amplifier Q1 to develop enough current flow to operate relay K1. Two standard 9-volt batteries, B1 and B2, provide power for IC1. One battery (B2) is also used to power the pulse generator (CPO) and relay K1 through dropping resistor R5 and potentiometer R1, respectively.

Construction. Both the pulse generator (CPO) and amplifier/relay circuits can be housed in a single compact box (see lead photo). Prepare the box by drilling 1/4" (6.4-mm) holes as follows: four evenly spaced across the front of

the box; two through the left side of the box; one through the rear of the box; and one through the top of the box. Locate the hole toward the front on the left side of the box well to the front but where it will not interfere with any other components. Also, locate the hole in the top well toward the front and midway between the front-panel center holes.

Deburr the holes and scrub the box with fine steel wool. When the box is completely dry, spray it with two or more

coats of paint, allowing each coat to dry before applying the next. Allow the final coat to dry for at least eight hours. Then use a dry-transfer lettering kit to label the holes as follows: PULSE GEN. for the hole in the top; TO TRACK for the hole in the rear; MAN/AUTO for the front and POWER PACK for the rear holes in the left side; and POWER OSC/AMP, PULSE IN, PULSE OUT, and BAT ON/OFF for the holes in the front panel from left to right. (Note: Legends with slashes indicate al-

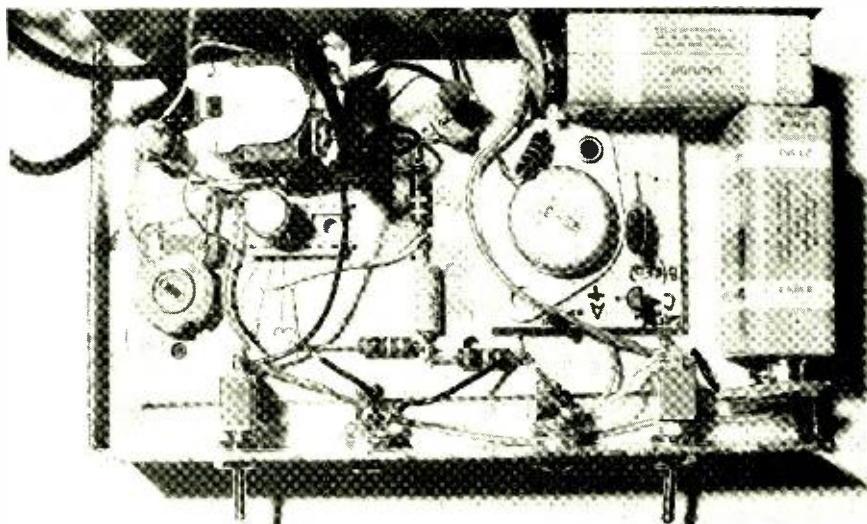

Photo shows layout and wiring of enclosure for the author's prototype Model Railroad Automatic Controller.

EVENT	PLACE	TIME	ELAPSED TIME MIN. SEC.
START OF RUN	SMITH RIVER	00.00	00.00
RUN TO →	REDSTONE LIVESTOCK	00.08	00.08
HOLD	" "	00.10	00.18
RUN TO →	HENRY TOWN WATER TOWER	00.19	00.37
HOLD	" "	00.11	00.48
RUN TO →	ADOBE BRIDGE	00.12	1.00
HOLD	" "	00.11	1.11
RUN TO →	ALICE SPRINGS	00.20	1.31
HOLD	" "	00.10	1.41
RUN TO →	SMITH RIVER	00.20	2.01
END			

Typical timing chart for a train run lasting about two minutes.

ternate positions of the switch. For example: POWER OSC/AMP means that this switch applies power to the CPO in one position and to the amplifier/relay circuit in the other position, but not to both circuits simultaneously.)

Mount the switches and jacks in their respective holes. Line the TO TRACK and POWER PACK holes with rubber grommets to protect the wires that will exit the box through these holes from being cut through by bare metal. Take care to avoid damaging the lettered legends.

Using appropriate machine hardware and spacers, mount the CPO, amplifier/relay circuit, and battery holders in the box. Interconnect the various elements

in the system with hookup wire and solder. Then carefully check your wiring and install the batteries.

Before you can put the Automatic Railroad Engineer into service, potentiometer *R1* must be properly adjusted. To do this, you will have to make a test tape. Connect one end of a patch cord to the PULSE OUT jack and the other end of the cord into the recorder's AUX (auxiliary) input jack. Place the recorder in the RECORD mode and turn up the volume to maximum. Now, press and hold the PULSE GEN switch for 10 seconds, release for another 10 seconds, and press and hold for a final 10 seconds. Rewind the tape to the start of the program.

Plug the patch cord into the remote-speaker output jack on the recorder and the PULSE IN jack on the Automatic Railroad Engineer and play the tape while observing the relay and with the POWER switch set to AMP. As the tape is playing, the relay's contacts should close, open, and then close again, each for a period of 10 seconds. If you do not observe this relay action, rewind the tape and play it again while adjusting *R1* for the proper response.

This completes test and adjustment. Assemble the Model Railroad Engineer's box and connect it into your model railroad system.

All Aboard. As you become familiar with the operation of the Automatic Model-Railroad Engineer, you will find that you can set up just about any combination of stop-and-go programs to suit any run, no matter how complex. Programs can be as long as you wish, up to the maximum length of time possible on a single side of a cassette tape. Now when you want a break, you can play a program cassette and sit back to drink your coffee and watch your model railroad run automatically. ◇

CLIP AND STRIP

Model CAS-130

\$198

- CUTS AWG 30 WIRE TO DESIRED LENGTH
- STRIPS 1" OF INSULATION

MINIMUM BILLING \$25.00
ADD SHIPPING CHARGE \$2.00
NEW YORK STATE RESIDENTS
ADD APPLICABLE TAX

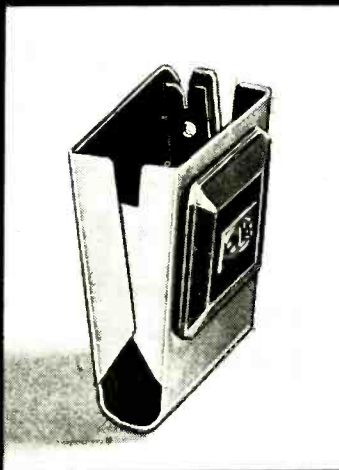

OK MACHINE & TOOL CORPORATION

3455 Conner St., Bronx, N.Y. 10475 • (212) 994-6600 • TELEX 125091



Vector MZ

The New Industry Standard From Vector Graphic. Under \$3800.

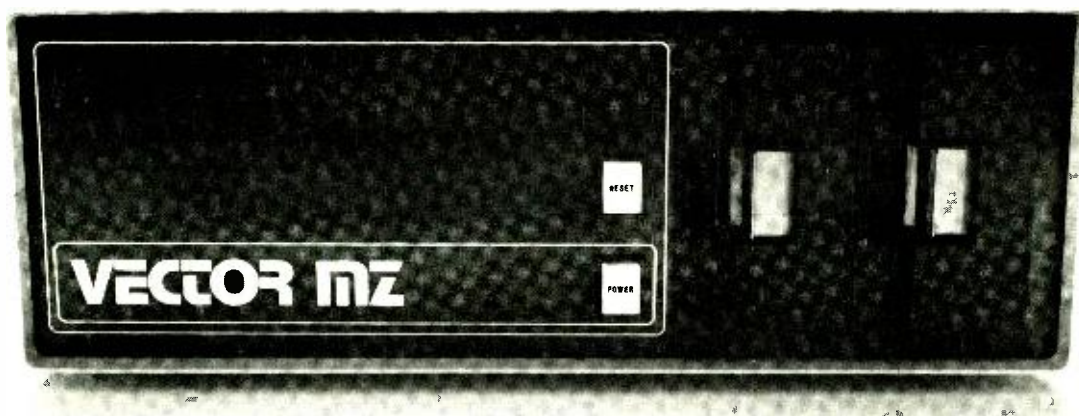

Vector Graphic's new super-star Vector MZ, the most powerful complete Z-80 micro-computer on the market today. It has four times the disk storage capacity of other systems – over 630K bytes formatted – enough power to get things done. Also standard is 32K of directly addressable memory – easily expandable to 64K.

Expansion is easy with its 18-slot S-100 motherboard. All Vector Graphic circuit boards (High Resolution Graphics Display, Flashwriter Video Display, Precision Analog Interface and other S-100 compatible boards) can be utilized.

The Vector MZ includes: four MHz Z-80 CPU, two quad-density Micropolis mini-floppy disk drives, disk controller board, Bit Streamer I/O board with one serial and two parallel ports, 32K static RAM, 12K PROM/RAM board with extended monitor,

complete DOS and extended disk BASIC – all standard.

Completely assembled and fully tested as a system, the Vector MZ is ready to go – just connect it to a terminal and optional printer and you'll have a complete microsystem.

That's why it makes good sense to see your local dealer and ask for Vector MZ. It also makes good sense to buy Vector MZ now at its low introductory price – \$3750.

Of all the leading microcomputer companies, Vector Graphic – and only Vector Graphic can make this offer.



VECTOR GRAPHIC INC.
Vector Graphic Inc., 31364 Via Colinas
Westlake Village, CA 91361, (213) 991-2302

SPECIAL FOCUS ON

computers

This special editorial section crams into more than 18 pages a host of personal computer articles that illustrate the field's continued vigor. It includes a new low-cost microcomputer project that employs the advanced 8085 CPU, a look at an upcoming peripheral that will put all the colors of the rainbow—and

then some—into the hands of computer users, an auxiliary-device project for the popular TRS-80 to make cassette program retrieval easier, a discussion about the new 16-bit CPUs and how they compare to the presently dominant 8-biters, and how to care for and handle floppy diskettes.

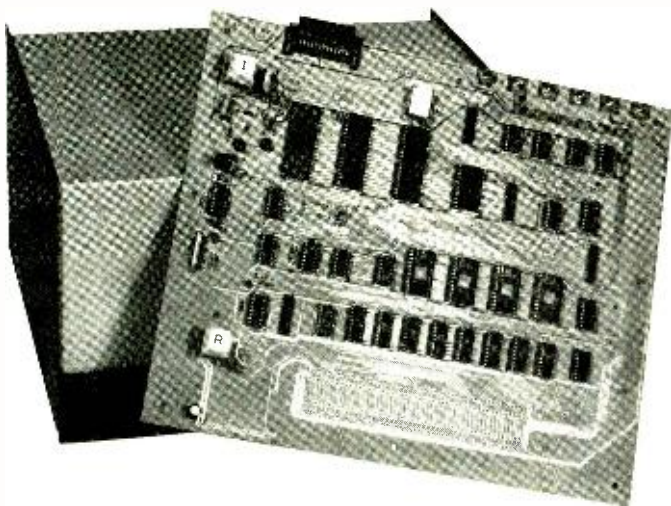

CONSTRUCTION PROJECT

“EXPLORER” 8085-Based Microcomputer

Expandable, single-board \$130 computer uses simplified hardware and is fully compatible with 8080 software

BY MARTIN MEYER

IT IS no secret that hundreds of thousands of programs have been written for 8080-based microcomputers. While the 8080 is an excellent microprocessor, it requires 30 support ICs and has a rather complicated system architecture. Consequently, users generally do not understand how the μ P works and are, therefore, relegated to being “appliance” operators and slaves of packaged software. The new Intel 8085 μ P, which is 100% software-compatible (though not pin-compatible) with the 8080A, simplifies hardware and software matters considerably because it requires only

three support ICs. Without a maze of flip-flops to fight through and with eight fewer connections and bus lines for every chip added, you need no longer be confused about μ P operation with the 8085.

In addition to using “canned” programs, one can learn the rudiments of machine language more easily with the 8085 than its 8080 predecessor. Hence, program debugging is simplified so that exchanged programs that are slightly askew from your BASIC can be corrected and modified. Also, programs published in magazines and other literature

can be made to work with your computer. Once you learn machine language with the 8085, you will no longer be a prisoner of canned software. This means that you will not have to search out software to instruct your computer to do a myriad of simple dedicated tasks. You will be able to program it yourself to, say, turn on and off a light with a specified delay, act as an alarm system or telephone dialer, etc.—all without expensive RAM or ROM or any special expertise.

The minimum-system 8085-based “Explorer” microcomputer presented

here has a host of other welcome attributes, including: built-in ROM monitor; 50% faster speed than the 8080A; S-100 bus compatibility; single 5-volt supply requirement; four *built-in* hardware and seven software interrupts; and multiplexed data/address lines. A basic starter kit with full on-board expansion capabilities (see Minimum System Parts List) allows one to grow at his own pace. System peripherals designed to work directly with the 8085 already include interval timers, DMA and interrupt controls, programmable floppy-disk and CRT controllers.

The Minimum System. The basic Minimum Explorer T-8085 computer system described here is built around just eight ICs, the most important of which is the 8085 μ P. Direct support of the 8085 is provided by an 8355 ROM and an 8155 RAM. The ROM contains a 2K monitor and two programmable 8-bit bidirectional parallel I/O ports (see table for commands contained in the ROM). The RAM contains two programmable 8-bit bidirectional and one programmable 6-bit bidirectional I/O ports and a programmable 14-bit binary counter/timer. The remaining five chips include operational amplifiers, inverters, and gates.

Bear in mind in the following circuit descriptions that all components with 100-series part numbers (C101, R115, U101, etc.) comprise the basic minimum system. Components labelled with 200-series numbers are required for S-100 bus expansion, 300-series components are for on-board RAM and ROM expansion, and 400-series components are for a hex keypad.

The 8085 (U101 in Fig. 1) utilizes a multiplexed address/data bus (pins 12 through 19). The lower eight bits of the address output is followed by eight bits of data or I/O. ALE pin 30 synchronizes the accessory chips in the system, which latch in first the address and then the eight bits of data. This greatly simplifies the system and use of the I/O ports and is largely responsible for its compactness and the saving of up to eight pins per add-on chip. High-order bus pins 21 through 28 contain the high-order address signals.

Transistors Q101, Q102, and Q103 are serial-output buffers and are selectable via S9 and S10 to be either a 20-

mA TTY or an RS232-C interface. (A negative supply is required to drive an RS232-C device.) The collector circuit of Q102 also includes light-emitting diode L100 and an output for a speaker or a headphone. The LED is useful for signalling the end of a program or event. (For example, the last statement in a program could be an instruction to turn on the LED after the program has been successfully executed.) The headphone or speaker is useful for monitoring music and audio programs.

Integrated circuits U104A, U104B, U105, and U106A are address decoders that specify the address of the system's ROM at F800 and RAM at F000. IC's U104C U104D, and U106B are part of the auto-boot that automatically points the system to the monitor on turn-on and when pressing the monitor switch. IC U106C is a memory-ready control that is employed only when using memories that are slower than the speed of the 8085.

Integrated circuit U102 is the 8355 system ROM. System port A at pin 24 is the tape-output port. Pin 25 is the tape-control port. Pin 26 is the cassette-tape output port. The 8155 U103 RAM is used to take data in and pass it out of the computer to a variety of different types of equipment. The 8155 also contains a 14-bit counter/timer.

Cassette tape operation is controlled by U108, Q104, and reed relay K1. (For more details, see Fig. 2.) The tape output is designed to drive a microphone input on a low-cost cassette recorder. Tape phase selectors S11A and S11B in Fig. 2C permit the use of virtually any tape recorder. If your recorder inverts the signal during record, a condition that might cause loading errors, simply install a jumper for S11B.

Reed relay K1 in Fig. 2B closes whenever you write or read a tape program and automatically turns off the tape recorder when the information being written or read is completed. ICs U209 and U210 are bidirectional data bus drivers, while U214 is used for on-board memory acknowledge, which turns off the S-100 data bus when either the on-board RAM/PROM or monitor is in use. Jack J2 is the hex keypad output jack. (The 200-series components mentioned here are *not* part of the basic system.)

Due to the complexity of the double-sided pc board, which includes expansion provisions, its etching and drilling guide is not given here. Since the basic system actually consists of so few parts, they can be direct-wired on perforated

Fig. 1. Schematic of the basic Minimum Explorer T-8085 computer system is shown on the opposite page. The Parts List is below. The system is built around eight ICs, the most important of which is the 8085.

MINIMUM SYSTEM PARTS LIST

C100—1- μ F, 35-volt tantalum capacitor
 C101—25- μ F, 25-volt upright electrolytic capacitor
 C102, C103—18-pF disc capacitor
 C104, C107, C115—0.1- μ F disc capacitor
 C105—0.0047- μ F Mylar capacitor
 C106—0.47- μ F Mylar capacitor
 C108 through C114—0.01- μ F disc capacitor
 D100, D101—1N4148 switching diode
 K1—Spst reed relay
 LED100—Red light-emitting diode
 Q101, Q104—2N4384 transistor
 Q102, Q103—2N4355 transistor
 The following resistors are 1/4-watt, 5% tolerance:
 R100, R134—47,000 ohms
 R101, R110, R111, R115, R119, R123, R124 through R128, R131—10,000 ohms
 R102—2200 ohms
 R103, R135—390 ohms
 R104, R105, R107, R108, R109, R116, R118, R129, R132—1000 ohms
 R106, R117, R133, R137—100 ohms
 R112—39,000 ohms
 R113—200 ohms
 R114—100,000 ohms
 R120, R121—1 megohm
 R122—22,000 ohms
 R130, R136—3900 ohms
 S1, S2, S3—Spst momentary-action keyswitch
 U101—8085A CPU
 U102—8355 I/O ROM (see test)
 U103—8155 RAM I/O-timer
 U104—74LS00 2-input NAND-gate
 U105—74LS20 4-input NAND-gate
 U106—74LS10 3-input NAND-gate
 U107—74LS04 hex inverter
 U108—LM3900 quad op-amp
 X100—6, 14-MHz crystal
 Misc.—Printed-circuit board; sockets for IC's (three 40-pin, five 14-pin); rubber feet (8); solder; etc.

Note: The following items are available from Netronics R&D Ltd., 333 Litchfield Rd., New Milford, CT 06776: Complete 8085 minimum system Explorer microcomputer kit, including IC sockets (No. 8085EIA for EIA terminals or No. 8085HEX for hex keypad systems) for \$129.95 plus \$3.00 postage and handling. The double-sided, plated-through hole pc board No. 8085PC is also available separately for \$49.95 plus \$2.00 postage and handling. Additional equipment not part of minimum system includes: No. PS5VR 5-volt regulated power supply for \$39.95 plus \$2.00 postage and handling; Explorer case for \$39.95 plus \$3.00 postage and handling; hex keypad kit (see Hex Keypad Parts List) for \$69.95 plus \$2.00 postage and handling; Intel 8085 User's Manual for \$7.50 ppd.

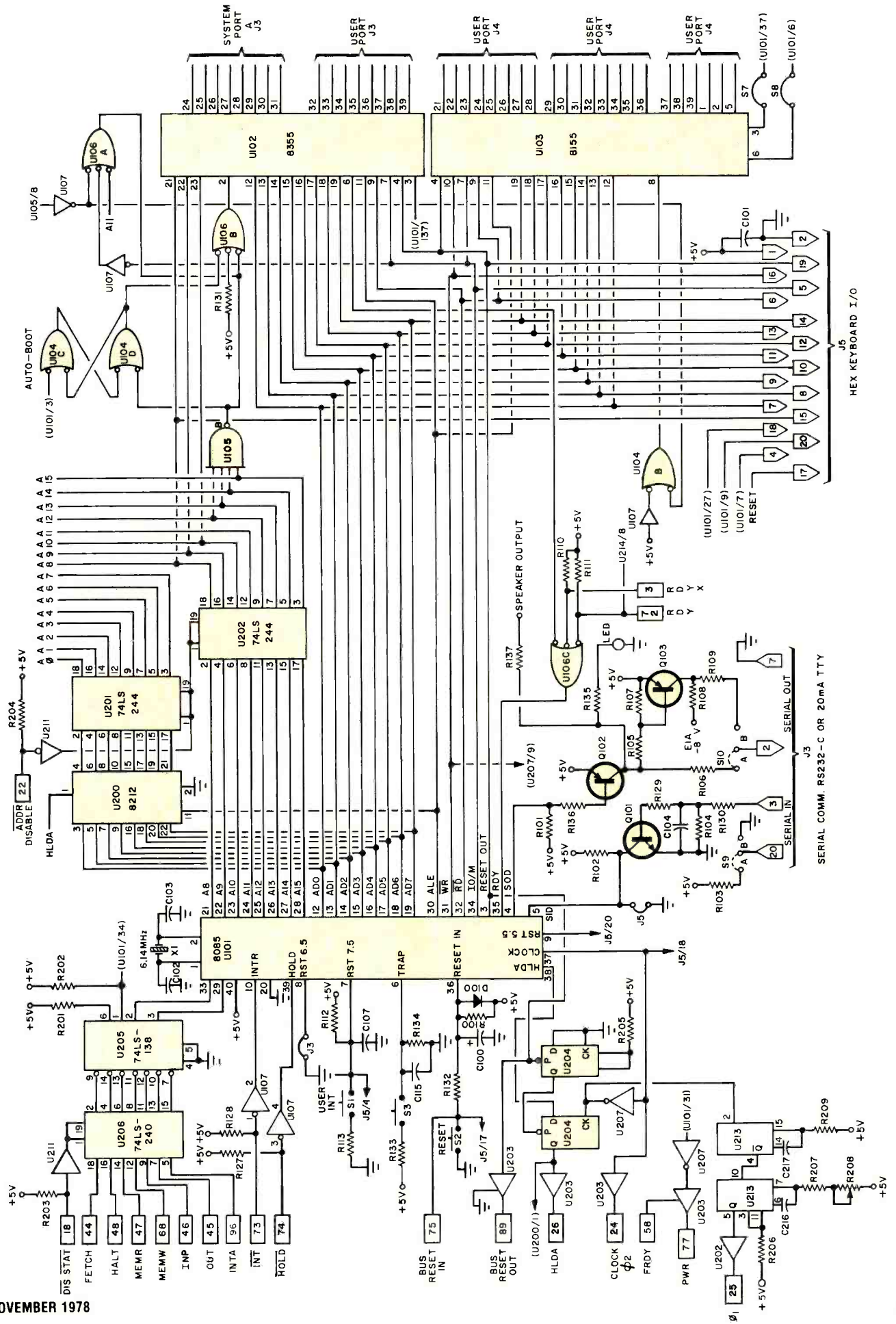

board; but a finished pc board is available to those desiring it from the source given in the Parts List.

General Information. The data bus used in the 8085 is multiplexed. The 16-bit address is divided into the high 8-bit address bus and lower 8-bit address/data bus. The address is sent out during the first part of the cycle. Then the least-significant eight bits of the address are latched into the peripherals by the address latch enable (ALE) signal. During the rest of the machine cycle, the data bus is used for memory or I/O data.

In addition to all of the functions provided by the 8080, the 8085 has on-chip: an internal clock generator; clock output; fully synchronized ready; Schmitt-action RESET IN; RESET OUT pin; RD, WR, and IO/M bus control signals; encoded status information; multiplexed address and data; direct restarts and mask-programmable interrupt; and serial I/O lines. An interrupt acknowledge signal (INTA) is also provided. Hold, ready, and all interrupts are synchronized. The serial input data (SID) and serial output data (SOD) lines are provided for simplified serial interface.

The internal clock requires an external crystal or RC network and oscillates at twice the operating frequency. A 50% duty-cycle, two-phase, nonoverlapping clock is generated from this oscillator. One phase of the clock ($\phi 2$) is available as an external clock.

COMMANDS CONTAINED IN 8355 ROM MONITOR

GETCM		Fetch command (from console).
DCMD	DXXXX,YYYY	Display data contained in memory locations XXXX through YYYY.
GCMD	GXXXX	Run user program beginning at memory location XXXX. If no location is specified, contents of user PC are used.
ICMD	IXXXX	Insert data into memory beginning at location XXXX.
MCMD	MXXXX,YYYY,ZZZZ	Move data in memory locations XXXX through YYYY to memory locations beginning at ZZZZ.
SCMD	SXXXX	Substitute or examine data in memory locations beginning at XXXX.
XCMD	X or X(REG)	Examine contents of all registers or just one register.
WCMD	WXXXX,YYYY,ZZ	Route contents of memory locations XXXX through YYYY to TTY punch or to cassette interface.
LCMD	LXX	Load contents of recorded program into memory. In cassette systems, XXth program can be selected.
FCMD	FXXXX,YYYY,ZZ	Fill contents of RAM locations from XXXX to YYYY with constant ZZ.

Fig. 2. Cassette tape operation is controlled by circuits shown. (A) Amplifies signal for tape deck. (B) Controls tape movement. (C) Amplifies output from deck to microcomputer and choice of normal or inverted signal. (D) Shows hex keypad hookups for tape functions.

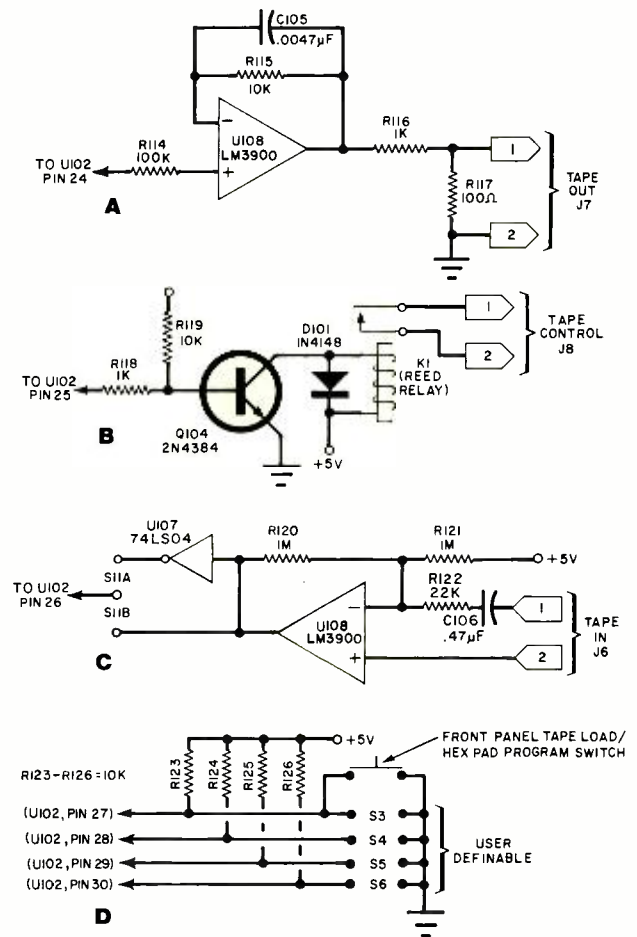

The 8085 directly provides the external RDY synchronization previously provided by a 8224 in the 8080 system.

The 8085 has five interrupts: INTR, RST 5.5, RST 6.5, RST 7.5, and TRAP. INTR is identical to INT in the 8080. Each restart (RST) input has a programmable mask. TRAP is also a restart input, but it is nonmaskable. The interrupts are arranged in a fixed priority order that determines the interrupt to be recognized if more than one is pending.

The TRAP interrupt is recognized as if it were any other interrupt, except that it has first priority. It is not recognized by any flag or mask. The TRAP input is both edge and level sensitive. It must go high and remain high to be acknowledged. It is not recognized again until it goes low and then high again. This avoids false triggering due to noise and logic glitches.

The instruction set for the 8085 includes five different types of instructions. The Data Transfer group moves data between registers or between memory and registers. The Arithmetic group adds, subtracts, and increments or decrements data in registers or memory. The Logical group ANDs, ORs, EX-ORs, compares, rotates, or comple-

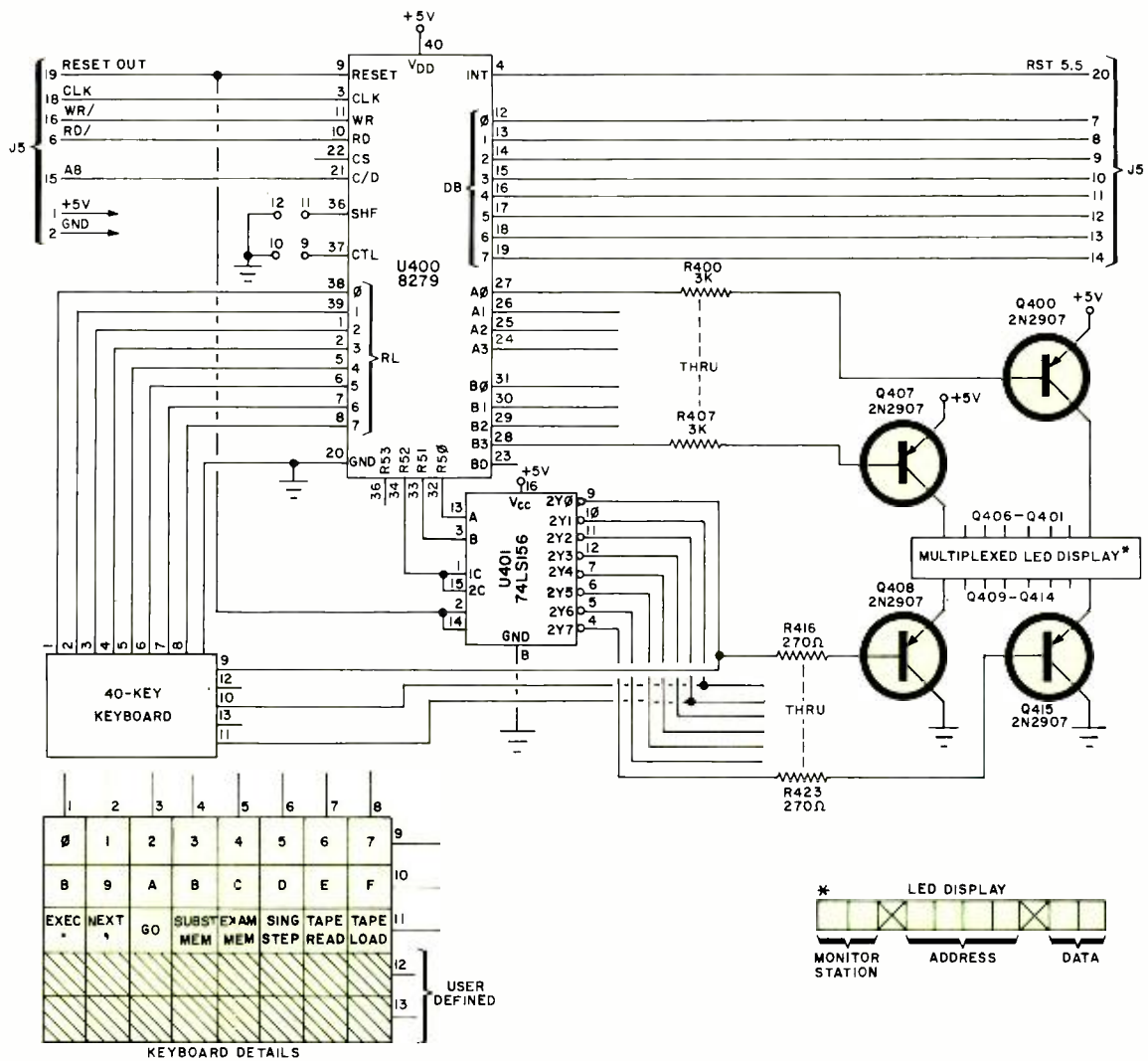

Fig. 3. Hex keypad terminal for use with Explorer computer.

HEX KEYPAD PARTS LIST

- DIS1—Eight-digit multiplexed calculator LED display array
- Q400 through Q415—2N2907 or equivalent transistor
- R400 through R407—3000-ohm, ¼-watt, 5% tolerance resistor
- R408 through R415—24-ohm, ¼-watt, 5% tolerance resistor
- R416 through R423—270-ohm, ¼-watt, 5% tolerance resistor
- U400—8279 keyboard decoder IC
- U401—74LS156 3-to-8 decoder IC

- U401—74LS156 3-to-8 decoder IC
- Misc.—40-key keyboard assembly; 16-conductor cable to mother board; printed circuit board; sockets for ICs (one each 40 pin and 16 pin); solder; etc.

Note: A complete kit of the above parts is available from the source given in the Minimum System Parts List. When a keypad is ordered with a Minimum System the latter will have an 8355 ROM programmed to talk to the keypad.

ments data in registers or memory. The Branch group permits conditional and unconditional jump instructions, and return instructions. The Stack I/O and Machine Control group includes I/O instructions and instructions for maintaining the stack and internal control flags.

Memory for the 8085 is organized into 8-bit bytes, each with a unique 16-bit binary address that corresponds to its sequential position in memory. (The 8085 can directly address up to 65K of memory, including both ROM and RAM.)

Data in the 8085 is stored in 8-bit registers. When a register or data word contains a binary number, the order in which the bits are to be written must be established. In the 8085, bit 0 is the least-significant bit (LSB), while bit 7 is the most-significant bit (MSB). Program instructions can be one, two, or three bytes long. Multiple-byte instructions must be

stored in successive memory locations. The address of the first byte is always used as the address of the instructions. The exact instruction format depends on the particular operation being executed.

The 8085 has four different modes for addressing data stored in memory or its registers. In the Direct mode, bytes two and three of the instruction contain the exact memory address of the data. The low-order bits of the address are in byte two, the high-order bits in byte three. In the Register mode, the instruction specifies the register or register-pair in which the data is located. In the Register Direct

mode, the instruction specifies a register-pair that contains the memory address where the data is located. The high-order bits of the address are in the first register of the pair, while the low-order bits are in the second register. In the Immediate mode, the instruction contains the data itself, which is either an 8- or a 16-bit quantity. The LSB bit goes in first, the MSB last.

Unless directed by an interrupt or branch instruction, the execution of instructions proceeds through consecutively increasing memory locations. A branch instruction can specify the ad-

dress of the next instruction to be executed, either directly or register indirectly. In the Direct mode, the branch instruction contains the address of the next instruction to be executed. Except for the RST instruction, byte two contains the low-order address and byte three contains the high-order address. In the Register Indirect mode, the branch instruction indicates a register-pair that contains the address of the next instruction to be executed. The high-order bits of the address are in the first and the low-order bits are in the second register of the pair.

The RST instruction is a special one-byte call instruction that is usually used during interrupt sequences. RST includes a three-bit field. Program control is transferred to the instruction whose address is eight times the contents of this three-bit field.

There are five condition flags associated with 8085 instruction execution. Each is represented by a 1-bit register in the CPU. A flag is set by forcing the bit to 1 and reset by forcing it to 0.

An instruction sets a flag as follows: Zero—if the result of an operation has the value 0; Sign—if the MSB of the result of an operation has the value 1; Parity—if the modulo 2 sum of the bits of the result of an operation is 0 (even parity); Carry—if the instruction results in a carry (from addition) or a borrow (from subtraction or a comparison) out of the high-order bit; Auxiliary Carry—if the instruction causes a carry out of bit three and into bit four of the resulting value. If the above criteria are not met, the individual flags are reset.

The Auxiliary Carry flag is affected by single precision additions, subtractions, increments, decrements, comparisons, and logical operations. However, it is principally used with additions and increments preceding a DAA (decimal adjust accumulator) instruction.

Hex Keypad. Obviously, you must have an input/output terminal to operate a computer. It can be a hex keypad, a TV terminal with an ASCII keyboard, or a Teletype terminal. (Teletype terminals can often be rented for about \$40.00 per month.) The hex keypad shown in Fig. 3 is the least expensive (see Hex Keypad Parts List for Fig. 3). It is adequate for the beginner in computing because machine-language programming is performed in hex code.

The Fig. 3 hex keypad input circuit utilizes an 8279 keyboard decoder chip (U400) and a 10-digit multiplexed calculator LED display (DIS400) output. In addition to the normal hex input, switches are provided for reset, vector-interrupt, single-step go-to, subst (substitute) memory, examine-registers, execute, next, tape-read, tape-load, plus any additional user-definable functions that may be needed.

This keypad is very simple to use. You simply plug it into the computer and start communicating. ◇

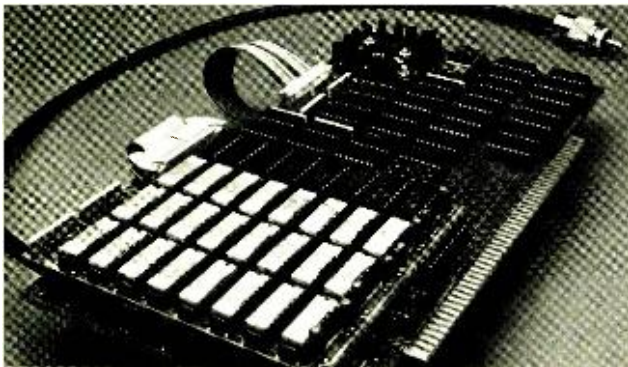

"CORONA" 256-Color Peripheral

BY JEFF LOWENSON, ROBERT MARSH & JAMES SPANN

Upcoming S-100 bus compatible kit with full color graphics and alphanumerics.

E EDITORS AT POPULAR ELECTRONICS are frequently privy to exciting new products that are in the final stages of pre-production design. This information includes all the details on how it works and "hands on" experience with custom-wired samples. One such product about which we'd like to share information with readers is Processor Technology's "Corona," a high-resolution, full-color graphics accessory for microcomputers. The Corona will provide 256 colors (or shades of grey in a 256-by-208

display with graphics and alphanumerics mixed—all under software control.

The Corona is designed to be fully bus compatible with the SOL-20 microcomputer and VDM-1 video display module, both made by Processor Technology. However, it can be modified as required to operate with other S-100 bus formats. The Corona-1K kit with 8K of memory will be marketed through computer stores in the near future for \$395.

Technical Details. The display resolution of the Corona is 256 × 256, with a display size of 256 horizontal by 208 vertical. Its 53,248 pixels can be used with a selection of any 16 out of 256 pos-

sible colors (or grey levels). The alphanumerics can be mixed and overlaid with the graphics and/or external video input. The Corona uses 8K of 8-bit bytes in the low-color range and 24K of 8-bit bytes in the full-range version. (See Corona Specifications Table.)

In addition to game playing, this new graphics system is a powerful tool for business, artistic, scientific, and educational applications, since vivid graphics, poster-like displays, and full-color animation are available.

Since the Corona's signals can be mixed with video from a low-cost monochrome TV camera and with alphanumerics from a computer, the final video can display a scene from a camera with

Note: on the cover is an artist's conception of a computer game using the Corona.

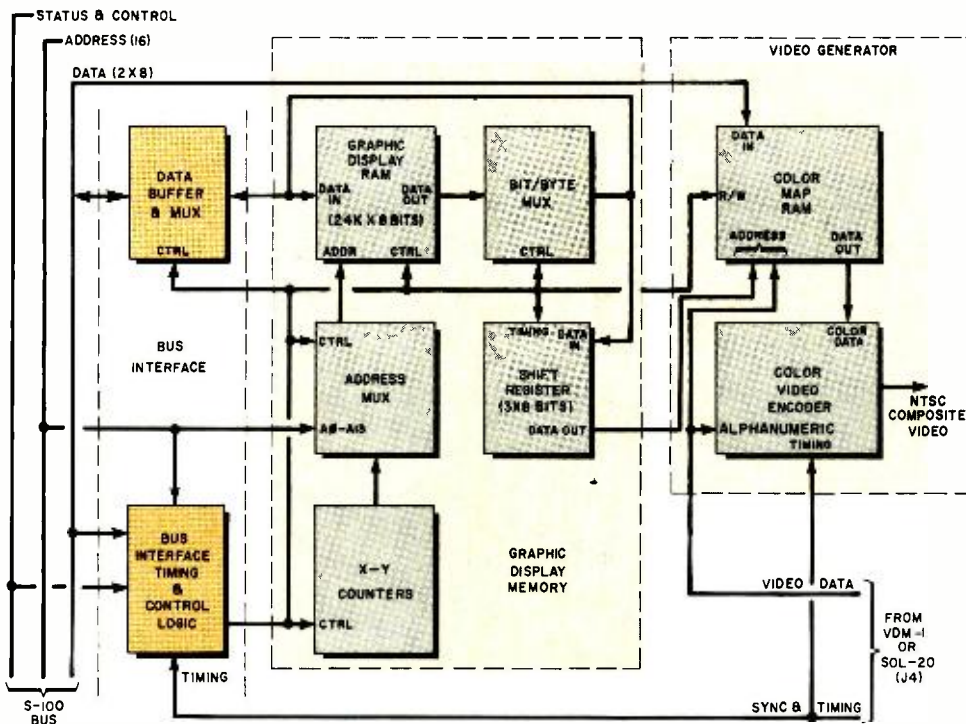

Fig. 1. Block diagram of Corona shows logic interconnections. The NTSC output means that it can be video recorded. Sync can also be obtained from an external source for interfacing to other video systems.

a set of color graphs superimposed on it. Scientific data can be transformed into a presentation that can be observed while an experiment is in progress. Alpha feedback experimenters will find this color approach valuable because of the wide range of its 256 colors.

It is recommended that the Corona be used with a color monitor to take advantage of the better color and crisper images available.

Circuit Operation. As shown in Fig. 1, the heart of the Corona system is the Graphic Display Memory that stores information in three $256 \times 256 \times 1$ bit planes, each of which represents a 256×256 CRT screen matrix. The three combined planes contain three bits of color information for each dot on the TV screen. The memory can be used in two ways—for color-picture storage or as conventional computer memory. This means that when the graphics are not used, the computer's memory is expanded by the amount of memory contained in the graphics interface (see Fig. 2 memory map).

Memory access by the computer is handled in two modes. In the *bit* mode, each full-color point can be individually read or written to by the computer. This mode simplifies interfacing with BASIC and FORTRAN to take advantage of their powerful trigonometric and matrix functions. (Matrix operations enable the programmer to write powerful software for scaling, translation, and rotation of

graphic images.) In this mode, the graphics display area looks to the programmer like a 256×256 Cartesian coordinate system, with the origin at the lower left corner.

In the *byte* mode, graphics data is transferred from the computer to the Corona, eight bits at a time, with the RAM organized as conventional 24K by 8-bit memory. The byte mode permits very fast loading of complete screens from peripheral devices, such as a floppy-disk or a cassette-tape system.

The bus interface and control logic section (Fig. 1) controls the flow of data between the computer and the Graphics Display Memory. This logic synchronizes the TV scan and computer memory requests. This functional block also contains the command registers, memory timing, and fast erase logic.

The address multiplexer selects the

source of the display memory address, which can originate either from the computer or from the X-Y logic. The X-Y counters generate the X-Y address coordinates that represent a point on the CRT screen. Data from the display memory is thus mapped on the TV.

The bit/byte multiplexer is used in the bit mode to change or read one bit into each of the three memory planes. The shift registers convert the eight and 24 bits of parallel data from the Graphics Display Memory into a serial address for the color-map RAM.

The video generator section can provide up to 256 different colors (or 32 shades of grey), eight of which can be displayed graphically at one time. Either SOL-20 or VDM-1 alphanumeric characters can be mixed under program control to interleave graphics and text information anywhere desired on the screen. All the video sync signals are provided by the SOL-20 or VDM-1.

Alphanumerics can be displayed in a distinct ninth color that is selected under software control to provide the best contrast with the eight graphics colors. There are also an additional eight colors where the graphics and alphanumerics intersect.

Any one or all of the displayed colors can be rapidly changed without rewriting the graphics memory contents (that is, without changing the form or shape of the picture). This unique feature can create a shimmering rainbow effect with very simple programming.

MEMORY MAP

FFFF	CORONA MEMORY
E000	NOT USED
D000	SOL/VDM-1 MEMORY
C000	PTDOS
8000	USER MEMORY SPACE
0000	

Fig. 2. Memory map shows RAM arrangement of Corona.

CORONA SPECIFICATIONS

Display resolution	256 × 256
Display size	256 horizontal × 208 vertical
Displayed pixels	53,248
Memory size	8192 8-bit bytes low version; 24,576 8-bit bytes full range
Memory access modes	bit/byte
Memory organization:	
Bit mode	53,248 3-bit pixels
Byte mode	Three 8K byte planes (can also be used for normal data storage)
S-100 bus memory space	8K maximum
S-100 bus I/O ports	Two input, two output
Possible colors	256 (or 32 levels of grey)
Displayed colors	Sixteen maximum.
Display options	Alphanumerics can be mixed and overlaid with graphics and/or external video input on color or monochrome displays
External video input	Software-selectable, accepts standard RS-170 video; external source must be synced to computer
One frame	Two identical fields (noninterlaced)
One field	16.667 ms (1/60 s)
Horizontal sweep cycle	64.1 μs
Horizontal blanking	From 6 to 14 μs
Active display	40.3 μs
Horizontal scanning	
frequency	15,600 Hz
Vertical scanning	
frequency	60 Hz
Color subcarrier	3.579 MHz
Scan lines per field (noninterlaced)	260
Vertical blanking field	833 to 1300 μs
Power requirements	+8 to +10 V dc, 2 A maximum +15 to +20 V dc, 0.2 A maximum -15 to -20 V dc, 0.2 A maximum

The color-map RAM is a high-speed 16-word by 8-bit RAM array. This organization permits the choice of 256 colors (more precisely, 64 colors, each of which has four intensities). Colors for each point on the screen are determined by the three-bit code stored in the Graphic Display Memory that addresses the color-map RAM. The color-map RAM is loaded under program control via the A register.

The function of the color-video encoder is to transform the red, green, blue, and luminance data from the color map into NTSC color signals. This encoder is comprised of timing, four two-bit D/A converter, and the actual color-encoder sections.

The timing section generates the color-burst flag and composite sync (from the SOL-20 or VDM-1 composite sync). The red/green/blue/luminance D/A converters accept digital data from their respective sections of the color map and convert it to analog color-difference signals (R - Y and B - Y). The encoder section is designed around an IC that modulates the color subcarrier with the color-difference signals and outputs the composite video that consists of the video, blanking, and sync signals.

Physical Details. The Corona's circuitry mounts on two large printed circuit boards. The larger board plugs directly into the S-100 bus of the computer and contains 73 ICs, four voltage regulators, and miscellaneous discrete components. The smaller board, which contains 32 ICs that include the RAM memory system and the data multiplexers, is then connected to a jack on the larger board. ◇

A CASSETTE CONTROL SYSTEM for Computers

If you store many computer programs on tape, use the Aux Box to retrieve them quickly and easily

BY A. A. MANGIERI

AUDIO CASSETTE tape recorders make excellent low-cost mass-storage devices for home and small-business computers. They provide an efficient approach for storing a single long program on a cassette tape. For short programs, however, it is usual to store a string of different programs, separated by guard bands, on a common tape track, which leads to retrieval problems. The "Aux Box" cassette deck controller presented here simplifies the process of saving and loading multiple programs that, of necessity, are stored serially on a tape. Although designed to interface directly between Radio Shack's Model

TRS-80 microcomputer and its mating cassette recorder without alterations, the Aux Box can be adapted to other systems.

There are two basic ways to locate a particular program on a cassette tape—strictly manually, using the tape deck's index counter, or with a computer-generated header that "tells" the computer when the named program is passing the playback head.

Working manually, you must "tease" the various tape-speed controls to get to the starting point of a desired program. When using the header approach, you may have to wait quite a while for the tape to get to the desired program. In many cases, including the header approach, you still must make the recorder move rapidly to the desired starting point, as specified by the tape counter. Also, with some computer/tape-deck systems, including the Model TRS-80, you must disconnect cables to regain manual control for rewinding, spotting tape, and monitoring. The Aux Box solves these problems.

With the Aux Box, you can transport tape at fast, medium, and slow speeds in either direction. This makes it very easy to accurately position the tape. Moreover, without removing any cables,

control can be transferred between the computer and the recorder at the flip of a switch, while retaining monitoring capability at all times. Another circuit in the Aux Box permits audio recording without the need to dismantle the setup. Finally, a separate circuit in the Aux Box provides backup protection for the computer's relay.

About the Circuit. The complete circuit for the Aux Box is shown in Fig. 1, along with the computer/cassette-recorder interface. With the plug removed, the recorder's REM (remote) jack is normally shorted to ground, which puts the recorder's negative bus at ground potential. With the plug inserted in the REM jack, the computer starts and stops the recorder via the computer's normally open, fully isolated relay contacts.

Switch S2 transfers control between the computer and the cassette recorder. With S2 set to its COMPUTER position, the computer controls the recorder via the solid-state switch made up of Q1 and Q2. This transistor switch eliminates the current surge through and provides full protection for the relay's contacts, which now carry only the very small base current for Q1.

Pushbutton switch S7 permits tape advance following a data dump without returning control to the recorder.

With S2 set to its RECORDER position and S3 set to its off (REM MIC/TAPE SPEED) position, pushbutton switches S4, S5, and S6 provide FAST, MEDIUM, and SLOW speed control, respectively, for the recorder's fast-forward and rewind modes. As selected by the pushbutton switches, diodes D1 through D5 vary the speed of the tape by controlling the voltage to the tape recorder's motor. The recorder's amplifier voltage is also varied, but monitoring is still available at a slightly reduced volume.

Switch S1 alternately breaks one of two circuit grounds between the computer and the recorder. This ground-loop break reduces or eliminates any slight ac hum that can otherwise be heard during monitoring.

Jack J3 accepts an earphone for audibly monitoring the signal from the tape recorder.

With S2 set to its RECORDER position, S3 is used to select either MIC or REM for audio recording with J4 and J6.

Construction. The circuit for the Aux Box can be assembled in a small plastic box, using the bottom of the box as the



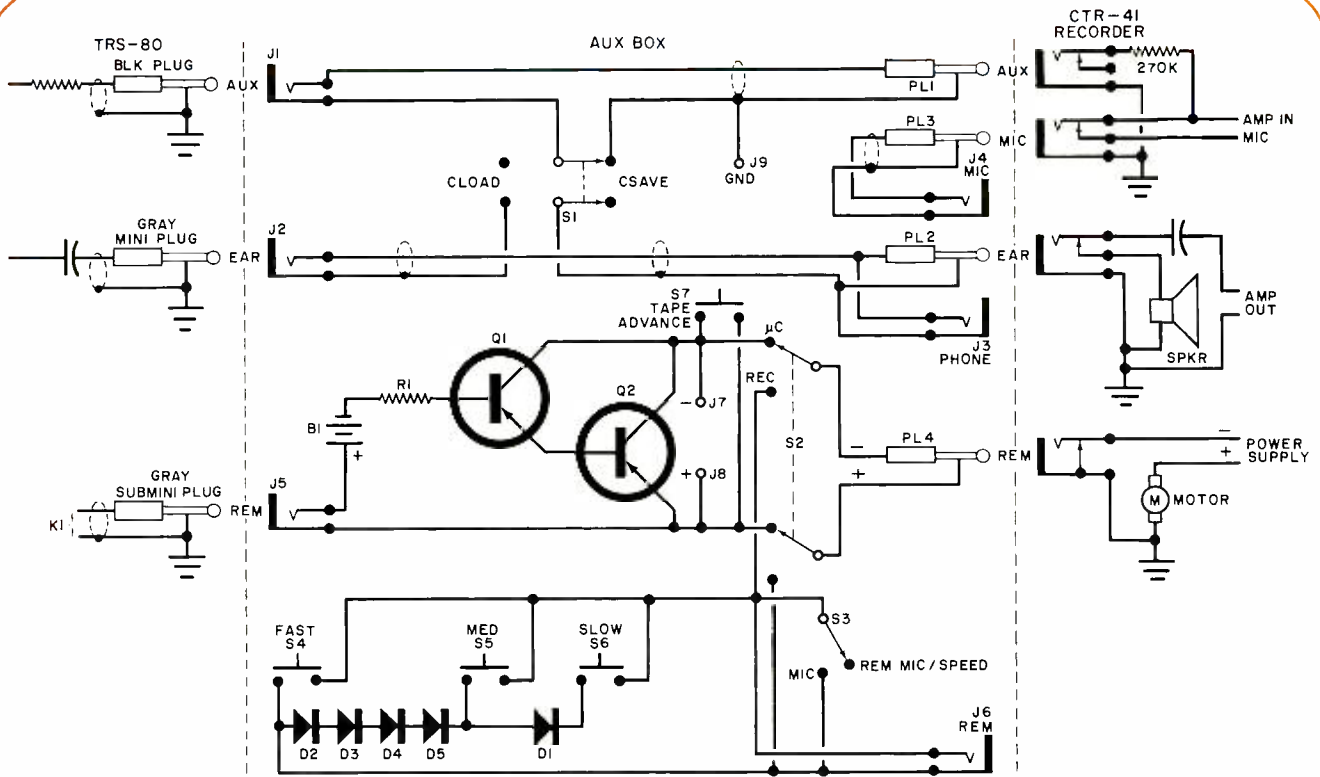

Fig. 1. Schematic of the Aux Box along with the computer/cassette-recorder interface.

PARTS LIST

B1—1.5-volt "C" cell
D1 through D5—1N4001 rectifier diode
J1 through J4—Miniature phone jack
J5, J6—Subminiature phone jack
J7, J8, J9—Phone tip jack
PL1, PL2, PL3—Miniature phone plug

PL4—Subminiature phone plug
Q1—HEP 251 (Motorola) or similar transistor
Q2—HEP 232 (Motorola) or similar transistor
R1—2200-ohm, 1/2-watt, 5% tolerance resistor
S1, S2—Dpdt toggle switch
S3—Spst toggle switch

S4 through S7—Spst normally open momentary-action pushbutton switch.
Misc.—Suitable plastic case; terminal strip; TO-3 transistor socket; battery holder; ear-phone; shielded cable; hookup wire; solder; machine hardware; etc.

control panel. Point-to-point wiring techniques are perfectly adequate for assembling the Aux Box. You can use a terminal strip for mounting Q1 and to provide a convenient means for connecting it into the circuit. Also, use a TO-3 socket, spacers, and machine hardware to mount Q2. Diodes D1 through D5 are best mounted on a tag or terminal strip to permit easy removal should you decide to alter the speed of the cassette transport.

The walls of the box in which the Aux Box is mounted are fairly thick. This means that you must use jacks with fairly long bushings. Alternatively, you can counterbore the mounting holes for the jacks and use standard-length jacks.

The AUX, EAR, and REM jacks (J1, J2, and J5) should be mounted on the rear wall of the box. Jacks J3, J4, and J6 (PHONE, MIC, and REMOTE jacks, respec-



Fig. 2. Photo shows controls and identification on front panel.

tively) go on the front of the box (see Fig. 2). CLOAD/CSAVE, COMPUTER/RECORDER, MIC/REM MIC, TAPE SPEED (FAST, MEDIUM, and SLOW), and TAPE ADV switches S1 through S7, respectively, all go on the bottom of the box, which becomes the control panel. After drilling the holes for but before mounting the jacks and switches in their respective locations, it is a good idea to label each with a white dry-transfer lettering kit as shown in Fig. 2.

Use insulated hookup wire for the REM circuit and shielded cable elsewhere. Check PL4 with an ohmmeter and wire the cable to S2 accordingly. Jacks J7 and J8 can be installed in any convenient location. The cables to which AUX plug PL1, MIC plug PL2, and EAR plug PL3 are attached should exit the box near the respective jacks on the rear of the box.

Inclusion of ground jack *J9* is optional. Use a battery holder for *B1*. Also, use either a 4-ohm or, preferably a 400-ohm, impedance earphone for low loading.

Test and Adjustment. Connect a dc milliammeter in series with a 10,000-ohm potentiometer across *J5* to measure the base current of *Q1* and a dc voltmeter between *J7* and *J8* to measure $V_{CE(sat)}$ of *Q2*. Set *S2* to COMPUTER and insert *PL4* into the recorder's REM jack.

Now, set the pot to minimum resistance and note the base current of *Q1*. With the recorder's PLAY lever engaged, $V_{CE(sat)}$ should be 0.2 volt or less. Advance the pot until $V_{CE(sat)}$ just begins to increase and note the base current of *Q1*. This is the minimum required base current for *Q1*. Note this current, multiply it by 2 or 3, and adjust the pot until the milliammeter indicates the result of your calculation.

Without disturbing the setting of the pot, remove it from the circuit and use an ohmmeter to measure its resistance. Then wire into the *R1* location in the circuit a fixed resistor whose value is as near as possible to your measurement. The reason for choosing a resistor whose value yields twice or three times the minimum base current for *Q1* is to allow for battery ageing.

Set *S2* to RECORDER and observe the speed of the cassette tape in both the fast forward and rewind modes with the recorder's PLAY lever engaged and disengaged. The speed can be altered by diode selection. If desired, a separate string of diodes can be used for *S5* and *S6*. On SLOW, different speeds can be observed on fast forward and rewind with the PLAY lever engaged and disengaged. This is of no consequence. A good choice for a MEDIUM tape speed is half the normal fast-forward speed.

Saving and Loading Programs.

Program locations on the tape are referenced to the recorder's tape-counter readings. Rewind the tape and reset the counter to 000. If the tape has a leader, advance the tape to just beyond the leader. Keep a record of the counter readings at the start and end of each program. Set the recorder up for recording and set *S1* and *S2* on the Aux Box to CSAVE and COMPUTER. Type CSAVE and hit ENTER on the computer to start recording data. Use the earphone at *J3* (PHONE jack) to verify that data is being transferred.

There will be very short blank spaces

on a tape if you allow the computer to space the programs. Therefore, it is a good idea to put the tape recorder in the play mode and press *S7* to advance the tape an additional three to five digits on the index counter after each program. (It has proven handy to assign program starting locations at numbers on the counter ending in 0 or 5. Then the actual recording can be started at, say, 23, 38, etc., to allow a short duration guard band. Also, allow two or three digits of blank tape on the other side of the assigned starting location.)

As an example of the foregoing, let us assume that a data dump ends at 144. Here, you might advance the tape to 153 and record the starting location of the program as being at location 150 on the index counter. When saving programs, remove the microphone from *J4* and *J6*.

The Aux Box also permits various procedures for loading programs. (You will eventually adopt your own.) First, the earphone monitor is active when the recorder is in fast forward, play, and re-

wind only when the PLAY lever is engaged. The monitor's volume drops slightly when the SLOW button on the Aux Box is pressed, but it will be adequate.

There are three general methods for positioning the tape, plus many variations. The tape can be positioned with the PLAY lever engaged at all times, with continual monitoring of the tape. As usual, the recorder's FAST-FORWARD and REWIND levers do not latch in the engage positions with the recorder in the play mode and, therefore, must be firmly held down to move the tape. Second, with the PLAY lever disengaged (monitor inactive), the tape can be run just short of the target location and then switched over to recorder play to access the monitor while setting the tape between data jumps. Finally, the tape can be positioned with the PLAY lever disengaged and use of the monitor deferred until a load is required. The last approach works well if you save programs as described above.

GRAPHICS STAR PROGRAM

The eye-catching star on the monitor in the lead photo can be duplicated with a TRS-80 computer. The program given here causes a star to be drawn, pauses, and then proceeds to draw the pattern in reverse. Conserving memory or execution time were secondary in this program; several improvements are possible. Look for them. Lines 40 through 90 draw three nested inverted V's. Lines 210 through 250 draw a left-to-right descending line. Lines 310 through 340 draw a right-to-left descending line. Lines 240 and 330 place lower limits on the screen.

The diagonal line routines merit close study for use in other graphic programs. In

line 210, try other integer and noninteger numbers for B along with several less than one. Some unexpected surprises are in store; try it! As you ponder the results, consider that screen X-Y coordinates are integers and that computation X/B is often a noninteger.

Lines 410 through 490 introduce a pause followed by reversal of screen. For some artistic effects, add STEP 5 to line 420. Add line 425 IF Y = 20 THEN NEXT Y and run. Isn't that something? Try other step increments in lines 420 and 430 alone and in combination. With a few more statements and functions, you can come up with some astonishing abstract stars.

```
10 REM * TRS-80 GRAPHICS STAR PRO-
PROGRAM *
20 REM * DRAW INVERTED V *
30 CLS
40 FOR Y = 0 TO 2
50 FOR A = 0 TO 47 - Y
60 SET (64 + A, Y + A)
70 SET (63 - A, Y + A)
80 NEXT A
90 NEXT Y
100 REM * DRAW HORIZONTAL LINE *
110 FOR X = 0 TO 127
120 SET (X, 20)
130 NEXT X
200 REM * DRAW LEFT DESCENDING DI-
AGONAL *
210 B = 4
220 FOR X = 0 TO 127
230 SET (X, 20 + X/B)
240 IF 20 + X/B > 47 THEN 310
```

```
250 NEXT X
300 REM * DRAW RIGHT DESCENDING DI-
AGONAL *
310 FOR X = 127 TO 0 STEP - 1
320 SET (X, 20 + (127 - X)/B)
330 IF 20 + (127 - X)/B > 47 THEN 410
340 NEXT X
400 REM * PAUSE AND REVERSE
SCREEN *
410 FOR N = 1 TO 2000: NEXT N
420 FOR Y = 0 TO 47
430 FOR X = 0 TO 127
440 IF POINT (X,Y) = 0 THEN 470
450 RESET (X,Y)
460 GOTO 480
470 SET (X,Y)
480 NEXT X
490 NEXT Y
999 GO TO 999
```

Here's an example of how the Aux Box can be used in conjunction with a cassette tape system. Assume that the assigned location of a program on tape is at 150 on the index counter. Rewind the tape by setting S2 to RECORDER and S3 to TAPE SPEED. Latch the recorder's REWIND lever and press S4 (FAST switch) to rewind a short tape. With long tapes, use S3 in the MIC position for rewinding. Reset the index counter and then operate the recorder's STOP lever.

To position the tape, press the recorder's FAST-F lever and latch it. Press S4

(FAST) and observe the counter's 10's and 100's digits. When 14X appears on the counter, release S4. The tape will probably coast to about 146. At this point, you must select between immediate use of the monitor (PLAY lever engaged) or defer use of the monitor (PLAY lever disengaged) and move the tape to 150 on the index counter, using S5 (MEDIUM) or S6 (SLOW).

The tape can be run back and forth to access other programs without rewinding or resetting the index counter. Going backward (rewinding) from 175 to 20, use the REWIND lever on the recorder and S4 (FAST switch) on the Aux Box, letting go of S4 when 03X appears in the index counter. Use SLOW reverse to jog

the tape to its final position. On the MEDIUM speed, the counter's 1's decade is at least readable and tape coasting is reduced by one-half. This can be used to great advantage.

Summing Up. If you store many programs on one cassette tape, the Aux Box lets you see just how easy it can be to retrieve programs quickly and precisely. Without having to pull cables, you can transfer control between the computer and tape deck at the flip of a switch and monitor the tape at all times. And you can transport tape at any of three speeds in either direction. In short, the Aux Box takes much of the hassle out of loading programs. ◇

A TIC-TAC-TOE GAME for your Elf Computer

Use a simple light pen as an input selector and the programs given here.

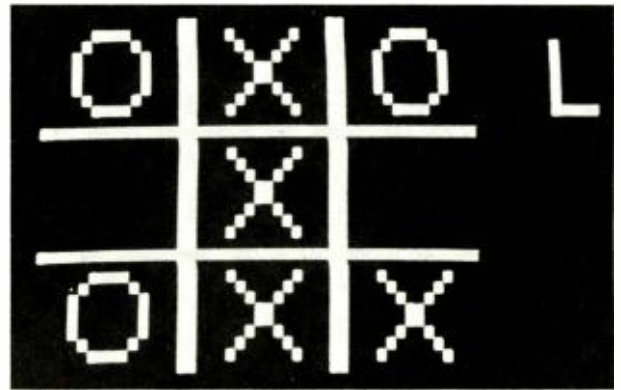

BY EDWARD M. McCORMICK

AN ELF computer that contains 1K of RAM can be programmed to play Tic-Tac-Toe if it is equipped with a video (1861) display and a light pen, the latter to be described here. The computer, using an O, plays against the human (X), and either the computer or the human can go first.

Unless forced to make some other play, the computer will randomly select any open position as its response. This results in a wide variety of games, and although the computer can be beaten, it will also win more than one might expect.

Playing the Game. The playing sequence is straightforward. The IN switch is operated to clear the screen. If any toggle switch is on, the computer will indicate its O after a pause of two seconds. If the input toggle switches are all off, the computer will wait for you to make the first move.

Whenever you are to play, a P will be displayed at the upper-right corner of the screen. You place the light pen in front of the position you wish to play, then depress the IN switch. An X will appear at the selected position. The computer will then indicate its response and you play again. This cycle continues until the game ends.

A D for draw, W for win, or L for lose will be shown at the upper-right corner at the end of a game. To clear the screen and set up for another game, simply operate the IN switch.

The Light Pen. The light pen consists of a cadmium-sulphide cell (Radio Shack 276-116) connected between EF-3 and ground in the Elf. Make sure that a 47,000-ohm resistor is connected between EF3 and +5 volts.

The main program, subroutines, and data sets are given in Tables I through V. Program execution starts at 0400. Ta-

ble VI indicates the initial contents of page 6, the display area. Note that this forms the familiar Tic-Tac-Toe grid.

The program requires about 525 bytes, including main program, subroutines, and data storage. In addition, 256 bytes are used for the display area. The remainder of the RAM space can be used for embellishments to the program.

Initially, the program sets up the registers used. After the IN switch has been operated, the nine playing positions and the status position are cleared and N (the number of plays) is set to zero. If the input toggle switches are not set to zero, the program goes to the "any place" position (Table I). The computer randomly selects one of the unplayed positions and places an O in that location. The program then adds a 1 to N and checks to see if all nine positions have been played. If not, it allows the opponent to play an X. Note that when the input toggle switches are at zero, the program goes directly to X.

TABLE I—MAIN PROGRAM

Loc.	Program	Comments			
04 00	C0 05 20	Initialize Registers	04 7F	F8 00 A7	Get playing position
04 03	E9 69	Start video display	04 82	FC E0 A3 E3	from table
04 05	3F 05 37 07	Operate IN Switch	04 86	F0 A6 BC	If it is occupied
04 09	F8 E0 A3	Clear All Positions	04 89	E6 F0 32 A1	get next position
04 0C	E3 F8 14 A5	including 9 playing	04 8D	87 FF 08	If all unoccupied
04 10	F0 32 18	and the status	04 90	32 98	positions scanned but
04 13	A6 D4 13	position	04 92	87 FC 01 A7	not recognized, turn
04 16	30 0C		04 96	30 82	on
04 18	F8 00 A8	N = O	04 98	F8 2C A5	'?' as status but
04 1B	E9 6C 32 4D	Toggle .Sw On?	04 9B	F8 0F A6 D4	continue
04 1F	8B AC 8C	Any Place	04 9F	30 7F	scan
04 22	FF 09 32 2A	Determine random	04 A1	F8 1C A5 D4	Write 'X' in
04 26	33 22 FC 09	position to play,	04 A5	F8 01 59 DD	unoccupied position,
04 2A	FC E0 A3	if occupied go	04 A9	F8 00 A3	make tries to see
04 2D	E3 F0 A6 E6	back for another	04 AC	36 BE	if it is pen
04 31	F0 3A 1F	random position	04 AE	83 FC 01 A3	light position
04 34	F8 80 59 DD	'O'	04 B2	FF 20 3A AC	
04 38	F8 24 A5 D4	Write 'O'	04 B6	9C A6	If not recognized
04 3C	88 FC 01 A8	N = N + 1	04 B8	F8 14 A5 D4	erase 'X' and go to
04 40	FF 09 3A 4D	N = 9?	04 BC	30 8D	next position.
04 44	F8 44 A5	'D'	04 BE	F8 14 A5	When 'X' recognized
04 47	F8 0F A6 D4	If N=9, write 'D',	04 C1	F8 0F A6 D4	clear status.
04 4B	30 05	return to restart	04 C5	F8 1B A5 DA	Lost?
04 4D	F8 4C A5	Operate IN Switch	04 C9	86 32 D5	If so, write
04 50	F8 0F A6 D4	Write 'P' then	04 CC	F8 3C	'L'
04 54	3F 54 37 56	wait for IN switch	04 CE	A5 F8 0F A6	and return
04 58	F8 01 59 DD	'X'	04 D2	D4 30 05	to restart
04 5C	F8 00 A3	If area bright	04 D5	88 FC 01 A8	N = N + 1
04 5F	36 6B	then skip to turn on	04 D9	FF 09 32 44	N = 9?
04 61	83 FC 01 A3	'?' and retry after	04 DD	F8 06 A5 DA	Win?
04 65	FF 20 3A 5F	short wait	04 E1	86 32 F0	If so, write
04 69	30 78		04 E4	F8 80 59 DD	'O'
04 6B	F8 2C A5	Put '?' in status	04 E8	F8 24 A5 D4	to win then write
04 6E	F8 0F A6 D4		04 EC	F8 34 30 CE	'W'
04 72	F8 20 59 DD		04 F0	F8 12 A5 DA	Def?
04 76	30 5C		04 F4	86 32 1F	If so, play that 'O',
04 78	F8 14 A5	If area dark, start	04 F7	30 34	else go to Any Place
04 7B	F8 0F A6 D4	scanning			

TABLE II—CHARACTER PRINT SUBROUTINE WITH DATA FOR CHARACTERS USED.

Loc.	Program	Comments
07 00	DF E5 F8 08 AC F0 56	Write reg 5 8 byte
07 07	8C FF 01 AC 32 00	* character into reg 6
07 01D	15 86 FC 08 A6 30 05	* position on screen
07 14	00 00 00 00 00 00 00	Blank
07 1C	81 42 24 18 18 24 42 81	X
07 24	3C 42 81 81 81 81 42 3C	O
07 2C	00 0E 11 02 04 04 00 04	?
07 34	00 11 11 11 15 15 1B 11	W
07 3C	00 10 10 10 10 10 1F	L
07 44	00 1E 11 11 11 11 1E	D
07 4C	00 1E 11 11 1E 10 10	P

TABLE III—DELAY SUBROUTINE

Loc.	Program
05 F0	DF E9 8B F4 AC 59
05 F6	8B F7 3A F6 30 F0

Immediately after the opponent has played, the computer checks to see if it has lost. If it has lost, the computer displays an L and waits for the IN switch to be operated to start the next game. If the computer has not lost, it adds 1 to N to see if all nine positions have been played and, if so, displays a D and awaits a new game.

If the computer has not lost and the game is not a draw, the computer checks to determine if it can win. All eight sets of positions are checked to find one that has two O's and the third position blank. If it finds such a combination, it will display an O in that third position, display a W and return to restart.

If the computer has neither lost nor won, the program then takes defensive action. The eight sets of positions are examined to see if the opponent has two X's and the third position blank. If it finds such a situation, the computer inserts an O at that position, and continues. If not compelled to make a defensive play, the

TABLE IV—LOSE-WIN-DEFENSIVE (L-W-D) SUBROUTINE

Loc.	Program	Comments
05 60	DF F8 C0 A7	Set addr init position
05 64	F8 00 A3 AC	Clear counters
05 68	E7 F0 AE EE F0 32 7F	Examine location
05 6F	FF 81 32 79	* addressed,
05 73	8C FC 03 AC 30 81	* if 'O' add 3,
05 79	8C FC 09 AC 30 81	* if 'X' add 9, else
05 7F	8E A6	* store blank position
05 81	17 83 FC 01 A3	Repeat for all 3 positions
05 86	FF 03 3A 68	* of combination
05 8A	85 59 E9 8C F7 32 9B	If L-W-D match not found,
05 91	87 FF D8 3A 64	* go to next combination
05 96	F8 00 A6 30 60	Exit if all 8 combs fail
05 9B	86 3A 60	Set register 6 and exit
05 9E	F8 01 A6 30 60	* if L-W-D match found
05 C0	09 0B 0D 09 63 BD	The eight combinations
05 C6	09 61 B9 0B 63 BB	* of three positions
05 CC	0D 63 B9 0D 65 BD	* (rows, columns)
05 D2	61 63 65 B9 BB BD	* and diagonals)
05 E0	63 09 0D B9 BD	The 9 playing and the
05 E5	0B 61 65 BB 0F 00	* status positions

TABLE VI—DISPLAY AREA IN PAGE 6 WITH TTT GRID

Loc.	Data
06 00	00 00 18 00 18 00 00 00
06 08	00 00 18 00 18 00 00 00
06 10	00 00 18 00 18 00 00 00
06 18	00 00 18 00 18 00 00 00
06 20	00 00 18 00 18 00 00 00
06 28	00 00 18 00 18 00 00 00
06 30	00 00 18 00 18 00 00 00
06 38	00 00 18 00 18 00 00 00
06 40	00 00 18 00 18 00 00 00
06 48	00 00 18 00 18 00 00 00
06 50	07 FF FF FF FF FF E0 00
06 58	00 00 18 00 18 00 00 00
06 60	00 00 18 00 18 00 00 00
06 68	00 00 18 00 18 00 00 00
06 70	00 00 18 00 18 00 00 00
06 78	00 00 18 00 18 00 00 00
06 80	00 00 18 00 18 00 00 00
06 88	00 00 18 00 18 00 00 00
06 90	00 00 18 00 18 00 00 00
06 98	00 00 18 00 18 00 00 00
06 A0	00 00 18 00 18 00 00 00
06 A8	07 FF FF FF FF FF E0 00
06 B0	00 00 18 00 18 00 00 00
06 B8	00 00 18 00 18 00 00 00
06 C0	00 00 18 00 18 00 00 00
06 C8	00 00 18 00 18 00 00 00
06 D0	00 00 18 00 18 00 00 00
06 D8	00 00 18 00 18 00 00 00
06 E0	00 00 18 00 18 00 00 00
06 E8	00 00 18 00 18 00 00 00
06 F0	00 00 18 00 18 00 00 00
06 F8	00 00 18 00 18 00 00 00

TABLE V—INTERRUPT ROUTINE FOR THE 1861 CHIP

Loc.	Program
05 00	72 70 22 78 22 52
05 06	C4 C4 C4
05 09	F8 06 B0 F8 00 A0
05 0F	80 E2
05 11	E2 20 A0 E2 20 A0
05 17	E2 20 A0
05 1A	3C 0F 1B 30 00

TABLE VII—REGISTER USE IN TTT PROGRAM

Register	Use
0	Interrupt DMA pointer
1	Interrupt routine
2	Stack pointer
3	Page 5 pointer
4	Character print subr
5	'From' char pointer
6	'To' char pointer
7	Page 5 pointer
8	N, number of plays
9	Temp storage pointer
A	L-W-D subr
B	Refresh count
C	Temp storage
D	Delay subr
E	Win, Lose, Draw
F	Main program

TABLE VIII—INITIALIZATION OF THE REGISTERS

Loc.	Program
05 20	F8 05 BF F8 27 AF DF
05 27	F8 05 B1 B2 B3
05 2C	B7 B9 BA BD F8 06
05 32	B6 BE F8 07 B4 B5
05 38	F8 02 A1 F8 BF A2
05 3E	F8 E0 A3 F8 01 A4
05 44	F8 FF A9 F8 61 AA
05 4A	F8 F1 AD C0 04 03

program returns to "any place" and randomly selects its next response.

If the light pen is placed in front of an already lit position when it is the opponent's turn to play, a ? will be displayed. As soon as the pen is moved to a dark position, the program will start scanning all unplayed positions to display the X. If the light pen is away from all positions, a ? will be displayed. The ? is erased when a valid X is written.

Program. The program consists of the Main Program shown in Table I and four subroutines. These are Character Print in Table II, Delay in Table III, L-W-D (Lose-Win-Defensive) in Table IV, and Video Chip Interrupt in Table V.

The character-print subroutine can print a blank or any of the seven characters X, O, ?, W, L, D, or P in any of the 10 positions on the screen. The delay subroutine is used for various delays including the 2-second delay before displaying an O. The L-W-D subroutine is used for the three tests to determine if

the computer has lost, can win, or must play defensively. For each row, column, or diagonal, the computer examines each of the three positions. If it is an X, nine is added to a register; if a O, three is added; and if blank, nothing is added. Thus, a total of 27 indicates a loss, a total of 6 a potential win, and a total of 18 indicates that defensive action is required. The video interrupt instruction is conventional.

The random position for "any place" is determined by the B register, which is used to count the number of refreshes of

the TV screen. Whenever "any place" is entered, the program takes the modulo-9 value of this count for the position to be played. If that position is already occupied, another number is generated and the process is repeated until an empty position is found.

The use of the various registers is shown in Table VII.

The first seven bytes of the register initialization section (Table VIII) makes the switch if the program register upon entry is not F. If it is F, this part of the initialization must be skipped. ◇

16-Bit VS 8-Bit Microprocessors

BY GORDON LETWIN & HAMPTON MILLER

Heath Co.

IT IS OUR purpose here to provide a brief comparison of the recently introduced 16-bit microprocessors with their predecessors, the 8-bit CPU's. While we cannot do full justice to a complete comparison of all aspects of the two types, some broad generalizations can be made that will give a good idea of what to expect from the new 16-bit machines.

The Differences. Microprocessors deal with elementary units of digital information called "bits." An 8-bit processor's registers and data paths are all eight bits wide. Therefore, it operates on data and instructions eight bits (one byte) at a time. This does not mean that an 8-bit processor cannot deal with data larger than eight bits wide. The data can be broken up into 8-bit bytes and processed one byte at a time.

Many processor instructions, such as branches and memory references, are 16 and 24 bits long and are known as 2- and 3-byte instructions. These processors may also contain a few instructions that deal directly with 16-bit values. However, these multibyte instructions and 16-bit operations are handled eight bits at a time and, therefore, take more time to execute than do single-byte instructions dealing with 8-bit values. Typical applications are process control and communication, tasks that require minimal computation.

In contrast to the 8-bit processor, the registers and data paths of a 16-bit

processor are all 16-bits wide. Consequently, the 16-bit processor operates on data and instructions 16 bits at a time. Since the number of operations per second is roughly the same for both 8- and 16-bit processors, two times as much work gets done per instruction with a 16-bitter. Hence, a 16-bit processor can be much faster than an 8-bitter.

The 16-bit processor is more than a double-sized 8-bit device. Since the 16-bitter fetches instructions from memory 16 bits at a time, its instruction set usually includes 16-, 32-, and 48-bit instructions. The longer instructions allow a 16-bit machine to implement sophisticated instructions that tend to be more general-purpose to take better advantage of a given architecture than does the 8-bit device. For example, to interpret the BASIC statement $A=B(4)$ with an 8-bit 8080A, the BASIC interpreter might execute the code as follows:

```
LXI H,B
LXI D,4
DAD D ;(HL)=address of value
MOV E,M
INX H
MOV D,M ;(DE)=value
XCHG
SHLD A ;store in A
```

On the other hand, a 16-bit computer such as an LSI-11 could use the following code:

```
MOV #4,R1 ;(R1)=subscript
MOV B(R1),A ;look up and store
```

Note how the 16-bit machine avoids the clumsy and time-consuming memory-access gyrations required by the 8-bit device.

Although 8-bit devices deal with smaller values than do 16-bit devices, this does not mean that the former cannot perform all the computations that a 16-bitter can perform. It just requires more time because calculations must be processed in smaller pieces that must be "fetched" sequentially from memory. To perform the operation $A=B-C$ with the 8080A requires the following code:

```
LHLD C
XCHG
LHLD B
MOV A,L
SUB E ;subtract low 8 bits
MOV L,A
MOV A,H
SBB D ;subtract high 8 bits
MOV H,A
SHLD A ;store result
```

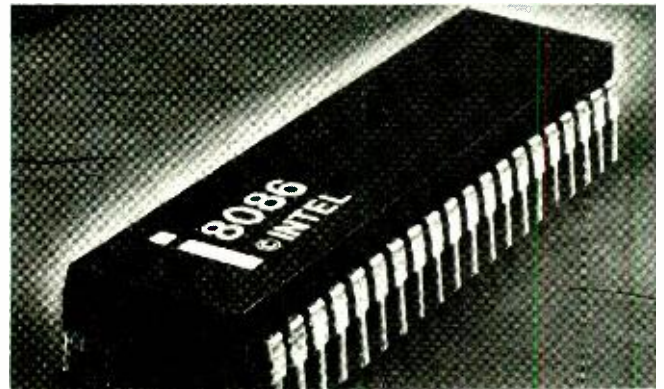

8086 CPU is part of Intel's new 16-bit family.

PROCESSOR COMPARISON TABLE

Processor	Data width	Register count	Memory (bytes)	Task timing in microseconds			
				Load	Subtract A=B-C	Code bytes	
8080	8	7	65K	8	14	273	22
6800	8	3	65K	8	14	266	30
LSI-11	16	7	65K	7	3.5	42.7	20
PACE	16	3	65K	9	9	61.0	36
9900	16	16	65K	7.3	4.7	49.9	24
8086	16	7	1M	2.8	0.6	17.6	24
Z8000	16	14	8M	2.25	1.0	14.0	24

The following very short code is required by the LSI-11:

```
MOV B,A ;store B in A
SUB C,A ;subtract C from B
```

The table lists the memory and time required by several popular 8- and 16-bit processors to execute the statement $C=B-A$, where A, B, and C are 32-bit integers. Many BASIC interpreters make use of 32-bit or larger numbers to provide the necessary accuracy.

Advantages and Disadvantages.

Since 16-bit devices operate on larger chunks of data and, thus, need perform fewer operations for a given task, their primary advantage is speed. This is usually several times faster than 8-bit devices. The larger the data items to be manipulated, the greater the advantage of the 16-bit design. This is true not only because the 16-bitter works with larger pieces, but also because the greater number of registers frequently reduce the number of memory references required.

A second major advantage of the 16-bit machine is the volume of *profession-*

al software available for them, since many of these machines execute the instruction set used by well-established mini-computers. For example, the Digital Equipment Corp. (DEC) LSI-11 executes the instruction set for the PDP-11 family. As a consequence, with the proper peripherals, it can run the DEC PDP-11 operating systems, such as PTS, RT-11, RSX-11, etc.

Another advantage of the 16-bitter is that some 16-bit systems can accept peripherals designed for minicomputer

members of the family. This provides the option of purchasing high-level printers, disks, etc., and obtaining service contracts on them as well.

A major disadvantage of the 16-bit system is its higher cost, which results from multichip configurations and relatively expensive support circuitry. Since memory is accessed in 16-bit words, a computer that uses a 16-bit processor requires 16-bit data paths. This means more bus interface, control circuitry, and connectors

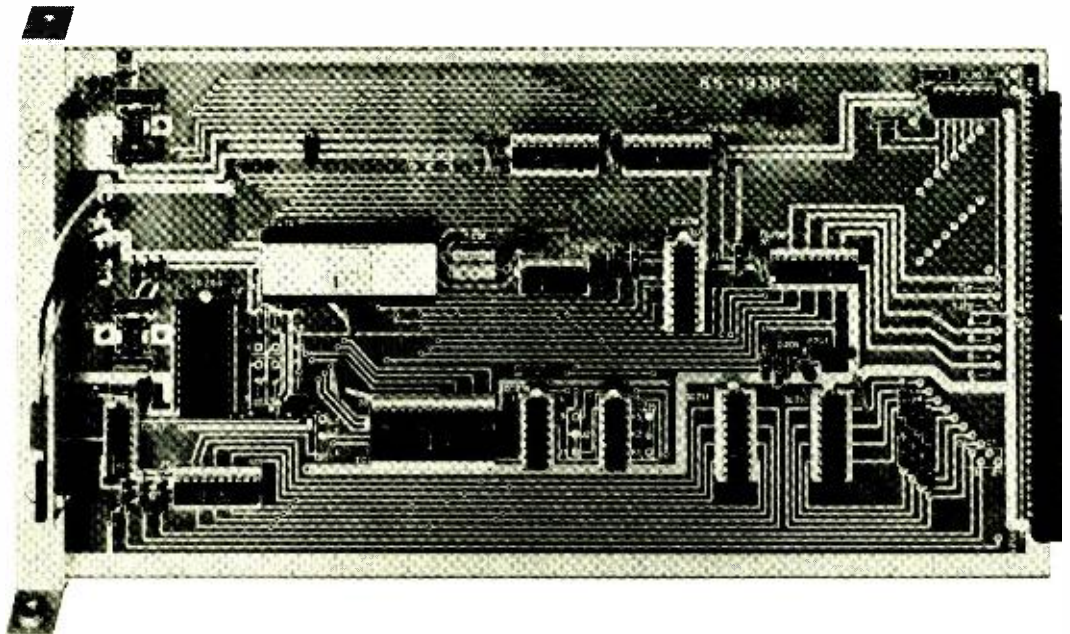

This photo, and the one on the facing page, illustrate the difference between an 8-bit CPU board (above) as used in the Heath H8 and the 16-bit CPU.

Also, current 16-bit processors tend to use more memory for a given task than do 8-bit machines. A program being run in a 16-bit machine may require 10% to 20% more memory bytes than the same program being run in an 8-bit machine. In addition, there are not, at present, many peripheral devices available for 16-bit machines, so 8-bit computers have the advantage here.

Candidates for 16-Bitters. Users with large computational needs (so-called "number crunchers") should definitely consider a 16-bit machine. Avid game players will find that many advanced and sophisticated games require the extra speed that a 16-bit machine can provide.

Some 16-bit machines have available optional floating-point hardware that can speed up numerical calculations by a factor of 20 or more. Users who are or plan to be sophisticated programmers will want a 16-bitter because of its sophisticated instruction set. As shown in the foregoing examples, assembly-language programming for these machines is many times easier for 16-bit machines than it is for 8-bit machines. In addition, the more powerful addressing capabilities allow the programmer to take advantage of algorithms that might be difficult to implement on an 8-bit machine.

If you plan to use your computer system primarily for business applications, you should consider factors other than just raw CPU speed. A primary concern in business applications is the availability of peripherals and loads of business software that have been in use for many years and are, thus, completely debugged. If the system under consideration is software-compatible with a mini-computer, it can take advantage of the already existing software for that mini-computer.

Much of the existing software is inexpensive or in the public domain and, therefore, available for a copying charge. However, much of it may be available from only the manufacturer of the "parent" mini-computer line and can be quite expensive. If you are interested in transferring existing minicomputer software to a compatible microcomputer, you should investigate this area closely with the microcomputer manufacturer and the manufacturer of the parent minicomputer before making a purchase. Either or both companies may sell software and/or have user groups that distribute programs.

The Future. The future appears bright for the 16-bit computer. Most of the new generation of 16-bit microprocessors will be single-chip devices that, together with high-volume production, will bring

chip prices to levels closer to current 8-bit processors. An important use of 16-bit μ P will likely be in military, automobile and large-system applications.

Chip designers are also working on memory utilization, which is another important cost factor. Due to their advanced architecture, the new generation of 16-bit chips will generally require less memory for a given program than do present 8- and 16-bit devices.

The new 16-bit chips will also provide vastly improved performance. Many of them will be capable of running faster than many present-day minis that cost \$60,000 or more.

Semiconductor memory prices have plummeted in recent years and may drop even faster in the future as new memory devices (like bubble memories) come along. New 16-bit processor designs have anticipated this "problem" by providing the capability of addressing extended amounts of memory. Intel's 8086, for example, can handle up to 1 megabyte of memory, while Zilog's Z8000 can address up to 8 megabytes. The combination of processor speed and memory capacity makes these chips suitable for use in large multi-user computer systems as well as in smaller single-user systems.

Manufacturers also realize that customers will be reluctant to rewrite their expensive software (developed for their 8-bit machines) to use their new 16-bit processors. Most have, therefore, designed their new processors to be "upward-compatible" with their previous products. Hence, programs written for the 8080A can be reassembled to run with the 8086, and Z80 programs can be reassembled for the Z8000.

Conclusion. Although we've concentrated on the merits and features of 16-bit processors, the 8-bit processor is far from dead. It currently enjoys a wide customer base and an ever-increasing amount of software and peripherals, and will continue to do so for many years to come. Though they do not have the processing capability of the 16-bit systems, the 8-biters are certainly fast enough for most home and small-business applications.

As 16-biters come into their own, they will likely eclipse and supersede our present 8-biters. This will happen when complex applications require more effective addressing and where memory requirements in larger systems become an important consideration. ◇

(Computer section continues on next page.)

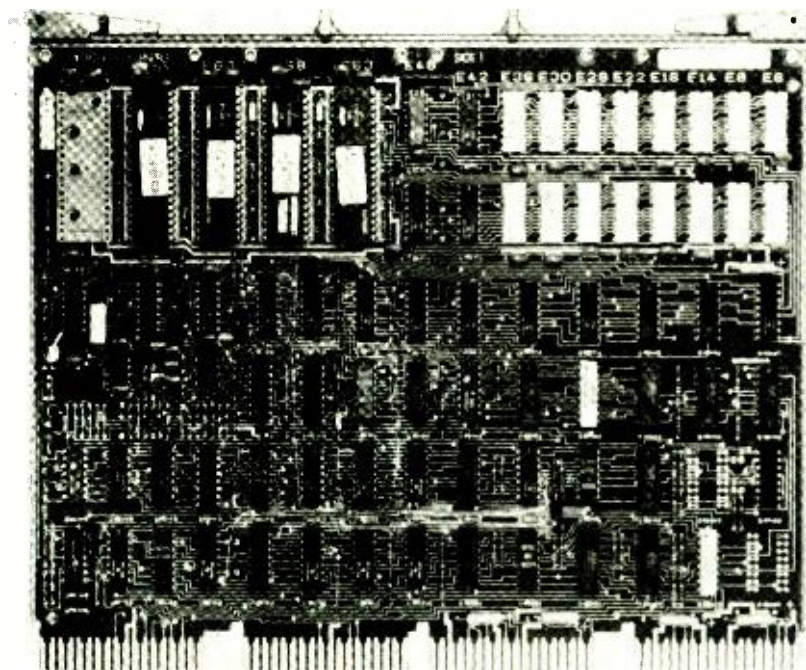

The 16-bit CPU above, used in the Heath H11, is much denser than the 8-bit unit at left. It also carries 4K of RAM; but both have necessary support chips.

How to Care for Diskettes

Correct handling and storage of diskettes ensures good data retrieval.

FLOPPY-DISK systems are being used in growing numbers in personal computing systems. Since about 70K of data can be stored on a small 5¼" (13.3-cm) diskette, you should be aware that all of the work put into creating and storing long programs can be catastrophically destroyed by improper handling. This problem can be caused by a single act like smoking near a disk system, touching a diskette with a fingertip, bringing metal tools near a diskette, and even by having an audio system or radio receiver too close to the disk system.

Let us take a brief look at how a disk system works and how improper handling can cause a diskette to lose data.

Physical Makeup. As shown in Fig. 1, a floppy diskette consists of a relatively heavy cardboard (or other nonmetallic) jacket whose dimensions vary with the size of the diskette. Inside the jacket is the actual diskette itself. The diskette is made of very thin, flexible Mylar on which is deposited a layer of magnetically active material similar to that used on audio magnetic recording tape.

When the diskette is inserted into the disk-drive mechanism, the large hole at its center is engaged by a spindle and the disk inside the jacket is made to revolve at high speed. This is similar to the playing of a conventional record on its player, except that the read/write head in the disk-drive mechanism does not contact the diskette. Also, there are no grooves on a diskette as there are on a record. Instead, the disk drive's mechanical system uses computer commands to position the read/write head at the correct track.

A large track-access slot extends part way along one radius of the protective jacket. This slot permits the read/write head to access the magnetic surface of the diskette. A small hole near the large disk-drive hole allows a sensor in the disk-drive system to detect the rotational position of the diskette.

Handling a Diskette. Before removing a diskette from its jacket, read the instructions printed on the back of

the jacket. Listed here are usually a lot of no-no's such as: do not touch the diskette's magnetic surface with fingers; keep the diskette away from magnetic fields; do not bend or fold the diskette; keep the diskette at a reasonable temperature; and keep the diskette in its protective jacket when not in use. Needless to say, heed the printed advice.

Since a diskette works because a magnetic track is laid down by the read/write head, the diskette's surface is extremely sensitive to magnetic fields. This means that a diskette should never be placed in a magnetic field. It is obvious that one would not intentionally bring a powerful magnet near a diskette, but accidents can occur if you are not on guard. For example, audio equipment and even a small pocket radio near a diskette can wreak havoc to the data on a diskette. Bear in mind that loudspeakers operate by powerful magnetic action and that the speaker's magnetic field does not stop at the surface of its enclosure or the plastic case of the radio.

It is best to keep all metal tools away from diskettes because chances are that the tools have become magnetized during use. You can easily check this by seeing how many paper clips your favorite screwdriver picks up. But even if your tools do not pick up paper clips, this is no guarantee that they are not slightly magnetized. So, play it safe; keep all tools away from diskettes.

There is also the problem of the ac field that surrounds some transformers and turned-on soldering guns. This field

is very similar to the ac field used in degaussing devices for audio tape heads. The degaussing effect of these fields can erase a diskette as fast as they degauss a tape head.

Foreign Matter. Although the illustration in Fig. 2 is not drawn to scale, it does serve to explain some important points. On a typical diskette, the magnetic coating is a mere 50 to 200 microinches thick and is deposited on a flexible 0.003" thick Mylar base. The read/write head, which has a curved surface close to the diskette, does not actually touch the magnetic surface but is maintained about 20 microinches away. As the diskette spins inside its jacket, the head-to-diskette speed can be as great as 140 mph!

A typical smoke particle can be up to 250 microinches thick, while a human hair is typically 0.003" thick. Hence, you can imagine the pounding that the very thin magnetic layer on the diskette gets if any of these particulants is between the head and the moving diskette.

Dust and lint particles can appear to be as big as boulders when compared to the gap between the read/write head and diskette. Since most of us have slight oil deposits on our fingertips, even touching an exposed diskette's surface can cause a loss of data. Bending or folding a diskette can produce serious "hills and valleys" that can disrupt data acceptance and delivery. Even a minute scratch can produce dropouts that will ruin the depositing and fetching of data.

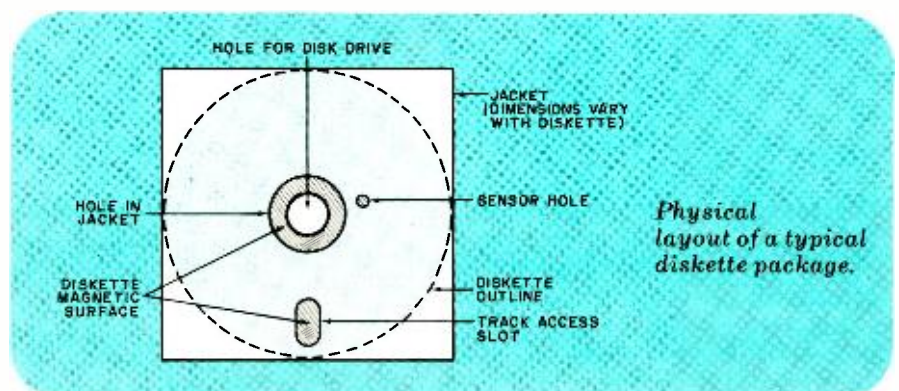

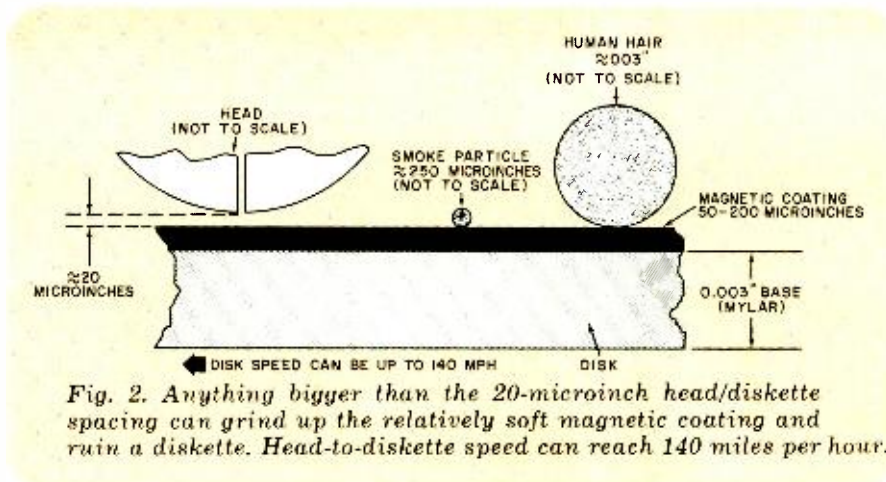

Identification labelling of a diskette's jacket can cause problems if you are not careful. Never write with a ballpoint pen on a label that is already in place on a jacket. (The pressure required to write with a ballpoint pen can transmit enough energy through the label and jacket to damage the relatively soft diskette surface.) In fact, it is a good idea to avoid using anything but a felt-tipped pen to write labels because these pens write cleanly, dry quickly, and cannot contaminate the surface of the diskette. Al-

ways write on your labels before attaching them to the diskette's jacket.

Do not attempt to erase a label after it is fixed to a diskette's jacket. Eraser particles can cause a lot of damage in the area between the diskette and read/write head, no matter how much care you exercise. It is far better and safer to simply make up another label and place it over the old one.

If possible, try to keep the read/write head scrupulously clean. Consult the manual supplied with your disk system

for the proper procedure to accomplish this. Be especially careful to avoid getting oil or grease on the head because they are contaminants themselves and they tend to attract dirt.

Storing Diskettes. Never stack diskettes on each other for storage. The proper way to store diskettes is to stand them vertically, preferably inside a metal cabinet to keep them safe from stray magnetic fields. The temperature in the room in which diskettes are stored should be between 60° and 90° F, with the humidity between 10% and 90%.

If you intend to store diskettes for long intervals, place them in their original heavy shipping boxes and store them just about anywhere the temperature is between -40° and +150° F. After prolonged storage, be sure to leave the diskettes in the room where they are to be used for at least 24 hours to allow them to stabilize.

On final word: store important diskettes inside antimagnetic, fire-resistant, and waterproof containers. For further protection, you might consider making duplicates of your important diskettes and storing them separately. ◇



Sol: The small computer that stands up to the minis.

Sol small computer systems are the serious solution to the small computer question. Though not cheap (what's good that is?), they won't fence you in with limited performance.

Sol systems offer up to 1.5 million bytes of disk and 64K on-board memory fully supported by an outstanding disk operating system. They feature new Sol printers with speeds from 40 to 200 lines per

minute. High-level languages include Extended BASIC, FORTRAN, FOCAL PILOT and Assembler on disk and cassette.

Sol computers solve engineering and scientific problems with up to 16 digit precision. Use them for both word processing and general office EDP. Use them for computer aided instruction.

Sol computers really stand up to the minis. Prices range from \$2,500 to

\$12,000. That's about one-fourth the cost of a mini.

For more information, please address Box 1, Processor Technology Corporation, 7100 Johnson Drive, Pleasanton, CA 94566.

**Toll-free Dealer Locator Hotline,
(800) 227-1241.**

Processor Technology

Inexpensive level detector for audio applications

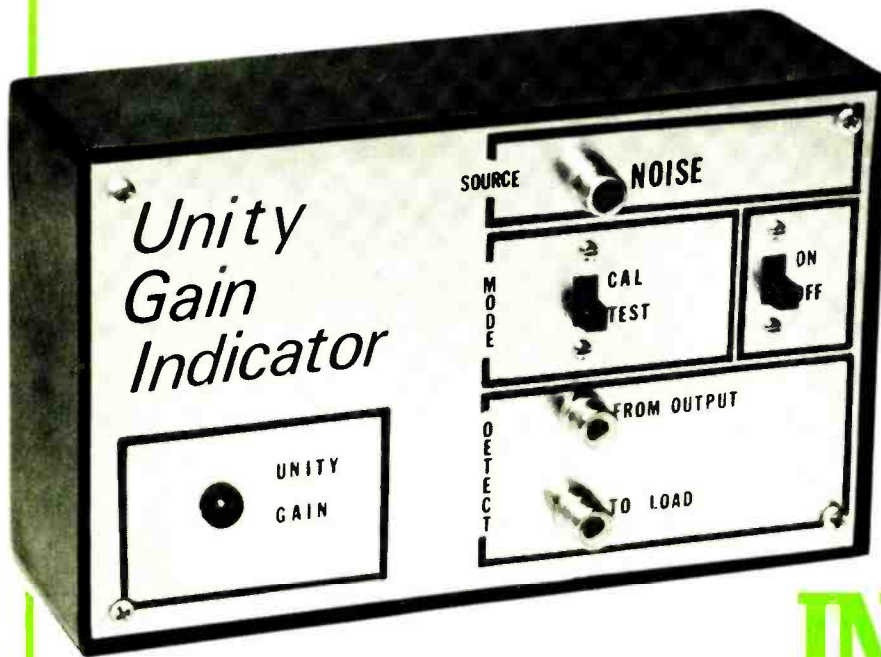

BY JAMES BARBARELLO

BUILD A UNITY GAIN INDICATOR

AUDIO components such as mixers and equalizers can have appreciable gain at certain control settings. This gain is undesirable if it drives subsequent components into nonlinearity. The project presented here—a combination wide-band noise source/unity-gain indicator (UGI)—allows the user to adjust master gain controls for unity gain $\pm 1/2$ dB. It uses standard parts and can be built for about \$10.

About the Circuit. The block diagram of the UGI is shown in Fig. 1. A wide-band noise source generates the test signal. Overall gain measurements of equalizers and other components which do not have flat frequency re-

sponse can thus be accomplished. When *S1* is placed in the CALIBRATE position, the reference and test detectors are both driven by the wide-band noise signal. A calibration potentiometer in the test detector stage is adjusted so that the LED driven by the window comparator glows. This compensates for differences in the detector circuits, and ensures a unity-gain indication when the input levels to the comparator are equal. Next, *S1* is placed in the TEST position and the gain of the device under test is varied until the LED glows, indicating unity gain. This procedure is performed under dynamic conditions (with the device under test fully loaded) to produce results that are more meaningful.

The schematic diagram of the UGI is shown in Fig. 2. Transistor *Q1*'s base-emitter junction is reverse biased by the positive supply voltage. This results in an output signal closely approximating white noise. The signal is capacitively coupled by *C1* to op amp *IC1*, which boosts the signal level to approximately 200 mV p-p. The output of the op amp is applied to *J1* and *IC3A*, which provides additional gain.

Diodes *D1* and *D2* rectify the output of *IC3A*. The rectified signal is averaged by *C3*, *R9*, *R10* and *R11*, and the resulting dc level across *R11* determines the lower threshold of the window comparator. The upper threshold is determined by the voltage across *R10* and *R11*. Dual op amp *IC4* comprises the window comparator. When the voltage at the noninverting inputs is less than the lower threshold, *IC4A* and *IC4B* act as high-gain inverting amplifiers with a positive differential input. Therefore, both outputs are at the negative supply voltage. With no potential difference across *LED1*, the LED does not glow.

When the voltage at the noninverting inputs of *IC4A* and *IC4B* exceeds the comparator's upper threshold, a negative differential is applied, and the outputs reach the positive supply voltage.

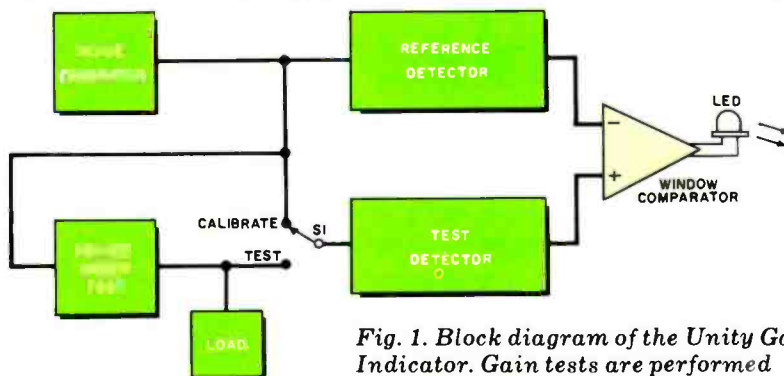

Fig. 1. Block diagram of the Unity Gain Indicator. Gain tests are performed with device under test fully loaded.

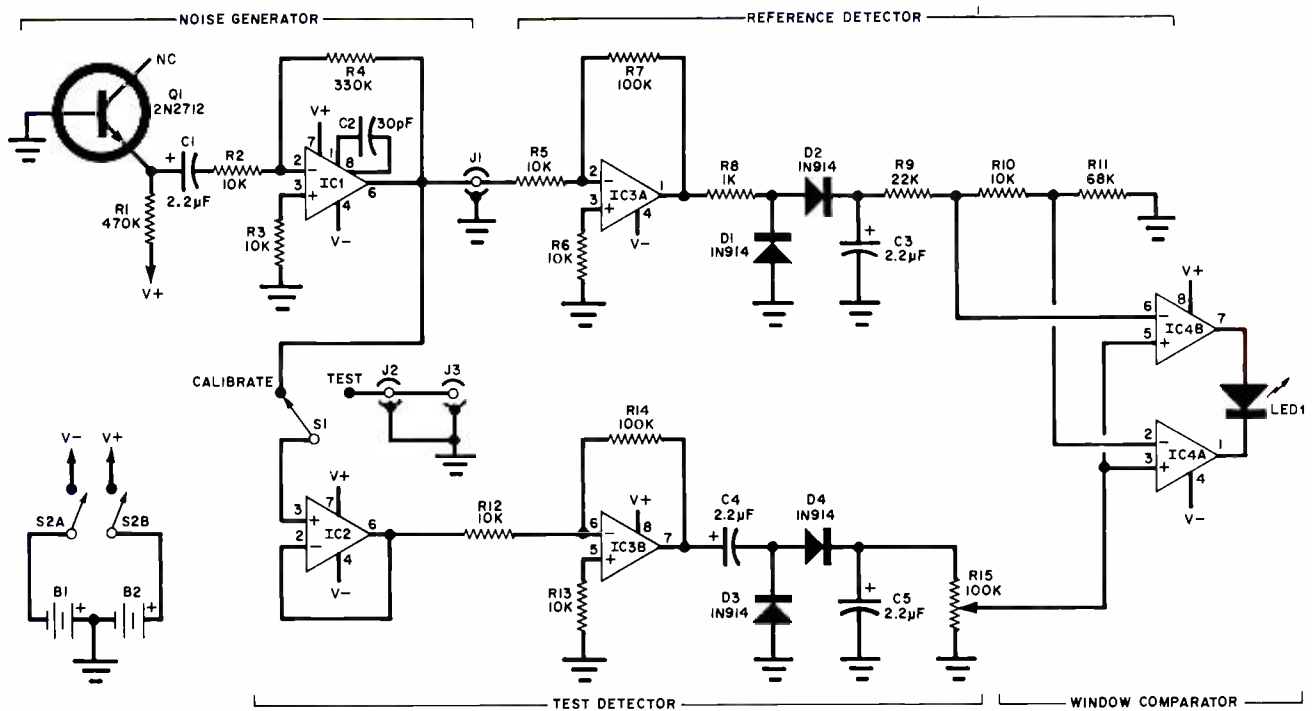

Fig. 2. Schematic Diagram. Reverse-biased transistor junction generates white-noise test signal.

PARTS LIST

B1, B2—9-volt transistor battery
 C1, C3 through C5—2.2- μ F, 25-volt electrolytic capacitor
 C2—30-pF disc ceramic capacitor
 D1 through D4—1N914 or 1N4148 silicon diode
 J1 through J3—RCA phono jack
 IC1— μ A748CV operational amplifier
 IC2— μ A741CV operational amplifier
 IC3, IC4—MC1458, LM1458N or 5558 dual operational amplifier

LED1—20-mA light emitting diode (TIL-32 or equivalent)
 Q1—2N2712 npn silicon transistor
 The following fixed resistors are $\frac{1}{4}$ -watt, 10% tolerance carbon composition components.
 R1—470,000 ohms
 R2, R3, R5, R6, R10, R12, R13—10,000 ohms
 R4—330,000 ohms
 R7, R14—100,000 ohms
 R8—1000 ohms

R9—22,000 ohms
 R11—68,000 ohms
 R15—100,000-ohm linear-taper trimmer potentiometer
 S1—Spdt switch
 S2—Dpnt switch
 Misc.—Printed circuit board, suitable enclosure, battery clips, battery holder, IC sockets or Molex Soldercons, shielded cable, hookup wire, solder, etc.

As before, there is no potential difference across the LED, which remains dark. However, if the voltage at the non-inverting op amp inputs is within the "window" established by the comparator thresholds the output of IC4B is positive and that of IC4A is negative. This

causes LED1 to conduct and glow. No series resistor is required to protect the LED because the op amps have on-chip output current limiting.

To prevent the test detector from being loaded down, input buffer IC2 is included. This op amp, a unity-gain, non-

inverting voltage follower, presents a very high input impedance. Gain is provided by IC3B. The output of this op amp is rectified by D3 and D4, which perform the same function as D1 and D2 in the reference detector. There is one important difference between these two de-

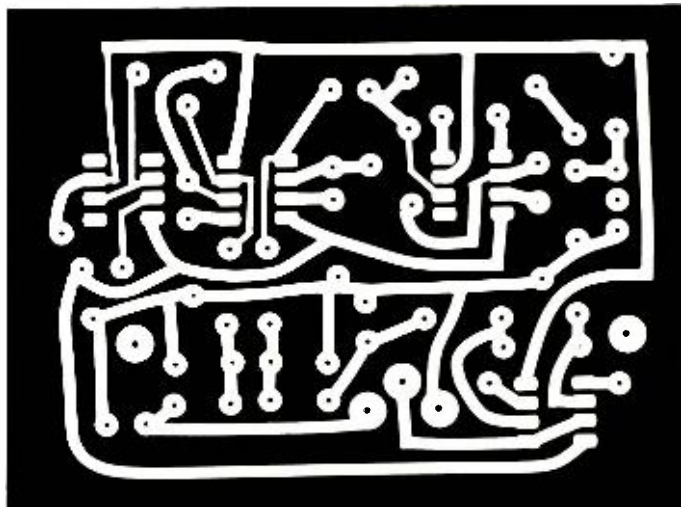
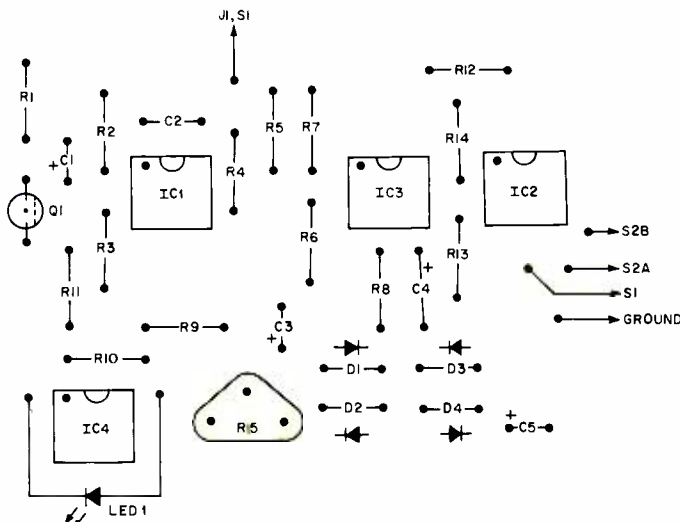
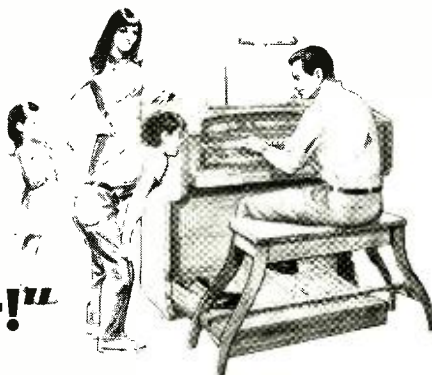

Fig. 3. Parts placement (left) and full-size etching and drilling (right) guides for pc board.

"Our whole family helped assemble this wonderful Schober Organ... now we all play it!"



Talk about real *family* fun! We all worked together, for a few hours almost every day. Almost too soon, our Schober Organ was finished. Our keen-eyed daughter sorted resistors. Mom soldered transistor sockets, although she'd never soldered anything before. And it did our hearts good to see the care with which our son—he's only 12—installed the transistors. Me? I was the quality control inspector—they let me do the final wiring. And when it came time to finish the beautiful walnut cabinet the easy Schober way, we all worked at it!

Now, we gather around our Schober Organ every evening to play and sing together. Some of us play better than the others, but we're all learning—with the help of the easy Schober Organ playing courses. I might add that I'm especially pleased with all the money we saved. Our completed Schober Organ compares favorably with a "ready-made" one costing twice as much! (The five models range from \$650 to \$2850.) And we didn't even need to pay the whole amount all at once, because we were able

to buy Schober Kits a component at a time, to spread costs out. Or we could have had two-year time payments!

Families like ours have been building Schober Organs for 20 years. How about *your* family? You can have all the details, without cost or obligation. Just send the coupon for the fascinating Schober color catalog (or enclose \$1 for a 12-inch LP record that lets you hear as well as see Schober quality). Clip the coupon right now—and mail it **TODAY!**

The *Schober* Organ Corp., Dept. PE-80
43 West 61st Street, New York, N.Y. 10023

- Please send me Schober Organ Catalog
 Enclosed please find \$1.00 for 12-inch L P record of Schober Organ music

NAME _____

ADDRESS _____

CITY _____ STATE _____ ZIP _____

CIRCLE NO. 6 ON FREE INFORMATION CARD

HOME COMPUTERS! VIDEO GAMES!

Read **BYTE**, the leading magazine in the personal computer field, and learn how to construct and/or program your own low-cost computer. Enjoy scores of video display games: Ping Pong, Blackjack, Space War – be captain of the Enterprise and try to out-manuever the Klingon battle-cruiser!

Home computers are now practical and affordable. Low-cost peripherals mean more hardware and software, more applications! **BYTE** brings it all to you with monthly issues packed with lively articles by professionals and serious amateurs.

All 6 to 8 weeks for processing. **BYTE**
Subscription Dept. 800-258-5485

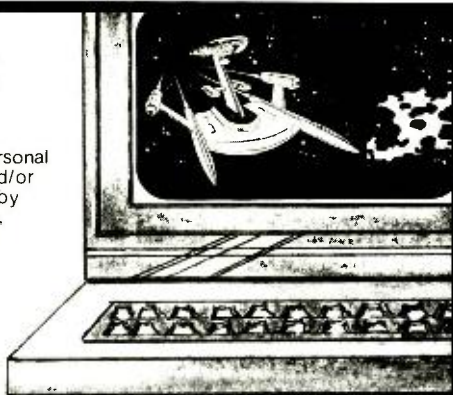

Fill in the coupon today. Read your first copy of **BYTE**; if it's everything you expected, honor our invoice. If it isn't, just write "CANCEL" across the invoice and mail back. You won't be billed, and the copy is yours.

BYTE Subscription Dept. • P.O. Box 590 • Martinsville, NJ 08836

PLEASE ENTER MY SUBSCRIPTION FOR:

- One year \$15 (12 issues) Two years \$27 Three years \$39
 Check enclosed (entitles you to 13 issues for price of 12)*
 Bill Visa Bill Master Charge Bill me*

BYTE®

The Small Systems Journal
© **BYTE** Publications, Inc. 1978

Card Number _____ Expiration Date _____

Signature _____ Name (please print) _____

Address _____

City _____ State/Country _____ Code _____

- FOREIGN RATES** (To expedite service, please remit in U.S. Funds)
 Canada or Mexico \$17.50 – One Year Two years \$32 Three years \$46.50
 Europe \$25 – One Year (Air delivered)
 All other countries except above \$25 – One year (surface delivery)
*North America only Air delivery available on request. 73B8

CIRCLE NO. 8 ON FREE INFORMATION CARD

tor stages. In the reference detector, the output of *IC3A* is dc coupled to *D1* and *D2* via *R8*. In the test detector, the output of *IC3B* is capacitively coupled by *C4* to diodes *D3* and *D4*. This is done to prevent any dc offset at the output of the device under test to be added to the averaged ac, which would produce an erroneous reading. A portion of the detected signal is tapped at *R15* and applied to the noninverting inputs of window comparator *IC4*. The circuit is powered by two 9-volt batteries.

Construction. Printed circuit guides are shown in Fig. 3. Wire the input and output jacks with shielded cable. Any suitable enclosure (metallic or plastic) can be used to house the project. When assembling the project, be sure to observe the polarities of battery leads, electrolytic capacitors, and semiconductors. The pin basing of *Q1* may vary from that shown in the parts placement guide. Be sure to orient *Q1* properly. Molex Soldercons or IC sockets can be used with the integrated circuit packages.

Calibration. When you have finished building the project, double check all wiring. Then connect the batteries and close switch *S2*. Patch the noise signal at *J1* to an external amplifier/loudspeaker combination and verify that the noise source is operating. Then place *S1* in the **CALIBRATE** position, and rotate the wiper of *R15* through its total range. You will notice that *LED1* will glow for a certain arc of *R15*'s rotation. Adjust the potentiometer so that the wiper is in the center of this arc. This is the only calibration adjustment necessary.

Using the UGI. When the project is first turned on, it takes a few seconds for the averaging capacitors to become fully charged and stabilized. It's therefore best to place *S1* in the **CALIBRATE** position, close *S2*, and wait until *LED1* glows before making any tests.

To adjust a component for unity gain, run a patch cord from *J1* to the component's input jack, and one from its output to *J2*. Then connect a patch cord from *J3* to the component's working load (power amplifier, tape deck, etc.). After the UGI's calibration has been verified, place *S1* in the **TEST** position. Adjust the component's master gain control for an indication by the LED. At that control setting, the component has unity gain. If the component has more than one output channel and individual gain controls, repeat the procedure for each. ◇

The Newsweek vs. Time showdown.

(You win either way.)

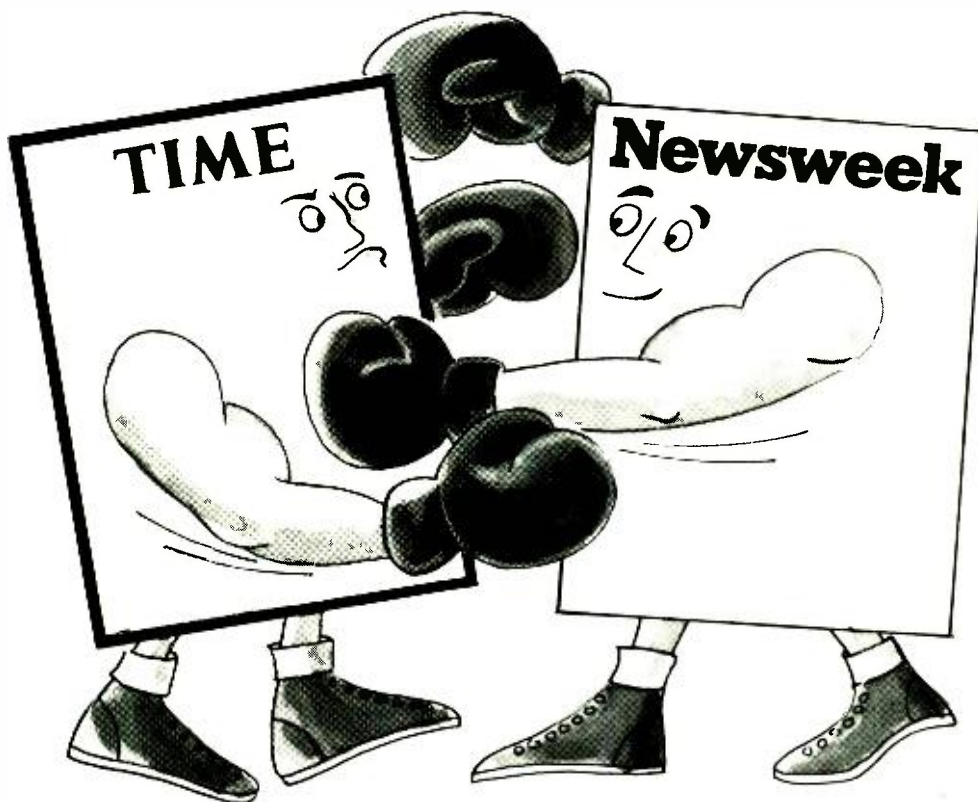

We're sticking our necks out.

If we're right, we're going to win a lot of friends for Newsweek. If we're wrong, the winner might be TIME.

What we propose to do is this. We'll enroll you as a subscriber to Newsweek at a 43% savings. You'll pay 43% less than the newsstand price. If, after reading Newsweek, you are disappointed, we're willing to send your name to TIME and tell them to give you their best offer.

Each week Newsweek plunges you behind the scenes to add substance to the news.

We clarify what's happening in the nation and world in a way that's understandable to you personally.

We tell you what everyone's talking about in entertainment and the arts.

We put the spotlight on the frenetic happenings of the sports arena.

We put you in touch with what's new in science, medicine, education... developments in the worlds of business and finance.

As a reader of Newsweek, the world is more fascinating to you. And you are more fascinating to the world.

Try being a Newsweek subscriber. We're betting you'll like it so much—TIME will have to look elsewhere for your name.

Try Newsweek at 43% savings, then decide.

Newsweek® The Newsweek Building
Livingston, N.J. 07039

YES. Please send me a subscription to Newsweek for the term checked below. I get the lowest price available to the general public and save 43¢ a week off the newsstand price of \$1.00 a copy. If I'm not delighted I'll write "cancel" on the bill and, if I wish, tell you to turn my name over to TIME for their best offer.

23 weeks for \$12.99 **46 weeks for \$25.98**
(Save \$10 off the cover price.) (Save \$20 off the cover price.)

Name _____

Address _____

City _____

State _____ Zip _____

51048831

Good Only in the 50 States of the U.S.A.

Try the Newsweek difference

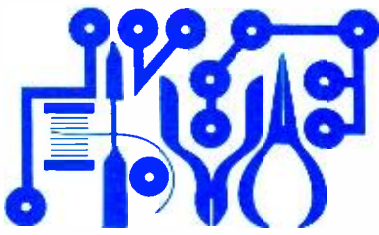

Experimenter's Corner

THE 74150 MULTIPLEXER

By Forrest M. Mims

DIGITAL logic circuits are amazingly versatile, and the multiplexer or data selector is no exception. The multiplexer, sometimes abbreviated MUX, provides a means of selecting one of several inputs and steering the logic level at that input to a single output. The selected input is determined by a binary address applied to one or more data select inputs. That's why multiplexers are often called *data selectors*.

Multiplexers have many applications. We'll look at several of them in this column, but first let's find out how the multiplexer works.

A Simple 1-of-2 Multiplexer. Figure 1 shows a simple two-input MUX with a single data select input. The circuit is called a 1-of-2 multiplexer because one of the two inputs is routed to the output at any given moment according to the status of the data select input. The binary bit pattern at the data select input is called an address because each possible data select bit combination (in this case 0 and 1) selects one and only one input.

Assume the data select input is logic 0. This means one of the inputs to AND gate A is logic 1. The gate is then able to provide a high or low output depending upon the state of the DATA A input. Simultaneously, one of the inputs to AND gate B is low so its output will be low no matter what logic state appears at its

second input (DATA B). If DATA A input is low, both AND gates will have a low output. If DATA A is high, the output of AND gate A will go high. The OR gate (C) will respond to either condition with, respectively, a low or high output.

If this explanation seems hard to follow, Fig. 1 also shows the truth tables for the 1-of-2 MUX as well as those of the inverters and gates from which it is composed. With this information you should be able to decipher the circuit's operation on your own.

Advanced Multiplexers. The simple multiplexer shown in Fig. 1 illustrates the basic operating principal but has limited utility. You can easily breadboard a working version of it if you want to explore its operation in detail. Far more flexibility, however, is available in the form of single-chip multiplexers having eight or sixteen inputs. Several such chips are readily available. TTL versions include the 74150 1-of-16 multiplexer and the 74151 and 74152 1-of-8 multiplexers. Another TTL MUX is the 74153 dual 1-of-4 data selector.

A number of multiplexers that select one of several multiple-bit words rather than single bits are also available, as is a family of CMOS multiplexers.

The 74150 1-of-16 Multiplexer. The pinout of the 74150 1-of-16 MUX is shown in Fig. 2. This data selector has

sixteen data inputs, any one of which can be selected by applying the appropriate 4-bit data select word or address to the four-line data select input. The 74150 also has an *enable* or *strobe* input. This input must be low (grounded) for the 74150 to function. When the enable input is high (disconnected or tied to V_{CC}), the output will be high regardless of the status of the selected input.

The simple 1-of-2 MUX we looked at earlier has an OR gate output. The 74150, however, uses a NOR gate output. This means the output is an inverted version of the selected input. Be sure to keep this in mind when using the 74150 in an actual circuit.

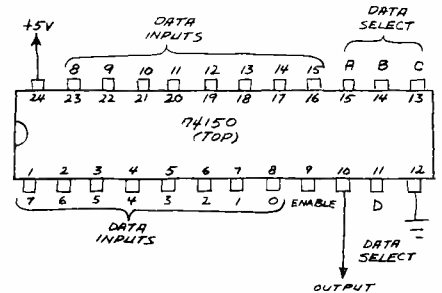

Fig. 2. Pin outline of 74150.

"Universal Logic Gate." It's often necessary for a digital circuit to generate the type of truth table that is not available from standard gates. Simple truth tables can be generated by interconnecting the gates in a 7400 quad NAND gate or other common gate package. Complex truth tables can be implemented with a ROM. The 74150 MUX offers a very simple way to generate a truth table with four inputs and a single output.

Since the 74150 has sixteen input addresses, there are 2¹⁶ or 65,536 possible input/output combinations. Here's a truth table for just one sequence.

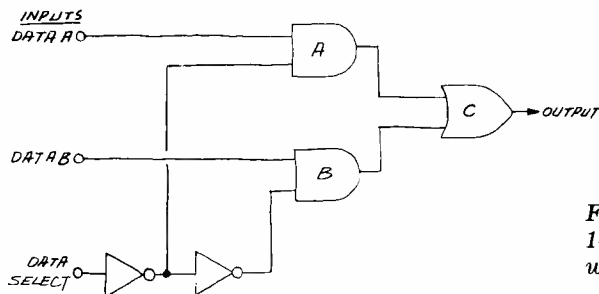

Fig. 1. A simple 1-of-2 multiplexer with truth table.

SELECT	DATA A	DATA B	OUTPUT
0	0	X	0
0	1	X	1
1	X	0	0
1	X	1	1

Address	Output
0	0 0 0 0
1	0 0 0 1
2	0 0 1 0
3	0 0 1 1
4	0 1 0 0
5	0 1 0 1
6	0 1 1 0
7	0 1 1 1
8	1 0 0 0
9	1 0 0 1
10	1 0 1 0
11	1 0 1 1
12	1 1 0 0
13	1 1 0 1
14	1 1 1 0
15	1 1 1 1

Designing a logic circuit to implement

this truth table would be both tedious and time consuming, but we can complete the entire design in less than a minute with the help of a 74150! All

that's necessary is to place the complement of the desired output for each address at the appropriate input.

Complements of the desired outputs

are placed at the inputs because the 74150 inverts the data at its inputs. Figure 3 shows how the 74150 is wired to implement the truth table. The 74150 in-

PROJECT OF THE MONTH

A HEXADECIMAL KEYBOARD ENCODER

The simple hex keyboard encoder described in this month's column can be significantly improved by adding a 4-bit register to store the hex code of the key that has been pressed. This means the LED readout will display the 4-bit code for a particular switch when the switch is initially closed and continue to display it *after* the switch has been released. The display will change only when the scanning circuit detects a new key closure.

Compare the complete circuit diagram for the hex encoder shown here with Fig. 7 and you'll note that a 74173 4-bit register has been added and the readout LEDs have been moved from the counter output to the register output.

The clock and scanner portions of the circuit have already been analyzed, and the 74173 was described in the March 1978 Experimenter's Corner. It's a flexible storage register with 3-state outputs that can be readily tied to the address or data

bus of a microcomputer or controller.

When the scanner circuitry detects a switch closure, the output of the 74150 sends a data enable pulse to the 74173 through one of the 7400 gates. The next clock pulse then loads the counter address into the 74173, and the circuit resumes its sequential scan of the switches. The four bits describing the previously closed switch, however, remain safely stored in the register.

The photograph shows a prototype version of the encoder assembled on a perforated board (Radio Shack 276-152 or equivalent). Note the extra space on the board for the addition of other circuits such as a RAM. Also note that a standard calculator keyboard was *not* used. These keyboards are inexpensive and readily available, but the switches are arranged in x-y format not compatible with this circuit. Instead, individual normally open pushbutton switches were used to make a custom hex keyboard.

I used wrapped-wire construction throughout with the exception of solder connections to the switch terminals, the LEDs and several of the resistor and capacitor leads. Total assembly time was about three hours. In a subsequent Project of the Month we'll add a 16-word RAM to the encoder. You'll find the resulting circuit very interesting, so be sure to consider building the basic encoder in the meantime. ♦

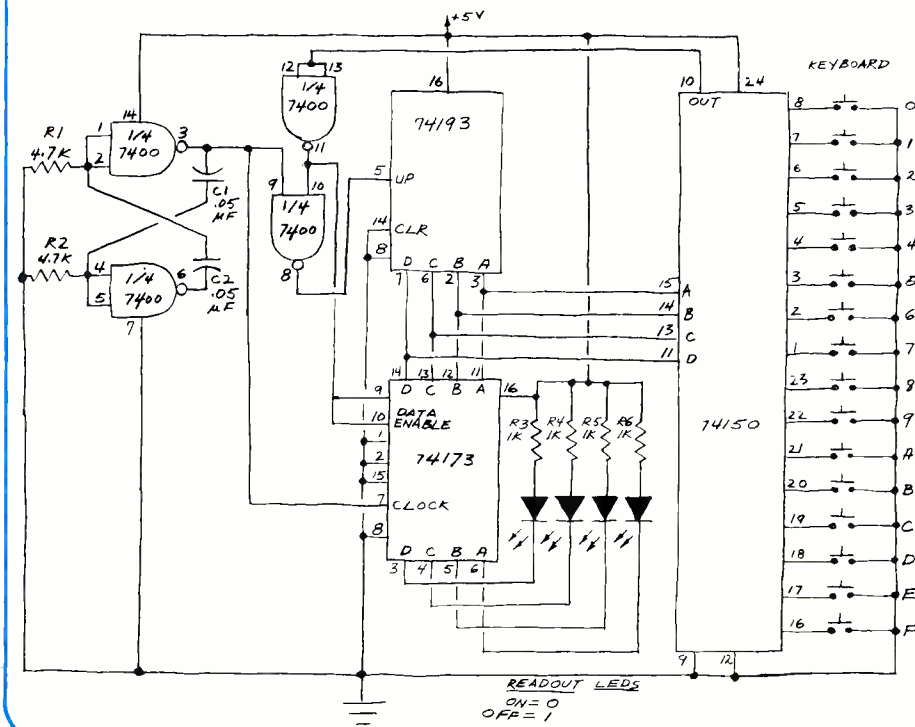
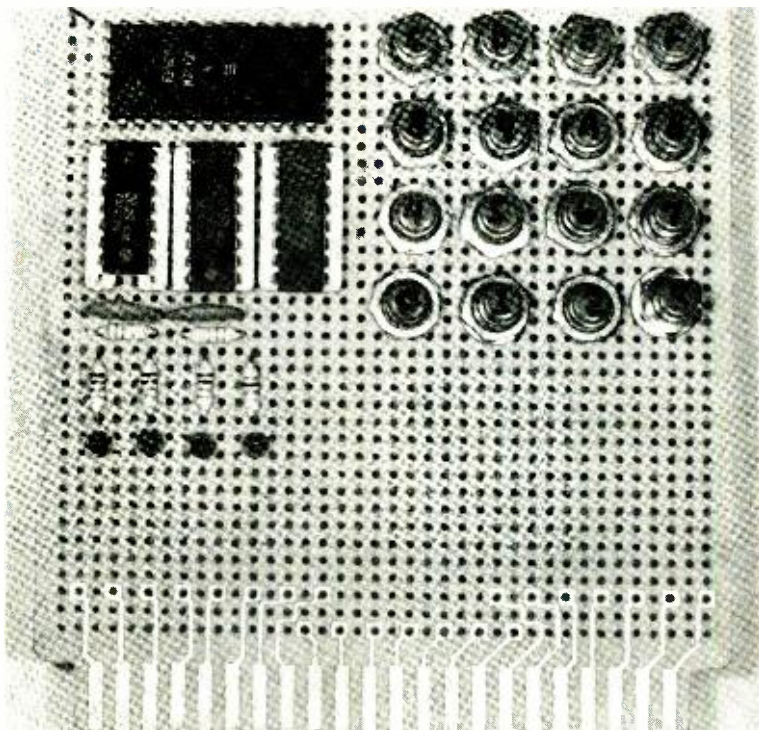

4-for-1 SALE!

Top Quality J.I.L. 4-in-1
IN-DASH
AM-FM CAR STEREO with
8-TRACK or CASSETTE
PLUS 40-CHANNEL CB!

AS
LOW \$ **149.00**
AS
WHILE SUPPLY LASTS



From J.I.L. a leader in car entertainment centers... a modular, compact, first quality 4-in-1 unit at a price you might pay for a radio only! Get stereo high-fidelity FM Radio, AM Radio, 8-Track or Cassette and CB all for one low price. Tens of thousands sold nationally. Order while supplies last!

#853/102 In-Dash Combination 8-Track Stereo, AM/FM/Stereo Radio and 40-Channel Digital Touch-Tuning AM-CB. Features LO/DX switch, Stereo light, 8-track program lights, CB standby switch, LED channel readout. Plus many other features
-while supply lasts only... **\$149.00**

#610/102 In Dash Combination Stereo Cassette Player, AM/FM/Stereo Radio and 40-Channel Digital Touch-Tuning AM-CB. Features cassette eject/FF button, CB selector, CB standby switch Plus many other features
-while supply lasts only... **\$159.00**

#202-SSB Single Sideband 40-Channel CB featuring Digital Touch-Tuning AM-SSB CB for 120 effective channels with greater clarity and reach. All functions right on the mike. A top-notch unit. Choose SSB instead of standard 40-channel CB with #853 or #610 above.
Please add **\$50.00**

ACCESSORIES

- AM/FM/CB Retractable Antenna (mounts like reg. car antenna)
List \$39.95 **NOW \$29.95**
- 5 1/4" Full-tone Coaxial Speakers
10 oz. magnet per speaker.
List \$39.95 pr. **NOW \$19.95 pr.**
- 6" x 9" Full-tone Coaxial Speakers
20 oz. magnet per speaker
List \$69.95 pr. **NOW \$29.95 pr.**
- Field Strength/SWR Meter to test Ant.
List \$29.95 **NOW \$19.95**

CLIP AD AND ATTACH TO LETTER
Pa. Res. Add 6% Sales Tax.

0200
LESLIE PAUL INC.
"DISCOUNT MAIL ORDER!"

70 James Way, Southampton, Pa. 18966
Phone Orders Call (215) 322-8599

NAME _____
ADDRESS _____
CITY _____ STATE _____ ZIP _____
BankAmericard/Visa/Master Charge -
Exp _____
Card # _____ Date _____

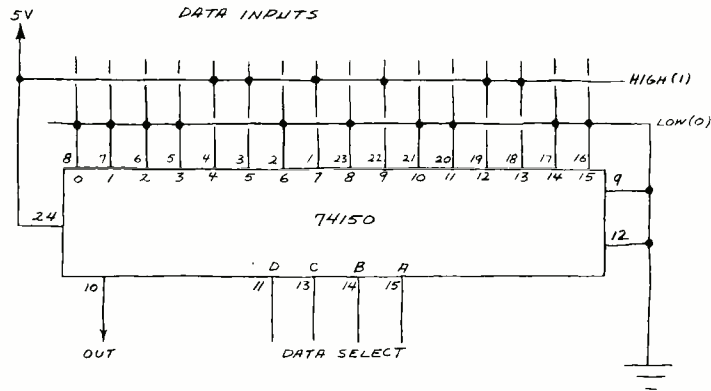

Fig. 3. How to connect a 74150 to implement truth table in text.

puts can be quickly rewired to provide any of the 65,536 possible combinations. For best results, a simple switching network can be used to speed up truth table changes. This is done by connecting each input to the pole of a spdt switch. The positions of each switch are connected to ground (low) and V_{CC} (high) as shown in Fig. 4.

Adding a Data Select Input.

There's a clever way to add a data select bit to the 74150 and other multiplexers. In the case of the 74150, the resulting 5-bit data select word gives 32 input addresses. This makes possible a truth table with an incredible 2^{32} or 4,294,967,304 input/output combinations!

Let's assume you want to implement the following 8-input (3-bit address) truth table with a 4-input (2-bit address) MUX:

Address	Output
C B A	
0 0 0	0
0 0 1	1
0 1 0	1
0 1 1	0
1 0 0	1
1 0 1	1
1 1 0	0
1 1 1	0

A 4-input MUX normally implements a truth table with a 2-bit address (00-01-10-11). Look back at the truth ta-

ble above and you'll notice this pattern is repeated *twice* under the B and A columns to give four pairs of 00, 01, 10 and 11. Rearrange the truth table so the identical B-A parts are adjacent to one another, and you'll notice the output for any of the four pairs can be low or high, C or the complement of C:

	A B C	OUTPUT
1.	0 0 0	0
	0 0 1	1
2.	0 1 0	1
	0 1 1	0
3.	1 0 0	1
	1 0 1	1
4.	1 1 0	0
	1 1 1	0

We're now ready to implement the truth table by connecting each of the four inputs of the MUX to low, high, C or the complement of C. The outputs of the first pair are identical to C, so C is connected to the first input. The outputs of the second pair are the opposite of C, so the complement of C is connected to the second input. Similarly, both outputs of the third pair are high so the third input is connected to logic 1. Both outputs of the fourth pair are low so the fourth input is

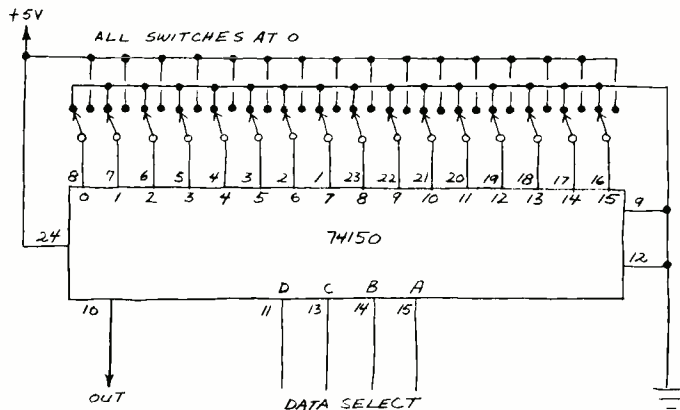

Fig. 4. Switch programmable 74150.

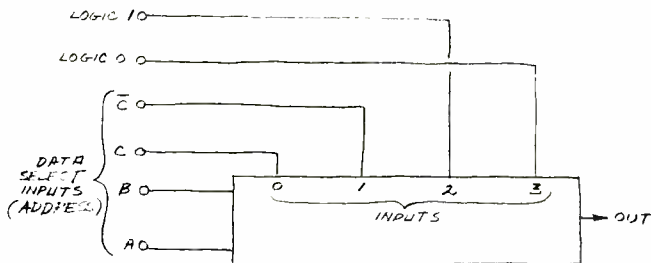

Fig. 5. Expanding a 4-input MUX to an 8-input MUX.

at logic 0. The resulting connection diagram for the expanded MUX is shown in Fig. 5.

Multiplexer Pattern Generator.

One application for a MUX truth table circuit like the one in Fig. 4 is a *binary pattern generator* that produces a string of sixteen preselected bits over and over again. This is accomplished by connecting a 4-bit, modulo-16 counter to the address inputs of the 74150. Each pulse from a clock connected to the counter produces the next output in the binary sequence.

Figure 6 shows a working version of a clock and counter that can be connected to a 74150 to make a pattern generator. This circuit is fairly straightforward, and you can use other clock and counter combinations if you prefer.

Pattern generators have many applications. One simple possibility is to use the 74150 output to strobe a tone generator on and off to produce programmed tone patterns. Another is to produce programmed LED flashing sequences.

Hexadecimal Keyboard Encoder.

A very useful application for the 74150 MUX is the hexadecimal keyboard encoder shown in Fig. 7. This circuit continuously scans each of sixteen normally open pushbutton switches. When a closed switch is detected, the LED read-out connected to the data select (address) inputs of the 74150 identifies in

binary form which switch has been closed.

Those of you who are microcomputer enthusiasts already know the value of a hex keyboard encoder, but *hexadecimal* probably sounds very intimidating to the uninitiated. The term simply means a number system based on sixteen. Binary, octal and decimal are number systems based, respectively, on 2, 8 and 10. Hexadecimal is important in digital logic because, as you already know, there are sixteen possible combinations of 0 and 1 in a 4-bit word (0000-1111). Here's a listing of the first sixteen decimal digits along with their binary and hex counterparts:

Decimal	Binary	Hexadecimal
0	0000	0
1	0001	1
2	0010	2
3	0011	3
4	0100	4
5	0101	5
6	0110	6
7	0111	7
8	1000	8
9	1001	9
10	1010	A
11	1011	B
12	1100	C
13	1101	D
14	1110	E
15	1111	F

A hex keyboard encoder allows any of the sixteen hex digits to be entered into a digital circuit by pressing a single key. This greatly speeds up the programming of read/write memories in microcomput-

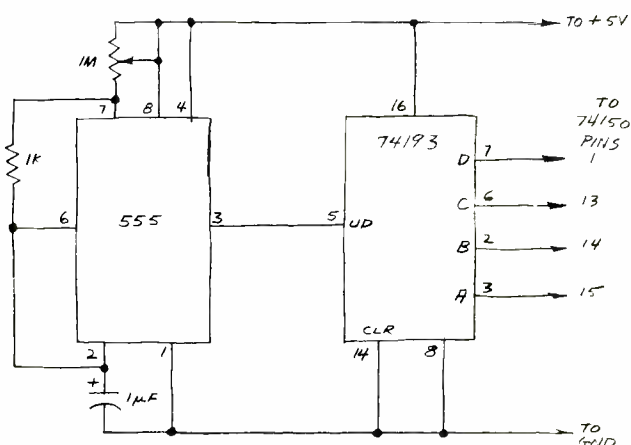

Fig. 6. Sequencer circuit for binary pattern generator.

how often
could you use
an Xcelite®
"99"?



it's every
tool you
need 99%
of the time...
an Xcelite original!

it's a screwdriver



for slotted, Phillips, Frearson, Bristol, clutch head, Scrulox® screws; in inch and metric size Allen hex and Allen hex ballpoint socket types; and Pozidriv® style.

it's a nutdriver

in inch and metric sizes, regular, stubby, and magnetic, for hex nuts, screws, and bolts.

it's a reamer



it's extendable



for greater reach and torque

5 DIFFERENT HANDLE STYLES

regular and Tee, with and without reversible ratchet; junior, and stubby; all with Xcelite's unique spring device for quick blade insertion and removal. All shockproof, breakproof (UL).

85 INTERCHANGEABLE BLADES

all the popular types and sizes. All precision-made, genuine Xcelite quality. Fit all five handles.

IN SETS, KITS, OR PIECEMEAL

roll-up service kits, compact, stand-up, plastic-cased sets; or individually as needed.



in stock at leading
electronic distributors... nationwide



The Cooper Group
Electronics Division

WELLER® • WISS® • XCELITE®
P.O. BOX 728 APEX NORTH CAROLINA 27502 919/362-7511
CIRCLE NO. 15 ON FREE INFORMATION CARD

HIDEAWAY

**40-CHANNEL
REMOTE CITIZEN'S BAND
TRANSCEIVER WITH ALL
CONTROLS IN MIKE!**

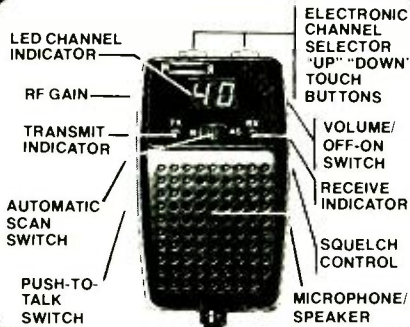

79⁹⁵ Plus \$2.95
Postage & Handling

WHILE SUPPLIES LAST.

ONLY MODEL CB 4100 BY
SPARKOMATIC
GIVES YOU THESE FEATURES
RIGHT ON THE DETACHABLE
MICROPHONE!

ALSO FEATURES - Built-In ANL;
External Speaker Jack; Phase Locked
Loop Technology.

INCLUDES Everything You Need for
Easy Glove Box, Firewall or Under
Seat Installation.

SPECIAL
Hideaway Magnetic Mount
CB Antenna **\$19.95**

Pa. Res. Add 6% Sales Tax

W&M ENTERPRISES, INC.

1633 Republic Road (215) 675-6900
Huntingdon Valley, PA. 19006

- Sparkomatic CB 4100
- Hideaway Antenna

Name _____

Address _____

City _____ State _____ Zip _____

Visa and MasterCard Accepted

Card No. _____

Exp. Date _____ Bank No. _____

(MasterCharge)

**SEND CHECK OR
MONEY ORDER TODAY!**

CIRCLE NO 71 ON FREE INFORMATION CARD

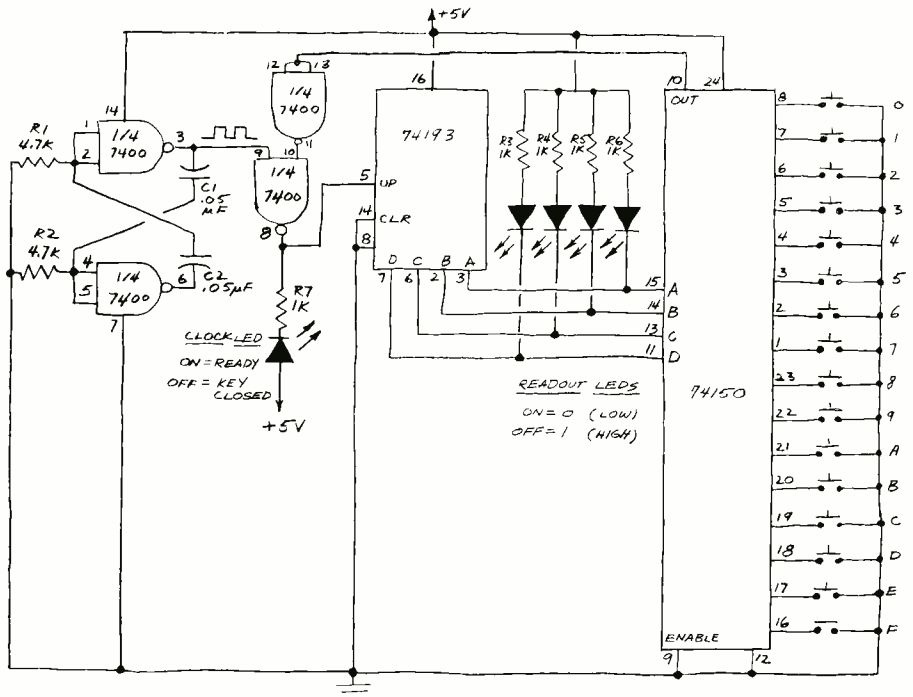

Fig. 7. Hex keyboard encoder circuit.

ers, controllers and other digital circuits that process data in 4-bit "nibbles."

Operation of the keyboard encoder shown in Fig. 7 is straightforward. An astable multivibrator comprising half the gates in a 7400 quad NAND gate serves as a clock. Pulses from the clock are steered to the count UP input of a 74193 counter through one of the remaining gates in the 7400. This gate permits clock pulses to pass as long as the output of the 74150 is low.

A switch closure causes the 74150 output to go high when the count from the 74193 matches the number of the closed switch. This, in turn, inhibits the clock gate, which prevents clock pulses from reaching the 74193. The four LED's connected to the 74193 output then indicate the bit pattern applied to the 74150 address in binary and thus the number of the closed switch.

When the closed switch is released, the 74150 output returns to the low state and the clock gate is no longer inhibited. The 74193 then continues to cycle the 74150 through a sequential scan of the switches.

An interesting feature of this circuit is that under normal conditions it operates as a form of *priority encoder*. This means it responds to the first of two or more key closures while ignoring all subsequent closures. Can you think of a circumstance where the encoder would respond to the *second* of two key closures? (Hint: Assume the clock is very slow or your fingers are very fast.)

The circuit shown in Fig. 7 is not necessarily usable in some applications. One reason is that the continuous scanning of the switches causes the four LEDs to appear continually on (binary 0000) between switch closures. This problem is partially alleviated by the single CLOCK LED that indicates when the clock pulses are getting through to the counter.

When the CLOCK LED is on, the circuit is ready to receive another switch closure. In other words, the 74150 is scanning the input switches and the fact that all four readout LEDs appear to indicate 0000 is irrelevant. When the CLOCK LED is off, a switch closure has been detected and the readout LEDs accurately indicate the selected switch. If, by coincidence, switch 0000 is selected, the four LEDs will all remain illuminated but their apparent brightness will increase significantly. This is because all four LEDs now receive a steady direct current rather than the very rapid pulsating current from the 0000-1111 count sequence.

Another drawback of the circuit in Fig. 7 is that it promptly "forgets" a switch closure once a switch has been released. Contrast this with the pocket calculator, which "remembers" each key closure until an operation is complete or a clear key is pressed. This disadvantage can be overcome by adding a data storage register to the circuit. For details, see the accompanying Project of the Month. ◇



By John McVeigh

HF'ERS AND LF'ERS

Q. *I own both a shortwave receiver and a CB base transceiver. It was my understanding that the frequencies allocated for the CB service were between approximately 26.9 and 27.4 MHz. However, as I was tuning my receiver, I heard stations below 26.9 MHz and above 27.4 MHz operating on single sideband from as far away as Colorado! Their callsigns did not resemble those issued to hams. Are these operators the "out-of-banders" I've heard about, and if they are, why doesn't the FCC stop them?—Don Wood, Westport, CT.*

A. Yes, the operators you heard are the "out-of-banders." It seems that those operating below 26.9 MHz call themselves "low-frequency operators" or "LF'ers." Those operating above 27.4 MHz call themselves "high-frequency operators" or "HF'ers." The origin of these bands can be traced to some CB operators with knowledge of electronics. They realized that by interchanging the 23 receive crystals and 23 transmit crystals in their transceivers they were able to create 23 "new" channels. Later, as crystal synthesizer designs were introduced, the five or six crystals these rigs contained were switched around and new frequencies were opened up.

Basically, there are two bootleg bands, displaced from the Citizens Band by the commonly used i-f of 455 kHz. The latest equipment development is that bootleggers are using Amateur equipment modified to work outside the 10-meter band. It's likely that such equipment was used in the SSB communications you heard, as AM has been almost totally abandoned on the Amateur bands below 30 MHz. Consequently, few ham rigs with AM capabilities are being produced.

Why doesn't the FCC do something about these bootleggers? The Commission is trying, but its field staff is so small and the number of illegal operators by comparison so large that the situation is really out of hand. Unless the FCC is

granted more funds from the Congress and more money is allocated to field activities, it's unlikely that the effectiveness of their policing will improve.

CLEANING UP RIPPLE

Q. *I have a 9-volt dc adaptor which, when connected to my small transistor projects, produces a loud 120-Hz hum. I suspect that the adaptor is just a diode/capacitor filter assembly. Is there some way of eliminating the ripple, or at least reducing it? I don't mind a change in supply voltage of about 20% if it will cure this problem. The supply is rated at 9 volts, 9 mA.—Tom Dycus, Albuquerque, NM.*

A. You can reduce the ripple in the output of the supply by supplementing its built-in filter capacitor. The addition of 500, 1000, or 2000 μF should reduce the ripple dramatically. The only potential danger posed by adding relatively large amounts of capacitance is that an increased surge current will flow through the diodes when the supply is first turned on. As you did not mention what diode type is used (probably the unit is sealed), I can't tell whether 2000 or more μF of capacitance will cause problems.

Another solution that immediately crossed my mind is to use a zener diode or IC voltage regulator. However, the rated current output of the battery eliminator is suspiciously low. A zener diode is not an acceptable solution because the current is so small that there's not enough to both power your circuits and keep a few mA flowing through the zener. Unless a sufficient current through the zener is maintained, the diode will not perform its regulating function. Similarly, most voltage regulators require a quiescent current of 6 or more mA. If the supply is rated at 90 mA of output current (as seems likely), an IC voltage regulator or zener diode and series resistor will eliminate your hum problems.

One other factor suggests that the

power supply is rated at 90 mA. In a power supply using a capacitive filter, the voltage regulation and lack of ripple is a function of the output current. The smaller the demand placed on the power supply, the less the capacitor discharges before being replenished by the diode(s). It seems highly unlikely that such a small current drain (9 mA) would cause serious ripple problems.

W1AW

Q. *I've read that the American Radio Relay League operates a radio station solely for the purpose of code practice. I would like to know when it is on the air and what frequencies are used. Can you help me?—David Reed, Jr., WDX4DR, Miami, FL.*

A. The ARRL does indeed operate Amateur station W1AW, but not solely for the purpose of transmitting code practice material. The current W1AW operating schedule shows that the station is on the air fourteen times each weekday. Four time slots are allocated to code practice sessions, and the remaining ten are devoted to the announcement of bulletins. These latter transmissions include news items about events of interest to Amateurs, such as FCC rule-making proposals, etc., propagation forecasts, information relating to the orbital paths of the OSCAR and weather satellites, and news of such operating events as contests.

At 9 a.m., 4, 7, and 10 p.m. EST, code practice text is transmitted. The early session is omitted on Saturday and Sunday. Depending on the day and time, a code session will be either a fast or slow one. Slow code practice includes eight-minute intervals of text at 5, 5, 7½, 7½, 10, 13 and 15 words per minute. Fast code practice comprises eight-minute intervals of text at 35, 30, 25, 20, 15, 13, and 10 wpm. The following frequencies are employed in the transmission of code practice: 1.835 MHz; 3.580 MHz; 7.080 MHz; 14.080 MHz; 21.080 MHz; 50.080 MHz and 147.555 MHz.

For complete details, consult a recent issue of QST magazine published by the American Radio Relay League, 225 Main Street, Newington, CT 06111. The operating schedule is reproduced in the Operating Events section.

Have a problem or question on circuitry, components, parts availability, etc? Send it to the Hobby Scene Editor, POPULAR ELECTRONICS, One Park Ave., New York, N.Y. 10016. Though all letters can't be answered individually, those with wide interest will be published.



Product Test Reports

J.I.L. Minicom SX-100 Scanning Monitor Receiver



*16-channel
programmable
microprocessor-
controlled
model*

THE J.I.L. Minicom SX-100 is a 16-channel, programmable mobile scanning monitor receiver that uses digital frequency synthesis and a microprocessor. More than 32,000 different channels in the 30-to-50-MHz vhf low band, 140-to-174-MHz vhf high band, and 410-to-514-MHz uhf band can be programmed via the microprocessor-controlled memory system, without additional crystals. Included in the high-vhf band is coverage of the 144-MHz Amateur Radio band.

The desired frequencies on the selected channels can be "memorized" by the receiver. Alternatively, a band can be manually scanned to seek an unknown signal when it comes up, the frequency and channel number for which are indicated by a green-LED numeric display. In addition, the receiver can be set up so that the display gives the time and date.

The receiver measures $9\frac{1}{4}''\text{W} \times 8''\text{D} \times 3''\text{H}$ (23.5 × 20.3 × 7.6 cm). Suggested retail price is \$489.95.

General Description. The receiver has two automatic scanning rates, one at eight channels/second and another at four channels/second. Likewise, there are two seeking rates, one at 10 channels/second and the other at five channels/second. A scan delay of 0 to 4 seconds can be set up. The two U.S. Weather Bureau frequencies can be in-

dependently selected by switches.

The front panel of the receiver is dominated by 39 calculator-type pushbutton keys. A 15-key pad on the left side of the panel is used for entering a frequency, which appears in the eight-digit display in the center of the panel. This keypad section also contains buttons for stopping the scan (ST), displaying the frequency (FR), scan write (SW), memory write (MW), and controlling the speed (SP) for both seeking and scanning.

Arranged in two horizontal rows across the top of the panel are keys for recalling from memory and displaying the frequency of any of the 16 channels keyed into the receiver. There is a separate key for each of the receiver's 16 memory channels. Separate WB1 and WB2 keys in this group permit instant display of the two weather-band frequencies.

To the right of the display window is the final grouping of keys. The SEEK key is for locating an inexact frequency. The SCAN A and SCAN B keys are for memorizing the frequencies of 16 stations and scanning them automatically and for scanning the memory for 16 stations already memorized, respectively. Two CLOCK keys, labelled DAY and HOUR, are for setting the date and time. The last key is for push-on/push-off POWER.

Finally, there are slide-type SCAN DELAY, SQUELCH, and VOLUME controls. These controls are arranged in a straight

horizontal line along the bottom of the front panel.

The receiver's front panel is slightly tilted backward for easy view of its display and manipulation of its keys and controls. Its standard features include a telescoping antenna plus facilities for connecting an external antenna rated at 50 to 75 ohms impedance, built-in top-facing speaker, external speaker jack, and mobile mounting hardware. Operation is designed to be primarily from a 12-to-16-volt dc source, but an ac adapter (supplied) allows operation from 110-to-125-volt ac sources.

No circuit diagram or other technical data was supplied with the receiver. Hence, the only thing we can state with certainty about its circuitry is that the main i-f is at 10.7 MHz. Frequency selection is apparently obtained with the usual digital frequency synthesis system. This includes memory and a microprocessor for setting up the various functions.

When power is first applied to the receiver, the frequency displayed is either 30.000 or 162.400 MHz, the date is 1-1 (January 1), and the time is 12-00 (AM). These must be set properly.

Most operations begin by selecting the numerical component of the function and then subsequently selecting the function. For example, to set up 155.415 MHz and place it in memory for channel 2, the keys are pressed in the following order: 1, 5, 5, ST, 4, 1, 5, MW, M2. The ST key enters the decimal point, MW places the frequency in memory, which, in turn, is set up for channel 2 using the M2 key. The frequency will appear in the display if the memory operation is made within 5 seconds. After 5 seconds, the time is displayed (as is the case after any channel frequency is displayed for this length of time).

Laboratory Measurements. On the lower two bands, the measured sensitivity of the receiver was better than 0.5 μV for 20 dB of noise quieting. (It actually varied between 0.25 and 0.5 μV , depending on the section of the band being tested.) The image rejection was at least 20 dB throughout the vhf bands, while it dropped to less than 10 dB on the uhf band.

The spurious-response rejection was nominally 40 dB over the receiver's entire range. Overload birdsies set in with a nominal 100- μV signal. The useful selectivity was 15 to 20 kHz on the high side of the signal and approximately 10 kHz on the low side.

Maximum sine-wave audio output measured 1 watt at less than 10% THD. This measurement was taken at 1000 Hz into an 8-ohm load.

User Comment. The large number of calculator-like keys at first appears to be a formidable obstacle to using this receiver properly. However, as we gained familiarity with the keys, confidence in operating the receiver was measurably increased. This is due in no small part to the logical manner in which the keys are laid out according to function.

During our use tests, we noted that the memory system holds its contents when power to the receiver is switched off. The built-in clock also keeps running when power is turned off, even during operation from a dc source.

This scanning monitor has excellent sensitivity and selectivity. Its FM modulation acceptance was tops. Audio quality was exceptionally clear, too. In all, this is an ideal scanning monitor receiver for both mobile and fixed-station operation, thanks to its performance, its ability to be operated on both dc and ac power, and its built-in telescoping antenna and external antenna facilities.

CIRCLE NO 105 ON FREE INFORMATION CARD



DX Listening

By Glenn Hauser

RADIO CLARIN

THE Dominican Republic has an official government station, *Radio-Televisión Dominicana*, which in the past has operated a shortwave service on 5970-5975 and 9505 kHz, including an occasional English talk promoting tourism. However, a private station, *Radio Clarin*, has really put the Dominican Republic on the map as a source of international broadcasts. *Clarin* is the largest private station in the country and had close ties with the Balaguer government. This worked to the advantage of *Clarin* and of DX listeners, until Balaguer lost a reelection bid last May.

Clarin just happened to have a 50-kilowatt transmitter that could be used on the 25-meter band. So it was fired up on 11,700 kHz, and the domestic AM programming relayed to Dominicans overseas, primarily in New York.

Fortunately, the director of *Radio Clarin* was Rodolfo (Rudy) Espinal, who speaks English and a number of other languages. He saw the potential of this transmitter in encouraging American tourism and propagating a friendly image for his native country. Espinal began a five-days-a-week English half-hour, called "This Is Santo Domingo," which soon expanded to six days a week and then to a full hour. At its peak last May, it expanded to three further repeat broadcasts each day.

It was truly a breath of fresh air—a free-form hour with a 'live' sound that was extremely informal, with personal calls to listeners, lots of promotion for DX clubs, and for Dominican tourism. And it was all interspersed with peppy *merengues*, the national musical style. Old-timers compared Espinal's style to that of Eddie Startz, during the heyday of Radio Nederland's "Happy Station." One student of international broadcasting went so far as to credit Espinal with revolutionizing shortwave programming.

But it all came to an end on June 17, 1978, when the shortwave transmitter was taken off the air so parts of it could be used to keep the more important domestic AM transmitter on the air. This was only the final blow in a story that had been building for several months.

Though *Radio Clarin's* broadcasts in English had stayed away from domestic politics, it was clear from listening to the Spanish programs that the station was backing President Balaguer in his campaign for reelection. A few months before, Espinal had mentioned that he was serving as official interpreter for Balaguer during a visit to Miami.

Following the May 16 election, we heard a different side of Rudy Espinal, as he staunchly maintained that there was no fraud and no problem with military intervention in the ballot-counting. He went on to criticize President Carter and Venezuelan President Pérez for meddling in Dominican affairs, all the while maintaining that everything was under control and people should continue planning their vacation trips to "this still-unspoiled half-island."

Some 10 days after the election, Espinal had to concede that Balaguer had lost to Guzmán. He then went on to predict that as a result, *Clarin's* international service would disappear. One explanation given was that *Radio Clarin* had had enough income from the government, for broadcasting the results of the National Lottery each Sunday ("120 pesos, 120 pesos"), to pay the costs of the international service, which he said amounted to about \$5000 a month. And since *Clarin* had supported the losing candidate, this income would be lost when Balaguer stepped down in August.

At about the time the SW transmitter was taken off for technical reasons, *Clarin* had to fire some 14 staffers because of a funding cut. Espinal said he had his

ANSWERS TO QUIZ (p.70)

- | | |
|-----|------|
| 1-D | 6-H |
| 2-J | 7-C |
| 3-F | 8-E |
| 4-I | 9-A |
| 5-B | 10-G |

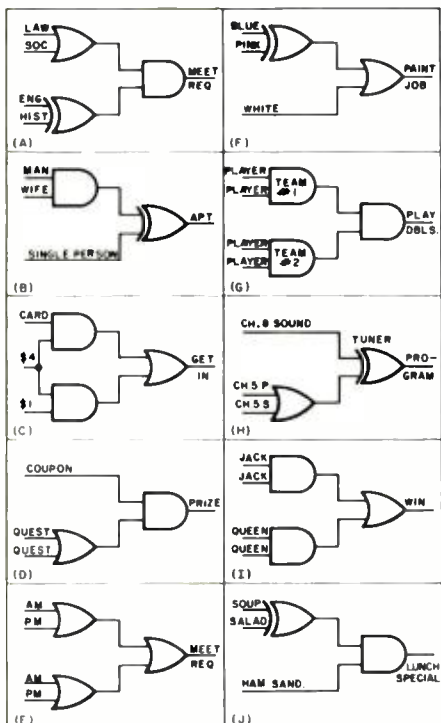

Introducing the personal computer you've waited for.



The Sorcerer

I waited for a personal computer that could do everything I wanted it to do. The Exidy Sorcerer™ does all that and a few things I never dreamed of.

The Sorcerer starts with the best features of other computers and adds some tricks of its own. Presto! My reasons for waiting disappeared.

I wanted pre-packaged programs: Application software on inexpensive cassette tape gets me going right away.

I wanted programmability: The Sorcerer's unique plug in Rom Pac™ Cartridges contain Standard BASIC and other programming languages, applications packages such as Word Processor, and a disk operating system.

I wanted easy to use graphics: Programming pictures is as easy as typing messages on the screen, and the 256 character set includes 128 user definable graphic symbols.

I wanted better video: Higher resolution with 122,880 points, and greater information display with 1920 characters.

I wanted a professional keyboard: The Sorcerer's got it.

I wanted expandability: The optional S-100 6-slot Expansion Unit provides it.

I wanted enough memory: 12k of ROM and 8k, 16k or 32k of RAM within the Sorcerer enclosure.

I wanted an affordable price: \$895 for 8k, \$1150 for 16k and \$1395 for 32k, including the Standard BASIC Rom Pak.

For more information and the name of your nearest dealer, write Exidy, Inc., Dept. PE, 969 W. Maude Ave., Sunnyvale, CA 94086.



hands full just running the AM station, as one could well imagine. However, 11,700 was soon back on the air for brief periods in Spanish only, and continued the lottery broadcasts through July.

Before the end, Espinal had appealed on the air for listeners to send in contributions to keep the international service on the air. All it would require were 5000 people sending in a dollar a month. Considering a previous unsubstantiated claim that *Radio Clarin* had 4,000,000 listeners, that shouldn't be too hard to accomplish. But this half-hearted attempt to undertake international listener-supported radio drew little response and criticism from Americans, in whose country domestic listener-supported radio does exist on a small scale.

Who is Rudy Espinal? Little is known about him, besides what he has rarely revealed on his program. His father was apparently in the diplomatic service or in business, when Rudy was born in Curacao. Later they were assigned to Lebanon. This accounts for some of his varied linguistic background. At one point, Rudy said he taught French in Santo Domingo. In March of this year he attended an international broadcasting conference at Syracuse University but cut short his stay in the U.S. for reasons unknown. No DX listeners are known to have met him while he was here, though he had invited contacts during his previous visit to Miami. He was invited to participate in this year's ANARC convention

in Montreal, but by July, he could not get away—and besides, that was about the same time as the "Merengue Festival" he had been promoting.

QSL hunters soon soured on *Radio Clarin* because, despite frequent requests for reports, mail was slow to emerge from Santo Domingo. Finally in June, a number of QSL cards did go out, postmarked New York, through an arrangement with the Dominican tourist agency.

But Espinal's friendliness to DX listeners cannot be doubted. He had set aside a 30-minute weekly block for "ClarindX." It turned out that I was the primary contributor of DX information and program reviews, though the program was open to all DX organizations.

This story is in the past tense, because at press time, the English broadcasts were off the air. But *Radio Clarin* has had setbacks before, resulting in lengthy, but temporary, absences from 11,700. So any time now, the *Clarin* cheer may be spreading again.

U.S. Stations. The Billy Graham Evangelistic Association, through its station in Honolulu, KAIM, has a construction permit to build a shortwave station on the island of Maui. Although property has been acquired, little progress has been made in building the station. So KAIM has decided to turn over the CP (but not the property) if the FCC approves, to HCJB. The latter already has some experience in running a shortwave

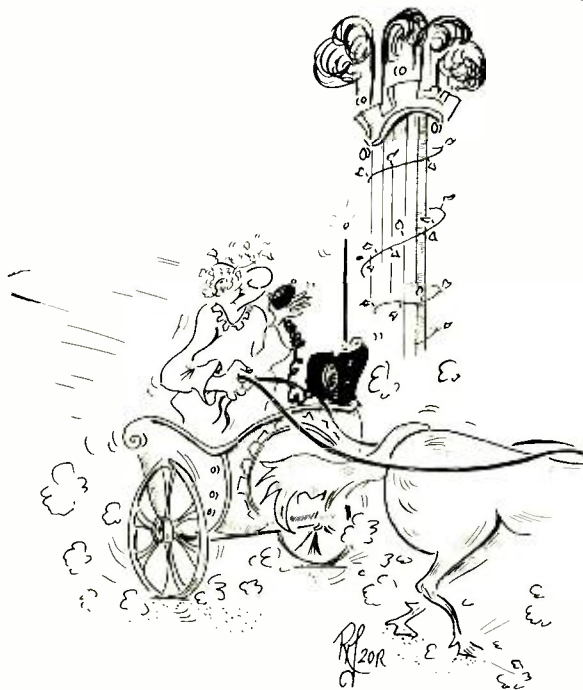

"That's a big X-IV, Good Buddy!! I'm in IIIrd place now!!!"

station, from Equador. But "KCJB" is out. Those call letters already belong in Minot, ND.

The historic Scituate, Mass. shortwave site is about to be closed down for good. The latest owner of the facility, WYFR, has been moving the five transmitters out, one by one, to their new site in Florida. The move is expected to be complete by year's end. This past summer, WYFR earned the gratitude of DX listeners by moving off Austria's frequency of 6155 to 5985 kHz.

Frequency management of some other U.S. stations leaves something to be desired. In a comedy of errors, KGEI, San Francisco, extended its transmission on 9580 kHz beyond 1100 GMT. The frequency had been used for many years by *Radio Australia*, one of only two stations to be broadcast to North America at that hour on the 31-meter band. Then KGEI showed up on 9505 kHz, the even longer-established frequency of the only *other* station broadcasting to North America on that band at that hour, *Radio Japan*. Finally, KGEI landed on two less critical frequencies, 9575 and 9530.

Trans-World Radio's new station on Guam, KTWR, has even more problems, hopping from one frequency to another without any apparent knowledge of actual band occupancy, often conflicting with *Radio Australia* and other strong Pacific signals.

DX Listening Tips. If you're looking for a low-power challenge, try this one: *Radio Republik Indonesia*, Sorong, Irian Jaya. It reportedly has a 50-watt transmitter on 9610 kHz. There may be some interference from Perth, Australia on 9610, running 50,000 watts.

Gabon has begun an international service, with four new 500,000-watt transmitters. There are as many watts in one of those as there are people in the entire country of Gabon. First tests were carried out at 0700-1900 GMT on 15,300, 9650, 7200, and 6030 kHz.

A private or pirate station in Turkey makes a rare appearance on exactly 18,000 kHz. I've heard it once, and Tony Bugajiar in Toronto has heard it twice. It comes on the air Saturdays only, perhaps once a month or less often. But when it's on, it stays on for many hours, playing Turkish music well into the night. If you hear something on 18,000 kHz, it could also be the third harmonic of a station on 6000 kHz, such as *Radio Budapest*.

Some other harmonics, heard by overseas DX listeners include: *RRI*, Bengkulu, Indonesia, on 6530, at 1000 past 1415 (its fundamental, 3265 kHz, is usually blocked in Australia by another Indonesian); *Conakry*, Guinea, was heard in Mauritania on 9820 kHz at 1300 (2×4910); and *Radio Cultura da Bahia*, Brazil, was heard in Italy on 18,465, at 2145 GMT (3×6155).

Correction. In the September DX Listening Column, I overlooked the fact that Israel has been broadcasting to North America on 21- and even 25-MHz.

Join A Club. The information you see in this column is only the tip of the shortwave iceberg. To keep fully informed on developments in international broadcasting, I suggest you join the North American Shortwave Association. NASWA's monthly magazine, *FRENDX*, contains a wealth of data, articles, loggings and QSL reports. A sample copy is \$1; or you can join for a year at \$13. This includes first-class mailing of *FRENDX*. ◇

The first professional quality
modem in kit form

The Pennywhistle 103



Think of it as the ultimate!

The only modem capable of
recording data to and from
an audio tape recorder.

Price: \$129.95
Add for postage: \$3.50
Interconnect cable: \$15.95

RS-232 Control Center

Includes:

- * 2 master ports
- * 3 slave ports
- * Plug in prom programmer, modem, computer, printer, terminal, etc. and selectively control data flow.



Price: \$89.95 (kit)

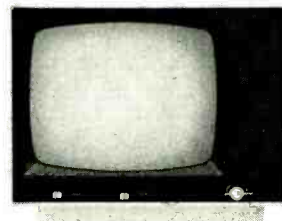

12" CRT Monitor

New, limited quantity.
Includes power supply
and case.

Sorry, no CRT shipments
out of U.S.

10 MHz BAND WIDTH

Price: \$149.95

SUP'RMOD II

UHF Channel 33 TV Interface Unit.

Works with Cromemco
Dazzler, Sol 20, TRS-80
or any video device that
outputs NTSC composite
video.



Plugs directly into the Apple II.

Price: \$29.95

M & R ENTERPRISES

P.O. Box 61011, Sunnyvale, CA 94088

The quick charge iron with 16 different quick change tips.



ISO-TIP®
QUICK CHARGE
 Cordless Soldering Iron completely recharges in 3½-4 hours. Low voltage, battery powered, ground free isolated tip design.

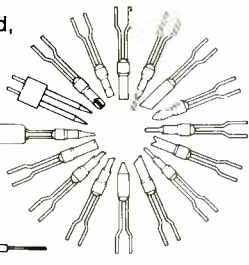

16 snap-in tips to fit any job plus a PC Drill.

WAHL CLIPPER CORPORATION
 ORIGINATORS OF PRACTICAL CORDLESS SOLDERING
 • Sterling, Illinois 61081 • (815) 625-6525
 "Manufacturing Excellence Since 1919"

CIRCLE NO. 72 ON FREE INFORMATION CARD

ADVANCING the state of the art



in automatic percussion units... the **PROGRAMMABLE DRUM SET** features: score editing, bridges, intro's, external sync to sequencers foot controls, memory save switch & much more.

Enter scores in seconds - NO PROGRAMMING KNOWLEDGE IS REQUIRED!

High Fidelity describes the 3750 as "an easy project... fun to do and yields delightful results... an excellent educational tool and versatile aid to the musician who can't afford a live rhythm section."

#3750 \$84.95... (+\$3 shipping)

Another Great Kit from: **F&A**
 8 P 1020 WEST WILSHIRE BLVD. OKLAHOMA CITY, OK 73116

- Send Programmable Drum Set Kit (\$84.95 + shipping enclosed)
- Factory assembled programmable Drum Set (\$149.95 + shipping enclosed)

name: _____

address: _____

City: _____ State: _____ Zip: _____

SEND FREE CATALOG

CIRCLE NO. 51 ON FREE INFORMATION CARD



Computer Bits

By Hal Chamberlin

COMPUTER ARITHMETIC—FLOATING POINT

IN OUR September 1978 column, we discussed multiple precision computer arithmetic in which two or more bytes were used to hold a single number. But why would one want to go to the trouble of using multiple precision arithmetic?

Many applications may involve numbers that are larger than the -128 to +127 range of a single byte. For applications using binary fractions, accuracy better than the 0.4% of full-scale figure attainable in a single byte is required. However many, if not most, applications requiring computation may include mixed numbers of widely varying magnitude as well.

Scale Factor. One method of handling mixed numbers involves the concept of a scale factor. Most of us have used this concept without realizing it. For example, one does not ask a sales person in an electronics shop for a 0.0000001-farad capacitor. Instead, a "point one microfarad" capacitor would be requested. The term *micro* implies a scaling factor of 1/1,000,000. When using scaling factors, the real number (0.0000001) is equal to the scaled number (0.1) multiplied by the scaling factor (1,000,000). When people use scale factors, it is in an attempt to make the scaled number close to unity. Thus 100,000 picofarads would also be an unnatural expression. In a computer, the scale factor concept can be used to reduce numbers, no matter how large or small, to a range around unity. If they are kept less than 1.0, fractional arithmetic can be used for all computations.

The arithmetic routines given earlier of course do not recognize scale factors. It is the responsibility of the programmer to keep track of scale factors. The situation is much like having a calculator with no decimal point logic. The machine calculates the digits and it is up to the user to figure out where the decimal point should be. For example, if two scaled numbers are multiplied together, the scale factor of their product is the prod-

uct of the scale factors. For division it is the quotient of the scale factors. This means that if both dividend and divisor scale factors are the same, the quotient scale factor is one.

When performing addition or subtraction, the scale factors of the operands *must* be equal and the scale factor of the answer will be the same as the operands. If the operands do not have the same scale factor, one of them must be rescaled. For example the series combination of 3.3k ohms and 51 ohms can either be 3300 ohms plus 51 ohms or 3.3k ohms plus 0.051k ohms. Rescaling in either case is usually accomplished by shifting the decimal point.

A good programmer may be able to sit down with a definition of the problem to be solved and select scale factors for the variables that simultaneously prevent overflow and maintain the maximum number of significant bits throughout the computation. To do this however, a good knowledge of the magnitude of the numbers in the *intermediate results* is required. This usually means that the problem must be solved before programming it. If the calculation is well defined and highly repetitive, this may not be much of a limitation, but it is unsuitable for experimental computation.

Floating-point arithmetic is an ingenious way of having the computer keep track of scaling factors as well. In addition, it provides for automatically rescaling intermediate results based on the size of the numbers at the time. Thus the programmer can become less concerned about the magnitude of intermediate results. The floating point method of doing computer arithmetic is so powerful and popular that it is an expected feature of any high-level computer language. In assembly language programming however, it is only used as a last resort because of the memory requirements and execution time of floating point arithmetic subroutines.

Number Format. Floating-point num-

POPULAR ELECTRONICS

Write and run machine language programs at home, display video graphics on your TV set and design microprocessor circuits—the very first night—even if you've never used a computer before!

ELF II featuring **RCA COSMAC** microprocessor / mini-**COMPUTER \$99.95**

ELF II by NETRONICS

As featured in POPULAR ELECTRONICS

Shown with optional 4k Memory Boards, GIANT BOARD™ & Kluge Board.

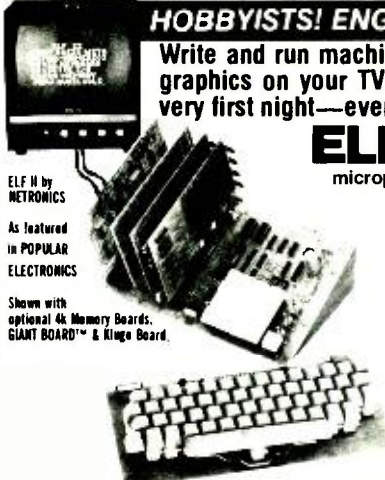

bers are represented in a computer much like scientific notation. Basically the number is split into two parts usually called the *mantissa* and the *characteristic*. These are actually rather poor, misapplied names derived from logarithm theory so the term *fraction* will be used instead of mantissa and *exponent* will replace characteristic. The fraction part of a floating-point number is just what its name implies; a number above 0 and just shy of 1.0 in magnitude. The exponent is simply a signed integer. The value of the entire floating-point number is the fraction multiplied by the base raised to the exponent power. The base is a constant integer chosen by the person who wrote the floating-point arithmetic routines being used and never changes. A floating-point number is said to be *normalized* when the fraction is greater than the reciprocal of the base but less than unity.

Perhaps an example will clear things up a bit. Using decimal numbers, consider the floating-point number 0.454×10^4 . The 0.454 is the fraction, the 10 is the base, and the 4 is the exponent. Since 10 to the fourth power is 10,000, this number is equal to 4540 in conventional notation. Other floating point numbers might be 0.789×10^{-2} which is the same as 0.00789 and 0.065×10^2 , which is equal to 6.5. Note that the preceding number is not normalized since the fraction is less than 1/10; in normalized form it would be 0.65×10^1 . Note also that normalization simply amounted to moving the decimal point right one position which multiplied the fraction by 10 and then reducing the exponent by 1, which divided the number by 10 leaving the overall number unchanged in value.

When writing a floating-point arithmetic package for a computer, the choice of the base is very important. When people do calculations they naturally choose 10 for the base because of familiarity with decimal numbers. Computers on the other hand are more at home with 2 as a base because of their binary nature. Other popular bases are 8 and 16 which, because they are powers of two, are as easily handled by a computer as 2. When using a microcomputer, the only advantage of 8 or 16 as a base is exact emulation of the floating-point arithmetic of large machines which use these bases to make their hardware floating-point instructions faster.

A typical binary (base-2) floating-point number format is shown in Fig. 1. Four bytes are used to represent the

Stop reading about computers and get your hands on one! With ELF II and our new *Short Course* by Tom Pittman, you can master computers in no time at all! ELF II demonstrates all 91 commands an RCA 1802 can execute and the *Short Course* quickly teaches you how to use each of the 1802's capabilities. ELF II's video output lets you display an alphanumeric readout or graphics on any TV screen or video monitor plus enjoy the latest video games, including an exciting new target/missile gun game that was specifically developed for ELF II.

But that's not all. Once you've mastered computer fundamentals, ELF II can give you POWER with add-ons that are among the most advanced found anywhere. No wonder IEEE chapters plus hundreds of universities and major corporations have chosen the ELF II to introduce their students and personnel to microprocessor computing!

Learn The Skill That May Soon Be Far More Important Than Your College Degree!

The ability to use a computer may soon be more important to your earning power than a college degree. Without a knowledge of computers, you are always at the mercy of others when it comes to solving highly complex business, engineering, industrial and scientific problems. People who understand computers can command MONEY and to get in on the action, you must learn computers. Otherwise you'll be left behind.

ELF II Is The F-A-S-T Way To Learn Computer Fundamentals!

Regardless of how minimal your computer background is now, you can learn to program a computer in almost no time at all. That's because Netronics has developed a special *Short Course on Microprocessor And Computer Programming* in non-technical language that leads you through every one of the RCA COSMAC 1802's capabilities so you'll understand everything ELF II can do... and how to get ELF II to do it!

All 91 commands that an 1802 can execute are explained to you, step-by-step. The text, written for Netronics by Tom Pittman, is a tremendous advance over every other programming book in print.

Keyed specifically to the ELF II, it's loaded with "hands on" illustrations. When you're finished, ELF II and the 1802 will no longer hold any mysteries to you.

In fact, not only will you be able to use a personal computer creatively, you'll also be able to read magazines such as BYTE... INTERFACE AGE... POPULAR ELECTRONICS and PERSONAL COMPUTING and understand the articles.

If you work with large computers, ELF II and our *short Course* will help you to understand what makes them tick.

A Dynamite Package For Just \$99.95!

With ELF II, you learn to use machine language—the fundamental language of all computers. Higher level languages such

as FORTRAN and BASIC must be translated into machine language before a computer can understand them. With ELF II you build a solid foundation in computers so you'll really know what you're doing, no matter how complicated things get.

Video output also makes ELF II unique among computers selling for such a low price. Attached to your TV set, ELF II becomes a fabulous home entertainment center. It's capable of providing endless hours of fun for both adults and children of all ages! ELF II can create graphics, alphanumeric displays and fantastic video games.

No additional hardware is required to connect ELF II to your TV's video input. If you prefer to connect ELF II to your antenna terminals instead, simply use a low cost RF modulator (to order one, see coupon below).

ELF II's 5-card expansion bus (connectors not included) allows you to expand ELF II as your needs for power grows. If you're an engineer or hobbyist, you can also use ELF II as a counter, alarm, lock, thermostat, timer or telephone dialer, or for countless other applications.

ELF II Explodes Into A Giant!

Thanks to ongoing work by RCA and Netronics, ELF II add-ons are among the most advanced anywhere. Plug in the **GIANT BOARD™** and you can record and play back programs, edit and debug programs, communicate with remote devices and make things happen in the outside world. Add **Kluge Board** to get ELF II to solve special problems such as operating a more complex alarm system or controlling a printing press. Add **4k RAM** board and you can write longer programs, store more information and solve more sophisticated problems.

Expanded, ELF II is perfect for engineering, business, industrial, scientific and personal finance applications. No other small computer anywhere near ELF II's low price is backed by such an extensive research and development program.

The **ELF-BUG™ Monitor** is an extremely recent breakthrough that lets you debug programs with lightning speed because the key to debugging is to know what's inside the registers of the microprocessor and, instead of single stepping through your program, the ELF-BUG™ Monitor, utilizing break points, lets you display the entire contents of the registers on your TV screen at any point in your program. You find out immediately what's going on and can make any necessary changes. Programming is further simplified by displaying 24 bytes of RAM with full address, blinking cursor and auto scrolling. A must for serious programmers!

Netronics will soon be introducing the ELF II **Color Graphics & Music System**—more breakthroughs that ELF II owners will be the first to enjoy!

Now BASIC Makes Programming ELF II Even Easier!

Like all computers, ELF II understands only "machine language"—the language computers use to talk to each other. But, to make life easier for you, we've developed an **ELF II Tiny BASIC**. It talks to ELF II in machine language for you so that you can program ELF II with simple words that can be typed out on a keyboard such as PRINT, RUN and LOAD.

"Ask Now What Your Computer Can Do... But What Can It Do For YOU!"

Don't be trapped into buying a dinosaur simply because you can afford it and it's big. ELF II is more useful and more fun than "big name" computers that cost a lot more money.

With ELF II, you learn to write and run your own programs. You're never reduced to being a mere keypunch operator, working blindly with someone else's predeveloped software.

No matter what your specialty is, owning a computer which you really know how to use is sure to make you a leader. ELF II is the fastest way there is to get into computers. Order from the coupon below!

<p>NOW AVAILABLE FOR ELF II—</p> <ul style="list-style-type: none"> <input type="checkbox"/> Tom Pittman's <i>Short Course On Microprocessor & Computer Programming</i> teaches you just about everything there is to know about ELF II or any RCA 1802 computer. Written in non-technical language, it's a learning breakthrough for engineers and laymen alike. \$5.00 postpaid! <input type="checkbox"/> Deluxe metal cabinet with plexiglas dust cover for ELF II. \$29.95 plus \$2.50 p&h. <input type="checkbox"/> ELF II connects to the video input of your TV set. If you prefer to use your antenna terminals, order RF Modulator, \$8.95 postpaid. <input type="checkbox"/> GIANT BOARD™ kit with cassette I/O, RS 232-C/TTY I/O, 8-bit P I/O, decoders for 14 separate I/O instructions and a system monitor/editor. \$39.95 plus \$2 p&h. <input type="checkbox"/> Kluge (Prototype) Board accepts up to 36 IC's. \$17.00 plus \$1 p&h. <input type="checkbox"/> 4k Static RAM kit. Addressable to any 4k page to 64k. \$89.95 plus \$3 p&h. <input type="checkbox"/> Gold plated 86-pin connectors (one required for each plug-in board). \$5.70 postpaid. <input type="checkbox"/> Professional ASCII Keyboard kit with 128 ASCII upper/lower case set, 96 printable characters, onboard regulator, parity, logic selection and choice of 4 handshaking signals to mate with almost any computer. \$64.95 plus \$2 p&h. 		<p>SEND TODAY!</p> <ul style="list-style-type: none"> <input type="checkbox"/> Deluxe metal cabinet for ASCII Keyboard. \$19.95 plus \$2.50 p&h. <input type="checkbox"/> ELF II Tiny BASIC on cassette tape. Commands include SAVE, LOAD, GOTO, GOSUB, RETURN, END, REM, CLEAR, LIST, RUN, PLOT, PEEK, POKE. Comes fully documented and includes alphanumeric generator and includes alphanumeric characters required to display alphanumeric characters directly on your TV screen without additional hardware. Also plays tick-tack-toe plus a drawing game that uses ELF II's hex keyboard as a joystick. 4k memory required. \$14.95 postpaid. <input type="checkbox"/> Tom Pittman's <i>Short Course on Tiny BASIC</i> for ELF II. \$5 postpaid. <input type="checkbox"/> Expansion Power Supply (required when adding 4k RAM). \$34.95 plus \$2 p&h. <input type="checkbox"/> ELF-BUG™ Deluxe System Monitor on cassette tape. Allows displaying the contents of all registers on your TV at any point in your program. Also displays 24 bytes of memory with full addresses, blinking cursor and auto scrolling. A must for the serious programmer! \$14.95 postpaid. 	
<p>Netronics R&D Ltd., Dept. PE 11 333 Litchfield Road. Phone New Milford, CT 06776 (203) 354-9375</p>		<p>Yes! I want to run programs at home and have enclosed: <input type="checkbox"/> \$99.95 plus \$3 postage & handling for RCA COSMAC ELF II kit, <input type="checkbox"/> \$4.95 for power supply (required), <input type="checkbox"/> \$5 for RCA 1802 User's Manual, <input type="checkbox"/> \$5 for <i>Short Course on Microprocessor & Computer Programming</i></p>	
<p><input type="checkbox"/> I want mine wired and tested with power supply, RCA 1802 User's Manual and <i>Short Course</i> included for just \$149.95 plus \$3 p&h!</p>		<p><input type="checkbox"/> I am also enclosing payment (including postage & handling) for the items checked at the left.</p>	
<p>Total Enclosed (Conn. res. add tax) \$ _____ <input type="checkbox"/> Check here if you are enclosing Money Order or Cashier's Check to expedite shipment</p>		<p>USE YOUR <input type="checkbox"/> VISA <input type="checkbox"/> Master Charge <input type="checkbox"/> Interbank # _____) Account # _____) Signature _____ Exp. Date _____</p>	
<p>PHONE ORDERS ACCEPTED (203) 354-9375</p>			
<p>Print Name _____</p>		<p>Address _____</p>	
<p>City _____</p>		<p>State _____ Zip _____</p>	
<p align="center">Call or write for wired prices!</p>			
<p align="center">DEALER INQUIRIES INVITED</p>			

AMAZING EARADIO
THIS IS PROBABLY THE WORLD'S SMALLEST RADIO. IT WEIGHS ONLY 1/2 OUNCE AND SWEARS BEHIND THE EAR. CONTAINS AN IC AND SEVERAL DISCRETE DEVICES TO GIVE AN EQUIVALENT OF 12 TRANSISTORS. THE RADIO HAS A I.R.F.F. DESIGN OPERATING FROM 1 STANDARD SIZE 1.5V HEARING AID BATTERY (INCLUDED). IT PROVIDES GOOD VOLUME TO EARPHONE ON SEVERAL STATIONS IN METROPOLITAN AREAS. DOESN'T REQUIRE ANY ANTENNA, GROUND OR OTHER ADDITIONAL WIRES - FULLY SELF-CONTAINED & TUNABLE. SIZE: 1 1/8" x 1 1/4" x 3/8" **\$5.95**

Crystal Oscillator 14.04 Mhz IC oscillator. **\$1.98**

Green Neon Same as NE2 but glows GREEN. Op. pressure on 120V. **\$1.00**

Crystal Watch 125 kHz Motorola. **\$1.25**

Slide Switch Assortment. **\$1.00**

Micro-Immature Pottery Switch. **79¢**

LASCR 200 VOLT 3 AMP. **4 for \$1.00**

100M PHOTOFLASH Kit
SIMPLE TO ASSEMBLE KIT INCLUDES PRE-ASSEMBLED CIRCUIT BOARD, CAPACITOR, FLASHTUBE, REFLECTOR, SWITCH AND WOOKUP DIAGRAM. LESS CASE, BATTERY HOLDER, AND BATTERIES (OPERATES ON 2 AA CELLS). GUIDE #28 AT ASA 25. **\$2.95**

14" STROBE / SHUTTER CORD **\$1**

Strobe Light Kit This battery operated device continuously emits a burst of orange light. Great safety device for bicyclists, skiers, skaters, skiers, boaters & campers. Comes complete with pre-wired, plastic quality glass epoxy P.C. board & wires. No soldering, no tools, no test equipment. Uses high output neon flash tube which flashes 2 times per second when battery is switched. Order set complete for 12 hours of operation. 12 batteries. You need only 1 supply the batteries and 12 hours of operation. **\$6.95**

Electronic Warning Flasher Kit This battery operated device continuously emits a burst of orange light. Great safety device for bicyclists, skiers, skaters, skiers, boaters & campers. Comes complete with pre-wired, plastic quality glass epoxy P.C. board & wires. No soldering, no tools, no test equipment. Uses high output neon flash tube which flashes 2 times per second when battery is switched. Order set complete for 12 hours of operation. 12 batteries. You need only 1 supply the batteries and 12 hours of operation. **\$6.95**

PHOTOFLASH CAPS
350 mf 330V **1.00**
720 mf 360V **1.50**
1600 mf 360V **\$2.25**

CALCULATOR BOARDS
WITH DISPLAY LESS KEYBOARD AND CASE (AS IS) **\$1.50**

STROBE TUBE ASSY. Brand new factory prime strobe tubes. Assortment of 5 strobe tubes. w/ schematics. **C23280 \$3.00**

MINIATURE REFLECTOR Appx. size 1 7/16" L x 7/16" W x 3/4" D. **C23227 \$1.00**

CHANEY electronics
P.O. BOX 27038, DENVER, CO 80227 Ph. (303) 973-1052
Send for our FREE GIANT CATALOG of unique items!
CIRCLE NO. 9 ON FREE INFORMATION CARD

number. The first byte is devoted to the exponent which can range between -128 and +127. This means that the scale factor applied to the fraction (base to exponent power) can range between 2^{-128} and 2^{127} which is equivalent to about 10^{-38} to 10^{37} . The fraction is a simple triple precision binary fraction ranging between, but not including, -1 and +1. This format gives an accuracy equivalent to 6 to 7 decimal places. Another popular format requires 8 bytes

plies the fractions together using a fractional multiply routine and adds the exponents together. Since the product of the fractions may be less than 1/2, normalization of the result might be necessary. In fact, only normalize left is ever required since the product will always be between 1/4 and 1.

Overflow is also possible. An overflow condition exists if the exponent ever exceeds 127 either as the result of the multiplication or during the normalization

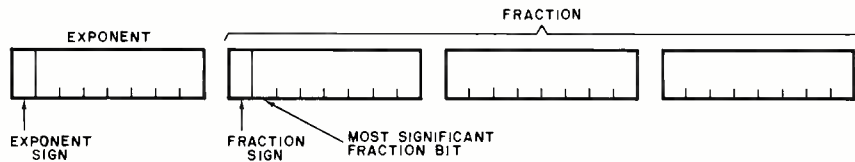

Fig. 1. Typical four-byte floating-point format.

and simply extends the fraction to 56 bits which is equivalent to about 17 decimal digits. Note that the fraction of a normalized base-2 floating-point number must be between 1/2 and 1 which means that the most significant fraction bit will always be a one. Some floating-point software packages take advantage of this fact and omit this bit. The fraction can then be shifted left one bit making room for an additional bit of accuracy at the right end with no increase in storage space.

process. Overflow is a serious error which renders any results useless. If the exponent should ever become more negative than -128, then underflow is said to have occurred. This means that the number has become so small that it cannot be distinguished from zero. This is a much less serious error and is usually handled by setting the result equal to zero and continuing.

Division is nearly as simple. One divides the fractions and subtracts the divisor exponent from the dividend exponent. Unnormalized results are again possible but this time they may range between 1/2 and 2 which means that a right shifting normalize may be required.

Floating add and subtract are more difficult and in fact may be nearly as slow as multiply and divide on a microcomputer.

Conversion Binary and Decimal.

Even though base-2 floating point is most efficient for the computer, people demand the use of decimal numbers. The conversion process, while relatively straightforward, is too complex to explain in detail here. One difficulty with the conversion is that round decimal fractions, such as 0.1, cannot be represented exactly in binary floating-point form. Likewise, round binary fractions such as $1/32,768$ cannot be represented exactly by fewer than 14 decimal digits. Integers smaller than about 8,000,000 for the 4-byte format discussed earlier are however converted exactly in both directions. The important point to remember is that the conversions are as accurate as the number of bits or digits allow, and that real-world data seldom involves "exact fractions" such as 0.1.

Normalization is a very important operation in floating-point arithmetic. As previously stated, a normalized binary floating-point number has a fraction between 1/2 and 1. An arithmetic operation however can produce an un-normalized result or even a "fraction" greater than 1. Normalization is accomplished by shifting the fraction in the appropriate direction and then either incrementing or decrementing the exponent to compensate, thus leaving the value of the number unchanged. For example, if an addition operation left the result 0.0813×2^9 (decimal representation of binary floating point) one would want to shift the fraction left which multiplies it by two for each shift. To compensate, the exponent must be decremented by one for each shift. After three shifts, the fraction becomes 0.6504 and the exponent becomes 6 which leaves the equivalent number, 41.6256, unchanged.

Arithmetic Operations. Floating-point number representation makes arithmetic on such numbers more difficult since now both the fraction and the exponent enter the arithmetic. Multiplication is probably the simplest floating-point operation. One simply multi-

Includes Functional Tilt Stand!

NEW EICO 270
3 1/2 DIGIT DMM KIT
ONLY \$79.95

Introductory Offer—FREE AC ADAPTOR

The first and only lab accuracy portable DMM Kit featuring MOS/LSI IC economy and reliability. Measures DC/AC Volts, Kilohms, DC/AC milliamps in 21 ranges. Polarity indicators and overload protection are provided, and 0.5 inch LED displays give easiest-to-read digital readout to 1999. The 270 features a basic 0.5% DC accuracy, 10 Megohm input impedance, low voltage drop in all current ranges and automatically-flashing overrange indicator. **Assembled \$109.95**

FREE '78 EICO CATALOG
Check reader service card or send 50¢ for first class mail. See your local EICO Dealer or call (516) 681-9300, 9:00 a.m.-5:00 p.m. EST. Major credit cards accepted.

EICO-108 New South Rd. Hicksville, N.Y. 11801

EICO

CIRCLE NO. 20 ON FREE INFORMATION CARD



Software Sources

Data File for 8080/Z80 and 6800.

The DATA FILE, which runs in 1K, is a data entry and search system, available for all 6800 and 8080/Z80 systems. Cross-referencing provisions allow such retrieval methods as finding phone numbers or addresses by entering the initials of the person desired. Other features include editing, for updating files, automatic top-of-memory check, continuous display of memory addresses (for saving data on tape or disk). Program comes with hex/assembly listing, and patches for most popular I/O boards. Listing only (specify 6800 or 8080) is \$10. Tapes (6800 KC-Std, 8080 Tarbell or National Multiplex cassettes or 8080 Intel format paper tapes) are \$15. SWTP or North Star disk versions are \$16. Practical Programming Co., Box 3069, North Brunswick, NJ 08902.

6800 Extended BASIC Compiler.

Not an interpreter (like most BASIC's) but a compiler, this program generates compact application programs (about 60% of source size) which run with increased speed. The code can be stored in ROM, and can also be distributed without revealing the source code.

Other features include formatted output, strings, file I/O, 10-digit decimal arithmetic, floating point, PEEK/POKE and long variable names. The compiler (used only to generate code, not used at run time) requires 16K; the runtime package requires 10K, plus approximately 2K for an I/O package. A 16K machine can run a 225-line BASIC program, a 32K machine can run an 1100-line. On Smoke Signal floppy disk, \$325, with manual and assembler. BASIC and Assembler manuals only, \$10. Smoke Signal Broadcasting, Box 2017, Hollywood, CA 90028.

BASIC Programs for Pet. Nineteen tapes of BASIC programs for the Commodore Pet computer are now available from Don Alan enterprises. Most of the cassettes (which are priced from \$4.95 to \$19.95) are game programs, but the series also includes biorhythm, loan amortization, sketch-pad plotting, and a checkbook program. Don Alan Enterprises, Box 401, Marlton, NJ 08053.

Heathkit H8 Utilities and Games.

This series of 10 programs for the H8 includes 2 cassettes of games in BH BASIC, 3 cassettes of machine-language games using

wirewrap

Incredible! but True
Precut wire is Cheaper than cutting your own!

Fast • Reliable • Economical
No more cutting & stripping by hand
Good clean uniform strip
Cheaper than using bulk wire

WIRE KITS

#1	\$6.95	#2	\$19.95
250 3" 100 4"		250 7" 250 7"	
250 3" 100 5"		250 3" 100 5"	
100 4" 100 6"		250 3" 250 6"	
		250 3" 100 6"	
		250 4" 100 7"	

Choose One Color or Assortment *250 ft Roll



\$34.95
HOBBY WRAP
Model BW 630

with **FREE** WIRE KIT #1
(\$6.95 Value)

It's **Like** getting it for **\$28.00**

Batteries & Charger \$11.00

PAGE DIGITAL ELECTRONICS

135 E. Chestnut St. #5 Monrovia, CA 91016 (213) 357-5005

We also have:
PRECUT WIRE BY SIZE
WIRE WRAP SOCKETS
WIRE WRAP TOOLS
INTERCONNECT CABLES
PROTOTYPING BOARDS
SOLDERLESS BREADBOARDS
AND MORE!

Catalog available on request

Ordering Information:
• Orders under \$25 and COD's add \$2
• All others, shipped Ppd in U.S. via UPS
• For Blue Label (Air) or 1st Class add \$1
• We accept Visa & MasterCard
Dealer Inquiries Invited

CIRCLE NO 50 ON FREE INFORMATION CARD

THE MICROCOMPUTER MART

COMPUTER RETAIL STORES

CALIFORNIA

Rainbow Computing
Complete Apple II Line
10723 White Oak Avenue
Granada Hills, CA 91344
(213) 360-2171

COLORADO

Byte Shop
Complete Apple II Line
3664 South Acoma Street
Englewood, CO 80110
(303) 761-6232

ILLINOIS

American Microprocessors
Equipment and Supply Corporation
6934 North University
Peoria, IL 61614
(309) 692-5852

American Microprocessors
Equipment and Supply Corporation
At The Chicagoland Airport
20 North Michigan Avenue
Half Day, IL 60069
(312) 234-0076

Lillipute Computer Mart, Inc.
Complete Microcomputers and Peripherals
4446 Oakton Street
Skokie, IL 60076
(312) 674-1383

MARYLAND

Computers Unlimited, Inc.
Tomorrow's Technology Today
907 York Road
Towson, MD 21204
(301) 321-1553

MICHIGAN

United Microsystems Corporation
The Professional Computer Store
2601 South State Street
Ann Arbor, MI 48104
(313) 668-6806

The Computer Mart
We Will Not Be Undersold
1800 West 14 Mile Road
Royal Oak, MI 48073
(313) 576-0900

NEW JERSEY

Computer Mart of New Jersey
The Microcomputer People™
501 Route 27
Iselin, NJ 08830
(201) 283-0600

NEW YORK

Computer Mart of New York
First In The East
118 Madison Avenue
(30th Street Entrance)
New York, NY 10016
(212) 360-686-7923

Byte Shop Of New York
The Affordable Computer Store
130 East 40th Street
New York, NY 10016
(212) 889-4204

OKLAHOMA

Microolithics, Inc.
Medical Systems-Differential Diagnosis
2918 North MacArthur Boulevard
Oklahoma City, OK 73127
(405) 947-5646

OHIO

Digital Design
Cincinnati's First Computer Store
7694 Camargo Road, Madeira
Cincinnati, OH 45243
(513) 561-673

Ohio Microcomputer Specialists, Inc.
IMSAI Personal and Business Systems
1265 Grandview Avenue
Columbus, OH 43212
(614) 488-1849

PENNSYLVANIA

Personal Computer Corporation
First In Pennsylvania
Frazer Mall
Lancaster Avenue & Route 352
Frazer, PA 19355
(213) 647-8463

SOUTH CAROLINA

Byte Shop #32
The Affordable Computer Store
1920 Blossom Street
Columbia, SC 29205
(803) 771-7824

VIRGINIA

The Computer Hardware Store
Alpha-Micro, Apple II, S-100
818 Franklin Street
Alexandria, VA 22314
(703) 584-8085

CANADA

TJB Microsystems LTD
Your Commodore PET Headquarters
10991-124th Street
Edmonton, Alberta, Canada
T5M 0H9
(403) 455-5298

Dealers: For information about how to have your store listed in THE MICROCOMPUTER MART, please contact: POPULAR ELECTRONICS, One Park Ave., New York, N.Y. 10016 • (212) 725-3568.

Put Professional Knowledge and a
COLLEGE DEGREE
in your Electronics Career through
HOME STUDY

Earn Your
DEGREE

by correspondence, while continuing your present job. No commuting to class. Study at your own pace. Learn from complete and explicit lesson materials, with additional assistance from our home-study instructors. Advance as fast as you wish, but take all the time you need to master each topic. Profit from, and enjoy, the advantages of directed but self-paced home study.

The Grantham electronics degree program begins with basics, leads first to the A.S.E.T. degree, and then to the B.S.E.E. degree. Our free bulletin gives complete details of the program itself, the degrees awarded, the requirements for each degree, and how to enroll. Write for *Bulletin B-79*.

Grantham College of Engineering
2000 Stoner Avenue
P. O. Box 25992
Los Angeles, CA 90025

Worldwide Career Training thru Home Study
CIRCLE NO. 25 ON FREE INFORMATION CARD

SAVE!

MONEY • TIME • FREIGHT

QUALITY STEREO EQUIPMENT
AT LOWEST PRICES.

YOUR REQUEST FOR QUOTA-
TION RETURNED SAME DAY.

FACTORY SEALED CARTONS—
GUARANTEED AND INSURED.

SAVE ON NAME BRANDS LIKE:

PIONEER	SANSUI
KENWOOD	DYNACO
SHURE	SONY
MARANTZ	KOSS

AND MORE THAN 50 OTHERS
BUY THE MODERN WAY
BY MAIL—FROM

illinois audio

12 East Delaware
Chicago, Illinois 60611
312-664-0020

CIRCLE NO. 29 ON FREE INFORMATION CARD

the H8 front panel, and one machine-language game for terminal use. Utility programs include: ham-code practice (front panel or terminal), calculator & clock (front panel), and Educator-8080, a programming-instruction program which displays registers after each command. BASIC programs will run in 8K, others in 4K. \$10 each. Multi-Micro Media, Box 1025, Arvada, CO 80001.

TRS-80 Machine-Language Software. Small System Software offers a series of TRS-80 utility and game program cassettes. For 4K machines, they offer a 21-command, 2K monitor (\$17.95), an expanded monitor with Z80 disassembler (\$23.95), the game of LIFE (\$14.95), and Microchess (\$19.95). For 16K machines, there is a TRS-80 version of Michael Shroyer's ESP-1 assembler/editor/monitor (\$29.95). Also a disassembled listing of Radio Shack's Level-I BASIC (\$7.95). Small System Software, Box 483, Newbury Park, CA 91320.

North Star Word Processor. SOL*STAR is a word processor designed for North-Star-equipped Sol computers. Also usable on any 8080 or Z80 system with keyboard. North-Star floppy disk system, at least 16K RAM beginning at 2000 hex, a Processor Technology VDM-1 and video monitor, and as a printer, either a Selecterm (Selectric II), Multiterm (Diablo) or Teletype. The system allows corrections, additions, deletions or movement of characters, words, phrases and large copy blocks, right and left justification, spacing and margin controls, character-string search and replacement, and word count. Disk "housekeeping" is handled automatically, and the system adds two disk commands (Append File and Insert File) not found in the North Star DOS. SOL*STAR is \$198, including manual (manual alone \$5, refundable with purchase). Micro Applications, 1913 Harbor Blvd., Costa Mesa, CA 92627.

8080 High-Level Language. OPUS, a high-level language for 8080 and Z80 computers, is now available in two versions, OPUS/ONE and OPUS/TWO. The command set shared by both versions includes many BASIC-like commands (GOSUB, GOTO, etc.), plus print formatting and extensive file-handling facilities. OPUS/TWO adds capabilities for error trapping, external and machine-code subroutines, jumping out of "blocks," extended substring search, overlays, and additional file and disc manipulation commands. OPUS/ONE programs are upward-compatible to run under OPUS/TWO. OPUS/TWO may also be run under TEMPOS, a multi-tasking operating system available separately. The programs are available on MITS (hard-sectored) or iCOM (IBM 3740-type) diskette, paper tape, or MITS cassette, at \$99 for OPUS/ONE, \$195 for OPUS/TWO. A User's Manual covering both versions is \$10.00. Write: Administrative Systems, Inc., 222 Milwaukee, Suite 102, Denver, CO 80206.

J&R BLANK TAPES & ACCESSORIES
AT WHOLESALE PRICES!

BLANK TAPES

CASSETTE TAPES

Ampeg Grand Master I C 60	\$2.14	TDK D C 60	\$1.20
Ampeg Grand Master II C 90	\$2.79	TDK D C 90	\$1.68
BASF Studio C 90	\$2.69	TDK D C 120	\$2.10
BASF Professional II or III C 90	\$2.99	TDK D 180	\$2.98
Maxell UD C 60	\$1.93	TDK AD C 60	\$1.79
Maxell UD C 90	\$2.84	TDK AD C 90	\$2.52
Maxell UDXL I or II C 60	\$2.47	TDK SA C 60	\$5.22
Maxell UDXL I or II C 90	\$3.47	TDK SA C 90	\$3.18
Scotch low noise C 90 / 3 pk	\$4.99 for 3		
Scotch Master I C 90	\$2.84		
Scotch Master II or III C 90	\$3.29		
Sony Ferrichrome C 90	\$3.58		

REEL-TO-REEL

Maxell UD 35-90B 1800 ft.	\$5.49
Maxell UDXL 35-90B 1800 ft.	\$6.62
Maxell UD 35-180 3600 ft.	\$14.70
Scotch 212 1800 ft.	\$4.35
Scotch 207 1800 ft.	\$5.19
TDK L 1800 1800 ft.	\$5.22

Minimum Order 12 Tapes — 100% Guaranteed

CARTRIDGES audio-technica

AT 20 SLA	\$119.00	V15 TYPE IV	\$89.90
AT 15 SA	\$82.50	V15 TYPE III	\$63.50
AT 14 SA	\$46.50	M912	\$21.00
AT 12 SA	\$34.50	M24H (QUAD)	\$36.50
AT 10	\$12.00	M70C	\$9.90

HEADPHONES

SE 205	\$19.95	PRO 4 AA	\$37.06
SE 505	\$46.70	PRO 4 AAA	\$45.00
SE 4	\$33.50	HV/1	\$26.97
SE 500	\$39.95	HV/TLC	\$35.97
SE 700	\$59.95	PHASE 2+2	\$93.00
		TECHNICIAN/VFR	\$49.00
		K/6A	\$13.97

HOW TO ORDER: For shipment within 48 hours, send money order or certified check. Two weeks delay on personal checks. Please add \$3.50 per order for shipping & handling, (\$5.50 for orders outside U.S.). N.Y.S. residents add tax. No C.O.D.'s. All merchandise 100% guaranteed, brand new & factory fresh.

J&R MUSIC WORLD
33 Park Row, Dept. PE, N.Y.C. 10038 (212) 732-8600

WRITE FOR FREE CATALOG
CIRCLE NO. 32 ON FREE INFORMATION CARD



NATCAM catalog
Shopping center for small and precision tools

A fine selection of small tools, measuring instruments, hard-to-find items for shop, home and lab. Convenient one-stop shopping for technicians, engineers, craftsmen, hobbyists. Major credit cards accepted, satisfaction assured. Get your NATCAM catalog today.

National Camera, Inc.
2000 West Union Ave., Dept. GGA
Englewood CO 80110 USA

CIRCLE NO. 41 ON FREE INFORMATION CARD

**DON'T BUY
IMITATIONS!
YOU DESERVE
THE BEST CB ANTENNA**

**PAL
'Firestiks'**

**5-YEAR*
UNCONDITIONAL
WARRANTY ON
ALL PAL WHIPS —
1 YEAR ON
ALL ACCESSORIES**

**SEND FOR FREE PAL
FULL-LINE
CATALOG AND DECAL**

**DEALER & DISTRIBUTOR
INQUIRIES INVITED**

PAL Antenna Corp.

2614 EAST ADAMS • PHOENIX, ARIZONA 85034

(602) 273-7151

Our 16th Year Serving the CB Market

*To original purchaser with receipt after 1 yr

CIRCLE NO 52 ON FREE INFORMATION CARD



Electronics Library

FIRST COMPUTER FAIRE PROCEEDINGS

edited by Jim C. Warren, Jr.

This fascinating book is a compilation of some 93 papers on home and hobby computing that were presented at the First West Coast Computer Faire in April, 1977. The papers are grouped in 25 sections, covering just about every area of this field. Many thought-provoking ideas are presented for both software and hardware. If you didn't get to the Faire (or even if you did), this book will certainly be educational, and suggest some fascinating ways to use a home computer.

Published by Computer Faire, Box 1579, Palo Alto, CA 94302. 334 pages. \$12 soft cover.

TESTS-ANSWERS FOR FCC FIRST AND SECOND CLASS COMMERCIAL LICENSE, REVISED 1978 EDITION

by Warren Weagant

Fifteen multiple-choice examinations based on actual FCC exams are included in this book to prepare the reader for the Commercial license tests given by the Federal Communications Commission. In addition to the actual exams, there are helpful tips on how to set up a home-study program, uncovering additional review material, how to register for the exam, and a "Self-Study Ability Test" to be taken before starting preparation for the FCC license exams. This test is designed to study and understand FCC test material.

Published by Command Productions, Radio Engineering Division, Box 26348, San Francisco, CA 94126. 198 p. \$9.95, soft cover.

HOME COMPUTERS: A BEGINNERS GLOSSARY AND GUIDE

by Merl K. Miller and Charles J. Sippl

This is a manageable reference text for newcomers to home computing. The book begins by enumerating possible home applications of computers and describes their widespread commercial use. An enlightening discussion of microcomputer systems and technology follows, and further chapters explain types and applications of microcomputer memory and illustrate the intricacies of computer-oriented number systems. Also covered are microcomputer peripherals, languages, and basic theory of logic gates. But the heart of the book is its glossary, which contains hundreds of plain-language definitions and facts of computer-related material, and from which

TAPE DISCOUNTS

Minimum order 10 tapes



CASSETTES

TDK-DC-45	1 09
TDK-DC-60	1 29
TDK-DC-90	1 69
TDK-DC-180	2 99
TDK-SAC-60	1 99
TDK-SAC-90	2 99
TDK-ADC-60	1 79
TDK-ADC-90	2 89

B-TRACK

TDK-45 D 9H	1 59
TDK-90 D 9H	1 99
TDK-45 A 2 BH	2 29
TDK-90 A 2 BH	2 99

OPEN REEL

TDK-L 1800	5 29
TDK-S 1800	4 29



maxell

CASSETTES

UDXL I OR II C-60	2 99
UDXL I OR II C-90	3 99
UDC-46	1 99
UDC-60	2 49
UDC-90	2 99
LNC-46	1 29
LNC-60	1 49
LNC-90	2 39
LNC-120	3 29

**OUR BRAND! C-90 CASSETTES, 3 for \$1.59;
40 Min BTR CART. - 99c ea**

LIFETIME PRODUCT GUARANTEE!

ORDER NOW! Orders shipped within 1-3 days.
Please add \$2.00 for shipping and handling per
order. N.Y.S. Res. add sales tax. N.C. C.O.D.'s.
FREE CATALOG!

CONSUMERS CO

P.O. Box 559 Dept. PC 111

Mt. Vernon, N.Y. 10551 Phone (914) 664-2909

CIRCLE NO 14 ON FREE INFORMATION CARD



Thousands of Communications Electronics customers
OWN A BEARCAT® SCANNER.
But since we've introduced the Bearcat® 250 crystalless
15,600 frequency, 50 channel synthesized scanner,
our specifications have been improved:

Sensitivity

0.4 microvolts for 12dB SINAD on VHF
bands, UHF band slightly less

Selectivity

Better than -60dB @ ±25 KHz

Audio Output

At least 2.0 Watts rms

Audio Quality

The BC-250 audio is more noise-free and
suffers less distortion than comparable
models by a margin of 10dB or more.

Image Rejection

The BC-250 rejects image frequencies by at least
8dB better in all bands than comparable models.

This month, we've got a special price
on the Bearcat® 250. Now, you can own this fantastic
professional monitor for only \$319.00. That's a
savings of over \$80.00. Order now for Christmas.

To start Bearcatting, Master Charge and Visa card
holders may call and order toll free 800-521-4414.
Outside the U.S. and Michigan dial 313-994-4441.
To order by mail, send \$319.00 plus \$5.00 for U.S.
U.P.S. shipping. Foreign orders invited at slightly
higher cost. Mail your orders or requests for a free
catalog completely describing all Bearcat® scanners to:
Communications Electronics, Box 1002,
Dept. HF1, Ann Arbor, Michigan 48106 U.S.A.
Bearcat® is a registered trademark of Masco Corporation of Indiana
Copyright ©1978 Communications Electronics

CIRCLE NO 11 ON FREE INFORMATION CARD

Buy Direct!

by phone
by catalog
that's free

We sell top name
brands of Hi-Fi equip-
ment, accessories,
records, and tapes at
incredibly discounted
prices. Our catalog
contains 48 pages of
select quality products
and its FREE.

Order one now, or call
TOLL FREE.

1-800-638-3920



PE 1178

Name _____

Address _____

City _____

State _____ Zip _____

STEREO DISCOUNTERS

6730 Santa Barbara Court Balto. Md. 21227



YOU'RE READING POPULAR ELECTRONICS.

That already says a lot about you. That you're fascinated by the diversity of electronics.

Everything from microcomputers to audio, from construction projects to ham radio. Who knows what area of electronics will catch your interest next? That's why you read P.E. To keep in touch with all that's new and best in the many worlds of consumer electronics.

Popular Electronics

World's largest-selling electronics magazine

the reader can obtain much accurate knowledge of the home computer field.

Published by dilithium Press, 30 NW 23rd Place, Portland, OR 97210. 147 pages. \$6.95 soft cover.

IEEE STANDARD DICTIONARY OF ELECTRICAL & ELECTRONICS TERMS

edited by Frank Jay

This reference text defines over 20,000 electrical and electronics terms and includes 7000 items not covered in the previous edition. Definitions include listings of documents from which information is drawn (mostly IEEE Standards). Highlights of the new book's format include simplified identification of sources, easy-to-read presentation of equations and formulas, notes on preferred terminology, cross-indexing of related terms, and many explanatory notes. Additionally, this dictionary identifies 10,000 electronics acronyms. It is one of the most authoritative and up-to-date reference texts of its kind, valuable to anyone involved with electronics.

Published by IEEE, 345 E 47th St., New York, NY 10017. 882 pages. \$24.95, hard cover.

THE SCIENCE OF HI-FIDELITY

by Kenneth W. Johnson and Willard C. Walker

This exciting text uses hi-fidelity as the vehicle for teaching basic college physics. It is an excellent reference for audiophiles who wish to increase their technical knowledge and gain a better understanding of the scientific laws governing their hobby. First, a basic hi-fi system is analyzed, while details of hi-fi components and features are related. Then the physics starts: the next few chapters cover waves and sound, including forced vibrations, the Doppler effect, sound power and decibels, the Fletcher-Munson curves, wave interference, and Fourier analysis. These principles are subsequently examined as applied to speaker systems, along with speaker specifications and properties. Next, basic electricity is investigated, followed by a detailed look at amplifiers, tuners, and preamplifiers and their functions, characteristics, and features. Electromagnetism is discussed too, with examples of applications to speakers, tape recorders, and phono cartridges. An in-depth look at records, turntables, phono cartridges, and tonearms is included. The final chapters of the book report on tape equipment, noise-reduction systems, recording aids, and four-channel sound. Each of the 14 chapters features numerous photographs and diagrams, a summary of terms with definitions, and multiple-choice exercises to test one's knowledge of the material covered.

Published by Kendall/Hunt Publishing Company, 2460 Kerper Blvd., Dubuque, IA 52001. 519 pages. \$14.95 soft cover.

FM ATLAS AND STATION DIRECTORY FIFTH EDITION

by Bruce F. Elving, Ph. D.

A comprehensive list of the FM radio stations

broadcasting in North America, this book's "FMaps" show cities with FM stations, giving their call letters and frequencies. Station Directories are arranged by geography and frequency, listing individual station musical formats, network affiliations, primary and secondary coverage radii in miles. Coverage figures have been calculated from new FCC curves. The book also notes whether a station broadcasts in stereo, has vertical polarization (best for reception in automobiles), and SCA service with specific SCA uses noted. Revised editorial content includes discussions of developments in FM broadcasting, "phony" stereo, quadrphony, tips on buying an FM radio for your car, improving reception, and "SCA: Radio's Great Unexploited Frontier."

Published by the FM Atlas Publishing Co., Adolph, MN 55701. 112 pages. \$3.95, soft cover.

110 ELECTRONIC ALARM PROJECTS

by R. M. Marston

The guide describes 110 alarm circuits suitable for use in homes, vehicles, and industrial applications. The leading chapter discusses contact-operated alarm circuits, along with bell, relay, and loudspeaker outputs. A comprehensive explanation of burglar alarms and sensor systems follows, with notes on accessory circuits and installation. Other alarm types include those sensitive to heat, light, liquid and steam, pressure, ultrasonic and audible sound, vibration, current, voltage, resistance, and capacitance. Typical applications presented use light-sensitive circuits as smoke detectors, ultrasonic transceiving systems as intruder alerts, capacitance-sensitive circuits as proximity detectors, and concealed switching circuits as automobile anti-theft devices. The theory of operation and a schematic diagram are provided for each of the 110 easy-to-build projects.

Published by Hayden Book Company, Inc., 50 Essex St., Rochelle Park, NJ 07662. 112 pages. \$4.95, soft cover.

THE DESIGN OF OPERATIONAL AMPLIFIER CIRCUITS, WITH EXPERIMENTS

by Howard M. Berlin

This book, one of E & L Instrument's BUG-BOOKS,™ covers the design and application of basic operational amplifier circuits. The text's theory sections are coupled with a series of more than 35 experiments that can be performed by the reader. Among the topics presented are linear amplifiers, differentiators, integrators, voltage and current converters, comparators, rectifiers, oscillators, active filters, and op-amp circuits using single-ended power supplies. Applications information and pinouts for common operational amplifier IC's, derivation of closed-loop responses, and a guide to E & L's Model OA-2 Op-Amp Designer are included.

Published by E & L Instruments, Inc., 61 First Street, Derby, CT 06418. 271 pages, including index and appendices. \$8.50, soft cover.

Radio Shack: No. 1 Parts Place

Low Prices and New Items Everyday!

Top-quality devices, fully functional, carefully inspected. Guaranteed to meet all specifications, both electrically and mechanically. All are made by well-known American manufacturers, and all have to pass manufacturer's quality control procedures. These are not rejects, not fallouts, not seconds. In fact, there are none better on the market! Always count on Radio Shack for the finest quality electronic parts!

Linear ICs

By National Semiconductor and Motorola — first quality

Type	Cat. No.	ONLY
301CN	276-017	49¢
324N	276-1711	1.49
339N	276-1712	1.49
386CN	276-1731	99¢
555CN	276-1723	79¢
556CN	276-1728	1.39
585CN	276-1724	1.89
587CN	276-1721	1.99
723CN	276-1740	69¢
741CN	276-007	49¢
741H	276-010	49¢
3900N	276-1713	99¢
3909N	276-1705	99¢
3911N	276-1706	1.99
4558CN	276-038	79¢
75491	276-1701	99¢
75492	276-1702	99¢
7805	276-1770	1.29
7812	276-1771	1.29
7815	276-1772	1.29

Hand-Held 6-Digit Frequency Counter

- Counts from 100 Hz to 45 MHz **99⁹⁵**
- kHz and MHz Decimals

A high quality "pocket" counter with accuracy of 3ppm at 25°C or less than 30 Hz at 10 MHz! Overload-protected 1-meg input. Sensitivity, 30 mV up to 30 MHz. Lead-zero blanking. Just 3x4 1/2". With mini-rod antenna, leads, case, instructions. Requires 9V alkaline battery. 22-351 **99.95**



Wire Wrapping Accessories

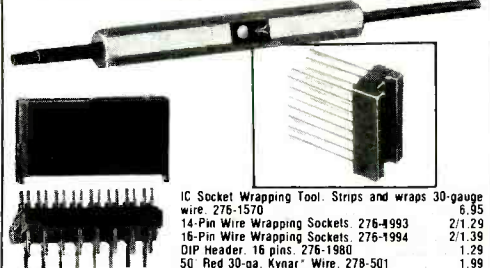

IC Socket Wrapping Tool. Strips and wraps 30-gauge wire. 276-1570 **6.95**
 14-Pin Wire Wrapping Sockets. 276-4993 **21.29**
 16-Pin Wire Wrapping Sockets. 276-1994 **21.39**
 DIP Header. 16 pins. 276-1980 **1.29**
 50 Red 30-ga. Kynar® Wire. 278-501 **1.99**
 50 White 30-ga. Kynar Wire. 278-502 **1.99**
 50 Blue 30-ga. Kynar Wire. 278-503 **1.99**

Computer Chip



8-Bit Data Bus, 16-Bit Address Bus

8080A Microprocessor. 100% prime CPU handles up to 65K bytes memory. 276-2510. **12.95**

RAM Memory IC



Under 450 nS Access Time

2102 1K Static RAM. Low power version. 16-pin DIP. Buy 8 and save! 276-2501 **2.49 Ea. or 8/14.95**

TTL and CMOS Logic ICs



Full-Spec. Devices Direct from Motorola and National Semiconductor

Type	Cat. No.	ONLY
7400	276-1801	35¢
7402	276-1811	39¢
7404	276-1802	35¢
7406	276-1821	49¢
7410	276-1807	39¢
7413	276-1815	79¢
7420	276-1809	39¢
7427	276-1823	49¢
7432	276-1824	49¢
7441	276-1804	99¢
7447	276-1805	99¢
7448	276-1816	99¢
7451	276-1825	39¢
7473	276-1803	49¢
7474	276-1818	49¢
7475	276-1806	79¢
7476	276-1813	59¢
7485	276-1826	1.19
7486	276-1827	49¢
7490	276-1808	79¢
7492	276-1819	69¢
74123	276-1817	99¢
74145	276-1828	1.19
74150	276-1829	1.39
74154	276-1834	1.29
74192	276-1831	1.19
74193	276-1820	1.19
74194	276-1832	1.19
74196	276-1833	1.29
4001	276-2401	49¢
4011	276-2411	49¢
4013	276-2413	89¢
4017	276-2417	1.49
4020	276-2420	1.49
4027	276-2427	89¢
4049	276-2449	69¢
4050	276-2450	69¢
4511	276-2447	1.69
4518	276-2490	1.49

NEW IC Breadboard Sockets



Modular boards snap together and feature standard 0.3" center. Accepts 22 through 30-gauge solid hook wire.

- ⓐ 550 connections in 2 bus strips of 40 tie points each with 47 rows of 5 connected tie points. 2 1/2"x6". 276-174 **9.95**
- ⓑ 270 connections in 2 bus strips of 40 tie points each with 23 rows of 5 connected tie points. 2 1/2"x3 3/4". 276-175 **5.95**
- ⓒ Mini-Socket. 22 rows of 5 tie points each, plus 2 bus strips with 10 connections each. 2 1/2"x1 1/2". 276-176 **3.95**

Solar Cells Electricity from Light!

4cm x 2cm Silicon Cell

2 1/4" Dia. Silicon Cell



Silicon type cell converts light to electrical power, delivering up to 100 mA at 0.5V. Use several in series-parallel for higher voltage or current. 276-120 **2.99**

Highly efficient! Delivers up to 400 mA at 0.5V. Ideal for solar power projects, battery charging and operating electronic equipment. 276-121 **5.99**

Low-Cost Power Transformers

- Primaries Designed to Operate from 120VAC, 60 Hz
- Solder Lugs for Easy Wiring or PC Board Mounting

Volts	Current	Cat. No.	Each	Volts	Current	Cat. No.	Each
6.3	1.2A	273-050	2.49	6.3 CT	3A	273-1510	3.99
6.3	300 mA	273-1384	1.99	12.6 CT	3A	273-1511	4.69
12	300 mA	273-1385	1.99	25.2 CT	2A	273-1512	4.99
24	300 mA	273-1386	2.49	12	5A	273-1513	8.95
24	1.2A	273-1480	2.99	18 CT*	4A	273-1514	8.95
12.6 CT	1.2A	273-1505	2.89	18 CT*	2A	273-1515	4.99

* Ideal for 5V (using CT) or 12V solid-state regulators

NEW 3-Amp 4PDT Relay



With Clear Protective Cover

Switch up to four different circuits! Contacts rated 3 amps at 125VAC. 12VDC coil. 160 ohms resistance. Solder terminals. Just 1 1/2"x1 1/2"x1 1/2". 275-214 **4.99**

Radio Shack Reference Books



Digital Integrated Circuits. Complete specs. AC test circuits, waveforms. 62-1370 **3.95**
Voltage Regulator Handbook. 62-1371 **2.95**
Linear Integrated Circuits. Covers op-amps, voltage regulators, more. 62-1372 **3.95**
Linear Applications. Fully indexed and cross-referenced. 62-1373 **2.95**
Linear Applications, Vol. 2. The latest data sheets, applications. 62-1374 **2.95**

CMOS Integrated Circuits. Complete specs. CD4000 with data specs. 62-1375 **3.95**
Memory Data Book. 62-1376 **3.95**
Intel® 8080/8085 Programming Manual. Uses Intel's assembly language. 62-1377 **3.95**
Intel Memory Design Handbook. Companion to Data Catalog, below. 62-1378 **3.95**
Intel Data Catalog. 928 pages of complete specs on most intel standard devices. 62-1379 **4.95**

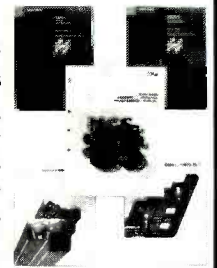

Paddle Switches



NEW

Rated 6 Amps at 125VAC

Mounts in 3/4" round hole — no need to cut square opening. SPST Black. 275-641 **1.69**
 SPDT Red. 275-642 **1.89**
 DPDT Black. 275-643 **2.19**

Lighted DPDT Pushbutton Switch



NEW

Push-on/push-off switch rated 4A at 12VDC. Button glows red in "on" position. Mounts in 1/2" hole. U.L. listed. 275-675 **4.69**

8-Rocker DIP Switch

Standard .100x.300" DIP



Designed for easy change of preset logic states in digital circuits. Fits 16-pin IC socket or mounts on PC board. 275-1301 **1.99**

Epoxy-Glass Plug-In PC Boards



For 22-pin connectors. 4 1/2"x4 1/2" grid. 3 styles available. Standard. 276-155 **4.49**
 Digital. 276-156 **4.49**
 Op-Amp. 276-157 **4.49**
 22-Pin Dual Connector. 276-1551 **2.99**

WHY WAIT FOR MAIL ORDER DELIVERY? IN STOCK NOW AT OUR STORE NEAR YOU!

Radio Shack®

A DIVISION OF TANDY CORPORATION • FORT WORTH, TEXAS 76102
 OVER 7000 LOCATIONS IN NINE COUNTRIES

Prices may vary at individual stores and dealers

ELECTRONICS Market Place

For free catalog including parts lists and schematics, send a self-addressed stamped envelope.

APPLE II SERIAL I/O INTERFACE *

Part no. 2
Baud rate is continuously adjustable from 0 to 30,000 • Plugs into any peripheral connector • Low current drain. RS-232 input and output • On board switch selectable 5 to 8 data bits, 1 or 2 stop bits, and parity or no parity either odd or even • Jumper selectable address • SOFTWARE • Input and Output routine from monitor or BASIC to teletype or other serial printer. • Program for using an Apple II for a video or an intelligent terminal. Also can output in correspondence code to interface with some selectrics Board only — \$15.00; with parts — \$42.00; assembled and tested — \$62.00.



T.V. TYPEWRITER

Part no. 106
• Stand alone TVT
• 32 char/line, 16 lines, modifications for 64 char/line included • Parallel ASCII (TTL) input • Video output • 1K on board memory • Output for computer controlled cursor • Auto scroll • Non-destructive cursor • Cursor inputs: up, down, left, right, home, EOL, EOS • Scroll up, down • Requires +5 volts at 1.5 amps, and -12 volts at 30 mA • All 7400, TTL chips • Char gen. 2513 • Upper case only • Board only \$39.00, with parts \$145.00

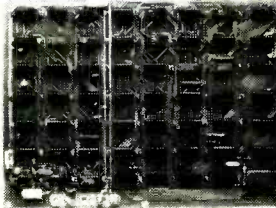

8K STATIC RAM

Part no. 300
• 8K Altair bus memory • Uses 2102 Static memory chips • Memory protect • Gold contacts • Wait states • On board regulator • S-100 bus compatible • Vector input option • TRI state buffered • Board only \$22.50; with parts \$160.00

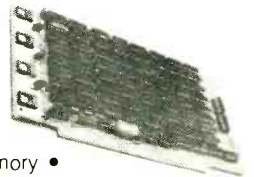

MODEM *

Part no. 109
• Type 103 • Full or half duplex • Works up to 300 baud • Originate or Answer • No coils, only low cost components • TTL input and output-serial • Connect 8 ohm speaker and crystal mic. directly to board • Uses XR FSK demodulator • Requires +5 volts • Board \$7.60; with parts \$27.50



TIDMA *

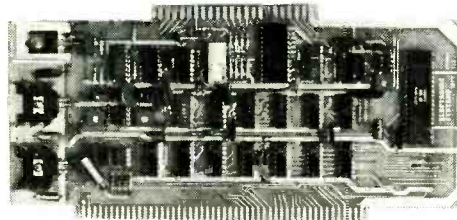

Part no. 112
• Tape Interface Direct Memory Access • Record and play programs without bootstrap loader (no prom) has FSK encoder/decoder for direct connections to low cost recorder at 1200 baud rate, and direct connections for inputs and outputs to a digital recorder at any baud rate. • S-100 bus compatible • Board only \$35.00; with parts \$110.00

RF MODULATOR *

Part no. 107
• Converts video to AM modulated RF, Channels 2 or 3. So powerful almost no tuning is required. On board regulated power supply makes this extremely stable. Rated very highly in Doctor Dobbs' Journal. Recommended by Apple. • Power required is 12 volts AC C.T., or +5 volts DC • Board \$7.60; with parts \$13.50



DC POWER SUPPLY *

Part no. 6085
• Board supplies a regulated +5 volts at 3 amps., +12, -12, and -5 volts at 1 amp. • Power required is 8 volts AC at 3 amps., and 24 volts AC C.T. at 1.5 amps • Board only \$12.50; with parts excluding transformers \$42.50



RS 232/TTY *

Part no. 600
• Converts RS-232 to 20mA current loop, and 20mA current loop to RS-232 • Two separate circuits • Requires +12 and -12 volts • Board only \$4.50, with parts \$7.00

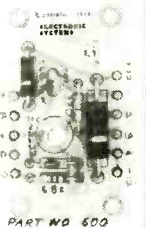

TAPE INTERFACE *

Part no. 111
• Play and record Kansas City Standard tapes • Converts a low cost tape recorder to a digital recorder • Works up to 1200 baud • Digital in and out are TTL-serial • Output of board connects to mic. in of recorder • Earphone of recorder connects to input on board • No coils • Requires +5 volts, low power drain • Board \$7.60; with parts \$27.50



UART & BAUD RATE GENERATOR *

Part no. 101
• Converts serial to parallel and parallel to serial • Low cost on board baud rate generator • Baud rates: 110, 150, 300, 600, 1200, and 2400 • Low power drain +5 volts and -12 volts required • TTL compatible • All characters contain a start bit, 5 to 8 data bits, 1 or 2 stop bits, and either odd or even parity • All connections go to a 44 pin gold plated edge connector • Board only \$12.00, with parts \$35.00 with connector add \$3.00

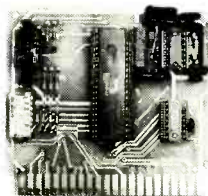

RS 232/TTL *

Part no. 232
• Converts TTL to RS-232, and converts RS-232 to TTL • Two separate circuits • Requires -12 and +12 volts • All connections go to a 10 pin gold plated edge connector • Board only \$4.50, with parts \$7.00 with connector add \$2.00

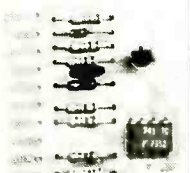

ELECTRONIC SYSTEMS

Dept. PE, P.O. Box 21638, San Jose, CA, USA 95151

To Order:

Mention part number and description. For parts kits add "A" to part number. In USA, shipping paid for orders accompanied by check, money order, or Master Charge, BankAmericard, or VISA number, expiration date and signature. Shipping charges added to C.O.D. orders. California residents add 6.5% for tax. Outside USA add 10% for air mail postage, no C.O.D.'s. Checks and money orders must be payable in US dollars. Parts kits include sockets for all ICs, components, and circuit board. Documentation is included with all products. All items are in stock, and will be shipped the day order is received via first class mail. Prices are in US dollars. No open accounts. To eliminate tariff in Canada boxes are marked "Computer Parts". Dealer inquiries invited. 24 Hour Order Line: (408) 226-4064



* Circuits designed by John Bell

NLS 15 Megahertz PORTABLE MINI-SCOPES

DUAL TRACE MS-215 \$435.00

SINGLE TRACE MS-15 \$318.00

with RECHARGEABLE BATTERIES & CHARGER

PORTABLE (2.7" Hx 6.4" Wx 7.5" D)

AVAILABLE OPTIONS - usable on both the MS-215 and the MS-15

41-140 Leather Carrying Case \$45.00 - 41-141 10 to 1 Probe \$24.50

DIP SWITCHES JS8722-03 \$1.40 JS8722-07 \$1.85
 SPST SLIDE TYPE JS8722-04 1.70 JS8722-08 1.95
 JS8722-01 \$1.00 JS8722-05 1.75 JS8722-09 2.00
 JS8722-02 1.08 JS8722-06 1.80 JS8722-10 2.20

Dash No. indicates number of switch positions on DIP Switch.

ALUMINUM ELECTROLYTIC (RADIAL LEAD)

val	10 volt	16 volt	25 volt	35 volt	50 volt
1	85/100	75/100	75/100	65/100	65/100
4	75/100	75/100	65/100	55/100	45/100
10	75/100	75/100	65/100	55/100	45/100
22	75/100	65/100	55/100	45/100	45/100
33	65/100	65/100	45/100	45/100	45/100
47	65/100	65/100	45/100	45/100	45/100
100	55/100	45/100	45/100	45/100	45/100
220	45/100	35/100	35/100	25/100	25/100
330	35/100	35/100	25/100	25/100	25/100
470	35/100	25/100	25/100	25/100	25/100
1000	4.40	2.85	2.50	2.50	2.50
2200	---	---	\$1.30	\$1.60	\$2.50

50 VOLT CERAMIC DISC CAPACITORS

of Qty	50 pF	100 pF	220 pF	470 pF	1000 pF	2200 pF	4700 pF	10000 pF
1	50 pF	220 pF	470 pF	1000 pF	2200 pF	4700 pF	10000 pF	---
5	50 pF	220 pF	470 pF	1000 pF	2200 pF	4700 pF	10000 pF	---
10	50 pF	220 pF	470 pF	1000 pF	2200 pF	4700 pF	10000 pF	---
25	50 pF	220 pF	470 pF	1000 pF	2200 pF	4700 pF	10000 pF	---
47	50 pF	220 pF	470 pF	1000 pF	2200 pF	4700 pF	10000 pF	---
100	50 pF	220 pF	470 pF	1000 pF	2200 pF	4700 pF	10000 pF	---
220	50 pF	220 pF	470 pF	1000 pF	2200 pF	4700 pF	10000 pF	---
330	50 pF	220 pF	470 pF	1000 pF	2200 pF	4700 pF	10000 pF	---
470	50 pF	220 pF	470 pF	1000 pF	2200 pF	4700 pF	10000 pF	---
1000	50 pF	220 pF	470 pF	1000 pF	2200 pF	4700 pF	10000 pF	---
2200	50 pF	220 pF	470 pF	1000 pF	2200 pF	4700 pF	10000 pF	---

UART

1-24	25 up	100 up
COM2017P	5.70	4.60
COM2017HP	8.00	6.85
COM2502P	9.00	7.85
COM2502HP	9.00	7.85
COM5402P	8.00	6.85
COM5402HP	8.00	6.85
IM6403-1PL	10.40	8.35
USRT	28.00	22.00
COM2601P	28.00	22.00
ASTRO	42.00	36.90
COM1671	42.00	36.90
DUAL BAUD RATE Generator	13.20	10.60
COM5036	13.20	10.60
BAUD RATE GENERATOR	11.00	8.80
COM5046	11.00	8.80
Multi-Protocol Syn Trans/Receiver	54.00	48.00
COM5025	54.00	48.00

VIDEO DISPLAY CONTROLLER

1-24	25 up	100 up
CRT8002A	35.00	29.90

LINEAR

1-24	25 up	100 up
LM100H	\$7.00	\$5.55
LM101H	1.65	1.32
LM101AH	1.80	1.44
LM105H	4.85	3.90
LM105H	4.80	3.80
LM107H	2.10	1.68
LM109K	5.70	4.50
LM110H	6.00	4.80
LM111H	4.50	3.60
LM112	4.50	3.60
LM118H	12.75	10.20
LM124D	3.23	2.58
LM200H	6.00	4.80
LM201H	1.80	1.44
LM201AN(14)	2.10	1.68
LM202H	7.50	6.00
LM205H	5.50	4.40
LM206H	4.25	3.40
LM208H	6.60	5.25
LM209H	3.25	2.60
LM209K	3.25	2.60
LM210H	6.05	4.85
LM211H	3.45	2.75
LM211N(8)	5.50	4.40
LM218H	10.50	8.40
LM300H	2.70	2.15
LM301AH	95	78
LM301AJ	1.25	98
LM302H	3.75	3.00
LM302H	4.00	3.20
LM304H	3.25	2.58
LM305H	1.45	1.15
LM306H	1.80	1.40
LM307H	1.20	90
LM307N(14)	90	72
LM308H	1.28	1.02
LM308AH	5.10	4.10
LM308AD	6.75	5.40
LM308AN(8)	4.50	3.60
LM308D	3.45	2.75
LM308N(8)	68	58
LM309H	1.85	1.45
LM309K	2.40	2.00
LM310H	2.55	2.00
LM310D	4.80	3.85
LM310N(8)	2.00	1.55
LM311D	5.50	3.20
LM311H	1.05	84
LM311N(8)	1.05	84
LM312H	3.53	2.82
LM316H	6.45	5.15
LM317H	3.45	2.80
LM317K	3.95	3.15
LM318H	3.38	2.70
LM318N(8)	3.00	2.25
LM319H	2.65	2.10
LM319N(14)	2.48	1.95
LM324D	1.58	1.26
LM324N(14)	1.50	1.20
LM339AD	3.00	2.40

FLUCHE MODEL 8020A \$169.00

THE DMM FOR THE PROFESSIONAL

- 26 Ranges for 7 Functions • Weight 13 ozs.
- 200 Hr. Battery Life • Diode Test Function
- 2000 Count Resolution • High Lowpower ohms
- Autozero and Auto polarity • MOV protected to 5000V against hidden transients and overload protection to 300VAC • Conductance Function checks leakage resistance to 10,000 Meg Ohms
- Size: HWL (7.1 x 3.4 x 1.8 in.) (18.0 x 8.6 x 4.5 cm)

KIM-1 MICROCOMPUTER

Fully Assembled & Tested Including Documentation

NEW LOW PRICE

\$179.00

COMPUTER INTERFACE and PERIPHERAL BOARDS

Electronic Systems - includes Documentation and Parts List

MODEM - Type 103 Full or Half Duplex \$ 7.60

TV TYPEWRITER - Stand Alone \$39.00

TAPE INTERFACE - Converts low cost recorder to digital recorder. \$ 7.60

8K STATIC RAM - Designed to operate with S100 (Altair) bus memory-uses 2102 \$22.50

RF MODULATOR - Converts video to AM mod. RF \$ 7.60

RS 232/TTY INTERFACE - Converts RS 232 to 20ma and 20ma to RS 232 \$ 4.50

DC POWER SUPPLY - Provides regulated -5V@3A & -12V -12V & -5V@1A Requires 8VAC @3A & 24VAC C T @1.5A \$12.50

MODEL 303 QUAL TRACE PORTABLE OSCILSCOPE

15MHz/5mV - Fully Automatic Triggering - Three Power Source, AC, Rechargeable Ni-cad, or external DC source from 11 to 30V - Safety Recharging - Small & Light - Stabilized Power Supplies - High Reliability

MODEL 303 Complete w/Probes and Ni-cad Bat. \$895.00

INTERSL

1-24	25 up	100 up	AMD	1-24	25 up	100 up
ICL8038CPD	\$ 4.45	\$ 3.75	\$ 3.13	MH0026CN	\$1.68	\$1.47
ICL7106CP	14.70	11.75	9.80	2524V	2.50	2.25
ICL7107CP	13.85	11.10	9.25	2525V	3.65	3.56
FAIRCHILD	---	---	---	2533V	4.98	4.82
741PC	35	30	25	AM6808PC	7.50	5.00

POWER SUPPLIES from ADETECH POWER

MODEL NUMBER	RATING Vdc	Amps	MODEL NUMBER	RATING Vdc	Amps
APS5-3	5	3	DAPS 8	8	0.8
APS6-2.5	6	2.5	DAPS 9-12.5	9-12	0.5
APS12-1.6	12	1.6	DAPS 12-15	12	0.75
APS15-1.5	15	1.5	DAPS 15-60	15	0.60
---	5	9	10 up	---	---
---	---	---	---	5	9
---	---	---	---	10 up	---

\$42.00 \$34.00 \$32.20 \$53.00 \$43.00 \$40.70

1802 SERIES MICROPROCESSOR INTEGRATED CIRCUITS

CERAMIC	55 to 125 C	100 up	EPoxy	30 to 85 C	100 up	
1802LD	\$19.95	\$17.35	\$15.90	1802LE	\$11.20	\$10.60
1802LD	14.00	13.20	11.00	1822LE	8.05	7.20
1824LD	7.75	6.75	6.10	1822LE	3.55	3.35
1852LD	8.25	7.15	6.50	1852LE	1.90	1.80
1853LD	5.65	4.90	4.45	1853LE	1.45	1.40
1854LD	11.70	11.00	9.20	1854LE	8.50	8.00
1856LD	5.50	4.75	4.30	1856LE	1.10	1.05
1857LD	5.50	4.75	4.30	1857LE	1.10	1.05
1858LD	5.65	4.90	4.45	1858LE	1.45	1.40
1859LD	5.65	4.90	4.45	1859LE	1.45	1.40

MICROMEMORIES

SCM5101E	8.55	7.65	6.45	SCM5505AE	9.00	7.40
----------	------	------	------	-----------	------	------

VIM-1 THE COMPLETE MICROCOMPUTER SYSTEM

Fully Assembled Features KIM-1 hardware compatibility 28 Double Function keypad w/audio response) 6 Digit HEX display 3 on board programmable interval timers 4K byte ROM-resident monitor - 1K byte 2114 static RAM (expandable to 4K bytes on board) 3 PROM ROM expansion sockets for 2316; 2332; 2716 EPROMS STANDARD INTERFACE Audio Cassette Recorder (135 Baud KIM-1 compatible and 2400 Baud) - Full Duplex 20ma TTY Interface - System Expansion Bus (KIM-1 compatible) TV Controller Board CRT compatible interface Application Port w/15 B-directional TTL lines for user applications Requires a single 5 volt supply.

ORDER YOURS TODAY \$269.00

Use a POWERACE for faster and easier prototyping of all types of electronic circuits

POWERACE 103 (shown) \$124.95

POWERACE 101 \$ 84.95

POWERACE 102 \$114.95

ANCRONA

Send Check or Money Order to PO Box 2208P, Culver City, Calif. 90230. California residents add 6% sales tax. Minimum Order: \$10.00. Add \$1.00 to cover postage and handling. Master Charge and Visa welcomed. Please include your charge card number, Interbank number and expiration date.

EZ-HOOK AVAILABLE IN 10 REMA COLORS

MICRO HOOK

Part No.	Length	Price
204X 12W	12"	\$1.80
204X 24W	24"	\$1.80

MINI HOOK

Part No.	Length	Price
204 12W	12"	\$1.70
204 24W	24"	\$1.70

MICRO HOOK SET (includes 1 each red, black, blue, green, orange, yellow, white, brown, silver and grey Micro Hook). At this low price you can afford more than one! Only \$8.95. **MINI HOOK SET** (100 MICRO HOOKS) \$8.95

EXTRA LONG MINI HOOK

Part No.	Length	Price
201X 32"	32"	\$1.50
201W 32"	32"	\$1.45

EXTRA LONG MINI HOOK SET (includes 1 each red, black, blue, green, orange, yellow, white, brown, silver and grey Mini Hook). At this low price you can afford more than one! Only \$8.95. **EXTRA LONG MINI HOOK SET** (100 MICRO HOOKS) \$8.95

Intersil LED or LCD 3 1/2 DIGIT PANEL METER KITS

BUILD A WORKING DPM IN 1/2 HOUR WITH THESE COMPLETE EVALUATION KITS

Test these DPM kits for yourself with Intersil's low cost prototyping kits complete with A/D converter and LCD display for the 100 or LED display for the 1000. Kits provide all materials including PC board for a functioning panel meter.

ICL7106EV (LCD) \$29.95 ICL7107 (LED) \$24.95

HYBRID AUDIO POWER AMPLIFIER

SI-1010G (10W output)	\$ 6.90
SI-1020G (20W output)	\$13.95
A-SI-8 (Socket for above)	95
SI-1030G (30W output)	\$19.00
SI-1050G (50W output)	\$27.80
A-SI-10 (Socket for above)	95

Data with Application Notes

Soft-Touch TONE DIALER

- Convert standard rotary phones into Touch Tone
- Included microphone for better audio
- Soft State reliability • Convenient operation
- Simple for tone signaling also

Free send out installation. Unscrew the mouthpiece on your telephone and drop out the carbon microphone disk. Screw on the Soft-Touch unit and it's ready for use.

Comes in Six colors - Black, Tan, Green, White, Red and Yellow

ORDER YOURS TODAY P/N 2006 color \$24.95

HIGH QUALITY 1/4 Watt 5% Carbon Film RESISTOR SETS

EACH SET CONTAINS 840 RESISTORS - 20 each of the following values (in ohms): 68, 1, 1.5, 2, 3.3, 4.7, 6.8, 10, 15, 22, 33, 47, 68, 100, 150, 220, 330, 470, 680, 1K, 1.5K, 2.2K, 3.3K, 4.7K, 6.8K, 10K, 15K, 22K, 33K, 47K, 68K, 100K, 150K, 220K, 330K, 470K, 680K, 1M, 1.5M, 2M, 3.3M, 4.7M, 6.8M, 10M, 15M, 20M, 30M, 40M, 50M, 60M, 70M, 80M, 90M, 100M

Complete with Storage Bin Part No. RS-14-25 \$24.90

5% CARBON FILM RESISTORS

Only in Multiples of 100 pcs per value	1/4W	\$1.69	1/2W	\$1.69
10	100	10K	10K	10K
11	110	11K	11K	11K
12	120	12K	12K	12K
13	130	13K	13K	13K
14	140	14K	14K	14K
15	150	15K	15K	15K
16	160	16K	16K	16K
17	170	17K	17K	17K
18	180	18K	18K	18K
19	190	19K	19K	19K
20	200	20K	20K	20K
21	210	21K	21K	21K
22	220	22K	22K	22K
23	230	23K	23K	23K
24	240	24K	24K	24K
25	250	25K	25K	25K
26	260	26K	26K	26K
27	270	27K	27K	27K
28	280	28K	28K	28K
29	290	29K	29K	29K
30	300	30K	30K	30K
31	310	31K	31K	31K
32	320	32K	32K	32K
33	330	33K	33K	33K
34	340	34K	34K	

7400 TTL

Table of 7400 TTL components including SN7410N, SN74104N, SN74105N, etc. with quantities and prices.

20% Discount 100 pcs combined order 25% -1000 pcs combined order.

C/MOS

Table of C/MOS components including CD1000, CD1002, CD1006, etc. with quantities and prices.

7400C

Table of 7400C components including 74C00, 74C02, 74C04, etc. with quantities and prices.

LINEAR

Table of Linear components including LM300H, LM300CN, LM300M, etc. with quantities and prices.

74LS00 TTL

Table of 74LS00 TTL components including 74LS00, 74LS02, 74LS04, etc. with quantities and prices.

BUGBOOK



Continuing Education Series... THE 555 TIMER APPLICATIONS SOURCEBOOK WITH EXPERIMENTS... INSTRUCTOR'S MANUAL... EXP. MAN. MANUAL... DEBUG... COMPLETE MANUAL FOR DIGITAL CLOCKS...

BUGBOOKS I and II

BUGBOOK I and II by Peter R. Hoy David G. Larson \$17.00 per set... Includes 100 pages of material...

BUGBOOK III by Peter R. Hoy David G. Larson \$15.00... Includes 100 pages of material...

BUGBOOK IV by Peter R. Hoy David G. Larson \$19.00 per set... Includes 100 pages of material...

CMOS-M - DESIGN PRIMER AND HANDBOOK... \$8.50... Includes 100 pages of material...

DISCRETE LEADS

Table of Discrete Leads components including KT29, KT29A, KT29B, etc. with quantities and prices.

DISPLAY LEADS

Table of Display Leads components including MAN 1, MAN 2, MAN 3, etc. with quantities and prices.

RCA LINEAR

Table of RCA Linear components including CA3013, CA2023, CA3035, etc. with quantities and prices.

CLOCK CHIPS

Table of Clock Chips components including MM5908, MM5911, MM5912, etc. with quantities and prices.

WIRE WRAP SOCKETS

Table of Wire Wrap Sockets components including 8 pin WW, 10 pin WW, etc. with quantities and prices.

50 PCS. RESISTOR ASSORTMENTS \$1.75 PER ASST.

Table of Resistor Assortments including ASST. 1, ASST. 2, ASST. 3, etc. with quantities and prices.

NEW 1979 Catalog

Jameco Electronics logo and contact information: PHONE ORDERS WELCOME (415) 592-8097

WIRE-WRAP KIT - WK-2-W

WRAP • STRIP • UNWRAP... Tool for 30 AWG Wire... Roll of 50 Ft. White or Blue 30 AWG Wire... \$12.95

WIRE WRAP WIRE - 30 AWG

25 ft. min. \$1.95 50 ft. \$1.95 100 ft. \$2.95 1000 ft. \$15.00... SPECIFY COLOR - White - Yellow - Red - Green - Blue - Black

WIRE DISPENSER - WD-30

50 ft. roll 30 AWG KYNAR wire wrap wire \$3.95 ea... Cuts wire to desired length... \$1.99/spool

EXAR Function Generator Kit

XR-L555 \$1.50 XR2242CP \$1.50... Micro Power version of the popular 555 Timer...

ZENERS - DIODES - RECTIFIERS

Table of Zeners, Diodes, and Rectifiers components including 1N4148, 1N4001, etc. with quantities and prices.

SCR AND FW BRIDGE RECTIFIERS

Table of SCR and FW Bridge Rectifiers components including M1A, M1B, etc. with quantities and prices.

TRANSISTORS

Table of Transistors components including 2N2219, 2N3055, etc. with quantities and prices.

CAPACITOR CORNER

Table of Capacitors components including 100 VOLT MYLAR FILM CAPACITORS, 20% DIPPED TANTALUMS, etc.

MINIATURE ALUMINUM ELECTROLYTIC CAPACITORS

Table of Miniature Aluminum Electrolytic Capacitors components including 100 uF, 220 uF, etc. with quantities and prices.

Regency **SCANNER**
4 Channels UHF

- POLICE
- FIRE
- Continuously Monitors 4-Channels
- Hear UHF (450-500MHz)
- Model ACT-C4U



Reg. ~~39⁹⁵~~
\$33
RA-214

RADAR DETECTOR
BEARFINDER

55⁵⁵
AU-651

- Audible and Visual Indicator
- Detects Stationary and Moving Radar



* Ask about BEARFINDERS Out of Warranty Special!
Reg. ~~89⁹⁹~~

RECORDER
"MESSAGE MINDER"



Reg. ~~7⁹⁹~~
4⁹⁹
RA-731
AS-IS

SWR METER



7⁹⁹
CB-067
INCLUDES ANTENNA

LOCKMOUNT
For Under Dash Mounting of CB's, Radios, etc.



99^c
AU-149
Reg. ~~1⁹⁹~~

AM AUTO RADIO
Pushbutton Controls



Reg. ~~10⁹⁹~~
8⁹⁹
AU-580

CASSETTE
30-Minute Blank



29^c
TA-987

8-TRACK
40-Minute Blank
LIMIT 30

49^c
TA-907

MULTIMETER
Olson 1000 Ohms/Volt



For Best CB Performance
8⁹⁹
TE-184
Reg. ~~12⁵⁰~~

AC ADAPTER
AC to 6, 7.5, 9 VDC



2⁹⁹
BA-159
Reg. 2 for \$11

8-TRACK TAPE DECK CHASSIS



7⁹⁹
RA-617
Reg. ~~9⁹⁰~~

Olson electronics Dept. IJ
260 S. Forge St.
Akron, Ohio 44327

NAME _____
ADDRESS _____
CITY _____
STATE _____ Zip _____

Qty.	Stk. #	Description	Price Ea.	Total

Tax _____
Postage _____
Total _____

FREE!

Please send me a free subscription to Olson Value Packed Catalog.

OLSON COMPUTERS

Commodore 'PET'
Ohio Scientific
Challenger III
Challenger IIP
VideoBrain



Olson - 8 8080

Write for FREE Computer Catalog

DIODES/ZENERS			
1N914	100v	10mA	.05
1N4005	600v	1A	.08
1N4007	1000v	1A	.15
1N4148	75v	10mA	.05
1N4733	5.1v	1 W Zener	.25
1N753A	6.2v	500 mW Zener	.25
1N758A	10v	"	.25
1N759A	12v	"	.25
1N5243	13v	"	.25
1N5244B	14v	"	.25
1N5245B	15v	"	.25

SOCKETS/BRIDGES			
8-pin	pcb	.20	ww .35
14-pin	pcb	.20	ww .40
16-pin	pcb	.20	ww .40
18-pin	pcb	.25	ww .75
22-pin	pcb	.35	ww .95
24-pin	pcb	.35	ww .95
28-pin	pcb	.45	ww 1.25
40-pin	pcb	.50	ww 1.25
Molex pins	.01	To-3 Sockets	.25
2 Amp Bridge		100-prv	.95
25 Amp Bridge		200-prv	1.95

TRANSISTORS, LEDS, etc.		
2N2222	NPN (2N2222 Plastic .10)	.15
2N2907	PNP	.15
2N3906	PNP (Plastic - Unmarked)	.10
2N3904	NPN (Plastic - Unmarked)	.10
2N3054	NPN	.35
2N3055	NPN 15A 60v	.50
T1P125	PNP Darlington	.95
LED Green, Red, Clear, Yellow		.15
D.L.747	7 seg 5/8" High com-anode	1.95
MAN72	7 seg com-anode (Red)	1.25
MAN3610	7 seg com-anode (Orange)	1.25
MAN82A	7 seg com-anode (Yellow)	1.25
MAN74A	7 seg com-cathode (Red)	1.50
FND359	7 seg com-cathode (Red)	1.25

C MOS	
4000	.15
4001	.15
4002	.20
4004	3.95
4006	.95
4007	.20
4008	.75
4009	.35
4010	.35
4011	.20
4012	.20
4013	.40
4014	.75
4015	.75
4016	.35
4017	.75
4018	.75
4019	.35
4020	.85
4021	.75
4022	.75
4023	.20
4024	.75
4025	.20
4026	1.95
4027	.35
4028	.75
4030	.35
4033	1.50
4034	2.45
4035	.75
4040	.75
4041	.69
4042	.65
4043	.50
4044	.65
4046	1.25
4049	.45
4050	.45
4066	.55
4069/74C04	.25
4071	.25
4081	.30
4082	.30
MC 14409	14.50
MC 14419	4.85
4511	.95
74C151	1.90

- T T L -			
7400	.10	7473	.25
7401	.15	7474	.30
7402	.15	7475	.35
7403	.15	7476	.40
7404	.10	7480	.55
7405	.25	7481	.75
7406	.25	7483	.75
7407	.55	7485	.55
7408	.15	7486	.25
7409	.15	7489	1.05
7410	.15	7490	.45
7411	.25	7491	.70
7412	.25	7492	.45
7413	.25	7493	.35
7414	.75	7494	.75
7416	.25	7495	.60
7417	.40	7496	.80
7420	.15	74100	1.15
7426	.25	74107	.25
7427	.25	74121	.35
7430	.15	74122	.55
7432	.20	74123	.35
7437	.20	74125	.45
7438	.20	74126	.35
7440	.20	74132	.75
7441	1.15	74141	.90
7442	.45	74150	.85
7443	.45	74151	.65
7444	.45	74153	.75
7445	.65	74154	.95
7446	.70	74156	.70
7447	.70	74157	.65
7448	.50	74161	.55
7450	.25	74163	.85
7451	.25	74164	.60
7453	.20	74165	1.10
7454	.25	74166	1.25
7460	.40	74175	.80
7470	.45		
7472	.40		
74H72	.35	74H72	.35
74H101	.75	74H101	.75
74H103	.55	74H103	.55
74H106	.95	74H106	.95
74L00	.25	74L00	.25
74L02	.20	74L02	.20
74L03	.25	74L03	.25
74L04	.30	74L04	.30
74L10	.20	74L10	.20
74L20	.35	74L20	.35
74L30	.45	74L30	.45
74L47	1.95	74L47	1.95
74L51	.45	74L51	.45
74L55	.65	74L55	.65
74L72	.45	74L72	.45
74L73	.40	74L73	.40
74L74	.45	74L74	.45
74L75	.55	74L75	.55
74L93	.55	74L93	.55
74L123	.85	74L123	.85
74S00	.35	74S00	.35
74S02	.35	74S02	.35
74S03	.25	74S03	.25
74S04	.25	74S04	.25
74S05	.35	74S05	.35
74S08	.35	74S08	.35
74S10	.35	74S10	.35
74S11	.35	74S11	.35
74S20	.25	74S20	.25
74S40	.20	74S40	.20
74S50	.20	74S50	.20
74S51	.25	74S51	.25
74S64	.15	74S64	.15
74S74	.35	74S74	.35
74S112	.60	74S112	.60
74S114	.65	74S114	.65
74S133	.40	74S133	.40
74S140	.55	74S140	.55
74S151	.30	74S151	.30
74S153	.35	74S153	.35
74S157	.75	74S157	.75
74S158	.30	74S158	.30
74S194	1.05	74S194	1.05
74S257 (8123)	1.05	74S257 (8123)	1.05
74LS00	.20	74LS00	.20
74LS01	.20	74LS01	.20
74LS02	.20	74LS02	.20
74LS04	.20	74LS04	.20
74LS05	.25	74LS05	.25
74LS08	.25	74LS08	.25
74LS09	.25	74LS09	.25
74LS10	.25	74LS10	.25
74LS11	.25	74LS11	.25
74LS20	.20	74LS20	.20
74LS21	.25	74LS21	.25
74LS22	.25	74LS22	.25
74LS32	.25	74LS32	.25
74LS37	.25	74LS37	.25
74LS38	.35	74LS38	.35
74LS40	.30	74LS40	.30
74LS42	.65	74LS42	.65
74LS51	.35	74LS51	.35
74LS74	.35	74LS74	.35
74LS86	.35	74LS86	.35
74LS90	.55	74LS90	.55
74LS93	.55	74LS93	.55
74LS107	.40	74LS107	.40
74LS123	1.00	74LS123	1.00
74LS151	.75	74LS151	.75
74LS153	.75	74LS153	.75
74LS157	.75	74LS157	.75
74LS164	1.00	74LS164	1.00
74LS193	.95	74LS193	.95
74LS367	.75	74LS367	.75
74LS368	.65	74LS368	.65

9000 SERIES		
9301	.85	95H03 1.10
9309	.35	9601 .20
9322	.65	9602 .45

MICRO'S, RAMS, CPU'S, E-PROMS			
74S188	3.00	8214	8.95
1702A	4.50	8224	3.25
MM5314	3.00	8228	6.00
MM5316	3.50	8251	8.50
2102-1	1.45	8255	8.50
2102L-1	1.75	8T13	1.50
2114	9.50	8T23	1.50
TR1602B	3.95	8T24	2.00
TMS 4044-	9.95	8T97	1.00
		2107B-4	4.95
8080	8.95	2708	9.50
8212	2.95	Z80 PIO	8.50

MCT2 .95				LINEARS, REGULATORS, etc.			
8038	3.95	LM320T5	1.65	LM340K15	1.25	LM723	.40
LM201	.75	LM320T12	1.65	LM340K18	1.25	LM725N	2.50
LM301	.45	LM320T15	1.65	LM340K24	1.25	LM739	1.50
LM308 (Mini)	.95	LM324N	1.25	78L05	.75	LM741 (8-14)	.25
LM309H	.65	LM339	.75	78L12	.75	LM747	1.10
LM309K (340K-5)	.85	7805 (340T5)	.95	78L15	.75	LM1307	1.25
LM310	.85	LM340T12	.95	78M05	.75	LM1458	.65
LM311D (Mini)	.75	LM340T15	.95	LM373	2.95	LM3900	.50
LM318 (Mini)	1.75	LM340T18	.95	LM380 (8-14 PIN)	.95	LM75451	.65
LM320K5 (7905)	1.65	LM340T24	.95	LM709 (8, 14 PIN)	.25	NE555	.35
LM320K12	1.65	LM340K12	1.25	LM711	.45	NE556	.85
						NE565	.95
						NE566	1.25
						NE567	.95

INTEGRATED CIRCUITS UNLIMITED

CIRCLE NO 30 ON FREE INFORMATION CARD

7889 Clairemont Mesa Boulevard, San Diego, California 92111
(714) 278-4394 (Calif. Res.)

All orders shipped prepaid No minimum
 Open accounts invited COD orders accepted

Discounts available at OEM Quantities California Residents add 6% Sales Tax
 All IC's Prime/Guaranteed. All orders shipped same day received.

24 Hour Toll Free Phone 1-800-854-2211

American Express / BankAmericard / Visa / MasterCard

SPECIAL DISCOUNTS

Total Order	Deduct
\$35 - \$99	10%
\$100 - \$300	15%
\$301 - \$1000	20%

HOLIDAY SPECIALS from **JADE**

Computer Products

PLACE ORDERS TOLL FREE: 800/421-5809 Continental U.S.
800/262-1710 inside California

PANA VISE

PRICE \$16.95
315 Same as 315, but with 1/2" bar to accommodate 3/16" boards.
PRICE \$19.95

PRICE \$12.95
303
PRICE \$12.95
306
PRICE \$12.95
306
PRICE \$11.95
305
PRICE \$11.95
306
PRICE \$16.95
380

PANA VISE TILTS, TURNS, AND ROTATES TO ANY POSITION. IT HOLDS YOUR WORK EXACTLY WHERE YOU WANT IT.

BW 630 WIRE WRAP TOOL

- Auto-Indexing
- Anti-Overwrapping
- Modified Wrap
- Includes Bit for #30 Wire

BW 630 \$34.95
BT 30 (Bit for #30) 3.95
BT 2628 (Bit for #26) 7.95
Batteries & Charger 11.00

Uses "C" Nicad Batteries (Not Included)

HAND WRAP TOOL

STRIP WRAP UNWRAP

Regular Wrap Modified Wrap

Regular Wrap	WSU-30	\$6.95
Modified Wrap	WSU-30M	\$7.95

Wire wrapping stripping unwrapping tool for AWG 30 on .025 square post

Apple II computer

One of the best "Total Package" home and business computers on the market. "Basic" in ROM, Color Graphics, Floating Point Basic Package, etc.

16K version only \$1,095.00

Introducing POWERACE

POWERACE 103 \$124.95
Triple in-circuit power supply checker for strip wiring both linear and digital circuits.

POWERACE 101 \$84.95
The general purpose model for strip wiring all types of circuits.

POWERACE 102 \$114.95
The complete digital prototyping kit with FREE logic probe built in!

Use a POWERACE for faster and easier prototyping of all types of electronic circuits. (Other important features: ...)

WIRE WRAPPING TOOLS for 0.025 inch (.64 mm) SQUARE POSTS

Slit-N-Wrap wiring is easy to use and is up to four times faster than ordinary manual wrapping because there is no wire measuring or pre-stripping required. Slit-N-Wrap tools have a patented action which slit wire insulation while the tool is wrapping wire on 0.025 inch (.64 mm) square posts. Connections are just as reliable as with conventional wrapping tools. Tests show Slit-N-Wrapped connections exceed MIL Spec requirements for pull-off, air flow resistance (less than .001 ohm) and air gas tight. All tools and bits are guaranteed to provide at least 10,000 reliable wraps before bit replacement is required.

P180 Series Tools Using Polyurethane Nylon Coated Wire.
Polyurethane nylon coated copper wire is used in all P180 series tools. The small diameter of this insulated 28 gage wire permits two 7 pin wraps on a 0.025 inch (.64 mm) square post occupying only .21 inch (.53 mm) of post length. Soldering is not required on rectangular posts, but if wrapped on round or irregular posts it may be soldered using a 750°F (399°C) iron which melts the insulation as solder flow occurs.

P180 Manual Wrapping Tool \$24.50
P180 4T Nicad Battery Powered P180 \$75.00
P180 4T AC Powered Version of P180 \$80.00

All P180 Series Tools include 140 100 ft. spools of polyurethane nylon insulated wire, P183 forming knife and chisel tool, complete instructions.

WIRE
Polyurethane nylon insulated copper 28 gage wire comes on 100 ft. spools as follows:
W28-28 gpg 3 GREEN \$2.75 W28-PC gpg 3 CLEAR \$2.75
W28-28 gpg 3 RED \$2.75 W28-20 gpg 3 BLUE \$2.75

"daisy chain" wraps

4116 (16K x 1, 300ns) MEMORY EXPANSION KIT

Dynamic RAM chip can be used for expanding APPLE II or TRS-80. Instructions Incl. 8 for \$98.00

TU-1

Convert your T.V. set into a Video Monitor Kit \$8.95

Just plug in any components with leads to .032" dia. Interconnect with solid wire up to 20 g. Assembled models tool!

ACE • All-Circuit Evaluator

for fast, solderless, plug-in circuit building and testing

LIQUID CRYSTAL DIGITAL CLOCK-CALENDAR

APPLIED MARKETING

- For Auto, Home, Office
- Small in size (2x2 1/2 x 1/2)
- Push button for seconds release for date.
- Clocks mount anywhere with either 3M double sided tape or VELCRO, included.
- 2 MODELS AVAILABLE
- LCD 101, portable model runs on self-contained batteries for better than a year.
- LCD 102, runs on 12 VOLT system and is back lighted.
- LCD 101 or LCD 102 show choice.

\$34.95..

THE PIGGY IS COMING!

EXPANDORAM

MODULAR SOLDERING TOOLS

Designed for Professionals by Professionals

Ungar

UNGAR matic

Controlled Soldering Station

THREAD-TOGETHER MODULAR DESIGN FOR QUICK, ON-LINE HEATER OR TIP CHANGE

- Available in 3 pre-set temperatures: 600 F, 700 F or 800 F for any application.
- Closed loop, non-magnetic control.
- Low voltage system, 3 wire grounded.
- Biometallic of glass graded handle with cool grip for operator comfort. Cord is super flexible 3 wire grounded, heat resistant.

OUR Price \$52.00
List \$57.50

TYPE 200 QUICK CHARGE CORDLESS SOLDERING STATION

\$24.95

- For Auto, Home, Office
- Small in size (2x2 1/2 x 1/2)
- Push button for seconds release for date.
- Clocks mount anywhere with either 3M double sided tape or VELCRO, included.
- 2 MODELS AVAILABLE
- LCD 101, portable model runs on self-contained batteries for better than a year.
- LCD 102, runs on 12 VOLT system and is back lighted.
- LCD 101 or LCD 102 show choice.

\$34.95..

EXPANDORAM

JADE

Computer Products

4901 W. ROSECRANS AVENUE
Department "P"
HAWTHORNE, CALIF. 90250

Cash, Checks, Money Orders, and Credit Cards accepted. Add freight charge of \$2.50 for orders under 10-lbs. Add 6% sales tax on all parts delivered in California. Discounts available at OEM quantities.

WRITE FOR OUR FREE CATALOG !

COMPLETE STATION AND REPLACEABLE HEATER SELECTION GUIDE

Temperature	Complete Station	Controlled Heater No.
600 F	5076	236
700 F	5077	277
800 F	5078	278

Each of the above stations include: #700 Power Supply with on/off switch, indicator light and 3 wire power cord, #71 Handle with 3 wire heat resistant secondary cord, #89 Tray and Sponges, #72 Iron holder, Control and heater with #87 Screwdriver tip.

#95 TIP ADAPTER Tip Adapter #95 has special micro adjusting. This adapter is designed for the use of "T" thread in Princess' Nibs.

Controlled Heaters \$14.95 Each
Tip Adapter \$1.50 Each

EXPANDO-32 KIT

Uses 4115 (8Kx1)
Dynamic RAM's, can be expanded in 8K increments up to 32K.

8K	\$179.00
16K	\$255.00
24K	\$325.00
32K	\$400.00

EXPANDO-64 KIT

Uses 4116 (16Kx1)
Dynamic RAM's, can be expanded in 16K increments up to 64K.

16K	\$260.00
32K	\$579.00
48K	\$757.00
64K	\$925.00

Cards Welcome

Active Electronic Sales Corp.

1978 IC MASTER

Complete integrated circuit data selector. New 1978 edition (2200 pages) is twice as big as last year. Master guide to the latest IC's including microprocessors and consumer circuits.

Free quarterly updates

\$24.95 \$19.95

Tremendous Opportunity. Subject to Prior Sale. Lowest Price Ever Offered Anywhere.

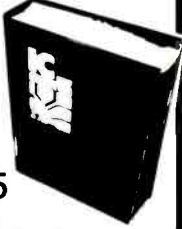

TTL LOW POWER SCHOTTKY PLASTIC DUAL-IN-LINE I.C.

Part No.	Price	Part No.	Price	Part No.	Price	Part No.	Price	Part No.	Price	Part No.	Price
74LS00	15	74LS47	89	74LS123	79	74LS170	125	74LS258	75	74LS368	55
74LS01	15	74LS48	89	74LS124	99	74LS173	95	74LS259	145	74LS373	175
74LS02	15	74LS49	89	74LS125	59	74LS174	69	74LS260	29	74LS374	175
74LS03	15	74LS51	19	74LS126	59	74LS175	69	74LS261	185	74LS375	65
74LS04	19	74LS54	19	74LS132	79	74LS181	250	74LS266	39	74LS377	150
74LS05	19	74LS55	19	74LS133	29	74LS183	350	74LS273	165	74LS378	125
74LS08	19	74LS63	150	74LS136	39	74LS190	89	74LS275	450	74LS379	135
74LS09	19	74LS73	29	74LS138	64	74LS191	89	74LS279	59	74LS386	49
74LS10	15	74LS74	35	74LS139	64	74LS192	95	74LS280	175	74LS390	150
74LS11	19	74LS75	49	74LS145	99	74LS193	95	74LS283	85	74LS393	125
74LS12	19	74LS76	39	74LS147	195	74LS194	75	74LS290	85	74LS395	150
74LS13	35	74LS78	39	74LS148	99	74LS195	66	74LS293	110	74LS396	170
74LS14	59	74LS83	79	74LS151	59	74LS196	109	74LS295	125	74LS398	265
74LS15	19	74LS85	99	74LS153	59	74LS197	109	74LS298	125	74LS399	150
74LS20	15	74LS86	35	74LS155	99	74LS221	125	74LS299	295	74LS424	450
74LS21	19	74LS90	59	74LS156	80	74LS240	195	74LS324	125	74LS445	125
74LS22	19	74LS91	99	74LS157	59	74LS241	195	74LS325	255	74LS447	125
74LS26	25	74LS92	59	74LS158	69	74LS242	195	74LS326	255	74LS490	195
74LS27	21	74LS93	49	74LS160	84	74LS243	195	74LS327	255	74LS668	90
74LS28	21	74LS95	70	74LS161	84	74LS244	195	74LS347	125	74LS669	90
74LS30	15	74LS96	99	74LS162	84	74LS245	195	74LS348	175	74LS670	200
74LS32	25	74LS107	39	74LS163	84	74LS247	125	74LS352	135		
74LS33	27	74LS109	32	74LS164	89	74LS248	125	74LS353	135		
74LS37	23	74LS112	32	74LS165	125	74LS249	125	74LS362	700		
74LS38	23	74LS113	39	74LS166	145	74LS251	85	74LS365	55		
74LS40	19	74LS114	39	74LS168	150	74LS253	85	74LS366	55		
74LS42	54	74LS122	50	74LS169	150	74LS257	60	74LS367	55		

Dual In-line Sockets

Finest Quality Sockets Available Anywhere

- PLUGGABLE SOCKET FOR IC PACKAGES WITH LEADS
- HIGH RELIABILITY GAS TIGHT JOINT
- FULLY QUALIFIED TO MIL-S-8874
- COMPACT LOW PROFILE DESIGN
- NO WICKING WHEN SOLDERED TO PC BOARD
- FLAMMABILITY RATING: UL 94V-0

Stock level	Contacts	Price
14000	8 PIN	.11
345000	14 PIN	.13
156000	16 PIN	.15
33000	18 PIN	.19
18000	22 PIN	.27
84000	24 PIN	.28
25000	28 PIN	.36
46000	40 PIN	.48

All new major manufacturer production material offered. Largest variety of device types available anywhere.

UV EPROM

Stock level	Part No.	Price
7300	2708	7.99
6800	TMS 2716	24.95

3 power supply version. 16K pin for pin plug-in replacement for 2708.

MOS Static RAM'S

Stock level	Part No.	Price
41400	2114	7.50
	4K (1K x 4) 450NS	
59500	2102LFPC	1.19
	1K 350NS (Low Power)	

MICROPROCESSOR CHIPS

CPU's

Stock level	Part No.	Price
21600	8080A	5.95 5.50
2700	6800	8.95 7.95

GENERAL INSTRUMENT

1 Amp Rectifiers (Epoxy)

Stock level	Part No.	Price	Stock level	Part No.	Price
1.7 Million	1N4001	50V 028	29000	W02M	200V 28
9 Million	1N4002	100V 039	57000	W04M	400V 32
5 Million	1N4003	200V 045	390000	W06M	600V 34
5.7 Million	1N4004	300V 049	80000	W08M	800V 39
1.6 Million	1N4005	600V 055	7000	W10M	1000V 60
8 Million	1N4006	800V 065			
1.8 Million	1N4007	1000V 07			

1.5 AMP Single Phase Silicon Bridge Rectifiers

MOS Dynamic RAM'S

Stock level	Part No.	Price
21110	4K 4060	3.95
	300NS	
27550	16K 416-3	11.95
	200NS	
18650	16K 416-5	8.95
	300NS	

INTERFACE SUPPORT CIRCUITS

Stock level	Part No.	Price
1250	8212	1.98
1800	8214	4.95 3.95
11200	8216	1.98
1700	8224	2.75
2800	8226	1.98
1500	8228	4.75
1000	8238	4.75
4900	8251	5.95 4.95
500	8253	14.95
5200	8255	5.95
1100	8257	9.95
300	8259	14.95

SWITCHING DIODES

Part No.	Price
1N914 (100V 4NS)	.027
1N4148 (100V 4NS)	.027

UART'S

Stock level	Part No.	Price
29000	AY5-1013A	4.95
9200	AY3-1015	5.95

1K CMOS RAM

Stock level	Part No.	Price
4400	5101	4.95
	450NS (Low Power)	

Zilog

Z80-CPU	14.95	Z80-S10/0	59.00
Z80A-CPU	24.95	Z80A-S10/0	68.00
Z80-PIO	7.95	(common TX & RX clocks with DTRB)	
Z80A-PIO	11.95		
Z80-CTC	7.95	Z80-SIO/1	59.00
Z80A-CTC	11.95	Z80A-SIO/1	68.00
Z80-DMA	46.00	(separate TX & RX clocks without DTRB)	

MINIMUM ORDER \$10.00 • ADD \$2.00 TO COVER POSTAGE & HANDLING

Over-the-counter sales, 12 Mercer Rd., Natick, Mass. 01760 Behind Zayras on Rte. 9 Telephone Orders & Enquires (617) 879-0077

IN CANADA 3 LOCATIONS

5651 FERRIER ST. MONTREAL, QUEBEC H4P 2K5 Tel: (514) 735-6425	4800 DUFFERIN ST. DOWNSVIEW, ONTARIO M3H 5S6 Tel: (416) 661-1115	BAXTER CENTRE 1059 BAXTER ROAD CITY AWA, ONTARIO K2C 3P2 Tel: (613) 820-9471
---	--	--

Foreign customers please remit payment on an international bank draft or international postal money order in American dollars.

Active Electronic Sales Corp.

138

CIRCLE NO. 1 ON FREE INFORMATION CARD

www.americanradiohistory.com

POPULAR ELECTRONICS



JUMBO LED READOUT ARRAY



\$1.95 LIMITED STOCK

By Bowmar. .5 in. character common cathode. Designed for use with multiplexed clock chips 4 digits in 1 pack!

NATIONAL SEMICONDUCTOR JUMBO CLOCK MODULE

MA1008A BRAND NEW!

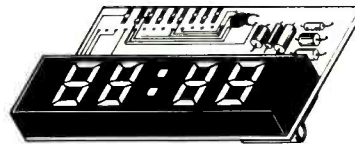

\$6.95

2 FOR \$13

(AC XFMR \$1.95)

- FEATURES
- FOUR JUMBO 1/2 INCH LED DISPLAYS
 - 12 HR REAL TIME FORMAT
 - 24 HR ALARM SIGNAL OUTPUT
 - 50 OR 60 Hz OPERATION
 - LED BRIGHTNESS CONTROL
 - POWER FAILURE INDICATOR
 - SLEEP & SNOOZE TIMERS
 - DIRECT LED DRIVE (LOW RFI)
 - COMES WITH FULL DATA

ASSEMBLED! NOT A KIT!

ZULU VERSION!
We have a limited number of the 24 HR Real time version of this module in stock.
#MA1008D — \$9.95

PERFECT FOR USE WITH A TIMEBASE.

COMPARE AT UP TO TWICE OUR PRICE!

MANUFACTURER'S CLOSEOUT!

MICRO-MINI TOGGLE SWITCH



99¢

EACH

SPDT. By RAYTHEON. MADE IN USA! WITH HDWR.

6 FOR \$5

16K DYNAMIC RAM CHIP

16K X 1 Bits. 16 Pin Package. Same as Mostek 4116-4. 250 NS access 410 NS cycle time. Our best price yet for this state of the art RAM. 32K and 64K RAM boards using this chip are readily available. These are new, fully guaranteed devices by a major mfg.

\$17.95 EACH

8 FOR \$129

EXPERIMENTER'S CRYSTAL



262 144KHZ. This frequency is 2 to the 18th power. Easily divided down to any power of 2, and even to 1HZ. New by CTS-Knight. A \$5 value!

\$1.25 each

SALE!

1N4148 DIODES

High speed switching diodes. Silicon. Same as 1N914. Brand New. Full Leads. Prime!

100 FOR \$2 1000 FOR \$17.50

FAIRCHILD JUMBO READOUTS
.5 inch Char. High Efficiency!
FND-503-Common Cathode
FND-510-Common Anode
YOUR CHOICE 69¢
10 FOR \$5.75

DISC CAPACITORS
.1 MFD 16V. P.C. leads. Most popular value! By Sprague.
20 for \$1.00

Full Wave Bridge
4 Amp 200 PIV
69¢ea. 10/5.75

MALLORY POWER SUPPLY CAPACITOR
1500 MFD 16 WVDC
3/\$1.00 10/\$2.95
FACTORY FRESH! SMALL SIZE

RECTIFIER SALE!
1N4006. Prime New by ITT.
1 Amp. 800 PIV.
15 FOR \$1

FET SALE!
2N4304 Brand New N Channel. Junction FET
BVGD0-30V IDSS-15 MA Typ
1500 uMHOS. TO-18 Plastic Case. Mfg. by Teledyne.
6 FOR \$1

Motorola PNP Power!
2N4905 TO-3 case. 90W. VCE0-60. HFE-100 max. at 2.5A Good mate for the 2N3055. PRIME!
75¢ ea. 4/\$2.50

COMPUTER CAPACITOR
By GE. 36,000 MFD 15V VDC Small Size: 4% x 1 1/4 Inches. SUPER DEAL! **\$2.95 Each**
3 FOR \$8

RCA MICRO-POWER OP AMP.
#CA3078T. 8-pin Can. Most OPAMPS require -15V to operate. But the CA3078 is designed to operate from +7.5V to -6V! Perfect for battery use. Standby power as low as 700 NW! High Gain. 92 DB typical Open Loop Gain. Requires only one capacitor for compensation. See RCA Linear Data Book for more details. Similar to National LM112. Originally cost about \$2 each.
75¢ EACH 3 FOR \$2

Digital Research Corporation
(OF TEXAS)
P. O. BOX 401247A GARLAND, TEXAS 75040 • (214) 271-2461

TERMS: Add 30¢ postage, we pay balance. Orders under \$15 add 75¢ handling. No C.O.D. We accept Visa, MasterCard, and American Express cards. Tex. Res. add 5% Tax. Foreign orders (except Canada) add 20% P & H. 90 Day Money Back Guarantee on all items.

PRIME TTL & CMOS AT LOWEST PRICES

74xx TTL	74LSxx TTL	74Sxx TTL	74Cxx TTL	4xx CMOS
7400 .50 14	7480 .03 31	74181 .15 75	74LS42 .00 70	74S78 .05 58
7401 .05 15	7482 .05 50	74182 .05 75	74LS47 .05 75	74S112 .05 58
7402 .05 15	7483 .05 54	74184 .05 75	74LS48 .05 72	74S113 .05 58
7403 .05 15	7485 .08 80	74185 .15 75	74LS51 .05 25	74S114 .05 58
7404 .05 16	7486 .02 27	74188 .20 80	74LS54 .05 25	74S132 .05 75
7405 .05 16	7489 .15 75	74190 .05 95	74LS55 .05 25	74S133 .05 75
7406 .02 24	7490 .04 40	74191 .05 95	74LS73 .05 38	74S134 .05 38
7407 .02 24	7491 .05 41	74192 .05 80	74LS74 .05 35	74S135 .05 49
7408 .01 17	7492 .04 40	74193 .05 80	74LS76 .05 37	74S136 .05 49
7409 .01 17	7493 .04 40	74194 .05 80	74LS78 .05 36	74S139 .05 75
7410 .01 18	7494 .04 40	74195 .05 80	74LS83 .05 75	74S140 .05 47
7411 .01 18	7495 .05 60	74196 .05 73	74LS85 .05 75	74S151 .05 75
7412 .02 20	7496 .05 60	74197 .05 73	74LS86 .05 75	74S152 .05 75
7413 .02 25	7497 .24 25	74198 .05 73	74LS88 .05 75	74S153 .05 75
7414 .05 55	7498 .05 60	74199 .10 30	74LS90 .05 50	74S154 .05 75
7415 .02 22	7499 .05 60	74200 .05 50	74LS92 .05 50	74S155 .05 75
7416 .02 22	7499 .05 60	74201 .05 50	74LS93 .05 50	74S156 .05 75
7417 .02 22	7499 .05 60	74202 .05 50	74LS94 .05 50	74S157 .05 75
7418 .02 22	7499 .05 60	74203 .05 50	74LS95 .05 50	74S158 .05 75
7419 .02 22	7499 .05 60	74204 .05 50	74LS96 .05 50	74S159 .05 75
7420 .02 22	7499 .05 60	74205 .05 50	74LS97 .05 50	74S160 .05 75
7421 .02 22	7499 .05 60	74206 .05 50	74LS98 .05 50	74S161 .05 75
7422 .02 22	7499 .05 60	74207 .05 50	74LS99 .05 50	74S162 .05 75
7423 .02 25	7499 .05 60	74208 .05 50	74LS100 .05 35	74S163 .05 75
7424 .02 25	7499 .05 60	74209 .05 50	74LS101 .05 35	74S164 .05 75
7425 .02 25	7499 .05 60	74210 .05 50	74LS102 .05 35	74S165 .05 75
7426 .02 22	7499 .05 60	74211 .05 50	74LS103 .05 35	74S166 .05 75
7427 .02 19	7499 .05 60	74212 .05 50	74LS104 .05 35	74S167 .05 75
7428 .02 19	7499 .05 60	74213 .05 50	74LS105 .05 35	74S168 .05 75
7429 .02 19	7499 .05 60	74214 .05 50	74LS106 .05 35	74S169 .05 75
7430 .02 19	7499 .05 60	74215 .05 50	74LS107 .05 35	74S170 .05 75
7431 .02 19	7499 .05 60	74216 .05 50	74LS108 .05 35	74S171 .05 75
7432 .02 19	7499 .05 60	74217 .05 50	74LS109 .05 35	74S172 .05 75
7433 .02 19	7499 .05 60	74218 .05 50	74LS110 .05 35	74S173 .05 75
7434 .02 19	7499 .05 60	74219 .05 50	74LS111 .05 35	74S174 .05 75
7435 .02 19	7499 .05 60	74220 .05 50	74LS112 .05 35	74S175 .05 75
7436 .02 19	7499 .05 60	74221 .05 50	74LS113 .05 35	74S176 .05 75
7437 .02 19	7499 .05 60	74222 .05 50	74LS114 .05 35	74S177 .05 75
7438 .02 19	7499 .05 60	74223 .05 50	74LS115 .05 35	74S178 .05 75
7439 .02 19	7499 .05 60	74224 .05 50	74LS116 .05 35	74S179 .05 75
7440 .02 19	7499 .05 60	74225 .05 50	74LS117 .05 35	74S180 .05 75
7441 .02 19	7499 .05 60	74226 .05 50	74LS118 .05 35	74S181 .05 75
7442 .02 19	7499 .05 60	74227 .05 50	74LS119 .05 35	74S182 .05 75
7443 .02 19	7499 .05 60	74228 .05 50	74LS120 .05 35	74S183 .05 75
7444 .02 19	7499 .05 60	74229 .05 50	74LS121 .05 35	74S184 .05 75
7445 .02 19	7499 .05 60	74230 .05 50	74LS122 .05 35	74S185 .05 75
7446 .02 19	7499 .05 60	74231 .05 50	74LS123 .05 35	74S186 .05 75
7447 .02 19	7499 .05 60	74232 .05 50	74LS124 .05 35	74S187 .05 75
7448 .02 19	7499 .05 60	74233 .05 50	74LS125 .05 35	74S188 .05 75
7449 .02 19	7499 .05 60	74234 .05 50	74LS126 .05 35	74S189 .05 75
7450 .02 19	7499 .05 60	74235 .05 50	74LS127 .05 35	74S190 .05 75
7451 .02 19	7499 .05 60	74236 .05 50	74LS128 .05 35	74S191 .05 75
7452 .02 19	7499 .05 60	74237 .05 50	74LS129 .05 35	74S192 .05 75
7453 .02 19	7499 .05 60	74238 .05 50	74LS130 .05 35	74S193 .05 75
7454 .02 19	7499 .05 60	74239 .05 50	74LS131 .05 35	74S194 .05 75
7455 .02 19	7499 .05 60	74240 .05 50	74LS132 .05 35	74S195 .05 75
7456 .02 19	7499 .05 60	74241 .05 50	74LS133 .05 35	74S196 .05 75
7457 .02 19	7499 .05 60	74242 .05 50	74LS134 .05 35	74S197 .05 75
7458 .02 19	7499 .05 60	74243 .05 50	74LS135 .05 35	74S198 .05 75
7459 .02 19	7499 .05 60	74244 .05 50	74LS136 .05 35	74S199 .05 75
7460 .02 19	7499 .05 60	74245 .05 50	74LS137 .05 35	74S200 .05 75
7461 .02 19	7499 .05 60	74246 .05 50	74LS138 .05 35	74S201 .05 75
7462 .02 19	7499 .05 60	74247 .05 50	74LS139 .05 35	74S202 .05 75
7463 .02 19	7499 .05 60	74248 .05 50	74LS140 .05 35	74S203 .05 75
7464 .02 19	7499 .05 60	74249 .05 50	74LS141 .05 35	74S204 .05 75
7465 .02 19	7499 .05 60	74250 .05 50	74LS142 .05 35	74S205 .05 75
7466 .02 19	7499 .05 60	74251 .05 50	74LS143 .05 35	74S206 .05 75
7467 .02 19	7499 .05 60	74252 .05 50	74LS144 .05 35	74S207 .05 75
7468 .02 19	7499 .05 60	74253 .05 50	74LS145 .05 35	74S208 .05 75
7469 .02 19	7499 .05 60	74254 .05 50	74LS146 .05 35	74S209 .05 75
7470 .02 19	7499 .05 60	74255 .05 50	74LS147 .05 35	74S210 .05 75
7471 .02 19	7499 .05 60	74256 .05 50	74LS148 .05 35	74S211 .05 75
7472 .02 19	7499 .05 60	74257 .05 50	74LS149 .05 35	74S212 .05 75
7473 .02 19	7499 .05 60	74258 .05 50	74LS150 .05 35	74S213 .05 75
7474 .02 19	7499 .05 60	74259 .05 50	74LS151 .05 35	74S214 .05 75
7475 .02 19	7499 .05 60	74260 .05 50	74LS152 .05 35	74S215 .05 75
7476 .02 19	7499 .05 60	74261 .05 50	74LS153 .05 35	74S216 .05 75
7477 .02 19	7499 .05 60	74262 .05 50	74LS154 .05 35	74S217 .05 75
7478 .02 19	7499 .05 60	74263 .05 50	74LS155 .05 35	74S218 .05 75
7479 .02 19	7499 .05 60	74264 .05 50	74LS156 .05 35	74S219 .05 75
7480 .02 19	7499 .05 60	74265 .05 50	74LS157 .05 35	74S220 .05 75
7481 .02 19	7499 .05 60	74266 .05 50	74LS158 .05 35	74S221 .05 75
7482 .02 19	7499 .05 60	74267 .05 50	74LS159 .05 35	74S222 .05 75
7483 .02 19	7499 .05 60	74268 .05 50	74LS160 .05 35	74S223 .05 75
7484 .02 19	7499 .05 60	74269 .05 50	74LS161 .05 35	74S224 .05 75
7485 .02 19	7499 .05 60	74270 .05 50	74LS162 .05 35	74S225 .05 75
7486 .02 19	7499 .05 60	74271 .05 50	74LS163 .05 35	74S226 .05 75
7487 .02 19	7499 .05 60	74272 .05 50	74LS164 .05 35	74S227 .05 75
7488 .02 19	7499 .05 60	74273 .05 50	74LS165 .05 35	74S228 .05 75
7489 .02 19	7499 .05 60	74274 .05 50	74LS166 .05 35	74S229 .05 75
7490 .02 19	7499 .05 60	74275 .05 50	74LS167 .05 35	74S230 .05 75
7491 .02 19	7499 .05 60	74276 .05 50	74LS168 .05 35	74S231 .05 75
7492 .02 19	7499 .05 60	74277 .05 50	74LS169 .05 35	74S232 .05 75
7493 .02 19	7499 .05 60	74278 .05 50	74LS170 .05 35	74S233 .05 75
7494 .02 19	7499 .05 60	74279 .05 50	74LS171 .05 35	74S234 .05 75
7495 .02 19	7499 .05 60	74280 .05 50	74LS172 .05 35	74S235 .05 75
7496 .02 19	7499 .05 60	74281 .05 50	74LS173 .05 35	74S236 .05 75
7497 .02 19	7499 .05 60	74282 .05 50	74LS174 .05 35	74S237 .05 75
7498 .02 19	7499 .05 60	74283 .05 50	74LS175 .05 35	74S238 .05 75
7499 .02 19	7499 .05 60	74284 .05 50	74LS176 .05 35	74S239 .05 75
7500 .02 19	7499 .05 60	74285 .05 50	74LS177 .05 35	74S240 .05 75

VOLUME DISCOUNT SCHEDULE

Merchandise Total Discount

\$ 0.00-\$ 9.99 NET

\$ 10.00-\$ 24.99 LESS 5%

\$ 25.00-\$ 99.99 LESS 10%

\$ 100.00-\$499.99 LESS 15%

\$ 500.00-\$999.99 LESS 20%

\$1000.00 and up LESS 25%

STANDARD SHIPPING CHARGES

If your Merchandise Total is between:

\$ 0.00-\$ 4.99 add \$2.00

\$ 5.00-\$24.99 add \$1.00

\$ 25.00-\$49.99 add \$0.75

\$ 50.00-\$99.99 add \$0.50

\$100 and up NO CHARGE

The above charges include shipping via First Class Mail or UPS (your choice), and insurance on all domestic shipments.

SPECIAL SHIPPING CHARGES

COD \$1.00-additional

UPS Blue \$2.00-additional

Postal Insurance \$1.00-additional

Special Delivery

\$135 = 8K

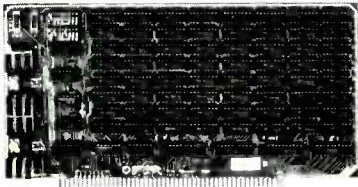

Econoram II™ kit plugs into any S-100 machine. Static design, buffering, low current, high speed, 2 block configuration. Extremely cost effective. 3 kits/\$375. Assembled/tested \$155.

all time best seller!

\$279 = 16K

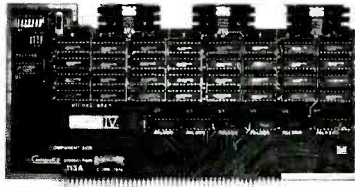

Econoram IV™ "unkit" comes with sockets, bypass caps pre-soldered in place. Plugs into any S-100 machine; fully static design, memory protect, buffered lines, under 2000 mA current. Assembled/tested. \$314; CSC qualified* \$414.

\$445 = 24K

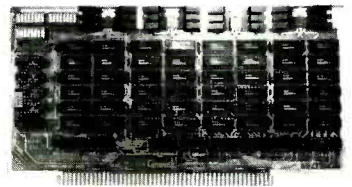

Econoram VII™ "unkit" comes with sockets, bypass caps pre-soldered in place. Plugs into any S-100 machines. Same features and specs as above plus extras (4 block configuration, phantom line option, more). Assembled/test \$485; CSC qualified* \$605.

*Certified Systems Components board are assembled, tested, serial numbered, burned in for 200 hours, and guaranteed to run at 4 MHz over full temp range. Board exchanged if failure occurs within 1 year of invoice date.

SEE **CompuKit™** AT YOUR LOCAL COMPUTER STORE.

TRS-80 memory SPECIAL

Our Conversion Kit upgrades TRS-80 mainframe from 4K to 16K, or populates Memory Expansion Module. With conversion instructions. Also works with APPLES. ONLY \$159 (3 kits/\$450) . . . and we back up our parts with a 1 year warranty.

HEATH H8 memory SPECIAL

Econoram VI™ brings 12K of Econoram quality to the H8 buss. Fully static. Regular price: \$235 for "unkit" (sockets, bypass caps pre-soldered in place); now, through cover month of magazine, buy 2 unkits for \$399.

MA1003 clock module \$16.50



Simple to apply; requires only 3 time-setting switches and 12V DC. Ideal for car, van, other portable use thanks to built-in timebase. Four 0.3" blue-green fluorescent digits. Extra features included for car use. With applications data. \$16.50 ea., 3/\$46.

TERMS: Add 5% shipping, excess refunded. Cal res add tax. COD OK with street address for UPS. VISA/Mastercharge orders call 24 hrs (415) 562-0636. Thank you!

GODBOUT
BILL GODBOUT ELECTRONICS
BOX 2355, OAKLAND AIRPORT, CA 94614
CIRCLE NO 24 ON FREE INFORMATION CARD

FORDHAM BEST BUYS

BK PRECISION 3 1/2-Digit Portable DMM
• Overhead Protected • Battery or AC operation • 3 1/2 High LED Display • Auto Zeroing
Model 2800
\$85
comes complete with test leads, operating manual and spare fuses.

EICO 3 1/2 Digit DMM Kit \$65.00
• Flushing Over-Range Indicator • Auto Polarity • Overload Protected
Model 270 wired Reg. \$80.00

ESE CONTINENTAL SPECIALTIES 100 MHz 8-Digit Counter
• 20 Hz-100 MHz Range • 6 LED Display • Fully Automatic • Includes 100-IPC clip lead input cable, manual
Model MAX 100
\$119.00

WAHL NEW ISO-TIP "Quick Charge"
1-2 units \$27.95
3 or more \$26.95
• Model 7500 Cordless Soldering Iron \$17.95
• Model 5800 Thermal Spot Circuit Tester \$22.50

NLS 15 MHz Mini Oscilloscope Model MS 15
Reg. \$318.00
\$270.30
• Battery or line operation • Automatic and line sync modes • Power consumption less than 15 W
NOW AVAILABLE Dual Trace Version
Model MS 15 Reg. \$318.00 Model MS 215 Reg. \$435.00
\$349.95 \$385.00

RCA Color Generator Model WR 508
Reg. \$89.50
\$59.95

Weller Xcelite Service Master Attache Style Tool Kit \$39.95
• Model 99SM
Tool Cases Model TC-100/ST \$239.50
• Model 99PR
Roll Kit \$13.95

BSR Record Changer Accessories
Model BSR-129
\$24.95

ESE Logic Probe Model LP-1 \$40.00 complete
• Compact, direct powered • Multi-family compatibility DTL/TTL/CMOS • Detects pulses as short as 50 nSec.

LEADER Instruments Corp 20 MHz. Dual Trace Model LBO 508
Reg. \$769.95
• Add, subtract modes per CH 1 & CH 2 • Front panel X-Y operation • 17.5 nSec rise time
\$654.50 with accessories

ESE QT Sockets & Bus Strips

QT type	# holes	price
QT 596	590	12.50
QT 598	bus strip	2.50
QT 475	470	10.00
QT 478	bus strip	2.25
QT 355	350	6.50
QT 358	bus strip	2.00
QT 185	180	4.75
QT 125	120	3.75
QT 85	80	3.25
QT 75	70	3.00

Econo-Lamp Model XL 334A \$14.95
Colors: Red, yellow, blue, black, oyster, white U.L. listed

HICKOK Function Generator Model 270 \$169.15
Reg. \$199.00
6" x 9" 3-Way Speaker Model 20 or ceramic magnet \$14.95

Logic Monitor Model LM-1 \$67.50 complete
• Automatically displays static and dynamic logic • Works with DTL, TTL, TTL and CMOS • 16 LED display • Circuit powered design

Transistor Tester Model 100 \$22.00
9 volt battery included
• Movable base pin (conforms to TO-5, TO-18 and small in-line leads) • Tests transistors in or out of circuit • Operates on contact • Clear speaker, tone, no visual observations to make

Magnifier LAMP Model MG 10A \$42.50
700 Series Precision ground and polished magnification lens. Uses 22W T-9 Circuarc Fluorescent

Call TOLL FREE (800) 645-9518
For N.Y. State call 1516-752-0050
Before you buy test equipment any make or model, check our prices
MasterCharge • Bank America • CO • Check • Money Order
Add \$3.00 for shipping and insurance
C.O.D. • Extra New York State residents add
VISA
prop sales tax

LEADER Instruments Corp Transistor Checker Model LTC 906 Reg. \$159.95 \$136.00

BK PRECISION 15MHz Portable 3" Dual Trace Scope Model 1432P Reg. \$780.00 \$663.00 with probes

VOM Multimeters 20K ohm/v \$17.95 with mirrored scale. 1K ohm/v \$9.95

SENCORE UHF Prescaler Model PR-47 \$79.95
• Extends counter range to 600 MHz • FCC accurate with FC 45
SUPER BUY

SEND FOR YOUR FREE CATALOG - THOUSANDS OF SURPLUS BARGAINS AVAILABLE FOR YOU

DO-IT-YOURSELF

FAMOUS NAME SPEAKER ENCLOSURES

Mfg. Close Out - FAMOUS MANUFACTURER had model change & close out of production run. They might have slight blemishes, or 2nds on the finish - Only we saved big for you. (Sample picture shown) - most are ducked port 3 & 4 way with popoff grills & tweeters mid-range controls on front. Sold pair only.
D.P. = Ducked Port - P.R. = Passive Radator - L.P. = List Price.
10" - 35wt - 3 way - DP - L.P. \$198.00... Cost \$118.88
10" - 50wt - 3 way - DP - L.P. \$279.50... Cost \$179.88
12" - 70wt - 3 way - DP - L.P. \$349.50... Cost \$199.88
12" - 90wt - 4 way - 12" P.R. - \$399.50... Cost \$248.88



RACK CABINETS EQUIPTO

Size: 24"x24"x68 1/2" with rails on front & back for mounting equipment on 19" centers. No doors or sides - list price \$185.00 - NEW SURPLUS! Your cost only \$50.00 each. Qty Ltd. Frt. collect.
80B2049 \$50.00

WHERE SURPLUS REIGNS SUPREME

MOTION DETECTOR



This alarm sensor fills the protected area with an energy screen that cannot be seen, felt or heard. Triggers your alarm whenever burglar moves through detector field. Mounts on ceiling, wall, desk, shelf etc. Optional delay mode, desk-top. Operates on 12.5 VDC. A close-out that originally sold for \$179.00! 3 Lbs. Qty. Ltd. 48D30336 \$49.88

REMOTE CONTROL SYSTEM

Brand New! Originally for TV use... you can use it to control stereo - on/off tape, on/off power, volume, & more. All are controlled from across the room with a hand held xmitter. For the serious custom designer. Includes transmitter & receiver. Also includes Mfg.'s schematics.
Sh. Wt. 1 Lb. 8C30372 \$25.00/Set

AM/FM STEREO RECEIVER/AMP CHASSIS

Surplus Brand-name receiver/amplifier chassis, including bulls-eye stereo light on tuning needle, slide controls, amp & tuner (no case). Mfr.'s "questionables" may need repair. You fix & save! Qty. is limited. AS IS (no returns). W/data.
5 Lbs. 8K30357 \$19.88 Ea



3 1/2" Super Horn. \$7.88 Ea. \$14.88 Pr.
2XS" Horn Tweeter... \$17.88 /Pair
2X6" Horn Tweeter... \$23.88/Pair

Send orders to:
B & F ENTERPRISES
Dept. P10
119 Foster Street
Peabody, MA. 01960
(617) 531-5774

Use your BAINC or AI for telephone orders - Call (617) 531-5774 - No C.O.D.'s Please. Add POSTAGE, UPS, or PARCEL POST.
CIRCLE READER SERVICE CARD FOR FREE JUMBO CATALOG
CIRCLE NO. 5 ON FREE INFORMATION CARD

PHONE ORDERS WELCOMED - (617) 531-5774 - BANKRUPT CARD - MASTER CHARGE - AMERICAN EXPRESS ACCEPTED

INTEGRATED ELECTRONICS

540 Weddell Drive, #4, Sunnyvale, CA 94086 (408) 734-8470

CMOS	74C08	65	7427	.35	74161	1.00	8973	2.95	8334	4.00	
	74C10	.25	7430	.15	74163	1.30	8974	2.95	8553	6.50	
	74C14	1.75	7432	.30	74164	1.45	8976	2.95	8556	3.25	
4000	20	74C20	.26	7437	.44	74165	1.35	75107	3.25	8599	3.25
4002	20	74C30	.26	7440	.18	74166	1.20	75450	1.00		
4007	20	74C32	.30	7442	1.00	74173	1.70	75451	.80		
4010	.36	74C42	1.40	7445	.70	74175	1.05	75452	.80		
4011	.20	74C48	2.75	7446	.70	74177	.90	75453	.80		
4012	.20	74C73	1.25	7448	.70	74182	.95	75491	1.25		
4013	.35	74C74	.75	7449	.25	74191	1.20	75492	1.40		
4014	.80	74C86	1.00	7451	.25	74192	1.45	75494	1.50		
4015	.80	74C90	1.10	7453	.25	74193	1.35				
4016	.35	74C93	1.25	7454	.35	74195	1.00				
4017	.92	74C151	2.75	7460	.22	74196	1.10				
4018	.92	74C154	3.00	7472	.40	74197	1.10				
4019	.20	74C157	1.10	7473	.40	74199	2.25				
4020	1.00	74C160	1.40	7474	.40	74367	.90				
4022	.83	74C162	2.70	7475	.55						
4023	.21	74C164	1.75	7476	.45						
4024	.75	74C165	1.75	7483	1.05	0025	3.50				
4025	.20	74C174	1.50	7485	1.10	002G	1.75	2513	9.50		
4027	.34	74C902	.85	7486	.43	8640	1.25	2516	9.50		
4028	.79	74C904	.85	7489	2.00	8861	2.75	1013	6.50		
4079	1.00	74C905	3.00	7492	.75	8906	3.00				
4030	.20	74C914	1.95	7493	.85						
4035	.95			7496	.78						
4040	1.00			7498	.85	8830	4.90	8797	1.75		
4041	1.00	7400	.16	74121	.35	8833	2.45	8092	.95		
4042	.70	7401	.17	74122	.49	8835	2.45	8094	.60		
4044	.60	7403	.17	74123	.65	8836	1.25	8095	.80		
4049	.35	7404	.19	74126	.65	8837	2.45	8096	.90		
4051	1.10	7406	.40	74132	1.25	8838	2.45	8098	.90		
4066	.70	7407	.40	74141	1.15	8859	1.50	8121	2.25		
4068	.40	7409	.25	74145	1.10	8865	1.50	8136	3.25		
4069	.40	7410	.18	741481	1.20	8866	1.50	8220	3.25		
4075	.20	7413	.78	74150	.90	8867	1.85	8231	2.25		
4082	.23	7414	.68	74153	1.10	8869	1.75	8242	1.75		
74C00	.25	7417	.38	74154	1.25	8879	2.25	8250	1.75		
74C02	.45	7420	.18	74155	.75	8880	2.75	8260	2.25		
74C04	.32	7421	.35	74157	1.00	8884	2.45	8281	1.00		

* For more 74LSxx, refer to our ad in the June issue of this magazine.

SPECIAL DISCOUNT
OEM EDUCATORS AND SCHOOLS
For a low quote, send a list of your needs and, if possible, desired prices. No quantity is too small.

Minimum order \$5.00 US currency. Check or money order only. Add 5% to cover shipping and handling charges. Calif. residents add 6% sales tax. Santa Clara County residents add 6.5% sales tax.

CIRCLE NO. 28 ON FREE INFORMATION CARD

New Tone Electronics

Quality components at fair prices

HIGH FIDELITY SPEAKERS

- 8-INCH COAXIAL**
Combines a high quality 8" woofer and a tweeter into a pre-phased sound reproducer. Built-in cross-over network. Excellent choice for a low cost Hi-Fi system for autos, vans, or in your home. Frequency response is a smooth 80-15000 Hz. 8-ohm VC, 10 oz ceramic ring magnet. 25W rating. **NT577 \$13.99 plus 40 cents postage**
- 10-INCH WOOFER**
The speaker for your "big sound" system. Frequency response is 20-4000 Hz; 8-ohm aluminum VC; powerful 20 oz ceramic ring magnet and a rubberized accordion-edge suspension for excellent compliance. Handles 50W max. Use with the NT576 for a super system. **NT578 \$17.99 plus 40 cents postage**
- 50W DOME TWEETER**
Here is the super tweeter. A rugged 10 cm (4") dome tweeter which handles 50W max. Frequency response is 4000-20000 Hz. 3-ohm VC, 8-oz. ceramic magnet. Your system can have a brilliance you never imagined. **NT576 \$6.99**

- Resistors** Standard values, ± 5%, first quality. Packed 5 of one value.
¼W 5 for \$.25 ½W 5 for \$.30
- Capacitor Special** 3600 mF, 40Vdc Sprague "Powerlytic" **\$1.89**
- Relay** SPDT, 12Vdc - 5A contacts **NT565 \$1.79**
- Sound Activated Switch** Complete, ready to use. Built-in microphone's output triggers a Triac which acts as a switch. Measures only 1" x 3". Requires 3-6Vdc.
NT527 \$1.29

And, the largest inventory of domestic and Japanese transistors and ICs in the United States.

ALL PARTS GUARANTEED
WRITE FOR FREE CATALOG

Minimum Order \$5. Add \$1.50 Postage and Handling. Canada add \$2.00. N.J. Residents add 5% Sales Tax.



New Tone Electronics
PO BOX 1738
Bloomfield, N.J. 07003

CIRCLE NO. 44 ON FREE INFORMATION CARD

www.americanradiohistory.com

Digital Auto Security System

3-Way Protection For Your Entire Car or Van

- Proximity Triggered Theft Protection - for valuables, CB or Ham equipment.
- Voltage Triggered Entry Protection - for doors and trunk.
- Mechanically Triggered Entry Protection - for under-hood parts.
- Activated by Personal 4-Digit Code.
- Uses Your Auto Horn As An Alarm, Or Add A Siren.

Forget about anything you may have heard about other anti-theft systems. The OCULAR 2[®], total security system, adds a new dimension to automobile security - Proximity Detection. Even if the would-be thief could enter your car without triggering the voltage sensing circuit (not likely) - just approaching the protected area will sound your alarm instantly. He does not have to touch anything! Attention is the one thing the "rip-off" artist doesn't want.

And, there's more protection. Raising the hood sounds the alarm. Any change in voltage (dome or trunk light on, starting the car) sounds the alarm. If the cable connecting the units in the passenger compartment is cut, the OCULAR 2 turns itself on and sounds the alarm.

Your personal 4-digit code activates and deactivates the whole system. Just enter your code through the attractive push-button "Code Lok" keyboard when you leave your car and the system is activated. When you return, there's enough time to enter your code to deactivate the system before the alarm sounds.

Installation is easy and requires only simple hand tools. Complete with all hardware, instructions and your personal code. For 12-volt, negative-ground electrical systems only.

Sorry, but at this price, we must limit each order to only two systems per customer.

Was \$49.95, now **Ocular 2 \$19.95**

ABOUT YOUR SUBSCRIPTION

Your subscription to POPULAR ELECTRONICS is maintained on one of the world's most modern, efficient computer systems, and if you're like 99% of our subscribers, you'll never have any reason to complain about your subscription service.

We have found that when complaints do arise, the majority of them occur because people have written their names or addresses differently at different times. For example, if your subscription were listed under "William Jones, Cedar Lane, Middletown, Arizona," and you were to renew it as "Bill Jones, Cedar Lane, Middletown, Arizona," our computer would think that two separate subscriptions were involved, and it would start sending you two copies of POPULAR ELECTRONICS each month. Other examples of combinations of names that would confuse the computer would include: John Henry Smith and Henry Smith; and Mrs. Joseph Jones and Mary Jones. Minor differences in addresses can also lead to difficulties. For example, to the computer, 100 Second St. is not the same as 100 2nd St.

So, please, when you write us about your subscription, be sure to enclose the mailing label from the cover of the magazine—or else copy your name and address exactly as they appear on the mailing label. This will greatly reduce the chance of error, and we will be able to service your request much more quickly.

Some day shipment. First line parts only. Factory tested. Guaranteed money back. Quality IC's and other components at factory prices.

INTEGRATED CIRCUITS

74007TL	74LS28N	41	LM340T-15	110	2114	8.50
7402N	74LS20N	17	LM340T-18	110	4116	17.95
7402N	74LS20N	25	LM340T-24	110	CD111	94
7402N	74LS20N	30	LM340T-30	110	CD238	24
7402N	74LS20N	35	LM340T-35	110	CD4515	1.50
7402N	74LS20N	41	LM340T-41	110	CD4516	1.50
7402N	74LS20N	47	LM340T-47	110	CD4517	1.50
7402N	74LS20N	53	LM340T-53	110	CD4518	1.50
7402N	74LS20N	59	LM340T-59	110	CD4519	1.50
7402N	74LS20N	65	LM340T-65	110	CD4520	1.50
7402N	74LS20N	71	LM340T-71	110	CD4521	1.50
7402N	74LS20N	77	LM340T-77	110	CD4522	1.50
7402N	74LS20N	83	LM340T-83	110	CD4523	1.50
7402N	74LS20N	89	LM340T-89	110	CD4524	1.50
7402N	74LS20N	95	LM340T-95	110	CD4525	1.50
7402N	74LS20N	101	LM340T-101	110	CD4526	1.50
7402N	74LS20N	107	LM340T-107	110	CD4527	1.50
7402N	74LS20N	113	LM340T-113	110	CD4528	1.50
7402N	74LS20N	119	LM340T-119	110	CD4529	1.50
7402N	74LS20N	125	LM340T-125	110	CD4530	1.50
7402N	74LS20N	131	LM340T-131	110	CD4531	1.50
7402N	74LS20N	137	LM340T-137	110	CD4532	1.50
7402N	74LS20N	143	LM340T-143	110	CD4533	1.50
7402N	74LS20N	149	LM340T-149	110	CD4534	1.50
7402N	74LS20N	155	LM340T-155	110	CD4535	1.50
7402N	74LS20N	161	LM340T-161	110	CD4536	1.50
7402N	74LS20N	167	LM340T-167	110	CD4537	1.50
7402N	74LS20N	173	LM340T-173	110	CD4538	1.50
7402N	74LS20N	179	LM340T-179	110	CD4539	1.50
7402N	74LS20N	185	LM340T-185	110	CD4540	1.50
7402N	74LS20N	191	LM340T-191	110	CD4541	1.50
7402N	74LS20N	197	LM340T-197	110	CD4542	1.50
7402N	74LS20N	203	LM340T-203	110	CD4543	1.50
7402N	74LS20N	209	LM340T-209	110	CD4544	1.50
7402N	74LS20N	215	LM340T-215	110	CD4545	1.50
7402N	74LS20N	221	LM340T-221	110	CD4546	1.50
7402N	74LS20N	227	LM340T-227	110	CD4547	1.50
7402N	74LS20N	233	LM340T-233	110	CD4548	1.50
7402N	74LS20N	239	LM340T-239	110	CD4549	1.50
7402N	74LS20N	245	LM340T-245	110	CD4550	1.50
7402N	74LS20N	251	LM340T-251	110	CD4551	1.50
7402N	74LS20N	257	LM340T-257	110	CD4552	1.50
7402N	74LS20N	263	LM340T-263	110	CD4553	1.50
7402N	74LS20N	269	LM340T-269	110	CD4554	1.50
7402N	74LS20N	275	LM340T-275	110	CD4555	1.50
7402N	74LS20N	281	LM340T-281	110	CD4556	1.50
7402N	74LS20N	287	LM340T-287	110	CD4557	1.50
7402N	74LS20N	293	LM340T-293	110	CD4558	1.50
7402N	74LS20N	299	LM340T-299	110	CD4559	1.50
7402N	74LS20N	305	LM340T-305	110	CD4560	1.50
7402N	74LS20N	311	LM340T-311	110	CD4561	1.50
7402N	74LS20N	317	LM340T-317	110	CD4562	1.50
7402N	74LS20N	323	LM340T-323	110	CD4563	1.50
7402N	74LS20N	329	LM340T-329	110	CD4564	1.50
7402N	74LS20N	335	LM340T-335	110	CD4565	1.50
7402N	74LS20N	341	LM340T-341	110	CD4566	1.50
7402N	74LS20N	347	LM340T-347	110	CD4567	1.50
7402N	74LS20N	353	LM340T-353	110	CD4568	1.50
7402N	74LS20N	359	LM340T-359	110	CD4569	1.50
7402N	74LS20N	365	LM340T-365	110	CD4570	1.50
7402N	74LS20N	371	LM340T-371	110	CD4571	1.50
7402N	74LS20N	377	LM340T-377	110	CD4572	1.50
7402N	74LS20N	383	LM340T-383	110	CD4573	1.50
7402N	74LS20N	389	LM340T-389	110	CD4574	1.50
7402N	74LS20N	395	LM340T-395	110	CD4575	1.50
7402N	74LS20N	401	LM340T-401	110	CD4576	1.50
7402N	74LS20N	407	LM340T-407	110	CD4577	1.50
7402N	74LS20N	413	LM340T-413	110	CD4578	1.50
7402N	74LS20N	419	LM340T-419	110	CD4579	1.50
7402N	74LS20N	425	LM340T-425	110	CD4580	1.50
7402N	74LS20N	431	LM340T-431	110	CD4581	1.50
7402N	74LS20N	437	LM340T-437	110	CD4582	1.50
7402N	74LS20N	443	LM340T-443	110	CD4583	1.50
7402N	74LS20N	449	LM340T-449	110	CD4584	1.50
7402N	74LS20N	455	LM340T-455	110	CD4585	1.50
7402N	74LS20N	461	LM340T-461	110	CD4586	1.50
7402N	74LS20N	467	LM340T-467	110	CD4587	1.50
7402N	74LS20N	473	LM340T-473	110	CD4588	1.50
7402N	74LS20N	479	LM340T-479	110	CD4589	1.50
7402N	74LS20N	485	LM340T-485	110	CD4590	1.50
7402N	74LS20N	491	LM340T-491	110	CD4591	1.50
7402N	74LS20N	497	LM340T-497	110	CD4592	1.50
7402N	74LS20N	503	LM340T-503	110	CD4593	1.50
7402N	74LS20N	509	LM340T-509	110	CD4594	1.50
7402N	74LS20N	515	LM340T-515	110	CD4595	1.50
7402N	74LS20N	521	LM340T-521	110	CD4596	1.50
7402N	74LS20N	527	LM340T-527	110	CD4597	1.50
7402N	74LS20N	533	LM340T-533	110	CD4598	1.50
7402N	74LS20N	539	LM340T-539	110	CD4599	1.50
7402N	74LS20N	545	LM340T-545	110	CD4600	1.50
7402N	74LS20N	551	LM340T-551	110	CD4601	1.50
7402N	74LS20N	557	LM340T-557	110	CD4602	1.50
7402N	74LS20N	563	LM340T-563	110	CD4603	1.50
7402N	74LS20N	569	LM340T-569	110	CD4604	1.50
7402N	74LS20N	575	LM340T-575	110	CD4605	1.50
7402N	74LS20N	581	LM340T-581	110	CD4606	1.50
7402N	74LS20N	587	LM340T-587	110	CD4607	1.50
7402N	74LS20N	593	LM340T-593	110	CD4608	1.50
7402N	74LS20N	599	LM340T-599	110	CD4609	1.50
7402N	74LS20N	605	LM340T-605	110	CD4610	1.50
7402N	74LS20N	611	LM340T-611	110	CD4611	1.50
7402N	74LS20N	617	LM340T-617	110	CD4612	1.50
7402N	74LS20N	623	LM340T-623	110	CD4613	1.50
7402N	74LS20N	629	LM340T-629	110	CD4614	1.50
7402N	74LS20N	635	LM340T-635	110	CD4615	1.50
7402N	74LS20N	641	LM340T-641	110	CD4616	1.50
7402N	74LS20N	647	LM340T-647	110	CD4617	1.50
7402N	74LS20N	653	LM340T-653	110	CD4618	1.50
7402N	74LS20N	659	LM340T-659	110	CD4619	1.50
7402N	74LS20N	665	LM340T-665	110	CD4620	1.50
7402N	74LS20N	671	LM340T-671	110	CD4621	1.50
7402N	74LS20N	677	LM340T-677	110	CD4622	1.50
7402N	74LS20N	683	LM340T-683	110	CD4623	1.50
7402N	74LS20N	689	LM340T-689	110	CD4624	1.50
7402N	74LS20N	695	LM340T-695	110	CD4625	1.50
7402N	74LS20N	701	LM340T-701	110	CD4626	1.50
7402N	74LS20N	707	LM340T-707	110	CD4627	1.50
7402N	74LS20N	713	LM340T-713	110	CD4628	1.50
7402N	74LS20N	719	LM340T-719	110	CD4629	1.50
7402N	74LS20N	725	LM340T-725	110	CD4630	1.50
7402N	74LS20N	731	LM340T-731	110	CD4631	1.50
7402N	74LS20N	737	LM340T-737	110	CD4632	1.50
7402N	74LS20N	743	LM340T-743	110	CD4633	1.50
7402N	74LS20N	749	LM340T-749	110	CD4634	1.50
7402N	74LS20N	755	LM340T-755	110	CD4635	1.50
7402N	74LS20N	761	LM340T-761	110	CD4636	1.50
7402N	74LS20N	767	LM340T-767	110	CD4637	1.50
7402N	74LS20N	773	LM340T-773	110	CD4638	1.50
7402N	74LS20N	779	LM340T-779	110	CD4639	1.50
7402N	74LS20N	785	LM340T-785	110	CD4640	1.50
7402N	74LS20N	791	LM340T-791	110	CD4641	1.50
7402N	74LS20N	797	LM340T-797	110	CD4642	1.50
7402N	74LS20N	803	LM340T-803	110	CD4643	1.50
7402N	74LS20N	809	LM340T-809	110	CD4644	1.50
7402N	74LS20N	815	LM340T-815	110	CD4645	1.50
7402N	74LS20N	821	LM340T-821	110	CD4646	1.50
7402N	74LS20N	827	LM340T-827	110	CD4647	1.50
7402N	74LS20N	833	LM340T-833	110	CD4648	1.50
7402N	74LS20N	839	LM340T-839	110	CD4649	1.50
7402N	74LS20N	845	LM340T-845	110	CD4650	1.50
7402N	74LS20N	851	LM340T-851	110	CD4651	1.50
7402N	74LS20N	857	LM340T-857	110	CD4652	1.50
7402N	74LS20N	863	LM340T-863	110	CD4653	1.50
7402N	74LS20N	869	LM340T-869	110	CD4654	1.50
7402N	74LS20N	875	LM340T-875	110	CD4655	1.50
7402N	74LS20N	881	LM340T-881	110	CD4656	1.50
7402N	74LS20N	887	LM340T-887	110	CD4657	1.50
7402N	74LS20N	893	LM340T-893	110	CD4658	1.50
7402N	74LS20N	899	LM340T-899	110	CD4659	1.50
7402N	74LS20N	905	LM340T-905	110	CD4660	1.50
7402N	74LS20N	911	LM340T-911	110	CD4661	1.50
7402N	74LS20N	917	LM340T-917	110	CD4662	1.50
7402N	74LS20N	923	LM340T-923	110	CD4663	1.50
7402N	74LS20N	929	LM340T-929	110	CD4664	1.50
7402N	74LS20N	935	LM340T-935	110	CD4665	1.50
7402N	74LS20N	941	LM340T-941	110	CD4	

EDMUND SCIENTIFIC

BUILD THESE NEW ELECTRONICS KITS

New electronics learning kit lets you build 100 items such as lie-detectors, wireless telegraph, sound effects machine and more. Even becomes a working AM radio! Contains 36 plug-in modules, printed circuits, crystal earphone, transistors, diodes, etc. 500mW 6V power supply runs on 4 "AA" batteries (not incl.). Size: 10 1/4 x 8 x 2". Wt.: 1 1/2 lbs.



No. 72,424AV **\$53.95** Ppd.
Deluxe Kit: Same as above No. 72,423AV
with 150 experiments **\$76.95** Ppd.

SUPER POWER FOR ANY AM RADIO

Antenna assist has pulled in station 1,000 miles off! No wires, clips, grounding tubes, plugs



No. 72,147AV **\$29.95** Ppd.

SEE MUSIC IN PULSATING COLOR

3-Channel Color Organ lets you modulate 3 independent strings of colored lamps with intensity of your music. "Audio light show" flashes, responds to rhythm, pitch!



No. 42,309AV **\$20.95** Ppd.

SUPER QUALITY 10X MAGNIFIER

Full 10X, color-corrected, flat-field, cemented lens system. Great for jewelers, collectors, engravers, hobbyists, etc. Mtd. in aluminum cell, chrome-plate case. 3/4" x 1 1/4" closed; clear lens dia 1/2"



No. 30,344AV **\$18.95** Ppd.

SEND FOR FREE CATALOG



EDMUND SCIENTIFIC CO., Dept. AV 22
Edscorp Bldg., Barrington, N.J. 08007

GIANT 164 Pg. Catalog packed with unusual bargains.

Name _____
Address _____
City _____ State _____ Zip _____
(Please Print)

Mail Coupon Today

EDMUND SCIENTIFIC CO., Dept. AV 22
Edscorp Bldg., Barrington, N.J. 08007

Enclosed please find check/M.O.
Charge My Amer. Exp. BAC/VISA MC

Card # _____ Interbank # _____ Exp. Date # _____
Qty _____ Stock No. _____ Unit Price _____ Total _____

Qty	Stock No.	Unit Price	Total
N.J. residents add 5% Handling Service			\$1.00
Signature _____			Total _____

Address _____
City _____ State _____ Zip _____

Operation Assist

If you need information on outdated or rare equipment—a schematic, parts list, etc.—another reader might be able to assist. Simply send a postcard to Operation Assist, POPULAR ELECTRONICS, 1 Park Ave., New York, N.Y. 10016. For those who can help readers, please respond directly to them. They'll appreciate it. (Only those items regarding equipment not available from normal sources are published.)

G.E. "Ham News" Need any edition circa 1952. C. Wayne, Box E., Garden Grove, CA 92642.

B&K model 160 transistor tester. Operation manual. Dennis Blasberg 2501 45th St., Des Moines, IA 50310.

Hallicrafters SW-500 shortwave receiver. Schematic, alignment information and manual. Dennis Vanderhei, 1236 18th St., NW, Cedar Rapids, IA 52405.

RCA model 721 TS television. Circuit diagram and list of tubes. M.G. Cunningham, West Redding, Rd., Danbury, CT 06810.

Sony reel-to-reel tape recorder model TC-377. Service manual, schematics or any available information. Rocco Nicholas Arturo, 511 Hendee St., New Orleans, LA 70114.

Telequipment type S31 oscilloscope. Manual and schematic. Wayne Gunn, Rt. 1, Box 89A, Rusk, TX 75785.

CMI model SG-410 guitar amplifier. Schematic, instructions and service manual. Scott DellaPerata, 510 Country Club Rd., Bridgewater, NJ 08807.

Precision sweep generator series E-400. Operating manual. Nelson Baxter, RT 1, Box 41, Hager City, WI 54014.

Hallicrafters model SX100 shortwave receiver. Schematics and any information. Sam Murphy, 3413 Baldwin, Tyler, TX 75702.

Sencore CR 128A CRT tester. Need tube chart and operating instructions. Stephen Upchurch, 317 E. Elm, Elkhart, IA 50073.

Hickok 890 transistor tester. Operation manual and schematic. Dave Whitmore, 23 Jackson Heights, Essex Junction, VT 05452.

Hallicrafters model S 20R receiver. Operation and repair manual. Douglas Miller, 2035 Valley View Blvd., East Watahchee, WA 98801.

Hickok model 530B dynamic mutual conductance tube tester. Tube charts needed. Joe Montalbano, 1145 Larkin St., San Francisco, CA 94109.

Knight CB model Safan I. Schematic, parts list and other information. J.W. Haga, Box 33, Cates, IN 47927.

Heathkit model DX-40 transmitter with Heathkit vfo. Schematic and operating manual. Ted Wright, 3929 Wood Lane, Ft. Worth, TX 76117.

Rolecor RTA-630 solid-state FM stereo receiver. Parts list with substitution part numbers needed. Tim Mooney, 11 Cornell Dr., Delran, NJ 08075.

Becker model Europa-MU auto radio. Schematic, repair information. Jerome Knapp, 4243 West 8th St., Cincinnati, OH 45205.

Superior Instruments model TD-55. Schematic, manual and tube chart. Stanley Ondrusek, 7468 Larne La., Lorton, VA 22079.

Hickok dynamic mutual conductance multi-tester model 550X. Manual and schematic. Craig Smith, 421 Westminster, Wenonah, NJ 08090.

Callmaster model 330 (phone answering device). Schematic. Ellsworth Gosling, 3-A Oklahoma Way, Whiting, NJ 08759.

Hallicrafters model HT-40 transmitter. Operating manual and schematic. Bill Boyer, 6500 Poco Ct., Ft. Worth, TX 76133.

Bell T-337, RP-320A pre-amp reel recorder. Service and repair manual. H.A. Dobson, 1219 Nelson NE, Orangeburg, SC 29115.

Dumont type 304A, type 274, and type 411 oscilloscopes. Operation manuals and schematics. Eric Ericson, 7100 Hightower, Ft. Worth, TX 76112.

THE NEW HOBBY WORLD CATALOG

Your source for factory prime, professional quality equipment. Computers, add-on boards, IC's, sockets, resistors, supplies, tools, test equipment,

books, and more. Shop your buy list at Hobby World. You'll find what you want, and at a solid savings. For example, look at this month's specials:

THE NEW ELENCO 3 1/2 DIGIT SOLID STATE MULTIMETER

The ultimate in performance: measures resistance to .01 ohms, voltage to 100 micro-volts, current to one micro-amp. Assembled and tested, with 2-Year warranty. Lists at \$99.95. **HOBBY WORLD PRICE ONLY \$74.95!**

16K MEMORY ADD-ON FOR APPLE OR TRS-80

HOBBY WORLD PRICE IS ONLY \$145.00 (specify when ordering)

WAHL ISO-TIP CORDLESS SOLDERING IRON

Includes nicad batteries and wall plug transformer. Lists at \$19.95, **BUT HOBBY WORLD HAS IT FOR \$14.95!**

SEND ME A FREE CATALOG!

Name _____
Address _____
City _____ State _____

Hobby World
19355 Business Center Dr #6
Northridge CA 91324

TELEPHONE ORDERS
Inside Cal 213 886 9200
Outside Cal 800 423 5387

PE-11

UNIVERSAL 4Kx8 MEMORY BOARD KIT \$69.95
32-2102-1 fully buffered, 16 address lines, on board decoding for any 4 of 64 pages, standard 44 pin buss, may be used with F-8 & K1M

EXPANDABLE F8 CPU BOARD KIT \$99.00
Featuring Fairchild PSU 1K of static ram, RS 232C interface, documentation. 64 BYTEmaster

C/MOS (DIODE CLAMPED)

4001	18	4019	37	4049	35	74C73	35	
4002	-	18	4020	90	4050	35	74C74	45
4006	-	95	4021	90	4051	110	74C83	115
4007	18	4022	90	4052	125	74C85	40	
4009	37	4023	18	4066	70	74C93	75	
4010	-	37	4024	75	4071	18	74C151	140
4011	18	4025	-	18	4076	97	74C160	105
4012	18	4027	-	37	4571	70	74C161	105
4013	29	4028	80	74C00	22	74C174	105	
4014	-	75	4029	95	74C02	22	74C175	105
4015	75	4030	33	74C04	24	74C193	120	
4016	29	4035	97	74C08	22	74C901	48	
4017	-	90	4042	65	74C10	27	74C902	48
4018	90	4046	135	74C42	85	74C93A	170	

PRINTED CIRCUIT BOARD

BOARD 1/16" SOLDER STRIP (100) \$5.20
BOARD 1/16" SOLDER STRIP (50) \$2.60

7 WATT LD-65 LASER DIODE IR \$8.95

2N 3820 P.F.E.T \$ 45
2N 4575 P.F.E.T \$ 45
2N2646 UJT \$ 45
1R 500V TRIGGER DIODES 4 \$ 11.00
7N 6138 PROBJ UJT \$ 65

MINIATURE MULTI-TURN TRIM POTTS
100, 1K, 2K, 5K, 10K, 20K, 50K, 100K,
200K, 500K, 1Meg, 2Meg, \$75 each 3/32" 00

CHARGED COUPLE DEVICES

CCD 201C 100x100 Image Sensor \$95.00
CCD 202C 100x100 Image Sensor \$145.00

VERIPAC PCB BOARD \$4.00
This board is a 1/16" single sided paper epoxy board 4 1/2" x 6 1/2" DRILLED and ETCHED which will hold up to 21 single 14 pin IC's or 8,16 or 151 DIP IC's with busses for power supply connection.

RED YELLOW GREEN or AMBER
LARGE LED'S \$ 6.50
TIL 118 OPTO-ISOLATOR 100 \$1.00
MIL PIN'S 100 \$8.00

1 WATT ZENERS 3.3 4.7 5.6 9.1 10,
15 18 18 V 22V \$ 6.50
MCM6860 MODEM CHIP \$9.95
MCM 6571A 7 x 9 character gen \$10.75

TRANSISTOR SPECIALS

2N6223 PN PNP SWITCHING POWER \$ 1.95
MRF-8004 C.B. RF Transistor NPN \$ 7.00
2N3772 PNP S.T. 1.0 \$ 1.75
2N1546 PNP GE TO-3 \$ 1.75
2N2906 PNP S.T. 1.0 \$ 1.75
2N6056 PNP S.T. 1.0 \$ 1.75
2N5086 PNP S.T. 1.0 \$ 1.75
2N3137 NPN S.T. RF \$ 1.50
2N3919 PNP S.T. 5.0 \$ 1.50
2N1420 NPN S.T. 5.0 \$ 1.50
2N3766 PNP S.T. 1.0 \$ 1.75
2N3766 PNP S.T. 1.0 \$ 1.75
2N3055 PNP S.T. 3.0 \$ 1.50
2N3838 PNP S.T. 1.0 \$ 1.75
2N3956 PNP S.T. 1.0 \$ 1.75
2N6101 PNP S.T. 200 \$ 5.50
MPSA 13 NPN S.T. 4 \$ 1.00

TLI IC SERIES

7400-13	7445-65	74151-61
7401-13	7446-68	74153-61
7402-13	7447-88	74154-94
7403-13	7448-58	74155-58
7404-15	7449-15	74157-55
7405-13	7473-28	74163-55
7406-13	7474-28	74164-85
7407-20	7475-45	74165-95
7408-18	7476-30	74170-168
7409-18	7480-31	74173-120
7410-18	7485-87	74174-95
7411-18	7483-65	74175-85
7412-13	7486-28	74176-75
7413-36	7489-125	74177-75
7414-60	7490-42	74180-65
7416-22	7491-58	74181-190
7417-25	7492-43	74190-100
7420-13	7493-43	74191-100
7421-13	7494-67	74192-79
7426-22	7495-65	74193-79
7427-19	7496-65	74194-86
7430-13	74107-28	74195-86
7432-22	74121-28	74196-86
7437-21	74122-38	74279-55
7438-21	74123-45	74367-50
7440-13	74175-40	75729-150
7441-70	74126-40	75431-50
7442-37	74150-94	75492-50

Full Wave Bridges

PRV	2A	6A	25A
100	1.30	1.30	1.30
200	1.25	1.25	1.25
400	1.30	1.30	1.30
600	1.20	1.20	1.20

DIP SOCKETS

8 PIN 1/7 21 PIN 35
14 PIN 20 28 PIN 40
16 PIN 22 40 PIN 60
18 PIN 25

SANKEN AUDIO POWER AMPS

S-1000 G 10 WATTS \$ 7.80
S-1020 G 20 WATTS \$15.70
S-1050 G 50 WATTS \$28.50

2704 * PROM 4500 \$ 3.25
2716 * PROM 4500 \$ 3.25
2722 * PROM 4500 \$ 3.25
2733 * PROM 4500 \$ 3.25
2734 * PROM 4500 \$ 3.25
2735 * PROM 4500 \$ 3.25
2736 * PROM 4500 \$ 3.25
2737 * PROM 4500 \$ 3.25
2738 * PROM 4500 \$ 3.25
2739 * PROM 4500 \$ 3.25
2740 * PROM 4500 \$ 3.25
2741 * PROM 4500 \$ 3.25
2742 * PROM 4500 \$ 3.25
2743 * PROM 4500 \$ 3.25
2744 * PROM 4500 \$ 3.25
2745 * PROM 4500 \$ 3.25
2746 * PROM 4500 \$ 3.25
2747 * PROM 4500 \$ 3.25
2748 * PROM 4500 \$ 3.25
2749 * PROM 4500 \$ 3.25
2750 * PROM 4500 \$ 3.25
2751 * PROM 4500 \$ 3.25
2752 * PROM 4500 \$ 3.25
2753 * PROM 4500 \$ 3.25
2754 * PROM 4500 \$ 3.25
2755 * PROM 4500 \$ 3.25
2756 * PROM 4500 \$ 3.25
2757 * PROM 4500 \$ 3.25
2758 * PROM 4500 \$ 3.25
2759 * PROM 4500 \$ 3.25
2760 * PROM 4500 \$ 3.25
2761 * PROM 4500 \$ 3.25
2762 * PROM 4500 \$ 3.25
2763 * PROM 4500 \$ 3.25
2764 * PROM 4500 \$ 3.25
2765 * PROM 4500 \$ 3.25
2766 * PROM 4500 \$ 3.25
2767 * PROM 4500 \$ 3.25
2768 * PROM 4500 \$ 3.25
2769 * PROM 4500 \$ 3.25
2770 * PROM 4500 \$ 3.25
2771 * PROM 4500 \$ 3.25
2772 * PROM 4500 \$ 3.25
2773 * PROM 4500 \$ 3.25
2774 * PROM 4500 \$ 3.25
2775 * PROM 4500 \$ 3.25
2776 * PROM 4500 \$ 3.25
2777 * PROM 4500 \$ 3.25
2778 * PROM 4500 \$ 3.25
2779 * PROM 4500 \$ 3.25
2780 * PROM 4500 \$ 3.25
2781 * PROM 4500 \$ 3.25
2782 * PROM 4500 \$ 3.25
2783 * PROM 4500 \$ 3.25
2784 * PROM 4500 \$ 3.25
2785 * PROM 4500 \$ 3.25
2786 * PROM 4500 \$ 3.25
2787 * PROM 4500 \$ 3.25
2788 * PROM 4500 \$ 3.25
2789 * PROM 4500 \$ 3.25
2790 * PROM 4500 \$ 3.25
2791 * PROM 4500 \$ 3.25
2792 * PROM 4500 \$ 3.25
2793 * PROM 4500 \$ 3.25
2794 * PROM 4500 \$ 3.25
2795 * PROM 4500 \$ 3.25
2796 * PROM 4500 \$ 3.25
2797 * PROM 4500 \$ 3.25
2798 * PROM 4500 \$ 3.25
2799 * PROM 4500 \$ 3.25
2800 * PROM 4500 \$ 3.25

CRYSTALS \$3.45 ea. RIBBON CABLE \$3.00 WIRE \$1.50 WIRE \$1.50 WIRE \$1.50
4000 KHZ \$3.00 WIRE \$1.50 WIRE \$1.50
5000 KHZ \$3.00 WIRE \$1.50 WIRE \$1.50
6000 KHZ \$3.00 WIRE \$1.50 WIRE \$1.50
8000 KHZ \$3.00 WIRE \$1.50 WIRE \$1.50
10000 KHZ \$3.00 WIRE \$1.50 WIRE \$1.50

CTS 206-8 eight position dip switch \$1.60
CTS 206-4 four position dip switch \$1.45
LIGHT ACTIVATED SCR TO 18 200V 1A \$.70

SILICON SOLAR CELLS 2 1/4" diameter 4V at 500 ma \$4.00

FLAT READOUTS
FND 359 C.C. 4" x 5" \$ 5.00
FCS 8024 4 digit DL 704 C.A. 3" x 7/8" \$ 5.00
CC 8 C display \$5.95 DL 747 C.C. 6" x 1 1/2" \$ 5.00
FND 503 C.C. 5" x 8" FND 703 C.C. 8" x 9" \$ 5.95
FND 510 C.C. 5" x 8" FND 810 C.C. 8" x 9" \$ 5.95
DL 704 C.C. 5" x 8" \$ 5.95

Silicon Power Rectifiers

PRV	1A	2A	3A	5A	10A	20A	30A
100	06	14	30	80	377	5.00	
200	07	21	39	115	475	6.50	
400	09	25	50	140	6.50	9.50	
600	11	30	70	180	8.90	12.50	
800	15	35	90	230	10.50	16.50	
1000	20	45	110	275	12.50	20.00	

SAD 1024 A REDICON 1024 stage analog Bucket Brigade shift register \$18.95

IN 4148 IN914 15 \$1.30

RS232 CONNECTORS

DB 25P male	\$2.25
DB 25S female	\$2.95
HOODS	\$1.00

REGULATORS

309K	\$.95	340K 12,15	
723	\$.50	or 24V	\$.95
LM 376	\$.60	340T 5, 6, 8, 12	
320T 12, 15	\$.95	15, 18 or 24V	\$.95
or 24V	\$1.25	78 MG	\$1.35
		79 MG	\$1.35

DATA CASSETTES 1 1/2 HR \$.95

22 44 Pin Solder Tag 156" Conv. \$1.95

MM 5387AA new clock chip which will directly drive LEDs 12/24 hrs. 1 supply & alarm \$5.95

NO. 30 WIRE WRAP WIRE SINGLE STRAND 100' \$1.40

ALCORN LIGHT TOUCH SWITCHES
MTA 106 SPDT \$.95
MTA 206 DPDT \$ 1.70
MTA 206 PDPDT CENTER OFF \$ 1.85
MSD 206 PDPDT CENTER OFF \$ 1.85

TANTULUM CAPACITORS

220UF 35V	\$1.00	680UF 50V	\$1.40
470UF 35V	\$1.00	100UF 10V	\$.25
68UF 50V	\$1.00	22UF 25V	\$.40
1UF 35V	\$1.00	15UF 35V	\$1.00
2.2UF 20V5	\$1.00	30UF 5V	\$1.00
3.3UF 20V 4	\$1.00	47UF 20V	\$.35
4.7UF 15V	\$1.00	68UF 15V	\$.50
		100UF 10V	\$.40

74LS SERIES

74LS00	19	74LS117	75
74LS01	19	74LS118	75
74LS02	19	74LS119	75
74LS03	19	74LS120	75
74LS04	19	74LS121	75
74LS05	19	74LS122	75
74LS06	19	74LS123	75
74LS07	19	74LS124	75
74LS08	19	74LS125	75
74LS09	19	74LS126	75
74LS10	19	74LS127	75
74LS11	19	74LS128	75
74LS12	19	74LS129	75
74LS13	19	74LS130	75
74LS14	19	74LS131	75
74LS15	19	74LS132	75
74LS16	19	74LS133	75
74LS17	19	74LS134	75
74LS18	19	74LS135	75
74LS19	19	74LS136	75
74LS20	19	74LS137	75
74LS21	19	74LS138	75
74LS22	19	74LS139	75
74LS23	19	74LS140	75
74LS24	19	74LS141	75
74LS25	19	74LS142	75
74LS26	19	74LS143	75
74LS27	19	74LS144	75
74LS28	19	74LS145	75
74LS29	19	74LS146	75
74LS30	19	74LS147	75
74LS31	19	74LS148	75
74LS32	19	74LS149	75
74LS33	19	74LS150	75
74LS34	19	74LS151	75
74LS35	19	74LS152	75
74LS36	19	74LS153	75
74LS37	19	74LS154	75
74LS38	19	74LS155	75
74LS39	19	74LS156	75
74LS40	19	74LS157	75
74LS41	19	74LS158	75
74LS42	19	74LS159	75
74LS43	19	74LS160	75
74LS44	19	74LS161	75
74LS45	19	74LS162	75
74LS46	19	74LS163	75
74LS47	19	74LS164	75
74LS48	19	74LS165	75
74LS49	19	74LS166	75
74LS50	19	74LS167	75
74LS51	19	74LS168	75
74LS52	19	74LS169	75
74LS53	19	74LS170	75
74LS54	19	74LS171	75
74LS55	19	74LS172	75
74LS56	19	74LS173	75
74LS57	19	74LS174	75
74LS58	19	74LS175	75
74LS59	19	74LS176	75
74LS60	19	74LS177	75
74LS61	19	74LS178	75
74LS62	19	74LS179	75
74LS63	19	74LS180	75
74LS64	19	74LS181	75
74LS65	19	74LS182	75
74LS66	19	74LS183	75
74LS67	19	74LS184	75
74LS68	19	74LS185	75
74LS69	19	74LS186	75
74LS70	19	74LS187	75
74LS71	19	74LS188	75
74LS72	19	74LS189	75
74LS73	19	74LS190	75
74LS74	19	74LS191	75
74LS75	19	74LS192	75
74LS76	19	74LS193	75
74LS77	19	74LS194	75
74LS78	19	74LS195	75
74LS79	19	74LS196	75
74LS80	19	74LS197	75
74LS81	19	74LS198	75
74LS82	19	74LS199	75
74LS83	19	74LS200	75
74LS84	19	74LS201	75
74LS85	19	74LS202	75
74LS86	19	74LS203	75
74LS87	19	74LS204	75
74LS88	19	74LS205	75
74LS89	19	74LS206	75
74LS90	19	74LS207	75
74LS91	19	74LS208	75
74LS92	19	74LS209	75
74LS93	19	74LS210	75
74LS94	19	74LS211	75
74LS95	19	74LS212	75
74LS96	19	74LS213	75
74LS97	19	74LS214	75
74LS98	19	74LS215	75
74LS99	19	74LS216	75
74LS100	19	74LS217	75
74LS101	19	74LS218	75
74LS102	19	74LS219	75
74LS103	19	74LS220	75
74LS104	19	74LS221	75
74LS105	19	74LS222	75
74LS106	19	74LS223	75
74LS107	19	74LS224	75
74LS108	19	74LS225	75
74LS109	19	74LS226	75
74LS110	19	74LS227	75
74LS111	19	74LS228	75
74LS112	19	74LS229	75
74LS113	19	74LS230	75
74LS114	19	74LS231	75
74LS115	19	74LS232	75
74LS116	19	74LS233	75
74LS117	19	74LS234	75
74LS118	19	74LS235	75
74LS119	19	74LS236	75
74LS120	19	74LS237	75
74LS121	19	74LS238	75

Electronics Classified

REGULAR CLASSIFIED: COMMERCIAL RATE: For firms or individuals offering commercial products or services, \$2.50 per word. Minimum order \$37.50. **EX-PANAD-AD® CLASSIFIED RATE:** \$3.75 per word. Minimum order \$56.25. Frequency discount: 5% for 6 months; 10% for 12 months paid in advance. **PERSONAL RATE:** For individuals with a personal item to buy or sell, \$1.50 per word. No minimum! **DISPLAY CLASSIFIED:** 1" by 1 column (2-1/4" wide), \$300.00. 2" by 1 column, \$600.00. 3" by 1 column, \$900.00. Advertiser to supply film positives. For frequency rates, please inquire. **COLOR:** Color avail. for all classified ad styles at earned rate plus additional 25%. Color choice Publisher's option and subject to availability. Publisher reserves right to run ad in black if color not avail. on classified pages. In such cases color charge will be refunded or credited. **GENERAL INFORMATION:** Ad copy must be typewritten or clearly printed. Payment must accompany copy except when ads are to be billed on credit cards — American Express, Diners Club, Master Charge, VISA — or when ads are placed by accredited advertising agencies. First word in all ads set in caps. All copy subject to publisher's approval. All advertisers using Post Office Boxes in their addresses **MUST** supply publisher with permanent address and telephone number before ad can be run. Advertisements will not be published which advertise or promote the use of devices for the surreptitious interception of communications. Ads are not acknowledged. They will appear in first issue to go to press after closing date. Closing Date: 1st of the 2nd month preceding cover date (for example, March issue closes January 1st). Send order and remittance to Classified Advertising, **POPULAR ELECTRONICS**, One Park Avenue, New York, N.Y. 10016. For inquiries, contact Gladys Mathieu at (212) 725-3926.

FOR SALE

FREE! Bargain Catalog—I.C.'s, LED's, readouts, fiber optics, calculators parts & kits, semiconductors, parts. Poly Paks, Box 942PE, Lynnfield, Mass. 01940.

GOVERNMENT and industrial surplus receivers, transmitters, sniperscopes, electronic parts. Picture Catalog 25 cents. Meshna, Nahant, Mass. 01908.

LOWEST Prices Electronic Parts. Confidential Catalog Free. KNAPP, 4750 96th St N., St. Petersburg, FL 33708.

ELECTRONIC PARTS, semiconductors, kits. **FREE FLYER.** Large catalog \$1.00 deposit. **BIGELOW ELECTRONICS,** Bluffton, Ohio 45817.

RADIO—T.V. Tubes—36 cents each. Send for free catalog. Cornell, 4213 University, San Diego, Calif. 92105.

AMATEUR SCIENTISTS, Electronics Experimenters, Science Fair Students . . . Construction plans — Complete, including drawings, schematics, parts list with prices and sources . . . Robot Man — Psychedelic shows — Lasers — Emotion/Lie Detector — Touch Tone Dial — Quadraphonic Adapter — Transistorized Ignition — Burglar Alarm — Sound Meter . . . over 60 items. Send 50 cents coin (no stamps) for complete catalog. Technical Writers Group, Box 5994, University Station, Raleigh, N.C. 27607.

ROTARY SWITCH 4P11P 5/55; 6P11P 5/7.25. Dip Switch 10-SPST 10/\$15. Transformers 12.2 V CT-6A plus 8.5V-5A \$6.95. 24V-5A \$5.95. 10' RG58C/U 12/\$10. Fertiks, 5400 Ella St., Philadelphia, PA 19120.

SOUND SYNTHESIZER KITS—Surf \$14.95, Wind \$14.95, Wind Chimes \$19.95, Musical Accessories, many more. Catalog free. PAIA Electronics, Box J14359, Oklahoma City, OK 73114.

UNSCRAMBLERS: Fits any scanner or monitor, easily adjusts to all scrambled frequencies. Only 4" square \$29.95, fully guaranteed. Dealer inquiries welcomed. PDQ Electronics, Box 841, North Little Rock, Arkansas 72115.

TELETYPE EQUIPMENT for sale for beginners and experienced computer enthusiast. Teletype machines, parts, supplies. Catalogue \$1.00 to: ATLANTIC SALES, 3730 Nautilus Ave., Brooklyn, NY 11224. Tel: (212) 372-0349.

WHOLESALE C.B., Scanners, Antennas, Catalog 25 cents. Crystals: Special cut, \$4.95, Monitor \$3.95. Send make, model, frequency. G. Enterprises, Box 461P, Clearfield, UT 84015.

UNSCRAMBLE CODED MESSAGES from Police, Fire and Medical Channels. Same day service. Satisfaction guaranteed. Don Nobles Electronics, Inc., Rt. 7, Box 265B, Hot Springs, Arkansas 71901. (501) 623-6027.

BUILD AND SAVE TELEPHONES, TELEVISION, DETECTIVE, BROADCAST Electronics. We sell construction plans with an Engineering Service. Speakerphones, Answering Machines, Carphones, Phonevision, Dialers, Color TV Converters, VTR, Games, \$25 TV Camera, Electron Microscope, Special Effects Generator, Time Base Corrector, Chroma Key, Engineering Courses in Telephone, Integrated Circuits, Detective Electronics. **PLUS MUCH MORE.** NEW Super Hobby Catalog PLUS year's subscription to Electronic News Letter, \$1.00. Don Britton Enterprises, 6200 Wilshire Blvd., Los Angeles, Calif. 90048.

NAME BRAND Test Equipment. Up to 50% discount. Free catalog. Salen Electronics, Box 82, Skokie, Illinois 60076.

SURPLUS COMPONENTS, Communication and test equipment. Illustrated catalog 25 cents. E. French, P.O. Box 249, Aurora, Illinois 60505.

TELEPHONES UNLIMITED, Equipment Supplies. All types. Regular, Keyed, Modular. Catalog 50 cents. Box 1147E, San Diego, California 92112.

CARBON FILM RESISTORS 1/4W, 1/2W - 1.7 cents each. FREE sample / specifications. Other components. COMPO-NENTS CENTER, Box 295, W. Islip, New York 11795.

WEATHER MAP RECORDERS: Copy Satellite Photographs. National-Local Weather Maps. Learn How! \$1.00. Atlantic Sales, 3730 Nautilus Ave., Brooklyn, N.Y. 11224. Tel: (212) 372-0349.

NAME BRAND TEST EQUIPMENT at discount prices. 72 page catalogue free. Write: Dept. PE, North American Electronics, 1468 West 25th Street, Cleveland, OH 44113.

UNSCRAMBLERS FOR any scanner. Several models available. Free literature. Capri Electronics, 8753T Windom, St. Louis, MO 63114.

RADIO SHACK Authorized Sales Center offering 10% discount on products including TRS-80. 1117 Conway, Mission, TX 78572.

TRANSISTORS FOR CB REPAIR, IC's and diodes. TV audio repairs, 2SC799 — \$3.00, 2SC1306 — \$2.95, 2SC1307 — \$3.85, TA7205 — \$3.50, more. Free catalog and transistor. B&D Enterprises, Box 32, Mt. Jewett, PA 16740.

UNSCRAMBLER KIT. Tunes all scramble frequencies, may be built in most scanners, 2-3/4 x 2-1/4 X 1/2. \$19.95. Factory built Code-Breaker. \$29.95. Free Catalog: KRYSTAL KITS, Box 445, Bentonville, Ark. 72712. (501) 273-5340.

ELECTRONIC SURPLUS
FREE CATALOGS
ETCO ELECTRONICS, Dept. EB
North Country Shopping Center
Rt. 9N, Plattsburgh, N.Y. 12901

B&K Test Equipment. Free catalog. Free Shipping. Dinosaur discounts. Spacetrak-AC, 948 Prospect, Elmhurst, IL 60126.

SURPLUS ELECTRONICS
ATTENTION HOBBYISTS — SEND FOR YOUR FREE CATALOG
Great buys in tape drives, keyboards, power supplies, and transformers. We also have heat sinks, steel cabinets, I/O terminals, video displays, printers, and equipment cases. And of course components, fans, wire, and cable. Write now to
130 Northeastern Blvd.
Worldwide Electronics Nashua, N.H. 03060

TANDY TRS-80, HEATH H-8 Adapters to S-100 bus, \$49.95 kit. **MINIMART,** 1618 James, Syracuse, N.Y. 13203.

SAVE 15% or more NORTHSTAR, CROMEMCO, others. **MINI MICRO MART,** 1618 James, Syracuse, N.Y. 13203. (315) 422-4467.

POLICE/FIRE SCANNERS, crystals, antennas, CBs, Radar Detectors. **HPR,** Box 19224, Denver, CO 80219.

THE UNRUSTABLES



NOW carry up to 40 extra gallons with auxiliary tanks for Pickups & Vans

econo-tank

DETROIT APPROVED: No rust or weld sediment • Install one hour—lightweight, no bodywork required • Complete Kit • Guaranteed life of vehicle • Meets Federal & State standards

For FREE Catalog—TOLL FREE 800/433-2386
(In TEXAS call 817/756-6221)

PICKUP & VAN EQUIPMENT CO.
Dept. PE, P.O. Drawer C, Hewitt, TX 76643

BUILD THE ARTISAN ELECTRONIC ORGAN . . . The 20th century successor to the classic pipe organ. Kits feature modular construction, with logic controlled stops and RAM Pre-Set Memory System. Be an arti-san. Write for our free brochure. AOK Manufacturing, Inc., Box 445, Kenmore, WA 98028.

SPEAKER INFORMATION KIT

Get 70 pages of speaker facts, specs, construction tips plus info on our raw speakers, crossovers and a line of 9 quality hi-fi speaker system kits. We'll send you our **full-color catalog**; plus **How to Hook Up Your System.** An exhaustive step-by-step treatise on hi-fi system installation; and our **Speaker Operating Manual,** check full of facts on how to get the most from any speaker system, for only \$1.00. Even if you don't buy from us we want you to have the facts. That's how we got to be the world's largest manufacturer of speaker kits.



Send to:
Speakerlab, Dept. PE-W
735 N. Northlake
Seattle, WA 98103

THE BEST CB ANTENNA
SEND FOR FREE **PAL** FULL LINE CATALOG AND DECAL

PAL Antenna Corp.

2614 EAST ADAMS • PHOENIX ARIZONA 85034

PRINTED CIRCUITRY. Complete supplies. Failproof instructions. Major credit cards. Catalog \$1.00 refundable. **CIRCOLEX,** Box 198, Marcy, NY 13403.

1802 EXTENDED MONITOR. Relocatable, K.C. tape routines, 18 powerful subroutines. requires 1K memory. K.C. tape \$20.00, paper tape \$18.00. w/manual and listing. Information sase. Benchmark Computer Systems, 17 Hanover Place, Hicksville, L.I., N.Y. 11801.

TEST EQUIPMENT CATALOG listing used Tektronix, HP and GR equipment at bargain prices. PTI, Box 8699, White Bear Lake, MN 55110. Price \$1.00 refundable with first order.

CRYSTAL CONTROLLED DIGITAL CROSSHATCH/DOT GENERATOR. Kit \$31.95, built \$41.95. Free Catalog. **PHOTOLUM CORP.,** 118 East 28 Street, New York, NY 10016.

SEND for free C.B. & Hi-Fi catalog, top value prices. Mesa Enterprises, Rt. 4, Box 273B, Tucumcari, New Mexico 88401.

CONNECTORS, UHF, BNC, and audio types. Low Prices, Free Catalog. Coakit, Box 101L, Dumont, New Jersey 07628.

SANKEN 50 WATT POWER AMP \$22.50 Postpaid, 50 Watt Transformer for above \$8.00 Postpaid, 100 Watt Stereo Basic Amplifier Kit, Complete \$99.50. Prairie Sounds, PO Box 982, Champaign, IL 61820

PLASTIC BAGS. All sizes. Buy in small quantities. Free Catalog. SAKet, 6151-D Colbath, Van Nuys, Ca 91401.

CB RADIOS, VHF-UHF Scanners, Crystal, Antennas, Radar Detectors. Wholesale. Southland, Box 3591, Baytown, TX 94043.



These PC-mounted power supplies are just the thing for amp projects where a dual voltage power supply is required. Line and load regulation normally less than 30 mv. Input 115 VAC. Fully repairable

Jim Turner
10305 Newport
El Paso, TX 79924

\$21.95

Texas residents add 5% sales tax
Specify voltage output required.

PHONE CALL RECORDING ADAPTER

Record incoming and outgoing calls automatically with this all solid state unit connected to your telephone jack and tape recorder. Tape becomes a permanent record. Don't depend on your memory to recall important details of business and personal calls. Easily installed. No extra monthly phone chgs. FCC Approved



AMAZING ELECTRONIC MICRO MINI MIKE

World's smallest, solid state, self contained with 1.3V Merc. Bat. fern. Picks up most sounds and transmits without wires up to 300 ft. thru FM Radio. Tuneable. Use as mike, ampl., alarm & alert system, baby sitter, hot line, etc. Mike \$18.95, Phone Call Adapter \$24.50 (* plus \$1.00 ea. for pstg. & indlg.) Cal. res. add tax. Free data. Mail Order, B/A, M/C, cod's u.k. Qty. disc. avail. AMG SALES, Dept. 24, 9335 Lubec St., Box 928, Oxnard, CA 90241.

BAIT, TRAP, and kill flying insects simply and electronically. Rush \$3.50 to: M.J.M. Enterprises, P.O. Box 131, Omaha, NE 68101.

WIRE — CABLES — CONNECTORS — PLUGS — JACKS — TRANSFORMERS — etc. For Telephone, TV, CB-Ham. FREE Catalog. Able Cable Electronics, Box 204, New Hyde Park, N.Y. 11040.

PRIME PARTS, surplus prices. CMOS, clocks, linear, TTL, MSI, resistors, capacitors, trim pots. Minimum orders only, send 50¢ for catalog. W A Z, PO Box 624, Bridgeport, CA 93517.

TRS-80 LEVEL I: Text Editor, 18 commands, \$16.95. 1/2K Monitor, run machine language programs, \$12.95. MICROTXT, Box 776, Norristown, PA 19041.

FIBER OPTICS—Data link kits, construction plans and supplies. Free Catalogue. Fibertron, Box 322, Pirmos, PA 19018.

INCREDIBLE MICRO PROCESSOR POSTER. Tiny chip shown 5000 times actual size in beautiful blue. \$3.00. Global, Box 304, Falls Church, VA 22046.

3 DIGIT LED VOLTMETER KIT \$19.50 complete, s.a.s.e. brings specifications, schematic. ALPHA-SUPERKIT, Box 21105, Woodhaven, New York 11421.

FREE ELECTRICITY! FREE HEAT! 24 Plans. Collection, storage, sun-wind energy. \$1.95 complete guaranteed! Solar, Concord, MI 49237.

DISCOUNT SCANNERS, CB's, car stereos, accessories. Catalog \$1.00. Karl Langner, 453 Gorwin, Hanson, MA 02341.

BARGAINS GALORE! Buy-sell-trade classifieds in "Electronics Trader" only 10¢ word! Send \$2.00 for next four issues. Box 1333, Sun Valley, CA 91352.

CARTRIVISION CTI-IB VTR'S (two) with service manual, 25 MT Cartridges, and more. \$500.00 Complete. Jim Hansen, 1055 Leffingwell N.E., Grand Rapids, MI 49506. (616) 949-5932.

TRANSISTORS FOR C-B Repair, IC's and diodes TV audio repairs 2SC756A — \$2.40, 2SC1306 — \$2.95, 2SC1307 — \$3.85, PLOZAG — \$7.50, AN239 — \$5.50, STK439 — \$8.95. Many more. FREE Catalog and transistor. B&D Enterprises, Box 32, Mt. Jewett, PA 16740.

NEW ELECTRONIC PARTS. Continuously stocked. Stamp brings catalog. Daytrap Electronics, 3029 Wilshire Ln., Arlington Hts., IL 60004.

PRINTED CIRCUIT boards from sketch or artwork. Affordable prices, free details. DANOCINTHS INC., Box 261, Westland, MI 48185.

NEW, ADJUSTABLE, THREE OUTPUT, REGULATED POWER SUPPLY plus 900 parts worth over \$400.00 in complete CARTRIVISION television electronic assembly. Documentation included. Perfect for MICROPROCESSOR and all electronic applications. \$16.95 plus \$4.50 S&H. Master Charge, VISA. Free brochure. Madison Electronics, 369, Madison, Alabama 35758. SATISFACTION GUARANTEED.

VIDEO RECORDERS and programs — all formats. Cartrivision recorder only \$225.00. Spare parts, blanks movies available. Media Associates, 616 National, Mountain View, CA 94043, Dept-1P.

ULTRA MINI WIRELESS MICROPHONE

Amazing new model features both ultra miniature size & a battery saving on-off switch. Picks up & transmits sounds without wires up to 300 ft. through any FM radio. Use as remote mike, intercom, baby sitter, alert/alarm syst., hot line etc. Great at parties. FCC appd Compl w batt Money back guar. Only \$19.95 = \$1.50 post-hdg. Mass. Res. add tax. Order Today. M/C, COD ok

MLI INDUSTRIES, Dept. PE11
50 HUNT ST., WATERTOWN, MASS 02172

AUDIOPHILE'S HIGH FIDELITY COMPONENTS. Over 100 Domestic and Foreign Brands, including analog and digital time delay systems. Low prices! Efficient, personalized service. Buy with confidence! Audio America, Box 445 P, Lexington Park, Maryland 20653. (301) 862-3088. 5-9pm Week-days, 9AM-9PM Saturday and Sundays.

PRINTED CIRCUIT BOARDS from camera-ready artwork. Free details. Quantity discounts. CM Circuits, 22 Maple Ave., Lackawanna, NY 14218.

MAGNETS

MAGNETS. All types. Specials-20 disc, or 10 bar, or 2 stick or 8 assorted magnets. \$1.00. Magnets, Box 192-H, Randallstown, Maryland 21133.

PLANS AND KITS

AMAZING ELECTRONIC PRODUCTS

Lasers Super Powered Rifle Pistol Pocket - See in Dark - Pyro Technical - De-Bugging - Uncramblers - Giant Tesla Stunwand - TV Disrupter - Energy Producing - Scientific Detection, Electrifying - Chemical - Ultrasonic - CB, Aero, Auto and Mech Devices, Hundreds More - All New Plus Info Unltd Parts Service

INFORMATION unlimited
Catalog \$1 Dept. E8, Box 716, Amherst, NH 03031

FREE KIT Catalog contains Test and Experimenter's Equipment. Dage Scientific Instruments, Box 1054P, Livermore, CA 94550.

TIGER SST SIMPLI-KIT

FOR THE DO-IT-YOURSELFER NOW! a high quality CD Electronic Ignition System in kit form.

Contains all components and solder to build complete Solid State Electronic CD Ignition System for your car. Assembly requires less than 3 hours.

- Increases MPG 15%
- Increases horsepower 15%
- Plugs and Points last 50,000 miles
- Eliminates 4 of 5 tune-ups
- Instant starting, any weather
- Dual system switch

Fits only 12 volt neg ground ... Only \$21.95 postpaid

Tri-Star Corporation
P.O. Box 1727 Grand Junction, Colorado 81501

CB/HAM HIGH GAIN ANTENNAS. Modulation boosting VOX-COMPRESSOR. Portable 300MHz COUNTER with memory! Plans \$3.00 ea. \$7.50/all. Many others, catalog with order, PANAXIS, Box 130-A11, Paradise, CA 95969.

PROJECTION TV . . . Convert your TV to project 7 Foot picture. Results equal to \$2,500 projector. Total cost less than \$20.00. PLANS & LENS \$16.00. Illustrated info. FREE: Macrocomp, Washington Crossing, PA 18977.

BUILD YOUR OWN SYMPHONY OF SOUND!

It's fun and easy — takes just minutes a day! Complete kits for organs, pianos, strings, rhythms, amplifiers, synthesizers. Also factory assembled. 104-page catalog \$2.00

WERSI
Wersi Electronics, Inc.
Dept. ZD, 1720 Hempstead Road
Lancaster, PA 17601

ELECTRONIC HELP JUST A PHONE CALL AWAY. We'll help you design projects, find components, advice. Low rates, first 2 minutes free. 24 hours a day, 7 days a week. BAC, VISA, MASTERCHARGE; Don Britton Enterprises, (808) 395-7458.

MODIFY YOUR P.L.L. or Crystal Synthesis C.B. for extra channels, linear and antenna tips. Send \$12.95 for instruction book. Action Protection Systems, RD1, Box 6003, Milford, PA 18337.

BUILD YOUR OWN FM TRANSMITTER. Be your own FM disc jockey and transmit to any FM radio. Plans and parts list \$2.00, or complete kit for beginners \$16.95. Send to: JRC Electronics Corp., Box 711-E, Glen Ellyn, IL 60137.

TESLA COIL — 40" SPARKS! Plans \$7.50. Information 75 cents. Huntington Electronics, Box 2009-P, Huntington, Conn. 06484.

CBers! NEW MOBILE Regulator/Booster. Maximum RF Power. Easy construction. Schematic, complete details, \$3.00. RS ELECTRONICS, Box 8, Lyndon Center, VT 05850.

"HIGH POWER LASER DESIGN AND CONSTRUCTION" \$7.00 — "FUNDAMENTALS OF ROBOT DESIGN" \$10.00, 43 page manual!! Advanced Research Scientific, P.O. Box 19041, Detroit, Michigan 48219.

WELDING-BURNING LASER—\$9.00, Five Laser Plans—\$8.00, Laser Light Show—\$19.00, "Wild Ideas" Catalog — \$2.00. Booksellers, "PE1178" Box 1015, Claremont, CA 91711.

TV-OSCILLOSCOPE CONVERTER externally adapts TV into audio frequency oscilloscope. Info. \$1.00, Plans \$5.00, with P.C. \$12.00. Evolutionics, Box 855-A, San Rafael, CA 94902.

CHRISTMAS STAR beautiful optoelectronic display. Complete plans, send \$3.00 to: C. Rohde, 370 West Market St., Hellam, PA 17406.

MUSICAL INSTRUMENTS

UP TO 60% DISCOUNT. Name brand instruments catalog. Freeport Music, 114 G. Mahan St., W. Babylon, N.Y. 11704.

HIGH FIDELITY

DIAMOND NEEDLES and Stereo Cartridges at Discount prices for Shure, Pickering, Stanton, Empire, Grado and ADC. Send for free catalog. LYLE CARTRIDGES, Dept. P, Box 69, Kensington Station, Brooklyn, New York 11218. For Fast Service call Toll Free 800-221-0906.

Lambda Series II by SpeakerKit, Ltd.

Woofers with butyl surrounds. Transmission lines. Open dome midrange and tweeters. Infra-woofers and ultra-tweeters. Accurate sound at a reasonable price. Send 25¢ for Series II catalog and manual.

Speakerkit, Box 12PE, Menomonie, WI 54751

MICROCOMPUTERS

MICROCOMPUTERS: BUILD. LEARN!! Save Money!!! Complete System Design Plans. Catalog \$1.00. Design Resources, Box 4991PN, Thousand Oaks, CA 91360.

MICROCOMPUTER PARTS at discount prices. FND-70 7 segment displays 50 cents. Intel 16 Bit Micro Computer Kit MCS-86 \$300.00. Send for free catalogue. SEMCON Inc., 325 So. Winding Drive, Pontiac, MI 48054.

TELEPHONES & PARTS

CORDLESS TELEPHONES: Operate 300 ft. from base. Factory rechecked, schematics included for personal maintenance. Originally \$399.50 — now \$149.95. Check. M.O. or Credit Card. Telephone Marketers, P.O. Box 216, Brookfield, WI 53005.

TELEPHONES AND PARTS Free catalog. Write: Surplus Saving Center, P.O. Box 117, Wayman, PA 18472.

ALARMS

QUALITY BURGLAR-FIRE ALARM EQUIPMENT at discount prices. Free Catalog! Steffens, Box 624K, Cranford, N.J. 07016.

Burglar • Fire • Smoke Alarm Catalog

- Billions of dollars lost annually due to lack of protective warning alarms.

FREE CATALOG Shows you how to protect your home, business and person. Wholesale prices. Do-it-yourself. Free engineering service.



Burdex Security Co.

Box 82802 PE-108 Lincoln, Ne. 68501

TUBES

RADIO & T.V. Tubes—36 cents each. Send for free Catalog. Cornell, 4213 University, San Diego, Calif. 92105.

TUBES: "Oldies", Latest. Supplies, components, schematics. Catalog Free (stamp appreciated). Steinmetz, 7519-PE Maplewood, Hammond, Ind. 46324.

TUBES-RECEIVING, Industrial and Semiconductors Factory Boxed. Free price sheet including TV, Radio and audio parts list. Low, low prices. Transelctronic, Inc., 1365 39th St., Brooklyn, New York 11218. Telephone: (212) 633-2800. Toll free: 800-221-5802.

TUBES — Send 10 cents for large conclusive list. Low Prices. T-J Specialties, Box 43, Bradley Beach, New Jersey 07720. (201) 774-8429.

TUBES SALES!!! Sylvania, G.E.—Brand new receiving tubes 70%-75% discount. Semiconductors—LOW LOW! prices. U.J.I., 18374 Oxnard St., Tarzana, CA 91356. Phone (213) 996-4222.

TUBES 29¢ up, no minimum order necessary. Also have obsolesces. Free list. Conelco, Box 1333, Sun Valley, CA 91352.

TAPE AND RECORDERS

RECORDS — TAPES! Discounts to 73%; all labels, no purchase obligations; newsletter; discount dividend certificates; 100% guarantees. Free details. Discount Music Club, 650 Main St., Dept. 5-1178, New Rochelle, N.Y. 10801.

CASSETTE SAVINGS BREAKTHROUGH!!! Proven best or your-money-back. No minimum. Free same-day shipping. Sample \$1.00. Facts free. Larkson, Box 468E11, Point Arena, CA 95468.

GOVERNMENT SURPLUS

MANUALS for Govt Surplus radios, test sets, scopes. List 50 cents (coin). Books, 7218 Roanne Drive, Washington, D.C. 20021.

JEEPS—\$59.30! — CARS—\$33.50! — 200,000 ITEMS! — GOVERNMENT SURPLUS — Most COMPREHENSIVE DIRECTORY AVAILABLE tells how, where to buy — YOUR AREA — \$2.00 — MONEYBACK GUARANTEE — Government Information Services, Department GE-35, Box 99249, San Francisco, California 94109 (433 California).

GOVERNMENT SURPLUS. Buy in your Area. How, where. Send \$2.00. Surplus, 30177-PE Headquarters Building, Washington, D.C. 20014.

WANTED

GOLD, Silver, Platinum, Mercury, Tantalum wanted. Highest prices paid by refinery. Ores assayed. Free circular. Mercury Terminal, Norwood, MA 02062.

COMIC BOOKS—Send SASE for listing of prices paid. ROB'S, Box 319, Wilber, NE 68465.

POEMS, SONGS WANTED. Songs recorded-published. Radio released. Broadway Music Productions, Box 7438-CM, Sarasota, FL 33578.

WANTED! CB DEALERS AND DISTRIBUTORS

PAL Antenna Corp.

2614 EAST ADAMS • PHOENIX, ARIZONA 85034

PERSONALS

MAKE FRIENDS WORLDWIDE through international correspondence, illustrated brochure free. Hermes-Verlag, Box 110660/Z, D-1000 Berlin 11, Germany.

INSTRUCTION

SCORE high on F.C.C. Exams . . . Over 300 questions and answers. Covers 3rd, 2nd, 1st and even Radar. Third and Second Test, \$14.50; First Class Test, \$15.00. All tests, \$26.50. R.E.I., Inc., Box 806, Sarasota, Fla. 33577.

UNIVERSITY DEGREES BY MAIL! Bachelors, Masters, Ph.D's. Free revealing details. Counseling, Box 317-PE011, Tustin, California 92680.

LEARN WHILE ASLEEP! HYPNOTIZE! Astonishing details, strange catalog free! Autosuggestion, Box 24-ZD, Olympia, Washington 98507.

GRANTHAM'S FCC LICENSE STUDY GUIDE — 377 pages, 1465 questions with answers/discussions — covering third, second, first radiotelephone examinations. \$13.50 postpaid. GSE, P.O. Box 25992, Los Angeles, California 90025.

INTENSIVE 5 week course for Broadcast Engineers. FCC First Class license. Student rooms at the school. Radio Engineering Inc., 61 N. Pineapple Ave., Sarasota, FL 33577 and 2402 Tidewater Trail, Fredericksburg, VA 22401.

1978 "TESTS - ANSWERS" for FCC First Class License. Plus - "Self Study Ability Test." Proven! \$9.95 Moneyback Guarantee. Command Productions, Box 26348-P, San Francisco, CA 94126.

BROADCAST STATION: Start your own. Home, school, church, business operation. Get free equipment, records. Details free. "Broadcasting", Box 130-A11, Paradise, CA 95969.

FCC License Study Course prepares you to pass examinations for 1st, 2nd, 3rd and radar. Study Guide manual gives examples, problems and solutions. Question-Answer manual provides hundreds of practice questions. \$9.95 each or both manuals \$14.95. Postpaid. Oeffinger, Box 1240, Garden Grove, Calif. 92642.

LEARN ELECTRONICS Capsule Course basic d.c. textbook plus taped instruction. Details send to: Box 4457, Ind. Sta., St. Paul, MN 55104.

LEARN ELECTRONIC DRAFTING: PCB design. Complete course \$1.00. VANDERLAAN, 6102-2 Turnabout Lane, Columbia MD 21044.

INVENTIONS WANTED

IDEAS, INVENTIONS, New Products needed by innovative manufacturers. Marketing assistance available to individuals, tinkerers, universities, companies with feasible concepts. Write for Kit-PE, IMI, 701 Smithfield, Pittsburgh, PA 15222.

BUSINESS OPPORTUNITIES

I MADE \$40,000.00 Year by Mailorder! Helped others make money! Free Proof. Torrey, Box 318-NN, Ypsilanti, Michigan 48197.

\$3,000 MONTHLY, fabulous mailing profits, daily earnings. Free report. Send long, stamped, addressed envelope. Modern, Box 22-E, Upland, CA 91786.

FREE CATALOGS. Repair air conditioning, refrigeration. Tools, supplies, full instructions. Doolin, 2016 Canton, Dallas, Texas 75201.

HIGHLY PROFITABLE ONE-MAN ELECTRONIC FACTORY

Investment unnecessary, knowledge not required, sales handled by professionals. Postcard brings facts about this unusual opportunity. Write today! Barta-DK, Box 248, Walnut Creek, CA 94597.

NEW LUXURY Car Without Cost. Free Details! Codex-ZZ, Box 6073, Toledo, Ohio 43614.

GET RICH!!! Secret law erases debts. Free report exposes millionaire's secrets. Blueprints, No. EE11, 453 W. 256, NYC 10741.

\$650 WEEKLY for beginners!! Free report: Mailorder Consultants MEE11, 453 W256, NYC 10471.

MECHANICALLY INCLINED individuals desiring ownership of Small Electronics Manufacturing Business — without investment. Write: BUSINESSSES, 92-K2 Brighton 11th, Brooklyn, New York 11235.

MILLIONS in Mail!!! Free Secrets. Transworld-17, Box 6226, Toledo, OH 43614.

1000% RETURN EASY in the television rental business. Free details. Carank-AK, Box 7696, Naples, FL 33941.

\$500.00 WEEKLY POSSIBLE mailing circulars! Free information. Wayne, Box 644, Ottawa, Kansas 66067.

ESTABLISH YOUR OWN Profitable Mail Order Business! Everything supplied. Michael-W, 46 Tanager Rd., Monroe, N.Y. 10950.

\$3000 MONTHLY. Start immediately. Stuff envelopes at home. Information, send self-addressed stamped envelope. Village, Box 508-NNG, West Covina, CA 91706.

\$1200.00 MONTHLY Correcting Pupils' Lessons!!! Start immediately. Free Report. Send self-addressed stamped envelope. Home, Box 9201-SJXH, San Diego, CA 92109.

\$480.00 WEEKLY! Home mailing program. Start Immediately. Free Details: ALLTIME, Box 25131-EP, Tamarac, FL 33320.

YOU CAN MAKE \$700.00 a month/spare time, stuffing envelopes! Free Proof. Write: Hagler, 500 W. University Parkway, Baltimore, MD 21210.

PAY OFF HOME SPARE TIME. 1000's immediately thru mail. Satisfaction guaranteed. Free details. \$ Enterprises, 33-306 Lakeview, Athens, Ohio 45701.

EMPLOYMENT OPPORTUNITIES

ELECTRONICS/AVIONICS EMPLOYMENT OPPORTUNITIES. Report on jobs now open. Details FREE. Aviation Employment Information Service, Box 240E, Northport, New York 11768.

RESUMES THAT GET ACTION! Informative booklet only \$2.00. Resumes, Box 83, Bridgeport, PA 19405.

DO-IT-YOURSELF

MODULAR TELEPHONES now available. Sets and components, compatible with Western Electric concept. Catalog 50 cents. Box 1147W, San Diego, California 92112.

AUDIO/ANALOG/SYNTHESIS. Plans, parts, kits, etc. for the most exciting sound projects ever. Get on our mailing list, send 25¢ to: CFR Associates Inc., Newton, N.H. 03858.

REAL ESTATE

BIG . . . FREE . . . CATALOG! Over 2,500 top values coast to coast!!! UNITED FARM AGENCY, 612-EP, West 47th, Kansas City, MO 64112.

RUBBER STAMPS

RUBBER STAMPS, BUSINESS CARDS. Many new products. Catalog. Jackson's, Dept. K, Brownsville Rd., Mt. Vernon, Ill. 62864.

OVER \$16.50 an hour. Spare time at home! Rubber Stamp industry needs small manufacturers. We furnish all equipment and know-how! Particulars free! Write: Roberts, Room RC-376-HL, 1512 Jarvis, Chicago, IL 60626.

BOOKS AND MAGAZINES

FREE book prophet Elijah coming before Christ. Wonderful bible evidence. MEGIDDO Mission, Dept. 64, 481 Thurston Rd., Rochester, N.Y. 14619.

POPULAR ELECTRONICS INDEXES For 1977 now available. Prepared in cooperation with the Editors of "P/E," this index contains hundreds of references to product tests, construction projects, circuit tips and theory and is an essential companion to your magazine collection. 1977 Edition, \$1.50 per copy. All editions from 1972 onward still available at the same price. Add \$.25 per order for postage and handling. \$5.00 per copy, foreign orders. INDEX, 6195 Deer Path, Manassas, Va. 22110.

HOW DOES THE OPERATOR KNOW your telephone number without you telling her? Ten digit, state of the art, call tracing systems and Telco operation detailed in depth. Government and C.C.I.T.T. publications tell it all. For comprehensive listing send s.a.s.e. and \$2.00. Tell It, Box 523, Westbrook, CT 06498.

FREE MAGAZINE featuring 500 books... natural health, gardening, occult, other interesting subjects. Provoker Press, St. Catharines-545, Ontario L2R 7C9. U.S. Inquiries.

HYPNOTISM

FREE Hypnotism. Self-Hypnosis. Sleep Learning Catalog! Drawer H400, Ruidoso, New Mexico 88345.

MOTION PICTURE FILMS

CHRISTMAS SALE — S-8 Snd Color & B/W Universal & Columbia 400' Features. Bye Bye Birdie (Ann-Margaret), Thoroughly Modern Millie (Julie Andrews), Machine Gun McCain (Peter Falk), Bryan's Song (Winner of 5 Emmys), Centurians (George C. Scott), Anderson Tapes (Sean Connery — all in S-8 Eastman Color. Indicate in order of preference, \$44.95 ea Post-paid. B/W — Mr. Smith Goes To Town; Requiem for a Heavyweight (Anthony Quinn); On the Waterfront (Marlon Brando); Breakout (Charles Bronson), \$39.95 ea Postpaid. Operation Tall Ships; The Detective (Frank Sinatra); Poseidon Adventure (Gene Hackman) — special, \$29.95 ea + \$1.00 shipping — all 200' S-8 Color Snd. Invisible Man (Claude Rains); Frenzy (Alfred Hitchcock) — 200' S-8 B/W Snd, \$19.95 ea + \$1.00 shipping. Universal 64-pg catalog \$1.00 (\$2.00 foreign). Sportlite: Ring Classics. Universal; Columbia order forms, \$0.35. SPORTLITE FILMS, Elect-11/78, 20 North Wacker Drive, Chicago, IL 60606.

MOVIE FILMS

WHOLE MOVIES AT HALF PRICE. Three terrific classic comedies starring Laurel and Hardy, W.C. Fields or Buster Keaton on sale now. Outstanding values. Uproarious fun. Send \$1.00 for information and sixty-eight page Film Catalog listing comedies, westerns, dramas, horror and others. (Or send \$1.00 for Video Catalog with more than 140 titles.) Write: Blackhawk Films, Dept. 4628 Davenport, Iowa 52808.

MISCELLANEOUS

MPG INCREASED! Bypass Pollution Devices easily. REVERSIBLY!! Free details — Posco GEE11, 453 W. 256, NYC 10471.

AUTOMOTIVE EFFICIENCY PRODUCTS Better mileage, increased life. Dealership opportunities. Information: \$2.00. Anderson Engineering, Epsom, N.H. 03234.

1978 COMMUNICATIONS HANDBOOK



Everything you want to know—need to know—about Ham Radio, SWL, Police-Fire Monitoring, CB, Marine Radio, and Radar Detectors. Features, specifications, latest prices, and photographs of equipment on the market are at your fingertips. Order your copy from COMMUNICATIONS HANDBOOK, P.O. Box 278, Pratt Station, Brooklyn, N.Y. 11205. Enclose \$3* (postage and handling included). *Residents of CA, CO, FL, IL, MI, MO, NY STATE, DC and VT add applicable sales tax.

NEW-TONE ELECTRONICS INTERNATIONAL
A Division of New-Tone Electronics
Specializing in Japanese Semiconductors with THE LARGEST INVENTORY AND LOWEST PRICES ANYWHERE
ORDER TOLL FREE 800-631-1250 HOURS: Daily 9 AM - 7 PM E.S.T. SATURDAYS 9 AM to 5 PM E.S.T.
CHECK PRICES IN THIS PARTIAL LIST • DEALERS: SEND FOR COMPLETE VOLUME DISCOUNT PRICE LIST •

INTEGRATED CIRCUITS			
AN228	4.65	LD3110A	3.75
AN272	3.90	LD3150	1.95
AN313	4.85	M5109P	3.30
AN321	2.25	M5112Y	6.70
AN326	3.30	M5118L	2.50
AN362	2.70	M5130P	3.12
AN366	2.49	M5135P	3.40
AN606	4.50	M5142P	5.70
AN612	2.70	M5340P	1.55
BA401	1.50	M5930P	.85
BA402	1.50	M5935P	1.20
BA505	6.30	M5946P	.85
BA612	2.40	M5953P	2.55
BA1310	2.34	M5962P	.85
HA1125	2.10	M51202	1.55
HA1329	2.45	M53216P	1.80
HA1366W	3.30	M53273P	1.60
HA1366WR	3.30	M58473P	7.90
HA1388	3.35	MB3710	2.95
HA1406	1.20	MB8719	7.70
LA1222	1.59	MN3006	5.90
LA1365	2.20	MN3007	19.95
LA1368	3.42	NPC5107	14.95
LA3101	3.75	PLL03A	14.95
LA4220	2.55	SG264A	7.80
LA4430	2.70	SG609	4.50
LD3000	2.25	SG629-3	3.40

SI1010	6.90	UPC572C	4.10
SI1020	13.95	UPC574	1.20
SI1030	19.00	UPC583C	3.30
SI1050	27.80	UPC1028	1.80
SM5104	8.90	UPC1031H	2.98
SM5107C	11.95	UPC1032H	1.35
STK013	11.25		
STK014	8.65		
STK041	17.40		
STK075	8.22		
STK413	6.75		
TA7092P	5.45		
TA7117P	3.60		
TA7206P	3.06		
TA7214P	5.15		
TA7217AP	3.30		
TA7222P	3.50		
TA7521M	3.55		
TA7607P	9.90		
TA7609P	4.80		
TBA810AS	3.30		
TBA810DS	3.30		
TBA810S	3.30		
TBA810SH	3.30		
TBA820	2.10		
TDA1190Z	6.50		
TDA2002	4.60		

ALL PARTS GUARANTEED AGAINST FACTORY DEFECTS			
2SA772	89	2SB509	2.79
2SA786	39	2SB528	.99
2SA811	54	2SB549	.79
2SA818	1.05	2SB567	2.30
2SA835	1.35	2SB618	2.65
2SA840	1.68	2SC352A	2.55
2SA841	.43	2SC356	.95
2SA842	.43	2SC583C	.81
2SA861	1.29	2SC895	4.90
2SA879	.93	2SC983	.89
2SA880	75	2SC1056	5.50
2SA911	6.33	2SC1424	2.98
2SA915	7.7	2SC1429	1.49
2SA922	3.98	2SC1452	1.40
2SA923	4.50	2SC1474	.96
2SA940	96	2SC1548	.79
		2SC1583	.68
		2SC1622	.49
		2SC1630	3.60
		2SC1681	.39
		2SC1682	.39
		2SC1761	1.58
		2SC1762	4.85
		2SC1775	54
		2SC1778	.45
		2SC1787	.62
		2SC1811	1.29

TRANSISTORS			
2SC867	3.95	2SC1885	.79
2SC871	.35	2SC1906	.48
2SC930	.35	2SC1923	.39
2SC943	.65	2SC1940	.64
2SC945	.35	2SC1945	6.75
2SC959	1.25	2SC1951	1.59
2SC982	.68	2SC1959	.39
2SC1000BL	.45	2SC1963	3.30
2SC1014	.83	2SC1981	2.60
2SC1018	.65	2SC1982	3.30
2SC1030	2.35	2SC2009	.85
2SC1034	5.45	2SC2120	.65
2SC1047	.49	2SC2122	45
2SC1051	2.80	2SC2124	1.65
2SC1060	1.10	2SC2125	1.45
2SC1061	1.00	2SC2214	2.95
2SC1076	25.80	2SD388	3.65
2SC1099	3.95	2SD477	1.65
2SC1096	.75	2SD528	3.30
2SC1098	.65	2SK58	4.45
2SC1114	.80	2SK97	4.85
2SC1116	3.95	2SK107	1.15
2SC1145	1.45	2SK120	1.20
2SC1163	1.35	2SK121	1.20
2SC1177	12.80	2SK125	1.75
2SC1209	.56	2SK130A	3.90
2SC1212A	1.15		
2SC1215	.65		
2SC1226A	.70		
2SC1237	2.15		
2SC1239	3.15		
2SC1243	.76		
2SC1279	.55		
2SC1306	2.45		
2SC1307	3.85		
2SC1308	5.45		
2SC1312	.45		
2SC1316	8.25		
2SC1317	.35		
2SC1318	.40		
2SC1325A	7.40		
2SC1347	.59		
2SC1358	4.70		
2SC1359	.39		
2SC1362	.45		
2SC1364	.65		
2SC1377	4.10		
2SC1383	.45		
2SC1384	.55		
2SC1407	.75		
2SC1445	2.95		
2SC1447	.85		
2SC1448	.95		
2SC1451	1.75		
2SC1475	.90		
2SC1509	.65		

POPULAR TYPES			
AN211	2.40	TA7054P	2.29
AN214	2.75	TA7055P	2.50
AN217	1.70	TA7060P	1.05
AN239	6.50	TA7061AP	1.05
AN240	2.10	TA7062P	1.50
AN241	2.10	TA7063P	1.10
AN245	5.50	TA7064P	1.20
AN247	4.10	TA7066P	1.04
AN264	2.25	TA7074P	2.90
AN274	2.60	TA7075P	3.50
AN277	2.90	TA7076P	3.50
AN277B	2.90	TA7089P	2.75
AN289	6.50	TA7106P	3.00
AN315	2.80	TA7108P	1.95
AN328	2.70	TA7120P	1.05
AN343	3.60	TA7122AP	1.35
AN380	7.25	TA7124P	1.40
BA511A	2.65	TA7130P	2.20
BA521	2.75	TA7146P	3.70
CX101G	6.20	TA7150P	3.50
CX104A	6.20	TA7159P	2.30
CX157	6.00	TA7200P	3.05
HA1137	3.18	TA7201P	3.15
HA1138	3.00	TA7203	3.60
HA1151	3.20	TA7204	3.20
HA1156	2.40	TA7205	2.60
HA1158	3.90	TA7310P	2.95
HA1159	4.40	TA78005P	3.50
HA1201	1.30	TA78012M	3.50
HA1202	1.20	TC5080P	4.90
HA1211	1.25	TC5081P	3.05
HA1306W	3.50	UH1C002	5.60
HA1322	3.65	UH1C003	5.60
HA1339A	3.75	UH1C004	5.60
HA1342A	3.70	UH1C005	5.60
LA1201	1.95	UPC16C	1.85
LA1364	3.50	UPC27C	2.75
LA3155	1.85	UPC30C	3.40
LA3300	2.40	UPC41C	2.70
LA3301	2.40	UPC554C	1.80
LA3350	2.70	UPC555H	1.80
LA4030P	3.08	UPC563	3.65
LA4031P	2.65	UPC566H	1.15
LA4032P	2.75	UPC571	3.80
LA4051P	2.70	UPC573	3.05
LA4400	3.10	UPC575C2	3.35
LD3120	2.30	UPC576	2.10
M5115AP	4.90	UPC577	1.65
M5152L	2.30	UPC592H2	1.05
M51513L	3.90	UPC595C	2.65
MN3001	19.50	UPC596C	2.50
MN3002	11.70	UPC1001H	3.40
MN3003	11.70	UPC1008C	5.75
PLL01A	8.60	UPC1020H	3.05
PLL02A	8.40	UPC1025H	2.85
PLL02A-G	8.40	UPC1026H	2.29
STK011	5.80	UPC1028	1.75
STK015	6.15	UPC1152H	3.25
STK016	8.20	UPD858C	7.20
STK032	13.80	UPD861C	12.29
STK415	8.10	2SA49	.45
STK435	7.80	2SA102	.39
STK439	10.10	2SA473	.65
TA7027M	3.10	2SA483	2.45
TA7028M	3.10	2SA484	2.25
2SA493	.49	2SB507	1.05
2SA495	.39	2SB511	.90
2SA497	1.39	2SB531	2.70
2SA509	.45	2SB541	3.70
2SA562	.39	2SB554	7.50
2SA564A	.39	2SB556	4.60
2SA606	1.39	2SB557	3.20
2SA607	1.48	2SB600	5.90
2SA624	.99	2SC372	.35
2SA628	.49	2SC373	.35
2SA634	.65	2SC380	.35
2SA636	1.25	2SC381	.35
2SA640	.45	2SC382	.55
2SA643	.55	2SC387A	.45
2SA659	.49	2SC388A	.59
2SA661	.62	2SC394	.39
2SA671	1.25	2SC403	.45
2SA673	.55	2SC454	.45
2SA678	.55	2SC458	.45
2SA679	4.75	2SC460	.45
2SA682	1.35	2SC461	.45
2SA683	.45	2SC481	1.45
2SA684	.45	2SC482	1.35
2SA695	.45	2SC484	1.25
2SA699A	.80	2SC485	1.20
2SA705	.65	2SC495	.79
2SA706	1.25	2SC515A	1.20
2SA715	1.20	2SC517	3.25
2SA719	.45	2SC535	.45
2SA720	.45	2SC562	.65
2SA721	.45	2SC563	.90
2SA726	.45	2SC605	.65
2SA733	.35	2SC620	.45
2SA740	1.85	2SC627	1.35
2SA743A	1.08	2SC632A	.39
2SA747	.49	2SC634A	.45
2SA755	1.32	2SC642A	3.90
2SA765	4.60	2SC681A	2.80
2SA777	.59	2SC696	1.65
2SA794A	.89	2SC710	.37
2SA815	.85	2SC711	.37
2SA816	.55	2SC712	.43
2SA818	.55	2SC717	.37
2SA839	1.75	2SC730	3.95
2SA885	.59	2SC732	.35
2SA913	1.10	2SC733	.35
2SB22	.45	2SC734	.35
2SB54	.35	2SC735	.35
2SB77	.35	2SC738	.38
2SB173	.38	2SC741	3.64
2SB175	.39	2SC756A	2.40
2SB178	.48	2SC773	.55
2SB303	.45	2SC776	2.40

ELECTRONICS WORLD® *News Highlights in Brief*

Magnetic Listening Centers

The Murdock Audio Deck® Listening Center is a vinyl-covered metal plate which can be connected to any audio source and will accommodate as many as 16 headphones. The latter are attached to the deck by magnetic couplers instead of conventional phone plugs. Each coupler remains firmly attached to the deck even if the cord is twisted, but disengages completely if the listener walks away wearing the headset. The Audio Deck Listening Centers are said to be ideal for use by students, including the handicapped. Headphones are available with or without volume control.

Electronic Drafting Device

MAGIC™ is Western Electric's acronym for Machine Aided Graphics for Illustration and Composition and has been designed to enable the rapid construction of line drawings and supportive text for technical docu-

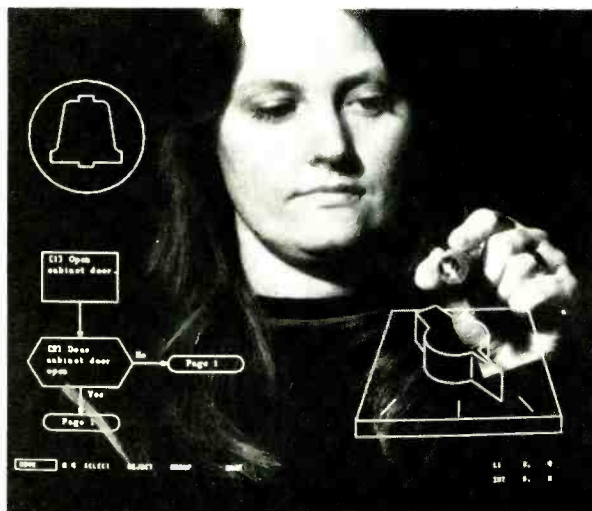

ments. A technical illustrator sits before a 21-inch CRT screen, points a lightpen at it and, working the pushbuttons with one hand and occasionally entering text on a keyboard, produces complex drawings up to 32 inches square in an average time of 30 to 45 minutes. Software for the system is being offered for license to other industries. The total package provides a computer graphics system for preparation, editing, production and storage of line pictorials, diagrams, and technical data.

Two Card Calculators

Casio, Inc. has introduced two new "card" calculators—a Time Card and a Math Card. The former, Model ST-24, is a credit-card size 8-digit calculator with four basic math functions, independent memory system and a perfect seven function percent key. It is also a time-piece, giving the time in hours, minutes and seconds on the 24-hour system. It can be used as a stopwatch in that it records standard as well as lap time. It can be set to

count down to zero and then emit a tone or it can be set as a continuous loop timer. The Model FX-48 Math Card has 32 essential scientific functions in addition to the basic math functions. It includes trigonometrics, parenthesis, logarithms, factorials, square root, powers, power extraction, etc. The ST-24 is 1/8" thick and weighs 2 oz. The FX-48 is 1/4" thick and weighs 1.6 oz. Each retails at a suggested price of \$39.95.

Experimental FM Station Identifier

Tuning to FM stations can be made easier with "Station Programme Identification," a display system developed



by the Philips Research Laboratories, Eindhoven, the Netherlands, in co-operation with the Dutch Broadcasting Corporation. The system would respond to a specially coded signal from the station by displaying the station and program on an alphanumeric readout. Introduction of this new product will depend upon international agreements and on the cooperation of broadcasting authorities.

Ideographic I/O

Until recently, users of the complicated Chinese language and character set could not efficiently use it to communicate with technologically advanced telecommunications and digital computing equipment. The crux of the problem is that the language is not conducive to phonetic classification, as are Western languages, for example. Now, Cable and Wireless Ltd., a British concern, has acquired a patent for an ideographic encoder originally developed by the Chinese Language Project of Cambridge University. This system can code, store, and decode ideographs. It then identifies each by two seven-bit words. A total of 43565 characters is stored on a revolving drum (read by optical sensors) and selected by a cursor, while additional, more rarely used characters are also available, bringing the number of usable characters up to 20,000. Cable and Wireless Ltd. hopes to market the device in commercial form this year.



It may be a hobby, or it may be an asset... It SHOULD be a Heathkit® Computer System

No matter what your computer system needs may be, Heathkit computers make sense! Heathkit "total design" computer systems give you a wide selection of peripherals, software programs to get you up and running fast; plus the reliability, service and responsibility that come from being a leader in the electronics industry for some 50 years!

OUR 8-BIT COMPUTER

Every Heathkit Computer Product is designed to offer substantial benefits over competitive products on the market. Our 8080A-based H8 for example, is more than just a simple 8-bit machine. With its "intelligent" front panel and keyboard entry and digital display, it actually lets you compute and program without the addition of any peripherals. It's an ideal computer training system, and when you're ready to advance, it's ready too. It's one of the most expandable computers around, and now with its NEW floppy disk system, it could be the only computer you'll ever need.

OUR 16-BIT COMPUTER

If you need the power, speed and versatility of a 16-bit machine, there's nothing better than our H11A. Based on the famous DEC LSI-11/2, the H11A provides complete DEC compatibility and access to the thousands of practical software programs and applications that entails. Along with our own complete systems software and our line of DEC-compatible peripherals including the DEC Writer

II and our new floppy disk, you'll have state-of-the-art computing power at its very best!

OUR PERIPHERALS

The Heathkit Computer peripherals offer the same competitive advantages of our two computers. Our H9 CRT terminal, H10 paper tape reader/punch, ECP-3801 cassette storage recorder/player, and our new WH14 line printer, plus the new floppy disk storage systems all give you the quality, performance and value that Heath company is famous for. And we sell the memory, I/O interfaces and accessories you need to custom design a system to your particular specifications!

ALL THIS, PLUS HEATH DOCUMENTATION, SERVICE AND SUPPORT

One of the most important parts of ANY computer system is documentation. And Heath documentation is quite simply, the best around. If you buy our computer products in kit form, you get a comprehensive step-by-step assembly manual that takes you every step of the way from unpacking to final plug-in. The knowledge you gain in building your Heathkit computer is invaluable—for service if it's ever needed, for quick troubleshooting and correction, and just for understanding the workings of the machine. In both our kit and fully assembled products, our comprehensive operating and instruction manuals are fully detailed, thorough and accurate. This documentation, plus Heathkit technical consultants and service nationwide, make your Heathkit computer system one you can depend on—to work right the first time, and to last for years!

SEND FOR YOUR FREE CATALOG

Read all about these Heathkit computer products and peripherals in the new FREE Heathkit catalog. Write Heath Company, Dept. 010-472 for your FREE copy. Or visit your Heathkit Electronic Center (Units of Schlumberger Products Corporation).

HEATHKIT COMPUTERS

Systems Engineered
for Personal Computing



Heath Co. Dept. 010-472
Benton Harbor, MI 49022
CP-159

CIRCLE NO. 5 ON FREE INFORMATION CARD

We didn't have to make a better 2 track than our RS-1500. So we made a 4 track. Introducing the RS-1506.



Ingenuity is truly rare. Repeated ingenuity is true genius. Like the Technics 4-track RS-1506. It offers twice the program time of our 2-track RS-1500.

It also offers the award-winning RS-1500's "Isolated Loop" tape transport with a quartz-locked, phase-controlled, direct-drive capstan.

By isolating the tape from external influences we minimized tape tension to a constant 80 mgs. Providing extremely stable tape transport and low head wear. While reducing modulation noise and wow and flutter to a point where they are barely measurable on conventional laboratory equipment.

Electronically, too, Technics RS-1506 provides the same level of professional control as its predecessor. A separate microphone amplifier. Mixing amplifier. And separate three-position bias/equalization switches. While IC full-logic function permits absolute freedom in switching modes. Also available is an optional full-feature infrared wireless remote control (RP-070). It lets you operate

all transport functions and record from up to 20 feet.

For the same performance as the RS-1506 with the convenience of auto reverse, there's the RS-1700.

Component specifications. Even with the best 2-track decks TRACK SYSTEM: 4-track, 2-channel recording, playback and erase. 2-track, 2-channel playback 4-head system. **FREQ. RESP.:** 30-30,000Hz, ± 3 dB (-10 dB rec. level) at 15ips. **WOW & FLUTTER:** 0.018% WRMS ± 1 15ips. **S/N RATIO:** 57dB (NAB weighted) at 15ips. **SEPARATION:** Greater than 50dB. **RISE TIME:** 0.7 secs. **SPEED DEVIATION:** $\pm 0.1\%$ with 1.0 or 1.5mil tape at 15ips. **SPEED FLUCT.:** 0.05% with 1.0 or 1.5mil tape at 15ips. **PITCH CONTROL:** $\pm 6\%$.

Technics 4-track RS-1506 and auto-reverse RS-1700. A rare combination of audio technology. A new standard of audio excellence.

Technics
Professional Series

CIRCLE NO. 15 ON FREE INFORMATION CARD